

**TOXICOLOGICAL PROFILE FOR  
PERCHLORATES**

U.S. DEPARTMENT OF HEALTH AND HUMAN SERVICES  
Public Health Service  
Agency for Toxic Substances and Disease Registry

September 2008

## **DISCLAIMER**

The use of company or product name(s) is for identification only and does not imply endorsement by the Agency for Toxic Substances and Disease Registry.

## UPDATE STATEMENT

A Toxicological Profile for Perchlorates, Draft for Public Comment was released in July 2005. This edition supersedes any previously released draft or final profile.

Toxicological profiles are revised and republished as necessary. ATSDR considers updating Toxicological profile as new research data becomes available that may significantly impact the Minimal Risk Levels (MRLs) or other conclusions. For information regarding the update status of previously released profiles, contact ATSDR at:

Agency for Toxic Substances and Disease Registry  
Division of Toxicology and Environmental Medicine/Applied Toxicology Branch  
1600 Clifton Road NE  
Mailstop F-32  
Atlanta, Georgia 30333

This page is intentionally blank.

## FOREWORD

This toxicological profile is prepared in accordance with guidelines developed by the Agency for Toxic Substances and Disease Registry (ATSDR) and the Environmental Protection Agency (EPA). The original guidelines were published in the *Federal Register* on April 17, 1987. Each profile will be revised and republished as necessary.

The ATSDR toxicological profile succinctly characterizes the toxicologic and adverse health effects information for the hazardous substance described therein. Each peer-reviewed profile identifies and reviews the key literature that describes a hazardous substance's toxicologic properties. Other pertinent literature is also presented, but is described in less detail than the key studies. The profile is not intended to be an exhaustive document; however, more comprehensive sources of specialty information are referenced.

The focus of the profiles is on health and toxicologic information; therefore, each toxicological profile begins with a public health statement that describes, in nontechnical language, a substance's relevant toxicological properties. Following the public health statement is information concerning levels of significant human exposure and, where known, significant health effects. The adequacy of information to determine a substance's health effects is described in a health effects summary. Data needs that are of significance to protection of public health are identified by ATSDR and EPA.

Each profile includes the following:

- (A) The examination, summary, and interpretation of available toxicologic information and epidemiologic evaluations on a hazardous substance to ascertain the levels of significant human exposure for the substance and the associated acute, subacute, and chronic health effects;
- (B) A determination of whether adequate information on the health effects of each substance is available or in the process of development to determine levels of exposure that present a significant risk to human health of acute, subacute, and chronic health effects; and
- (C) Where appropriate, identification of toxicologic testing needed to identify the types or levels of exposure that may present significant risk of adverse health effects in humans.

The principal audiences for the toxicological profiles are health professionals at the Federal, State, and local levels; interested private sector organizations and groups; and members of the public.

This profile reflects ATSDR's assessment of all relevant toxicologic testing and information that has been peer-reviewed. Staff of the Centers for Disease Control and Prevention and other Federal scientists have also reviewed the profile. In addition, this profile has been peer-reviewed by a nongovernmental panel

and was made available for public review. Final responsibility for the contents and views expressed in this toxicological profile resides with ATSDR.



Howard Frumkin M.D., Dr.P.H.  
Director  
National Center for Environmental Health/  
Agency for Toxic Substances and  
Disease Registry

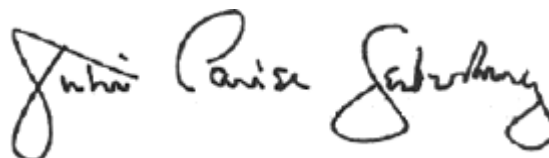

Julie Louise Gerberding, M.D., M.P.H.  
Administrator  
Agency for Toxic Substances and  
Disease Registry

\*Legislative Background

The toxicological profiles are developed in response to the Superfund Amendments and Reauthorization Act (SARA) of 1986 (Public Law 99 499) which amended the Comprehensive Environmental Response, Compensation, and Liability Act of 1980 (CERCLA or Superfund). This public law directed ATSDR to prepare toxicological profiles for hazardous substances most commonly found at facilities on the CERCLA National Priorities List and that pose the most significant potential threat to human health, as determined by ATSDR and the EPA. The availability of the revised priority list of 275 hazardous substances was announced in the Federal Register on December 7, 2005 (70 FR 72840). For prior versions of the list of substances, see Federal Register notices dated April 17, 1987 (52 FR 12866); October 20, 1988 (53 FR 41280); October 26, 1989 (54 FR 43619); October 17, 1990 (55 FR 42067); October 17, 1991 (56 FR 52166); October 28, 1992 (57 FR 48801); February 28, 1994 (59 FR 9486); April 29, 1996 (61 FR 18744); November 17, 1997 (62 FR 61332); October 21, 1999 (64 FR 56792); October 25, 2001 (66 FR 54014) and November 7, 2003 (68 FR 63098). Section 104(i)(3) of CERCLA, as amended, directs the Administrator of ATSDR to prepare a toxicological profile for each substance on the list.

## QUICK REFERENCE FOR HEALTH CARE PROVIDERS

Toxicological Profiles are a unique compilation of toxicological information on a given hazardous substance. Each profile reflects a comprehensive and extensive evaluation, summary, and interpretation of available toxicologic and epidemiologic information on a substance. Health care providers treating patients potentially exposed to hazardous substances will find the following information helpful for fast answers to often-asked questions.

---

### *Primary Chapters/Sections of Interest*

**Chapter 1: Public Health Statement:** The Public Health Statement can be a useful tool for educating patients about possible exposure to a hazardous substance. It explains a substance's relevant toxicologic properties in a nontechnical, question-and-answer format, and it includes a review of the general health effects observed following exposure.

**Chapter 2: Relevance to Public Health:** The Relevance to Public Health Section evaluates, interprets, and assesses the significance of toxicity data to human health.

**Chapter 3: Health Effects:** Specific health effects of a given hazardous compound are reported by type of health effect (death, systemic, immunologic, reproductive), by route of exposure, and by length of exposure (acute, intermediate, and chronic). In addition, both human and animal studies are reported in this section.

**NOTE:** Not all health effects reported in this section are necessarily observed in the clinical setting. Please refer to the Public Health Statement to identify general health effects observed following exposure.

**Pediatrics:** Four new sections have been added to each Toxicological Profile to address child health issues:

- Section 1.6**     **How Can (Chemical X) Affect Children?**
- Section 1.7**     **How Can Families Reduce the Risk of Exposure to (Chemical X)?**
- Section 3.7**     **Children's Susceptibility**
- Section 6.6**     **Exposures of Children**

### **Other Sections of Interest:**

- Section 3.8**     **Biomarkers of Exposure and Effect**
  - Section 3.11**   **Methods for Reducing Toxic Effects**
- 

### **ATSDR Information Center**

**Phone:** 1-800-CDC-INFO (800-232-4636) or 1-888-232-6348 (TTY)     **Fax:** (770) 488-4178  
**E-mail:** [cdcinfo@cdc.gov](mailto:cdcinfo@cdc.gov)     **Internet:** <http://www.atsdr.cdc.gov>

The following additional material can be ordered through the ATSDR Information Center:

*Case Studies in Environmental Medicine: Taking an Exposure History*—The importance of taking an exposure history and how to conduct one are described, and an example of a thorough exposure history is provided. Other case studies of interest include *Reproductive and Developmental Hazards*; *Skin Lesions and Environmental Exposures*; *Cholinesterase-Inhibiting Pesticide Toxicity*; and numerous chemical-specific case studies.

*Managing Hazardous Materials Incidents* is a three-volume set of recommendations for on-scene (prehospital) and hospital medical management of patients exposed during a hazardous materials incident. Volumes I and II are planning guides to assist first responders and hospital emergency department personnel in planning for incidents that involve hazardous materials. Volume III—*Medical Management Guidelines for Acute Chemical Exposures*—is a guide for health care professionals treating patients exposed to hazardous materials.

*Fact Sheets (ToxFAQs)* provide answers to frequently asked questions about toxic substances.

---

### ***Other Agencies and Organizations***

*The National Center for Environmental Health (NCEH)* focuses on preventing or controlling disease, injury, and disability related to the interactions between people and their environment outside the workplace. Contact: NCEH, Mailstop F-29, 4770 Buford Highway, NE, Atlanta, GA 30341-3724 • Phone: 770-488-7000 • FAX: 770-488-7015.

*The National Institute for Occupational Safety and Health (NIOSH)* conducts research on occupational diseases and injuries, responds to requests for assistance by investigating problems of health and safety in the workplace, recommends standards to the Occupational Safety and Health Administration (OSHA) and the Mine Safety and Health Administration (MSHA), and trains professionals in occupational safety and health. Contact: NIOSH, 200 Independence Avenue, SW, Washington, DC 20201 • Phone: 800-356-4674 or NIOSH Technical Information Branch, Robert A. Taft Laboratory, Mailstop C-19, 4676 Columbia Parkway, Cincinnati, OH 45226-1998 • Phone: 800-35-NIOSH.

*The National Institute of Environmental Health Sciences (NIEHS)* is the principal federal agency for biomedical research on the effects of chemical, physical, and biologic environmental agents on human health and well-being. Contact: NIEHS, PO Box 12233, 104 T.W. Alexander Drive, Research Triangle Park, NC 27709 • Phone: 919-541-3212.

---

### ***Referrals***

*The Association of Occupational and Environmental Clinics (AOEC)* has developed a network of clinics in the United States to provide expertise in occupational and environmental issues. Contact: AOEC, 1010 Vermont Avenue, NW, #513, Washington, DC 20005 • Phone: 202-347-4976 • FAX: 202-347-4950 • e-mail: AOEC@AOEC.ORG • Web Page: <http://www.aoec.org/>.

*The American College of Occupational and Environmental Medicine (ACOEM)* is an association of physicians and other health care providers specializing in the field of occupational and environmental medicine. Contact: ACOEM, 25 Northwest Point Boulevard, Suite 700, Elk Grove Village, IL 60007-1030 • Phone: 847-818-1800 • FAX: 847-818-9266.



## CONTRIBUTORS

### CHEMICAL MANAGER(S)/AUTHOR(S):

Sharon Wilbur, M.A.  
ATSDR, Division of Toxicology and Environmental Medicine, Atlanta, GA

Gary Diamond, Ph.D.  
Fernando Lladós, Ph.D.  
Marc Odin, M.S., D.A.B.T.  
Mario Citra, Ph.D.  
Daniel Plewak, B.S.  
Jay Tunkel, Ph.D.  
Syracuse Research Corporation, North Syracuse, NY

### THE PROFILE HAS UNDERGONE THE FOLLOWING ATSDR INTERNAL REVIEWS:

1. Health Effects Review. The Health Effects Review Committee examines the health effects chapter of each profile for consistency and accuracy in interpreting health effects and classifying end points.
2. Minimal Risk Level Review. The Minimal Risk Level Workgroup considers issues relevant to substance-specific Minimal Risk Levels (MRLs), reviews the health effects database of each profile, and makes recommendations for derivation of MRLs.
3. Data Needs Review. The Applied Toxicology Branch reviews data needs sections to assure consistency across profiles and adherence to instructions in the Guidance.
4. Green Border Review. Green Border review assures the consistency with ATSDR policy.

This page is intentionally blank.

## PEER REVIEW

Peer reviewers were selected to review the ATSDR Toxicological Profile for Perchlorates.

The post-public comment draft was reviewed on April 18, 2007 by:

1. Dr. Jeffrey Fisher, Department Head and Professor, Department of Environmental Health Science, the University of Georgia, Athens, Georgia;
2. Dr. Stephen LaFranchi, Professor, Department of Pediatrics, Head, Pediatric Endocrinology, Associate Chair for Education, Oregon Health Sciences University (CDRCP), Portland, Oregon;
3. Dr. Kannan Krishnan, Professor of Occupational and Environmental Health, University of Montreal, Montreal, Quebec, Canada; and
4. Dr. R. Thomas Zoeller, Professor, Department of Biology, University of Massachusetts at Amherst, Morrill Science Center, Amherst, Massachusetts.

The pre-public comment draft was reviewed on June 26, 2002 by:

1. Dr. Kannan Krishnan, Professor of Occupational and Environmental Health, University of Montreal, Montreal, Quebec, Canada;
2. Dr. R. Thomas Zoeller, Professor, Department of Biology, University of Massachusetts at Amherst, Morrill Science Center, Amherst, Massachusetts; and
3. Dr. Gary Williams, Professor of Pathology, Department of Pathology, New York Medical College, Valhalla, New York.

These experts collectively have knowledge of perchlorates' physical and chemical properties, toxicokinetics, key health end points, mechanisms of action, human and animal exposure, and quantification of risk to humans. All reviewers were selected in conformity with the conditions for peer review specified in Section 104(I)(13) of the Comprehensive Environmental Response, Compensation, and Liability Act, as amended.

Scientists from the Agency for Toxic Substances and Disease Registry (ATSDR) have reviewed the peer reviewers' comments and determined which comments will be included in the profile. A listing of the peer reviewers' comments not incorporated in the profile, with a brief explanation of the rationale for their exclusion, exists as part of the administrative record for this compound.

The citation of the peer reviewers should not be understood to imply their approval of the profile's final content. The responsibility for the content of this profile lies with the ATSDR. Nevertheless, the expert peer reviewers on April 18, 2007 concluded that the minimal risk level (MRL) should still be based on the Reference Dose (RfD) as recommended by the NAS Panel Report (2005) given the research data available at the time of the 2007 peer review.

This page is intentionally blank.

## CONTENTS

DISCLAIMER .....	ii
UPDATE STATEMENT .....	iii
FOREWORD .....	v
QUICK REFERENCE FOR HEALTH CARE PROVIDERS.....	vii
CONTRIBUTORS .....	ix
PEER REVIEW .....	xi
CONTENTS.....	xiii
LIST OF FIGURES .....	xvii
LIST OF TABLES .....	xix
1. PUBLIC HEALTH STATEMENT.....	1
1.1 WHAT ARE PERCHLORATES?.....	1
1.2 WHAT HAPPENS TO PERCHLORATES WHEN THEY ENTER THE ENVIRONMENT? .....	3
1.3 HOW MIGHT I BE EXPOSED TO PERCHLORATES? .....	5
1.4 HOW CAN PERCHLORATES ENTER AND LEAVE MY BODY?.....	6
1.5 HOW CAN PERCHLORATES AFFECT MY HEALTH?.....	7
1.6 HOW CAN PERCHLORATES AFFECT CHILDREN?.....	9
1.7 HOW CAN FAMILIES REDUCE THE RISK OF EXPOSURE TO PERCHLORATES?.....	10
1.8 IS THERE A MEDICAL TEST TO DETERMINE WHETHER I HAVE BEEN EXPOSED TO PERCHLORATES?.....	11
1.9 WHAT RECOMMENDATIONS HAS THE FEDERAL GOVERNMENT MADE TO PROTECT HUMAN HEALTH?.....	11
1.10 WHERE CAN I GET MORE INFORMATION? .....	13
2. RELEVANCE TO PUBLIC HEALTH .....	15
2.1 BACKGROUND AND ENVIRONMENTAL EXPOSURES TO PERCHLORATES IN THE UNITED STATES.....	15
2.2 SUMMARY OF HEALTH EFFECTS .....	17
2.3 MINIMAL RISK LEVELS (MRLs).....	22
3. HEALTH EFFECTS .....	27
3.1 INTRODUCTION .....	27
3.2 DISCUSSION OF HEALTH EFFECTS BY ROUTE OF EXPOSURE.....	27
3.2.1 Inhalation Exposure .....	28
3.2.1.1 Death .....	28
3.2.1.2 Systemic Effects .....	28
3.2.1.3 Immunological and Lymphoreticular Effects.....	33
3.2.1.4 Neurological Effects.....	33
3.2.1.5 Reproductive Effects .....	33
3.2.1.6 Developmental Effects .....	33
3.2.1.7 Cancer.....	33
3.2.2 Oral Exposure.....	33
3.2.2.1 Death .....	33
3.2.2.2 Systemic Effects .....	33
3.2.2.3 Immunological and Lymphoreticular Effects.....	65
3.2.2.4 Neurological Effects.....	67
3.2.2.5 Reproductive Effects .....	67
3.2.2.6 Developmental Effects .....	69

3.2.2.7	Cancer .....	79
3.2.3	Dermal Exposure .....	80
3.2.3.1	Death .....	80
3.2.3.2	Systemic Effects .....	80
3.2.3.3	Immunological and Lymphoreticular Effects .....	80
3.2.3.4	Neurological Effects .....	80
3.2.3.5	Reproductive Effects .....	80
3.2.3.6	Developmental Effects .....	80
3.2.3.7	Cancer .....	80
3.3	GENOTOXICITY .....	80
3.4	TOXICOKINETICS .....	81
3.4.1	Absorption .....	81
3.4.1.1	Inhalation Exposure .....	81
3.4.1.2	Oral Exposure .....	82
3.4.1.3	Dermal Exposure .....	82
3.4.2	Distribution .....	83
3.4.2.1	Inhalation Exposure .....	83
3.4.2.2	Oral Exposure .....	83
3.4.2.3	Dermal Exposure .....	84
3.4.2.4	Other Routes of Exposure .....	84
3.4.3	Metabolism .....	85
3.4.4	Elimination and Excretion .....	85
3.4.4.1	Inhalation Exposure .....	85
3.4.4.2	Oral Exposure .....	86
3.4.4.3	Dermal Exposure .....	86
3.4.4.4	Other Routes of Exposure .....	87
3.4.5	Physiologically Based Pharmacokinetic (PBPK)/Pharmacodynamic (PD) Models .....	87
3.5	MECHANISMS OF ACTION .....	108
3.5.1	Pharmacokinetic Mechanisms .....	108
3.5.2	Mechanisms of Toxicity .....	110
3.5.3	Animal-to-Human Extrapolations .....	120
3.6	TOXICITIES MEDIATED THROUGH THE NEUROENDOCRINE AXIS .....	123
3.7	CHILDREN'S SUSCEPTIBILITY .....	126
3.8	BIOMARKERS OF EXPOSURE AND EFFECT .....	129
3.8.1	Biomarkers Used to Identify or Quantify Exposure to Perchlorates .....	130
3.8.2	Biomarkers Used to Characterize Effects Caused by Perchlorates .....	132
3.9	INTERACTIONS WITH OTHER CHEMICALS .....	132
3.10	POPULATIONS THAT ARE UNUSUALLY SUSCEPTIBLE .....	134
3.11	METHODS FOR REDUCING TOXIC EFFECTS .....	135
3.11.1	Reducing Peak Absorption Following Exposure .....	136
3.11.2	Reducing Body Burden .....	136
3.11.3	Interfering with the Mechanism of Action for Toxic Effects .....	136
3.12	ADEQUACY OF THE DATABASE .....	136
3.12.1	Existing Information on Health Effects of Perchlorates .....	137
3.12.2	Identification of Data Needs .....	137
3.12.3	Ongoing Studies .....	146
4.	CHEMICAL AND PHYSICAL INFORMATION .....	149
4.1	CHEMICAL IDENTITY .....	149
4.2	PHYSICAL AND CHEMICAL PROPERTIES .....	149

5. PRODUCTION, IMPORT/EXPORT, USE, AND DISPOSAL .....	153
5.1 PRODUCTION.....	153
5.2 IMPORT/EXPORT.....	156
5.3 USE.....	157
5.4 DISPOSAL.....	161
6. POTENTIAL FOR HUMAN EXPOSURE .....	165
6.1 OVERVIEW.....	165
6.2 RELEASES TO THE ENVIRONMENT .....	169
6.2.1 Air.....	169
6.2.2 Water.....	171
6.2.3 Soil.....	172
6.3 ENVIRONMENTAL FATE.....	173
6.3.1 Transport and Partitioning.....	174
6.3.2 Transformation and Degradation .....	176
6.3.2.1 Air.....	176
6.3.2.2 Water.....	177
6.3.2.3 Sediment and Soil.....	179
6.4 LEVELS MONITORED OR ESTIMATED IN THE ENVIRONMENT .....	179
6.4.1 Air.....	180
6.4.2 Water.....	180
6.4.3 Sediment and Soil.....	184
6.4.4 Other Media .....	185
6.5 GENERAL POPULATION AND OCCUPATIONAL EXPOSURE .....	191
6.6 EXPOSURES OF CHILDREN .....	194
6.7 POPULATIONS WITH POTENTIALLY HIGH EXPOSURES.....	196
6.8 ADEQUACY OF THE DATABASE.....	197
6.8.1 Identification of Data Needs .....	197
6.8.2 Ongoing Studies.....	202
7. ANALYTICAL METHODS .....	205
7.1 BIOLOGICAL MATERIALS.....	206
7.2 ENVIRONMENTAL SAMPLES.....	207
7.3 ADEQUACY OF THE DATABASE.....	208
7.3.1 Identification of Data Needs .....	208
7.3.2 Ongoing Studies.....	209
8. REGULATIONS AND ADVISORIES .....	211
9. REFERENCES .....	217
10. GLOSSARY .....	251
APPENDICES	
A. ATSDR MINIMAL RISK LEVELS AND WORKSHEETS .....	A-1
B. USER'S GUIDE.....	B-1
C. ACRONYMS, ABBREVIATIONS, AND SYMBOLS.....	C-1
D. INDEX.....	D-1

This page is intentionally blank.



**LIST OF FIGURES**

3-1. Levels of Significant Exposure to Perchlorates – Inhalation.....	31
3-2. Levels of Significant Exposure to Perchlorates – Oral.....	49
3-3. Conceptual Representation of a Physiologically Based Pharmacokinetic (PBPK) Model for a Hypothetical Chemical Substance.....	89
3-4. Structure of PBPK Model of Perchlorate in Typical Adult Humans and Male Rats.....	93
3-5. Structure of PBPK Models of Perchlorate in the Pregnant and Lactating Woman .....	94
3-6. Pathways Uptake and Metabolism of Iodide in the Thyroid Gland.....	111
3-7. Hypothalamic-pituitary-thyroid (HPT) Feedback Pathways for Regulation of Thyroid Hormone Production and Secretion .....	113
3-8. Comparison of Dose-Response Relationships for the Inhibitory Effect of Perchlorate on 24-hour Thyroid Iodide Uptake in Humans and Rats .....	122
3-9. Changes in Serum Thyroid Hormone Levels in Rats Exposed to Perchlorate in Drinking Water for 14 Days.....	124
3-10. Existing Information on Health Effects of Perchlorate .....	138
6-1. Frequency of NPL Sites with Perchlorate Contamination.....	166

This page is intentionally blank.

## LIST OF TABLES

3-1. Levels of Significant Exposure to Perchlorates – Inhalation.....	30
3-2. Levels of Significant Exposure to Perchlorates – Oral.....	34
3-3. Perchlorate and Radioiodide Parameter Values for the Adult Male Rat and Human PBPK Models.....	91
3-4. Perchlorate Chemical-specific Parameters for Human Gestation and Lactation Models.....	96
3-5. Radioiodide Chemical-specific Parameters for Human Gestation and Lactation Models.....	98
3-6. Perchlorate Chemical-specific Parameters for Rat Gestation and Lactation Models .....	100
3-7. Iodide Chemical-specific Parameters for Rat Gestation and Lactation Models .....	102
3-8. Model-predicted Serum $\text{ClO}_4^-$ Area Under the Curve (AUC) Across Lifestages.....	106
3-9. Model-predicted Inhibition of Thyroid Iodide Uptake (Percent Inhibition) Across Lifestages .....	107
3-10. Typical Reference Ranges for Serum Thyroid Hormones and TSH in Humans.....	116
4-1. Chemical Identity of Perchlorates .....	150
4-2. Physical and Chemical Properties of Perchlorates .....	151
5-1. U.S. Manufacturers of Perchlorates.....	154
5-2. Import and Export Data for Products that may Contain Perchlorate .....	158
6-1. Measurements of Perchlorate in Samples of 27 Types of Food and Beverages Collected From Various Locations in the United States.....	187
6-2. Percent Contribution Organized by Food Group to the Total Estimated Daily Intake for Perchlorate for 2005–2006 .....	188
6-3. Range of Estimated Lower and Upper Bound Average Perchlorate Intake for 2005–2006.....	189
6-4. Ongoing Studies on the Potential for Human Exposure to Perchlorates (Including Studies on Fate and Occurrence) .....	203
8-1. Regulations and Guidelines Applicable to Perchlorates.....	213

This page is intentionally blank.

## 1. PUBLIC HEALTH STATEMENT

This public health statement tells you about perchlorates and the effects of exposure to them.

The Environmental Protection Agency (EPA) identifies the most serious hazardous waste sites in the nation. These sites are then placed on the National Priorities List (NPL) and are targeted for long-term federal clean-up activities. Perchlorates have been found in at least 49 of the 1,581 current or former NPL sites. The possibility exists that the number of sites at which perchlorates are found may increase in the future as more sites are evaluated. In addition, perchlorate exposure has been found to be more widespread, so that waste sites are only a part of the potential perchlorate sources. Other potential sources of exposure include food, some water supplies, fireworks, road flares, consumer products such as bleach and matches, and natural sources.

When a substance is released either from a large area, such as an industrial plant, or from a container, such as a drum or bottle, it enters the environment. Such a release does not always lead to exposure. You can be exposed to a substance only when you come in contact with it. You may be exposed by breathing, eating, or drinking the substance, or by skin contact.

If you are exposed to perchlorates, many factors will determine whether or not you will be affected. These factors include the physical form of the chemical, the dose (how much), the duration (how long), and how you come in contact with them. You must also consider any other chemicals to which you are exposed and your age, sex, diet, family traits, lifestyle, and state of health.

### 1.1 WHAT ARE PERCHLORATES?

The terms perchlorate or perchlorate anion refer to a negatively charged group of atoms consisting of a central chlorine atom bonded to four oxygen atoms. Perchlorate has the molecular formula  $\text{ClO}_4^-$ . The terms perchlorates or perchlorate salts refer to the inorganic compounds that contain the perchlorate anion bonded to a positively charged group such as ammonium or an alkali or alkaline earth metal.

## 1. PUBLIC HEALTH STATEMENT

Perchlorates can form naturally in the atmosphere, leading to trace levels of perchlorate in precipitation. High levels of perchlorates occur naturally in some locations, such as regions of west Texas and northern Chile.

Perchlorates are colorless and have no odor. Five perchlorates are manufactured in large amounts: magnesium perchlorate, potassium perchlorate, ammonium perchlorate, sodium perchlorate, and lithium perchlorate. Perchlorates are found in the environment in two forms, either as a solid or dissolved in water. If no water is present, as in a drum or on top of dry ground, then they will exist as solids. If water is present, then they will quickly dissolve. When perchlorates dissolve, they separate into two parts. One part has a positive charge, and the other part has a negative charge. The part with the negative charge is called the perchlorate anion or just perchlorate. This is the part of the chemical that people look for in the environment or in your body.

Perchlorates are stable at normal temperatures, but when they are heated to a high temperature, they begin to react. Once they begin to react, they produce a large amount of heat. This causes more of the perchlorates to begin reacting, which makes even more heat. This chain reaction process repeats itself over and over until an explosion occurs. Because perchlorates react this way, they are used in rocket motors, fireworks, flares, gunpowder, and explosives.

Because perchlorates can react quickly at high temperatures, people did not expect to find them in the environment. But at normal Earth temperatures, perchlorates react much more slowly. We have learned only recently that perchlorates may last in the environment unreacted for several years.

One of the perchlorate salts, ammonium perchlorate, is produced in large amounts because it is used in rocket fuels. The solid booster rocket on the space shuttle is almost 70% ammonium perchlorate. Perchlorates are also used in explosives. Because perchlorates are used for some military applications, many countries consider the amounts that they make confidential. This is one reason why we do not know the exact amount of perchlorates produced or used in the United

## 1. PUBLIC HEALTH STATEMENT

States or around the world. As with most chemicals, private companies in the United States are not required to provide information on the amount of perchlorates that they make or use. We also do not know the exact amount of perchlorates brought into the United States from other countries, although the largest amount probably comes from fireworks. It is important to note that production figures for a limited set of the larger profile of perchlorate applications do not readily translate into environmental release data or accurately characterize the universe of perchlorate uses and potential for release.

Other uses of perchlorates include temporary adhesives, electrolysis baths, batteries, air bags, drying agents, etching agents, cleaning agents and bleach, and oxygen generating systems. Little data are available on the nature, amount, and potential for release of these possible sources of perchlorate to the environment. Perchlorates are also used for making other chemicals. Many years ago, perchlorates were used as a medication in the United States to treat overactive thyroid glands, and they still have some medical uses in the United States and other parts of the world. Perchlorate is also used in treatment of side effects of amiodarone, a drug used in the treatment of cardiac arrhythmias and angina.

You will find more information on the properties of perchlorates in Chapter 4. In Chapter 5, you will find more information on the uses of perchlorates and how they are made.

### **1.2 WHAT HAPPENS TO PERCHLORATES WHEN THEY ENTER THE ENVIRONMENT?**

Perchlorates are soluble in water and generally have high mobility in soils. This characteristic results in their ability to move from soil surfaces into groundwater (a process called leaching) when they enter the environment. Perchlorates are ionic substances and therefore, do not volatilize from water or soil surfaces. Perchlorates are known to remain unreacted in the environment for long periods of time; however, there is evidence that microorganisms found in soil and water may eventually reduce perchlorate to other substances. If perchlorates are released to air, then they will eventually settle out of the air, primarily in rainfall. Perchlorates do not appear to accumulate in animals. Chapter 6 contains more information regarding the environmental fate and release of perchlorates. Our understanding of perchlorates continues to

## 1. PUBLIC HEALTH STATEMENT

evolve, and scientific understanding related to perchlorates will continue to be reviewed and re-evaluated when new information becomes available.

Before 1997, it was very hard to measure perchlorates in the environment. In 1997, a much better method was developed, and low levels of perchlorates in water and other media can now be measured. Scientists first began looking for perchlorates near sites where they had been used or discarded, and were surprised when they found them in many other places, including areas where there was no known perchlorate use. They did not think that perchlorates would last very long in the environment because of perchlorate's reactivity. Since then, scientists have been looking for perchlorates in water at more and more places. Perchlorates have recently been found in environmental media such as soil, plants, and animals located in areas where perchlorate was used and released, and in areas where there was no known use or man made releases of perchlorates.

Perchlorates can enter the environment from several sources, both human-made (called anthropogenic) and natural sources. Since perchlorate is used in rockets and certain military applications, the manufacture, use, and disposal of products like rockets and missiles has led to perchlorate being released into the environment. When rockets undergo successful launches, the intense heat leads to nearly complete reaction of the perchlorate. Therefore, release of perchlorate to the environment often occurs when its intended use does not occur (for example, dismantling and disposal of rockets, accidental release from manufacturing facilities, or unsuccessful rocket launches). In the past, some of these activities resulted in high levels of perchlorate contamination of soil and groundwater at many military installations and rocket manufacturing facilities. Today, great effort is made to minimize the release of perchlorates when rockets or missiles are dismantled or when perchlorates are manufactured. Other human-made sources for perchlorate release into the environment include road-side safety flares and fireworks. Perchlorate has also been detected at low levels as an impurity in certain consumer products such as bleach, and the use and disposal of these products could also lead to releases. Perchlorate is a natural component of a nitrate fertilizer from Chile that was imported and regularly used in the United States for many years. Although the use of this fertilizer has declined in recent years, perchlorate was released directly to soil and plants in areas where this



## 1. PUBLIC HEALTH STATEMENT

fertilizer was applied. In addition, there appear to be natural sources of perchlorate in the environment. Perchlorates can form naturally in the atmosphere, leading to trace levels of perchlorate in rainfall. Higher than expected levels of perchlorates occur naturally in some locations such as regions of west Texas, New Mexico, and northern Chile. A combination of human activities and natural sources has led to the widespread presence of perchlorates in the environment.

**1.3 HOW MIGHT I BE EXPOSED TO PERCHLORATES?**

You may be exposed to perchlorates if you eat food or drink water that contains perchlorates. Perchlorates have been found in food and milk. Some plants, especially leafy green vegetables, have been found to have elevated levels of perchlorate. When water containing perchlorate is used to irrigate the plants, perchlorate is left behind when water evaporates from the leaves of the plants. Cows may eat fodder containing perchlorate and pass them on in their milk. The Food and Drug Administration (FDA) recently published the results of measurements of perchlorate and iodine levels in the food supply. The FDA found that 74% of the foods analyzed had at least one sample in which perchlorate was detected. The perchlorate dietary intake was estimated for 14 different age/gender groups in the United States. The lowest intake range was estimated as 0.08–0.11 µg/kg/day (micrograms/kilogram/day) for males aged 25–30 years, and the highest estimated intake was to be 0.35–0.39 µg/kg/day for children 2 years old. These levels are not expected to affect human health. The FDA did not recommend any changes in eating habits of Americans based upon the measured levels of perchlorate.

Perchlorates have been found in lakes, rivers, and groundwater wells. Perchlorate has been identified at least once in approximately 4% of over 3,800 community water systems sampled throughout the United States. From 26 different states and 2 territories, the detectable levels averaged 9.8 µg/L (micrograms/liter) and ranged from the minimum reporting level of 4 µg/L to a maximum at 420 µg/L.

Additional potential sources of perchlorate may be found if you live near a rocket manufacturing or testing facility, if you live near or work at a factory where they are made, or if you live near a

## 1. PUBLIC HEALTH STATEMENT

factory that makes fireworks, flares, or other explosive devices. As mentioned earlier, perchlorate is being found in small amounts in areas where it has not been known to be manufactured, used, or released by humans. Exposure to perchlorates at these locations may be possible because natural levels of perchlorates occur in the environment.

Perchlorate has been detected at low levels as an impurity in certain products that are commonly used by humans. Some of these products include bleach and cleaning products that may contain bleach, bottled water, and tobacco products; even some nutritional supplements (vitamins and minerals) have been found to contain perchlorates. However, vitamin and mineral supplements are typically formulated to include iodine, a factor that would provide protection against any possible effect of perchlorate. For more information on how you can be exposed to perchlorates, see Chapter 6.

### **1.4 HOW CAN PERCHLORATES ENTER AND LEAVE MY BODY?**

Perchlorates can enter the body after you have swallowed food or water containing them. Since they easily dissolve in water, they quickly pass through the stomach and intestines and enter the bloodstream. If you breathe in air containing dust or droplets of perchlorate, it can pass through your lungs and enter the bloodstream. Perchlorates probably do not enter the body directly through the skin, but if present on your hands, hand-to-mouth-activity could contribute to oral exposure.

The blood stream carries perchlorate to all parts of the body. Perchlorate is not changed inside the body. A few internal organs (for example, the thyroid, breast tissue, and salivary glands) can take up relatively large amounts of perchlorate from the bloodstream. Perchlorate generally leaves these organs in a few hours.

When perchlorates are swallowed, a small percentage is eliminated in the feces. More than 90% of perchlorate taken in by mouth enters the bloodstream. In the blood, perchlorate passes into the kidneys, which then release it into the urine. The body begins to clear itself of perchlorate through the kidneys within 10 minutes of exposure. Although most of the

## 1. PUBLIC HEALTH STATEMENT

perchlorate that is taken into the body is quickly eliminated, the presence of perchlorate in many foods and in some drinking water sources means that exposure may continue to occur on a daily basis.

More information on this subject is found in Chapter 3.

## 1.5 HOW CAN PERCHLORATES AFFECT MY HEALTH?

The main target organ for perchlorate toxicity in humans is the thyroid gland. Perchlorate has been shown to partially inhibit the thyroid's uptake of iodine. Iodine is required as a building block for the synthesis of thyroid hormone. Thyroid hormones regulate certain body functions after they are released into the blood. Although not demonstrated in humans, it is anticipated that people exposed to excessive amounts of perchlorate for a long time may develop a decreased production of thyroid hormones. The medical name for this condition is hypothyroidism. Hypothyroidism is usually caused by conditions totally unrelated to perchlorates. In hypothyroidism, the lower amounts of thyroid hormones in your blood cause increases in pituitary hormones that can lead to an increase in the size of the thyroid gland. The medical name for this condition is goiter. Because thyroid hormones perform important functions throughout the body, many normal body activities also are affected by the lower hormone levels. Because perchlorates were known to lower thyroid hormone levels, at one time, perchlorates were given as a drug (more than 400 mg per day, which is many times higher than the doses that people receive from environmental exposures) to treat people with overactive thyroid glands (a condition known as hyperthyroidism). Side effects seen in a small number of treated patients were skin rashes, nausea, and vomiting. A few patients developed severe shortages of blood cells, and some of them died. Healthy volunteers who took approximately 35 mg of perchlorate every day (equivalent to drinking 2 liters of water containing 17 mg/L or 17 parts per million [ppm] perchlorate every day) for 2 weeks or 3 mg daily for 6 months (equivalent to drinking 2 liters of water containing 1.5 mg/L [1.5 ppm] perchlorate every day) showed no signs of abnormal functioning of their thyroid gland. A study of adults in Nevada found that the number of cases of thyroid disease in a group of people who drank water contaminated with perchlorate was no different than the number of cases found in a group of people who drank water without

## 1. PUBLIC HEALTH STATEMENT

perchlorate. This means that levels of perchlorate in the water were not the cause of the thyroid disease, and a search of the literature confirms no evidence of perchlorate inducing thyroid disease. Two studies of people who worked for years in the production of perchlorate found no evidence of alterations in the workers' thyroids, livers, kidneys, or blood. One of these studies estimated that the workers may have taken up about 34 mg of perchlorate per day. A recent study showed that perchlorate levels to which the general population of the United States is exposed via food and drinking water, were associated with changes in thyroid hormone levels in women with low iodine intake, suggesting that the effect of perchlorate in people depends on gender, the length of exposure, and how much iodine the people consume. Further research is recommended to affirm these findings.

As mentioned in the preceding sections, perchlorate is a naturally occurring chemical that has been found in some foods and in some drinking water supplies. Other naturally occurring chemicals, such as thiocyanate (in food and cigarette smoke) and nitrate (in some food), are also known to inhibit iodide uptake. Further studies are needed to completely answer all questions about potential toxicity of perchlorate.

The thyroid gland is also the main target organ for perchlorate toxicity in animals. The thyroid changes caused by perchlorate in animals may lead to tumors in the thyroid after a long period. This has occurred after administering high amounts (928 to 2,573 milligrams perchlorate/kg/day) of perchlorate to the animals. The National Academy of Sciences (NAS) concluded that based on the understanding of the biology of human and rodent thyroid tumors, it is unlikely that perchlorate poses a risk of thyroid cancer in humans. Perchlorates have not been classified for carcinogenic effects by the Department of Health and Human Services (DHHS) or the International Agency for Research on Cancer (IARC). The EPA has determined that perchlorate is not likely to pose a risk of thyroid cancer in humans, at least at doses below those necessary to alter thyroid hormone homeostasis, based on the hormonally-mediated mode of action in rodent studies and species differences in thyroid function.

Studies in animals also showed that perchlorate did not affect the reproductive organs or the animals' capacity to reproduce. The NAS found that the studies in animals provided important

## 1. PUBLIC HEALTH STATEMENT

information, but their usefulness to predict whether harmful effects could occur in humans is small.

## 1.6 HOW CAN PERCHLORATES AFFECT CHILDREN?

This section discusses potential health effects in humans from exposures during the period from conception to maturity at 18 years of age.

Children and developing fetuses may be more likely to be affected by perchlorate than adults because thyroid hormones are essential for normal growth and development. Two studies were conducted of newborn babies and school-age children from an area in Chile where levels of perchlorate in the drinking water were much higher than those detected in some U.S. water supplies due to natural sources of perchlorate. No evidence of abnormal thyroid function was found among the babies or the children. The mothers and the children may have taken approximately 0.2 mg of perchlorate per day in the drinking water. Some studies of newborn babies in areas from Arizona, California, and Nevada, where perchlorate has been found in the drinking water, have not provided convincing evidence of thyroid abnormalities associated with perchlorate. A Centers for Disease Control and Prevention (CDC) study of people all over the United States showed that all of the people that were tested had detectable concentrations of perchlorate in their urine, thus making it difficult to find an unexposed comparison group as a control population.

As indicated above, perchlorate has been found in breast milk, so that nursing mothers can transfer perchlorate to their babies. Nevertheless, the beneficial aspects (biological and psychological) of breast-feeding outweigh any risks from exposure to perchlorate from mother's milk, especially if they consume adequate iodine from food and supplements.

Animal studies have shown a low level of thyroid activity in developing animals exposed to perchlorates through the placenta before birth or through the mother's milk after birth. Modern studies of the effects of perchlorate on developing animals have been conducted mostly in rats. Several studies in which pregnant rats were given relatively low amounts of perchlorate have

## 1. PUBLIC HEALTH STATEMENT

shown that perchlorate can alter the thyroid gland in the newborn animals. This has generally occurred when perchlorate also affected the thyroid of the mothers. In addition, a study suggested an alteration in an area of the brain of pups born to rats. The NAS (2005) indicated that rats are more sensitive to agents that disturb thyroid function than are humans, so the relevance of rat studies in quantitative terms to humans is limited.

### **1.7 HOW CAN FAMILIES REDUCE THE RISK OF EXPOSURE TO PERCHLORATES?**

Although perchlorate is present in food, milk, and drinking water, it is very unlikely that it will be present in the air of the average home or apartment. Perchlorates are found in some consumer products that people use. They are present in highway and marine signal flares, small fireworks, gunpowder, and matches. Storing these items out of the reach of children and not igniting them in a closed environment, such as inside the house or the garage, will decrease the potential for exposure.

Although perchlorate has been detected in a few samples of bottled water, the levels have been very low. Therefore, if you live near a location where perchlorates have been found in drinking water at high levels, using bottled drinking water may reduce the risk to your family, particularly if you drink well water that may contain perchlorate. If you live in one of these areas, prevent your children from playing in dirt and from eating dirt. Make sure your children wash their hands frequently, and before eating. Discourage your children from putting their hands in their mouths or doing other hand-to-mouth activities. You may also contact local public health authorities and follow their advice.

If you work in a factory that makes or uses perchlorates, it is possible to carry perchlorate dust from work on your clothing, skin, or hair. You may then get perchlorate dust in your car, home, or other locations outside of work where family members might be exposed. You should know about this possibility if you work with perchlorates. Taking a shower will remove any perchlorate dust from your skin or hair. Washing your clothes will remove any perchlorates dust from them.

## 1. PUBLIC HEALTH STATEMENT

**1.8 IS THERE A MEDICAL TEST TO DETERMINE WHETHER I HAVE BEEN EXPOSED TO PERCHLORATES?**

Methods to measure perchlorate in the body are not routinely available, but perchlorate can be measured in the urine. Because perchlorate leaves the body fairly rapidly (in a matter of hours), perchlorate in the urine can only indicate very recent exposure. Levels of thyroid hormones in the blood can be monitored. Such tests will tell you if your hormone levels are altered, but will not tell you the cause (exposure to perchlorate is only one of many possibilities). Medical tests can also measure the capacity of the thyroid gland to take iodide from the blood to manufacture thyroid hormones. Exposure to perchlorate can decrease this capacity, but so can exposure to other chemicals, as well as iodine deficiency and medical conditions unrelated to any exposure to chemicals.

**1.9 WHAT RECOMMENDATIONS HAS THE FEDERAL GOVERNMENT MADE TO PROTECT HUMAN HEALTH?**

The federal government develops regulations and recommendations to protect public health. Regulations *can* be enforced by law. The EPA, the Occupational Safety and Health Administration (OSHA), and the Food and Drug Administration (FDA) are some federal agencies that develop regulations for toxic substances. Recommendations provide valuable guidelines to protect public health, but *cannot* be enforced by law. The Agency for Toxic Substances and Disease Registry (ATSDR) and the National Institute for Occupational Safety and Health (NIOSH) are two federal organizations that develop recommendations for toxic substances.

Regulations and recommendations can be expressed as “not-to-exceed” levels, that is, levels of a toxic substance in air, water, soil, or food that do not exceed a critical value that is usually based on levels that affect animals; they are then adjusted to levels that will help protect humans. Sometimes these not-to-exceed levels differ among federal organizations because they used different exposure times (an 8-hour workday or a 24-hour day), different animal studies, or other factors.

## 1. PUBLIC HEALTH STATEMENT

Recommendations and regulations are also updated periodically as more information becomes available. For the most current information, check with the federal agency or organization that provides it. Some regulations and recommendations for perchlorates include the following:

The EPA is currently undertaking efforts to make a determination as to whether or not a national primary drinking water regulation is needed for perchlorate. To make this determination, EPA is evaluating information to more fully characterize perchlorate exposure to determine if regulation of perchlorate in drinking water would represent a meaningful opportunity for reducing risks to human health as required under the Safe Drinking Water Act (SDWA).

The EPA has developed a Reference Dose (RfD) of 0.0007 mg/kg/day for perchlorate. The RfD is an estimate of a daily oral exposure to the human population (including sensitive subgroups) that is likely to be without appreciable risk of deleterious effects during a lifetime. This RfD leads to a drinking water equivalent level (DWEL) of 24.5 ppb. EPA calculates the DWEL using the RfD, multiplied by an adult body weight of 70 kg, and divided by a tap water consumption value of 2 L/day. EPA's Office of Solid Waste and Emergency Response has provided guidance for perchlorate that indicates that the RfD and its corresponding DWEL of 24.5 ppb are respectively the recommended "to be considered" (TBC) value and the preliminary remediation goal (PRG) for cleanup under the Comprehensive Environmental Response, Compensation, and Liability Act of 1980 (CERCLA). The EPA is also responsible for developing guidelines for controlling hazardous waste from the time it is generated until its ultimate disposal—in effect, from "cradle to grave".

The Department of Transportation (DOT) has designated perchlorate as a hazardous material and limits the quantity that is transported aboard aircraft and vessels. The DOT also provides identification and protective guidance for an emergency response to a transportation incident involving a hazardous material.

The Department of Defense (DOD) must comply with any EPA cleanup standards and processes under all applicable environmental laws and regulations, including CERCLA, the Resource Conservation and Recovery Act (RCRA), the Clean Water Act (CWA), and the SDWA. DOD



## 1. PUBLIC HEALTH STATEMENT

policy requires the testing of perchlorate when it is reasonably expected that a release has occurred. Specifically, the DOD's policy states that in the absence of federal or state standards, if perchlorate levels in water exceed 24 ppb (current level of concern for managing perchlorate), a site-specific risk assessment must be conducted. When an assessment indicates that the perchlorate contamination could result in adverse health effects, the site must be prioritized for risk management. DOD will also comply with applicable state or federal promulgated standards, whichever is more stringent. Additionally, DOD established the Emerging Contaminants Directorate in 2006 to help the department proactively approach emerging contaminants to enable a fully informed, risk-based investment decision process that protects human health and DOD operations capabilities; perchlorate is one of seven emerging contaminants included on DOD's Action List.

The FDA has developed Dietary Guidelines that promote health and reduce risk for chronic diseases through diet and physical activity. FDA is not recommending any changes to infants' and children's diets and eating habits based on current perchlorate data. FDA continues to recommend a healthy eating plan, consistent with the Dietary Guidelines for Americans, that emphasizes fruits, vegetables, whole grains, and fat-free or low-fat milk and milk products; includes lean meats, poultry, fish, beans, eggs, and nuts; and is low in saturated fats, trans fats, cholesterol, salt (sodium), and added sugars. Additionally, adequate intake of iodine has previously been recognized as important for healthy thyroid function.

See Chapter 8 for more information on regulations and advisories regarding perchlorates.

### **1.10 WHERE CAN I GET MORE INFORMATION?**

If you have any more questions or concerns, please contact your community or state health or environmental quality department, or contact ATSDR at the address and phone number below.

ATSDR can also tell you the location of occupational and environmental health clinics. These clinics specialize in recognizing, evaluating, and treating illnesses that result from exposure to hazardous substances.

## 1. PUBLIC HEALTH STATEMENT

Toxicological profiles are also available on-line at [www.atsdr.cdc.gov](http://www.atsdr.cdc.gov) and on CD-ROM. You may request a copy of the ATSDR ToxProfiles™ CD-ROM by calling the toll-free information and technical assistance number at 1-800-CDCINFO (1-800-232-4636), by e-mail at [cdcinfo@cdc.gov](mailto:cdcinfo@cdc.gov), or by writing to:

Agency for Toxic Substances and Disease Registry  
Division of Toxicology and Environmental Medicine  
1600 Clifton Road NE  
Mailstop F-32  
Atlanta, GA 30333  
Fax: 1-770-488-4178

Organizations for-profit may request copies of final Toxicological Profiles from the following:

National Technical Information Service (NTIS)  
5285 Port Royal Road  
Springfield, VA 22161  
Phone: 1-800-553-6847 or 1-703-605-6000  
Web site: <http://www.ntis.gov/>

## 2. RELEVANCE TO PUBLIC HEALTH

### 2.1 BACKGROUND AND ENVIRONMENTAL EXPOSURES TO PERCHLORATES IN THE UNITED STATES

Perchlorates are high melting point inorganic salts that are soluble in water. There are five perchlorate salts that are manufactured in substantial amounts: magnesium, potassium, ammonium, sodium, and lithium perchlorate. Perchlorates are powerful oxidizing agents and at elevated temperatures, they can react explosively. The production volume of ammonium perchlorate far outpaces the other salts and it is used primarily as the oxidant for solid rocket boosters as well as some other industrial applications. The solid propellant on U.S. Space Shuttle booster rockets is approximately 70% ammonium perchlorate. The rockets that use perchlorates in defense and aerospace activities are engineered to utilize all of the perchlorate during a successful launch. Perchlorates are also used extensively in electroplating, fireworks, munitions, and other pyrotechnic devices. Perchlorates are also present in fertilizers that were made with Chilean saltpeter.

Perchlorates are released to the environment from a combination of anthropogenic and natural sources. Perchlorate releases from accidents at manufacturing facilities and unsuccessful rocket launches, as well as activities related to the manufacture, disposal, or research of propellants, explosives, or pyrotechnics, are well documented. Perchlorate releases from fireworks, road safety flares, the use of certain fertilizers, and natural sources of perchlorate in the environment have also been documented. Perchlorate may be released to the environment when certain consumer products that contain perchlorate are used or disposed of. These potential releases are discussed in greater detail in Chapter 6.

In water, perchlorates will rapidly dissolve and completely dissociate into the perchlorate anion and the corresponding cation. The cations of the solid perchlorate salts listed in Table 4-1 are naturally occurring and ubiquitous in the environment. It is the perchlorate anion that is responsible for the potential adverse health effects. In the remainder of this document, perchlorates will be used to refer to the solid salts and perchlorate anion (or simply perchlorate) will be used to refer to the anionic species that is monitored in the environment.

The perchlorate anion is highly mobile in wet soil and it is expected to ultimately partition to surface water and groundwater. On dry soil, it is immobile. Perchlorate is an ionic compound and therefore, does not volatilize from soil or water surfaces. Few studies were located that discuss bioaccumulation of perchlorates. Based on existing data, bioconcentration of perchlorate appears to be low for aquatic and

## 2. RELEVANCE TO PUBLIC HEALTH

terrestrial species, although it has been detected in mammals, amphibians, fish, and insects near a site of known contamination. Perchlorates have been shown to accumulate in the leaves of some food crops, tobacco plants, and more generally in broad leaf plants. As water transpires from the leaves, perchlorate remains behind in the leaf due to its involatility under most environmental conditions. Although experimental studies detailing the environmental fate of perchlorates are limited, the current consensus indicates that they are persistent under most environmental conditions. The *in situ* degradation of the perchlorate anion in the environment has not yet been demonstrated, although laboratory studies indicate that it undergoes biodegradation by a wide variety of microorganisms under anaerobic conditions. There is also a growing body of evidence that the perchlorate anion may be reduced to chloride by plants.

Human exposure to perchlorates is expected to occur primarily through the ingestion of food and water containing perchlorate. Efforts are being made to determine the relative contribution of perchlorate from food and water. Data from the recently completed FDA Total Diet Study indicate that 74% of the foods analyzed had at least one sample in which perchlorate was detected. The perchlorate dietary intake was estimated for 14 different age/gender groups in the United States. The lowest intake range was estimated as 0.08–0.11 µg/kg/day for males aged 25–30 years, and the highest estimated intake was 0.35–0.39 µg/kg/day for children 2 years old. Children had the highest estimated intake on a body weight basis as compared to the other age groups because they consume more food per body weight and have different food consumption patterns when compared to the other age groups. Perchlorate has also been detected in breast milk and in certain consumer products such as dietary (vitamin and mineral) supplements, bottled water, and tobacco products.

The detection of perchlorate in drinking water supplies and in tap water samples indicates that members of the general population may be exposed by ingestion of water. Perchlorate has been identified at least once in approximately 4% of community water systems from 26 different states and 2 territories, with detectable levels averaging 9.8 µg/L and ranging from the method detection limit of 4 µg/L to a maximum at 420 µg/L.

Occupational exposure to perchlorates may occur through the inhalation of the dusts formed during their manufacture and use. Deposition of perchlorate dust into the mouth is also possible. Section 6.5 discusses exposures to the general population and occupational exposures in greater detail.

## 2. RELEVANCE TO PUBLIC HEALTH

**2.2 SUMMARY OF HEALTH EFFECTS**

The primary and most sensitive target of the perchlorate anion (perchlorate) is the thyroid gland. Perchlorate inhibits the transport of iodide (I<sup>-</sup>) from the blood into the thyroid follicle cells. The inhibition is thought to be accomplished by perchlorate competitively blocking iodide binding to a carrier, or sodium/iodide symporter (NIS), which catalyzes the simultaneous transfer of Na<sup>+</sup> and I<sup>-</sup> across the basolateral membrane of thyroid follicle cells. Perchlorate inhibition of the NIS can limit the availability of iodide needed for the production of the thyroid hormones thyroxine (T<sub>4</sub>) and triiodothyronine (T<sub>3</sub>), which in turn, may affect the circulating levels of T<sub>4</sub> and T<sub>3</sub>. All known effects of perchlorate on the thyroid hormone system derive directly or secondarily from the inhibition of the NIS.

T<sub>3</sub> is essential for normal development of the nervous system and for the regulation of metabolism of cells in nearly all tissues of the body. Disruption in the availability of T<sub>3</sub> in target tissues can result in adverse effects on a wide variety of organs and systems. Although some production of T<sub>3</sub> occurs in the thyroid, most of the T<sub>3</sub> that is available to extrathyroidal target tissues derives from deiodination of T<sub>4</sub> outside the thyroid. This reaction is catalyzed by selenium-requiring microsomal enzymes known as iodothyronine deiodinases.

Because of its ability to inhibit thyroid iodide uptake, perchlorate (potassium perchlorate) was used in the past to treat subjects with hyperactive thyroids, including people with Graves' disease, an autoimmune disorder. Perchlorate currently is used to treat amiodarone-induced thyrotoxicosis and for diagnosing impairments in the synthesis of thyroid hormones in the thyroid (perchlorate iodide discharge test). Doses for clinical uses of perchlorate have ranged from 5 to 20 mg/kg/day. Considerable information exists on the effects of perchlorate in patients with Graves' disease and in subjects with hyperthyroidism of other etiology, and some of this information is also presented in Chapter 3 of this document. However, the main purpose of this review is to describe the effects of perchlorate on subjects otherwise without thyroid disorders.

The main route of exposure to perchlorate for the general population and those exposed to contaminated media is through ingestion of food and/or water. As noted previously, efforts are being made to determine the relative contribution of perchlorate from food and water. Information on the effects of perchlorate in humans comes from occupational studies, studies of the general population (adults, children, and neonates), and studies of controlled exposure in volunteers. Occupational studies and studies in volunteers who ingested daily doses of perchlorate  $\leq 0.05$  mg/kg/day for 14 days or

## 2. RELEVANCE TO PUBLIC HEALTH

$\leq 0.04$  mg/kg/day for 6 months days showed no evidence of adverse hematological, hepatic, renal effects, or clinically significant thyroid effects. A study of the general population exposed to perchlorate via the drinking water found no significant increase in the incidence of thyroid diseases relative to a comparison group whose drinking water did not have perchlorate. Most studies of children and neonates in areas where perchlorate has been detected in the drinking water have reported no significant alterations in indices of thyroid function among the subjects studied. Two studies of Arizona and California residents found that increased levels of perchlorate in drinking water were associated with increased serum concentration of thyroid stimulating hormone (TSH) in neonates, but the methods used in these two studies have been criticized in the literature. There are no reports of exposure to perchlorate being associated with adverse reproductive effects or cancer in humans, or with adverse immunologic effects in healthy humans.

The thyroid is also the main target of perchlorate toxicity in animals. Most experimental studies in animals designed to characterize the effects of perchlorate exposure have been done in rats. Rats have been shown to be more sensitive to agents that disturb thyroid function than are humans. Significant changes in serum levels of thyroid hormones at perchlorate doses as low as 0.009 mg/kg/day were observed in 14- and 90-day studies in adult rats. Studies in mice have reported similar findings. In general, morphological alterations in the thyroid become noticeable at doses higher than those that induced changes in serum hormone levels. There is no conclusive evidence that perchlorate is an immunotoxicant in animals. Perchlorate did increase the response to a known contact sensitizer in mice, but it is not known whether perchlorate itself is a contact sensitizer. Perchlorate has shown no evidence of being a neurotoxicant when administered to adult animals, although no comprehensive testing has been done in adult animals. A 2-generation reproductive study in rats did not observe any significant alterations in standard reproductive indices. Several developmental studies have shown that administration of low doses of perchlorate ( $\geq 0.009$  mg/kg/day) to pregnant animals results in alterations in thyroid parameters (serum T4, T3, and TSH, and changes in morphology of the thyroid) in newborn and young animals. Some studies that conducted neurobehavioral testing in offspring of rats exposed to perchlorate during pregnancy reported no significant treatment-related effects, but the interpretation of the results has generated some debate among scientists. Perchlorate has produced thyroid cell hyperplasia and papillary and/or follicular adenomas and/or carcinomas in rats and mice exposed to relatively high doses. Perchlorate itself does not appear to be genotoxic.

An expanded discussion of thyroid effects of perchlorate in healthy adults and the young exposed perinatally is presented below. Neurodevelopmental effects are included under the same heading of

## 2. RELEVANCE TO PUBLIC HEALTH

*Endocrine (Thyroid) Effects* since neurodevelopmental alterations are assumed to occur due to perchlorate-induced perturbation of maternal and/or fetal thyroid function.

**Endocrine (Thyroid) Effects.** As mentioned above, adverse effects on a wide variety of organ systems can result from disruption in the availability of T3 to target tissues. Organ systems affected by disturbances in T3 levels include the skin, cardiovascular system, pulmonary system, kidneys, gastrointestinal tract, liver, blood, neuromuscular system, central nervous system, skeleton, male and female reproductive systems, and numerous endocrine organs, including the pituitary and adrenal glands. Such an array of secondary potential targets underscores the need to maintain an adequate level of circulating thyroid hormones. Furthermore, because thyroid hormones play a critical role in the neurological development of the fetus, there is concern that altered thyroid levels (maternal and/or fetal) during pregnancy could result in neurodevelopmental effects.

For the most part, recent studies do not indicate that perchlorate exposure produces large changes in thyroid function in males or in women with adequate iodine intake. In an occupational study in which the investigators estimated a maximum ingested dose of 34 mg perchlorate/day, or approximately 0.5 mg/kg/day assuming a body weight of 70 kg, no significant alterations of thyroid parameters were observed. Another study of adults from the general population found no significant increase in the prevalence of thyroid diseases in a population exposed to perchlorate in the drinking water (4–24 µg/L) (0.0001–0.0007 mg/kg/day) relative to a comparison population not exposed to perchlorate. With two exceptions, studies of neonates in areas with perchlorate contamination in the drinking water have also found no evidence of altered thyroid parameters among the newborns. One study found that increased levels of perchlorate in drinking water (6 µg/L) (0.0002 mg/kg/day) were associated with increased serum concentration of TSH in a study of neonates in Arizona. Another study reported similar findings of neonates in California. However, as indicated earlier, the methods used in the latter two studies have been criticized in the literature. A study also examined school-age children in Chile, and found no association between the concentration of perchlorate in water and altered thyroid function. In that study, residents from one location were exposed to perchlorate in water at a concentration of approximately 100 µg/L. Assuming a daily intake of 1–2 L of water for the school-age children and a body weight of about 25 kg (measured in the study), the daily intake of perchlorate via drinking water could have been 0.004–0.008 mg/kg/day. As often occurs with human studies, the studies mentioned above have various design limitations that must be considered in applying findings to health risk assessment. For example, in some of the occupational studies, there could have been exposure misclassification. In addition, occupational studies had a cross-sectional design and, thus, were unable to account for any effects of

## 2. RELEVANCE TO PUBLIC HEALTH

exposure to perchlorate that might have occurred in workers who left employment for any reason. In the studies that measured TSH in neonates, TSH was measured on a low T4 percentile subset without consideration of age at screen; since T4 distribution depends on age, births with screen ages that have higher T4 are less likely to be selected for TSH analysis. Explicit measures of perchlorate exposure were not obtained in these studies. For example, in a study, exposures were estimated from place of birth; thus, individual levels of exposure could not be linked to T4 levels. Regardless of these and other limitations, these studies collectively appear to rule out a large perchlorate-related effect on thyroid function.

The 14-day studies of controlled exposure in volunteers showed that iodide uptake by the thyroid (assessed as radioiodine uptake) can be inhibited to a considerable extent in humans without a significant change in circulating levels of thyroid hormone and TSH. This is not unexpected given the relatively large storage capacity of the thyroid gland of humans. A study reported a maximum inhibition of approximately 70% relative to baseline in subjects who received the highest dose of perchlorate, 0.5 mg/kg/day. No significant inhibition was observed at a dose of 0.02 mg/kg/day. Another study in volunteers administered up to approximately 0.04 mg perchlorate/kg/day for 6 months found no significant alterations in thyroid function tests, including radioiodine uptake.

Studies in animals have shown that exposure to perchlorate can induce a wide range of effects on the thyroid depending on the dose and duration of exposure. Studies conducted in the past 10 years have used much lower doses than earlier studies and have described changes in thyroid parameters in rats administered doses as low as 0.009 mg perchlorate/kg/day. The effects have been observed in adults and also in young rats exposed *in utero* and via dams' milk. A study reported a 20% decrease in serum T3 in male rats following 14 days of dosing with 0.009 mg perchlorate/kg/day, and a 14% decrease in T4 and 12% decrease in T3 in males given the same dose level for 90 days. The magnitude of the effects was dose-related and the effects were also observed in females, although the latter appeared somewhat less sensitive. At higher doses ( $\geq 0.17$  mg/kg/day), serum levels of TSH increased and histological alterations were evident in the thyroid gland (8.5 mg/kg/day).

Administration of perchlorate to pregnant animals can result in alterations in thyroid parameters in the offspring. The lowest maternal dose at which this has been reported is 0.009 mg perchlorate/kg/day. This dose level (and higher) significantly increased TSH and decreased T4 in the dams on gestation day 21, and decreased T3 in newborn pups. Whether alterations in fetal thyroid parameters are due solely to an altered maternal thyroid, to altered fetal thyroid, or to a combined effect is not totally clear. However, there is sufficient information that supports the view that maternal thyroid hormones are crucial for



## 2. RELEVANCE TO PUBLIC HEALTH

normal development. Rat fetal tissues have been shown to contain both T4 and T3 prior to the onset of hormone production by the fetal thyroid on approximately day 17 of gestation. Furthermore, thyroid hormone-responsive genes that are important in early development of the brain are expressed in the rat fetus prior to fetal thyroid hormone production, and expression of these genes is sensitive to the maternal thyroid hormone status. Disruption of the maternal thyroid hormone system of rats by removal of the maternal thyroid or maternal iodide deficiency results in decreased levels of thyroid hormones in the fetus and congenital hypothyroidism. In studies with perchlorate, there is only one published report of thyroid effects in the offspring in the absence of apparent maternal thyroid effects. This was reported in a study in guinea pigs administered doses as high as 531 mg/kg/day of perchlorate during pregnancy. Overall, the available information in animals suggests that as long as serum maternal levels of thyroid hormones are maintained within normal levels during pregnancy, there is no apparent developmental risk. Observations in humans show that placental transfer of maternal thyroid hormones results in cord blood levels that are just below the lower range of normal in newborn infants, suggesting that transfer during fetal life is at least partially protective in cases where the fetus cannot produce adequate amounts of T4, providing that the maternal thyroid hormone production is not compromised. If this is the case, then inhibition of fetal thyroid iodide uptake by perchlorate would not be expected to be sufficient, in itself, to produce hypothyroidism *in utero*, and any effects of perchlorate on fetal hormone status are likely to be caused by the combined effects of limiting iodide uptake in the maternal and fetal thyroids. PBPK models predict that pregnant women and the fetus will have higher blood concentrations of perchlorate and greater iodide uptake inhibition at a given concentration of perchlorate in drinking water than either nonpregnant adults or older children.

As discussed in detail in Section 3.5.3, Animal-to-Human Extrapolations, the response of human adults to short-term oral dosages (mg/kg/day) of perchlorate is quantitatively different from the response observed in rats given comparable dosages. Similar doses of perchlorate result in a more pronounced hypothalamic-pituitary-thyroid (HPT) response in rats, which serves to regulate thyroid iodide transport and hormone production in response to a decrease in serum thyroid hormones and iodide levels. Differences in the perchlorate dose-response relationships between human and rats are thought to be related to a smaller and more rapid turnover of the hormone pool in the rat thyroid and to a more rapid clearance of secreted hormone in the rat (serum half-life for T4 is shorter in rats than in humans). The NAS recommended that animal studies did not adequately serve as a surrogate for human studies due to specific species differences with humans, as demonstrated in the studies discussed above.

## 2. RELEVANCE TO PUBLIC HEALTH

**2.3 MINIMAL RISK LEVELS (MRLs)**

Estimates of exposure levels posing minimal risk to humans (MRLs) have been made for perchlorates. An MRL is defined as an estimate of daily human exposure to a substance that is likely to be without an appreciable risk of adverse effects (noncarcinogenic) over a specified duration of exposure. MRLs are derived when reliable and sufficient data exist to identify the target organ(s) of effect or the most sensitive health effect(s) for a specific duration within a given route of exposure. MRLs are based on noncancerous health effects only and do not consider carcinogenic effects. MRLs can be derived for acute, intermediate, and chronic duration exposures for inhalation and oral routes. Appropriate methodology does not exist to develop MRLs for dermal exposure. In addition, no dermal exposure risk from perchlorate has been documented in the literature.

Although methods have been established to derive these levels (Barnes and Dourson 1988; EPA 1990), uncertainties are associated with these techniques. Furthermore, ATSDR acknowledges additional uncertainties inherent in the application of the procedures to derive less than lifetime MRLs. As an example, acute inhalation MRLs may not be protective for health effects that are delayed in development or are acquired following repeated acute insults, such as hypersensitivity reactions, asthma, or chronic bronchitis. As these kinds of health effects data become available and methods to assess levels of significant human exposure improve, these MRLs will be revised.

***Inhalation MRLs***

No MRLs were derived for inhalation exposure to perchlorate since adequate experimental data were not available by this route of exposure. No inhalation studies in animals were located. The inhalation database in human is limited to three studies of workers at ammonium perchlorate production facilities exposed during an unusual schedule of three 12-hour shifts followed by 3 days without exposure (long-time, intermittent exposure) (Braverman et al. 2005; Gibbs et al. 1998; Lamm et al. 1999).

***Oral MRLs***

ATSDR adopts the National Academy of Sciences (NAS 2005, *Health Implications of Perchlorate Ingestion*) recommended chronic reference dose (RfD) of 0.0007 mg/kg/day for the chronic oral MRL for the perchlorate anion (rather than for individual salts). EPA has also adopted this value and the perchlorate Integrated Risk Information System (IRIS) (*Perchlorate and Perchlorate Salts Summary*)

## 2. RELEVANCE TO PUBLIC HEALTH

summary was first posted on 02/18/2005. ATSDR's decision was made after a careful evaluation of the NAS report and of studies that have been published after the NAS (2005) report. The results from newer studies do not change the bottom-line recommendation.

NAS based its derivation of the RfD on the findings of a study by Greer et al. (2002). The RfD was based on a no-observed-effect level (NOEL) of 0.007 mg perchlorate/kg/day for thyroidal uptake of radioactive iodine (RAIU) in 37 healthy (euthyroid) volunteers (16 males, 21 females) who consumed potassium perchlorate in drinking water in doses of 0.007, 0.02, 0.1, or 0.5 mg perchlorate/kg/day for 14 days. In 24 subjects, thyroidal uptake of RAIU was measured 8 and 24 hours after administration of radioactive iodine on exposure days 2 and 14 and also 15 days after exposure. To estimate daily iodine intake, 24-hour urine samples were collected. Free and total T4, T3, and TSH were sampled 16 times throughout the study. Serum antibodies to thyroglobulin and thyroid peroxidase were also measured. Hematological and clinical chemistry tests were also conducted throughout the study. Baseline thyroid iodide uptake varied greatly among the subjects: 5.6–25.4% for the 8-hour uptake and 9.8–33.7% for the 24-hour uptake. Perchlorate inhibited RAIU in a dose-related manner. As a percentage of baseline RAIU, inhibition in the 0.007, 0.02, 0.1, and 0.5 mg/kg/day dose groups was 1.8, 16.4, 44.7, and 67.1%, respectively. The small decrease in RAIU at 0.007 mg/kg/day was not statistically significant and is well within the variation of repeated measurements in normal subjects. The dose is considered the NOEL. No significant differences were seen between the 8- and 24-hour measurements or between the 2- and 14-day measurements. On post exposure day 15, RAIU rebounded to values slightly over but not significantly >100%. Consumption of perchlorate did not significantly alter serum TSH, free T4, or total T4 and T3 levels. Serum anti-thyroglobulin levels were below detection levels in all samples tested. Serum anti-thyroid peroxidase levels were elevated in two subjects at the screening visit and thus, were not related to treatment with perchlorate. Hematology and clinical chemistry tests to assess liver and kidney function revealed no significant deviations from normal ranges. No difference was observed between the response of male and female subjects. The RfD was calculated by dividing the NOEL of 0.007 mg/kg/day for inhibition of radioiodide uptake and serum hormone levels by an uncertainty factor of 10 (see below). As indicated by the NAS (2005), iodide uptake inhibition is a key biochemical event that precedes all potential thyroid-mediated effects of perchlorate exposure. Using a nonadverse effect that is upstream of adverse effects is a conservative approach to perchlorate hazard assessment.

Based on the known mechanism of action of perchlorate as a competitive inhibitor of NIS and on the elimination half-time of perchlorate of approximately 8 hours (perchlorate is not expected to accumulate in the body), the NAS concluded that a dose that produced minimal inhibition of thyroid iodide uptake

## 2. RELEVANCE TO PUBLIC HEALTH

after 14 days of continuous exposure would also have no appreciable effects on thyroid iodide uptake with more prolonged (i.e., intermediate or chronic) exposure. On this basis, the 14-day study was used as the basis for adopting the RfD for the chronic MRL. This is supported by another 14-day study (Lawrence et al. 2000), long-term studies of workers (Braverman et al. 2005; Gibbs et al. 1998; Lamm et al. 1999), and studies of the general population (Li et al. 2001; Téllez et al. 2005) exposed to perchlorate that found no significant alterations in thyroid function in the populations examined. A study by Braverman et al. (2006) in which 13 volunteers dosed with perchlorate in capsules for 6 months at doses of 0, 0.5, and 3 mg/day exhibited no changes in iodine uptake or thyroid hormone level was considered for derivation of the MRL. However, this study was limited by a small number of subjects per group (4–5), dosing by capsule rather than intermittent exposure in drinking water, and lack of information on RAIU during the first 3 months of the study.

An uncertainty factor of 10 was applied to the NOEL of 0.007 mg/kg/day. The uncertainty factor of 10 is intended to protect the most sensitive population—the fetuses of pregnant women who might have hypothyroidism or iodide deficiency. Other sensitive populations include preterm infants and nursing infants. As discussed by NAS (2005), preterm infants are more sensitive than term infants. The fetus is dependent on maternal thyroid hormones at least until the fetal thyroid begins to produce T4 and T3 (Zoeller and Crofton 2000). In humans, this occurs at approximately 16–20 weeks of gestation. Thyroid hormones are present in human amniotic fluid at 8 weeks of gestation prior to the onset of fetal thyroid hormone production (Contempre et al. 1993; Thorpe-Beeston et al. 1991). Thyroid hormone receptors are present and occupied by hormone at this time as well, suggesting that the fetus is capable of responding to maternal thyroid hormones (Bernal and Pekonen 1984; Ferreiro et al. 1988). The contribution of maternal thyroid hormones to the fetal thyroid hormone status is also evident from infants who have an inherited disorder that abolishes T4 production but are born, nevertheless, with normal serum thyroid hormone levels (i.e., euthyroid) and become hypothyroid after birth if not administered thyroid hormones within the first 2 weeks after birth (Larsen 1989; van Vliet 1999; Vulsma et al. 1989). This suggests that in the complete absence of fetal thyroid function, the maternal thyroid is able to maintain at least partially protective levels of thyroid hormone in the fetus at late term. Uncorrected maternal hypothyroidism, on the other hand, may result in impaired neurodevelopment of the fetus (Haddow et al. 1999; Pop et al. 1999). By inhibiting NIS in breast tissue (Levy et al. 1997; Smanik et al. 1997; Spitzweg et al. 1998), perchlorate may also limit the availability of iodide to nursing infants, who depend entirely on breast milk for the iodide needed to produce thyroid hormone (Agency for Toxic Substances and Disease Registry 2004). No information is available on the doses in humans that might decrease iodide uptake into breast milk. A recent study of 57 women in the Boston area found that 47%

## 2. RELEVANCE TO PUBLIC HEALTH

of the women sampled may have been providing breast milk with insufficient iodine to meet the infants' requirements (Pearce et al. 2007); however, the breast milk iodine concentrations were not correlated with perchlorate exposure. Radioiodine uptake into mammary milk was decreased in rats exposed to 1 or 10 mg/kg/day perchlorate in drinking water (Yu et al. 2002). Studies conducted in cows and goats have also shown that perchlorate can decrease radioiodine uptake into mammary milk (Howard et al. 1996). As discussed by Ginsberg et al. (2007), additional factors that make neonates a sensitive group include their shorter serum half-life for T<sub>4</sub> of approximately 3 days compared to approximately 7–10 days in adults, a lower storage capacity of the thyroid for T<sub>4</sub>, and possibly slower urinary clearance of perchlorate due to immature renal function. Another potential susceptible population is women with urinary iodine levels <100 µg/L, as regression analysis of a population study by Blount et al. (2006) indicated that perchlorate exposure was correlated with decreased T<sub>4</sub> and increased TSH. Limitations of the study acknowledged by the investigators include those common to cross-sectional analyses, the assumption that urinary perchlorate correlate with levels in the thyroid stroma and tissue, and the measurement of total T<sub>4</sub> rather than free T<sub>4</sub>. According to the World Health Organization (WHO 2004), median urinary iodine levels ≥100 µg/L indicate sufficient iodine intake for the non-pregnant population, whereas pregnant women should maintain urinary levels of iodine >150 µg/L. The American Thyroid Association (2006) recommends that women generally consume iodine from dairy products, bread, seafood, meat, and some iodized salt, but pregnant and lactating women may require additional supplements and vitamins.

Recently, Blount et al. (2007) assessed perchlorate exposure in a representative sample of the U.S. population and compared the results with the NAS-recommended RfD (NAS 2005). The study comprised 2,820 participants of National Health and Nutrition Survey (NHANES) (2001–2002), 6 years and older. The investigators assessed perchlorate exposure based on urinary perchlorate, urinary creatinine concentration, and physiological parameters predictive of creatinine excretion rate. By measuring perchlorate in urine, the investigators assessed combined exposure to perchlorate from all sources. In adults, the estimated median dose of perchlorate was 0.066 µg/kg/day and the 95th percentile of the distribution of estimated daily dose was 0.234 µg/kg/day (CI, 0.202–0.268 µg/kg/day), both values lower than the MRL of 0.0007 mg/kg/day (0.7 µg/kg/day) that ATSDR adopted from the NAS. Only 11 out of 1,532 adults aged 20 years and older had estimated perchlorate exposure that exceeded the NAS-recommended RfD. Since the study included participants 6-year-old and older, the investigators did not have exposure information for infants. In women of reproductive age, which Blount et al. (2007) suggested can be used as surrogate population for assessment of fetal exposure, the median estimated perchlorate dose was 0.057 µg/kg/day and the 95th percentile 0.214 µg/kg/day. For a subset of 110 pregnant women, the estimated median perchlorate dose was 0.066 µg/kg/day. The median dose of

## 2. RELEVANCE TO PUBLIC HEALTH

0.066 µg/kg/day for adults estimated by Blount et al. (2007) is in the same range of the lower-bound range of average perchlorate food intakes for men and women over 20 years of age of 0.08–0.11 µg/kg/day recently estimated by the FDA in the Total Diet Study (Murray et al. 2008).

The MRL has been reviewed by experts in the field of perchlorate toxicology in 2007 after publication of the NAS (2005) report and the publication of the results of the Centers for Disease Control and Prevention (CDC) National Health and Nutrition Examination Survey (NHANES) data (Blount et al. 2007). The expert peer reviewers concluded that the MRL should still be based on the RfD as recommended by the NAS Panel Report (2005) given the research data available at the time of the 2007 peer review.

### 3. HEALTH EFFECTS

#### 3.1 INTRODUCTION

The primary purpose of this chapter is to provide public health officials, physicians, toxicologists, and other interested individuals and groups with an overall perspective on the toxicology of perchlorates. It contains descriptions and evaluations of toxicological studies and epidemiological investigations and provides conclusions, where possible, on the relevance of toxicity and toxicokinetic data to public health.

A glossary and list of acronyms, abbreviations, and symbols can be found at the end of this profile.

The perchlorate anion forms salts with a wide variety of cations. There are five perchlorate salts that are manufactured in substantial amounts: magnesium, potassium, ammonium, sodium, and lithium perchlorate (see Section 4.1). The potassium, sodium, and ammonium salts are the ones most commonly encountered in the toxicology literature. Therefore, data on potassium, sodium, ammonium, and other perchlorate salts were considered pertinent to the assessment of the perchlorate anion. Perchloric acid was not included because it is a strong acid and its toxicity is dominated by the irritating effects of the hydrogen cation. In the absence of water, the five commercial perchlorates listed above will exist as a solid. In water, perchlorate salts (perchlorates) will rapidly dissolve and completely dissociate into the perchlorate anion, also referred to as perchlorate, and the corresponding metal cation. Potassium, ammonium, and sodium cations are ubiquitous in the environment and are considered spectator ions. Therefore, the species of concern in this document is the perchlorate anion.

#### 3.2 DISCUSSION OF HEALTH EFFECTS BY ROUTE OF EXPOSURE

To help public health professionals and others address the needs of persons potentially exposed to perchlorate, the information in this section is organized first by route of exposure (inhalation, oral, and dermal) and then by health effect (death, systemic, immunological, neurological, reproductive, developmental, genotoxic, and carcinogenic effects). These data are discussed in terms of three exposure periods: acute (14 days or less), intermediate (15–364 days), and chronic (365 days or more).

Levels of significant exposure for each route and duration are presented in tables and illustrated in figures. The points in the figures showing no-observed-adverse-effect levels (NOAELs) or lowest-observed-adverse-effect levels (LOAELs) reflect the actual doses (levels of exposure) used in the studies. LOAELs have been classified into "less serious" or "serious" effects. "Serious" effects are those that

### 3. HEALTH EFFECTS

evoke failure in a biological system and can lead to morbidity or mortality (e.g., acute respiratory distress or death). "Less serious" effects are those that are not expected to cause significant dysfunction or death, or those whose significance to the organism is not entirely clear. ATSDR acknowledges that a considerable amount of judgment may be required in establishing whether an end point should be classified as a NOAEL, "less serious" LOAEL, or "serious" LOAEL, and that in some cases, there will be insufficient data to decide whether the effect is indicative of significant dysfunction. However, the Agency has established guidelines and policies that are used to classify these end points. ATSDR believes that there is sufficient merit in this approach to warrant an attempt at distinguishing between "less serious" and "serious" effects. The distinction between "less serious" effects and "serious" effects is considered to be important because it helps the users of the profiles to identify levels of exposure at which major health effects start to appear. LOAELs or NOAELs should also help in determining whether or not the effects vary with dose and/or duration, and place into perspective the possible significance of these effects to human health.

The significance of the exposure levels shown in the Levels of Significant Exposure (LSE) tables and figures may differ depending on the user's perspective. Public health officials and others concerned with appropriate actions to take at hazardous waste sites may want information on levels of exposure associated with more subtle effects in humans or animals (LOAELs) or exposure levels below which no adverse effects (NOAELs) have been observed. Estimates of levels posing minimal risk to humans (Minimal Risk Levels or MRLs) may be of interest to health professionals and citizens alike.

A User's Guide has been provided at the end of this profile (see Appendix B). This guide should aid in the interpretation of the tables and figures for Levels of Significant Exposure and the MRLs.

#### **3.2.1 Inhalation Exposure**

##### **3.2.1.1 Death**

No studies were located regarding lethality in humans or animals after inhalation exposure to perchlorate.

##### **3.2.1.2 Systemic Effects**

No studies were located regarding respiratory, cardiovascular, gastrointestinal, musculoskeletal, dermal, or ocular effects in humans or animals after inhalation exposure to perchlorate.



## 3. HEALTH EFFECTS

The highest NOAEL values for systemic effects from the two occupational studies available are recorded in Table 3-1 and plotted in Figure 3-1.

**Hematological Effects.** No hematological effects were found in ammonium perchlorate workers (22–31 high-dose and 18–27 low-dose versus 72–150 controls) exposed for 1–27 years (mean=8.3 years) to average perchlorate concentrations of up to 0.63 mg/m<sup>3</sup> (Gibbs et al. 1998). The researchers estimated an average cumulative lifetime perchlorate absorbed dose of 38 mg/kg in the high-dose workers in this study, which corresponds to a daily dose of 0.01 mg/kg/day based on the approximate average exposure duration of 9 years for high-dose workers. Oral exposure due to deposition in the mouth and throat was also likely to have occurred. The accuracy of dose estimates from this study is questionable; however, because the researchers estimated the fraction absorbed using a study on an unrelated chemical and did not consider the size of the inhaled ammonium particles in their calculations. Particle size (mean and distribution) is an important determinant of inhaled dose for particulates (EPA 1994). A similar study of 37 ammonium perchlorate workers also found no evidence of hematological effects among the workers (Lamm et al. 1999). The workers were assigned to one of three categories of presumptive exposure based on visible dust generated. The average airborne exposure for the high-exposure group was 8.6 mg/day (respirable fraction; particle size 0.1–10 µm) or 59.4 mg/day (total particulate perchlorate). Dividing by the default inhalation volume of 10 m<sup>3</sup>/day results in a respirable concentration of 0.86 mg/m<sup>3</sup>. The absorbed oral dose per shift was calculated using urinary perchlorate measurements and the assumption that the absorbed dose that is excreted is 95%. In the low-, medium-, and high-exposure categories, the absorbed doses were estimated to be 4, 11, and 34 mg perchlorate/day, respectively. Assuming a body weight of 70 kg, the 34 mg/kg oral dose corresponds to about 0.5 mg perchlorate/kg/day. Measures of cumulative exposure were not considered in this study. It should be noted that workers exposed to perchlorate have an unusual work schedule consisting of three 12-hour day shifts followed by 3 days unexposed.

No studies were located regarding hematological effects in animals after inhalation exposure to perchlorate.

**Hepatic Effects.** No effects on serum enzymes indicative of liver toxicity were found in the ammonium perchlorate workers studied by Gibbs et al. (1998) or among those studied by Lamm et al. (1999) (see Hematological Effects above for further details on these studies). No further relevant information was located.

Table 3-1 Levels of Significant Exposure to Perchlorates - Inhalation

Key to Figure <sup>a</sup>	Species (Strain)	Exposure/ Duration/ Frequency (Route)	System	NOAEL (mg/m <sup>3</sup> )	LOAEL		Reference Chemical Form	Comments
					Less Serious (mg/m <sup>3</sup> )	Serious (mg/m <sup>3</sup> )		
<b>CHRONIC EXPOSURE</b>								
<b>Systemic</b>								
1	Human	1-27 yr (avg=8.3 yr) (occup)	Hemato	0.63			Gibbs et al. 1998 NH <sub>4</sub> ClO <sub>4</sub>	
			Hepatic	0.63				
			Renal	0.63				
			Endocr	0.63				
2	Human	40% over 5 yr (occup)	Hemato	0.86			Lamm et al. 1999 NH <sub>4</sub> ClO <sub>4</sub>	
			Hepatic	0.86				
			Renal	0.86				
			Endocr	0.86				

<sup>a</sup> The number corresponds to entries in Figure 3-1.

avg = average; Endocr = endocrine; Hemato = hematological; LOAEL = lowest-observed-adverse-effect level; NOAEL = no-observed-adverse-effect level; occup = occupational; yr = year(s)

Figure 3-1. Levels of Significant Exposure to Perchlorates - Inhalation  
Chronic ( $\leq 365$  days)

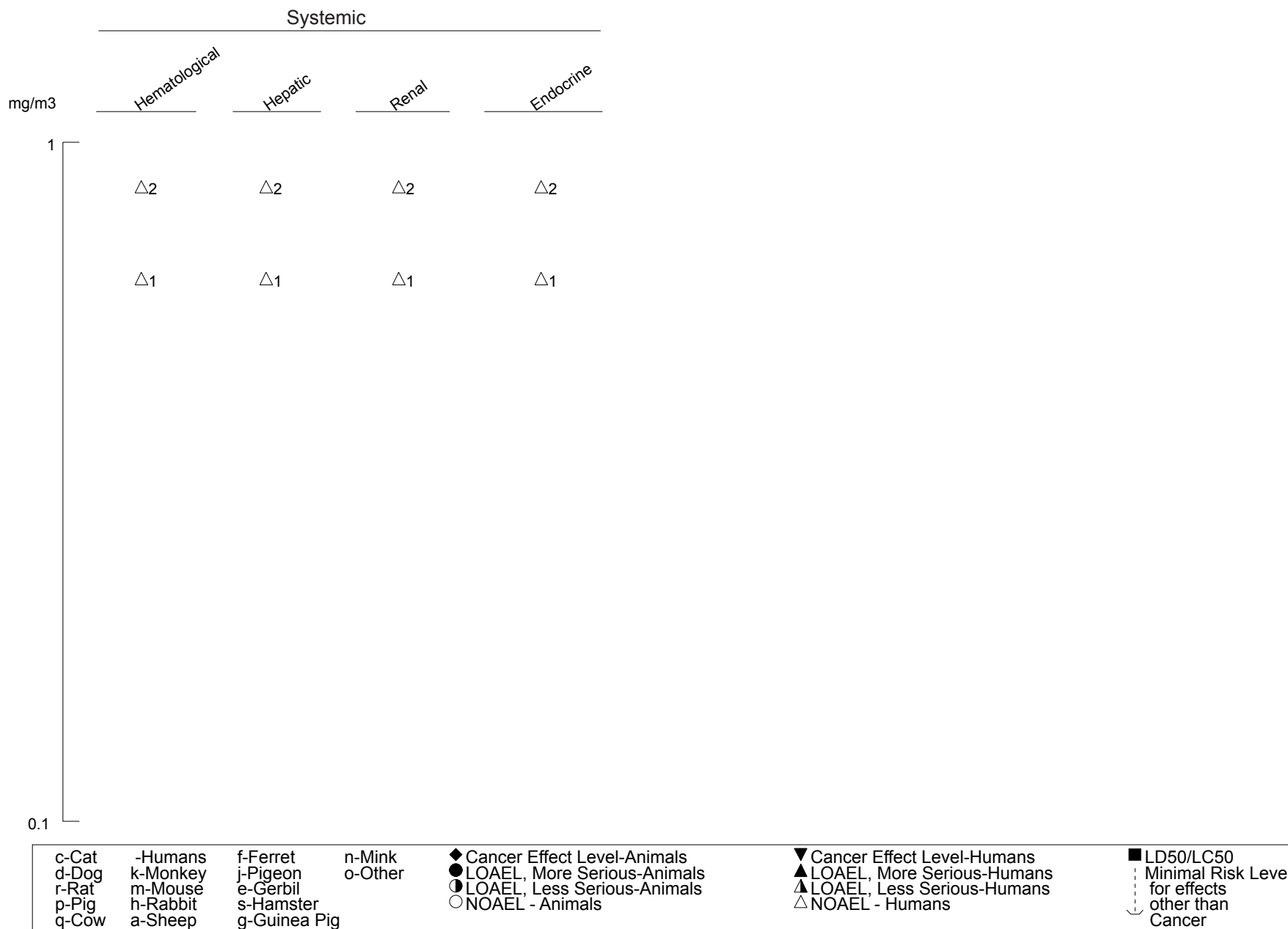

## 3. HEALTH EFFECTS

No studies were located regarding hepatic effects in animals after inhalation exposure to perchlorate.

**Renal Effects.** No effects on serum enzymes indicative of kidney toxicity or in serum creatinine and blood urea nitrogen (BUN) were found in the ammonium perchlorate workers evaluated by Gibbs et al. (1998) or Lamm et al. (1999) (see Hematological Effects above for further details on these studies).

No studies were located regarding renal effects in animals after inhalation exposure to perchlorate.

**Endocrine Effects.** No significant effects on serum levels of TSH, total serum thyroxine (TT4), T3, or free thyroxine index (FTI) were found among the ammonium perchlorate workers studied by Gibbs et al. (1998). The mean airborne concentration of perchlorate to which the workers were exposed ranged from 0.02 to 0.63 mg/m<sup>3</sup>. The researchers estimated that exposure to airborne perchlorate provided an average cumulative lifetime absorbed dose of up to 0.01 mg perchlorate/kg/day for high-exposure workers. Comparison of pre- and post-shift serum thyroid hormone measurements for individual workers failed to find any evidence of a transient effect associated with daily exposure. In the occupational-exposure study conducted by Lamm et al. (1999), there were also no significant alterations in serum TSH, T3, T4, FTI, thyroid hormone binding ratio, or thyroid peroxidase antibody concentrations among the workers. In this study, it was estimated that the high-exposure workers, who were exposed to an average of 0.86 mg of respirable airborne perchlorate particles/m<sup>3</sup>, absorbed doses of approximately 0.5 mg perchlorate/kg/day (see above under Hematological Effects for further details on these studies). A study conducted in the same manufacturing facility studied by Lamm et al. (1999) found that intermittent, high exposure to perchlorate for many years did not induce goiter or any evidence of hypothyroidism among the workers as judged by no significant alterations in serum TSH or thyroglobulin even though iodine uptakes were decreased during the work shift (Braverman et al. 2005). The median estimated absorbed dose was 0.167 mg/kg/day, equivalent to drinking approximately 2 L of water containing 5 mg perchlorate/L. It should be mentioned that perchlorate workers are exposed during an unusual schedule of three 12-hour shifts followed by 3 days without exposure (long-time, intermittent exposure). Given the relatively short elimination half-life of chlorine in workers of approximately 8 hours (Lamm et al. 1999), perchlorate would not be expected to accumulate to levels that would cause thyroid problems.

No studies were located regarding endocrine effects in animals after inhalation exposure to perchlorate.

## 3. HEALTH EFFECTS

No studies were located regarding the following effects in humans or animals after inhalation exposure to perchlorate:

**3.2.1.3 Immunological and Lymphoreticular Effects****3.2.1.4 Neurological Effects****3.2.1.5 Reproductive Effects****3.2.1.6 Developmental Effects****3.2.1.7 Cancer****3.2.2 Oral Exposure**

NOAEL and LOAEL values in Table 3-2 and Figure 3-2 represent amounts of the perchlorate anion, not of the perchlorate salt.

**3.2.2.1 Death**

Several cases of human deaths were reported among hyperthyroid patients treated with potassium perchlorate (Barzilai and Sheinfeld 1966; Fawcett and Clarke 1961; Gjerdal 1963; Hobson 1961; Johnson and Moore 1961; Krevans et al. 1962). Deaths were due to aplastic anemia or severe agranulocytosis and were considered to be causally related to potassium perchlorate. The lethal doses in these patients were in the low-to-moderate range of doses employed in thyrotoxicosis therapy: 600–1,000 mg potassium perchlorate/day, or roughly 5–12 mg perchlorate/kg/day. The patients had received treatment for anywhere between 2 and 8 months. All of the deaths were females (Graves' disease, the most common cause of hyperthyroidism, is far more common in women than in men) and their ages ranged from 24 to 82 years.

Gauss (1972) reported an LD<sub>50</sub> dietary concentration of 3.55% (approximately 3,621 mg perchlorate/kg/day) for potassium perchlorate in mice exposed for up to 30 days. The first deaths occurred within 4 days of the start of treatment. The LD<sub>50</sub> value for mice is recorded in Table 3-2 and plotted in Figure 3-2.

**3.2.2.2 Systemic Effects**

The highest NOAEL values and all LOAEL values from each reliable study for systemic effects in each species and duration category are recorded in Table 3-2 and plotted in Figure 3-2.

Table 3-2 Levels of Significant Exposure to Perchlorates - Oral

Key to Figure <sup>a</sup>	Species (Strain)	Exposure/Duration/Frequency (Route)	System	NOAEL (mg/kg/day)	LOAEL		Reference Chemical Form	Comments
					Less Serious (mg/kg/day)	Serious (mg/kg/day)		
<b>ACUTE EXPOSURE</b>								
<b>Death</b>								
1	Mouse (NMRI)	6 d ad lib (F)				3621 F (LD50)	Gauss 1972 KClO <sub>4</sub>	
<b>Systemic</b>								
2	Human	14 d (W)	Hemato	0.5			Greer et al. 2002 KClO <sub>4</sub>	
			Hepatic	0.5				
			Renal	0.5				
			Endocr	0.007 <sup>b</sup>	0.1	(42% inhibition of radioiodine uptake by the thyroid)		
3	Human	14 d (W)	Hemato	0.14			Lawrence et al. 2000 KClO <sub>4</sub>	
			Hepatic	0.14				
			Renal	0.14				
			Endocr	0.14				
4	Human	14 d (W)	Endocr	0.04			Lawrence et al. 2001 KClO <sub>4</sub>	

Table 3-2 Levels of Significant Exposure to Perchlorates - Oral

(continued)

Key to Figure <sup>a</sup>	Species (Strain)	Exposure/Duration/Frequency (Route)	System	NOAEL (mg/kg/day)	LOAEL		Reference Chemical Form	Comments
					Less Serious (mg/kg/day)	Serious (mg/kg/day)		
5	Rat (Sprague-Dawley)	14 d ad lib (W)	Endocr		0.1	(increased serum TSH in females, decreased T4 in males and females, and decrease T3 in females)	Caldwell et al. 1995 NH <sub>4</sub> ClO <sub>4</sub>	
			Bd Wt	39.9				
			Other	39.9				
6	Rat (Sprague-Dawley)	4 d ad lib (W)	Endocr	1.4 M	7.2 M	(approximately 20% decrease in T3 and 37% decrease in T4)	Mannisto et al. 1979 KClO <sub>4</sub>	

Table 3-2 Levels of Significant Exposure to Perchlorates - Oral

(continued)

Key to Figure	Species (Strain)	Exposure/Duration/Frequency (Route)	System	NOAEL (mg/kg/day)	LOAEL		Reference Chemical Form	Comments
					Less Serious (mg/kg/day)	Serious (mg/kg/day)		
7	Rat (Sprague-Dawley)	14 d ad lib (W)	Resp	8.5			Siglin et al. 2000 NH4ClO4	
			Cardio	8.5				
			Gastro	8.5				
			Hemato	8.5				
			Musc/skel	8.5				
			Hepatic	8.5				
			Renal	8.5				
			Endocr		0.009 M (approximately 20% decreased serum T3 in males)			
			Dermal	8.5				
			Ocular	8.5				
	Bd Wt	8.5						
	Other	8.5						
8	Rat (Sprague-Dawley)	14 d ad lib (W)	Endocr		0.09 M (increased TSH and decreased serum T3)		Yu et al. 2002 NH4ClO4	
9	Mouse (B6C3F1)	14 d ad lib (W)	Endocr	0.05 F	0.2 F (significant decrease in serum T4 levels; non-significant increase in TSH)		BRT 2000 NH4ClO4	



Table 3-2 Levels of Significant Exposure to Perchlorates - Oral

(continued)

Key to Figure	Species (Strain)	Exposure/Duration/Frequency (Route)	System	NOAEL (mg/kg/day)	LOAEL		Reference Chemical Form	Comments
					Less Serious (mg/kg/day)	Serious (mg/kg/day)		
10	Mouse (B6C3F1)	14 d ad lib (W)	Hemato	25.5 F			DOD 1999 NH4ClO4	
			Hepatic	25.5 F				
			Renal	25.5 F				
			Endocr		2.6 F (15% decrease serum T4)			
			Bd Wt	25.5 F				
			Other	25.5 F				
<b>Immuno/ Lymphoret</b>								
11	Mouse (B6C3F1)	14 d ad lib (W)			0.05 F (increased response to sensitizer 2,4-dinitrochlorobenzene)		BRT 2000 NH4ClO4	
12	Mouse (B6C3F1)	14 d ad lib (W)		25.5 F			DOD 1999 NH4ClO4	
<b>Neurological</b>								
13	Rat (Sprague-Dawley)	14 d ad lib (W)		8.5			Siglin et al. 2000 NH4ClO4	
<b>Reproductive</b>								
14	Rat (Wistar)	Gd 2-8 ad lib (W)		532 F			Brown-Grant 1966 KClO4	

Table 3-2 Levels of Significant Exposure to Perchlorates - Oral

(continued)

Key to Figure	Species (Strain)	Exposure/Duration/Frequency (Route)	System	LOAEL			Reference Chemical Form	Comments
				NOAEL (mg/kg/day)	Less Serious (mg/kg/day)	Serious (mg/kg/day)		
15	Rat (Wistar)	Gd 1-13 ad lib (W)		1752 F			Brown-Grant and Sherwood 1971 KClO <sub>4</sub>	
16	Rat (Sprague-Dawley)	14 d ad lib (W)		8.5			Siglin et al. 2000 NH <sub>4</sub> ClO <sub>4</sub>	
<b>INTERMEDIATE EXPOSURE</b>								
<b>Systemic</b>								
17	Human	4 wk (IN)	Endocr		9 M (decreased thyroid I and serum TSH)		Brabant et al. 1992 KClO <sub>4</sub>	
18	Human	6 mo 1 x/d (C)	Endocr	0.04			Braverman et al. 2006 KClO <sub>4</sub>	The NOAEL is for thyroid function.
19	Rat (Wistar)	19 wk ad lib (F)	Hepatic	64 M			Hiasa et al. 1987 KClO <sub>4</sub>	
			Endocr			64 M (thyroid weight doubled; 24% decrease in serum T <sub>4</sub> ; 100% increase in TSH)		
			Bd Wt	64 M				

Table 3-2 Levels of Significant Exposure to Perchlorates - Oral

(continued)

Key to Figure	Species (Strain)	Exposure/Duration/Frequency (Route)	System	NOAEL (mg/kg/day)	LOAEL		Reference Chemical Form	Comments
					Less Serious (mg/kg/day)	Serious (mg/kg/day)		
20	Rat (Wistar)	6 wk ad lib (W)	Cardio		2327 M (decreased heart weight)		MacDermott 1992 KClO <sub>4</sub>	
			Musc/skel		2327 M (decreased membrane potential and intracellular K <sup>+</sup> activity)			
			Endocr			2327 M (thyroid weight more than doubled; 71% decrease in serum T <sub>4</sub> )		
			Bd Wt			2327 M (27% reduced weight at 6 weeks)		
21	Rat (Wistar)	25 d ad lib (W)	Endocr			175 M (thyroid weight tripled; undetectable levels of T <sub>3</sub> and T <sub>4</sub> in serum; 50% increase in TSH)	Ortiz-Caro et al. 1983 KClO <sub>4</sub>	
			Bd Wt			175 M (40% reduction in weight gain)		
			Metab		175 M (decreased alpha-GPD activity)			
22	Rat (Wistar)	45 d 1 x/d (G)	Metab		359 (decreased glucose and increased urea in serum; increased activity of aldolase, LDH, arginase; decreased G-6-Pase)		Sangan and Motlag 1986 KClO <sub>4</sub>	

Table 3-2 Levels of Significant Exposure to Perchlorates - Oral

(continued)

Key to Figure	Species (Strain)	Exposure/Duration/Frequency (Route)	System	NOAEL (mg/kg/day)	LOAEL		Reference Chemical Form	Comments	
					Less Serious (mg/kg/day)	Serious (mg/kg/day)			
23	Rat (Wistar)	3 mo ad lib (W)	Hemato			1059 M (decreased hematopoiesis)	Shevtsova et al. 1994 KClO <sub>4</sub>		
24	Rat (Sprague-Dawley)	90 d ad lib (W)	Resp	8.5			Siglin et al. 2000 NH <sub>4</sub> ClO <sub>4</sub>		
			Cardio	8.5					
			Gastro	8.5					
			Hemato	8.5					
			Musc/skel	8.5					
			Hepatic	8.5					
			Renal	8.5					
			Endocr		0.009 (significant decreases in T4 and T3 in both males and females)				
			Dermal	8.5					
			Ocular	8.5					
Bd Wt	8.5								
Other	8.5								

Table 3-2 Levels of Significant Exposure to Perchlorates - Oral

(continued)

Key to Figure <sup>a</sup>	Species (Strain)	Exposure/Duration/Frequency (Route)	System	NOAEL (mg/kg/day)	LOAEL		Reference Chemical Form	Comments
					Less Serious (mg/kg/day)	Serious (mg/kg/day)		
25	Rat (Wistar)	45 d 1 x/d (G)	Metab		406 M (decreased activity of lipase, phospholipase A; decreased free fatty acids; increased cholesterol, triglycerides, phospholipids)		Vijayalakshmi and Motlag 1989a NaClO <sub>4</sub>	
26	Rat (Sprague-Dawley)	>19 wk ad lib (W)	Endocr	0.26	2.6 (increased absolute and relative thyroid weight in both sexes; hypertrophy and hyperplasia in males; increased TSH)		York et al. 2001a NH <sub>4</sub> ClO <sub>4</sub>	
			Bd Wt	25.5				
			Other	25.5				
27	Rat (Sprague-Dawley)	16 wk ad lib (W)	Endocr	0.26	2.6 (hypertrophy/hyperplasia of the thyroid)		York et al. 2001a NH <sub>4</sub> ClO <sub>4</sub>	
			Bd Wt	25.5				
			Other		0.26 M (decreased water consumption)			

Table 3-2 Levels of Significant Exposure to Perchlorates - Oral

(continued)

Key to Figure <sup>a</sup>	Species (Strain)	Exposure/Duration/Frequency (Route)	System	NOAEL (mg/kg/day)	LOAEL		Reference Chemical Form	Comments		
					Less Serious (mg/kg/day)	Serious (mg/kg/day)				
28	Rat (Sprague-Dawley)	14 pmd Gd 1-21 pnd 1-10 pnd 1-22 ad lib (W)	Endocr	0.009	0.09	(17% increase in serum TSH)	York et al. 2003 NH4ClO4			
			Bd Wt	25.5						
			Other	25.5						
29	Rat (Sprague-Dawley)	45 d (W)	Endocr		0.009 F	(increase serum TSH and decrease T4)	York et al. 2005a NH4ClO4			
			Bd Wt	25.5 F						
30	Mouse (B6C3F1)	90 d ad lib (W)	Endocr	0.02 F	0.05 F	(17% increase in serum TSH)	BRT 2000 NH4ClO4			
31	Mouse (B6C3F1)	90 d ad lib (W)	Hemato	25.5 F			DOD 1999 NH4ClO4			
			Hepatic	25.5 F						
			Renal	25.5 F						
			Endocr	0.09 F	0.85 F	(significant decrease in serum T4 levels)			25.5 F	(colloid depletion; intrafollicular capillary congestion)
			Bd Wt	25.5 F						
Other	25.5 F									

Table 3-2 Levels of Significant Exposure to Perchlorates - Oral

(continued)

Key to Figure	Species (Strain)	Exposure/Duration/Frequency (Route)	System	NOAEL (mg/kg/day)	LOAEL		Reference Chemical Form	Comments
					Less Serious (mg/kg/day)	Serious (mg/kg/day)		
32	Mouse (BALB/c)	3 mo ad lib (W)	Hemato			1750 M (decreased hematopoiesis)	Shevtsova et al. 1994 KClO <sub>4</sub>	
33	Gn Pig (NS)	30, 60, or 90 d ad lib (W)	Endocr			531 F (thyroid weight almost tripled; thyroid hyperplasia and colloid depletion)	Postel 1957 KClO <sub>4</sub>	
34	Dog (NS)	3 wk 1 x/d (G)	Gastro		3811 (mucosal irritation)		Selivanova and Vorobieva 1969 NH <sub>4</sub> ClO <sub>4</sub>	
			Hemato			3811 (inhibition of hematopoiesis in bone marrow)		
			Endocr			3811 (inhibited thyroid function)		
<b>Immuno/ Lymphoret</b>								
35	Rat (Sprague-Dawley)	90 d ad lib (W)		8.5			Siglin et al. 2000 NH <sub>4</sub> ClO <sub>4</sub>	
36	Mouse (B6C3F1)	90 d ad lib (W)		0.02 F	0.05 F (increased sensitization response to 2,4-dinitrochlorobenzene)		BRT 2000 NH <sub>4</sub> ClO <sub>4</sub>	

Table 3-2 Levels of Significant Exposure to Perchlorates - Oral

(continued)

Key to Figure <sup>a</sup>	Species (Strain)	Exposure/Duration/Frequency (Route)	System	LOAEL		Reference Chemical Form	Comments
				NOAEL (mg/kg/day)	Less Serious (mg/kg/day)		
37	Mouse (B6C3F1)	90 d ad lib (W)		25.5 F			DOD 1999 NH <sub>4</sub> ClO <sub>4</sub>
<b>Neurological</b>							
38	Rat (Sprague-Dawley)	90 d ad lib (W)		8.5			Siglin et al. 2000 NH <sub>4</sub> ClO <sub>4</sub>
<b>Reproductive</b>							
39	Rat (Sprague-Dawley)	90 d ad lib (W)		8.5			Siglin et al. 2000 NH <sub>4</sub> ClO <sub>4</sub>
40	Rat (Sprague-Dawley)	16 wk ad lib (W)		25.5			York et al. 2001a NH <sub>4</sub> ClO <sub>4</sub>
41	Rat (Sprague-Dawley)	45 d (W)		25.5 F			York et al. 2005a NH <sub>4</sub> ClO <sub>4</sub>  The NOAEL is for standard reproductive end points assessed at parturition.
<b>Developmental</b>							
42	Rat (Sprague-Dawley)	2 wk pmd Gd 1-21 pnd 1-10 ad lib (W)		8.5			Bekkedal et al. 2000 NH <sub>4</sub> ClO <sub>4</sub>



Table 3-2 Levels of Significant Exposure to Perchlorates - Oral

(continued)

Key to Figure	Species (Strain)	Exposure/Duration/Frequency (Route)	System	NOAEL (mg/kg/day)	LOAEL		Reference Chemical Form	Comments
					Less Serious (mg/kg/day)	Serious (mg/kg/day)		
43	Rat (Sprague-Dawley)	31 d Gd 2-21 pnd 1-10 ad lib (W)			1	(increased TSH and decreased T4 in pups exposed via maternal milk)		Mahle et al. 2003 NH <sub>4</sub> ClO <sub>4</sub>
44	Rat (Sprague-Dawley)	16 wk ad lib (W)		0.26	2.6	(thyroid hypertrophy and hyperplasia in F1 females and in F2 males and females)		York et al. 2001a NH <sub>4</sub> ClO <sub>4</sub>
45	Rat (Sprague-Dawley)	15 pmd Gd 1-21 ad lib (W)		0.85	25.5	(delayed sternal and phalanges ossification)		York et al. 2003 NH <sub>4</sub> ClO <sub>4</sub>
46	Rat (Sprague-Dawley)	14 pmd Gd 1-21 pnd 1-10 pnd 1-22 ad lib (W)			0.009	(decreased T3 in fetuses; increased absolute thyroid weight in 10-day-old pups; increased TSH and decreased T4 in 22-day-old pups; increased cerebellum thickness in 22-day-old pups)		York et al. 2003 NH <sub>4</sub> ClO <sub>4</sub>

Table 3-2 Levels of Significant Exposure to Perchlorates - Oral

(continued)

Key to Figure <sup>a</sup>	Species (Strain)	Exposure/Duration/Frequency (Route)	System	NOAEL (mg/kg/day)	LOAEL		Reference Chemical Form	Comments
					Less Serious (mg/kg/day)	Serious (mg/kg/day)		
47	Rat (Sprague-Dawley)	31 d Gd 1-21 Ld 1-10 ad lib (W)		2.6	8.5	(hypertrophy/hyperplasia of follicular epithelium and decrease in follicle size in pups on pnd 5)	York et al. 2004 NH <sub>4</sub> ClO <sub>4</sub>	
48	Rat (Sprague-Dawley)	45 d (W)			0.009	(increased TSH and decreased T4 in pups; decreased T3 in fetuses)	York et al. 2005a NH <sub>4</sub> ClO <sub>4</sub>	
49	Rat (Sprague-Dawley)	31-45 d (W)		25.5			York et al. 2005b NH <sub>4</sub> ClO <sub>4</sub>	NOAEL is for brain morphometry. A NOAEL of 8.5 mg/kg/day was defined for motor activity (25.5 mg/kg/day not tested).
50	Gn Pig (NS)	Gd 21-48 ad lib (W)				531 (increased weight of fetal thyroid and hyperplasia in fetal thyroid)	Postel 1957 KClO <sub>4</sub>	
51	Rabbit (NS)	Gd 1-28 ad lib (F)				72 (significantly enlarged fetal thyroid and histological changes in fetal thyroid )	Lampe et al. 1967 KClO <sub>4</sub>	

Table 3-2 Levels of Significant Exposure to Perchlorates - Oral

(continued)

Key to Figure <sup>a</sup>	Species (Strain)	Exposure/Duration/Frequency (Route)	System	NOAEL (mg/kg/day)	LOAEL		Reference Chemical Form	Comments
					Less Serious (mg/kg/day)	Serious (mg/kg/day)		
52	Rabbit (New Zealand)□	22 d Gd 6-28 ad lib (W)		85			York et al. 2001b NH <sub>4</sub> ClO <sub>4</sub>	
<b>Cancer</b>								
53	Rat (Wistar)	12 mo ad lib (W)				928 (CEL: thyroid follicular adenoma)	Florencio Vicente 1990 KClO <sub>4</sub>	
54	Mouse (NMRI)	160 d ad lib (F)				1020 F (CEL: thyroid adenoma)	Gauss 1972 KClO <sub>4</sub>	
55	Mouse (BALB/c)	46 wk ad lib (W)				2573 F (CEL: thyroid follicular cell carcinoma in 5/6)	Pajer and Kalisnik 1991 NaClO <sub>4</sub>	
<b>CHRONIC EXPOSURE</b>								
<b>Systemic</b>								
56	Human	lifetime (W)	Endocr	0.0014 F			Tellez et al. 2005 NH <sub>4</sub> ClO <sub>4</sub>	The women's iodide uptake was higher than common in the U.S.
57	Rat (Wistar)	24 mo ad lib (W)	Endocr			956 M (thyroid fibrosis)	Kessler and Kruskemper 1966 KClO <sub>4</sub>	
			Bd Wt	956 M				

Table 3-2 Levels of Significant Exposure to Perchlorates - Oral

(continued)

Key to Figure <sup>a</sup>	Species (Strain)	Exposure/Duration/Frequency (Route)	System	NOAEL (mg/kg/day)	LOAEL		Reference Chemical Form	Comments	
					Less Serious (mg/kg/day)	Serious (mg/kg/day)			
58	Rat (Wistar)	15 mo ad lib (W)	Endocr			928	(thyroid hypertrophy and hyperplasia)	Toro Guillen 1991 KClO <sub>4</sub>	
			Bd Wt		928	(unspecified decreased weight gain)			
<b>Developmental</b>									
59	Human	gestational (W)		0.0014				Tellez et al. 2005 NH <sub>4</sub> ClO <sub>4</sub>	
<b>Cancer</b>									
60	Rat (Wistar)	24 mo ad lib (W)				956 M	(CEL: increased papillary and/or follicular adenomas in thyroid)	Kessler and Kruskemper 1966 KClO <sub>4</sub>	
61	Rat (Wistar)	15 mo ad lib (W)				928	(CEL: follicular and papillary carcinoma of thyroid)	Toro Guillen 1991 KClO <sub>4</sub>	

a The number corresponds to entries in Figure 3-2.

b ATSDR has adopted the NAS chronic RfD of 0.0007 mg/kg/day for the chronic oral MRL. The RfD was calculated by dividing the NOEL of 0.007 mg/kg/day by an uncertainty factor of 10 (for the protection of sensitive populations).

c Although inhibition of iodide uptake is not considered adverse, this dose is shown to illustrate the dose at which the effect became statistically significant.

ad lib = ad libitum; Bd Wt = body weight; (C) = capsule; Cardio = cardiovascular; CEL = cancer effect level; d = day(s); Endocr = endocrine; (F) = food; F = female; (G) = gavage; Gastro = gastrointestinal; Gd = gestation day; GPD = glycerophosphate dehydrogenase; (GW) = gavage in water; (IN) = ingestion; Hemato = hematological; Ld = lactation day; LD50 = lethal dose, 50% kill; LDH = lactate dehydrogenase; LOAEL = lowest-observable-adverse-effect level; M = male; Metab = metabolic; mo = month; Musc/skel = musculoskeletal; NOAEL = no-observed-adverse-effect level; pmd = pre-mating day; pnd = post-natal day; Resp = respiratory; TSH = thyroid-stimulating hormone; (W) = drinking water; wk = week(s); x = times; yr = year(s)





Figure 3-2 Levels of Significant Exposure to Perchlorates - Oral (Continued)  
Intermediate (15-364 days)

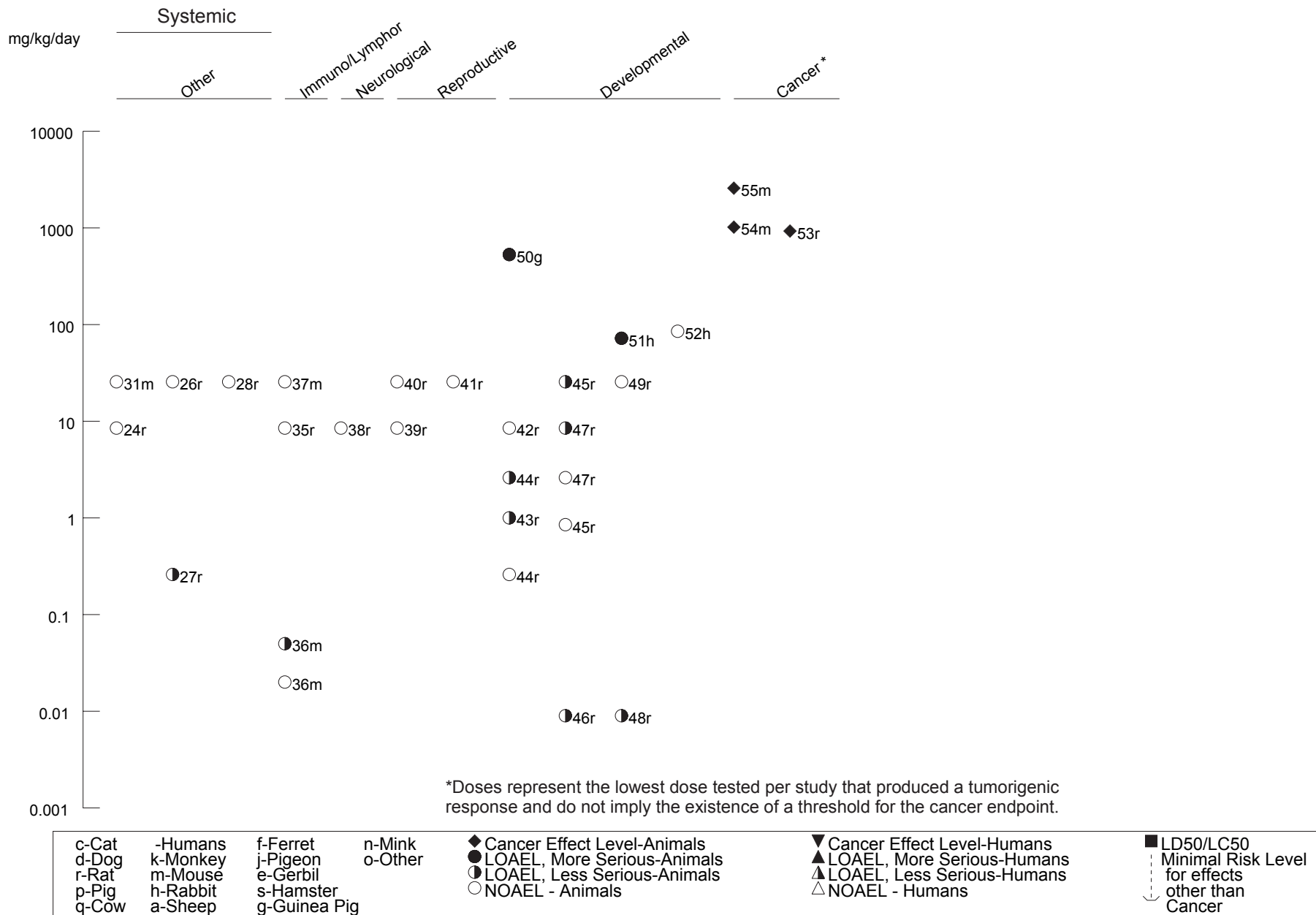
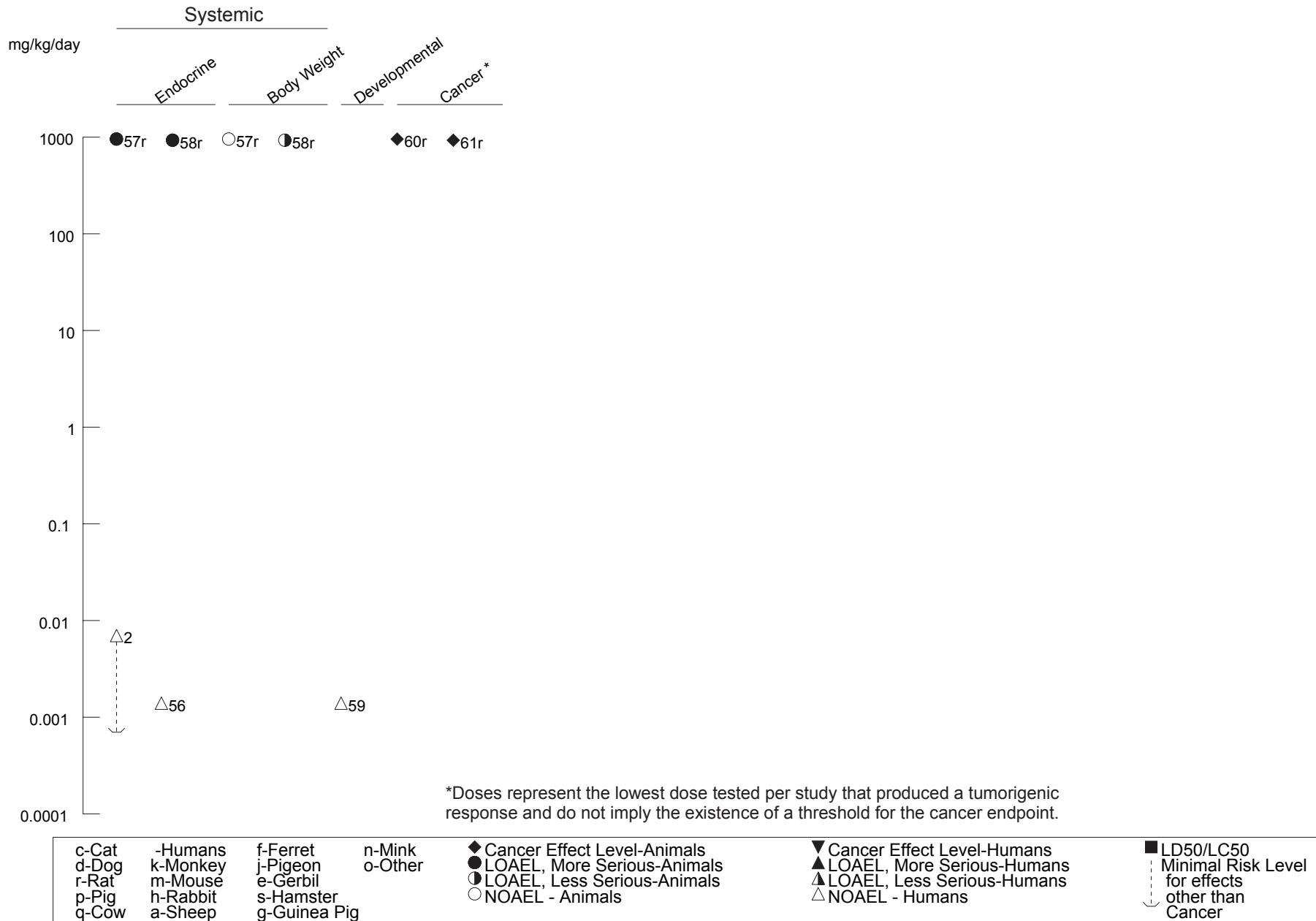

Figure 3-2 Levels of Significant Exposure to Perchlorates - Oral (Continued)  
 Chronic (≥365 days)





## 3. HEALTH EFFECTS

**Respiratory Effects.** No studies were located regarding respiratory effects in humans after oral exposure to perchlorate. The only relevant information in animals is that from a study by Siglin et al. (2000) in which no significant effects on lung weight and no gross or microscopic alterations were found in the lungs from rats administered up to 8.5 mg perchlorate/kg/day (as ammonium perchlorate) in the drinking water for up to 90 days.

**Cardiovascular Effects.** No studies were located regarding cardiovascular effects in humans after oral exposure to perchlorate.

Absolute and relative heart weights were significantly decreased in rats treated with 2% potassium perchlorate (approximately 2,327 mg perchlorate/kg/day) in the drinking water for 6 weeks (MacDermott 1992). No gross or microscopical alterations were observed in the heart of rats administered ammonium perchlorate in the drinking water at doses of up to 8.5 mg perchlorate/kg/day for up to 90 days (Siglin et al. 2000); the weight of the heart was also not affected by exposure to perchlorate.

**Gastrointestinal Effects.** No information was located regarding gastrointestinal effects of perchlorate in healthy humans. Symptoms of gastrointestinal distress, including nausea and vomiting, have been reported in a small percentage of cases of hyperthyroid patients treated with potassium perchlorate (Crooks and Wayne 1960; Godley and Stanbury 1954). In a review of 250 cases, the incidence of nausea was 1.5% (3/200) among patients given 600 or 1,000 mg potassium perchlorate/day (approximately 6 or 10 mg perchlorate/kg/day) and 4% (2/50) among patients given 1,500 or 2,000 mg potassium perchlorate/day (approximately 15 or 20 mg perchlorate/kg/day) (Crooks and Wayne 1960). Although gastrointestinal distress was limited to nausea in most cases, there was one case of a 22-year-old anorectic female Graves' disease patient who experienced burning epigastric discomfort and frequent vomiting within days of starting perchlorate treatment (600 mg potassium perchlorate/day or 6 mg perchlorate/kg/day), and developed a ruptured duodenal ulcer a week later (Godley and Stanbury 1954).

Irritation of the gastric mucosa was reported in dogs given 3,811 mg perchlorate/kg/day as ammonium perchlorate by gavage for 3 weeks (Selivanova and Vorobieva 1969). In rats administered up to 8.5 mg perchlorate/kg/day as ammonium perchlorate in the drinking water for up to 90 days, there was no evidence of gross or histological alterations of any section of the gastrointestinal tract (Siglin et al. 2000).

**Hematological Effects.** Two recent controlled acute exposure studies in euthyroid volunteers provide information of hematological effects of perchlorate in humans. No alterations in hematological

## 3. HEALTH EFFECTS

parameters (complete blood count and routine chemistries) were observed in a group of nine male subjects who consumed once a day for 14 consecutive days a solution of potassium perchlorate that provided 10 mg of perchlorate/day (Lawrence et al. 2000). Blood tests were repeated on days 7 and 14 of dosing and 14 days after perchlorate was discontinued. Assuming a body weight of 70 kg, the perchlorate intake was approximately 0.14 mg/kg/day. Similar lack of hematological alterations was reported among a group of 37 volunteers who ingested up to 0.5 mg of perchlorate/kg/day for 14 days (Greer et al. 2002).

Hematological parameters were evaluated in an epidemiological study of school-age children from three cities with different concentrations of perchlorate in drinking water in northern Chile (Crump et al. 2000). The city with the highest perchlorate concentration was Taltal, 100–120 µg perchlorate/L (ppb); water from the city of Chañaral had 5–7 µg/L. Perchlorate was not detected in water from the city of Antofagasta. Assuming a default consumption of 1–2 L of water/day and a measured body weight of approximately 25 kg, the children in Taltal may have consumed up to 0.004–0.008 mg perchlorate/kg/day via the drinking water only, but the Chilean population also has large dietary sources of perchlorate. The study comprised 162 children 6–8 years of age of which 127 had resided continuously in their respective city since conception. There was nearly an equal number of boys and girls. Analysis of complete blood counts showed no significant differences between the three groups of children whether the analysis included all of the children or only the lifelong residents.

Severe hematological effects were found in several cases of hyperthyroid patients treated with potassium perchlorate. Some patients developed aplastic anemia, characterized by drastic reductions in circulating granulocytes, erythrocytes, and thrombocytes, and a lack of erythropoietic and granulopoietic cells in the bone marrow (Barzilai and Sheinfeld 1966; Fawcett and Clarke 1961; Gjerdal 1963; Hobson 1961; Johnson and Moore 1961; Krevans et al. 1962). Aplastic anemia was the cause of death in most of the documented fatalities associated with potassium perchlorate treatment of thyrotoxicosis. In other patients, the decrease in formed blood elements was limited to the granulocytes (agranulocytosis) and/or thrombocytes (thrombocytopenia). Agranulocytosis was fatal in at least one case (Barzilai and Sheinfeld 1966), although other patients survived this condition (Barzilai and Sheinfeld 1966; Crooks and Wayne 1960; Southwell and Randall 1960; Sunar 1963). The doses in patients who developed agranulocytosis and aplastic anemia were mostly in the low-to-moderate range of doses employed in thyrotoxicosis therapy: 600–1,000 mg potassium perchlorate/day, or roughly 5–12 mg perchlorate/kg/day. Cases of agranulocytosis were found within 14 days to 3 months of the start of potassium perchlorate treatment. Although aplastic anemia was found after 2 months of treatment in one case, in most cases, it was only found after 4–8 months. All of the documented cases of aplastic anemia and agranulocytosis were

## 3. HEALTH EFFECTS

females (Graves' disease, the most common cause of hyperthyroidism, is far more common in women than in men), with ages ranging from 24 to 82 years.

Inhibition of hematopoiesis in the bone marrow has also been reported in dogs given 3,811 mg perchlorate/kg/day as ammonium perchlorate by gavage for 3 weeks (Selivanova and Vorobieva 1969), and in rats and mice exposed to 1% potassium perchlorate in the drinking water for 3 months (approximate doses of 1,059 and 1,750 mg perchlorate/kg/day, respectively) (Shevtsova et al. 1994). No significant alterations in hematological parameters were reported following administration of ammonium perchlorate in a drinking water study in mice at doses up to 25.5 mg perchlorate/kg/day for 14 or 90 days (DOD 1999). Similarly, a recent study in rats found no evidence of hematotoxicity after administration of up to 8.5 mg perchlorate/kg/day in the drinking water for 90 days (Siglin et al. 2000). The investigators evaluated routine hematology and clinical chemistry parameters.

**Musculoskeletal Effects.** No studies were located regarding musculoskeletal effects in humans after oral exposure to perchlorate.

MacDermott (1992) observed a decrease in membrane potential and in intracellular potassium ion activity in skeletal muscle from rats treated with 2% potassium perchlorate (approximately 2,327 mg perchlorate/kg/day) in the drinking water for 6 weeks. The observed changes are consistent with a decrease in the number of sodium-potassium pump units in the muscle. No alterations in gross or microscopic appearance of skeletal muscle were reported in rats exposed to doses up to 8.5 mg perchlorate/kg/day as ammonium perchlorate in the drinking water for 90 days (Siglin et al. 2000).

**Hepatic Effects.** No evidence of liver toxicity, as judged by blood chemistry tests, was observed in a group of nine volunteers who ingested approximately 0.14 mg of perchlorate/kg/day as potassium perchlorate for 14 consecutive days (Lawrence et al. 2000). Similar results were reported by Greer et al. (2002) in a study of 37 volunteers who consumed up to 0.5 mg of perchlorate/kg/day also for 14 days. In the study by Crump et al. (2000) of 162 school-age children from three cities in northern Chile with different perchlorate concentration in the drinking water (up to 100–120 µg/L), there were no indications of altered liver function among the children as measured by serum aspartate aminotransferase (AST), alkaline phosphatase (AP), and lactate dehydrogenase (LDH) activities.

Godley and Stanbury (1954) reported no evidence of liver toxicity in a series of 24 hyperthyroid patients treated with potassium perchlorate (600 mg, or approximately 6 mg perchlorate/kg/day) for up to

### 3. HEALTH EFFECTS

52 weeks. However, it is not clear what tests were conducted to monitor effects on the liver or how frequently such tests may have been conducted.

A 0.1% concentration of potassium perchlorate in the diet (about 64 mg perchlorate/day) for 19 weeks had no effect on liver weight in rats (Hiasa et al. 1987). A more recent study in rats found that administration of ammonium perchlorate in the drinking water at doses up to 8.5 mg perchlorate/kg/day for up to 90 days caused no significant alterations in liver weight, in the gross or microscopic appearance of the liver, or in serum transaminase activities (Siglin et al. 2000). No effects on liver weight were reported in 14- and 90-day studies in mice administered up to 25.5 mg perchlorate/kg/day in the drinking water as the ammonium salt (DOD 1999).

**Renal Effects.** Limited information exists regarding renal effects of perchlorate in humans. Two studies in euthyroid volunteers who ingested up to 0.5 mg of perchlorate/kg/day as the potassium salt for 14 days found no evidence of renal effects as judged by standard clinical chemistry tests (Greer et al. 2002; Lawrence et al. 2000). Also, no alterations in BUN or in serum creatinine levels were observed in a group of 60 school-age children from northern Chile exposed to perchlorate in their drinking water at concentrations up to 100–120 µg/L (Crump et al. 2000).

In a case report, a patient with severe hyperthyroidism who was treated with an average of 1,068 mg sodium perchlorate/day (approximately 12 mg perchlorate/kg/day) for 3.5 months developed nephrotic syndrome, as diagnosed by albuminuria, decreased serum albumin, and increased serum cholesterol. The effects subsided after treatment was stopped, and were considered by the researchers to probably have been treatment-related (Weber and Wolf 1969).

There is also limited information on the renal effects of perchlorate in animals. In 14- and 90-day drinking water studies in rats, doses of up to 8.5 mg/kg/day produced no significant alterations in kidney weight or in gross or microscopical appearance of the kidneys (Siglin et al. 2000). In addition, kidney function, monitored by measurements of BUN and serum creatinine, was not affected by exposure to perchlorate (Siglin et al. 2000). A similar study in mice also found no effects of ammonium perchlorate on kidney weight following 14 or 90 days of exposure to up to 25.5 mg perchlorate/kg/day, but kidney function tests were not performed (DOD 1999).

**Endocrine Effects.** The findings of groundwater contamination with perchlorate in western areas of the United States has triggered considerable research on the effects of this anion on the thyroid gland, its

## 3. HEALTH EFFECTS

main target organ, in efforts to describe dose-response relationships at low doses and to define no-effect-level of exposure. For example, Lawrence et al. (2000) evaluated serum TSH, FTI, total serum triiodothyronine (TT3), and RAIU; serum and 24-hour urine perchlorate; and 24-hour urinary iodide excretion in volunteers who ingested approximately 0.14 mg perchlorate/kg/day in drinking water for 14 days. Tests were conducted pre-dosing, on day 7 and 14, and 14 days after perchlorate ingestion was discontinued. The only significant finding was a significant decrease in 4-, 8-, and 24-hour RAIU values by a mean of about 38% relative to baseline on day 14 of dosing. Fourteen days later, RAIU had recovered to a mean of 25% above baseline values. Greer et al. (2002) conducted a similar study in volunteers administered 0.007, 0.02, 0.1, or 0.5 mg perchlorate/kg/day in drinking water for 14 days. RAIU was measured on exposure days 2 and 14, and 15 days after dosing ceased. To estimate daily iodine intake, 24-hour urine samples were collected. As a percentage of baseline RAIU, inhibition in the 0.007, 0.02, 0.1, and 0.5 mg/kg/day dose groups was 1.8, 16.4, 44.7, and 67.1%, respectively. There were no significant differences between the RAIU values measured on day 2 and 14. Fifteen days after perchlorate treatment was discontinued, RAIU values were slightly higher than baseline values. Greer et al. (2002) also found no significant effects of perchlorate treatment on serum TSH, free T4, TT4, and TT3, and on serum antithyroid peroxidase levels; serum antiglobulin levels were below detection levels in all samples tested. The National Academy of Sciences (NAS 2005) recommended a chronic RfD of 0.0007 mg/kg/day for perchlorate based of the findings of Greer et al. (2002). ATSDR has adopted the RfD recommended by NAS for the chronic oral MRL.

A study similar to Greer et al. (2002) was conducted by Braverman et al. (2006) who administered capsules containing potassium perchlorate to 13 volunteers (4 males, 9 females) once a day for 6 months. The estimated doses were 0 (placebo), 0.5, and 3.0 mg perchlorate/day (approximately 0.04 and 0.007 mg perchlorate/kg/day). The outcomes measured were serum thyroid function tests, 24-hour RAIU, serum thyroglobulin (Tg), urinary iodine and perchlorate, and serum perchlorate. RAIU, measured at baseline, 3 and 6 months, and 1 month after termination, was not significantly affected by administration of perchlorate, and there were no significant changes in serum total T3, FTI, TSH, or Tg levels during or after perchlorate exposure compared to baseline values. The small number of subjects per group (4–5), the dosing by capsule rather than intermittent exposure in drinking water, and the lack of information on RAIU during the first 3 months of the study weaken the conclusions of this study.

Other earlier studies in healthy human subjects also showed that perchlorate administered in doses between 7 and 10 mg/kg/day reduced thyroid iodide uptake, increased serum iodide levels, and increased urinary iodide excretion (Brabant et al. 1992; Bürgi et al. 1974; DeGroot and Buhler 1971; Faure and

## 3. HEALTH EFFECTS

Dussault 1975). Higher doses of perchlorate were used in the past to treat subjects with hyperactive thyroids. For example, Stanbury and Wyngaarden (1952) found that a single oral dose of 100 mg of potassium perchlorate (approximately 1 mg perchlorate/kg) dramatically reduced uptake of iodide by the thyroid gland in Graves' disease patients. Subsequent to this finding, potassium perchlorate became an accepted treatment for hyperthyroidism, and was widely used for this purpose for several years (Connell 1981; Crooks and Wayne 1960; Godley and Stanbury 1954; Morgans and Trotter 1960). The use of perchlorate for the treatment of hyperthyroidism came to a virtual stop due to the appearance of cases of aplastic anemia (see Hematological Effects).

Epidemiological studies evaluating adults, children, and newborns have also been conducted (studies of children and newborns are summarized in Section 3.2.2.6, Developmental Effects). However, caution should be exercised in the interpretation of the results from the ecological studies due to the ubiquitous nature of perchlorate exposure and because the effects of perchlorate are dependent upon iodine uptake, so that differences in iodine levels will be important.

In a study of the general population, Li et al. (2001) examined the prevalence of thyroid diseases in Nevada Counties with respect to perchlorate in drinking water. The cohort consisted of all users of the Nevada Medicaid program during the period of January 1, 1997 to December 31, 1998. Disease prevalence in residents from Clark County (Las Vegas), whose drinking water had 4–24 µg/L of perchlorate (0.0001–0.0007 mg perchlorate/kg/day), were compared with those from another urban area of similar size (Reno, Washoe County), but with no perchlorate in the water, and also with those from all other counties, also with no perchlorate exposure. Patients were defined as those having one or more of the following diagnoses of thyroid disease: simple and unspecified goiter, nontoxic nodular goiter, thyrotoxicosis with or without goiter, congenital hypothyroidism, acquired hypothyroidism, thyroiditis, other disorders of the thyroid, or malignant neoplasm of the thyroid gland. Analysis of the data showed no statistically significant period-prevalence rate difference between Clark County and Washoe County. For acquired hypothyroidism, the prevalence was lower in Clark County than in other counties (opposite to what would be expected). Li et al. (2001) acknowledged that their analysis was a crude analysis since age- and sex-adjusted prevalence could not be calculated because of lack of information on age and sex distributions of the Medicaid-eligible population in each county.

A study of 184 pregnant women from three cities (Antofagasta, Chañaral, and Taltal) in northern Chile found no significant association between levels of perchlorate in the drinking water and serum levels of TSH, T4, or thyroglobulin measured early (16.1 weeks) or late (32.4 weeks) during pregnancy (Téllez et

## 3. HEALTH EFFECTS

al. 2005). The mean concentrations of perchlorate in the drinking water from Chañaral and Taltal were 5.8 and 113.9  $\mu\text{g/L}$ , respectively; drinking water from Antofagasta had 0.46  $\mu\text{g/L}$  of perchlorate. The doses of perchlorate estimated by the investigators for subjects in Antofagasta, Chañaral, and Taltal were 0.42, 6.1, and 93.5  $\mu\text{g}$  perchlorate/day, respectively. Using a mean measured body weight of 66.8 kg, the women from Taltal took doses of approximately 0.0014 mg perchlorate/kg/day. Because of the high iodide intake and high background perchlorate in the Chilean diet, the studied women may not be representative of the U.S. population. Furthermore, such high iodide intake may effectively compete with perchlorate binding sites on the NIS.

A recent study of 2,299 male and female participants in NHANES (2001–2002) found that, for women ( $n=1,111$ ) but not men, urinary perchlorate was a significant predictor of both serum TT4 and TSH concentrations (Blount et al. 2006). Blood and spot urine samples were collected from the subjects. Separate analysis of women with urinary iodine  $<100$   $\mu\text{g/L}$  showed that urinary perchlorate was a significant negative predictor of TT4 ( $p<0.0001$ ) and a positive predictor of TSH ( $p<0.001$ ). For women with urinary iodine  $\geq 100$   $\mu\text{g/L}$ , urinary perchlorate was a significant positive predictor of TSH ( $p=0.025$ ), but not of TT4 ( $p=0.550$ ). These associations of perchlorate exposure with TT4 and TSH are coherent in direction and independent of other variables known to affect thyroid function, but are present at perchlorate exposure levels found in the general population (median estimated dose 0.059  $\mu\text{g/kg}$  bw/day). Covariates included in the analyses were: age, race/ethnicity, body mass index, estrogen use, menopausal status, pregnancy status, premenarche status, serum C-reactive protein, serum albumin, serum cotinine, hours of fasting, urinary thiocyanate, urinary nitrate, and selected medication groups. Of these, several were also predictors of thyroid hormones with various degrees of significance. For example, for women with urinary iodine  $<100$   $\mu\text{g/L}$ , estrogen use, menopause, pregnancy, premenarche, C-reactive protein, and total kilocalorie intake were also predictors of TT4 levels. In the low-iodine group of females, urinary perchlorate accounted for 24% of the variance in serum TT4. Limitations acknowledged by the investigators include those common to cross-sectional analyses, the assumption that urinary perchlorate correlate with levels in the thyroid stroma and tissue, and the measurement of total T4 rather than free T4. In addition, not all variables that may impact thyroid function, such as some dietary factors, were accounted for. Also, the study does not address a logical temporal association or biologic plausibility. The investigators also stated that further research is needed to affirm these findings.

Studies in laboratory animals have described the thyroid effects of perchlorate in great detail. Reported findings have included reduced thyroid iodide uptake, increased levels of iodide in serum, decreased serum T4 and T3, increased serum TSH, increased thyroid size and weight, and hypertrophy and

## 3. HEALTH EFFECTS

hyperplasia of thyroid cells, eventually leading to fibrosis and tumor development (see Cancer section), (Fernandez-Rodriguez et al. 1991; Florencio Vicente 1990; Gauss 1972; Hartmann et al. 1971; Hiasa et al. 1987; Kapitola et al. 1971; Kessler and Kruskemper 1966; Logonder-Mlinsek et al. 1985; MacDermott 1992; Mannisto et al. 1979; Matsuzaki and Suzuki 1981; Ortiz-Caro et al. 1983; Pajer and Kalisnik 1991; Postel 1957; Schonbaum et al. 1965; Selivanova and Vorobieva 1969; Spreca and Musy 1974; Tarin-Remohi and Jolin 1972; Toro Guillen 1991; Wyngaarden et al. 1952). In general, many studies conducted in the early 1990s and before used relatively high doses of perchlorate, and/or only one dose level was tested, thus precluding establishing dose-response relationships that defined no-effect dose levels. Perchlorate doses reported to produce the effects mentioned above ranged from 7 to 3,811 mg/kg/day after durations ranging from 1 day to 2 years.

Studies conducted within the past 10 years in adult nonpregnant animals have used much lower doses of perchlorate. For example, Caldwell et al. (1995) conducted a pilot 14-day drinking water study in rats. The animals were exposed to one of seven doses of perchlorate ranging from 0.1 to 39.9 mg perchlorate/kg/day. Perchlorate administration induced dose-related increases in TSH and decreases in T4 and T3 in both males and females, but females appeared to be more sensitive than males. The lowest administered dose, 0.1 mg/kg/day, increased TSH and decreased T4 and T3 in females roughly by 15, 12, and 34%, respectively, relative to controls. An additional 14-day study in rats reported a significant increase in serum TSH and a nonsignificant decrease in T3 at perchlorate doses 0.09 mg/kg/day, the lowest level tested (Yu et al. 2002). A more comprehensive 14-day study in rats was conducted by Siglin et al. (2000). Perchlorate was administered in the drinking water as the ammonium salt in doses of 0, 0.009, 0.04, 0.17, 0.85, or 8.5 mg perchlorate/kg/day. At the end of the exposure period, blood TSH was significantly increased in males at  $\geq 0.17$  mg/kg/day (23%) and in females at  $\geq 0.04$  mg/kg/day (17%). Blood T4 showed a decreasing trend with increasing perchlorate doses, the differences relative to controls achieved statistical significance in both males (23% decrease) and females (18% decrease) only at the highest dose level. Blood T3 was significantly decreased (dose-related) in all male groups (21% at the lowest dose), but was not significantly affected in any female group. Both absolute and relative thyroid weights were significantly increased in males from the highest dose group, no significant effects were seen in females. Histological alterations in the thyroid were observed only at the high dose ranging in severity classified as minimal, mild, or moderate. Minimal or mild lesions were seen in 7/10 high-dose females and 3/10 high-dose males. Moderate lesions were seen in 7/10 males at 8.5 mg/kg/day and consisted of follicular cell hypertrophy with microfollicle formation and colloid depletion. There was no evidence of focal hyperplasia.



## 3. HEALTH EFFECTS

In a 14-day study in mice exposed to 0, 0.09, 0.85, 2.6, or 25.5 mg perchlorate/kg/day, serum T4 was significantly decreased at 2.6 and 25.5 mg/kg/day (14 and 22%, respectively) (DOD 1999). T3 was lower than controls, although not significantly, in all treated groups except the 0.85 mg/kg/day group. There was no clear pattern of change in TSH levels. Morphological evaluation of the thyroid showed colloid depletion, intrafollicular capillary congestion, and mildly hypertrophied follicular epithelium in mice from the highest dose group. An additional 14-day study in mice reported a significant decrease in serum T4 levels at  $\geq 0.2$  mg perchlorate/kg/day and a significant increase in TSH at  $\geq 1.7$  mg/kg/day; serum T3 was not measured (BRT 2000). Microscopical examination of the thyroid revealed colloid depletion and hypertrophy in 5 out of 5 mice dosed with 42.5 mg/kg/day, but no significant alterations at the next lower dose level, 1.7 mg/kg/day.

A 90-day study was conducted in rats exposed to 0, 0.009, 0.04, 0.17, 0.85, or 8.5 mg perchlorate/kg/day in the drinking water (Siglin et al. 2000). Following the exposure period, the rats were provided uncontaminated drinking water for an additional 30-day period. After the 90 days of exposure to perchlorate, relative to controls TSH was significantly increased in males at  $\geq 0.17$  mg/kg/day (17% increase) and in females at 8.5 mg/kg/day (21% increase). Blood T4 was significantly decreased in both males and females from all treated groups (dose-related) (decreases ranged from 14 to 43% in males). The effect of perchlorate on blood T3 was similar to that on T4 (12–35% decrease in males). At 120 days, hormone levels approached control levels except for T4 in males and TSH in females. Both absolute and relative thyroid weights were significantly increased in males and females at 8.5 mg/kg/day at 90 days but returned to near control values at 120 days. Histological alterations in the thyroid ranged in severity from minimal to mild and were seen only at the 8.5 mg/kg/day dose level in both male and female rats. The lesions consisted of follicular cell hypertrophy with microfollicle formation and colloid depletion. There was no evidence of focal hyperplasia. No abnormal pathology was seen in the thyroid after 120 days.

In a 2-generation reproductive study in rats, the F1 generation was exposed directly to perchlorate (0.26, 2.6, or 25.5 mg/kg/day) from weaning to 19 weeks of age, at which time, the animals were killed (York et al. 2001a). In these adult rats, a significant increase in absolute and relative thyroid weight was seen in males at 2.6 and 25.5 mg/kg/day and in all female groups (dose-related). Hypertrophy and hyperplasia of the thyroid also occurred at 2.6 and 25.5 mg/kg/day in males and in high-dose females. TSH increased only in high-dose males and females and T4 decreased in high-dose males (26% decrease); T3 levels were not significantly affected. Hypertrophy and hyperplasia of the thyroid was reported at  $\geq 2.6$  mg perchlorate/kg/day in the paternal generation of rats in the 2-generation study mentioned above in which

## 3. HEALTH EFFECTS

the rats were exposed for a period that included pre mating, pregnancy, and lactation (York et al. 2001a); the NOAEL was 0.26 mg/kg/day. The highest dose tested, 25.5 mg/kg/day, induced a significant increase in TSH and a decrease in T4 in males.

In developmental studies in rats in which dosing with ammonium perchlorate at doses of 0, 0.009, 0.09, 0.85, and 25.5 mg perchlorate/kg/day began 14 days pre mating and continued to gestation day 10 or 21, TSH and T4 were significantly increased and decreased, respectively, in a dose-related manner in all dosed groups of dams (York et al. 2003, 2005a). In an additional developmental study in rats in which exposure started 14 days before mating and continued until postnatal day (PND) 10, treatment with up to 8.5 mg perchlorate/kg/day caused no maternal toxicity as judged by clinical observations, body and thyroid weights, and thyroid histology (York et al. 2004).

BRT (2000) evaluated serum TSH and T4 levels and thyroid histology in mice in a 90-day study. The exposure levels were 0, 0.02, 0.05, 0.2, 1.7, or 42.5 mg perchlorate/kg/day. Treatment with ammonium perchlorate decreased serum T4 levels, and the magnitude of the difference relative to controls achieved statistical significance at the 1.7 mg/kg/day dose level (18% decrease). The decrease in T4 was dose-related at  $\geq 0.2$  mg/kg/day and higher. Serum TSH was significantly elevated at  $\geq 0.05$  mg/kg/day relative to controls (17% increase at the 0.05 mg/kg/day dose level). Microscopical examination of the thyroid revealed hypertrophy in 3 out of 15 mice at 1.7 mg/kg/day, and in 4 out of 5 high-dose mice. Colloid depletion was present in 5 out of 5 mice dosed with 42.5 mg/kg/day. No significant treatment-related differences were observed between the other groups and controls.

In a developmental study in New Zealand rabbits, exposure to up to 85 mg perchlorate/kg/day on gestation days 6–28 did not significantly alter absolute or relative thyroid weight (York et al. 2001b). However, hypertrophy of the follicular epithelium was seen in the does at  $\geq 8.5$  mg/kg/day, and the incidence was dose-related. Neither serum TSH nor T3 levels were significantly affected by treatment with perchlorate. Serum T4 was significantly reduced at 25.5 and 85 mg/kg/day; T4 was also reduced at 0.85 and 8.5 mg/kg/day, but not significantly.

Other endocrine effects reported in perchlorate-treated animals included pituitary hypertrophy and hyperplasia (Pajer and Kalisnik 1991), reduced serum growth hormone levels (Ortiz-Caro et al. 1983), and reduced serum insulin (Tarin-Remohi and Jolin 1972). All of these effects were accompanied by thyroid effects in the same studies. Direct correlation of these diverse animal studies to human endocrine

## 3. HEALTH EFFECTS

systems is not provided, reflecting the NAS (2005) recommendation that such animal studies were not indicative or representative of humans.

**Dermal Effects.** No reports were found of adverse dermal effects of perchlorate in healthy humans. Skin rash was the most frequent side effect of potassium perchlorate therapy in thyrotoxicosis patients, occurring primarily in patients receiving doses at the high end of the therapeutic range. Rash was observed in 10% (5/50) of patients treated with 1,500 or 2,000 mg (approximately 15 or 20 mg perchlorate/kg/day) by Crooks and Wayne (1960), and in 15% (10/67) of patients treated with 1,200 or 1,600 mg (approximately 12 or 16 mg perchlorate/kg/day) by Morgans and Trotter (1960). However, rash was seen in only 0.5% (1/200) patients treated with 600 or 1,000 mg (approximately 6 or 10 mg perchlorate/kg/day) by Crooks and Wayne (1960), and in none of the 24 patients treated with 600 mg (approximately 6 mg perchlorate/kg/day) by Godley and Stanbury (1954). The observed rash was characterized as maculopapular by Crooks and Wayne (1960), and was attributed by these authors to a hypersensitivity reaction. Hemorrhagic skin lesions were frequently noted in cases with severe hematological effects (Barzilai and Sheinfeld 1966; Fawcett and Clarke 1961; Gjerdal 1963; Hobson 1961; Johnson and Moore 1961; Krevans et al. 1962; Southwell and Randall 1960). The lesions, which were described as punctate erythema, hemorrhagic pustulae, purpuric rash, skin hemorrhage, bleeding into the skin, and petecchiae, apparently occurred secondary to the hematological effects.

In rats administered up to 8.5 mg perchlorate/kg/day as ammonium perchlorate in the drinking water for 90 days, no significant gross or microscopical alterations in the skin were found throughout the study (Siglin et al. 2000).

**Ocular Effects.** No studies were located regarding ocular effects in humans after oral exposure to perchlorate. Ophthalmological examinations on rats dosed with up to 8.5 mg of perchlorate/kg/day for up to 90 days revealed no treatment-related effects (Siglin et al. 2000).

**Body Weight Effects.** No studies were located regarding body weight effects in humans after oral exposure to perchlorate.

In acute-duration rat studies, reduced growth was reported at an estimated dose of 1,830 mg perchlorate/kg/day (Arieli and Chinet 1985), but not at doses of 1,500 mg perchlorate/kg/day or below (Caldwell et al. 1995; Kapitola et al. 1971; Matsuzaki and Suzuki 1981; Schonbaum et al. 1965; Siglin et al. 2000). In longer-term studies, there are reports of reduced body weight gain in rats at doses of 175 mg

## 3. HEALTH EFFECTS

perchlorate/kg/day for 25 days (Ortiz-Caro et al. 1983), 1,362 mg/kg/day for 18 days (Tarin-Remohi and Jolin 1972), 928 mg/kg/day for 12 months (Florencio Vicente 1990), 2,327 mg/kg/day for 6 weeks (MacDermott 1992), and 928 mg/kg/day for 15 months (Toro Guillen 1991). Treatment of rats for 90 days with up to 8.5 mg of perchlorate/kg/day in the drinking water did not result in significant effects on growth (Siglin et al. 2000), nor did treatment with 64 mg/kg/day for 19 weeks (Hiasa et al. 1987). Also, in a 2-generation reproduction study in rats, no significant effects on body weight were seen in F1 animals treated directly with up to 25.5 mg perchlorate/kg/day from weaning to 19 weeks of age in addition to being exposed perinatally (York et al. 2001a); no significant effects on body weight were seen in the paternal generation also in that study. A study in mice also found no alterations in body weight or weight gain following 14 or 90 days of exposure to ammonium perchlorate in the drinking water in doses up to 25.5 mg perchlorate/kg/day (DOD 1999). Where present, reduced growth is considered secondary to hypothyroidism produced by perchlorate.

**Metabolic Effects.** No studies were located regarding metabolic effects in humans after oral exposure to perchlorate.

Researchers in India conducted a number of studies investigating the metabolic effects of perchlorate in rats given 500 mg/kg/day of potassium, sodium, or ammonium perchlorate by daily gavage for 45 days (Sangan and Motlag 1986, 1987; Vijayalakshmi and Motlag 1989a, 1989b, 1990, 1992). They found that perchlorate increased protein metabolism (increased liver arginase activity and serum urea levels), altered carbohydrate metabolism (decreased serum glucose and increased liver and kidney glycogen levels, reflecting increased activity of aldolase, lactate dehydrogenase, and glycogen synthase, and decreased activity of glucose-6-phosphatase and glycogen phosphorylase), and modified lipid metabolism (increased cholesterol, triglyceride, and phospholipid, and decreased free fatty acid levels, reflecting decreased activity of lipase and phospholipase). They also found that perchlorate reduced the activities of mitochondrial enzymes involved in cellular respiration, apparently due to changes in lipid composition of mitochondrial membranes (increased cholesterol and decreased phospholipid) reducing membrane fluidity.

Other studies reported only a small (11%), nonsignificant decrease in serum glucose levels in rats exposed to potassium perchlorate (1,362 mg perchlorate/kg/day) in the drinking water for 18 days (Tarin-Remohi and Jolin 1972), and no effect on serum glucose in rats exposed to 0.1% potassium perchlorate (approximately 175 mg perchlorate/kg/day) in the drinking water for 25 days (Ortiz-Caro et al. 1983). No

### 3. HEALTH EFFECTS

effects were observed on serum glucose levels in rats exposed to up to 8.5 mg of perchlorate/kg/day as ammonium perchlorate in the drinking water for up to 90 days (Siglin et al. 2000).

Ortiz-Caro et al. (1983) observed a significant decrease in the activity of  $\alpha$ -glycerophosphate dehydrogenase ( $\alpha$ -GPD) in hepatic mitochondria in their study that was considered secondary to hypothyroidism produced by perchlorate. However, Arieli and Chinet (1985) found no effect on cytoplasmic  $\alpha$ -GPD in brown fat in rats that received 2% potassium perchlorate (1,830 mg perchlorate/kg/day) in the drinking water for 2 weeks.

**Other Systemic Effects.** No studies were located regarding other systemic effects in humans after oral exposure to perchlorate.

Eskin et al. (1975) observed reduced iodide uptake, decreased weight, and dysplastic histopathological lesions in the mammary gland of rats treated with 459 mg perchlorate/kg/day as sodium perchlorate in the drinking water for 8 weeks. Mammary gland dysplasia was also seen in ovariectomized rats given estrogen replacement and then dosed with 494 mg perchlorate/kg/day for 8 weeks (Eskin et al. 1976).

Water consumption was not significantly altered in rats administered up to 40 mg of perchlorate/kg/day for 14 days in the drinking water (Caldwell et al. 1995). Neither food or water consumption were affected in rats exposed to perchlorate via drinking water in doses up to 8.5 mg/kg/day for up to 90 days (Siglin et al. 2000). In a 2-generation reproduction study in rats, paternal males exposed for 16 weeks showed a reduction in absolute and relative water consumption at 0.26 and 25.5 mg perchlorate/kg/day, but not at 2.6 mg/kg/day (York et al. 2001a). In that same study, no significant effects were seen on water consumption in the F1 generation exposed directly to up to 25.5 mg perchlorate/kg/day in the drinking water from weaning to 19 weeks of age. No significant effects on water consumption were also reported in 14- and 90-day studies in mice given ammonium perchlorate in the drinking water in doses of up to 25.5 mg perchlorate/kg/day (DOD 1999).

#### 3.2.2.3 Immunological and Lymphoreticular Effects

No reports were found of perchlorate-induced alterations in immune system parameters in healthy humans. Two cases of lymphadenopathy (not further described) were reported among a series of 247 hyperthyroid patients treated with potassium perchlorate (Morgans and Trotter 1960). Both cases

## 3. HEALTH EFFECTS

occurred in patients treated with 1,200 or 1,600 mg potassium perchlorate/day (roughly 12 or 16 mg perchlorate/kg/day). Lymphoreticular effects were not reported in other case studies.

Spreca and Musy (1974) found increases in the proportion of degranulated mast cells in the thyroid, skin, liver, and lungs of rats treated with potassium perchlorate (approximately 323 mg perchlorate/kg/day) for 1 day. The effect was greatest in the thyroid (27% decrease) and skin (21% decrease). Degranulation of mast cells is typically associated with exposure to an allergen; degranulation releases pharmacological mediators of immediate hypersensitivity responses (histamine, heparin, etc.), leading to allergy symptoms. Clinical signs of hypersensitivity response were not monitored in this study. There was also an increase in the number of mast cells in the thyroid and small decreases in mast cell numbers in the skin, liver, and lung. The researchers suggested that the increase in the thyroid was associated with hyperplasia in this tissue, and that the decrease in the other tissues may reflect loss of cells by degranulation. An increase in mast cell numbers in the thyroid of mice treated with sodium perchlorate (1.2% in drinking water, or roughly 2,622 mg perchlorate/kg/day) for 64 days was also reported by Logonder-Mlinsek et al. (1985). The extent of mast cell degranulation was not reported in this study.

More recent studies in animals have tested much lower doses of perchlorate and conducted a more complete evaluation of the immune system. For example, 14- and 90-day studies in rats administered ammonium perchlorate in the drinking water in doses up to 8.5 mg perchlorate/kg/day reported no significant effects on spleen weight and no gross or microscopic alterations in lymph nodes, spleen, and thymus; no tests of immunocompetence were conducted in these studies (Siglin et al. 2000). DOD (1999) evaluated a series of immunological end points in 14- and 90-day studies in mice exposed to ammonium perchlorate in the drinking water in doses of 0, 0.09, 0.9, 2.6, and 25.5 mg perchlorate/kg/day. End points evaluated included thymus and spleen weight and cellularity, CD4/CD8 splenocyte and thymocyte subpopulations, stem cell progenitors (90-day), melanoma tumor incidence (90-day), natural killer (NK) cell activity, delayed-type hypersensitivity (DTH), cytotoxic T cell activity, response to challenge with *Listeria monocytogenes* (90-day), peritoneal macrophage phagocytosis and nitrite production, and specific IgM and IgG response to cell dependent sheep red blood cell (SRBC) challenge. Significant findings in the 14-day study included an increase in the percent of CD4-/CD8+ thymic lymphocytes at 0.09 and 0.9 mg/kg/day, decreased macrophage phagocytosis at 0.9 and 25.5 mg/kg/day, and increased DTH response at 25.5 mg/kg/day. In the 90-day study, NK cell activity was increased in the highest-dose group, macrophage phagocytosis was decreased in all treated groups, the DTH response was also increased at 25.5 mg/kg/day, and increased resistance to the challenge with *Listeria* in the high-dose group when challenged only with high immunization levels. Overall, because only a few immunological

### 3. HEALTH EFFECTS

parameters were affected and resistance to the challenge with *Listeria* was not decreased, the results of this study do not suggest an immunosuppressive function for perchlorate at the doses tested.

Additional 14- and 90-day drinking water studies exposed mice to 0, 0.02, 0.05, 0.2, 1.7, or 42.5 mg perchlorate/kg/day examined the plaque forming cell (PFC) response following sheep red blood cells (SRBC) immunization and the ability of mice to generate a hypersensitivity response (local lymph node assay [LLNA]) to 2,4-dinitrochlorobenzene (DNCB), a known sensitizing chemical (BRT 2000). No significant effects were seen on the PFC response after 14 days of treatment, but an increased response was seen after 90 days in the 1.7 and 42.5 mg/kg/day dose groups when the results were expressed as number of response per spleen and only at 42.5 mg/kg/day when the responses were expressed per number of spleen cells. In the LLNA assay, perchlorate increased the sensitizing potential of DNCB at all doses except 1.7 mg/kg/day in the 14-day experiment, whereas in the 90-day experiment, perchlorate increased the sensitizing potential of DNCB at 0.05 and 0.2 mg/kg/day, had no effect at 0.02 or 1.7 mg/kg/day, and decreased it at 42.5 mg/kg/day. It should be mentioned, however, that cyclophosphamide, the positive control, did not abolish the sensitizing effect of DNCB alone, calling into question the reliability of the experiment. The physiological relevancy of the enhancement of the LLNA is unclear. Further research in this area is needed to determine whether perchlorate is a contact sensitizer.

NOAEL and LOAEL values for immune system effects from the rodent studies are shown in Table 3-2 and Figure 3-2.

#### **3.2.2.4 Neurological Effects**

No studies were located regarding neurological effects in humans after oral exposure to perchlorate and limited information is available in animals. No gross or microscopic alterations were observed in the brain from rats treated with ammonium perchlorate in drinking water in doses up to 8.5 mg perchlorate/kg/day for 14 or 90 days (Siglin et al. 2000). Brain weight was also not significantly altered by exposure to perchlorate.

Neurodevelopmental effects resulting from perinatal exposure to perchlorate are discussed in Section 3.2.2.6, Developmental Effects.

#### **3.2.2.5 Reproductive Effects**

No studies were located regarding reproductive effects in humans after oral exposure to perchlorate.

## 3. HEALTH EFFECTS

Exposure to 1% potassium perchlorate (roughly 532 mg perchlorate/kg/day) in the drinking water on days 2 through 8 of gestation had no effect on the number of live litters produced, mean litter size, or duration of pregnancy in rats (Brown-Grant 1966). Nor was there any effect on the number or weight of implantation sites in lactating pregnant female rats that received approximately 1,752 mg perchlorate/kg/day in the drinking water on days 1 through 13 of gestation (Brown-Grant and Sherwood 1971).

A more recent 14-day study in male and female rats administered ammonium perchlorate in the drinking water at doses up to 8.5 mg perchlorate/kg/day found no alterations in absolute weight of the uterus, testes, or ovaries (Siglin et al. 2000). Also, there were no gross or microscopic alterations in the testes, prostate, epididymis, uterus, ovaries, or mammary glands. Examination of these end points following 90 days of exposure to the same doses also revealed no significant effects (Siglin et al. 2000). In addition, the 90-day study showed no significant effects on sperm motility, concentration, count, or morphology.

In a 2-generation reproductive study, male and female rats (P generation) were exposed to ammonium perchlorate in the drinking water at target doses of 0, 0.26, 2.6, or 25.5 mg perchlorate/kg/day for 10 weeks before mating and during pregnancy and lactation (York et al. 2001a). Males were sacrificed after 13 weeks of exposure and females were sacrificed on postpartum day (PPD) 21. Offspring (F1) were dosed from weaning to 19 weeks of age. Mating of F1 generation females and males produced the F2 generation. Male and female mating and fertility parameters were not affected by perchlorate; estrous cycling (before cohabitation) was also not altered by exposure to perchlorate. No significant effects were seen on number of dams delivering litters, duration of gestation, implantations, any litter parameter, lactation index, or sex ratios. In the F1 generation, there were no effects on mating and fertility or in sperm parameters; in F1 females, there were no effects on estrous cycling, fertility, sexual maturation, or in delivery and litter observations. The NOAEL for reproductive effects of perchlorate in this study was 25.5 mg/kg/day. Exposure of female rats to up to 25.5 mg perchlorate/kg/day beginning 2 weeks before cohabitation with untreated males and continuing during gestation did not result in any significant alterations in numbers of corpora lutea and implantations, percent implantation loss, litter size, early or late resorptions, or sex ratio (York et al. 2005a).

The NOAEL values for reproductive effects in these studies are shown in Table 3-2 and Figure 3-2.



## 3. HEALTH EFFECTS

**3.2.2.6 Developmental Effects**

Several developmental studies of perchlorate in humans have focused on the evaluation of neonatal thyroid parameters. Lamm and Doemland (1999) examined rates of congenital hypothyroidism in seven counties of Nevada and California with perchlorate contamination in the drinking water (4–16 µg/L [ppb]) (0.0001–0.0005 mg/kg/day). The investigators analyzed data from the neonatal screening programs of the two states for any increased incidence of congenital hypothyroidism in those counties. The rates for the California births were adjusted for Hispanic ethnicity, which was known to be a risk factor for congenital hypothyroidism. During 1996 and 1997, nearly 700,000 newborns were screened. The risk ratio in the seven counties was 1.0 (95% confidence interval [CI] 0.9–1.2) (249 cases observed/243 expected). The risk ratios for the individual counties relative to statewide expected rates ranged from 0.6 to 1.1. While the results showed no increase in rates of congenital hypothyroidism, it is known that congenital hypothyroidism is caused by developmental events that are not suspected of being affected by perchlorate exposure.

Kelsh et al. (2003) also found no relationship between congenital hypothyroidism and exposure to perchlorate through the drinking water in a study of newborns (n=15,348) whose mothers resided in the community of Redlands, California, during the period 1983 through 1997 and who were screened by the California Newborn Screening Program. Perchlorate was detected in the water system serving the community at a concentration of up to 9 µg/L (mean, <1 µg/L). Two adjacent communities with no detectable perchlorate in their water systems, San Bernardino and Riverside (n=695,967), served as comparison groups. The majority of the newborns had blood collected for TSH assay 18 hours or more after birth. Cases were defined as infants diagnosed with congenital hypothyroidism or whose TSH screening concentrations were >25 µU/mL or sometimes >16 µU/mL. Covariates included in the model were age at specimen collection, sex, race, ethnicity, birth weight, multiple birth status, and calendar year of birth. Analysis of the results showed an adjusted prevalence ratio for congenital hypothyroidism of 0.45 (95% CI, 0.06–1.64) and an odds ratio for elevated TSH of 1.24 (95% CI, 0.89–1.68) among all newborns screened and 0.69 (95% CI, 0.27–1.45) for newborns whose age at screening was ≥18 hours. Limitations of the study include the fact that data from a single year were used to characterize exposures over the entire 15 years of the study.

Li et al. (2000b) compared mean monthly neonatal T4 levels for days 1–4 of life for newborns from the city of Las Vegas and Reno, both in Nevada. Las Vegas has perchlorate in its drinking water, whereas Reno does not. The cohorts consisted of 17,308 newborns in Las Vegas and 5,882 newborns in Reno

## 3. HEALTH EFFECTS

evaluated during the period of April 1998 through June 1999; the analysis was restricted to newborns whose birth weights were between 2,500 and 4,000 grams. Perchlorate was detected in the drinking water from Las Vegas during 7 of the 15 months of the study period at levels of 9–15  $\mu\text{g/L}$  (0.0003–0.0004  $\text{mg/kg/day}$ ). Analyses were performed comparing serum T4 levels of children born during the 7 months in which perchlorate was detected in the drinking water (period A) and children born during the months in which perchlorate was not detected in the drinking water (period B). The mean T4 levels were compared in a univariate analysis both crude and stratified by time period. In a multivariate analysis, T4 was the outcome variable, city and time period were the main effect variables, and gender, birth weight, and age and time of blood collection were the covariates. There was no significant difference in mean T4 level between Las Vegas and Reno in the crude analysis or when data were stratified by time period (period A or B). Gender, birth weight, and age and time of blood collection were significant covariates.

The same group of investigators also evaluated blood TSH levels in newborns in their first month of life from Las Vegas ( $n=4,070$ ) and Reno ( $n=133$ ) from December 1998 to October 1999 (Li et al. 2000a). TSH levels were measured on screening samples that were below the 10<sup>th</sup> percentile of T4 daily measurements in blood samples collected throughout the state. The analysis was restricted to birth weights between 2,500 and 4,500 grams, adjusted for gender and age at screen (days 2–7 vs. 8–30). The mean TSH levels of the two cities did not differ significantly, whether crude or stratified by age or sex. Multiple linear regression analysis showed that the TSH level was significantly affected by age at which the sample was collected (higher at earlier age) and by sex (higher for males), but not by location. These findings suggested that neonatal TSH levels were not affected by living in areas where drinking water contained up to 15  $\mu\text{g/L}$  of perchlorate (0.0004  $\text{mg/kg/day}$ ).

A similar study of newborn TSH levels was conducted by Brechner et al. (2000). TSH levels were compared between two cities in Arizona, Yuma and Flagstaff, representing areas of exposure and nonexposure, respectively. The study covered a 3-year period between October 1994 and December 1997. Exposure data for the study period were not available. However, measurements done by EPA in 1999 showed perchlorate at 6  $\mu\text{g/L}$  (0.0002  $\text{mg/kg/day}$ ) in Yuma and nondetectable levels in Flagstaff. Since the water processing facilities had not changed, and perchlorate persists in water for a long time, Brechner et al. (2000) assumed that comparable differences in perchlorate levels existed during the study period. The final analysis comprised 1,099 newborns from Yuma and 443 from Flagstaff. The study controlled for age at screen and Hispanic ethnicity, but not for gender, gestational age, or birth weight. The median first TSH level in Yuma was significantly higher than in Flagstaff (19.9  $\text{mU/L}$  vs.

## 3. HEALTH EFFECTS

13.4 mU/L); this difference occurred in both non-Hispanics and Hispanics. A residual confounding by age may have persisted in the analysis due to the higher percentage of newborns screened in the first 24 hours (when TSH levels peak) in Yuma (11%) compared with Flagstaff (3.1%). Lamm (2003) reanalyzed the study and compared TSH neonatal values of Yuma and two cities near Yuma, Somerton and San Luis, which get their water from a different source than the city of Yuma. The water from Somerton and San Luis is assumed to have no perchlorate contamination. Lamm's analysis showed no significant difference in TSH values between newborns from Yuma and Somerton/San Luis, suggesting that the results of Brechner et al. (2000) reflected regional differences, possibly related to the difference in altitude (7,000 feet) between Yuma and Flagstaff.

In an additional, unpublished, study of newborns, Schwartz (2001) evaluated T4 and TSH levels for all newborns in California during 1996. All infants were screened for serum T4 and TSH levels, and the samples with a low T4 ( $\leq 9$  mg/dL and the next lowest 5% of the values in each tray of samples) were further analyzed for TSH levels. Information on the concentration of perchlorate in tap water was not available for this study. Therefore, perchlorate exposure was estimated using the mother's postal zip code, concentration of perchlorate in underground water sources measured between February 1997 and June 2000, water source production, water purchases and sales, and characteristics of the water distribution system. Ultimately, four categories of exposure were made: 0 (n=255,382), 1–2  $\mu\text{g/L}$  (n=127,041), 3–12  $\mu\text{g/L}$  (n=131,483), and  $\geq 13$   $\mu\text{g/L}$  (n=1,945). Using default values for daily water consumption and for body weight, a concentration of 13  $\mu\text{g}$  of perchlorate/L would provide doses of approximately 0.0004 mg perchlorate/kg/day. This study used an analysis of the covariance model. After controlling for age at screening, gender, single versus multiple birth, and ethnicity, a statistically significant declining trend for T4 was observed with increasing perchlorate exposure. Infants in the low, medium, and high exposure groups had 0.97, 1.12, and 1.82  $\mu\text{g/dL}$  lower T4 levels, respectively, than unexposed infants. Log transformed TSH values showed a significant increase trend with perchlorate exposure (0.029, 0.03, and 0.128 ln  $\mu\text{U/mL}$ , in the low, medium, and high exposure groups, respectively). Although significant associations were found, Schwartz (2001) noted that 90% of the variability in the infants' hormone levels remained unexplained by perchlorate exposure, gender, multiple birth, birth weight, and blood sample age. Schwartz (2001) also noted that no adjustment was made in the study for gestational age and laboratory measurement variability, two strong predictors of T4 and TSH.

As previously mentioned, Crump et al. (2000) conducted a study of school-age children from three cities with different concentrations of perchlorate in drinking water in northern Chile. The city with the highest perchlorate concentration was Taltal, 100–120  $\mu\text{g}$  perchlorate/L (ppb), water from the city of Chañaral

## 3. HEALTH EFFECTS

had 5–7  $\mu\text{g/L}$ , and perchlorate was not detected in water from the city of Antofagasta. The study comprised 162 children 6–8 years of age, of which 127 had resided continuously in their respective city since conception. The children underwent examination of the thyroid gland and a blood sample was taken for analysis of TSH, T4, FTI, T3, and antiperoxidase antibody. After adjusting for sex, age, and urinary iodide excretion, the children from Taltal and Chañaral had slightly lower TSH levels than children from Antofagasta (opposite to expected), but the differences were not statistically significant. Serum T4 levels in the city with the highest perchlorate levels were significantly higher than in the city with no perchlorate (opposite to expected). Analysis of all of the children included in the study revealed a small nonsignificant increase risk of goiter in the cities with perchlorate compared with the city without perchlorate, however, there was virtually no difference in risk when only lifelong residents were analyzed. The study also found that lifelong residents of Taltal (high perchlorate) were >5 times more likely to report a family history of thyroid disease compared with lifelong residents of Antofagasta (no perchlorate). Assuming a reference daily consumption of water of 1–2 L and using a body weight for the children of approximately 25 kg (measured in the study), a concentration of perchlorate in the drinking water of 100  $\mu\text{g/L}$  would provide doses of approximately 0.004–0.008 mg perchlorate/kg/day via drinking water alone, but the Chilean population also has large dietary sources of perchlorate.

Crump et al. (2000) also evaluated TSH levels in neonates from the three cities in northern Chile mentioned above. A total of 9,784 neonatal records were analyzed for TSH levels, sex, and date of screening for infants born between February 1996 and January 1999. The study did not control for iodine intake, ethnicity, or birth weight. The rate of congenital hypothyroidism detected in Chile from 1992 to 1999 was 1 per 3,484 cases (based on 773,440 newborns screened). In their study, Crump et al. (2000) detected seven cases of presumptive congenital hypothyroidism corresponding to a rate of 1 per 1,270 newborns. All of these cases originated in the city with no detectable levels of perchlorate. Linear regression comparisons of TSH by city showed a statistically significant decline in TSH with increasing perchlorate concentration in the drinking water, opposite to the known effect of perchlorate. The magnitude of the differences in TSH concentrations did not seem to be clinically significant.

In the Téllez et al. (2005) study of 184 pregnant women in northern Chile mentioned earlier, end points evaluated included neonatal weight, length, head circumference, gestational length, and FT4, T3, thyroglobulin, and perchlorate in cord serum. The evaluation showed no significant differences between the three cities regarding indicators of fetal development or in FT4 or TSH. T3 and thyroglobulin were significantly lower among neonates from Chañaral (low perchlorate, 5.8  $\mu\text{g/L}$ ) than in the other two cities.

## 3. HEALTH EFFECTS

T3 and thyroglobulin were not significantly different between newborns from Antofagasta (no perchlorate) and Taltal (high perchlorate, 114 µg/L).

A study conducted in Israel evaluated T4 levels (not specified whether TT4 or FT4) in newborns from mothers living in areas with very high ( $\leq 340$  µg/L, n=97), high (42–94 µg/L, n=216), and low ( $< 3$  µg/L, n=843) levels of perchlorate (Amitai et al. 2007). Levels of perchlorate in blood from donors living in the three areas were used as proxy indicators of exposure. Respective blood perchlorate levels in the very high, high, and low exposure proxy groups were 5.99, 1.19, and 0.44 µg/L; these donors had similar blood levels of thiocyanate and nitrate. Blood samples from the newborns collected at the age of 36–48 hours did not reveal significant differences in T4 levels among the three groups. Mean T4 values in the very high, high, and low exposure groups were 13.9, 13.9, and 14.0 µg/L, respectively. In addition, neither birth weight nor gestational age was significantly different among the three groups. Although individual iodine measures were not conducted, the investigators stated that the study was conducted in iodine-sufficient areas.

Chang et al. (2003) evaluated the potential association between exposure to perchlorate via the drinking water and the incidence of attention-deficit-hyperactivity disorder (ADHD) and autism among children less than 18 years of age who were recipients of Medicaid in Nevada. The study included subjects from Clark County, which includes Las Vegas and in which the concentration of perchlorate in the public water supply ranged from undetected to 23.8 µg/L (mean, 10.9 µg/L), as measured in 1997–2001; subjects from Washoe County, which includes Reno, with no detectable perchlorate in the water supply served as an unexposed comparison group, and the remainder of Nevada served as a rural control. No perchlorate was detected in public water supplies from the rural areas. Analysis of the data from the Nevada Medicaid program showed that the rates for ADHD and for autism in the area with perchlorate in the drinking water did not exceed the rates in the areas without perchlorate in the drinking water. Furthermore, there was no difference between the three groups regarding overall fourth-grade school performance. No control was made in the analysis for age, sex, race, or ethnicity.

Studies in laboratory animals have shown that maternal exposure to relatively high doses of perchlorate during pregnancy and/or lactation leads to reduced thyroid function. Pups of rats exposed to 1% sodium perchlorate in the drinking water (about 1,300 mg perchlorate/kg/day) throughout gestation and lactation had reduced growth, increased thyroid weight, drastically decreased serum T4 and T3 levels, and markedly increased serum TSH levels compared with controls (Golstein et al. 1988). These effects are the typical indicators of hypothyroidism in juvenile and adult rats treated with perchlorate directly. In a

## 3. HEALTH EFFECTS

study in guinea pigs, near-term fetuses from dams treated with 1% potassium perchlorate (about 531 mg perchlorate/kg/day) in the drinking water during the latter half of gestation had thyroid hyperplasia and a dramatic 15-fold increase in relative thyroid weight compared with controls, while maternal thyroids were unaffected (Postel 1957). This suggests that perchlorate may have entered the fetal circulation and directly affected the fetal thyroid gland. Similar fetal effects were seen in rabbits dosed with 72 mg perchlorate/kg/day in the diet throughout gestation, but in this study, effects on the maternal thyroid, although considerably less intense than in the fetuses, were observed (Lampe et al. 1967). Rat pups exposed to perchlorate only for 10 days during lactation had body weights similar to controls, but significantly increased relative thyroid weights (Brown-Grant and Sherwood 1971). The dams in this study, which were pregnant with a new litter while nursing these pups, had received an approximate dose of 1,752 mg perchlorate/kg/day, and showed an increase in relative thyroid weight of similar magnitude to the pups.

Several developmental studies in animals have focused on the effects of perchlorate on the thyroid and also on neurodevelopmental effects following perinatal exposure to relatively low doses of perchlorate. Information on developmental effects of perchlorate is available in the 2-generation reproduction study in rats by York et al. (2001a) previously described in Section 3.2.2.5, Reproductive Effects. Perchlorate doses were 0, 0.26, 2.6, and 25.5 mg perchlorate/kg/day, and exposure started 10 weeks before mating and continued during pregnancy and lactation. The F1 generation was dosed from weaning (21 days old) to 19 weeks of age, but some pups were sacrificed on PND 21. The second generation (F2) was sacrificed at 3 weeks of age. F1 and F2 generations were exposed *in utero*, via maternal milk, and through maternal water. Exposure to perchlorate had no significant effect on pup weight. High-dose F1 pups killed on PND 21 showed a significant increase in thyroid weight (males and females) and in spleen weight (females). Significant hypertrophy and hyperplasia of the thyroid was seen in high-dose males and females and in mid-dose females. Also, there was a significant reduction in serum T3 in high-dose females, TSH was reduced in low- and mid-dose males, and serum T4 was increased in low-dose females. Thyroid weight from high-dose F2 female pups was significantly increased, and both male and female from the mid- and high-dose group exhibited hyperplasia and hypertrophy of the thyroid. TSH, T3, and T4 levels were not significantly altered in F2 pups, although T3 was somewhat lower in high-dose females. On the basis of morphological alterations in the thyroid observed in mid- and high-dose pups, the 0.26 mg/kg/day dose level is considered a developmental NOAEL. Parental (F0) effects were restricted to the thyroid and consisted mainly in hypertrophy and hyperplasia of the thyroid in the mid- and high-dose groups and significantly increased serum TSH levels in high-dose males.

## 3. HEALTH EFFECTS

A subsequent study in rats by York et al. (2003) examined the developmental effects of ammonium perchlorate in doses of 0, 0.009, 0.09, 0.85, and 25.5 mg perchlorate/kg/day. Dosing began 14 days pre-mating and continued to gestation day (GD) 21, at which time, all rats were sacrificed. Satellite groups of rats were treated similarly and were used for collection of blood and thyroid tissues. The rats were observed for clinical signs, abortions, premature deliveries, and deaths. Body weights and food and water consumption were also monitored. At sacrifice, gravid uterine weights were recorded, and the uterus was examined for pregnancy, number and distribution of implantations, live and dead fetuses, and early and late resorptions. In addition, the number of corpora lutea in each ovary was recorded; the placenta was also examined. The fetuses were weighed and examined for gross alterations; one-half was examined for soft tissues alterations and the other half was examined for skeletal alterations and cartilage development. There were no maternal deaths and all clinical observations were considered unrelated to the test material. There were no significant effects on body weights, weight gains, and gravid uterine weights. There were no treatment-related effects on absolute or relative food or water consumption values. Cesarean sectioning and litter parameters were not affected by exposure to perchlorate. Evaluation of the fetuses showed that the average number of ossification sites per litter for sternal centers and for forelimb phalanges was significantly reduced in the 25.5 mg/kg/day exposure group. Examination of the satellite group of pups showed a statistically significant and dose-related decrease in T3 in all dosed groups. No developmental NOAEL is identified in this study and the 0.009 mg/kg/day dose level is a developmental LOAEL. T3 levels also were reduced in pooled serum samples from fetuses exposed through gestation and examined on GD 21 (York et al. 2005a). The lowest dose tested, 0.009 mg/kg/day, induced a 17% decrease in T3 relative to controls, whereas at the highest dose tested, 25.5 mg/kg/day, T3 was decreased by 33%. In this study, perchlorate also induced a dose-related increase in TSH (15% at 0.009 mg/kg/day) and decrease in T4 (16% at 0.009 mg/kg/day) in male pups sacrificed on PND 22.

An additional study was conducted in rats given ammonium perchlorate via the drinking water that provided doses of 0, 0.09, 0.9, 2.6, and 8.5 mg perchlorate/kg/day (York et al. 2004). Exposure began on GD 1 and continued for additional 10 days postpartum. Dams were sacrificed on PND 10 or 22 (12-day recovery period). Four subsets of pups were formed: subset 1 was sacrificed on PND 12 for neurohistological examination; subset 2 was used for neurobehavioral testing (avoidance testing on PND 23–32, water maze on PND 59–70) and sacrificed on PND 90–92, at which time blood was collected for TSH, T4, and T3 determinations; subset 3 was tested for motor activity on PND 14, 18, 22, and 59, and for auditory startle habituation on PND 23 and 60 and sacrificed on PND 67–69; and subset 4 was sacrificed on PND 80–86 and used for thyroid pathology and neurohistological examination and

## 3. HEALTH EFFECTS

morphology. In addition, on PND 5, litters were culled to eight pups, blood was collected for hormone analysis, and the thyroid was processed for histopathology.

Treatment with perchlorate caused no maternal toxicity as judged by clinical observations, body and thyroid weights, and thyroid histology. Perchlorate did not significantly affect gestation length, litter size, number of stillborn, gestation index, pup viability index, or pup's weight. In the pups, there were no significant changes in body weight, absolute and relative food consumption, or exposure to perchlorate did not affect the day of vaginal latency or the day of preputial separation. Microscopic examination of the thyroid from pups culled on PND 5 revealed changes restricted mainly to high-dose males consisting of hypertrophy/hyperplasia of the follicular epithelium and decrease in follicle size. TSH was elevated only in pups born to dams treated with 8.5 mg/kg/day, but T3 levels were significantly reduced at 0.9 mg/kg/day and higher doses. T4 was significantly reduced at 2.6 mg/kg/day and higher doses. In pups sacrificed on PND 12 (subset 1), a significant increase in thickness of the corpus callosum was seen in high-dose females; this also was observed in high-dose males but the difference with controls was not statistically significant. Evaluation of the next lower dose group (2.6 mg/kg/day) revealed a significant decrease in the hippocampal gyrus size in males, increase in the anterior to posterior cerebellum size and decrease in the caudate putamen in females, but no significant difference in the corpus callosum. Evaluations of subsets 2 and 3 revealed no behavioral effects in the offspring of dams exposed up to 8.5 mg perchlorate/kg/day (passive avoidance, swimming water maze, motor activity, and auditory startle). Also in subsets 2 and 3, there were no necropsy observations that seemed perchlorate-related, and terminal body weights and absolute and relative thyroid weights were comparable among the groups. In subset 4, there were no necropsy observations related to treatment, no significant effect on final body weight or thyroid weight, and no treatment-related neuropathological changes in the brain. However, morphometry evaluation of eight specific brain areas revealed a significant increase in mean thickness of the frontal cortex, caudate putamen, and corpus callosum from high-dose males. Based on the thyroid effects on pups culled on PND 5, the dose of 0.09 mg/kg/day can be considered a developmental NOAEL. The highest dose tested, 8.5 mg/kg/day is a maternal NOAEL. It should be mentioned that questions and concerns have been raised regarding the brain morphology findings. A more recent refinement of the study from the same group of investigators in which rats were exposed to perchlorate during gestation (0, 0.009, 0.09, 0.9, or 25.5 mg perchlorate/kg/day) and via maternal milk through lactation day 10 showed no treatment-related neuropathological alterations at sacrifice on PND 10 or 22 (York et al. 2005b). The most significant finding was an increased thickness of the corpus callosum in male pups in the 0.09 and 0.9 mg/kg/day dose groups, but not in the 25.5 mg/kg/day dose group. Differences in other brain structures were not statistically significant and/or were present in only one dose group (i.e., thickness of



## 3. HEALTH EFFECTS

the right and left frontal cortex, right and left parietal cortex, left striatum, and right hippocampal gyrus were increased only at 0.9 mg/kg/day). Issues that were raised by NAS (2005) include: “(1) apparent systematic differences in the plane of section among treatment groups, (2) lack of a clear and consistent dose-response relationship, (3) doubts about the biological plausibility of the changes that were observed, and (4) concerns that the measures that were used were relatively insensitive and would be unlikely to pick up subtle differences in neurodevelopment.”

In a study of similar design, exposure began 2 weeks before mating and was terminated on PND 10 (Bekkedal et al. 2000, 2004). On PND 5, all of the pups were weighed and the litter culled to four males and four females. Tests of motor activity were conducted on one male and one female selected randomly on PND 14, 18, and 22. Nine measures of motor activity were monitored: frequency and time of ambulatory movements, frequency and time of stereotypic movements, frequency of movements in the horizontal plane, distance traveled in the horizontal plane, frequency of rears, total number of horizontal movements made while in rearing position, and time spent resting. Each measure of activity was recorded for 90 consecutive minutes on each test day. Data were divided into nine 10-minute blocks. The results showed that the main effect for perchlorate dose was not significant for any of the nine dependent variables, and there were no reliable interactions for treatment. The highest dose tested, 8.5 mg perchlorate/kg/day, is considered a NOAEL for neurodevelopmental effects in this study. Replication of this study by York et al. (2005b) showed that there were no significant alterations in test results due to consumption of perchlorate relative to controls. However, there was a pattern of response suggesting that exposed pups may have had a lower rate of habituation, and thus maintained a higher level of activity than untreated pups.

Because of EPA's concerns that the changes in motor activity in the rats in the two studies summarized above had biological significance, the results of both studies were re-analyzed (Dunson 2001). Each study was re-analyzed separately and combined using a Bayesian Hierarchical Modeling Approach. According to Dunson (2001), the re-analysis showed evidence of an increasing dose-response trend in motor activity in both studies, though the effect in the York et al. (2004) study was less pronounced. After reviewing the two studies in question and the re-analysis by Dunson, NAS (2005) concluded that: “general motor activity is not necessarily the most relevant or most sensitive aspect of motor function to assess if neonatal hypothyroidism is the suspected mechanism of action”.

A cross-fostering study in rats was conducted by Mahle et al. (2003). Pregnant Sprague-Dawley rats were administered ammonium perchlorate in the drinking water at doses of 0 or 1 mg perchlorate/kg/day from

## 3. HEALTH EFFECTS

GD 2 to PND 21. Cross-fostering was done on PND 1 such that four groups of pups were formed: never exposed, exposed *in utero* and via maternal milk, exposed only *in utero*, and exposed only via maternal milk. Dams and pups were sacrificed on PND 10. There was no indication of maternal toxicity during the study. However, serum T4 was significantly decreased and TSH was significantly increased in exposed dams that nursed their own pups; TSH was also increased in dams that nursed unexposed pups. The two cross-fostered litters (exposed only *in utero* and exposed only via nursing) had significantly lower weight than control pups and than pups exposed both *in utero* and via milk. T3 was not significantly affected in any pup group (male or female). T4 was significantly reduced in female pups exposed only via milk and in females exposed *in utero* plus via milk; the decrease was more marked in the latter group. T4 was not significantly affected in male pups. TSH was increased significantly in male and female pups (more pronounced in females) from groups that received double exposure and in groups exposed only via milk; there was no significant difference between these two groups. The results suggest that: (1) exposure *in utero* to perchlorate at the dose tested had little or no impact on serum levels of thyroid hormone and TSH measured in pups on PND 10, (2) the changes in serum thyroid hormone and TSH levels seen in PND 10 pups exposed both *in utero* and via maternal milk appear to be completely due to postnatal exposure to perchlorate through lactation, and (3) perchlorate could be acting directly on the pups' thyroid and/or may be limiting the availability of iodide to nursing pups by inhibiting NIS in breast tissue.

The developmental effects of perchlorate were also examined in rabbits administered 0, 0.09, 0.85, 8.5, 25.5, or 85 mg perchlorate/kg/day in the drinking water on GD 6–28 (York et al. 2001b). Sacrifices were conducted on GD 29. There were no deaths attributed to treatment with the test material or chemical-related clinical signs, or effects on body weight or uterine weight. There were no compound-related effects on any of the litter parameters studied including litter averages for corpora lutea, implantations, litter sizes, live and dead fetuses, percent dead or resorbed fetuses, and fetal body weights. All placentae appeared normal. There were no treatment-related increases in gross alterations or in skeletal and soft tissue anomalies. This study defined a maternal NOAEL of 0.85 mg/kg/day (see Endocrine Effects section for summary of maternal effects) and a developmental NOAEL of 85 mg/kg/day.

Developmental NOAEL and LOAEL values from these studies are shown in Table 3-2 and Figure 3-2.

## 3. HEALTH EFFECTS

**3.2.2.7 Cancer**

Limited information was located regarding exposure to perchlorate and cancer in humans. In the ecologic study by Li et al. (2001) described earlier, the prevalence of thyroid cancer was not significantly higher among residents from Clark County (Las Vegas), whose drinking water had 4–24 µg/L of perchlorate (0.0001–0.0007 mg perchlorate/kg/day) than in residents from another urban area of similar size (Reno, Washoe County), but with no perchlorate in the water, or than those from all other counties, also with no perchlorate exposure.

Morgan and Cassady (2002) conducted an ecologic study among residents of 13 contiguous census tracts in Redlands, California, San Bernardino County. Residents had been exposed to various concentrations of trichloroethylene (TCE) and ammonium perchlorate. Testing for TCE began in 1980, whereas, testing for perchlorate began in 1997. The concentration of perchlorate in the wells in 2001 was reported to be in the range 5–98 ppb, with drinking water concentrations not exceeding 18 ppb. The concentration of TCE in the wells initially ranged from 0.09 to 97 ppb, but did not exceed 5 ppb in the drinking water since 1991 after the water underwent treatment or the highly contaminated wells were removed from service. The standardized incidence ratios (SIRs, observed/expected) for all cancers combined or for any specific cancer site was not significantly different than 1.00, except for colon and rectum (SIR, 0.86; 99% CI, 0.74–0.99) and lung and bronchus (SIR, 0.71; 99% CI, 0.61–0.81), which were lower than expected, and melanoma of the skin (SIR, 1.42; 99% CI, 1.13–1.77) and uterine cancer (SIR, 1.35; 99% CI, 1.06–1.70), which were higher than expected. The SIR for thyroid cancer was 1.0 (99% CI, 0.63–1.47) based on 40 observed cases. When the analysis was restricted to children, no cancers were observed more often than expected. NAS (2005) notes that limitations of the study include the fact that timing and duration of exposure to perchlorate is unclear, that there also was exposure to TCE, and that there was no adjustment for other potential confounding variables. NAS (2005) further notes that the expected numbers were derived from the four-county region as a whole, which included the exposed community, not from an unexposed area. The latter could have resulted in an underestimate of the SIR.

Potassium and sodium perchlorates have been shown to produce thyroid tumors (papillary and/or follicular adenomas and/or carcinomas) in rats and mice with long-term exposure (1–24 months) to 1–1.2% concentrations in the feed or drinking water (Fernandez-Rodriguez et al. 1991; Florencio Vicente 1990; Gauss 1972; Kessler and Kruskemper 1966; Pajer and Kalisnik 1991; Toro Guillen 1991). Estimated doses in these studies ranged from 928 to 2,573 mg perchlorate/kg/day. The cancer effect levels from these studies are shown in Table 3-2 and Figure 3-2. In a related study in rats, Fernández-

### 3. HEALTH EFFECTS

Santos et al. (2004) determined the incidence of Ki-ras oncogene mutations in follicular cell carcinomas of the thyroid induced by administration of radioactive iodine and potassium perchlorate (1% in drinking water) for up to 18 months. Direct sequencing showed no mutations in the amplified gene segment of any of the induced thyroid tumors. The results suggested that Ki-ras activation via mutations at codons 12 and 13 is neither a constant event nor an early event in the development of rat thyroid follicular cell carcinoma. An additional study found that low level exposure to potassium perchlorate (0.1% in the feed, corresponding to a dose of 64 mg perchlorate/kg/day) for 19 weeks promoted the development of thyroid tumors initiated by N-bis(2-hydroxypropyl)nitrosamine (Hiasa et al. 1987).

NAS (2005) noted that: “on the basis of the understanding of the biology of human and rodent thyroid tumors, it is unlikely that perchlorate poses a risk of thyroid cancer in humans”. The EPA has concluded that perchlorate is not likely to pose a risk of thyroid cancer in humans, at least at doses below those necessary to alter thyroid hormone homeostasis, based on the hormonally-mediated mode of action in rodent studies and species differences in thyroid function (IRIS 2007).

#### **3.2.3 Dermal Exposure**

No studies were located regarding the following effects in humans or animals after dermal exposure to perchlorate:

##### **3.2.3.1 Death**

##### **3.2.3.2 Systemic Effects**

##### **3.2.3.3 Immunological and Lymphoreticular Effects**

##### **3.2.3.4 Neurological Effects**

##### **3.2.3.5 Reproductive Effects**

##### **3.2.3.6 Developmental Effects**

##### **3.2.3.7 Cancer**

### **3.3 GENOTOXICITY**

No studies were located regarding genotoxic effects in humans after inhalation, oral, or dermal exposure to perchlorates. Limited information is available from studies in animals. Siglin et al. (2000) found no evidence of bone marrow erythrocyte micronucleus formation in male and female rats as a result of exposure to 8.5 mg perchlorate/kg/day as ammonium perchlorate in the drinking water for 90 days. Zeiger et al. (1998b) also reported no increase in micronucleus formation in bone marrow from mice

### 3. HEALTH EFFECTS

injected intraperitoneally with 500 mg of ammonium perchlorate/kg/day for 3 consecutive days; higher doses were lethal to the mice. Cyclophosphamide was used as positive control in both studies.

Magnesium perchlorate was negative in a test for SOS-inducing activity in *Salmonella typhimurium* strain 1535 (Nakamura and Kosaka 1989) and in a test for production of deoxyribonucleic acid (DNA)-protein cross links in cultured human lymphocytes (Costa et al. 1996). Zeiger et al. (1998a) found no evidence of mutagenicity for ammonium perchlorate with or without metabolic activation in six different *Salmonella* strains. Ammonium perchlorate was not mutagenic in the mouse lymphoma assay with or without metabolic activation (San and Clarke 1999).

The available data suggest that perchlorate is not a mutagenic or clastogenic agent.

### 3.4 TOXICOKINETICS

**Overview.** Short-term studies on humans and animals demonstrate that perchlorate appears to be readily absorbed by the digestive system after oral exposure. Maximum blood levels appear within a few hours after ingestion. Perchlorate is rapidly taken up into the thyroid gland, by an active transport mechanism, and reaches a maximum level in the thyroid in approximately 4 hours in rats. Elimination of perchlorate from the thyroid is also rapid; half-lives of 10–20 hours have been estimated in rats. Perchlorate does not appear to be modified in the body, either by degradation or covalent binding. Perchlorate is rapidly eliminated from the body in the urine with half-lives of approximately 8–12 hours in humans and 10–20 hours in rats. No studies on the kinetics of long-term administration of perchlorate in humans or animals have been reported.

#### 3.4.1 Absorption

##### 3.4.1.1 Inhalation Exposure

No studies were found regarding quantitative absorption of perchlorate after inhalation exposure. Occupational studies have measured urinary perchlorate in workers, suggesting that pulmonary absorption may occur (Lamm et al. 1999), although swallowing of particles may have also occurred. Under normal ambient temperatures, the vapor pressure of a perchlorate salt solution is expected to be low, which would reduce the likelihood of exposure to perchlorate fumes or vapors from that source. However, if perchlorate particles were suspended in air, absorption by inhalation would be possible, depending on the particle size. It is also possible that a portion of perchlorate particles suspended in the air could be

## 3. HEALTH EFFECTS

swallowed and absorbed orally. Given the aqueous solubility of perchlorate salts, it is likely that small particles reaching the alveoli would dissolve and readily enter the systemic circulation.

**3.4.1.2 Oral Exposure**

Perchlorate has been shown, in both human and animal studies, to be readily absorbed after oral exposure. In human subjects who ingested 10 mg/day perchlorate as potassium perchlorate in drinking water for 14 days (0.14 mg/kg/day), urinary excretion rate of perchlorate was 77% of the dose/day, after 7 days of exposure, indicating that at least 77% of the ingested dosage had been absorbed (Lawrence et al. 2000). Evidence for rapid absorption in humans is provided by studies of elimination patterns. Anbar et al. (1959) detected potassium perchlorate in urine samples collected from four subjects 3 hours after ingestion of 200 mg perchlorate. Durand (1938) gave sodium perchlorate in a single oral dose (784 mg perchlorate per person) to two individuals and found perchlorate in the urine as early as 10 minutes after ingestion. Approximately 30% of the ingested dose had been eliminated in the urine within 3 hours after the dose, and 95% was eliminated within 48 hours. In a study of 13 subjects given 0.5 or 3 mg perchlorate/day for 6 months, serum perchlorate increased from undetected at baseline to an average of 24.5 µg/L in the low-dose group and 77.9 µg/L in the high-dose group over the 6 months (Braverman et al. 2006). The investigators estimated that approximately 65–70% of the daily dose was excreted during a 24-hour period. These results suggest rapid and near complete absorption of perchlorate through the digestive system.

Selivanova et al. (1986) examined the absorption of ammonium perchlorate in rats, rabbits, and calves after a single oral dose (2, 20, 200, or 600 mg perchlorate/kg). In rats, a maximum concentration of perchlorate in blood was noted between 30 and 60 minutes after administration (suggesting entrance into the systemic circulation before 30 minutes); in cattle, the maximum blood concentration of perchlorate occurred at 5 hours. In this study, only 8.5% of the administered dose was excreted in feces, and the rest was excreted in the urine, suggesting that >90% of the administered oral dose was absorbed.

**3.4.1.3 Dermal Exposure**

No studies were found regarding absorption of perchlorate after dermal exposure. As a general rule, electrolytes applied from aqueous solutions do not readily penetrate the skin (Scheuplein and Bronaugh 1983). On this basis, dermal absorption of perchlorate is expected to be low.

## 3. HEALTH EFFECTS

**3.4.2 Distribution**

Perchlorate binds to bovine and human serum albumin (Carr 1952; Scatchard and Black 1949).

Perchlorate binds only weakly to either of the two binding sites of transferrin (association constants 7 and 35 M) (Harris et al. 1998).

Studies conducted in rabbits and rats indicate that perchlorate concentrations in most soft tissues (e.g., kidney, liver, skeletal muscle) are similar to the serum concentrations; tissue:serum concentration ratios >1 have been found in thyroid (5–10) and skin (1–2) (Durand 1938; Yu et al. 2002). Accumulation of perchlorate in the thyroid occurs by a saturable, active transport process (see Section 3.5.1). As a result, thyroid serum concentrations and the amount of perchlorate in the thyroid as a fraction of the absorbed dose decrease with increasing dose (Chow and Woodbury 1970). Elimination of perchlorate from the thyroid gland is relatively rapid, with half-times in rats estimated to be approximately 10–20 hours (Fisher et al. 2000; Goldman and Stanbury 1973; Yu et al. 2002).

Studies conducted in rats administered intravenous injections of perchlorate indicate that perchlorate is secreted into the gastric lumen (Yu et al. 2002). Perchlorate secreted into the gastric lumen may be absorbed in the small intestine.

**3.4.2.1 Inhalation Exposure**

No studies were found in humans or in animals regarding distribution of perchlorate after inhalation exposure.

**3.4.2.2 Oral Exposure**

In a survey of 36 healthy lactating volunteers, perchlorate was detected in breast milk at a mean concentration of 10.5 µg/L (range, 0.6–92. µg/L) (Kirk et al. 2005). Exposure of the lactating women was presumed to have occurred mainly from perchlorate in food and drinking water. No correlation was apparent between the concentration of perchlorate in the breast milk and the water that the respective mothers consumed. Serial collection of breast milk from 10 lactating women over a 3-day period revealed that the concentrations of perchlorate, iodide, and thiocyanate varied significantly over time (Kirk et al. 2007). For perchlorate, the range, mean and median in 147 samples were 0.5–39.5, 5.8, and 4.0 µg/L, respectively. A study of women from three different cities in Chile also detected perchlorate in breast milk at mean concentrations ranging from 17.7 to 95.6 µg/L (Téllez et al. 2005). This study also

### 3. HEALTH EFFECTS

found no significant correlations between breast milk perchlorate and either urine perchlorate or breast milk iodine concentrations. A study of 57 lactating women in Boston reported a median concentration of perchlorate in milk of 9.1  $\mu\text{g/L}$  (range 1.3–411  $\mu\text{g/L}$ ) (Pearce et al. 2007).

Perchlorate also has been detected in dairy milk. A survey of 12 U.S. states showed a mean milk perchlorate level of 5.81  $\mu\text{g/L}$  in 125 samples (FDA 2007a, 2007b), which was lower than a reported mean of 9.39  $\mu\text{g/L}$  for Japanese samples (Dyke et al. 2007). The recent Total Diet Study (TDS) study conducted by the FDA reported a mean concentration of perchlorate of 7  $\mu\text{g/L}$  in eight samples of milk (Murray et al. 2008).

Studies conducted in rabbits and rats indicate that perchlorate concentrations in most soft tissues (e.g., kidney, liver, skeletal muscle) are similar to the serum concentrations; tissue:serum concentration ratios  $>1$  have been found in thyroid (5–10) and skin (1–2) (Durand 1938; Yu et al. 2002). Accumulation of perchlorate in the thyroid occurs by a saturable, active transport process (see Section 3.5.1).

Perchlorate has been shown to cross the placenta of rats. In rats exposed to perchlorate in drinking water, fetal:maternal serum concentration ratios were approximately 1 when the maternal dosage was 1 mg/kg/day or lower, and were  $<1$  when the maternal dosage was 10 mg/kg/day, suggesting the possibility of a dose-dependent limitation in the capacity of transplacental transfer (Clewell et al. 2003a).

#### **3.4.2.3 Dermal Exposure**

No studies were found regarding distribution of perchlorate after dermal exposure.

#### **3.4.2.4 Other Routes of Exposure**

Several studies have examined the distribution of perchlorate in animals after intravenous, intramuscular, or peritoneal injection (Anbar et al. 1959; Chow and Woodbury 1970; Chow et al. 1969; Durand 1938; Goldman and Stanbury 1973; Yu et al. 2002). These studies have shown that absorbed perchlorate, regardless of the route of exposure, will distribute to soft tissues, including adrenal, brain, kidney, liver, mammary gland, skeletal muscle, spleen, testes, and thyroid. The highest concentrations occur in the thyroid, where tissue:serum concentration ratios of 5–10 have been observed (Chow and Woodbury 1970). The elimination half-time for the thyroid was estimated in rats to be approximately 10–20 hours (Fisher et al. 2000; Goldman and Stanbury 1973; Yu et al. 2002).



## 3. HEALTH EFFECTS

Other tissues that appear to concentrate perchlorate are the salivary gland and skin, although not to the same degree as the thyroid (Anbar et al. 1959; Lazarus et al. 1974; Yu et al. 2002). Tissue:blood concentration ratios of 1.5–2 have been observed for the salivary gland (Anbar et al. 1959) and 1–2 for the skin (Yu et al. 2002).

**3.4.3 Metabolism**

There is no evidence that perchlorate is metabolized in the body. Anbar et al. (1959) assayed for potential metabolites of potassium perchlorate (radiolabeled with  $^{36}\text{Cl}$  and  $^{18}\text{O}_4$ ) in the urine of patients 3 hours after a single oral dose (200 mg perchlorate per person). They did not detect any isotopic exchange of the oxygen atoms in excreted perchlorate; furthermore, although they found that 1–3% of the excreted  $^{36}\text{Cl}$  was chloride ion, this value was within experimental error. They concluded that the perchlorate excreted after 3 hours was unmodified. There has been no investigation as to whether perchlorate that is eliminated at later time points would exhibit the same isotopic pattern.

Goldman and Stanbury (1973) found that perchlorate reached a maximum concentration (>3% of the administered dose/g tissue) in the thyroid gland of rats 4 hours after an intraperitoneal injection of radiolabeled potassium perchlorate ( $\text{K } ^{36}\text{ClO}_4$ ; 18 or 24 mg perchlorate/kg). However, trichloroacetic acid precipitates of thyroid homogenates contained only background levels of radioactivity, indicating that perchlorate is not covalently bound to thyroid protein.

**3.4.4 Elimination and Excretion**

The few studies of the elimination and excretion of perchlorate, described in the sections that follow, suggest that it is rapidly eliminated from the body through the urinary tract. Similar results have been obtained after oral exposure or after intravenous or intraperitoneal injection; the specific cation appears not to influence the pattern of excretion.

**3.4.4.1 Inhalation Exposure**

A study in two workers occupationally exposed to perchlorate found that the urinary perchlorate concentration increased over 3 days of perchlorate exposure, but there was a decrease between the 12-hour work shifts (Lamm et al. 1999). Excretion after the last exposure appeared to follow a first-order kinetics pattern, particularly when the urinary perchlorate concentration was between 0.1 and 10 mg/L.

### 3. HEALTH EFFECTS

The average elimination half-life for the two workers was approximately 8 hours. No information was located regarding excretion of perchlorate in animals following inhalation exposure.

#### 3.4.4.2 Oral Exposure

In adult human subjects who ingested potassium perchlorate in drinking water (0.14 mg/kg/day) for 14 days, urinary excretion rate of perchlorate was 77% of the dose/day after 7 days of exposure, indicating that urine is the main excretory pathway for absorbed perchlorate (Lawrence et al. 2000). The urinary excretion rate of perchlorate returned to control levels (<0.5 mg/day) within 14 days after exposure to perchlorate was terminated (Lawrence et al. 2000). Perchlorate was detected in the urine of two adults at 10 minutes after a single oral dose of sodium perchlorate (784 mg perchlorate per person); urinary excretion as a percentage of the dose was 30% at 3 hours, 50% in at 5 hours, 85% at 24 hours, and 95% at 48 hours (Durand 1938). This suggests an excretion half-time of approximately 12 hours. The latter estimate is consistent with the elimination kinetics of perchlorate from serum. The elimination half-time for perchlorate in serum was estimated to be approximately 8 hours in adult human subjects who ingested potassium perchlorate in drinking water (0.5 mg/kg/day) for 14 days (Greer et al. 2002). In another study in adult humans, it was estimated that approximately 65–70% of a daily dose of 0.5–3 mg perchlorate/day was excreted over a 24-hour period (Braverman et al. 2006). Thus, in humans, perchlorate is rapidly eliminated and would not be expected to accumulate in the body with prolonged exposure. Based on an elimination half-time of approximately 8–12 hours, a steady state would be achieved within 3–4 days of continuous exposure. The detection of perchlorate in breast milk from lactating women (Kirk et al. 2005; Pearce et al. 2007; Téllez et al. 2005) also indicates breast milk as an excretion route in humans.

Studies conducted in a variety of experimental animals, including rats, rabbits, and calves, have shown that absorbed perchlorate is rapidly and nearly completely excreted in the urine (Fisher et al. 2000; Selivanova et al. 1986; Yu et al. 2002).

Studies conducted in rats have shown that perchlorate is excreted in mammary milk (Clewell et al. 2003b). Perchlorate has also been detected in dairy milk (Howard et al. 1996; Kirk et al. 2005).

#### 3.4.4.3 Dermal Exposure

No studies were found regarding elimination or excretion of perchlorates after dermal exposure.

## 3. HEALTH EFFECTS

**3.4.4.4 Other Routes of Exposure**

Studies in which rats received intravenous or intraperitoneal injections of perchlorate provide additional support for the rapid excretion of perchlorate in urine. Rats that received a single intravenous injection of 0.01, 0.1, 1.0, or 3.0 mg/kg perchlorate (as ammonium perchlorate) excreted 85, 86, 80, or 79% of the administered dose, respectively, in urine (Fisher et al. 2000). The elimination half-time for intravenously injected perchlorate (approximately 0.04 mg, 0.18–0.25 mg/kg, as potassium perchlorate) from serum, and the urinary excretion half-time were estimated in rats to be approximately 20 hours (Goldman and Stanbury 1973). Similarly, rats injected with sodium perchlorate (2, 8, or 49 mg perchlorate/kg) excreted 50% of the administered dose in urine during the first 6 hours and had excreted 93–97% of the dose by 60 hours (Eichler and Hackenthal 1962); in this study, higher doses of perchlorate were eliminated at a faster rate than lower doses. Similar results were obtained in rats that received a single intravenous dose of 3.3 mg/kg perchlorate as ammonium perchlorate; urinary excretion of perchlorate was essentially complete within 12 hours (Yu et al. 2002). Possible contributors to the relatively longer elimination half-life of perchlorate in rats than in humans include differences in serum protein binding or perhaps the NIS protein in the gastrointestinal tract may sequester perchlorate temporarily to a greater degree in the rat than human.

**3.4.5 Physiologically Based Pharmacokinetic (PBPK)/Pharmacodynamic (PD) Models**

Physiologically based pharmacokinetic (PBPK) models use mathematical descriptions of the uptake and disposition of chemical substances to quantitatively describe the relationships among critical biological processes (Krishnan et al. 1994). PBPK models are also called biologically based tissue dosimetry models. PBPK models are increasingly used in risk assessments, primarily to predict the concentration of potentially toxic moieties of a chemical that will be delivered to any given target tissue following various combinations of route, dose level, and test species (Clewell and Andersen 1985). Physiologically based pharmacodynamic (PBPD) models use mathematical descriptions of the dose-response function to quantitatively describe the relationship between target tissue dose and toxic end points.

PBPK/PD models refine our understanding of complex quantitative dose behaviors by helping to delineate and characterize the relationships between: (1) the external/exposure concentration and target tissue dose of the toxic moiety, and (2) the target tissue dose and observed responses (Andersen and Krishnan 1994; Andersen et al. 1987). These models are biologically and mechanistically based and can be used to extrapolate the pharmacokinetic behavior of chemical substances from high to low dose, from route to route, between species, and between subpopulations within a species. The biological basis of

## 3. HEALTH EFFECTS

PBPK models results in more meaningful extrapolations than those generated with the more conventional use of uncertainty factors.

The PBPK model for a chemical substance is developed in four interconnected steps: (1) model representation, (2) model parameterization, (3) model simulation, and (4) model validation (Krishnan and Andersen 1994). In the early 1990s, validated PBPK models were developed for a number of toxicologically important chemical substances, both volatile and nonvolatile (Krishnan and Andersen 1994; Leung 1993). PBPK models for a particular substance require estimates of the chemical substance-specific physicochemical parameters, and species-specific physiological and biological parameters. The numerical estimates of these model parameters are incorporated within a set of differential and algebraic equations that describe the pharmacokinetic processes. Solving these differential and algebraic equations provides the predictions of tissue dose. Computers then provide process simulations based on these solutions.

The structure and mathematical expressions used in PBPK models significantly simplify the true complexities of biological systems. If the uptake and disposition of the chemical substance(s) are adequately described, however, this simplification is desirable because data are often unavailable for many biological processes. A simplified scheme reduces the magnitude of cumulative uncertainty. The adequacy of the model is, therefore, of great importance, and model validation is essential to the use of PBPK models in risk assessment.

PBPK models improve the pharmacokinetic extrapolations used in risk assessments that identify the maximal (i.e., the safe) levels for human exposure to chemical substances (Andersen and Krishnan 1994). PBPK models provide a scientifically sound means to predict the target tissue dose of chemicals in humans who are exposed to environmental levels (for example, levels that might occur at hazardous waste sites) based on the results of studies where doses were higher or were administered in different species. Figure 3-3 shows a conceptualized representation of a PBPK model.

If PBPK models for perchlorates exist, the overall results and individual models are discussed in this section in terms of their use in risk assessment, tissue dosimetry, and dose, route, and species extrapolations.

## 3. HEALTH EFFECTS

**Figure 3-3. Conceptual Representation of a Physiologically Based Pharmacokinetic (PBPK) Model for a Hypothetical Chemical Substance**

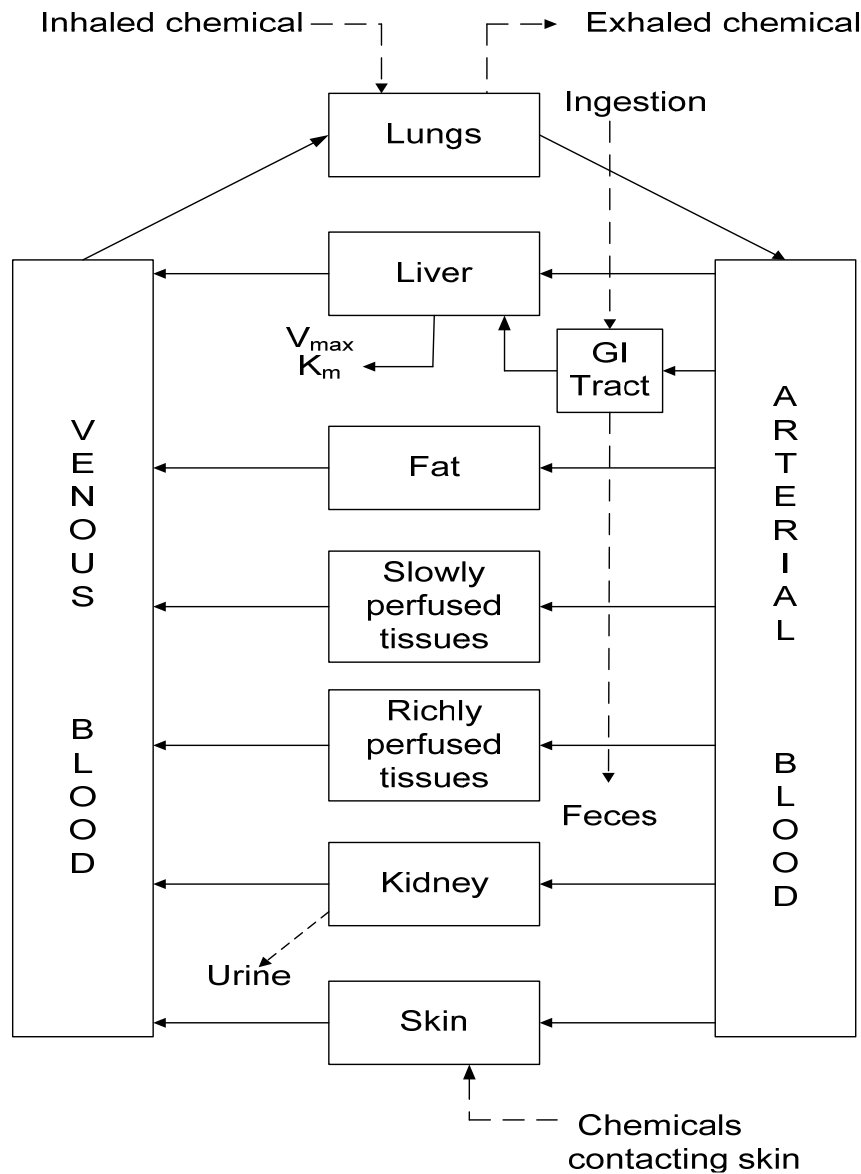

Note: This is a conceptual representation of a physiologically based pharmacokinetic (PBPK) model for a hypothetical chemical substance. The chemical substance is shown to be absorbed via the skin, by inhalation, or by ingestion, metabolized in the liver, and excreted in urine, feces, or by exhalation.

Source: adapted from Krishnan and Andersen 1994

## 3. HEALTH EFFECTS

**Perchlorate PBPK Models**

**Description of the models.** PBPK models of the kinetics of ingested or injected perchlorate in rats and humans have been developed (Fisher et al. 2000; Merrill et al. 2003, 2005). The models were developed simultaneously with models of radioiodide biokinetics. When combined, the perchlorate and radioiodide models simulate the competitive inhibition of radioiodide transport by perchlorate in thyroid and other tissues that have NIS activity. The adult rat model was extended to include pregnancy and maternal-fetal transfer of perchlorate, and lactation and maternal-pup perchlorate transfer through milk (Clewell et al. 2003a, 2003b). Corresponding human models of pregnancy, maternal-fetal transfer, and maternal-infant transfer of perchlorate were developed (Clewell et al. 2007).

The adult rat and human models have the same structure and differ only in values for physiological and some of perchlorate parameters (Table 3-3, Figure 3-4). Both models simulate nine tissue compartments: blood, kidney, liver, skin, stomach, thyroid, fat, other slowly perfused tissues, and other richly perfused tissues. Uptakes from blood into the tissue vascular compartments are simulated as flow-limited processes. Distributions within blood, skin, stomach, and thyroid are simulated as diffusion limited processes with first-order clearance terms. Excretion is described with a first-order clearance term for transfer of perchlorate from the kidney into urine. Uptake of perchlorate into tissues that have NIS activity are simulated using a Michaelis-Menten approach with tissue- and species-specific maximum velocities and affinity constants that are conserved across tissues and species. This includes uptake of perchlorate into thyroid follicle cells. Secretion of perchlorate into the follicle lumen, thought to be mediated by the pendrin anion transporter, is simulated using a Michaelis-Menten approach. Upregulation of NIS (i.e., induction in response to TSH) is simulated by fitting increased maximum velocities of perchlorate and radioiodide transport into the thyroid gland. The model does not explicitly include TSH-dependence of NIS levels or other aspects of the metabolism of iodide within the thyroid (e.g., hormone production and secretion), and does not simulate changes in TSH levels resulting from NIS inhibition. Active transport of perchlorate into the stomach lumen and in skin is also simulated in the models.

Extensions of the adult models to simulate perchlorate (and radioiodide) kinetics during pregnancy in rats and humans include the addition of two additional compartments representing the mammary gland and placenta (Clewell et al. 2003a, 2003b, 2007). The structure of the human pregnancy and lactation models for perchlorate (which are identical to the corresponding rat models) are shown in Figure 3-5. Parameter

## 3. HEALTH EFFECTS

**Table 3-3. Perchlorate and Radioiodide Parameter Values for the Adult Male Rat and Human PBPK Models**

Parameter	Male rat		Human	
	Perchlorate	Radioiodide	Perchlorate	Radioiodide
Partition coefficients (unitless)				
Slowly perfused/plasma	0.31	0.21	0.31	0.21
Richly perfused/plasma	0.56	0.40	0.56	0.40
Fat/plasma	0.05	0.05	0.05	0.05
Kidney/plasma	0.99	1.00	0.99	1.09
Liver/plasma	0.56	0.44	0.56	0.44
Gastric tissue/gastric blood	0.70	1.0	1.80	0.50
Gastric juice/gastric tissue	1.70	3.50	2.30	3.50
Skin tissue/skin blood	1.0	0.70	1.15	0.70
Thyroid follicle/thyroid stroma	0.15	0.15	0.13	0.15
Thyroid lumen/thyroid follicle	8.00	8.00	7.00	7.00
Red blood cells/plasma	0.73	1.00	0.80	1.00
Max capacity (ng/hour/kg)				
Thyroid follicle	$1.0 \times 10^3$	$5.4 \times 10^4$	$5.0 \times 10^5$	$\sim 1.5 \times 10^5$ $\pm 8.2 \times 10^4$
Thyroid lumen	$2.0 \times 10^4$	$4.0 \times 10^6$	$2.5 \times 10^4$	$7.0 \times 10^7$
Skin	$5.0 \times 10^5$	$5.0 \times 10^5$	$1.0 \times 10^6$	$6.0 \times 10^5$
Gastric	$2.0 \times 10^4$	$2.0 \times 10^6$	$1.0 \times 10^5$	$9.0 \times 10^5$
Plasma binding	$3.4 \times 10^3$	$1.0 \times 10^2$	$5.0 \times 10^2$	$2.0 \times 10^2$
Affinity constants (ng/L)				
Thyroid lumen	$1.0 \times 10^8$	$1.0 \times 10^9$	$1.0 \times 10^8$	$1.0 \times 10^9$
Thyroid follicle	$1.8 \times 10^5$	$4.0 \times 10^6$	$1.6 \times 10^5$	$4.0 \times 10^6$
Skin	$1.8 \times 10^5$	$4.0 \times 10^6$	$2.0 \times 10^5$	$4.0 \times 10^6$
Gastric	$1.7 \times 10^5$	$4.0 \times 10^6$	$2.0 \times 10^5$	$4.0 \times 10^6$
Plasma binding	$1.1 \times 10^4$	NA	$1.8 \times 10^4$	$7.8 \times 10^5$
Permeability area cross products (L/hour/kg)				
Gastric blood to gastric tissue	1.00	1.00	0.6	0.2
Gastric tissue to gastric juice	0.80	0.10	0.8	2.0
Skin blood to skin tissue	0.80	0.10	1.0	0.01
Plasma to red blood cells	1.00	1.00	1.0	1.0
Thyroid follicle to thyroid stroma	$6.0 \times 10^{-5}$	$1.0 \times 10^{-4}$	$1.0 \times 10^{-4}$	$6.0 \times 10^{-4}$
Thyroid lumen to thyroid follicle	0.01	$4.0 \times 10^{-7}$	0.01	$1.0 \times 10^{-4}$

## 3. HEALTH EFFECTS

**Table 3-3. Perchlorate and Radioiodide Parameter Values for the Adult Male Rat and Human PBPK Models**

Parameter	Male rat		Human	
	Perchlorate	Radioiodide	Perchlorate	Radioiodide
Clearance values (L/hour/kg)				
Urinary excretion	0.07	0.05	0.13±0.05	0.11
Plasma unbinding	0.032	NA	0.025	No data
Hormone production	NA	0.10	NA	0.01
Hormone secretion	NA	1.2x10 <sup>-6</sup>	NA	1.2x10 <sup>-6</sup>
Hormone deiodination	NA	NA	NA	9.0x10 <sup>-4</sup>

NA = not applicable; PBPK = physiologically based pharmacokinetic

Sources: Merrill et al. 2003, 2005



3. HEALTH EFFECTS

**Figure 3-4. Structure of PBPK Model of Perchlorate in Typical Adult Humans and Male Rats\***

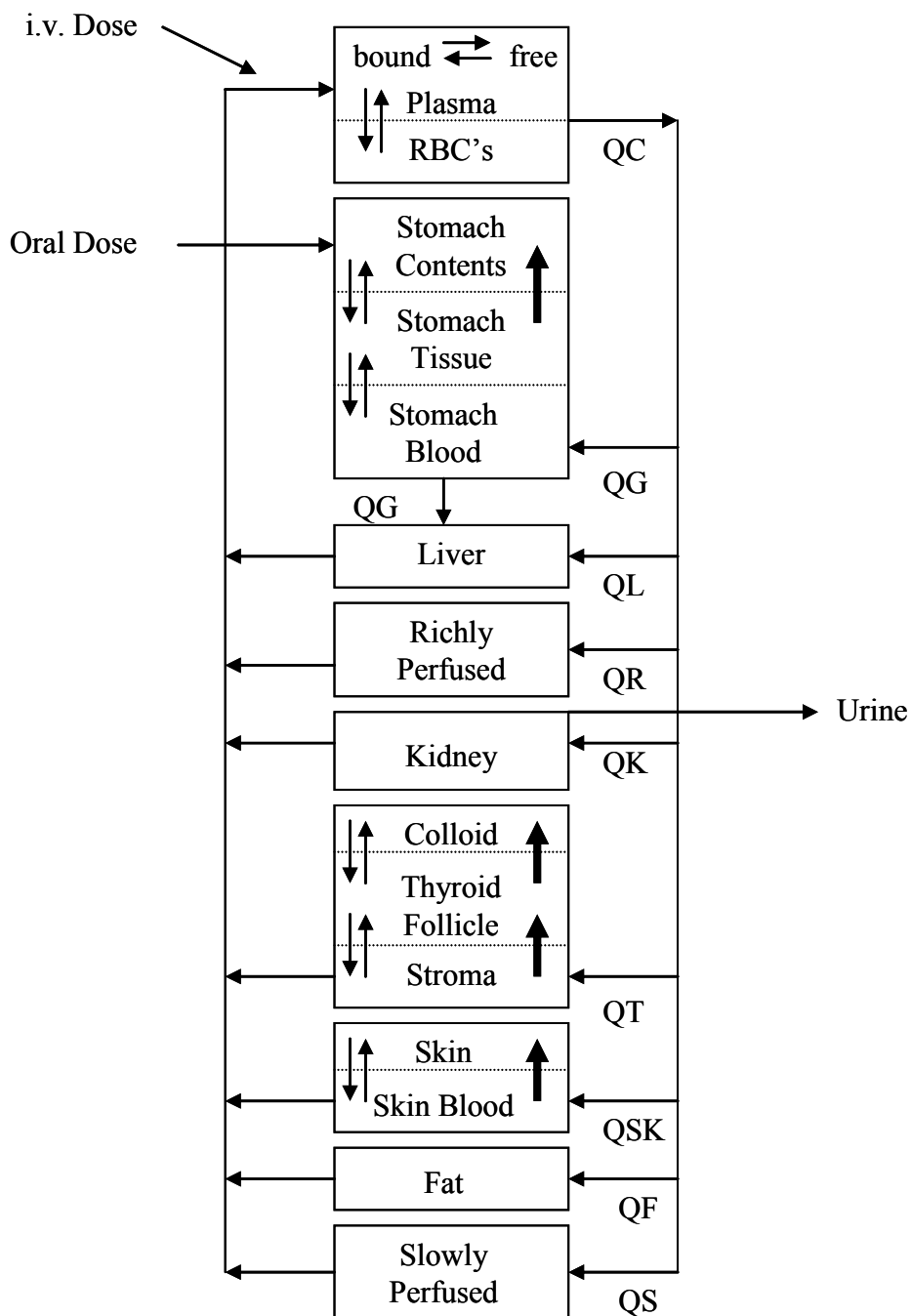

\*Bold arrows within tissue compartments indicate active transport (i.e., Michaelis-Menten), thin arrows represent first-order rate transfers, and double arrows represent passive diffusion. Q indicates blood flow.

PBPK = physiologically based pharmacokinetic

## 3. HEALTH EFFECTS

**Figure 3-5. Structure of PBPK Models of Perchlorate in the Pregnant and Lactating Woman**

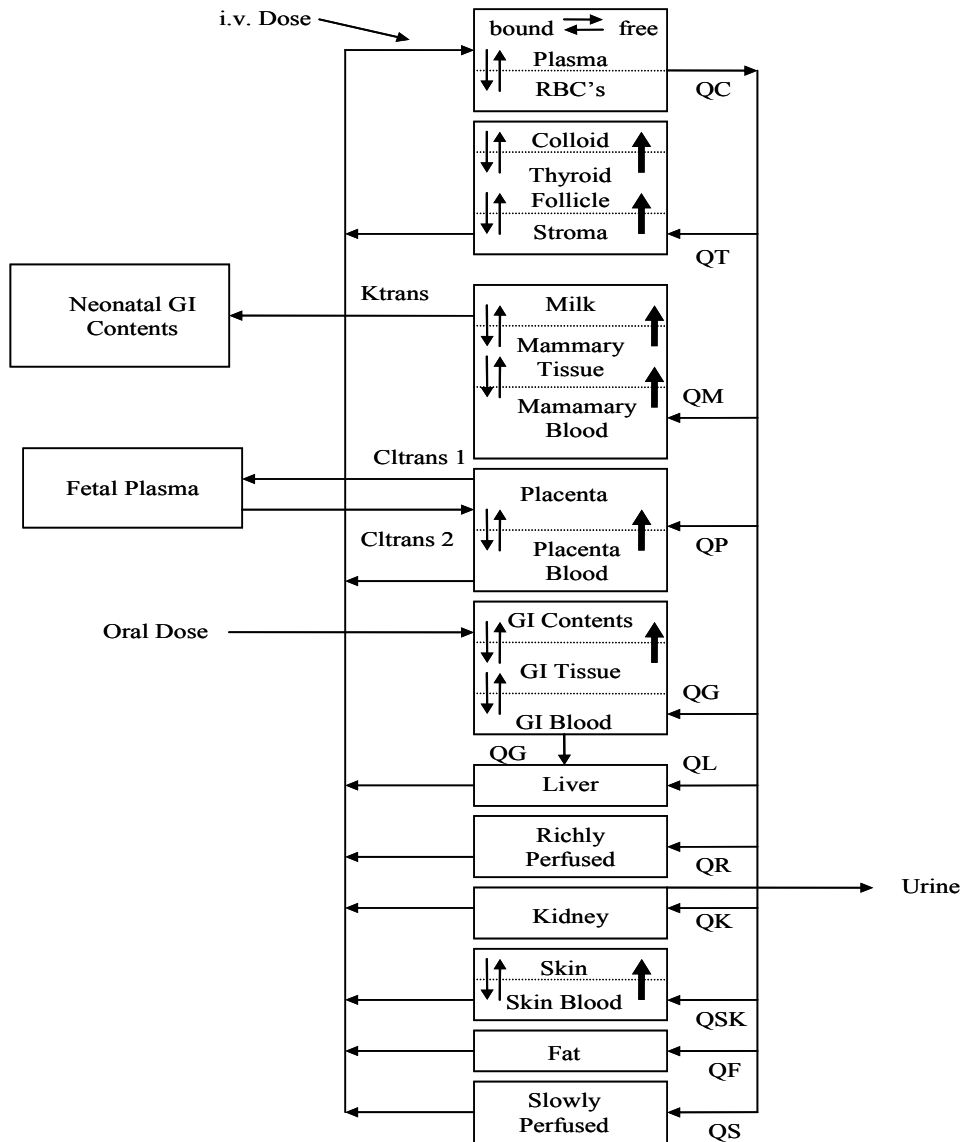

Differences between fetal, neonatal, and adult models are described in the text. Bold arrows within tissue compartments indicate active transport (i.e., Michaelis-Menten), thin arrows represent first-order rate transfers, and double arrows represent passive diffusion. Q indicates blood flow. A PBPK model for radioiodide has the same structure with addition of radioiodide incorporation into thyroid hormones within the thyroid and subsequent secretion into the plasma and further estimate for whole-body deiodination (release of iodide from thyroid hormones). Parameter values for the perchlorate and radioiodide models are presented in Tables 3-4 and 3-5.

Source: Clewell et al. 2007

## 3. HEALTH EFFECTS

values for the perchlorate and radioiodide human models are presented in Tables 3-4 and 3-5, respectively. Corresponding rat model parameter values are presented in Tables 3-6 and 3-7.

Uptake of perchlorate into the mammary gland tissue from the mammary tissue vascular space is simulated as a capacity-limited transport process, representing the activities of NIS and pendrin in this tissue. Uptake of perchlorate into the placenta from blood into placental blood is simulated as a diffusion-limited process with capacity-limited transport from placenta blood to placental tissue via NIS.

Exchanges of perchlorate between the placenta and fetus are simulated with first-order clearance terms.

The fetal model is identical in structure to the adult (nonpregnant) model, with adjustments in the physiological and perchlorate parameters to reflect the fetus, and the following exceptions: (1) fetal exposure is described as a first-order transfer from the placenta to the serum of the fetus; (2) clearance in the fetus is described as first-order loss from the fetal serum to the placenta; and (3) binding of iodine is not represented in the fetal thyroid and plasma.

The lactating rat and human models include a milk compartment in mammary tissue and a first-order clearance term for describing secretion of perchlorate from mammary tissue into milk (Clewell et al. 2003b, 2007). Transfer of perchlorate from milk to the neonate is simulated as a first-order clearance process. The neonate model is identical in structure to the adult (nonpregnant) model, with adjustments to the physiological and perchlorate parameter values to reflect the neonate (Clewell et al. 2003a).

Parameter values for perchlorate and radioiodide in children were allometrically scaled from adult values.

**Validation of the models.** The rat adult perchlorate model has been evaluated for predicting kidney, serum, gastric lumen, tissue (including thyroid), and urine perchlorate concentrations in adult rats that received acute intravenous injection of radiolabeled perchlorate ( $^{36}\text{ClO}_4^-$ ), (Merrill et al. 2003; Yu et al. 2002). In general, model predictions were within 1–2 standard deviations of observed values. When the same parameter values were used to predict perchlorate concentrations in the thyroid in rats that were exposed to repeated doses of perchlorate in drinking water for 14 days, the model predicted lower levels of perchlorate in thyroid than were observed for dosages  $\geq 3$  mg/kg/day. At doses of perchlorate  $>1$  mg/kg/day, only slight inhibition of thyroid radioiodide uptake was observed (Yu et al. 2002); presumably, a result of upregulation of NIS by TSH, whereas the model predicted greater inhibition. However, good correspondence with observations was achieved by adjusting the parameters for maximum velocity of transport of perchlorate and radioiodide into the thyroid gland. This adjustment mimics induction of NIS that occurs in response to elevations in serum TSH, which was observed in the rats exposed to perchlorate in drinking water (Uyttersprot et al. 1997; Yu et al. 2002). TSH stimulates

## 3. HEALTH EFFECTS

**Table 3-4. Perchlorate Chemical-specific Parameters for Human Gestation and Lactation Models**

Parameters	Gestation		Lactation	
	Woman	Fetus	Woman	Neonate
Gastric tissue/gastric blood <i>PG</i>	1.29 <sup>a</sup>	1.79 <sup>a</sup>	4.6 <sup>a</sup>	8.25 <sup>a</sup>
Gastric juice/gastric tissue <i>PGJ</i>	1.76 <sup>a</sup>	2.3 <sup>a</sup>	3.1 <sup>a</sup>	7.63 <sup>a</sup>
Skin tissue/skin blood <i>PSk</i>	1.32 <sup>a</sup>	1.32 <sup>a</sup>	1.32 <sup>a</sup>	1.32 <sup>a</sup>
Mammary tissue/mammary blood <i>PM</i>	0.66 <sup>b</sup>	NA	0.66 <sup>b</sup>	NA
Mammary/milk <i>PMk</i>	NA	NA	2.39 <sup>b</sup>	NA
Placenta/placental blood	0.56 <sup>b</sup>	NA	NA	NA
Maximum capacity (ng/hour/kg)				
Thyroid follicle <i>VmaxcTF</i>	6.0x10 <sup>3a</sup>	0–2x10 <sup>5e</sup>	9.0x10 <sup>3a</sup>	0.6–2.4x10 <sup>5e</sup> /6x10 <sup>3c</sup>
Thyroid colloid (lumen) <i>VmaxcTL</i>	1.7x10 <sup>4a</sup>	1.7x10 <sup>4a</sup>	8.4x10 <sup>3a</sup>	1.7x10 <sup>4a</sup>
Skin <i>VmaxcS</i>	1.2x10 <sup>6a</sup>	8.0x10 <sup>5a</sup>	1.6x10 <sup>6a</sup>	1.6x10 <sup>6a</sup>
Gastrointestinal <i>VmaxcG</i>	3.2x10 <sup>7a</sup>	4.0x10 <sup>6a</sup>	5.0x10 <sup>6a</sup>	5.0x10 <sup>6a</sup>
Mammary <i>VmaxcM</i>	2.2x10 <sup>4b</sup>	NA	2.0x10 <sup>4b</sup>	NA
Milk <i>VmaxcMk</i>	NA	NA	2.0x10 <sup>4b</sup>	NA
Placenta <i>VmaxcP</i>	6.0x10 <sup>4b</sup>	NA	NA	NA
Affinity constants (ng/L)				
Mammary <i>KmM</i>	2.0x10 <sup>5c</sup>	NA	2.0x10 <sup>5c</sup>	NA
Milk <i>KmMk</i>	NA	NA	1.0x10 <sup>6b</sup>	NA
Placenta <i>KmP</i>	2.0x10 <sup>5c</sup>	NA	NA	NA
Permeability area cross products (L/hour/kg)				
Gastric blood to gastric tissue <i>PAGc</i>	0.6 <sup>a</sup>	0.6	0.6	0.6 <sup>a</sup>
Gastric tissue to gastric juice <i>PAGJc</i>	1.0 <sup>a</sup>	1.0	1.0	1.0 <sup>a</sup>
Thyroid stroma to thyroid follicle <i>PATFc</i>	1.0x10 <sup>-4a</sup>	1.0x10 <sup>-2f</sup>	6.7x10 <sup>-5</sup>	6.7x10 <sup>-5a</sup>
Thyroid follicle to thyroid colloid (lumen) <i>PATLc</i>	0.01 <sup>a</sup>	0.01 <sup>a</sup>	0.01	0.01 <sup>a</sup>
Skin blood to skin tissue <i>PASkc</i>	1.25 <sup>a</sup>	1.25 <sup>a</sup>	0.63	1.25 <sup>a</sup>
Mammary blood to mammary tissue <i>PAMc</i>	0.04 <sup>a</sup>	NA	0.01	NA
Mammary tissue to milk <i>PAMkc</i>	NA	NA	0.1	NA
Placenta blood to placenta <i>PAPCc</i>	0.1 <sup>b</sup>	NA	NA	NA
Clearance values (L/hour/kg)				
Urinary excretion <i>CLUc</i>	0.05 <sup>d</sup>	NA	0.05 <sup>d</sup>	0.13 <sup>c</sup>
Placenta to fetal blood <i>Cltrans1c</i>		0.12 <sup>f</sup>	NA	NA
Fetal blood to placenta <i>Cltrans2c</i>		0.12 <sup>b</sup>	NA	NA

## 3. HEALTH EFFECTS

**Table 3-4. Perchlorate Chemical-specific Parameters for Human Gestation and Lactation Models**

Parameters	Gestation		Lactation	
	Woman	Fetus	Woman	Neonate
Binding constants (ng/hour/kg)				
Plasma binding $V_{max}cB$	$5.9 \times 10^{2a}$	$5.0 \times 10^{2c}$	$1.32 \times 10^{3a}$	$5.0 \times 10^{2c}$

*Note:* Partition coefficients for perfusion limited compartments (i.e., fat, liver, kidney, rapidly and slowly perfused tissues) were the same across species and life stages.

<sup>a</sup>Calculated using parallelogram approach (Clewell 2008).

<sup>b</sup>Set to rat value (in absence of equivalent human parameter).

<sup>c</sup>Set to adult human value.

<sup>d</sup>Adjusted to fit data set.

<sup>e</sup>Calculated from human perinatal iodide parameter and  $ClO_4^-:I^-$  ratio in adult.

<sup>f</sup>Set to human perinatal iodide value (in absence of equivalent perchlorate data).

NA = not applicable

Source: Clewell 2008; Clewell et al. 2007)

## 3. HEALTH EFFECTS

**Table 3-5. Radioiodide Chemical-specific Parameters for Human Gestation and Lactation Models**

Parameters	Gestation		Lactation	
	Woman	Fetus	Woman	Neonate
Gastric tissue/gastric blood <i>PG</i>	1.0 <sup>a</sup>	1.0 <sup>a</sup>	0.5 <sup>a</sup>	0.6 <sup>a</sup>
Gastric juice/gastric tissue <i>PGJ</i>	2.0 <sup>a</sup>	2.0 <sup>a</sup>	1.0 <sup>a</sup>	1.0 <sup>a</sup>
Skin tissue/skin blood <i>PSk</i>	1.0 <sup>a</sup>	1.0 <sup>a</sup>	1.0 <sup>a</sup>	1.0 <sup>a</sup>
Mammary tissue/mammary blood <i>PM</i>	0.66 <sup>b</sup>	NA	0.8 <sup>b</sup>	NA
Mammary/milk <i>PMk</i>	NA	NA	1.0 <sup>b</sup>	NA
Placenta/placental blood	0.40 <sup>b</sup>	NA	NA	NA
Maximum capacity (ng/hour/kg)				
Thyroid follicle <i>VmaxcTF</i>	1.22x10 <sup>5a</sup>	0–5.0x10 <sup>6d</sup>	1.4x10 <sup>5a</sup>	1.5–6x10 <sup>6d</sup> /1.5x10 <sup>5c</sup>
Thyroid colloid (lumen) <i>VmaxcTL</i>	1.0x10 <sup>8a</sup>	1.0x10 <sup>8a</sup>	1.0x10 <sup>8a</sup>	1.0x10 <sup>8a</sup>
Skin <i>VmaxcS</i>	7.2x10 <sup>4a</sup>	8.4x10 <sup>5a</sup>	5.6x10 <sup>5a</sup>	3.5x10 <sup>5a</sup>
Gastrointestinal <i>VmaxcG</i>	4.6x10 <sup>5a</sup>	9.0x10 <sup>5a</sup>	9.0x10 <sup>5a</sup>	9.0x10 <sup>5a</sup>
Mammary <i>VmaxcM</i>	4.0x10 <sup>4a</sup>	NA	8.0x10 <sup>5b</sup>	NA
Milk <i>VmaxcMk</i>	NA	NA	5.0x10 <sup>5b</sup>	NA
Placenta <i>VmaxcP</i>	5.5x10 <sup>4b</sup>	NA	NA	NA
Affinity constants (ng/L)				
Mammary <i>KmM</i>	4.0x10 <sup>6b</sup>	NA	4.0x10 <sup>6b</sup>	NA
Milk <i>KmMk</i>	NA	NA	1.0x10 <sup>7b</sup>	NA
Placenta <i>KmP</i>	4.0x10 <sup>6b</sup>	NA	NA	NA
Permeability area cross products, (L/hour/kg)				
Gastric blood to gastric tissue <i>PAGc</i>	0.16 <sup>a</sup>	0.12 <sup>a</sup>	0.16 <sup>a</sup>	0.01 <sup>a</sup>
Gastric tissue to gastric juice <i>PAGJc</i>	12.0 <sup>a</sup>	0.3 <sup>a</sup>	12.0 <sup>a</sup>	1.8 <sup>a</sup>
Thyroid stroma to thyroid follicle <i>PATFc</i>	1.0x10 <sup>-4a</sup>	1.0x10 <sup>-2d</sup>	1x10 <sup>-4a</sup>	1.0x10 <sup>-4a</sup>
Thyroid follicle to thyroid colloid (lumen) <i>PATLc</i>	1.5x10 <sup>-5a</sup>	1.0x10 <sup>-4a</sup>	2.0x10 <sup>-3a</sup>	1.25x10 <sup>-3a</sup>
Skin blood to skin tissue <i>PASkc</i>	0.06 <sup>a</sup>	0.06 <sup>a</sup>	0.12 <sup>a</sup>	0.012 <sup>a</sup>
Mammary blood to mammary tissue <i>PAMc</i>	0.01 <sup>b</sup>	NA	0.02 <sup>b</sup>	NA
Mammary tissue/milk <i>PAMkc</i>	NA	NA	0.02 <sup>b</sup>	NA
Placenta blood to placenta <i>PAPCc</i>	0.005 <sup>b</sup>	NA	NA	NA

## 3. HEALTH EFFECTS

**Table 3-5. Radioiodide Chemical-specific Parameters for Human Gestation and Lactation Models**

Parameters	Gestation		Lactation	
	Woman	Fetus	Woman	Neonate
Clearance values, (L/hour/kg)				
Urinary excretion <i>CLUc</i>	0.05 <sup>a</sup>	NA	0.1 <sup>a</sup>	0.1 <sup>c</sup>
Placenta to fetal blood <i>Cltrans1c</i>		0.12 <sup>d</sup>	NA	NA
Fetal blood to placenta <i>Cltrans2c</i>		0.12 <sup>b</sup>	NA	NA

*Note:* Partition coefficients for perfusion limited compartments (i.e., fat, liver, kidney, rapidly and slowly perfused tissues) were the same across species and life stages.

<sup>a</sup>Calculated using parallelogram approach.

<sup>b</sup>Set to rat value (in absence of equivalent human parameter).

<sup>c</sup>Set to adult human value.

<sup>d</sup>Adjusted to fit data set.

NA = not applicable

Source: Clewell et al. 2007

## 3. HEALTH EFFECTS

**Table 3-6. Perchlorate Chemical-specific Parameters for Rat Gestation and Lactation Models**

Parameters	Gestation		Lactation	
	Dam	Fetus	Dam	Pup
Partition coefficients (unitless)				
Slowly perfused/plasma <i>PS</i>	0.31	0.31	0.31	0.31
Rapidly perfused/plasma <i>PR</i>	0.56	0.56	0.5	0.5
Fat/plasma <i>PF</i>	0.05	NA	0.05	0.05
Kidney/plasma <i>PK</i>	0.99	0.99	0.99	0.99
Liver/plasma <i>PL</i>	0.56	0.56	0.56	0.56
Gastric tissue/gastric blood <i>PGI</i>	0.50	1.80	1.8	3.21
Gastric juice/gastric tissue <i>PGIJ</i>	1.30	2.30	2.3	5.64
Skin tissue/skin blood <i>PSk</i>	1.15	1.15	1.15	1.15
Thyroid tissue/thyroid blood <i>PTF</i>	0.15	0.15 <sup>a</sup>	0.13	0.13
Thyroid lumen/thyroid tissue <i>PTL</i>	7.0	7.0	7.0	7.0
Red blood cells/plasma <i>PRBC</i>	0.73	0.73	0.73	0.73
Placenta/plasma <i>PPI</i>	0.56	NA	NA	NA
Mammary/plasma <i>PM</i>	0.66	NA	NA	NA
Mammary tissue/mammary blood <i>PM</i>	NA	NA	0.66	NA
Mammary/plasma <i>PMk</i>	NA	NA	2.39	NA
Max capacity, <i>Vmaxc</i> (ng/hour/kg)				
Thyroid follicle <i>VmaxcTF</i>	2.6x10 <sup>3</sup>	0–2.25x10 <sup>3</sup>	1.5x10 <sup>3</sup>	1.5x10 <sup>3</sup>
Thyroid colloid <i>VmaxcTL</i>	1.0x10 <sup>4</sup>	1.0x10 <sup>4b</sup>	1.0x10 <sup>4</sup>	1.0x10 <sup>4</sup>
Skin <i>VmaxcSk</i>	6.0x10 <sup>5</sup>	4.0x10 <sup>5</sup>	8.0x10 <sup>5</sup>	8.0x10 <sup>5</sup>
Gut <i>VmaxcGI</i>	8.0x10 <sup>5</sup>	1.0x10 <sup>5</sup>	1.0x10 <sup>6</sup>	1.0x10 <sup>6</sup>
Placenta <i>VmaxcP</i>	6.0x10 <sup>4</sup>	NA	NA	NA
Mammary <i>VmaxcM</i>	2.2x10 <sup>4</sup>	NA	2.0x10 <sup>4</sup>	NA
Milk <i>VmaxcMk</i>	NA	NA	2.0x10 <sup>4</sup>	NA
Affinity constants, <i>Km</i> (ng/L)				
Thyroid follicle <i>KmTF</i>	1.0x10 <sup>5</sup>	1.0x10 <sup>5</sup>	1.5x10 <sup>5</sup>	1.5x10 <sup>5</sup>
Thyroid colloid <i>KmTL</i>	1.0x10 <sup>8</sup>	1.0x10 <sup>8</sup>	1.0x10 <sup>8</sup>	1.0x10 <sup>8</sup>
Skin <i>KmSk</i>	1.0x10 <sup>5</sup>	1.0x10 <sup>5</sup>	1.5x10 <sup>5</sup>	1.5x10 <sup>5</sup>
Gut <i>KmGI</i>	1.0x10 <sup>5</sup>	1.0x10 <sup>5</sup>	1.5x10 <sup>5</sup>	NA
Placenta <i>KmP</i>	1.0x10 <sup>5</sup>	NA	NA	NA
Mammary <i>KmM</i>	1.0x10 <sup>5</sup>	NA	1.5x10 <sup>5</sup>	NA
Milk <i>KmMk</i>	NA	NA	1.0x10 <sup>6</sup>	NA
Permeability area cross-products (L/hour/kg)				
Gastric blood to gastric tissue <i>PAGIc</i>	1.00	1.00	1.00	1.00
Gastric tissue to gastric juice <i>PAGIJc</i>	1.00	1.00	1.00	1.00
Thyroid stroma to follicle <i>PATFc</i>	6.0x10 <sup>-5</sup>	6.0x10 <sup>-5</sup>	4.0x10 <sup>-5</sup>	4.0x10 <sup>-5</sup>
Thyroid follicle to colloid (lumen) <i>PATLc</i>	0.01	0.01 <sup>b</sup>	0.01	0.01
Skin blood to skin tissue <i>PASk</i>	1.00	1.00	0.50	1.00



## 3. HEALTH EFFECTS

**Table 3-6. Perchlorate Chemical-specific Parameters for Rat Gestation and Lactation Models**

Parameters	Gestation		Lactation	
	Dam	Fetus	Dam	Pup
Placenta blood to placenta tissue <i>PAPc</i>	0.1	NA	NA	NA
Plasma to red blood cells <i>PARBCc</i>	1.00	1.00	1.00	1.00
Mammary blood to mammary tissue <i>PAMc</i>	0.04	NA	0.01	NA
Mammary tissue/milk <i>PAMkc</i>	NA	NA	0.10	NA
Clearance values (L/hour/kg)				
Urinary excretion <i>CIUc</i>	0.07	NA	0.07	0.0075
Fraction of pup urine ingested by dam	NA	NA	0.80	NA
Transfer from placenta to fetus <i>CITrans1c</i>	0.065	NA	NA	NA
Transfer from fetus to placenta <i>CITrans2c</i>	0.12	NA	NA	NA
Binding constants				
Association to binding sites <i>VmaxcB</i> (ng/hour/kg)	4.0x10 <sup>3</sup>	1.5x10 <sup>3</sup>	9.0x10 <sup>3</sup>	2.0x10 <sup>3</sup>
Affinity for binding sites <i>KmB</i> (ng/L)	1.0x10 <sup>4</sup>	1.5x10 <sup>4</sup>	1.0x10 <sup>4</sup>	1.0x10 <sup>4</sup>
Dissociation from plasma binding sites <i>CIUnbc</i> (hour <sup>-1</sup> )	0.034	0.01	0.034	0.01

<sup>a</sup>Parameters with two values indicate acute and drinking water parameters, respectively.

<sup>b</sup>Fetus was given maternal values for Vmax (scaled by fetal body weight) in the absence of data.

NA = not applicable

Source: Clewell et al. 2003a

## 3. HEALTH EFFECTS

**Table 3-7. Iodide Chemical-specific Parameters for Rat Gestation and Lactation Models**

Parameters	Gestation		Lactation	
	Dam	Fetus	Dam	Pup
Partition coefficients (unitless)				
Slowly perfused/plasma <i>PS</i>	0.21	0.21	0.21	0.21
Rapidly perfused/plasma <i>PR</i>	0.40	0.40	0.40	0.40
Fat/plasma <i>PF</i>	0.05	NA	0.05	0.05
Kidney/plasma <i>PK</i>	1.09	1.09	1.09	1.09
Liver/plasma <i>PL</i>	0.44	0.44	0.44	0.44
Gastric tissue/gastric blood <i>PGI</i>	1.00	1.00	1.00	1.20
Gastric juice/gastric tissue <i>PGIJ</i>	2.00	2.00	1.00	1.00
Skin tissue/skin blood <i>PSk</i>	0.70	0.70	0.70	1.00
Thyroid tissue/thyroid blood <i>PTF</i>	0.15	0.15	0.15	0.15
Thyroid lumen/thyroid tissue <i>PTL</i>	7.0	7.0	7.0	7.0
Red blood cells/plasma <i>PRBC</i>	1.00	1.00	1.00	1.00
Placenta/plasma <i>PPI</i>	0.40	NA	NA	NA
Mammary/plasma <i>PM</i>	0.66	NA	NA	NA
Mammary tissue/mammary blood <i>PM</i>	NA	NA	0.80	NA
Mammary/plasma <i>PMk</i>	NA	NA	1.0	NA
Max capacity, <i>Vmaxc</i> (ng/hour/kg)				
Thyroid follicle <i>VmaxcTF</i>	$4.4 \times 10^4$	$0-5.0 \times 10^4$	$5.0 \times 10^4$	$1.3 \times 10^4$
Thyroid colloid <i>VmaxcTL</i>	$4.0 \times 10^6$	$4.0 \times 10^{6b}$	$6.0 \times 10^7$	$6.0 \times 10^7$
Skin <i>VmaxcSk</i>	$6.0 \times 10^4$	$7.0 \times 10^5$	$4.0 \times 10^5$	$2.5 \times 10^5$
Gut <i>VmaxcGI</i>	$1.0 \times 10^6$	$2.0 \times 10^6$	$2.0 \times 10^6$	$2.0 \times 10^6$
Placenta <i>VmaxcP</i>	$5.5 \times 10^4$	NA	NA	NA
Mammary <i>VmaxcM</i>	$4.0 \times 10^4$	NA	$8.0 \times 10^5$	NA
Milk <i>VmaxcMk</i>	NA	NA	$4.0 \times 10^5$	NA
Affinity constants, <i>Km</i> (ng/L)				
Thyroid follicle <i>KmTF</i>	$4.0 \times 10^6$	$4.0 \times 10^6$	$1.5 \times 10^5$	$1.5 \times 10^5$
Thyroid colloid <i>KmTL</i>	$1.0 \times 10^9$	$1.0 \times 10^9$	$1.0 \times 10^8$	$1.0 \times 10^8$
Skin <i>KmSk</i>	$4.0 \times 10^6$	$4.0 \times 10^6$	$1.5 \times 10^5$	$1.5 \times 10^5$
Gut <i>KmGI</i>	$4.0 \times 10^6$	$4.0 \times 10^6$	$1.5 \times 10^5$	NA
Placenta <i>KmP</i>	$4.0 \times 10^6$	NA	NA	NA
Mammary <i>KmM</i>	$4.0 \times 10^6$	NA	$4.0 \times 10^6$	NA
Milk <i>KmMk</i>	NA	NA	$1.0 \times 10^7$	NA
Permeability area cross-products (L/hour/kg)				
Gastric blood to gastric tissue <i>PAGIc</i>	0.80	0.10	0.80	0.04
Gastric tissue to gastric juice <i>PAGIJc</i>	0.60	0.30	0.60	0.09
Thyroid stroma to follicle <i>PATFc</i>	$1.0 \times 10^{-4}$	$1.0 \times 10^{-4}$	$1.0 \times 10^{-4}$	$1.0 \times 10^{-4}$
Thyroid follicle to colloid (lumen) <i>PATLc</i>	$4.0 \times 10^{-7}$	$4.0 \times 10^{-4}$	$1.0 \times 10^{-4}$	$1.0 \times 10^{-4}$
Skin blood to skin tissue <i>PASk</i>	0.10	0.02	0.20	0.02

## 3. HEALTH EFFECTS

**Table 3-7. Iodide Chemical-specific Parameters for Rat Gestation and Lactation Models**

Parameters	Gestation		Lactation	
	Dam	Fetus	Dam	Pup
Placenta blood to placenta tissue <i>PAPc</i>	0.005	NA	NA	NA
Plasma to red blood cells <i>PARBCc</i>	1.00	1.00	1.00	1.00
Mammary blood to mammary tissue <i>PAMc</i>	0.01	NA	0.02	NA
Mammary tissue/milk <i>PAMkc</i>	NA	NA	0.02	NA
Clearance values (L/hour/kg)				
Urinary excretion <i>CIUc</i>	0.03	NA	0.06	0.012
Fraction of pup urine ingested by dam	NA	NA	0.80	NA
Incorporation of iodide into hormones <i>CIProdc</i>	0.03	NA	0.10	0.06
Incorporated iodine secretion to serum <i>CSecrC</i>	$1.0 \times 10^{-6}$	NA	$7.0 \times 10^{-7}$	$1.0 \times 10^{-6}$
Deiodination	NA	NA	0.02	0.025
Transfer from placenta to fetus <i>CITrans1c</i>	0.06	NA	NA	NA
Transfer from fetus to placenta <i>CITrans2c</i>	0.12	NA	NA	NA
Binding constants				
Association to binding sites <i>VmaxcB</i> (ng/hour/kg)	NA	NA	$1.5 \times 10^3$	500
Affinity for binding sites <i>KmB</i> (ng/L)	NA	NA	$1.0 \times 10^5$	$1.0 \times 10^5$
Dissociation from plasma binding sites <i>CIUnbc</i> (hour <sup>-1</sup> )	NA	NA	0.09	0.05

<sup>a</sup>Parameters with two values indicate acute and drinking water parameters, respectively.

<sup>b</sup>Fetus was given maternal values for Vmax (scaled by fetal body weight) in the absence of data.

NA = not applicable

Source: Clewell et al. 2003a

## 3. HEALTH EFFECTS

other changes in radioiodide metabolism in the thyroid (e.g., hormone production and secretion) that are not simulated by the model.

The adult human model (nonpregnant, non-lactating) also predicted reasonably well (i.e., within 1–2 standard deviations of observations) perchlorate concentrations in plasma and urine in subjects who received oral doses of perchlorate (Durand 1938; Eichler 1929; Greer et al. 2002; Kamm and Drescher 1973; Merrill et al. 2005). Model predictions of radioiodide in gastric juice, serum, thyroid, and urine following an intravenous dose of radioiodide also corresponded with observations made in healthy adults (Hays and Solomon 1965). Model predictions of thyroid radioiodine uptake in subjects who received oral doses of perchlorate agreed with observations when the kinetic parameters for iodide in the thyroid (i.e., maximum transport into the thyroid follicle) were adjusted to achieve good correspondence to the observations (Greer et al. 2002; Merrill et al. 2005). When the model was calibrated by adjusting the maximum transport rate for iodide into the thyroid follicle, it accurately predicted the observed time course for radioiodine uptake in a Graves' disease patient who received a single tracer dose of radioiodine (Stanbury and Wyngaarden 1952); however, the model substantially overpredicted iodide uptake after the same patient received a dose of perchlorate. The error in predictions of the effect of perchlorate on iodide uptake may reflect humoral regulation of iodide transport and organification mechanisms or a response to perchlorate in Graves' disease patients that is not simulated in the model.

The rat maternal/fetal model was evaluated by comparing predictions of perchlorate concentrations in maternal and fetal serum and maternal thyroid in rats exposed to perchlorate in drinking water (Clewell et al. 2001, 2003a). Model predictions agreed well (within 1–2 standard deviations of observations) with observations. Predictions of maternal and fetal radioiodine uptakes in thyroid were also in reasonable agreement with observations in rats that received single injections of iodine with or without single injections or oral gavage doses of perchlorate, or at the conclusion of 18 days of exposures to perchlorate in drinking water (Brown-Grant 1966; Clewell et al. 2001, 2003a; Sztanyik and Turai 1988).

Similar outcomes occurred in evaluations of the lactating dam/neonate model (Clewell et al. 2003b). The model accurately predicted serum and thyroid iodide concentrations in the dam and neonate following single intravenous injections of radioactive iodine, with or without concurrent injection of perchlorate, and in maternal thyroid following an 18-day exposure to perchlorate in drinking water (Clewell et al. 2003b). Model predictions of radioiodide levels in mammary gland and milk, in rats that did or did not receive single doses of perchlorate, corresponded with observations (Clewell et al. 2003b).

## 3. HEALTH EFFECTS

The human pregnancy and lactation models were evaluated by comparing model predictions of perchlorate concentrations in serum with observations made in pregnant women (15 and 33 weeks of gestation) and their infants at birth (from cord blood), and in a group of children (mean age 7.4 years) (Télliez et al. 2005). Exposures simulated in the model were the continuous perchlorate intake corresponding to the mean  $\pm 1$  standard deviation drinking water exposure concentrations ( $114 \pm 13$  ppm) for a cohort in the Télliez et al. (2005) study. Model predictions for maternal, fetal, and child serum perchlorate concentrations agreed well (within  $\pm 1$  standard deviation of observed means) with observations. Télliez et al. (2005) also reported perchlorate concentrations in breast milk measured at 5–6 weeks postpartum. Simulation of the continuous perchlorate intake corresponding to the group means ( $\pm$  standard deviation) of drinking water exposure concentrations ( $5.8 \pm 0.6$  ppm or  $114 \pm 13$  ppm) yielded predictions of breast milk perchlorate concentrations that were within  $\pm 1$  standard deviation of the observed means.

**Risk assessment.** The rat (Clewell et al. 2003a, 2003b; Merrill et al. 2003) and human models (Clewell et al. 2007; Merrill et al. 2005) can be used to estimate the human equivalent exposure level for perchlorate that would give rise to a given percent inhibition of thyroidal radioiodide uptake. The models do not include downstream effects on the thyroid axis, such as decreases in serum thyroid hormones. The Clewell et al. and Merrill et al. model estimates have been used to extrapolate dose-response relationships for perchlorate observed in rats to humans, and across various human lifestages (e.g., fetus, neonate, child, adult, pregnancy, lactation). External dose–internal dose relationships for various human lifestages predicted from the human models are presented in Tables 3-8 and 3-9 (Clewell et al. 2007). The models predict a relatively high vulnerability of the fetus, pregnant woman, and lactating woman to perchlorate-induced thyroid iodine uptake, compared to other lifestages (i.e., greater inhibition of thyroid iodide uptake occurs in these lifestages in association with lower external doses), compared to neonates, child or nonpregnant or nonlactating adult). The potential impact of external exposures to perchlorate on inhibition on thyroidal radioiodide uptake is sensitive to assumptions about urinary clearance of perchlorate, especially in neonates and young infants. The estimates based on external exposures from consumption of drinking water are also dependent on assumptions regarding age-related changes in contribution of drinking water to liquid consumption across lifestages (e.g., milk in children).

**Target tissues.** Tissues simulated in the perchlorate models are shown in Figures 3-4 and 3-5. The models were designed to calculate perchlorate concentrations in serum and thyroid and inhibition of radioiodide uptake into the thyroid resulting from exposures to perchlorate for various lifestages (e.g., fetus, neonate, child, adult, pregnancy, lactation).

## 3. HEALTH EFFECTS

**Table 3-8. Model-predicted Serum  $\text{ClO}_4^-$  Area Under the Curve (AUC) Across Lifestages**

External dose (mg/kg/day)	Fetus <sup>a</sup> (mg/L)	Neonate <sup>b</sup> (mg/L)	Child (mg/L)	Adult (mg/L)	Pregnant <sup>a</sup> woman (mg/L)	Lactating <sup>c</sup> woman (mg/L)
0.001	0.010	0.008	0.001	0.002	0.005	0.008
0.01	0.06	0.05	0.01	0.01	0.04	0.05
0.1	0.2	0.2	0.1	0.1	0.3	0.3
1.0	1.2	0.5	0.8	1.0	2.5	2.5

<sup>a</sup>Fetus and pregnant woman shown in gestation week 38.

<sup>b</sup>Neonate shown at postnatal month 1.5.

<sup>c</sup>Lactating woman shown at postnatal day 7.

Source: Clewell et al. 2007

## 3. HEALTH EFFECTS

**Table 3-9. Model-predicted Inhibition of Thyroid Iodide Uptake (Percent Inhibition) Across Lifestages**

External dose (mg/kg/day)	Percent Inhibition					
	Fetus <sup>a</sup>	Neonate <sup>b</sup>	Child	Adult	Pregnant <sup>a</sup> woman	Lactating <sup>c</sup> woman
0.001	1.1	0.9	0.3	0.6	1.0	1.1
0.01	10	8	3	4	9	10
0.1	49	34	21	31	50	54
1.0	84	63	72	81	91	92

<sup>a</sup>Fetus and pregnant woman shown in gestation week 38 (birth).

<sup>b</sup>Neonate shown at postnatal month 1.5.

<sup>c</sup>Lactating woman shown at postnatal day 7.

Source: Clewell et al. 2007

## 3. HEALTH EFFECTS

**Species extrapolation.** The models are designed for applications to rat or human dosimetry and cannot be applied to other species without modification and validation.

**Interroute extrapolation.** The models are designed to simulate intravenous or oral exposures to perchlorate and cannot be applied to other routes of exposure without modification and validation.

### 3.5 MECHANISMS OF ACTION

#### 3.5.1 Pharmacokinetic Mechanisms

Perchlorate is readily soluble in water and is quickly absorbed through the digestive tract. The mechanism by which perchlorate is transferred from the digestive system to the blood has not been investigated. Since Durand (1938) detected perchlorate in the urine of subjects 10 minutes after oral administration, it seems likely that absorption of perchlorate may begin in the stomach and continue in the small intestine. Anbar et al. (1959) determined that perchlorate eliminated in the urine 3 hours after an oral dose had not been metabolized (see Section 3.4.1). Whether microflora of the gut or intestinal enzymes modify perchlorate that is finally eliminated in the feces has not been investigated.

Whatever the mechanism of absorption, perchlorate is distributed throughout the body via the circulation (see Section 3.4.2). It apparently is not metabolized (Anbar et al. 1959) and it binds only weakly to cations. Concentrations of perchlorate rise above serum levels only for those tissues that are equipped with the anion transporter mechanism that normally takes up iodide. The effects of perchlorate on the thyroid gland are known from studies on humans and animals (see Section 3.2); perchlorate levels in the thyroid reach a maximum several hours after administration. Chow and co-workers (Chow and Woodbury 1970; Chow et al. 1969) determined that perchlorate is taken up from interstitial fluid by active transport at the base of thyroid follicular cells, which then actively transport it out into the follicular lumen. The effects of perchlorate on the transfer of maternal iodide in milk have been studied in rats and cattle (Clewel et al. 2003b; Dobian et al. 2007; Howard et al. 1996; Kirk et al. 2005). The accumulation of perchlorate in ducts of the salivary gland has been described in mice (Lazarus et al. 1974). Studies on rodents have demonstrated that perchlorate can cross the placental barrier and affect the thyroid gland of the fetus (see Section 3.2).

Perchlorate transport in the thyroid gland and in other tissues that express NIS (e.g., mammary epithelium) appears to be mediated by NIS. Perchlorate is accumulated in thyroid follicle cells and lumen



## 3. HEALTH EFFECTS

against an electrochemical gradient, indicating an active transport mechanism, and possibly different mechanisms at the basolateral and luminal membranes (Chow and Woodbury 1970; Chow et al. 1969; Clewell et al. 2004; Goldman and Stanbury 1973). Thyroid uptake of perchlorate in hypophysectomized rats is stimulated by administration of TSH (Chow et al. 1969). Perchlorate competitively inhibits iodide transport in thyroid slices, cultured thyrocytes, cultured cells transformed to express thyroid NIS, and thyrocyte membrane vesicles (Dohán et al. 2007; Eskandari et al. 1997; O'Neill et al. 1987; Tran et al. 2008; Wolff and Maurey 1962, 1963; Yoshida et al. 1997). The above observations suggest that perchlorate transport into thyroid follicle cells, and possibly into other tissues where NIS is expressed, is mediated by NIS (Wolff 1998). Perchlorate uptake into thyroid cells is stimulated by TSH (Tran et al. 2008). Unlike the NIS-mediated transport of iodide, transport of perchlorate by NIS appears to be electroneutral (Dohán et al. 2007; Eskandari et al. 1997; Yoshida et al. 1997). Chinese hamster ovary (CHO) cells transfected with the rat thyroid NIS gene and *Xenopus* oocytes transfected with rat thyroid NIS mRNA express active NIS that exhibits a Na(2):I(1) stoichiometry, is electrogenic (inward directed current), occurs against an electrochemical gradient for iodide in the presence of an inward electrochemical gradient for sodium, and is inhibited by perchlorate (Eskandari et al. 1997; Yoshida et al. 1997). Both systems, when clamped at an interior negative potential (40–50 mV), exhibit sodium-dependent inward currents in the presence of  $I^-$  and  $SCN^-$ ; the transfected oocyte exhibits sodium-dependent inward currents in the presence of a variety of anions, including  $I^-$ ,  $ClO_3^-$ ,  $SCN^-$ ,  $SeCN^-$ ,  $NO_3^-$ ,  $Br^-$ ,  $BF_4^-$ ,  $IO_4^-$ ,  $BrO_3^-$ ,  $SO_4^{2-}$ ,  $F^-$ , and  $HPO_4^{2-}$ . However, these systems do not show perchlorate-stimulated currents in the presence or absence of a favorable inward-directed Na gradient. FRTL5 cells and other cell types that have been transfected to express NIS transport the structural tetrahedral oxyanion analogs of perchlorate, perrhenate ( $ReO_4^-$ ), and pertechnetate ( $TcO_4^-$ ), providing further support for NIS-mediated perchlorate transport. Furthermore, in MDCK cells transfected to express NIS-mediated electrogenic transport of iodide, transport of perchlorate, perrhenate ( $ReO_4^-$ ), and pertechnetate ( $TcO_4^-$ ) was also electroneutral (Dohán et al. 2007).

Studies of the kinetics of excretion and elimination of perchlorate from serum in humans indicate that absorbed perchlorate is excreted in urine with an elimination half-time of 8–14 hours (Durand 1938; Greer et al. 2002; Lawrence et al. 2000). Thus, in humans, perchlorate would not be expected to accumulate in the body with prolonged exposure. Based on an elimination half-time of approximately 8–12 hours, a steady state would be achieved within 3–4 days of continuous exposure. Rapid elimination of perchlorate (half-time of 20 hours) has also been observed in rats (Eichler and Hackenthal 1962; Fisher et al. 2000; Goldman and Stanbury 1973; Yu et al. 2002). The mechanisms of renal excretion of perchlorate are not understood.

## 3. HEALTH EFFECTS

**3.5.2 Mechanisms of Toxicity**

Perchlorate is an inhibitor of NIS, the primary mechanism by which iodide enters thyroid follicle cells from the blood, and the first step in the uptake of iodide into the thyroid and formation of thyroid hormones (Figure 3-6; Carrasco 1993; Taurog 2000; Wolff 1998). All toxic effects of perchlorate on the thyroid hormone system derive directly or secondarily from this mechanism. Because the primary and most sensitive target of the perchlorate anion is the thyroid gland, only toxicities related to the thyroid hormone system are addressed below.

**Thyroid Hormone.** The thyroid hormone, T3, is essential for normal development of the nervous system and for the regulation of metabolism of cells in nearly all tissues of the body. Adverse effects on a wide variety of organ systems can result from disruption in the availability of T3 to target tissues. Organ systems affected by disturbances in T3 levels include the skin, cardiovascular system, pulmonary system, kidneys, gastrointestinal tract, liver, blood, neuromuscular system, central nervous system, skeleton, male and female reproductive systems, and numerous endocrine organs, including the pituitary and adrenal glands.

T3 exerts its wide range of actions by binding to thyroid hormone receptors (TRs) in the cell nucleus, which, when bound with hormone, modulate the transcription of a variety of genes (Anderson et al. 2000). TRs consist of a family of structurally similar proteins within the so-called *steroid receptor superfamily* that includes receptors for steroid hormones, vitamin D, retinoic acid, and peroxisomal proliferator activators (Lazar 1993). Each receptor has DNA binding domains capable of forming two zinc fingers; the sequence of the latter determine hormone receptor specificity to response elements on DNA that modulate gene transcription of hormone-sensitive genes. A ligand binding domain is responsible for conferring specificity for hormone binding.

Modulation of gene expression occurs when the T3–TR complex binds to a region of DNA associated with a thyroid hormone response element (TRE). Studies in humans and experimental animals have identified TREs associated with a variety of genes, including growth hormone, myelin basic protein,  $\alpha$ -myosin heavy chain, malic enzyme and protein S14 (important in lipogenesis), sarcoplasmic reticulum  $\text{Ca}^{2+}$ -ATPase, Pcp-2 (in Purkinje cells),  $\text{Na}^{+}/\text{K}^{+}$ -ATPase, and TSH (Anderson et al. 2000; Klein and Levey 2000; Schwartz et al. 1994).

## 3. HEALTH EFFECTS

Figure 3-6. Pathways Uptake and Metabolism of Iodide in the Thyroid Gland\*

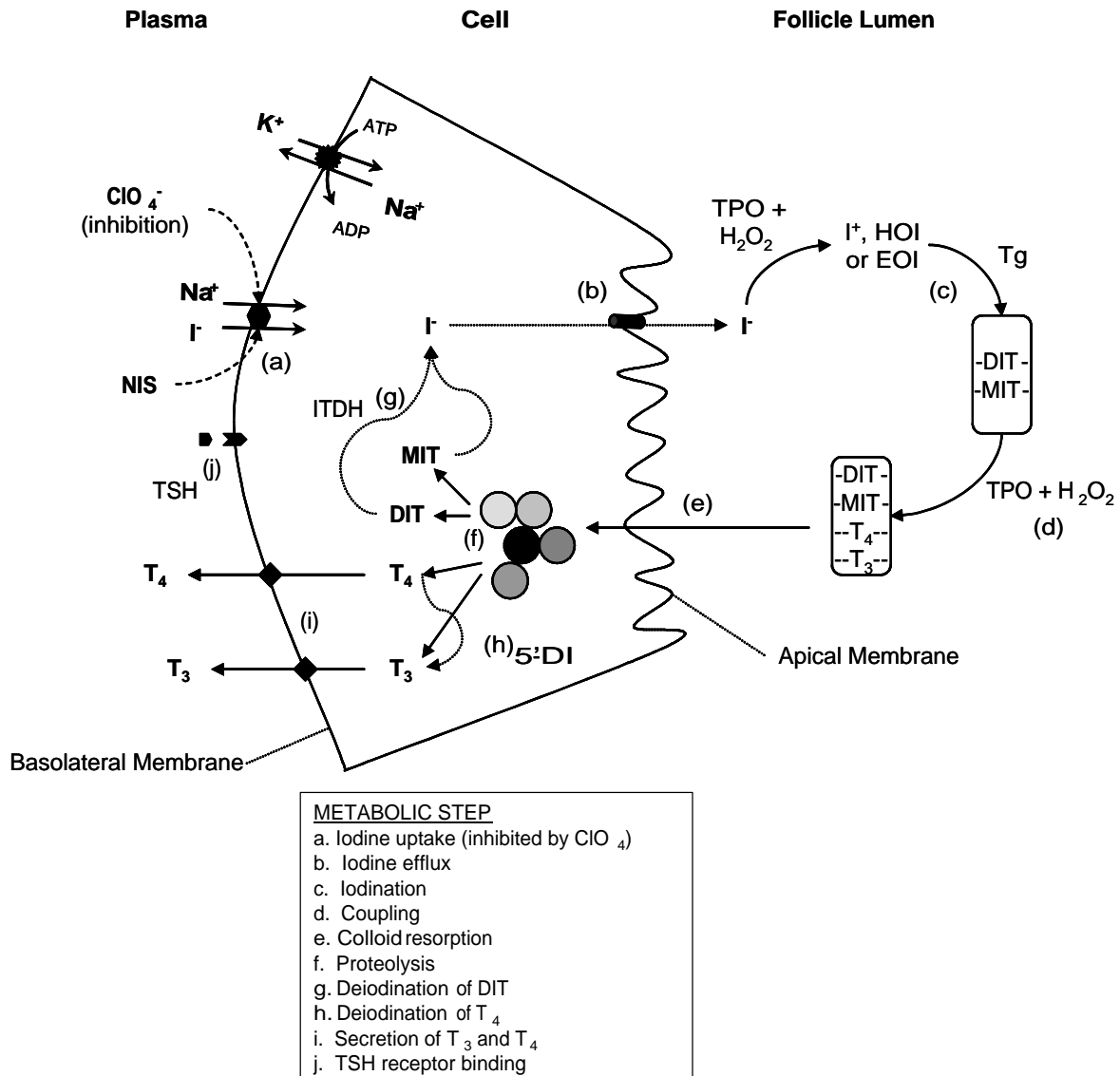

\*The diagram depicts a single thyroid follicle cell, with the plasma side of the follicle on the left and the follicle lumen on the right. Iodide uptake (a) occurs through a  $\text{Na}^+/\text{I}^-$  symporter (NIS) in the basolateral membrane; the perchlorate ion competitively inhibits the NIS, preventing uptake of iodide into the follicle cell. Efflux into the follicle lumen (b) is thought to occur through an  $\text{I}^-$  channel in the apical membrane. Iodination occurs in the follicle lumen (c). The enzyme thyroid peroxidase (TPO), depicted in the follicle lumen, is actually located in the apical membrane. Deiodination of iodotyrosines (g) is catalyzed by a microsomal enzyme, iodotyrosine dehalogenase (ITDH); monodeiodination of  $\text{T}_4$  (h) is catalyzed by the microsomal enzyme, 5'-diodinase. All steps in the uptake of iodine and synthesis of thyroid hormones (a–h) are stimulated by binding of thyroid stimulating hormone (TSH) to a receptor in the basolateral membrane.

DIT = diiodotyrosine; EOI = enzyme-linked species; HOI = hypoidous acid; ITDH = iodotyrosine dehalogenase; MMI = methimazole; MIT = monoiodotyrosine; PTU = propylthiouracil;  $\text{T}_3$  = triiodothyronine;  $\text{T}_4$  = thyronine; Tg = thyroglobulin; TPO = thyroid peroxidase; TSH = thyroid stimulating hormone

Source: adapted from Taurog 2000

## 3. HEALTH EFFECTS

Adverse effects on cell metabolism and growth can result from either understimulation or overstimulation of target tissues by T3. The amount of T3 available to target tissues is highly controlled by feedback regulation of the production, secretion, and elimination of both T3 and its metabolic precursor, T4 (Figure 3-7). Major components of this mechanism include negative feedback control mediated by T4 and T3 of the synthesis and release of thyrotropin-releasing hormone (TRH) in the hypothalamus and of TSH in the pituitary. TRH stimulates the synthesis and secretion of TSH in the pituitary and modulates the biologic potency of TSH. The latter is thought to result from effects of TRH on posttranslational glycosylation of TSH (Cohen et al. 2000; Scanlon and Toft 2000). TSH promotes growth of the thyroid gland follicle cells and stimulates thyroid iodide uptake and synthesis and secretion of T4 and T3 (Spaulding 2000).

The metabolism of T4 and T3 is also regulated by feedback control mechanisms (Darras et al. 1999). T3 is synthesized from the deiodination of T4 in a reaction catalyzed by selenium requiring, microsomal enzymes known as iodothyronine deiodinases. Although some production of T3 occurs in the thyroid, most of the T3 that is available to extrathyroidal target tissues derives from deiodination of T4 that occurs outside of the thyroid (Figure 3-7). The liver and kidney are thought to be major sites of production of T3 in the circulation; however, local tissue production of T3 from T4 is thought to be the predominant source of T3 in the brain and pituitary. Iodothyronine deiodinases also catalyze the inactivation of T4 and T3. The activities of deiodinases are under feedback control, mediated by T3, T4, and reverseT3 (rT3) an inactive deiodination product of T4 (Darras et al. 1999).

***Mechanism of Uptake of Iodide into the Thyroid.*** Synthesis of T4 and T3 in the thyroid is dependent on delivery of iodide into the thyroid follicle where the iodination of thyroglobulin occurs in the first steps of hormone synthesis (Figure 3-6). Uptake of iodide into the thyroid is facilitated by a membrane carrier in the basolateral membrane of the thyroid follicle cell (Carrasco 1993; Levy et al. 1998a; Shen et al. 2001). The carrier, or NIS, catalyzes the simultaneous transfer of Na<sup>+</sup> and I<sup>-</sup> across the basolateral membrane (Chambard et al. 1983; Iff and Wilbrandt 1963; Nilsson et al. 1990). The NIS enables the follicle cell to achieve intracellular/extracellular concentration ratios of 10–50 for iodide (Andros and Wollman 1991; Bagchi and Fawcett 1973; Shimura et al. 1997; Vroye et al. 1998; Weiss et al. 1984b; Wolff 1964).

The NIS has been studied extensively in several *in vitro* preparations, including isolated plasma membrane vesicles of mammalian thyroid (O'Neill et al. 1987), FRTL-5 cells, a cell line derived from normal rat thyroid (Weiss et al. 1984b), *Xenopus laevis* oocytes transformed by intracellular injection of FRTL-5 RNA to express NIS (Eskandari et al. 1997), and other mammalian cells cultures transformed to

## 3. HEALTH EFFECTS

**Figure 3-7. Hypothalamic-pituitary-thyroid (HPT) Feedback Pathways for Regulation of Thyroid Hormone Production and Secretion\***

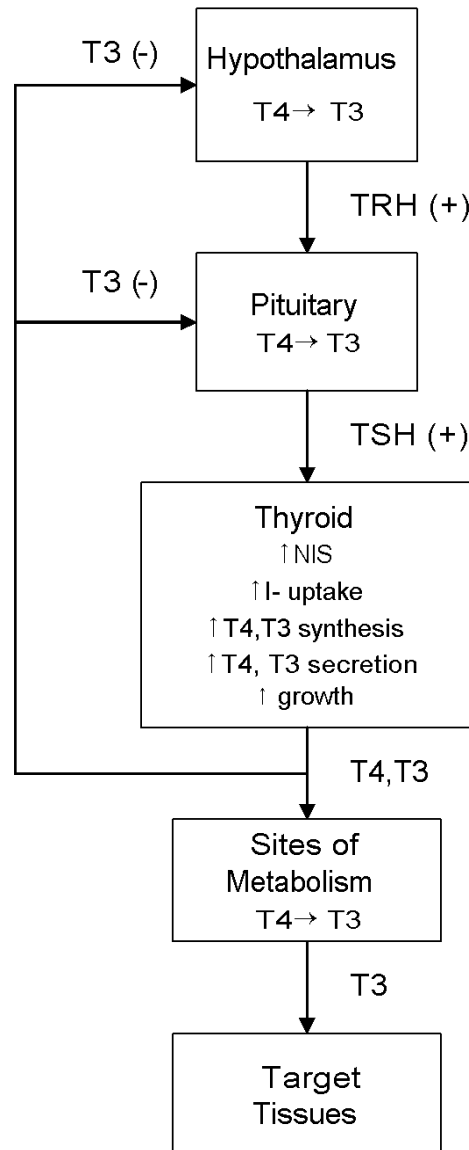

\*T3 inhibits the synthesis and secretion of thyroid releasing hormone (TRH) in the paraventricular nuclei of the hypothalamus and the synthesis and secretion of thyroid stimulating hormone (TSH) in the thyrotrophs of the anterior pituitary. Most of the T3 in these tissues derives from local deiodination of T4; as a result, TRH and TSH synthesis and secretion are sensitive to circulating levels of both T3 and T4. Doses of perchlorate that decrease circulating levels of T3 or T4 can trigger the HPT feedback mechanism to stimulate thyroid growth, including hypertrophy and hyperplasia of follicle cells. Chronic stimulation of thyroid growth is thought to be contributor to the development of thyroid tumors in rats exposed to perchlorate.

## 3. HEALTH EFFECTS

express NIS (Levy et al. 1997; Nakamura et al. 1990; Smanik et al. 1996; Yoshida et al. 1997). Iodide transport by the NIS is inhibited by other anions, most notably, thiocyanate ( $\text{SCN}^-$ ) and perchlorate ( $\text{ClO}_4^-$ ) (Carrasco 1993; Wolff 1964). Thiocyanate is one of several anions other than  $\text{I}^-$  that can be transported by the NIS, including  $\text{SeCN}^-$ ,  $\text{NO}_3^-$ ,  $\text{ClO}_3^-$ ,  $\text{Br}^-$ ,  $\text{BF}_4^-$ ,  $\text{IO}_4^-$ ,  $\text{BrO}_3^-$ ,  $\text{ReO}_4^-$ , and  $\text{TcO}_4^-$  (Eskandari et al. 1997; Van Sande et al. 2003). Direct evidence for perchlorate transport by NIS (i.e., measurement of radioperchlorate flux through the NIS) is lacking; however, transport activity is likely given that the NIS transports the structural analogs, perrhenate and pertechnetate. Perchlorate transport by NIS may be electroneutral, preventing its detection from measurements of ion currents or electrochemical gradients (Dohán et al. 2007; Eskandari et al. 1997; Yoshida et al. 1997).

The NIS is expressed in a variety of other tissues, including breast tissue where it is thought to function in the transport of iodide into breast milk (Levy et al. 1997; Smanik et al. 1997; Spitzweg et al. 1998). In the rat, expression of the NIS, or a structurally similar membrane protein, increases during nursing and decreases after weaning (Levy et al. 1998a). In the mouse, expression of NIS in mammary tissue appears to be stimulated by prolactin (Perron et al. 2001; Rillema and Rowady 1997; Rillema et al. 2000).

***Inhibition of Thyroid NIS and Thyroid Hormone Production by Perchlorate.*** Perchlorate inhibition of NIS can limit the availability of iodide needed for the production of T4 and T3 in the thyroid. The degree of perchlorate-induced iodide uptake inhibition required to impair T4 or T3 synthesis has not been studied, but the duration of exposure required to produce a reduction in circulating levels of thyroid hormones appears to vary with species. In this regard, the duration of perchlorate exposure required to cause a reduction in circulating levels of thyroid hormones appears to be shorter in rats than in humans (see Section 3.5.3). This difference is thought to derive from the rat thyroid gland having a smaller store of iodinated thyroglobulin that is more quickly depleted when the availability of iodide is limited, and from the rat having a shorter T4 half-life (about 1 day) compared to humans (about 7 days). In humans, THBG functions as an important storage depot for circulating T4 and a buffer for homeostatic regulation of free T4 levels in serum (Robbins 2000). If the production of T4 and T3 is impaired sufficiently to deplete the thyroid of stored iodinated thyroglobulin, the thyroid cannot produce or secrete amounts of T4 and T3 needed to support physiological demands, circulating levels of T4 (fT4) and T3 decrease, and a state of thyroid hormone insufficiency ensues. A decrease in the levels of circulating thyroid hormones triggers HPT feedback control mechanisms that serve to adjust thyroïdal iodide transport and hormone production in response to changes in circulating levels of T4, T3, and iodide. Major components of this mechanism include inhibition of the secretion of TRH from the hypothalamus, TRH-stimulated secretion of TSH from the pituitary, TSH-stimulated induction of thyroid follicle cell NIS (i.e., *upregulation*) and

## 3. HEALTH EFFECTS

other thyroid cell proteins, increased capacity for transport of iodide into thyroid follicle cells, and increased synthesis and secretion of T4 and T3 from the thyroid. This system normally maintains circulating levels of T4 and T3 within narrow individual limits (Andersen et al. 2002). Doses of perchlorate that are sufficient to decrease circulating levels of thyroid hormones outside of these individual limits will result in increased secretion of TSH. Thus, an increase in the circulating levels of TSH is a sign that perchlorate has perturbed circulating levels of thyroid hormones. In humans, intra-individual variation in T4 levels is less than inter-individual variation, suggesting that the HPT feedback mechanism can detect relatively small changes in thyroid hormone levels that are well within the range of variation expected in populations (Andersen et al. 2002). Triggering of the HPT feedback response in profound iodide deficiency can affect the response of the thyroid to perchlorate. Rats maintained on an iodine-deficient diet for sufficient periods to lower serum T<sub>4</sub> levels, exhibited higher 24-hour thyroid radioiodide uptake when exposed to perchlorate in drinking water (1.1–28 mg/L) for 5 weeks than iodine-replete rats (Paulus et al. 2007). The increased resistance to perchlorate-induced inhibition of thyroid iodide uptake in iodine deficiency has been attributed, at least in part, to induction of NIS in the thyroid, which partially overcomes the competitive inhibition of NIS resulting from a given dosage of perchlorate.

***Perchlorate-induced Hypothyroidism.*** Inhibition of thyroid iodide uptake can potentially deplete stores of T4 and T3 in the thyroid and lower serum T4 and T3 levels. Thus, perchlorate has the potential for producing hypothyroidism or for aggravating an ongoing hypothyroid condition. The term hypothyroidism refers to a state of suppressed production and/or secretion of thyroid hormones. The term clinical hypothyroidism refers to a condition in which the circulating levels of T4 and/or T3 are depressed below their normal ranges (usually accompanied with elevated serum TSH levels above the normal range) and in which there are clinical symptoms of thyroid hormone insufficiency (Ladenson 2000). Typical normal ranges for hormone levels are shown in Table 3-10. Subclinical hypothyroidism refers to an increase in serum TSH (usually mild) with serum T4 and T3 remaining in their respective normal ranges for age. An important question is whether small changes in circulating levels of thyroid hormones that trigger the HPT feedback mechanism, but do not fall outside of the normal population range, are detected as thyroid hormone insufficiency in tissues other than the hypothalamus or pituitary, including the embryo or fetal brain.

In humans, relatively large doses of perchlorate (600–900 mg/day, 8–13 mg/kg/day) are required to deplete thyroidal iodine stores sufficiently to decrease serum levels of T4 (Brabant et al. 1992; Bürgi et al. 1974). A 4-week oral exposure to 900 mg/day (approximately 13 mg/kg/day) did not produce clinical hypothyroidism in healthy adults (Brabant et al. 1992); however, a dosage considerably lower,

## 3. HEALTH EFFECTS

**Table 3-10. Typical Reference Ranges for Serum Thyroid Hormones and TSH in Humans**

Hormone	Reference range	
	Metric	SI unit
Total T4	4–11 µg/dL	60–140 nM <sup>a</sup>
Free T4	0.7–2.1 ng/dL	10–25 pM <sup>a</sup>
Total T3	75–175 ng/dL	1.1–2.7 nM <sup>a</sup>
Free T3	0.2–0.5 ng/dL	3–8 pM
Reverse T3	15–45 ng/dL	0.2–0.7 nM
TSH	0.3–4.0 mU/L <sup>b,c</sup>	1–15 pM

<sup>a</sup>Children may have higher levels

<sup>b</sup>Assumes a biologic potency of 7–15 mU/mg

<sup>c</sup>Higher in neonates (de Zegher et al. 1994)

SI = Systems Integration; T3 = 3,5,3'-triiodo-L-thyronine; T4 = 3,5,3',5'-tetraiodo-L-thyronine (thyroxine);  
TSH = thyroid stimulating hormone

Sources: Stockigt 2000; Vanderpump and Tunbridge 1996



## 3. HEALTH EFFECTS

0.5 mg/kg/day for 14 days, produced a 70% inhibition of thyroid iodide uptake with no effects on the levels of circulating T4, T3, or TSH in serum, at least over the 14-day dosing period (Greer et al. 2002). In these short-term studies, it is possible that thyroid hormone production could have been suppressed by perchlorate inhibition of thyroid NIS without changing serum thyroid hormone levels. This could occur because the human adult thyroid contains a surplus of T4 to support normal levels of serum levels for several months (Greer et al. 2002). The ability of high dosages of perchlorate to lower T4 and T3 levels in serum is the basis for use of perchlorate in the pharmacological management of thyrotoxicosis, the clinical manifestation of abnormally elevated circulating levels of T4 and/or T3 (Soldin et al. 2001).

***Perchlorate-induced Thyroid Enlargement and Cancer.*** Although there is no direct evidence of perchlorate causing cancer in humans, perchlorate has produced thyroid cell hyperplasia and papillary and/or follicular adenomas and/or carcinomas in rats and mice (see Section 3.2.2.7). Perchlorate itself does not appear to be genotoxic (see Section 3.3). Production of thyroid tumors in rodents appears to be related to perchlorate-induced inhibition of thyroid iodide uptake and the resulting triggering of the HPT feedback control mechanism that elevates serum TSH levels. Persistent stimulation of the thyroid by TSH results in hypertrophy and hyperplasia of thyroid follicle cells, which are reflected in an increase in the size and weight of the thyroid (goiter). Tumors appear to be a progression of this hyperplasia. The mechanism by which gland enlargement leads to thyroid tumors is not completely understood. Thyroid gland proliferation may increase the fixation of mutations in the thyroid and promote the development of autonomous nodules, regions of thyroid follicle tissue that are less responsive or unresponsive to serum TSH concentrations (Corvilain et al. 2000; Fagin 2000). Consistent with the concept that TSH-stimulation and the resulting thyroid cell hypertrophy and hyperplasia are contributing factors to thyroid tumorigenesis are the observations that thyroid tumors can be produced in rats by a variety of different treatments that chronically elevate serum TSH levels, including maintaining the animals on a diet deficient in iodide, or by exposing the animals to chemical agents (e.g., thiouracil compounds, sulfonamides) that disrupt thyroid hormone production (Capen 1997).

***Developmental Effects of Perchlorate.*** Thyroid hormones are essential for normal development of the nervous system, lung, skeletal muscle, and possibly other organ systems (Forhead et al. 2002; Hume et al. 2001; Porterfield and Hendrich 1993). The fetus is dependent on maternal thyroid hormones at least until the fetal thyroid begins to produce T4 and T3 (Zoeller and Crofton 2000). In humans, this occurs at approximately 16–20 weeks of gestation. Brain development begins in humans prior to the onset of fetal thyroid hormone production, with a major growth spurt occurring between 12 and 18 weeks of gestation with the beginning of neuron multiplication (Pintar 2000). This is followed by glial cell multiplication,

## 3. HEALTH EFFECTS

myelination, and formation of dendritic extensions and synapses, which begin at approximately 18 weeks, reaching their peak near the end of gestation and continuing through postnatal years 1 and 2 (Boyages 2000; Fisher and Brown 2000; Oppenheimer and Schwartz 1997). Thyroid hormones are present in human amniotic fluid at 8 weeks of gestation prior to the onset of fetal thyroid hormone production (Contempre et al. 1993; Thorpe-Beeston et al. 1991). Thyroid hormone receptors are present and occupied by hormone at this time as well, suggesting that the fetus is capable of responding to maternal thyroid hormones (Bernal and Pekonen 1984; Ferreiro et al. 1988). Calvo et al. (2002) showed that first trimester fetal tissues are exposed to concentrations of free T4 (FT4) that depend ultimately on the circulating maternal levels of T4 or FT4. Thus, a decrease in the maternal supply results in lower concentrations of FT4 in fetal fluids and, consequently, of T4 available to the developing brain. The contribution of maternal thyroid hormones to the fetal thyroid hormone status is also evident from infants who have an inherited disorder that abolishes T4 production but are born, nevertheless, with normal serum thyroid hormone levels (i.e., euthyroid) and become hypothyroid after birth if not administered thyroid hormones within 2 weeks after birth (Larsen 1989; Vulsma et al. 1989). This suggests that transfer during fetal life is at least partially protective in cases where the fetus cannot produce adequate amounts of T4, providing that the maternal thyroid hormone production is not compromised. However, athyrotic babies, although born euthyroid, show retarded skeletal maturation at birth, suggesting that fetal thyroid function during earlier phases of gestation may be necessary for normal skeletal development (Rovet et al. 1987; Wolter et al. 1979). Uncorrected maternal hypothyroidism, on the other hand, may result in impaired neurodevelopment of the fetus with severe long-lasting implications. For example, Pop et al. (1999) studied a cohort of 220 healthy children and found that children of women with FT4 levels below the 5<sup>th</sup> and 10<sup>th</sup> percentiles at 12 weeks of gestation showed impaired psychomotor development at 10 months of age. In women with the lowest 10<sup>th</sup> percentile FT4 concentrations at 12 weeks of gestation, maternal FT4 concentration was positively correlated with the children's psychomotor development. Haddow et al. (1999) measured TSH levels in serum collected from 25,216 women and found that the 7–9-year-old children of the 62 women with high TSH levels performed less well in 15 tests relating to intelligence, attention, language, reading ability, school performance, and visual-motor performance than children of women with normal TSH values. Their full-scale IQ scores on the Wechsler Intelligence Scale for Children averaged 4 points lower than those of the children of matched control women.

Studies in rats provide further support for the importance of maternal thyroid hormones in development. Both T4 and T3 are present in rat fetal tissues prior to the onset of hormone production by the fetal thyroid on approximately day 17 of gestation, and maternal hormones appear to make a significant contribution to hormone levels in the fetus in late gestation as well (Calvo et al. 1990; Escobar del Rey et

## 3. HEALTH EFFECTS

al. 1986; Morreale de Escobar et al. 1990; Zoeller and Crofton 2000). Furthermore, thyroid hormone-responsive genes that are important in early development of the brain are expressed in the rat fetus prior to fetal thyroid hormone production, and expression of these genes is sensitive to the maternal thyroid hormone status (Dowling and Zoeller 2000; Dowling et al. 2001). Disruption of the maternal thyroid hormone system of rats by removal of the maternal thyroid or maternal iodide deficiency results in decreased levels of thyroid hormones in the fetus, and maternal iodide deficiency will result in fetal iodide deficiency and congenital hypothyroidism (Escobar del Rey et al. 1986; Morreale de Escobar et al. 1985). These observations suggest an important role of maternal thyroid hormones in development of the rat fetus and that, by limiting the availability of thyroid hormones to the early fetus, suppression of maternal thyroid hormone production by perchlorate could translate into disruptions of fetal development. The availability of maternal T4 to the fetus appears to be particularly important for maintenance of T3 levels in the fetal rat brain. Treatment of pregnant rats with methimazole, an inhibitor of thyroid hormone synthesis, resulted in decreased levels of both T4 and T3 in fetal tissues, including fetal brain (Calvo et al. 1990). Maternal infusions of T4 restored brain T3 levels; however, maternal infusion of T3 had little restorative effect on brain T3 levels, although it was able to restore T3 levels in other fetal tissues. Studies in which radiolabelled T4 was administered to neonatal rats made hypothyroid by maternal or neonatal treatment with methimazole provide direct evidence for the enhanced production of brain T3 from T4 (Silva and Matthews 1984). These observations are consistent with an important role of local generation of T3 from T4 in the brain by the action of brain iodothyronine deiodinases in maintaining brain T3 levels (Darras et al. 1999; Zoeller and Crofton 2000). From a toxicological perspective, these observations also suggest that in the rat, a decrease in maternal serum T4 levels, even in the absence of changes in maternal serum T3 levels may have adverse consequences on fetal brain development. Zoeller and Rovet (2004), and others cited therein, have reviewed the issue of the role of thyroid hormones in brain development and concluded that studies of models of maternal hypothyroidism, hypothyroxinemia and congenital hypothyroidism suggest that the timing and severity of thyroid hormone insufficiency predicts the type and severity of the neurological deficits.

Perchlorate could potentially disrupt fetal thyroid hormone status by three mechanisms. Perchlorate inhibition of maternal thyroid iodide uptake, and the resulting suppression in production and levels of maternal thyroid hormones, could limit the availability of thyroid hormones needed for normal fetal development prior to the onset of fetal thyroid hormone production if thyroid function in the mother is compromised. Perchlorate can also cross the placenta and may directly inhibit fetal thyroid iodide uptake and, secondarily, fetal thyroid hormone production. By inhibiting NIS in breast tissue, perchlorate may also limit the availability of iodide to nursing infants, who depend entirely on breast milk for the iodide

### 3. HEALTH EFFECTS

needed to produce thyroid hormone (Agency for Toxic Substances and Disease Registry 2004). No information is available on the doses in humans that might decrease iodide uptake into breast milk. Radioiodine uptake into mammary milk was decreased in rats exposed to 1 or 10 mg/kg/day perchlorate in drinking water (Clewell et al. 2003b). Studies conducted in cows and goats have also shown that perchlorate can decrease radioiodine uptake into mammary milk (Howard et al. 1996).

Thyroid suppression at birth has been observed in infants born to mothers who received potassium perchlorate during pregnancy for treatment of hyperthyroidism (Crooks and Wayne 1960; Fisher et al. 1962). Direct evidence of maternal-fetal transfer of perchlorate and suppression of fetal thyroid iodide uptake and hormone production has been provided from studies of rats and guinea pigs (Clewell et al. 2003a; Postel 1957; Schröder-van der Elst et al. 2001; York et al. 2001b). Several epidemiological studies have explored the strength of possible associations between perchlorate exposures and neonatal thyroid hormone status. Although some of these studies are suggestive of a possible association between perchlorate exposures and elevated serum TSH levels in infants, the findings of the currently available epidemiological literature, taken *in toto*, is inconclusive regarding effects of perchlorate on neonatal thyroid hormone status (Brechner et al. 2000; Crump et al. 2000; Lamm and Doemland 1999; Li et al. 2000a, 2000b; Schwartz 2001). Furthermore, these studies were likely to be confounded because they did not obtain individual estimates of perchlorate exposure. Without this information, it is likely that these studies were comparing T4 levels, on average, among groups of people that were not, on average, exposed to different levels of perchlorate. Studies conducted in rats provide direct evidence that perchlorate exposures during pregnancy or lactation can disturb thyroid hormone status in the neonate (Brown-Grant 1966; Brown-Grant and Sherwood 1971; Clewell et al. 2003a, 2003b; Golstein et al. 1988; Lampe et al. 1967; Mahle et al. 2003; York et al. 2001a, 2003, 2004). The mechanisms for these effects have not been elucidated.

#### **3.5.3 Animal-to-Human Extrapolations**

The ability of perchlorate to inhibit thyroid uptake of iodide in both humans (Bürgi et al. 1974; DeGroot and Buhler 1971; Faure and Dussault 1975; Greer et al. 2002; Lawrence et al. 2000, 2001; Stanbury and Wyngaarden 1952) and animals (Kapitola et al. 1971; Ortiz-Caro et al. 1983; Schonbaum et al. 1965; Wyngaarden et al. 1952) is well established. Based on this ability, potassium perchlorate was widely used for a time as treatment to restore normal thyroid activity in patients with hyperactive thyroids (e.g., Crooks and Wayne 1960; Morgans and Trotter 1960). Therapeutically effective doses in humans were in the range of 5–20 mg perchlorate/kg/day.

## 3. HEALTH EFFECTS

Although abundant evidence exists to show that perchlorate can inhibit thyroid iodide uptake in humans, direct evidence that perchlorate can disrupt thyroid hormone levels and produce changes in thyroid morphology (in the absence of underlying thyroid disorder, such as Graves' disease or other causes such as thyrotoxicosis) derives largely from animal studies. Changes in serum levels of thyroid hormones, indicative of suppressed hormone production, and thyroid hypertrophy, indicative of stimulation of the thyroid gland by TSH, have been shown to occur in rats and mice exposed to perchlorate by the oral route (see Section 3.2.2.2, Endocrine Effects). Evidence that perchlorate can produce thyroid tumors also derives from the results of studies conducted in mice and rats (see Section 3.2.2.7). In humans and other mammals, a limitation in the availability of iodide for thyroid hormone production, regardless of the cause of the limitation, triggers an HPT feedback mechanism, which serves to maintain serum hormones at sufficient levels to satisfy physiological requirements. Extrapolation of dose levels that disrupt thyroid hormone status in animals to pharmacodynamically equivalent doses in humans must take into account not only potential species differences in perchlorate biokinetics, but also potential species differences in the compensatory response to a limitation in iodide availability to the thyroid.

Few studies have been reported that allow direct comparisons of the dose-response relationships for the effects of perchlorate on thyroid hormone status in humans and experimental animals. However, these studies indicate that the response of human adults to short-term oral dosages (mg/kg/day) of perchlorate is quantitatively different from the response observed in rats given comparable dosages. Inhibition of thyroid iodide uptake has been observed in healthy euthyroid adults who were exposed to dosages exceeding 0.007 mg/kg/day in drinking water (Greer et al. 2002; Lawrence et al. 2000). The dosage that produced a 50% inhibition of 24-hour thyroid iodide uptake was approximately 0.15 mg/kg/day when the exposure duration was either for 2 or 14 days (Figure 3-8; Greer et al. 2002). Oral doses that ranged from 0.007 to 0.5 mg/kg/day for 14 days had no observable effect on serum TSH or thyroid hormone levels in healthy adults (Greer et al. 2002; Lawrence et al. 2000). Oral doses of perchlorate that produced the same magnitude of inhibition of 24-hour thyroid iodide were higher in rats compared to humans. For example, in rats, 1 mg/kg/day in drinking water for 1 or 14 days produced a 0 or 15% inhibition, respectively (Figure 3-8; Yu et al. 2002). However, this same study observed inhibition of thyroid iodide uptake (10–30%) that was similar in magnitude to that observed in humans when iodide was administered to rats 2 hours following a single intravenous dose of 0.01 or 0.1 mg perchlorate/kg/day and thyroid iodide uptake was determined 2–9 hours following the radioiodide dose (Yu et al. 2002). Rats also exhibited elevated plasma levels of TSH when exposed to perchlorate for 14 days, and a pronounced attenuation of the inhibition in thyroid iodide uptake compared to the response observed following 2 days of exposure to

## 3. HEALTH EFFECTS

**Figure 3-8. Comparison of Dose-Response Relationships for the Inhibitory Effect of Perchlorate on 24-hour Thyroid Iodide Uptake in Humans and Rats**

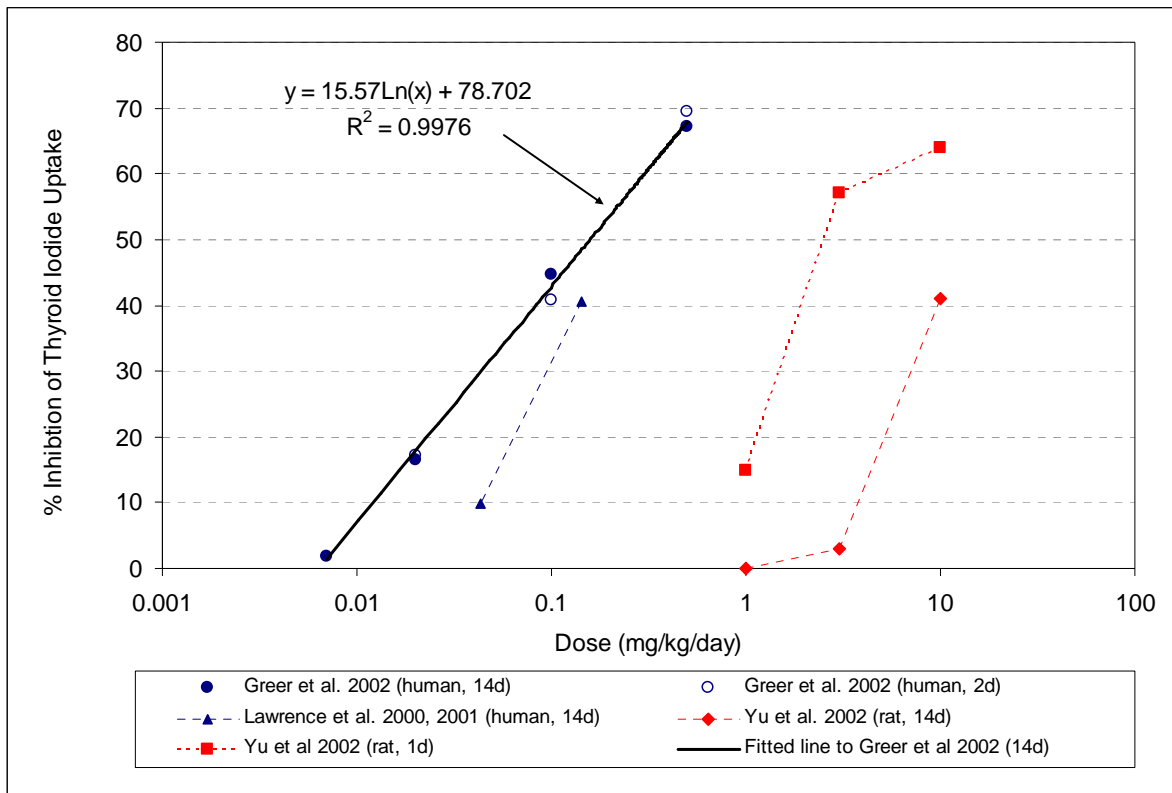

Greer et al. (2002) administered perchlorate in drinking water to adult humans for 14 days and measured RAIU on exposure days 2 or 14. Lawrence et al. (2000, 2001) administered perchlorate in drinking water to adult humans for 14 days and measured RAIU on exposure day 14. Yu et al. (2002) exposed rats to perchlorate in drinking water for 1 day (24 hours) and measured RAIU on day 2 (day following cessation of exposure); rats were also exposed to perchlorate for 14 days and RAIU was measured on day 15.

### 3. HEALTH EFFECTS

perchlorate (Yu et al. 2002). Differences in the perchlorate dose-response relationships for thyroid iodide uptake between humans and rats may reflect the triggering of HPT feedback control mechanisms and induction of NIS, which serve to regulate thyroid iodide transport and hormone production in response to a decrease in serum thyroid hormones and iodide levels. The involvement of the HPT control mechanism in the response to perchlorate in the rat is consistent with the observed dose-response relationship for changes in serum T3, T4, and TSH levels (Figure 3-9). Perchlorate dosages of 1–5 mg/kg/day for 14 days in drinking water depressed serum levels of T3 and T4 and increased levels of TSH (Caldwell et al. 1995; Siglin et al. 2000; Yu et al. 2002). By contrast, serum hormone levels were unchanged in human adults who received dosages of up to 0.5 mg/kg/day for the same duration and who exhibited as much as a 70% inhibition of thyroid iodide uptake (Greer et al. 2002; Lawrence et al. 2000). These observations suggest that dosages of perchlorate that inhibit thyroid iodide uptake must occur over a longer duration to produce effects on circulating levels of thyroid hormones in healthy, euthyroid adult humans than in healthy, euthyroid adult rats (see Lewandowski et al. 2004 for review on interspecies differences). This is thought to be related to a smaller and more rapid turnover of the hormone pool in the rat thyroid, and to a more rapid clearance of secreted hormone in the rat (serum half-life for T4 is shorter in rats than in humans).

Less is known about the relative sensitivities of humans and experimental animals to developmental effects of perchlorate. Outstanding uncertainties include potential differences in kinetics of maternal-fetal and maternal-infant transfer of perchlorate, as well as potential differences in the degree to which the fetus of the human, in comparison to experimental animals, is dependent on maternal thyroid hormone for development, particularly during the period of gestation prior to the onset of fetal hormone production.

NAS (2005) reviewed the human and animal data and concluded that the human data provided a more reliable point of departure for the risk assessment than the animal data. In agreement with the above discussion, NAS (2005) further noted that: “the rat is a good quantitative model for assessing inhibition of iodide uptake by the thyroid caused by perchlorate exposure, but it is only a good *qualitative* model for the effects of that inhibition.”

### 3.6 TOXICITIES MEDIATED THROUGH THE NEUROENDOCRINE AXIS

Recently, attention has focused on the potential hazardous effects of certain chemicals on the endocrine system because of the ability of these chemicals to mimic or block endogenous hormones. Chemicals with this type of activity are most commonly referred to as *endocrine disruptors*. However, appropriate

3. HEALTH EFFECTS

**Figure 3-9. Changes in Serum Thyroid Hormone Levels in Rats Exposed to Perchlorate in Drinking Water for 14 Days**

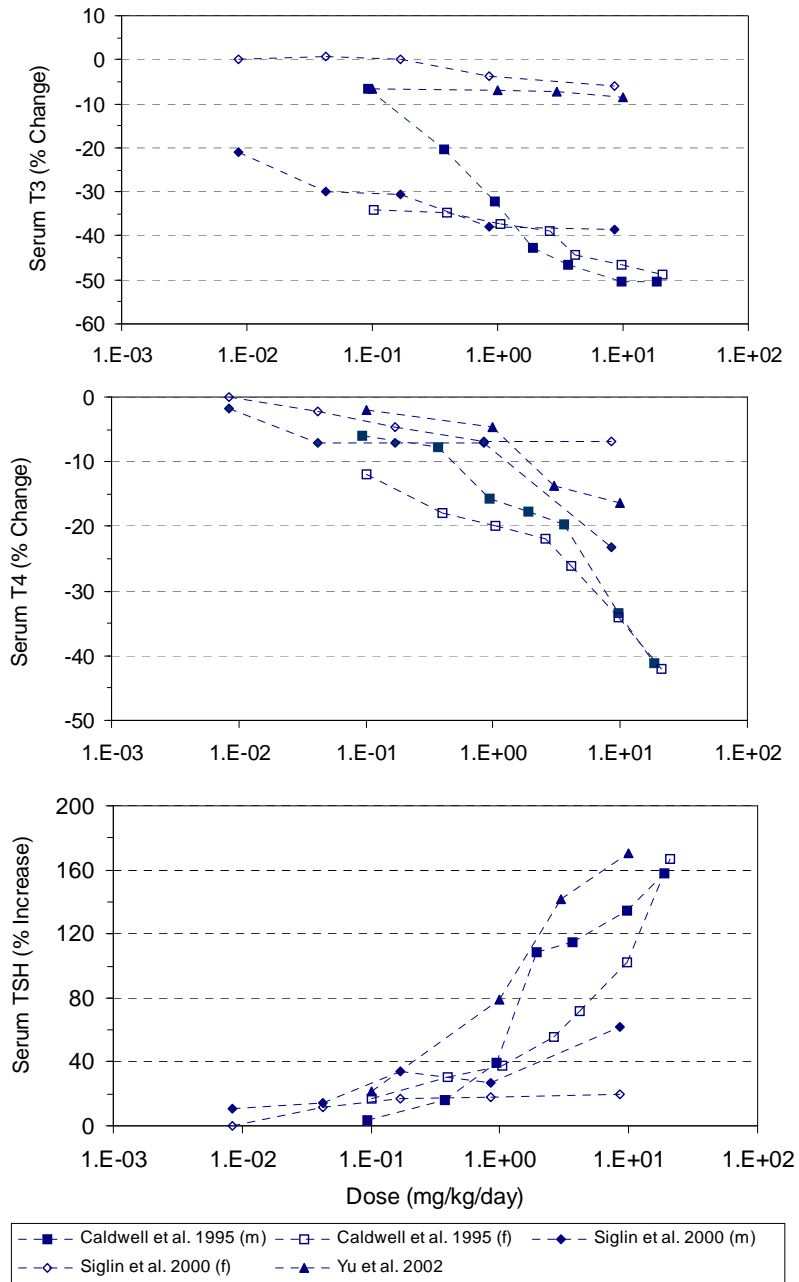



## 3. HEALTH EFFECTS

terminology to describe such effects remains controversial. The terminology *endocrine disruptors*, initially used by Thomas and Colborn (1992), was also used in 1996 when Congress mandated the EPA to develop a screening program for "...certain substances [which] may have an effect produced by a naturally occurring estrogen, or other such endocrine effect[s]...". To meet this mandate, EPA convened a panel called the Endocrine Disruptors Screening and Testing Advisory Committee (EDSTAC), and in 1998, the EDSTAC completed its deliberations and made recommendations to EPA concerning *endocrine disruptors*. In 1999, the National Academy of Sciences released a report that referred to these same types of chemicals as *hormonally active agents*. The terminology *endocrine modulators* has also been used to convey the fact that effects caused by such chemicals may not necessarily be adverse. Many scientists agree that chemicals with the ability to disrupt or modulate the endocrine system are a potential threat to the health of humans, aquatic animals, and wildlife. However, others think that endocrine-active chemicals do not pose a significant health risk, particularly in view of the fact that hormone mimics exist in the natural environment. Examples of natural hormone mimics are the isoflavonoid phytoestrogens (Adlercreutz 1995; Livingston 1978; Mayr et al. 1992). These chemicals are derived from plants and are similar in structure and action to endogenous estrogen. Although the public health significance and descriptive terminology of substances capable of affecting the endocrine system remains controversial, scientists agree that these chemicals may affect the synthesis, secretion, transport, binding, action, or elimination of natural hormones in the body responsible for maintaining homeostasis, reproduction, development, and/or behavior (EPA 1997a). Stated differently, such compounds may cause toxicities that are mediated through the neuroendocrine axis. As a result, these chemicals may play a role in altering, for example, metabolic, sexual, immune, and neurobehavioral function. Such chemicals are also thought to be involved in inducing breast, testicular, and prostate cancers, as well as endometriosis (Berger 1994; Giwercman et al. 1993; Hoel et al. 1992).

Perchlorate can impair thyroid hormone production and, therefore, can be classified as an *endocrine disruptor*. As discussed in Sections 3.2.2.2 (Systemic-Endocrine Effects) and 3.5.2 (Mechanisms of Toxicity), at sufficiently high dosages, perchlorate can limit the availability of iodide needed for the production of the hormones in the thyroid and can depress serum levels of the thyroid hormones, T4 and T3. The latter effect triggers HPT feedback control mechanisms to produce TSH, which stimulates growth of the thyroid and induces NIS, the primary mechanism by which iodide enters thyroid follicle cells from the blood and the first step in the uptake of iodide into the thyroid and formation of thyroid hormones. Thus, perchlorate exposure at sufficiently high doses has the potential for producing all of the adverse consequences of hypothyroidism including impairments in the development of the nervous systems and other organ systems, thyroid gland enlargement, and follicular cell hyperplasia and neoplasia.

## 3. HEALTH EFFECTS

However, studies discussed earlier indicate that at perchlorate levels routinely found in the environment, no evidence of such adverse effects have been observed or documented.

**3.7 CHILDREN'S SUSCEPTIBILITY**

This section discusses potential health effects from exposures during the period from conception to maturity at 18 years of age in humans, when most biological systems have fully developed. However, the brain continues to develop until about 25 years of age. Potential effects on offspring resulting from exposures of parental germ cells are considered, as well as any indirect effects on the fetus and neonate resulting from maternal exposure during gestation and lactation. Relevant animal and *in vitro* models are also discussed.

Children are not small adults. They differ from adults in their exposures and may differ in their susceptibility to hazardous chemicals. Children's unique physiology and behavior can influence the extent of their exposure. Exposures of children are discussed in Section 6.6, Exposures of Children.

Children sometimes differ from adults in their susceptibility to hazardous chemicals, but whether there is a difference depends on the chemical (Guzelian et al. 1992; NRC 1993). Children may be more or less susceptible than adults to health effects, and the relationship may change with developmental age (Guzelian et al. 1992; NRC 1993). Vulnerability often depends on developmental stage. There are critical periods of structural and functional development during both prenatal and postnatal life, and a particular structure or function will be most sensitive to disruption during its critical period(s). Damage may not be evident until a later stage of development. There are often differences in pharmacokinetics and metabolism between children and adults. For example, absorption may be different in neonates because of the immaturity of their gastrointestinal tract and their larger skin surface area in proportion to body weight (Morselli et al. 1980; NRC 1993); the gastrointestinal absorption of lead is greatest in infants and young children (Ziegler et al. 1978). Distribution of xenobiotics may be different; for example, infants have a larger proportion of their bodies as extracellular water, and their brains and livers are proportionately larger (Altman and Dittmer 1974; Fomon 1966; Fomon et al. 1982; Owen and Brozek 1966; Widdowson and Dickerson 1964). The infant also has an immature blood-brain barrier (Adinolfi 1985; Johanson 1980) and probably an immature blood-testis barrier (Setchell and Waites 1975). Many xenobiotic metabolizing enzymes have distinctive developmental patterns. At various stages of growth and development, levels of particular enzymes may be higher or lower than those of adults, and sometimes unique enzymes may exist at particular developmental stages (Komori et al. 1990; Leeder and

## 3. HEALTH EFFECTS

Kearns 1997; NRC 1993; Vieira et al. 1996). Whether differences in xenobiotic metabolism make the child more or less susceptible also depends on whether the relevant enzymes are involved in activation of the parent compound to its toxic form or in detoxification. There may also be differences in excretion, particularly in newborns who all have a low glomerular filtration rate and have not developed efficient tubular secretion and resorption capacities (Altman and Dittmer 1974; NRC 1993; West et al. 1948). Children and adults may differ in their capacity to repair damage from chemical insults. Children also have a longer remaining lifetime in which to express damage from chemicals; this potential is particularly relevant to cancer.

Certain characteristics of the developing human may increase exposure or susceptibility, whereas others may decrease susceptibility to the same chemical. For example, although infants breathe more air per kilogram of body weight than adults breathe, this difference might be somewhat counterbalanced by their alveoli being less developed, which results in a disproportionately smaller surface area for alveolar absorption (NRC 1993).

Fetuses, infants and children may be especially susceptible to the thyroid effects of perchlorate. Thyroid hormones regulate cell proliferation, migration, and differentiation during development, therefore, maintenance of normal levels is essential to normal growth and development. Disruption of circulating hormone levels can have markedly different effects, depending on the stage of development. Effects can include mental retardation, impaired motor skills, and hearing and speech impediments (Boyages 2000; Fisher and Brown 2000; Haddow et al. 1999; Pop et al. 1999). Several factors may contribute to a high vulnerability of the fetus and neonate to perchlorate (see Section 3.10, Susceptible Populations, for further details). In addition, as discussed by NAS (2005), preterm infants are more sensitive to thyroid hormone perturbations than term infants.

Thus far, there is no conclusive evidence that exposure to perchlorate produces developmental effects in humans. Two studies of newborns in Arizona and California reported that neonates from women whose drinking water contained perchlorate had higher TSH values than those from women with no exposure to perchlorate (Brechner et al. 2000; Schwartz 2001). However, the methods used in the two latter studies have been questioned. Other similar studies in the United States have found no significant associations between maternal exposure to perchlorate via the drinking water and T4 levels (Li et al. 2000a), TSH levels (Li et al. 2000b), and incidence of congenital hypothyroidism (Kelsh et al. 2003; Lamm and Doemland 1999). Two studies of Chilean neonates whose mothers may have been chronically exposed to up to 100–120 µg/L (ppb) of perchlorate in the drinking water found no evidence of adverse thyroid

## 3. HEALTH EFFECTS

effects among the neonates (Crump et al. 2000; Téllez et al. 2005). Studies in experimental animals have shown that exposure of the mother to perchlorate during gestation, or even during lactation, can lead to reduced thyroid hormone levels and associated thyroid effects in the offspring (Brown-Grant and Sherwood 1971; Golstein et al. 1988; Lampe et al. 1967; Postel 1957; York et al. 2001a, 2003, 2004). Evaluation of a series of neurobehavioral parameters in rat pups exposed to perchlorate *in utero* (maternal exposure up to 8.5 mg perchlorate/kg/day) and through maternal milk revealed no significant treatment-related effects (Bekkedal et al. 2000; York et al. 2004). Microscopic examination of the brain from 12-day-old pups showed a significant increase in the thickness of the corpus callosum from females in the highest dose group, 8.5 mg/kg/day (York et al. 2004), but a subsequent study by the same group of investigators reported a similar effect at 0.09 and 0.9 mg/kg/day, but not at highest dose tested, 25.5 mg/kg/day (York et al. 2005b). The toxicological significance of this finding is controversial and its biological significance has been questioned (NAS 2005). High-dose male offspring sacrificed at about 80 days of age had a significant increase in brain weight and in the weight of the prefrontal cortex and corpus callosum (York et al. 2004). Exposure to perchlorate has not caused teratogenic effects in animals.

Perchlorate has been shown to cross the placenta of rats (Clewell et al. 2003a; Schröder-van der Elst et al. 2001). Thus, in addition to the potential for perchlorate to exert effects on fetal development by depressing levels of maternal thyroid hormones, perchlorate may exert direct effects on the fetal thyroid. Thyroid suppression at birth has been observed in infants born to mothers who received potassium perchlorate during pregnancy for treatment of hyperthyroidism (Crooks and Wayne 1960; Fisher et al. 1962). Direct evidence of maternal-fetal transfer of perchlorate and suppression of fetal thyroid hormone production has been provided from studies of rats and guinea pigs (Postel 1957; York et al. 2001b; Yu et al. 2002).

Studies conducted in experimental animals have shown that perchlorate enters mammary milk (Clewell et al. 2003b). Perchlorate has also been detected in human breast milk at a mean concentration of 10 ppb (Kirk et al. 2005). Whereas this indicates that nursing infants may be exposed to perchlorate in breast milk, whether the amount of perchlorate in the breast milk is great enough to affect thyroid function of the infant has not been demonstrated. However, a recent study in rats showed that the NIS actively concentrates perchlorate in the milk and suggested that exposure of newborns to high levels of perchlorate may pose a greater health risk than previously thought because it could directly inhibit the newborn thyroidal iodide uptake (Dohán et al. 2007). Nevertheless, the beneficial aspects (biological and

### 3. HEALTH EFFECTS

psychological) of breast-feeding outweigh any risks from exposure to perchlorate from mother's milk, especially if they consume adequate iodine from food and supplements.

Models of the biokinetics of perchlorate in adult humans and rats have been developed (Fisher et al. 2000; Merrill et al. 2003, 2005). An adult rat model has been extended to include pregnancy and maternal-fetal transfer of perchlorate, and lactation and maternal-pup perchlorate transfer through milk (Clewell et al. 2003a, 2003b). These models have been used to develop predictive models for the human gestation and postnatal period (Clewell et al. 2007). In the latter study, pregnant and lactating women, the fetus, and nursing infants were predicted to have higher concentrations of perchlorate in blood and greater thyroid iodide uptake inhibition at a given concentration of perchlorate in drinking water than either nonpregnant adults or older children. Although the fetus was predicted to receive the greatest dose, the predicted extent of iodide inhibition was not significant (approximately 1%) at the NAS-recommended reference dose of 0.7  $\mu\text{g}/\text{kg}/\text{day}$  for perchlorate.

#### 3.8 BIOMARKERS OF EXPOSURE AND EFFECT

Biomarkers are broadly defined as indicators signaling events in biologic systems or samples. They have been classified as markers of exposure, markers of effect, and markers of susceptibility (NAS/NRC 1989).

Due to a nascent understanding of the use and interpretation of biomarkers, implementation of biomarkers as tools of exposure in the general population is very limited. A biomarker of exposure is a xenobiotic substance or its metabolite(s) or the product of an interaction between a xenobiotic agent and some target molecule(s) or cell(s) that is measured within a compartment of an organism (NAS/NRC 1989). The preferred biomarkers of exposure are generally the substance itself, substance-specific metabolites in readily obtainable body fluid(s), or excreta. However, several factors can confound the use and interpretation of biomarkers of exposure. The body burden of a substance may be the result of exposures from more than one source. The substance being measured may be a metabolite of another xenobiotic substance (e.g., high urinary levels of phenol can result from exposure to several different aromatic compounds). Depending on the properties of the substance (e.g., biologic half-life) and environmental conditions (e.g., duration and route of exposure), the substance and all of its metabolites may have left the body by the time samples can be taken. It may be difficult to identify individuals exposed to hazardous substances that are commonly found in body tissues and fluids (e.g., essential mineral nutrients such as copper, zinc, and selenium). Biomarkers of exposure to perchlorates are discussed in Section 3.8.1.

### 3. HEALTH EFFECTS

Biomarkers of effect are defined as any measurable biochemical, physiologic, or other alteration within an organism that, depending on magnitude, can be recognized as an established or potential health impairment or disease (NAS/NRC 1989). This definition encompasses biochemical or cellular signals of tissue dysfunction (e.g., increased liver enzyme activity or pathologic changes in female genital epithelial cells), as well as physiologic signs of dysfunction such as increased blood pressure or decreased lung capacity. Note that these markers are not often substance specific. They also may not be directly adverse, but can indicate potential health impairment (e.g., DNA adducts). Biomarkers of effects caused by perchlorates are discussed in Section 3.8.2.

A biomarker of susceptibility is an indicator of an inherent or acquired limitation of an organism's ability to respond to the challenge of exposure to a specific xenobiotic substance. It can be an intrinsic genetic or other characteristic or a preexisting disease that results in an increase in absorbed dose, a decrease in the biologically effective dose, or a target tissue response. If biomarkers of susceptibility exist, they are discussed in Section 3.10, Populations That Are Unusually Susceptible.

#### **3.8.1 Biomarkers Used to Identify or Quantify Exposure to Perchlorates**

Studies in workers exposed to perchlorate (Lamm et al. 1999) and in volunteers who ingested daily doses of perchlorate for 14 days (Lawrence et al. 2000) indicate that perchlorate is rapidly eliminated unchanged in the urine (see Section 3.4.4). Urine, therefore, is a convenient testing medium for perchlorate. However, the excretion of perchlorate is so rapid that an acute exposure might be detectable for only a few days after exposure. Both occupational studies and studies with volunteers have estimated an elimination half-life for perchlorate of approximately 8–12 hours (Greer et al. 2002; Lamm et al. 1999; Lawrence et al. 2000). The methods used for measuring perchlorate in urine have not been standardized (see also Section 7.1).

Using a highly selective analytical method of coupled ion chromatography and electrospray tandem mass spectrometry, Valentín-Blasini et al. (2005) found an association between urinary levels of perchlorate with the concentrations of perchlorate in drinking water in a population of women from Chile. In a population with no known perchlorate drinking water contamination, concentrations of perchlorate adjusted for urinary creatinine showed a median level of 7.8 µg perchlorate/g creatinine, with a range of 1–35 µg perchlorate/g creatinine. Although the intake of perchlorate through food had not been measured in this population, this population probably has a high background dietary intake of perchlorate because

## 3. HEALTH EFFECTS

Chilean soil is a natural source of perchlorate. When the urine samples of the pregnant women in three cities in the study in Chile (Crump et al. 2000) were analyzed by this method, the women in the city with a drinking water concentration of perchlorate of about 0.4 ng/mL had a median urinary concentration of 21 µg perchlorate/g creatinine, those with a drinking water concentration of about 5.8 ng/mL had a median urinary concentration of 37 µg perchlorate/g creatinine, and those with a drinking water concentration of about 114 ng/mL had a median urinary concentration of 120 µg perchlorate/g creatinine (Valentín-Blasini et al. 2005). Recently, Gibbs (2006) demonstrated a highly significant linear correlation between the concentration of perchlorate in serum and dose over a dose range covering almost four orders of magnitude. The studies that contributed data for Gibbs' analysis included Brabant et al. (1992), Crump et al. (2000), Lawrence et al. (2000), and Merrill et al. (2005).

Perchlorate has also been detected in human breast milk, but the concentrations were not correlated with the water consumed by the lactating women. As perchlorate is fairly rapidly cleared when exposure ceases, the presence of perchlorate in breast milk may be highly variable with time and recent dietary history (Kirk et al. 2005; Pearce et al. 2007).

Other potential biomarkers of exposure to perchlorate relate to their effect on the thyroid gland. As described in Section 3.5.2, Mechanisms of Toxicity, perchlorate blocks uptake of iodide into the thyroid, leading to an increase in the serum level of free iodine (i.e., not bound to T<sub>4</sub>), which is then excreted in urine. No study has developed a correlation between exposure to particular dose levels of perchlorate and specific relative increases of free iodine in serum or urine. In serum, the normal level of free iodine ranges from 1.0 to 5.2 µg/L and the level of protein-bound iodine ranges from 32 to 72 µg/L. Iodine is excreted in urine at a rate that is nearly equal to the rate of intake, or approximately 100–200 µg/24 hours (Agency for Toxic Substances and Disease Registry 2004). Saliva also has potential as a source of noninvasive biomarker because anions such as perchlorate are actively sequestered into the salivary gland by the NIS. Perchlorate produces a decrease in the levels of T<sub>3</sub> and T<sub>4</sub> in serum, while increasing the serum level of TSH in rats, but this has not been shown in humans at doses below those used in clinical medicine to treat thyrotoxicosis. Specific correlations between levels and duration of exposure to perchlorate and alterations in serum levels of T<sub>3</sub>, T<sub>4</sub>, or TSH in humans have not been developed. Furthermore, these potential biomarkers are not specific to perchlorate; other antithyroid agents, such as carbimazole, can have similar effects.

## 3. HEALTH EFFECTS

**3.8.2 Biomarkers Used to Characterize Effects Caused by Perchlorates**

The thyroid is the critical target for perchlorate. Perchlorate blocks uptake of iodide into the thyroid, leading to an increase in the serum level of free iodine (i.e., not bound to T<sub>4</sub>), which is then excreted in urine. If the dosage is sufficient to limit the availability of iodide for the production of thyroid hormones, then perchlorate can also produce a decrease in the levels of T<sub>3</sub> and T<sub>4</sub> in serum, while increasing the serum level of TSH. Therefore, levels of iodide in serum or urine, and levels of T<sub>3</sub>, T<sub>4</sub>, and TSH in serum, can all be considered to be biomarkers of effect for perchlorate. A recent study showed that in women with urinary iodine <100 µg/L, urinary perchlorate (which is a measure of perchlorate intake) was a significant negative predictor of TT<sub>4</sub> and a positive predictor of TSH (Blount et al. 2006). It should be noted that none of these biomarkers is specific to perchlorate; other antithyroid agents such as carbimazole can have similar effects. It should also be noted that TT<sub>4</sub> is not routinely measured for clinical significance as it is too impacted by other biological variables. Although the specific amount of change in these biomarkers associated with a demonstrably adverse effect has not been established, changes in these parameters can be considered to indicate potential impairment of health. Typical normal ranges for hormone levels are shown in Table 3-4.

**3.9 INTERACTIONS WITH OTHER CHEMICALS**

No studies were located regarding health effects in humans exposed to perchlorate in combination with other chemicals that are likely to be found with perchlorate in the environment, in the workplace, or at hazardous waste sites.

Limited information was found in studies in animals. Administration of a single dose of 7.5 or 75 µg/kg of 3,3',4,4'-pentachlorobiphenyl (PCB 126) to rats followed 9 days later by doses of up to 1 mg perchlorate/kg/day in the drinking water for additional 14 days showed less than additive effects on serum TSH, TT<sub>4</sub>, FT<sub>4</sub>, and hepatic T<sub>4</sub>-glucuronide (McLanahan et al. 2007). Exposure to lower doses of each chemical (NOEL doses), resulted in no interaction between the chemicals for the thyroid indices measured. In another study, simultaneous exposure of rats to various concentrations of ammonium perchlorate and sodium chlorate for 7 days reduced serum total T<sub>4</sub> to a greater extent than either chemical alone (Khan et al. 2005).

Tonacchera et al. (2004) investigated the simultaneous joint effects of perchlorate and other competitive inhibitors of iodide uptake (thiocyanate, nitrate, and non-radioactive iodide) in inhibiting RAIU in an *in vitro* test system in which human NIS was stably transfected into a Chinese hamster ovary (CHO) cell



## 3. HEALTH EFFECTS

line. The relative potency of perchlorate to inhibit  $^{125}\text{I}^-$  uptake at the NIS was 15, 30, and 240 times that of thiocyanate, non-radioactive iodide, and nitrate, respectively, on a molar concentration basis. The results showed that the anions interact in a simple additive fashion and that the concentration response for each inhibitor was indistinguishable from that of each of the others after adjusting for differences in inhibition potencies.

Nitrate and thiocyanate are widely distributed in nature and, because both anions also inhibit RAIU, as demonstrated by Tonacchera et al. (2004), should also be included in the discussion of the effects of inhibition of the NIS by anions. Nitrate is a natural constituent of green leafy vegetables and is also used as a preservative. Administration of a diet containing 3% potassium nitrate to rats for 4 weeks resulted in a significant increase in thyroid weight and serum TSH levels and in reductions in serum T3 and T4 (Mukhopadhyay et al. 2005). Thiocyanate can be derived from thioglucosides present in foods such as cabbage, cauliflower, and broccoli, and is also found in tobacco. The effects of thiocyanate on thyroidal function of humans have been known for a long time. Gibbs (2006) reviewed the literature and reported that no adverse or non-adverse thyroidal effects of thiocyanate occur at serum concentrations of thiocyanate  $<50 \mu\text{mol/L}$ . This concentration of thiocyanate is equivalent to approximately  $3.3 \mu\text{mol perchlorate/L}$  in terms of iodine uptake inhibition (Tonacchera et al. 2004). To achieve such concentration of perchlorate in serum, the daily dose of perchlorate would have to be  $0.27 \text{ mg/kg/day}$ , or a 70-kg adult would have to drink 2 L of water daily containing 9 mg perchlorate (Gibbs 2006). However, extrapolating data from the *in vitro* studies such as the Tonacchera et al. (2004) study to situations *in vivo* may not be appropriate because the *in vitro* studies cannot account for the relative human half-lives of perchlorate, thiocyanate, and nitrate or other factors such as protein binding and chronicity. In a related study, De Groef et al. (2006) examined the possible contribution of nitrate and thiocyanate to NIS inhibition. Using EPA's current Maximum Contaminant Level (MCL) for nitrate in drinking water, De Groef et al. (2006) showed that the concentration of nitrate allowed in water would cause an inhibition of iodine uptake by the NIS equivalent to 300 ppb perchlorate, 12 times greater than the concentration of about 25 ppb that corresponds to the RfD for perchlorate proposed by the NAS (assuming a 70-kg adult consuming 2 L of water per day). The same exercise with thiocyanate showed that the MCL for thiocyanate is equivalent to approximately 23 ppb perchlorate. The conclusion reached by the investigators was that "when considering the potential thyroid-related health risks posed by monovalent anions, perchlorate only accounts for a small fraction ( $<10\%$ ) of the exposure from drinking water."

## 3. HEALTH EFFECTS

**3.10 POPULATIONS THAT ARE UNUSUALLY SUSCEPTIBLE**

A susceptible population will exhibit a different or enhanced response to perchlorates than will most persons exposed to the same level of perchlorates in the environment. Reasons may include genetic makeup, age, health and nutritional status, and exposure to other toxic substances (e.g., cigarette smoke). These parameters result in reduced detoxification or excretion of perchlorates or compromised function of organs affected by perchlorates. Populations who are at greater risk due to their unusually high exposure to perchlorates are discussed in Section 6.7, Populations with Potentially High Exposures.

Any condition affecting processes by which circulating iodide ultimately becomes part of a functional thyroid hormone will increase the susceptibility to substances that affect thyroid function such as perchlorate. Among these conditions are genetic factors. This topic has been reviewed by Scinicariello et al. (2005) and original citations can be obtained therein. For example, people with congenital iodide transport deficit (ITD), an infrequent autosomic recessive condition that has been linked to mutations of the perchlorate-sensitive NIS gene, may exhibit a defective transport of iodide from circulation into the thyroid cell. People who suffer from Pendred Syndrome (PDS), an autosomal recessive disorder characterized by deafness and goiter, may have a diminished iodide transport over the apical membrane, which causes iodide to remain in the thyrocyte. The PDS gene product pendrin is a protein that transports chloride and iodide and mediates the exchange of chloride and formate. Increased susceptibility to perchlorate can also result from defects in iodide organification, a process by which iodide is oxidized and bound to thyrosine residue in thyroglobulin. Mutations identified in proteins involved in the iodination of the thyrosine residue may result in accumulation of iodide in the thyrocyte.

As discussed in NAS (2005), fetuses and preterm newborns constitute the most sensitive populations, although infants and developing children are also considered sensitive populations. The expected high sensitivity of developing organisms is due to the important role played by thyroid hormones during development (Zoeller 2006; see also Section 3.5.2). Perchlorate may reduce the level of circulating thyroid hormones in the blood, and low thyroid hormone levels during embryonic or fetal development can lead to effects such as mental retardation, impaired motor skills, and hearing and speech impediments (Haddow et al. 1999; Pop et al. 1999; Soldin et al. 2001). This is because the fetus is dependent on maternal thyroid hormones at least until the fetal thyroid begins to produce T4 and T3 (Zoeller and Crofton 2000). In humans, this occurs at approximately 16–20 weeks of gestation. Perchlorate also can inhibit the NIS in breast tissue (Levy et al. 1997; Smanik et al. 1997; Spitzweg et al. 1998), and therefore may limit the availability of iodide to nursing infants, who depend entirely on breast milk for the iodide

### 3. HEALTH EFFECTS

needed to produce thyroid hormone (Agency for Toxic Substances and Disease Registry 2004). However, in a study of 57 lactating women in Boston, Massachusetts, no correlation was found between perchlorate concentrations in breast milk and concentrations of iodide in breast milk (Pearce et al. 2007). As discussed by Ginsberg et al. (2007), additional factors that make neonates a sensitive group include their shorter serum half-life for T4 of approximately 3 days compared to approximately 7–10 days in adults, a lower storage capacity of the thyroid for T4, and possibly slower urinary clearance of perchlorate due to immature renal function. Hypothyroid pregnant women also constitute a susceptible group who may also put the fetus at higher risk if maternal hypothyroidism is present before the onset of fetal thyroid function at 10–12 weeks of gestation (Zoeller and Crofton 2000). Human models of pregnancy, maternal-fetal transfer, and maternal-infant transfer of perchlorate have also been developed (Clewell et al. 2007, see Section 3.4.5). These models have yielded predictions of external dose–internal dose relationships for various human lifestages (Clewell et al. 2007; see Tables 3-6 and 3-7). The models predict a relatively high vulnerability of the fetus, pregnant women, and lactating women to perchlorate-induced thyroid iodine uptake, compared to other lifestages (e.g., greater inhibition of thyroid iodide uptake occurs in the fetus in association with lower external doses). Women with low iodine intake may also constitute a susceptible group, as suggested by a recent study in which urinary perchlorate was reported to be a significant negative predictor of serum TT4 and a significant positive predictor of serum TSH in women with urinary iodine <100 µg/L (Blount et al. 2006).

People with reduced thyroid activity from other causes may also be an unusually susceptible population. This includes people living in endemic goiter areas with low iodine intake, people with exposure to other anti-thyroid drugs (e.g., lithium) (Green 1996; Spaulding et al. 1972), and people with Hashimoto's disease (autoimmune hypothyroidism [Weetman 2000]) or other diseases that reduce thyroid hormone levels. Exposure to perchlorate may produce additional deficiencies in these people beyond those due to their pre-existing conditions, potentially increasing the severity of their conditions.

#### **3.11 METHODS FOR REDUCING TOXIC EFFECTS**

This section will describe clinical practice and research concerning methods for reducing toxic effects of exposure to perchlorates. However, because some of the treatments discussed may be experimental and unproven, this section should not be used as a guide for treatment of exposures to perchlorates. When specific exposures have occurred, physicians who specialize in thyroid disorders should be consulted for medical advice.

### 3. HEALTH EFFECTS

No texts were located that provided specific information about treatment following exposures to perchlorate.

#### **3.11.1 Reducing Peak Absorption Following Exposure**

There are no established methods for managing initial exposure to perchlorate or for reducing peak absorption

Since perchlorate is readily excreted in the urine, it is reasonable to assume that increasing the water uptake would help the body eliminate perchlorate. No studies have investigated this issue.

#### **3.11.2 Reducing Body Burden**

Perchlorate is readily eliminated from the body and does not bioaccumulate or result in a body burden. The elimination half-life for perchlorate has been estimated to be 8–12 hours (Durand 1938; Greer et al. 2002; Lamm et al. 1999).

#### **3.11.3 Interfering with the Mechanism of Action for Toxic Effects**

There are no published studies on the treatment of perchlorate exposure by interfering with its mechanism of toxicity. Since the inhibition of the NIS by perchlorate can limit the availability of iodide needed for the production of T4 and T3 in the thyroid, it is important to maintain an adequate intake of iodine.

### **3.12 ADEQUACY OF THE DATABASE**

Section 104(I)(5) of CERCLA, as amended, directs the Administrator of ATSDR (in consultation with the Administrator of EPA and agencies and programs of the Public Health Service) to assess whether adequate information on the health effects of perchlorates is available. Where adequate information is not available, ATSDR, in conjunction with the National Toxicology Program (NTP), is required to assure the initiation of a program of research designed to determine the health effects (and techniques for developing methods to determine such health effects) of perchlorates.

The following categories of possible data needs have been identified. They are defined as substance-specific informational needs that if met would reduce the uncertainties of human health assessment. This definition should not be interpreted to mean that all data needs discussed in this section must be filled. In

## 3. HEALTH EFFECTS

the future, the identified data needs will be evaluated and prioritized, and a substance-specific research agenda will be proposed.

### 3.12.1 Existing Information on Health Effects of Perchlorates

The existing data on health effects of inhalation, oral, and dermal exposure of humans and animals to perchlorates are summarized in Figure 3-10. The purpose of this figure is to illustrate the existing information concerning the health effects of perchlorates. Each dot in the figure indicates that one or more studies provide information associated with that particular effect. The dot does not necessarily imply anything about the quality of the study or studies, nor should missing information in this figure be interpreted as a “data need”. A data need, as defined in ATSDR’s *Decision Guide for Identifying Substance-Specific Data Needs Related to Toxicological Profiles* (Agency for Toxic Substances and Disease Registry 1989), is substance-specific information necessary to conduct comprehensive public health assessments. Generally, ATSDR defines a data gap more broadly as any substance-specific information missing from the scientific literature.

Human studies on perchlorate include cross-sectional epidemiology studies of perchlorate workers with inhalation exposure, short-term oral experimental studies on healthy and hyperthyroid subjects, general population studies of adults, school-age children, and neonates, and case reports of hyperthyroid patients with intermediate- or chronic-duration oral treatment with perchlorate.

Animal studies for perchlorate are available only by the oral route. The available studies have included investigation of systemic effects by acute, intermediate, and chronic exposure, as well as immunological, reproductive, and developmental effects, lethality, and cancer. Limited information is available regarding effects of perchlorate on the nervous system in adult animals. No experimental studies have been conducted that examine the interactions of perchlorate exposure and dietary iodine levels.

### 3.12.2 Identification of Data Needs

**Acute-Duration Exposure.** Acute-duration studies are available for healthy humans (Bürge et al. 1974; DeGroot and Buhler 1971; Faure and Dussault 1975; Greer et al. 2002; Lawrence et al. 2000, 2001) and animals (Arieli and Chinet 1985; BRT 2000; Caldwell et al. 1995; DOD 1999; Kapitola et al. 1971; Mannisto et al. 1979; Matsuzaki and Suzuki 1981; Schonbaum et al. 1965; Siglin et al. 2000; Spreca and Musy 1974) orally exposed to perchlorate. These studies suggest that the thyroid is the main target for acute exposure to perchlorate. The study by Greer et al. (2002) identified a NOEL for radioactive iodine

3. HEALTH EFFECTS

**Figure 3-10. Existing Information on Health Effects of Perchlorate**

		Systemic									
		Death	Acute	Intermediate	Chronic	Immunologic/Lymphoretic	Neurologic	Reproductive	Developmental	Genotoxic	Cancer
Inhalation				●							
Oral		●	●	●	●	●		●			●
Dermal											

**Human**

		Systemic									
		Death	Acute	Intermediate	Chronic	Immunologic/Lymphoretic	Neurologic	Reproductive	Developmental	Genotoxic	Cancer
Inhalation											
Oral		●	●	●	●	●	●	●	●	●	●
Dermal											

**Animal**

● Existing Studies

## 3. HEALTH EFFECTS

uptake by the thyroid of 0.007 mg/kg/day. NAS (2005) recently completed an evaluation of the literature on perchlorate and derived an RfD of 0.0007 mg/kg/day based on the findings of Greer et al. (2002). ATSDR has adopted the EPA's chronic RfD recommended by NAS (2005) for the chronic oral MRL. Acute and intermediate MRL values will need to be assessed as relevant data from new studies are published. Conducting acute studies by the inhalation route does not seem warranted since this route of exposure does not play a significant role in environmental exposures to perchlorate. Although dermal absorption of perchlorate should be negligible, information on dermal absorption and dermal toxicity studies could be useful because skin contact with perchlorate in water supplies is likely when water contains perchlorate. In its review of perchlorate toxicity, NAS (2005) notes that further studies of perchlorate in rats would be of limited utility for clarifying the health effects of perchlorate in humans. Instead, NAS recommends conducting a series of *in vitro* studies using human tissues and animal studies to determine the role of NIS in placental iodide transport, the susceptibility of breast NIS to perchlorate inhibition, the role of iodide status in these effects, and the effects of perchlorate on development independently of effects on iodide transport. NAS (2005) further notes studies on the effects of perchlorate on other tissues that contain NIS could be conducted.

**Intermediate-Duration.** Intermediate-duration studies are available for humans (Brabant et al. 1992; Braverman et al. 2006) and animals (Bekkedal et al. 2000; BRT 2000; DOD 1999; Eskin et al. 1975; Gauss 1972; Hiasa et al. 1987; Logonder-Mlinsek et al. 1985; MacDermott 1992; Ortiz-Caro et al. 1983; Pajer and Kalisnik 1991; Postel 1957; Sangan and Motlag 1986, 1987; Selivanova and Vorobieva 1969; Shevtsova et al. 1994; Siglin et al. 2000; Tarin-Remohi and Jolin 1972; Vijayalakshmi and Motlag 1989a, 1989b, 1990, 1992; York et al. 2001a, 2001b, 2003, 2004, 2005a, 2005b) orally exposed to perchlorates. Brabant et al. (1992) studied the effect of administration of perchlorate for 4 weeks on thyroid hormone levels in healthy volunteers and their findings suggested that a period of iodide deficiency may increase the sensitivity of the thyroid to TSH. Braverman et al. (2006) reported that administration of up to approximately 0.04 mg perchlorate/kg/day to volunteers for 6 months caused no significant alterations in thyroid function tests, including radioiodine uptake. The studies in animals provided information on systemic, immunologic, reproductive, and developmental effects of perchlorate. The thyroid gland was shown to be the most sensitive target. Almost all of the earlier studies used only one dose level, usually quite high. Studies conducted in the past few years have used much lower doses, which allow the construction of dose-response relationships and the identification of NOAELs and LOAELs. In three of these studies (Siglin et al. 2000; York et al. 2003, 2005a), ATSDR identified LOAELs of 0.009 mg/kg/day. Additional studies in animals would be useful to clarify some controversial findings of the studies recently available. These findings concern effects of perchlorate on neurobehavioral effects

## 3. HEALTH EFFECTS

and brain morphometry in young animals exposed *in utero*. As indicated above, additional studies in rats for the purpose of clarifying the health effects of perchlorate in humans seem unnecessary given the difference in the manner rats and humans handle the inhibition of iodide uptake by the thyroid. As mentioned above, studies by inhalation and dermal exposure do not seem necessary at this time since the most relevant route of exposure for perchlorate is the oral route, specifically drinking water.

**Chronic-Duration Exposure and Cancer.** Humans with chronic inhalation exposure to perchlorate at work were the subject of cross-sectional epidemiology studies (Braverman et al. 2005; Gibbs et al. 1998; Lamm et al. 1999). These studies found no significant effects associated with perchlorate exposure. Cancer has not been reported in humans with exposure to perchlorate. A study by Li et al. (2001) found no significant association between perchlorate in drinking water and the prevalence of thyroid diseases or thyroid cancer residents in Nevada counties. However, no information was available on age, gender, ethnicity, iodine intake, and other risk factors. An additional study of cancer among residents of San Bernardino County, California, was limited by mixed exposures and lack of adjustment for potential confounding variables (Morgan and Cassady 2002). A few chronic-duration studies of toxicity and carcinogenicity are available in animals exposed to perchlorate orally (Kessler and Kruskemper 1966; Toro Guillen 1991). A few intermediate-duration carcinogenicity studies by the oral route are also available (Florencio Vicente 1990; Gauss 1972; Pajer and Kalisnik 1991). The data from these studies are limited for assessment of toxicity or carcinogenicity, however, because only a high dose level was used. Still, it was evident that the main target of toxicity was the thyroid gland, as thyroid adenomas and/or carcinomas were observed in the animals. It is unclear whether additional studies would provide new key information. As noted above, ATSDR has adopted the NAS (2005) recommended RfD for the chronic oral MRL. EPA adopted this chronic RfD based on the NAS (2005) recommendation. NAS (2005) recommended a clinical study designed to provide information on the potential chronic effects of low-dose perchlorate exposure on thyroid function, with a special focus on the ability and mechanisms of thyroid compensation. If for ethical or other reasons it is not possible to conduct studies in humans, NAS (2005) suggested that chronic studies in nonhuman primates could provide useful information. However, baseline thyroid studies would have to be conducted first to compare strains of monkeys to humans.

**Genotoxicity.** No genotoxicity studies were located for perchlorate in humans, but two studies were located in animals *in vivo*. Siglin et al. (2000) found no evidence of bone marrow micronucleus formation in male and female rats exposed to perchlorate in the drinking water for 90 days. Similar negative results were reported by Zeiger et al. (1998b) in mice treated with perchlorate intraperitoneally



## 3. HEALTH EFFECTS

for 3 days. *In vitro* studies were limited to a test for SOS-inducing activity in *S. typhimurium* (Nakamura and Kosaka 1989), a test for production of DNA-protein cross links in cultured human lymphocytes (Costa et al. 1996), tests for mutagenicity in various *Salmonella* strains (Zeiger et al. 1998a), and a mouse lymphoma assay (San and Clarke 1999). Perchlorate gave negative results in all tests. Additional testing does not seem necessary at this time.

**Reproductive Toxicity.** No data on reproductive effects of perchlorate in humans were located. Earlier reproductive toxicity studies available for perchlorate in animals (Brown-Grant 1966; Brown-Grant and Sherwood 1971) were of limited utility for assessing reproductive toxicity because they included only brief exposure of females during gestation, limited investigation of reproductive end points, and single dose levels. In a two-generation reproduction study, exposure of rats to up to 25.5 mg perchlorate/kg/day did not affect any reproductive index (York et al. 2001b). In another study, exposure of rats to up to 25.5 mg perchlorate/kg/day beginning 2 weeks before cohabitation with untreated males and continuing during gestation did not result in any significant alterations in numbers of corpora lutea and implantations, percent implantation loss, litter size, early or late resorptions, or sex ratio (York et al. 2005a). In addition, a 90-day drinking water in rats did not find gross or microscopic alterations in the testes, prostate, epididymis, uterus, ovaries, or mammary glands (Siglin et al. 2000). That study also reported no significant effects on sperm motility, concentration, count, or morphology. Further studies do not appear to be necessary at this time.

**Developmental Toxicity.** There are several oral studies available that evaluated the effects of perchlorate on thyroid parameters in human newborns (Amitai et al. 2007; Brechner et al. 2000; Crump et al. 2000; Kelsh et al. 2003; Lamm and Doemland 1999; Li et al. 2000a, 2000b; Schwartz 2001; Téllez et al. 2005). Crump et al. (2000) also examined the effects of perchlorate on thyroid function in school-age children. For the most part, no significant alterations were reported, although Brechner et al. (2000) and Schwartz (2001) reported an association between high levels of perchlorate in the drinking water and elevated serum levels of TSH, but the methods used in the two latter studies have been criticized. The neurodevelopmental progress of children presumed to have been exposed to perchlorate *in utero* could be followed in longitudinal studies in search of possible long-term effects. Developmental toxicity studies are available for perchlorate in animals (Bekkedal et al. 2000; Brown-Grant and Sherwood 1971; Golstein et al. 1988; Lampe et al. 1967; Mahle et al. 2003; Postel 1957; York et al. 2001a, 2001b, 2003, 2004, 2005a, 2005b). Although the earlier studies were of limited utility because standard developmental toxicity end points were not monitored and only single high dose levels were administered, the studies conducted in the past few years have been able to establish dose-response relationships using relatively

## 3. HEALTH EFFECTS

low exposure levels of perchlorate. Exposure of pregnant rats to perchlorate has resulted in thyroid alterations in the pups at maternal doses as low as 0.009 mg/kg/day (York et al. 2003, 2005a). In addition to evaluating thyroid effects in the offspring, some recent studies have conducted neurobehavioral testing in the offspring at various ages and have also conducted histological and morphometric evaluations of pups' brains (Bekkedal et al. 2000; York et al. 2003, 2004, 2005b). However, these studies have not evaluated known thyroid hormone-responsive end points in brain; for example, expression of genes that are known to respond to thyroid hormone or maturation specific brain structures (i.e., Purkinje cells) that respond to thyroid hormone (Porterfield and Hendrich 1993; Zoeller and Crofton 2000). Furthermore, there is no evidence that the linear measures of specific brain areas that have been evaluated in animal studies are responsive to changes in circulating levels of thyroid hormone. Studies directed at characterizing the reaction of thyroid hormone responsive end points in brain to small changes in thyroid hormone have not been conducted. NAS (2005) noted that studies of pregnant monkeys could provide useful information on the effects of perchlorate on fetal and neonatal development. Continued research is necessary to help improve our understanding of the potential mechanistic steps resulting in thyroid hormone level changes from exposure to low levels of perchlorate and other environmental contaminants such as thiocyanate and nitrate that can inhibit iodide uptake and potentially result in prenatal and infant/early childhood effects. In addition, metabolic differences between perchlorate and other goitrogens, such as nitrate and thiocyanate (availability in the body) need to be further explored.

**Immunotoxicity.** Immune system and lymphoreticular effects due to perchlorate have not been systematically studied in healthy humans. Lymphoreticular effects were reported in one case series of human thyrotoxicosis patients treated with potassium perchlorate (Morgans and Trotter 1960). Immune effects in animals treated with very high doses of perchlorate (300–2,600 mg/kg/day) were reported as increases in the number and degranulation of mast cells in the thyroid and other tissues (Logonder-Mlinsek et al. 1985; Spreca and Musy 1974). More recent acute- and intermediate-duration studies assessed indices of humoral- and cell-mediated immunocompetence in mice (0.1–50 mg/kg/day), but there were deficiencies in the studies (BRT 2000; DOD 1999). It would be helpful if some other end points were studied, such as the determination of whether perchlorate increases the sensitizing response to other chemicals or whether perchlorate is a sensitizer itself.

**Neurotoxicity.** No data were located regarding neurological effects in humans or animals exposed to perchlorate. Neither 14-day nor 90-day studies in animals observed any signs indicative of neurotoxicant in adult animals. However, since thyroid hormone insufficiency is known to affect brain function in adult humans, and perchlorate can produce decreased circulating levels of thyroid hormone, it is likely that

## 3. HEALTH EFFECTS

perchlorate can, at some dose, impair brain function in adults. The dose-response relationship for these effects has not been characterized. As mentioned above under Developmental Effects, some studies in rats have suggested that exposure to perchlorate during pregnancy can cause neurodevelopmental alterations in the offspring (York et al. 2004, 2005b). The biological significance of some of the neurodevelopmental alterations, particularly the changes in thickness of the corpus callosum (York et al. 2004, 2005b), has been questioned (NAS 2005).

**Epidemiological and Human Dosimetry Studies.** Information on effects of exposure to perchlorate in healthy humans is derived from occupational studies (Braverman et al. 2005; Gibbs et al. 1998; Lamm et al. 1999), studies of the general population, including adults, children, and neonates (Brechner et al. 2000; Chang et al. 2003; Crump et al. 2000; Kelsh et al. 2003; Li et al. 2000a, 2000b, 2001; Schwartz 2001; Téllez et al. 2005) and controlled exposures in volunteers (Braverman et al. 2006; Greer et al. 2002; Lawrence et al. 2000, 2001). All of these studies provide information on the effects of perchlorate on thyroid parameters, but a few of them provide additional information on hematological, hepatic, and renal effects. Although it is well known that the thyroid is the target organ for perchlorate, the existing studies of the general population have had design limitations that preclude establishing with confidence the levels of environmental exposure that may induce clinically significant alterations in thyroid function and, therefore, represent a health risk. Well-designed epidemiological studies of environmentally exposed populations could provide valuable information and decrease the uncertainty of using data collected in acute studies in volunteers to establish long-term safe exposure levels. NAS (2005) identified pregnant women, their fetuses, and newborns as populations at greatest risk of the adverse effects of iodide deficiency and recommended that epidemiologic research should focus on assessing possible health effects of perchlorate exposure in these populations. These studies should use direct methods of exposure to perchlorate in individuals and methods more suitable for examining potentially causal associations. NAS (2005) further suggested that future research could be organized into additional analysis of existing data, new studies of health effects in selected populations, and monitoring of the frequencies of specific conditions in communities affected by the continuing efforts to reduce perchlorate in drinking water. Regarding a study in Chile (Téllez et al. 2005), NAS (2005) recommended incorporating more extensive neurodevelopmental assessments of the children beginning in infancy and continuing through school age. Specific end points that should be assessed in follow-up studies include auditory function, including measures of otoacoustic emissions; visual attention; cognitive function, including tests for executive function and memory; and tests of motor function, particularly balance, coordination, and rapid finger movements (NAS 2005). Increasing the sample sizes of the birth cohorts from the cities studied in Chile would be desirable to achieve appropriate statistical power for

## 3. HEALTH EFFECTS

detecting possible differences among exposure groups on the developmental assessments. NAS (2005) also suggested that the question of whether or not exposures to perchlorate at concentrations present in municipal drinking water are related to an increased incidence of maternal hypothyroidism during gestation could be addressed in the study of pregnant women in Chile (Téllez et al. 2005) and that using larger samples would improve the precision of the estimates.

**Biomarkers of Exposure and Effect.**

**Exposure.** Potential biomarkers of exposure include perchlorate in urine, breast milk, iodide in blood and urine, thyroid (T4, T3) and pituitary (TSH) hormones in blood, and radioactive iodine uptake.

Perchlorate in urine is a biomarker that is specific for exposure to perchlorate; however, the biomarkers for iodine and thyroid hormones are not exclusive to perchlorate (changes may be produced by other anti-thyroid compounds and may be influenced by diet). One study of women from Chile found an association between urinary levels of perchlorate and drinking water concentrations of perchlorate (Valentín-Blasini et al. 2005). Further studies designed to correlate levels of one or more of these potential biomarkers with exposure levels would be useful to facilitate medical surveillance that can lead to early detection of exposure to perchlorate.

**Effect.** Biomarkers of effect for perchlorate also include levels of iodine in blood and urine, and thyroid (T4, T3) and pituitary (TSH) hormones in blood. Dosimetry has not been established to relate specific degrees of change in these markers to demonstrably adverse effects. Studies designed to perform this dosimetry would be useful to determine whether exposed populations may be experiencing adverse health effects due to perchlorate exposure.

**Absorption, Distribution, Metabolism, and Excretion.** Existing studies of absorption, distribution, metabolism, and excretion of perchlorate in humans provide information about the extent of absorption of ingested perchlorate and the extent and kinetics of urinary excretion of absorbed perchlorate (Anbar et al. 1959; Durand 1938; Greer et al. 2002; Lawrence et al. 2000). These studies lend support to estimates of elimination half-time of absorbed perchlorate of approximately 8–12 hours. Studies in animals provide support for the above estimates as well as information about the tissue distribution and kinetics of elimination of perchlorate from various tissues after intravenous or oral exposures (Chow and Woodbury 1970; Chow et al. 1969; Clewell et al. 2003a, 2003b; Durand 1938; Fisher et al. 2000; Goldman and Stanbury 1973; Lazarus et al. 1974; Selivanova et al. 1986; Yu et al. 2002). The above information has been used to support the development of PBPK models of perchlorate in adult humans,

## 3. HEALTH EFFECTS

adult rats, pregnant rats and rat fetus, and lactating rats and rat pups (Clewell et al. 2003a, 2003b, 2007; Fisher et al. 2000; Merrill et al. 2003, 2005).

All of the above studies were by the oral or parenteral routes; no information is available regarding absorption following inhalation or dermal exposure. Inhalation is a potential route of exposure for perchlorate workers, but may not be relevant for the general population; however, dermal absorption is expected to be negligible, but experimental information could confirm this expectation as dermal contact with water is likely when water contains perchlorate.

**Comparative Toxicokinetics.** Existing studies in humans and rats provide comparative information on the extent of absorption of ingested perchlorate, the routes of excretion of absorbed perchlorate, and the kinetics of excretion of absorbed perchlorate. PBPK models have been developed for the adult human and rat for the purpose of species extrapolation of oral or intravenous dosages of perchlorate (Clewell et al. 2003a, 2003b, 2007; Merrill et al. 2003, 2005). However, further research is necessary to determine how differences in thyroid physiology between humans and rats may affect the use of these models for human risk characterization and risk assessment. NAS (2005) identified a number of issues as potential data gaps with existing rat PBPK models including the need to: “(1) develop a more biologically-based description of placental transfer of perchlorate and iodide in rats, (2) determine whether perchlorate is transported by thyroid NIS if analytic methods of sufficient sensitivity can be developed or radiolabeled perchlorate with high radiochemical purity can be synthesized, (3) modify the adult human model to include the physiology of pregnancy and lactation to incorporate data from the recommended human clinical studies (if they are conducted), and (4) modify models to incorporate dietary iodide measurements from biomonitoring studies in pregnant or lactating women.” Issue (2) has been partially addressed by a study that showed that the NIS actively transports perchlorate (Dohán et al. 2007). Issue (3) also has been partially addressed by a recent study that described a model that is able to predict iodide and perchlorate kinetics in the human from fetal life through adulthood, thus allowing the quantitative estimation of dose in the target tissue, the developing thyroid (Clewell et al. 2007).

**Methods of Reducing Toxic Effects.** There are no established methods for reducing the toxic effects of perchlorate. Removal of the individual from exposure would also be effective since perchlorate is rapidly eliminated from the body (elimination half-time 8–12 hours) (Greer et al. 2002). Research into methods for reducing the toxic effects of perchlorate would enable treatment for individuals experiencing adverse health effects due to perchlorate exposure.

### 3. HEALTH EFFECTS

**Children's Susceptibility.** Data needs relating to both prenatal and childhood exposures, and developmental effects expressed either prenatally or during childhood, are discussed in detail in the Developmental Toxicity subsection above.

Children, infants, and the developing embryo and fetus may be especially susceptible to the thyroid effects of perchlorate because thyroid hormones are essential to normal growth and development. The embryo and fetus is dependent on maternal thyroid hormones prior to the onset of fetal thyroid hormone production at mid-gestation. Perchlorate studies in animals have shown that exposure of the mother to perchlorate during gestation, or even during lactation, can lead to reduced thyroid hormone levels and associated thyroid effects in the offspring (Brown-Grant and Sherwood 1971; Golstein et al. 1988; Lampe et al. 1967; Postel 1957; York et al. 2001b, 2003, 2004). Human models of pregnancy, maternal-fetal transfer, and maternal-infant transfer of perchlorate have also been developed (Clewell et al. 2007, see Section 3.4.5). These models have yielded predictions of external dose–internal dose relationships for various human lifestages (Clewell et al. 2007; see Tables 3-6 and 3-7). The models predict a relatively high vulnerability of the fetus, pregnant women, and lactating women to perchlorate-induced thyroid iodine uptake, compared to other lifestages (e.g., greater inhibition of thyroid iodide uptake occurs in the fetus in association with lower external doses). Further characterization of the toxicokinetics of perchlorate during pregnancy and lactation as well as comparisons of neurobehavioral tests between young animals exposed only *in utero* with animals exposed solely through lactation would provide valuable information.

Child health data needs relating to exposure are discussed in Section 6.8.1, Identification of Data Needs: Exposures of Children.

#### 3.12.3 Ongoing Studies

The following ongoing research has been identified in the Federal Research in Progress database (FEDRIP 2008).

Dr. J. Hershman from the Department of Veterans Affairs, Medical Center West Los Angeles, California, has proposed research to test the hypothesis that increasing iodide intake will prevent the deleterious effects of perchlorate on thyroid function; perchlorate does not alter thyroid cell growth; and perchlorate does not impair neural development through a direct effect on the brain. The research is sponsored by the Department of Veterans Affairs, Research and Development.

## 3. HEALTH EFFECTS

Drs. J. Fisher, F. Duncan, and J. Wagner from the University of Georgia are conducting research to develop biologically based pharmacokinetic (BBPK) maternal and fetal/neonatal models of the HPT axis in the rat by conducting experimental and computational research. The BBPK models of the HPT will describe the highly nonlinear relationships between the administered dose of thyroid active chemicals, mode-of-action, specific perturbations in the HPT axis, and developmental neurotoxicity. The research is sponsored by EPA's National Center for Environmental Research.

Dr. T. Zoeller from the University of Massachusetts is conducting research to test the hypothesis that thyroid hormone produces nonlinear, dose-dependent effects on end points within the developing brain, heart, and liver and to determine if some end points are more sensitive than others to thyroid hormones. Dr. Zoeller proposes that thyroid toxicants disrupting the HPT axis by different mechanisms will produce different dose-response curves on these end points. Dr. Zoeller suggests that a principle mechanism shaping the dose-response curve to thyroid hormone or by extension, thyroid disrupters, is a change in tissue metabolism of thyroid hormone in response to perturbations in the HPT axis. The research is sponsored by EPA's National Center for Environmental Research.

3. HEALTH EFFECTS

This page is intentionally blank.



## 4. CHEMICAL AND PHYSICAL INFORMATION

### 4.1 CHEMICAL IDENTITY

Information regarding the chemical identity of the most widely used perchlorates is located in Table 4-1.

### 4.2 PHYSICAL AND CHEMICAL PROPERTIES

Perchlorates are high melting point inorganic salts that are soluble in water at environmentally significant concentrations. There are five perchlorate salts that are manufactured in substantial amounts: magnesium, potassium, ammonium, sodium, and lithium perchlorate. Perchlorates are powerful oxidizing agents and at elevated temperatures can react explosively (Schilt 1979). The activation energy of ammonium perchlorate is 123.8 kJ/mol below 240 °C, 79.1 kJ/mol above 240 °C, and 307.1 kJ/mol between 400 and 440 °C (Mendiratta et al. 1996). The production volume of ammonium perchlorate far outpaces the other salts (Mendiratta et al. 1996).

Information regarding the physical and chemical properties of these five perchlorate salts is located in Table 4-2.

## 4. CHEMICAL AND PHYSICAL INFORMATION

**Table 4-1. Chemical Identity of Perchlorates<sup>a</sup>**

Characteristic	Magnesium perchlorate	Potassium perchlorate	Ammonium perchlorate	Sodium perchlorate	Lithium perchlorate
Synonym(s)	Anhydrous magnesium perchlorate; perchloric acid, magnesium salt (1:1)	Potassium hyperchloride; perchloric acid, potassium salt (1:1)	Perchloric acid, ammonium salt (1:1) PKHA, APC <sup>b</sup>	Perchloric acid, sodium salt (1:1)	No data
Registered trade name(s)	Anhydrone, Dehydrite	Peroidin, Astrumal, Irenal, Irenat	No data	Irenat	No data
Chemical formula	Mg(ClO <sub>4</sub> ) <sub>2</sub>	KClO <sub>4</sub>	NH <sub>4</sub> ClO <sub>4</sub>	NaClO <sub>4</sub>	LiClO <sub>4</sub> <sup>c</sup>
Chemical structure	[Mg <sup>2+</sup> ][ClO <sub>4</sub> ] <sub>2</sub>	[K <sup>+</sup> ][ClO <sub>4</sub> ]	[NH <sub>4</sub> <sup>+</sup> ][ClO <sub>4</sub> ]	[Na <sup>+</sup> ][ClO <sub>4</sub> ]	[Li <sup>+</sup> ][ClO <sub>4</sub> ]
Identification numbers:					
CAS Registry	10034-81-8	7778-74-7	7790-98-9	7601-89-0	7791-03-9 <sup>c</sup>
NIOSH RTECS	SC8925000	SC9700000	SC7520000	SC9800000	No data
EPA Hazardous Waste <sup>d</sup>	D003	D003	D003	D003	D003
OHM/TADS	No data	No data	7216589	No data	No data
DOT/UN/NA/IMDG	UN1475, IMO 5.1	UN 1489, IMO 5.1	UN1442, IMO 5.1	UN1502, IMO 5.1	UN1481 <sup>e</sup>
HSDB	661	1222	474	5038	No data
NCI	No data	No data	No data	No data	0106672 <sup>f</sup>

<sup>a</sup>All information was obtained from HSDB 2006 unless otherwise noted. Perchlorate ion was not included in this table since it is never found independent of a corresponding cation.

<sup>b</sup>Ashford 1994

<sup>c</sup>O'Neil 2001

<sup>d</sup>EPA 1992a

<sup>e</sup>ERG 2004

<sup>f</sup>ChemIDplus 2007

CAS = Chemical Abstracts Services; DOT/UN/NA/IMDG = Department of Transportation/United Nations/North America/International Maritime Dangerous Goods Code; EPA = Environmental Protection Agency; HSDB = Hazardous Substance Data Bank; NCI = National Cancer Institute; NIOSH = National Institute for Occupational Safety and Health; OHM/TADS = Oil and Hazardous Materials/Technical Assistance Data System; RTECS = Registry of Toxic Effects of Chemical Substances

## 4. CHEMICAL AND PHYSICAL INFORMATION

**Table 4-2. Physical and Chemical Properties of Perchlorates<sup>a</sup>**

Property	Magnesium perchlorate	Potassium perchlorate	Ammonium perchlorate	Sodium perchlorate	Lithium perchlorate
Molecular weight	223.21	138.55	117.49	122.44	106.39
Color	White	Colorless or white	White crystals <sup>b</sup>	White	Colorless crystals <sup>c</sup>
Physical state	Solid granular or flaky powder	Solid crystals	Solid orthombic crystals	Solid deliquesce crystals	Solid crystals
Melting point	~250 °C dec.	400 °C dec.	130 °C dec. <sup>d</sup>	471 °C dec. <sup>d</sup>	236 °C <sup>e</sup>
Boiling point	N/A	N/A	N/A	N/A	~400 °C dec. <sup>c</sup>
Density at -20 °C	2.21 g/mL <sup>f</sup>	2.52 g/mL	1.95 g/mL	2.02 g/mL <sup>g</sup>	2.43 g/mL
Odor <sup>b</sup>	No odor	No odor	No odor	No odor	No odor
Odor threshold:					
Water	N/A	N/A	N/A	N/A	N/A
Air	N/A	N/A	N/A	N/A	N/A
Taste	No data	No data	Imparts a bitter and salty taste to water <sup>c</sup>	No data	No data
Solubility:					
Freshwater at 25 °C <sup>f</sup>	9.96x10 <sup>5</sup> mg/L	2.06x10 <sup>4</sup> mg/L	2.49x10 <sup>5</sup> mg/L	2.10x10 <sup>6</sup> mg/L	5.97x10 <sup>5</sup> mg/L
Organic solvent(s) <sup>d</sup>					
Methanol	5.18x10 <sup>5</sup> mg/L	1.05x10 <sup>3</sup> mg/L	6.86x10 <sup>4</sup> mg/L	5.14x10 <sup>5</sup> mg/L	1.82x10 <sup>6</sup> mg/L
Ethanol	2.40x10 <sup>5</sup> mg/L	1.20x10 <sup>2</sup> mg/L	1.91x10 <sup>4</sup> mg/L	1.47x10 <sup>5</sup> mg/L	1.52x10 <sup>6</sup> mg/L
n-Propanol	7.34x10 <sup>5</sup> mg/L	1.00x10 <sup>2</sup> mg/L	3.87x10 <sup>3</sup> mg/L	4.89x10 <sup>4</sup> mg/L	1.05x10 <sup>6</sup> mg/L
Acetone	4.29x10 <sup>5</sup> mg/L	1.55x10 <sup>3</sup> mg/L	2.26x10 <sup>4</sup> mg/L	5.17x10 <sup>5</sup> mg/L	1.37x10 <sup>6</sup> mg/L
Ethyl acetate	7.09x10 <sup>5</sup> mg/L	1.00x10 <sup>1</sup> mg/L	3.20x10 <sup>2</sup> mg/L	9.65x10 <sup>4</sup> mg/L	9.51x10 <sup>5</sup> mg/L
Ethyl ether	2.91x10 <sup>3</sup> mg/L	No data	No data	No data	1.14x10 <sup>6</sup> mg/L
Vapor pressure at 25 °C <sup>a</sup>	Very low	Very low	Very low	Very low	Very low
Polymerization	N/A	N/A	N/A	N/A	N/A

## 4. CHEMICAL AND PHYSICAL INFORMATION

**Table 4-2. Physical and Chemical Properties of Perchlorates<sup>a</sup>**

Property	Magnesium perchlorate	Potassium perchlorate	Ammonium perchlorate	Sodium perchlorate	Lithium perchlorate
Incompatibilities	Oil, grease, benzene, calcium hydride, charcoal, olefins, ethanol, strontium hydride, sulfur, sulfuric acid, and carbonaceous material <sup>b,f</sup>	Charcoal, magnesium, reducing agents, sulfur, oil, grease, benzene, calcium hydride, olefins, ethanol, strontium hydride, sulfuric acid, carbonaceous material <sup>b,f</sup>	Nitryl perchlorate, potassium iodate, potassium permanganate, metals, powdered carbon, ferrocene, sulfur, organic matter, charcoal, copper <sup>b,f</sup>	Organic material, oil, grease, benzene, calcium hydride, charcoal, olefins, ethanol, strontium hydride, sulfur, sulfuric acid, carbonaceous material <sup>b,f,g</sup>	Sulfur, sulfuric acid, powdered magnesium, aluminum, benzene, calcium hydride, charcoal, olefins, ethanol, strontium hydride, carbonaceous material <sup>b,f</sup>
Other	Sensitive to rubbing, shock, percussion, sparks, and heating. <sup>c</sup> Dissolves in water with evolution of a considerable amount of heat.	Sensitive to rubbing, shock, percussion, sparks, and heating. <sup>c</sup>	Sensitive to rubbing, shock, percussion, sparks, and heating. <sup>c</sup>	Sensitive to rubbing, shock, percussion, sparks, and heating. <sup>c</sup> Hygroscopic. <sup>d</sup>	Sensitive to rubbing, shock, percussion, sparks, and heating. <sup>c</sup>

<sup>a</sup>Perchlorate ion was not included in this table since it is never found independent of a corresponding cation. All information was taken from O'Neil 2001 unless otherwise noted. Measured data were not available for the following end points: log  $K_{ow}$ ,  $K_{oc}$ , Henry's law constant. Conversion factors were also not available. Autoignition temperature, flashpoint, flammability limits, and explosive limits are not applicable.

<sup>b</sup>Lewis 2000

<sup>c</sup>Von Burg 1995

<sup>d</sup>Schilt 1979

<sup>e</sup>Bauer 1990

<sup>f</sup>Vogt et al. 1986

<sup>g</sup>Lewis 2001

dec. = decomposes; N/A = not applicable

## 5. PRODUCTION, IMPORT/EXPORT, USE, AND DISPOSAL

### 5.1 PRODUCTION

No information is available in the TRI database on facilities that manufacture or process perchlorates because these chemicals are not required to be reported under Section 313 of the Emergency Planning and Community Right-to-Know Act (Title III of the Superfund Amendments and Reauthorization Act of 1986) (EPA 1997a).

Commercial interest in perchlorates began in the late 1890s/early 1900s in Europe and the United States as a direct result of the pioneering efforts in rockets and their propulsion systems (Mendiratta et al. 1996). The production of ammonium perchlorate, the largest component of solid rocket propellants, far outpaced that of the other perchlorates listed in Table 4-1. Their commercial manufacture began later, and it was not until 1928 when GFS Chemicals began producing magnesium perchlorate for use as a desiccant (GFS 1997) that these salts became available on the U.S. market. Up until 1940, the total worldwide production of perchlorates had not exceeded 3.6 million pounds. An abrupt change in production was realized with the onset of World War II and the resulting increase in demand for rocket and missile propellants. Annual perchlorate production quickly increased to 36 million pounds because of this demand and remained at a high level thereafter (Mendiratta et al. 1996). By 1974, U.S. perchlorate production had reached 50 million pounds (Vogt et al. 2005).

Recent production data for ammonium perchlorate as well as for the other salts listed in Table 4-1 are lacking. In 1994, U.S. production of ammonium perchlorate was estimated at 22 million pounds or just 36% of capacity (Mendiratta et al. 1996). Actual production volumes for ammonium perchlorate have been historically dependent on the demand of aerospace and military applications due to its predominant use in propellants (Mendiratta et al. 1996). This use has resulted in defining ammonium perchlorate as a strategic chemical (Mendiratta et al. 1996; Vogt et al. 2005), and current worldwide production figures are not readily available.

Approximately 900,000 pounds of ammonium perchlorate in aqueous solution serve as the feedstock for the production of magnesium and lithium salts for use in batteries (Mendiratta et al. 1996). The wide variety of uses for perchlorates (see Section 5.3) suggests that the combined production of the salts listed in Table 4-1 would be significantly higher. U.S. facilities listed in the SRI Directory of Chemical Producers that currently manufacture perchlorates are provided in Table 5-1. According to data listed on

## 5. PRODUCTION, IMPORT/EXPORT, USE, AND DISPOSAL

**Table 5-1. U.S. Manufacturers of Perchlorates**

Producer	Aluminum perchlorate	Magnesium perchlorate	Potassium perchlorate	Ammonium perchlorate	Sodium perchlorate	Lithium perchlorate
GFS Chemicals, Inc. Columbus, Ohio	√	√	√		√	√
Western Electrochemical Co. <sup>a</sup> Cedar City, Utah			√	√	√	
Barium and Chemicals, Inc. Steubenville, Ohio			√			

<sup>a</sup>Western Electrochemical is a subsidiary of the AMPAC Corporation.

Source: SRI 2007

## 5. PRODUCTION, IMPORT/EXPORT, USE, AND DISPOSAL

EPA's website, there were 63 Federal agency facilities and 168 non-Federal facilities in the United States that were either known or suspected perchlorate manufacturers/users as of April, 2003 (EPA 2005c).

Potential source contributions of perchlorate from its intended uses and from its content as an impurity in various non-military products have been analyzed (Aziz et al. 2006; Dasgupta et al. 2006). Dasgupta et al. (2006) used data from the U.S. Government Accountability Office (GAO) and production capacities of individual plants to estimate ammonium perchlorate production and use within the United States. Based upon their analysis, an average annual perchlorate production rate of approximately  $1.06 \times 10^7$  kg per year had been estimated from 1951 to 1997 (Dasgupta et al. 2006). Potassium perchlorate is an important ingredient in fireworks and road safety flares. Using statistical data regarding total flare sales, average cost per flare and an assumed concentration of 3.6 g of perchlorate per flare, a perchlorate source contribution of  $1.4 \times 10^5$  kg per year was estimated (Dasgupta et al. 2006). No quantitative estimates were made for firework usage since the amounts of perchlorate in fireworks vary greatly. The perchlorate composition by weight percentage has been estimated to range from 4 to 70%, depending upon the type of firework (Aziz et al. 2006; SERDP 2005). Perchlorate is recognized as an impurity in the production of electrochemically produced chlorine products, including sodium chlorate. The pulp and paper industry uses most of the sodium chlorate consumed in the United States for on-site production of chlorine dioxide to bleach cellulose fibers (Aziz et al. 2006; SERDP 2005). Sodium chlorate has also been used as a non-selective contact herbicide and a defoliant for cotton, sunflowers, sundangrass, safflower, rice, and chili peppers (Aziz et al. 2006; SERDP 2005). Using a sodium chlorate consumption rate of approximately  $10^9$  kg per year and a 0.01% perchlorate content, a source strength of roughly  $10^5$  kg per year was calculated (Dasgupta et al. 2006). Perchlorate is also found as an impurity in other common consumer products that may ultimately lead to human exposure and release to the environment. The occurrence of perchlorates in these products as well as natural sources of perchlorate in the environment are discussed in Chapter 6.

The predominant commercial method for the manufacture of perchlorates begins with the production of the most soluble salt, sodium perchlorate. Electrochemical oxidation of an aqueous solution of sodium chloride is the most common method of producing sodium perchlorate (Schilt 1979; Vogt et al. 2005). Many variations for this process have been described over the years. They differ in the amount of current used, electrode composition, ionic strength of the bath, or temperature, although they all proceed via the following series of two-electron oxidations:

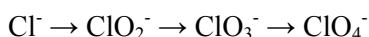

## 5. PRODUCTION, IMPORT/EXPORT, USE, AND DISPOSAL

The manufacture of all other perchlorate salts, including those listed in Table 4-1, is accomplished by selectively re-crystalizing the perchlorate salts that are less soluble than sodium perchlorate. Thus, adding common salts to a solution of sodium perchlorate leads to a metathesis (ion exchange) process that is driven to the right as the desired product precipitates out of solution:

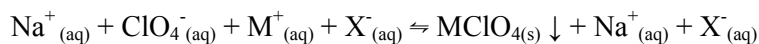

where M is magnesium, potassium, lithium, or ammonium; X is chloride, sulfate, or carbonate; and  $\text{MClO}_4(\text{s})$  is the desired perchlorate. The majority of sodium perchlorate produced in the United States is converted to ammonium perchlorate using this process (Grotheer 1994).

Given that the manufacture of perchlorates is typically accomplished in aqueous solution, the resulting perchlorate is produced as a hydrate. The anhydrous salt is required for pyrotechnic applications, and water molecules are removed from the hydrate by a number of methods including controlled heating, displacement of the water molecules by volatile amines (which are subsequently removed at reduced pressure or elevated temperatures), or through the use of a strong desiccant (Kamienski et al. 1995). High purity perchlorate salts are produced by a wide variety of methods. For example, lithium perchlorate may be prepared by direct electrochemical oxidation of lithium chloride or by reaction of 70% perchloric acid with lithium carbonate (Kamienski et al. 1995; Schilt 1979). A more recent approach in the production of high purity ammonium perchlorate involves the electrolytic conversion of chloric acid to perchloric acid, which is then neutralized by ammonia gas (Mendiratta et al. 1996). The ammonium perchlorate is spray dried to the desired crystal size at air temperatures below 150 °C.

## 5.2 IMPORT/EXPORT

The U.S. Census bureau does not list perchlorates as a separate, reportable item on its schedule B book on imports or exports. Instead, perchlorates are listed under the general category of perchlorates; bromates and perbromates; iodates and periodates. The total amount of imports for this category were  $1.867 \times 10^6$ ,  $1.881 \times 10^6$ , and  $1.281 \times 10^6$  kg for 2005, 2006, and 2007, respectively (USITC 2008). Exports totaled  $1.349 \times 10^6$ ,  $2.067 \times 10^6$ , and  $1.927 \times 10^6$  kg in 2005, 2006, and 2007, respectively (USITC 2008).

Using import/export volumes of substances in which perchlorates are contained may yield an indirect estimate of how much perchlorate is imported into the United States either from its intentional use in a



## 5. PRODUCTION, IMPORT/EXPORT, USE, AND DISPOSAL

specific product or unintentionally as an impurity of a product or commodity. For example, the import of Chilean nitrate fertilizer, which contains perchlorate as a natural component, peaked around 1920 and has dropped significantly since the 1960s. The total amount of Chilean nitrate fertilizer imported into the United States from 1930 to 1993 was estimated as  $2.4 \times 10^{10}$  kg (Dasgupta et al. 2006). Assuming an average perchlorate content of approximately 0.2%, the total amount of perchlorates imported over this time was approximately  $4.8 \times 10^7$  kg. Perchlorates are used in fireworks (see Section 5.3) and in 1997, U.S. imports of these pyrotechnic devices totaled \$93 million (U.S. Census Bureau 1999). U.S. exports of fireworks in 1997 totaled \$6.2 million. In 2003, 221 million pounds (approximately  $1 \times 10^8$  kg) of fireworks were consumed in the United States, with an estimated 3% produced domestically and the remainder (214 million pounds) imported from China (Aziz et al. 2006; SERDP 2005). Using data from the U.S. Trade Commission (USITC 2008), the import/export volumes for fireworks, signal flares, and propellant powders from 2005 to 2007 are provided in Table 5-2. The actual volume of perchlorates represented by these figures is difficult to estimate since the content of perchlorate in these commodities is not known or is highly variable.

### 5.3 USE

The predominant uses of perchlorates take advantage of their strong oxidizing power and relative stability at moderate temperatures (Conkling 1996; Mendiratta et al. 1996; Schilt 1979; Vogt et al. 2005). On heating, perchlorates decompose into chlorine, chlorides, and oxygen. As the reaction proceeds and temperatures increase, decomposition becomes self-propagating. In the presence of organics and other oxidizable materials (the fuel), large amounts of energy are released. The decomposition of ammonium perchlorate differs from that of the metal salts listed in Table 4-1 because it produces only the neutral products chlorine, water, oxygen, and nitrous oxide (or nitrogen oxide at high temperatures) and leaves no solid residue (e.g., sodium chloride residue is produced by the decomposition of sodium perchlorate).

Ammonium perchlorate is the largest volume perchlorate used in the United States (Mendiratta et al. 1996). Its primary use is as an oxidant for solid rocket boosters. The solid propellant used in the booster rockets on the U.S. Space Shuttle is approximately 70% ammonium perchlorate by weight (Conkling 1996). According to the Interstate Technology and Regulatory Council (ITRC) (2008), "Solid rocket products developed and manufactured by Aerojet consisted primarily of jet-assisted take-off motors; tactical rockets such as Falcon, Hawk, Harpoon, Sidewinder, Maverick, Bullpup, Genie, Sparrow, AMRAAM, Tartar, and Navy Standard Missile; ballistic missiles Minuteman I, II, and III, Polaris, Midgetman, Peacekeeper, and space boosters; and sounding rockets." DOD's use of perchlorates in

## 5. PRODUCTION, IMPORT/EXPORT, USE, AND DISPOSAL

**Table 5-2. Import and Export Data for Products that may Contain Perchlorate**

Product or commodity	2005	2006	2007
Imports (amount in kg)			
Fireworks	1.248x10 <sup>8</sup>	1.234x10 <sup>8</sup>	1.082x10 <sup>8</sup>
Signal flares	3.152x10 <sup>6</sup>	2.333x10 <sup>6</sup>	1.885x10 <sup>6</sup>
Propellant powders	3.755x10 <sup>6</sup>	4.755x10 <sup>6</sup>	3.150x10 <sup>6</sup>
Exports (amount in kg)			
Fireworks	2.39x10 <sup>5</sup>	3.98x10 <sup>5</sup>	3.07x10 <sup>5</sup>
Signal flares	4.36x10 <sup>5</sup>	3.35x10 <sup>5</sup>	3.54x10 <sup>5</sup>
Propellant powders	1.824x10 <sup>6</sup>	2.446x10 <sup>6</sup>	2.210x10 <sup>6</sup>

Source: USITC 2008

## 5. PRODUCTION, IMPORT/EXPORT, USE, AND DISPOSAL

weapon systems over the last 5 years was 6–8 million pounds per year, much of which is recovered and recycled (DOD 2007) (see Section 5.4)

The other perchlorates listed in Table 4-1, most notably potassium perchlorate, also find use as oxidants in solid booster rockets (Lindner 1993). Oxidant mixtures developed using metal perchlorate salts are less powerful than those using ammonium perchlorate (Schilt 1979).

Perchlorates are used extensively in pyrotechnic devices such as fireworks, safety flares, and blasting explosives (Aziz et al. 2006; SERDP 2005). Ammonium perchlorate is used in small amounts in gun powder (Lindner 1993). Ammonium perchlorate is used in a mixture with sulfamic acid to produce a dense smoke or fog for military applications. Perchlorates are also used in civilian explosives.

It has been widely published in the scientific literature that perchlorates are used in airbag inflator systems (see, for example, Cowan 2000; Lamm et al. 1999; Logan 2001; Smith et al. 2001; Von Burg 1995). When used in this application, a chlorine scavenger would be required to prevent this gas from entering the passenger compartment (Mausteller 1996). Encyclopedic sources limit their discussion of airbag inflator systems to sodium azide (Antonsen 1996; Conkling 1996; Jansen 1992; Jobelius and Scharff 1989; Stiefel 1995), although potassium perchlorate has been used in compositions described as suitable for this purpose (Schilt 1979). Airbag inflators containing perchlorate have been described in the patent literature (see, for example, Scheffee and Wheatley 1999). According to the Automotive Occupant Restraint Council, perchlorate-containing airbag initiators are sealed from the environment prior to deployment and during an accident in which they are deployed, and the perchlorate is destroyed through the combustion process, essentially resulting in little or no release of perchlorate (CADTSC 2005).

Perchlorates have also found use in a wide variety of other applications. They are used as oxygen generating systems (oxygen candles) for enclosed environments, such as submarines, spacecraft, and civilian and military aircraft (Vogt et al. 2005). Anhydrous perchlorates, most notably the magnesium salt, are used as a highly efficient drying agent for gases as well as for scrubbing the last traces of polar compounds from inert gases (Schilt 1979). Lithium and magnesium perchlorate have been used in batteries due to their low weight and high energy density. Potassium perchlorate, mixed with a reactive metal such as iron or zirconium, has been used in heat pellets for the activation of reserve battery cells (Cohen 1993). Perchlorate salts are being investigated as additives for conducting polymers although they have been problematic due to their explosive nature (Druy 1986).

## 5. PRODUCTION, IMPORT/EXPORT, USE, AND DISPOSAL

A novel use of ammonium perchlorate is as a component of temporary adhesives for steel or other metallic plates (Vogt et al. 2005). Ammonium perchlorate is mixed with an epoxy resin, which, after curing, forms the adhesive bond between the plates. When separation of the plates is required, they are heated to initiate the self-propagating perchlorate decomposition, which, in turn, decomposes the epoxy adhesive (Vogt et al. 2005).

Perchlorates find frequent use to adjust the ionic strength of electroplating baths (Schilt 1979; Vogt et al. 2005). Metals that have been used in this process include aluminum and its alloys, iron, steel, nickel and its alloys, tin and lead alloys, and zirconium and its alloys. Perchlorate electrolysis baths are specifically used in plating razor blades. Perchlorates are also routinely used to adjust the ionic strength of aqueous solutions of analytical and investigative procedures of metal solutions (Nair et al. 1997; Papini and Majone 1997; Puls and Powell 1992; Sposito and Traina 1987). They are used in this application because of the tendency of perchlorates not to form metal complexes in solution and, therefore, not to interfere with the chemical dynamics of the investigation (Cotton and Wilkinson 1980).

Perchlorates were widely used in the treatment of hyperthyroidism during the 1950s and early 1960s especially for people with Graves' disease (Von Burg 1995). Perchlorate is also available in the United States for administration (200–400 mg orally) to block radioactive technetium ( $^{99}\text{TcO}_4^-$ ) uptake in the thyroid, choroid plexus, and salivary glands during medical imaging of the brain, blood, and placenta (Gibbs et al. 1998). Potassium perchlorate is currently used as part of a treatment to counter the thyroid effects of the drug amiodarone (Martino et al. 2001).

Other uses for perchlorates include matches, etching and engraving agents, photography, and synthetic reagents (Lewis 2001). Lithium perchlorate has been described as a catalyst that should be used with caution for synthetic organic chemistry using the Diels-Alder reaction (Kamienski et al. 1995). Potassium perchlorate was used as an ignition ingredient in flash bulbs (Vogt et al. 2005) and has been approved for use as an additive in rubber gaskets for food containers (FDA 1998). Perchlorates have also been used in weed killers and as growth promoters in leguminous plants. Ammonium, sodium, and potassium perchlorates have also been used as stimulants for increasing the weight of farm animals and poultry (Von Burg 1995).

Chilean saltpeter, a naturally occurring material proven to contain perchlorates (Schilt 1979), has been marketed mainly as a granular product for fertilizers (Laue et al. 1991). Chilean researchers initiated a study in 1967 to establish why soybeans were exhibiting stunted growth, rugose, and crumpled leaves as a

## 5. PRODUCTION, IMPORT/EXPORT, USE, AND DISPOSAL

result of domestic fertilizer application and to determine what levels of perchlorate these plants could tolerate (Tollenaar and Martin 1972). The saltpeter used to produce the fertilizer at that time contained 0.12–0.26% perchlorate (by weight) as a contaminant. The United States first began importing Chilean saltpeter in 1830 (Hoffmeister 1993). U.S. importers of the refined Chilean nitrate reached historic highs prior to 1980 (Bortle 1996), and current annual imports are at 2 million pounds (Laue et al. 1991). However, this amount represents <0.1% of the total amount of nitrogen fertilizer usage in the United States (Hoffmeister 1993). Fertilizer derived from Chilean saltpeter has been traditionally applied mainly to tobacco plants, but is also marketed for citrus fruits, cotton, and some vegetable crops (Urbansky et al. 2001). The amount of perchlorate present in recent samples of these fertilizers was found to range from 0.7 to 2.0 mg/g, although steps have been taken to reformulate these products to remove perchlorate.

In 1999, perchlorate was also detected in nine different brands of synthetic fertilizer products (Susarla et al. 1999), raising concern for the potential widespread contamination from this source. The results of this study were questioned (Urbansky et al. 2000b) and a reinvestigation of many of the same products purchased at a later date found perchlorate in only one sample at a concentration two orders of magnitude lower than typically found in the original publication (Susarla et al. 2000). Nevertheless, it raised important questions as to why perchlorate would be present in synthetic fertilizers and how frequently it appeared. It also highlighted the difficulty in analyzing for perchlorate in solid samples and other complex matrices. Urbansky and Collette (2001) conducted a survey of approximately 40 fertilizer products comparing the results of six different laboratories. After an evaluation phase to determine the ability of each laboratory to quantify perchlorate in a fertilizer matrix, their results indicated that perchlorate was not detectable in any real-world fertilizer products (including synthetic fertilizers) that were not derived from Chilean caliche. During a survey of 48 fertilizer products collected from representative sites across the United States, perchlorate was detected in only 5 of the products (concentrations ranging from 1,800 to 4,200  $\mu\text{g/g}$ ) (EPA 2001a).

#### 5.4 DISPOSAL

In 1998, perchlorate was listed in the Drinking Water Contaminant Candidate List. The Safe Drinking Water Act, as amended in 1996, required EPA to publish a list of contaminants that were not subject to other primary drinking water regulation (EPA 1998a). In 1999, perchlorate was subsequently added to the Unregulated Contaminant Monitoring List that required public water systems that serve >10,000 persons, and other representative systems, to monitor for perchlorate and other substances

## 5. PRODUCTION, IMPORT/EXPORT, USE, AND DISPOSAL

beginning January, 2001 (EPA 1999b). The following year, EPA published a final rule indicating that standard method 314.0 should be used to monitor for perchlorate in drinking water (EPA 2000).

EPA would consider discarded perchlorate to be a solid waste and depending on the fact-specific circumstances, EPA believes that discarded perchlorate could be a hazardous waste under the Solid Waste Disposal Act (EPA 2006b). Specifically, because perchlorates are oxidizing chemicals, waste discarded chemical formulations of perchlorate and its salts are likely to be classified as D001 Resource Conservation and Recovery Act (RCRA) hazardous waste under 40 CFR 261.23, which regulates wastes that meet the reactivity characteristic. Such a determination is generally based on the nature of the waste at the point of generation; however, characteristic hazardous waste, such as D001, ceases to be hazardous waste once it no longer exhibits a hazardous waste characteristic. In addition, Comprehensive Environmental Response, Compensation, and Liability Act (CERCLA) 101(14) defines “hazardous substance.” According to that section, “the term hazardous substance means . . . any hazardous waste having the characteristics identified under or listed pursuant to Section 3001 of the Solid Waste Disposal Act. . . .” Therefore, depending on the fact-specific circumstances, discarded perchlorate could be classified as a D001 hazardous waste and therefore, under certain circumstances, EPA would consider perchlorate a CERCLA hazardous substance.

As noted in Section 5.3, of the 6–8 million pounds of perchlorates used annually by DOD in weapon systems, approximately 4 million pounds of ammonium perchlorate is recovered and returned to the manufacturer for use in commercial applications, such as, blasting agents or perchloric acid for glass etching (DOD 2007).

Water treatment technologies, including air stripping, activated carbon adsorption, chemical oxidation, and aerobic biodegradation are not efficient at removing perchlorate from water (Logan 1998; Urbansky 1998). Granular activated carbon columns do not economically remove the perchlorate anion from water. The useful lifetime of these columns was reduced from approximately 18 months to one month while treating tap water at the Texas Street Well facility in Redlands, California (Logan 2001).

The most promising physical removal process for treating perchlorate-contaminated water uses ion exchange technology (DOD 2005c, 2005d; EPA 2005e; Urbansky 2002). Perchlorate can be removed from water using ion exchange columns, although the resulting brine contains 7–12% perchlorate (Logan et al. 2001a). Currently, scientists are finding ways to improve this technology as well as to make it more cost efficient (Logan 2001). An ion exchange treatment facility has been installed at Edwards Air Force

## 5. PRODUCTION, IMPORT/EXPORT, USE, AND DISPOSAL

Base in California (DOE 2003). The DOD (2005c, 2005d) has reported that more than 9 million gallons of perchlorate contaminated groundwater have been successfully treated (perchlorate <4 ppb) since its implementation.

Perchlorate removal using anaerobic bioreactors has been proven for onsite applications and at the pilot-plant level (Urbansky 1998). Research in this area is active (Bardiya and Bae 2005; Brown et al. 2003; Cramer et al. 2004; Logan and LaPoint 2002; Min et al. 2004). Suspended growth, fixed bed, and fluidized bed bioreactors have been used to degrade perchlorate at influent concentrations ranging from 0.13 to 7,750 ppb (Logan et al. 2001b). Abatement and remediation of perchlorate in soil and groundwater was achieved using a biological permeable reactive barrier system at the McGregor, Texas Naval Weapons Industrial Reserve Plant (Cowan 2000). A biological fluidized bed reactor installed at the Longhorn Army Ammunition Plant in Karnack, Texas has successfully reduced perchlorate levels in groundwater at the site to below the detection limit (<4 ppb) (DOD 2005c, 2005d). Biological fluidized bed reactors are being used to remove perchlorate, with a 99.99% efficiency from contaminated groundwater at the Kerr-McGee site in Henderson, Nevada (EPA 2006a).

Phytoremediation is another method being explored as a possible treatment process for perchlorate-contaminated soil, sediment, and water (Nzengung et al. 1999, 2004; Tan et al. 2004b; Urbansky 2002; van Aken and Schnoor 2002). Plantings of lettuce and willow trees have been shown to reduce the concentration of perchlorate in contaminated soil (EPA 2004b; Nzengung et al. 1999, 2004; Yu et al. 2004). Uptake followed by accumulation was indicated as the main phytoremediation process in lettuce, whereas both uptake and rhizodegradation appear to be an important removal processes associated with woody plants.

5. PRODUCTION, IMPORT/EXPORT, USE, AND DISPOSAL

This page is intentionally blank.



## 6. POTENTIAL FOR HUMAN EXPOSURE

### 6.1 OVERVIEW

Perchlorates have been identified in at least 49 of the 1,581 hazardous waste sites that have been proposed for inclusion on the EPA National Priorities List (NPL) (EPA 2008b, 2008c). However, the number of sites evaluated for perchlorates is not known. The frequency of these sites can be seen in Figure 6-1.

Perchlorates are high melting inorganic salts that are soluble in water at environmentally significant concentrations. They are found in or released to the environment in two forms. In the absence of water, the perchlorate salts listed in Table 4-1 will be found (or released) as a solid. In water, perchlorates will rapidly dissolve and completely dissociate into the perchlorate anion and the corresponding cation (e.g., for potassium perchlorate, the corresponding cation would be  $K^+$ ). The cations of the perchlorates listed in Table 4-1, magnesium, potassium, ammonium, sodium, and lithium, are ubiquitous in the environment. Given that perchlorates completely dissociate at environmentally significant concentrations, their cations are, for all practical purposes, spectators in the aqueous fate of perchlorates. Therefore, the environmental fate of the perchlorate salts listed in Table 4-1 is dominated by the perchlorate anion.

Perchlorates are known to be highly reactive thermodynamically and therefore, they may react vigorously under the proper conditions. The activation energy of ammonium perchlorate is 123.8 kJ/mol below 240 °C, 79.1 kJ/mol above 240 °C, and 307.1 kJ/mol between 400 and 440 °C (Mendiratta et al. 1996). The decomposition of perchlorates is usually initiated using a high temperature source, such as a glow wire, to overcome the thermodynamic barrier. Once decomposition of some perchlorate molecules is initiated, the resulting reaction produces a large amount of heat. Between 200 and 300 °C, ammonium perchlorate undergoes an autocatalytic decomposition (Singh et al. 2000). At about 400 °C, ammonium perchlorate decomposes very fast and suddenly explodes. The reactivity is a function of the reaction pathway. Different reaction pathways for perchlorates would have different barriers than the thermal decomposition discussed above. Nevertheless, the existence of a large thermodynamic barrier for the decomposition of a reactive compound such as perchlorate is important in understanding its persistence in the environment.

6. POTENTIAL FOR HUMAN EXPOSURE

**Figure 6-1. Frequency of NPL Sites with Perchlorate Contamination**

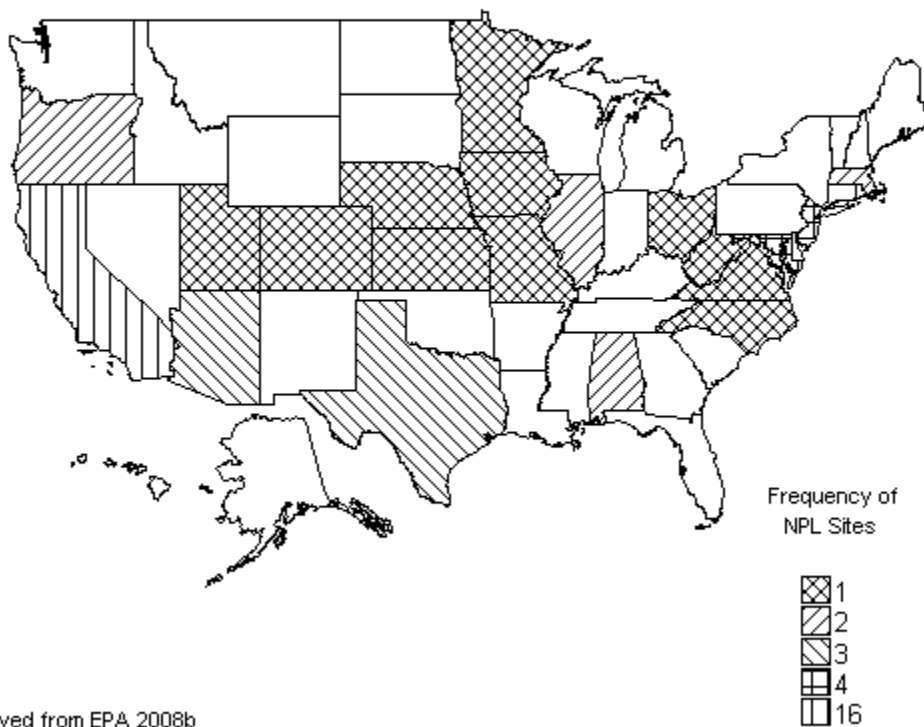

Derived from EPA 2008b

## 6. POTENTIAL FOR HUMAN EXPOSURE

When the perchlorate anion is detected in water, it is not always possible to determine the perchlorate salt that represents the original source of the contamination. That is, potassium perchlorate may be the compound that was released to the environment, yet some other perchlorate salt, such as sodium perchlorate, may be the "charge neutral" species present in the analyzed sample. For ammonium perchlorate, this is of particular relevance as the ammonium ion biodegrades in the environment and, therefore, must be replaced with some other cation to maintain the overall neutrality of the solution. From a practical standpoint, however, the concentration of the perchlorate ion is the most important factor when determining the potential for adverse effects to the perchlorates. It is the perchlorate ion that is analyzed for in environmental samples.

In Chapter 5 of this profile, the uses of the perchlorates listed in Table 4-1 were provided. Many of these uses result from the high reactivity and strong oxidizing power of perchlorates. The environmental fate of perchlorate is also dominated by this reactivity, yet its persistence is much longer than might be expected for a strong oxidizing agent. This apparent discrepancy can, in part, be explained by differences in its high energy of activation.

When released to the environment, perchlorates are expected to be highly mobile in soil and to partition to surface water or groundwater. They are not expected to significantly adsorb to sediment or suspended organic matter. They are also expected to readily settle from the atmosphere by wet and dry deposition. No degradation process for perchlorates in the environment has been unambiguously established. Laboratory experiments suggest that they may be reduced by anaerobic microbes in soil and water, although the presence of sulfates and nitrates in the environment attenuates this process. Laboratory experiments also suggest that perchlorates may undergo uptake by some plants and may be subsequently reduced to chloride. Neither the types of plants that take up perchlorate nor the types capable of reducing it have been well categorized. The mechanism for uptake by plants has not been established.

The potential for contamination resulting from discharges at facilities that manufacture and use perchlorate was studied following the accidental fire and subsequent explosion at the PEPCON rocket fuel plant, located in Henderson, Nevada in May 1988 (Urbansky 1998). This plant was one of the principal manufacturing facilities for ammonium perchlorate in the United States. Perchlorate concentrations as high as 630,000  $\mu\text{g/L}$  were observed in nearby surface water samples following the accident (Urbansky 1998). Nearby groundwater samples were also contaminated with perchlorate at concentrations ranging from 51,400 to 630,000  $\mu\text{g/L}$ . Monitoring data from 50 wells obtained near the

## 6. POTENTIAL FOR HUMAN EXPOSURE

Kerr-McGee ammonium perchlorate producing facility, also located in Henderson, Nevada, had perchlorate levels as high as 3.7 g/L (Urbansky 1998). The EPA has published a list of federal and private facilities in the United States from 25 states with known perchlorate releases to environmental media such as surface water, groundwater, and soil (EPA 2003, 2005c).

Perchlorate can also be released to the environment from the use of other commodities such as safety flares and fireworks. For example, following a July 4<sup>th</sup> fireworks display near a small lake in Oklahoma, a maximum perchlorate concentration of 44.2 µg/L was measured in the lake (Wilkin et al. 2007). This maximum level was roughly 1,000 times greater than the mean perchlorate concentration (0.043 µg/L) that was observed in the lake prior to the fireworks display.

In addition to the potential anthropogenic sources of perchlorate discussed in Chapter 5 and the use of products for which perchlorate is found as an impurity, there are natural sources of perchlorate in the environment (Dasgupta et al. 2006; Rajagopalan et al. 2006). Traces of perchlorate found in rain and snow may be caused by a series of reactions that result in the formation of atmospheric perchlorate (Dasgupta et al. 2006). In addition, perchlorate has been detected in laboratory experiments upon passage of sodium chloride aerosols through an electrical discharge that simulates lightning. Kang et al. (2006) demonstrated that perchlorate can be generated as an end-product of chlorine precursors such as aqueous salt solutions of hypochlorite, chlorite, and chlorate, following exposure to UV radiation. Using perchlorate levels observed in rainfall samples and estimated rainfall rates in the United States, the rate of natural atmospheric perchlorate deposition was estimated to range from  $1.3 \times 10^5$  to  $6.4 \times 10^5$  kg per year (Dasgupta et al. 2006). Further evidence of natural sources of perchlorate is the widespread occurrence in the arid Southwestern United States in places where no anthropogenic sources of perchlorate exist (Dasgupta et al. 2006; Rajagopalan et al. 2006). Perchlorate was detected in groundwater from several counties located in western Texas and eastern New Mexico at relatively low concentrations (<4 µg/L); however, some samples had levels of nearly 200 µg/L (Rajagopalan et al. 2006). The primary source of perchlorate in this area was postulated as deposition of naturally occurring atmospheric perchlorate.

Humans are primarily exposed to perchlorate through the ingestion of food items and also through the consumption of drinking water that contains perchlorate. Efforts are being made to determine the relative contribution of perchlorates from food and water. There are also consumer products that are widely available to the general population that also contain perchlorate. For example, household bleach has been shown to contain perchlorate, with concentrations ranging from 89 to 8,000 ppb (MassDEP 2006a). A correlation was observed between storage time of the bleach and higher levels of perchlorate. Perchlorate

## 6. POTENTIAL FOR HUMAN EXPOSURE

has also been detected in tobacco products (Ellington et al. 2001) and nutritional supplements (Snyder et al. 2006). General population and occupational exposure to perchlorate is discussed in greater detail in Section 6.5.

## 6.2 RELEASES TO THE ENVIRONMENT

### 6.2.1 Air

There is no information in the TRI database on releases of perchlorates to the atmosphere from manufacturing and processing facilities because these releases are not required to be reported (EPA 1997a).

The perchlorates listed in Table 4-1 are high melting inorganic salts that have very low vapor pressures. Therefore, solid perchlorates are not expected to directly volatilize to air as fugitive emissions during their manufacture, processing, transport, disposal, or use. Release to the air through volatilization from water is also not expected for perchlorates as dissociated inorganic ions are known to not be stripped from water (Bodek et al. 1988).

Solid perchlorate aerosols may be released to the atmosphere as fugitive emissions in dust-forming operations during manufacture, processing, and use. Gibbs et al. (1998) reported an occupational exposure investigation where they noted that dust was generated in an ammonium perchlorate production facility. Lamm et al. (1999) classified dust-forming manipulations at an ammonium perchlorate production facility as low for perchlorate solutions or slurries, moderate for limited quantities for dry perchlorates, and high when large quantities of dry perchlorates were used.

One documented major use of perchlorates is as a component of solid rocket boosters (Vogt et al. 1986). Solid rocket boosters rapidly release gases to provide propulsion through the atmosphere, and the release of unspent perchlorates may occur during this process. However, engineered design of rocket boosters target efficient and complete reaction of the perchlorate as a fundamental requirement to ensure successful launches. Studies on particulate emissions from propulsion systems have been performed (Hindman and Finnegan 1980), although it is not known if perchlorate was a targeted analyte. Perchlorates may be released to the environment from booster rockets during a catastrophic failure (Merrill and O'Drobinak 1998) or aborted flight. Following the Delta II flight failure that occurred at Cape Canaveral in January 1997, it was estimated that 200,000 pounds of perchlorate-containing hydroxyl-terminated polybutadiene (HTPB) solid propellant was released (Merrill and O'Drobinak 1998).

## 6. POTENTIAL FOR HUMAN EXPOSURE

Release of perchlorates to the atmosphere may also occur during open-burn decommissioning of rocket booster propellants or munitions (Chan et al. 2000). Emissions of regulated substances have been measured during tests of this disposal process (DOD 1995), although perchlorate was not one of the targeted analytes.

Perchlorates also find extensive use in fireworks and other pyrotechnic devices (Conkling 1996; Dasgupta et al. 2005; Lindner 1993; Schilt 1979). Release of unspent perchlorate may occur during the detonation of fireworks, flares, oxygen generators, flash-pots, smoke bombs, and other pyrotechnic devices, although very little information on the amounts, if any, was located in the available literature. Dasgupta et al. (2005) calculated an annual source strength of  $1.4 \times 10^5$  kg/year for perchlorate in road flares used in the United States, which is estimated as 1.4% of the production of total oxidizer perchlorate. These authors were not able to estimate perchlorate released from fireworks, since fireworks vary greatly in their type and composition. Release of perchlorate may also occur during catastrophic explosions at firework facilities (CSB 1999) or at facilities that manufacture other pyrotechnic devices based on this oxidant.

It has been postulated that perchlorate may be formed naturally in the atmosphere during photochemical transformation reactions involving chlorine precursors. Some possible mechanisms include the reaction of ClO radicals with sulfuric acid aerosols, electrical discharge through chloride aerosol, reaction of aqueous chloride with high concentrations of ozone, and direct photolysis of aqueous chlorite (Dasgupta et al. 2005; Jaegle et al. 1996; Kang et al. 2006). Accordingly, perchlorate may be produced in the atmosphere after volcanic eruptions. The authors suggest that perchlorate produced in volcanic eruptions similar to Mt. Pinatubo may represent a significant reservoir of chlorine in the lower stratosphere.

In an effort to locate the source of perchlorate contamination in the southern high plains desert in the Texas panhandle where there has been no known anthropogenic release of perchlorates nearby, Dasgupta et al. (2005) explored the possibility of perchlorate generation through atmospheric processes. The authors reported that perchlorate was formed during experiments where chloride aerosol was exposed to electrical discharge (lightning simulation) and where aqueous chloride was exposed to high amounts of ozone. Natural atmospheric perchlorate deposition was estimated to range from  $1.3 \times 10^5$  to  $6.4 \times 10^5$  kg per year in the United States (Dasgupta et al. 2006). However, additional testing is needed to determine whether these atmospheric processes are indeed natural pathways by which perchlorates enter the environment (Dasgupta et al. 2005; Erickson 2004; Renner 2005a).

## 6. POTENTIAL FOR HUMAN EXPOSURE

**6.2.2 Water**

There are no data in the TRI database on releases of perchlorates to the water from manufacturing and processing facilities because these releases are not required to be reported (EPA 1997a).

Perchlorates may be released to water in emissions from their manufacture, processing, or use. Waste water treatment processes used by POTWs and onsite treatment facilities, including stripping, precipitation, filtration, oxidation, or aerobic biodegradation, do not effectively remove perchlorates from waste streams (Urbansky 1998). Therefore, perchlorate in waste water may eventually be released to surface water.

EPA published a list of facilities from 25 states with perchlorate releases related to the manufacture, disposal, or research of explosives, propellants, or pyrotechnics (EPA 2003, 2005c). Maximum perchlorate concentrations observed in monitoring wells for several of these facilities exceeded 1,000 µg/L, with some observed concentrations in excess of 100,000 µg/L (EPA 2003, 2005c). Propellant removal during decommissioning or maintenance (reloading with new propellant) of solid rockets is known to have been accomplished using high pressure water sprays (Chan et al. 2000). The amount of ammonium perchlorate-laden washout from decommissioning rockets was expected to reach 8.5 million pounds in the first decade of the twenty-first century (Buckley et al. 1999), but since this estimate was made, significant changes in decommissioning and maintenance practices of rocket motors have substantially reduced the potential for future releases of perchlorate to the environment. According to the ITRC (2008), “There are times when rocket propellant must be removed from the rocket motor casing. To do so the rocket motor was taken to the ‘hog-out’ facility, where the propellant was removed using a water knife to avoid explosion hazards. The water containing ammonium perchlorate in both solid and dissolved forms was discharged to unlined and lined ponds (Aerojet Case Study)...Perchlorate is also found at areas where waste ammonium perchlorate rocket propellant was taken to be destroyed by burning and detonation (Aerojet Case Study)...Past management practices were not concerned with the release of perchlorate to the environment because it was not recognized or regarded as a contaminant of concern. Widespread perchlorate presence in the United States was observed after the spring of 1997 when an analytical method was developed with a quantitation level of 4 parts per billion. Subsequent advances in analytical chemistry have proven perchlorate to be more widespread in the environment than previously thought.”

## 6. POTENTIAL FOR HUMAN EXPOSURE

The catastrophic failure of a Delta II rocket in 1997 over the Atlantic Ocean resulted in unspent propellant falling into the ocean (Merrill and O'Drobinak 1998). Subsequent laboratory tests indicated that ammonium perchlorate will migrate from the propellant matrix to seawater. Similarly, perchlorates that have been released to the atmosphere may also enter environmental waters by deposition onto the surface of oceans, rivers, lakes, or ponds by either gravitational (dry settling) or wet (rain wash-out) processes.

Perchlorates may ultimately be released to surface water from the runoff from or erosion of perchlorate-laden sand or soil (Herman and Frankenberger 1998). The percolation of water through contaminated sand or soil is expected to bring perchlorate into underground aquifers; this is consistent with monitoring studies in wells sampled near known sites of its use (see Section 6.4.2). Runoff from perchlorate-laden soil is expected to lead to surface water contamination as determined by its detection in surface water samples down gradient from facilities that manufactured, maintained, decommissioned, or tested solid rocket boosters (Herman and Frankenberger 1998; Mendiratta et al. 1996; Urbansky 1998). The use of fireworks may also contaminate nearby water bodies. A small lake near Ada, Oklahoma had baseline perchlorate concentrations in surface water ranging from 0.005 to 0.081  $\mu\text{g/L}$ , with a mean value of 0.043  $\mu\text{g/L}$ . Following the release of a fireworks display (14 hours after the fireworks), perchlorate concentrations spiked to values ranging from 24 to 1,028 times the mean baseline value (Wilkin et al. 2007). A maximum perchlorate concentration of 44.2  $\mu\text{g/L}$  was determined following the July 4<sup>th</sup> event in 2006. After the fireworks displays, perchlorate concentrations decreased toward the background level within 20–80 days, with the rate of attenuation correlating to surface water temperature.

### 6.2.3 Soil

There are no data in the TRI database on releases of perchlorates to the soil from manufacturing and processing facilities because these releases are not required to be reported (EPA 1997a). As discussed in Section 6.2.2, facilities that manufactured, maintained, decommissioned, or tested solid rocket boosters likely released perchlorates to the environment. Their detection in groundwater wells at some of these sites (see Section 6.4.3) suggests that the initial release was to soil, and subsequent transport led to contamination of the aquifer. Information on the amount of perchlorate released to soil as a result of its manufacture, processing, and use in aerospace and military applications could not be located in the available literature.

The use of explosives that contain perchlorates in underground applications, such as mining (Vogt et al. 1986), may result in the release of unspent oxidant to soil. The amount of perchlorate used in explosives,



## 6. POTENTIAL FOR HUMAN EXPOSURE

the frequency of use in underground applications, and the amount of unspent oxidant released are not available.

Perchlorates that have been released to the atmosphere may be deposited directly on the Earth's surface by either dry or wet deposition processes. The catastrophic failure of a Delta II rocket was found to release unspent ammonium perchlorate propellant to land (Merrill and O'Drobinak 1998). Deposition of perchlorate to soil from the use of fireworks is also expected to be significant.

Perchlorate has been detected in fertilizers derived from Chilean caliche (Ellington et al. 2001; Urbansky et al. 2001). It was also detected in other fertilizer products (Susarla et al. 1999), although follow-up studies failed to detect perchlorate in the 40 products tested (Urbansky and Collette 2001). Fertilizer derived from Chilean saltpeter has been traditionally applied mainly to tobacco plants, but is also marketed for citrus fruits, cotton, and some vegetable crops (Urbansky et al. 2001). Perchlorate containing fertilizers would result in the contamination of soil as a direct result of their intended use. Using a perchlorate concentration of 0.2% and a total importation volume of  $2.4 \times 10^{10}$  kg of Chilean nitrate fertilizer (Dasgupta et al. 2006),  $4.8 \times 10^7$  kg of perchlorate may have been released directly to soil over the period from 1930 to 1993.

### 6.3 ENVIRONMENTAL FATE

Only a limited number of studies investigating the environmental fate of perchlorate were located in the peer-reviewed literature. Key aspects of its environmental fate have been assessed based on the analysis of physical and chemical properties, available monitoring data, and known sources of release. Although substantial research efforts are currently underway (see Section 6.8.2, Ongoing Studies), much has been learned concerning the behavior of perchlorates in the environment.

In water, perchlorates are expected to readily dissolve and dissociate into their component ions. Thermodynamic data on the dissolution of the perchlorates (Schilt 1979) indicate that the rate of this process should be rapid for all of the perchlorates listed in Table 4-1. The cations of the perchlorates listed in Table 4-1, magnesium, potassium, ammonium, sodium, and lithium, are ubiquitous in the environment. Given that perchlorates completely dissociate at environmentally significant concentrations, their cations are, for all practical purposes, spectators in the environmental fate of perchlorates dissolved in water. Therefore, when in water, the cations do not participate in, nor do they substantially influence, the fate of the perchlorate anion in the environment.

## 6. POTENTIAL FOR HUMAN EXPOSURE

**6.3.1 Transport and Partitioning**

Perchlorates are water soluble and the anion does not typically form insoluble metal complexes in solution (Cotton and Wilkinson 1980). Since the perchlorate ion is only weakly adsorbed to mineral surfaces in solutions of moderate ionic strength, its movement through soil is not retarded (Logan 2001; Urbansky and Brown 2003; Urbansky and Collette 2001). These two properties indicate that perchlorate will travel rapidly over soil with surface water runoff or be transported through soil with infiltration. Therefore, if released to soil, perchlorates are expected to be highly mobile and travel to groundwater and surface water receptors. This is consistent with surface water and groundwater monitoring data that indicate that perchlorates have been found far from known sites of their release to soil (see Section 6.4.2). Although data quantifying the extent of perchlorate adsorption to soil were not located in the available literature, a study on willow decontamination in sand bioreactors (Nzengung et al. 1999) established, through a mass-balance assessment, that perchlorates were not adsorbed by sand under the conditions of the experiment.

Perchlorates are not expected to volatilize from soil to the atmosphere given their very low vapor pressure. Moreover, dissociated inorganic ions do not undergo volatilization (Bodek et al. 1988). Perchlorates may be transported from soil to the atmosphere by wind-borne erosion. This convective process may release either aerosols or particulate matter to which dry perchlorate salts are adsorbed.

If released to water, perchlorates are not expected to volatilize to the atmosphere based on the extensive data set available for soluble inorganic ions that indicates this process does not occur (Bodek et al. 1988). The water solubility of perchlorates indicates that they will not be removed from the water column by physical processes and become adsorbed to sediment and suspended organic matter. Since the perchlorate ion is only weakly adsorbed to mineral surfaces in solutions of moderate ionic strength (Logan 2001; Urbansky and Brown 2003; Urbansky and Collette 2001), perchlorate is not expected to adsorb to sediment and organic matter. Since perchlorate does not serve as a ligand in aqueous solutions (Cotton and Wilkinson 1980), it is not expected to undergo removal from water through the formation of insoluble metal complexes. The water solubility and degree of complex formation of perchlorate do not change significantly as a function of acidity (Bodek et al. 1988), indicating that its fate is not expected to change within the pH range typically found in the environment. In cases where high concentration perchlorate brines enter the subsurface, the movement of perchlorate is expected to be controlled by gravity and the topography of confining layers (DOD 2006a). Perchlorate brines may sink through the

## 6. POTENTIAL FOR HUMAN EXPOSURE

subsurface and accumulate on or in confining layers where its release into groundwater is limited by diffusion.

Limited data indicate that perchlorate may accumulate in living organisms, as it has been detected in vegetation, fish, amphibian, insect, and rodent samples collected near a site of known contamination (Smith et al. 2001). The concentrations of perchlorate in male threespine stickleback fish (*Gasterosteus aculeatus*) were 0.63, 0.54, and 4.47 µg/g, corresponding to aquarium water perchlorate concentrations of 0, 1, and 10 ppm, respectively (U.S. Air Force Space Missile Systems Center 2002). Dean et al. (2004) reported bioconcentration factors of 1.854 for Asiatic clam (*Corbicula fluminea*) and 0.70 for bluegill (*Lepomis macrochirus*), indicating that bioconcentration of perchlorates in aquatic organisms is low. Theodorakis et al. (2006) analyzed fillets and heads of fish collected from Lakes Waco and Belton in Texas for perchlorates. These lakes are located near the Naval Weapons Industrial Reserve Plant where solid fuel rocket motors are manufactured. Perchlorate concentrations in positive samples ranged from 146 to 2,740 µg/kg wet weight in fillets and from 626 to 4,560 µg/kg wet weight in heads. Perchlorates were not detected in water samples from these lakes except for one instance at one of the three sampling sites in Lake Belton (14 µg/L) indicating that food chain transfer is possible. Possible routes of exposure for these fish include ingestion of contaminated periphyton (algae film), ingestion of contaminated detritus, and ingestion of perchlorate-containing invertebrates.

In a study on plant-mediated treatment of perchlorate-contaminated water (Nzengung et al. 1999), it was reported that uptake occurred in eastern cottonwoods (*Populus deltoides* and hybrid *populus*), *Eucalyptus cineria*, and willow (*Salix nigra*) in sand bioreactors. Willow was the only tree studied in detail. Perchlorate uptake was found to be initially rapid at a rate that was linear with the volume of water evapotranspired by the tree until a plateau was reached where perchlorate uptake ceased. At an initial application of 88.8 mg (at 96.4 mg/L), the total amounts of perchlorate in the root, lower stem, upper stem, and leaf after 26 days were 0.04, 0.18, 0.34, and 0.48 mg, respectively. In addition, 11% of the perchlorate was not accounted for, and was believed to be degraded to chloride in the leaves. Perchlorate uptake has also been established in salt cedar (*Tamarix ramosissima*) although the rate of uptake, excretion, and/or reduction was not determined (Urbansky et al. 2000c). Yu et al. (2004) observed uptake of perchlorate from sand in cucumber (*Cucumis sativus L.*), lettuce (*Lactuca sativa L.*), and soybean (*Glycine max*). Concentrations of perchlorate were higher in the lettuce (750 ppm) than in the cucumber (41 ppm) and soybean (18 ppm). It was reported that the presence of external nutrients such as nitrate may hinder uptake of perchlorate. The percent recovery of perchlorate in lettuce after it was applied at

## 6. POTENTIAL FOR HUMAN EXPOSURE

500, 1,000, 5,000, and 10,000 ppb to lettuce pots in a greenhouse was 82, 74, 76, and 73%, respectively (EPA 2004b).

A study on the uptake of perchlorate by tobacco plants from soil amended with Chilean-nitrate derived fertilizer (containing perchlorate at 36–1,544 mg/kg) found that extracts of the green and flue-cured leaves contained perchlorate at 12.4–164.6 mg/kg (dry weight) (Ellington et al. 2001). The authors point out that the available data set is not sufficient at this point in time to predict which plants undergo perchlorate uptake and accumulation and which ones are capable of completely reducing it to chloride, an important factor to consider given that food crops may be irrigated with contaminated water containing perchlorate. The uptake and transport of perchlorate from contaminated soil to the leaves of tobacco plants was also demonstrated over a wide range of initial soil concentrations (Sundberg et al. 2003). The results of this study indicate that perchlorates are taken up by the root system, transported up the stem via the xylem, and accumulate in the leaves and stems.

If released to the atmosphere, the perchlorate salts are expected to exist as a solid aerosol or be adsorbed to suspended particulate matter. Removal from the atmosphere is expected to occur by both dry and wet deposition to the Earth's surface. The water solubility and rapid rate of dissolution of perchlorates indicate that they may partition to clouds or fog, although subsequent deposition to the Earth's surface would be expected.

### **6.3.2 Transformation and Degradation**

#### **6.3.2.1 Air**

No data were located on the transformation or degradation of perchlorates in air. The dominant mechanism for the degradative removal of chemical compounds from the atmosphere is via their reaction with gas-phase oxidants (Lyman et al. 1990). Gas-phase oxidants include the neutral molecules, ozone and singlet oxygen, as well as hydroxyl radicals during the day or nitrate radicals at night. However, these species are all weaker oxidants than perchlorate, and atmospheric degradation via this pathway is, therefore, not expected to occur.

The other major atmospheric degradation process for chemical compounds is through direct photolysis. In general, this reaction is not sufficiently facile for solid phase materials for it to occur to any significant extent in the atmosphere. Since perchlorates are expected to exist as a solid dust in the atmosphere or be

## 6. POTENTIAL FOR HUMAN EXPOSURE

adsorbed to suspended particulate matter, direct photolysis is not expected to occur. Jaegle et al. (1996) estimated that the photolytic loss of perchloric acid in the atmosphere would be negligible.

**6.3.2.2 Water**

The ability of bacteria to utilize perchlorate as a terminal electron acceptor was first reported in 1976 (Logan et al. 2001b). Reviews by Logan (1998) and Herman and Frankenberger (1998) provide an extensive set of examples where laboratory experiments using microorganisms biodegrade (respire) perchlorate under anaerobic conditions. In the environment, anaerobic degradation has been found to be an important process in anoxic groundwater, sediments, and some soils. Microorganisms utilize alternative electron acceptors such as nitrate or sulfate anions in lieu of oxygen to generate energy and produce carbon-based building blocks in these anaerobic environs. In laboratory studies, the perchlorate anion has also been found to serve as an alternative electron acceptor in anaerobic microbial respiration. The reduction of perchlorate by microorganisms has been found to be inhibited by the electron acceptors most commonly found in anaerobic environments, most notably nitrate and/or sulfate. In a few cases, they were found to be reduced preferentially. The initial product from the respiration of perchlorate is chlorate ( $\text{ClO}_3^-$ ), which, in turn, is reduced by some of the isolates to chlorite ( $\text{ClO}_2^-$ ) and ultimately chloride ( $\text{Cl}^-$ ) and either oxygen or bicarbonate. A confounding aspect of the complete reduction of perchlorate is the production of oxygen, the absence of which defines a medium as anaerobic. For some microorganisms (obligate or strict anaerobes), perchlorate reduction was completely inhibited by the presence of oxygen. For others (facultative anaerobes), perchlorate reduction would subside with the introduction of oxygen and reoccur once it had been removed from the system via other processes.

Nzengung et al. (1999, 2004) studied the use of willows and other trees for the phytoremediation of perchlorate-contaminated water using hydroponic bioreactors. These investigators found that reduction of perchlorate to chloride occurred rapidly in the root zone (rhizosphere) after a relatively short acclimation period. Added nitrate inhibited the degradation of perchlorate indicating that reduction was occurring anaerobically, presumably in oxygen free micro-environments. The level of nitrate found to result in inhibition, 100 mg/L, is on the low end of the range typically found in soils, 0–1,200 mg/L. Tan et al. (2004b) reported that in the absence of nitrate, perchlorate was removed to levels below the detection limit (<4  $\mu\text{g/L}$ ) in wetland columns with perchlorate influents of 4, 8, 16, and 32 mg/L. van Aken and Schnoor (2002) studied poplar tree cuttings (*Populus deltoide x nigra*) grown in the presence of radiolabeled perchlorate at 25 mg/L. These authors reported that 50% of the perchlorate was reduced 30 days after perchlorate application.

## 6. POTENTIAL FOR HUMAN EXPOSURE

Despite the numerous observations that perchlorate is readily reduced by microorganisms in laboratory cultures and the perceived ubiquity of these microorganisms in the environment (Bruce et al. 1999; Coates et al. 1999), it has been found to be persistent in the environment (Logan et al. 1998). *In situ* removal of perchlorate has not yet been demonstrated (Coates and Anderson 2000). This is likely due to the ubiquitous presence of nitrate and sulfate in the environment and the preferential utilization of these electron acceptors by anaerobes. Nevertheless, work in this area is continuing and recent studies are available on the reduction of perchlorate by hydrogen utilizing bacteria (Giblin et al. 2000) in the presence of acetate (Bruce et al. 1999; Coates et al. 1999; Kim and Logan 2001; Logan et al. 2001b) and in the presence of nitrate (Giblin and Frankenberger 2001; Herman and Frankenberger 1999). Biodegradation of perchlorate has also been demonstrated in salt solutions (11% brine) (Logan et al. 2001a).

No other degradation processes that are likely to remove perchlorates from water were identified. Photo-oxidation in water by alkoxy, peroxy, or other reactive species (Mill 1982) is not expected to occur as these species are weaker oxidants than perchlorate. Millero (1990) studied the rates of the indirect photochemical oxidation of Cu(I) and Fe(II) by hydroxyl radicals in artificial seawater solutions prepared using sodium perchlorate. No correction for a hydroxyl radical reaction with perchlorate was included in the detailed kinetic analysis performed by the authors, indicating that the reaction of perchlorate with hydroxyl radicals did not occur to any significant extent.

Another common removal process in the environment is biodegradation under aerobic conditions. In this process, the substrate is oxidized by microorganisms. Given that the perchlorate anion is at its highest oxidation state, this process is not expected to occur.

No studies on the direct photochemical degradation of perchlorates in water were located in the available literature. One of the requirements for direct photolysis to occur is the possession of a suitable chromophore that absorbs light in the environmentally significant range of >290 nm (i.e., wavelengths not blocked by the ozone layer); it does not address to what extent, if any, a reaction will ensue after a quantum of light has been adsorbed. Aqueous solutions of sodium perchlorate have a broad absorption at 605–700 nm (GMELIN 1999). This wavelength of light is on the long-wavelength (red), low energy side of the visible spectrum. A quantum of light at this wavelength does not typically have sufficient energy to result in the direct photochemical degradation of chemical compounds.

## 6. POTENTIAL FOR HUMAN EXPOSURE

The other major removal process for chemical compounds in environmental waters is through hydrolysis. Hydrolysis does not occur for inorganic salts that ionize in aqueous solutions, and it will not occur for perchlorates.

**6.3.2.3 Sediment and Soil**

Very few studies on the degradation of perchlorates in sediment or soil have been located in the available literature. Microorganisms isolated from soil have been found to reduce perchlorates under anaerobic conditions in the laboratory (Herman and Frankenberger 1998; Logan 1998) suggesting the potential for removal from anoxic soils and sediments. As noted for the degradation and removal from water (Section 6.3.2.2), perchlorates have been found to be persistent; the importance of this process in anoxic sediment and soils is not known. Tipton et al. (2003) have stated that the necessary criteria for perchlorate degradation in soil are anaerobic conditions, an adequate carbon source, and an active perchlorate-degrading microbial population. Perchlorate applied to Yolo loam at 180 mg/L during an anaerobic flooded batch experiment was completely biodegraded after 30 days (Tipton et al. 2003). During an analysis of perchlorate contaminated streambed sediment located near the Naval Weapons Industrial Reserve Plant in McGregor, Texas, it was concluded that microbial degradation of perchlorate was taking place based on a sequential depletion of electron acceptors and a constant  $\text{Cl}^-$  concentration in the sediment (Tan et al. 2005). While studying the natural biodegradation of perchlorate in the Las Vegas Wash area in Nevada, Zhang et al. (2002) concluded that this process is hindered by the lack of an electron donor, the presence of nitrate, and salinity levels in the area.

No other degradation process can be predicted for perchlorates in soil or sediment.

**6.4 LEVELS MONITORED OR ESTIMATED IN THE ENVIRONMENT**

Reliable evaluation of the potential for human exposure to perchlorates depends in part on the reliability of supporting analytical data from environmental samples and biological specimens. Concentrations of perchlorates in unpolluted atmospheres and in pristine surface waters are often so low as to be near the limits of current analytical methods. In reviewing data on perchlorates levels monitored or estimated in the environment, it should also be noted that the amount of chemical identified analytically is not necessarily equivalent to the amount that is bioavailable. The analytical methods available for monitoring perchlorates in a variety of environmental media are detailed in Chapter 7.

## 6. POTENTIAL FOR HUMAN EXPOSURE

**6.4.1 Air**

No monitoring data on the atmospheric concentration of perchlorates were located in the available literature.

**6.4.2 Water**

Drinking water samples from 3,858 public water systems located across the United States were collected from 2000 to 2004 as part of the Unregulated Contaminants Monitoring Rule (UCMR) (EPA 2005g). EPA found that approximately 4.1% (or 160) of these systems had at least one analytical detection of perchlorate (in at least one entry/sampling point) at levels greater than or equal to the minimum reporting level of 4 micrograms per liter ( $\mu\text{g/L}$ ). These 160 systems are located in 26 states and 2 territories. Perchlorate was detected at  $>4 \mu\text{g/L}$  in 365 of 13,401 (2.7%) samples from 67 of 1,247 (5.4%) surface water systems that serve  $>10,000$  people with a mean (range) concentration of  $15.6 \mu\text{g/L}$  ( $4.0\text{--}420 \mu\text{g/L}$ ). Perchlorate was detected at  $>4 \mu\text{g/L}$  in 29 of 1,496 (1.9%) samples from 5 of 236 (2.1%) surface water systems that serve  $<10,000$  people with a mean (range) concentration of  $6.4 \mu\text{g/L}$  ( $4.1\text{--}17 \mu\text{g/L}$ ). Perchlorate was detected at  $>4 \mu\text{g/L}$  in 214 of 14,972 (1.4%) samples from 69 of 962 (7.2%) groundwater systems that serve  $>10,000$  people with a mean (range) concentration of  $11.3 \mu\text{g/L}$  ( $4.0\text{--}200 \mu\text{g/L}$ ). Perchlorate was detected at  $>4 \mu\text{g/L}$  in 6 of 2,459 (0.2%) samples from 5 of 485 (1%) groundwater systems that serve  $<10,000$  people with a mean (range) concentration of  $7.8 \mu\text{g/L}$  ( $4.3\text{--}20 \mu\text{g/L}$ ). Based on analysis of 2004 UCMR data, NAS (2005) estimated that more than 11 million people are served by public drinking water supplies from which samples containing at least  $4 \mu\text{g/L}$  of perchlorate were collected.

According to information provided by the California Department of Health Services (CADHS 2007), perchlorate has been detected above  $4 \mu\text{g/L}$  in 267 out of approximately 7,000 drinking water sources located across California during monitoring conducted between March 2002 and March 2007. The greatest numbers of detections were in Los Angeles, Riverside, San Bernardino, and Orange Counties where perchlorate was found in 106, 64, 57, and 18 sources, respectively. The peak concentrations reported for these counties were 100, 73, 88, and  $10.6 \mu\text{g/L}$ , respectively. Perchlorate was detected drinking water from only four sources in Sacramento County; however, the peak concentration reported was  $95.9 \mu\text{g/L}$ .

In drinking water wells tested in Riverside and San Bernardino Counties, California, the maximum perchlorate concentration measured was  $216 \mu\text{g/L}$  (Herman and Frankenberger 1998). Five of six well-



## 6. POTENTIAL FOR HUMAN EXPOSURE

water samples obtained near Sacramento, California, March–April 1997, contained 4–260 µg/L of perchlorate (Okamoto et al. 1999). The concentrations of perchlorate measured in six water supply wells that serve the city of Loma Linda, California during 1997–1998 ranged from <4 to 29 µg/L (Agency for Toxic Substances and Disease Registry 2000). Jackson et al. (2005b) detected perchlorate above 0.5 µg/L in 179 out of 254 public water system and private wells in nine counties in the Texas Southern High Plains. Perchlorate concentrations were >4 µg/L in 88 wells. The maximum concentrations were 58.8 µg/L for private wells and 45.6 µg/L for public water system wells. The Massachusetts Department of Environmental Protection (MassDEP 2006a) reported that perchlorate concentrations were at or above the analytical reporting limit of 1 µg/L in only 9 of 600 tested public water supply systems in that state. Elevated perchlorate concentrations (maximum 1.5–1,300 µg/L) were measured near areas where blasting agents and fireworks were used.

Snyder et al. (2005) measured perchlorate concentrations ranging from 0.06 to 6.8 µg/L in 12 of 13 waters from various sources (seven surface waters, one groundwater, one spring water, and four treated waters) in the United States. The level in the spring water sample was reported to be “clearly visible” but below the reporting limit of 0.05 µg/L. These authors also detected perchlorate in 10 of 21 bottled water samples from various sources at levels ranging from 0.07 to 0.74 µg/L. Eleven of these samples were below the method reporting limit of 0.05 µg/L. In a separate study, perchlorate was not detected in 16 brands of imported and domestic bottled water (Urbansky et al. 2000a).

During a 1997–1998 drinking water survey, perchlorate was not detected (reporting limit=4.0 µg/L) in surface water samples from 40 sites in 11 states (Gullick et al. 2001). Out of 367 groundwater wells in 17 states tested during this survey, only 9 wells located in California and New Mexico contained perchlorate. Concentrations in samples from these wells ranged from <4–7 µg/L. The Southern Nevada Water Authority detected perchlorate at 11 µg/L in tap water samples (Urbansky 1998). Perchlorate was detected in the drinking water supply for Clark County, Nevada, at 4–15 µg/L (Li et al. 2000a). The perchlorate level in finished drinking water supplies in Yuma, Arizona, 1999, was 6 µg/L (Brechtner et al. 2000). Drinking water advisory levels for perchlorate have been set in Arizona (14 µg/L), Maryland (1 µg/L), Nevada (18 µg/L), New Mexico (1 µg/L), New York (5 and 18 µg/L), and Texas (17 and 51 µg/L) (Dasgupta et al. 2005; EPA 2005c; Tikkanen 2006). Drinking water standards have been set in California (6 µg/L) and Massachusetts (2 µg/L). Perchlorate was generally not detected in surface water samples collected from 50 sites across the Great Lakes Basin (Backus et al. 2005). Concentrations were near the method detection limit of 0.2 µg/L in two samples from Hamilton Harbour and six creek/river water samples from the Mailtand Valley and the Upper Thames River watersheds in Canada.

## 6. POTENTIAL FOR HUMAN EXPOSURE

Perchlorate contamination in drinking water has been reported at 12 DOD facilities and 2 other federal agency facilities located in California, Illinois, Maryland, Massachusetts, New Mexico, Ohio, and Utah as of March, 2005 (EPA 2005c). Maximum reported perchlorate concentrations in surface water at these sites range from approximately 1 to 720  $\mu\text{g/L}$ . Perchlorate contamination in drinking water has been reported at 16 private facilities located in Arizona, California, Iowa, Nebraska, New Mexico, Nevada, New York, and Utah as of March, 2005 (EPA 2005c). Maximum reported perchlorate concentrations in surface water at these sites range from approximately 5 to 811  $\mu\text{g/L}$ .

Surface water samples taken in August 1997 from the Las Vegas Wash, which feeds into Lake Mead, had perchlorate concentrations of 1,500–1,680  $\mu\text{g/L}$  (Herman and Frankenberger 1998; Urbansky 1998). Smith et al. (2004) reported a mean perchlorate concentration of 450  $\mu\text{g/L}$  in 24 water samples from 3 sites at the Las Vegas Wash collected in March, 2002 near Henderson, Clark County, Nevada. The Los Angeles Metropolitan Water District has detected perchlorate at 8  $\mu\text{g/L}$  at an intake located in Lake Mead (Urbansky 1998). In a separate study, perchlorate was detected in 57% of 147 surface water samples and 50% of 10 pore water samples collected in the Lake Mead area with average (maximum) concentrations of 10.5 (130) and 19.6 (98.0)  $\text{mg/kg}$ , respectively (Dean et al. 2004). Reported concentrations of perchlorate in the Colorado River are 5–9  $\mu\text{g/L}$  (Sanchez et al. 2005b, 2006). In Utah, perchlorate concentrations in groundwater wells at Alliant Techsystems, a rocket manufacturing site, ranged from 4 to 200  $\mu\text{g/L}$  (Urbansky 1998). According to a report issued by the EPA in December 2005, surface water concentrations in Las Vegas Wash, Lake Mead, and the Lower Colorado River have declined by 85, 70, and 60%, respectively, since the inception of a seep capture and treatment program at the Kerr-McGee site in Henderson, Nevada began in November 1999 (EPA 2006a).

Groundwater samples from a shallow aquifer near the Aerojet General Corporation's solid rocket fuel facility near Sacramento, California had maximum perchlorate levels of 8,000  $\mu\text{g/L}$  (Herman and Frankenberger 1998). Sampling wells at the Kennecott Utah Copper mines in Magna, Utah had perchlorate levels of 13  $\mu\text{g/L}$ . In well water samples in California, 30% had detectable levels of perchlorate (detection limit presumably 4  $\mu\text{g/L}$ ) and the concentration of perchlorate in 9% of them was over 18  $\mu\text{g/L}$ .

Perchlorate has been detected in surface and groundwater samples in Texas, Arkansas, Maryland, New York, California, Utah, and Nevada (Coates et al. 1999). It was detected in 30 groundwater wells by the California Department of Health Services at concentrations  $>18 \mu\text{g/L}$  and in 50% of the wells test in

## 6. POTENTIAL FOR HUMAN EXPOSURE

Suffolk County, New York at concentrations up to 40 µg/L (Kim and Logan 2001; Logan et al. 2001b). In 1998, a survey by the California Department of Health Services found that 144 wells were contaminated at levels >18 µg/L (Giblin et al. 2000).

Perchlorate contamination in surface water has been reported at 17 DOD facilities located in Alabama, Arizona, Indiana, Maryland, New Mexico, Ohio, Oklahoma, Texas, and West Virginia as of March, 2005 (EPA 2005c). Maximum reported perchlorate concentrations in surface water at these sites vary widely, ranging from approximately 1 to 16,000 µg/L. Maximum reported concentrations of perchlorate in surface water at three private locations, Aerojet Company in Arkansas, Boeing/Rocketdyne in Nevada, and Elf Atochem in Oregon, were 12,500, 120,000, and 14 µg/L, respectively.

Perchlorate contamination in groundwater has been reported at 48 DOD facilities and 5 other federal agency facilities located in Alabama, Arizona, Arkansas, California, Colorado, Illinois, Indiana, Iowa, Maryland, Massachusetts, Minnesota, Missouri, New Jersey, New Mexico, Oregon, South Carolina, South Dakota, Tennessee, Texas, Utah, Virginia, Washington, and West Virginia as of March, 2005 (EPA 2005c). Maximum reported perchlorate concentrations in groundwater at these sites vary widely, ranging from approximately 1 to 276,000 µg/L. Perchlorate contamination in groundwater has been reported at 29 private facilities located in Arizona, Arkansas, California, Iowa, Kansas, Missouri, Nebraska, Nevada, New York, Oregon, and Utah as of March, 2005 (EPA 2005c). Maximum reported perchlorate concentrations in surface water at these sites vary widely, ranging from approximately 5 to 3,700,000 µg/L. Similar data listing concentrations of perchlorate in surface and groundwater at both federal and private facilities in the United States as of April, 2003 have been reported by EPA (2003, 2005c). The suspected source of these high levels of perchlorate in groundwater was usually related to the manufacture, disposal, testing, or research of explosives, rockets, or propellants (EPA 2003, 2005c).

Perchlorate levels in 8 of 12 groundwater and surface water samples at the Longhorn Army Ammunition plant, Texas, 1999, ranged from 3 to 776 µg/L (Smith et al. 2001). The concentration of perchlorate near the McGregor, Texas Naval Weapons Industrial Reserve Plant was 5,600 µg/L in tributary surface water samples collected at the site boundary and <4.0–91,000 µg/L in groundwater samples taken in the area (Cowan 2000). In a nearby wet weather spring connected to a boundary tributary, the concentration was 22,000 µg/L, while approximately 1 and 3 miles downstream in a creek, the concentrations were 200 and 56 µg/L, respectively. Perchlorate was detected in 13 of 25 local groundwater samples collected in Livermore, California, at 1–37 µg/L (Koester et al. 2000) and in drinking water from southern Nevada at 8–9 µg/L (Magnuson et al. 2000). Perchlorate concentrations measured in groundwater from remote

## 6. POTENTIAL FOR HUMAN EXPOSURE

locations in the Middle Rio Grande Basin in north-central New Mexico ranged from 0.12 to 1.8 µg/L (Plummer et al. 2006).

A study of 54 counties in west Texas and 2 adjacent counties in New Mexico found perchlorate levels in several groundwater samples (Rajagopalan et al. 2006). The concentration of perchlorate was generally low (<4 µg/L); however, some samples had detectable levels approaching 200 µg/L. While a single definitive source for these perchlorate levels could not be identified, the authors concluded that the majority of perchlorate detected at these sites could result from atmospheric deposition.

The U.S. Government Accountability Office listed perchlorate concentrations measured in surface water, groundwater, and drinking water samples from 395 sites from 35 states, the District of Columbia, and two commonwealths of the United States (GAO 2005). The concentrations at these locations ranged from 4 to 3,700,000 µg/L. According to the survey, 110 sites were located near defense-related activities, 36 sites were located near perchlorate manufacturing and handling operations, 16 sites were located near fireworks and flare manufacturing, general manufacturing, and hazardous waste sites, 6 sites were located near agricultural operations, and 227 sites were not located near activities linked to perchlorate.

Seawater samples collected off the coasts of Texas, Massachusetts, California, Hawaii, Oregon, Maine, and Mexico contained perchlorate at concentrations ranging from below the detection limit (0.07 µg/L) to 0.345 µg/L (Martinelango et al. 2006). The concentrations of perchlorate measured in 22 rain and 4 snow samples collected in Lubbock, Texas ranged from <0.01 to 1.6 and from <0.01 to 0.4 µg/L, respectively (Dasgupta et al. 2005).

### 6.4.3 Sediment and Soil

Perchlorate contamination in soil or sediment has been reported at 27 DOD facilities and 2 other federal agency facilities located in Alabama, Arizona, California, Indiana, Massachusetts, Maryland, New Jersey, New Mexico, Texas, Utah, Washington, and West Virginia as of March, 2005 (EPA 2005c). Maximum reported perchlorate concentrations in soil at these sites vary widely, ranging from approximately 32 to 2,000,000 ppb. Maximum reported concentrations of perchlorate in sediment were 17 ppb at the Aberdeen Proving Ground in Maryland, 230 ppb at the Naval Surface Warfare Center in Maryland, 186 ppb at the Lone Star Army Ammunition Plant in Texas, and 190 ppb at the Allegheny Ballistics Laboratory in West Virginia. Perchlorate contamination in soil was also reported at two private sites in Arizona and one private site in Arkansas; however, concentrations were not provided.

## 6. POTENTIAL FOR HUMAN EXPOSURE

Perchlorate levels in 4 of 12 sediment samples at the Longhorn Army Ammunition plant, Texas, 1999, ranged from 12 to 704  $\mu\text{g/L}$  (Smith et al. 2001). It was also detected in 4 of 18 soil samples near a single building at the facility at 50–322  $\mu\text{g/kg}$ . The concentration of perchlorate in soil samples underneath the foundations of former propellant mixing facilities at the McGregor, Texas Naval Weapons Industrial Reserve Plant ranged from 23 to 1,800,000  $\mu\text{g/kg}$  (Cowan 2000). Perchlorate was detected in 38% of 113 soil samples and 93% of 93 sediment samples collected from the Lake Mead area of Nevada with average (maximum) concentrations of 57.7 (1,470)  $\text{mg/kg}$  and 12.8 (56.0)  $\text{mg/kg}$ , respectively (Dean et al. 2004). Smith et al. (2004) reported a mean perchlorate concentration of 24.7  $\mu\text{g/g}$  in 51 soil samples from 3 sites at the Las Vegas Wash near Henderson, Clark County, Nevada.

The concentration of perchlorate in soil samples taken from a tobacco field, December 1999, was 340  $\mu\text{g/kg}$  (Ellington et al. 2001). Tobacco plants grown in this field had been fertilized that summer using products derived from Chilean caliche (which contained perchlorate at 35,800 and 1,544,000  $\mu\text{g/kg}$ ). The concentrations of perchlorate measured in the saturation extract of six soil samples from the Mission Valley Formation in San Diego, California ranged from below the detection limit (2  $\mu\text{g/L}$ ) to 40.2  $\mu\text{g/L}$  (Duncan et al. 2005).

#### 6.4.4 Other Media

FDA (2007b) presented measurements of perchlorate in 27 foods and beverages obtained in fiscal years 2004–2005. Lettuce samples were collected from growers in various locations in Arizona, California, Texas, New Jersey, and/or Florida. Mean perchlorate levels were 10.6 ppb ( $\mu\text{g/kg}$ ) in green leaf lettuce, 8.06 ppb ( $\mu\text{g/kg}$ ) in iceberg lettuce, 11.19 ppb ( $\mu\text{g/kg}$ ) in red leaf lettuce, and 11.75 ppb ( $\mu\text{g/kg}$ ) in romaine lettuce (fresh/dry weight not specified). Bottled water with location sources from Georgia, Missouri, California, North Carolina, Texas, Colorado, Maryland, Minnesota, Nebraska, South Carolina, Arkansas, Kansas, Wisconsin, and Pennsylvania generally contained no detectable perchlorate. Milk samples from Maryland, California, Pennsylvania, Virginia, Arizona, Georgia, Kansas, Louisiana, New Jersey, North Carolina, Texas, and Washington had a mean perchlorate level of 5.81 ppb. For comparison, Dyke et al. (2007) provide concentrations of perchlorate in dairy milk from Japan that are higher than the preliminary data values reported for the United States by FDA. Perchlorate concentrations in the Japanese samples ranged from 5.47 to 16.40  $\mu\text{g/L}$  with a mean value of 9.39  $\mu\text{g/L}$  and a median value of 9.34  $\mu\text{g/L}$ . Sanchez et al. (2007) compared perchlorate levels in broccoli, cauliflower, and cabbage grown in fields irrigated with water from the Colorado River, which contains

## 6. POTENTIAL FOR HUMAN EXPOSURE

perchlorate, with levels of thiocyanate and nitrate, two other anions that inhibit iodide uptake. The authors concluded that brassica irrigated with Colorado River water do accumulate trace levels of perchlorate. However, the levels of perchlorate observed are much lower than the levels of nitrate and thiocyanate, which are naturally present in these food plants.

Perchlorate concentrations in other foods reported by FDA (2007b) are listed in Table 6-1.

Following the preliminary assessment on perchlorate exposure (FDA 2007b), FDA completed its Total Diet Study (TDS) and released estimated dietary intakes for perchlorate and iodine for 14 age and gender groups (Murray et al. 2008). These perchlorate intakes are based on data collected from the TDS from 2005 to 2006. TDS sampling is conducted four times annually, once in each of the major geographical regions of the country (west, north central, south, and northeast). Each round of sampling is referred to as an individual market basket survey and for each market basket survey, samples of 285 selected food and beverages are obtained from three cities within the region. The TDS results found that detectable levels of perchlorate were observed in 59% of all samples analyzed, with 74% (211 of the 285) of the TDS foods having at least one positive sample. Perchlorate was not detected in 26% (74 of 285) of TDS foods. The contribution by food groups to the total intake of perchlorate for these age/gender groups are illustrated in Table 6-2. Table 6-3 provides the actual estimated dietary intake of perchlorate for these groups.

During a study of perchlorate concentrations in lettuce irrigated with Colorado River water (5 mg/L perchlorate concentration), perchlorate concentrations ranged from below quantifiable levels to 142 µg/kg (fresh weight) in the total above ground plant, 195 µg/kg (fresh weight) in the frame and wrapper leaves, and below detection to 26 µg/kg (fresh weight) in the edible head (Sanchez et al. 2005b). Perchlorate was detected above 0.2 µg/L in 144 out of 438 leafy vegetable samples produced in California (outside the Colorado River region), Colorado, New Jersey, New Mexico, New York, Michigan, Ohio, and Quebec (Sanchez et al. 2005a). Quantifiable perchlorate concentrations ranged from 18 to 104 µg/kg fresh weight in conventionally grown vegetables and from 21 to 628 µg/kg fresh weight in organically grown vegetables. Sanchez et al. (2006) measured perchlorate in citrus fruit grown from trees in the Southwest that were irrigated with perchlorate contaminated water (mean concentration of approximately 6 µg/L). Mean, median, and maximum perchlorate concentrations were 2.3, 1.3, and 14.8 µg/L fresh weight, respectively, in 33 lemon samples, 3.3, 1.3, and 16.2 µg/L fresh weight, respectively, in 15 grapefruit samples, and 7.4, 4.8, and 37.6 µg/L fresh weight, respectively, in 28 orange samples. Krynetsky et al. (2004) detected perchlorate in 11 edible cantaloupe and 10 whole cantaloupe samples with median

## 6. POTENTIAL FOR HUMAN EXPOSURE

**Table 6-1. Measurements of Perchlorate in Samples of 27 Types of Food and Beverages Collected From Various Locations in the United States**

Type of food or beverage	Mean residue ( $\mu\text{g}/\text{kg}$ ) <sup>a</sup>	Number of samples
Lettuce (green leaf)	10.3 4.4 <sup>b</sup>	137 2 <sup>b</sup>
Lettuce (iceberg)	8.1 2.1 <sup>b</sup>	43 4 <sup>b</sup>
Milk	5.81 <sup>c</sup> 7 <sup>b</sup>	125 8 <sup>b</sup>
Tomatoes	13.7 78 <sup>b</sup>	73 4 <sup>b</sup>
Carrots	15.8	59
Spinach	115 40 <sup>b</sup>	36 4 <sup>b</sup>
Collards	95.1 17.7 <sup>b</sup>	13 4 <sup>b</sup>
Cantaloupes	28.6 24.4 <sup>b</sup>	48 4 <sup>b</sup>
Apples	0.15 <sup>c</sup>	9
Grapes	8.58	12
Oranges	3.47 2.7 <sup>b</sup>	10 4 <sup>b</sup>
Strawberries	2.14	19
Watermelon	1.96	19
Fruit juices (apple and orange)	2.31 <sup>c</sup>	14
Broccoli	8.49	14
Cabbage	8.80	13
Greens	92.4	14
Cucumber	6.64 19.1 <sup>b</sup>	20 4 <sup>b</sup>
Green beans	6.12	19
Onions	0.53	12
Potatoes	0.15 <sup>d</sup>	6
Sweet potatoes	1.24	6
Corn meal	1.16	22
Oatmeal	3.96	22
Rice (brown and white)	0.50 <sup>d</sup>	19
Whole wheat flour	4.27	19
Catfish	1.02	7
Salmon	1.06	11
Shrimp	19.83	5

<sup>a</sup>Mean values are reported as ppb in source. Mean values were calculated treating non-detections as equal to one-half the detection limit. Fresh/dry weight not specified.

<sup>b</sup>Murray et al. 2008

<sup>c</sup>Mean value is in  $\mu\text{g}/\text{L}$ .

<sup>d</sup>All samples were non-detects.

Source: FDA 2007b

## 6. POTENTIAL FOR HUMAN EXPOSURE

**Table 6-2. Percent Contribution Organized by Food Group to the Total Estimated Daily Intake for Perchlorate for 2005–2006**

Food group	Intake (percent of total)						
	Infants 6–11 months	Children 2 years	Children 6 years	Children 10 years	Females 14–16 years	Males 14–16 years	Women 25–30 years
Baby food	49	0	0	0	0	0	0
Beverages	1	3	3	4	7	7	12
Dairy	32	51	50	47	29	37	20
Egg	0	0	0	0	0	0	0
Fat/oil	0	0	0	0	0	0	0
Fruit	4	15	11	9	11	7	8
Grain	2	6	8	8	8	9	8
Legume	0	0	0	0	0	0	0
Mixture	6	8	9	10	14	12	14
Meat, poultry, fish	1	4	6	5	7	7	11
Sweets	0	1	1	1	1	1	1
Vegetables	5	12	12	16	23	20	26

Food group	Men 25–30 years	Women 40–45 years	Men 40–45 years	Women 60–65 years	Men 60–65 years	Women 70+ years	Men 70+ years
	Baby food	0	0	0	0	0	0
Beverages	12	12	11	9	9	6	7
Dairy	20	17	21	17	19	23	22
Egg	0	0	0	0	0	0	0
Fat/Oil	0	0	0	0	0	0	0
Fruit	5	11	8	12	9	12	12
Grain	8	8	9	8	8	8	9
Legume	0	0	0	0	0	0	0
Mixture	16	13	13	9	10	10	10
Meat, poultry, fish	9	7	8	7	8	5	7
Sweets	0	1	1	0	0	0	0
Vegetables	30	31	29	38	37	36	33

Source: Murray et al. 2008



## 6. POTENTIAL FOR HUMAN EXPOSURE

**Table 6-3. Range of Estimated Lower and Upper Bound Average Perchlorate Intake for 2005–2006**

Food group	Intake ( $\mu\text{g}/\text{person}/\text{day}$ )						
	Infants 6–11 months	Children 2 years	Children 6 years	Children 10 years	Females 14–16 years	Males 14–16 years	Women 25–30 years
Baby food	1.1–1.3	0.0–0.0	0.0–0.0	0.0–0.0	0.0–0.0	0.0–0.0	0.0–0.0
Beverages	0.0–0.1	0.0–0.3	0.0–0.4	0.0–0.5	0.02–0.8	0.0–0.1	0.2–1.2
Dairy	0.8–0.8	2.6–2.6	2.9–2.9	3.1–3.1	1.6–1.6	3.1–3.1	1.2–1.2
Egg	0.0–0.0	0.0–0.0	0.0–0.0	0.0–0.0	0.0–0.0	0.0–0.0	0.0–0.0
Fat/oil	0.0–0.0	0.0–0.0	0.0–0.0	0.0–0.0	0.0–0.0	0.0–0.0	0.0–0.0
Fruit	0.1–0.1	0.7–0.9	0.6–0.7	0.5–0.6	0.6–0.7	0.5–0.6	0.5–0.6
Grain	0.0–0.1	0.3–0.3	0.4–0.5	0.5–0.5	0.4–0.5	0.7–0.8	0.4–0.5
Legume	0.0–0.0	0.0–0.0	0.0–0.0	0.0–0.0	0.0–0.0	0.0–0.0	0.0–0.0
Mixture	0.1–0.1	0.4–0.5	0.5–0.6	0.6–0.7	0.8–0.8	1.0–1.1	0.9–0.9
Meat, poultry, fish	0.0–0.0	0.2–0.2	0.3–0.3	0.3–0.4	0.3–0.4	0.5–0.6	0.7–0.7
Sweets	0.0–0.0	0.0–0.0	0.0–0.1	0.0–0.1	0.0–0.1	0.0–0.1	0.0–0.1
Vegetables	0.1–0.1	0.6–0.6	0.7–0.7	1.0–1.0	1.2–1.3	1.7–1.7	1.5–1.5
Total intake	2.4–2.7	4.9–5.5	5.4–6.1	6.1–6.9	5.1–6.1	7.7–9.1	5.4–6.8
Total intake ( $\mu\text{g}/\text{kg}/\text{day}$ )	0.26–0.29	0.35–0.39	0.25–0.28	0.17–0.20	0.09–0.11	0.12–0.14	0.09–0.11
	Men 25–30 years	Women 40–45 years	Men 40–45 years	Women 60–65 years	Men 60–65 years	Women 70+ years	Men 70+ years
Baby food	0.0–0.0	0.0–0.0	0.0–0.0	0.0–0.0	0.0–0.0	0.0–0.0	0.0–0.0
Beverages	0.2–1.6	0.3–1.3	0.2–1.7	0.2–1.0	0.2–1.3	0.1–0.7	0.1–0.9
Dairy	1.5–1.5	1.1–1.1	1.8–1.8	1.1–1.1	1.5–1.5	1.4–1.4	1.7–1.7
Egg	0.0–0.0	0.0–0.0	0.0–0.0	0.0–0.0	0.0–0.0	0.0–0.0	0.0–0.0
Fat/oil	0.0–0.0	0.0–0.0	0.0–0.0	0.0–0.0	0.0–0.0	0.0–0.0	0.0–0.0
Fruit	0.3–0.4	0.7–0.8	0.6–0.7	0.7–0.8	0.6–0.8	0.7–0.8	0.8–1.0
Grain	0.6–0.7	0.5–0.6	0.7–0.8	0.5–0.5	0.6–0.7	0.5–0.6	0.6–0.7
Legume	0.0–0.0	0.0–0.0	0.0–0.0	0.0–0.0	0.0–0.0	0.0–0.0	0.0–0.0
Mixture	1.2–1.3	0.8–0.9	1.1–1.1	0.6–0.6	0.8–0.9	0.6–0.6	0.7–0.8
Meat, poultry, fish	0.7–0.7	0.5–0.5	0.6–0.7	0.4–0.5	0.6–0.7	0.3–0.4	0.5–0.6
Sweets	0.0–0.0	0.0–0.0	0.1–0.1	0.0–0.0	0.0–0.0	0.0–0.0	0.0–0.0
Vegetables	2.2–2.2	1.9–2.0	2.4–2.4	2.4–2.4	2.8–2.9	2.2–2.2	2.5–2.5
Total intake	6.7–8.6	5.9–7.3	7.4–9.4	5.9–7.1	7.2–8.8	5.8–6.9	7.1–8.3
Total intake ( $\mu\text{g}/\text{kg}/\text{day}$ )	0.08–0.11	0.09–0.11	0.09–0.11	0.09–0.10	0.09–0.11	0.09–0.11	0.11–0.12

Source: Murray et al. 2008

## 6. POTENTIAL FOR HUMAN EXPOSURE

(range) concentrations of 9.6 (<2.0–18.2) and 23.9 (<2.0–39.3) µg/kg, respectively (fresh/dry weight not specified).

According to El Aribi et al. (2006), perchlorate was detected in all produce, wine, and beer samples purchased in grocery and liquor stores located in the greater Toronto, Ontario area between January 2005 and February 2006. These products were harvested or produced in many parts of the world. Median concentrations reported for perchlorate in products from each country ranged from 0.047 to 169.698 µg/kg in 63 produce samples, 0.013–15.54 µg/L in 77 wine samples, and 0.03–10.663 µg/L in 144 beer samples, and below detection (5 ng/L). Perchlorate was detected above 5 ng/L in 11 out of 12 beverage samples and in 7 out of 10 bottled water samples from around the world at reportable concentrations of 0.067–5.098 µg/L and 0.021–4.795 µg/L, respectively. Median, minimum, and maximum perchlorate concentrations in samples harvested or produced in the United States were 0.252, 0.094, and 19.29 µg/kg, respectively, in 8 produce samples, 20.9, 0.197, and 4.593 µg/L, respectively, in 12 wine samples, and 0.662, 0.364, and 2.014 µg/L, respectively, in 8 beer samples.

Perchlorate was detected in 20 out of 31 dietary supplements with mean, median, and maximum reportable concentrations of 247, 25, and 2,420 ng/g, respectively (Snyder et al. 2006). The limits of detection ranged from 2 to 15 ng/g. Perchlorate was also detected in two samples of kelp granules, a flavor enhancing ingredient, at concentrations of 709 and 740 ng/g.

In a survey of 10 randomly selected off-the-shelf tobacco products, perchlorate was detected in six of seven brands of different plug chewing tobacco at 2.3–149.3 mg/kg (dry weight), two of two brands of cigarettes at 15.1–71.7 mg/kg, and one of one brand of cigars at 7.1 mg/kg (Ellington et al. 2001).

Mean perchlorate concentrations measured in the blood, milk, urine, and feces of cows with calculated perchlorate intakes of 0.46 mg/day from feed and 0.03 mg/day from water were 0.24, 4.37, 3.68, and 5.84 ng/mL, respectively (Capuco et al. 2005). Perchlorate concentrations were monitored in vegetation and animal samples collected at various locations at the Longhorn Army Ammunition plant, Texas, 1999. It was detected in green tree frog samples (86–153 µg/kg), harvest mouse samples (1,120–2,328 µg/kg), cotton mouse samples (356 µg/kg), mosquitofish samples (83–206 µg/kg), juvenile sunfish samples (132 µg/kg), blackstripe minnow samples (104 µg/kg), bullfrog tadpole samples (1,130–2,567 µg/kg), chorus frog samples (580 µg/kg), *Notropis spp.* samples (77 µg/kg), weed shiner samples (100 µg/kg), bullrush samples (555–9,487 µg/kg dry weight), crabgrass samples (1,060,000–5,557,000 µg/kg dry weight), and damselfly larvae (811–2,036 µg/kg) (Smith et al. 2001). Perchlorate was not detected in

## 6. POTENTIAL FOR HUMAN EXPOSURE

Northern cricket frog samples, American toad sample, bullfrog samples, or largemouth bass samples. For most of these samples, it was not specified whether measurements were conducted on a wet- or dry-weight basis. The concentrations of perchlorate were below the detection limit of 2.5 µg/L wet weight in most fish samples (tissue extracts) collected from lakes, rivers, and streams located near the Naval Weapons Industrial Reserve Plant in McLennan County, Texas (Theodorakis et al. 2006). Concentrations in fish with quantifiable levels ranged from 10.8 to 4,560 µg/kg wet weight. Perchlorate was detected in 18% of 88 terrestrial mammals, 3% of 107 fish, and 12% of 42 terrestrial birds sampled in the Lake Mead area, Nevada with average (maximum) concentrations of 13.4 (53.0), 16.4 (44.3), and 1.5 (4.2) mg/kg, respectively (Dean et al. 2004). It was not specified whether these measurements were conducted on a wet or dry-weight basis.

In wood samples from dormant salt cedars near the Las Vegas Wash, Nevada, date not provided, perchlorate concentrations ranged from 5 to 6 mg/kg in twigs extending above the water and at 300 mg/kg in submersed stalks (Urbansky et al. 2000c). The rate and selectivity of perchlorate uptake by the salt cedars was not determined. The mean concentration of perchlorate was 289.3 µg/g in 71 vegetation samples collected from 3 sites at the Las Vegas Wash during March, 2002 (Smith et al. 2004). Perchlorate has been detected in 50% of 177 terrestrial vegetation samples and 24% of 50 aquatic vegetation samples from the Lake Mead area in Nevada with average (maximum) concentrations of 34.7 (428) and 38.8 (176) mg/kg, respectively (Dean et al. 2004). Tan et al. (2004b) tested several plants and trees (smartweed [*Polygonum spp.*], watercress (*Nasturtium spp.*), ash (*Fraxinus greggii A. Gray*), chinaberry (*Melia azedarach L.*), elm (*Ulmus parvifolia Jacq.*), willow (*Salix nigra Marshall*), mulberry (*Broussonetia papyrifera [L.] Vent.*), and hackberry (*Celtis laevigata Willd.*) that were growing beside streams near the Naval Weapons Industrial Reserve Plant at McGregor, Texas for perchlorate. Perchlorate was detected above 1 µg/L in streamwater at five out of six locations with average concentrations ranging from <1 to 281 µg/L. The average concentrations of perchlorate in the plants and trees at these locations ranged from <1 to 40,600 µg/kg dry weight. Martinelango et al. (2006) measured perchlorate concentrations ranging from 29 to 878 µg/kg dry weight in 13 commercially available seaweed species.

### 6.5 GENERAL POPULATION AND OCCUPATIONAL EXPOSURE

The general population is likely to be exposed to perchlorate through some dietary routes, drinking water sources, and consumer products.

## 6. POTENTIAL FOR HUMAN EXPOSURE

Data from the FDA TDS indicated that 74% (211 of the 285) of the foods analyzed had at least one sample in which perchlorate was detected (Murray et al. 2008). The perchlorate dietary intake was estimated to range from 0.08 to 0.11  $\mu\text{g}/\text{kg}/\text{day}$  for males aged 25–30 years to 0.35–0.39  $\mu\text{g}/\text{kg}/\text{day}$  for children 2 years old (see Table 6-3). These estimates are in good agreement with previous estimates based upon limited sets of data. Daily dose for perchlorate exposure via ingestion of lettuce, dietary supplements, and citrus fruit have been calculated (Sanchez et al. 2005a, 2005b, 2006; Snyder et al. 2006). None of these estimates were above the EPA reference dose (0.7  $\mu\text{g}/\text{kg}/\text{day}$ ). Blount et al. (2007) estimated a daily perchlorate dose based on measured concentrations in urine, which account for the combined exposure from all sources. Reported geometric mean and 95th percentile urinary perchlorate concentrations of 3.35 and 12  $\mu\text{g}/\text{L}$ , respectively, were measured in a nationally representative population of 1,618 U.S. residents, ages  $\geq 20$  years, during 2001 and 2002 as part of the National Health and Nutrition Survey (NHANES). Based on these monitoring data, the geometric mean and 95th percentile values of the estimated perchlorate dose in adults were 0.066 and 0.234  $\mu\text{g}/\text{kg}/\text{day}$ , respectively. Only 11 adults had estimated doses greater than the EPA reference dose.

The detection of perchlorate in drinking water supplies (Brechner et al. 2000; Giblin et al. 2000; Herman and Frankenberger 1998; Li et al. 2000a; Urbansky 1998) and in tap water samples (Urbansky 1998) indicates that members of the general population may be exposed by ingestion of water containing perchlorate. Perchlorate has been identified at least once in approximately 4% of over 3800 community water systems from 26 different states and 2 territories, with detectable levels averaging 9.8  $\mu\text{g}/\text{L}$  and ranging from the method detection limit of 4  $\mu\text{g}/\text{L}$  to a maximum at 420  $\mu\text{g}/\text{L}$  (EPA 2007).

Contaminated groundwater sources near known ammonium perchlorate production or use sites (Giblin et al. 2000; Herman and Frankenberger 1998; Kim and Logan 2001; Logan et al. 2001b; Smith et al. 2001; Urbansky 1998) suggest that populations that obtain drinking water from down gradient wells at such sites may also be exposed to perchlorates. Since more sensitive analytical techniques have been developed, perchlorate is also being found in areas other than where it has been manufactured, used, or released by humans, suggesting that exposure from natural sources are possible (Dasgupta et al. 2005; Rajagopalan et al. 2006; Urbansky 2002; Valentín-Blasini et al. 2005).

Valentín-Blasini et al. (2005) measured perchlorate concentrations ranging from 0.66 to 21 (median 32)  $\text{ng}/\text{mL}$  in urine samples from 61 healthy adult donors from Atlanta, Georgia with no known perchlorate exposure. These authors also measured perchlorate in urine samples from 60 pregnant women from 3 Chilean cities (Antofagasta, Chañaral, and Taltal) where perchlorate concentrations in tap

## 6. POTENTIAL FOR HUMAN EXPOSURE

water range from approximately 0.4 to 114 ng/mL. The median and range of concentrations of perchlorate in the samples were 35 and 0.49–1,100 ng/mL, respectively. Pearce et al. (2007) reported perchlorate concentrations ranging from 0.37 to 127 µg/L measured in 56 urine samples from 57 Boston-area nursing mothers.

Perchlorate has been detected in different types of tobacco products (Ellington et al. 2001). It is likely that smokeless tobacco products (chewing tobacco) will result in greater exposure than cigarettes since the combustion of the perchlorate upon lighting will result in a reaction before it is inhaled. Individuals that reload their own ammunition may also be exposed to perchlorates due to their presence in gunpowder (Lindner 1993). Members of the general population undergoing some types of medical imaging may be exposed to small amounts (200–400 mg orally) of perchlorate (Gibbs et al. 1998). Perchlorate has also been identified in certain common household products such as bleach. Perchlorate levels in bleach were reported to range from 89 to 8,000 ppb, with concentrations increasing with time of product storage (MassDEP 2006a). Perchlorate has also been detected in dietary (vitamin and mineral) supplements and flavor-enhancing ingredients collected from various commercial vendors in two large U.S. cities (Snyder et al. 2006). The highest level of perchlorate was found in a supplement recommended for pregnant women as a prenatal vitamin/mineral supplement.

Workers at facilities where perchlorates are manufactured or used may be exposed by inhalation. Workers at an ammonium perchlorate facility were exposed to calculated single-shift absorbed doses of 0.2–436 µg/kg with a 35 µg/kg average (Gibbs et al. 1998). Lifetime cumulative doses for workers over an average of 8.3 years ranged from 8,000 to 88,000 µg/kg. Workers may also be exposed to perchlorate dusts through oral routes through deposition of particles via mouth breathing (Gibbs et al. 1998). In a survey at an ammonium perchlorate manufacturing facility, respirable air samples had an average perchlorate concentration of 0.091 mg/day for workers at low dust-forming operations. The average perchlorate concentration for moderate and high dust-forming operations was 0.601 and 8.591 mg/day, respectively (Lamm et al. 1999). Exposure through inhalation or dermal contact may also occur from aqueous perchlorate solutions if aerosol-producing operations, such as spray drying, are used; however, dermal absorption of perchlorate is expected to be low since electrolytes applied from aqueous solutions do not readily penetrate the skin (Scheuplein and Bronaugh 1983).

The National Occupational Exposure Survey (NOES), conducted from 1981 to 1983, indicates that 2,641 total workers were exposed to potassium perchlorate, 1,452 to sodium perchlorate, 1,445 to ammonium perchlorate, and 1,906 to magnesium perchlorate in the United States (NIOSH 1995). No

## 6. POTENTIAL FOR HUMAN EXPOSURE

values were reported for lithium perchlorate. Exposure for female workers was reported as 1,948 (potassium), 230 (sodium), 230 (ammonium), and 713 (magnesium). It is not known why females represented a higher percentage of the total worker exposure for lithium and magnesium perchlorates relative to that for the sodium and ammonium salts.

These NOES data suggest that the highest production volume salts, sodium and ammonium perchlorates, were used in operations involving fewer people than magnesium and potassium perchlorates. These data also suggest that magnesium and potassium perchlorates were used either in a wider range of applications, in processes requiring more human manipulation, or in applications that were performed at multiple sites in the United States.

## 6.6 EXPOSURES OF CHILDREN

This section focuses on exposures from conception to maturity at 18 years in humans. Differences from adults in susceptibility to hazardous substances are discussed in Section 3.7, Children's Susceptibility.

Children are not small adults. A child's exposure may differ from an adult's exposure in many ways. Children drink more fluids, eat more food, breathe more air per kilogram of body weight, and have a larger skin surface in proportion to their body volume. A child's diet often differs from that of adults. The developing human's source of nutrition changes with age: from placental nourishment to breast milk or formula to the diet of older children who eat more of certain types of foods than adults. A child's behavior and lifestyle also influence exposure. Children crawl on the floor, put things in their mouths, sometimes eat inappropriate things (such as dirt or paint chips), and spend more time outdoors. Children also are closer to the ground, and they do not use the judgment of adults to avoid hazards (NRC 1993).

Children are expected to undergo environmental exposure to perchlorates via the same routes predicted for adult members of the general population in Section 6.5, primarily through the ingestion of food and drinking water containing perchlorate. Blount et al. (2007) reported geometric mean and 95<sup>th</sup> percentile urinary perchlorate concentrations of 4.93 and 19 µg/L, respectively, measured in 374 children living in the United States, ages 6–11 years, during 2001 and 2002 as part of the NHANES. Geometric mean and 95<sup>th</sup> percentile concentrations in 828 children ages 12–19 years measured during this study were 3.80 and 12 µg/L, respectively. The authors note that the adjusted geometric mean of urinary perchlorate concentrations is higher for children (5.40 µg/L) than for adolescents (3.30 µg/L) and adults (3.41 µg/L). Possible explanations for this are differences in pharmacokinetics, the relationship of dose per body

## 6. POTENTIAL FOR HUMAN EXPOSURE

weight, and differences in dietary habits between children and adults such as the consumption of milk and green leafy vegetables.

The estimated dietary intakes for children have been calculated based upon the FDA TDS (see Table 6-3). These data indicate that children have the highest estimated intake on a body weight basis as compared to the other age groups because they consume more food per body weight and have different food consumption patterns when compared to the other age groups (Murray et al. 2008). Children 2 years of age had the highest estimated intake ranging from 0.35 to 0.39  $\mu\text{g}/\text{kg}/\text{day}$ , which is roughly 50–56% of the EPA reference dose (RfD). Dairy products provided over 50% of the total perchlorate intake in their diets. Using measured urinary concentration data, Blount et al. (2007) estimated the daily dose of perchlorate for women of reproductive age to give an indication of possible fetal exposure to perchlorate. The median and 95th percentile values of the estimated perchlorate dose were 0.057 and 0.214  $\mu\text{g}/\text{kg}/\text{day}$ , respectively, in 662 women of reproductive age. The median of the estimated dose was 0.066  $\mu\text{g}/\text{kg}/\text{day}$  in 110 pregnant women (95th percentile value was not reported).

Measurements of perchlorate concentration in mother's milk, a potential route of exposure for infants, indicated a mean level of 10.5  $\mu\text{g}/\text{L}$  and a maximum level of 92  $\mu\text{g}/\text{L}$  in 35 human milk samples from 18 states (Kirk et al. 2005). Kirk et al. (2007) reported perchlorate concentrations ranging from 0.5 to 39.5  $\mu\text{g}/\text{L}$  measured in the breast milk of 10 women (from Texas, Colorado, Florida, Missouri, New Mexico, and North Carolina). Mean and median concentrations were 5.8 and 4.0  $\mu\text{g}/\text{L}$ , respectively. Téllez et al. (2005) reported mean perchlorate concentrations of 81.6, 18.3, and 85.6  $\mu\text{g}/\text{L}$  measured in the breast milk of women from the Chilean cities of Antofagasta (14 samples), Chañaral (16 samples), and Taltal (25 samples), respectively. Perchlorate was detected in all 49 breast milk samples from 57 Boston-area women ranged at concentrations ranging from 1.3 to 411  $\mu\text{g}/\text{L}$  (Pearce et al. 2007). These authors also measured perchlorate in infant formulae; perchlorate was detected in all 17 samples measured at concentrations ranging from 0.22 to 4.1  $\mu\text{g}/\text{L}$ . Using data from Kirk et al. (2005) for levels of perchlorate in human milk and exposure factors described in EPA (1997b), Baier-Anderson et al. (2006) estimated that infants breastfed for 6 months may have daily doses of perchlorate that exceed the NAS recommended RfD of 0.7  $\mu\text{g}/\text{kg}/\text{day}$ . This information needs to be put in context by reiterating that the RfD is, by definition, an estimate spanning as much as an order of magnitude, and that the perchlorate RfD is based on a precursor to an adverse effect.

Perchlorate has also been detected in dairy milk, another source of exposure of children and adults (Kirk et al. 2005). The mean level of perchlorate in 47 cow's milk samples from 11 states was 2  $\mu\text{g}/\text{L}$ , with a

## 6. POTENTIAL FOR HUMAN EXPOSURE

maximum level of 11 µg/L. The FDA has reported a mean concentration of 5.81 ppb measured in 125 dairy milk samples collected from 12 states (FDA 2007b). Data from the most recent FDA TDS found a mean concentration of 7 ppb measured in 8 samples of milk (Murray et al. 2008). Rice et al. (2007) demonstrated the transfer of perchlorate from feed to cows was a significant source of perchlorate in subsequent milk samples. Analysis of the ingredients of the total mixed ration (TMR) determined that the majority of perchlorate arose from corn silage, alfalfa, and hay.

Perchlorates may be released to soil by a number of pathways. Because children sometimes eat inappropriate things and put dirt in their mouths, they may be exposed to perchlorates through ingestion of contaminated soil. The presence of certain household products that contain perchlorates could also lead to a child being exposed. Children may be exposed to perchlorates if they use or disassemble flares; infants may be exposed orally if they put them in their mouths.

**6.7 POPULATIONS WITH POTENTIALLY HIGH EXPOSURES**

Members of the general population who live near hazardous waste sites containing perchlorates and draw their drinking water from underground wells may potentially receive high exposure to perchlorates. Similarly, people who live near facilities that manufacture, process, use, or dispose of large amount of perchlorates may also receive potentially higher exposures.

Workers in facilities that manufacture or use large amounts of solid perchlorates may receive potentially high inhalation exposures. Twenty-nine individuals were tested for perchlorate exposure after 3 consecutive days of 12-hour shifts working at an ammonium perchlorate production facility near Cedar City, Utah (Braverman et al. 2005). The mean and median concentrations of perchlorates in serum samples collected from the workers were 2 and 0 µg/L, respectively, before exposure and 838.4 and 358.9 µg/L, respectively, after exposure. The mean and median concentrations of perchlorates in urine samples were 0.16 and 0.11 mg/g creatinine, respectively, before exposure and 43.0 and 19.2 mg/g creatinine, respectively, after exposure. Gibbs et al. (1998) calculated that workers at an ammonium perchlorate manufacturing facility may receive doses that are 2–3 orders of magnitude greater than a person might receive from drinking water obtained from Lake Mead or the Colorado River and 2–3 orders of magnitude less than that historically prescribed for the treatment of Grave's disease.

Due to their presence and potential emission in signal flares, members of the population that use these devices on a frequent basis, such as law enforcement officers, may be exposed to higher levels of



## 6. POTENTIAL FOR HUMAN EXPOSURE

perchlorates than the general public. Similarly, frequent users of perchlorate-based civilian explosives, fireworks display technicians, and related occupations may be exposed to higher levels.

## 6.8 ADEQUACY OF THE DATABASE

Section 104(i)(5) of CERCLA, as amended, directs the Administrator of ATSDR (in consultation with the Administrator of EPA and agencies and programs of the Public Health Service) to assess whether adequate information on the health effects of perchlorates is available. Where adequate information is not available, ATSDR, in conjunction with NTP, is required to assure the initiation of a program of research designed to determine the health effects (and techniques for developing methods to determine such health effects) of perchlorates.

The following categories of possible data needs have been identified. They are defined as substance-specific informational needs that if met would reduce the uncertainties of human health assessment. This definition should not be interpreted to mean that all data needs discussed in this section must be filled. In the future, the identified data needs will be evaluated and prioritized, and a substance-specific research agenda will be proposed.

### 6.8.1 Identification of Data Needs

**Physical and Chemical Properties.** Perchlorates have been manufactured commercially for nearly 100 years (Schilt 1979). Their fundamental physical and chemical properties have been well described in the literature. Vapor pressure data are not available for the perchlorate salts listed in Table 4-1; however, they are high melting ionic solids and would be expected to be nonvolatile. No further investigation of the physical/chemical properties of perchlorates is required to assess their potential for human and environmental exposure.

**Production, Import/Export, Use, Release, and Disposal.** According to the Emergency Planning and Community Right-to-Know Act of 1986, 42 U.S.C. Section 11023, industries are required to submit substance release and off-site transfer information to the EPA. Reliable data on the production of perchlorates are not available. Reasonable estimates are available for past ammonium perchlorate production, although current values are not available. Past or present production data for the remainder of the perchlorates listed in Table 4-1 are not available. Accurate production data may not become available because perchlorates are considered strategic chemicals due to their extensive use in military and aerospace applications and there are no requirements to track and report for the numerous industrial and

## 6. POTENTIAL FOR HUMAN EXPOSURE

commercial applications for perchlorate. Accordingly, available worldwide perchlorate production data are unlikely to be complete. Accurate production data is one factor that is required to establish the foundation from which potential human and environmental exposure to perchlorates can be determined.

The techniques used in manufacturing perchlorates have been well described in the available literature and there are no data needs in this area.

Accurate import and export data on perchlorate are not readily available. Perchlorates are not listed as a separate, reportable item on U.S. Census Bureau's schedule B book on imports. Production, import and export data are available for certain products that may contain perchlorate. For example, large amounts of fireworks (approximately  $1 \times 10^8$  kg) are imported into the United States (USITC 2008). The actual volume of perchlorates represented by these figures is not known since the content of perchlorate varies by firework type and origin. Reliable data on the importation of fireworks as well as the amount of perchlorate they contain are important in determining human exposure.

The numerous uses of perchlorates have been described in the available literature. However, the amount of perchlorates used in these applications is not always available. Determining the amount of perchlorates in these products is essential in fully establishing the extent, level, and route of potential occupational exposures. Moreover, the amount of perchlorate contained in pyrotechnic devices, especially consumer products (i.e., small fireworks, flares, and gunpowder) is required to establish worker exposure as well as potential exposure to members of the general population. This data gap requires additional research to characterize and document potential significant sources of perchlorate released to the environment.

Limited data on the release of perchlorates to the environment were located. Releases are known to be associated with the perchlorate production for propellants as well as rocket manufacture, testing, and decommissioning. The amount, frequency, and duration of these releases are not well documented. Researchers have speculated that the current extent of perchlorate contamination in western waters is a direct result of these activities. A better understanding of historical releases, used in combination with an extensive monitoring database, will allow the development of robust models that can be used to predict the potential for human and environmental exposure

The wide variety of uses for perchlorates suggests that other releases are likely during production, processing, formulation, transport, use, and disposal. No data on the resulting release of perchlorates were located in the available literature. The water solubility of perchlorates suggests that disposal in

## 6. POTENTIAL FOR HUMAN EXPOSURE

aqueous waste streams may occur during their production and use. Given that perchlorates are not known to be removed from waste water streams in POTWs or other common treatment processes, release to waste water represents a point source release to surface water. Since perchlorates are known to persist in surface water, a comprehensive understanding of point source releases to the environment is required to fully establish the potential for human exposure.

Perchlorates are explosive chemicals that see extensive use in pyrotechnic devices including fireworks. Catastrophic accidents resulting from manufacturing of perchlorates (Urbansky 1998) and products in which it is contained (CSB 1999) are known to have occurred. Release of unspent perchlorates to the environment is a likely result of these events. Members of the general population who live near these facilities may therefore be exposed to perchlorates as a result of a catastrophic explosion. Similarly, perchlorates are known to be released during the catastrophic explosion of booster rockets (Merrill and O'Drobinak 1998). Determining the amount released during these events is required to estimate potential human and environmental exposure.

Unspent perchlorates may be released to the environment in the effluent of propulsion systems in solid propellant rockets and fireworks. Unspent oxidant may also be released during the "burst" at fireworks displays. The amount of perchlorates released via these mechanisms, if any, is not known but may be significant. Given the large volume of perchlorates used in rockets and that members of the general population frequent firework displays, the amount released from these potential pathways is required for a comprehensive determination of general population exposure.

Concern over the disposal of perchlorate has not arisen until recently (Urbansky 1998). DOD recovers much of the perchlorate that is used in weapon systems and returns it to the manufacturer for use in commercial applications (DOD 2007). More information on the level, frequency, amount, composition, method, route, duration, and chronology of perchlorate disposal would be needed for a thorough assessment of the environmental burden of perchlorates.

**Environmental Fate.** Studies of sufficient number and breadth to rigorously establish the environmental fate of perchlorates have not been performed, and currently, there are no regulations in place that restrict their use. Very few studies on the transport and partitioning of perchlorates in the environment were located. Moreover, current methodologies for estimating key predictors of fate processes, including the octanol/water partition coefficient, soil adsorption coefficient, and

## 6. POTENTIAL FOR HUMAN EXPOSURE

bioconcentration factor are not sufficiently robust to provide accurate results for inorganic ions in general and perchlorates specifically.

Some aspects of the environmental fate of perchlorates can be reliably predicted. Volatilization from water or soil to the atmosphere is not expected to occur to a significant extent. If released directly to the atmosphere, deposition through wet and dry process is expected to return perchlorates to the Earth's surface (although the importance of long-range transport in air was not located in the available literature). Analysis of physical/chemical properties and available monitoring data indicate that perchlorates are unlikely to be strongly adsorbed to soil or sediment.

There is also a paucity of data available on the degradation of perchlorate in the environment. Given that they are fully oxidized, perchlorates are not expected to react with the common environmental oxidants found in air and surface waters. Direct photolysis is also not expected to be a significant process.

Numerous workers have demonstrated that in laboratory studies, isolated microorganisms can respire perchlorates, although to date, no evidence of the biodegradation of perchlorate in the environment has been located. The anaerobic biodegradation of perchlorates would be expected to occur in anoxic soils and groundwater. Because members of the general population may be exposed to perchlorates through the ingestion of contaminated well water, aerobic biodegradation studies that establish its potential removal from drinking water sources are important. Ingestion of perchlorate-contaminated drinking water may be a route of exposure for those members of the general population living near hazardous waste sites containing perchlorates.

The available data on the fate of perchlorates in the environment do not allow an accurate prediction of their lifetime in soil and water.

**Bioavailability from Environmental Media.** No data are available to determine the bioavailability of perchlorate from environmental media. It has been detected in plants (Nzengung et al. 1999) and tobacco products (Ellington et al. 2001) and may be present in food crops irrigated with perchlorate contaminated water. The bioavailability of perchlorate from environmental media would provide additional information to help determine potential levels of human exposure.

**Food Chain Bioaccumulation.** Limited data are available on the uptake of perchlorates in biota. A laboratory study (Nzengung et al. 1999) provides evidence for the uptake and depuration of perchlorates

## 6. POTENTIAL FOR HUMAN EXPOSURE

in willows. It has been detected in vegetation, fish, amphibian, insect, and rodent samples near a site of known contamination (Smith et al. 2001). Few studies of perchlorate bioconcentration in fish and aquatic organisms or food chain bioaccumulation have been identified. These data are required in order to determine the potential exposure of higher organisms to perchlorates.

**Exposure Levels in Environmental Media.** Reliable monitoring data for the levels of perchlorates in contaminated media at hazardous waste sites are needed so that the information obtained on levels of perchlorates in the environment can be used in combination with the known body burden of perchlorates to assess the potential risk of adverse health effects in populations living in the vicinity of hazardous waste sites.

No monitoring data are available on the concentration or frequency of detection of perchlorates in air, or plant materials, while there are data on the concentration of perchlorates in soil, surface water and groundwater at various sites where perchlorates have been used or disposed or are naturally occurring.

**Exposure Levels in Humans.** Recent data are available on perchlorate exposure levels in humans for both age and gender groups (Blount et al. 2007; Murray et al. 2008). Continued monitoring data and estimates of human exposure are necessary to compare exposure levels and observed health effects in the population.

This information is necessary for assessing the need to conduct health studies on these populations.

**Exposures of Children.** Children are expected to be exposed to perchlorates primarily through the ingestion of food (including milk) and drinking water containing perchlorate. Infants may be exposed through mother's milk. Since younger children have the propensity to place objects in their mouths, the levels of perchlorate in soil and consumer items needs to be determined.

Child health data needs relating to susceptibility are discussed in Section 3.12.2, Identification of Data Needs: Children's Susceptibility.

**Exposure Registries.** No exposure registries for perchlorates were located. This substance is not currently one of the compounds for which a sub-registry has been established in the National Exposure Registry. The substance will be considered in the future when chemical selection is made for sub-registries to be established. The information that is amassed in the National Exposure Registry facilitates

## 6. POTENTIAL FOR HUMAN EXPOSURE

the epidemiological research needed to assess adverse health outcomes that may be related to exposure to this substance.

**6.8.2 Ongoing Studies**

The Federal Research in Progress (FEDRIP 2008) database and the Current Research and Information System database funded by the U.S. Department of Agriculture (CRIS 2008) provide additional information obtainable from a few ongoing studies that may fill in some of the data needs identified in Section 6.8.1. These studies are summarized in Table 6-4.

In addition, DOD is pursuing recycling technology to recover ammonium perchlorate from demilitarized rocket motors for military reuse, which should significantly reduce the amount of propellants that must be destroyed by open burn/open detonation (DOD 2008).

It should be noted that additional information on the potential for human exposure to perchlorates is continually appearing in the scientific literature. Much of this work is being performed by both private and governmental laboratories and, therefore, would not be cited in FEDRIP. Interested readers who require the latest information on the potential for human exposure to perchlorates are urged to consult the scientific literature.

## 6. POTENTIAL FOR HUMAN EXPOSURE

**Table 6-4. Ongoing Studies on the Potential for Human Exposure to Perchlorates (Including Studies on Fate and Occurrence)**

Investigator	Affiliation	Research description
EPA	EPA, Office of Research and Development, National Exposure Research Lab	Survey of industrial and foodgrade chemicals for perchlorate content
CDC	CDC, NCEH	Perchlorate exposure in the US population (ages 6+ using NHANES data (2001–)
CDC	CDC, NCEH	Maternal and perinatal fetal perchlorate exposure
CDC	CDC, NCEH	Perchlorate exposure of infants consuming either breastmilk or infant formula
CDC	CDC, NCEH	Mechanisms of active transport of perchlorate in cultured mammalian cells
CDC	CDC, NCEH	Perchlorate exposure and thyroid hormone levels in a population of women with low iodine intake
FDA	FDA	Ongoing FDA Total Diet Survey analysis for perchlorate
Follet RF	Agricultural Research Service	Improving soil and nutrient management systems for sustained productive and environmental quality
Mylon S	Lafayette College	Removal and destruction of perchlorate from aqueous systems using polymer ligand technology and packed bed reactors
Raskin LM	University of Illinois at Urbana-Champaign, Department of Civil and Environmental Engineering	Process optimization, molecular microbial characterization, and biofilm modeling of a bioreactor for perchlorate removal from drinking water
Sanchez CA	University of Arizona	Assessment of perchlorate content of food crops irrigated with water from the Colorado River
Sanchez CA	University of Arizona	Study of the fate and transport of perchlorate in the soil of the lower Colorado River region of Arizona
Scow KM	University of California	Study of microbial degradation of contaminants in soil, vadose, and groundwater
Stewart VJ	University of California	Study of bacterial anaerobic respiration in relation to its use and application in environmental microbiology and bioremediation
Strathmann T	University of Illinois at Urbana-Champaign	Development of a sustainable catalytic treatment process for perchlorate

CDC = Centers for Disease Control and Prevention; EPA = Environmental Protection Agency; FDA = Food and Drug Administration; NCEH = National Center for Environmental Health; NHANES = National Health and Nutrition Examination Survey

Source: CRIS 2008; FEDRIP 2008; SI/EPA 2008

6. POTENTIAL FOR HUMAN EXPOSURE

This page is intentionally blank.



## 7. ANALYTICAL METHODS

The purpose of this chapter is to describe the analytical methods that are available for detecting, measuring, and/or monitoring perchlorates, their metabolites, and other biomarkers of exposure and effect to perchlorates. The intent is not to provide an exhaustive list of analytical methods. Rather, the intention is to identify well-established methods that are used as the standard methods of analysis. Many of the analytical methods used for environmental samples are the methods approved by federal agencies and organizations such as EPA and the National Institute for Occupational Safety and Health (NIOSH). Other methods presented in this chapter are those that are approved by groups such as the Association of Official Analytical Chemists (AOAC) and the American Public Health Association (APHA). Additionally, analytical methods are included that modify previously used methods to obtain lower detection limits and/or to improve accuracy and precision.

In January 1997, the California Department of Health Services (DHS) began to test for perchlorate in drinking water wells near the Aerojet production facility outside of Sacramento (EPA 1999a). At that time, the best analytical method available had sensitivities of 400  $\mu\text{g/L}$ . Subsequently, it was improved to 100  $\mu\text{g/L}$  by Aerojet Corporation. Existing data indicated that a 4  $\mu\text{g/L}$  detection limit was required for a comprehensive assessment of the Aerojet site. By March of the same year, the California DHS, in collaboration with an analytical equipment manufacturer, refined the methodology to achieve a method detection limit of approximately 1  $\mu\text{g/L}$  and a reporting limit of 4  $\mu\text{g/L}$ .

With this analytical methodology in place, monitoring studies soon indicated that perchlorate contamination existed far beyond the boundaries of the Aerojet site. Because of concern for potential widespread perchlorate contamination and the importance of ammonium perchlorate in military and aerospace operations there has been a dramatic increase in the research on determining trace quantities of the perchlorate anion, especially in raw and finished drinking water supplies (Urbansky 2000). Extensive effort has also been expended to modify the quantitative techniques developed for water to measure perchlorate in other environmental matrices, such as soil, plants, blood, or sludge.

Four standardized methods are available for quantifying perchlorate in drinking water. These include EPA Method 314.0 (Ion Chromatography), EPA Method 314.1 (Inline Column Concentration/Matrix Elimination Ion Chromatography with Suppressed Conductivity Detection), EPA Method 331.0 (Liquid Chromatography Electrospray Ionization Mass Spectrometry), and EPA Method 332.0 (Ion Chromatography with Suppressed Conductivity and Electrospray Ionization Mass Spectrometry) (EPA

## 7. ANALYTICAL METHODS

1999c, 2005h, 2005i, 2005j). High salt concentrations can cause interference when using Methods 314.0 and 314.1 (Tikkanen 2006). Method detection limits and minimal reporting levels are 0.5 and 4.0  $\mu\text{g/L}$ , respectively, for Method 314.0 and 0.03 and 0.13–0.14  $\mu\text{g/L}$ , respectively, for Method 314.1 (EPA 1999c, 2005h). EPA Methods 332.0 and 331.0 require isotopically labeled internal standards for quantitation (Tikkanen 2006). Method 332.0 has greater sensitivity than Methods 314.0 and 314.1 with a method detection limit of 0.02  $\mu\text{g/L}$  and a minimum reporting level of 0.10  $\mu\text{g/L}$  (EPA 2005j; Tikkanen 2006). Method 331.0 offers the greatest sensitivity with a method detection limit of 0.005–0.008  $\mu\text{g/L}$  and a minimum reporting level of 0.022–0.056  $\mu\text{g/L}$  (EPA 2005i; Tikkanen 2006).

### 7.1 BIOLOGICAL MATERIALS

No standardized methods for the detection of perchlorates in biological samples have been reported. Ion chromatography (IC) has been used to detect perchlorate in human breast milk and cow's milk (Kirk et al. 2005). Ells et al. (2000) describe a method for determining perchlorate in urine samples using electrospray ionization mass spectrometry. A method using ion chromatography (IC) and electrospray (ES) tandem mass spectrometry (MSMS) for determining perchlorate in urine (limit of detection 0.025  $\text{ng/mL}$ ) showed an association between urinary levels and drinking water concentrations of perchlorate (Valentín-Blasini et al. 2005). Similarly, Blount et al. (2006) used IC-ES-MSMS to measure perchlorate in amniotic fluid. This analytical method included measurement of iodide so that the levels of perchlorate relative to iodide could be assessed. Because perchlorate competitively inhibits iodide uptake, the presence of larger quantities of iodide may minimize impact of perchlorate on thyroid function. A method to quantify perchlorate, thiocyanate, nitrate, and iodide in human urine, milk, serum, blood spots, amniotic fluid, and infant formula using IC-ES-MSMS has been published (Blount and Valentín-Blasini 2007).

Methods for detecting perchlorate in food using IC-ES-MSMS have been described (El Aribi et al. 2006; Krynitsky et al. 2004). According to El Aribi et al. (2006), detection of perchlorate at levels as low as 5  $\text{ng/L}$  in food is possible. An IC-MSMS method was employed by the FDA for its Total Diet Study, which achieved a detection limit of 1 ppb and a quantification limit of 3 ppb (Murray et al. 2008). Perchlorate has also been measured in plants (Nzengung et al. 1999; Smith et al. 2001; Urbansky et al. 2000c) and mammals, amphibians, fish, and insects (Dodds et al. 2004; Smith et al. 2001) using IC. Narayanan et al. (2003) described a method for measuring perchlorate in biological samples that uses IC coupled with conductivity detection. The detection limits determined for perchlorate in the fluids and tissues of rats were reported to be 3–6  $\text{ng/mL}$  and 0.007–0.7  $\text{mg/kg}$ , respectively. Perchlorate exposure

## 7. ANALYTICAL METHODS

was previously assessed by using IC-conductivity to measure perchlorate in urine and serum (Lamm et al. 1999; Lawrence et al. 2000); however, the analytical methods lacked sensitivity (detection limit 500 ng/mL).

## 7.2 ENVIRONMENTAL SAMPLES

EPA method 314.0 (EPA 1999c) was developed for the analysis of perchlorate in drinking water samples by IC. This method reports a minimum detection limit of 0.53  $\mu\text{g/L}$  and a minimum reporting limit of 4  $\mu\text{g/L}$ . Separation of anions is accomplished on a Dionex IonPac AS5 ion chromatography column (or equivalent) using a 50 mM sodium hydroxide eluent. Sample detection is accomplished using a suppressed conductivity detector (Dionex CD20). Large concentrations of other anions, such as chloride, sulfate, or carbonate may interfere with the analysis. Perchlorate identification is based on retention time. Other variations of the IC method for determining perchlorate in water samples have also been described (Ellington and Evans 2000; Jackson et al. 1999, 2000; Liu and Mou 2003; Liu et al. 2002; Okamoto et al. 1999; Polesello et al. 2001; Tian et al. 2003). According to the Department of Defense Perchlorate Handbook, EPA Method 331.0 (Liquid Chromatography Electrospray Ionization Mass Spectrometry), and EPA Method 332.0 (Ion Chromatography with Suppressed Conductivity and Electrospray Ionization Mass Spectrometry) (EPA 1999c, 2005h, 2005i, 2005j) are the preferred methods for drinking water analysis at Department of Defense sites (DOD 2006a).

Another technique that is used to determine perchlorate in water samples is electrospray ionization mass spectrometry, which provides better analytical selectivity compared with conductivity detection (Urbansky 2000). This technique has been used to determine perchlorate in a variety of water samples (Ells et al. 2000; Koester et al. 2000; Magnuson et al. 2000). The detection limit of this technique is approximately 0.030  $\mu\text{g/L}$  if microextraction using an organic solvent was employed before analysis (Urbansky 2000). Winkler et al. (2004) describe a method for detecting perchlorate in water and soil by ES liquid chromatography/MSMS. The method detection limits were 0.05  $\mu\text{g/L}$  for water and 0.5  $\mu\text{g/kg}$  for soil. U.S. Army Corp of Engineers (2004) described a calorimetric method for the field screening of water and soil samples. Detection limits were 1  $\mu\text{g/L}$  for water and 0.3  $\mu\text{g/g}$  for soil.

IC has also been used to analyze fertilizer samples for perchlorate (Collette et al. 2003; De Borba and Urbansky 2002; Urbansky and Collette 2001). In addition to IC, Collette et al. (2003) analyzed fertilizer for perchlorate using complexation electrospray ionization mass spectrometry, and high field asymmetric waveform mass spectrometry in addition to IC. These authors reported that using these techniques in

## 7. ANALYTICAL METHODS

concert offers a more powerful approach since each method depends on a different property of perchlorate for detection.

### 7.3 ADEQUACY OF THE DATABASE

Section 104(i)(5) of CERCLA, as amended, directs the Administrator of ATSDR (in consultation with the Administrator of EPA and agencies and programs of the Public Health Service) to assess whether adequate information on the health effects of perchlorates is available. Where adequate information is not available, ATSDR, in conjunction with NTP, is required to assure the initiation of a program of research designed to determine the health effects (and techniques for developing methods to determine such health effects) of perchlorates.

The following categories of possible data needs have been identified. They are defined as substance-specific informational needs that if met would reduce the uncertainties of human health assessment. This definition should not be interpreted to mean that all data needs discussed in this section must be filled. In the future, the identified data needs will be evaluated and prioritized, and a substance-specific research agenda will be proposed.

#### 7.3.1 Identification of Data Needs

**Methods for Determining Biomarkers of Exposure and Effect.** Perchlorate levels in human urine, milk, blood, or other tissue are biomarkers of exposure. In humans, perchlorate is primarily excreted in the urine; however, lactating mothers also excrete perchlorate in milk (Anbar et al. 1959; Kirk et al. 2005). IC-conductivity and IC-MS have been used to measure perchlorate in human milk as a biomarker of exposure (Kirk et al. 2005). Human exposure to perchlorate has also been assessed by using IC-ES-MSMS to measure perchlorate in urine (Valentín-Blasini et al. 2005). A similar analytical approach was used to measure perchlorate in amniotic fluid as a biomarker of exposure of the developing fetus (Blount et al. 2006). Serum levels of free iodine, T4, T3, and TSH hold potential as biomarkers of effect if they can be correlated with environmental exposures. These methods for measuring biomarkers of exposure and effect should improve the assessment of human exposure to perchlorate and potential health effects.

**Methods for Determining Parent Compounds and Degradation Products in Environmental Media.** Surface water, groundwater, and drinking water have been monitored using EPA Method 314.0. Derivations of this ion chromatography method have been used to determine perchlorate in a

## 7. ANALYTICAL METHODS

variety of different environmental media. Although further work to develop methods that can quantify perchlorate in a wider variety of matrices is required, this is currently a highly active area of research. These methods involve electrospray ionization mass spectrometry.

**7.3.2 Ongoing Studies**

No ongoing analytical methodology studies were located as a result of a search of Federal Research in Progress (FEDRIP 2008). It should be noted that new techniques are continually being applied to the IC method to allow a variety of different sample matrices to be analyzed. It should also be noted that additional information on the accuracy of other quantitative techniques that can be used to measure perchlorate is continually appearing in the scientific literature. Much of this work is being performed by both private and Governmental laboratories and, therefore, would not be cited in FEDRIP. Interested readers that require the latest information on analytical techniques that can be used to quantify perchlorate are urged to consult the scientific literature.

## 7. ANALYTICAL METHODS

This page is intentionally blank.

## 8. REGULATIONS AND ADVISORIES

The international, national, and state regulations and guidelines regarding perchlorate compounds in air, water, and other media are summarized in Table 8-1.

ATSDR has adopted the EPA's chronic RfD of 0.0007 mg/kg/day recommended by the NAS (2005) for the chronic oral MRL for perchlorate. NAS based the RfD derivation on a NOEL of 0.007 mg/kg/day corresponding to a nonstatistical significant change in thyroidal uptake of radioactive iodine in volunteers exposed to potassium perchlorate in water for 14 days (Greer et al. 2002). As indicated by the NAS (2005), iodide uptake inhibition is a key biochemical event that precedes all potential thyroid-mediated effects of perchlorate exposure. Using a nonadverse effect that is upstream of adverse effects is a conservative approach to perchlorate hazard assessment. An uncertainty factor of 10 was applied to the NOEL for the protection of sensitive subpopulations.

EPA (IRIS 2007) has developed a chronic RfD of 0.0007 mg/kg/day for perchlorate based on the NAS (2005) recommendation to use a NOEL of 0.007 mg/kg/day for changes in thyroid hormone and TSH in serum, and thyroidal uptake of radioactive iodine in volunteers exposed to potassium perchlorate in water for 14 days (Greer et al. 2002) as the basis for an RfD. An uncertainty factor of 10 was applied to the NOEL for the protection of sensitive subpopulations. This RfD leads to a drinking water equivalent level (DWEL) of 24.5 ppb (EPA 2006c). EPA calculates the DWEL using the RfD, multiplied by an adult body weight of 70 kg, and divided by a tap water consumption value of 2 L/day. EPA's Office of Solid Waste and Emergency Response has provided guidance for perchlorate that indicates that the RfD and its corresponding DWEL of 24.5 ppb are respectively the recommended "to be considered" (TBC) value and the preliminary remediation goal (PRG) for cleanup under the Comprehensive Environmental Response, Compensation, and Liability Act of 1980 (CERCLA) (EPA 2006c).

The federal government has set standards and guidelines to protect people from the possible harmful health effects of perchlorate. Specifically, EPA would consider discarded perchlorate to be a solid waste and depending on the fact-specific circumstances, EPA believes that discarded perchlorate could be a hazardous waste under the Solid Waste Disposal Act (EPA 2006b). That is, because perchlorates are oxidizing chemicals, waste discarded chemical formulations of perchlorate and its salts are likely to be classified as D001 RCRA hazardous waste under 40 CFR 261.23, which regulates wastes that meet the reactivity characteristic. Such a determination is generally based on the nature of the waste at the point of generation; however, characteristic hazardous waste, such as D001, ceases to be hazardous waste once it

## 8. REGULATIONS AND ADVISORIES

no longer exhibits the hazardous waste characteristics. In addition, CERCLA 101(14) defines “hazardous substances.” According to that section, “the term hazardous substance means. . . . any hazardous waste having the characteristics identified under or listed pursuant to Section 3001 of the Solid Waste Disposal Act . . . .” Therefore, depending on the fact-specific circumstances, discarded perchlorate could be classified as a D001 hazardous waste and therefore, under certain circumstances, EPA would consider perchlorate a CERCLA hazardous substance.

DOT has designated perchlorate as a hazardous material and limits the quantity that is transported aboard aircraft and vessels. DOT also provides identification and protective guidance for an emergency response to a transportation incident involving a hazardous material. FDA has restricted potassium perchlorate from coming in contact with food containers.

DOD must comply with any EPA cleanup standards and processes under all applicable environmental laws and regulations, including the CERCLA, RCRA, the CWA, and the SDWA. DOD policy requires for the testing of perchlorate when it is reasonably expected that a release has occurred. Specifically, DOD policy states that in the absence of federal or state standards, if perchlorate levels exceed 24 ppb in water, a site-specific risk assessment must be conducted. When an assessment indicates that the perchlorate contamination could result in adverse health effects, the site must be prioritized for risk management (DOD 2006b). DOD will also comply with applicable state or federal promulgated standards, whichever is more stringent. Additionally, DOD established the Emerging Contaminants Directorate in 2006 to help the department proactively approach emerging contaminants to enable a fully informed, risk-based investment decision process that protects human health and DOD operational capabilities (DOD 2008); perchlorate is one of seven contaminants on DOD’s action list.



## 8. REGULATIONS AND ADVISORIES

**Table 8-1. Regulations and Guidelines Applicable to Perchlorates**

Agency	Description	Information	Reference
<u>INTERNATIONAL</u>			
Guidelines:			
IARC	Carcinogenicity classification	No data	IARC 2004
WHO	Air quality guidelines	No data	WHO 2000
	Drinking water quality guidelines	No data	WHO 2004
<u>NATIONAL</u>			
Regulations and Guidelines:			
a. Air			
ACGIH	TLV (8-hour TWA)	No data	ACGIH 2004
DOT	Hazardous Materials Table	Yes	DOT 2007 49CFR172.101
	Ammonium perchlorate, magnesium perchlorate, potassium perchlorate, and sodium perchlorate		
NIOSH	REL (10-hour TWA)	No data	NIOSH 2005
OSHA	Threshold quantity for highly hazardous chemicals for general industry		OSHA 2005d 29CFR1910.119, Appendix A
	Ammonium perchlorate	7,500 pounds	
	Threshold quantity for highly hazardous chemicals for construction industry		OSHA 2005c 29CFR1926.64, Appendix A
	Ammonium perchlorate	500 pounds	
b. Water			
EPA	National primary drinking water regulations; monitoring requirements for unregulated contaminants		EPA 2005a 40CFR141.40 (a)(3)
	Perchlorate		
	EPA analytical method	314.0	
	Minimum reporting level	4.0 µg/L <sup>a</sup>	
	Sampling location	EPDTS <sup>b</sup>	
	Period during which monitoring be completed	2001–2003	
	Office of Solid Waste and Emergency Response		
	Perchlorate Preliminary Remediation Goal (PRG)	24.5 µg/L	EPA 2006c
DOD	Policy on DOD Required Actions Related to Perchlorate	24 µg/L	DOD 2006b

## 8. REGULATIONS AND ADVISORIES

**Table 8-1. Regulations and Guidelines Applicable to Perchlorates**

Agency	Description	Information	Reference
<u>NATIONAL</u> (cont.)			
c. Food			
FDA	Substances for use as basic component of single and repeated use food contact surfaces; closures with sealing gaskets for food containers		FDA 2005 21CFR177.1210 (b)(5)
	Potassium perchlorate	Not to exceed 1%	
d. Other			
ACGIH	Carcinogenicity classification	No data	ACGIH 2004
EPA	Carcinogenicity classification	Not likely to be carcinogenic	IRIS 2007
	RfC <sup>c</sup>	Has not been derived <sup>d</sup>	
	RfD <sup>c</sup>	7x10 <sup>-4</sup> mg/kg/day	
	Standards for owners and operators of hazardous waste TSD facilities; potentially incompatible waste; the mixing of Group 6-A (perchlorate) with Group 6-B may have the potential consequence as noted	Generation of toxic hydrogen cyanide or hydrogen sulfide gas	EPA 2005b 40CFR264, Appendix V
NTP	Carcinogenicity classification	No data	NTP 2004
<u>STATE</u>			
California	Presumed hazardous wastes	Yes	CalEPA 2007 22 CCR Chapter 11, Appendix X
	Ammonium perchlorate, magnesium perchlorate, potassium perchlorate, and sodium perchlorate		
	Public health goal for perchlorate in drinking water	6 ppb	CalEPA 2004
Massachusetts	Maximum contaminant level for perchlorate	2 ppb	MassDEP 2006b
	Right-to-Know list	Yes	MassDPH 2006 105 CMR 670, Appendix A
	Ammonium perchlorate, magnesium perchlorate, potassium perchlorate, and sodium perchlorate		

## 8. REGULATIONS AND ADVISORIES

**Table 8-1. Regulations and Guidelines Applicable to Perchlorates**

Agency	Description	Information	Reference
<i>STATE (cont.)</i>			
New Jersey	List of hazardous substances Ammonium perchlorate, lithium perchlorate, potassium perchlorate, and sodium perchlorate	Yes	NJDEP 2007 NJAC 7:13, Appendix A
	Workplace hazardous substance list and special health hazard substance list Ammonium perchlorate, magnesium perchlorate, potassium perchlorate, and sodium perchlorate	Yes	NJDHSS 2006 NJAC 8:59, Subchapter 9
Pennsylvania	Hazardous substance list Ammonium perchlorate, magnesium perchlorate, potassium perchlorate, and sodium perchlorate	Yes	PADLI 2007 Title 34, Chapter 323, Appendix A
Rhode Island	Hazardous substance list Ammonium perchlorate, magnesium perchlorate, potassium perchlorate, and sodium perchlorate	Yes	RIDLT 2007

<sup>a</sup>Minimum reporting level was established at a concentration, which is at least 1/4th the lowest known adverse health concentration, at which acceptable precision and accuracy has been demonstrated in spiked matrix samples.

<sup>b</sup>Entry Points to the Distribution System (EPTDS), after treatment, representing each non-emergency water source in use over the 12-month period of monitoring; this only includes entry points for sources in operation during the months in which sampling is to occur. Sampling must occur at the EPTDS, unless the State has specified other sampling points that are used for compliance monitoring under 40 CFR 141.24(f)(1), (2), and (3). See 40 CFR 141.40(a)(5)(ii)(C) for a complete explanation of requirements, including the use of source (raw) water sampling points.

<sup>c</sup>IRIS record for perchlorate and perchlorate salts include ammonium perchlorate, lithium perchlorate, potassium perchlorate, and sodium perchlorate.

<sup>d</sup>An inhalation RfC has not been derived because the available inhalation data are insufficient to characterize dose-response relationships or portal-of-entry modulation of internal dose.

ACGIH = American Conference of Governmental Industrial Hygienists; CFR = Code of Federal Regulations; CCR = California Code of Regulations; CMR = Code of Massachusetts Regulations; DOT = Department of Transportation; EPA = Environmental Protection Agency; EPTDS = Entry Points to the Distribution System; IARC = International Agency for Research on Cancer; IRIS = Integrated Risk Information System; NIOSH = National Institute for Occupational Safety and Health; NJAC = New Jersey Administrative Code; NTP = National Toxicology Program; OSHA = Occupational Safety and Health Administration; REL = recommended exposure limit; RfC = inhalation reference concentration; RfD = oral reference dose; TLV = threshold limit values; TSD = treatment, storage, and disposal; TWA = time-weighted average; WHO = World Health Organization

## 8. REGULATIONS AND ADVISORIES

This page is intentionally blank.

## 9. REFERENCES

- ACGIH. 2004. Perchlorates. Threshold limit values for chemical substances and physical agents and biological exposure indices. Cincinnati, OH: American Conference of Governmental Industrial Hygienists.
- Adinolfi M. 1985. The development of the human blood-CSF-brain barrier. *Dev Med Child Neurol* 27:532-537.
- Adlercreutz H. 1995. Phytoestrogens: Epidemiology and a possible role in cancer protection. *Environ Health Perspect Suppl* 103(7):103-112.
- Agency for Toxic Substances and Disease Registry. 1989. Decision guide for identifying substance-specific data needs related to toxicological profiles; notice. Agency for Toxic Substances and Disease Registry. *Fed Regist* 54(174):37618-37634.
- Agency for Toxic Substances and Disease Registry. 1990. Biomarkers of organ damage or dysfunction for the renal, hepatobiliary, and immune systems. Atlanta, GA: Subcommittee on Biomarkers of Organ Damage and Dysfunction, Agency for Toxic Substances and Disease Registry.
- Agency for Toxic Substances and Disease Registry. 2000. Public health assessment for Lockheed Propulsion Company: Evaluation of exposure to perchlorate contamination in the city of Loma Linda's domestic water supply. Atlanta, GA: Agency for Toxic Substances and Disease Registry. CERCLIS No. CAD980893093. PB2000105429.
- Agency for Toxic Substances and Disease Registry. 2004. Toxicological profile for iodine. Atlanta, GA: U.S. Department of Health and Human Services, Public Health Service.
- Altman PL, Dittmer DS. 1974. Biological handbooks: Biology data book. Vol. III. 2nd ed. Bethesda, MD: Federation of American Societies for Experimental Biology, 1987-2008, 2041.
- American Thyroid Association. 2006. Iodine supplementation for pregnancy and lactation-United States and Canada: Recommendations of the American Thyroid Association. *Thyroid* 16(10):949-951.
- Amitai Y, Winston G, Sack J, et al. 2007. Gestational exposure to high perchlorate concentrations in drinking water and neonatal thyroxine levels. *Thyroid* 17(9):843-850.
- Anbar M, Guttmann S, Lweitus Z. 1959. The mode of action of perchlorate ions on the iodine uptake of the thyroid gland. *Int J Appl Radiat Isot* 7:87-96.
- Andersen ME, Krishnan K. 1994. Relating *in vitro* to *in vivo* exposures with physiologically based tissue dosimetry and tissue response models. In: Salem H, ed. *Animal test alternatives: Refinement, reduction, replacement*. New York, NY: Marcel Dekker, Inc., 9-25.
- Andersen ME, Clewell HJ, Gargas ML, et al. 1987. Physiologically based pharmacokinetics and the risk assessment process for methylene chloride. *Toxicol Appl Pharmacol* 87:185-205.

---

\*Not cited in text

## 9. REFERENCES

- Andersen S, Pedersen KM, Bruun NH, et al. 2002. Narrow individual variations in serum T4 and T3 in normal subjects: A clue to the understanding of subclinical thyroid disease. *J Clin Endocrinol Metab* 87(3):1068-1072.
- Anderson GW, Mariash CN, Oppenheimer JH. 2000. Molecular actions of thyroid hormone. In: Braverman LE, Utiger RD, eds. *Werner and Ingbar's the thyroid: A fundamental and clinical text*. 8th ed. Philadelphia, PA: Lippincott Williams & Wilkins, 174-195.
- Andros G, Wollman SH. 1991. Kinetics of equilibration of radioiodide in individual mouse thyroid follicles *in vivo*. *Am J Physiol* 261(24):E529-E538.
- Antonsen DH. 1996. Nickel compounds. In: Kroschwitz JI, Howe-Grant M, eds. *Kirk-Othmer encyclopedia of chemical technology*. Vol. 17. New York, NY: John Wiley & Sons, 20.
- Arieli A, Chinnet A. 1985. Brown adipose tissue heat production in heat acclimated and perchlorate treated rats. *Horm Metab Res* 17:12-15.
- Ashford RD. 1994. *Ashford's dictionary of industrial chemicals: Properties, production, uses*. Wavelength Publications Ltd., 758, 821, 823.
- Aziz C, Borch R, Nicholson P, et al. 2006. Alternative causes of wide-spread, low concentration perchlorate impacts to groundwater. In: Gu B, Coates JD, eds. *Perchlorate. Environmental occurrence, interactions and treatment*. New York, NY: Springer Science and Business Media, Inc., 71-91.
- Backus SM, Klawuun P, Brown S. 2005. Determination of perchlorate in selected surface waters in the Great Lakes Basin by HPLC/MS/MS. *Chemosphere* 61:834-843.
- Bagchi N, Fawcett DM. 1973. Role of sodium ion in active transport of iodide by cultured thyroid cells. *Biochim Biophys Acta* 318:235-251.
- Baier-Anderson C, Blount BC, Lakind JS, et al. 2006. Estimates of exposures to perchlorate from consumption of human milk, dairy milk, and water, and comparison to current reference dose. *J Toxicol Environ Health A* 69(4):319-330.
- Bardiya N, Bae J. 2005. Bioremediation potential of a perchlorate-enriched sewage sludge consortium. *Chemosphere* 58:83-90.
- Barnes DG, Dourson M. 1988. Reference dose (RfD): Description and use in health risk assessments. *Regul Toxicol Pharmacol* 8:471-486.
- \*Bartha KG. 1974. Utilization of iodine kinetic coefficients for the analysis of pharmacological responses. *Acta Med Acad Sci Hung* 31(1-2):51-57.
- Barzilai D, Sheinfeld M. 1966. Fatal complications following use of potassium perchlorate in thyrotoxicosis. Report of two cases and a review of the literature. *Isr J Med Sci* 2(4):453-456.
- Bauer RJ. 1990. Lithium and lithium compounds. In: Elvers B, Hawkins S, Schulz G, eds. *Ullmann's encyclopedia of industrial chemistry*, Vol. A15. New York, NY: VCH Publishers, 393-414.

## 9. REFERENCES

- Bekkedal MYV, Arfsten D, Mattie D. 2004. An evaluation of neurobehavioral tests used to assess the neurodevelopmental effects of early ammonium perchlorate exposure. *J Toxicol Environ Health A* 67:835-844.
- Bekkedal MYV, Carpenter TL, Smith J. 2000. A neurodevelopmental study of oral ammonium perchlorate exposure on the motor activity of pre-weanling rat pups. Wright-Patterson Air Force Base, OH: Naval Health Research Center Detachment (Toxicology), Report No. TOXDET-00-03.
- Berger GS. 1994. Epidemiology of endometriosis. In: Berger GS, ed. *Endometriosis: Advanced management and surgical techniques*. New York, NY: Springer-Verlag.
- Bernal J, Pekonen F. 1984. Ontogenesis of the nuclear 3,5,3'-triiodothyronine receptor in the human fetal brain. *Endocrinology* 114(2):677-679.
- Blount BC, Valentin-Blasini L. 2007. Biomonitoring as a method for assessing exposure to perchlorate. *Thyroid* 17(9):837-841.
- Blount BC, Pirkle JL, Osterloh JD, et al. 2006. Urinary perchlorate and thyroid hormone levels in adolescent and adult men and women living in the United States. *Environ Health Perspect* 114(12):1865-1871.
- Blount BC, Valentin-Blasini L, Osterloh JD, et al. 2007. Perchlorate exposure of the U.S. population, 2001-2002. *J Expo Anal Environ Epidemiol* 1-8. [www.nature.com/jes](http://www.nature.com/jes). March 12, 2007.
- Bodek I, Lyman WJ, Reehl W, et al. 1988. *Environmental inorganic chemistry: Properties, processes, and estimation methods*. New York, NY: Pergamon Press.
- Bortle WH. 1996. Sodium nitrate. In: Kroschwitz JI, Howe-Grant M, eds. *Kirk-Othmer encyclopedia of chemical technology*. Vol. 22. New York, NY: John Wiley & Sons, Inc., 383-403.
- Boyages SC. 2000. The neuromuscular system and brain in hypothyroidism. In: Braverman LE, Utiger RD, eds. *Werner and Ingbar's the thyroid: A fundamental and clinical text*. 8th ed. Philadelphia, PA: Lippincott Williams & Wilkins, 803-810.
- Brabant G, Bergmann P, Kirsch CM, et al. 1992. Early adaptation of thyrotropin and thyroglobulin secretion to experimentally decreased iodine supply in man. *Metabolism* 41:1093-1096.
- Braverman LE, Utiger RD, eds. 2000. *Werner and Ingbar's the thyroid: A fundamental and clinical text*. 8th ed. Philadelphia, PA: Lippincott Williams & Wilkins, 593-666, 774-832.
- Braverman LE, He XM, Pino S, et al. 2005. The effect of perchlorate, thiocyanate, and nitrate on thyroid function in workers exposed to perchlorate long-term. *J Clin Endocrinol Metab* 90(2):700-706.
- Braverman LE, Pearce EN, He X, et al. 2006. Effects of six months of daily low-dose perchlorate exposure on thyroid function in healthy volunteers. *J Clin Endocrinol Metab* 91(7):2721-2724.
- Brechner RJ, Parkhurst GD, Humble WO, et al. 2000. Ammonium perchlorate contamination of Colorado River drinking water is associated with abnormal thyroid function in newborns in Arizona. *J Occup Environ Med* 42(8):777-782.

## 9. REFERENCES

- Brown JC, Snoeyink VL, Raskin L, et al. 2003. The sensitivity of fixed-bed biological perchlorate removal to changes in operating conditions and water quality characteristics. *Water Res* 37(1):206-214.
- Brown-Grant K. 1966. Failure of orally administered perchlorate to affect deciduoma formation or pregnancy in the rat. *J Reprod Fertil* 12:353-357.
- Brown-Grant K, Sherwood MR. 1971. Viability of the rat blastocyst following the oral administration of potassium perchlorate or potassium iodide to the mother. *J Reprod Fertil* 27:265-267.
- BRT. 2000. Ammonium perchlorate: Effect on immune function. Burlison Research Technologies. Raleigh, NC.
- Bruce RA, Achenbach LA, Coates JD. 1999. Reduction of (per)chlorate by a novel organism isolated from paper mill waste. *Environ Microbiol* 1(4):319-329.
- Buckley SG, Sclippa GC, Bazter LL, et al. 1999. Combustion tests of rocket motor washout material: Focus on air toxics formation potential of asbestos remediation. Sandia National Laboratories: Albuquerque, NM. DE00005953.
- Bürgi H, Benguerel M, Knopp J, et al. 1974. Influence of perchlorate on the secretion of non-thyroxine iodine by the normal human thyroid gland. *Eur J Clin Invest* 4:65-69.
- CADHS. 2007. Perchlorate in California drinking water. California Department of Health Services, Division of Drinking Water and Environment Management. <http://www.dhs.ca.gov/ps/ddwem/chemicals/perch/default.htm>. January 2, 2007.
- CADTSC. 2005. Perchlorate letters and comments. Past workshops on perchlorate best management practices. California Department of Toxic Substances Control. [http://www.dtsc.ca.gov/LawsRegsPolicies/Regs/upload/HWMP\\_FLY\\_PLC.pdf](http://www.dtsc.ca.gov/LawsRegsPolicies/Regs/upload/HWMP_FLY_PLC.pdf). February 14, 2008.
- Caldwell DJ, King JH, Kinkead ER, et al. 1995. Results of a fourteen day oral-dosing toxicity study of ammonium perchlorate. Chemical Propulsion Information Agency Publication.
- CalEPA. 2004. Public health goal for perchlorate in drinking water. Sacramento, CA: California Environmental Protection Agency, Office of Environmental Health Hazard Assessment. <http://www.oehha.org/water/phg/pdf/finalperchlorate31204.pdf>. February 07, 2008.
- CalEPA. 2007. Identification and listing of hazardous waste. Sacramento, CA: California Environmental Protection Agency, Department of Toxic Substances Control. California Code of Regulations. 22 CCR Chapter 11, Appendix X. <http://chemcite.bna.com/chlw4/htm/1337.htm>. February 06, 2008.
- Calvo R, Jauniaux E, Gulbis B, et al. 2002. Fetal tissues are exposed to biologically relevant free thyroxine concentrations during early phases of development. *J Clin Endocrinol Metab* 87(4):1768-1777.
- Calvo R, Obregon MJ, Ruiz de Ona C, et al. 1990. Congenital hypothyroidism, as studied in rats. *J Clin Invest* 86:889-899.
- Capen CC. 1997. Mechanistic data and risk assessment of selected toxic end points of the thyroid gland. *Toxicol Pathol* 25(1):39-48.



## 9. REFERENCES

- Capuco AV, Rice CP, Baldwin RL, et al. 2005. Fate of dietary perchlorate in lactating dairy cows: Relevance to animal health and levels in the milk supply. *Proc Natl Acad Sci USA* 102(45):16152-16157.
- Carr CW. 1952. Studies on the binding of small ions in protein solutions with the use of membrane electrodes. I. The binding of the chloride ion and other inorganic anions in solutions of serum albumin. *Arch Biochem Biophys* 40:286-294.
- Carrasco N. 1993. Iodide transport in the thyroid gland. *Biochim Biophys Acta* 1154:65-82.
- Chambard M, Verrier B, Gabrion J, et al. 1983. Polarization of thyroid cells in culture: Evidence for the basolateral localization of the iodide "pump" and of the thyroid-stimulating hormone receptor-adenyl cyclase complex. *J Cell Biol* 96:1172-1177.
- Chan ML, Reed R, Ciaramitaro DA. 2000. Advances in solid propellant formulations. In: Yang V, Brill TB, Ren W, eds. *Solid propellant chemistry, combustion, and motor interior ballistics*. Vol. 185. Reston, VA: American Institute of Aeronautics and Astronautics, Inc., 185-206.
- Chang S, Crothers C, Lai S, et al. 2003. Pediatric neurobehavioral diseases in Nevada counties with respect to perchlorate in drinking water: An ecological inquiry. *Birth Defects Res A Clin Mol Teratol* 67:886-892.
- ChemIDplus. 2007. Lithium perchlorate. ChemIDplus. Bethesda, MD: U.S. National Library of Medicine. <http://sis.nlm.nih.gov/chemical.html>. July 9, 2007.
- Chow SY, Woodbury DM. 1970. Kinetic of distribution of radioactive perchlorate in rat and guinea-pig thyroid glands. *J Endocrinol* 47:207-218.
- Chow SY, Chang LR, Yen MS. 1969. A comparison between the uptakes of radioactive perchlorate and iodine by rat and guinea-pig thyroid glands. *J Endocrinol* 45:1-8.
- Clewell HJ III, Andersen ME. 1985. Risk assessment extrapolations and physiological modeling. *Toxicol Ind Health* 1(4):111-131.
- Clewell RA. 2008. Personal communication from Rebecca Clewell, The Hamner Institutes for Health Sciences, Research Triangle Park, NC to Agency for Toxic Substances and Disease Registry, Division of Toxicology and Environmental Medicine, Atlanta, GA. June 19, 2008.
- Clewell RA, Merrill EA, Gearhart JM, et al. 2007. Perchlorate and radioiodide kinetics across life stages in the human: Using PBPK models to predict dosimetry and thyroid inhibition and sensitive subpopulations based on developmental stage. *J Toxicol Environ Health A* 70:408-428.
- Clewell RA, Merrill EA, Narayanan L, et al. 2004. Evidence for competitive inhibition of iodide uptake by perchlorate and translocation of perchlorate into the thyroid. *Int J Toxicol* 23(1):17-23.
- Clewell RA, Merrill EA, Robinson PJ. 2001. The use of physiologically based models to integrate diverse data sets and reduce uncertainty in the prediction of perchlorate kinetics across life stages and species. *Toxicol Ind Health* 17:210-222.

## 9. REFERENCES

- Clewell RA, Merrill EA, Yu KO, et al. 2003a. Predicting fetal perchlorate dose and inhibition of iodide kinetics during gestation: A physiologically-based pharmacokinetic analysis of perchlorate and iodide kinetics in the rat. *Toxicol Sci* 73:235-255.
- Clewell RA, Merrill EA, Yu KO, et al. 2003b. Predicting neonatal perchlorate dose and inhibition of iodide uptake in the rat during lactation using physiologically-based pharmacokinetic modeling. *Toxicol Sci* 74:416-436.
- \*Cline TR, Plumlee MP, Christian JE, et al. 1969. Effect of potassium perchlorate and sodium chloride given orally upon radioiodine deposition into milk of goats. *J Dairy Sci* 52(7):1124-1126.
- Coates JD, Anderson RT. 2000. Emerging techniques for anaerobic bioremediation of contaminated environments. *Trends Biotechnol* 18(10):408-412.
- Coates JD, Michaelidou U, Bruce RA, et al. 1999. Ubiquity and diversity of dissimilatory (per)chlorate-reducing bacteria. *Appl Environ Microbiol* 65(12):5234-5241.
- Cohen AP. 1993. Desiccants. In: Kroschwitz JI, Howe-Grant M, eds. *Kirk-Othmer's encyclopedia of chemical technology*. Vol. 7. New York, NY: John Wiley & Sons, Inc., 1031-1055.
- Cohen RN, Weintraub BD, Wondisford FE. 2000. Thyrotropin. In: Braverman, LE, Utiger RD, eds. *Werner and Ingbar's the thyroid: A fundamental and clinical text*. 8th ed. Philadelphia: Lippincott Williams & Wilkins, 202-219.
- Collette TW, Williams TL, Urbansky ET, et al. 2003. Analysis of hydroponic fertilizer matrixes for perchlorate: Comparison of analytical techniques. *Analyst* 128(1):88-97.
- Conkling JA. 1996. Pyrotechnics. In: Kroschwitz JI, Howe-Grant M, eds. *Kirk-Othmer encyclopedia of chemical technology*. Vol. 20. New York, NY: John Wiley & Sons, Inc., 680-697.
- Connell JMC. 1981. Long-term use of potassium perchlorate. *Postgrad Med J* 57:516-517.
- Contempre B, Jauniaux E, Calvo R, et al. 1993. Detection of thyroid hormones in human embryonic cavities during the first trimester of pregnancy. *J Clin Endocrinol Metab* 77(6):1719-1722.
- \*Conti A, Kneubuehl F, Studer H, et al. 1975. Increased iodotyrosine deiodinase activity in human goiters and in rats treated with perchlorate. In: Robbins J, Braverman LE, eds. *Thyroid research: Proceedings of the 7th International Thyroid Conference, Boston, Massachusetts, June 9-13, 1975*, 166-168.
- Corvilain B, Dumont HE, Vassart G. 2000. Toxic adenoma and toxic multinodular goiter. In: Braverman LE, Utiger RD eds. *Werner and Ingbar's the thyroid: A fundamental and clinical text*. 8th ed. Philadelphia, PA: Lippincott Williams & Wilkins, 564-572.
- Costa M, Zhitkovich A, Gargas M, et al. 1996. Interlaboratory validation of a new assay for DNA-protein crosslinks. *Mutat Res* 369:13-21.
- Cotton FA, Wilkinson G. 1980. *Advanced inorganic chemistry*. New York, NY: John Wiley & Sons, 560.

## 9. REFERENCES

- Cowan D. 2000. Innovative abatement and remediation of perchlorate at McGregor, Texas weapons plant site. *Soil Sediment Groundwater* 5:25-26.
- Cramer RJ, Yates C, Hatzinger P, et al. 2004. Field demonstration of in situ perchlorate bioremediation at building 1419. Indian Head, MD: U.S. Naval Sea Systems Command. ADA421555.
- CRIS. 2008. Perchlorates. Current Research Information System. U.S. Department of Agriculture. <http://cris.csrees.usda.gov/>. February 6, 2008.
- Crooks J, Wayne EJ. 1960. A comparison of potassium perchlorate, methylthiouracil, and carbimazole in the treatment of thyrotoxicosis. *Lancet* 1:401-404.
- Crump C, Michaud P, Tellez R, et al. 2000. Does perchlorate in drinking water affect thyroid function in newborns or school-age children? *J Occup Environ Med* 42(6):603-612.
- CSB. 1999. Chemical safety board investigators dispatched to site of fireworks factory explosion. Chemical Safety and Hazard Investigation Board. <http://www.csb.gov/>. April 20, 1999.
- Darras VM, Hume R, Visser TJ. 1999. Regulation of thyroid hormone metabolism during fetal development. *Mol Cell Endocrinol* 151:37-47.
- Dasgupta PK, Dyke JV, Kirk AB, et al. 2006. Perchlorate in the United States. Analysis of relative source contributions to the food chain. *Environ Sci Technol* 40:6608-6614.
- Dasgupta PK, Martinelango PK, Jackson WA, et al. 2005. The origin of naturally occurring perchlorate: The role of atmospheric processes. *Environ Sci Technol* 39(6):1569-1575.
- Dean KE, Palachek RM, Noel JM, et al. 2004. Development of freshwater water-quality criteria for perchlorate. *Environ Toxicol Chem* 23(6):1441-1451.
- De Borba BM, Urbansky ET. 2002. Performance of poly (vinyl alcohol) gel columns on the ion chromatographic determination of perchlorate in fertilizers. *J Environ Monit* 4(1):49-55.
- De Groef B, Decallonne R, Van der Geytem, et al. 2006. Perchlorate versus other environmental sodium/iodide symporter inhibitors: Potential thyroid-related health effects. *Eur J Endocrinol* 155:17-25.
- DeGroot LJ, Buhler U. 1971. Effect of perchlorate and methimazole on iodine metabolism. *Acta Endocrinol* 68:696-706.
- de Zegher F, Vanhole C, Van den Berghe G, et al. 1994. Properties of thyroid-stimulating hormone and cortisol secretion by the human newborn on the day of birth. *J Clin Endocrinol Metab* 79:576-581.
- DOD. 1995. Instrumentation advances in emissions characterization from propellant/explosive combustion. Washington, DC: Department of Defense. DE960008231.
- DOD. 1999. Effects of ammonium perchlorate on immunotoxicological, hematological, and thyroid parameters in B6C3F1 female mice. United States Department of Defense.
- \*DOD. 2005a. Success stories: Longhorn Army Ammunition Plant. Department of Defense, Perchlorate Work Group. <http://www.dodperchlorateinfo.net/efforts/successes/army/longhorn.html>. June 29, 2005.

## 9. REFERENCES

- \*DOD. 2005b. Perchlorate treatment technology: Fact sheet: Bioreactors. Department of Defense. AFCEE/ERT Fact Sheet. <http://www.dodperchlorateinfo.net/efforts/successes/army/documents/bioreactors.pdf>. June 30, 2005.
- DOD. 2005c. Success stories: Edwards Air Force Base. Department of Defense, Perchlorate Work Group. <http://www.dodperchlorateinfo.net/efforts/successes/air-force/edwards.html>. June 30, 2005.
- DOD. 2005d. Perchlorate treatment technology. Fact sheet. Ion exchange. Department of Defense. AFCEE/ERT Fact Sheet. <http://www.dodperchlorateinfo.net/efforts/successes/air-force/documents/Ion-Exchange.pdf>. June 30, 2005.
- DOD. 2006a. DOD perchlorate handbook. U.S. Department of Defense. Prepared by the Department of Defense Environmental Data Workgroup.
- DOD. 2006b. Policy on DoD required actions relating to perchlorate. Office of Undersecretary of Defense. Washington, DC: U.S. Department of Defense, Office of Undersecretary of Defense. <https://www.denix.osd.mil/portal/page/portal/content/environment/MERIT/EC/ECAL/Perchlorate/PolicyGuidance/PERCHLORATEPOLICY.PDF>. August 7, 2008.
- DOD. 2007. Department of Defense concerns with findings section of H.R. 1747, 110<sup>th</sup> Congress, the "Safe Drinking Water for Health Communities Act of 2007." Washington, DC: U.S. Department of Defense.
- DOD. 2008. Emerging contaminants/MERIT. Emerging contaminants (EC): EC action list: Perchlorate: Perchlorate facts. Office of Undersecretary of Defense. U.S. Department of Defense. Washington, DC. <https://www.denix.osd.mil/portal/page/portal/denix/environment/MERIT/EC/ECAL/Perchlorate/PerchlorateFacts>. July 02, 2008.
- Dodds ED, Kennish JM, Von Hippel FA, et al. 2004. Quantitative analysis of perchlorate in extracts of whole fish homogenates by ion chromatography: Comparison of suppressed conductivity detection and electrospray ionization mass spectrometry. *Anal Bioanal Chem* 379(5-6):681-687.
- DOE. 2003. Treatment of perchlorate-contaminated groundwater using highly-selective, regenerable anion-exchange resins at Edwards Air Force Base. Oak Ridge, TN: U.S. Department of Energy. DE2003814536.
- Dohán O, Portulano C, Basquin C, et al. 2007. The Na<sup>+</sup>/I<sup>-</sup> symporter (NIS) mediates electroneutral active transport of the environmental pollutant perchlorate. *Proc Natl Acad Sci USA* 104(51):20250-20255.
- DOT. 2007. Hazardous materials table. Washington, DC: U.S. Department of Transportation, Research and Special Programs Administration. Code of Federal Regulations 49 CFR 172.101. [http://a257.g.akamaitech.net/7/257/2422/16nov20071500/edocket.access.gpo.gov/cfr\\_2007/octqtr/pdf/49cfr172.101.pdf](http://a257.g.akamaitech.net/7/257/2422/16nov20071500/edocket.access.gpo.gov/cfr_2007/octqtr/pdf/49cfr172.101.pdf). February 14, 2008.
- Dowling ALS, Zoeller RT. 2000. Thyroid hormone of maternal origin regulates the expression of RC3/neurogranin mRNA in the fetal rat brain. *Mol Brain Res* 82:126-132.

## 9. REFERENCES

- Dowling ALS, Iannacone EA, Zoeller RT. 2001. Maternal hypothyroidism selectivity affects the expression of neuroendocrine-specific protein A messenger ribonucleic acid in the proliferative zone of the fetal rat brain cortex. *Endocrinology* 142(1):390-399.
- Drury MA. 1986. More about perchlorates and conducting polymers. *Chem Eng News* 64:2.
- Duncan PB, Morrison RD, Vavricka E. 2005. Forensic identification of anthropogenic and naturally occurring sources of perchlorate. *Environ Forensics* 6:205-215.
- Dunson DB. 2001. Statistical analysis of the effects of perchlorate on neurobehavior (motor activity) in SD rats. Memorandum (November 1, 2001) to Annie M. Jarabek, National Center for Environmental Assessment (MD-52). Research Triangle Park, NC: U.S. Environmental Protection Agency.
- Durand MJ. 1938. Recherches sur l'elimination des perchlorates, sur leur repartition dans les organes et sur leur toxicite. *Bull Soc Chim Biol* 20:428-435.
- Dyke JV, Ito K, Obitsu T, et al. 2007. Perchlorate in dairy milk. Comparison of Japan versus the United States. *Environ Sci Technol* 41:88-92.
- Eichler O. 1929. [The pharmacology of the perchlorate effect. Naunyn-Schmiedebergs.] *Arch Exp Pathol Pharmacol* 144:251-260. (German)
- Eichler O, Hackenthal E. 1962. [Secretion and metabolism of perchlorate measured with  $^{36}\text{ClO}_4$ .] *Naunyn-Schmiedebergs Arch Exp Pathol Pharmacol* 243:554-565. (German)
- El Aribi H, Le Blanc YJC, Antonsen S, et al. 2006. Analysis of perchlorate in foods and beverages by ion chromatography coupled with tandem mass spectrometry (IC-ESI-MS/MS). *Anal Chim Acta* 567:39-47.
- Ellington JJ, Evans JJ. 2000. Determination of perchlorate at parts-per-billion levels in plants by ion chromatography. *J Chromatogr A* 898:193-199.
- Ellington JJ, Wolfe NL, Garrison AW, et al. 2001. Determination of perchlorate in tobacco plants and tobacco products. *Environ Sci Technol* 35(15):3213-3218.
- Ells B, Barnett DA, Purves RW, et al. 2000. Trace level determination of perchlorate in water matrices and human urine using ESI-FAIMS-MS. *J Environ Monitor* 2(5):393-397.
- EPA. 1990. Interim methods for development of inhalation reference concentrations. Washington, DC: U.S. Environmental Protection Agency, Office of Health and Environmental Assessment, Office of Research and Development, Environmental Criteria and Assessment Office. EPA600890066A.
- EPA. 1992a. Code of federal regulations. U.S. Environmental Protection Agency. 49 CFR 261.22.
- \*EPA. 1992b. U.S. Environmental Protection Agency. Provisional non-cancer and cancer toxicity values for potassium perchlorate. Superfund Health Risk Technical Support Center. Chemical Mixtures Assessment Branch.
- EPA. 1994. Methods for derivation of inhalation reference concentrations and application of inhalation dosimetry. U.S. Environmental Protection Agency. EPA600890066F.

## 9. REFERENCES

EPA. 1997a. Special report on environmental endocrine disruption: An effects assessment and analysis. Washington, DC: U.S. Environmental Protection Agency, Risk Assessment Forum. EPA630R96012.

EPA. 1997b. Exposure factors handbook. Washington, DC: U.S. Environmental Protection Agency, National Center of Environmental Assessment, Office of Research and Development. EPA600P95002Fa. [http://rais.ornl.gov/homepage/EFH\\_Final\\_1997\\_EPA600P95002Fa.pdf](http://rais.ornl.gov/homepage/EFH_Final_1997_EPA600P95002Fa.pdf). July 09, 2007.

EPA. 1998a. Announcement of the drinking water contaminant candidate list. U.S. Environmental Protection Agency. Fed Regist 63(40):10274-10287.

\*EPA. 1998b. Assessment of thyroid follicular cell tumors. U.S. Environmental Protection Agency. Risk Assessment Forum. EPA630R97002.

\*EPA. 1998c. Perchlorate environmental contamination: Toxicological review and risk characterization based on emerging information. Washington, DC: U.S. Environmental Protection Agency, Office of Research and Development. NCEA-1-0503.

\*EPA. 1998d. Perchlorate ecological risk studies: A report on literature reviews and studies conducted by the ecological impact/transport and transformation subcommittee of the interagency perchlorate steering committee. Edison, NJ: U.S. Environmental Protection Agency. TR20010004. ADA397933.

EPA. 1999a. Perchlorate. U.S. Environmental Protection Agency. Office of Ground Water and Drinking Water. <http://www.epa.gov/ogwdw000/ccl/perchlor/perchlo.html>. June 21, 2000.

EPA. 1999b. Revisions to unregulated contaminant monitoring regulation for public water systems. U.S. Environmental Protection Agency. Fed Regist 64(180):50556-50620.

EPA. 1999c. Method 314.0. Determination of perchlorate in drinking water using ion chromatography. In: Methods for the determination of organic and inorganic compounds in drinking water. Volume 1. U.S. Environmental Protection Agency. EPA815R00014. <http://nepis.epa.gov/>. July 06, 2007.

EPA. 2000. Unregulated contaminant monitoring regulation for public water systems: Analytical methods for perchlorate and acetochlor; announcement of laboratory approval and performance testing (PT) program for the analysis of perchlorate. U.S. Environmental Protection Agency. Fed Regist 65(42):11372-11385.

EPA. 2001a. Survey of fertilizers and related materials for perchlorate ( $\text{ClO}_4^-$ ). Cincinnati, OH: U.S. Environmental Protection Agency. PB2005103648. EPA600R01047.

\*EPA. 2001b. Ion chromatographic determination of perchlorate ion: Analysis of fertilizers and related materials. Washington, DC: U.S. Environmental Protection Agency. PB2001105531. EPA600R01026.

\*EPA. 2002a. Drinking water contaminant candidate list. U.S. Environmental Protection Agency. [wysiwyg://40/http://www.epa.gov/OGWDW/ccl/cclfs.html](http://www.epa.gov/OGWDW/ccl/cclfs.html). June 2, 2002.

\*EPA. 2002b. National primary drinking water regulations. Monitoring requirements for unregulated contaminants. U.S. Environmental Protection Agency. Code of Federal Regulations. 40 CFR 141.40(a)(3). <http://ecfr.access.gpo.gov/otcqi/cfr/otfil...Y=71724&RGN=BSECCT&SUBSET=SUBSET&FROM=1&TEM=1>. June 2, 2002.

## 9. REFERENCES

EPA. 2002c. Perchlorate environmental contamination: Toxicological review and risk characterization. U.S. Environmental Protection Agency. Office of Research and Development. NCEA-1-0503.

\*EPA. 2002d. Perchlorate. U.S. Environmental Protection Agency. Office of Water. [wysiwyg://30/http://www.epa.gov/ogwdw/ccl/perchlor/perchlo.html](http://www.epa.gov/ogwdw/ccl/perchlor/perchlo.html). July 16, 2003.

\*EPA. 2002e. Standards for owners and operators of hazardous waste treatment, storage, and disposal facilities. Examples of potentially incompatible waste. Appendix V. U.S. Environmental Protection Agency. Code of Federal Regulations. 40 CFR 264. <http://ecfr.access.gpo.gov/otcg...=BAPPCT&SUBSET=SUBSET&FROM=1&ITEM=1>. June 20, 2005.

\*EPA. 2002f. Perchlorate ecological studies - A report on literature reviews and studies conducted by the ecological impact/transport and transformation subcommittee of the interagency perchlorate steering committee. Edison, NJ: U.S. Environmental Protection Agency. ADA397933.

EPA. 2003. Occurrence and potential sources of perchlorate releases to the environment as of April, 2003. U.S. Environmental Protection Agency. [http://www.epa.gov/fedfac/pdf/perchlorate\\_occurrence\\_april03a.pdf](http://www.epa.gov/fedfac/pdf/perchlorate_occurrence_april03a.pdf). July 5, 2005.

\*EPA. 2004a. Drinking water contaminant candidate list 2: Notice. Washington, DC: U.S. Environmental Protection Agency. Fed Regist 69(64):17406-17415.

\*EPA. 2004b. A study on the accumulation of perchlorate in young head lettuce. Research Triangle Park, NC: U.S. Environmental Protection Agency. PB2005105427. EPA600R03003.

EPA. 2005a. National primary drinking water regulations. Monitoring requirements for unregulated contaminants. U.S. Environmental Protection Agency. Code of Federal Regulations. 40 CFR 141.40(a)(3).

EPA. 2005b. Standards for owners and operators of hazardous waste treatment, storage, and disposal facilities. Examples of potentially incompatible waste. Appendix V. U.S. Environmental Protection Agency. Code of Federal Regulations. 40 CFR 264.

EPA. 2005c. Known perchlorate releases in the U.S. – March 25, 2005. U.S. Environmental Protection Agency. [http://www.epa.gov/fedfac/documents/detection\\_with\\_dates\\_03\\_25\\_05.xls](http://www.epa.gov/fedfac/documents/detection_with_dates_03_25_05.xls). June 30, 2005.

\*EPA. 2005d. Known or suspected perchlorate manufacturers/users in U.S. – as of April 2003. U.S. Environmental Protection Agency. [http://www.epa.gov/fedfac/documents/known\\_perch\\_mftrs\\_usr\\_04\\_03.xls](http://www.epa.gov/fedfac/documents/known_perch_mftrs_usr_04_03.xls). June 29, 2005.

EPA. 2005e. Perchlorate. Drinking water contaminant candidate list. Ground water & drinking water. U.S. Environmental Protection Agency. <http://www.epa.gov/safewater/ccl/perchlorate/perchlorate.html>. June 30, 2005.

\*EPA. 2005f. Perchlorate. Federal facilities restoration and reuse. U.S. Environmental Protection Agency. <http://www.epa.gov/fedfac/documents/perchlorate.htm>. June 25, 2005.

EPA. 2005g. Accessing unregulated contaminant monitoring data. Office of Ground Water and Drinking Water. U.S. Environmental Protection Agency. <http://www.epa.gov/safewater/data/ucmrgetdata.html>. June 30, 2005.

## 9. REFERENCES

- EPA. 2005h. Method 314.1. Determination of perchlorate in drinking water using inline column concentration/matrix elimination ion chromatography with suppressed conductivity detection. Cincinnati, OH: U.S. Environmental Protection Agency, Office of Ground Water and Drinking Water. EPA815R05009.
- EPA. 2005i. Method 331.0. Determination of perchlorate in drinking water by liquid chromatography electrospray ionization mass spectrometry. Cincinnati, OH: U.S. Environmental Protection Agency, Office of Ground Water and Drinking Water. EPA815R05007.
- EPA. 2005j. Method 332.0. Determination of perchlorate in drinking water by ion chromatography with suppressed conductivity and electrospray ionization mass spectrometry. Cincinnati, OH: U.S. Environmental Protection Agency, Office of Research and Development. EPA600R05049.
- EPA. 2005k. Toxic chemical release inventory reporting forms and instructions: Revised 2004 version. Section 313 of the Emergency Planning and Community Right-to-Know Act (Title III of the Superfund Amendments and Reauthorization Act of 1986). U.S. Environmental Protection Agency. Office of Environmental Information. EPA260B05001.
- EPA. 2006a. Perchlorate monitoring results-Henderson, Nevada to the lower Colorado River. December 2005 report. San Francisco, CA: U.S. Environmental Protection Agency. [http://www.epa.gov/fedfac/pdf/perrpt12\\_05.pdf](http://www.epa.gov/fedfac/pdf/perrpt12_05.pdf). February 12, 2008.
- EPA. 2006b. Written communication April 6, 2006 to Congresswomen Solis and Congressman Dingell, United States Congress, responses to questions regarding the presence of perchlorate and other constituents found at Department of Defense facilities. U.S. Environmental Protection Agency.
- EPA. 2006c. Assessment guidance for perchlorate. Washington, DC: U.S. Environmental Protection Agency, Office of Solid Waste and Emergency Response. [http://www.epa.gov/fedfac/pdf/perchlorate\\_guidance.pdf](http://www.epa.gov/fedfac/pdf/perchlorate_guidance.pdf). August 04, 2008.
- EPA. 2007. Drinking water: Regulatory determinations regarding contaminants on the second drinking water contaminant candidate list-preliminary determinations. U.S. Environmental Protection Agency. Fed Regist 72(83):24016-24058. <http://a257.g.akamaitech.net/7/257/2422/01jan20071800/edocket.access.gpo.gov/2007/pdf/E7-7539.pdf>. February 15, 2008.
- EPA. 2008a. Identification and listing of hazardous waste. U.S. Environmental Protection Agency. Code of Federal Regulations.40 CFR 261. <http://ecfr.gpoaccess.gov/cgi/t/text/text-idx?c=ecfr&sid=385ea9ac5d6e0fb83be2351f0836eb09&rgn=div5&view=text&node=40:25.0.1.1.2&idno=40#PartTop>. February 15, 2008.
- EPA. 2008b. Personal communication from Mary T. Cooke, U.S. Environmental Protection Agency Office of Solid Waste and Emergency Response Federal Facilities Restoration and Reuse Office (FFRRO) Washington, DC to Agency for Toxic Substances and Disease Registry, Division of Toxicology and Environmental Medicine, Atlanta, GA.
- EPA. 2008c. National Priorities List (NPL). NPL site totals by status and milestone. U.S. Environmental Protection Agency. <http://www.epa.gov/superfund/sites/query/queryhtm/npltotal.htm>. August 04, 2008.



## 9. REFERENCES

- ERG. 2004. 2004 Emergency response guidebook: A guidebook for first responders during the initial phase of a dangerous goods/hazardous materials incident. U.S. Department of Transportation, Transport Canada, Secretariat of Communications and Transportation of Mexico. <http://hazmat.dot.gov/pubs/erg/guidebook.htm>. July 9, 2007.
- Erickson BE. 2004. Tracing the origin of perchlorate. *Anal Chem* 76(21):388A-389A.
- Escobar del Rey F, Pastor R, Mallol J, et al. 1986. Effects of maternal iodine deficiency on the L-thyroxine and 3,5,3'-triiodo-L-thyronine contents of rat embryonic tissues before and after onset of fetal thyroid function. *Endocrinology* 118(4):1259-1265.
- Eskandari S, Loo DD, Dai G, et al. 1997. Thyroid Na<sup>+</sup>/I<sup>-</sup> symporter: Mechanism, stoichiometry, and specificity. *J Biol Chem* 272(43):27230-27238.
- Eskin BA, Merion JA, Krouse TB, et al. 1976. Blockade of breast iodine by perchlorate in estrogen deficiency. *Excerpta Medica* 378:625-629.
- Eskin BA, Shuman R, Krouse T, et al. 1975. Rat mammary gland atypia produced by iodine blockade with perchlorate. *Cancer Res* 35:2332-2339.
- Fagin JA. 2000. Molecular genetics of tumors of thyroid follicular cells. In: Braverman LE, Utiger RD, eds. *Werner and Ingbar's the thyroid: A fundamental and clinical text*. 8th ed. Philadelphia, PA: Lippincott Williams & Wilkins, 886-898.
- Faure N, Dussault J-H. 1975. [The effect of a single dose of perchlorate on the 24-hour I 131 uptake.] *Union Med Can* 104(8):1208-1210. (French)
- Fawcett JW, Clarke CWF. 1961. Aplastic anaemia due to potassium perchlorate. *Br Med J* 1:1537.
- FDA. 1998. Code of federal regulations-Indirect food additives: Polymers. Food and Drug Administration. 21 CFR 177.1210. <http://squid.law.cornell.edu/cgi-bin/21&PART-177&SECTION-1210&TYPE=TEXT>. June 2, 1999.
- FDA. 2005. Substances for use as basic components of single and repeated use food contact surfaces. Closures with sealing gaskets for food containers. Food and Drug Administration. Code of Federal Regulations. 21 CFR 177.1210(b)(5). <http://www.access.gpo.gov/cgi-bin/cfrassemble.cgi?title=200521>. June 24, 2005.
- FDA. 2007a. Preliminary estimation of perchlorate dietary exposure based on FDA 2004/2005 exploratory data. Food and Drug Administration. <http://www.cfsan.fda.gov/~dms/clo4ee.html>. June 08, 2007.
- FDA. 2007b. 2004-2005 Exploratory survey data on perchlorate in food. Food and Drug Administration. <http://www.cfsan.fda.gov/~dms/clo4data.html>. June 08, 2007.
- FDA. 2007c. U.S. Food and Drug Administration's total diet study: dietary intake of perchlorate and iodine. College Park, MD: U.S. Food and Drug Administration, Center for Food Safety and Applied Nutrition. (Draft).
- FEDRIP. 2008. Perchlorates. Federal Research in Progress database. Springfield, VA: National Technical Information Service.

## 9. REFERENCES

- Fernandez-Rodriguez A, Galera-Davidson H, Salguero-Villadiego M, et al. 1991. Induction of thyroid proliferative changes in rats treated with antithyroid compound. *Anat Histol Embryol* 20:289-298.
- Fernández-Santos JM, De-Miguel M, Gonzalez-Campora R, et al. 2004. Ki-ras mutational analysis in rat follicular-cell proliferative lesions of the thyroid gland induced by radioactive iodine and potassium perchlorate. *J Endocrinol Invest* 27(1):12-17.
- Ferreiro B, Bernal J, Goodyear CG, et al. 1988. Estimation of nuclear thyroid hormone receptor saturation in human fetal brain and lung during early gestation. *J Clin Endocrinol Metab* 67:853-856.
- Fisher DA, Brown RS. 2000. Thyroid physiology in the perinatal period and during childhood. In: Braverman LE, Utiger RD, eds. *Werner and Ingbar's the thyroid: A fundamental and clinical text*. 8th ed. Philadelphia, PA: Lippincott Williams & Wilkins, 959-972.
- Fisher DA, Oddie TH, Burroughs JC. 1962. Thyroidal radioiodine uptake rate measurement in infants. *Am J Dis Child* 103:738-749.
- Fisher J, Todd P, Mattie D, et al. 2000. Preliminary development of a physiological model for perchlorate in the adult male rat: A framework for further studies. *Drug Chem Toxicol* 23(1):243-258.
- Florencio Vicente MDR. 1990. [Proliferative thyroid lesions: An experimental study.] *Diss Abstr Int C* 54(1):176. (Spanish)
- Fomon SJ. 1966. Body composition of the infant: Part I: The male "reference infant". In: Falkner F, ed. *Human development*. Philadelphia, PA: WB Saunders, 239-246.
- Fomon SJ, Haschke F, Ziegler EE, et al. 1982. Body composition of reference children from birth to age 10 years. *Am J Clin Nutr* 35:1169-1175.
- Forhead AJ, Li J, Gilmour RS, et al. 2002. Thyroid hormones and the mRNA of the GH receptor and IGFs in skeletal muscle of fetal sheep. *Am J Physiol Endocrinol Metab* 282(1):E80-E86.
- GAO. 2005. Perchlorate. A system to track sampling and cleanup results is needed. Report to the Chairman, Subcommittee on Environment and Hazardous Materials, Committee on Energy and Commerce, House of Representatives. United States Government Accountability Office. <http://www.gao.gov/new.items/d05462.pdf>. February 13, 2008.
- GAO. 2007. Department of Defense activities related to trichloroethylene, perchlorate, and other emerging contaminants. Washington, DC: United States Government Accountability Office. GAO-07-1042T. <http://www.gao.gov/new.items/d071042t.pdf>. February 12, 2008.
- Gauss W. 1972. [Physiological and histological criteria of thyroid gland function during a single or longer treatment of potassium perchlorate in adult mice (*Mus musculus*). I. Long-lasting medication experiments.] *Z Mikrosk Anat Forsch* 85:469-500. (German)
- GFS. 1997. GFS Chemical Company catalog. Powell, OH: GFS Chemicals, Inc., 79-89.
- Gibbs JP. 2006. A comparative toxicological assessment of perchlorate and thiocyanate based on competitive inhibition of iodine uptake as the common mode of action. *Hum Ecol Risk Assess* 12(1):157-173.

## 9. REFERENCES

- Gibbs JP, Ahmad R, Crump KS, et al. 1998. Evaluation of a population with occupational exposure to airborne ammonium perchlorate for possible acute or chronic effects on thyroid function. *J Occup Environ Med* 40:1072-1082.
- Giblin T, Frankenberger WT. 2001. Perchlorate and nitrate reductase activity in the perchlorate-respiring bacterium *perclace*. *Microb Releases* 156(4):311-315.
- Giblin TL, Herman DC, Frankenberger WT. 2000. Removal of perchlorate from ground water by hydrogen-utilizing bacteria. *J Environ Qual* 29:1057-1062.
- Ginsberg GL, Hattis DB, Zoeller RT, et al. 2007. Evaluation of the U.S. EPA/OSWER preliminary remediation goal for perchlorate in groundwater: Focus on exposure to nursing infants. *Environ Health Perspect* 115(3):361-369.
- Giwercman A, Carlsen E, Keiding N, et al. 1993. Evidence for increasing incidence of abnormalities of the human testis: A review. *Environ Health Perspect* 101(Suppl 2):65-71.
- Gjemdal N. 1963. Fatal aplastic anaemia following use of potassium perchlorate in thyrotoxicosis. *Acta Med Scand* 174:129-131.
- GMELIN. 1999. GMELIN97 (CAS Reg. No.: 7601-89-0; 89650-98-4). Gmelin-Institute last updated May 21, 1997. STN International. <http://stnweb.cas.org/> May 11, 1999.
- Godley AF, Stanbury JB. 1954. Preliminary experience in the treatment of hyperthyroidism with potassium perchlorate. *J Clin Endocrinol* 14:70-78.
- Goldman SJ, Stanbury JB. 1973. The metabolism of perchlorate in the rat. *Endocrinology* 92:1536-1538.
- Golstein J, Corvilain B, Lamy F, et al. 1988. Effects of a selenium deficient diet on thyroid function of normal and perchlorate treated rats. *Acta Endocrinol* 118:495-502.
- Green WL. 1996. Antithyroid compounds. In: Braverman LE, Utiger RD, eds. *Werner and Ingbar's the thyroid: A fundamental and clinical text*. 7th ed. Philadelphia, PA: Lippincott-Raven Publishers, 266-276.
- Greer MA, Goodman G, Pleus RC, et al. 2002. Health effects assessment for environmental perchlorate contamination: The dose-response for inhibition of thyroidal radioiodine uptake in humans. *Environ Health Perspect* 110(9):927-937.
- Grotheer MP. 1994. Electrochemical processing. In: Kroschwitz JI, Howe-Grant M, eds. *Kirk-Othmer encyclopedia of chemical technology*. Vol. 9. New York, NY: John Wiley & Sons, Inc, 111-159.
- Gullick RW, Lechevallier MW, Barhorst TS. 2001. Occurrence of perchlorates in drinking water sources. *J Am Water Works Assoc* 93:66-77.
- Guzelian PS, Henry CJ, Olin SS, eds. 1992. *Similarities and differences between children and adults: Implications for risk assessment*. Washington, DC: International Life Sciences Institute Press.

## 9. REFERENCES

- Haddow JE, Palomaki GE, Allan WC, et al. 1999. Maternal thyroid deficiency during pregnancy and subsequent neuropsychological development of the child. *N Engl J Med* 341:549-555.
- Harris WR, Cafferty AM, Abdollahi S, et al. 1998. Binding of monovalent anions to human serum transferrin. *Biochim Biophys Acta* 1383(2):197-210.
- Hartmann N, Vogler H, Vogler CH. 1971. [Effect of some thyroid inhibitors on the peripheral turnover of thyroid hormones.] *Acta Biol Med Ger* 26:513-521. (German)
- Hays MT, Solomon DH. 1965. Influence of the gastrointestinal iodide cycle on the early distribution of radioactive iodide in man. *J Clin Invest* 44:117-127.
- Herman DC, Frankenberger WT. 1998. Microbial-mediated reduction of perchlorate in groundwater. *J Environ Qual* 27:750-754.
- Herman DC, Frankenberger WT. 1999. Bacterial reduction of perchlorate and nitrate in water. *J Environ Qual* 28(3):1018-1024.
- Hiasa Y, Kitahori Y, Kato Y, et al. 1987. Potassium perchlorate, potassium iodide, and propylthiouracil: promoting effect on the development of thyroid tumors in rats treated with n-bis(2-hydroxypropyl)-nitrosamine. *Jpn J Cancer Res* 78:1335-1440.
- \*Hildebrandt JD, Halmi NS. 1981. Intrathyroidally generated iodine: The role of transport in its utilization. *Endocrinology* 106(3):842-849.
- Hindman EE II, Finnegan WG. 1980. Cloud-forming nuclei from combustion of solid-rocket-motor propellants. *CPIA Publ* 325:49-55.
- Hobson QJG. 1961. Aplastic anemia due to treatment with potassium perchlorate. *Br Med J* 5236:1368-1369.
- Hoel DG, Davis DL, Miller AB, et al. 1992. Trends in cancer mortality in 15 industrialized countries, 1969-1986. *J Natl Cancer Inst* 84(5):313-320.
- Hoffmeister G. 1993. Fertilizers. In: Kroschwitz JI, Howe-Grant M, eds. *Kirk-Othmer's encyclopedia of chemical technology*. Vol. 10. New York, NY: John Wiley & Sons, Inc., 441-514.
- Howard BJ, Voigt G, Segal MG, et al. 1996. A review of countermeasures to reduce radioiodine in milk of dairy animals. *Health Phys* 71(5):661-673.
- HSDB. 2006. Perchlorates. Hazardous Substances Data Bank. <http://toxnet.nlm.nih.gov/cgi-bin/sis/htmlgen?HSDB>. December 12, 2006.
- Hume R, Richard K, Kaptein E. 2001. Thyroid hormone metabolism and the developing human lung. *Biol Neonate* 80:18-21.
- IARC. 2004. Overall evaluations of carcinogenicity to humans: As evaluated in IARC Monographs volumes 1-82 (at total of 900 agents, mixtures and exposures). Lyon, France: International Agency for Research on Cancer. <http://www-cie.iarc.fr/monoeval/crthall.html>. February 15, 2005.

## 9. REFERENCES

- Iff HW, Wilbrandt W. 1963. [The dependency of iodine accumulation in thyroid slices on the ional composition of the incubation medium; influence of heart glycosides.] *Biochim Biophys Acta* 70:711-752. (German)
- IRIS. 2007. Perchlorate and perchlorate salts. Washington, DC: Integrated Risk Information System. U.S. Environmental Protection Agency. <http://www.epa.gov/iris/subst/>. July 11, 2007.
- ITRC. 2008. Remediation technologies for perchlorate contamination in water and soil (PERC-2). Interstate Technology and Regulatory Council, Perchlorate Team. March 2008. <http://www.itrcweb.org/homepage.asp>. August 04, 2008.
- Jackson PE, Gokhale S, Streib T, et al. 2000. Improved method for the determination of trace perchlorate in ground and drinking waters by ion chromatography. *J Chromatogr A* 888(1-2):151-158.
- Jackson PE, Laikhtman M, Rohrer JS. 1999. Determination of trace level perchlorate in drinking water and ground water by ion chromatography. *J Chromatogr A* 850(1-2):131-135.
- Jackson WA, Anadam SK, Anderson T, et al. 2005b. Perchlorate occurrence in the Texas southern high plains aquifer system. *Ground Water Monit Rem* 25(1):137-149.
- Jackson WA, Joseph P, Laxman P, et al. 2005a. Perchlorate accumulation in forage and edible vegetation. *J Agric Food Chem* 53(2):369-373.
- Jaegle L, Yung YL, Toon GC, et al. 1996. Balloon observations of organic and inorganic chlorine in the stratosphere: The role of HClO<sub>4</sub> production on sulfate aerosols. *Geophys Res Lett* 23(14):1749-1752.
- Jansen LH. 1992. Boron compounds. In: Kroschwitz JI, Howe-Grant M, eds. *Kirk-Othmer encyclopedia of chemical technology*. Vol. 4. New York, NY: John Wiley & Sons, 364.
- Jobelius HH, Scharff H-D. 1989. Hydrazoic acid and azides. In: Elvers B, Hawkins S, Ravenscroft M, et al., eds. *Ullmann's encyclopedia of industrial chemistry*, Vol. A13. Basel, Switzerland: VCH, 193-197.
- Johanson CE. 1980. Permeability and vascularity of the developing brain: Cerebellum vs. cerebral cortex. *Brain Res* 190:3-16.
- Johnson RS, Moore WG. 1961. Fatal aplastic anemia after treatment of thyrotoxicosis with potassium perchlorate. *Br Med J* 5236:1369-1371.
- Kamienski CW, McDonald DP, Stark MW. 1995. Lithium and lithium compounds. In: Kroschwitz JI, Howe-Grant M, eds. *Kirk-Othmer encyclopedia of chemical technology*. Vol. 15. New York, NY: John Wiley & Sons, Inc., 434-463.
- Kamm G, Drescher G. 1973. [Demonstration of perchlorate in urine.] *Beitr Gerichtl Med* 30:206-210. (German)
- Kang N, Anderson TA, Jackson WA. 2006. Photochemical formation of perchlorate from aqueous oxychlorine anions. *Anal Chim Acta* 567:48-56.

## 9. REFERENCES

- Kapitola J, Schullerova M, Schreiberova O. 1971. Blood flow and radioiodine uptake in the thyroid gland of rats after administration and discontinuation of carbimazole and perchlorate. *Acta Endocrinol* 68:817-825.
- Kelsh MA, Buffler PA, Daaboul JJ, et al. 2003. Primary congenital hypothyroidism, newborn thyroid function, and environmental perchlorate exposure among residents of a Southern California community. *J Occup Environ Med* 45:1116-1127.
- Kessler FJ, Kruskemper HL. 1966. [Experimental thyroid tumors caused by many years of potassium perchlorate administration.] *Klin Wochenschr* 44(19):1154-1156. (German)
- Khan MA, Fenton SE, Swank AE. 2005. A mixture of ammonium perchlorate and sodium chlorate enhances alterations of the pituitary-thyroid axis caused by the individual chemicals in adult male F344 rats. *Toxicol Pathol* 33:776-783.
- Kiesche ES. 1994. American Pacific get go-ahead on ammonium perchlorate, sodium azide. *Chem Week* 154:11.
- Kim K, Logan BE. 2001. Microbial reduction of perchlorate in pure and mixed culture packed-bed bioreactors. *Water Res* 35(13):3071-3076.
- Kirk AB, Martinelango PK, Tian K, et al. 2005. Perchlorate and iodine in dairy and breast milk. *Environ Sci Technol* 39:2011-2017.
- Kirk AB, Dyke JV, Martin CF, et al. 2007. Temporal patterns in perchlorate, thiocyanate, and iodide excretion in human milk. *Environ Health Perspect* 115(2):182-186.
- Klein I, Levey GS. 2000. The cardiovascular system in thyrotoxicosis. In: Braverman LE, Utiger RD, eds. *Werner and Ingbar's the thyroid: A fundamental and clinical text*. 8th ed. Philadelphia, PA: Lippincott Williams & Wilkins, 596-604.
- Koester CJ, Beller HR, Halden RU. 2000. Analysis of perchlorate in groundwater by electrospray ionization mass spectrometry/mass spectrometry. *Environ Sci Technol* 34(9):1862-1864.
- Komori M, Nishio K, Kitada M, et al. 1990. Fetus-specific expression of a form of cytochrome P-450 in human livers. *Biochemistry* 29:4430-4433.
- \*Kotzaurek R. 1965. Nil nocere!: Akute leberatrophie nach perchlorat-therapie. *Munch Med Wochenschr* 42:2067-2070.
- Krevans JR, Asper SP, Rienhoff WF. 1962. Fatal aplastic anemia following use of potassium perchlorate in thyrotoxicosis. *JAMA* 181:182-184.
- Krynitsky AJ, Niemann RA, Nortrup DA. 2004. Determination of perchlorate anion in foods by ion chromatography-tandem mass spectrometry. *Anal Chem* 76 (18):5518-5522.
- Krishnan K, Andersen ME. 1994. Physiologically based pharmacokinetic modeling in toxicology. In: Hayes AW, ed. *Principles and methods of toxicology*. 3rd ed. New York, NY: Raven Press, Ltd., 149-188.

## 9. REFERENCES

- Krishnan K, Andersen ME, Clewell HJ III, et al. 1994. Physiologically based pharmacokinetic modeling of chemical mixtures. In: Yang RSH, ed. Toxicology of chemical mixtures: Case studies, mechanisms, and novel approaches. San Diego, CA: Academic Press, 399-437.
- Krynitsky AJ, Niemann RA, Nortrup DA. 2004. Determination of perchlorate anion in foods by ion chromatography - tandem mass spectrometry. *Anal Chem* 76(18):5518-5522.
- Ladenson PW. 2000. Diagnosis of hypothyroidism. In: Braverman LE, Utiger RD, eds. *Werner and Ingbar's the thyroid: A fundamental and clinical text*. 8th ed. Philadelphia, PA: Lippincott Williams & Wilkins, 848-852.
- Lamm SH. 2003. Letters to the editor: Perchlorate exposure does not explain differences in neonatal thyroid function between Yuma and Flagstaff. *J Occup Environ Med* 45(11):1131-1132.
- Lamm SH, Doemland M. 1999. Has perchlorate in drinking water increased the rate of congenital hypothyroidism? *J Occup Environ Med* 41(5):409-411.
- Lamm SH, Braverman LE, Li FX, et al. 1999. Thyroid health status of ammonium perchlorate workers: A cross-sectional occupational health study. *J Occup Environ Med* 41(4):248-260.
- Lampe L, Modis L, Gehl A. 1967. Effect of potassium perchlorate on the foetal rabbit thyroid. *Acta Med Acad Sci Hung* 23(3):223-232.
- \*Langer P. 1968. Fluctuation of thyroid function following a single and repeated administration of antithyroid drugs. *Endocrinology* 83:1268-1272.
- Larsen PR. 1989. Maternal thyroxine and congenital hypothyroidism. *N Engl J Med* 321:44-46.
- \*Larsson-Nyren G. 1996. Perchlorate is hypoglycaemic by amplifying glucose-stimulated insulin secretion in mice. *Acta Physiol Scand* 158:71-76.
- Laue W, Thiemann M, Scheibler E, et al. 1991. Nitrates and nitrites. In: Elvers B, Hawkins S, Schulz G, eds. *Ullmann's encyclopedia of industrial chemistry*. Vol. A17. New York, NY: VCH Publishers, 265, 270, 271, 290, 291.
- Lawrence J, Lamm S, Braverman LE. 2001. Letter to the editor. Low dose perchlorate (3 mg daily) and thyroid function. *Thyroid* 11(3):295.
- Lawrence JE, Lamm SH, Pino S, et al. 2000. The effect of short-term low-dose perchlorate on various aspects of thyroid function. *Thyroid* 10(8):659-663.
- Lazar MA. 1993. Thyroid hormone receptors: Multiple forms, multiple possibilities. *Endocrine Rev* 14(2):184-193.
- Lazarus JH, Harden RM, Robertson JW. 1974. Quantitative studies of the inhibitory effect of perchlorate on the concentration of  $^{36}\text{ClO}_4^-$ ,  $^{125}\text{I}^-$  and  $^{99\text{m}}\text{TcO}_4^-$  in salivary glands of male and female mice. *Arch Oral Biol* 19(7):493-498.
- Leeder JS, Kearns GL. 1997. Pharmacogenetics in pediatrics: Implications for practice. *Pediatr Clin North Am* 44(1):55-77.

## 9. REFERENCES

- \*Lengemann FW. 1973. Reduction of iodine transfer to milk of cows after perchlorate ingestion. *J Dairy Sci* 56:753-756.
- Leung H-W. 1993. Physiologically-based pharmacokinetic modelling. In: Ballantine B, Marro T, Turner P, eds. *General and applied toxicology*. Vol. 1. New York, NY: Stockton Press, 153-164.
- Levy O, Dai G, Riedel C, et al. 1997. Characterization of the thyroid  $\text{Na}^+/\text{I}^-$  symporter with an anti-COOH terminus antibody. *Proc Natl Acad Sci U S A* 94:5568-5573.
- Levy O, De la Vieja A, Carrasco N. 1998a. The  $\text{Na}^+/\text{I}^-$  symporter (NIS): Recent advances. *J Bioenerg Biomembr* 30(2):195-206.
- Lewandowski TA, Seeley MR, Beck BD. 2004. Interspecies differences in susceptibility to perturbation of thyroid homeostasis: A case study with perchlorate. *Regul Toxicol Pharmacol* 39(3):348-362.
- Lewis RJ. 2000. *Sax's dangerous properties of industrial materials*. New York, NY: John Wiley & Sons, Inc., 2854-2856.
- Lewis RJ. 2001. Potassium perchlorate, magnesium perchlorate, lithium perchlorate, ammonium perchlorate, and sodium perchlorate. In: *Hawley's condensed chemical dictionary*. New York, NY: Van Nostrand Reinhold Company, 916, 689, 677, 65, 64, 1021.
- Li FX, Byrd DM, Deyhle GM, et al. 2000a. Neonatal thyroid-stimulating hormone level and perchlorate in drinking water. *Teratology* 62:429-431.
- Li Z, Li FX, Byrd D, et al. 2000b. Neonatal thyroxine level and perchlorate in drinking water. *J Occup Environ Med* 42(2):200-205.
- Li FX, Squartsoff L, Lamm SH. 2001. Prevalence of thyroid diseases in Nevada counties with respect to perchlorate in drinking water. *J Occup Environ Med* 43(7):630-634.
- Lindner V. 1993. Explosives and propellants. In: Kroschwitz J, Howe-Grant M, eds. *Kirk-Othmer encyclopedia of chemical technology*. Vol. 10. New York, NY: John Wiley & Sons, 69, 115-125.
- Liu Y, Mou S. 2003. Determination of trace levels of haloacetic acids and perchlorate in drinking water by ion chromatography with direct injection. *J Chromatogr A* 997(1-2):225-235.
- Liu Y, Mou S, Heberling S. 2002. Determination of trace level bromate and perchlorate in drinking water by ion chromatography with an evaporative preconcentration technique. *J Chromatogr A* 956(1-2):85-91.
- Livingston AL. 1978. Forage plant estrogens. *J Toxicol Environ Health* 4:301-324.
- Logan BE. 1998. A review of chlorate- and perchlorate-respiring microorganisms. *Biorem J* 2(2):69-79.
- Logan BE. 2001. Assessing the outlook for perchlorate remediation. *Environ Sci Technol* 35(23):482A-487A.
- Logan BE, LaPoint D. 2002. Treatment of perchlorate-and nitrate-contaminated groundwater in an autotrophic, gas phase, packed-bed bioreactor. *Water Res* 36(14):3647-3653.



## 9. REFERENCES

- Logan BE, Bliven AR, Olsen SR, et al. 1998. Growth kinetics of mixed cultures under chlorate-reducing conditions. *J Environ Eng* 124:1008-1011.
- Logan BE, Wu J, Unz RF. 2001a. Biological perchlorate reduction in high-salinity solutions. *Water Res* 35(12):3034-3038.
- Logan BE, Zhang H, Mulvaney P, et al. 2001b. Kinetics of perchlorate- and chlorate-respiring bacteria. *Appl Environ Microbiol* 67(6):2499-2506.
- Logonder-Mlinsek M, Kalisnik M, Pajer Z. 1985. Follicular, parafollicular and mast cells in mouse thyroid gland after antithyroid drug application. *Acta Sterol* 4(1):67-76.
- Lyman WJ, Reehyl WF, Rosenblatt DH. 1990. Handbook of chemical property estimation methods: Environmental behavior of organic compounds. Washington, DC: American Chemical Society.
- MacDermott M. 1992. Intracellular sodium and potassium activities of skeletal muscle fibres of hypothyroid rats. *Exp Physiol* 77:649-652.
- Magnuson ML, Urbansky ET, Kelty CA. 2000. Determination of perchlorate at trace levels in drinking water by ion-pair extraction with electrospray ionization mass spectrometry. *Anal Chem* 72:25-29.
- Mahle DA, Yu KO, Narayanan L, et al. 2003. Changes in cross-fostered Sprague-Dawley rat litters exposed to perchlorate. *Int J Toxicol* 22:87-94.
- Mannisto PT, Ranta T, Leppaluoto J. 1979. Effects of methylmercaptoimidazole (MMI), propylthiouracil (PTU), potassium perchlorate (KClO<sub>4</sub>) and potassium iodide (KI) on the serum concentrations of thyrotrophin (TSH) and thyroid hormones in the rat. *Acta Endocrinol* 91:271-281.
- Martinelango PK, Tian K, Dasgupta PK. 2006. Perchlorate in seawater. Bioconcentration of iodide and perchlorate by various seaweed species. *Anal Chim Acta* 567:100-107.
- Martino E, Bartalena L, Bogazzi F, et al. 2001. The effects of amiodarone on the thyroid. *Endocrine Rev* 22(2):240-254.
- MassDEP. 2006a. The occurrence and sources of perchlorate in Massachusetts. Massachusetts Department of Environmental Protection. <http://www.mass.gov/dep/water/drinking/percinfo.htm>. December 28, 2006.
- MassDEP. 2006b. Maximum contaminant level for inorganic chemicals. Boston, MA: Massachusetts Department of Environmental Protection. Code of Massachusetts Regulations. 310 CMR 22.06. <http://www.mass.gov/dep/service/regulations/310cmr22.pdf>. February 14, 2008.
- MassDPH. 1994. Right to Know list. Boston, MA: Massachusetts Department of Public Health. Code of Massachusetts Regulations. 105 CMR 670, Appendix A. <http://chemcite.bna.com/chlw4/htm/262.htm>. February 06, 2008.
- Matsuzaki S, Suzuki M. 1981. Paradoxical effect of perchlorate on thyroidal weight, glucose 6-phosphate dehydrogenase and polyamines in methylthiouracil-treated rats. *Acta Endocrinol* 97:491-495.

## 9. REFERENCES

- Mausteller JW. 1996. Oxygen-generation systems. In: Kroschwitz JI, Howe-Grant M, eds. Kirk-Othmer encyclopedia of chemical technology. Vol. 17. New York, NY: John Wiley & Sons, Inc., 940-952.
- Mayr U, Butsch A, Schneider S. 1992. Validation of two *in vitro* test systems for estrogenic activities with zearalenone, phytoestrogens and cereal extracts. *Toxicology* 74:135-149.
- McLanahan ED, Campbell JL, Ferguson DC, et al. 2007. Low-dose effects of ammonium perchlorate on the hypothalamic-pituitary-thyroid axis of adult male rats pretreated with PCB126. *Toxicol Sci* 97(2):308-317.
- Mendiratta SK, Dotson RL, Brooker RT. 1996. Perchloric acid and perchlorates. In: Kroschwitz JI, Howe-Grant M, eds. Kirk-Othmer encyclopedia of chemical technology. Vol. 18. New York, NY: John Wiley & Sons, Inc., 157-170.
- Merrill CI, O'Drobinak JD. 1998. Sea water immersion of GEM II propellant. 1998 JANNAF Propellant Development & Characterization Subcommittee and Safety & Environmental Protection Subcommittee Joint Meeting. Vol. 1. CPIA Publ 674:561-567.
- Merrill EA, Clewell RA, Gearhart JM, et al. 2003. PBPK predictions of perchlorate distribution and its effect on thyroid uptake of radioiodide in the male rat. *Toxicol Sci* 73:256-269.
- Merrill EA, Clewell RA, Robinson PJ, et al. 2005. PBPK model for radioactive iodide and perchlorate kinetics and perchlorate-induced inhibition of iodide uptake in humans. *Toxicol Sci* 83(1):25-43.
- Mill T. 1982. Hydrolysis and oxidation processes in the environment. *Environ Toxicol Chem* 1:135-141.
- Millero FJ. 1990. Effect of ionic interactions on the oxidation rates of metals in natural waters. Chemical modeling in aqueous systems II. Vol. 416. American Chemical Society.
- Min B, Evans PJ, Chu AK, et al. 2004. Perchlorate removal in sand and plastic media bioreactors. *Water Res* 38(1):47-60.
- Morgan JW, Cassady RE. 2002. Community cancer assessment in response to long-time exposure to perchlorate and trichloroethylene in drinking water. *J Occup Environ Med* 44:616-621.
- Morgans ME, Trotter WR. 1960. Potassium perchlorate in thyrotoxicosis. *Br Med J* 2:1086-1087.
- \*Morreale de Escobar G, Calvo R, Obregon MJ, et al. 1990. Contribution of maternal thyroxine to fetal thyroxine pools in normal rats near term. *Endocrinology* 126(5):2765-2767.
- Morreale de Escobar G, Obregon MJ, Escobar del Rey F. 2000. Is neuropsychological development related to maternal hypothyroidism or to maternal hypothyroxinemia? *J Clin Endocrinol Metab* 85(11):3975-3987.
- Morreale de Escobar G, Pastor R, Obregon MJ, et al. 1985. Effects of maternal hypothyroidism on the weight and thyroid hormone content of rat embryonic tissues, before and after onset of fetal thyroid function. *Endocrinology* 117(5):1890-1900.

## 9. REFERENCES

- Morselli PL, Franco-Morselli R, Bossi L. 1980. Clinical pharmacokinetics in newborns and infants: Age-related differences and therapeutic implications. *Clin Pharmacokin* 5:485-527.
- Mukhopadhyay S, Ghosh D, Chatterjee A, et al. 2005. Evaluation of possible goitrogenic and anti-thyroidal effect of nitrate. A potential environmental pollutant. *Indian J Physiol Pharmacol* 49(3):284-288.
- Murray CW, Egan SK, Kim H, et al. 2008. US Food and Drug Administration's Total Diet Study: Dietary intake of perchlorate and iodine. *J Expo Sci Environ Epidemiol* EPUB ahead of print (2 January 2008). <http://www.nature.com/jes>. February 14, 2008. doi:10.1038/sj.jes.7500648
- Nair LM, Saari-Nordhaus R, Montgomery RM. 1997. Applications of a new methacrylate-based anion stationary phase for the separation of inorganic anions. *J Chromatogr* 789:127-134.
- Nakamura S, Kosaka H. 1989. [Genotoxicity of inorganic metal compounds with umu test.] *Jpn J Ind Health* 31:430-431. (Japanese)
- Nakamura Y, Kotani T, Ohtaki S. 1990. Transcellular iodide transport and iodination on the apical plasma membrane by monolayer porcine thyroid cells cultured on collagen-coated filters. *J Endocrinol* 126:275-281.
- Narayanan L, Butler GW, Yu KO, et al. 2003. Sensitive high-performance liquid chromatography method for the determination of low levels of perchlorate in biological samples. *J Chromatogr B Analyt Technol Biomed Life Sci* 788(2):393-399.
- NAS. 2005. Health implications of perchlorate ingestion. Washington, DC: National Academies Press. <http://www.nap.edu/books/0309095689/html/>. January 31, 2005.
- NAS/NRC. 1989. Report of the oversight committee. In: *Biologic markers in reproductive toxicology*. Washington, DC: National Academy of Sciences, National Research Council, National Academy Press.
- Nilsson M, Bjorkman U, Ekholm R, et al. 1990. Iodide transport in primary cultured thyroid follicle cells: evidence of a TSH-regulated channel mediating iodide efflux selectively across the apical domain of the plasma membrane. *Eur J Cell Biol* 52:270-281.
- NIOSH. 1995. National Occupational Exposure Survey. Cincinnati, OH: Department of Health and Human Services, National Institute for Occupational Safety and Health. March 29, 1989.
- NIOSH. 2005. NIOSH pocket guide to chemical hazards. Atlanta, GA: National Institute for Occupational Safety and Health, Centers for Disease Control and Prevention, <http://www.cdc.gov/niosh/npg/npgdname.html>. June 24, 2005.
- NJDEP. 2007. NJ environmental hazardous substance list pursuant to NJ community right to know (N.J.A.C. 7:1G) by CAS number. Trenton, NJ: New Jersey Department of Environmental Protection. New Jersey Administrative Code. NJAC 7:1G, Appendix A. <http://www.nj.gov/dep/opppc/crtk/Melissa/ehscasno.pdf>. February 14, 2008.
- NJDHSS. 2006. Workplace hazardous substance list and special health hazard substance list. Trenton, NJ: New Jersey Department of Health and Senior Services. New Jersey Administrative Code. NJAC 8:59, Appendix A and B. <http://chemcite.bna.com/chlw4/hm/110.htm>. February 06, 2008.

## 9. REFERENCES

- NRC. 1993. Pesticides in the diets of infants and children. Washington, DC: National Academy Press. National Research Council.
- NTP. 2004. Report on carcinogens. 11th edition. Research Triangle Park, NC: U.S. Department of Health and Human Services, Public Health Service, National Toxicology Program. <http://ntp-server.niehs.nih.gov/ntp/roc/toc11.html>. February 15, 2005.
- Nzengung VA, Penning H, O'Niell W. 2004. Mechanistic changes during phytoremediation of perchlorate under different root-zone conditions. *Int J Phytoremediation* 6(1):63-83.
- Nzengung VA, Wang C, Harvey G. 1999. Plant-mediated transformation of perchlorate into chloride. *Environ Sci Technol* 33:1470-1478.
- Okamoto HS, Rishi DK, Steeber WR, et al. 1999. Using ion chromatography to detect perchlorate. *J Am Water Works Assoc* 91(10):73-84.
- O'Neil MJ, ed. 2001. The Merck index. 13th ed. Whitehouse Station, NJ: Merck & Co., Inc., 92, 992, 1017, 1371, 1545.
- O'Neill B, Magnolato D, Semenza G. 1987. The electrogenic, Na<sup>+</sup>-dependent I<sup>-</sup> transport system in plasma membrane vesicles from thyroid glands. *Biochim Biophys Acta* 896:263-274.
- Oppenheimer JH, Schwartz HL. 1997. Molecular basis of thyroid hormone-dependent brain development. *Endocrine Rev* 18(4):462-475.
- Ortiz-Caro J, Pastor RM, Jolin T. 1983. Effects of KClO<sub>4</sub> in propylthiouracil-hypothyroid rats. *Acta Endocrinol* 103:81-87.
- \*OSHA. 2005a. Safety and health regulations for construction. List of highly hazardous chemicals, toxics and reactives. Appendix A. Occupational Safety and Health Administration. Code of Federal Regulations. 29 CFR 1926.64.
- \*OSHA. 2005b. Occupational safety and health standards. List of highly hazardous chemicals, toxic and reactives. Appendix A. Occupational Safety and Health Administration. Code of Federal Regulations. 29 CFR 1910.119.
- OSHA. 2005c. Gases, vapors, fumes, dusts, and mists. Safety and health regulations for construction. Occupational Safety and Health Administration. Code of Federal Regulations. 29 CFR 1926.64, Appendix A. <http://www.osha.gov/comp-links.html>. June 24, 2005.
- OSHA. 2005d. Highly hazardous chemicals. Occupational safety and health standards. Code of Federal Regulations. 29 CFR 1910.119, Appendix A. <http://www.osha.gov/comp-links.html>. February 16, 2005.
- Owen GM, Brozek J. 1966. Influence of age, sex and nutrition on body composition during childhood and adolescence. In: Falkner F, ed. Human development. Philadelphia, PA: WB Saunders, 222-238.
- PADLI. 2007. Hazardous substance lists. Harrisburg, PA: Pennsylvania Department of Labor and Industry. Title 34, Chapter 323, Appendix A. <http://chemcite.bna.com/chlw4/hm/151/hm>. February 06, 2008.

## 9. REFERENCES

- Pajer Z, Kalisnik M. 1991. The effect of sodium perchlorate and ionizing irradiation on the thyroid parenchymal and pituitary thyrotropic cells. *Oncology* 48:317-320.
- Papini MP, Majone M. 1997. Experimental investigation of transport of strongly retained species by soil columns. *Water Air Soil Pollut* 95:337-351.
- Paulus BF, Bazar MA, Salice CJ, et al. 2007. Perchlorate inhibition of iodide uptake in normal and iodine-deficient rats. *J Toxicol Environ Health A* 70(13):1142-1149.
- Pearce EN, Leung AM, Blount BC, et al. 2007. Breast milk iodine and perchlorate concentrations in lactating Boston-area women. *J Clin Endocrine Metab* 92:1673-1677.
- Perron B, Rodriguez A-M, Leblanc G, et al. 2001. Cloning of the mouse sodium iodide symporter and its expression in the mammary gland and other tissues. *J Endocrinol* 170:185-196.
- Pintar JE. 2000. Normal development of the hypothalamic-pituitary-thyroid axis. In: Braverman LE, Utiger RD, eds. *Werner and Ingbar's the thyroid: A fundamental and clinical text*. 8th ed. Philadelphia, PA: Lippincott Williams & Wilkins, 7-19.
- Plummer IN, Bohlke JK, Doughten MW. 2006. Perchlorate in Pleistocene and Holocene groundwater in north-central New Mexico. *Environ Sci Technol* 40:1757-1763.
- Polesello S, Valsecchi S, Cavalli S, et al. 2001. Ion-chromatographic screening method for monitoring arsenate and other anionic pollutants in ground waters of Northern Italy. *J Chromatogr A* 920:231-238.
- Pop VJ, Kuijpenst JL, van Baar AL, et al. 1999. Low maternal free thyroxine concentrations during early pregnancy are associated with impaired psychomotor development in infancy. *Clin Endocrin* 50:149-155.
- \*Poredos P. 1981. The dependence of the microstructure of the rat's thyroid gland on the TSH. *Stereol Jugosl* 3(Supp 1):577-583.
- Porterfield SP, Hendrich CE. 1993. The role of thyroid hormones in prenatal and neonatal neurological development-current perspectives. *Endocrine Rev* 14(1):94-106.
- Postel S. 1957. Placental transfer of perchlorate and triiodothyronine in the guinea pig. *Endocrinology* 60:53-66.
- Puls RW, Powell RM. 1992. Transport of inorganic colloids through natural aquifer material: implications for contaminant transport. *Environ Sci Technol* 26:614-621.
- Rajagopalan S, Anderson TA, Fahlquist L, et al. 2006. Widespread presence of naturally occurring perchlorate in high plains of Texas and New Mexico. *Environ Sci Technol* 40:3156-3162.
- Renner R. 2005. Atmospheric processes may create perchlorate. *Environ Sci Technol* 39(6):120A.
- Rice CP, Baldwin RL, Abbott LC. 2007. Predicting perchlorate exposure in milk from concentrations in dairy feed. *J Agric Food Chem* 55(21):8806-8813.
- RIDL. 2007. Hazardous substance list. Cranston, RI: Rhode Island Department of Labor and Training. <http://chemcite.bna.com/chlw4/hm/617.htm>. February 06, 2008.

## 9. REFERENCES

- Rillema JA, Rowady DL. 1997. Characteristics of the prolactin stimulation of iodide uptake in mouse mammary gland explants. *Proc Soc Exp Biol Med* 215:366-369.
- Rillema JA, Yu TX, Jhiang SM. 2000. Effect of prolactin on sodium iodide symporter expression in mouse mammary gland explants. *Am J Physiol Endocrinol Metab* 279:E769-E772.
- Robbins J. 2000. Thyroid hormone transport proteins and the physiology of hormone binding. In: Braverman LE, Utiger RD, eds. *Werner and Ingbar's the thyroid: A fundamental and clinical text*. 8th ed. Philadelphia, PA: Lippincott Williams & Wilkins, 105-120.
- Rodriguez AF, Davidson HG, Villadiego MS, et al. 1991. Induction of thyroid proliferative changes in rats treated with antithyroid compound. *Anat Histol Embryol* 20:289-298.
- Rovet J, Ehrlich R, Sorbara D. 1987. Intellectual outcome in children with fetal hypothyroidism. *J Pediatr* 110(5):700-704.
- San RHC, Clarke JJ. 1999. *In vitro* mammalian cell gene mutation test (L5178Y/TK+/- mouse lymphoma assay). Rockville, MD: Perchlorate Study Group. BioReliance Study Number G98BAO6.702.
- Sanchez CA, Blount BC, Valentin-Blasini L, et al. 2007. Perchlorate, thiocyanate, and nitrate in edible cole crops (*Brassica* sp.) produced in the lower Colorado River region. *Bull Environ Contam Toxicol* 79:655-659.
- Sanchez CA, Crump KS, Krieger RI, et al. 2005a. Perchlorate and nitrate in leafy vegetables of North America. *Environ Sci Technol* 39(24):8381-9397.
- Sanchez CA, Krieger RI, Khandaker N, et al. 2005b. Accumulation and perchlorate exposure potential of lettuce produced in the lower Colorado River region. *J Agric Food Chem* 53(13):5479-5486.
- Sanchez CA, Krieger RI, Khandaker N, et al. 2006. Potential perchlorate exposure from *Citrus* sp. Irrigated with contaminated water. *Anal Chim Acta* 567:33-38.
- Sangan P, Motlag DB. 1986. Activities of aldolase, lactate dehydrogenase, glucose-6-phosphatase, and arginase in perchlorate toxicity. *Curr Sci* 55:1238-1240.
- Sangan P, Motlag DB. 1987. Glycogen metabolism in liver in perchlorate-treated rats. *Curr Sci* 56:88-90.
- Sato E, Nakashima T, Miura Y, et al. 2001. Phenotypes associated with replacement of His723 by Arg in the Pendred syndrome gene. *Eur J Endocrinol* 145:697-703.
- Scanlon MF, Toft AD. 2000. Regulation of thyrotropin secretion. In: Braverman LE, Utiger RD, eds. *Werner and Ingbar's the thyroid: A fundamental and clinical text*. 8th ed. Philadelphia, PA: Lippincott Williams & Wilkins, 234-253.
- Scatchard G, Black ES. 1949. The effect of salts on the isoionic and isoelectric points of proteins. *J Phys Colloid Chem* 53:88-99.

## 9. REFERENCES

- Scheffee RS, Wheatley BK. 1999. Ammonium perchlorate-based gas generator compositions containing chlorine scavengers for inflation of air bags. Patent # 5,861,571.
- Scheuplein RJ, Bronaugh RL. 1983. Percutaneous absorption. In: Goldsmith LA, ed. Biochemistry and physiology of the skin. New York, NY: Oxford University Press, 1255-1295.
- Schilt AA. 1979. Preparation and properties of perchloric acid. Perchloric acid and perchlorates. Columbus, Ohio: The G. Frederick Smith Chemical Company, 9-63.
- Schonbaum E, Sellers EA, Gill MJ. 1965. Some effects of perchlorate on the distribution of <sup>131</sup>I-iodide. *Acta Endocrinol* 50:195-201.
- Schröder-van der Elst JP, van der Heide D, Kasteljin J, et al. 2001. The expression of sodium/iodide symporter is up-regulated in the thyroid of fetuses of iodine-deficient rats. *Endocrinology* 142:3736-3741.
- Schwartz HL, Lazar MA, Oppenheimer JH. 1994. Widespread distribution of immunoreactive thyroid hormone [B]<sub>2</sub> receptor (TR[B]<sub>2</sub>) in the nuclei of extrapituitary rat tissues. *J Biol Chem* 269(40):24777-24782.
- Schwartz J. 2001. Gestational exposure to perchlorate is associated with measures of decreased thyroid function in a population of California neonates. Thesis. Berkely, CA: University of California.
- Scinicariello F, Murray HE, Smith L, et al. 2005. Genetic factors that might lead to different responses in individuals exposed to perchlorate. *Environ Health Perspect* 113(11):1479-1484.
- Selivanova LN, Vorobieva EN. 1969. [Toxicology of ammonium perchlorate during repeated action on the organism.] *Farmakol Toksikol* 32:480-482. (Russian)
- Selivanova LN, Boltromeyuk LP, Arefeva ZS, et al. 1986. [Dynamics of the absorption and elimination of perchloric acid salts in laboratory animals and livestock.] *Khim Selsk Khoz* 106(5):43-45. (Russian)
- SERDP. 2005. Alternative causes of wide-spread, low concentration perchlorate impacts to groundwater. Strategic Environmental Research and Development Program. Department of Defense. ADA. <http://stinet.dtic.mil/cgi-bin/GetTRDoc?AD=ADA435950&Location=U2&doc=GetTRDoc.pdf>. February 12, 2008.
- Setchell BP, Waites GMH. 1975. The blood-testis barrier. In: Creep RO, Astwood EB, Geiger SR, eds. Handbook of physiology: Endocrinology V. Washington, DC: American Physiological Society, 143-172.
- Shen DHY, Kloos RT, Mazzaferri EL, et al. 2001. Sodium iodide symporter in health and disease. *Thyroid* 11(5):415-425.
- Shevtsova NM, Kozlov IA, Novitskii VV. 1994. [Mechanism of hematopoietic disorders in primary experimental hypothyroidism.] *Patol Fiziol Eksp Ter* Jan-Mar 1994(1):14-16. (Russian)
- Shimura H, Haraguchi K, Miyazaki A, et al. 1997. Iodide uptake and experimental <sup>131</sup>I therapy in transplanted undifferentiated thyroid cancer cells expressing the Na<sup>+</sup>/I<sup>-</sup> symporter gene. *Endocrinology* 138(10):4493-4496.

## 9. REFERENCES

- SI/EPA. 2008. Perchlorates. The Science Inventory. U.S. Environmental Protection Agency. <http://cfpub.epa.gov/si/>. February 6, 2008.
- Siglin JC, Mattie DR, Dodd DE, et al. 2000. A 90-day drinking water toxicity study in rats of the environmental contaminant ammonium perchlorate. *Toxicol Sci* 57:61-74.
- Silva JE, Matthews PS. 1984. Production rates and turnover of triiodothyronine in rat-developing cerebral cortex and cerebellum. *J Clin Invest* 74:1035-1049.
- Singh G, Kapoor IPS, Mannan SM, et al. 2000. Studies on energetic compounds part 8: Thermolysis of salts of HNO<sub>3</sub> and HClO<sub>4</sub>. *J Hazard Mater A79*(1-2):1-18.
- Smanik PA, Liu Q, Furminger TL, et al. 1996. Cloning of the human sodium iodide symporter. *Biochem Biophys Res Commun* 226:339-345.
- Smanik PA, Ryu K, Theil KS, et al. 1997. Expression, exon-intron organization, and chromosome mapping of the human sodium iodide symporter. *Endocrinology* 138(8):3555-3558.
- Smith PN, Lu Y, McMurry ST, et al. 2004. Perchlorate in water, soil, vegetation, and rodents collected from the Las Vegas Wash, Nevada, USA. *Environ Pollut* 132(1):121-127.
- Smith PN, Theodorakis CW, Anderson TA, et al. 2001. Preliminary assessment of perchlorate in ecological receptors at the Longhorn Army ammunition plant (LHAAP), Karnack, Texas. *Ecotoxicology* 10:305-313.
- Snyder SA, Pleus RC, Vanderford BJ, et al. 2006. Perchlorate and chlorate in dietary supplements and flavor enhancing ingredients. *Anal Chim Acta* 567:26-32.
- Snyder SA, Vanderford BJ, Rexing DJ. 2005. Trace analysis of bromate, chlorate, iodate, and perchlorate in natural and bottled waters. *Environ Sci Technol* 39(12):4586-4593.
- Soldin OP, Braverman LE, Lamm SH. 2001. Perchlorate clinical pharmacology and human health: A review. *Ther Drug Monit* 23:316-331.
- Southwell N, Randall K. 1960. Potassium perchlorate in thyrotoxicosis. *Lancet* 1:653-654.
- Spaulding SW. 2000. Biological actions of thyrotropin. In: Braverman LE, Utiger RD, eds. *Werner and Ingbar's the thyroid: A fundamental and clinical text*. 8th ed. Philadelphia, PA: Lippincott Williams & Wilkins, 227-233.
- Spaulding SW, Burrow GN, Bermudez F, et al. 1972. The inhibitory effect of lithium on thyroid hormone release in both euthyroid and thyrotoxic patients. *J Clin Endocrinol Metab* 35:905-911.
- \*Spitzweg C, Joba W, Eisenmenger W. 1998. Analysis of human sodium iodide symporter gene expression in extrathyroid tissues and cloning of its complementary deoxyribonucleic acids from salivary gland, mammary gland, and gastric mucosa. *J Clin Endocrinol* 83(5):1746-1751.
- Spitzweg C, Joba W, Morris JC, et al. 1999. Regulation of sodium iodide symporter gene expression in FRTL-5 rat thyroid cells. *Thyroid* 9(8):65-69.



## 9. REFERENCES

- Sposito G, Traina SJ. 1987. An ion-association model for highly saline, sodium chloride-dominated waters. *J Environ Qual* 16:80-85.
- Spreca A, Musy JP. 1974. Comportement des mastocytes chez les rats traites au perchlorate de potassium. *Experientia* 30(3):278-279.
- \*Spreca A, Laszlo M, Musy JP. 1973. [Biochemical study of various mucopolysaccharide constituents and glycoproteins of serum and of several organs of rats treated with potassium perchlorate.] *Pharm Acta Helv* 48:297-306. (French)
- SRI. 2007. Directory of chemical producers: United States of America. Menlo Park, CA: SRI Consulting, 46, 47, 178, 179, 426.
- Stanbury JB, Wyngaarden JB. 1952. Effect of perchlorate on the human thyroid gland. *Metabolism* 1:533-539.
- Stiefel EI. 1995. Molybdenum compounds. In: Kroschwitz JJ, Howe-Grant M, eds. *Kirk-Othmer encyclopedia of chemical technology*. New York, NY: John Wiley & Sons, 957, 962.
- Stockigt JR. 2000. Serum thyrotropin and thyroid hormone measurements and assessment of thyroid hormone transport. In: Braverman LE, Utiger RD, eds. *Werner and Ingbar's the thyroid: A fundamental and clinical text*. 8th ed. Philadelphia, PA: Lippincott Williams & Wilkins, 376-392.
- Sundberg SE, Ellington JJ, Evans JJ, et al. 2003. Accumulation of perchlorate in tobacco plants: Development of a plant kinetic model. *J Environ Monit* 5:505-512.
- Sunar O. 1963. Case report—Agranulocytosis associated with potassium perchlorate treatment. *J Laryngol Otol* 77:353-355.
- Susarla S, Collette TW, Garrison AW, et al. 1999. Perchlorate identification in fertilizers. *Environ Sci Technol* 33(19):3469-3472.
- Susarla S, Collette TW, Garrison AW, et al. 2000. Additions and corrections; perchlorate identification in fertilizers. *Environ Sci Technol* 34(1):224.
- Sztanyik LB, Turai I. 1988. Modification of radioiodine incorporation in the fetus and newborn rats by the thyroid blocking agents. *Acta Phys Hungaria* 72:343-354.
- Tan K, Anderson TA, Jackson WA. 2005. Temporal and spatial variation of perchlorate in streambed sediments: Results from in-situ dialysis samplers. *Environ Pollut* 136(2):283-291.
- Tan K, Jackson WA, Anderson TA. 2004b. Fate of perchlorate-contaminated water in upflow wetlands. *Water Res* 38(19):4173-4185.
- Tarin-Remohi MJ, Jolin T. 1972. [Effects of corticoid and adrenalectomy on thyroid weight of rats treated with goitrogens.] *Rev Esp Fisiol* 28:1-12. (Spanish)
- Taurog A. 2000. Hormone synthesis: Thyroid iodine metabolism. In: Braverman LE, Utiger RD, eds. *Werner and Ingbar's the thyroid: A fundamental and clinical text*. 8th ed. Philadelphia, PA: Lippincott Williams & Wilkins, 61-84.

## 9. REFERENCES

- Téllez RT, Chacon PM, Abarca CR, et al. 2005. Long-term environmental exposure to perchlorate through drinking water and thyroid function during pregnancy and the neonatal period. *Thyroid* 15(9):963-975.
- Theodorakis C, Rinchar J, Anderson T, et al. 2006. Perchlorate in fish from a contaminated site in east-central Texas. *Environ Pollut* 139:59-69.
- Thomas K, Colborn T. 1992. Organochlorine endocrine disruptors in human tissue. In: Colborn T, Clement C, eds. *Chemically induced alterations in sexual and functional development: The wildlife/human connection*. Princeton, NJ: Princeton Scientific Publishing, 365-394.
- Thorpe-Beeston JG, Nicolaides KH, Felton CV, et al. 1991. Maturation of the secretion of thyroid hormone and thyroid-stimulating hormone in the fetus. *N Engl J Med* 324:532-536.
- Tian K, Dasgupta PK, Anderson TA. 2003. Determination of trace perchlorate in high-salinity water samples by ion chromatography with on-line preconcentration and preelution. *Anal Chem* 75(3):701-706.
- Tikkanen MW. 2006. Development of a drinking water regulation for perchlorate in California. *Anal Chim Acta* 567:20-25.
- Tipton DK, Rolston DE, Scow KM. 2003. Bioremediation and biodegradation: Transport and biodegradation of perchlorate in soils. *J Environ Qual* 32(1):40-46.
- Tollenaar H, Martin C. 1972. Perchlorate in Chilean nitrate as the cause of leaf rugosity in soybean plants in Chile. *Phytopathology* 62:1164-1166.
- Tonacchera M, Pinchera A, Dimida A, et al. 2004. Relative potencies and additivity of perchlorate, thiocyanate, nitrate, and iodide on the inhibition of radioactive iodide uptake by the human sodium iodide symporter. *Thyroid* 14(12):1012-1019.
- Toro Guillen M. 1991. [Reversibility of proliferative thyroid lesions.] *Diss Abstr Int C* 54:1186. (Spanish)
- Tran N, Valentín-Blasini, Blount BC, et al. 2008. Thyroid-stimulating hormone increases active transport of perchlorate into thyroid cells. *Am J Physiol Endocrinol Metab* 294:E802-E806.
- TRI05. 2007. TRI explorer: Providing access to EPA's toxics release inventory data. Washington, DC: Office of Information Analysis and Access. Office of Environmental Information. U.S. Environmental Protection Agency. Toxics Release Inventory. <http://www.epa.gov/triexplorer/>. July 6, 2007.
- Urbansky ET. 1998. Perchlorate chemistry: Implications for analysis and remediation. *Biorem J* 2(2):81-95.
- Urbansky ET. 2000. Quantitation of perchlorate ion: Practices and advances applied to the analysis of common matrices. *Crit Rev Anal Chem* 30(4):311-343.
- Urbansky ET. 2002. Perchlorate as an environmental contaminant. *Environ Sci Pollut Res Int* 9(3):187-192.
- Urbansky ET, Brown SK. 2003. Perchlorate retention and mobility in soils. *J Environ Monit* 5:455-462.

## 9. REFERENCES

- Urbansky ET, Collette TW. 2001. Comparison and evaluation of laboratory performance on a method for the determination of perchlorate in fertilizers. *J Environ Monitor* 3(5):454-462.
- Urbansky ET, Brown SK, Magnuson ML, et al. 2001. Perchlorate levels in samples of sodium nitrate fertilizer derived from Chilean caliche. *Environ Pollut* 112(3):299-302.
- Urbansky ET, Gu B, Magnuson ML, et al. 2000a. Survey of bottled waters for perchlorates by electrospray ionization mass spectrometry (ESI-MS) and ion chromatography. *J Sci Food Agric* 80(12):1798-1804.
- Urbansky ET, Magnuson ML, Kelty CA, et al. 2000b. Comment on "perchlorate identification in fertilizers" and the subsequent addition/correction. *Environ Sci Technol* 34(20):4452-4453.
- Urbansky ET, Magnuson ML, Kelty CA, et al. 2000c. Perchlorate uptake by salt cedar (*Tamarix ramosissima*) in the Las Vegas Wash riparian ecosystem. *Sci Total Environ* 256:227-232.
- U.S. Air Force Space Missile Systems Center. 2002. Biological effects of inadvertent perchlorate releases during launch operations. Los Angeles Air Force Base, CA: U.S. Air Force Space Missile Systems Center, Environmental Management Branch. ADA414070.
- U.S. Army Corp of Engineers. 2004. Field screening method for perchlorate in water and soil. Hanover, NH: U.S. Army Corp of Engineers.
- U.S. Census Bureau. 1999. Census bureau facts for features: Fireworks. June 25, 1998. <http://www.census.gov/Press-Release/ff98-08.html>.
- USITC. 2008. United States International Trade Commission. <http://dataweb.usitc.gov/>. February 11, 2008.
- Uyttersprot N, Pelgrims N, Carrasco N, et al. 1997. Moderate doses of iodide *in vivo* inhibit cell proliferation and the expression of thyroperoxidase and Na<sup>+</sup>/I<sup>-</sup> symporter mRNAs in dog thyroid. *Mol Cell Endocrinol* 131:195-203.
- Valentín-Blasini L, Mauldin JP, Maple D, et al. 2005. Analysis of perchlorate in human urine using ion chromatography and electrospray tandem mass spectrometry. *Anal Chem* 77(8):2475-2481.
- van Aken B, Schnoor JL. 2002. Evidence of perchlorate (C104) reduction in plant tissues (Poplar Tree) using radio-labeled 36C104. *Environ Sci Technol* 36(12):2783-2788.
- Vanderpump MPJ, Tunbridge WMG. 1996. The epidemiology of thyroid diseases. In: Braverman LE, Utiger RD, eds. *Werner and Ingbar's the thyroid: A fundamental and clinical text*. 8th ed. Philadelphia, PA: Lippincott Williams & Wilkins, 474-482.
- Van Sande J, Massart C, Beauwens, et al. 2003. Anion selectivity by the sodium iodide symporter. *Endocrinology* 144:247-252.
- van Vliet G. 1999. Merck AG thyroid symposium. *Thyroid* 9(1):79-84.
- Vieira I, Sonnier M, Cresteil T. 1996. Developmental expression of CYP2E1 in the human liver: Hypermethylation control of gene expression during the neonatal period. *Eur J Biochem* 238:476-483.

## 9. REFERENCES

- Vijayalakshmi K, Motlag DB. 1989a. Effect of perchlorate on plasma and tissue lipid pattern in rats. *J Health Sci* 15:72-75.
- Vijayalakshmi K, Motlag DB. 1989b. Lipoprotein profile during perchlorate toxicity. *Indian J Biochem Biophys* 26:273-274.
- Vijayalakshmi K, Motlag DB. 1990. Effect of perchlorate on mitochondrial function. *Indian J Biochem Biophys* 27(1):48-51.
- Vijayalakshmi K, Motlag DB. 1992. Biochemical changes in mitochondria during chronic perchlorate toxicity. *J Environ Biol* 13:149-158.
- Vogt H, Balej J, Bennett JE, et al. 1986. Chlorine oxides and chlorine oxygen acids. In: Gerhartz W, Yamamoto YS, Campbell FT, et al., eds. *Ullmann's encyclopedia of industrial chemistry*, Vol. A6. New York, NY: VCH Publishers, 483-525.
- Vogt H, Balej J, Bennett JE, et al. 2005. Chlorine oxides and chlorine oxygen acids. *Ullmann's encyclopedia of industrial chemistry*.  
[http://www.mrw.interscience.wiley.com/emrw/9783527306732/ueic/article/a06\\_483/current/pdf](http://www.mrw.interscience.wiley.com/emrw/9783527306732/ueic/article/a06_483/current/pdf).  
November 27, 2007.
- Von Burg R. 1995. Perchlorates. *J Appl Toxicol* 15:237-241.
- Vroye L, Beauwens R, Van Sande J, et al. 1998. The Na<sup>+</sup>-I<sup>-</sup> cotransporter of the thyroid: characterisation of new inhibitors. *Pflugers Arch (Eur J Physiol)* 435:259-266.
- Vulsma T, Gons MH, De Vijlder JJM. 1989. Maternal-fetal transfer of thyroxine in congenital hypothyroidism due to a total organification defect or thyroid agenesis. *N Engl J Med* 321:13-16.
- Weber A, Wolf J. 1969. [Nephrotic syndrome during thyreostatic treatment with sodium perchlorate.] *Munch Med Wochenschr* 111:2274-2275. (German)
- Weetman AP. 2000. Chronic autoimmune thyroiditis. In: Braverman LE, Utiger RD, eds. *Werner and Ingbar's the thyroid: A fundamental and clinical text*. Philadelphia, PA: Lippincott Williams & Wilkins, 721-732.
- Weiss SJ, Philp NJ, Grollman EF. 1984b. Effect of thyrotropin on iodide efflux in FRTL-5 cells mediated by Ca<sup>+2</sup>. *Endocrinology* 114:1108-1113.
- West JR, Smith HW, Chasis H. 1948. Glomerular filtration rate, effective renal blood flow, and maximal tubular excretory capacity in infancy. *J Pediatr* 32:10-18.
- WHO. 2000. Air quality guidelines. 2nd edition. World Health Organization. Geneva, Switzerland. [http://www.euro.who.int/air/Activities/20050104\\_1](http://www.euro.who.int/air/Activities/20050104_1). February 15, 2005.
- WHO. 2004. Guidelines for drinking-water quality. 3rd edition. World Health Organization. Geneva, Switzerland. [http://www.who.int/water\\_sanitation\\_health/dwq/gdwq3/en/](http://www.who.int/water_sanitation_health/dwq/gdwq3/en/). February 15, 2005.
- Widdowson EM, Dickerson JWT. 1964. Chemical composition of the body. In: Comar CL, Bronner F, eds. *Mineral metabolism: An advanced treatise*. Volume II: The elements Part A. New York: Academic Press.

## 9. REFERENCES

- Wilkin RT, Fine DD, Burnett NG. 2007. Perchlorate behavior in a municipal lake following fireworks display. *Environ Sci Technol* 41(11):3966-3971.
- Winkler P, Minter M, Willey J. 2004. Analysis of perchlorate in water and soil by electrospray LC/MS/MS. *Anal Chem* 76(2):469-473.
- Wolff J. 1964. Transport of iodide and other anions in the thyroid gland. *Physiol Rev* 44:45-90.
- Wolff J. 1998. Perchlorate and the thyroid gland. *Pharmacol Rev* 50(1):89-105.
- Wolff J, Maurey JR. 1962. Thyroidal iodide transport III. Comparison of iodide with anions of periodic group VIIA. *Biochim Biophys Acta* 57:422-426.
- Wolff J, Maurey JR. 1963. Thyroidal iodide transport IV. The role of ion size. *Biochim Biophys Acta* 69:48-58.
- Wolter R, Noël P, DeCock P, et al. 1979. Neuropsychological study in treated thyroid dysgenesis. *Acta Paediatr Scand Suppl* 227:41-46.
- Wyngaarden JB, Wright BM, Ways P. 1952. The effect of certain anions upon the accumulation and retention of iodide by the thyroid gland. *Endocrinology* 50:537-549.
- \*Yamada T. 1967. Effects of perchlorate and other anions on thyroxine metabolism in the rat. *Endocrinology* 81(6):1285-1290.
- York RG, Barnett J, Brown WR, et al. 2004. A rat neurodevelopmental evaluation of offspring, including evaluation of adult and neonatal thyroid, from mothers treated with ammonium perchlorate in drinking water. *Int J Toxicol* 23:191-214.
- York RG, Barnett J, Girard MF, et al. 2005b. Refining the effects observed in a developmental neurobehavioral study of ammonium perchlorate administered orally in drinking water to rats. II. Behavioral and neurodevelopment effects. *Int J Toxicol* 24(6):451-467.
- York RG, Brown WR, Girard MF, et al. 2001a. Two-generation reproduction study of ammonium perchlorate in drinking water in rats evaluates thyroid toxicity. *Int J Toxicol* 20(4):183-197.
- York RG, Brown WR, Girard MF, et al. 2001b. Oral (drinking water) developmental toxicity study of ammonium perchlorate in New Zealand white rabbits. *Int J Toxicol* 20(4):199-205.
- York RG, Funk KA, Girard MF, et al. 2003. Oral (drinking water) developmental toxicity study of ammonium perchlorate in Sprague-Dawley rats. *Int J Toxicol* 22(6):453-464.
- York RG, Lewis E, Brown WR, et al. 2005a. Refining the effects observed in a developmental neurobehavioral study of ammonium perchlorate administered orally in drinking water to rats. I. Thyroid and reproductive effects. *Int J Toxicol* 24(6):403-418.
- Yoshida A, Sasaki N, Mori A, et al. 1997. Different electrophysiological character of I<sup>-</sup>, ClO<sub>4</sub><sup>-</sup>, and SCN<sup>-</sup> in the transport by Na<sup>+</sup>/I<sup>-</sup> symporter. *Biochem Biophys Res Commun* 231:731-734.

## 9. REFERENCES

- Yu KO, Narayanan L, Mattie DR, et al. 2002. The pharmacokinetics of perchlorate and its effect on the hypothalamus-pituitary-thyroid axis in the male rat. *Toxicol Appl Pharmacol* 182(2):148-159.
- Yu L, Canas JE, Cobb GP, et al. 2004. Uptake of perchlorate in terrestrial plants. *Ecotoxicol Environ Saf* 58(1):44-49.
- Zeiger E. 1998a. Salmonella mutagenicity testing of ammonium perchlorate [memorandum with attachment to Annie Jarabek]. Research Triangle Park, NC: U.S. Department of Health and Human Services, National Institute of Environmental Health Services.
- Zeiger E. 1998b. Ammonium perchlorate MN test results [memorandum with attachment to Annie Jarabek]. Research Triangle Park, NC: U.S. Department of Health and Human Services, National Institute of Environmental Health Services.
- Zhang Z, Else T, Amy P, et al. 2002. Evaluation of in situ biodegradation of perchlorate in a contaminated site. In: Leeson A, ed. *International in situ on-site bioremediation symposium*. 6th ed. Columbus, OH: Batelle Press, 257-263.
- Ziegler EE, Edwards BB, Jensen RL, et al. 1978. Absorption and retention of lead by infants. *Pediatr Res* 12:29-34.
- Zoeller RT. 2006. Collision of basic and applied approaches to risk assessment of thyroid toxicants. *Ann NY Acad Sci* 1076:169-170.
- Zoeller RT, Crofton KM. 2000. Thyroid hormone action in fetal brain development and potential for disruption by environmental chemicals. *Neurotoxicology* 21(6):935-946.
- Zoeller RT, Rovet J. 2004. Timing of thyroid hormone action in the developing brain: Clinical observations and experimental findings. *J Neuroendocrinol* 16:809-818.

## 10. GLOSSARY

**Absorption**—The taking up of liquids by solids, or of gases by solids or liquids.

**Acute Exposure**—Exposure to a chemical for a duration of 14 days or less, as specified in the Toxicological Profiles.

**Adsorption**—The adhesion in an extremely thin layer of molecules (as of gases, solutes, or liquids) to the surfaces of solid bodies or liquids with which they are in contact.

**Adsorption Coefficient ( $K_{oc}$ )**—The ratio of the amount of a chemical adsorbed per unit weight of organic carbon in the soil or sediment to the concentration of the chemical in solution at equilibrium.

**Adsorption Ratio ( $K_d$ )**—The amount of a chemical adsorbed by sediment or soil (i.e., the solid phase) divided by the amount of chemical in the solution phase, which is in equilibrium with the solid phase, at a fixed solid/solution ratio. It is generally expressed in micrograms of chemical sorbed per gram of soil or sediment.

**Benchmark Dose (BMD)**—Usually defined as the lower confidence limit on the dose that produces a specified magnitude of changes in a specified adverse response. For example, a  $BMD_{10}$  would be the dose at the 95% lower confidence limit on a 10% response, and the benchmark response (BMR) would be 10%. The BMD is determined by modeling the dose response curve in the region of the dose response relationship where biologically observable data are feasible.

**Benchmark Dose Model**—A statistical dose-response model applied to either experimental toxicological or epidemiological data to calculate a BMD.

**Bioconcentration Factor (BCF)**—The quotient of the concentration of a chemical in aquatic organisms at a specific time or during a discrete time period of exposure divided by the concentration in the surrounding water at the same time or during the same period.

**Biomarkers**—Broadly defined as indicators signaling events in biologic systems or samples. They have been classified as markers of exposure, markers of effect, and markers of susceptibility.

**Cancer Effect Level (CEL)**—The lowest dose of chemical in a study, or group of studies, that produces significant increases in the incidence of cancer (or tumors) between the exposed population and its appropriate control.

**Carcinogen**—A chemical capable of inducing cancer.

**Case-Control Study**—A type of epidemiological study that examines the relationship between a particular outcome (disease or condition) and a variety of potential causative agents (such as toxic chemicals). In a case-controlled study, a group of people with a specified and well-defined outcome is identified and compared to a similar group of people without outcome.

**Case Report**—Describes a single individual with a particular disease or exposure. These may suggest some potential topics for scientific research, but are not actual research studies.

**Case Series**—Describes the experience of a small number of individuals with the same disease or exposure. These may suggest potential topics for scientific research, but are not actual research studies.

## 10. GLOSSARY

**Ceiling Value**—A concentration of a substance that should not be exceeded, even instantaneously.

**Chronic Exposure**—Exposure to a chemical for 365 days or more, as specified in the Toxicological Profiles.

**Cohort Study**—A type of epidemiological study of a specific group or groups of people who have had a common insult (e.g., exposure to an agent suspected of causing disease or a common disease) and are followed forward from exposure to outcome. At least one exposed group is compared to one unexposed group.

**Cross-sectional Study**—A type of epidemiological study of a group or groups of people that examines the relationship between exposure and outcome to a chemical or to chemicals at one point in time.

**Data Needs**—Substance-specific informational needs that if met would reduce the uncertainties of human health assessment.

**Developmental Toxicity**—The occurrence of adverse effects on the developing organism that may result from exposure to a chemical prior to conception (either parent), during prenatal development, or postnatally to the time of sexual maturation. Adverse developmental effects may be detected at any point in the life span of the organism.

**Dose-Response Relationship**—The quantitative relationship between the amount of exposure to a toxicant and the incidence of the adverse effects.

**Embryotoxicity and Fetotoxicity**—Any toxic effect on the conceptus as a result of prenatal exposure to a chemical; the distinguishing feature between the two terms is the stage of development during which the insult occurs. The terms, as used here, include malformations and variations, altered growth, and *in utero* death.

**Environmental Protection Agency (EPA) Health Advisory**—An estimate of acceptable drinking water levels for a chemical substance based on health effects information. A health advisory is not a legally enforceable federal standard, but serves as technical guidance to assist federal, state, and local officials.

**Epidemiology**—Refers to the investigation of factors that determine the frequency and distribution of disease or other health-related conditions within a defined human population during a specified period.

**Genotoxicity**—A specific adverse effect on the genome of living cells that, upon the duplication of affected cells, can be expressed as a mutagenic, clastogenic, or carcinogenic event because of specific alteration of the molecular structure of the genome.

**Half-life**—A measure of rate for the time required to eliminate one half of a quantity of a chemical from the body or environmental media.

**Immediately Dangerous to Life or Health (IDLH)**—The maximum environmental concentration of a contaminant from which one could escape within 30 minutes without any escape-impairing symptoms or irreversible health effects.

**Immunologic Toxicity**—The occurrence of adverse effects on the immune system that may result from exposure to environmental agents such as chemicals.



## 10. GLOSSARY

**Immunological Effects**—Functional changes in the immune response.

**Incidence**—The ratio of individuals in a population who develop a specified condition to the total number of individuals in that population who could have developed that condition in a specified time period.

**Intermediate Exposure**—Exposure to a chemical for a duration of 15–364 days, as specified in the Toxicological Profiles.

**In Vitro**—Isolated from the living organism and artificially maintained, as in a test tube.

**In Vivo**—Occurring within the living organism.

**Lethal Concentration<sub>(LO)</sub> (LC<sub>LO</sub>)**—The lowest concentration of a chemical in air that has been reported to have caused death in humans or animals.

**Lethal Concentration<sub>(50)</sub> (LC<sub>50</sub>)**—A calculated concentration of a chemical in air to which exposure for a specific length of time is expected to cause death in 50% of a defined experimental animal population.

**Lethal Dose<sub>(LO)</sub> (LD<sub>LO</sub>)**—The lowest dose of a chemical introduced by a route other than inhalation that has been reported to have caused death in humans or animals.

**Lethal Dose<sub>(50)</sub> (LD<sub>50</sub>)**—The dose of a chemical that has been calculated to cause death in 50% of a defined experimental animal population.

**Lethal Time<sub>(50)</sub> (LT<sub>50</sub>)**—A calculated period of time within which a specific concentration of a chemical is expected to cause death in 50% of a defined experimental animal population.

**Lowest-Observed-Adverse-Effect Level (LOAEL)**—The lowest exposure level of chemical in a study, or group of studies, that produces statistically or biologically significant increases in frequency or severity of adverse effects between the exposed population and its appropriate control.

**Lymphoreticular Effects**—Represent morphological effects involving lymphatic tissues such as the lymph nodes, spleen, and thymus.

**Malformations**—Permanent structural changes that may adversely affect survival, development, or function.

**Minimal Risk Level (MRL)**—An estimate of daily human exposure to a hazardous substance that is likely to be without an appreciable risk of adverse noncancer health effects over a specified route and duration of exposure.

**Modifying Factor (MF)**—A value (greater than zero) that is applied to the derivation of a Minimal Risk Level (MRL) to reflect additional concerns about the database that are not covered by the uncertainty factors. The default value for a MF is 1.

**Morbidity**—State of being diseased; morbidity rate is the incidence or prevalence of disease in a specific population.

**Mortality**—Death; mortality rate is a measure of the number of deaths in a population during a specified interval of time.

## 10. GLOSSARY

**Mutagen**—A substance that causes mutations. A mutation is a change in the DNA sequence of a cell's DNA. Mutations can lead to birth defects, miscarriages, or cancer.

**Necropsy**—The gross examination of the organs and tissues of a dead body to determine the cause of death or pathological conditions.

**Neurotoxicity**—The occurrence of adverse effects on the nervous system following exposure to a chemical.

**No-Observed-Adverse-Effect Level (NOAEL)**—The dose of a chemical at which there were no statistically or biologically significant increases in frequency or severity of adverse effects seen between the exposed population and its appropriate control. Effects may be produced at this dose, but they are not considered to be adverse.

**Octanol-Water Partition Coefficient ( $K_{ow}$ )**—The equilibrium ratio of the concentrations of a chemical in *n*-octanol and water, in dilute solution.

**Odds Ratio (OR)**—A means of measuring the association between an exposure (such as toxic substances and a disease or condition) that represents the best estimate of relative risk (risk as a ratio of the incidence among subjects exposed to a particular risk factor divided by the incidence among subjects who were not exposed to the risk factor). An OR of greater than 1 is considered to indicate greater risk of disease in the exposed group compared to the unexposed group.

**Organophosphate or Organophosphorus Compound**—A phosphorus-containing organic compound and especially a pesticide that acts by inhibiting cholinesterase.

**Permissible Exposure Limit (PEL)**—An Occupational Safety and Health Administration (OSHA) allowable exposure level in workplace air averaged over an 8-hour shift of a 40-hour workweek.

**Pesticide**—General classification of chemicals specifically developed and produced for use in the control of agricultural and public health pests.

**Pharmacokinetics**—The dynamic behavior of a material in the body, used to predict the fate (disposition) of an exogenous substance in an organism. Utilizing computational techniques, it provides the means of studying the absorption, distribution, metabolism, and excretion of chemicals by the body.

**Pharmacokinetic Model**—A set of equations that can be used to describe the time course of a parent chemical or metabolite in an animal system. There are two types of pharmacokinetic models: data-based and physiologically-based. A data-based model divides the animal system into a series of compartments, which, in general, do not represent real, identifiable anatomic regions of the body, whereas the physiologically-based model compartments represent real anatomic regions of the body.

**Physiologically Based Pharmacodynamic (PBPD) Model**—A type of physiologically based dose-response model that quantitatively describes the relationship between target tissue dose and toxic end points. These models advance the importance of physiologically based models in that they clearly describe the biological effect (response) produced by the system following exposure to an exogenous substance.

## 10. GLOSSARY

**Physiologically Based Pharmacokinetic (PBPK) Model**—Comprised of a series of compartments representing organs or tissue groups with realistic weights and blood flows. These models require a variety of physiological information: tissue volumes, blood flow rates to tissues, cardiac output, alveolar ventilation rates, and possibly membrane permeabilities. The models also utilize biochemical information, such as air/blood partition coefficients, and metabolic parameters. PBPK models are also called biologically based tissue dosimetry models.

**Prevalence**—The number of cases of a disease or condition in a population at one point in time.

**Prospective Study**—A type of cohort study in which the pertinent observations are made on events occurring after the start of the study. A group is followed over time.

**$q_1^*$** —The upper-bound estimate of the low-dose slope of the dose-response curve as determined by the multistage procedure. The  $q_1^*$  can be used to calculate an estimate of carcinogenic potency, the incremental excess cancer risk per unit of exposure (usually  $\mu\text{g/L}$  for water,  $\text{mg/kg/day}$  for food, and  $\mu\text{g/m}^3$  for air).

**Recommended Exposure Limit (REL)**—A National Institute for Occupational Safety and Health (NIOSH) time-weighted average (TWA) concentration for up to a 10-hour workday during a 40-hour workweek.

**Reference Concentration (RfC)**—An estimate (with uncertainty spanning perhaps an order of magnitude) of a continuous inhalation exposure to the human population (including sensitive subgroups) that is likely to be without an appreciable risk of deleterious noncancer health effects during a lifetime. The inhalation reference concentration is for continuous inhalation exposures and is appropriately expressed in units of  $\text{mg/m}^3$  or ppm.

**Reference Dose (RfD)**—An estimate (with uncertainty spanning perhaps an order of magnitude) of the daily exposure of the human population to a potential hazard that is likely to be without risk of deleterious effects during a lifetime. The RfD is operationally derived from the no-observed-adverse-effect level (NOAEL, from animal and human studies) by a consistent application of uncertainty factors that reflect various types of data used to estimate RfDs and an additional modifying factor, which is based on a professional judgment of the entire database on the chemical. The RfDs are not applicable to nonthreshold effects such as cancer.

**Reportable Quantity (RQ)**—The quantity of a hazardous substance that is considered reportable under the Comprehensive Environmental Response, Compensation, and Liability Act (CERCLA). Reportable quantities are (1) 1 pound or greater or (2) for selected substances, an amount established by regulation either under CERCLA or under Section 311 of the Clean Water Act. Quantities are measured over a 24-hour period.

**Reproductive Toxicity**—The occurrence of adverse effects on the reproductive system that may result from exposure to a chemical. The toxicity may be directed to the reproductive organs and/or the related endocrine system. The manifestation of such toxicity may be noted as alterations in sexual behavior, fertility, pregnancy outcomes, or modifications in other functions that are dependent on the integrity of this system.

**Retrospective Study**—A type of cohort study based on a group of persons known to have been exposed at some time in the past. Data are collected from routinely recorded events, up to the time the study is undertaken. Retrospective studies are limited to causal factors that can be ascertained from existing records and/or examining survivors of the cohort.

## 10. GLOSSARY

**Risk**—The possibility or chance that some adverse effect will result from a given exposure to a chemical.

**Risk Factor**—An aspect of personal behavior or lifestyle, an environmental exposure, or an inborn or inherited characteristic that is associated with an increased occurrence of disease or other health-related event or condition.

**Risk Ratio**—The ratio of the risk among persons with specific risk factors compared to the risk among persons without risk factors. A risk ratio greater than 1 indicates greater risk of disease in the exposed group compared to the unexposed group.

**Short-Term Exposure Limit (STEL)**—The American Conference of Governmental Industrial Hygienists (ACGIH) maximum concentration to which workers can be exposed for up to 15 minutes continually. No more than four excursions are allowed per day, and there must be at least 60 minutes between exposure periods. The daily Threshold Limit Value-Time Weighted Average (TLV-TWA) may not be exceeded.

**Standardized Mortality Ratio (SMR)**—A ratio of the observed number of deaths and the expected number of deaths in a specific standard population.

**Target Organ Toxicity**—This term covers a broad range of adverse effects on target organs or physiological systems (e.g., renal, cardiovascular) extending from those arising through a single limited exposure to those assumed over a lifetime of exposure to a chemical.

**Teratogen**—A chemical that causes structural defects that affect the development of an organism.

**Threshold Limit Value (TLV)**—An American Conference of Governmental Industrial Hygienists (ACGIH) concentration of a substance to which most workers can be exposed without adverse effect. The TLV may be expressed as a Time Weighted Average (TWA), as a Short-Term Exposure Limit (STEL), or as a ceiling limit (CL).

**Time-Weighted Average (TWA)**—An allowable exposure concentration averaged over a normal 8-hour workday or 40-hour workweek.

**Toxic Dose<sub>(50)</sub> (TD<sub>50</sub>)**—A calculated dose of a chemical, introduced by a route other than inhalation, which is expected to cause a specific toxic effect in 50% of a defined experimental animal population.

**Toxicokinetic**—The absorption, distribution, and elimination of toxic compounds in the living organism.

**Uncertainty Factor (UF)**—A factor used in operationally deriving the Minimal Risk Level (MRL) or Reference Dose (RfD) or Reference Concentration (RfC) from experimental data. UFs are intended to account for (1) the variation in sensitivity among the members of the human population, (2) the uncertainty in extrapolating animal data to the case of human, (3) the uncertainty in extrapolating from data obtained in a study that is of less than lifetime exposure, and (4) the uncertainty in using lowest-observed-adverse-effect level (LOAEL) data rather than no-observed-adverse-effect level (NOAEL) data. A default for each individual UF is 10; if complete certainty in data exists, a value of 1 can be used; however, a reduced UF of 3 may be used on a case-by-case basis, 3 being the approximate logarithmic average of 10 and 1.

**Xenobiotic**—Any chemical that is foreign to the biological system.

## APPENDIX A. ATSDR MINIMAL RISK LEVELS AND WORKSHEETS

The Comprehensive Environmental Response, Compensation, and Liability Act (CERCLA) [42 U.S.C. 9601 et seq.], as amended by the Superfund Amendments and Reauthorization Act (SARA) [Pub. L. 99–499], requires that the Agency for Toxic Substances and Disease Registry (ATSDR) develop jointly with the U.S. Environmental Protection Agency (EPA), in order of priority, a list of hazardous substances most commonly found at facilities on the CERCLA National Priorities List (NPL); prepare toxicological profiles for each substance included on the priority list of hazardous substances; and assure the initiation of a research program to fill identified data needs associated with the substances.

The toxicological profiles include an examination, summary, and interpretation of available toxicological information and epidemiologic evaluations of a hazardous substance. During the development of toxicological profiles, Minimal Risk Levels (MRLs) are derived when reliable and sufficient data exist to identify the target organ(s) of effect or the most sensitive health effect(s) for a specific duration for a given route of exposure. An MRL is an estimate of the daily human exposure to a hazardous substance that is likely to be without appreciable risk of adverse noncancer health effects over a specified duration of exposure. MRLs are based on noncancer health effects only and are not based on a consideration of cancer effects. These substance-specific estimates, which are intended to serve as screening levels, are used by ATSDR health assessors to identify contaminants and potential health effects that may be of concern at hazardous waste sites. It is important to note that MRLs are not intended to define clean-up or action levels.

MRLs are derived for hazardous substances using the no-observed-adverse-effect level/uncertainty factor approach. They are below levels that might cause adverse health effects in the people most sensitive to such chemical-induced effects. MRLs are derived for acute (1–14 days), intermediate (15–364 days), and chronic (365 days and longer) durations and for the oral and inhalation routes of exposure. Currently, MRLs for the dermal route of exposure are not derived because ATSDR has not yet identified a method suitable for this route of exposure. MRLs are generally based on the most sensitive chemical-induced end point considered to be of relevance to humans. Serious health effects (such as irreparable damage to the liver or kidneys, or birth defects) are not used as a basis for establishing MRLs. Exposure to a level above the MRL does not mean that adverse health effects will occur.

MRLs are intended only to serve as a screening tool to help public health professionals decide where to look more closely. They may also be viewed as a mechanism to identify those hazardous waste sites that

## APPENDIX A

are not expected to cause adverse health effects. Most MRLs contain a degree of uncertainty because of the lack of precise toxicological information on the people who might be most sensitive (e.g., infants, elderly, nutritionally or immunologically compromised) to the effects of hazardous substances. ATSDR uses a conservative (i.e., protective) approach to address this uncertainty consistent with the public health principle of prevention. Although human data are preferred, MRLs often must be based on animal studies because relevant human studies are lacking. In the absence of evidence to the contrary, ATSDR assumes that humans are more sensitive to the effects of hazardous substance than animals and that certain persons may be particularly sensitive. Thus, the resulting MRL may be as much as 100-fold below levels that have been shown to be nontoxic in laboratory animals.

Proposed MRLs undergo a rigorous review process: Health Effects/MRL Workgroup reviews within the Division of Toxicology and Environmental Medicine, expert panel peer reviews, and agency-wide MRL Workgroup reviews, with participation from other federal agencies and comments from the public. They are subject to change as new information becomes available concomitant with updating the toxicological profiles. Thus, MRLs in the most recent toxicological profiles supersede previously published levels. For additional information regarding MRLs, please contact the Division of Toxicology and Environmental Medicine, Agency for Toxic Substances and Disease Registry, 1600 Clifton Road NE, Mailstop F-32, Atlanta, Georgia 30333.

## APPENDIX A

**MINIMAL RISK LEVEL (MRL) WORKSHEET**

Chemical Name: Perchlorates  
CAS Numbers: 10034-81-8, 7778-74-7, 7790-98-9, 7601-89-0  
Date: August 2008  
Profile Status: Post-Public, Final Draft  
Route:  Inhalation  Oral  
Duration:  Acute  Intermediate  Chronic  
Graph Key: 2  
Species: Humans

Minimal Risk Level: ATSDR adopts the National Academy of Sciences (NAS 2005) recommended chronic RfD of 0.0007 mg/kg/day for chronic oral MRL. NAS based the RfD on the findings of a human study by Greer et al. (2002) summarized below.

References: Greer MA, Goodman G, Pleus RC, et al. 2002. Health effects assessment for environmental perchlorate contamination: The dose-response for inhibition of thyroidal radioiodine uptake in humans. Environ Health Perspect 110(9):927-937.

NAS. 2005. Health implications of perchlorate ingestion. Washington, DC: National Academies Press. <http://www.nap.edu/books/0309095689/html/>. January 31, 2005.

Experimental design: The study was conducted in 37 healthy (euthyroid) volunteers (16 males, 21 females) who consumed potassium perchlorate in drinking water in doses of 0.007, 0.02, 0.1, or 0.5 mg perchlorate/kg/day for 14 days. In 24 subjects, thyroidal uptake of radioactive iodine (RAIU) was measured 8 and 24 hours after administration of radioactive iodine on exposure days 2 and 14 and also 15 days after exposure. To estimate daily iodine intake, 24-hour urine samples were collected. Free and total T4, T3, and TSH were sampled 16 times throughout the study. Serum antibodies to thyroglobulin and thyroid peroxidase were also measured. Hematological and clinical chemistry tests were also conducted throughout the study.

Effects noted in study and corresponding doses: Baseline thyroid iodine uptake varied greatly among the subjects: 5.6–25.4% for the 8-hour uptake and 9.8–33.7% for the 24-hour uptake. Perchlorate inhibited RAIU in a dose-related manner. As a percentage of baseline RAIU, inhibition in the 0.007, 0.02, 0.1, and 0.5 mg/kg/day dose groups was 1.8, 16.4, 44.7, and 67.1%, respectively. The small decrease in RAIU at 0.007 mg/kg/day was not statistically significant and is well within the variation of repeated measurements in normal subjects. The dose is considered the study NOEL. No significant differences were seen between the 8- and 24-hour measurements or between the 2- and 14-day measurements. On post-exposure day 15, RAIU rebounded to values slightly over but not significantly greater than 100%. Consumption of perchlorate in drinking water did not significantly alter serum TSH, free T4 or total T4 and T3 levels. Serum antiglobulin levels were below detection levels in all samples tested. Serum anti-thyroid peroxidases were elevated in two subjects at the screening visit and thus, were not related to treatment with perchlorate. Hematology and clinical chemistry tests to assess liver and kidney function revealed no significant deviations from normal ranges. No difference was observed between the response of male and female subjects.

Based on the known mechanism of action of perchlorate as a competitive inhibitor of NIS and on the elimination half-time of perchlorate of approximately 8 hours (perchlorate is not expected to accumulate in the body), the NAS concluded that a dose that produced minimal inhibition of thyroid iodide uptake after 14 days of continuous exposure would also have no appreciable effects on thyroid iodide uptake with more prolonged (i.e., intermediate or chronic) exposure. On this basis, the 14-day study was used as

## APPENDIX A

the basis for adopting the RfD for the chronic MRL. This is supported by another 14-day study (Lawrence et al. 2000), long-term studies of workers (Braverman et al. 2005; Gibbs et al. 1998; Lamm et al. 1999), and studies of the general population (Li et al. 2001; Téllez et al. 2005) exposed to perchlorate that found no significant alterations in thyroid function in the populations examined. A study by Braverman et al. (2006) in which 13 volunteers dosed with perchlorate in capsules for 6 months at doses of 0, 0.5, and 3 mg/day exhibited no changes in iodine uptake or thyroid hormone level, was considered for derivation of the MRL.

An uncertainty factor of 10 was applied to the NOEL of 0.007 mg/kg/day. The uncertainty factor of 10 is intended to protect the most sensitive population—the fetuses of pregnant women who might have hypothyroidism or iodide deficiency. Other sensitive populations include preterm infants and nursing infants. As discussed by NAS (2005), preterm infants are more sensitive than term infants. The fetus is dependent on maternal thyroid hormones at least until the fetal thyroid begins to produce T4 and T3 (Zoeller and Crofton 2000). In humans, this occurs at approximately 16–20 weeks of gestation. Thyroid hormones are present in human amniotic fluid at 8 weeks of gestation prior to the onset of fetal thyroid hormone production (Contempre et al. 1993; Thorpe-Beeston et al. 1991). Thyroid hormone receptors are present and occupied by hormone at this time as well, suggesting that the fetus is capable of responding to maternal thyroid hormones (Bernal and Pekonen 1984; Ferreiro et al. 1988). The contribution of maternal thyroid hormones to the fetal thyroid hormone status is also evident from infants who have an inherited disorder that abolishes T4 production but are born, nevertheless, with normal serum thyroid hormone levels (i.e., euthyroid) and become hypothyroid after birth if not administered thyroid hormones within the first 2 weeks after birth (Larsen 1989; van Vliet et al. 1999; Vulsma et al. 1989). This suggests that, in the complete absence of fetal thyroid function, the maternal thyroid is able to maintain at least partially protective levels of thyroid hormone in the fetus at late term. Uncorrected maternal hypothyroidism, on the other hand, may result in impaired neurodevelopment of the fetus (Haddow et al. 1999; Pop et al. 1999; Soldin et al. 2001). By inhibiting NIS in breast tissue (Levy et al. 1997; Smanik et al. 1997; Spitzweg et al. 1998), perchlorate may also limit the availability of iodide to nursing infants, who depend entirely on breast milk for the iodide needed to produce thyroid hormone (Agency for Toxic Substances and Disease Registry 2002). No information is available on the doses in humans that might decrease iodide uptake into breast milk. It is important to note that a recent study of 51 women in the Boston area found that 47% of the women sampled may have been providing breast milk with insufficient iodine to meet the infants' requirements (Pearce et al. 2007). Radioiodine uptake into mammary milk was decreased in rats exposed to 1 or 10 mg/kg/day perchlorate in drinking water (Yu et al. 2002). Studies conducted in cows and goats have also shown that perchlorate can decrease radioiodine uptake into mammary milk (Howard et al. 1996). As discussed by Ginsberg et al. (2007), additional factors that make neonates a sensitive group include their shorter serum half-life for T4 of approximately 3 days compared to approximately 7–10 days in adults, a lower storage capacity of the thyroid for T4, and possibly slower urinary clearance of perchlorate due to immature renal function. In addition, PBPK models predict that pregnant women and the fetus will have higher blood concentrations of perchlorate and greater iodide uptake inhibition at a given concentration of perchlorate in drinking water than either nonpregnant adults or older children (Clewell et al. 2007).

Another potential susceptible population is women with urinary iodine levels <100 µg/L (Blount et al. 2006), as regression analysis indicated that perchlorate exposure was correlated with decreased T4 and increased TSH. According to the World Health Organization (WHO 2004), median urinary iodine levels ≥100 µg/L indicate sufficient iodine intake for the non-pregnant population, whereas pregnant women should maintain urinary levels of iodine >150 µg/L. The American Thyroid Association (2006) recommends that women generally consume iodine from dairy products, bread, seafood, meat, and some iodized salt, but pregnant and lactating women may require additional supplements and vitamins.



## APPENDIX A

Dose and end point used for MRL derivation: 0.007 mg/kg/day (NOEL for inhibition of iodide uptake into the thyroid). As indicated by the NAS (2005), iodide uptake inhibition is a key biochemical event that precedes all potential thyroid-mediated effects of perchlorate exposure. Using a nonadverse effect that is upstream of adverse effects is a conservative approach to perchlorate hazard assessment.

Uncertainty Factors used in MRL derivation: 10

Was a conversion factor used from ppm in food or water to a mg/body weight dose? Not applicable.

If an inhalation study in animals, list conversion factors used in determining human equivalent dose: Not applicable.

Was a conversion used from intermittent to continuous exposure? Not applicable.

Other additional studies or pertinent information that lend support to NAS's RfD: Lawrence et al. (2000) evaluated serum TSH, free thyroxine index (FTI), total serum triiodothyronine (TT3), and RAIU; serum and 24-hour urine perchlorate; and 24-hour urinary iodide excretion in volunteers who ingested approximately 0.14 mg perchlorate/kg/day in drinking water for 14 days. Tests were conducted pre-dosing, on day 7 and 14, and 14 days after perchlorate ingestion was discontinued. The only significant finding was a significant decrease in 4-, 8-, and 24-hour RAIU values by a mean of about 38% relative to baseline on day 14 of dosing. Fourteen days later, RAIU had recovered to a mean of 25% above baseline values. In another study, Braverman et al. (2006) administered capsules containing potassium perchlorate to 13 volunteers (4 males, 9 females) for 6 months. The estimated doses were 0 (placebo), 0.5 and 3.0 mg perchlorate/day (approximately 0.04 and 0.007 mg perchlorate/kg/day). The outcomes measured were serum thyroid function tests, 24-hour RAIU, serum thyroglobulin (Tg), urinary iodine and perchlorate, and serum perchlorate. RAIU, measured at baseline, 3, 6 months and 1 month after termination, was not significantly affected by administration of perchlorate and there were no significant changes in serum total T3, FTI, TSH, or Tg levels during or after perchlorate exposure compared to baseline values. The small number of subjects per group (4–5), the dosing by capsule rather than intermittent exposure in drinking water, and the lack of information on RAIU during the first 3 months of the study somewhat diminish the strengths of this study.

Relatively large doses of perchlorate (600–900 mg/day, 8–13 mg/kg/day) are required to deplete thyroidal iodine stores sufficiently to decrease serum levels of T4 (Brabant et al. 1992; Bürgi et al. 1974). A 4-week oral exposure to 900 mg/day (approximately 13 mg/kg/day) significantly decreased serum levels of FT4 (not out of the normal range), but not FT3 and did not significantly change serum TSH levels (Brabant et al. 1992).

A study conducted in an ammonium perchlorate manufacturing facility found that intermittent, high exposure to perchlorate for many years did not induce goiter or any evidence of hypothyroidism among the workers, as judged by no significant alterations in serum TSH or thyroglobulin even though iodine uptakes were decreased during the work shift (Braverman et al. 2005). The median estimated absorbed dose was 0.167 mg/kg/day, equivalent to drinking approximately 2 L of water containing 5 mg perchlorate/L.

Agency Contact (Chemical Manager): Sharon Wilbur

This page is intentionally blank.

## APPENDIX B. USER'S GUIDE

### Chapter 1

#### Public Health Statement

This chapter of the profile is a health effects summary written in non-technical language. Its intended audience is the general public, especially people living in the vicinity of a hazardous waste site or chemical release. If the Public Health Statement were removed from the rest of the document, it would still communicate to the lay public essential information about the chemical.

The major headings in the Public Health Statement are useful to find specific topics of concern. The topics are written in a question and answer format. The answer to each question includes a sentence that will direct the reader to chapters in the profile that will provide more information on the given topic.

### Chapter 2

#### Relevance to Public Health

This chapter provides a health effects summary based on evaluations of existing toxicologic, epidemiologic, and toxicokinetic information. This summary is designed to present interpretive, weight-of-evidence discussions for human health end points by addressing the following questions:

1. What effects are known to occur in humans?
2. What effects observed in animals are likely to be of concern to humans?
3. What exposure conditions are likely to be of concern to humans, especially around hazardous waste sites?

The chapter covers end points in the same order that they appear within the Discussion of Health Effects by Route of Exposure section, by route (inhalation, oral, and dermal) and within route by effect. Human data are presented first, then animal data. Both are organized by duration (acute, intermediate, chronic). *In vitro* data and data from parenteral routes (intramuscular, intravenous, subcutaneous, etc.) are also considered in this chapter.

The carcinogenic potential of the profiled substance is qualitatively evaluated, when appropriate, using existing toxicokinetic, genotoxic, and carcinogenic data. ATSDR does not currently assess cancer potency or perform cancer risk assessments. Minimal Risk Levels (MRLs) for noncancer end points (if derived) and the end points from which they were derived are indicated and discussed.

Limitations to existing scientific literature that prevent a satisfactory evaluation of the relevance to public health are identified in the Chapter 3 Data Needs section.

#### Interpretation of Minimal Risk Levels

Where sufficient toxicologic information is available, ATSDR has derived MRLs for inhalation and oral routes of entry at each duration of exposure (acute, intermediate, and chronic). These MRLs are not meant to support regulatory action, but to acquaint health professionals with exposure levels at which adverse health effects are not expected to occur in humans.

## APPENDIX B

MRLs should help physicians and public health officials determine the safety of a community living near a chemical emission, given the concentration of a contaminant in air or the estimated daily dose in water. MRLs are based largely on toxicological studies in animals and on reports of human occupational exposure.

MRL users should be familiar with the toxicologic information on which the number is based. Chapter 2, "Relevance to Public Health," contains basic information known about the substance. Other sections such as Chapter 3 Section 3.9, "Interactions with Other Substances," and Section 3.10, "Populations that are Unusually Susceptible" provide important supplemental information.

MRL users should also understand the MRL derivation methodology. MRLs are derived using a modified version of the risk assessment methodology that the Environmental Protection Agency (EPA) provides (Barnes and Dourson 1988) to determine reference doses (RfDs) for lifetime exposure.

To derive an MRL, ATSDR generally selects the most sensitive end point which, in its best judgment, represents the most sensitive human health effect for a given exposure route and duration. ATSDR cannot make this judgment or derive an MRL unless information (quantitative or qualitative) is available for all potential systemic, neurological, and developmental effects. If this information and reliable quantitative data on the chosen end point are available, ATSDR derives an MRL using the most sensitive species (when information from multiple species is available) with the highest no-observed-adverse-effect level (NOAEL) that does not exceed any adverse effect levels. When a NOAEL is not available, a lowest-observed-adverse-effect level (LOAEL) can be used to derive an MRL, and an uncertainty factor (UF) of 10 must be employed. Additional uncertainty factors of 10 must be used both for human variability to protect sensitive subpopulations (people who are most susceptible to the health effects caused by the substance) and for interspecies variability (extrapolation from animals to humans). In deriving an MRL, these individual uncertainty factors are multiplied together. The product is then divided into the inhalation concentration or oral dosage selected from the study. Uncertainty factors used in developing a substance-specific MRL are provided in the footnotes of the levels of significant exposure (LSE) tables.

## **Chapter 3**

### **Health Effects**

#### **Tables and Figures for Levels of Significant Exposure (LSE)**

Tables and figures are used to summarize health effects and illustrate graphically levels of exposure associated with those effects. These levels cover health effects observed at increasing dose concentrations and durations, differences in response by species, MRLs to humans for noncancer end points, and EPA's estimated range associated with an upper-bound individual lifetime cancer risk of 1 in 10,000 to 1 in 10,000,000. Use the LSE tables and figures for a quick review of the health effects and to locate data for a specific exposure scenario. The LSE tables and figures should always be used in conjunction with the text. All entries in these tables and figures represent studies that provide reliable, quantitative estimates of NOAELs, LOAELs, or Cancer Effect Levels (CELs).

The legends presented below demonstrate the application of these tables and figures. Representative examples of LSE Table 3-1 and Figure 3-1 are shown. The numbers in the left column of the legends correspond to the numbers in the example table and figure.

## APPENDIX B

**LEGEND****See Sample LSE Table 3-1 (page B-6)**

- (1) **Route of Exposure.** One of the first considerations when reviewing the toxicity of a substance using these tables and figures should be the relevant and appropriate route of exposure. Typically when sufficient data exist, three LSE tables and two LSE figures are presented in the document. The three LSE tables present data on the three principal routes of exposure, i.e., inhalation, oral, and dermal (LSE Tables 3-1, 3-2, and 3-3, respectively). LSE figures are limited to the inhalation (LSE Figure 3-1) and oral (LSE Figure 3-2) routes. Not all substances will have data on each route of exposure and will not, therefore, have all five of the tables and figures.
- (2) **Exposure Period.** Three exposure periods—acute (less than 15 days), intermediate (15–364 days), and chronic (365 days or more)—are presented within each relevant route of exposure. In this example, an inhalation study of intermediate exposure duration is reported. For quick reference to health effects occurring from a known length of exposure, locate the applicable exposure period within the LSE table and figure.
- (3) **Health Effect.** The major categories of health effects included in LSE tables and figures are death, systemic, immunological, neurological, developmental, reproductive, and cancer. NOAELs and LOAELs can be reported in the tables and figures for all effects but cancer. Systemic effects are further defined in the "System" column of the LSE table (see key number 18).
- (4) **Key to Figure.** Each key number in the LSE table links study information to one or more data points using the same key number in the corresponding LSE figure. In this example, the study represented by key number 18 has been used to derive a NOAEL and a Less Serious LOAEL (also see the two "18r" data points in sample Figure 3-1).
- (5) **Species.** The test species, whether animal or human, are identified in this column. Chapter 2, "Relevance to Public Health," covers the relevance of animal data to human toxicity and Section 3.4, "Toxicokinetics," contains any available information on comparative toxicokinetics. Although NOAELs and LOAELs are species specific, the levels are extrapolated to equivalent human doses to derive an MRL.
- (6) **Exposure Frequency/Duration.** The duration of the study and the weekly and daily exposure regimens are provided in this column. This permits comparison of NOAELs and LOAELs from different studies. In this case (key number 18), rats were exposed to "Chemical x" via inhalation for 6 hours/day, 5 days/week, for 13 weeks. For a more complete review of the dosing regimen, refer to the appropriate sections of the text or the original reference paper (i.e., Nitschke et al. 1981).
- (7) **System.** This column further defines the systemic effects. These systems include respiratory, cardiovascular, gastrointestinal, hematological, musculoskeletal, hepatic, renal, and dermal/ocular. "Other" refers to any systemic effect (e.g., a decrease in body weight) not covered in these systems. In the example of key number 18, one systemic effect (respiratory) was investigated.
- (8) **NOAEL.** A NOAEL is the highest exposure level at which no harmful effects were seen in the organ system studied. Key number 18 reports a NOAEL of 3 ppm for the respiratory system, which was used to derive an intermediate exposure, inhalation MRL of 0.005 ppm (see footnote "b").

## APPENDIX B

- (9) LOAEL. A LOAEL is the lowest dose used in the study that caused a harmful health effect. LOAELs have been classified into "Less Serious" and "Serious" effects. These distinctions help readers identify the levels of exposure at which adverse health effects first appear and the gradation of effects with increasing dose. A brief description of the specific end point used to quantify the adverse effect accompanies the LOAEL. The respiratory effect reported in key number 18 (hyperplasia) is a Less Serious LOAEL of 10 ppm. MRLs are not derived from Serious LOAELs.
- (10) Reference. The complete reference citation is given in Chapter 9 of the profile.
- (11) CEL. A CEL is the lowest exposure level associated with the onset of carcinogenesis in experimental or epidemiologic studies. CELs are always considered serious effects. The LSE tables and figures do not contain NOAELs for cancer, but the text may report doses not causing measurable cancer increases.
- (12) Footnotes. Explanations of abbreviations or reference notes for data in the LSE tables are found in the footnotes. Footnote "b" indicates that the NOAEL of 3 ppm in key number 18 was used to derive an MRL of 0.005 ppm.

**LEGEND****See Sample Figure 3-1 (page B-7)**

LSE figures graphically illustrate the data presented in the corresponding LSE tables. Figures help the reader quickly compare health effects according to exposure concentrations for particular exposure periods.

- (13) Exposure Period. The same exposure periods appear as in the LSE table. In this example, health effects observed within the acute and intermediate exposure periods are illustrated.
- (14) Health Effect. These are the categories of health effects for which reliable quantitative data exists. The same health effects appear in the LSE table.
- (15) Levels of Exposure. Concentrations or doses for each health effect in the LSE tables are graphically displayed in the LSE figures. Exposure concentration or dose is measured on the log scale "y" axis. Inhalation exposure is reported in mg/m<sup>3</sup> or ppm and oral exposure is reported in mg/kg/day.
- (16) NOAEL. In this example, the open circle designated 18r identifies a NOAEL critical end point in the rat upon which an intermediate inhalation exposure MRL is based. The key number 18 corresponds to the entry in the LSE table. The dashed descending arrow indicates the extrapolation from the exposure level of 3 ppm (see entry 18 in the table) to the MRL of 0.005 ppm (see footnote "b" in the LSE table).
- (17) CEL. Key number 38m is one of three studies for which CELs were derived. The diamond symbol refers to a CEL for the test species-mouse. The number 38 corresponds to the entry in the LSE table.

## APPENDIX B

- (18) Estimated Upper-Bound Human Cancer Risk Levels. This is the range associated with the upper-bound for lifetime cancer risk of 1 in 10,000 to 1 in 10,000,000. These risk levels are derived from the EPA's Human Health Assessment Group's upper-bound estimates of the slope of the cancer dose response curve at low dose levels ( $q_1^*$ ).
- (19) Key to LSE Figure. The Key explains the abbreviations and symbols used in the figure.

**SAMPLE**

1 →

**Table 3-1. Levels of Significant Exposure to [Chemical x] – Inhalation**

Key to figure <sup>a</sup>	Species	Exposure frequency/ duration	System	NOAEL (ppm)	LOAEL (effect)		Reference
					Less serious (ppm)	Serious (ppm)	
<b>INTERMEDIATE EXPOSURE</b>							
	5	6	7	8	9		10
3 →	Systemic	↓	↓	↓	↓	↓	↓
4 →	18	Rat	13 wk 5 d/wk 6 hr/d	Resp	3 <sup>b</sup>	10 (hyperplasia)	Nitschke et al. 1981
<b>CHRONIC EXPOSURE</b>							
	Cancer					11	
					↓		
	38	Rat	18 mo 5 d/wk 7 hr/d			20 (CEL, multiple organs)	Wong et al. 1982
	39	Rat	89–104 wk 5 d/wk 6 hr/d			10 (CEL, lung tumors, nasal tumors)	NTP 1982
	40	Mouse	79–103 wk 5 d/wk 6 hr/d			10 (CEL, lung tumors, hemangiosarcomas)	NTP 1982

12 →

<sup>a</sup> The number corresponds to entries in Figure 3-1.

<sup>b</sup> Used to derive an intermediate inhalation Minimal Risk Level (MRL) of  $5 \times 10^{-3}$  ppm; dose adjusted for intermittent exposure and divided by an uncertainty factor of 100 (10 for extrapolation from animal to humans, 10 for human variability).



**SAMPLE**

**Figure 3-1. Levels of Significant Exposure to [Chemical X] - Inhalation**

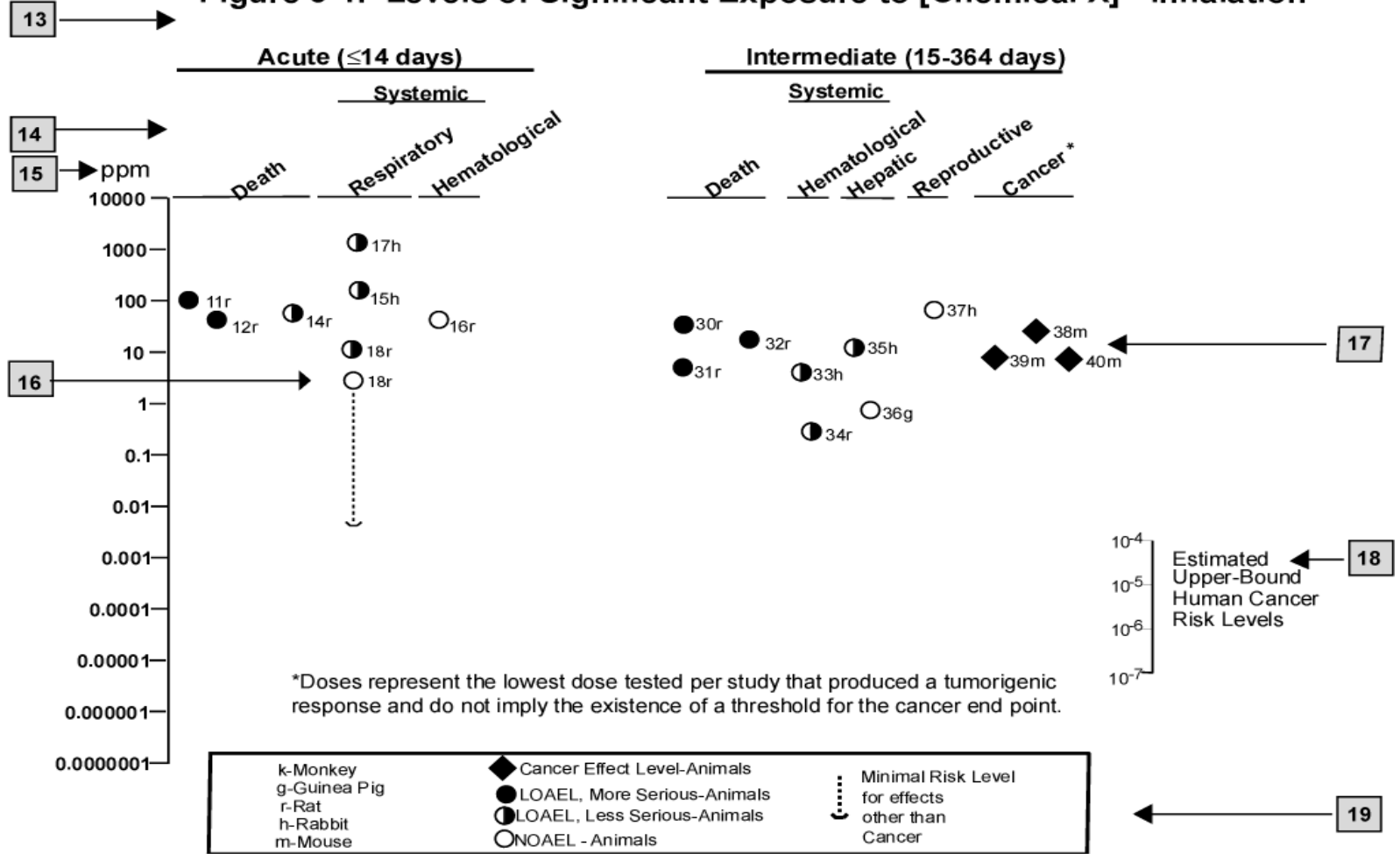

This page is intentionally blank.

## APPENDIX C. ACRONYMS, ABBREVIATIONS, AND SYMBOLS

ACGIH	American Conference of Governmental Industrial Hygienists
ACOEM	American College of Occupational and Environmental Medicine
ADI	acceptable daily intake
ADME	absorption, distribution, metabolism, and excretion
AED	atomic emission detection
AFID	alkali flame ionization detector
AFOSH	Air Force Office of Safety and Health
ALT	alanine aminotransferase
AML	acute myeloid leukemia
AOAC	Association of Official Analytical Chemists
AOEC	Association of Occupational and Environmental Clinics
AP	alkaline phosphatase
APHA	American Public Health Association
AST	aspartate aminotransferase
atm	atmosphere
ATSDR	Agency for Toxic Substances and Disease Registry
AWQC	Ambient Water Quality Criteria
BAT	best available technology
BCF	bioconcentration factor
BEI	Biological Exposure Index
BMD	benchmark dose
BMR	benchmark response
BSC	Board of Scientific Counselors
C	centigrade
CAA	Clean Air Act
CAG	Cancer Assessment Group of the U.S. Environmental Protection Agency
CAS	Chemical Abstract Services
CDC	Centers for Disease Control and Prevention
CEL	cancer effect level
CELDS	Computer-Environmental Legislative Data System
CERCLA	Comprehensive Environmental Response, Compensation, and Liability Act
CFR	Code of Federal Regulations
Ci	curie
CI	confidence interval
CL	ceiling limit value
CLP	Contract Laboratory Program
cm	centimeter
CML	chronic myeloid leukemia
CPSC	Consumer Products Safety Commission
CWA	Clean Water Act
DHEW	Department of Health, Education, and Welfare
DHHS	Department of Health and Human Services
DNA	deoxyribonucleic acid
DOD	Department of Defense
DOE	Department of Energy
DOL	Department of Labor
DOT	Department of Transportation
DOT/UN/ NA/IMCO	Department of Transportation/United Nations/ North America/Intergovernmental Maritime Dangerous Goods Code

## APPENDIX C

DWEL	drinking water exposure level
ECD	electron capture detection
ECG/EKG	electrocardiogram
EEG	electroencephalogram
EEGL	Emergency Exposure Guidance Level
EPA	Environmental Protection Agency
F	Fahrenheit
F <sub>1</sub>	first-filial generation
FAO	Food and Agricultural Organization of the United Nations
FDA	Food and Drug Administration
FEMA	Federal Emergency Management Agency
FIFRA	Federal Insecticide, Fungicide, and Rodenticide Act
FPD	flame photometric detection
fpm	feet per minute
FR	Federal Register
FSH	follicle stimulating hormone
FT4	free T4
g	gram
GC	gas chromatography
gd	gestational day
GLC	gas liquid chromatography
GPC	gel permeation chromatography
HPLC	high-performance liquid chromatography
HRGC	high resolution gas chromatography
HSDB	Hazardous Substance Data Bank
IARC	International Agency for Research on Cancer
IDLH	immediately dangerous to life and health
ILO	International Labor Organization
IRIS	Integrated Risk Information System
K <sub>d</sub>	adsorption ratio
kg	kilogram
kgg	metric ton
K <sub>oc</sub>	organic carbon partition coefficient
K <sub>ow</sub>	octanol-water partition coefficient
L	liter
LC	liquid chromatography
LC <sub>50</sub>	lethal concentration, 50% kill
LC <sub>Lo</sub>	lethal concentration, low
LD <sub>50</sub>	lethal dose, 50% kill
LD <sub>Lo</sub>	lethal dose, low
LDH	lactic dehydrogenase
LH	lutinizing hormone
LOAEL	lowest-observed-adverse-effect level
LSE	Levels of Significant Exposure
LT <sub>50</sub>	lethal time, 50% kill
m	meter
MA	<i>trans,trans</i> -muconic acid
MAL	maximum allowable level
mCi	millicurie
MCL	maximum contaminant level
MCLG	maximum contaminant level goal

## APPENDIX C

MF	modifying factor
MFO	mixed function oxidase
mg	milligram
mL	milliliter
mm	millimeter
mmHg	millimeters of mercury
mmol	millimole
mppcf	millions of particles per cubic foot
MRL	Minimal Risk Level
MS	mass spectrometry
NAAQS	National Ambient Air Quality Standard
NAS	National Academy of Science
NATICH	National Air Toxics Information Clearinghouse
NATO	North Atlantic Treaty Organization
NCE	normochromatic erythrocytes
NCEH	National Center for Environmental Health
NCI	National Cancer Institute
ND	not detected
NFPA	National Fire Protection Association
ng	nanogram
NHANES	National Health and Nutrition Examination Survey
NIEHS	National Institute of Environmental Health Sciences
NIOSH	National Institute for Occupational Safety and Health
NIOSHTIC	NIOSH's Computerized Information Retrieval System
NIS	Sodium/iodide symporter
NLM	National Library of Medicine
nm	nanometer
nmol	nanomole
NOAEL	no-observed-adverse-effect level
NOES	National Occupational Exposure Survey
NOHS	National Occupational Hazard Survey
NPD	nitrogen phosphorus detection
NPDES	National Pollutant Discharge Elimination System
NPL	National Priorities List
NR	not reported
NRC	National Research Council
NS	not specified
NSPS	New Source Performance Standards
NTIS	National Technical Information Service
NTP	National Toxicology Program
ODW	Office of Drinking Water, EPA
OERR	Office of Emergency and Remedial Response, EPA
OHM/TADS	Oil and Hazardous Materials/Technical Assistance Data System
OPP	Office of Pesticide Programs, EPA
OPPT	Office of Pollution Prevention and Toxics, EPA
OPPTS	Office of Prevention, Pesticides and Toxic Substances, EPA
OR	odds ratio
OSHA	Occupational Safety and Health Administration
OSW	Office of Solid Waste, EPA
OTS	Office of Toxic Substances
OW	Office of Water

## APPENDIX C

OWRS	Office of Water Regulations and Standards, EPA
PAH	polycyclic aromatic hydrocarbon
PBPD	physiologically based pharmacodynamic
PBPK	physiologically based pharmacokinetic
PCE	polychromatic erythrocytes
PEL	permissible exposure limit
pg	picogram
PHS	Public Health Service
PID	photo ionization detector
pmol	picomole
PMR	proportionate mortality ratio
ppb	parts per billion
ppm	parts per million
ppt	parts per trillion
PSNS	pretreatment standards for new sources
RAIU	radioactive iodine uptake
RBC	red blood cell
REL	recommended exposure level/limit
RfC	reference concentration
RfD	reference dose
RNA	ribonucleic acid
RQ	reportable quantity
RTECS	Registry of Toxic Effects of Chemical Substances
SARA	Superfund Amendments and Reauthorization Act
SCE	sister chromatid exchange
SGOT	serum glutamic oxaloacetic transaminase
SGPT	serum glutamic pyruvic transaminase
SIC	standard industrial classification
SIM	selected ion monitoring
SMCL	secondary maximum contaminant level
SMR	standardized mortality ratio
SNARL	suggested no adverse response level
SPEGL	Short-Term Public Emergency Guidance Level
STEL	short term exposure limit
STORET	Storage and Retrieval
T3	triiodothyronine
T4	thyronine
TT4	total T4
TD <sub>50</sub>	toxic dose, 50% specific toxic effect
TLV	threshold limit value
TOC	total organic carbon
TPQ	threshold planning quantity
TRH	thyrotropin-releasing hormone
TRI	Toxics Release Inventory
TSCA	Toxic Substances Control Act
TSH	thyroid-releasing hormone
TWA	time-weighted average
UF	uncertainty factor
U.S.	United States
USDA	United States Department of Agriculture
USGS	United States Geological Survey

## APPENDIX C

VOC	volatile organic compound
WBC	white blood cell
WHO	World Health Organization

>	greater than
≥	greater than or equal to
=	equal to
<	less than
≤	less than or equal to
%	percent
α	alpha
β	beta
γ	gamma
δ	delta
μm	micrometer
μg	microgram
q <sub>1</sub> *	cancer slope factor
-	negative
+	positive
(+)	weakly positive result
(-)	weakly negative result

This page is intentionally blank.



## APPENDIX D. INDEX

absorbed dose.....	19, 29, 32, 83, 123, 185
active transport.....	81, 83, 84, 94, 102
adrenal gland.....	18, 103
adsorbed.....	166, 168, 169, 170, 192
adsorption.....	154, 166, 192
aerobic.....	154, 163, 170, 192
anaerobic.....	16, 154, 159, 169, 171, 192, 195
anemia.....	33, 54, 58
aspartate aminotransferase (see AST).....	56
AST (see aspartate aminotransferase).....	56
bioaccumulation.....	15, 193
bioavailability.....	192
bioconcentration factor.....	167, 192
biodegradation.....	16, 154, 163, 170, 171, 192
biokinetics.....	90, 114, 122
biomarker.....	122, 123, 124, 125, 137, 197, 200
body weight effects.....	63
breast milk.....	9, 24, 83, 86, 98, 107, 113, 122, 124, 128, 137, 186, 187, 198
cancer.....	8, 18, 79, 80, 109, 120, 130, 133
carcinogenic.....	8, 21, 27, 206
carcinogenicity.....	133
carcinoma.....	18, 79, 80, 109, 133
cardiovascular.....	18, 28, 53, 103
cardiovascular effects.....	53
clearance.....	20, 24, 90, 97, 115, 128
cognitive function.....	137
death.....	27, 28, 54
deoxyribonucleic acid (see DNA).....	81
dermal effects.....	63
developmental effects.....	33, 58, 68, 69, 74, 75, 78, 80, 111, 115, 121, 130, 133, 136, 139
DNA (see deoxyribonucleic acid).....	81, 105, 123, 134
elimination half-time.....	23, 84, 86, 87, 103, 138, 139
endocrine.....	18, 33, 63, 103, 118, 119
endocrine effects.....	32, 33, 57, 63, 78, 114, 119
erythema.....	63
fetal tissue.....	21, 111, 112
fetus.....	19, 21, 24, 25, 97, 99, 102, 111, 112, 118, 119, 121, 122, 128, 138, 139, 200
gastrointestinal effects.....	53
general population.....	7, 16, 17, 19, 23, 25, 58, 59, 122, 130, 136, 138, 160, 183, 184, 185, 186, 188, 190, 191, 192
genotoxic.....	18, 27, 80, 109
genotoxicity.....	134
groundwater.....	3, 4, 15, 57, 154, 159, 160, 164, 166, 167, 169, 172, 173, 174, 175, 176, 184, 192, 193, 195, 200
half-life.....	20, 24, 33, 86, 87, 108, 115, 123, 124, 128, 129
hematological effects.....	29, 32, 54, 58, 63
hepatic effects.....	32, 55
hydrolysis.....	171

## APPENDIX D

hydroxyl radical .....	170
immune system .....	66, 67, 142
immunological .....	27, 66, 130
K <sub>ow</sub> .....	144
LD <sub>50</sub> .....	33, 53
lymphoreticular .....	135
melanoma.....	66, 79
metabolic effects .....	64
milk .....	5, 9, 10, 20, 24, 74, 77, 78, 83, 84, 86, 90, 95, 96, 97, 98, 99, 102, 113, 121, 122, 124, 177, 182, 186, 187, 193, 198, 200
musculoskeletal effects .....	55
neonatal.....	69, 70, 71, 72, 73, 78, 94, 98, 99, 112, 113, 135, 140
neoplasm .....	58
neurobehavioral.....	18, 76, 119, 121, 133, 135, 139
neurodevelopmental.....	18, 19, 74, 77, 135, 136, 137
neurological effects.....	33, 67, 80, 136
ocular effects.....	28, 63
odds ratio.....	69
pharmacodynamic .....	87
pharmacokinetic .....	87, 88, 89, 92, 93, 120, 140, 186
photolysis .....	162, 168, 170, 192
placenta .....	9, 75, 84, 90, 95, 96, 97, 113, 121, 152
placental barrier .....	102
renal effects.....	17, 32, 56, 136
reproductive effects.....	18, 33, 68, 69, 74, 80, 134
respiratory effects.....	53
retention .....	199
sequestered.....	125
solubility .....	82, 166, 168, 191
systemic effects.....	28, 29, 53, 65, 80, 130
T3 .....	16, 17, 18, 20, 21, 23, 24, 30, 32, 34, 57, 60, 61, 62, 72, 73, 74, 75, 76, 78, 94, 103, 104, 105, 106, 107, 108, 109, 110, 111, 112, 115, 119, 125, 126, 128, 129, 137, 200
T4 .....	16, 17, 18, 19, 20, 23, 24, 32, 57, 59, 60, 61, 62, 70, 71, 72, 73, 74, 75, 76, 78, 94, 104, 105, 106, 107, 108, 109, 110, 111, 112, 114, 115, 119, 121, 124, 125, 126, 128, 129, 137, 200
thrombocytopenia .....	54
thyroid.....	3, 6, 8, 9, 10, 16, 17, 18, 19, 20, 23, 24, 25, 32, 57, 58, 59, 60, 61, 62, 63, 66, 69, 72, 74, 75, 76, 78, 79, 80, 81, 83, 84, 85, 90, 91, 94, 95, 96, 97, 98, 99, 102, 103, 104, 105, 106, 107, 108, 109, 110, 111, 112, 113, 114, 118, 119, 120, 121, 122, 124, 125, 126, 127, 128, 129, 132, 133, 134, 135, 136, 137, 138, 139, 140, 152, 198, 203
thyroid stimulating hormone.....	17, 104, 106, 110
thyroxine .....	16, 32, 57, 110
toxicokinetic.....	27, 139
triiodothyronine.....	16, 57, 104
TSH.....	17, 18, 19, 20, 23, 24, 32, 57, 59, 60, 61, 62, 69, 70, 71, 72, 73, 74, 75, 76, 78, 90, 97, 102, 104, 105, 106, 108, 109, 110, 111, 112, 113, 114, 115, 119, 121, 125, 126, 128, 132, 135, 137, 200, 203
tumors .....	8, 79, 80, 106, 109, 111, 114
vapor pressure .....	81, 161, 166
volatilization .....	161, 166

