

**A Guide for
Environmental Protection and Best Management Practices
for
Tennessee Valley Authority
Transmission Construction and Maintenance Activities**

Revision 2.1 - 2012



Prepared for Tennessee Valley Authority Transmission/Power Supply Group
original by Jack A. Muncy Norris, Tennessee November 1992

Revision 1: Chris Austin, Chris Brewster, Alicia Lewis, Kenton Smithson, Tina Broyles, Tom
Wojtalik Chattanooga, Tennessee December 1999

Revision 2: Abigail Bowen, Jodie Branum, Corey Chandler, Adam Dattilo, Britta Dimick, Shea
Gaither, Casey Henley, Todd Liskey, Joe Melton, Cherie Minghini, Paul Pearman, Kenton
Smithson, Joe Turk, Emily Willard, Robby Wilson
Chattanooga, Tennessee Spring 2012

CONTENTS

Chapter 1 - Introduction	1
Chapter 2 - Sediment and Erosion Control Processes and Principles	2
Chapter 3 - Best Management Practices for Transmission and Substation Construction and Maintenance Activities	4
A. Preconstruction Planning	5
B. Clearing Practices	6
C. Construction Site Measures	8
D. Good Housekeeping	9
E. Waste Disposal	10
F. Herbicide Use.....	11
G. Storm Water Discharge Management.....	14
H. Inspection, Recordkeeping, and Reporting	15
I. Field Change Documentation Guidance	16
Chapter 4 – Sensitive Resources and Buffer Zones	
A. Streamside Management Zone	18
B. Wetlands	25
C. In-Wetland Clearing, Construction, and Restoration Techniques	27
D. Sensitive Biological Resources	32
E. Other Sensitive Resources	34
Chapter 5 - Structural Controls Standards and Specifications	
A. Straw Bale Barrier	36
B. Straw Wattle	38
C. Mulch Berms	40
D. Silt Fence/Filter Barrier	41
E. Check Dams.....	49
F. Rock Filter Dams.....	52
G. Diversion	54
H. Riprap.....	57
I. Access Road and Parking Area Stabilization	59
J. Water Turnouts	61
K. Water Bars	62
L. Broad-based Drainage Dips	63
M. Temporary Stream Crossing	65
N. Culverts	69
O. Construction Entrance/Exit.....	76
P. Sediment Basins & Temporary Sediment Trap	78
Q. Polyacrylamide	81

Chapter 6 - Seeding and Stabilization Techniques

A. Soil Sampling 84
B. Seedbed Preparation and Soil Amendments 85
C. Mulching 86
D. Erosion Control Blankets and Netting 86
E. Seeding Temporary Vegetation 87
F. Seeding Permanent Vegetation 87
G. Federal Noxious Weeds 88

Chapter 7 - Seed and Plant Species Lists

A. Single Plant Species for Establishing Temporary Cover 90
B. Seed Mixtures for Establishing Permanent and Temporary Cover 91
C. Non Native, Non Invasive Species List 94

TABLES

Chapter 4 – Sensitive Resources and Buffer Zones

4 - 1. Recommended Minimum Width of Streamside Management Zone	18
--	----

Chapter 5 - Structural Controls Standards and Specifications

5 - 1. Typical Criteria for Silt Fence Placement.....	41
5 - 2. Silt Fence Post Specifications.....	47
5 - 3. Proper Spacing of Water Bars	62
5 - 4. Recommended Spacing of Broad-Based Drainage Dips.....	64
5 - 5. Pipe Diameters for Stream Crossings.....	71
5 - 6. Spacing of Pipe Culverts.....	72
5 - 7. Pipe Culvert Sizing for Access Road	73

Chapter 6 - Seeding and Stabilization Techniques

6 - 1. Application Rate for Common Soil Amendments Used in Revegetaiton of Disturbed Lands.....	85
6 - 2. Application Rate for Straw Mulch on Disturbed Lands.....	86

FIGURES

Chapter 4 – Sensitive Resources and Buffer Zones

4 - 1. Streamside Management Zone.....	24
--	----

Chapter 5 - Structural Controls Standards and Specifications

5 - 1. Straw Bale.....	37
5 - 2. Straw Wattle.....	39
5 - 3. Silt Fence - J-Hook	43
5 - 4. Silt Fence - Type A	44
5 - 5. Silt Fence - Type B	45
5 - 6. Silt Fence - Type C	46
5 - 7. Silt Fence - Joint Detail	47
5 - 8. Stone Check Dam.....	51
5 - 9. Spacing Between Check Dams	51
5 - 10. Rock Filter Dam	53
5 - 11. Diversion Cross Sections.....	56
5 - 12. Temporary Stream Crossing.....	67
5 - 13. Ford Stream Crossing.....	68
5 - 14. Installing Pipe Culvert	74
5 - 15. Culverts.....	75
5 - 16. Construction Exit.....	77
5 - 17. Temporary Sediment Trap and Outlet	80

Chapter 1 Introduction

This Guide for Environmental Protection and Best Management Practices (BMPs) was prepared to serve as a practical resource document for Tennessee Valley Authority (TVA) personnel and contractors when planning and conducting transmission construction and maintenance activities. Projects covered under a state National Pollutant Discharge Elimination System (NPDES) Construction Storm Water general permit or Municipal Separate Sewer System (MS4) permit would adhere to any state or MS4 specific BMP manual in lieu of this manual, as required by the permit.

Where disturbance does not meet or exceed the state and/or local permitted threshold, BMPs should still be used to minimize impacts from erosion and sedimentation. The environmental review package or CEC/EA/EIS for the project would contain BMPs that should be used if required. Notification to the environmental representative should be completed before the amount of disturbance from a small project meets or exceeds the threshold of state and/or local permitting requirements.

BMPs are practices chosen to minimize erosion and prevent or control sedimentation and other pollutants from land disturbance and land management activities. If properly applied, BMPs would help protect the quality of surface waters and ground water. BMPs are economical and effective methods for ensuring that TVA's construction and maintenance forces and contractors contribute to a high standard of water quality throughout the Tennessee River Watershed and the TVA Power Service Area (PSA).

The recommended BMPs outlined herein are based on current knowledge and the best judgment of experts. Other BMPs not listed or modifications of these practices may be used if allowed by state and/or local regulations and when known to be effective through personal knowledge and experience.

Chapter 2

Sediment and Erosion Control Processes and Principles

The major ground disturbing activities associated with transmission construction and maintenance are right-of-way (ROW) clearing and reclearing, construction and maintenance of access roads, and site grading for the construction of transmission line structures, substations, and communication facilities. Excessive right-of-way clearing, improper or careless road construction, and construction site grading can result in soil erosion and sediment deposition in surface waters, wetlands, and points of access to ground water. Sediment transport can contribute both nutrients and contaminants trapped on the soil particles when flushed into water bodies. Suspended sediment in surface waters reduces their beneficial uses, increases water treatment costs, and harms the growth of aquatic life. Sediment deposition can block navigation channels, springs and ground water infiltration zones, reduce water storage capacities of surface waters and wetlands, increase flooding, degrade or destroy wildlife and fishery habitat, and adversely impact sensitive plants and animals.

Because sediment is the major potential pollutant, and because sediment is a product of soil erosion, the major emphasis of this BMP manual will be on those practices designed to reduce or prevent erosion. Practices that keep the soil in place also aid in reducing the risk of other pollutants reaching surface waters, wetlands, and ground water.

Factors Influencing Erosion:

Climate. The frequency, intensity and duration of rainfall and temperature extremes are principle factors influencing the volume of runoff from a given area. As the volume and intensity of rainfall increases, the ability of water to detach and transport soil particle increases. When storms are frequent, intense, and of long duration, the potential for erosion of bare soils is high. Temperature has a major influence on soil erosion. Frozen soils are relatively erosion resistant. However, soils with high moisture content are subject to “spew”, or uplift by freezing action, and are usually very easily eroded upon thawing.

Topography. The size, shape and slope characteristics of a watershed influence the amount and duration of runoff. The greater the slope, length, and gradient, the greater the potential for both runoff and erosion. Velocities of water will increase as the distance from the top of the slope or the grade of the slope increases.

Soils. The soil type will determine its vulnerability to erosion. Properties determining the erodability of a soil are texture, structure, organic matter content and permeability. Soil containing high percentages of fine sands and silt are normally the most erodable. As the clay and organic matter content of these soils increases, the erodability decreases. Clays act as a binder to soil particles, and therefore reduces erodability. Although clays have a tendency to resist erosion, they are easily transported by water once eroded. Soils high in organic matter resist rain drop impact and the organic matter also increases the binding characteristics of the soil. Well-graded and well-drained gravels are usually the least erodable soils. The high infiltration rates and permeabilities either prevent or delay runoff.

Vegetative Cover. Vegetative cover is an extremely important factor in reducing erosion from a site. It will

- absorb energy of rain drops,
- bind soil particles,
- slow velocity of runoff,
- increase the ability of a soil to absorb water, and
- remove subsurface water between rainfalls through the process of evapotranspiration.

By limiting the amount of vegetation disturbed and the exposure of soils to erosive elements, soil erosion can be greatly reduced.

Chapter 3

Best Management Practices for Transmission and Substation Construction and Maintenance Activities

BMPs are practices chosen to minimize erosion and prevent or control water pollution resulting from land disturbance and land management activities. If properly applied, BMPs will protect the quality of our waters. The best stormwater management strategy is to use BMPs that increase infiltration in the drainage area to reduce the amount of rainfall that actually becomes runoff.

The basic principles of erosion and sediment control which must be considered in selecting appropriate BMPs are

1. plan clearing, grading, and construction to minimize the area and duration of soil exposure;
2. maintain existing vegetation wherever and whenever possible;
3. minimize disturbance of natural contours and drains;
4. as much as practicable, operate on dry soils when they are least susceptible to structural damage and erosion;
5. limit vehicular and equipment traffic in disturbed areas;
6. keep equipment paths dispersed or designate single traffic flow paths with appropriate road BMPs to manage runoff;
7. divert runoff away from disturbed areas;
8. provide for dispersal of surface flow that carries sediment into undisturbed surface zones that have high infiltration capacity and ground cover conditions;
9. prepare drainage ways and outlets to handle concentrated or increased runoff;
10. minimize length and steepness of slopes. Interrupt long slopes frequently.
11. keep runoff velocities low and/or check flows;
12. trap sediment on-site;
13. inspect and maintain control measures on a regular basis and after significant rainfall events; and,
14. revegetate and mulch disturbed areas as soon as practical after each disturbance.

Some measures or controls can be used independently others must be used jointly. Erosion and sediment controls are not limited to the following practices. However, alternative measures must be at least as effective in controlling erosion and sedimentation.

3 - A. Preconstruction Planning

Prior to any ground disturbing activity, a plan should be developed that addresses any erosion, sediment, or storm water control issues. The issues should be clearly conveyed to all parties involved in the ground disturbing activity during a preconstruction meeting before project work begins. Preconstruction planning includes the collection and use of information about the project site, borrow areas and access roads.

An effective plan will

1. consider clearing, construction, and maintenance activities that could cause erosion or degrade water quality;
2. identify the specific BMPs needed to minimize any adverse effects and show the proposed location for implementation;
3. address regulatory requirements of each state and any applicable federal agency; and,
4. clearly outline responsibility for overseeing BMP plan implementation, and designate that responsibility to individuals on each project site.

Individuals responsible for overseeing BMP plan implementation have the authority to make decisions based on field conditions for BMP locations. A copy of the plan should be kept on-site and be made available upon request. Field changes to the plan should be communicated to the plan preparer in order to ensure all necessary revisions are made.

3 - B. Clearing Practices

General - Clearing operations should be conducted in a manner that will prevent any unnecessary destruction, scarring, or defacing of the remaining natural vegetation and adjacent surroundings in the vicinity of the work. In sensitive public or environmental areas, appropriate buffer zones should be observed, and the methods of clearing or re-clearing should be modified to protect the buffer and sensitive area. The condition of cleared soils should be preserved to the maximum extent practical by avoiding compacting and deep scarring. As soon as possible after initial disturbance of the soil, temporary cover material should be placed to prevent erosion of soil and sedimentation of water bodies or conveyances to surface waters. Vegetation will be protected from damage in areas beyond the boundary of the clearing work and access roads.

Streamside Management Zone(s) (SMZs) - Refer to Streamside Management Zone section for clearing specifications. Equipment should cross streams, ditches, and wet areas only at designated locations after appropriate BMPs have been installed. Steps should also be taken to protect wet weather conveyances even when they are not identified as such on project or topographic maps.

Wetlands - See Wetland Clearing section for clearing specifications.

Historic Area Preservation - If prehistoric or historic artifacts or features that might be of archaeological significance are discovered during clearing or re-clearing operations, the activity should immediately cease within a 100-foot radius, and a TVA right-of-way inspector or responsible environmental support person should be notified. The site should be protected and left as found until a determination about the resources, their significance, and site treatment is made by TVA's Cultural Resources Program. Work may continue beyond the perimeter of the 100-foot radius encircling the finding zone.

Water Quality Control - Erosion and sediment control measures such as silt fences, water bars, and sediment traps should be installed as soon as practicable after initial right-of-way disturbance in accordance with applicable permit or regulatory requirements. BMP inspections will be conducted and documented in accordance with permit requirements. If temporary clearing activities must interrupt natural drainage, appropriate drainage facilities and erosion/sediment controls should be provided to avoid erosion and siltation in streams and other water bodies or water conveyances. Turbidity levels in receiving waters or at storm water discharge points should be monitored, documented, and reported if required by the applicable permit. Mechanized equipment should not be operated in flowing water except when expressly approved by TVA beforehand, and, then, only to construct necessary stream crossings under direct guidance of TVA. Construction of stream fords or other crossings will only be permitted at approved locations and to current TVA construction access road standards. Material should not be deposited in watercourses or within stream bank areas where it could be washed away by high stream flows. Any clearing debris that enters streams or other water bodies should be removed as soon as possible. TVA will secure appropriate Corps of Engineers and state or local permits for stream crossings.

Air Quality Control - Burning of clearing debris is allowed as long as local burning permits' and forestry or local fire departments' requirements are met. All operations must be conducted in a manner that prevents nuisance conditions or damage to adjacent land, crops, dwellings, roads, or people. If weather conditions such as wind speed or wind direction change rapidly, the burning operation should cease until weather conditions improve. Residue from burning will be

disposed of according to permit stipulations. Oil or refuse that includes trash, rags, tires, plastics, or other manufactured debris should not be burned anywhere on the job site.

Dust Control - Clearing activities should be conducted in a manner that minimizes the creation of fugitive dust. This may require limitations as to type of equipment, allowable speeds, and routes utilized. Control measures such as water, gravel, or similar measures may be used subject to approval. On new construction sites and easements, refer to Construction Entrance/Exit section for specifications.

Brush and Timber Disposal - Trees may be cut and left in place in specified areas with approval from the appropriate regulatory agency. These areas may include sensitive wetlands or SMZs where tree removal would cause excessive ground disturbance or very rugged terrain where windrowed trees are used as sediment barriers along the edge of the right-of-way.

3 - C. Construction Site Measures

Where possible, large construction projects should be staged or phased in order to minimize exposure time of cleared soils. Stabilization should be accomplished by temporary or permanent protection of the disturbed soil surface from rainfall impacts and runoff.

Grading activities should be avoided to the maximum extent practical during months of highly erosive rainfall.

Initial erosion and sediment control measures must be in place and functional before earth moving operations begin. All control measures must be properly constructed, maintained, and inspected throughout the construction and stabilization period.

Construction debris must be kept from entering surface waters, wetlands, wet weather conveyances, and other types of access points to existing water bodies or ground water.

Stockpiled soil should be located far enough from streams, wetlands, and drainage ways so that runoff cannot carry sediment downstream or into adjacent wetlands.

3 - D. Good Housekeeping

BMPs minimize the movement of pollutants other than sediments. Those pollutants that are mixed in solution, or are carried on fine grained sediments, may pass through all BMPs and eventually reach downstream water bodies. The only practical control option available to prevent these pollutants from reaching runoff or flood waters is through the use of proper application techniques and good housekeeping practices.

Used oil, grease, and rags must be disposed of in proper receptacles and kept out of contact with rainfall or runoff water.

Dumping or burying of waste materials at the construction site is prohibited.

Liquid and solid waste must be collected in containers and regularly transported from the construction site to applicable storage or disposal facility.

Equipment repairs and washing must be undertaken at designated locations. Routine maintenance of personnel vehicles will not be performed on the right-of-way. However, if emergency situations arise, minimal/temporary maintenance to personnel vehicles is acceptable in order to mobilize the vehicle to an off-site maintenance shop. Heavy equipment may be serviced on the right-of-way except in designated sensitive areas. In this situation, proper ground cloths, matting, or plastic sheeting must be used to prevent releases of oil, fuel, or grease into the environment. Construction personnel will properly maintain these vehicles with approved spill protection controls and countermeasures. If emergency maintenance in a sensitive or questionable area arises, environmental personnel will be consulted. Used oil and waste will be recycled or disposed of properly. Equipment should not be temporarily stored in stream floodplains overnight, on weekends, or on holidays.

All on-site vehicles must be monitored for leaks and receive regular preventative maintenance to reduce the chance of leakage.

Any petroleum products, paints, or chemicals present at the site must be stored in tightly sealed containers that are clearly labeled and are properly stored when not in use. Mobile and/or portable oil or fuel storage tanks should be positioned or located to prevent spilled oil from reaching watercourses. Containment should be provided for oil or fuel storage tanks according to the project's Spill Prevention Control and Countermeasure (SPCC) plan. The tank(s) should be located where it will not be subjected to periodic flooding or washout.

Spill response equipment and sufficient absorbent material to contain and clean up fuel or chemical spills or leaks must be maintained on-site or be readily available. Spills of paint, chemicals, oil, etc. must be immediately cleaned up, and contaminated soil and absorbent materials must be promptly removed and placed into appropriate waste containers. The wastes must then be properly characterized to determine the required method of disposal. Solid wastes may be removed and disposed of in an approved landfill. Special or hazardous wastes must be managed by appropriate permitted facilities according to all applicable regulations.

3 - E. Waste Disposal

Solid waste - All trash and construction debris from the site will be hauled to an approved landfill. No construction waste material will be buried or burned on-site. Clearing debris (brush and timber) may be burned on-site in accordance with local fire regulations. Employee waste and other loose materials will be collected and properly disposed of to prevent the release of floatables during runoff or flood events. Liquid wastes will be properly collected in a Department of Transportation (DOT) approved container on-site. A responsible environmental person will be designated to characterize the waste and coordinate and manage the disposal with the appropriate permitted facilities according to applicable regulations as necessary.

Hazardous Waste - In general, hazardous wastes are not expected to be generated or encountered in these projects. However, the hazardous materials used do present the potential for hazardous waste generation (e.g., painting/stripping, chemical spills, fuel spills). In the event that hazardous waste is generated, all wastes will be properly collected, managed, and disposed of according to the Environmental Protection Agency (EPA), state, and/or local regulations. A responsible environmental person will be designated to support any events.

Sanitary Waste - Portable sanitary units will be provided for use by all workers throughout the life of construction projects. They should not be located closer than 100 feet to any stream or tributary or to any wetland. The facilities should be required to have proper servicing and maintenance, and the waste disposal contractor should verify in writing that the waste disposal will be in state-approved facilities. Containment may be required depending on local regulations.

Concrete Waste - Concrete that is delivered to the site but remains unused should be transported offsite by the concrete vendor. Concrete trucks should use a designated concrete washout area to clean their mixer chute if necessary. It is not permissible to discharge concrete wash directly onto the ground including areas within 50 feet of streams, storm drains or areas with potential for runoff directly into streams and/or storm drains.

3 - F. Herbicide Use

Herbicides are sometimes used on stumps and low growing brush during ROW clearing for transmission line construction projects. Herbicides are routinely used along with mechanical mowing and hand clearing as an integrated form of vegetation management during ROW maintenance. Herbicides can be liquid, granular, pellets, or powder; can be applied aerially or by ground equipment; and, may be selectively applied or broadcast depending on the site requirements, species present, and condition of the vegetation. "Applicators" must be trained and licensed; and follow manufacturers' label instructions, EPA guidelines, and respective state regulations and laws; including NPDES pesticide general permit requirements for any discharge to surface waters. Water quality considerations include measures taken to keep herbicides that are not approved for aquatic use from reaching streams whether by direct application or through runoff of or flooding by surface water.

When herbicides are used, their potential adverse impacts must be considered in selecting the compound, formulation, and application method. Conditions that contribute to the offsite migration of an herbicide should be avoided. For example, an herbicide that is hand applied in pelletized form can be very mobile and adversely impact non-target areas. A list of herbicides commonly used on TVA ROWs can be found in Right-Of-Way Vegetation Guidelines located on the Energy Delivery (ED) environmental website.

Herbicides that are designated "Restricted Use" by the EPA require application by or under the supervision of applicators certified by the respective state control board. They also require detailed records of application developed on a timely basis.

Knowledge of the chemical being used and adherence to the manufacturer's specifications and directions are essential to the protection of water quality. The label contains information regarding applicator safety, species for which the chemical is registered, the application rate or concentration, appropriate weather conditions during application, environmental impacts, and proper container disposal. Material Safety Data Sheets (MSDS), available from the chemical manufacturer, provide toxicological data.

Transportation regulations for herbicides must be followed. Accidents that result in spillage must be promptly reported to proper authorities and immediately cleaned up.

Disposal of herbicide containers must be in accordance with directions given on the label.

Herbicide containers or applicator equipment must never be cleaned in or near streams, water bodies, or ground water infiltration zones.

Mixing of herbicides must be done with care to avoid spillage and to ensure that excessive amounts of chemicals are not being applied.

Application equipment will be properly maintained and adjusted to prevent spillage and excessive application of vegetation control materials. Frequent inspection and calibration of equipment is recommended.

Guidelines for aerial application and ground application of liquid, granular, pellet, or powder formulations

For all applications (by contractors or TVA forces), the sites to be treated should be selected and the application directed by the appropriate TVA official (e.g., contract administrator, Transmission Service Center Manager, Right-of-way Specialist, or line foreman).

A preflight walking or flying inspection must be made within 72 hours prior to applying herbicides aerially. This inspection should ensure that no land use changes have occurred, sensitive areas are clearly pointed out to the pilot, and proper buffer zones are maintained.

Aerial application of liquid herbicides normally will not occur when surface wind speeds exceed five miles per hour, in areas of fog, or during periods of temperature inversion or when other conditions exist that the label restricts.

Pellet application normally will not occur when the surface wind speeds exceed ten miles per hour or on frozen or water saturated soils.

Liquid application will cease when the temperature reaches 95 degrees (F) or above. Application during unstable, unpredictable, or changing weather patterns will be avoided. Equipment and techniques will be used that are designed to ensure maximum control of the spray swath with minimum drift.

Under no circumstances will herbicides or herbicide related fertilizers be applied to the surface of water bodies, wetlands or ground water infiltration zones unless specifically labeled for aquatic use. Filter and buffer strips must conform at least to federal and state regulations and any label requirements. The use of aerial or broadcast application of herbicides is not allowed in any SMZ adjacent to perennial streams, ponds, and other water sources. Hand application of certain herbicides may be labeled for use within SMZs; however, they should be used only selectively. For additional information on SMZs, see the Streamside Management Zone section of this guide.

Buffers and filter strips (200 feet minimum width) are required next to agricultural crops, gardens, farm animals, orchards, apiaries, horticultural crops, and other valuable vegetation.

During all ground applications, the applicator should periodically calibrate the application equipment to ensure that the herbicide is being applied at the proper rate.

Herbicides used for stump treatments and tree growth regulators must be applied according to the specimen label.

Herbicides are not to be applied

- around trees that would fall and hit a conductor or support structure;
- in fence rows and other areas where cattle might eat wilted cherry leaves;
- in city, state, and national parks or forests or other special areas without written permission and/or required permits from the proper governmental officials;
- areas adjacent to and off the right-of-way;
- during rainy periods or during the 48-hour interval prior to rainfall predicted with a 20 percent or greater probability by local forecasters (this applies when soil-active herbicides are used); or,
- in areas where soil erosion might occur or soil might be mechanically relocated (this applies when soil-active herbicides are used).

Accurate and up-to-date records are to be maintained concerning the plan for and the application of all herbicides. The locations, herbicide applied, amount of herbicide applied, application method, and size of the area treated are to be recorded on the appropriate form.

3 - G. Storm Water Discharge Management

All potential sources of pollution which could affect the quality of storm water discharges must be identified, and the appropriate control measures must be implemented to ensure that the following conditions are met both during and after construction activities.

1. There should be no distinctly visible floating scum, oil, or other matter contained in the storm water discharge.
2. The storm water discharge must not cause an objectionable color contrast in the receiving stream.
3. The storm water discharge must not result in materials in concentrations sufficient to be hazardous or otherwise detrimental to humans, terrestrial life, plant life, and/or aquatic life in the receiving stream.

3 - H. Inspection, Recordkeeping, and Reporting

Regular maintenance is vital to the success of an erosion and sediment control system. All control measures should be checked and repaired as necessary. Inspections should be conducted during dry periods and following rainfall events. During prolonged rainfall, daily checking and repairing may be necessary. Discharge monitoring and stream sampling may be required to verify minimal site sediment contribution to water bodies.

Records must be kept on all inspections and repairs to erosion and sediment control measures. These records are to be maintained on-site or at a nearby office.

Inspection records and information resulting from water quality monitoring activities required by state and/or local regulations must be retained per the Environmental Management System (EMS) Records Management Process.

3-I. Field Change Documentation Guidance

Minor Changes

For the purpose of this document a minor change is defined as the addition of 100 feet or less of any perimeter control BMP (e.g. silt fence, wattle, etc.) or the maintenance and repair of existing BMP's.

For minor SWPPP changes:

1. No notification to SWPPP preparer is required
2. BMP drawings in SWPPP shall be redlined to reflect change

Major Changes

All other addition, subtraction, or changing of BMP's as shown in the project SWPPP and/or changes made by ED to the project (e.g. new access roads, design change, etc.) shall be coordinated with and approved by the SWPPP preparer. Any approved changes shall be documented on the revision log located in the SWPPP for the project. Additionally the BMP drawings that are onsite should reflect the actual field conditions. These drawings can be red lined with changes by field personnel or a revised set may be provided by the SWPPP preparer.

In order to determine a need for additional BMP's or to discuss project changes, an onsite meeting should occur between the environmental technician and ROW specialist and/or construction technician. The location and scope of the additional work will be determined from this meeting.

For major SWPPP changes:

1. The proposed changes shall be sent (email or phone call) to the SWPPP preparer for review and approval or denial.
2. The SWPPP preparer will analyze proposed changes and determine if changes are compliant with environmental regulations. Once a determination is made, the SWPPP preparer will notify the environmental tech along with the ROW Specialist or construction technician if the change is approved or denied.
3. If changes are approved, the SWPPP preparer will make the necessary revision to the SWPPP which may include updating ED project information (e.g. access road maps). The SWPPP preparer in coordination with the environmental technician will ensure all approved changes are documented in the SWPPP. This may include red lining BMP drawings and updating SWPPP revision log.
4. If the changes are approved the ROW specialist and/or construction technician will coordinate the completion of the work with the resources that are available.

Chapter 4 Sensitive Resources and Buffer Zones

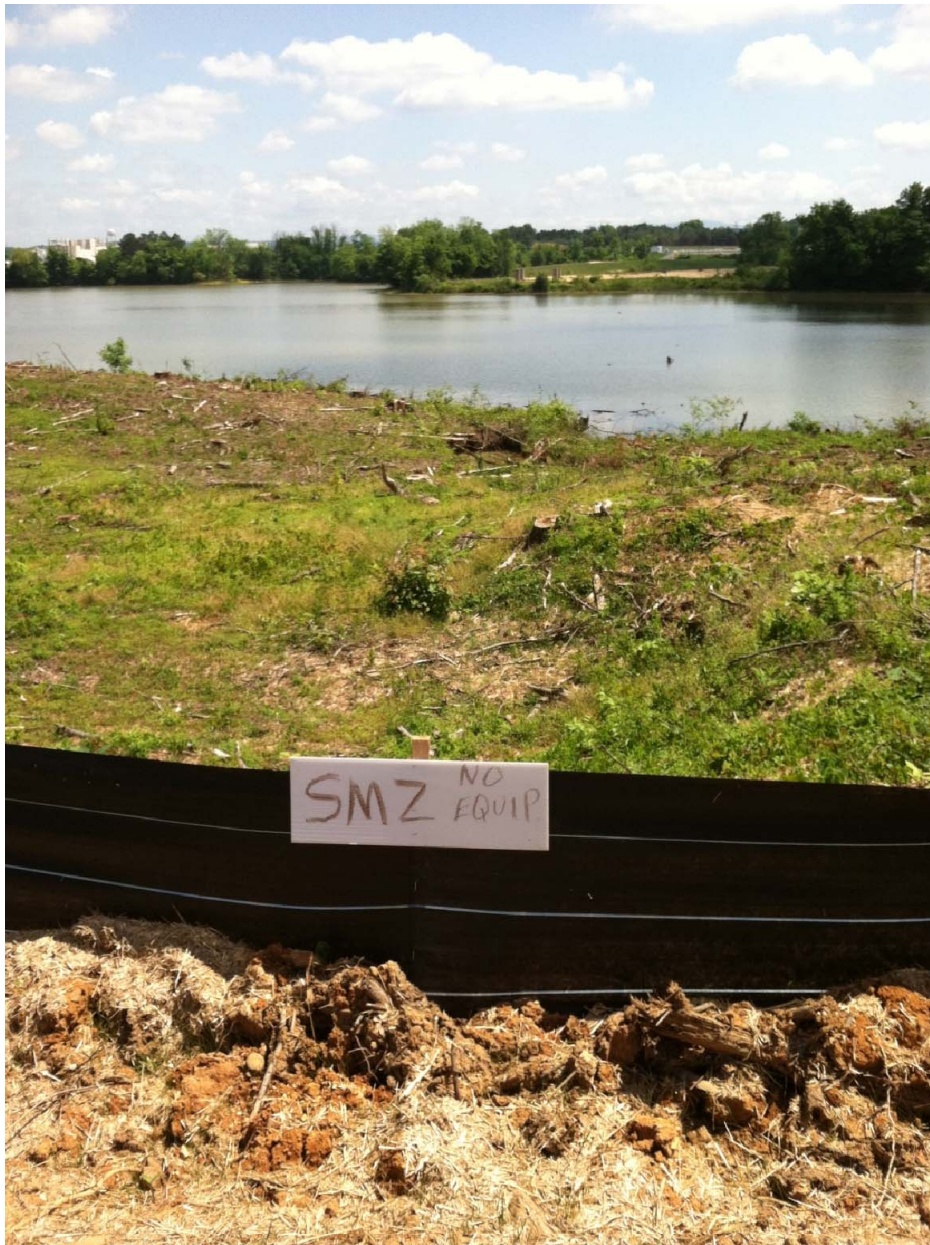

4 - A. Streamside Management Zone

Definition

An area or zone, covered with vegetation on both sides of perennial and intermittent streams and along the margins of bodies of open water, where extra precaution is used in carrying out construction activities to protect stream banks and water quality (Figure 4-1). The zone also functions as a buffer when herbicides, fertilizers, etc. are applied to adjacent lands.

Purpose

To slow and spread surface-water flow.

To trap and filter out suspended sediment before these particulates reach the stream channel.

To protect stream bank and floodplain integrity.

To protect stream water temperature for aquatic ecosystems.

To improve impacts from biological pollution agents.

Conditions Where Practice Applies

Along perennial and intermittent streams and along edges of bodies of water where disturbances occur and where surface runoff, flooding, or back flows may carry sediment loads to the watercourse.

Specifications

Establish a SMZ along each intermittent and perennial stream and perennial waterbody.

The width of the SMZs may vary (increase or decrease in width) depending on type of watercourse, primary use of water resource, topography, or existing features or land use (i.e. existing roads or agricultural fields).

SMZ width is measured along the slope in linear feet on each side from the edge of the waterbody to the toe of road or other surface disturbance.

Table 4-1. Recommended minimum width of streamside management zone. (State and local requirements should be consulted and implemented when they are more restrictive than TVA guidelines.)

SMZ Category	% Slope of Adjacent Lands				
	1-10	11-20	21-30	31-40	41+
	SMZ Width each side				
A - Standard	50	70	90	110	130
B - Important	70	90	110	130	150
C - Unique	90	110	130	150	170

(SMZ width increases 20 ft for each 10% increase in slope)

Regardless of the width, the SMZ must provide effective sediment protection for the watercourse.

Limited construction and maintenance activities are allowed within most SMZs. Where activities are allowed, additional and more effective BMPs may be required to fully protect the stream channel or other water body and water quality. Extra care is recommended within SMZs near public water supplies (streams and reservoirs), springs, and sinkholes to reduce the risk of sudden and severe contamination due to failure of BMPs with unusual storms. Projects with coverage under state stormwater NPDES general permits or coverage under Municipal Separate Storm Sewer System (MS4) permits may also have buffer requirements. These buffer requirements could also be more restrictive.

Unnecessary canopy removal along streams is discouraged during clearing or re-clearing. Fell trees away from the watercourse. Remove trees and tops with extreme care. Leave as many rooted ground cover plants as possible in the buffer zone such that it is essentially undisturbed. Within SMZ areas along perennial streams, no more than 20 percent bare disturbed ground, evenly distributed, is allowed resulting from construction or maintenance activities; and, along intermittent streams, no more than 40 percent bare disturbed ground, evenly distributed, is allowed. On those areas where bare disturbed ground exceeds the 20 or 40 percent limit, a ground cover must be provided. Seeding or planting native materials that stabilize the soil surface and benefit wildlife should be considered. See Seeding/Stabilization Techniques for details on vegetation specifications.

The Energy Policy Act of 2005 granted Federal Energy Regulatory Commission (FERC) the authority to oversee mandatory reliability standards for the nation's bulk power system. FERC sets vegetation management standards for large interstate transmission facilities. Clearance between power lines and trees must ensure reliable operation of the bulk power system and includes accounting for future tree growth, movement of trees or conductor due to wind, and sag. Trees with the potential to interfere with the TVA Clearances and violate FERC standards should be removed and the stumps may be treated to prevent re-sprouting. These tall growing species include maple, oak, walnut, spruce, pine, etc. Lower growing trees identified by TVA as marginal electrical clearance problems may be cut, then stump treated with growth regulators to allow low, slow growing canopy development and active root growth. Smaller trees with mature tree heights of approximately ten feet may be left to provide canopy to the stream.

Within SMZ areas where ephemeral streams intersect perennial or intermittent streams (confluence), only minimal surface disturbance is allowed. Wheel- or track-type equipment should not operate within these zones.

All construction debris resulting from clearing and re-clearing operations or building or structure removal must be kept out of intermittent and perennial stream channels, wetlands, or ground water infiltration zones. Should debris reach these areas, it would be promptly removed.

Broadcast application of herbicides and fertilizers or spraying of herbicides (except those labeled for aquatic use) should be conducted so that chemicals are not applied directly into intermittent and perennial streams and perennial waterbodies or allowed to drift into such watercourses. Refer to Herbicide section. Broadcast application of chemicals should not be applied to the land surface closely adjacent to water surfaces or channels, or to the surface of ephemeral streams or drainage channels within SMZs where direct washoff into the

stream or waterbody could occur. Hand application of certain herbicides may be labeled for use within SMZs; however, they should be used only selectively. Refer to Herbicide section.

Operations involving chemical or fuel storage or resupply and vehicle servicing will be handled outside of SMZs and in such a manner as to prevent these items from reaching the watercourse. Earthen berms or other effective means must be installed to protect the stream channel from direct surface runoff. Servicing will be done with care to avoid leakage, spillage, and subsequent stream, wetland, or ground water contamination. Oil waste, filters, and other litter will be collected and disposed of properly. Refer to Good Housekeeping section for further discussion.

Locate roads outside of SMZs except where stream crossings are necessary and where physical restrictions cause roads to be within the SMZ. Where restrictions exist (existing roads, trails, right-of-way boundary, property boundary, agricultural crops, existing land use, topography, etc.) inside an SMZ that would potentially reduce the width of the SMZ, alternate techniques or measures must be employed to effectively protect the stream channel. Establish right-angle crossings to stream channels. Avoid the use of fill material placed over construction debris as a stream crossing.

Promptly revegetate or provide adequate ground cover for bare soil areas within an SMZ (roads, ditches, crossings, cut and fill banks). See Seeding/Stabilization Techniques for details on vegetation specifications. SMZ planning can include the development and enhancement of wildlife habitat..

During the environmental review of transmission line, substation, or telecommunication projects, TVA Environmental Biological Compliance staff will have studied each possible stream impact and identified it as falling into one of three categories: (A) standard SMZ protection; (B) protection of important permanent streams, springs, and sinkholes; or, (C) protection of unique habitats that exist in the stream. These category designations are based on the variety of species and habitats that exist in the stream as well as federal requirements to avoid harming certain species.

(A) Standard SMZ Protection

This is the standard (basic) level of protection for streams, springs, sinkholes, and the habitats around them. The purpose of the following guidelines is to minimize the amount and length of disturbance to the water bodies without causing adverse impacts on the construction work.

Guidelines:

1. All construction work around streams, springs and sinkholes will be done using pertinent BMPs such as those described in Chapter 5, "Structural Controls Standards and Specifications".
2. All equipment crossings of streams and shorelines must comply with appropriate state permitting requirements. Crossings of all drainage channels, intermittent streams, and permanent streams must be done in ways that avoid erosion problems and long-term changes in water flow. Crossings of any permanent streams must allow for natural movement of fish and other aquatic life.

3. Cutting of trees within SMZs must be accomplished by using either hand-held equipment or other appropriate clearing equipment (e.g., a feller-buncher) that would result in minimal soil disturbance and damage to low-lying vegetation. The method will be selected based on site-specific conditions and topography to minimize soil disturbance and impacts to the SMZ and surrounding area. Stumps can be cut close to ground level but must not be removed or uprooted.
4. Other vegetation near streams must be disturbed as little as possible during construction. Soil displacement as a result of clearing operations by the actions of plowing, disking, blading, other tillage, or grading equipment will be minimized in SMZs. Shorelines that have to be disturbed must be stabilized as soon as feasible.

(B) Protection of Important Permanent Streams, Springs, and Sinkholes

This category will be used when there is one or more specific reason(s) why a permanent (always-flowing) stream, spring, or sinkhole requires protection beyond that provided by standard BMPs. Reasons for requiring this additional protection include high potential for occupancy by federal-listed or significant state-listed species, the presence of suitable habitat for federal-listed or significant state-listed species, federally designated critical habitat, or areas designated as a special use classification (e.g. trout waters). The purpose of the following guidelines is to minimize the disturbance of the banks and water in the flowing stream(s) where this level of protection is required.

Designation of this category should be discussed with the TVA Environmental Energy Delivery staff as early as possible after field survey by the TVA Biological Compliance Staff.

Guidelines:

1. Except as modified by guidelines 2-4 below, all construction work around streams would be done using pertinent BMPs such as those described in Chapter 5, "Structural Controls Standards and Specifications."
2. All equipment crossings of streams must comply with appropriate state (and, at times, federal) permitting requirements. Crossings of drainage channels and intermittent streams must be done in ways that avoid erosion problems and long-term changes in water flow. Category B designations will be discussed with the TVA Environmental Energy Delivery staff as early as possible in the process to allow time to discuss possible avoidance or minimization of impacts with design and construction.
3. Cutting of trees within SMZs must be accomplished by using either hand-held equipment or other appropriate clearing equipment (e.g., a feller-buncher) that would result in minimal soil disturbance and damage to low-lying vegetation. The method would be selected based on site-specific conditions and topography to minimize soil disturbance and impacts to the SMZ and surrounding area. Cutting of trees near permanent streams should be limited to those required to meet National Electrical Safety Code, FERC standards, and danger tree requirements. Stumps can be cut close to ground level but must not be removed or uprooted.
4. Other vegetation near streams must be disturbed as little as possible during construction. Soil displacement as a result of clearing operations by the actions of plowing, disking, blading, other tillage, or grading equipment would be minimized in

SMZs. Shorelines that have to be disturbed must be stabilized as soon as possible and revegetated as soon as feasible.

(C) Protection of Unique Habitats

This category would be used when, for one or more specific reasons, a temporary or permanent aquatic habitat requires special protection. This relatively uncommon level of protection would be appropriate and required when a unique habitat requiring special protection is present (for example, the spawning area of a rare species), the stream is known to be occupied by a federal-listed or significant state-listed species, or when required as a special condition resulting from consultation with the U.S. Fish and Wildlife Service to avoid project effects on a listed species or designated critical habitat. The purpose of the following guidelines is to avoid or minimize any disturbance of the unique aquatic habitat.

Designation of this category should be discussed with the TVA Environmental Energy Delivery staff as early as possible after field survey by the TVA Biological Compliance Staff.

Guidelines:

1. Except as modified by Guidelines 2-4 below, all construction work around the unique habitat would be done using pertinent BMPs such as those described in Chapter 5, "Structural Controls Standards and Specifications."
2. Category C designations would be discussed with the TVA Environmental Energy Delivery staff as early as possible in the process to allow time to discuss possible avoidance or minimization of impacts with design and construction. Environmental Energy Delivery staff would discuss construction activities to take place in the SMZ with the Environmental Biological Compliance staff. On-site planning sessions would be conducted as needed. All crossings of streams also must comply with appropriate state (and, at times, federal) permitting requirements
3. Cutting of trees within SMZs must be accomplished by using either hand-held equipment or other appropriate clearing equipment (e.g., a feller-buncher) that would result in minimal soil disturbance and damage to low-lying vegetation. The method would be selected based on site-specific conditions and topography to minimize soil disturbance and impacts to the SMZ and surrounding area. Cutting of trees near permanent streams should be limited to those required to meet National Electrical Safety Code, FERC standards, and danger tree requirements. Stumps can be cut close to ground level but must not be removed or uprooted..
4. Other vegetation near the unique habitat must be disturbed as little as possible during construction. Soil disturbance by plowing, disking, blading, or grading must be kept to a minimum. Areas that have to be disturbed must be stabilized as soon as possible and revegetated as soon as feasible.
5. Special SMZ requirements would be coordinated with Environmental Biological Compliance staff.

Maintenance

During ongoing operations, inspect SMZs frequently; and, inspect occasionally during inactive periods. Check for potentially damaging or failing situations that may cause

unacceptable water quality impacts. Correct failing situations as soon as practical.

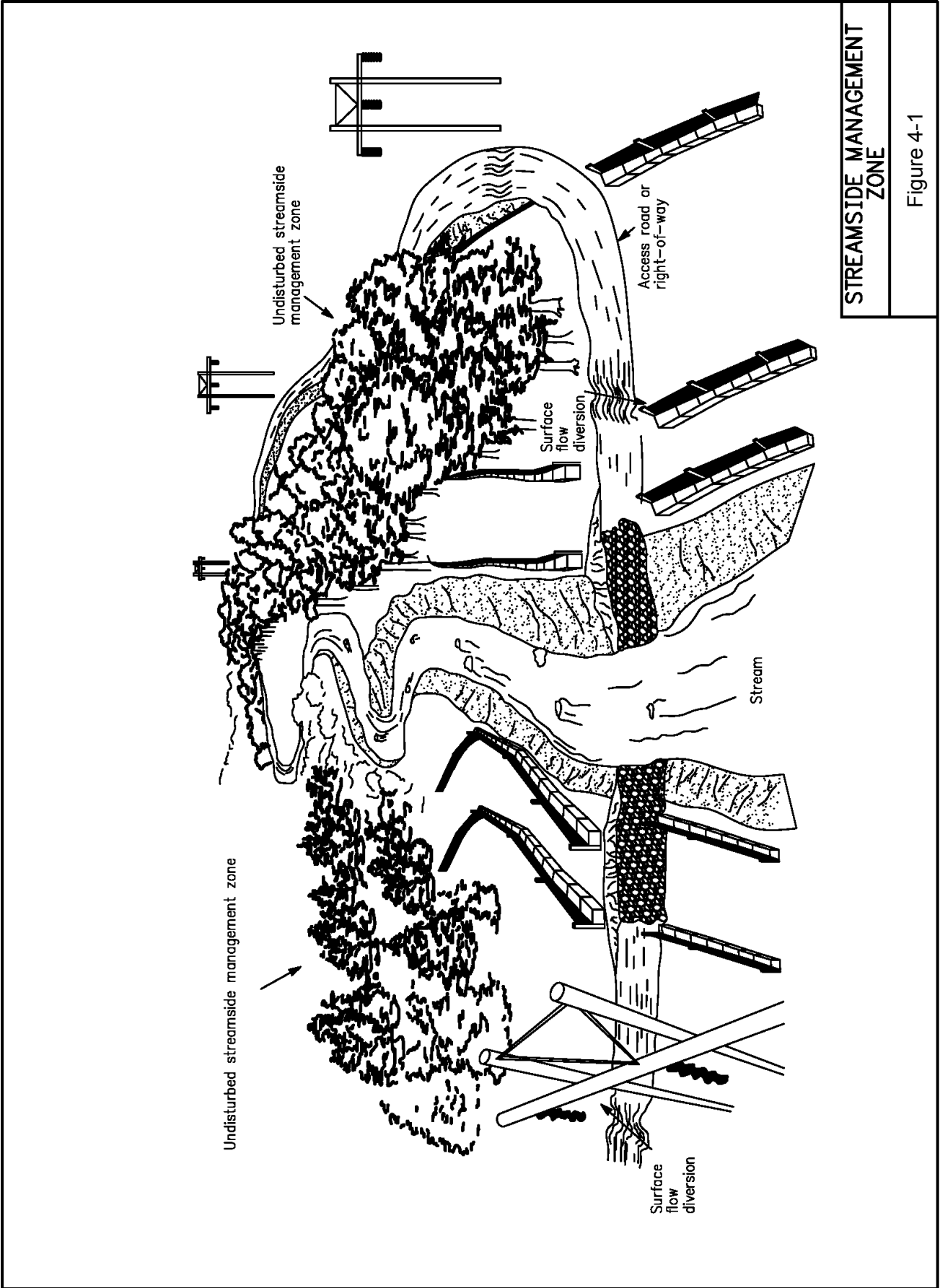

STREAMSIDE MANAGEMENT ZONE
Figure 4-1

4 - B. Wetlands

The U.S. Army Corps of Engineers (Corps) and the EPA define wetlands as “*areas that are inundated or saturated by surface or ground water at a frequency and duration sufficient to support, and that under normal conditions, do support a prevalence of vegetation typically adapted for life in saturated soil conditions. Wetlands generally include swamps, marshes, bogs, and other similar areas*”. They can also be less obvious areas such as flats and bottoms that do not appear wet, in isolated depressions surrounded by dry land (i.e. “pot-holes”), along the margins of lakes or ponds, and in other low-lying areas where precipitation sufficiently saturates the soil (vernal pool sand bogs). Inland wetlands, such as those found in the TVA service area, include marshes and wet meadows dominated by herbaceous plants, swamps dominated by shrubs, and wooded swamps dominated by trees.

Wetlands have been recognized as one of the Nation’s important resources. Wetlands have many functions and values among which include: water quality improvement, timber production, fish and wildlife habitat, scenic beauty, recreation, nutrient cycling, ground water recharge, flood abatement, education, and research.

Properly and carefully implemented BMPs would protect and enhance important wetland functions on most sites under most weather conditions. On extremely sensitive sites or in extremely severe weather conditions, more stringent measures may be required, including complete avoidance of such sites.

A national standard exists that helps reduce some of the confusion about identifying wetlands areas and delineating their boundaries. The methodology is found in the Federal Manual for Identifying and Delineating Jurisdictional Wetlands (Environmental Laboratory 1987). According to federal guidelines, wetlands possess three essential characteristics: (1) wetland hydrology, (2) hydrophytic vegetation, and (3) hydric soils. Each characteristic is described in the following text.

Wetland Hydrology

Areas with wetland hydrology are periodically inundated or have soils saturated to the surface at some point during the growing season. This situation usually creates anaerobic (oxygen depleted) conditions in the soil which affect the type of plants that can grow and the types of soils that develop. All wetlands usually have an abundance of seasonal water that may come from direct precipitation, overbank flooding, surface water runoff, or ground water discharge. Factors that influence the wetness of an area include precipitation, stratigraphy, topography, soil permeability, and plant cover.

Evidence of periodic presence of inundation typically seen in wetlands are water marks, drift lines, water-borne sediment deposits, surface scouring, and morphological plant adaptations such as cypress knees and buttressed trunks on trees.

Hydrophytic Vegetation

Hydrophytic plants are adapted to growing in water, soil, or on a substrate that is at least periodically deficient in oxygen as a result of excessive water content. A national interagency panel has developed a “National List of Plant Species That Occur in Wetlands” (www.library.fws.gov/Pubs9/wetlands_plantlist96.pdf) that has been subdivided into regional lists (US Fish & Wildlife, 1997). The list separates vascular plants into five basic groups commonly called “wetland indicator status” based on a plant species frequency occurrence in

wetlands. They are (1) obligate wetland, (2) facultative wetland, (3) facultative, (4) facultative upland, and (5) obligate upland. An area has met the hydrophytic vegetation criteria when, under normal circumstances, more than 50 percent of the composition of the dominant species from all the strata (trees, shrubs, grasses) are obligate wetland (OBL), facultative wetland (FACW), and /or facultative (FAC) species.

Hydric Soils

The U.S. Department of Agriculture Natural Resource Conservation Service (1999) has defined hydric soils as soils that are saturated, flooded, or ponded long enough during the growing season to develop anaerobic conditions that favor growth and regeneration of hydrophytic vegetation. Most soils in TVA's Power Service Area are thermic with a growing season of March - October. Site-specific soil types, including hydric, have been delineated at the county level and can be viewed at the following web address:

<http://websoilsurvey.nrcs.usda.gov/app/WebSoilSurvey.aspx>

If the name of the soil in your area is not known, an examination of the soil may generically indicate the presence of hydric soil.

Hydric Soil Characteristics

1. Soil consists predominantly of decomposed plant material (peats or mucks).
2. Soil has a thick layer of decomposing plant material on the surface.
3. Soil has a bluish gray or gray color below the surface, or the major color of the soil at this depth is dark (brownish black or black) and dull.
4. Soil has the odor of rotten eggs.
5. Soil is sandy and has a layer of decomposing plant material at the soil surface.
6. Soil is sandy and has dark stains or dark streaks of organic material in the upper layer below the soil surface. These streaks are decomposed plant material attached to the soil particles. When soil from these streaks is rubbed between the fingers, a dark stain is left on the fingers.

4 - C. In-Wetland Clearing, Construction, and Restoration Techniques

The most desirable BMP pertaining to wetland areas is avoidance of wetlands and leaving intact naturalized wetland buffers. Once all avoidance strategies are explored, employed, and/or eliminated due to other constraints, then properly and carefully implemented BMPs are to be used to minimize wetland impacts and protect important wetland functions during transmission line construction and maintenance.

The following material describes the methods to be used to minimize impacts of clearing and transmission line construction in wetland areas. Work in wetland areas may be subject to approval from local, state, and/or federal regulatory agencies. Use of these methods may be subject to approval by the appropriate regulatory agencies (Corps, state water pollution control agency, etc.) and must be carefully selected on a site-by-site basis. Any of these methods may be modified or eliminated by a regulatory agency at any time.

To evaluate the appropriate BMPs to be implemented, the following approach is in place.

1. Identify and delineate wetland area on-site, according to current acceptable definitions.
2. Evaluate alternatives; implement wetland and wetland buffer avoidance strategies to the extent practicable; determine wetland area/location/type of unavoidable wetland impact(s).
3. Map wetland area on all site plans and include a minimum 50 foot wetland buffer.
4. Implement a site specific clearing/construction/restoration plan designed by a qualified wetland biologist for each project which involves work in wetlands. This plan would outline the selected BMPs that would be used as the project proceeds.
5. Incorporate Integrated Vegetation Management strategies in cleared wetland areas on new lines, wherever practicable, to reduce maintenance costs in the long-term.

General Rules for BMPs for work in wetlands

Pre-job briefing would be conducted such that TVA employees, TVA contractors, and/or TVA subcontractors will know where wetland resources are located within the project footprint, how activities will be conducted in wetlands and wetland buffers, and/or how wetlands will be crossed.

Silt fence installation and/or weed free bale barrier (staked straw bales) (one or both, depending on the specifications of the project) is installed where soil disturbance is proposed within 50 feet of wetland buffer. Silt fence and/or staked straw bales are installed along wetland buffer or limits of soil disturbance (whichever is further from wetland boundary) where disturbance takes place within 50 feet of wetland buffer. Silt fence should not constrict flow. Refer to Silt Fence section for more information.

Adhere to a dry season schedule for work activities in wetlands (September to mid-November), when practicable.

Only low ground pressure equipment or other vehicles such as those with rubberized tracks, wide tires, or lightweight equipment (ATVs) should enter delineated wetland areas. Matting should be used when heavy equipment entry is necessary.

Woody debris should be removed a minimum of 50 feet outside any wetland boundary or drainage feature when possible and damage to the wetland will not occur. When necessary to

minimize soil disturbance and water quality impacts, woody debris may be allowed to remain in the wetland. In these circumstances, the Corps would be contacted if necessary.

Woody vegetation should be cut less than 12 inches from ground level.

Stumps are not removed or grubbed unless stated otherwise according to approved project specifications.

Where potential for soil ruts greater than 12 inches deep is present, temporary wetland crossings are to be used for equipment access: wood mats, pipe mats, panels or pallets, metal grating, cut-and-cross lay road, pole road, etc. All temporary crossings should be removed following completion of work.

Flow into or out of the wetland should not be restricted during work activities, unless stated otherwise according to approved project specifications.

All contours or elevations within wetland and wetland buffer are to be restored to preconstruction specifications unless stated otherwise according to approved project specifications.

No mechanical bed preparation or fertilization for restoration purposes should take place in wetlands unless stated otherwise according to approved project specifications.

All disturbed and exposed soils within wetland or wetland buffers should be seeded with the approved and appropriate vegetation seed mix within 14 days of exposure or immediately after the cessation of work activities, whichever comes first.

Only aquatic approved herbicides will be used within wetlands and wetland buffers. Refer to Herbicide section for more information.

Possible Wetland and Wetland Buffer Clearing Methods (WCM)

WCM-1: *Wetland Avoidance*

The wetland and wetland buffer is a scrub-shrub, emergent, or grazed wetland with no clearing required, and all vehicular traffic can navigate around the wetland. No heavy equipment would be used in the site.

WCM-2: *Manual Clearing Using Hand Carried Tools (selective)*

Using hand carried tools, brush and timber would be cut less than 12 inches from ground level or trimmed to a height which eliminates electrical clearance and safety problems. Timber would be removed by standard forestry practices with minimal ground disturbance (no rutting deeper than 12 inches). Woody stumps would be treated with an approved herbicide to prevent re-sprouts. A follow-up restoration plan may be necessary to establish an early successive herbaceous/scrub-shrub vegetative community in order to minimize long term maintenance efforts and associated costs.

WCM-3: *Clearing Using Low Ground Pressure Equipment (non-selective)*

Using low-ground pressure equipment, brush & timber would be cut less than 12 inches from ground level or trimmed to a height which eliminates electrical clearance and safety problems. Timber would be removed by standard forestry practices with minimal ground disturbance (no

rutting deeper than 12 inches). Woody stumps would be treated with an approved herbicide to prevent re-sprouts. A follow-up restoration plan may be necessary to establish an early successive herbaceous/scrub-shrub vegetative community and deter long term maintenance efforts and associated costs.

WCM-4: Herbicide Application, Individual Stems (selective)

Using an approved herbicide, individual brush and timber within the wetland and wetland buffer would be selectively herbicided such that electrical clearance and safety problems are eliminated and a low growing vegetative community is maintained. A follow-up restoration plan may be necessary to establish an early successive herbaceous/scrub-shrub vegetative community and deter long term maintenance efforts and associated costs.

WCM-5: Herbicide Application, Broadcast (non-selective)

Using an approved herbicide, the wetland and wetland buffer within the ROW would be broadcast herbicided such that electrical clearance and safety problems are eliminated and a low growing vegetative community is maintained. A follow-up restoration plan may be necessary to establish an early successive herbaceous/scrub-shrub vegetative community and deter long term maintenance efforts and associated costs.

WCM-6: Herbicide Application, Aerial Spray (non-selective)

Using an approved herbicide, the wetland and wetland buffer within the ROW would be broadcast herbicided such that electrical clearance and safety problems are eliminated and a low growing vegetative community is maintained. A follow-up restoration plan may be necessary to establish an early successive herbaceous/scrub-shrub vegetative community and deter long term maintenance efforts and associated costs.

Possible Wetland Access Methods (WAM)

WAM-1: Wetland Avoidance

No access will be conducted across wetland areas.

WAM-2: Cut and Cross-lay (Pole) Road

Cut and cross-lay (pole) road may be constructed for clearing and line construction or re-clearing and maintenance access. If a cut and cross-lay road is constructed, the road should be removed once line construction or maintenance is. The cut and cross-lay road may be allowed to remain based upon the Corps' District determination in order to minimize soil disturbance and water quality impacts.

WAM-3: Temporary Crossings - Matting

Wood mats, pipe mats, panels or pallets, metal grating, or similar materials may be laid for temporary crossings or access through wetlands. All temporary crossings are removed following completion of work.

Possible Wetland and Wetland Buffer Structure Placement Methods (WSP)

WSP-1: Wetland and Wetland Buffer Avoidance

No structures will be located within the boundaries of the wetland or wetland buffer.

WSP-2: Low Ground Pressure Equipment

Structure placement would be accomplished using low ground pressure equipment. Rutting would not exceed 12 inches within the boundaries of the wetland. Visual inspections of

soil/hydraulic conditions will be used to determine appropriate times for ingress and egress.

WSP-3: Standard Construction with Matting

Structure placement will be accomplished using standard construction techniques, with access accomplished from upland sites. Matting would be used to minimize soil disturbance in immediate vicinity of structure. When the ground is not saturated and when rutting would be less than 12 inches, mats maybe omitted from use.

WSP-4: Helicopter

Structure placement would be accomplished using a helicopter. Excavation would be accomplished by hand, pneumatic power equipment, or some other method not requiring ingress & egress of heavy equipment/large vehicles.

Possible Wetland and Wetland Buffer Restoration Methods (WRM)

WRM-1: Re-grading

Following vegetation clearing and soil disturbance, the original contours would be restored. All separated top soil would be placed on top of excavated/restored soils.

WRM-2: No Vegetation Restoration

Brush and timber clearing does not result in soil disturbance, such that understory vegetation is allowed to remain and gaps are allowed to be filled in with naturalized vegetation present in the seed banks.

WRM-3: Temporary Vegetation Restoration

Approved species (See Appendix TEMPORARY SEED MIXTURE for WETLANDS) are hand or broadcast seeded or hydroseeded and seed-free mulched to encourage establishment and prevent erosion during temporary exposure of disturbed soils.

WRM-4: Permanent Vegetation Restoration

Approved native species (See Appendix PERMANENT SEED MIXTURE for WETLANDS) are hand or broadcast seeded or hydroseeded followed by seed-free mulch to encourage establishment and prevent erosion once construction has ceased. No mechanical seedbed preparation (disking) would be done, and no fertilizer would be used, unless approved and permitted by the Corps.

WRM-5: Integrated Vegetation Management

A detailed wetland restoration plan developed and approved by a qualified wetland biologist is implemented to incorporate Integrated Vegetation Management and reduce long-term costs associated with ROW maintenance. The restoration plan includes a low-growing herbaceous or scrub-shrub community within the wire zones (below the wires and 10 feet out), and a small tree or scrub-shrub community outside the wire zone within the ROW. Wetland and wetland buffer vegetation is established via re-growth from existing seed bank, introduction of native seed (hand, broadcast, hydroseeding), and/or installation of bare root or balled and burlapped woody wetland species.

Possible Structure Retirement (Demolition) Methods (WSR):

WSR-1: The existing transmission line would be retired (demolished) by using a low-ground pressure equipment and labor crews. If soil rutting potential is greater than 12 inches, other wetland access BMPs would be in place to minimize wetland impacts.

WSR-2: Conventional equipment (dozers, trucks, etc.) would be used to take down the existing line. If heavy equipment is required to enter delineated wetland area and soil rutting potential is greater than 12 inches, wetland access BMPs would be in place to minimize wetland impacts.

WSR-3: Precision cutting and helicopter removal would be used to remove the line. No wheeled equipment would be allowed in the wetland area.

4 - D. Sensitive Biological Resources

New Transmission Line Construction

When federally listed threatened or endangered plant species occur in areas where new transmission line is being constructed, the following avoidance measures may be used to minimize damage to the species. Project specific commitments (including avoidance of significant state listed species) would be included in the environmental review and be decided on a project by project basis by Energy Delivery Environmental Support staff and the Biological Compliance staff.

Areas containing listed plants would be recorded on the plan and profile sheets specific to the proposed project.

The TVA right-of-way specialist overseeing clearing and construction would notify personnel at the pre-construction meeting that the listed species occurs in the project area.

Clearing of woody vegetation in areas with listed species would occur between November and mid-April if practicable and would be accomplished with a feller-buncher.

Heavy equipment would not be used to re-contour, remove tree stumps, or otherwise intentionally disturb the soil profile in areas containing listed plant species.

Vehicle and equipment access would be excluded from areas where listed species occur.

TVA Energy Delivery personnel would erect temporary fencing around areas where listed species occur.

Areas containing listed species would be revegetated only with native species or the non-native, non-invasive annual species listed in Chapter 7, "Seed and Plant Species List". Adjacent disturbed areas should be revegetated with a suitable permanent seed mix.

Specific requirements for the protection of sensitive resources may be outlined in the environmental reviews and/or detailed on maps and construction drawings.

Work on Existing Transmission Line Right of Way

Federally listed threatened and endangered plant species can occur on existing transmission line ROW. These species often occur on ROW because the plants prefer the open habitats found there. When federally listed threatened or endangered plant species occur in areas where work would occur on existing ROW, the following avoidance measures may be used to minimize damage to the species

Heavy equipment would not be used to re-contour, remove tree stumps, or otherwise intentionally disturb the soil profile in areas containing listed plant species.

Vehicle and equipment access would be excluded from areas where listed species occur.

TVA Energy Delivery personnel would erect temporary fencing around areas where listed species occur.

Areas containing listed species would be revegetated only with native species or the non-native, non-invasive annual species listed in Chapter 7, "Seed and Plant Species List". Adjacent disturbed areas should be revegetated with a suitable permanent seed mix.

Specific requirements for the protection of sensitive resources may be outlined in the environmental reviews and/or detailed on maps and construction drawings.

4 - E. Other Sensitive Resources

Site preparation, construction, and subsequent maintenance activities must not directly or indirectly cause adverse impacts to areas that possess certain unique values. Often times these areas are collectively referred to as “sensitive resources.” Sensitive resources can include, but are not limited to, caves, threatened/endangered or special status species (plants and animals), public water supplies, groundwater, and critical or unique wildlife habitat (e.g., trout streams, waterfowl habitat, wading-bird nesting areas, heronies, caves, sinkholes). If sensitive resources are identified by desktop or field reviews, specific buffer requirements and BMPs would be recommended by TVA’s Environmental Permitting & Compliance Biological and Cultural Compliance staff on a case-by-case basis in order to avoid or reduce the impact associated with that specific resource.

Additionally, in order to avoid adverse impacts, resources with archaeological, historical, ecological, geological, recreational, and scenic value may need protection during site preparation, construction, and maintenance activities. Examples of these special sites or areas include archaeological sites and historic structures or sites, state parks, forests, wildlife management areas and refuges, monuments, designated natural areas, recreational areas, and scenic rivers or parts of the National Wild and Scenic River System.

Sensitive resources that have been identified, would be marked on maps and construction drawings. Specific requirements for the protection of sensitive resources would be outlined in the environmental reviews and/or detailed on the maps and construction drawings. If a potentially sensitive resource is encountered in the field, and not marked on a map or detailed in the environmental review, contact Energy Delivery Environmental Support Staff.

Chapter 5
Structural Controls, Standards and Specifications



5 - A. Straw Bales

Definition

A temporary sediment barrier consisting of a row of entrenched and anchored straw bales (Figure 5-1).

Purpose

To capture sediment carried by sheet flow from disturbed areas by slowing and filtering construction stormwater.

Conditions where practice applies

The use of straw bales is not recommended as a primary erosion or sediment control method. Use only in conjunction with other approved BMPs (i.e. silt fence) for sediment control, primarily because they are 'temporary' in nature.

Straw bales should only be used in areas with very low sheet flow velocity .

Construction Specifications

Bales should be placed lengthwise on contour, embedded in the soil up to a minimum of 4 inches deep, and secured with a minimum of 2 foot wooden stakes or rebar through the bale.

The first stake in each bale must be driven toward the previously laid bale to force the bales together.

The upslope or runoff side of the bale should have compacted soil at the base of the bale (Figure 5-1).

The bale must be properly installed to work effectively as a sediment barrier.

Inspection and Maintenance

Straw bales should be inspected regularly, and maintenance should be expected as the bales deteriorate.

All straw bales should be removed once all project areas have been fully stabilized.

Points A should be higher than point B.

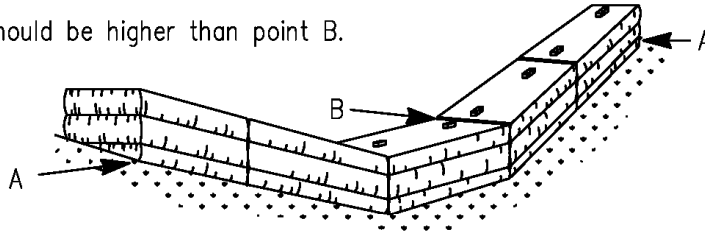

A. Proper placement of a straw bale barrier in a drainage way.

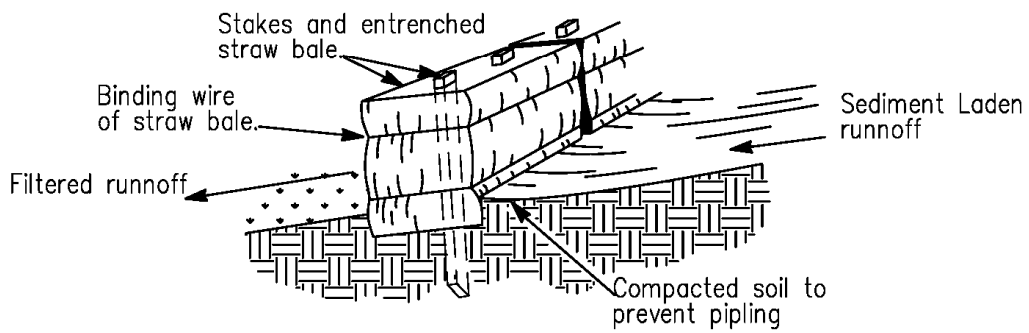

B. Cross-section of a properly installed straw bale.

DETAILS OF STRAW BARRIER

Figure 5-1

5 - B. Straw Wattles

Definition

Sediment barriers that are tubular in nature and conform to the lay of the land; they are generally made of wheat straw, rice straw, coir, or other material.

Come in a variety of sizes, most commonly 9 inches - 20 inches in diameter and generally 10 - 20 feet in length.

Can vary in strength and density of compaction (Figure 5-2).

Purpose

To capture sediment carried by sheet flow from disturbed areas by slowing and filtering construction stormwater.

Conditions where practice applies

Wattles are designed as an effective and economical method for sediment control and storm water runoff.

Wattles should only be used in areas with low sheet velocity.

Construction Specifications

Always refer to manufacturer's guidelines prior to installing wattles. Manufacturer's guidelines take precedence over specifications listed below.

Excavate a 2-3 inches deep by 9 inches wide (width should equal diameter of wattle) trench along the contour of the slope.

Place excavated soil up-slope of trench, and place wattle in trench ensuring good contact to soil surface.

Compact loose soil against wattle on uphill side. Secure wattle with 18-24 inches stakes every 4 feet with a stake on each end.

Stakes should be driven through middle of wattle leaving at least 2-3 inches extending above the wattle (Figure 5-2).

Inspection and Maintenance

Wattles should be inspected regularly, and maintenance should be expected as the bales deteriorate.

All wattles should be removed once all project areas have been fully stabilized

STRAW WATTLE

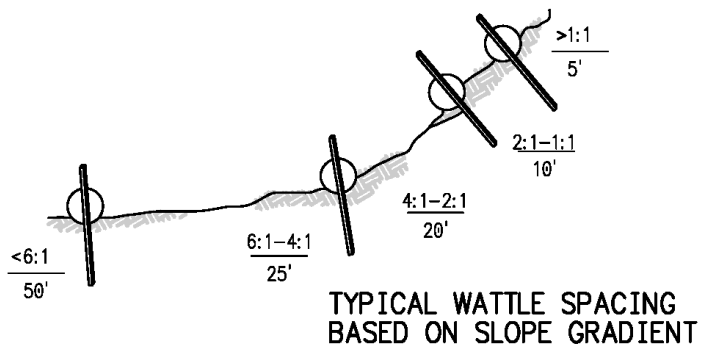
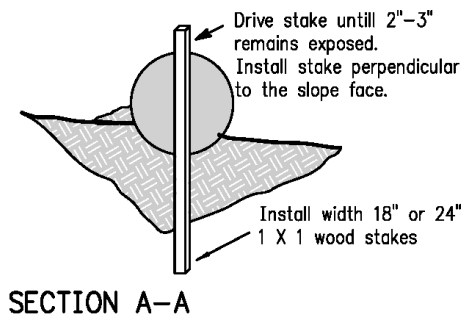
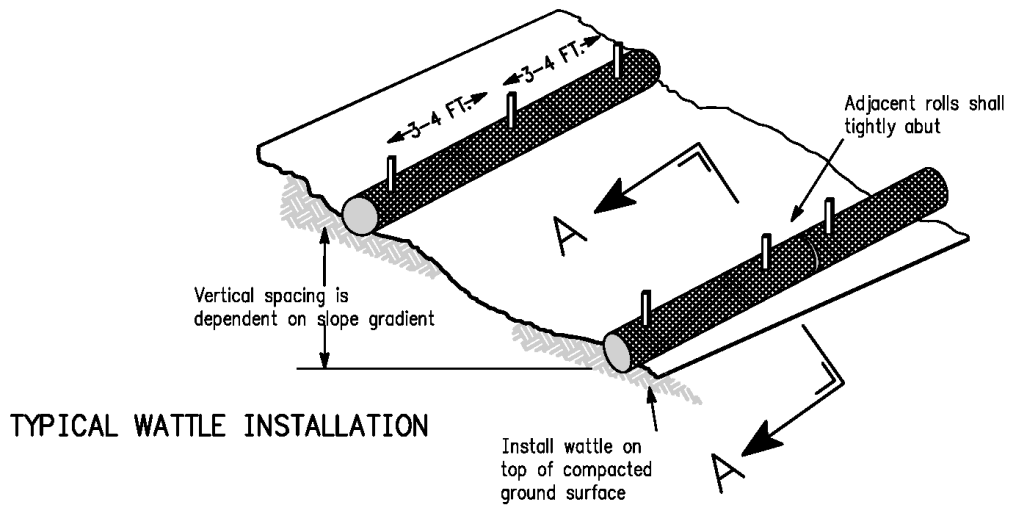

Notes:
Typical dimensions are shown.
Refer to wattle manufacturers
installation instructions.

STRAW WATTLE

Figure 5-2

5 - C. Mulch Berms

Definition

An embankment composed of mulch from trees, brush, grass and other materials as a result of land clearing activities

Purpose

To capture sediment carried by sheet flow from disturbed areas by slowing and filtering construction stormwater.

Conditions where practice applies

Mulch berms should be used on contour of disturbed slopes, therefore diminishing the velocity of surface runoff from up-slope areas. Mulch berms are 'temporary' in nature and are not to be placed in high flow areas

Construction Specifications

Type and, density of material, and width/height of berm must all be taken into account when selecting desired location.

Mulch berms are generally built 2-3 feet in height and 3-5 feet in width. The height of mulch berms should not violate transmission line clearances. Mulch berms are oriented to intercept sediment and storm water runoff.

Mulch berms should be used in conjunction with other BMPs to be most effective.

Compaction may be required depending upon the material used and uphill slope. Windrow on contour as practicable.

Inspection and Maintenance

Mulch berms should be inspected regularly, and maintenance should be expected as the mulch deteriorates.

All mulch berms should be removed once all project areas have been fully stabilized.

5 - D. Silt Fence

Definition

A temporary sediment barrier consisting of a woven, synthetic filtration fabric supported by steel or wood posts and entrenched into the soil (Figures 5-3 to 5-7).

Purpose

To capture sediment carried by sheet flow from disturbed areas by slowing and filtering construction storm water.

Conditions Where Practice Applies

Below disturbed areas where erosion would occur in the form of sheet and rill erosion.

In areas where sheet flow runoff can be stored by silt fence without damaging the silt fence or the submerged area behind the silt fence.

Silt fence should not be installed across streams, ditches, waterways, or other areas of concentrated flow.

Design Criteria

No formal design is required.

Silt fence should be installed along the contour of the slope.

See table 1 below for typical criteria of silt fence installed vs. slope length.

Table 5-1: Typical Criteria for Silt Fence Placement

Land Slope	Maximum Slope Length Above Fence
Percent	Feet
<2	100
2 - 5	75
5 - 10	50
10 - 20	25
>20*	15

*In areas where the slope is greater than 20%, a flat area length of 10 feet between the toe of the slope to the fence should be provided.

Normally, the drainage area should not exceed 0.25 acres per 100 feet of silt fence.

For long runs of silt fence, use J-hooks where appropriate to slow storm water flow and avoid silt fence failure. See Figure 5-3.

If possible, provide offset from toe of slope and silt fence for access and maintenance.

Silt fences are by and large divided into 3 categories; Type A, Type B, and Type C Silt Fence. The design criteria for each type are listed below. Refer to the applicable state BMP Manual for state specific silt fence criteria (e.g. Tennessee Type C silt fence mirrors the specifications for Alabama Type A silt fence):

Type A silt fence - This 36 inch wide filter fabric should be used on projects with a duration equal to or greater than 6 months. See Figure 5-4.

Type B silt fence - This silt fence should only be used on projects where stabilization will be achieved within 6 months. The filter fabric of Type B silt fence is only 22 inches wide but has the same flow rate as Type A silt fence. See Figure 5-5.

Type C silt fence - Similar to Type A silt fence, this filter fabric is 36 inches wide. It is installed on steel posts and includes wire reinforcement which allows a flow rate of almost 3 times the flow rate of Type A silt fence. Type C silt fence should be used on areas that produce high storm water velocity, sensitive environmental areas, and/or steep slopes. See Figure 5-6.

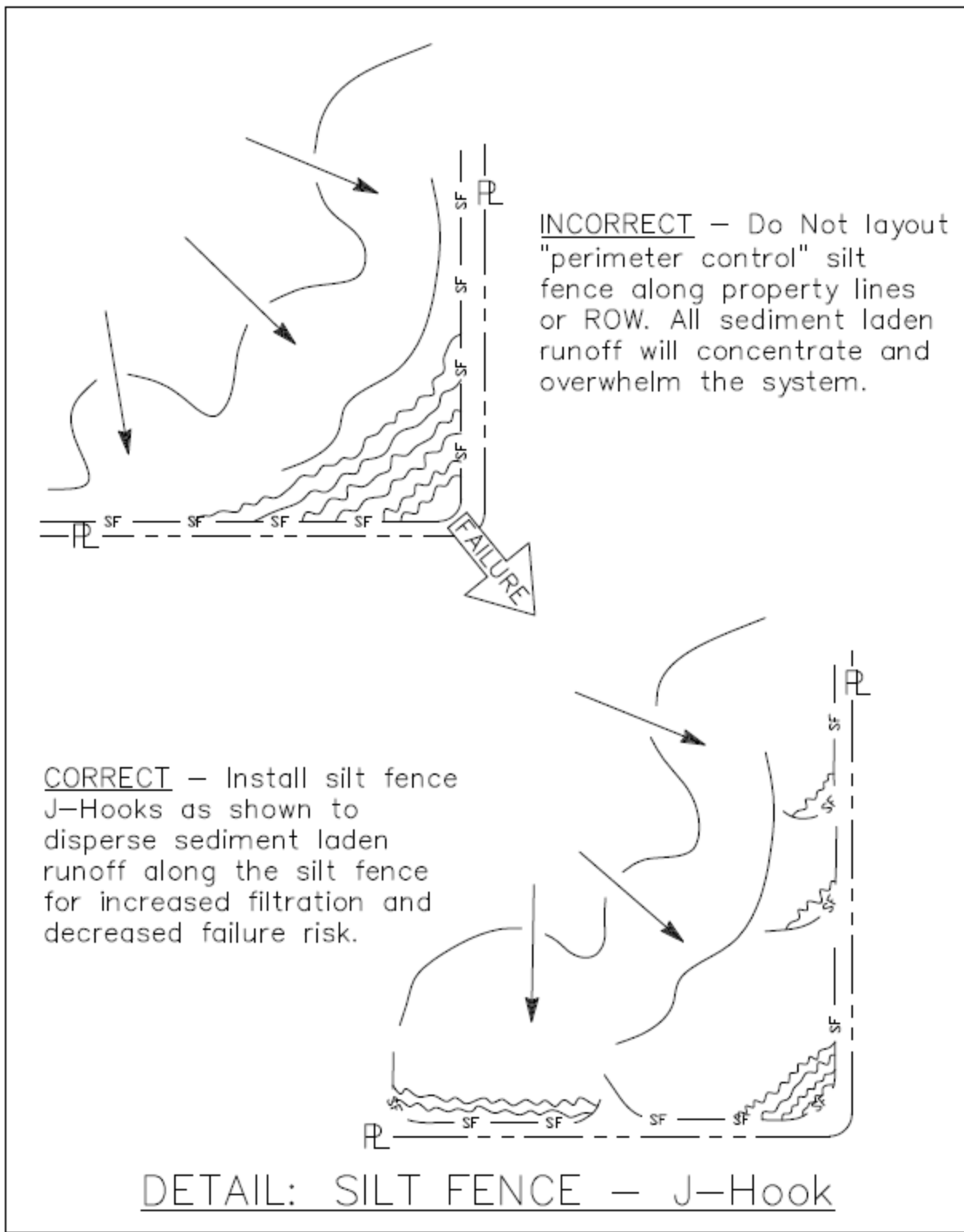

Figure 5-3

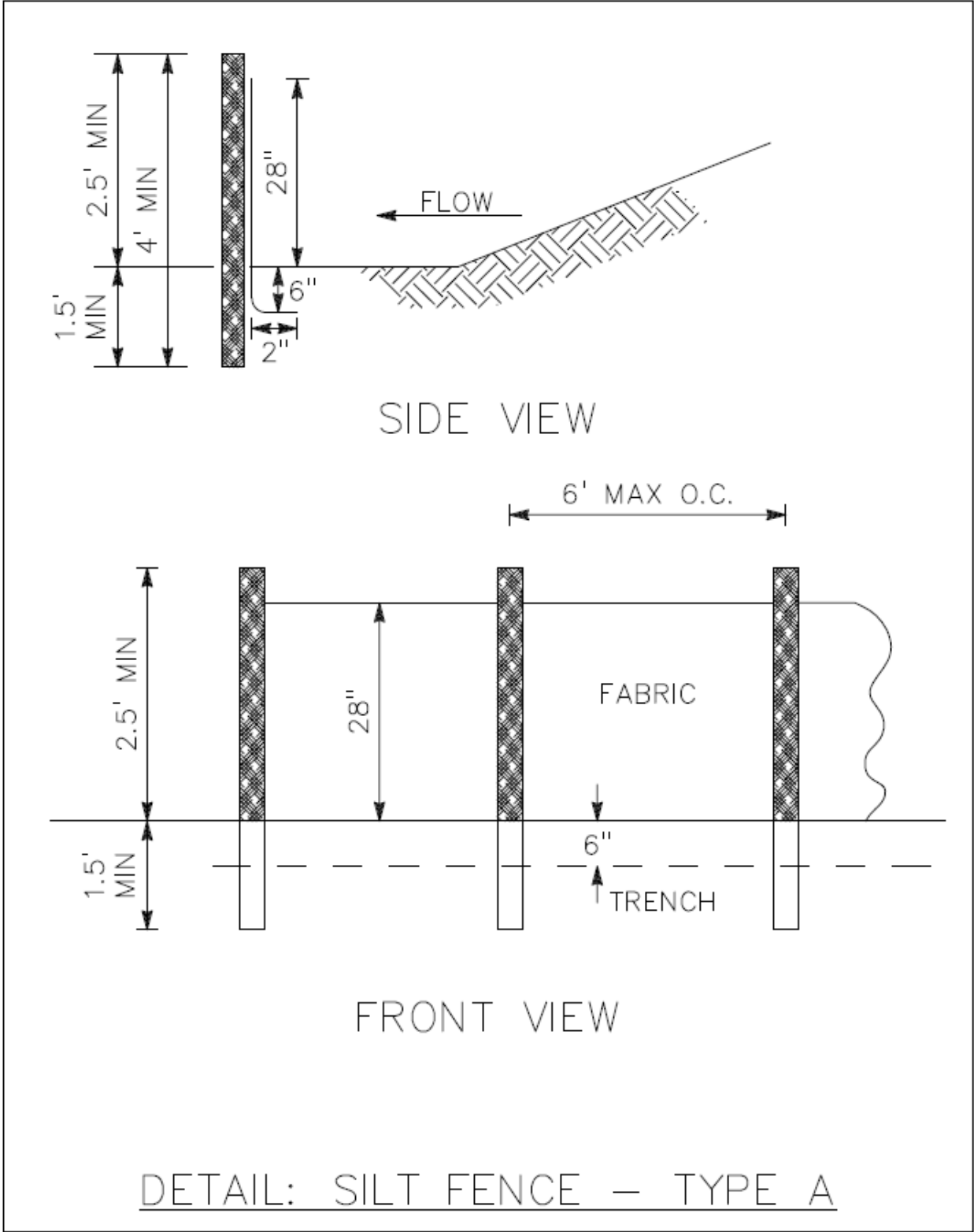

Figure 5-4

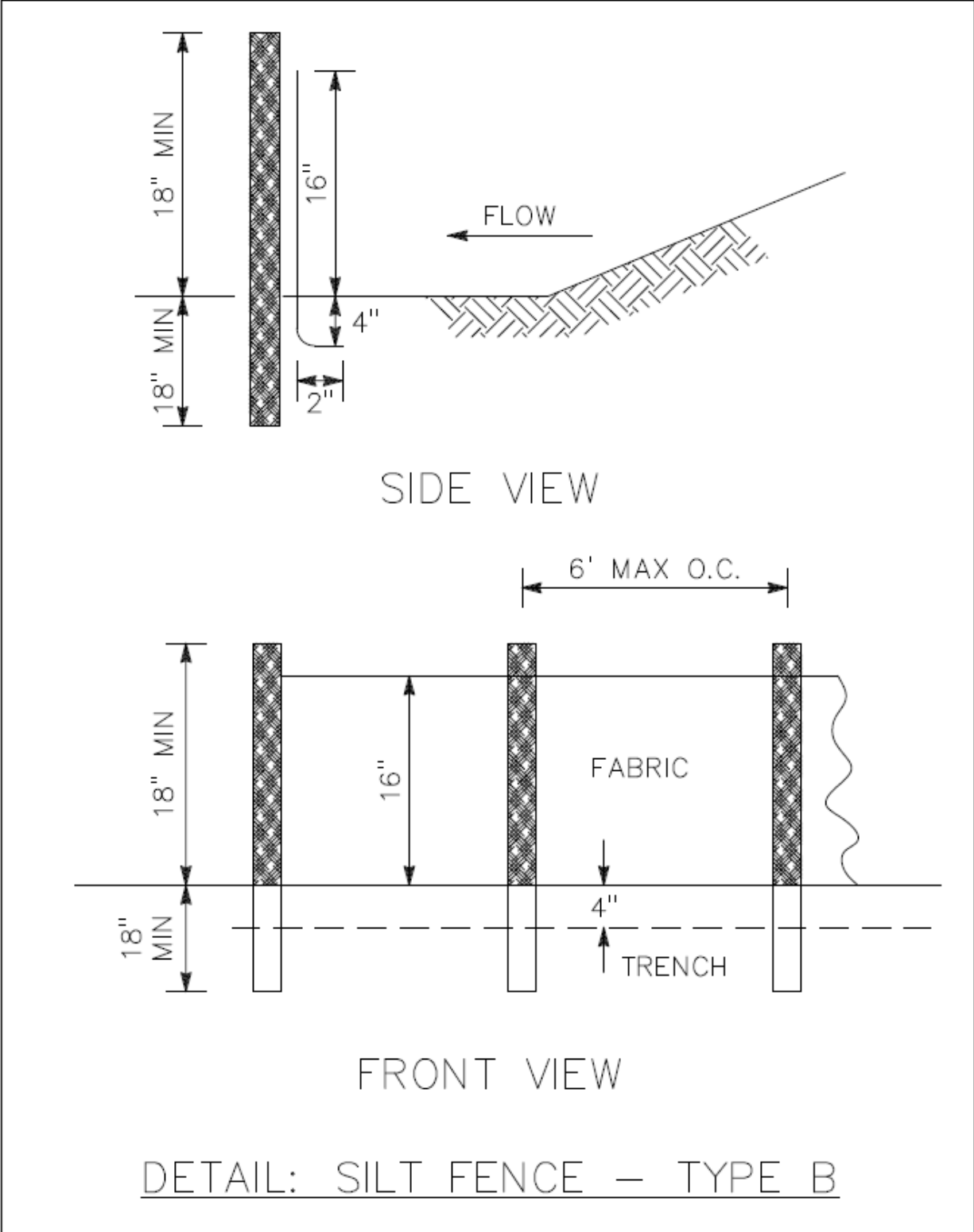

Figure 5-5

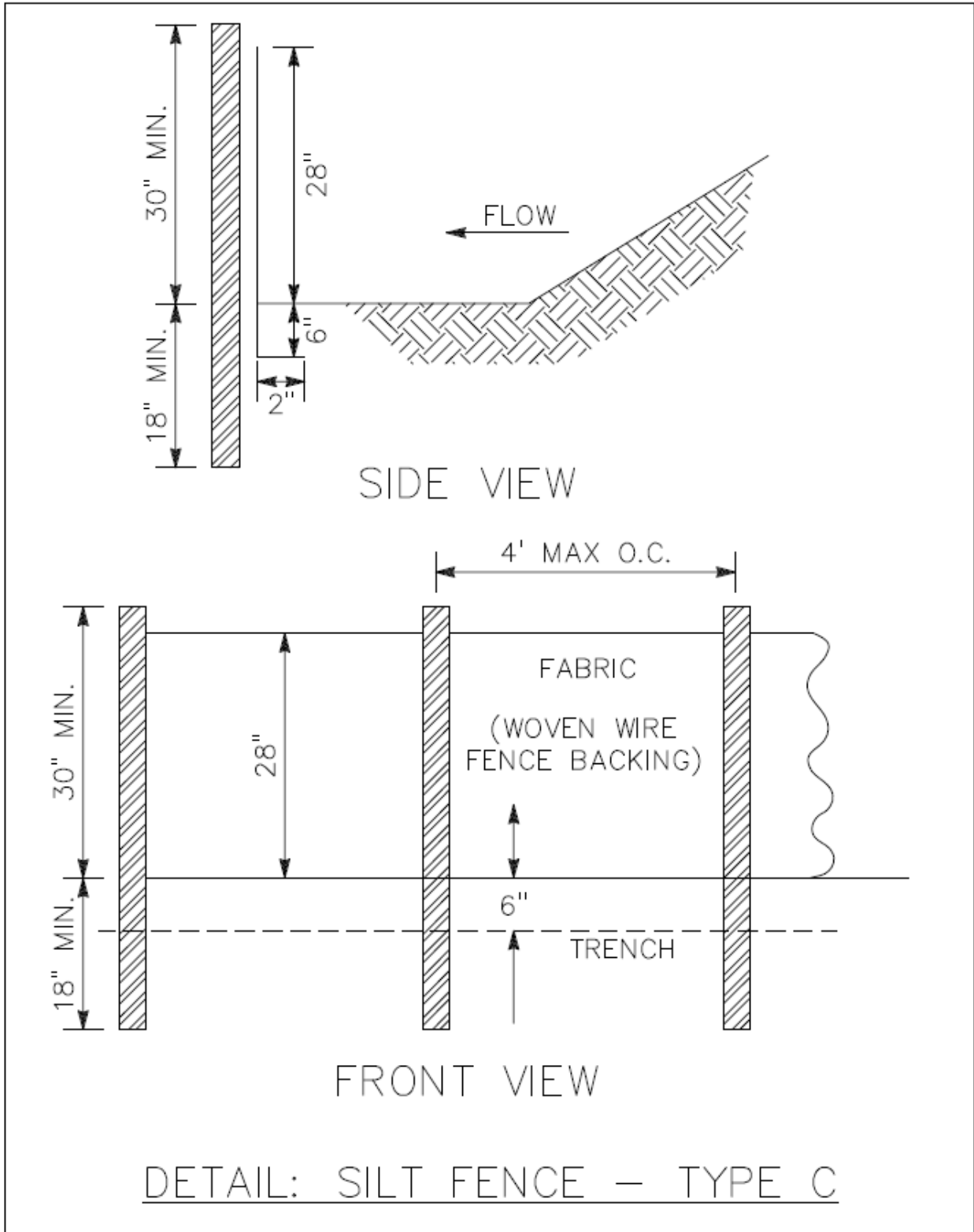

Figure 5-6

Construction Specifications

Silt fence is typically installed according to Figures 5-3 - 5-7. For Type A and B silt fence, posts should be staked 6 feet apart and can be either wood or steel. For Type C silt fence, posts should be staked 4 feet apart and must be steel due to higher flow rates. See Table 5-2 for recommended post specifications.

Table 5-2: Silt Fence Post Specifications

	Minimum Length	Type of Post	Size of Post
Type A	4'	Soft wood Oak Steel	3" dia. or 2x4 1.5" x 1.5" 1.3lb./ft. min
Type B	3'	Soft wood Oak Steel	2" dia. or 2x2 1" x 1" .75lb./ft. min
Type C	4'	Steel	1.3lb./ft. min.

The filter fabric should be purchased in a continuous roll cut to the length of the barrier to avoid the use of joints. When joints are necessary, filter cloth is usually spliced together only at a support post, with a minimum 6-inch overlap, and securely sealed. See Figure 5-7 for joint details.

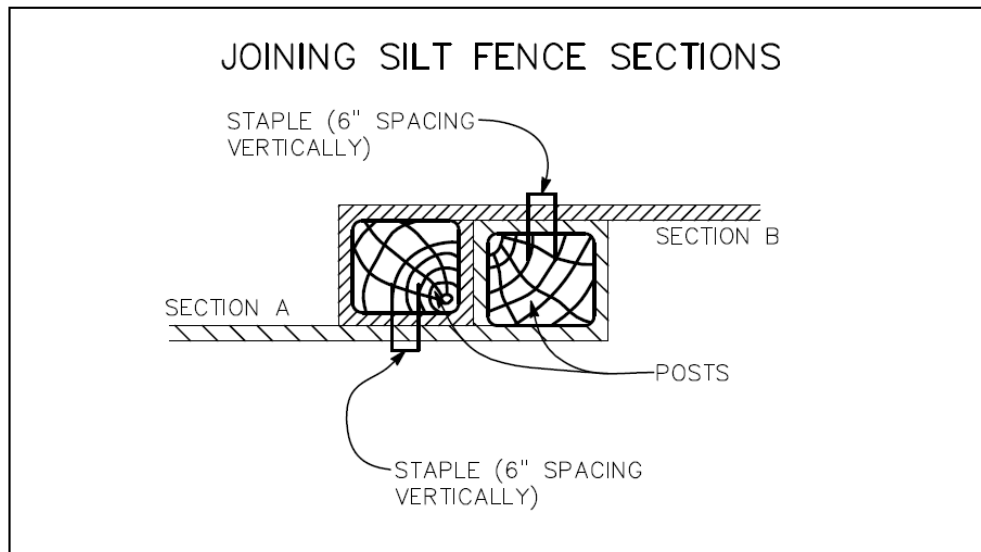

Figure 5-7: Silt Fence Joint Detail

Wire fence reinforcement for Type C silt fence using standard strength filter cloth is typically a minimum of 14 gauge and should have a maximum mesh spacing of 6 inches.

Post and/or wire reinforcement should be installed on the downhill side of the fabric.

Silt fence must be entrenched and backfilled with compacted soil to be effective in collecting sediment.

The ends of the silt fence should be turned uphill or otherwise configured to prevent end-around stormwater bypass.

Maintenance

Silt fence fabric that has deteriorated to such an extent that renders the silt fence ineffective should be replaced in areas that have not undergone final stabilization.

Sediment deposits should be removed when deposits reach approximately one-half the height of the barrier.

Any sediment accumulated by the silt fence must be properly removed to a secure area (e.g. spoil pile) and stabilized before the silt fence can be removed.

All silt fence should be removed once all project areas have been finally stabilized.

Wood Chip Guidelines

Different requirements from state to state govern the use of wood chips on the ROW. When wood chips are not able to be used on the ROW it is the responsibility of the clearing contractor to dispose of the wood chips.

State Guidelines:

Wood chip berms can be used in conjunction with silt fence as an effective BMP in all valley states except for Georgia. To gain permission to use wood chip berms in Georgia, the stormwater permit preparer should consult with Georgia EPD to obtain approval.

Use Guidelines:

In areas where it is not practical to put silt fence (i.e. extremely rocky soil) wood chips berms can be used instead of silt fence. The berms should be 5-6 feet wide at the base, 3-4 feet tall, and 3-4 wide at the top. The wood chips can be used as temporary ground cover on the ROW as long as they are not spread so deep that re-vegetation of the area is not possible. Wood Chips can be left in place or incorporated into the soil as final restoration as long as they don't impeded the establishment of permanent vegetation.

If permanent vegetation is going to be planted in an area where wood chips have been spread, lime should be supplemented at 2-3 tons per acre.

5 - E. Check Dams

Definition

A small temporary barrier or center-overflow dam constructed across a swale, drainage ditch, or area of concentrated flow (Figures 5-8 and 5-9).

Purpose

To minimize the erosion rate by reducing the velocity of storm water in areas of concentrated flow.

To filter turbid water and capture sediment.

Conditions where practice applies

Check dams are applicable for use in small open channels and should not be used in a live stream.

Temporary or permanent ditches or swales which need protection during the establishment of grass linings.

Temporary or permanent ditches or swales which, because of their short length of service, cannot receive a nonerodible lining but still need some protection to reduce erosion.

Other locations where small localized erosion and resulting sedimentation problems exist.

Design Criteria

Formal design is not required.

Typical check dams must be limited to use in small, open ditches that drain 5 acres or less.

The center of the check dam should be lower than its outer edges. Normally, the maximum check dam height is 2 feet measured from the center of the check dam. Ensure that edges of the dam tie into the upper portion of the ditch or channel to prevent bypass. See Figure 5-8.

When two or more check dams are used in series, the toe of the upstream check dam should be at the same elevation as the top of the downstream check dam. See Figure 5-9.

Check dam side slopes typically should not exceed 2:1.

A woven or nonwoven geotextile should be used as a separator between the stone and subgrade. This will prevent the migration of soil particles from the subgrade into the stone. Geotextile should be keyed into the subgrade on the upstream side.

Construction Specifications

Riprap should be used for check dams with rock diameter ranging from 6 inches to 12 inches. This riprap should be clean of any fines.

Mechanical and/or hand placement of stone should be used to ensure proper height, spacing, etc. of check dams.

Inspection and Maintenance

Check dams should be monitored for sediment accumulation after each significant rainfall. Sediment should be removed from behind the check dams when it has accumulated to one-half of the original height of the dam.

Check dams should be removed once all upstream drainage areas have been permanently stabilized. This can be accomplished by smoothing out the rock to create a rock lined ditch. If the area where the check dam is located is to be landscaped and mowed, then it should be removed completely. Any disturbed areas that remain should be seeded and mulched immediately.

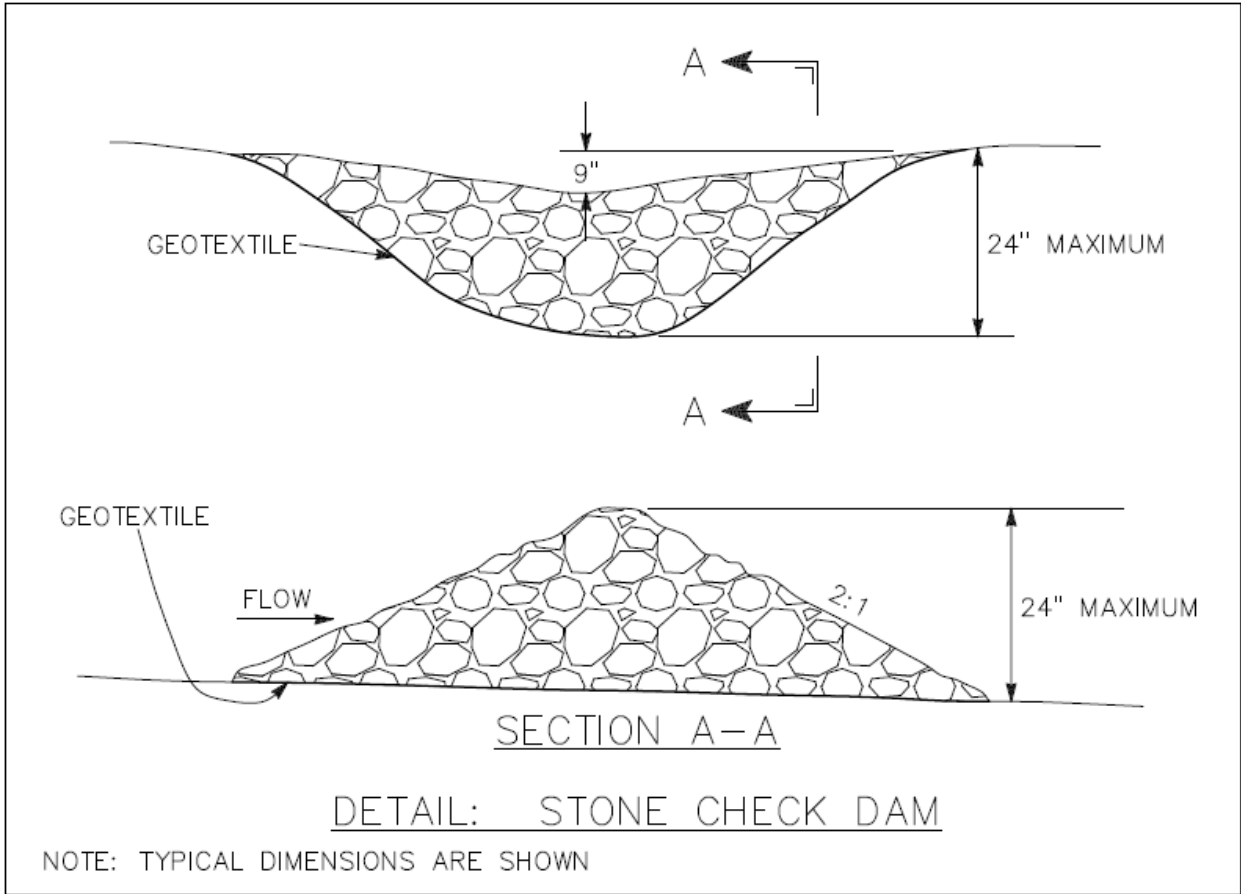

Figure 5-8

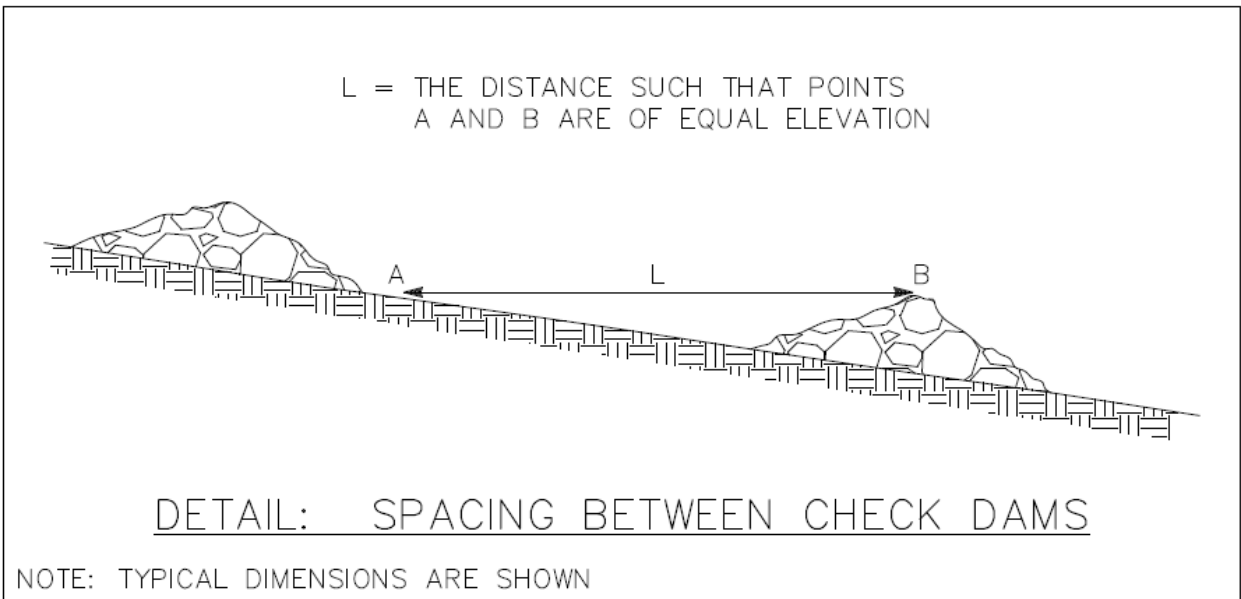

Figure 5-9

5 - F. Rock Filter Dam

Definition

A temporary or permanent stone filter dam installed across small streams or drainage ways. (Figure 5-10)

Purpose

To minimize the erosion rate by reducing the velocity of storm water.

To filter turbid water and capture sediment.

Conditions where practice applies

Rock filter dams are applicable for use in small streams and natural or constructed drainage ways on construction sites.

Because rock filter dams may be installed in state waters, all local, state, and federal laws and regulations must be followed during design, installation, and maintenance of rock filter dams.

These structures should be designed so that impounded water behind the structures would not overtop adjacent streambanks or otherwise encroach on adjoining property owners.

Design Criteria

Formal design is not required, but it is recommended that a qualified engineer be consulted for permanent rock filter dams and/or rock filter dams installed in state waters.

Rock filter dams should be installed as close to the disturbed area as possible to decrease the upstream drainage area and reduce the filtered storm water volume.

The center of the dam should be 9 inches lower than its outer edges. Ensure that edges of the dam tie into the upper portion of the ditch or channel to prevent bypass. See Figure 5-10.

The width across the top of the dam should be no less than 4 feet.

Rock filter dam side slopes should not exceed 2:1.

Geotextile: A woven or nonwoven geotextile should be used as a separator between the large and small stone as well as the stone and subgrade. This will aid in filtration and prevent the migration of soil particles from the subgrade into the stone. Geotextile should be keyed into the subgrade on the upstream side.

Construction Specifications

Riprap should be used as the base for rock filter dams with rock diameter ranging from 6 to 12 inches. This riprap should be clean of any fines.

Stone ranging from 0.75 inches to 1.50 inches should be used as the smaller stone on the upstream side of the rock filter dam. This stone should be clean of any fines.

Mechanical and/or hand placement of stone should be used to ensure proper height, spacing, etc. of the dams.

Inspection and Maintenance

Rock filter dams should be monitored for sediment accumulation after each significant rainfall. Sediment should be removed from behind the dams when it has accumulated to one-half of the original height of the dam.

Rock filter dams should be removed once all upstream drainage areas have been permanently stabilized. This can be accomplished by smoothing out the rock to create a rock lined ditch. If the area where the dam is located is to be landscaped and mowed, then it should be removed completely. Any disturbed areas that remain should be seeded and mulched immediately.

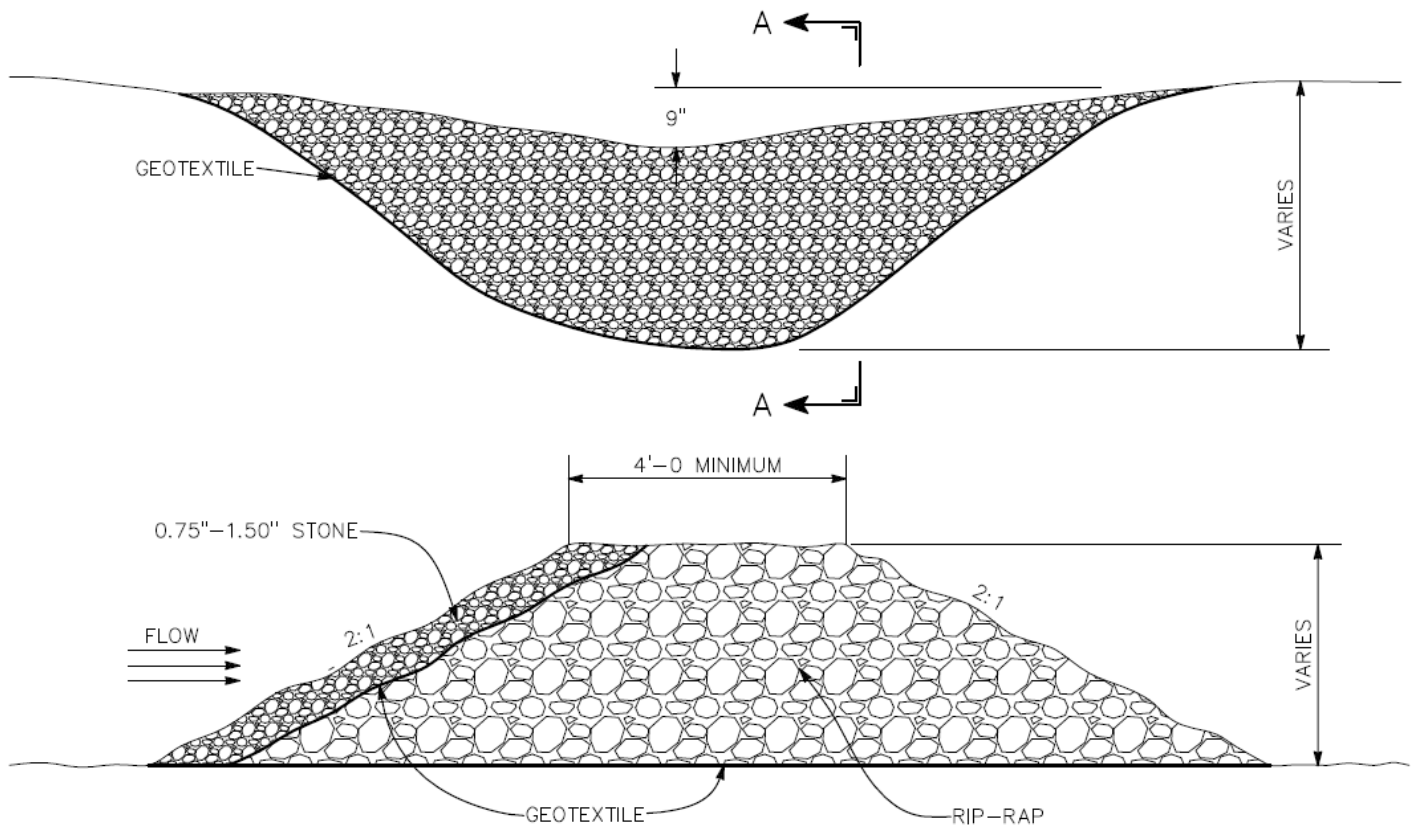

SECTION A-A
DETAIL: ROCK FILTER DAM

Figure 5-10

5 - G. Diversion

Definition

A temporary or permanent ridge of compacted soil, combined with an excavated channel, located at the top or base of a sloping disturbed area.

A diversion may consist of only a ridge of compacted soil or an excavated channel, but typically both are present. (Figure 5-11)

Purposes

To divert storm water runoff from higher drainage areas away from unprotected slopes to a stabilized outlet.

To divert sediment-laden runoff from a disturbed area to a sediment trapping facility.

To redirect storm water runoff on long slope lengths.

Conditions Where Practice Applies

Wherever stormwater runoff must be temporarily diverted to protect disturbed slopes or retain sediments on-site during construction.

Where runoff from higher areas may damage property, cause erosion, or interfere with the establishment of vegetation on lower areas.

Where the slope length needs to be reduced to minimize soil loss.

Planning Considerations

When used at the top of a slope, the structure protects exposed slopes by keeping upland runoff away. On moderately sloping areas, they may be placed at intervals to trap and divert sheet flow before it has a chance to concentrate and cause rill and gully erosion. When used at the base of a slope, the structure protects adjacent and downstream areas by diverting sediment-laden runoff to a sediment trapping facility. They can be used to protect structures, parking lots, adjacent properties, bodies of water, and other areas from flooding.

Adequate vegetation should be established as soon as possible after installation. It is equally important to stabilize the drainage area above the diversion so that sediment would not enter and accumulate in the diversion channel.

Design Criteria

No formal design is required for temporary diversions. Permanent diversions require design by a qualified professional. Diversion location should be determined by considering outlet conditions, topography, land use, soil type, length of slope, etc. The diversion channel may be parabolic, trapezoidal, or V-shaped. See Figure 5-11.

The maximum suggested allowable drainage area is 5 acres.

The typical minimum allowable height measured from the upslope side of the dike is 18 inches. A settlement factor of 10 percent should be considered.

Side slopes are typically 2:1 or flatter with a typical minimum ridge base width of 4.5 feet.

Typical freeboard, measured between the top of the channel design flow depth and the top of the compacted ridge is 0.3 feet.

On steeper slopes, narrow and deep channels may be required. On more gentle slopes, broad and shoulder channels are usually more appropriate. Channels should be sloped to ensure drainage and to avoid ponding.

The diverted runoff, if free of sediment, must be released through a stabilized outlet or channel. Sediment-laden runoff must be diverted and released through a sediment trapping structure.

Construction Specifications

Whenever feasible, the dike should be built before project construction begins.

The dike should be adequately compacted to prevent failure.

All trees, brush, stumps, obstructions, and other objectionable material should be removed to allow the proper functioning of the diversion

Temporary or permanent seeding and mulch should be applied to the dike following its construction.

The dike should be located to minimize damages by construction operations and traffic.

Inspection and Maintenance

Before final stabilization, the diversion should be inspected after every significant rainfall.

Sediment should be removed from the ditch line and repairs made as necessary. Seeded areas which fail to establish a vegetative cover should be reseeded as necessary.

Damages caused by construction traffic or other activity must be repaired quickly for diversion to operate properly.

Diversions may be removed after all disturbed areas have been stabilized.

Typical Diversion Cross-Sections

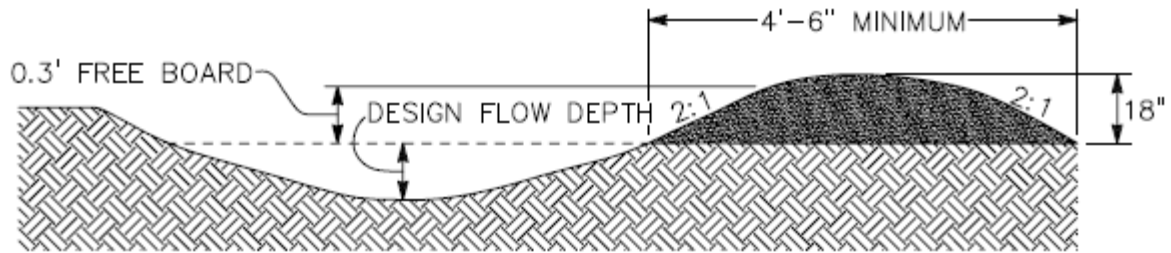

Typical Parabolic Diversion

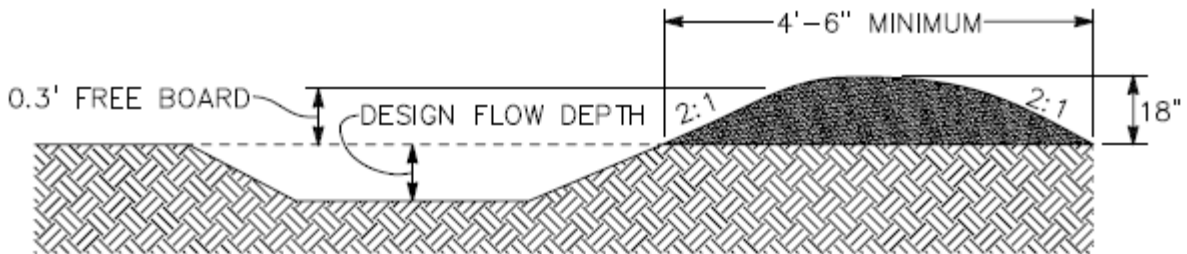

Typical Trapezoidal Diversion

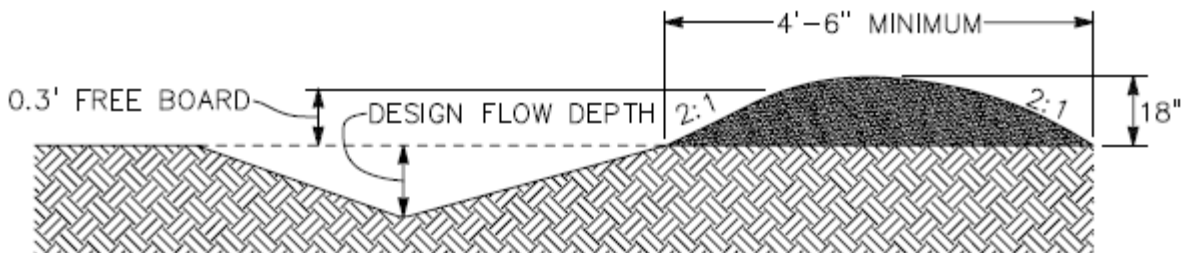

Typical Vee-Shaped Diversion

NOTE: TYPICAL DIMENSIONS ARE SHOWN

Figure 5-11

5 - H. Riprap

Definition

A permanent, erosion-resistant ground cover of large, loose, angular stone.

Purposes

To protect the soil surface from the erosive forces of concentrated runoff.

To slow the velocity of concentrated runoff while enhancing the potential for infiltration.

To stabilize slopes with seepage problems and/or noncohesive soils.

Conditions Where Practice Applies

Wherever the soil conditions, water turbulence and velocity, expected vegetative cover, etc. are such that the soil may erode under the design flow conditions.

Riprap may be used, as appropriate, at stormdrain outlets, on channel banks and/or bottoms, roadside ditches, drop structures, at the toe of slopes, etc

Planning Considerations

Graded vs. Uniform Riprap

Riprap is classified as either graded or uniform. A sample of graded riprap would contain a mixture of stones which vary in size from small to large. A sample of uniform riprap would contain stones which are all fairly close in size.

Graded riprap is cheaper to install, requiring only that the stones be dumped so that they remain in a well-graded mass. Hand or mechanical placement of individual stones may be necessary to achieve the proper thickness and line. Uniform riprap requires placement in a more or less uniform pattern, requiring more hand or mechanical labor.

Riprap sizes can be designated by either the diameter or the weight of the stones. However, it is simpler to specify the diameter of an equivalent size of spherical stone. Tables 1 and 2 list some typical stones by weight, spherical diameter, and the corresponding rectangular dimensions.

Sequence of Construction

Because riprap is used where erosion potential is high, construction must be sequenced so that the riprap is put in place with the minimum possible delay. Disturbance of areas where riprap is to be placed should be undertaken only when final preparation and placement of the riprap can follow immediately behind the initial disturbance. Where riprap is used for outlet protection, the riprap should be placed before or in conjunction with the construction of the pipe or channel so that it is in place when the pipe or channel begins to operate.

Gradation

The riprap should be composed of a well-graded mixture down to the one-inch size particle such that 50 percent of the mixture by weight should be larger than the d_{50} size as determined from the design procedure. A well-graded mixture as used herein is defined as a mixture composed

primarily of the larger stone sizes but with a sufficient mixture of other sizes to fill the progressively smaller voids between the stones.

Thickness

The minimum thickness of the riprap layer should be 1.5 times the maximum stone diameter but not less than 6 inches for most applications

Quality of Stone

Stone for riprap should consist of clean or washed field stone or rough unhewn quarry stone of approximately rectangular shape. The stone should be hard and angular and of such quality that it would not disintegrate on exposure to water or weathering, and it should be suitable in all other respects for the purpose intended. The specific gravity of the individual stones should be at least 2.5. Riprap stone must not adversely impact water chemistry of streams.

Riprap at Outlets

A stabilized discharge structure must be provided. Design criteria for sizing the stone and determining the dimensions of riprap pads used at the outlets of drainage structures are contained in several of the references cited in this manual. Geotextile should be used as an underlayment between the stone and bare ground.

Riprap for Channel Stabilization

State water pollution control departments require that they be contacted prior to any stream channel disturbance.

Riprap for channel stabilization should be designed to be stable for the condition of bank-full flow in the reach of the channel being stabilized. Riprap should extend up the banks of the channel to a height equal to the maximum depth of flow or to a point where vegetation can be established to adequately protect the channel.

The riprap size to be used in a channel bend should extend upstream from the point of curvature and downstream from the point of tangence. The riprap should extend across the bottom and up both sides of the channel.

Where riprap is used only for bank protection and does not extend across the bottom of the channel, riprap should be keyed into the bottom of the channel to a minimum depth equal to the thickness of the layer of riprap, and it should extend across the bottom of the channel the same distance.

Riprap for Slope Stabilization

Riprap for slope stabilization should be designed so that the natural angle of repose of the stone mixture is greater than the gradient of the slope being stabilized.

Inspection and Maintenance

A riprap installation should require very little maintenance. It should, however, be inspected periodically to determine if high flow events have caused scour beneath the riprap or dislodged any stone. If repairs are needed, they should be done immediately.

5 - I. Access Road and Parking Area Stabilization

Definition

The temporary stabilization of access roads, parking areas, and other on-site vehicle transportation routes with stone immediately after grading in preparation of excessive use.

Purposes

To reduce the erosion of temporary roadbeds caused by construction traffic during wet weather.

To reduce erosion and any regrading of permanent roadbeds between the time of initial grading and final stabilization.

Conditions Where Practice Applies

Wherever stone-base roads or parking areas are constructed, whether permanent or temporary, for use by construction traffic.

Construction Specifications

Temporary Access Roads and Parking Areas

The goal should be to drain water off the roads as soon as possible within practical and economical limits. Several drainage structures and techniques are available. The type, number, and mix needed are dependent upon topography, length of slope, soil types, equipment usage, and objectives for road use. Locations and types of drainage structures should be identified before road construction begins.

Temporary roads should follow the contour of the natural terrain to the extent possible. Slopes should not exceed 10 percent except in very short distances.

Temporary parking areas should be located on naturally flat areas to minimize grading. Grades should be sufficient to provide drainage but should not exceed 4 percent.

Access road corridors should be cleared to a width of 16 feet wide by 12 feet high, so as to allow passage of transport vehicles and heavy equipment.

Clearing includes removal of limbs, trees, downed timber, snags and underbrush which obstruct the prescribed corridor, as well as, the disposal of any debris.

Access roads should be graded to a width of 16 feet and have a smooth surface and uniform cross section. This item includes the installation of appropriate access road BMPs including but not limited to broad based drainage dips and/or water turnouts.

All cuts and fills should be 2:1 or flatter to the extent possible.

Drainage ditches should be provided as needed and should be designed and constructed to carry anticipated storm flows.

The roadbed or parking surface should be cleared of all vegetation, roots, and other objectionable material.

In select areas, a 3 inch (or more depending on field conditions) layer of clean aggregate should be placed, spread, and shaped on the graded access roads.

In some locations, conditions may warrant the use of geotextile in conjunction with crushed stone to increase soil bearing capacity. The geotextile fabric should be placed and covered with crushed stone in a manner which minimizes tearing (fabric specification: 15'-wide, woven synthetic, and 8-ounce or more per square yard).

All roadside ditches, cuts, fills, and disturbed areas adjacent to parking areas and roads should be stabilized with appropriate temporary or permanent vegetation.

Permanent Roads and Parking Areas should be designed and constructed in accordance with applicable state Department of Transportation or local criteria except that an initial base course of gravel of at least 6 inches should be applied after grading.

Inspection and Maintenance

Both temporary and permanent roads and parking areas may require periodic top dressing with new gravel.

Seeded areas adjacent to the roads and parking areas should be checked periodically to ensure that a vigorous stand of vegetation is maintained.

Roadside ditches and other drainage structures should be checked regularly to ensure that they do not become clogged with silt or other debris.

5 - J. Water Turnouts

Definition

A ditch, trench, or waterway that diverts water away from the road and/or side ditch. The turnout is usually formed of on-site soil material. Shape and size varies to meet site-specific needs.

Purpose

To carry water into undisturbed areas and to disperse surface flow to prevent energy build-up.

Conditions Where Practice Applies

Usually any road or ditch section where water accumulates. Turnouts are used to dissipate water energy, velocity, and volume.

Construction Specifications

A turnout should intersect the ditch line at the same depth and be outsloped 1 to 3 percent.

On sloping roads, a turnout should be 30- to 45-degrees downslope. Turnouts should not empty directly into adjacent drainages or channels of any type.

Inspection and Maintenance

Inspect frequently during on-going operations and immediately following significant rain events to evaluate their effectiveness.

Promptly correct conditions or situations that are ineffective.

5 - K. Water Bars

Definition

A combination “mound-trench” built into an access road and placed on a downslope angle across the travelway. Water bars can provide conditions suitable for natural or artificial vegetative cover and are typically installed after regular use of the road has ended.

Purpose

To intercept and divert surface water off the access road and minimize excessive erosion and/or gullyng.

Conditions Where Practice Applies

This practice can be used on road grade where runoff may cause erosion of the exposed soil.

Water bars are usually installed after regular use of the road has ended.

Construction Specifications

Water bars should be at an angle of 15 to 30 degrees downslope to turn surface water off the road, depending on the terrain.

The uphill end of the bar should extend into the side ditch line of the road and tie into the bank to fully intercept any ditch flows.

The outlet end of the bar is to be fully open and extend far enough to safely disperse runoff onto an undisturbed area.

Place energy absorbers, such as riprap or a level spreader, at water bar outlets when the potential for gullyng is evident.

Table 5-3: Proper Spacing of Water Bars

Road Grade (percent slope)	Distance Between Water Bars (feet)
5	135
10	80
15	60
20	45
30	35

Inspection and Maintenance

Inspect water bars after major rain storms or during inspections until area becomes adequately stabilized.

Promptly correct failing conditions.

5 - L. Broad-based Drainage Dips

Definition

A technique used to form a reverse slope in a road surface with an outsloped cross drain. Usually not used on steep roads.

Purpose

To provide cross drainage on flat and insloped access roads to prevent buildup of excessive surface runoff and subsequent erosion.

Conditions Where Practice Applies

Usually used on access roads having gradient of 12 percent or less. They should not be used for cross draining of spring seeps or intermittent or perennial streams.

Broad-based drainage dips in the road surface are very effective in collecting surface water and directing it safely off the road. This type structure allows normal truck speed with minimal stress to the vehicle.

Construction Specifications

Install broad-based drainage dips following basic clearing and grading of roadway.

A 20 foot (approx.) long, 3 percent reverse grade is formed using cut material from the upper side of the dip.

The bottom of the dip would be outsloped 2 to 3 percent maximum and extend the full width of the roadway. For maximum self-cleaning, angle cross drain 10 to 25 degrees downslope.

An energy absorber such as riprap or a level spreader, should be installed at the outlet of the dip to dissipate water velocity ensuring minimal erosion of cast materials.

The dip and reverse grade section may require bedding with 3 inch crushed stone in some soils to stabilize and avoid unacceptable rutting (i.e., grades over 10 percent and/or areas having highly erosive soils).

This structure consists of two planes rather than one unbroken plane. One plane is the 15 to 20 foot reverse grade toward the uphill grade and outlet. The second plane is the long grade from the top of a hump or start of a down grade and ends at the outlet of the dip.

Neither the dip nor the hump should have a sharp, angular break but should be rounded to allow a smooth flow of traffic. Only the dip itself should be outsloped to provide sufficient break in grade to turn the water.

Spacing of broad-based drainage dips may be determined by the following formula: Spacing in feet - 400 feet + 100 feet * Slope percent

Table 5-4: Recommended Spacing of Broad-Based Drainage Dips

Road Grade (percent)	Distance Between Dips (feet)
4	200
5	180
6	165
7	155
8	150
9	145
10	140
12	135

Inspection and Maintenance

During on-going operations, inspect frequently. Check for erosion, rutting, plugging, and general effectiveness.

Correct unacceptable situations promptly.

5 - M. Temporary Stream Crossing

Definition

A temporary structural or non-structural span installed across a flowing watercourse for use by construction or maintenance traffic. Structures may include bridges, round pipes, oval pipes, or pipe arches (Figure 5-12).

Refer to Culvert section for details on pipe crossings. Nonstructural is a ford-type crossing (Figure 5-13).

Purposes

To provide a means for traffic to cross flowing streams without damaging the stream channel or banks or causing flooding.

To keep sediment generated by traffic out of the stream.

To cross waterways with minimal negative impact to the stream.

Conditions Where Practice Applies

Generally applicable to flowing streams with drainage areas less than one square mile. Non-structural crossings are applicable for streams with maximum bank heights of 5 feet.

Planning Considerations

Temporary stream crossings are necessary to prevent vehicles and heavy equipment from damaging stream banks. All crossings are subject to the rules and regulations of the Corps and state water pollution control departments for in-stream modifications. All crossings are subject to an environmental review under the National Environmental Policy Act (NEPA) prior to installation.

Design Criteria

Temporary stream crossings are necessary to prevent vehicles and heavy equipment from damaging stream banks. All crossings are subject to the rules and regulations of the Corps of Engineers and state water pollution control departments. All crossings are subject to an environmental review under the National Environmental Policy Act (NEPA) prior to installation.

Keep stream crossings at right angles, if possible. The temporary stream crossing may vary up to 15 degrees from perpendicular with stable banks and channel bottoms.

The approach sections should consist of stone pads meeting the following specifications:

1. Stone--Class I -- Average 2-4 inches
2. Minimum thickness--6 inches
3. Minimum width equal to width necessary for vehicles or equipment to safely cross
4. Minimum approach lengths--25 feet unless physical or ROW restraints preclude

Construction Specifications

Clearing, grubbing, excavation, and other disturbance to the riparian vegetation of the stream bed and banks should be kept to a minimum.

Fords are "minimum use" crossings where the stream system has an existing or applied firm base. To avoid unacceptable impacts, apply adequate riprap stone or other effective material to crossings to stabilize road banks and stream channel. The final surface of the stone in the bottom of the watercourse should be the same elevation as the watercourse bottom in order to eliminate any overflow and possible scour problems. Riprap stone must not adversely impact water chemistry of streams.

Geotextile filter fabric cloth should be placed on the streambed and stream banks prior to placement of aggregate. This would prevent migration of soil particles from the subgrade into the graded stone.

Maintenance

Ford-type crossings require frequent inspections to determine their functional condition.

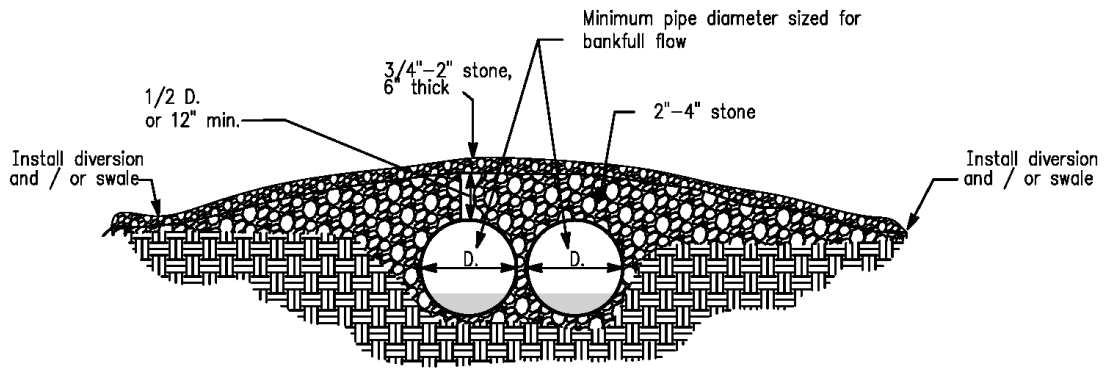

ELEVATION

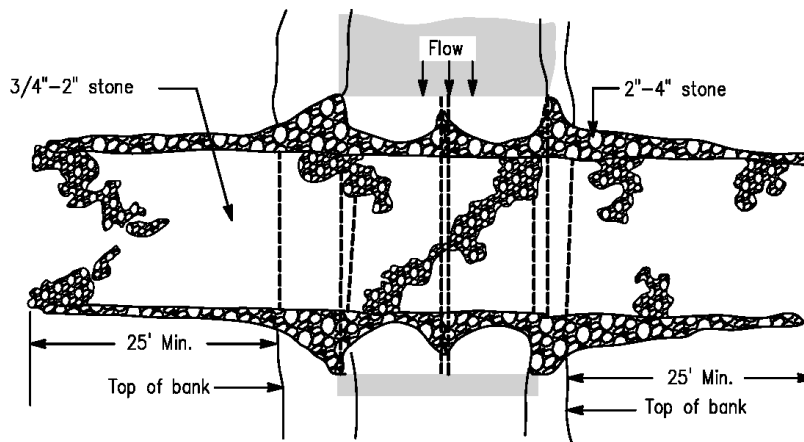

PLAN

Notes:

1. Not to scale.
2. Typical dimensions are shown.
3. Geotextile may be used under stone placed outside the stream channel.
4. No fines, soils, or other wastes or contaminants shall be placed in stream.
5. Remove on project completion unless otherwise directed.

**TEMPORARY STREAM
CROSSING**

Figure 5-12

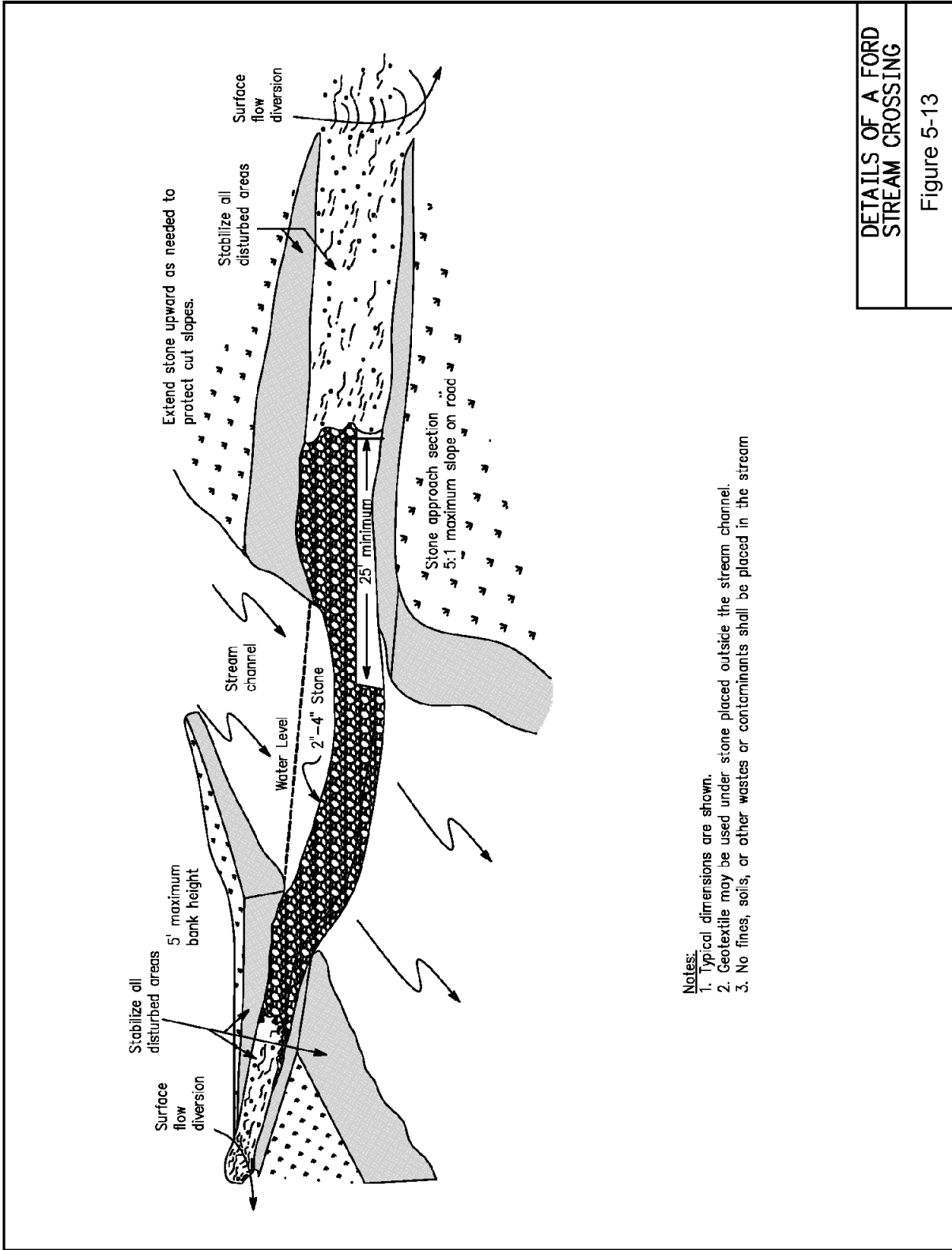

Notes:

1. Typical dimensions are shown.
2. Geotextile may be used under stone placed outside the stream channel.
3. No fines, soils, or other wastes or contaminants shall be placed in the stream

DETAILS OF A FORD
STREAM CROSSING

Figure 5-13

5 - N. Culvert

Definition

A conduit installed for the movement or transfer of water.

A culvert may be installed across a flowing watercourse or channel for use by construction or maintenance traffic or may be installed across a road for cross-road drainage (Figures 5-14 and 5-15).

Purposes

To provide a means for traffic to cross flowing streams without damaging the stream channel or banks or causing flooding

To keep sediment generated by traffic out of the stream.

To cross waterways or channels with minimal negative impact.

To keep petrochemical leakage on the undersurfaces of construction or maintenance equipment out of the watercourse.

To provide cross drainage or ditch-to-ditch transfer of surface water.

Conditions Where Practice Applies

When working in Tennessee, refer to TN's Aquatic Resource Alteration Permit (ARAP) requirements. All state and local requirements must be met.

Cross-road drainage is recommended on any road where storm water runoff, ditch-to-ditch transfer, or overland seepage might create wet areas and erosion.

Temporary stream crossings are generally applicable to flowing streams with drainage areas less than one square mile. See Table 5-5 for sizing temporary stream crossings.

For cross-drainage culvert sizing, Table 5-7 may be utilized for temporary drainage structures in drainage areas less than 400 acres.

Temporary structures that must handle flow from larger drainage areas should be designed by an engineer with methods which more accurately define the actual hydrologic and hydraulic parameters.

All permanent structures should also be designed by an engineer and should consider greater frequency storm events to ensure adequate sizing whereas flooding could not cause public harm, environmental and safety hazards, economic damage, etc.

Planning Considerations

Temporary stream crossings are necessary to prevent vehicles and heavy equipment from damaging stream banks and continually tracking sediment and other pollutants into the watercourse. However, these structures are also undesirable in that they represent a channel constriction that can cause flow backups or washouts during periods of high flow. For this

reason, the temporary nature of stream crossings is stressed. They should be planned to be in service for the shortest practical period of time and to be removed as soon as their function is completed.

The specifications contained in this practice pertain primarily to flow capacity and resistance to washout of the structure. From a safety and utility standpoint, the designer must also be sure that the span is capable of withstanding the expected loads from heavy equipment and that the width of the crossing be wide enough for the construction equipment to safely use. The designer must also be aware that such structures are subject to the rules and regulations of the Corps and state water pollution control departments.. All crossings are subject to an environmental review under the National Environmental Policy Act (NEPA) prior to installation.

Temporary Stream Crossing Design Criteria

The structure should be large enough to convey the bank full flow expected from a 2 year, frequency storm without appreciably altering the stream-flow characteristics. The structure may be a span or culvert. If culverts are used, Table 5-5 provides aid in selecting the appropriate size. Multiple culverts may be used in place of one large culvert if they have the equivalent capacity of the larger one and should be separated by one-half the pipe diameter or 12 inches, whichever is greater. The minimum-sized culvert that may be used is 24 inches.

Where culverts are installed, clean crushed stone should be used to form the crossing. The depth of soil cover over the culvert should be equal to 1/2 of the diameter of the culvert or 12 inches, whichever is greater. To protect the sides of the fill from erosion, riprap should be used.

The length of the culvert should be adequate to extend the full width of the crossing, including side slopes.

The slope of the culvert should be at least 0.25 inch per foot.

The culvert should be placed on or as close as possible to the stream bed to prevent impoundment.

The approaches to the structure should consist of stone pads meeting the following specifications:

1. Stone--Class I -- Average 2-4 inches
2. Minimum thickness--6 inches
3. Minimum width equal to the width of the structure
4. Minimum approach lengths--25 feet unless physical or ROW restraints preclude

Keep stream crossings at right angles, if possible. The temporary stream crossing may vary up to 15 degrees from perpendicular with stable banks and channel bottoms.

The invert elevation should be installed on the natural streambed grade to minimize interference with movement of fish and aquatic life.

Table 5-5: Pipe Diameters for Stream Crossings

Drainage Area(Acres)	Average Slope of Watershed			
	1%	4%	8%	16%
1-25	24	24	30	30
26-50	24	30	36	36
51-100	30	36	42	48
101-150	30	42	48	48
151-200	36	42	48	54
201-250	36	48	54	54
251-300	36	48	54	60
301-350	42	48	60	60
351-400	42	54	60	60
401-450	42	54	60	72
451-500	42	54	60	72
501-550	48	60	60	72
551-600	48	60	60	72
601-640	48	60	72	72

^{4/} Assumptions for determining the table: USDA-SCS Peak Discharge Method; CN = 65; Rainfall depth = 3.5 inches for 2-year frequency storm.

Temporary Stream Crossing Construction Specifications

Clearing, grubbing, excavation, and other disturbance to the riparian vegetation of the stream bed and banks should be kept to a minimum.

The structure should be removed as soon as it is no longer necessary for project construction. Removal should be done during periods of low flow, or in the dry to the maximum extent possible by diverting flow, utilizing cofferdams, berms, temporary channels, or pipes.

Upon removal of the structure, the stream should immediately be reshaped to its original cross-section and properly stabilized.

Geotextile filter fabric cloth should be placed on the streambed and stream banks prior to placement of pipe culvert(s) and aggregate. This would prevent migration of soil particles from the subgrade into the graded stone.

Cross-Road Drainage Design Criteria

Pipe culverts are usually installed on access roads at the time of construction and/or maintenance. They are used where access is required by vehicles and/or heavy construction equipment.

Pipe culverts should be long enough so both ends extend beyond the toe of the fill slopes.

Culvert sizing is determined by the area to be drained. However, pipe sizes of less than 18 inches in diameter tend to clog easily with floating leaves, twigs, etc. For this reason, cross-drain pipe culverts should be 18 inches or larger.

A culvert should be placed on grade at 2 percent more than the grade of the ditch it drains.

On steep slopes, installation should be skewed 15 to 30 degrees downgrade to provide better entrance conditions at inlet end.

Table 5-6: Spacing of Pipe Culverts

Road Gradient, %	Spacing (ft)
2-5	300-500
6-10	200-300
11-15	100-200
16-20	100

Cross-Road Drainage Construction Specifications

Erosion protection may be needed at inlet and outlet ends of the pipe. Where channel scouring and gullying is excessive, riprap stone or other material or techniques may be used to function as an energy absorber.

Earth cover (compacted) over a pipe culvert must be at least 1/2 the pipe diameter but never less than 12 inches.

Raise cross-drain culvert above ground level on the inlet end to allow sediment to settle. Provide a short fall at the outlet end so water would move away from culvert.

Table 5-7: Pipe Culvert Sizing for Access Roads

Acres Drained	Light Soils			Medium Soils			Heavy Soils		
	Flat 0-5%	Moderate 6 - 15%	Steep +15%	Flat 0-5%	Moderate 6 - 15%	Steep +15%	Flat 0-5%	Moderate 6 - 15%	Steep +15%
2	18 in	18 in	18 in	18 in	18 in	18 in	18 in	18 in	18 in
4	18 in	18 in	18 in	18 in	18 in	18 in	21 in	21 in	21 in
6	18 in	18 in	18 in	18 in	18 in	21 in	21 in	27 in	27 in
8	18 in	18 in	18 in	18 in	18 in	21 in	24 in	27 in	30 in
10	18 in	18 in	18 in	18 in	21 in	24 in	27 in	30 in	36 in
20	18 in	18 in	18 in	21 in	24 in	30 in	30 in	36 in	42 in
30	18 in	18 in	18 in	21 in	27 in	36 in	36 in	42 in	48 in
40	18 in	18 in	18 in	24 in	30 in	36 in	42 in	48 in	54 in
50	18 in	18 in	18 in	27 in	36 in	42 in	42 in	48 in	
60	18 in	18 in	18 in	27 in	36 in	42 in	42 in	54 in	
70	18 in	18 in	18 in	27 in	36 in	42 in	48 in	54 in	
80	18 in	18 in	21 in	30 in	36 in	48 in	48 in		
90	18 in	18 in	21 in	30 in	36 in	48 in	48 in		
100	18 in	18 in	21 in	30 in	42 in	48 in	48 in		
150	18 in	21 in	24 in	36 in	42 in	54 in	54 in		
200	21 in	21 in	27 in	63 in	48 in				
250	21 in	24 in	27 in	42 in	48 in				
300	21 in	27 in	30 in	42 in	54 in				
350	24 in	27 in	30 in	42 in	54 in				
400	24 in	27 in	36 in	48 in					

Soils which have a dominant coarse-textured, sand component are termed light compared to heavy soils which are fine textured and mostly silt and clay. Light soils are more permeable than heavy soils.

Maintenance

Culverts should be inspected frequently for clogging, plugging, collapsed or broken structures, and general effectiveness.

Temporary stream crossings should be inspected after significant rainfall.

Remove debris, trash, and other materials that restrict flow.

Damages or ineffective conditions should be repaired immediately.

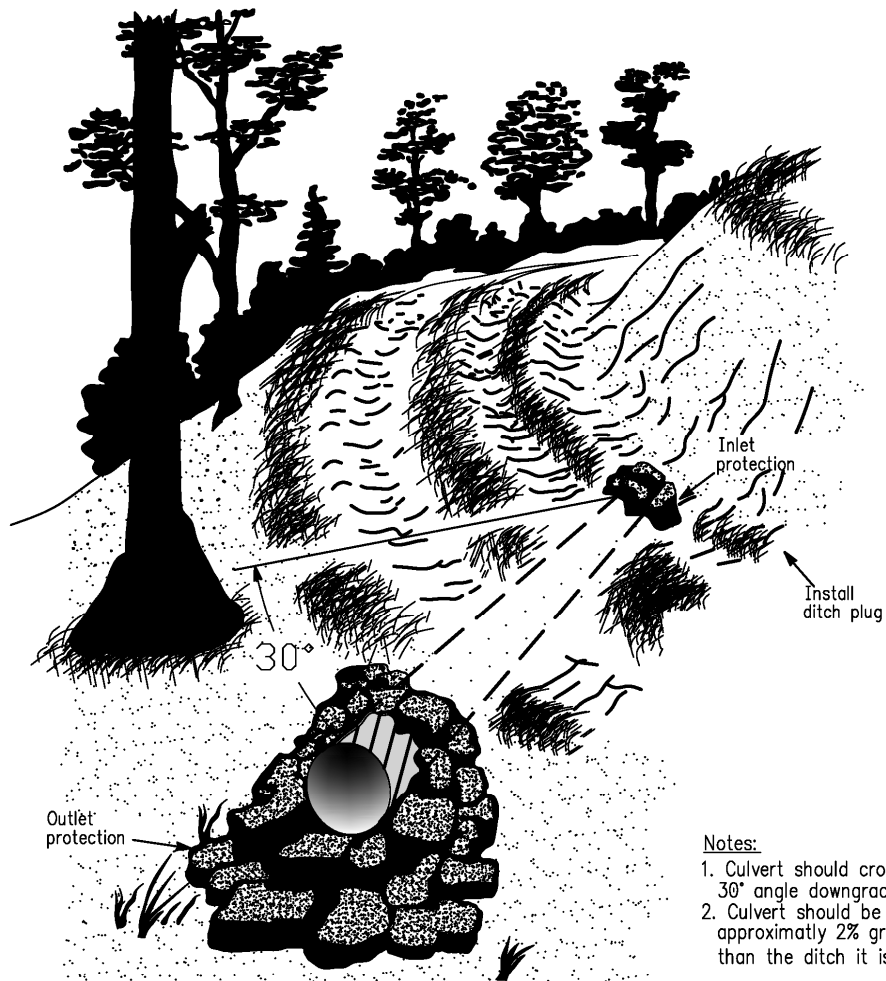

- Notes:**
1. Culvert should cross at a 30° angle downgrade.
 2. Culvert should be placed on approximately 2% grade greater than the ditch it is draining.

A. PLAN

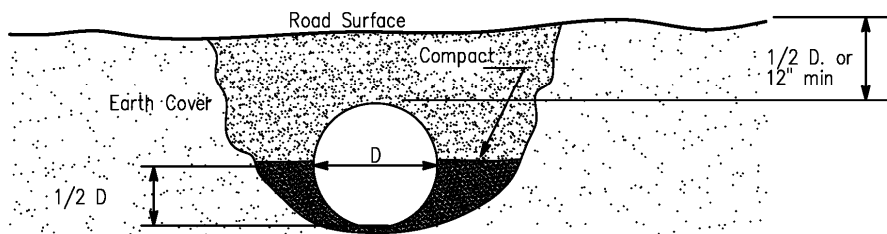

B. CROSS-SECTION

INSTALLING PIPE CULVERT

Figure 5-14

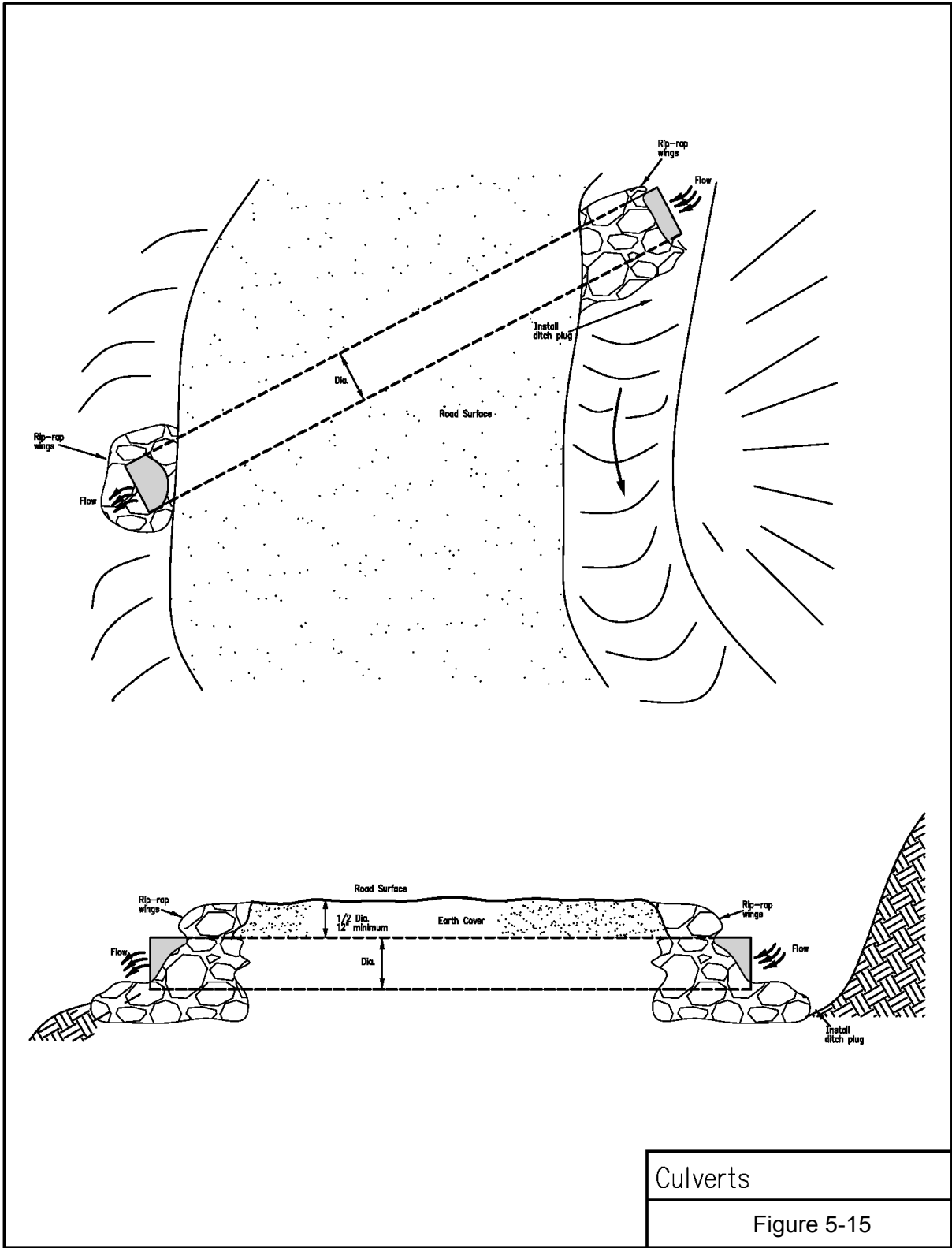

Culverts
Figure 5-15

5 - O. Construction Entrance/Exit

Definition

A pad of stone at any point where traffic will be leaving a construction site to a public right-of-way.

Purpose

A construction entrance/exit is intended to reduce off-site sedimentation and improve public safety by eliminating the tracking or other movement of sediment onto public rights-of-way.

Specifications

The entrance/exit must be designed using angular stone approximately 1.5 to 3.5 inches . Geotextile filter fabric must be used as an underliner between the soil and the stone. At a minimum, the construction pad must measure 20 feet wide by 50 feet in length with a minimum thickness of 6 inches. Refer to state specific guidelines on minimum size of stone as size may vary. (See Figure 5-17)

Inspection and Maintenance

Construction entrances/exits should be inspected regularly, and maintenance should be expected as heavy vehicular traffic decreases its effectiveness.

The entrance/exit should be removed once all project areas have been fully stabilized.

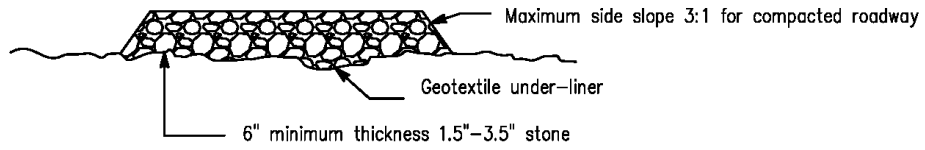

SECTION A-A

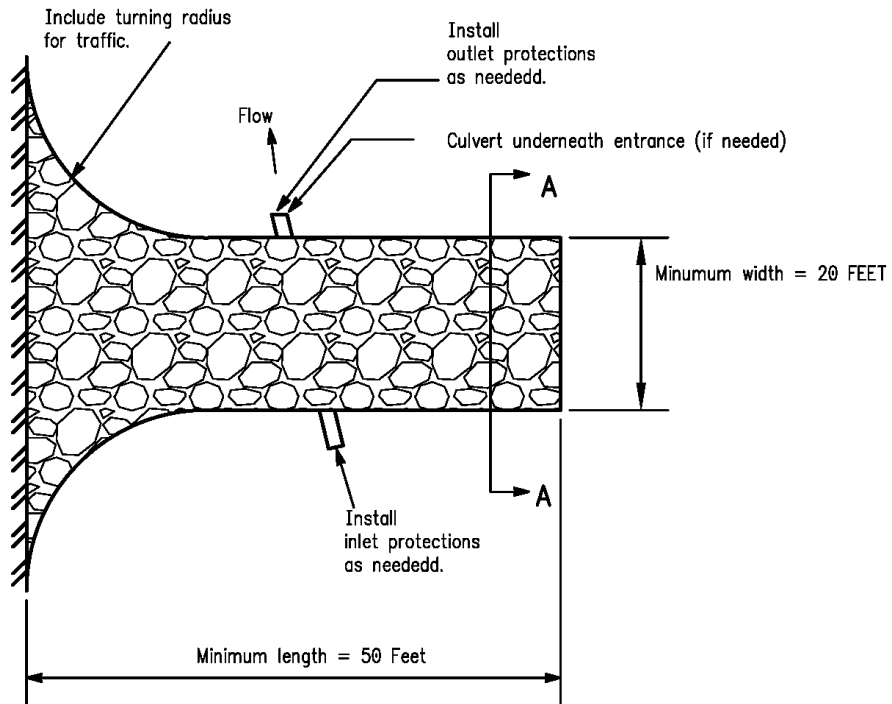

CONSTRUCTION EXIT

Figure 5-16

5 - P. Sediment Basin & Temporary Sediment Trap

Definition

A sediment basin is a pond created by excavation and/or construction of an embankment designed to capture and hold construction storm water runoff. It typically includes a principal spillway, emergency spillway, and other flow control devices such as baffles. The size of the sediment basin would depend on its location, size of the drainage area, local storm event data, etc.

A temporary sediment trap is a small temporary ponding area, formed by constructing an earthen embankment with a gravel outlet, across a drainage swale. Sediment traps are typically used below drainage areas of 5 acres or less and where the sediment trap would be used no longer than 18 months. If conditions warrant a longer time or larger drainage areas, then a permanent sediment basin should be considered (Figure 5-17).

Purpose

To sufficiently capture and detain construction stormwater runoff to allow sediment to settle to the bottom of the basin/trap while allowing the water to be slowly released.

To protect downstream areas from surges of construction stormwater runoff.

Conditions where practice applies

Sediment basins are often required by state and/or local construction storm water permits. Refer to any applicable permits for site specific requirements.

They could also be used in critical or sensitive areas where other erosion and sediment controls are not sufficient in retaining sediment on-site.

Appropriate topography and space must be present for sediment basins to be effective.

Design Criteria

Given their ability to hold and release large volumes of water, sediment basins must be designed according to good engineering practices. Sediment Basin design and construction should comply all local, state, and federal laws and regulations. Refer to state and/or local permits and/or BMP manuals for site specific requirements.

Sediment basins should never be placed in a live stream. They should be located so as to receive the largest amount of runoff possible from disturbed areas and for clean-out ease of trapped sediment.

Designers should incorporate features to maximize detention time within the basin. Suggested methods include:

1. Length (distance between the inlet and outlet) to width ratio greater than 2:1
2. Use of baffles or diversions

The storm water captured in the basin should be released at the water surface where the least turbid water is found. An emergency spillway should be designed and installed according to a large storm event to prevent embankment failure.

An outlet should be provided to drain the collected stormwater in an erosion-free manner to an existing stabilized area.

Construction Specifications

Areas underneath the sediment basin should be cleared, grubbed, and stripped of topsoil.

The fill material used for embankments should be taken from an approved borrow area. It should be clean soil free of roots, vegetation, rocks, or other perishable or objectionable material.

All areas of the sediment basin should be permanently stabilized with vegetation or suitable material (e.g. rock).

State and local requirements should be met concerning fencing, warning signs, and the presence of soft, saturated sediment and flood water.

Inspection and Maintenance

Sediment basins should be inspected to monitor sediment accumulation and to ensure correct operation. Sediment should be removed from the basin and stabilized in an upland area according to approved erosion and sediment control plan.

When temporary structures have served their intended purpose and the contributing drainage area has been properly stabilized, the embankment and resulting sediment deposit should be treated according to the approved erosion and sediment control plan.

TEMPORARY SEDIMENT TRAP

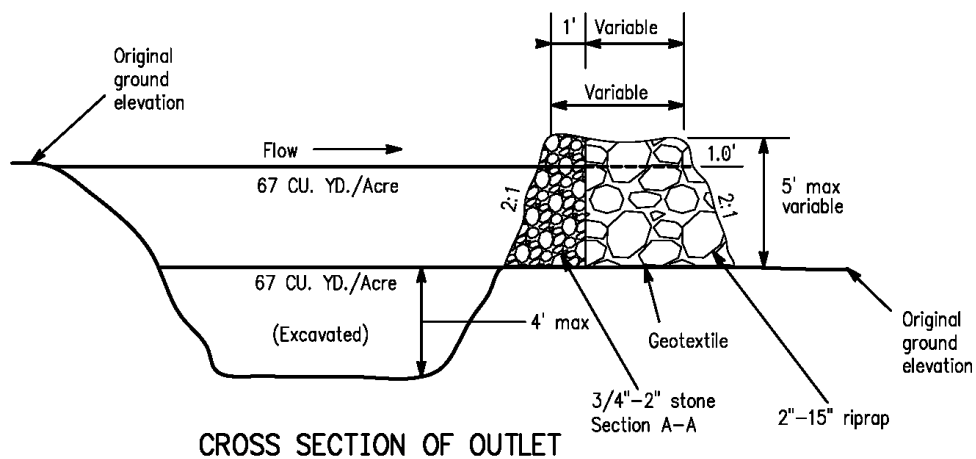

CROSS SECTION OF OUTLET

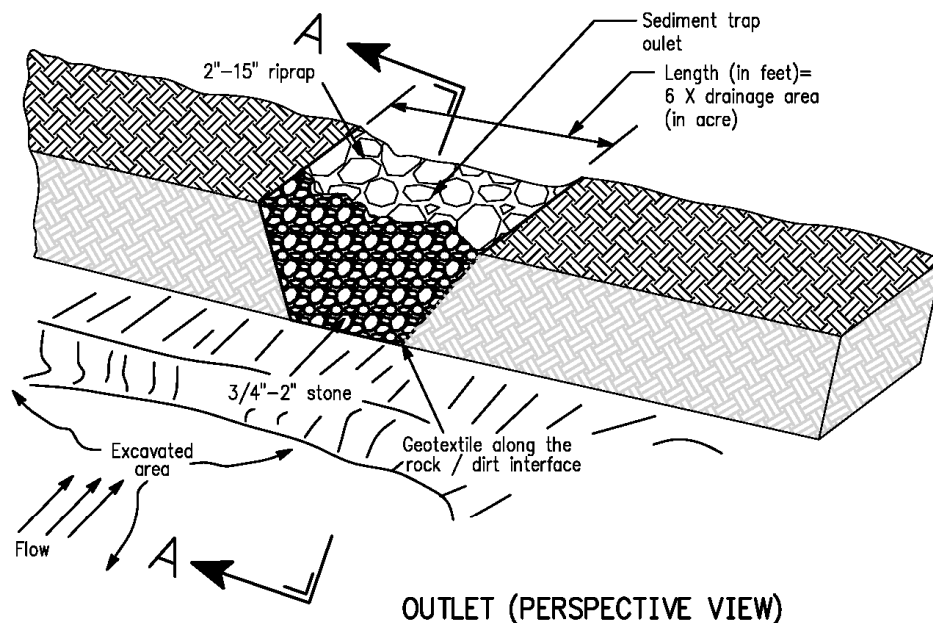

OUTLET (PERSPECTIVE VIEW)

TEMP. SED. TRAP
AND OUTLET

Figure 5-17

5 - Q. Polyacrylamide (PAM)

Definition

The land application or stormwater application of products containing anionic polyacrylamide (PAM), a chemical agent that binds soil particles together, which reduces erosion in the field and promotes flocculation and sedimentation.

Purpose

Land application of PAM is performed to reduce soil surface erosion due to wind or water forces. PAM can also improve permanent vegetation establishment by acting as a tackifier and soil conditioner.

Stormwater applications of PAM promote settling of fine soil particles in sediment basins and enhanced sediment collection upstream of other BMPs (i.e. check dam).

Conditions where practice applies

This practice is not intended for application to surface waters of the state. It should only be used at construction sites on bare soil areas, constructed storm water ditches, and/or storm drains which feed into sediment basins or other BMPs.

Use of anionic PAM should comply with all local, state, and federal laws and regulations governing anionic PAM.

Only the anionic form of PAM should be used. Cationic PAM is toxic and should not be used. PAM and PAM mixtures should be environmentally benign, harmless to fish, wildlife, and plants.

Design Criteria

Formal design is not required; however, a qualified professional should design the location and application rates of PAM.

Application rates should follow manufacturer's guidelines, MSDSs, etc.

PAM is available in many forms including emulsions, powders, bars, or logs.

Other BMPs should be designed for use in conjunction with PAM, such as sediment basins, check dams, rock filter dams, etc. These BMPs would provide settling time and area needed to maximize flocculation and sedimentation.

Construction Specifications

Never add water to PAM as clumping can occur which can clog dispensers, small storm drains, etc. Clumping indicates incomplete dissolving of the PAM which greatly reduces its effectiveness.

Add PAM slowly to water to ensure it dissolves correctly.

Inspection and Maintenance

Areas where PAM is applied should be inspected to ensure PAM is working properly by dissolving into stormwater.

PAM, used in the form of gel bars or logs, should be inspected per manufacturer's recommendations and replaced when the gel bar or log has fulfilled its useful purpose.

Maintenance includes following the PAM application frequency in the site BMP plan.

Chapter 6
Seeding and Stabilization Techniques



6 - A. Seeding and Stabilization Techniques

Soil pH and fertility can significantly affect the success of revegetating disturbed areas. The need for soil sampling would be determined on a project by project basis, taking into account the size of the area of disturbance, and the expected benefit of the sampling.

Since the chemical properties of soil that limit plant establishment and growth vary greatly from site to site, specific recommendations from soil tests are useful for manipulating soil factors and optimizing plant growth.

For soil tests to yield accurate results, soil samples must be representative of the entire area to be revegetated. To accomplish this, a composite soil sample comprised of 15 to 20 sub-samples should be collected for a given site.

To collect a composite sample,

1. use a spade, auger, or soil probe to obtain a sub-sample from the upper 6 inches of the soil profile;
2. place the sub-sample in a clean plastic bag or bucket;
3. discard rocks over ½ inch and large pieces of wood or vegetation;
4. after all sub-samples are collected, mix the contents thoroughly and place in a new plastic bag (Wet samples may be hard to mix adequately.);
5. label the bag clearly and permanently to identify the collection site; and,
6. ship each composite sample to the testing facility.

Composite samples should be collected for each distinct area found throughout a project area. Distinct areas are sections of a project area that “look” similar and can be included in broad categories like wetlands, well drained valley bottoms, steep slopes, rolling hills, and ridge tops. For example, soil fertility and pH may differ drastically between a bottomland field and an adjacent slope so these areas should be sampled separately. A particular transmission line segment can extend for many miles, so sampling everywhere is not feasible, but a few individual composite samples can be collected for each distinct area.

6 - B. Seedbed Preparation and Soil Amendments

A suitable seedbed is required for successful seed germination and establishment. A suitable seedbed is comprised of a relatively loose, uncompacted soil with a rough surface that allows seeds to become embedded in approximately the top ½ to 1 inch of the soil profile. A favorable seedbed can be prepared using a variety of implements and techniques that would be chosen based on site conditions, equipment availability, and the discretion of the project supervisor. Special care should be taken when working near water, all state and local requirements should be met.

To prepare a seed bed, it is essential that operators

1. scarify, disk, or otherwise loosen heavily compacted soils prior to seeding; and,
2. ensure the soil surface is adequately roughened to provide suitable environment for seedling germination and growth.

Soil amendments like lime and fertilizer should be applied at rates that are consistent with soil test results, but, since incorporating amendments into the top few inches of the soil is often advantageous, applications can be made during or immediately following seed bed preparation. On very steep slopes vulnerable to erosion, amendments can be applied to the soil surface only. For small disturbed areas where soil test data was not obtained, the general recommendations below can be used (Table 6-1).

Table 6-1 Application rate for common soil amendments used in revegetation of disturbed lands.

Amendment	Large areas of disturbance	Smaller areas of disturbance
Lime	Use soil test results	2 - 3 tons/ac OR 90 - 140 lbs/ 1000 ft ²
15-15-15 (Temporary Cover)	Use soil test results	300 lbs/ac OR 7 lbs/1000 ft ²
6-12-12 (Permanent Cover)	Use soil test results	1,000 lbs/ac OR 23 lbs/1000 ft ²

6 - C. Mulching

Mulch can be applied to disturbed land to reduce erosion, maintain soil moisture, moderate soil temperature, and to promote seed germination. Mulching can be used in conjunction with seeding or as a standalone method to provide temporary cover. Mulch should be anchored with a tackifier, disk, or other mechanical implement.

Table 6-2 Application rate for straw mulch on disturbed lands.

Mulching Method	Surface Cover Requirements	Approximate Application Rate
Straw Mulch (with seed)	75%	1.5 - 2 tons/ac. OR 70- 90 lbs./1000 sqft.
Straw Mulch (without seed)	95%	2.5 - 3 tons/ac. OR 115 - 160 lbs./1000 sqft

6 - D. Erosion Control Blankets and Netting

On steep slopes and areas with heavy surface water runoff conditions, erosion control blankets or mats are effective in providing temporary erosion control during the critical seedling establishment period. Several types and grades of blankets are available. Blankets are usually made with wood excelsior, straw, or coconut fibers. The mulch material is generally held together with a plastic or nylon mesh netting and/or cotton thread and is manufactured in rolls. Consult state and local BMP manuals for specific application requirements in each state.

General Installation Practices

Roll blankets directly up or down the slope, not across, overlapping the seams at each join.

Install pins or anchors according to manufacturers specifications

6- E. Seeding Temporary Vegetation

Fast-growing, temporary vegetation can be seeded on a disturbed site to reduce erosion when it is not possible or appropriate to establish permanent vegetation. For instance, if additional work is planned for a disturbed site but the work would not occur for several months, seeding temporary vegetation may be a good option. Also, if work concludes on a disturbed site in a season unsuitable for establishing permanent vegetation, establishing a cover of annual vegetation can hold a site until perennial species can be planted. See seed listing in Chapter 7, "Seed and Plant Species List".

Consider the season when the planting would occur as some species perform better than others at different times of year.

Price and purchase quality seed sold on a pure live seed (PLS) basis.

Ensure good seed/soil contact by covering broadcast seed by raking or chain dragging if necessary.

Coordinate planting of the annual species with seeding of permanent vegetation.

Inspect plantings to ensure sufficient cover is achieved. Replant if needed.

6 - F. Seeding Permanent Vegetation

Actively establishing permanent vegetation is necessary for sites where the soil profile has been extensively disturbed. Annual species grow quickly and prevent erosion in the short-term, but these species do not persist for more than one growing season. For this reason, seed mixtures comprised of fast growing annual species and long-lived perennial species are used to permanently revegetate disturbed sites. See seed listing in Chapter 7.

Consider the season when the planting would occur as some species perform better than others at different times of year.

Price and purchase quality seed sold on a pure live seed (PLS) basis.

Disk or mow before seeding if a dense stand of temporary vegetation was established separately from permanent seeding.

Inoculate legume seed according to product specification prior to planting.

Ensure good seed/soil contact by covering broadcast seed by raking or chain dragging if necessary.

Inspect planting to ensure sufficient cover is achieved. Replant if needed.

6 - G. Noxious Weeds and Non-native Invasive Species

Executive Order (EO) 13112 serves to prevent the introduction of invasive species and provides for their control to minimize the economic, ecological, and human health impacts that non-native invasive species cause. As a federal-agency, it is TVA's responsibility to comply with Executive Order 13112.

In the context of transmission construction and maintenance, TVA should, to the extent practicable,

1. prevent the introduction of invasive species;
2. detect and respond rapidly to and control populations of such species in a cost-effective and environmentally sound manner;
3. monitor invasive species populations accurately and reliably; and,
4. provide for restoration of native species and habitat conditions in ecosystems that have been invaded.

Practical application of this executive order would be determined on a case by case basis, taking into consideration each projects parameters, the feasibility of success and practicality of implementation of the EO.

Chapter 7
Seed and Plant Species Lists

7-A. Single Plant Species for Establishing Temporary Cover

Options for establishing temporary cover using a single plant species.

Consider project location when using seed dates as precipitation and first/last frost dates vary considerably across the TVA PSA.

Common Name	Scientific Name	PLS Seeding Rate		Seeding Dates	Comments
		(lbs./ac)	(lbs./1,000 ft ²)		
Annual Ryegrass	<i>Lolium multiflorum</i>	20 - 30	0.5 - 0.7	Aug. 15 – Oct. 31 for winter cover; Mar. 1 – Apr. 30 for temporary cover	Heat-sensitive annual that can produce winter cover
Cereal Rye	<i>Secale cereale</i>	80 - 120	1.8 - 2.8	Oct. 1 - Nov. 15 for winter cover; Feb. 15 - Apr. 15 for temporary cover	Heat-sensitive annual that can produce winter cover
Foxtail Millet	<i>Setaria italica</i>	20 - 30	0.5 - 0.7	May 1 - Aug. 31	Warm-season annual; frost-sensitive
Oats	<i>Avena sativa</i>	80 - 120	1.8 - 2.8	Feb. 15 - Apr. 15 for temporary cover	Similar to wheat and rye, but better if warm season grasses would be planted on-site
Redtop	<i>Agrostis gigantea</i>	4 - 5	0.1	Apr. 15. - Aug. 31	Perennial; performs well on wet sites
Sudangrass	<i>Sorghum bicolor</i>	25 - 40	0.6 - 0.9	May 1 - Aug. 31	Warm-season annual; frost-sensitive
Weeping Lovegrass	<i>Eragrostis curvula</i>	3 - 5	0.1	May 1 - Jul. 15	Good erosion control on steep sites
Winter wheat	<i>Triticum aestivum</i>	80 - 120	1.8 - 2.8	Oct. 1 - Nov. 15 for winter cover; Feb. 15 - Apr 15 for temporary cover	Heat-sensitive annual that can produce winter cover

7-B. Seed Mixtures for Establishing Permanent and Temporary Cover

Options for permanent and temporary cover using site specific species mixes.

Consider project location when using seed dates as precipitation and first/last frost dates vary considerably across the TVA PSA.

Site Specific Mix	Suitability Comments	Species (Scientific Name)	PLS Seeding Rate		Seeding Dates
			(lbs./ac)	(lbs./1,000 ft ²)	
Pasture Mix A	Disturbed sites surrounded by pasture or developed areas	Tall Fescue (<i>Festuca arundinacea</i>)	15 - 20	0.4 - 0.5	Feb. 15 - Apr. 15 Aug. 15 - Oct. 15
Pasture Mix B (North PSA)	Disturbed sites surrounded by pasture or developed areas	Orchard Grass (<i>Dactylis glomerata</i>) and/or Perennial Ryegrass (<i>Lolium perrene</i>) and/or Kentucky Bluegrass (<i>Poa pratensis</i>) and/or Tall Fescue (<i>Festuca arundinacea</i>) with White (Landino) Clover (<i>Trifolium repens</i>)	15 total 3 total	0.4 total 0.1 total	Feb. 15 - Apr. 15 Aug. 15 - Oct. 15
Pasture Mix C (South PSA - Central MS)	Disturbed sites surrounded by pasture or developed areas	Tall Fescue (<i>Festuca arundinacea</i>) and/or Perennial Ryegrass (<i>Lolium perrene</i>) with White (Landino) Clover (<i>Trifolium repens</i>)	20 total 3 total	0.5 total 0.1 total	Feb. 15 - Apr. 15 Sep. 1 - Nov. 1
Pasture Mix D (South PSA - Central MS)	Disturbed sites surrounded by pasture or developed areas	Dallisgrass (<i>Paspalum dillatum</i>) and/or Bahagrass (<i>Paspalum notatum</i>)	20 total	0.5 total	Mar. 1 - Jul. 1
Shady Mix	Shady sites unsuitable for other species	Hard Fescue (<i>Festuca trachyphylla</i>) Chewing's Fescue (<i>Festuca rubra</i>) Red Fescue (<i>Festuca rubra</i>)	20 total	0.5 total	Feb. 15 - Apr. 15 Aug. 15 - Oct. 15

Site Specific Mix	Suitability Comments	Species (Scientific Name)	PLS Seeding Rate		Seeding Dates
			(lbs./ac)	(lbs./1,000 ft ²)	
Upland A	Upland sites surrounded by natural vegetation. Adequate competition control and drilling seed no deeper than 1/4" essential for success.	Spring Oats (<i>Avena sativa</i>)	50	1.2	Feb. 15 - May 10
		Big Bluestem (<i>Andropogon gerardii</i>)	3	0.1	
		Indiangrass (<i>Sorghastrum nutans</i>)	3	0.1	
		Switchgrass (<i>Panicum virgatum</i>)	4	0.1	
		Partridge Pea (<i>Cassia fasciculata</i>)	1	0.1	
		Black-eyed Susan (<i>Rudbeckia hirta</i>)	1	0.1	
Upland B	Upland sites surrounded by natural vegetation. Adequate competition control and drilling seed no deeper than 1/4" essential for success.	Browntop Millet (<i>Panicum ramosum</i>)	15	0.4	May 10 - Jun. 30
		Big Bluestem (<i>Andropogon gerardii</i>)	3	0.1	
		Indiangrass (<i>Sorghastrum nutans</i>)	3	0.1	
		Switchgrass (<i>Panicum virgatum</i>)	4	0.1	
		Partridge Pea (<i>Cassia fasciculata</i>)	1	0.1	
		Black-eyed Susan (<i>Rudbeckia hirta</i>)	1	0.1	
Upland C	Upland sites surrounded by natural vegetation. Adequate competition control and drilling seed no deeper than 1/4" essential for success.	Winter Oats (<i>Avena sativa</i>)	50	1.2	Aug. 20 - Nov. 15
		Big Bluestem (<i>Andropogon gerardii</i>)	3	0.1	
		Indiangrass (<i>Sorghastrum nutans</i>)	3	0.1	
		Switchgrass (<i>Panicum virgatum</i>)	4	0.1	
		Partridge Pea (<i>Cassia fasciculata</i>)	1	0.1	
		Black-eyed Susan (<i>Rudbeckia hirta</i>)	1	0.1	
Temporary Wildlife Habitat	Annual mix for fall and winter wildlife food	Soybean (<i>Glycine max</i>)	8	0.2	Apr. 15 - Jun. 15
		Cowpea (<i>Vigna unguiculata</i>)	4	0.1	
		Browntop Millet (<i>Panicum ramosum</i>)	4	0.1	
		Sudangrass (<i>Sorghum bicolor</i>)	2	0.05	
		Buckwheat (<i>Fagopyrum sagittatum</i>)	2	0.05	
Permanent Wildlife Habitat A	Provide year-round rearing and feeding habitat	Orchardgrass (<i>Dactylis glomerata</i>)	10	0.3	Feb. 15 - Apr. 15
		Landino clover (<i>Trifolium repens</i>)	3	0.1	
		Oats (<i>Avena sativa</i>)	32	0.8	
		Korean lespedeza (<i>Kummerowia stipulacea</i>)	8	0.2	
		or			
		Kobe lespedeza (<i>Kummerowia striata</i>)			

Site Specific Mix	Suitability Comments	Species (Scientific Name)	PLS Seeding Rate		Seeding Dates
			(lbs./ac)	(lbs./1,000 ft ²)	
Permanent Wildlife Habitat B	Provide year-round rearing and feeding habitat	Orchardgrass (<i>Dactylis glomerata</i>)	8	0.2	Feb. 15 - Apr. 15
		Timothy (<i>Phleum pratense</i>)	4	0.1	
		Kobe lespedeza (<i>Kummerowia striata</i>)	12	0.3	
		Oats (<i>Avena sativa</i>)	32	0.8	
Permanent Wildlife Habitat C	Provide year-round rearing and feeding habitat	Orchardgrass (<i>Dactylis glomerata</i>)	10	0.3	Aug.15 - Sep. 15
		Landino clover (<i>Trifolium repens</i>)	3	0.07	
		Winter wheat (<i>Secale cereale</i>)	60	1.4	
		Korean lespedeza (<i>Kummerowia stipulacea</i>)	8	0.2	
		or Kobe lespedeza (<i>Kummerowia striata</i>)			
Permanent Wildlife Habitat D	Provide year-round rearing and feeding habitat	Perennial Ryegrass (<i>Lolium perrene</i>)	8	0.2	Aug. 15 - Oct. 1
		Timothy (<i>Phleum pratense</i>)	4	0.1	
		Kobe lespedeza (<i>Kummerowia striata</i>)	12	0.3	
		Winter wheat (<i>Secale cereale</i>)	60	1.4	

C. Non-Native, Non-Invasive Species List

Species suitable for public use areas, erosion control/stabilization and wildlife habitat plantings. List was compiled by Wes James (TVA Wildlife Biologist) as a result of the implementation of the Executive Order on Invasive Species

KY 31 AND OTHER FESCUES - for dam reservations, public use areas, and other facilities; transmission line construction stabilization where fescue is currently present as forage or lawn grasses, or when landowners request it. Not to be used in wildlife plantings or in agricultural license areas.

ZOYSIA VARIETIES - for dam reservations, public use areas, and other facilities.

BERMUDAGRASS - for dam reservations, public use areas, and other facilities.

ANNUAL RYEGRASS - suitable for all sites.

FOXTAIL, BROWNTOP AND JAPANESE MILLETS - suitable for all sites.

BUCKWHEAT - suitable for wildlife plantings.

WINTER WHEAT - suitable for wildlife plantings.

OATS - suitable for wildlife plantings.

ORCHARDGRASS - suitable for all sites.

PERENNIAL RYEGRASS - suitable for all sites.

REDTOP - suitable for all sites.

RYE - suitable for all sites.

TIMOTHY - suitable for all sites.

WEEPING LOVEGRASS - for erosion control use only.

CRIMSON, RED AND LADINO CLOVERS - suitable for all sites.

SOYBEANS - suitable for wildlife plantings.

SORGHUM-MILO - suitable for wildlife plantings.