



As Amended
by NCA 85-74
Dec. 2, 1985

NCA 84-04

AN ORDINANCE OF THE MUSCOGEE (CREEK) NATION REGULATING PUBLIC GAMING
WITHIN THE MUSCOGEE (CREEK) NATION

Section 100. Be it enacted by the Muscogee Nation in Council Assembled:

TITLE I. - GENERAL PROVISIONS

Section 101. Findings. The National Council finds that:

- A. Under the 1979 Constitution of the Muscogee (Creek) Nation, the National Council may legislate upon subjects to become Ordinances of the Nation, including:
- (1) To promote the public health and safety, education and welfare that may contribute to the social, physical well-being and economic advancement of citizens of the Muscogee (Creek) Nation. [Article VI, Section 7(a)].
 - (2) To create authorities with attendant powers to achieve objectives allowed within the scope of this Constitution. [Article VI, Section 7(i)].
 - (3) To exercise any power not specifically set forth in this Article which may at some future date be exercised by the Muscogee (Creek) Nation. [Article VI, Section 7(j)].
- B. The present needs of the Muscogee people include employment and training, health care, educational opportunities, nutrition, mental health, juvenile services, housing, planning and development, legal services, elders programs and social services which are not presently being met in sufficient quantity by United States government agencies.
- C. The Muscogee Nation desires to be self-sufficient in its internal affairs, as reliance upon federal resources has been adverse to the quality of life within this tribe in both the recent and far past.
- D. The regulation of public gaming within the Muscogee (Creek) Nation is in the interest of the Muscogee people and their health and welfare.
- E. The Muscogee Nation, prior to the creation of the State of Oklahoma, prohibited public gaming operations under Article X, Section 1 of the 1880 codification of the Constitution and Laws of the Muscogee Nation, as follows:
- "Any person who shall willfully, by word or deed, disturb any private or public boarding or day school, church, council, or any other religious, political or other lawful gathering, or private family, ... or keep houses of ill fame, or gambling houses, shall be guilty of misdemeanor, and upon convictions shall receive fifty lashes on the bare back."
- F. Public gaming operations have been introduced to the Muscogee Nation under the color of the State of Oklahoma, and it is of vital interest to the public health, safety and welfare of the Muscogee people that the Nation, instead of again prohibiting public gaming operations, regulate public gaming in a manner commensurate with the interests of the Muscogee people.

- G. By virtue of the treaties between the United States of America and the Muscogee (Creek) Nation and the Statutes and Court decisions of the United States, which together have established and maintained the doctrine of Indian sovereignty, there is left intact the federal guarantee of the perpetual integrity of the Muscogee (Creek) National Government.
- H. The Muscogee (Creek) National Government requires methods for establishing a base to generate revenues for self perpetuation and essential governmental services.

Section 102. Short Title. The Code shall be known and may be cited as the Muscogee Nation Public Gaming Code.

Section 103. Definitions. The following words and phrases when used in this Code shall, for the purposes of this Code, have the meanings respectively ascribed to them in this Section, except where the context otherwise requires:

- A. "Gaming" is the act of paying for the opportunity and participation in a game or games of chance for money or something of value, where motor skills play no part or are of no consequence in determining the outcome of the game.

To operate, carry on, conduct, maintain, or expose for play: money, property, or any representative of value; wherein the outcome of a game is decided by chance or in which chance is a material element, but does not include social games played solely for consumable goods, i.e. foodstuff or games played in private homes or residences for prizes or games operated by charitable and educational organizations; which are approved by the Commissioner pursuant to provisions of NCA 84-04.

- B. "Shall" is used in this Code as imposing an obligation to act.
- C. "Commissioner" is the Commissioner of Public Gaming as provided by the terms of this Code.
- D. "Bingo" is the activity commonly known as 'bingo' where participants pay a sum of money for the use of one or more cards. A winning pattern is announced prior to each game. When the game begins, numbers are drawn by chance, one by one, and announced. The players cover or mark those numbers in the pattern which has been pre-announced for that particular game. This player calls out "bingo" and is declared the winner of a predetermined prize.
- E. "Instant Bingo" is the activity wherein participants pay a sum of money for the use of one or more cards. Winning patterns are announced upon the card. When one card is played, paper tabs are pulled off of the card board backing to reveal the patterns printed on the cardboard card. If a player receives patterns which are printed as an "Instant Bingo", the player turns in the card for a predetermined prize.
- F. "Parimutuel horse racing" is the activity wherein participants bet a sum of money, in predetermined increments, to wager on which horses shall place first (or "win"), second (or "place"), or third (or "show") in a race for a predetermined distance. If a horse is determined to have properly won the first, second, or third place in the race, the participants who have bet upon that horse are paid upon their wager according to formulas approved under the laws of the State of Oklahoma. Players may also be paid upon a combination basis or upon a mutual field basis.
- G. Muscogee (Creek) Nation - is as established by the Muscogee (Creek) Constitution of 1979 with political jurisdiction as described in Attachment A. Individual tribal towns of the

Muscogee (Creek) Nation are considered component, inseparable subdivisions of the Muscogee (Creek) Nation and may only benefit from the rights and privileges from the Muscogee (Creek) Nation under this Code, when they are chartered as a community organization under the laws of the central government of the Muscogee (Creek) Nation.

- H. "Permit" - license or instrument granted by the official(s) of excise certifying that the duties on certain goods have been paid or secured and permitting their removal from some specified place to another.

A written license or warrant issued by a person in authority empowering the grantee to do some act not forbidden by Muscogee (Creek) Nation law but not allowable without such authority.

- I. "License" - the permission by authority of the Muscogee (Creek) Nation to do an act, which without permission could be illegal.

A permit granted by the Gaming Commissioner of the Muscogee (Creek) Nation for a consideration to a person, group, community, firm, or corporation to pursue some occupation to carry on some business subject to regulation under the jurisdiction of the Muscogee (Creek) Nation.

License, with respect to real property of the Muscogee (Creek) Nation, is a privilege to go on the premises for a certain purpose but does not operate to confer on, vest in, or license any title, interest, or estate in such property.

- J. "Hearing De Novo" - a new hearing or a hearing for the second time contemplating an entire trial in the same manner in which matter was originally heard and a review of previous hearing.

Section 104. Liberal interpretation. The provisions of this Code, being necessary for the welfare of the tribe and its inhabitants, shall be liberally construed to effect the purpose and object hereof.

Section 105. Effect of headings. Article and section headings contained herein shall not be deemed to govern, limit, modify or in any manner affect the scope, meaning or intent of the provisions of any article or section hereof.

Section 106. Penalty provisions. It shall be a violation of the laws of the Muscogee Nation to violate the provisions of this Code, any regulations promulgated by the Commissioner, or any proper order issued under the authority of this Code. Any person or licensee so violating shall be punished by a fine of not more than Five Hundred Dollars (\$500.00) or by suspension of license for a period not to exceed One Hundred Eighty (180) days or by both such fine and suspension or other penalty alternative under Tribal law.

Section 107. Severability. The provisions of this Code are severable and if any part or provision hereof shall be held void by tribal or federal court, the decision of the court so holding shall not affect or impair any of the remaining parts of provisions of the Code.

Section 108. Repeal. All titles, chapters, articles and sections of Tribal Ordinance NCA 82-33, as amended which are in effect as of the date this Code becomes operative, are hereby repealed, and all other laws or parts of laws inconsistent with the provisions of this Code are hereby repealed.

Section 109. Effect of repeal. Repeal by this Code of any Ordinance shall not have the effect of reviving any prior law theretofore repealed or suspended by such repealed Code.

Section 110. Emergency. It being immediately necessary for the preservation of the public peace, health and safety, an emergency is hereby declared to exist, by reason thereof this Code shall take effect and be in full force from and after its passage and approval.

TITLE II. - DEVELOPMENT, ADMINISTRATION AND ENFORCEMENT

Section 201. Office of Public Gaming Commissioner Established. In order to provide for the orderly development, administration, and regulation of Bingo, as well as other authorized enterprises within the exterior boundaries of the Muscogee Nation, there is established the Muscogee (Creek) Public Gaming Commissioner (hereinafter referred to as the "Commissioner"). The Principal Chief shall nominate a full citizen of the Muscogee Nation to serve as the Commissioner, subject to confirmation by Ordinance. Said Commissioner may be seated for a period of three (3) years. The Commissioner may be removed from office prior to the end of any term only for cause under the Removal for Office Ordinance, NCA 81-03, or may be removed by Ordinance. The Commissioner may be suspended by the Principal Chief for 90 days, and the power of the Principal Chief to commission during a vacancy is extended to include commission of a full citizen to serve during the suspension of any Commissioner.

Section 202. The Commissioner may not hold other tribal positions except temporary duties assigned by Executive Order to be performed without increase in compensation and may be engaged in business. Provided, however, that the Commissioner shall not engage in any business which is subject to provisions of this Code or which has commerce with any licensee under this Code. The Commissioner shall post a bond with the Muscogee Nation in the amount of One Hundred Thousand Dollars (\$100,000.00).

Section 203. A. The Commissioner shall be charged with the sole responsibilities of administering and enforcing the provisions of this Code.

B. It shall be the responsibility of the Commissioner to promulgate regulations necessary to administer the provisions of this Code. These duties shall include but not be limited to the following:

- (1) Printing and making available application forms for initial and renewal licenses, as well as any other necessary licenses.
- (2) Supervising the collection of all fees and taxes prescribed in this Code.
- (3) Processing all license applications.
- (4) Issuing licenses;
- (5) Determining applicable license fees;
- (6) Auditing all returns;
- (7) Review all gaming operation contracts, records, documents, and anything else necessary and pertinent to the financial accountabilities of licensees or enforcement of any provision of gaming operation contracts, agreements, this, and related Ordinances.
- (8) The Commissioner shall have the power and authority to deny any application, to limit, condition, suspend, or restrict any license or permit, make a finding of suitability or approval of the license or permit, or a finding of suitability or approval of or the imposition of a fine upon any person licensed or permitted for any cause deemed reasonable by the Commissioner.

- (9) The performance of any other duties required in the Code or any amendments thereto or other duties which may hereafter be specified by the Commissioner.
- (10) Employ legal counsel with consent of the Muscogee Nation by Ordinance.
- (11) Defend this Code in any court of law.

- Section 204. The Commissioner may exercise any proper power and authority necessary to perform the duties assigned by this Code, and is not limited by any enumeration of powers in this chapter.
- Section 205. The Commissioner may refuse to reveal, at any court proceedings, the identity of any informant, if such revelation would subject the informant to bodily harm.
- Section 206. Regular and special meetings of the Commissioner may be held, at the discretion of the Commissioner, at such time and places as may be convenient and open to tribal members, with notice posted in a public place at least 24 hours prior to the meeting.
- Section 207. The Commissioner may organize any functional divisions as may be necessary and from time to time alter such plan of organization as may be expedient. The Commissioner shall recommend this office's own budget for operations to the Principal Chief, and take any other steps necessary to fulfill duties and responsibilities under the code.
- Section 208. In adopting, amending, or repealing any regulations under this Code, the Commissioner shall give prior notice of the proposed action to all licensees and other persons whom the Commissioner has reason to believe have a legitimate and bona fide interest in such proposed action.
- Section 209. The Commissioner shall afford an applicant for a license or permit an opportunity for a hearing prior to final action denying such application and shall afford a licensee or any other person(s) subject to this Code the opportunity for a hearing prior to taking final action resulting in terminating, revoking, suspending, or limiting a license or permit or any other adverse action the Commissioner deems appropriate; Provided, that the Commissioner may summarily temporarily suspend or extend suspension of license for sixty (60) days or withdraw a permit in those cases where such action is deemed appropriate by the Commissioner. In cases where a license is suspended or a permit withdrawn prior to a hearing, an opportunity for a hearing shall be provided.
- Section 210. Whenever upon specific factual finding the Commissioner determines that any person has failed to comply with the provisions of this Code or any regulation promulgated hereunder, the Commissioner shall make a certification of findings with a copy thereof to the subject or subjects of that determination. After five (5) days notice and within ninety (90) days thereof, the Commissioner shall hold a hearing at which time the subject shall have an opportunity to be heard and present evidence.
- Section 211. At such hearing it shall be the obligation of the subject to show cause why the determination is incorrect, why the application in question shall not be denied, why the license, licenses, or permit in question shall not be revoked or suspended, why the period of suspension should not be extended, or to show cause why special conditions or limitations upon a license or permit should not be imposed, or to show cause why any other action regarding any other person or persons subject to any action should not be taken.
- Section 212. Following such hearing the Commissioner shall, within seven (7) days, reach a determination concerning the accuracy of the preliminary certification of facts and whether the license or permit in question should be granted, continued or suspended,

revoked, conditioned or limited, and whether or not any other action recommended to or by the Commissioner (including but not limited to forfeitures or fines) should be taken.

Section 213. Within three (3) days following this determination the Commissioner shall inform the subject in writing of that determination.

Section 214. Right to appeal. The subject shall have the right to appeal the determination of the Commissioner to the Tribal District Court for a de novo hearing. Such appeal must be filed with the Tribal District Court in written form on or before the tenth (10) day following the determination of the Commissioner. The determination of such appeal by the Tribal District Court shall be subject to review or appeal to the Tribal Supreme Court as provided under Tribal Ordinance.

Section 215. Sanctions. Any person who engages in activities on property subject to the provisions of this Code without a license or permit, in violation of the terms imposed thereon, in violation of terms of suspension, or in violation of any other provision of this Code, regulations promulgated thereunder or amendments thereto, shall be in violation of the Code including any person who unlawfully trespasses upon any premises licensed by this Code without the consent of the licensee and/or the Commissioner. Separate violation shall be prosecuted as separate offenses. Each day of violation shall constitute a separate count or violation of this Code. A violator shall also be required to pay court costs, storage fees, auction or sales fees. All property used in each and every separate violation of this Code may become the property of the Muscogee Nation. Persons may be prohibited from trespassing on premises licensed under this Code; licenses may be suspended, or revoked, or limited, and/or establishments may be forceably closed. All such action shall be taken at the discretion of the Commissioner subject to the right of appeal to Tribal District Court. Winnings found to have been received in violation of this Code are forfeited and become property of the Muscogee Nation, recoverable by order, judgement, and execution of the Tribal District Court as provided by Ordinance.

TITLE III. - LICENSING/PERMITS

Section 301. License required. Any person conducting Public Gaming operations on property within the exterior boundaries of the Muscogee Nation and which is subject to the jurisdiction of the Muscogee (Creek) Nation shall be required to have and display prominently an appropriate, valid and current Public Gaming license issued pursuant to the provisions of this Code. Any other forms of Public Gaming operations being conducted within the jurisdiction of the Muscogee Nation without the lawful written approval of the Muscogee (Creek) Public Gaming Commissioner are prohibited under Title IX.

Section 302. Classes and Fees. Different Classes of licenses shall be issued, and each have a separate fee, and each shall grant separate privileges. Each license shall be for a specific place, and licensees desiring to operate multiple locations shall be required to obtain multiple licenses. Licensee shall operate and conduct only those activities authorized under each license as listed below and as may be further specified in regulations promulgated hereunder:

- A. Class "A". A Class A License may be issued to the Creek Nation Festival Committee, or the Creek Nation Rodeo Committee, at an annual rate of \$100.00, for the revocable privilege of conducting bingo games for the remainder of the Calendar year.
- B. Class "C". A Class C License may be issued to any applying Muscogee (Creek) Indian chartered community, church, or

ceremonial ground at a monthly rate of \$10.00, for the revocable privilege of conducting bingo games during the remainder of that calendar month.

Class "C-2". A Class C-2 License may be issued to tribal entities, where the use of tribal funds are involved, at an annual rate of \$25.00 for the revocable privilege of conducting bingo games during the remainder of the calendar year.

- C. Class "N". A Class N License may be issued to any person or group which holds a valid bingo license from the State of Oklahoma or its political subdivision, at an annual rate of \$600.00 or a monthly rate of \$50.00 for the revocable privilege of conducting bingo games for the remainder of the licensed period.
- D. Class "P". A Class P License may be issued to any person or group which holds a valid parimutuel horse racing license from the State of Oklahoma or its political subdivision, at an annual rate of Ten Thousand Dollars (\$10,000), for the revocable privilege of conducting parimutuel horse races for the remainder of the calendar year.
- E. Class "T". A Class T License may be issued to an entity holding a contract with the Muscogee Nation, at an annual rate of \$1,200.00 for the revocable privilege of conducting bingo games in a specific location within the reservation of the Muscogee Nation for the remainder of the calendar year.
- F. Class "S". A Class S license may be issued at an annual rate of \$1,200 for the revocable privilege of transmitting satellite bingo games in a specific location within the reservation (note Attachment B).
- G. Reserved classes. All other classes of licensees of public gaming are reserved from approval by the Commissioner. The Muscogee Nation hereby reserves for itself a Class D License for conducting parimutuel dog races. Said license shall require approval by and Ordinance of the Muscogee Nation.
- H. Amendment of Classes and Fees. Amendments of Section 302 of this Code shall become effective on January 1 of the following calendar year.

Section 303. Exemptions. The following activities are not public gaming operations under the terms of this Code, and therefore do not require a license under this title:

A. GAMING NOT FOR GAIN. Gaming in which no cash or valuable prizes are won, other than 'points' for cumulative competitive ratings, or 'places' for immediate competitive rankings, is not subject to the provisions of this Code. However, gaming for gain which is conducted by a non-profit organization is subject to the requirements of this Code if cash or valuable prizes are awarded. "Valuable prize" means an object or service worth One Hundred Dollars or more in fair market value.

B. [Reserved]

Section 304. All persons or organizations, who may seek to engage in Public Gaming activities within the Muscogee Nation, must apply for the same at least thirty (30) days prior to the scheduled activities. All other licenses must be applied for no less than sixty (60) days prior to the scheduled activities.

Section 305. Every licensee intending to continue engaging in Public Gaming activities within the Muscogee Nation during the next following calendar year shall apply for renewal of the license at least thirty (30) days prior to the end of the previous license period.

Section 306. Every licensee shall display in a prominent place a current and valid license for that location.

Section 307. When a licensee changes a location of Public Gaming activities

within the Muscogee Nation, the Commissioner shall issue a corrected license for the balance of the current period reflecting the new address upon reasonable proof of change of address and without imposition of an additional license fee.

Section 308. Fees. Each application for an initial or renewal license shall be accompanied by payment of the license fee. Subject only to the appeal as provided under this Code, the Commissioner's determination of the license fee properly owed under this Code shall be final. This fee is imposed for the revocable privilege of being licensed to engage in public gaming activities within the Muscogee Nation.

Section 309. Non-transferability. The license issued pursuant to the provisions of this Code is valid only for the person(s) or organization(s) at the place of business shown on the face thereof. It is not assignable or otherwise transferable to any other person or organization or for any other location without the written approval of the Commissioner.

Section 310. All license fees shall be paid to the Treasury of the Muscogee Nation.

Section 311. The Public Gaming Operations license is a revocable privilege, and no holder thereof shall be deemed to have a part in any vested rights therein or thereunder. The burden of proving qualifications to hold any license rests at all times in the licensee. The Commissioner is charged by law with the duty of continually observing the conduct of all licensees to the end that licenses shall not be held by unqualified or disqualified persons or unsuitable person or persons whose operations are conducted in an unsuitable manner.

Section 312. Violation of any provisions of this Code or any of the Commissioner's rules by a licensee, his agent, or employee shall be deemed contrary to the public health, safety, morals, good order, and general welfare of the Muscogee Nation and the inhabitants of the Muscogee Nation, and grounds for refusing to grant or renew a license, suspension or revocation of a license or ground for the filing of criminal charges or civil action in Tribal District Court on behalf of the Commissioner. Acceptance of a license or renewal thereof, or condition imposed thereon, by a licensee constitutes an agreement on the part of the licensee to be bound by all the regulations and/or conditions of the Commissioner and by the provisions of this Code as the same are now or may hereafter be amended or promulgated. It is the responsibility of the licensee to keep himself informed of the contents of all such regulations, provisions, and conditions, and ignorance thereof will not excuse the violations.

Section 313. As a provision of licensing, all contracts or agreements with the Muscogee Nation that include gaming or related activities must be reviewed by the Commissioner.

Section 314. Permits Required. Any activity conducted on tribal trust property in relation to or in conjunction with a licensed function shall be required to obtain either a limited/temporary or annual permit.

Section 315. Permit Class and Fees. Different permit class and fees shall be established by regulation of the Commissioner for all activities and devices listed shall include, but not limited, to the following activities and devices:

- A. Activities:
 1. Games or activities for periods of less than seven (7) days or one time.
 2. Games or activities on an annual or semi-annual schedule.
 3. Games or activities on a intermittent basis throughout the year.

- B. Devices
1. Mechanical or electronic devices except slot machines that are played by any method either for amusement or with expectation of remuneration of either cash prize awards.
 2. Mechanical or electronic devices except slot machines that dispense any type of merchandise for a set amount of money or tokens with a fixed value.

TITLE IV. - RULES OF OPERATION AND GENERAL APPLICABILITY

- Section 401. Records, Returns and Audits. It shall be the responsibility of the Public Gaming Commissioner to promulgate regulations establishing proper accounting procedures and methods of operations for all licensees, so that all monies or things of value received and/or paid out may be properly monitored and accounted for. All licensees under this Code shall be required to keep an approved accounting system, which shall comply with, but not be limited to all applicable provisions of this Code or regulation of the Commissioner. Said accounting system shall reflect all business and financial transactions involved or connected in any manner with the operation and conducting of activities authorized by this Code.
- Section 402. All bingo licensees shall charge players only for the bingo cards to be used in each game. The rate to be charged players for cards or packs shall be fixed by each licensee and posted conspicuously on the premises. Each person paying for the opportunity to participate in a bingo game shall be given an approved receipt for the bingo card or pack, which shall be numbered and dated, which can be readily identified as belonging to that licensee. Each card or pack issued shall represent a specific amount of money which has been paid to the licensee. The amount of money represented by each card or pack issued shall be clearly made known to all players prior to anyone paying to participate in the activity.
- Section 403. Any delay, maneuver or action of any kind, which in the opinion of the Commissioner, is effectuated by any licensee to unlawfully avoid paying the proceeds properly owing to the Muscogee Nation shall constitute grounds for taking any disciplinary action deemed necessary by the Commissioner, including but not limited to fining, revoking, suspending, limiting, or refusing to renew the license of any licensee.
- Section 404. No applicant, licensee, or employee thereof shall neglect or refuse to produce records or evidence under their control, or to give information upon proper and lawful demand by the Commissioner, or shall otherwise interfere with any proper and lawful efforts by the Commissioner to produce such information. The Commissioner may summon any licensee or a licensee's agents, employees, or suppliers to appear to testify with regard to the conduct of any licensee or the agents, employees, or suppliers of any licensee. All such testimony shall be given under oath and may embrace any matters, which the Commissioner may deem relevant to the discharge of his official duties. Any person so summoned to appear shall have the right to be represented by counsel. Any testimony so taken may be used by the Commissioner as evidence in any proceeding or matter before the Commissioner or the Tribal District Court or, which may later come before the Commissioner or the Tribal District Court. Failure to so appear and testify fully at the time and place designated, unless excused, shall constitute grounds for revocation or suspension of any license held by the person summoned, his principal, or employee, or the loss of the privilege to further supply any person licensed under this Code.
- Section 405. Licensees shall provide for their facility security, Provided, that contracts are reviewed, security plans, or amendments thereto are approved by the Commissioner prior to implementation.

- Section 406. Unless prior written approval is obtained from the Commissioner, no person employed in the conduct of Public Gaming operating under one license shall be employed under any other license authorized to operate under this Code.
- Section 407. Age Limit for Bingo. No person, who is under the age of eighteen (18), shall operate nor shall be allowed to participate in any manner in the operation of any bingo game. No person(s) under the age of sixteen (16) shall be allowed on premises where bingo games are being conducted. It shall be the responsibility of the licensee to enforce the provisions of this section.
- Section 408. On duty operators shall not play. No operator shall allow a person who manages or receives any compensation, directly or indirectly, for the operation of any bingo games conducted by the operator to play in a bingo game while on duty. No operator shall allow any person who assists in the operation of any bingo game conducted by the operator to play in any bingo game conducted by the operator within 24 hours of the time said person did so assist.
- Section 409. No free games for winners. No free cards or any opportunity to play in a bingo game shall be awarded or given to a person as prize for or conditioned upon winning a bingo game or games, Provided, that the Commissioner shall have the authority to grant exceptions upon request by the operators.
- Section 410. No bingo game shall be conducted to include a prize determined other than by the matching of letters and/or numbers on a bingo card with letters and/or numbers called by the licensee or an employee of the licensee in competition with all players in the bingo game. All equipment used directly in the operation of a bingo game except bingo cards from which letters and/or numbers are obtained to call, balls or other items containing letters and/or numbers to call or used for the purpose of displaying numbers and/or letters called to the public, and any sound amplification system necessary for the convenience and comfort of the players and operators must be approved by the Commissioner.
- Section 411. Every prize awarded during the operation authorized shall be awarded only to the person(s) actually winning the prize and displaying the proper admission ticket.
- Section 412. Bingo cards or pack shall be sold and paid for only in advance for use in a specified game or specified numbered games. All sales of bingo cards or pack shall take place upon the premises. All bingo cards or packs must be used on the day sold.
- Section 413. Promotional Activities and Renumeration. Certain licensees may be exempt from §409 and engage in promotions and activities that include prizes or the award of cards or packs as an incentive to allow certain individuals, who provide a specified service or meet other stated requirements, to participate in games the same as regular participants. Licensees participating in promotional activities must provide the Office of Public Gaming full details of all such activities and receive advance approval for each such promotional activities. Written approval for such activities must remain on file in the Office of Public Gaming and with the licensee for a period of not less than one (1) year.
- Section 414. Each numbered ball or other device used in a bingo game for the selection of numbers to be called in play shall be the same weight and size as each of the other balls or devices used for that purpose of that game.
- Section 415. In all cases the bingo operator must have and exercise complete control over that portion of the premises being used for bingo at all times said games are being played. The licensee or permit holder shall be held liable for any violation of the Code.

- Section 416. Bingo games shall be operated and conducted only on the appropriate licensed premises authorized under this Code.
- Section 417. No manufacturer, distributor, or operator shall by agreement either express or otherwise with any other manufacturer, distributor, or operator fix the price at which any device, paraphenalia, machine, equipment, prize or any other items used in connection with any of the activities authorized under this Code shall be sold or which services in connection therewith shall be rendered. The price of these items in a competitive market place shall be established by each manufacturer, distributor, or operator for the products and services offered by each and shall not be established, directly or indirectly, in concert with another.
- Section 418. Licensees must own, supervise, and be directly responsible for all activities on their premises authorized by license under this Code, except as specifically outlined in Management Agreement approved by Ordinance.
- Section 419. It is the policy of the Commissioner and the Muscogee Nation to require that all establishments, wherein bingo is conducted within the reservation, be operated in a manner suitable to protect the public health, safety, morals, good order, and general welfare of the inhabitants of the reservation. Responsibility for the employment and maintenance of suitable methods of operation rests with the licensee and willful and persistent use or toleration of unsuitable methods of operation will constitute grounds for license revocation or other disciplinary actions.
- Section 420. Receipt required for income and prizes in bingo. All income from bingo games shall be receipted by the licensee at the time the income is received from each individual player, and all prizes shall be receipted for by the winner of each prize at the time the prize is distributed to each individual winner.
- A. Income receipts forms. Income receipt forms shall be supplied by the licensee. They may be tickets or disposable bingo cards numbered consecutively, or they may be based upon a cash register system if an identification number is on the receipt given to the customer, which is one of a series of such numbers printed consecutively, and a corresponding number is recorded together with a record of the transaction being kept inside the cash register.

In the event a cash register system is used, the following information shall appear upon the receipt given a customer and upon the record being kept inside the machine; the name of the licensee operating the activity; the date the transaction took place, the receipt number; the amount of money paid, or a description of other consideration paid for the opportunity to play. The cash register receipt rolls retained in the machine showing those transactions shall be retained with the records of the licensee for a period not less than two (2) years.

- (1) Receipts from income from all sales except those of opportunities to play bingo on disposable cards. Each person paying for the opportunity to participate in a bingo game, except as provided in sub-section (2), who does not receive a cash register receipt shall be given a ticket or tickets, which shall be consecutively serially numbered. Each ticket issued shall represent a specific amount of money which has been paid to the licensee. The amount of money represented by each ticket issued shall be clearly made known to all players prior to anyone paying to participate in the activity. Licensee shall record in his daily records the lowest numbered ticket issued as a receipt on each day or occasion and highest numbered ticket issued on this day or occasion. Tickets bearing numbers falling between these high and low

numbers issued, which were not issued as receipts on that day or occasion, shall be retained by the licensee as part of its daily records and shall not be otherwise be used or disposed of by the licensee for a period of not less than three (3) months or until such ticket has been duly inspected and accounted for by the Office of Public Gaming, at which time said receipts may be disposed of by the licensee.

- (2) Receipt for income from sales of opportunities to play Bingo on disposable Bingo cards. As to each person playing for the opportunity to play bingo on disposable bingo cards, the disposable cards themselves may be used as the receipt required by this rule, Provided, that each set of disposable cards used is consecutively numbered from the first card to the last, and each card contains both its individual consecutive serial number and the identification number assigned by the manufacturer to that set of disposable cards on its face, except for licensees specifically exempt by the Commissioner to minimize duplicate cards and avoid excess waste.

No disposable card in any game plays shall be a duplicate of any other card in that game. Each disposable card should represent a specific amount of money which has been paid to the licensee, which amount has been clearly disclosed to all players in advance of any player participating in the activity. Each disposable card shall be sold for the same price, as each other disposable card of the same class being used during any particular bingo game.

All licensees shall record in its daily records the set number of each set or portion of a set, which has been used during each bingo game on each occasion immediately following the playing of that game together with the serial number of the cards with the lowest and highest number of cards sold from each of those sets. The licensee shall retain, as a part of his daily records, each unsold disposable card with the serial number falling between the lowest and highest number sold from each set on that occasion and shall not otherwise use or dispose of those cards so retained for a period of not less than three (3) months or until such cards have been duly inspected and accounted for by the Office of Public Gaming, at which time said cards may be disposed of by the licensee.

- B. Receipts for prizes. Receipts for prizes shall contain the following information: The name of the licensee operating the activity; the date the transaction took place; the receipt number and the game number; the true name and address of the winner of the prize; a description of the prize won and any value of that prize, which has been represented to the player by the licensee.

It shall be the responsibility of the licensee to see that the prize winners are properly and accurately identified upon the receipt for the prize, and the licensee shall require such proof of identification as is necessary to properly establish the winner's identity. The licensee shall not pay out any prize unless and until the winner has fully and accurately furnished to the licensee all information required by this rule to be upon the receipt for the prize. One duplicate of each prize receipt shall be given to the winner, and the other duplicate of prize receipts shall be retained by the licensee as part of its records for a period of not less than five (5) years.

Section 421. All establishments, wherein bingo operations are to be conducted, must be certified as safe by the Commissioner prior to the

issuance of a license. All alterations or modifications must be approved by the Commissioner.

Section 422. Any premises licensed or any premises connected physically or otherwise with a licensed business, including vehicles used in connection therewith, shall at all times be open to inspection by the Commissioner. At any time during which a licensed gaming or related administrative activity is being conducted on a premises, the Commissioner or any authorized representative of the Commissioner may enter upon the premises without advance notice and:

- A. Make an account of all monies on the premises and all monies received during the operation of the licensed activity located on the premises, inspect all receipts for prizes which have been awarded by the licensee;
- B. Inspect any other records, accounts or other related information of the licensee, or of any member who directly participates in the management, operation, or promotion of a licensed activity; or of any employee of the licensee; or of any operator of the licensed activity;
- C. Inspect, including the dismantling of all pieces of equipment or parts thereof or devices of any nature, which are being used to conduct the licensed activity.
- D. When the Commissioner finds cause to believe that there is a reasonable probability that the provisions of this Code, including any amendments thereto or any of the rules passed by the Commissioner have been or are being violated by the licensee or its employees or operators, they may move to another location or locations for further inspection or investigation of any and all records and any and all equipment, part thereof, devices, or thing(s) of any nature located upon the premises related to the operation of the licensed activity or any other gambling activity. A receipt shall be issued to the licensee or operator of the activity which shall list and describe each record, that piece of equipment or part thereof, device, or thing(s) which has been removed from the premises. Each such record, piece of equipment, part thereof, or thing(s) so removed shall be returned to the premises or to the address of the licensee within ten (10) days, except Saturdays, Sundays, and days when tribal offices are legally closed. After its removal in as good condition as it was when it was removed unless the Commissioner determines that the record, equipment, devices, or thing(s) so removed are necessary for an ongoing investigation and/or evidence of possible violations of this Code or rules of the Commissioner by the licensee, by employers of the licensee or by operators of the licensed activity, or for possible forfeiture under Title II hereof with the Commissioner so notifying the licensee of the reasons said property or thing(s) are to be so held.

Section 423. No beverage containing alcohol, including but not limited to beer or liquor, shall be offered or awarded as a prize or in lieu of a prize for winning at any of the activities authorized by this Code, nor sold on the premises at any time.

Section 424. No firearms, air guns which are capable of discharging dangerous projectiles or gases, including but not limited to "B.B.'s" or CO₂ guns, rifles, shotguns, pistols, or revolvers shall be allowed on the premises, except as permitted by regulation of the Office of Public Gaming.

Section 425. No licensee or any of its members or employees, or any operator conducting or in any way participating in the conducting of any of the activities, which are authorized by this Code or by the Commissioner's rules, shall allow a person to play that activity on credit or shall grant a loan of any kind at any time to a person playing the activity.

- Section 426. No person involved in the operation of any activity authorized by this Code or a rule of the Commissioner shall, directly or indirectly, in the course of such operation employ any device, scheme, or artifice to defraud; make any untrue statement of a fact, or omit to state a fact necessary in order to make a statement not misleading in consideration of the circumstances under which such statement was made; engage in any act, practice, or course of operation as would operate as a fraud of deceit upon any person.
- Section 427. Each licensee shall obtain, maintain, and keep current a copy of the Bingo Code and all rules of the Commissioner and any amendments to either, which shall be located upon the premises used for the conduct of a licensed activity by a licensee during all times the activity is there conducted. The rules shall be produced by the licensee and shown to any person upon demand. The fact that the licensee may not have a current copy of each of the rules of the Commissioner shall not in any way diminish the licensee's obligation to abide these rules.
- Section 428. No licensee shall conduct any activity authorized under this Code upon any premises, if the lease, license, contract, or any other agreement under which right to use said premises is not first fully disclosed to the Commissioner.
- Section 429. No manufacturer or distributor shall make or have an agreement or understanding with any licensee that either of them shall be restricted in the operation and carrying on of business to a specific geographic area or areas, and such a restriction shall not be a condition of any sales between manufacturer, distributor and any other licensee, Provided, that this shall not prevent a distributor or manufacturer from assigning sales territories among its bona fide representatives.
- Section 430. All licensees shall be responsible to insure that each manufacturer and each distributor selling or distributing equipment or other things used, directly or indirectly, in said licensee's gambling activities and who is not a Muscogee Nation resident or resident corporation shall designate a natural person, who is a resident living in the Muscogee Nation and who is eighteen (18) years of age or older, as a resident agent for the purpose of receipt and acceptance of service of process and other communications on behalf of the manufacturer distributor. The name and business address where service of process and delivery of mail can be made, and home address of such designated resident agent shall be filed with the Commissioner. All said manufacturers or distributors must be listed with the Commissioner.
- Section 431. Immediately before the calling of each number in a bingo game, the caller shall turn the portion of the ball or other device used to determine which number is called, which shows the number and letter to the participants in the game, so that participants may know that the proper number is being called out.
- Section 432. All licensees conducting games with a progressive payout feature will provide the Office of Public Gaming, for approval, the system for accumulation and account restrictions of funds so designated. The procedure and any amendments thereto must receive prior written approval of the Commissioner.
- Section 433. All employees must be listed with the Commissioner. Such lists are to be kept current.

TITLE V. - PARA HORSE RACING

(RESERVED)

TITLE VI. - PARA DOG RACING

(RESERVED)

TITLE VII. - OTHER PUBLIC GAMING

(RESERVED)

TITLE IX. - REGULATION OF UNPERMITTED PUBLIC GAMING

Section 901. Policy; Construction. It is hereby declared to be the policy of the Muscogee Nation, recognizing the close relationship between professional gambling and other organized crime, to restrain all persons from seeking profit from gambling activities in this reservation; to restrain all person from patronizing such activities when conducted for the profit of any person; to safeguard the public against the evils induced by common gamblers and common gambling houses; and at the same time to preserve the freedom of the press; and to avoid restricting participation by individuals in sport and social pastimes which are not for profit, do not affect the public and do not breach the peace. All the provisions of this title shall be liberally construed to achieve these ends, and administered and enforced with a view to carrying out the above declaration of policy.

Section 902. Definitions. As used in this Code:

- (1) "Gain" means the direct realization of winnings; "profit" means any other realized or unrealized benefit, direct or indirect, including without limitation benefits from proprietorship, management, or unequal advantage in a series of transactions.
- (2) "Gambling" means risking any money, credit, deposit or other thing of value for gain contingent in whole or in part upon lot, chance or the operation of a gambling device, but does not include: bonafide contests of skill, speed, strength or endurance in which awards are made only to entrants or the owners of entries; bona fide business transactions which are valid under the law of contracts; and other acts or transactions now or hereafter expressly authorized by law.
- (3) "Professional gambling" means accepting or offering to accept, for profit, money, credit, deposits or other things of value risked in gambling, or any claim thereon or interest therein. Without limiting the generality of this definition, the following shall be included: pool-selling and bookmaking; maintaining slot machines, one-ball machines or variants thereof, pinball machines which award anything other than an immediate and unrecorded right of replay, roulette wheels, dice tables, or money or merchandise pushcards, punch boards, jars or spindles, in any place accessible to the public; and conducting lotteries, gift enterprises, or policy or numbers games, or selling chances therein; and the following shall be presumed to be included: conducting any banking or percentage game played with cards, dice or counters, or accepting any fixed share of the stakes therein.
- (4) "Gambling device" means any device or mechanism by the operation of which a right to money, credits, deposits or other things of value may be created, in return for a consideration, as the result of the operation of an element of chance; any device or mechanism which when operated for a consideration does not return the same value or thing of value for the same consideration upon each operation thereof; any device, mechanism, furniture, fixture, construction or installation designed primarily for use in connection with professional gambling; and any sub-assembly or essential part designed or intended for use in connection with any such device, mechanism, furniture, fixture, construction or installation. But in the application of this definition an immediate and unrecorded right of replay mechanically conferred on players of pinball machines and similar amusement devices shall be presumed to be without value.

- (5) "Gambling record" means any record, receipt, ticket, certificate, token, slip or notation given, made, used or intended to be used in connection with professional gambling.
- (6) "Gambling information" means a communication with respect to any wager made in the course of and any information intended to be used for professional gambling. In the application of this definition the following shall be presumed to be intended for use in professional gambling: information as to wagers, betting odds or change in betting odds.
- (7) "Gambling premise" means any building, room, enclosure, vehicle, vessel or other place whether open or enclosed, used or intended to be used for professional gambling. In the application of this definition, any place where a gambling device is found shall be presumed to be intended to be used for professional gambling.
- (8) "Whoever" and "person" include natural persons, partnerships and associations of persons, and corporations; and any corporate officer, director or stockholder who authorizes, participates in, or knowingly accepts benefits from any violation of this act committed by his corporation.
- (9) "Officer" means any deputy or designated agent of the Commissioner, the Tribal Lighthouse Administration, or Tribal District Court.
- (10) "Court" means the District Court of the Muscogee (Creek) Nation.

Section 903. Gambling; Exemption; Professional Gambling.

- (1) Whoever engages in gambling, solicits, or induces another to engage in gambling, shall be fined by the Commissioner or prosecuted under Federal Law.
- (2) Natural persons shall be exempt from prosecution and punishment under subsection (1) for any game, wager or transaction which is incidental to a bona fide social relationship, is participated in by natural persons only, and in which no person is participating, directly or indirectly, in professional gambling.
- (3) Whoever engages in professional gambling or knowingly causes, aids, abets, or conspires with another to engage in professional gambling shall be fined by the Commissioner or prosecuted under Federal Law.

Section 904. Gambling Devices; Gambling Records.

- (1) All gambling devices are common nuisances and are subject to seizure immediately upon detection by any officer, who shall hold the same subject to confiscation and destruction by order of a court having jurisdiction.
- (2) No property right in any gambling device shall exist or be recognized in any person, except the possessory right of officers enforcing this act.
- (3) All furnishings, fixtures, equipment, and stock including without limitation furnishings and fixtures adaptable to non-gambling uses, and equipment and stock for printing, recording, computing, transporting, safekeeping, or [except as otherwise provided in subsection (3) of Section 905] communication used in connection with professional gambling or maintaining a gambling premise, and all money or other things of value at stake or displayed in or in connection with professional gambling or any gambling device, shall be

subject to seizure, immediately upon detection, by an officer, and shall, unless good cause is shown to the contrary by the owner, be forfeited to the tribe by order of a court having jurisdiction, for sale by public auction, or as otherwise provided by law. Bona fide liens against property so forfeited shall, on good cause shown by the lienor, be transferred from the property to the proceeds of the sale of the property. Forfeit monies and other proceeds realized from the enforcement of this subsection shall be paid equally into the general funds of the tribe and the general funds of the political subdivision or other public agency, if any, whose officers make the seizure except as otherwise provided by law.

- (4) Whoever knowingly owns, manufactures, possesses, buys, sells, rents, leases, stores, repairs or transports any gambling device, or offers or solicits any interest therein; whether through an agent or employee or otherwise, shall be fined by the Commissioner or prosecuted under Federal Law. Subsection (2) of this section shall have application in the enforcement of this subsection.
- (5) Whoever knowingly prints, makes, possesses, stores, or transports any gambling record, or buys, sells, offers or solicits any interest therein; whether through an agent or employee or otherwise, shall be fined by the Commissioner or prosecuted under federal law, and in the enforcement of this subsection direct possession of any gambling record shall be presumed to be knowing possession thereof.

Section 905. Gambling Information.

- (1) Whoever knowingly transmits or receives gambling information by telephone, telegraph, radio, semaphore, or other means or knowingly installs or maintains equipment for the transmission or receipt of gambling information shall be fined by the Commissioner or prosecuted under Federal Law.
- (2) When any public utility is notified in writing by a law enforcement agency acting within its jurisdiction that any service, facility or equipment furnished by it is being used or will be used to violate this section, it shall discontinue or refuse the furnishing of such service, facility or equipment, and no damages, penalty or forfeiture, civil or criminal, shall be found against any public utility for any act done in compliance with such notice. Unreasonable failure to comply with such notice shall be prima facie evidence of knowledge against such public utility. Nothing in this subsection shall be deemed to prejudice the right of any person affected thereby to secure an appropriate determination, as otherwise provided by law, that such service, facility or equipment should not be discontinued or removed, or should be restored.
- (3) Facilities and equipment furnished by a public utility in the regular course of business, and which remain the property of such utility while so furnished, shall not be seized pursuant to subsection (3) of Section 904 of this act, except in connection with an alleged violation of this act by such public utility, and shall be forfeited only upon conviction of such public utility therefore.

Section 906. Gambling Premises.

- (1) All gambling premises are common nuisances and shall be subject to abatement by injunction or as otherwise provided by Federal law. In any action brought under this subsection the plaintiff need not show damage and may, in the discretion of the court, be relieved of all requirements as to giving security.

- (2) When any property or premise is determined by a court having jurisdiction to be a gambling premise, the owner shall have the right to terminate all interest of anyone holding the same under him.
- (3) When any property or premise for which one or more licenses, permits, or certificates issued by this Tribe, or any political subdivisions, or other public agency thereof are in effect is determined by a court having jurisdiction to be a gambling premise; all such licenses, permits, and certificates shall be void, and no license, permit, or certificate so cancelled shall be reissued for such property or premise for a period of six (6) months thereafter. Enforcement of this subsection shall be the duty of all officers and all taxing or licensing officials of this Tribe and its political subdivisions and other agencies.
- (4) Whoever as owner, lessee, agent, employee, operator, occupant, or otherwise knowingly maintains, or aids, or permits the maintaining of a gambling premise shall be fined or imprisoned, or both, and whoever does any act in violation of this paragraph within any locked, barricaded, or camouflaged place or in connection with any electrical or mechanical alarm or warning system or arrangement shall be prosecuted under Federal Law.

Section 907. Repeated Offenses.

Any person who has been convicted of a violation of Section 903(2), 904(4), 905(1), or 906(4) of this act may upon any subsequent violation of Section 903(2), 904(4), 905(1), or 906(4) be prosecuted as a repeating offender under Federal Law.

Section 908. Witness Immunity.

In any proceeding arising out of a violation of this act, if a natural person refuses to answer a question or produce evidence of any other kind on the ground that he may be incriminated under this act thereby, the court when requested in writing by the prosecuting attorney, shall, unless it finds that to do so would be clearly contrary to public interest, order such person to answer or produce the evidence, and that person shall comply with the order. After complying with the order, and if, but for this section, he would have been privileged to withhold the answer given or the evidence produced by him, such person shall not be prosecuted or subjected to penalty or forfeiture under this act for or on account of any transaction, matter or thing concerning which, in accordance with the order, he gave answer or produced evidence. He may nevertheless be prosecuted or subjected to penalty or forfeiture for any perjury or contempt committed in answering or failing to answer, in producing, or failing to produce, evidence in accordance with the order.

TITLE X. - NOTICE TO RESERVATION RESIDENTS

Section 1001. The Principal Chief shall publish 100 copies of this Code and shall make them available for sale to the public at cost.

Section 1002. The Principal Chief shall publish a Legal Notice in one newspaper of general circulation within each Legislative District of the Muscogee Nation. Said Notice shall read as follows:

The Muscogee Nation has adopted a Code regulating public gaming within the Muscogee (Creek) Nation. All natural and legal persons who reside or do business within tribal boundaries are hereby notified that said Code is in effect.

Effective _____, 198____, general provisions have been adopted, the tribal office of Commissioner of Public Gaming is established, and Notice to Reservation Residents is required.

Effective , 198 , tribal licenses are required for public gaming activities, rules of operation and general applicability for public gaming are in force, a Public Gaming Transaction Tax is adopted, and unlicensed public gaming is prohibited.

One aspect of this Code is that any person subject to this Code who operates bingo games under state license shall also be required to obtain tribal licenses and to pay the Public Gaming Transaction Tax. Another aspect of this Code is that the Muscogee Nation has adopted the Model Anti-Gambling Act drafted by the National Conference of Commissioners of Uniform Laws.

Copies of the Code are available for \$. from the Office of the Principal Chief, P.O. Box 580, Okmulgee, Oklahoma, 74447.

/s/
Principal Chief
Muscogee (Creek) Nation
(date)

Section 1003. The Principal Chief shall request in writing that the Bureau of Indian Affairs cause the Notice in Section 1002 to be published in the Federal Register. Failure of the Bureau to publish said Notice shall not be construed as limiting notice to reservation residents.

Section 1004. The Principal Chief shall notify the National Conference of Commissioners on Uniform Laws that the Muscogee Nation has adopted the Model Anti-Gambling Act.

ENACTED by the Muscogee (Creek) National Council on this 23rd day of November, 1985.

IN WITNESS WHEREOF, the Presiding Officer of the Muscogee (Creek) National Council has hereto attached his signature.

Carney Roberts
Carney Roberts, Speaker
Muscogee (Creek) National Council

CERTIFICATION

I, the undersigned, certify that the foregoing is a true extract from the minutes of the Muscogee (Creek) National Council, comprised of seventeen members with thirteen members attending this meeting the 23rd day of November, 1985, and that the above is in conformity with the provisions therein adopted by a vote of Seven IN FAVOR, Six AGAINST, No ABSTENTIONS, and that said Ordinance has not been rescinded or amended in any way and that the above is the signature of the Speaker of the Muscogee (Creek) National Council.

Kay Willie
Kay Willie, Recording Secretary
Muscogee (Creek) National Council

I, the Principal Chief of the Muscogee (Creek) Nation hereby affix my signature this 2 day of Dec, 1985 to the above authorizing it to become an Ordinance under Article VI, Section VI of the Constitution of the Muscogee (Creek) Nation.



Claude A. Cox
Claude A. Cox, Principal Chief
Muscogee (Creek) Nation



Certified Copy
Musco
(Creek) National Council

NCA 85-74
AN ORDINANCE OF THE MUSCOGEE (CREEK) NATION AMENDING NCA 84-04,
"REGULATING PUBLIC GAMING WITHIN THE MUSCOGEE (CREEK) NATION"

- Section 100. Be it enacted by the Muscogee Nation in Council Assembled:
- Section 101. FINDINGS. The National Council finds that:
 - A. The Office of Public Gaming has submitted amendments to NCA 84-04 to the National Council for legislative Action.
 - B. The amendments to NCA 84-04 have received a "DO PASS" recommendation from the Committee on Business and Governmental Services.
- Section 102. The National Council hereby authorizes and approves the amendments to NCA 84-04 as recommended by the Committee on Business and Governmental Services.
- Section 103. The National Council Secretary shall execute an original copy of NCA 84-04 to reflect the amendments as approved by the Committee on Business and Governmental Services; the Speaker and the Principal Chief shall sign the amended Ordinance.
- Section 104. The amendments to NCA 84-04 shall become effective upon the signature of the Principal Chief of the Muscogee (Creek) Nation.

Enacted by the Muscogee (Creek) National Council on this 23rd day of November, 1985.

IN WITNESS WHEREOF the Presiding Officer of the Muscogee (Creek) National Council has hereto attached his signature.

James Roberts

James Roberts, Speaker
National Council, Muscogee Nation

CERTIFICATION

I, the undersigned, certify that the foregoing is a true extract from the minutes of the Muscogee (Creek) National Council, comprised of seventeen members with thirteen members attending this meeting on the 23rd day of November, 1985, and that the above is in conformity with the provisions therein adopted by a vote of seven in favor, six Against, No Abstentions, and that said Ordinance has not been rescinded or amended in any way and that the above is the signature of the Speaker of the Muscogee (Creek) National Council.

Kay Willie

Kay Willie, Recording Secretary
National Council, Muscogee Nation

NCA 85-74 , and Amendment to NCA 84-04

Certified Copy
Muscogee (Creek) National Council
APPROVAL

I, the Principal Chief of the Muscogee (Creek) Nation hereby affix my signature this 7 day of Dec, 1985, to the above authorizing it to become an Ordinance under Article VI, Section VI of the Constitution of the Muscogee (Creek) Nation.

Claude A. Cox
Claude A. Cox, Principal Chief
Muscogee (Creek) Nation

Certified Copy
Muscogee (Creek) National Council

Certified Copy
Muscogee (Creek) National Council



ATTACHMENT A

BOUNDARIES OF THE MUSCOGEE NATION

Prior to 1707, the Muscogee Nation occupied a large aboriginal territory in Georgia, Alabama and Florida. Through a series of treaties with Great Britain and her colonies, tracts were ceded through 1733. In 1790, cessions to the United States were commenced.

In 1830, the Indian Removal Act, 4 Stat. 412, authorized exchanges of tribal lands east of the Mississippi River for new tracts west of the Arkansas territory. In 1832, the Muscogee Nation signed a Treaty which permitted the exchange to take place, Treaty of March 24, 1832, 7 Stat. 366.

Less than eleven months later, the boundaries of the new tribal lands in the west were established by the Treaty of February 14, 1833, 7 Stat. 417, which provided:

Article II. The United States hereby agree, by and with the consent of the Creek and Cherokee delegates, this day obtained, that the Muscogee or Creek country west of the Mississippi, shall be embraced within the following boundaries, viz:

--Beginning at the mouth of the north fork of the Canadian river, and run northerly four miles -- thence running a straight line so as to meet a line drawn from the south bank of the Arkansas river opposite to the east or lower bank of Grand River, at its junction with the Arkansas, and which runs a course south, 44 deg. west, one mile, to a post placed in the ground -- thence along said line to the Arkansas, and up the same and the Verdigris river, to where the old territorial line crosses it -- thence along said line north to a point twenty-five miles from the Arkansas river where the old territorial line crosses the same -- thence running a line at right angles with the territorial line aforesaid, or west to the Mexico line -- thence along the said line southerly to the Canadian river or to the boundary of the Choctaw country -- thence down said river to the place of beginning.

The lines, hereby defining the country of the Muscogee Indians on the north and east, bound the country of the Cherokee along these courses, as settled by treaty concluded this day between the United States and that tribe.

Article III. The United States will grant a patent, in fee simple, to the Creek Nation of Indians for the land assigned said nation by this treaty or convention, whenever the same shall have ratified by the President and Senate of the United States -- and the right thus guaranteed by the United States shall be continued to said tribe of Indians, so long as they shall exist as a nation, and continue to occupy the country hereby assigned them.

This area was diminished by the Treaty of August 7, 1856, 11 Stat. 699, which provided a tract between the north and south forks of the Canadian River, west of Pond Creek, to the Seminoles.

The tribal area was diminished again by the Treaty of June 14, 1866, 14 Stat. 785, which provided:

Article 3. In compliance with the desire of the United States to locate other Indians and freedmen thereon, the Creeks hereby cede and convey to the United States, to be sold and used as homes for such other civilized Indians as the United States may choose to settle thereon, the west half of their entire domain, to be divided by a line running north and south; the eastern half of said Creek lands, being retained by them, shall, except as herein otherwise stipulated, be forever set apart as a home for said Creek Nation.

Article B. It is agreed that Secretary of the Interior forthwith cause the line dividing the Creek country, as provided for by the terms of the sale of Creek lands to the United States in article third of this treaty, to be accurately surveyed under the direction of the Commissioner of Indian Affairs, the expenses of which survey shall be paid by the United States.

The conditional cession in Article 3 (supra) was released by the Muscogee Nation in the Agreement of January 19, 1889, 25 Stat. 757.

Since the ratifications of the 1889 Agreement, the boundaries of the Muscogee Nation have not been altered nor diminished by an Act of Congress, nor has any federal statute abolished said boundaries, nor has any federal statute terminated the tribal government of this tribe, nor has any tract of land been severed from the reservation by Act of Congress.

Muscogee (Creek) National Council

Certified Copy

Muscogee (Creek) National Council

Certified Copy

Muscogee (Creek) National Council



NCA 88-51

AN ORDINANCE OF THE MUSCOGEE (CREEK) NATION TO AUTHORIZE THE SENDING
AND RECEIVING OF SATELLITE BINGO TRANSMISSION SERVICES

Section 100. Be it enacted by the Muscogee Nation in Council Assembled:

FINDINGS. The National Council finds that:

A. The Muscogee (Creek) Nation, in order to create avenues for economic growth and to utilize technologies for the economic advancement of the Nation, hereby establishes this the Satellite Bingo Ordinance.

Section 101. Definition. Satellite Bingo is the activity wherein bingo games are electronically transmitted by the utilization of live or pre-recorded pictures or data from predesignated satellites owned, leased or thru use of agreement to authorized sending units, places or areas.

Section 102. It is hereby determined that in the best interest of the Muscogee Nation, licensing and regulation should be established to preserve and protect the interests of the Nation.

Section 103. A new class of licensing for satellite bingo titled "Class S" shall be established and may be issued by the Commissioner of Public Gaming at an annual rate of \$1,200 for the revocable privilege of transmitting satellite bingo games in a specific location within the reservation. Upon enactment, this "Class S" license classification shall become effective immediately.

Section 104. "Class S" licensees shall and must abide by the rules and regulations, as set out in NCA 84-04, as amended.

Section 105. Approval of leases or contracts for satellite bingo enterprises between the Muscogee Nation and any third party will be facilitated thru Ordinance.

Enacted by the Muscogee (Creek) National Council on this 27th day of August, 1988.

IN WITNESS WHEREOF, the Presiding Officer of the Muscogee (Creek) National Council has hereto attached his signature.

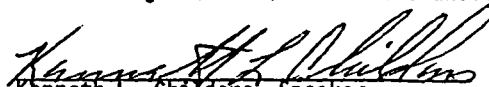
Kenneth L. Childers, Speaker
National Council, Muscogee Nation

CERTIFICATION

I, the undersigned, certify that the foregoing is a true extract from the minutes of the Muscogee (Creek) National Council, comprised of twenty-six members with 23 members attending this meeting on this 27 day of August 1988, and that the above is in conformity with the provisions therein adopted by a vote of 10 in favor, 6 against, 1 abstentions, and that the above is the signature of the Speaker of the Muscogee (Creek) National Council.

Kay Willie, Recording Secretary
National Council, Muscogee Nation

APPROVAL

I, the Principal Chief of the Muscogee (Creek) Nation hereby affix my signature this 1 day of Sept, 1988, to NCA 88-51 to authorize it to become an Ordinance under Article VI, Section VI of the Constitution of the Muscogee (Creek) Nation.

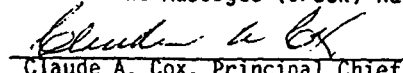
Claude A. Cox, Principal Chief
Muscogee (Creek) Nation

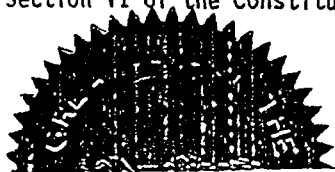

INDEX OF REGULATIONS

84-01.....	Space Requirements
84-02.....	Sale or Use of Alcohol
84-03.....	Credit
84-04.....	Age of Workers
84-05.....	Sundays
84-06.....	Visitors to Facility
84-07.....	Drivers of Chartered Vehicles
84-08.....	Pull-Tabs
84-09.....	Paying of Winnings
84-10.....	Free Games
84-11.....	Door Prizes
84-12.....	Wage Law Compliance
84-13.....	Compliance with Laws
84-14.....	Notice of Cost and Prize (Specials)
84-15.....	Illicit Remuneration
84-16.....	Security
84-17.....	Initial Accounting Procedure
84-18.....	Disclosure
84-19.....	Personnel
84-20.....	Insurance
84-21.....	Sanitation Regulations
84-22.....	Assignment
84-23.....	Termination in Advance of Expiration
84-24.....	Records, Consideration and Payments
84-25.....	Indemnification
84-26.....	Provisions Applicable upon Expiration or Termination
85-01.....	Employee Suspension
85-02.....	Caller's Area
85-03.....	Official Representative
85-04.....	Proper Attire
85-05.....	Prohibited Advertising/Publication/Materials and Distribution
85-06.....	General Manager On Premises
85-07.....	Firearms
86-01.....	Operations/Controls
86-02.....	Clandestine Activities
86-03.....	Identification Standards
89-01.....	Verification of Satellite Game
89-02.....	Do-It-Yourself Game
89-03.....	Application Fee and Investigation Expense
90-01.....	Posting of Gaming Ordinance
90-02.....	Manager Off Premises
90-03.....	Food Service Sanitation
90-04.....	Emergency/Evacuation Procedures
91-01.....	Employee Gaming License/Permit

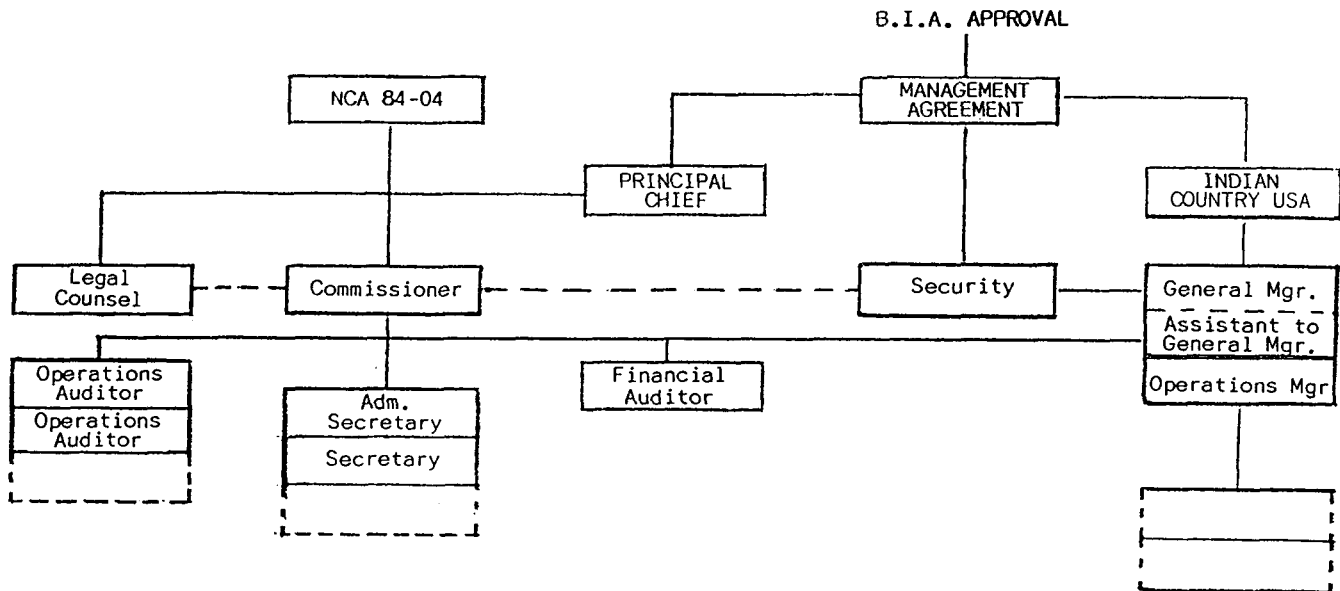

BREIF DESCRIPTIONS OF FUNCTIONS OF ENTITY

Legal Counsel

Legal advisor to Principal Chief and Commissioner. Legal interpretation of NCA Ordinances, Muscogee (Creek) Nation Constitution, state, county, municipal, or federal law affecting the interest of the Muscogee (Creek) Nation with regard to gaming and related activity.

Security

Protect the patrons, premises, and assets on Muscogee (Creek) Nation tribal trust land under the direction and responsibility of Management, however; the Commissioner shall have contingent ad hoc authority to administer and enforce the provisions of NCA 84-04.

Management

Manage and operate for the benefit of the Muscogee (Creek) Nation and Indian Country U.S.A.

Commissioner

Verify operation of gaming and related activity is conducted according to standards and policies as established by NCA 84-04, the Muscogee (Creek) Nation Constitution, and applicable federal laws.

REGULATION 84-01
SPACE REQUIREMENTS

In order that the office of Public Gaming may fulfill its functions and duties, as established by NCA 84-04, it shall be a requirement of a licensee to furnish adequate space and facilities for the Commissioner and/or his staff as provided for by this regulation.

Set forth in the following outline is the space required as it applies to the various levels of gaming activities.

- A. Activities involving less than 500 participants.
1. Space for viewing, auditing and any other activity, shall consist of desk space and the use of typewriter, calculator, telephone, etc., as may be necessary, to carry out related activities.
 2. Space requirement shall be 1% of total gaming area and its related activities, minimum of 100 sq. ft.
 3. Space shall provide visibility of the gaming area and caller. If office space is not situated as such it shall be the privilege of the Commissioner to utilize any other facilities available, in order to accomplish this goal, at and during times as may be necessary.

4. The work area shall be available during normal business hours and any other time as required, upon proper notice, in order to conduct the business of the Gaming Commissioner or his representative.

B. Activities involving 500 or more participants.

1. Space requirements shall be based on total footage allocated or provided as gaming area and other related activities as they may apply when they are part of or supportive to the gaming function (with the exception of adjoining storage facilities, barns, stables, etc., which may be related but detached).
2. Space allocation shall be 1% of total sq. ft. plus 1/10 of 1% per one hundred of planned designated seating of participants or; 1% plus 100 sq. ft. per fraction of each 300 planned participants. The only exception being Class "P" & "D" License which shall be 1% plus 100 sq. ft. per every 3,000 seating capacity. This office space shall be separate, permanent and provide a view of gaming area, caller and related activities. It shall have separate comfort facilities (bathroom, heating, and cooling) and be independent of main systems. Viewing shall be afforded utilizing glass.

3. Space as provided under this regulation for activities by Gaming Commissioner's Office shall be included in the preliminary planning state of any new construction and remodeling of existing structure where applicable for licensing under Class "P", "T" and "D".

Section 203 of the Ordinance.

REGULATION 84-02
SALE OR USE OF ALCOHOL

The sale or allowed use of beverage or drink containing alcohol including but not limited to beer or liquor will not be permitted. Neither will items identified as such be offered or awarded as a prize or in lieu of a prize for winning or as a consolation prize by the licensee, or as a gift, consideration, or gratuity to employees, or people of unofficial employee status.

Section 423 of the Muscogee (Creek) Nation Public Gaming Ordinance is in effect at all times.

REGULATION 84-03

CREDIT

The Muscogee (Creek) Nation Public Gaming Ordinance prohibits credit with the exception of major credit cards, travelers checks, or money orders. There will be no exceptions made by the licensee or any of it's member or employees, agent or operator.

No person shall play on credit, receive merchandise on credit, sign for games or merchandise, be granted a loan or gift by licensee to play or participate.

Items of value offered as barter or exchange for the privilege of playing or for merchandise is prohibited.

Major credit cards with proper identification will be accepted only for price of admission and merchandise.

The licensee will establish and institute procedures and follow such to assure the Gaming Commissioner that all credit card, money order, and traveler check transactions are made in accordance with established business practices, approved of by the Commissioner.

Personal checks are considered credit and will not be accepted.

Section 425 of the Ordinance.

REGULATION 84-04

AGE OF WORKERS

In accordance with the Muscogee (Creek) Nation Public Gaming Ordinance no one under the age of eighteen (18) shall be employed in any capacity by the licensee of a Class "P" or "T" license. Neither shall they operate or be allowed to participate in any manner in the operation of any bingo activity. It shall be the responsibility of the licensee to determine that no unauthorized person under the age of eighteen (18) be allowed to participate in any manner in the operation of any bingo activity.

Section 407 of the Ordinance.

REGULATION 84-05

SUNDAYS

It is hereby established that the hours of Sunday bingo activity be between the hours of 12:00 noon and 7:00 p.m. The facility may open prior to or close after established hours, but shall not conduct bingo (the calling of numbers) before 12:00 noon as defined by Section 110 of the Ordinance.

Pull-tab activity shall be limited to the hours the doors of the facility are open to the general public. No employees or person(s) shall purchase or engage in pull-tab activity before or after the hours established as the normal hours of business.

Section 110 and 204 of the Ordinance.

REGULATION 84-06
VISITORS TO FACILITY

No admission to anyone beyond the lobby area unless they are accompanied by someone paying the regular admission fee and if seating space is available.

The Management or Commissioner may grant visitor or guest status to individuals as it may pertain to their official function.

No person(s) under the age of eighteen (18) shall be allowed in the gaming area. (Tulsa facility lower floor level.)

No person(s) under the age of sixteen (16) shall be allowed on the premises.

No person(s) under the age of eighteen (18) shall be allowed to participate in gaming activity.

Section 203 and 407 of the Ordinance.

REGULATION 84-07
DRIVERS OF CHARTERED VEHICLES

Drivers of chartered vehicles (buses, vans, etc.) shall be considered an unofficial employee and permitted access to the facility. Licensee shall be responsible for activities and conduct of such individuals while on the premises. The responsibility for suitable methods of operation rest at all times with the licensee. The Transportation Officer shall report to the Commissioner in writing any incidents involving vehicle accidents, vehicle related personal injury accidents, personal incidents involving drivers of chartered vehicles, etc. that concern his office or such incidents that the Commissioner may request of his office.

Sections 203 and 419 of the Ordinance.

REGULATION 84-08
PULL-TABS

Sales and distribution of pull-tabs shall be limited:

- A. To hours stated as the normal hours of business as pertains to each facility;
- B. To the gaming area (Tulsa facility lower floor area);

Cashed pull-tabs shall be voided (by punching, marking, etc.) at time of payment.

When pull-tab activity is the only gaming activity at a facility, the facility's business hours will regulate hours of sale and activity of pull-tabs.

No prize or any form of consideration shall be awarded, given or issued by licensee before or after the hours established as the normal hours of business.

Section 203 of the Ordinance.

REGULATION 84-09

PAYING OF WINNINGS

Licensee shall make known to the prize winner and licensee shall have the privilege of paying by check or cash at the request of prize winner, to the amount of \$2,500.00 or less.

A prize exceeding \$2,500.00 may be paid in form of check or cash at the request of the prize winner while the remaining portion in the amount or in excess of \$2,500.00 shall be satisfied by check.

All prizes or monies awarded to winners in excess of \$1,200.00 in cash or fair market value shall be awarded to the individual after identification establishing the winner and the individual filling out IRS Form W-2G are the one and the same true person so identified. Additionally, IRS Form 1040-ES, or equivalent estimated tax forms, shall be issued to all such winners who did receive the Form W-2G.

Such prize winners will be receipted for the prize or monies they receive and asked to sign a receipt. Upon completion of IRS Form W-2G and signature for receipt, prize or monies shall be released to that individual.

Copies of IRS Form W-2G and signed receipt for prize or monies won shall be provided to the winner, IRS, licensee and the Commissioner by licensee.

IRS Form W-2G and prize receipt copies shall be provided by licensee minimally once a week to the Office of the Gaming Commissioner.

Section 203 of the Ordinance.

REGULATION 84-10

FREE GAMES

In concurrence with the Ordinance, awarding of free playing shall be prohibited with the exception of specified free games won as door prizes.

Section 409 of the Ordinance.

REGULATION 84-11

DOOR PRIZES

Door prizes by drawing may be awarded including free specified games.

No beverage containing alcohol shall be offered as a prize or in lieu of a prize.

No firearms or air guns, which are capable of discharging dangerous projectiles, shall be offered or awarded as a prize.

Section 423 and 424 of the Ordinance.

REGULATION 84-12
WAGE LAW COMPLIANCE

Licensee shall abide by all federal laws where applicable in relation to wage(s) and hours worked including such benefits, compensation, earnings, deductions as stated by statute(s).

Licensee shall not adjust, compensate, reimburse, indemnify, or settle account with employee other than by the regular, prescribed practice of issuing a serialized numbered payroll check recorded and holding such document by copy as an instrument of record for inspection.

Section 203, 419 and 422 of the Ordinance.

REGULATION 84-13
COMPLIANCE WITH LAWS

Licensee shall comply with all federal laws, ordinances, rules and regulations of the Muscogee (Creek) Nation. Licensee shall not suffer to be done anything on premises, in the operation of, the gaming activity and facility in violation of any such laws, ordinances, rules or regulations as they may pertain to restricted Indian trust lands.

Sections 203 and 204 of the Ordinance.

REGULATION 84-14

NOTICE OF PROMOTIONS AND ADVERTISEMENT

Cost of "specials" shall be published and notice given. Licensee shall make known to the public by announcement, print, and signs any "special(s)" included in the gaming activity.

All advertisement and promotional material shall be subject to the review/approval of the Commissioner. Licensee shall be required to submit the proposed materials for approval in a reasonable amount of time (at least 48 hours) prior to the publication of same, thereby allowing ample time for thorough review by the Commissioner.

Universal or generic type materials may be reviewed/approved on a quarterly basis. Thus, additional publication of the materials, which do not deviate from the immediate preceding approved version, do not require approval, provided that same is submitted within the three month time frame. However, materials which do deviate from the preceding version shall be submitted to the Commissioner for review/approval.

Section 203 of the Ordinance.

REGULATION 84-15

ILLICIT REMUNERATION

Licensee or employees shall accept nothing of value, take advantage, or benefit in exchange for extending business privileges to manufacturer, distributor, supplier, etc. other than by promulgated agreement.

Licensee or employees shall not engage to defraud by depriving the Muscogee (Creek) Nation its right to have its affairs conducted free from kickbacks, bribes, payoffs, corruption, and conflict of interest.

Sections 203, 419 and 426 of the Ordinance.

REGULATION 84-16

SECURITY

All security personnel will undergo a background check by the licensee, and a copy shall be provided to the Commissioner.

Licensee shall give first consideration of in-house security sub-contractors and/or security personnel to citizens of the Muscogee (Creek) Nation.

Uniform and accessories worn by security personnel shall be standard in color and design.

Nameplates shall be worn on the uniform identifying the person and bearing the name of the licensed gaming operation; ie. Creek Nation Bingo, picture, and social security number of the individual attached to the badge or emblem bearing the identity of the security firm.

The Commissioner of Gaming shall retain the privilege to place the aggregate level of personnel required to secure the vested interest of the Muscogee (Creek) Nation.

The Office of Public Gaming shall reserve the right to cause with reasonable and cautionable care any objectionable person or persons to be ejected or removed from the premises.

The Commissioner of Gaming or his office representative shall have contingent authority of security personnel in/for preserving the vested interest of the Muscogee (Creek) Nation and the vested interest of the second party of any joint venture entered into by the Muscogee (Creek) Nation. This privilege shall be superior to any rights of licensee yet not relieve licensee of responsibility and liability of the actions of security personnel on such warranted occasions.

The terms of the security contract shall be fully disclosed with a copy provided by licensee before any authorized activity under this Ordinance is conducted.

Sections 203, 204, 421 and 428 of the Ordinance.

REGULATION 84-17
INITIAL ACCOUNTING PROCEDURE

Licensee shall submit a proposed Accounting Policy and Procedure Manual and flow chart of accounting system proposed to be used, subject to approval.

Such proposed Accounting Policy and Procedure Manual shall include and establish the following:

- 1) Personnel: Requirements establishing competence and integrity of personnel in key positions, the independence of their assigned functions, and their understanding of the prescribed procedures.

- 2) Segregation of Functions: Separation of personnel responsible for recordkeeping, personnel responsible for custody of or access to assets, and personnel responsible for authorization signatures.

- 3) Execution of Transactions: Requirements that transactions are executed as authorized, that authorizations are issued by persons acting within the scope of their authority, and that transactions conform with the terms of authorization.

- 4) Recording of Transactions: Recording of transactions at the amounts and in the accounting periods in which they were executed and be classified in appropriate accounts.

- 5) Access to Assets: Require that access to assets be limited to authorized personnel.

- 6) Comparison of Recorded Accountability with Assets: Requirements to determine whether the actual assets agree with the recorded accountability, and consequently achieving reliability of the records for preparing financial statements.

Section 401 of the Ordinance.

REGULATION 84-18

DISCLOSURE

Licensee shall produce a copy of all agreements written or otherwise expressed entered into affecting this Ordinance or related to the vested interest of the Muscogee (Creek) Nation.

Such copy shall be a true copy disclosing all information necessary for determination by the Commissioner that the agreement does not deprive, defraud, or neglect the interest of the Muscogee (Creek) Nation.

Any delay, maneuver, or action of any kind effected by the licensee to avoid full disclosure shall meet with sanctions provided by this Ordinance.

Sections 203, 404, 417, 418, 419, 422, 426, 428 and 429 of the Ordinance.

REGULATION 84-19

PERSONNEL

Licensee may employ such persons as may be necessary to the operation of the gaming facility herein granted under such terms and conditions as may be satisfactory to licensee and such employees. It is specifically understood and agreed that licensee is the employer of any such persons, that as such, licensee is solely responsible and assumes all liability for the actions and conduct of said employees perspicuous to the Management Agreement, and that such employees are not the agents, servants, or employees of the Muscogee (Creek) Nation. It is further understood and agreed that all employees of licensee, if any, shall be competent, qualified persons who shall at all times maintain a personal cleanliness, neat appearance, and shall present a courteous and cooperative attitude to the public. In the event any employee of licensee is found lacking in the standards herein required or for any other reason is deemed unsatisfactory to the Commissioner, the Commissioner shall give licensee written notice stating the reasons for such dissatisfaction, and licensee shall within two (2) weeks of receipt of such notice advise the Commissioner in writing of the steps which have been taken to correct the reasons causing notice to licensee of such dissatisfaction. In the event any second notice by the Commissioner of an individual employee's unsatisfactory appearance or conduct is required, licensee shall not permit any such employee to continue to work at any operation of the gaming concession granted. This provision regulation is not to be construed so as to vest control in the Commissioner of the actions of any of licensee's employees, but rather such provision is intended only to establish a requisite standard of personnel to be employed by licensee.

Section 418 and 419 of the Ordinance.

REGULATION 84-20

INSURANCE

INSURANCE. During the term of this license, licensee shall, as an operating expense, maintain in full force and effect such insurance policies (underwritten by an insurance company authorized to do business in the state of Oklahoma and the Muscogee (Creek) Nation) in such form and with such endorsements as shall protect the Muscogee (Creek) Nation against any and all damages, claims or expense resulting from the operation of any and all gaming and related activities granted licensee. Specifically, licensee shall maintain an adequate general liability insurance policy, which shall provide insurance coverage in the sum of not less than One Million Dollars (\$1,000,000.00) for property damage, One Million Dollars (\$1,000,000.00) for any single person injured, and Three Million Dollars (\$3,000,000.00) for multiple persons injured in any one accident. Whereas there is a food and beverage concession herein granted, such general liability insurance policy shall include a products liability insurance endorsement, providing coverage of up to One Million Dollars (\$1,000,000.00) for personal injuries; and, because it is specifically herein anticipated that the activities hereunder granted will require licensee to utilize motor vehicles in the provision of security, licensee shall provide automobile (inclusive of pickups and trucks, if applicable) liability insurance in the same amounts of liability as required for the general liability insurance policy.

All such policies of insurance shall name the Muscogee (Creek) Nation, a federally recognized Indian Nation, as an "additional insured" thereunder. In the event of cancellation, termination or material alteration of any of the insurance policies and minimum liability limits herein required, the insurance company issuing said policies must give the Muscogee (Creek) Nation and the Office of the Commissioner of Public Gaming at least 15 days prior written notice of such cancellation, termination or material alteration, and upon receipt of such notice this license shall come under consideration of penalty.

Until such insurance policies or certificates of insurance showing full compliance have been approved by the Tribal Attorney and a copy filed with the Commissioner of Public Gaming of the Muscogee (Creek) Nation, this license shall be without force and effect and any person who engages in activities on property shall be in violation of the Ordinance. Each day of violation shall constitute a separate count or violation of this Ordinance.

Section 203, 204, 215 and 419 of the Ordinance.

REGULATION 84-21
SANITATION REGULATIONS

Licensee shall at all times conduct the business and operation of this gaming concession in strict compliance with all federal ordinances and all health, safety and protective laws, codes, ordinances or regulations as standards applicable to the facility accepted by the Muscogee (Creek) Nation and the Commissioner of Gaming. Licensee shall at all times keep the premises and all equipment located therein clean, sanitary and in such attractive condition as may be satisfactory to the Muscogee (Creek) Nation and the Commissioner. Licensee hereby specifically agrees to comply with any and all reasonable directions which may be given by the Muscogee (Creek) Nation or the Commissioner of Gaming, relative to maintaining such attractive and sanitary conditions.

Licensee shall, from time to time, maintain an area surrounding the facility to assure that same is kept in a neat, attractive and sanitary condition. Licensee shall pursue whatever steps are reasonably necessary to assure waste material and refuse created from the facility is removed so that in no event will same become offensive or create any health or sanitation hazard.

Licensee shall neither commit nor, to the extent reasonably possible, permit any nuisance to be committed within the area immediately surrounding the facility.

Section 418, 419, and 421 of the Ordinance.

REGULATION 84-22

ASSIGNMENT

This license is personal to licensee and shall not be transferred or assigned without the written consent of the Commissioner of Gaming.

Section 309 of the Ordinance.

REGULATION 84-23

TERMINATION IN ADVANCE OF EXPIRATION

In the event of licensee's failure to comply with any of the terms, regulations, or conditions herein set forth, the Commissioner of Gaming may deny, limit, condition, suspend or restrict any license upon the giving of five (5) days prior written notice to licensee. Time is hereby expressly declared to be of the essence of this regulation, and should licensee fail to make an accounting of and/or promptly make any of the payments as required by licensee, the Commissioner of Gaming at his option, may fine, revoke, suspend, limit or refuse to renew the license of any licensee. In cases where a license is suspended prior to a hearing, an opportunity for a hearing shall be provided.

In the event of voluntary or involuntary bankruptcy or receivership of the assets of licensee, this license shall automatically and immediately terminate, except as to licensee's liability for sums then due and owing the Muscogee (Creek) Nation.

Section 209 and 403 of the Ordinance.

REGULATION 84-24
RECORDS, CONSIDERATION AND PAYMENTS

Licensee shall keep true, accurate and correct accounts and records of the business authorized and such records shall be subject to inspection by the Commissioner's office during any regular business day and at any reasonable hour thereof. On or before the 15th day of each calendar month, licensee shall submit to the Commissioner a true and correct itemized statement of licensee's gross and net receipts for the preceding calendar month and as consideration for the granting of this business shall pay to the Muscogee Nation it's due percentage collected from the operation of gaming and related activities during such immediately preceding calendar month. Licensee hereby specifically agrees to file such report and pay amounts due by the 15th day of the month immediately following the month in which this Agreement is terminated.

Acceptance by the Muscogee (Creek) Nation of the amount tendered by licensee shall not be deemed an accord as to the actual amount owed by licensee, but the actual amount due the Muscogee (Creek) Nation shall remain subject to audit by the Muscogee (Creek) Nation of licensee's accounts. However, submission and tender of an amount by licensee shall be conclusive as to licensee after ninety (90) days from the due date of such submission or tender and no claim for overpayment of the required percentage shall be made by licensee or honored by the Muscogee (Creek) Nation after said period.

In addition to other records previously herein required, licensee shall also keep a daily ledger or account book reflecting daily itemization of all receipts and disbursements related to licensee's operation of this business and such ledger book, together with the itemized statement previously herein required, shall be submitted monthly to the Commissioner's office for audit thereof. Licensee also agrees to adhere to and abide by all accounting rules and requirements which have been or may hereafter be promulgated by the office of the Commissioner of Public Gaming of the Muscogee (Creek) Nation.

Section 203 and 401 of the Ordinance.

REGULATION 84-25

INDEMNIFICATION

Licensee agrees to wholly indemnify and hold the Muscogee (Creek) Nation harmless for any claim, loss, damage or injury to any persons or property, which claim, loss, damage or injury arises directly, indirectly or consequentially from licensee's operation of this business. Such indemnification agreement shall apply regardless of whether policies of insurance as herein required or furnished by licensee provide coverage for any such claim, loss, damage or injury to person or property.

Section 203 of the Ordinance.

REGULATION 84-26
PROVISIONS APPLICABLE UPON EXPIRATION
OR TERMINATION

Upon the expiration or termination of a Management Agreement, licensee shall surrender to the Muscogee (Creek) Nation quiet and peaceable possession of all premises utilized by licensee in the operation of this business, and together with any and all improvements therein or thereon, specifically exempting such portable buildings, fixtures and equipment that licensee may have used in connection with such business and which have been supplied and are owned by licensee and which are removable without damage to any pertinent structure and the premises therein or thereon located. Licensee shall execute, if applicable, such bills of sale, assignments or transfers as may be necessary or convenient to transfer title of any improvements and equipment not so furnished or owned by licensee or which are left upon the premises more than thirty (30) days subsequent to termination or cancellation of this Agreement. Muscogee (Creek) Nation's rights to any such property shall be superior to the rights of any and all persons with respect to any such improvements and equipment, and licensee shall execute the bills of sale, assignments or transfers as previously hereinbefore required in such a manner as to convey same to the Muscogee (Creek) Nation free and clear of any lien, claim or mortgage of any kind with respect thereto.

Section 203 and 419 of the Ordinance.

The Commissioner of Public Gaming, July 1st to date, has promulgated twenty-six (26) regulations in accordance with the responsibilities and duties established under Title II - Section 203 of the Muscogee (Creek) Nation Gaming Ordinance. Each regulation has been scrutinized and reviewed to assist in establishing credibility to the administration, enforcement and regulation of all aspects of gaming activity on Muscogee (Creek) Nation land.

Future regulations promulgated by the Office of Public Gaming shall as it's goal protect and secure the interest of all citizens engaged in gaming within the exterior boundaries of the Muscogee (Creek) Nation.

REGULATION 85-01

EMPLOYEE SUSPENSION

Suspension of an employee of a licensed gaming facility shall be of two categories.

- A. The individual shall be put on notice of suspension, and upon the act of suspension the individual shall receive day(s) off without pay.
- B. The individual shall be placed upon immediate suspension without pay. However, if the allegation brought forward as the reason for suspension are not upheld or confirmed, the individual shall receive pay for the scheduled hours of work missed on the next scheduled pay period.

Further, upon disciplinary action, i.e. suspension, termination, licensee shall be required to inform the individual of the grievance procedure and shall issue a written copy of same.

Section 204 and 419 of the Ordinance.

REGULATION 85-02

CALLER'S AREA

Licensee shall neither allow food or drink in the designated caller's area of the bingo operation. This defined area shall be utilized with the intent to promote a business and professional approach to this area of operation with no disturbance by way of food, drink, or other intrusions.

Licensee shall provide callers with appropriate time and/or substitute to take care of his/her personal needs.

Section 204 of the Ordinance.

REGULATION 85-03
OFFICIAL REPRESENTATIVE

The Official Representative of the licensed premises shall be the Gaming Commissioner in all matters concerning the interest of the Muscogee (Creek) Nation thru the licensed tribal enterprise and its related activity.

As such, dicussion, contact, or response concerning the tribal enterprise with other recognized authorities will be initiated at the discretion of the Muscogee (Creek) Nation thru the Commissioner of Gaming. A Representative of Management of the licensed gaming activity and Security will be notified at such times, so as to be informed and to keep the peace.

Section 204 of the Ordinance.

Revised
1/30/89

REGULATION 85-04

PROPER ATTIRE

Licensee shall institute a dress code to be adhered to by the employees of the licensed gaming establishment. Such code shall not obviate the usual dress code of like establishments, yet shall stipulate to §419 of the Ordinance.

The employee dress code shall apply to all individuals viewed by the gaming public. The dress code shall be appropriate to position level, e.g. Management personnel to wear jacket and tie with coordinating slacks/skirt and other employees to wear contrasting separates, such as white shirt and black slacks. The dress code for daytime office/administration staff shall be appropriate attire to maintain a professional appearance.

It is the responsibility of the licensee to provide dress code plans or amendments thereto to the Commissioner for approval prior to implementation.

Sections 204 and 419 of the Ordinance.

REGULATION 85-05
PROHIBITED ADVERTISING/PUBLICATION/MATERIALS
AND DISTRIBUTION

Licensee shall be prohibited from displaying, having or holding for distribution any notice, playcard, handbill, flyer, leaflet, throwaway, broadside, advertisement, other forms of literature or distributions, etc. on the licensed premises unless above said instrument(s) are related to the licensed activity and/or the vested interest of the Muscogee (Creek) Nation.

Such printed material whether intended for distribution, promotion, or otherwise shall be required to be of good taste and good moral tone and not offensive to the patrons, employees of the licensed activity, or to the citizens of the Muscogee (Creek) Nation.

Upon inspection, the Commissioner of Gaming shall interpret the relationship status between the aforementioned instrument(s) and the licensed activity and/or the vested interest of the Muscogee (Creek) Nation. Any violation or wanton disregard for the interpretation of finding by the Commissioner of Gaming of the Muscogee (Creek) Nation shall subject licensee to the penalty provisions provided by the Ordinance.

Sections 105, 204, and 419 of the Ordinance.

REGULATION 85-06
GENERAL MANAGER ON PREMISES

It is the policy of the Commissioner of Gaming to require availability of complete and full authority to execute pre-eminent decisions and to consummate all duties and responsibilities associated with the licensed activity and ancillary business on the premises.

The licensee shall direct or require the General Manager and/or the Assistant General Manager to be on the licensed premises at all times the licensed activity authorized by this Ordinance is being conducted.

Sections 418 and 419 of the Ordinance.

REGULATION 85-07
FIREARMS

The privilege to bear arms while on the gaming premises shall be limited to on site Security personnel and federally recognized law enforcement officials holding and showing proper identification and authorization.

The use of standard game hunting firearms, as prizes, related to the gaming activities may be utilized by the licensee when approved by the Commissioner prior to promotion.

Section 204 and 424 of the Ordinance.

Revised 11-85

MUSCOGEE (CREEK) NATION



P.O. BOX 580
OKMULGEE, OK 74447
(918) 756-8700

The Office of Public Gaming as established by Muscogee (Creek) National Council Act 84-04 to regulate gaming within the exterior boundaries of the Muscogee (Creek) Nation in a manner commensurate with the interest of the Muscogee (Creek) citizens. In order to provide for the orderly administration and regulation of authorized gaming enterprises, the Office of Public Gaming Commissioner, charged with the sole responsibility of administering and enforcing the provisions of this Code has promulgated regulations necessary to administer the Muscogee Nation Public Gaming Ordinance.

It shall be the intent of the Office of Public Gaming to provide confidence and assurance that such individuals groups or persons so licensed by this office to engage in gaming activity do so with proper respect to the "Sovereignty of the Muscogee (Creek) Nation", and with high regard to the public health, safety, morals, good order and general welfare of all residents of the Muscogee (Creek) Nation.

Since July 1, 1984 to date hereof, the Commissioner of Public Gaming of the Muscogee (Creek) Nation has promulgated thirty-three (33) regulations pursuant to Title II - Section 203 of the Muscogee Nation Public Gaming Code in accordance with the responsibilities and duties assigned by the provisions of said code.

Each regulation has been scrutinized and reviewed to implement the administration, enforcement and regulation of all gaming activity conducted in Indian Country within the jurisdictional exterior boundries of the Muscogee (Creek) Nation.

These regulations are hereby adopted by the Muscogee (Creek) Nation Office of Public Gaming.

Wm. E. Foster, Commissioner

Reaffirmed
Effective: December 2, 1985

REGULATION 86-01
OPERATIONS/CONTROLS

The licensee in general, and the specific individuals designated by training and job description by this regulation in particular shall maintain and make available to the Commissioner all records and documents required by this regulation; a description of the rules and conditions and conduct of actions of all individuals involved in the conduct of gaming activities.

No licensee shall permit any game or activity related to the licensed premises to be conducted in a manner which would reflect or tend to discredit the Muscogee (Creek) Nation, or the gaming industry is operating in an unsuitable manner and shall be grounds for disciplinary action by the Commissioner in accordance with the Muscogee Nation Public Gaming Act and other Acts and regulations within the scope of prerogative of the Commissioner of Gaming.

Without limiting the generalities of the foregoing, the following acts or omissions may be determined to be unsuitable methods of operation:

1. Conducting, carrying on or operating any cheating or thieving game or device on the premises, either knowingly or unknowingly, which may have in any manner be marked or tampered with or otherwise placed in a condition, or operated in a manner, which tends to deceive the public or which might make the game or any individual, player, or participant, liable to win or lose, or which tends to alter the normal random selection of criteria which determine the results of the game.

- 1a. It should be a condition of the operation of the bingo activity that the motor of the blower/mixer unit shall not be turned off by the caller so as to affect the aforementioned outcome of any game.

2. RESERVED

The Commissioner in the exercise of his sound discretion shall make determination of whether or not the licensee has failed to comply with the aforementioned.

Section 419 of the Ordinance

REGULATION 86-02
CLANDESTINE ACTIVITIES

The use or employment of any devices by licensee, management or employees that may be determined as a practice or course of operation, as would operate as a fraud of deceit upon any person, is in direct violation of the public trust and the vested interest of the Muscogee (Creek) Nation.

It shall be a violation for any person or persons not an employee or agent of the Office of Public Gaming/Taxation without written consent (except federal enforcement authority) to enter into or conduct any activity that could be construed as a covert act to collect, gather, assimilate or record activities, conversations, reports or records of any person, agent or entity on any properties or in any facility where gaming or related activities are conducted within the jurisdictional boundaries of the Muscogee (Creek) Nation. Participation, whether it be by direction as an agent or as an individual person in any part of such clandestine activity, shall be considered a direct violation and such persons, agents or entities may be considered persona non grata and forfeit any rights to do business or conduct any other function within the jurisdictional boundaries of the Muscogee (Creek) Nation pursuant to the Muscogee (Creek) Nation Public Gaming Code.

Further, any person, agent or entity so designated as persona non grata will forfeit any claim whatsoever from any gaming or related activity(s) conducted within the Muscogee (Creek) Nation permanently or until such time, as he regains persona grata status.

Sections 203, 204, 215, 312, 403, 404, 419, and 426 of the Ordinance.

REGULATION 86-03
IDENTIFICATION STANDARDS

Every licensee shall cause for identification purposes to be issued an identification badge to be worn by all employees, licensees, agents, contractors or operators. The stated purpose for identification being such; it shall be necessary that all badges be worn visible and in clear view of anyone so desiring to view, read and ascertain the identity of the wearer. As such, all identification badges issued by the licensee shall be worn on the top one-third front of the body of the wearer. All information and photo (if any) shall be unobstructed at all times for said purpose of identification.

Any attempt or effort, intentional or not, that results in total or part to hide, conceal, deface, obstruct or bring about non-compliance with this Regulation shall be deemed to be contra to the interest of the gaming public. This Provision Regulation is not to be construed to vest control in the Commissioner of the actions of any of licensee's employees, but rather such provision is intended only to establish a requisite standard of identification to be employed by licensee.

Section 418 and 419 of the Ordinance.

REGULATION 89-01

VERIFICATION OF SATELLITE GAME

Licensee shall meet the following requirements, which will emphasize credibility, concerning the satellite game.

Licensee shall ensure that the participating facilities shall acknowledge their reception of the satellite game in a manner, whereas the acknowledgement from the satellite location may be heard by the gaming public, via public address system, of the transmitting facility.

Further, licensee shall ensure that whenever a bingo is verified, the actual verification process shall be performed in a manner to provide audio availability to the gaming public. The verification process shall be limited to the representative of the winning facility and the announcer of the game from the transmitting facility. Additionally, the process shall apply to each and every winner so verified on the satellite system.

Section 203 of the Ordinance.

Pursuant to NCA 84-04, as amended, the Office of Public Gaming, Muscogee (Creek) Nation, hereby adopts Regulation 89-01 effective 11/22/88.

REGULATION 89-02

DO-IT-YOURSELF GAME

In order to maintain the credibility of the Do-It-Yourself game, it shall be a condition of the Licensee to insure that no person is to enter the Do-It-Yourself booth, which contains the duplicate copies, while the game is in progress. Therefore, the employee(s) working the Do-It-Yourself booth on that day/evening shall be the only person(s) permitted during play of said game, which shall be defined as the interval between the first number called of the game and the closing of the game by the bingo caller.

Further, to emphasize credibility, a barrier shall be constructed and shall separate the contents of the booth, duplicate copies and booth employees, from all other persons during play of said game. The barrier shall be constructed whereby, the normal procedure of submitting the duplicate copies to the booth employee is not altered. Also the booth barrier shall be transparent to allow the process of separating the tickets to be viewed by the public.

Additionally, as the prize amount exceeds \$50,000.00, no less than two Supervisory personnel shall be present at the time the winning duplicate ticket is transferred from the booth employee to the employee who verbally verifies the bingo.

Section 203 of the Ordinance.

Regulation 89-03

Application Fee and Investigation Expense

All new applications for Class N, P, T or S gaming licenses shall be subject to a non-refundable application fee of \$250.00. The application fee shall be submitted in the form of a check, money order or other certified funds separate from the required license fee.

The expense of conducting any necessary background investigations relating to the parties applying for license shall be the responsibility of the applicant(s). Any expenses incurred by the Tribe in conducting background investigations (utilizing a third party) shall be fully reimbursed by the applicant(s).

Section 203 of the Ordinance.

Pursuant to NCA 84-04, as amended, the Office of Public Gaming, Muscogee (Creek) Nation, hereby adopts Regulation 89-05 effective November 22, 1988.

Approved and Adopted:

Wm. E. Foster, Commissioner 8/24/89
Date

Effective: September 1, 1989

Regulation 90-01

Posting of Gaming Ordinance

Each tribally licensed gaming facility shall keep posted a current copy of NCA 84-04, as amended and attendant regulations, in a location accessible to all employees.

The Ordinance shall be displayed in a respectable, concise manner within the facility so as every employee will have access to the Ordinance during normal business hours. No copy of the Ordinance shall be displayed in a tattered, torn or otherwise dishevelled condition.

The Gaming Commission shall approve all postings of said Ordinance.

Section 427 of the Ordinance.

Pursuant to NCA 84-04, as amended, the Office of Public Gaming, Muscogee (Creek) Nation, hereby adopts Regulation 90-01 effective October 26, 1989.

Approved and Adopted:

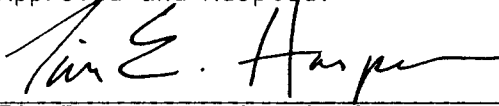
Tim E. Harper, Commissioner 10/26/89
Date

Effective: October 26, 1989

Regulation 90-02

Manager Off Premises

The General Manager shall keep this office (and appropriate subordinate staff) informed of where he can be contacted during any scheduled/unscheduled trips out of town.

The Manager shall provide a telephone number where he may be contacted within a four hour time period.

During those trips in which the manager will not be following an established itinerary, (facility/O.P.G. has no way to contact the manager), he shall telephone the facility at least once per day to receive pertinent messages.

Section 418 and 419 of the Ordinance.

Pursuant to NCA 84-04, as amended, the Office of Public Gaming, Muscogee (Creek) Nation, hereby adopts Regulation 90-02 effective October 26, 1989.

Approved and Adopted:

 10/26/89
Tim E. Harper, Commissioner Date

Effective: October 26, 1989

**REGULATION 90-03
FOOD SERVICE SANITATION
CHAPTER ONE- GENERAL PROVISIONS**

1-101 Definitions.

FOR THE PURPOSE OF THIS REGULATION:

(a) "Corrosion-resistant materials" means those materials that maintain their original surface characteristics under prolonged influence of the food to be contacted, the normal use of cleaning compounds and bactericidal solutions, and other conditions-of-use environment.

(b) "Employee" means individuals having supervisory or management duties and any other person working in a food service establishment under direction of licensee.

(c) "Equipment" means stoves, ovens, ranges, hoods, slicers, mixers, meatblocks, tables, counters, refrigerators, sinks, dishwashing machines, steam tables, and similar items other than utensils, used in the operation of a food service establishment.

(d) "Food-contact surface" means those surfaces of equipment and utensils with which food normally comes in contact, and those surfaces from which food may drain, drip, or splash back onto surfaces normally in contact with food.

(e) "Kitchenware" means all multi-use utensils other than tableware.

(f) "Law" includes Tribal and Federal ordinances, and regulations.

(g) "Regulatory authority" means the Commissioner of Public Gaming or Official/Designate and Federal authorities having jurisdiction over the food service establishment.

(h) "Sanitization" means effective bactericidal treatment by a process that provides enough accumulative heat or concentration of chemicals for enough time to reduce the bacterial count, including pathogens, to a safe level on utensils and equipment.

(i) "Single-service articles" means cups, containers, lids, closures, plates, knives, forks, spoons, stirrers, paddles, straws, napkins, wrapping materials, toothpicks and similar articles intended for one-time, one-person use and then discarded.

**CHAPTER TWO-FOOD CARE
FOOD SUPPLIES**

2-101 General.

Food shall be in sound condition, free from spoilage, filth, or other contamination and shall be safe for human consumption. Food shall be obtained from sources that comply with all laws relating to food and food labeling.

FOOD PROTECTION

2-201 General.

At all times, including while being stored, prepared, displayed, served, or transported, food shall be protected from potential contamination, including dust, insects, rodents, unclean equipment and utensils, unnecessary handling, coughs and sneezes, flooding, drainage, and overhead leakage or overhead drippage from condensation. The temperature of potentially hazardous food shall be 45 degrees Fahrenheit or below or 140 degrees Fahrenheit or above at all times, except as otherwise provided in this Regulation.

2-202 Emergency Occurrences.

In the event of a fire, flood, power outage, or similar event that might result in the contamination of food, or that might prevent potentially hazardous food from being held at required temperatures, the licensee shall immediately contact the Office of Public Gaming.

FOOD STORAGE

2-301 General.

(a) Food, whether raw or prepared, if removed from the container or package in which it was obtained, shall be stored in a clean covered container except during necessary periods of preparation or service.

(b) Containers of food shall be stored a minimum of 6 inches above the floor in a manner that protects the food from splash and other contamination, and that permits easy cleaning of the storage area, except that:

(1) Metal pressurized beverage containers, and cased food packaged in cans, glass or other waterproof containers need not be elevated when the food container is not exposed to floor moisture; and

(2) Containers may be stored on dollies, racks or pallets, provided such equipment is easily movable.

(c) Food and containers of food shall not be stored under exposed or unprotected sewer lines or water lines, except for automatic fire protection sprinkler heads that may be required by law.

(d) Packaged food shall not be stored in contact with water or undrained ice.

2-302 Refrigerated Storage.

(a) Enough conveniently located refrigeration facilities or effectively insulated facilities shall be provided to assure the maintenance of potentially hazardous food at required temperatures during storage. Each mechanically refrigerated facility storing potentially hazardous food shall be provided with a numerically scaled indicating thermometer, accurate to ± 3 degrees Fahrenheit, located to measure the air temperature in the warmest part of the facility and located to be easily readable. Recording thermometers, accurate to ± 3 degrees Fahrenheit, may be used in lieu of indicating thermometers.

(b) Frozen food shall be kept frozen and should be stored at a temperature of 0 degrees Fahrenheit or below.

(c) Ice intended for human consumption shall not be used as a medium for cooling stored food, food containers or food utensils, except that such ice may be used for cooling tubes conveying beverages or beverage ingredients to a dispenser head. Ice used for cooling stored food and food containers shall not be used for human consumption.

2-303 Hot Storage.

(a) Enough conveniently located hot food storage facilities shall be provided to assure the maintenance of food at the required temperature during storage. Each hot food facility storing potentially hazardous food shall have a numerically scaled indicating thermometer, accurate to ± 3 degrees Fahrenheit, located to measure the air temperature in the coolest part of the facility and located to be easily readable. Recording thermometers, accurate to ± 3 degrees Fahrenheit, may be used in lieu of indicating thermometers.

FOOD PREPARATION

2-401 General.

Food shall be prepared with the least possible manual contact, with suitable utensils, and on surfaces that prior to use have been cleaned, rinsed and sanitized to prevent cross-contamination.

2-402 Raw Fruits and Raw Vegetables.

Raw fruits and vegetables shall be thoroughly washed with potable water before being cooked or served.

2-403 Cooking Potentially Hazardous Foods.

Potentially hazardous foods requiring cooking shall be cooked to heat all parts of the food to a temperature of at least 140 degrees Fahrenheit, except that:

(a) Poultry, poultry stuffings, stuffed meats and stuffings containing meat shall be cooked to heat all parts of the food to at least 165 degrees Fahrenheit with no interruption of the cooking process.

(b) Pork and any food containing pork shall be cooked to heat all parts of the food to at least 150 degrees Fahrenheit.

2-404 Reheating.

Potentially hazardous foods that have been cooked and then refrigerated, shall be reheated rapidly to 165 degrees Fahrenheit or higher throughout before being served or before being placed in a hot food storage facility.

2-405 Product Thermometers.

Metal stem-type numerically scaled indicating thermometers, accurate to ± 2 degrees Fahrenheit, shall be provided and used to assure the attainment and maintenance of proper internal cooking, holding, or refrigeration temperatures of all potentially hazardous foods.

2-406 Thawing Potentially Hazardous Foods.

Potentially hazardous foods shall be thawed:

(a) In refrigerated units at a temperature not to exceed 45 degrees Fahrenheit; or

(b) In a microwave oven only when the food will be immediately transferred to conventional cooking facilities as part of a continuous cooking process or when the entire, uninterrupted cooking process takes place in the microwave oven; or

(c) As part of the conventional cooking process.

FOOD DISPLAY AND SERVICE

2-501 Potentially Hazardous Food.

Potentially hazardous food shall be kept at an internal temperature of 45 degrees Fahrenheit or below or at an internal temperature of 140 degrees Fahrenheit or above during display and service.

2-502 Condiment Dispensing.

(a) Condiments, seasonings, dressings and sugar for consumer use shall be provided in individual packages.

2-503 Ice Dispensing.

Ice for consumer use shall be dispensed only by employees with scoops, tongs, or other ice-dispensing utensils or through automatic self-service, ice-dispensing equipment. Between uses, ice dispensing utensils and transfer receptacles shall be stored in a way that protects them from contamination. Ice storage bins shall be drained through an air gap.

2-504 Dispensing Utensils.

To avoid unnecessary manual contact with food, suitable dispensing utensils shall be used by employees or provided to consumers who serve themselves. These utensils shall be stored in a way that protects them from contamination.

2-505 Re-Service.

Once served to a consumer, portions of leftover food shall not be served again except that packaged food other than potentially hazardous food, that is still packaged and is still in sound condition, may be re-served.

2-506 Re-Use of Tableware.

Re-use of soiled tableware by self-service consumers returning to the service area for additional food is prohibited. Beverage cups and glasses are exempt from this requirement.

CHAPTER THREE-PERSONNEL EMPLOYEE HEALTH

3-101 General.

No person, while infected with a disease in a communicable form that can be transmitted by foods or who is a carrier of organisms that cause such a disease or while afflicted with a boil, an infected wound, or an acute respiratory infection, shall work in a food service establishment in any capacity in which there is a likelihood of such person contaminating food or food-contact surfaces with pathogenic organisms or transmitting disease to other persons.

PERSONAL CLEANLINESS

3-201 General.

Employees shall thoroughly wash their hands and the exposed portions of their arms with soap and warm water before starting work, during work as often as is necessary to keep them clean, and after smoking, eating, drinking, or using the toilet. Employees shall keep their fingernails clean and trimmed.

CLOTHING

3-301 General.

(a) The outer clothing of all employees shall be clean.
(b) Employees shall use effective hair restraints to prevent the contamination of food or food-contact surfaces, effective hair restraints include caps, hairnets or hairspray.

EMPLOYEE PRACTICES

3-401 General.

(a) Employees shall not use tobacco in any form while engaged in food preparation or service, nor while in areas used for equipment or utensil washing or for food preparation. Employees shall use tobacco only in designated areas.

(b) Employees shall maintain a high degree of personal cleanliness and shall conform to good hygienic practices during all working periods in the food service establishment.

CHAPTER FOUR-EQUIPMENT AND UTENSILS MATERIALS

4-101 General.

Multi-use equipment and utensils shall be constructed and repaired with safe materials, including finishing materials; shall be corrosion resistant and nonabsorbent; and shall be smooth, easily cleanable, and durable under conditions of normal use. Single-service articles shall be made from clean, sanitary, safe materials.

4-102 Plastics.

Safe plastic or safe rubber or safe rubber-like materials that are resistant under normal conditions of use to scratching, scoring, decomposition, crazing, chipping and distortion, that are of sufficient weight and thickness to permit cleaning and sanitizing by normal dishwashing methods, are permitted for repeated use.

DESIGN AND FABRICATION

4-201 General.

All equipment and utensils, including plasticware, shall be designed and fabricated for durability under conditions of normal use and shall be resistant to denting, buckling, pitting, chipping, and crazing.

(a) Food-contact surfaces shall be easily cleanable, smooth, and free of breaks, open seams, cracks, chips, pits, and similar imperfections, and free of difficult-to-clean internal corners and crevices.

(b) Sinks and drain boards shall be self-draining.

4-202 Non-Food-Contact Surfaces.

Surfaces of equipment not intended for contact with food, but which are exposed to splash or food debris or which otherwise require frequent cleaning, shall be designed and fabricated to be smooth, washable, and readily accessible for cleaning, and to be easily maintained in a clean and sanitary condition.

4-203 Ventilation Hoods.

Ventilation hoods and devices shall be designed to prevent grease or condensation from collecting on walls and ceilings, and from dripping into food or onto food-contact surfaces. Filters or other grease extracting equipment shall be readily removable for cleaning and replacement if not designed to be cleaned in place.

4-204 Existing Equipment.

Equipment that was installed in a food service establishment prior to the effective date of this regulation, and that does not fully meet all of the design and fabrication requirements of this section, shall be deemed acceptable in that establishment if it is in good repair, capable of being maintained in a sanitary condition, and the food-contact surfaces are nontoxic. Replacement equipment and new equipment acquired after the effective date of this regulation shall meet the requirements of this regulation.

EQUIPMENT INSTALLATION AND LOCATION

4-301 General.

Equipment, including ice makers and ice storage equipment, shall not be located under exposed or unprotected sewer lines or water lines, open stairwells, or other sources of contamination. Aisles and working spaces between units of equipment and walls shall be unobstructed and of sufficient width to permit employees to perform their duties readily without contamination of food or food-contact surfaces by clothing or personal contact.

CHAPTER FIVE-CLEANING, SANITIZATION AND STORAGE OF EQUIPMENT AND UTENSILS EQUIPMENT AND UTENSIL CLEANING AND SANITIZATION

5-101 Cleaning Frequency.

(a) To prevent cross-contamination, kitchenware and food-contact surfaces of equipment shall be washed, rinsed, and sanitized after each use and following any interruption of operations during which time contamination may have occurred.

(b) The food-contact surfaces of grills, griddles, and similar cooking devices and the cavities and door seals of microwave ovens shall be cleaned at least once a day; except that this shall not apply to hot oil cooking equipment and hot oil filtering systems.

(c) Non-food-contact surfaces of equipment shall be cleaned as often as is necessary to keep the equipment free of accumulation of dust, dirt, food particles, and other debris.

5-102 Wiping Cloths.

(a) Cloths used for wiping food spills on tableware, such as plates or bowls being served to the consumer, shall be clean, dry and used for no other purpose.

(b) Moist cloths or sponges used for cleaning non-food-contact surfaces of equipment such as counters, dining table tops and shelves shall be clean and rinsed and used for no other purpose. These cloths and sponges shall be stored in the sanitizing solution between uses.

5-103 Manual Cleaning and Sanitizing.

(a) For manual washing, rinsing and sanitizing of utensils and equipment, a sink with not fewer than three compartments shall be provided and used. Sink compartments shall be large enough to permit the accommodation of the equipment and utensils, and each compartment of the sink shall be supplied with hot and cold potable running water.

(b) Drain boards or easily movable dish tables of adequate size shall be provided for proper handling of soiled utensils prior to washing and for cleaned utensils following sanitizing and shall be located so as not to interfere with the proper use of the dishwashing facilities.

(c) Equipment and utensils shall be preflushed or prescraped and, when necessary, presoaked to remove gross food particles and soil.

(d) Except for fixed equipment and utensils too large to be cleaned in sink compartments, manual washing, rinsing and sanitizing shall be conducted in the following sequence:

(1) Sinks shall be cleaned prior to use.

(2) Equipment and utensils shall be thoroughly washed in the first compartment with a hot detergent solution that is kept clean.

(3) Equipment and utensils shall be rinsed free of detergent and abrasives with clean water in the second compartment.

(4) Equipment and utensils shall be sanitized in the third compartment according to the method stated in section 5-103(e).

(e) The food-contact surfaces of all equipment and utensils shall be sanitized by:

(1) Immersion for at least one-half (1/2) minute in clean, hot water at a temperature of at least 170 degrees Fahrenheit.

(f) When hot water is used for sanitizing, the following facilities shall be provided and used:

(1) An integral heating device or fixture installed in, on, or under the sanitizing compartment of the sink capable of maintaining the water at a temperature of at least 170 degrees Fahrenheit; and

(2) A numerically scaled indicating thermometer, accurate to ± 3 degrees Fahrenheit, convenient to the sink for frequent checks of water temperature; and

(3) Dish baskets of such size and design to permit complete immersion of the tableware, kitchenware, and equipment in the hot water.

5-104 Mechanical Cleaning and Sanitizing.

(a) Cleaning and sanitizing may be done by spray-type or immersion dishwashing machines or by any other type of machine or device if it is demonstrated that it thoroughly cleans and sanitizes equipment and utensils. These machines and devices shall be properly installed and maintained in good repair. Machines and devices shall be operated in accordance with manufacturers' instructions, and utensils and equipment placed in the machine shall be exposed to all dishwashing cycles. Automatic detergent dispensers, wetting agent dispensers, and liquid sanitizer injectors, if any, shall be properly installed and maintained.

(b) All dishwashing machines shall be thoroughly cleaned at least once a day or more often when necessary to maintain them in a satisfactory operating condition.

5-105 Drying.

After sanitization, all equipment and utensils shall be air dried.

EQUIPMENT AND UTENSIL STORAGE

5-201 Handling.

Cleaned and sanitized equipment and utensils shall be handled in a way that protects them from contamination. Spoons, knives, and forks shall be touched only by their handles. Cups, glasses, bowls, plates and similar items shall be handled without contact with inside surfaces or surfaces that contact the user's mouth.

5-202 Storage.

(a) Cleaned and sanitized utensils and equipment shall be stored at least 6 inches above the floor in a clean, dry location in a way that protects them from contamination by splash, dust, and other means. The food-contact surfaces of fixed equipment shall also be protected from contamination.

(b) Glasses and cups shall be stored inverted. Other stored utensils shall be covered or inverted, wherever practical. Facilities for the storage of knives, forks, and spoons shall be designed and used to present the handle to the employee or consumer.

5-203 Single-Service Articles.

(a) Single-service articles shall be stored at least 6 inches above the floor in closed cartons or containers which protect them from contamination and shall not be placed under exposed sewer lines or water lines, except for automatic fire protection sprinkler heads that may be required by law.

(b) Single-service knives, forks and spoons packaged in bulk shall be inserted into holders or be wrapped by an employee who has washed his hands immediately prior to sorting or wrapping the utensils. Unless single-service knives, forks and spoons are prewrapped or prepackaged, holders shall be provided to protect these items from contamination and present the handle of the utensil to the consumer.

5-204 Prohibited Storage Area.

The storage of food equipment, utensils or single-service articles in toilet rooms or vestibules is prohibited.

CHAPTER SIX-SANITARY FACILITIES AND CONTROLS WATER SUPPLY

6-101 General.

Enough potable water for the needs of the food service establishment shall be provided from a source constructed and operated according to law.

6-102 Water Under Pressure.

Water under pressure at the required temperatures shall be provided to all fixtures and equipment that use water.

6-103 Steam.

Steam used in contact with food or food-contact surfaces shall be free from any materials or additives other than those specified in 21 CFR 173.310.10

SEWAGE

6-201 General.

All sewage, including liquid waste, shall be disposed of by a public sewerage system or by a sewage disposal system constructed and operated according to law.

PLUMBING

6-301 General.

Plumbing shall be sized, installed, and maintained according to law. There shall be no cross-connection between the potable water supply and any non-potable or questionable water supply nor any source of pollution through which the potable water supply might become contaminated.

6-302 Grease Traps.

If used, grease traps shall be located to be easily accessible for cleaning.

6-303 Garbage Grinders.

If used, garbage grinders shall be installed and maintained according to law.

6-304 Drains.

Except for properly trapped open sinks, there shall be no direct connection between the sewerage system and any drains originating from equipment in which food, portable equipment, or utensils are placed. When a dishwashing machine is located within 5 feet of a trapped floor drain, the dishwasher waste outlet may be connected directly on the inlet side of a properly vented floor drain trap if permitted by law.

LAVATORY FACILITIES

6-401 Lavatory Installation.

(a) Lavatories shall be at least the number required by law, shall be installed according to law, and shall be located to permit convenient use by all employees in food preparation areas and utensil-washing areas.

(b) Lavatories shall be accessible to employees at all times.

(c) Lavatories shall also be located in or immediately adjacent to toilet rooms or vestibules.

6-402 Lavatory Faucets.

Each lavatory shall be provided with hot and cold water tempered by means of a mixing valve or combination faucet. Any self-closing, slow-closing, or metering faucet used shall be designed to provide a flow of water for at least 15 seconds without the need to reactivate the faucet. Steam-mixing valves are prohibited.

6-403 Lavatory Supplies.

A supply of hand-cleansing soap or detergent shall be available at each lavatory. A supply of sanitary towels or a hand-drying device providing heated air shall be conveniently located near each lavatory. Common towels are prohibited. If disposable towels are used, easily cleanable waste receptacles shall be conveniently located near the hand-washing facilities.

6-404 Lavatory Maintenance.

Lavatories, soap dispensers, hand-drying devices and all related fixtures shall be kept clean and in good repair.

GARBAGE AND REFUSE

6-501 Containers.

(a) Garbage and refuse shall be kept in durable, easily cleanable, insect-proof and rodent-proof containers that do not leak and do not absorb liquids. Plastic bags and wet-strength paper bags may be used to line these containers, and they may be used for storage inside the food service establishment.

(b) There shall be a sufficient number of containers to hold all the garbage and refuse that accumulates.

(c) Soiled containers shall be cleaned at a frequency to prevent insect and rodent attraction. Each container shall be thoroughly cleaned on the inside and outside in a way that does not contaminate food, equipment, utensils, or food preparation areas.

6-502 Storage.

(a) Garbage and refuse on the premises shall be stored in a manner to make them inaccessible to insects and rodents. Outside storage of unprotected plastic bags or wet-strength paper bags or baled units containing garbage or refuse is prohibited. Cardboard or other packaging material not containing garbage or food wastes need not be stored in covered containers.

(b) Outside storage areas or enclosures shall be large enough to store the garbage and refuse containers that accumulate and shall be kept clean. Garbage and refuse containers, dumpsters and compactor systems located outside shall be stored on or above a smooth surface of nonabsorbent material such as concrete or machine-laid asphalt that is kept clean and maintained in good repair.

6-503 Disposal.

(a) Garbage and refuse shall be disposed of often enough to prevent the development of odor and the attraction of insects and rodents.

INSECT AND RODENT CONTROL

6-601 General.

Effective measures intended to minimize the presence of rodents, flies, cockroaches, and other insects on the premises shall be utilized. The premises shall be kept in such condition as to prevent the harborage or feeding of insects or rodents.

CHAPTER SEVEN-CONSTRUCTION AND MAINTENANCE OF PHYSICAL FACILITIES FLOORS

7-101 Floor Construction.

Floors and floor coverings of all food preparation, food storage, and utensil-washing areas, and the floors of all walk-in refrigerating units, toilet rooms and vestibules shall be constructed of smooth durable material such as sealed concrete, terrazzo, ceramic tile, durable grades of linoleum or plastic, or tight wood impregnated with plastic, and shall be maintained in good repair.

7-102 Floor Carpeting.

Carpeting is prohibited in food preparation, equipment-washing, utensil-washing, food storage, and toilet room areas where urinals or toilet fixtures are located.

7-103 Floor Drains.

Properly installed, trapped floor drains shall be provided in floors that are water-flushed for cleaning or that receive discharges of water or other fluid waste from equipment, or in areas where pressure spray methods for cleaning equipment are used.

WALLS AND CEILINGS

7-201 Maintenance.

Walls and ceilings, including doors, windows, skylights, and similar closures, shall be maintained in good repair.

7-202 Construction.

The walls, including nonsupporting partitions, wall coverings, and ceilings of walk-in refrigerating units, food preparation areas, equipment-washing and utensil-washing areas, toilet rooms and vestibules shall be light colored, smooth, nonabsorbent, and easily cleanable.

7-203 Utility Line Installation.

Exposed utility service lines and pipes shall be installed in a way that does not obstruct or prevent cleaning of the walls and ceilings.

7-204 Attachments.

Light fixtures, vent covers, wall-mounted fans, decorative materials, and similar equipment attached to walls and ceilings shall be easily cleanable and shall be maintained in good repair.

7-205 Covering Material Installation.

Wall and ceiling covering materials shall be attached and sealed so as to be easily cleanable.

CLEANING PHYSICAL FACILITIES

7-301 General.

Cleaning of floors and walls, except emergency cleaning of floors, shall be done during periods when the least amount of food is exposed, such as after closing or between meals. Floors, mats, duckboards, walls, ceilings, and attached equipment and decorative materials shall be kept clean. Only dustless methods of cleaning floors and walls shall be used, such as vacuum cleaning, wet cleaning, or the use of dust-arresting sweeping compounds with brooms.

LIGHTING

7-401 Protective Shielding.

(a) Shielding to protect against broken glass falling onto food shall be provided for all artificial lighting fixtures located over, by, or within food storage, preparation, service, and display facilities, and facilities where utensils and equipment are cleaned and stored.

VENTILATION

7-501 General.

All rooms shall have sufficient ventilation to keep them free of excessive heat, steam, condensation, vapors, obnoxious odors, smoke and fumes. Ventilation systems shall be installed and operated according to law and, when vented to the outside, shall not create an unsightly, harmful or unlawful discharge.

POISONOUS OR TOXIC MATERIALS

7-601 Materials Permitted.

There shall be present in food service establishments only those poisonous or toxic materials necessary for maintaining the establishment, cleaning and sanitizing equipment and utensils, and controlling insects and rodents.

7-602 Labeling Of Materials.

Containers of poisonous or toxic materials shall be prominently and distinctly labeled according to law for easy identification of contents.

7-603 Storage Of Materials.

(a) Poisonous or toxic materials consist of the following categories:

- (1) Insecticides and rodenticides;
- (2) Detergents, sanitizers, and related cleaning or drying agents;
- (3) Caustics, acids, polishes, and other chemicals.

(b) Each of the three categories set forth in paragraph (a) of this section shall be stored and physically located separate from each other. All poisonous or toxic materials shall be stored in cabinets or in a similar physically separate place used for no other purpose. To preclude contamination, poisonous or toxic materials shall not be stored above food, food equipment, utensils or single-service articles, except that this requirement does not prohibit the convenient availability of detergents or sanitizers at utensil or dishwashing stations.

7-604 Use Of Materials.

(a) Bactericides, cleaning compounds or other compounds intended for use on food-contact surfaces shall not be used in a way that leaves a toxic residue on such surfaces or that constitutes a hazard to employees or other persons.

(b) Poisonous or toxic materials shall not be used in a way that contaminates food, equipment, or utensils, nor in a way that constitutes a hazard to employees or other persons, nor in a way other than in full compliance with the manufacturer's labeling.

7-605 First-Aid Supplies.

First-aid supplies shall be stored in a way that prevents them from contaminating food and food-contact surfaces.

PREMISES

7-701 General.

(a) Food service establishments and all parts of property used in connection with their operations shall be kept free of litter.

(b) The walking and driving surfaces of all exterior areas of food service establishments shall be surfaced with concrete or asphalt, or with gravel or similar material effectively treated to facilitate maintenance and minimize dust. These surfaces shall be graded to prevent pooling and shall be kept free of litter.

(c) The traffic of unnecessary persons through the food-preparation and utensil-washing areas is prohibited.

7-702 Linens And Clothes Storage.

(a) Clean clothes and linens shall be stored in a clean place and protected from contamination until used.

(b) Soiled clothes and linens shall be stored in nonabsorbent containers or washable laundry bags until removed for laundering.

7-703 Cleaning Equipment Storage.

Maintenance and cleaning tools such as brooms, mops, vacuum cleaners and similar equipment shall be maintained and stored in a way that does not contaminate food, utensils, equipment, or linens and shall be stored in an orderly manner for the cleaning of that storage location.

7-704 Animals.

Live animals, including birds and turtles, shall be excluded from within the food service operational premises and from adjacent areas under the control of the licensee. Patrol dogs accompanying security or police officers, or guide dogs accompanying blind persons, shall be permitted.

CHAPTER EIGHT-INSPECTIONS

8-101 Inspection Frequency.

An inspection of a food service establishment shall be performed at least once every 6 months by a recognized health inspection entity. Additional inspections of the food service establishment shall be performed as often as necessary for the enforcement of this regulation.

8-102 Report Of Inspections.

Whenever an inspection of a food service establishment or commissary is made, the findings shall be recorded on the inspection report form. The inspection report form shall summarize the requirements of this regulation and shall set forth a weighted point value for each requirement. Inspectional remarks shall be written to reference, by section number, the section violated and shall state the correction to be made. The rating score of the establishment shall be the total of the weighted point values for all violations, subtracted from 100. A copy of the completed inspection report form shall be furnished to the person in charge of the establishment at the conclusion of the inspection. The completed inspection report form is a public document that shall be made available for public disclosure to any person who requests it according to law.

8-103 Correction Of Violations.

(a) The completed inspection report form shall specify a reasonable period of time for the correction of the violations found; and correction of the violations shall be accomplished within the period specified, in accordance with the following provisions:

(1) If an imminent health hazard exists, such as complete lack of refrigeration or sewage backup into the establishment, the establishment shall immediately cease food service operations. Operations shall not be resumed until authorized by the Office of Public Gaming and/or recognized health authority.

(2) All violations of 4- or 5-point weighted items shall be corrected as soon as possible, but in any event, within 10 days following inspection. Within 15 days after the inspection, the licensee shall submit a written report to the Office of Public Gaming stating that the 4- or 5-point weighted violations have been corrected.

(3) All 1- or 2-point weighted items shall be corrected as soon as possible, but in any event, by the time of the next routine inspection.

(4) When the rating score of the establishment is less than 60, the establishment shall initiate corrective action on all identified violations within 48 hours. One or more reinspections will be conducted at reasonable time intervals to assure correction.

(b) The inspection report shall state that failure to comply with any time limits for corrections may result in cessation of food service operations. An opportunity for hearing on the inspection findings or the time limitations or both will be provided upon written request is filed with the Office of Public Gaming.

(c) Whenever a food service establishment is required to cease operations, it shall not resume operations until it is shown on reinspection that conditions responsible for the order to cease operations no longer exist. Opportunity for reinspection shall be offered within a reasonable time.

REVIEW OF PLANS

8-201 Submission Of Plans.

Whenever a food service establishment is constructed or extensively remodeled and whenever an existing structure is converted to use as a food service establishment, properly prepared plans and specifications for such construction, remodeling, or conversion shall be submitted to the Office of Public Gaming for review and approval before construction, remodeling or conversion is begun. The plans and specifications shall indicate the proposed layout, arrangement, mechanical plans, and construction materials of work areas, and the type and model of proposed fixed equipment and facilities. The Office of Public Gaming shall approve the plans and specifications if they meet the requirements of this regulation. No food service establishment shall be constructed, extensively remodeled, or converted except in accordance with plans and specifications approved by the Office of Public Gaming.

PROCEDURE WHEN INFECTION IS SUSPECTED

8-301 General.

When the Office of Public Gaming has reasonable cause to suspect possible disease transmission by an employee of a food service establishment, it may secure a morbidity history of the suspected employee or make any other investigation as indicated and shall take appropriate action. The Office of Public Gaming may require any or all of the following measures:

- (a) The immediate exclusion of the employee from employment in food service establishments;
- (b) The immediate closing of the food service establishment concerned until, in the opinion of the Office of Public Gaming, no further danger of disease outbreak exists;
- (c) Restriction of the employee's services to some area of the establishment where there would be no danger of transmitting disease.

Sections 203, 204, 211, 311, 404, 418, 419, 421, 422 of the Ordinance.

Pursuant to NCA 84-04, as amended, the Office of Public Gaming, Muscogee (Creek) Nation, hereby adopts Regulation 90-03 effective February 7, 1990.

Approved and Adopted:

Tim E. Harper, Commissioner 2/7/90
Date

Effective: February 7, 1990

REGULATION 90-04

EMERGENCY/EVACUATION PROCEDURES

Licensee shall establish written emergency procedures filed with the Office of Public Gaming for the following occurrences:

1. Fire
2. Tornado
3. Bomb Threat
4. Inclement Weather
5. Emergency Health Incidents (Customer/Employee)
6. Hold up/Armed Robbery Procedures

Facility procedures filed with the Office of Public Gaming will include a description and diagram to be used for evacuation, handling emergency situations; further, rationale to be used by Management and staff in making said determination and notification to respective authorities.

Emergency procedures shall be communicated to all employees and same shall be posted in the facility for review by staff.

Section 203 and 419 of the Ordinance.

Pursuant to NCA 84-04, as amended, the Office of Public Gaming, Muscogee (Creek) Nation, hereby adopts Regulation 90-04 effective February 7, 1990.

Approved and Adopted:



Tim E. Harper, Commissioner

2/7/90
Date

Effective: February 7, 1990

Regulation 91-01

EMPLOYEE GAMING LICENSE/PERMIT

(I) Policy. Recognizing the need for an established procedure for the licensing/permitting of Muscogee Nation gaming facility employees, the following is hereby declared to be a policy of the Muscogee Nation Office of Public Gaming. Pursuant to Federal law (P.L. 100-497) regarding gaming on Indian lands, each gaming tribe shall ensure that there exists a standard whereby any person whose prior activities, criminal record, if any, or reputation, habits and associations pose a threat to the public interest or to the effective regulation of gaming, or create or enhance the dangers of unsuitable, unfair, or illegal practices and methods and activities in the conduct of gaming shall not be eligible for employment. Therefore, the purpose of this Regulation shall be construed to protect Creek Nation gaming operations from potentially detrimental influences.

(II) Definitions. As used in this Regulation:

- (1) "Key employee" means any Executive, employee or agent of a gaming entity having the authority to exercise a significant influence over decisions concerning any part of the daily operation of a gaming entity.

The Commissioner shall have the authority to designate those positions which shall be considered as a key employee according to the operational structure of each establishment.

- (2) "Gaming staff employee" means all those employees not included in the key employee classification.
- (3) "Key employee license" means that license issued to a qualified key employee candidate by the Commissioner upon completion of appropriate background investigations.
- (4) "Staff permit" means a work permit issued to those qualified gaming staff employees by the Commissioner upon completion of appropriate background investigations.
- (5) "Provisional key employee license" means a temporary license issued to an individual who is employed in the classification of key employee at the execution of this Regulation. The provisional key employee license is valid for a period not to exceed one hundred and eighty (180) days and is instituted to allow sufficient time to perform background investigations upon the individual.

- (6) "Provisional gaming staff permit" means a temporary permit issued to a gaming staff employee who is employed by the facility at the execution of this Regulation. The provisional permit is valid for a period not to exceed thirty (30) days and is instituted to allow sufficient time to perform background investigations upon the employee. The provisional permit shall also apply to new hires by the facility to allow sufficient time to perform background investigations upon same.

(III) Key employee license.

- (1) Those individuals within or considered to be within the key employee classification shall be licensed by the Commissioner of Public Gaming.
- (2) An individual shall be allowed to provisionally execute duties in the key employee classification until he/she has been approved and has obtained a key employee license, or has been formally denied licensing.
- (3) Upon determination that an individual does not pose a threat to the conduct of the gaming operation, a Class E-1 license shall be issued to the individual.
 - (A) A Class E-1 license shall be valid for the remainder of the calendar year.
 - (B) The license is valid only at the location stipulated on the license.
 - (C) The individual shall apply for renewal of the license no less than 30 days prior to the expiration date of the existing license.
 - (D) All facilities shall be required to submit one or more of the following fees for reimbursement of investigative costs for each application.
 - (i) \$14.00 - FBI felony check
 - (ii) \$10.00 - OSBI felony check
 - (iii) As a applicable - city/county records check/other
- (4) Upon receipt of the request for license renewal, the Commissioner shall evaluate the licensed individuals personnel record regarding work ethics and activities which may have an effect upon the credibility of the gaming operation to determine if the renewal of such license is appropriate.
- (5) Each license shall remain on the facility premises for which the license was issued in a conspicuous space as designated by the facility General Manager.

- (6) Conditional upon receiving a key employee license, the holder thereof must acknowledge the terms, including but not limited to all provisions of this Regulation and conditions of receiving said license and adherence to same.

(IV) Gaming staff permit.

- (1) Those individuals who do not occupy a key employee position shall be required to obtain a gaming staff permit.
- (2) Upon application for permit, an individual shall be issued a provisional work permit, which will allow the individual to execute those duties for which he/she was employed.
- (3) A provisional permit shall be issued to a facility new hire to allow such individual to perform those job duties until a gaming staff permit may be issued, or a determination of denial of a staff permit is issued.
- (4) Upon determination that an individual does not pose a threat to the proper conduct of the gaming operation, a work permit shall be issued to the individual.
 - (A) A work permit shall be valid for the individual's period of continuous employment.
 - (B) The permit shall be surrendered upon termination of employment. Employees terminated but rehired shall reapply for a new permit.
 - (C) The permit is valid only at the location stipulated on the permit.
 - (D) The permit shall be incorporated as part of the employee's identification badge and must be in the employee's possession at all times while on the gaming premises.
 - (E) All facilities shall be required to submit one or more of the following fees for reimbursement of investigative costs for each application.
 - (i) \$14.00 - FBI felony check
 - (ii) \$10.00 - OSBI felony check
 - (iii) As applicable - city/county records check/other
- (5) A permit may be revoked if granted under false pretenses, or if the holder thereof blatantly violates policies, terms or conditions of permit.
- (6) The holder thereof shall be reviewed by the Office of Public Gaming on an annual basis regarding work ethics and activities which may have an effect upon the credibility of the gaming operation for consideration of continued permit status.

(V) Key Employee Investigative procedures.

- (1) Each individual desiring to become an employee of a Muscogee Nation gaming facility shall complete an application(s) which will reveal pertinent information regarding previous employment, activities and associations.
- (2) The investigation process shall relate to the information which the applicant has submitted and the applicant shall be required to sign a release of information request to facilitate access to appropriate information.
- (3) The applicant shall be required to sign a waiver to release, remise, and forever discharge the Muscogee Nation, Commissioner, agents thereof, and the facility operation from any and all actions, suits and judgements arising from information revealed through the investigation process.
- (4) The investigative process may include:
 - (A) Investigation of criminal activities through -
 - (i) Federal Bureau of Investigation; and/or
 - (ii) Oklahoma State Bureau of Investigation.
 - (B) Investigation of previous employment.
 - (C) Fingerprint cards-FBI (Key Employee only)
 - (D) Investigation of other pertinent items as stipulated on the submitted application relating to previous activities and habits.

(VI) Approval/acceptance standards.

- (1) An applicant shall be issued a license/permit if the determination of the background investigation indicates the individual does not pose a threat to the ethical conduct of the gaming operation.
- (2) An applicant shall not be issued a license/permit if -
 - (A) he/she has had any felony conviction(s) for any capital crime (capital crimes are considered murder, murder for hire homicide, and other crimes of violence).
 - (B) he/she has had any felony conviction(s) for theft, embezzlement, sale and or possession of drugs, or racketeering within the past five (5) years (key employee applicant) or three (3) years (gaming staff applicant).
 - (C) the applicant's previous employment indicates improprieties by the individual, including but not limited to embezzlement and/or fraudulent activities.

- (D) the applicant's previous activities and habits are considered detrimental to the ethical conduct of the gaming operation or to the effective regulation of gaming.
 - (E) any pertinent information submitted in the application proves to be incorrect and/or intentionally misleading.
- (VII) The license/permit may be revoked and/or suspended by the Commissioner for violation of any provision of this Regulation and for any activities which are considered to be detrimental to the public interest or to the effective regulation of gaming.
- (VIII) Upon notification of nonacceptance/revocation of licensing/permitting, applicant will be informed and acknowledge appeal procedures and opportunity for hearing pursuant to established tribal law as stipulated in Sections 209, 210, 211, 213 and 214 of NCA 84-04, as amended.

Sections 103 I, 104, 204, 215, 311, 315, 404, 419, 433 of the Ordinance.
25 USC 2710 (b)(2)(F) and 25 USC 2710 (c)(4) of P.L. 100-487.

Pursuant to NCA 84-04, as amended, the Office of Public Gaming, Muscogee (Creek) Nation, hereby adopts Regulation 91-01 effective November 5, 1990.

Approved and Adopted:

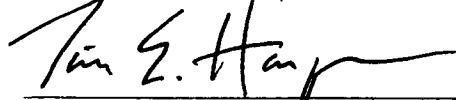

Tim E. Harper, Commissioner

11/5/90

Date

Effective: November 5, 1990