

Modernized e-File (MeF) Guide for Software Developers And Transmitters

Tax Year 2011/Processing Year 2012



Department of the Treasury
Internal Revenue Service

www.irs.gov

Publication 4164 (03-2012)
Catalog Number 36166N

Table of Contents

Table of Contents	i
Nature of Changes	1
1 Introduction	1
1.1 Modernized e-File (MeF)	4
1.2 Communications	4
1.2.1 IRS Web site	5
1.2.2 Communication Vehicles.....	5
1.3 Highlights	5
1.3.1 General Items	6
1.3.2 A2A MeF Software Developer Kit (SDK) and Client Applications.....	6
1.3.3 Identity Protection PIN.....	7
1.4 General Information about MeF	8
1.4.1 Current and prior 2 Tax Years are Accepted	9
1.4.2 Perfection Periods for Rejected Submissions	10
1.4.3 Electronic Postmark	10
1.4.4 Transmission timeframe affected by routine maintenance	11
1.4.5 SubmissionIds in Transmission Manifest and Attachment Mismatch.....	11
1.4.6 SubmissionType in the IRS Submission Manifest.....	12
1.4.7 Short period returns for partnerships or corporations	12
1.4.8 Taxpayers required to e-file original and amended returns.	13
1.4.9 VIN (Vehicle Identification Number) for Form 2290	14
1.5 Amended Returns and Superseding Returns	14
1.5.1 Superseding Returns	15
1.5.2 Amended Returns Forms 1120, 1120-F and 1120S.....	15
1.5.3 Amended Partnership, Exempt Organization, Excise Tax and Individual Returns.....	16
1.6 Exclusions to Electronic Filing	16
1.6.1 Forms 1120/1120S Exclusions:	16
1.6.2 Form 7004 Exclusions	18
1.6.3 Forms 990 & 990-EZ Exclusions	18
1.6.4 <i>e-Postcard</i> Form 990-N Exclusions.....	18
1.6.5 Form 990-PF Exclusions	19
1.6.6 Form 1120-POL Exclusions	19

1.6.8	Excise Tax Forms 720, 2290 and 8849 Exclusions	19
1.6.9	Form 1040 Exclusions	19
1.6.10	Form 4868 Exclusions	20
2	XML Overview for MeF.....	20
2.1	MeF XML Structure.....	20
2.1.1	Schemas	20
2.1.2	Submission Size	21
2.1.3	Tag Names	21
2.1.4	Attributes.....	21
2.1.5	Repeating Group	22
2.1.6	Choice Construct.....	25
2.1.7	e-file Types	25
2.1.9	Attachments to Corporate Returns, Partnership Returns, Excise Tax Returns, Individual Returns and Extensions.....	31
2.1.10	General Dependency	32
2.1.11	XML Character Representation.....	33
2.2	Binary Attachments (PDF files).....	33
2.2.1	Attach a PDF File.....	34
2.2.2	A Sample non-XML document attached to the Submission.....	36
2.2.3	A Sample non-XML document attached to a form.....	36
2.2.4	Names and Descriptions for PDFs.....	37
2.2.5	Form 1040 Paper Document Indicator.....	39
2.3	Special Instructions for “schedule” attachments to Form 8865.....	40
2.4	Special instructions for Form 4466	40
2.5	Special instructions for other forms and attachments that require signatures	40
2.5.1	Form 8838.....	40
2.5.2	Form 7004.....	40
2.6	Exempt Organization Return Attachments.....	41
2.6.1	General Explanation Attachment.....	41
2.6.2	Binary Attachments for Exempt Organization returns	42
2.7	Special Instructions for Consolidated Returns	42
2.8.1	MeF Transmission File Structures for IFA.....	46
2.8.2	Submission File Structure for the IFA Channel.....	47
2.8.3	Creating an MeF Attachment.....	48
2.8.3.1	Create Individual SubmissionZip Archive(s)	48
2.8.3.2	Generate the MeF Attachment	49
2.8.4	MeF Transmission File Structures for Application-to-Application (A2A)	52
2.8.4.1	SOAP Message without Attachments.....	52

2.8.4.2	Messages with Attachments.....	54
2.8.5	MeF State Submission File Structure for Application-to-Application	54
2.9	Version Control for MeF Schemas and Business Rules	56
2.9.1	Schema and Business Rules Updates.....	56
2.9.2	General Information about Version Numbers.....	56
2.9.3	Version Numbering Scheme	57
2.9.4	Validating Schema Versions.....	59
2.9.5	Example of Schema Versioning.....	60
2.10	MeF XML Schema File Structures	61
2.10.1	Form 1040 XML Schema File Structure	63
2.10.2	Form 4868 XML Schema File Structure	64
2.10.3	Form 2350 XML Schema File Structure	66
2.10.4	Form 56 Schema File Structure	67
2.10.5	Form 9465 XML Schema File Structure	68
2.10.6	1120/1120-F/1120S XML Schema File Structure	70
2.10.7	7004 XML Schema File Structure	73
2.10.8	Exempt Organization Forms XML Schema File Structures	75
2.10.9	990-N Package.....	74
2.10.10	8868 XML Schema File Structure.....	75
2.10.11	1120-POL XML Schema File Structure.....	76
2.10.12	1065/1065-B XML Schema File Structure.....	80
2.10.13	Excise Tax Forms 720/2290/8849 XML Schema File Structure.....	82
3	MeF Fed/State Program.....	85
3.1	State Acknowledgements and State Submission Manifest.....	86
3.2	Linked Returns (Fed/State returns).....	86
3.3	Unlinked State Returns (State Standalone returns)	87
3.4	Workflow for Individual, Corporate, Partnership and Exempt Organization State Returns	87
3.4.1	Exempt Organization Fed/State Program – Providing Copy of IRS Return to State	88
4	Transmission Methods for MeF	90
4.1	Transmitting Through Application-to-Application (A2A)	90
4.1.1	Security Directive Rules of Behavior for Access to IRS Business Systems	90
4.1.1.1	Penalty for Non-Compliance	91
4.1.1.2	Compliance with U.S. Internet Cryptographic Standards.....	91
4.1.1.3	Compliance Enforcement.....	92
4.1.1.4	Data Removal.....	92
4.1.2	Registration for A2A credentials	92
4.1.3	Strong Authentication	93

4.1.4	Certificate Management.....	94
4.1.5	Transmitting through MeF Application-to-Application (A2A).....	95
4.1.6	Password Management	96
4.1.7	General Information and Lessons Learned.....	97
4.2	Transmitting Through the Internet Filing Application (IFA).....	101
4.2.1	Applying to Submit Returns through the Internet.....	101
4.2.2	Accessing and Logging into MeF IFA.....	103
4.2.3	Submitting a Transmission File	112
4.2.4	MeF IFA Error Conditions When Uploading a File	119
4.2.5	Help Tab.....	128
4.2.6	Browsers and Operating Systems	129
4.3.1	Through Internet Filing.....	129
4.3.2	Through Application-to-Application (A2A).....	129
5	Validating the Transmission and Return Data	130
5.1	Business Rules (Categories/Severity)	130
5.3	Validating Tax Returns	134
5.3.1	Schema Validation.....	134
5.3.2	Business Rule Validation.....	135
5.3.3	Checksum and Data Values Returned in the Acknowledgement File	136
5.4	Status Record for Federal Returns	137
5.5	Acknowledgement Schema.....	138
5.6	Generating Acknowledgement Files.....	140
6	Retrieval Methods for MeF.....	141
6.1	Retrieving the Acknowledgement through Internet Filing.....	142
6.1.1	Retrieving an Acknowledgement File	142
6.1.2	MeF Error Messages When Retrieving Acknowledgments.....	149
	System Error Retrieve.....	155
6.2	Viewing a List of Participating States in the Fed/State Program.....	157
6.3	Retrieving Production Federal and/or State Submission Status Records	160
6.5	Retrieving Acknowledgements through Application-to-Application (A2A).....	170
6.6	Retrieving State Submissions through Application-to-Application (A2A)	171
7	Payment Options.....	172
7.1	Electronic Funds Withdrawal.....	172

7.1.1	EFW Payment When Return is Rejected	173
7.1.2	EFW Payment Cancellation and Payment Inquiry	174
8.1	Electronic Signature Requirement for Corporations, Partnerships, Exempt Organization Returns (except Form 990-N), Forms 720 and 8849	176
8.2	Electronic Signature Requirement for Form 2290	176
8.2.1	Alternate Signature Requirements for Form 2290 online filers only	177
8.3	Electronic Signature Requirement for Extension Forms 4868, 7004 and 8868	177
8.4	Electronic Signature Requirement for Form 990-N	178
8.5	Electronic Signature Requirement for Forms 1040 Series	178
8.6	Electronic Signature Methods	178
8.6.1	Practitioner PIN Option	178
8.6.3	Scanned Form 8453 Option	182
8.7	Elections That Require Separate Signatures.....	183
8.8	Forms Attached to 1120/1120S with Separate Signatures	183
9	Electronic Signature Specifications.....	184
9.1	Jurat/Disclosure Guidelines	184
9.2	Jurat Language Text Selections.....	184
9.2.1	Form 1040, 1040A, 1040EZ, 1040SS, and 1040 PR Jurat	182
9.2.2	Form 2350 Jurat.....	184
9.2.3	Form 4868 Jurat	188
9.2.4	Forms 56 Jurat.....	190
9.2.5	Form 9465 (Standalone) Jurat.....	190
9.2.6	Form 1120, 1120-F and 1120S Jurat	191
9.2.7	Form 7004 Jurat	193
9.2.8	Forms 1065 and 1065-B Jurat.....	194
9.2.9	Forms 990, 990-EZ, 990-PF, 1120-POL and 8868 Jurat.....	195
9.2.10	Forms 720, 2290 and Form 8849 Jurat	197
10	Form 7004, Automatic Extension of Time to File Certain Business Income Tax, Information and Other Returns.....	198
10.1	Types of Returns and Conditions for Which Form 7004 May Be Used to Request Extension of Time to File	199
10.2	Data Entry for Form 7004.....	199
10.3	Timely Filing of Form 7004.....	200

11 Exempt Organization Section	200
11.1 Form 8868, Application for Extension of Time to File an Exempt Organization Return	200
11.2 Reasonable Cause for Late Filing of Form 990, 990-EZ, 990-PF or 1120- POL.....	201
13 Individual Return/Extension Section	202
13.1 Foreign Employer Compensation (FEC) Record.....	202
13.2 New field “Purpose” in Form 1040/4868 Attachments	203
13.3 Conditions Which May Affect Refund	203
13.4 Extensions	203
13.5 Filer Name Format.....	204
13.6 Form 1040 Address Format	206
Exhibits	208
Exhibit 1 - Business Name Control	209
Exhibit 2 - Individual Name Control	210
Exhibit 3 – Exempt Organization Name Control.....	214
Exhibit 4 - Identifiers	214
Exhibit 5 - Standard Postal Service State Abbreviations and ZIP Codes	217
Exhibit 6 - Foreign Country Codes	217
Exhibit 7 - Forms and Attachment Listing	217
Exhibit 8 - Return Due Dates Tables	217
Exhibit 9 – Recommended Names and Descriptions for PDFs	217

Changes to October 2011 Revision

Section	Change
1.3.3 Identity Protection PIN (IP PIN)	Instructions have been added for the use of the IP PIN.
2.2.5 Form 1040 Paper Document Indicator	Form 8858 has been added to the list of forms for the paper document indicators for the Form 1040 Return Header.

Changes to March 2012 Revision

Section	Change
1.4.2 Perfection Periods for Rejected Submissions	April date has been corrected.
9.2.5 Form 9465 (Standalone) Jurat	Instructions have been updated for Electronic Funds Withdrawal Consent.
Exhibit 8 – Return Due Dates Tables	Corrected link for MeF Forms on IRS.gov.

1 Introduction

This publication outlines the communication procedures, transmission formats, business rules and validation procedures for returns e-filed through the Modernized e-File (MeF) system. To develop software for use with the MeF system, Software Developers and Transmitters should use the guidelines provided in this publication along with the Extensible Markup Language (XML) Schemas published on IRS.gov.

The procedures in this publication should be used in conjunction with the most current version of the following publications:

- **Publication 1345**, Handbook for Authorized IRS e-file Providers of Individual Income Tax Returns
This publication provides important information for Authorized IRS e-file Providers of Individual Income Tax Returns, including information regarding return submission, record keeping requirements, payment options, and refunds.
- **Publication 1436**, Test Package for Electronic Filers of Individual Income Tax Returns for TY 2011
This Publication contains instructions and suggested scenarios for preparing test returns for Participants Acceptance Testing (PATs) using the current e-file system referred to as Legacy and The Modernized e-File (MeF) platform, Assurance Testing System, (ATS). The Electronic Program Operations requires that all Software Developers and Transmitters pass PATs/ATS before they can be accepted into the electronic filing program each Tax Year/filing season.
- **Publication 3112**, IRS e-file Application and Participation
This publication provides important information for Tax Professionals and Authorized IRS e-file Providers regarding applying and participating in IRS e-file. All participants should read this publication to become familiar with the requirements for continued participation. ,
- **Publication 4162**, Modernized e-File Test Package for Forms,1120/1120-S/1120-F/7004
This publication is used by Electronic Return Originators (EROs) in preparing and submitting Test Corporate tax returns and extensions.
- **Publication 4163**, Modernized e-File (MeF) Information for Authorized IRS e-file Providers for Business Returns
This publication is used by Electronic Return Originators in preparing and submitting Corporate, Partnership, ETEC and Exempt Organization tax returns and extensions.

- **Publication 4205**, Modernized e-File Test Package for Exempt Organization Filings
Publication 4205 is provided for software developers and transmitters who create electronic templates for Forms 990, 990-EZ, 990-N, 990-PF, 1120-POL and 8868 in order for forms to be e-filed

- **Publication 4505**, Modernized e-File Test Package for Forms 1065/1065-B
Contains the instructions and test case scenarios for software developers and transmitters to use for Assurance Testing (ATS) of 1065/1065-B.

- **Publication 4557**, Safeguarding Taxpayer Data: A Guide for Your Business
Publication 4557 is the IRS Guide to Safeguarding Taxpayer Data. The target audience is non-government businesses involved in the preparation and filing of income tax returns. The purpose of this Publication is to provide information on legal requirements to safeguard taxpayer data.

- **Publication 4594**, Modernized e-File Test Package for Forms 2290, 8849 & 720
Publication 4594 contains Electronic test information for software developers for Forms 720, 2290 and 8849.

- **Publication 4600**, Safeguarding Taxpayer Information Quick Reference Guide for Businesses
Target Audience: Non-government businesses involved in the preparation and filing of tax returns. Purpose: Provide information on requirements to safeguard taxpayer information, safeguarding techniques, and data security incidents.

The following guides/documents provide additional guidance for e-filing through MeF.

- **MeF Submission Composition Guide – Modernized e-File System**
This Guide provides guidance to IRS trading partners (Software Developers, Originators, and Transmitters) with composing submissions and transmission files that are sent to the IRS for processing by MeF.

- **MeF State and Trading Partners Reference Guide**, describes the interaction between MeF and the State and Trading Partners through the Internet Filing Application (IFA) and Application-to-Application (A2A) platforms.

- **Automated Enrollment External User Guide**
The purpose of this document is to describe the User Interface (UI) for the Automated Enrollment (AE) Application. The AE application provides authorized delegated users the ability to enroll and update Application System IDs (ASID) using the Registered User Portal (RUP).

MeF publications and guides can be found on IRS.gov at <http://www.irs.gov/efile/article/0,,id=171946,00.html>.

1.1 Modernized e-File (MeF)

For Tax Year 2011/Processing Year 2012 (TY2011/PY2012), the MeF platform will take in the remaining 1040-related forms from the current e-File programs and Electronically Transmitted Documents (ETD) projects. This will conclude the 3 phased approach that started with Tax Year 2009.

IRS will use the procedures in this publication as the standard for all e-file programs.

IRS has combined information for Corporate, Partnership, Excise Tax, Exempt Organization and Individual returns in this publication. Unless otherwise indicated, all information applies to all five return types.

This publication and its updates or revisions are available at www.irs.gov.

1.2 Communications

IRS worked in partnership with many MeF stakeholders to develop the information contained within this publication. Your continued cooperation is requested.

On occasion, you may need to contact IRS regarding e-filing issues, including MeF topics. The e-help Desk has been designated as the first point of contact for e-filing issues. Software Developers, Transmitters, EROs, Accounting Firms, and Large Taxpayers should contact the e-help Desk at 1-866-255-0654 for assistance in the following areas:

- IRS e-file application
- ATS or Communication Testing
- Transmission issues
- Strong authentication for A2A
- Rejects
- Technical questions on schemas or business rules

If the e-help Desk is unable to answer the question at the time of the call, the inquiry will be forwarded to the appropriate area for a response. By streamlining this communication process through the e-help Desk, IRS can better monitor the inquiries to ensure a timely response.

During the implementation of new forms to the MeF platform related to the remaining 1040 forms being added, a mailbox is provided specifically for questions related to those forms. For Processing Year 2012, questions relating to the implementation of these new forms should be sent to the MeFMailbox@irs.gov.

If you have any questions, suggestions or comments regarding Exempt Organization Forms 990/990-EZ, 990-N, 990-PF, 1120-POL and 8868, please contact us at:

TEGE-EO-efile@irs.gov, or by mail at:
IRS – Tiwana Holland

SE:T:BSP 6N1
1111 Constitution Avenue, NW
Washington, DC 20224

1.2.1 IRS Web site

MeF uses IRS.gov to communicate information about the program. The Modernized e-File (MeF) Program Information page, located at <http://www.irs.gov/efile/content/0,,id=171945,00.html>, provides links to:

- New Program information Coming Soon to MeF
 - Modernized e-File (MeF) Assurance Testing System (ATS) Updates
 - Information on what forms can be filed through MeF
 - MeF Program Overview
 - Current User Guides and Publications
 - Schemas and Business Rules
 - List of MeF e-file Providers
 - MeF Stylesheets
 - Internet Filing information
 - MeF Systems Status
-
- If you encounter an issue or limitation that prevents a return from being e-filed through MeF, and the solution is not posted on the Web in the link above for the MeF Program Overview pages, please contact the e-help Desk at 1-866-255-0654. MeF will then work on making the appropriate corrections. Until corrections can be implemented, MeF will develop “workarounds”, which is guidance on what temporary changes are needed so the return can be e-filed. Workarounds are posted by Tax Year under the “Known e-file Issues and Solutions”. The resolutions are listed under the appropriate form family heading on the [Modernized e-File \(MeF\) Schemas and Business Rules page](#).

1.2.2 Communication Vehicles

MeF uses *QuickAlerts* to distribute information and updates to MeF stakeholders. *QuickAlerts* is a **free** online service that keeps Tax Professionals up to date on events that affect e-file throughout the filing season and beyond. Subscribers will receive communications 24/7 regarding processing delays, IRS e-file program updates, and early notification of upcoming seminars and conferences. Sign up on the "[subscription page](#)" on IRS.gov. More information can be found on the [QuickAlerts “More” e-file Benefits for Tax Professionals](#) page on www.IRS.gov.

1.3 Highlights

1.3.1 General Items

- MeF is accepting all 1040 family returns and all forms that can be attached to a Form 1040 for Tax Year 2011. Form 1040 returns can be filed for prior Tax Years 2009 and 2010. The prior year 1040 returns may only include the 21 1040-related forms developed for those tax years. In addition to the 1040 family and all related forms, MeF will also accept forms 2350, 56, and 9465.
- Advanced Earned Income Credit (AEIC) was repealed and ended on December 31, 2010. The option of receiving advance payroll payments of EIC expired on December 31, 2010. Individuals eligible for EIC in 2011 can still claim the credit when they file their federal income tax return. Individuals who received advance payments of EIC in 2010 must file a 2010 federal income tax return.
- Paid tax return preparers must use a Preparer Tax Identification Number (PTIN) issued by the Internal Revenue Service (IRS) to identify themselves in the paid preparer section of the tax return. In future years, tax returns may be rejected if an SSN, or any number that is not a valid PTIN, is included in this field.
- For Tax Year 2011, embedded Schedule A was removed from Forms 1065, 1065-B, 1120, 1120-F, and 1120S. The Schedule A information will now be filed on new Form 1125-A.
- For Tax Year 2011, embedded Schedule E was removed from Forms 1120 and 1120-F. The Schedule E information will now be filed on new Form 1125-E.
- Tax Year in the IRS Submission Manifest is optional. A business rule has been developed to require the tax year for applicable tax types.
- The IRS no longer provides tax preparers and associated financial institutions with the “debt indicator”. Taxpayers will continue to have access to information about their tax refunds and any offsets through the “Where’s My Refund?” service on IRS.gov.
- In January 2011, Form 8868, Part II, Additional (Not Automatic) 3-month Extension was added to the MeF platform. Additionally, MeF now accepts all Forms 8868, Application for Extension of Time to File an Exempt Organization Return, with no exclusions including:
 - Both Parts I and II
 - Returns from organizations not recognized as exempt (application pending)
 - Short period returns
 - Group returns
 - Extensions for composite and consolidated Forms 990-T

- Extensions for Forms 990-BL and 6069

Forms 8868 Part I and II filed for Form 8870 must be sent in paper format to:

Department of the Treasury
Internal Revenue Service Center Mail Stop 1112
Ogden, UT 84201-0045

1.3.2 A2A MeF Software Developer Kit (SDK) and Client Applications

The IRS is providing tools to assist developers and submitters with preparing to use MeF. These tools are broken into two broad types:

- Software Developers Kit (SDK)
- Client Applications

The SDK is comprised of source code that is freely distributed to developers. This source code provides developers with the majority of the functions they will need to start using MeF. Additionally this code is written to create local log files for key MeF functions. If these logging functions are used in production by submitters the IRS together with the developer can use these log files to assist submitters in trouble shooting any issue that may arise. The IRS will assist all users but the use of SDK code and log files makes it much easier to help MeF users. The SDK has source code available for developer using both:

- Java
- .net

The MeF Client Applications are operational MeF applications that a state or transmitter can load to any machine that can run a JRE. (This includes all windows and UNIX machines) The application is limited in that it is single threaded so that high volume users may not find it suitable for use. Users however who do not expect high volumes will find the MeF Client Applications a very fast way to get started using MeF. User of the MeF Client Applications will need to format the submissions into the appropriate XML, all other functions are fully developed in the applications.

The A2A Toolkit and client applications are now available to those transmitters and states interested in using the Modernized e-File (MeF) system to send or receive returns. If you are interested in receiving either the toolkit or client application please send an e-mail to the:MeFmailbox@irs.gov to request a copy. Please put A2A Toolkit in the subject line and include your name, your company name, address and phone number along with your request for the toolkit.

1.3.3 Identity Protection PIN

Interview-Driven Software will provide:

- A prompt asking the taxpayer(s) if they received IRS Letter 4869C. This letter contains a unique 6-digit Identity Protection PIN (IP PIN) which is valid only for the

- tax year for which it was issued and only for Tax Forms 1040, 1040A, or 1040 EZ.
- Clear and concise instructions to direct the taxpayer(s) to enter their unique 6-digit IP PIN in the proper location [Element name: IdentityProtectionPIN]. The instructions should also advise the taxpayer(s) however, that if they are filing jointly and both filers received IRS Letter 4869C and an IP PIN, only the taxpayer appearing first on the return (the primary taxpayer) should input their respective IP PIN.

Forms Based Software will provide:

- Clear and concise instructions to direct the taxpayer to enter their unique 6-digit Identity Protection PIN (IP PIN) if they received IRS Letter 4869C and that the IP PIN they received is valid only for the tax year for which it was issued and only for Tax Forms 1040, 1040A, and 1040EZ.
- Clear and concise instructions advising the taxpayer(s) that if they are filing jointly and both filers received IRS Letter 4869C and an IP PIN, only the taxpayer appearing first on the return (the primary taxpayer) should input their respective IP PIN in the proper location.

1.4 General Information about MeF

MeF accepts the following form types:

- Individual (Form 1040, 1040A, 1040EZ, 1040SS and 1040PR)
- Corporations (Forms 1120, 1120-F and 1120S)
- Exempt Organizations (Forms 990, 990-EZ, 990-N, 990-PF, and 1120-POL)
- Partnerships (Forms 1065 and 1065-B)
- Fiduciaries (Form 56)
- Excise Tax (Forms 720, 2290 and 8849)
- Extensions (Forms 2350, 4868, 7004 and 8868)
- Installment Agreements (Form 9465)

The list of TY2011 Forms and Schedules for each form can be found on the [MeF User Guide and Publication page](#) on IRS.gov.

- A Temp ID is included in the state submission manifest and acknowledgement schemas. This is an alphanumeric element used by some states who assign TEMP IDs to taxpayers. The Temp ID can be used in place of an Employer Identification Number (EIN) or SSN.
- Selection of EIN, SSN, or Temp ID is now a choice in the state submission manifest. Either EIN, primary SSN, and name control (with optional spouse SSN and name control), or Temp ID must be provided or the submission will be rejected.
- The acknowledgement will either be populated with Taxpayer Identification Number (TIN) (EIN or SSN) or Temp ID. The submission category can be used to determine if TIN is an EIN or SSN. TIN/Temp ID is implemented as a choice.
- The element “SubmissionType” in the Federal Submission Manifest is now the “FederalSubmissionType” and includes an enumerated list.
- The literal “UNKNOWN” is returned in the acknowledgement for the elements EFIN, Government Code, Federal Submission Type, Tax Year, Submission Category, and Acceptance Status when the submission manifest fails schema validation or the submission zip file cannot be opened. ”Unknown is now included as an enumerated value in those elements that have an enumerated list.

1.4.1 Current and prior 2 Tax Years are Accepted

When a new tax form type is added to the MeF platform, tax returns will be accepted for the first Processing Year only. For example:

Form 1040 was added in Processing Year 2010 for Tax Year (TY) 2009. MeF accepted TY2009 returns for Form 1040 in Processing Year 2010.

The second year that a new form is accepted, MeF will accept two Tax Years: the current Tax Year and the first Tax Year the form was accepted on the MeF platform. For example:

In Processing Year 2011, MeF accepted TY2009 and TY2010 returns for Form 1040 (23 form population) with the exception of Form 4868 which can only be filed for the current Tax Year.

The third year that a new form is accepted, MeF will accept three Tax Years: the current Tax Year and the first two Tax Years the form was accepted on the MeF platform. For example:

In Processing Year 2012, MeF will accept TY2009, TY2010 and TY2011 returns for Form 1040.

Note!!!! This is only true for the 23-form returns that MeF supported during those Tax Years. MeF won't begin accepting prior-year returns for the full complement of forms until PY2014. During PY2014, MeF will accept prior year returns for the full complement of forms for TY2011, and during PY2014 prior-year returns for the full complement of forms will be accepted for TY2011 and TY2012. Form 4868 can only be filed for the current Tax Year.

As subsequent Tax Years are added to the system, MeF will accept the current year and two prior Tax Years. Tax Years beyond the two prior years can no longer be filed through MeF.

1.4.2 Perfection Periods for Rejected Submissions

When a transmitted electronic business return (except excise returns 2290, 720, and 8849) is rejected in Processing Year 2010 and subsequent Processing Years, there is a 10-day Transmission Perfection Period to perfect that return for electronic re-transmission. When a previously rejected electronic return is "Accepted" by the IRS within the 10-day Transmission Perfection Period, it will be deemed to have been received on the date of the first reject that occurred within that 10-day period. The transmission perfection period for business returns transmitted in Processing Year 2009 and earlier was 20 days. Publication 4163 has detailed perfection period information for MeF business returns.

The transmission perfection period for an extension to file, Form 4868, 7004 or 8868, is 5 days.

The following transmission dates pertain to individual returns:

- April 22, 2012 – Last day for retransmitting rejected timely filed Form **1040 family** returns.
- June 20, 2012 – Last day for retransmitting rejected timely filed Form 1040 family returns and/or Form 4868 extensions to meet overseas exception and Form 2350.
- October 22, 2012 – Last day for retransmitting rejected timely filed Form 1040 family returns on extension from Form 4868.

See Publication 1345 for additional information on transmission timeframes for individual returns/extensions.

1.4.3 Electronic Postmark

A Transmitter may provide an electronic postmark to taxpayers that file Tax Returns and Extensions of Time to File Tax Returns, through an ERO or through an Online Provider (Online Filing).

The Transmitter creates the electronic postmark bearing the date and time, GMT time format, (in the Transmitter's time zone) that the return is received at the Transmitter's

host computer.

The electronic postmark must be adjusted to the time zone where the taxpayer resides to determine the postmark's actual time.

For example, if the Transmitter provides an electronic postmark with a time in the Pacific Time Zone but the taxpayer resides in the Eastern Time Zone, the taxpayer must add three hours to the postmark time to determine the actual postmark time (Eastern Time Zone).

Conversely, if the Transmitter provides an electronic postmark with a time in the Eastern Time Zone but the taxpayer resides in the Pacific Time Zone, the taxpayer must subtract three hours to the postmark time to determine the actual postmark time (Pacific Time Zone).

If an electronic postmark is created on or before a prescribed deadline for filing but the return is received by the IRS after the prescribed filing deadline, the return will be treated as filed on the electronic postmark date if received within two (2) days of the electronic postmark. In order for a return to be treated as filed on the electronic postmark's date, all requirements for signing the return must be met. If a return is rejected, a corrected return must be filed in accordance with the rules for timely filing corrected returns after rejection of an electronic return.

1.4.4 Transmission timeframe affected by routine maintenance

A routine maintenance window is generally scheduled on Sunday from 1:00 am to 7:00 am, Eastern Time. This process may result in intermittent down time for transmitters. Work scheduled during this window will generally not be communicated to the software developers. For more information about system status and possible delays, refer to the Modernized e-File Status page on IRS.gov at: <http://www.irs.gov/efile/article/0,,id=168537,00.html>

1.4.5 SubmissionIds in Transmission Manifest and Attachment Mismatch

MeF will process a transmission with a count mismatch between the manifest and attachment in the following manner:

1. The transmission is accepted and a receipt is returned to the transmitter. The receipt contains the SubmissionIds listed in the transmission manifest (SOAP body).
2. The transmitter will receive a reject acknowledgement when a SubmissionId indicated in the manifest is not in the attachment:

Business Rule X0000-010 - For each SubmissionId provided in the transmission manifest, there must be a submission zip archive entry present in the Attachment Zip file whose name (without the ".zip" extension) matches the SubmissionId.

3. Submissions in the attachment that are not in the manifest are deleted from the system. No acknowledgement is generated or returned to the transmitter for these submissions; however, MeF will keep a record of the deletion.

Due to the above process, Business Rule T0000-003 was deleted for processing year 2010:

The number of returns indicated in the transmission manifest must equal the number of returns included in the transmission file.

1.4.6 SubmissionType in the IRS Submission Manifest

The SubmissionType element is no longer shared between IRS Submission Manifest and State Submission Manifest. For federal submissions, the SubmissionType element has been renamed FederalSubmissionType, and an enumerated list of submission types is included. For State Submissions, the SubmissionType element has been renamed StateSubmissionType, and no enumerated list is included. For Federal Submissions, the FederalSubmissionType must match the Return Type in the Return Header or the submission will be rejected (Business Rule R0000-051). The Return Header lists the values for each form's Return Type.

Return Header file	Values for Return Type & IRS SubmissionType
ReturnHeader56.xsd	56
ReturnHeader720.xsd	720
ReturnHeader990x.xsd	990, 990EZ, 990PF
ReturnHeader990N.xsd	990N
ReturnHeader1040x.xsd	1040, 1040A, 1040EZ, 1040SS(PR)
ReturnHeader1065x.xsd	1065, 1065B
ReturnHeader1120x.xsd	1120, 1120S, 1120F
ReturnHeader1120POL.xsd	1120POL
ReturnHeader2290.xsd	2290
ReturnHeader4868.xsd	4868
ReturnHeader7004.xsd	7004
ReturnHeader8849.xsd	8849
ReturnHeader8868.xsd	8868
ReturnHeader9465.xsd	9465

1.4.7 Short period returns for partnerships or corporations

MeF accepts short period returns for partnerships or corporations. There are situations where a taxpayer may need to file a short period return before software is ready for the next Tax Year. For instance, at the beginning of a calendar year, a taxpayer may need to file a short period return with Tax Period Beginning Date 01/01/2011 and Tax Period Ending Date 01/31/2011. This return should be filed using the 2011 TY software but

the software for that Tax Year has not been developed yet. In this case, the taxpayer may use TY2010 software.

When a taxpayer needs to file a short period return, ensure that the Tax Year in the Return Manifest and Return Header reflect the Tax Year of the schemas being used. Enter the actual beginning and ending date of the short period return. For example, the short period return described above will be e-filed using the TY2010 software and include these entries:

- “2010” for the Tax Year in the Return Manifest
- “2010” for the Tax Year in the Return Header
- “01/01/2011” for the Tax Period Beginning Date
- “01/31/2011” for the Tax Period Ending Date

When a short period return is being filed, the regulations may require the taxpayer to attach Form 1128 or an explanation of why the short period return is being filed. If you use the Form 1128, attach it to the top level of the return as a PDF file and describe it as “Form 1128 for Short Period Return.” Use the ShortPeriodReason1120SInd or ShortPeriodReason11201120FInd fields to provide the regulatory citation or reason for the Short Period return. See Publication 4163 for more information.

1.4.8 Taxpayers required to e-file original and amended returns.

IRS requires that certain taxpayers file their returns electronically:

- Forms **1065/1065-B** – Section 1224, of the Taxpayer Relief Act of 1997, requires partnerships with more than 100 partners (Schedules K-1) to file their return on magnetic media (electronically as prescribed by the IRS Commissioner). This law became effective for partnership returns with taxable years ending on or after December 31, 2000. Announcement 2002-3 excluded fiscal year filers from this requirement for Tax Year 2001 only.
- Forms **1120/1120S/1120-F** - Treasury Decision (T.D.) 9363 requires corporations that have assets of \$10 million or more and file at least 250 returns annually to electronically file Forms 1120 and 1120S for Tax Years ending on or after December 31, 2006, and this requirement extends to foreign corporations filing Form 1120-F who have Tax Years ending on or after December 31, 2008, have assets of \$10 million or more and who file at least 250 returns annually.
- Form **990** – T.D. 9363 requires exempt organizations with \$10 million or more in total assets to electronically file their Form 990 if the organization files at least 250 returns in a calendar year, including income, excise, employment tax and information returns for Tax Years ending on or after December 31, 2006.
- Form **990-PF** – T.D. 9363 requires private foundations and non-exempt charitable trusts to file Form 990-PF electronically regardless of their asset size, if they file at least 250 returns annually for Tax Years ending on or after December 31, 2006.

- Form **990-N** (e-Postcard) - Section 6033(i)(1) of the Protection Act of 2006, Public Law 109– 208, 120 Stat. 1090 (2006) (PPA 2006), and T.D. 9454 requires that, effective for tax periods beginning after 2006, every organization exempt from taxation under section 501(a) that is not required to file a return described in § 1.6033– 2(a)(2), other than an organization described in section 401(a) or 501(d), shall submit annually, an electronic notification to the IRS. The notification will provide evidence of the continuing basis for the organization’s exemption from the filing requirements under section 6033(a)(1).
- Form **2290** – The American Jobs Creation Act requires taxpayers who register 25 or more vehicles for any taxable period to electronically file their Form 2290 tax return. Though this requirement became effective July 1, 2005, excise e-file was not available until August 2007.

The IRS developed special guidance to assist corporations, partnerships and exempt organizations with the transition from filing a paper return to electronic filing.

This guidance applies to corporations and exempt organizations required to e-file under final regulations (T.D. 9363, 12-03-2007). The directions to e-file are provided by Tax Year. Use TY2011 *Directions to e-file* when filing a TY2011 return. Fiscal year filers submitting TY2010 returns on TY2010 schemas may use TY2010 *Directions to e-file*.

Corporations, partnerships, exempt organizations and Form 2290 filers required to e-file should review the information available on IRS.gov at the following links:

- For corporations the link is:
<http://www.irs.gov/businesses/corporations/article/0,,id=146959,00.html>
- For partnerships the link is: <http://www.irs.gov/efile/article/0,,id=200526,00.html>
- For exempt organizations the link is:
<http://www.irs.gov/efile/article/0,,id=108211,00.html>
- For Form 2290 filers the link is:
<http://www.irs.gov/efile/article/0,,id=170570,00.html>

1.4.9 VIN (Vehicle Identification Number) for Form 2290

IRS has developed a VIN (Vehicle Identification Number) data store, which collects VIN data from Form 2290. If the taxpayer has indicated consent, the VIN data will be shared with state registration agencies to verify that the Heavy Vehicle Use Tax (HVUT) obligation was paid for a vehicle. This publication will be updated when the process for sharing the VIN data store has been implemented.

1.5 Amended Returns and Superseding Returns

The MeF system processes both superseding and amended returns for certain forms. A superseded return is a subsequent return filed within the filing period (including extensions). An amended return is a subsequent return filed after the expiration of the filing period (including extensions).

IRS has issued final regulations (T.D. 9363) requiring electronic filing of corporate returns (1120, 1120-F and 1120S) and exempt organization returns (990 series). Both amended and superseding returns are required to be e-filed if the taxpayer is required to file electronically, unless a taxpayer has received an approved waiver to file that particular return in paper. Section 1224 of the Taxpayer Relief Act of 1997 provides the e-filing requirements for partnership returns.

1.5.1 Superseding Returns

The superseding return designation is available for Forms 1120, 1120-F, 1120S, 1065 and 1065-B.

The superseding return designation is not available for Forms 990, 990-EZ, 990-PF, 1040, 1120-POL, and 2290. The amended return box must be checked for any subsequent Forms 990, 990-EZ, 990-PF or 1120-POL returns to be accepted.

1.5.2 Amended Returns Forms 1120, 1120-F and 1120S

MeF can accept amended returns for Forms 1120-F for Tax Years 2009 and forward.

Amended returns for Forms 1120, 1120-F and 1120S require at a minimum:

- The corrected Form 1120, 1120-F or 1120S completed in its entirety (pages 1 – 4) with the Amended Return checkbox selected.
- All forms, schedules and attachments that changed or that support changes on the amended Form 1120, 1120-F or 1120S, including any subsidiary returns (if changed) and the information to support those changes.
- For Form 1120, attach to the amended Form 1120:
 - the XML Form 1120X completed through Part I, line 10 or 11, as applicable, and Part II with the line number of each amended item
 - the corrected amount or treatment of the item
 - an explanation of the reasons for each change
- For Form 1120S, attach to the amended Form 1120S the XML document, AmendedReturnChanges, that identifies:
 - the line number of each amended item
 - description of each amended item
 - the amount on the previous return
 - the amount on the amended return
 - an explanation of the reasons for each change
- For Form 1120-F, attach to the amended Form 1120-F the XML document,

AmendedReturnChanges, that identifies:

- the line number of each amended item
 - description of each amended item
 - the amount on the previous return
 - the amount on the amended return
 - an explanation of the reasons for each change
- A signed signature document (Form 8453-C/S/I), as applicable, or use of a Practitioner’s Personal Identification Number (PIN).
 - Appropriate forms to make a payment, request a refund, or request a credit carryover to another year.

For more information on corporate returns, please refer to the following page on IRS.gov: <http://www.irs.gov/businesses/corporations/article/0,,id=146959,00.html>

1.5.3 Amended Partnership, Exempt Organization, Excise Tax and Individual Returns

MeF can accept e-filed amended returns for Forms 1065, 1065-B, 990, 990-EZ, 990-PF, 1120-POL and Form 2290.

The amended return for the Form 720 (Form 720X) and Form 1040 (1040X) must be filed using the existing paper procedures for Processing Year 2012.

MeF can accept multiple Forms 2290 for the same tax period. An amended return for Form 2290 is filed when there is a change to “Additional Tax From Increase in Taxable Gross Weight “ or “Suspended Vehicles Exceeding the Mileage Use Limit“. When an amended return is filed for Form 2290, the amended return box should be checked.

For additional Partnership information, please refer to the [MeF for Partnership page](#) on IRS.Gov.

1.6 Exclusions to Electronic Filing

Returns and extensions meeting the conditions below cannot currently be filed electronically. (Note: Paper documents can be scanned and attached to electronic returns, but no paper documents will be accepted.

1.6.1 Forms 1120/1120S Exclusions:

The Tax Year 2011 MeF Program does not accept and process certain corporate returns. Therefore, the corporation is excluded from the electronic filing requirement under Temporary Treasury Regulation Section 301.6011-5T unless otherwise noted.

These returns include:

- Returns with Tax Years ending prior to December 31, 2009
- Returns covering multiple tax periods
- Bank Holding Company Tax Act - Election to make installment payments for a portion of the total tax attributable to the Bank Holding Company Tax Act
- Prompt Assessments
- Requests for overpayments to be applied to another account
- Corporations who meet the Treasury Decision (T.D.) 9363, 2007-49 Internal Revenue Bulletin [I.R.B.] 1084 criteria are still required to e-file their TY2009 return. In order to comply with the mandatory e-file regulations, corporations must send the request to apply overpayments as a separate letter to:

Internal Revenue Service
ARKA Monterrey Park
1973 N. Rulon White Blvd
Mail Stop 6552 (ARKA)
Attn: AM Clerical
Ogden, Utah 84404.

The following 1120 family of forms cannot be filed electronically as a return at the parent level:

- 1120-L Life Insurance Company
- 1120-PC Property and Casualty

Corporations required to e-file who have 1120-L or 1120-PC subsidiary returns should refer to the specific Tax Year *Directions to e-file* for additional information at: <http://www.irs.gov/businesses/corporations/article/0,,id=146959,00.html>

- 990-C (formerly 990-C) Farmer's Cooperative Association
- 1120-C U.S. Income Tax Return for Cooperative Associations
- 1120-H Homeowners Association
- 1120-FSC Foreign Sales Corporations
- 1120RIC Regulated Investment Companies
- 1120REIT Real Estate Investment Trust
- 1120-SF Settlement Funds
- 1120ND Nuclear Decommission Trusts
- 1120-IC-DISC Interest Charge Domestic International Sales

Forms 1120-C through 1120-IC-DISC listed above are only required to be e-filed if they are part of a consolidated return filing. If these forms are part of a consolidated return, they should be included in PDF format, named appropriately and attached to the top-return level. Otherwise, they must be filed on paper since MeF does not process them at this time.

- 1120X Amended Corporate Return

The Form 1120X cannot be filed as a stand-alone return. It can only be submitted

as an attachment to a Form 1120 return. [See Section 1.5.2 Amended Corporate Returns Forms 1120, 1120-F and 1120S.](#)

1.6.2 Form 7004 Exclusions

- Name change applications
- Reasonable cause for failing to pay timely
- Reasonable cause for failing to file application timely
- Requests for refunds
- Election to make installment payments for a portion of balance due amount
- Applications requesting extension due to change in accounting period unless prior approval has been applied for from IRS or certain conditions have been met. See Publication 538, Accounting Periods and Methods.
- Applications with Net Operating Loss Carryback - Form 1138 should be sent separately, not with the application.
- Applications attaching a Power of Attorney (POA). POA should be sent separately, not with the application.
- Early filed returns (filed before end of tax period)
- Filing short period extension due to termination of 1120S status
- Extensions for the following forms:
 - Form 706-GS(D)
 - Form 8612
 - Form 8613
 - Form 8725
 - Form 8831
 - Form 8876

1.6.3 Forms 990 & 990-EZ Exclusions

- Returns from organizations not recognized as exempt (application pending, etc.)
- Name change returns
- Returns showing a change in accounting period
- Short period returns (except for short period final returns)
- Early filed returns (filed before end of Tax Year except for final returns)
- Returns with tax periods ending prior to December 2009

1.6.4 e-Postcard Form 990-N Exclusions

- Returns from organization not recognized as exempt (application for exemption pending, etc.)
- Returns with attachments
- Organizations required to file Form 990, Form 990-EZ, Form 990-PF or Form 1120-POL
- Organizations included in a group return
- Section 509(a)(3) supporting organizations required to file form 990 or form

990-EZ

Note: This filing requirement does not apply to churches, their integrated auxiliaries, and conventions or associations of churches.

- Short period returns (except for short period final returns).

Note: Initial F990-N calendar filers should list their Tax Year beginning as January regardless of the actual first month of operation

1.6.5 Form 990-PF Exclusions

- Returns from organizations not recognized as exempt (application for exemption pending, etc.)
- Foreign private foundations
- Name change returns
- *Limited* 990-PFs (*Limited* 990-PFs are filed by organizations that originally received advance rulings as public charities but were later determined to be private foundations)
- 507(b)(1)(A) terminations
- Foundations in 60-month terminations

1.6.6 Form 1120-POL Exclusions

- Short period returns (except for short period final returns)
- Name change returns
- Returns with non-numbered attachments/schedules (unless allowed for an attached form shared with Forms 1120/1120S) for which an IRS format has not been developed

1.6.7 Forms 1065/1065-B Exclusions

- Returns granted approved waivers from electronic filing
- Returns with Tax Years ending prior to December 31, 2009

1.6.8 Excise Tax Forms 720, 2290 and 8849 Exclusions

- Form 2290: no returns will be accepted for tax periods ending prior to July 1, 2009
- Form 720: no returns will be accepted for tax periods prior to the first quarter 2009
- Form 8849: no returns will be accepted for tax periods ending prior to December 31, 2010

1.6.9 Form 1040 Exclusions

- Fiscal year returns
- Amended Returns
- Returns with Tax Years ending prior to December 31, 2009

1.6.10 Form 4868 Exclusions

- Fiscal year returns
- Extensions for Tax Years ending prior to December 31, 2011

2 XML Overview for MeF

The IRS uses XML (Extensible Markup Language), the language that specifies the structure and content of an XML document, to implement all forms and schedules in electronic format for Modernized e-File. This section explains some of the elements of an XML document.

2.1 MeF XML Structure

Like a paper tax return, a MeF tax return consists of a series of tax forms, schedules, and attachments that can be submitted for a specific type of tax return or extension.

For example, an 1120 submission includes Form 1120 and any attached forms, schedules, or attachments needed to file a complete return. A consolidated structure includes the consolidated return, the parent return, and one or more subsidiary returns in addition to their respective forms, attachments, and schedules. A mixed consolidated return provides the structure to file a consolidated return with 1120-L and/or 1120-PC sub-consolidations.

For more information on how to compose Submissions and Transmission Files sent to IRS for processing using the Modernized e-File System, refer to the MeF Submission Composition Guide posted to IRS.gov at: <http://www.irs.gov/efile/article/0,,id=171946,00.html>

2.1.1 Schemas

IRS has structured tax return data into a series of schemas. A schema is an XML document that specifies the data elements, structure and rules for each form, schedule, document and/or attachment. In addition to formats defined by schemas, returns must also adhere to business rules, which provide a second level of validation for tax forms processed by MeF. [See Section 5.1 Business Rules](#) for more information.

Within the XML schema, data elements are the basic building blocks of an XML document. The schema recognizes two categories of element types: simple and complex. A simple type element contains only one data type and may only have documentation attributes, such as description or line number. A complex type element is an element that has one or more attributes or is the parent to one or more child elements.

In the schemas, IRS has declared most data elements for forms, schedules, and supporting data are optional. This is consistent with the way paper returns are filed. The taxpayer

and return preparer have the responsibility to provide information as specified by IRS forms, instructions and regulations.

Most of the required elements are in the return header schema. For example, the 1120 return header schema (ReturnHeader1120x.xsd file) contains the identifying information for the entity filing the return and the name of the officer signing the return. The return header also contains optional information such as the preparer information and the preparing firm information.

2.1.2 Submission Size

The instance of a federal or state submission XML file cannot exceed 3.79 GB compressed. The maximum size of an individual PDF file attached to the submission is 60 MB uncompressed.

We recommend chunking for submissions greater than or equal to 50 MB; otherwise responses will take longer and you may timeout before receiving a response.

2.1.3 Tag Names

Each field on a tax form, document or attachment is identified using an XML tag name within the XML schema.

Tag names were created using the following conventions:

- a meaningful phrase with the first letter of each word capitalized and using no spaces (upper Camel case)
- a length of not more than 30 characters
- standard abbreviations to meet the tag name 30 character limit

2.1.4 Attributes

Attributes provide additional information or describe a feature of a data element.

- The first letter of the first word of an attribute name is lower case; the first letter of each subsequent word is capitalized (lower Camel case).
- Fixed attributes are for IRS internal use only; do not include these with the instance XML data for transmission.

Every return document (form, schedule or attachment), which has an XML schema, has the following three attributes in its root element:

- **documentName attribute**: An attribute of type FIXED (a string literal type) and has a value equal to the name of the form, schedule or a supporting document it represents. This attribute (wherever it occurs in the return) is used for IRS internal use only and must not be included in the tax return. However, after the return is received

IRS XML parsers will add such attributes to the appropriate elements in the return for IRS downstream processing. Here is an example:

- In the XML data to be transmitted by the preparer:

```
<IRS1120 DocumentId="RetDoc010">
```

- After transmission, IRS XML parser will add:

```
<IRS1120 DocumentId="RetDoc010" documentName="IRS1120" displayName="1120">
```

- **DocumentId attribute:** An attribute that uniquely identifies the document within the context of the whole return. Tax return preparer's software is responsible for generating a unique id of IdType defined in efileTypes.xsd for each of the return documents. See the following examples:

- <IRS1120 DocumentId="DOC0001">

- <IRS1120ScheduledD DocumentId="0020.2225">

- <DualConsolidatedLossesStatement DocumentId="ABC:002.XY">

- **displayName attribute:** An attribute of type FIXED (a string literal type) and has a value equal to the display name of the form, schedule or a supporting document it represents.

This attribute (wherever it occurs in the return) is used for IRS internal use only and must not be included in the tax return. However, after the return is received, IRS XML parsers will add such attributes to the appropriate elements in the return for downstream processing.

Example:

- In the XML data to be transmitted by the preparer:

```
<IRS1120 DocumentId="RetDoc010">
```

After transmission, IRS XML parser will add:

```
<IRS1120 DocumentId="RetDoc010" documentName="IRS1120" displayName="1120">
```

2.1.5 Repeating Group

A repeating group is a data element or a group of data elements that can repeat up to the number of times specified in the maxOccurs attribute. This provides a consistent structure through which MeF users can capture an unlimited amount of requested information. Paper forms are limited by a number of rows defined on the form, and paper filers may need to include attachments to a return to capture all requested information. For example:

Schedule D (Form 1120), Line 1 Short-Term Capital Gains and Losses, allows seven entries on the paper form. A paper filer would need to include an attachment if there are more than seven entries. In contrast, the corresponding MeF schema allows an unlimited number of entries within this repeating group of elements.

MeF schemas implement repeating groups by creating a form "type" that consists of data

elements that can repeat the number of times specified in the “minOccurs” and “maxOccurs”.

The following figures illustrate a Form 8621 repeating group where DistriAndDisposOfStockType is the complex type that defines the content model for the repeating group:

```
<!-- Distributions and Disposition of Stock in a Section 1291 Fund -->
<xsd:element name="DistriAndDispositionOfStock" type="DistriAndDisposOfStockType" minOccurs="0" maxOccurs="unbounded">
  <xsd:annotation>
    <xsd:documentation>
      <Description>Distributions and disposition of stock in a Section 1291 fund</Description>
      <LineNumber>Part IV Lines 10a-11f</LineNumber>
    </xsd:documentation>
  </xsd:annotation>
</xsd:element>
```

Figure 2-1: Complex Type Identified for Repeating Group

```
<!-- Distribution and Disposition of Stock Type -->
<xsd:complexType name="DistriAndDisposOfStockType">
  <xsd:sequence>
    - <!-- Enter Your Total Distributions from the PFIC During the Current Tax Year -->
    <xsd:element name="TotalPFICDistriDuringCurrentTY" type="USAmountType" minOccurs="0">
      <xsd:annotation>
        <xsd:documentation>
          <Description>Enter your total distributions from the PFIC during the current Tax Year</Description>
          <LineNumber>Part IV Line 10a</LineNumber>
        </xsd:documentation>
      </xsd:annotation>
    </xsd:element>
  </xsd:sequence>
</xsd:complexType>
```

```

    </xsd:element>
    - <!-- Enter the Total Distributions Made by the Company for Each of the 3 Years Preceding the Current Tax Year-->
  <xsd:element name="DistributionsIn3PrecedingTY" type="USAmountType" minOccurs="0">
    <xsd:annotation>
    <xsd:documentation>
    <Description>Enter the total distributions made by the company for each of the 3 years preceding the current Tax
      Year</Description>
    <LineNumber>Part IV Line 10b</LineNumber>
    </xsd:documentation>
    </xsd:annotation>
    </xsd:element>
    - <!-- Divide Line 10b by 3 -->
  <xsd:element name="AvgDistribution3PrecedingTY" type="USAmountType" minOccurs="0">
    <xsd:annotation>
    <xsd:documentation>
    <Description>Divide Line 10b by 3</Description>
    <LineNumber>Part IV Line 10c</LineNumber>
    </xsd:documentation>
    </xsd:annotation>
    </xsd:element>
    - <!-- Multiply Line 10c by 125% -->
  <xsd:element name="AverageDistri3PreviousTY125Pct" type="USAmountType" minOccurs="0">
    <xsd:annotation>
    <xsd:documentation>
    <Description>Multiply Line 10c by 125%</Description>
    <LineNumber>Part IV Line 10d</LineNumber>
    </xsd:documentation>
    </xsd:annotation>
    </xsd:element>

    (Note: information for Lines 10e through 11d removed in this example for space purposes only)

    - <!-- Subtract Line 11d from Line 11c -->
  <xsd:element name="AggregateIncrLessForeignTaxCr" type="USAmountType" minOccurs="0">
    <xsd:annotation>
    <xsd:documentation>
    <Description>Subtract Line 11d from Line 11c</Description>
    <LineNumber>Part IV Line 11e</LineNumber>
    </xsd:documentation>
    </xsd:annotation>
    </xsd:element>
    - <!-- Determine Interest on Each Net Increase in Tax Determined on Line 11e Using the Rates and Methods of Section 6621 --
    >
  <xsd:element name="InterestOnEachNetIncreaseInTax" type="USAmountType" minOccurs="0">
    <xsd:annotation>
    <xsd:documentation>
    <Description>Determine interest on each net increase in tax determined on Line 11e using the rates and methods of
      Section 6621</Description>
    <LineNumber>Part IV Line 11f</LineNumber>
    </xsd:documentation>
    </xsd:annotation>
    </xsd:element>
    </xsd:sequence>
  </xsd:complexType>

```

Figure 2-2: Complex Type Defining Contents of Repeating Group

2.1.6 Choice Construct

The choice construct within an XML schema batches a group of data elements between choice tags and only allows one of the data elements to be provided in an instance. Figure 2-3 below illustrates an optional choice. In this choice, the address may be present or not, but if it is present, then either USAddress or ForeignAddress must be used.

```
<xsd:choice minOccurs="0">
  <xsd:element name="USAddress" type="USAddressType"/>
  <xsd:element name="ForeignAddress" type="ForeignAddressType"/>
</xsd:choice>
```

Figure 2-3: Optional Choice

Figure 2-4 below illustrates a required choice. In this XML instance, one of the elements (either SSN or EIN) must be present.

```
- <xsd:choice>
-   - <!-- Employer Identification Number -->
-   - <xsd:element name="EmployerIdentificationNumber" type="EINType">
-     - <xsd:annotation>
-     - <xsd:documentation>
-       <Description>Employer identification number</Description>
-     - </xsd:documentation>
-     - </xsd:annotation>
-     - </xsd:element>
-   - <!-- Social Security Number -->
-   - <xsd:element name="SocialSecurityNumber" type="SSNType">
-     - <xsd:annotation>
-     - <xsd:documentation>
-       <Description>Social security number</Description>
-     - </xsd:documentation>
-     - </xsd:annotation>
-     - </xsd:element>
-   - </xsd:choice>
```

Figure 2-4: Required Choice

2.1.7 e-file Types

E-file types are IRS defined data types, which can be used in more than one MeF schema and are stable and universal in nature. E-file types define the rule(s) for each of the data elements and may include length and character restrictions and the range of acceptable data. The data types are specified in and validated against the efileTypes.xsd document included in the MeF XML schema package. The IRS is committed to standardizing elements whenever possible.

The following examples illustrate MeF e-file types defined in the efileTypes.xsd XML document. For a complete list of e-file types go to IRS.gov and visit the Web page that hosts the Current Valid XML Schemas for the appropriate return type (included in the Return Schema package).

- **Address:** MeF standardized addresses with the USAddressType e-file type and foreign addresses with ForeignAddressType. All the data elements in these e-file types are required except for data element AddressLine2. Additional e-file types, OtherUSAddressType and OtherForeignAddressType, were added for situations where no elements are required. These e-file types contain only optional elements.

The **USAddressType** (Figure 2-5) has the following data elements:

- AddressLine1, which is a required field if the address field is present
- AddressLine2, which is optional
- City, which is a required field if the address field is present
- State, which is a required field if the address field is present
- ZIPCode, which is a required field if the address field is present

```

<xsd:complexType name="USAddressType">
  <xsd:sequence>
    <xsd:element name="AddressLine1" type="StreetAddressType">
      <xsd:annotation>
        <xsd:documentation>Address line 1</xsd:documentation>
      </xsd:annotation>
    </xsd:element>
    <xsd:element name="AddressLine2" type="StreetAddressType" minOccurs="0">
      <xsd:annotation>
        <xsd:documentation>Address line 2</xsd:documentation>
      </xsd:annotation>
    </xsd:element>
    <xsd:element name="City" type="CityType">
      <xsd:annotation>
        <xsd:documentation>City</xsd:documentation>
      </xsd:annotation>
    </xsd:element>
    <xsd:element name="State" type="StateType">
      <xsd:annotation>
        <xsd:documentation>State</xsd:documentation>
      </xsd:annotation>
    </xsd:element>
    <xsd:element name="ZIPCode" type="ZIPCodeType">
      <xsd:annotation>
        <xsd:documentation>ZIP code</xsd:documentation>
      </xsd:annotation>
    </xsd:element>
  </xsd:sequence>
</xsd:complexType>

```

Figure 2-5: USAddress e-file type

Note: If any data element within the complex element is present, then all of the required fields must be present.

The **OtherUSAddressType** (Figure 2-6) has the same elements as USAddress type; however, all the data elements are optional:

- AddressLine1, which is optional
- AddressLine2, which is optional
- City, which is optional
- State, which is optional
- ZIPCode, which is optional

```
<xsd:complexType name="OtherUSAddressType">
  <xsd:sequence>
    <xsd:element name="AddressLine1" type="StreetAddressType" minOccurs="0">
      <xsd:annotation>
        <xsd:documentation>Address line 1</xsd:documentation>
      </xsd:annotation>
    </xsd:element>
    <xsd:element name="AddressLine2" type="StreetAddressType" minOccurs="0">
      <xsd:annotation>
        <xsd:documentation>Address line 2</xsd:documentation>
      </xsd:annotation>
    </xsd:element>
    <xsd:element name="City" type="CityType" minOccurs="0">
      <xsd:annotation>
        <xsd:documentation>City</xsd:documentation>
      </xsd:annotation>
    </xsd:element>
    <xsd:element name="State" type="StateType" minOccurs="0">
      <xsd:annotation>
        <xsd:documentation>State</xsd:documentation>
      </xsd:annotation>
    </xsd:element>
    <xsd:element name="ZIPCode" type="ZIPCodeType" minOccurs="0">
      <xsd:annotation>
        <xsd:documentation>ZIP code</xsd:documentation>
      </xsd:annotation>
    </xsd:element>
  </xsd:sequence>
</xsd:complexType>
```

Figure 2-6: OtherUSAddress e-file type

- **Business Name Control:** Special characters in the Name Control must be encoded correctly. Refer to the Note under Text Type section for additional information on encoding special characters. For more information on creating a business name control, refer to [Exhibit 1](#).

```
<xsd:simpleType name="BusinessNameControlType">
  <xsd:annotation>
    <xsd:documentation>Used for a Name Control. Legal Characters: A-Z, 0-9, hyphen and
      ampersand. Illegal Character: spaces and symbols.</xsd:documentation>
  </xsd:annotation>
  <xsd:restriction base="xsd:string">
    <xsd:pattern value="([A-Z0-9\-\&#x26;]){1,4}" />
  </xsd:restriction>
</xsd:simpleType>
```

Figure 2-7: BusinessNameControlType e-file type

- **Person Name Control:** The Person Name control only allows characters A-Z, hyphen and space. The first character must be a letter from A-Z.

```
<xsd:simpleType name="PersonNameControlType">
  <xsd:annotation>
    <xsd:documentation>Used for a Name Control. Legal Characters: A-Z, hyphen and space. Illegal
      Character: numbers and symbols.</xsd:documentation>
  </xsd:annotation>
  <xsd:restriction base="xsd:string">
    <xsd:pattern value="[A-Z][A-Z\ ]{0,3}" />
  </xsd:restriction>
</xsd:simpleType>
```

Figure 2-8: PersonNameControlType e-file type

- **Business Name:** MeF standardized the business name with the BusinessNameType. It includes the following data elements:
 - BusinessNameLine1, which is a required field if the business name is present
 - BusinessNameLine2, which is optional

```
<xsd:complexType name="BusinessNameType">
  <xsd:sequence>
    <xsd:element name="BusinessNameLine1" type="BusinessNameLine1Type">
      <xsd:annotation>
        <xsd:documentation>Business name line 1</xsd:documentation>
      </xsd:annotation>
    </xsd:element>
    <xsd:element name="BusinessNameLine2" type="BusinessNameLine2Type" minOccurs="0">
      <xsd:annotation>
        <xsd:documentation>Business name line 2</xsd:documentation>
      </xsd:annotation>
    </xsd:element>
  </xsd:sequence>
</xsd:complexType>
```

Figure 2-9 BusinessNameType e-file type

Person Name and Person Full Name: MeF provides different e-file types for a person's name such as: PersonNameType and PersonFullNameType

- **PersonNameType:** allows 35 characters total for the first and last name

```

<xsd:simpleType name="PersonNameType">
  <xsd:annotation>
    <xsd:documentation>Typically used for a person's name. Legal Characters: A-Z, a-z, 0-9,
    hyphen, apostrophe and single space. Illegal Character: leading space, trailing space, adjacent spaces, and other
    symbols.</xsd:documentation>
  </xsd:annotation>
  <xsd:restriction base="xsd:string">
    <xsd:maxLength value="35" />
    <xsd:pattern value="([A-Za-z0-9\-\-])" />
  </xsd:restriction>
</xsd:simpleType>

```

Figure 2-10: PersonNameType e-file type

- **PersonFullNameType** is a complex type, which includes PersonFirstNameType and PersonLastNameType. Each of these e-file types allows for 20 characters.

```

<xsd:complexType name="PersonFullNameType">
  <xsd:sequence>
    <xsd:element name="PersonFirstName" type="PersonFirstNameType">
      <xsd:annotation>
        <xsd:documentation>Person First Name</xsd:documentation>
      </xsd:annotation>
    </xsd:element>
    <xsd:element name="PersonLastName" type="PersonLastNameType" minOccurs="0">
      <xsd:annotation>
        <xsd:documentation>Person Last Name</xsd:documentation>
      </xsd:annotation>
    </xsd:element>
  </xsd:sequence>
</xsd:complexType>

```

Figure 2-11: PersonFullNameType e-file type

- **IdType:** MeF standardized identifiers using the IdType data type. Below is just one type of identifier, others include TransmissionId, MessageId, etc. ([see Exhibit 4 Identifiers](#))

```

:simpleType name="IdType">
  d:annotation>
  d:documentation>Pattern used for generating TransmissionId, OriginId, ItemId, and
  AcknowledgementId. A timestamp may be used as an ID as long as it is unique within its parent
  element and within the filing season. Up to 4-decimal fractional digits may be used for the second in
  a timestamp to increase its uniqueness. Legal Characters: A-Z, a-z, 0-9, colon, period and
  hyphen.</xsd:documentation>
</xsd:annotation>
  d:restriction base="xsd:string">
  d:pattern value="[A-Za-z0-9:\-\-]{1,30}" />
</xsd:restriction>
</xsd:simpleType>

```

Figure 2-12: IdType e-file type

- **Text Type:** As a general rule, the allowable characters in a field defined as TextType include printable characters, symbols, Spanish characters (shown below), and the

single space used within a phrase. Leading spaces, (spaces before the beginning of the phrase), extra spaces (double or more) and trailing spaces (spaces after the end of the phrase) are never allowed. They will cause the schema validation for that field to fail. Additionally, some TextType fields are defined with restrictions and will only allow a subset of these characters to be used (for example, All Numeric, All Positive Numbers, etc.).

!, ", #, \$, %, &, ', (,), *, +, ,, -, ., /, 0, 1, 2, 3, 4, 5, 6, 7, 8, 9, :, ;, <, =, >, ?, @, A, B, C, D, E, F, G, H, I, J, K, L, M, N, O, P, Q, R, S, T, U, V, W, X, Y, Z, [, \,], ^, _ , ` , a, b, c, d, e, f, g, h, i, j, k, l, m, n, o, p, q, r, s, t, u, v, w, x, y, z, {, |, }, ~, ¡, ¢, £, ¤, ¥, ¦, §, ¨, ©, ª, «, ¬, ®, ¯, °, ±, ², ³, ´, µ, ¶, ·, ¸, ¹, º, » ,¼, ½, ¾, ¿, Á, Ê, Ë, Ì, Í, Î, Ï, ×, Ú, Û, á, é, í, ñ, ó, ú, ü.

Note: For normal text (not markup), characters having special meaning to XML must be encoded by the software used. If the following special characters are used in text by the preparer, the software will need to encode the XML special characters as such:

- < is encoded as <
- > is encoded as >
- & is encoded as &
- " is encoded as "
- a single space is encoded as
- ‘ is encoded as '
- § is encoded as §

2.1.8 Optional Choice for e-file Types with Required Fields

Section 2.1.6 of this publication explained the Optional Choice and Required Choice constructs. In Figure 2-3 (repeated below), the option of USAddress or ForeignAddress was illustrated.

```

<xsd:choice minOccurs="0">
  <xsd:element name="USAddress" type="USAddressType"/>
  <xsd:element name="ForeignAddress" type="ForeignAddressType"/>

```

If a choice is mandatory, then one and only one element within the choice must be selected. If the element selected is a complex element, then it is composed of one or more elements. Use the minOccurs and maxOccurs directives associated with

each element to determine which ones are required. Remember, at least one must be present, and if either minOccurs or maxOccurs is not present the default value for each is 1. For example:

The schema for Line F of Schedule K-1 (Form 1065), has an optional choice of USAddress or ForeignAddress. If USAddress is selected, then the e-file type (in this case “USAddressType”) will determine which fields are optional or required.

As shown in Section 2.1.6, the following fields in e-file type “USAddressType” are required:

- AddressLine1
- City
- State
- Zip Code

If an entry is made in any of the fields for USAddressType, then all the required fields above must have an entry or the return will reject. Although the choice to select either USAddress or Foreign Address is optional, once the taxpayer populates a USAddress or ForeignAddress, the respective e-file types will determine which fields are optional or required.

2.1.9 Attachments to Corporate Returns, Partnership Returns, Excise Tax Returns, Individual Returns and Extensions

Taxpayers are instructed to attach supporting information to the tax return. This includes tax forms, statements, elections, notices, schedules or other types of miscellaneous information that IRS identifies in the form instructions, regulations or publications. These “attachments” are mostly submitted electronically as XML documents or binary files.

When IRS defines a schema for information that is requested, the information must be provided in XML format. Information included in schemas includes:

- Data elements that have been defined for Tax forms like Forms 6478 and 5884.
- Information requested on tax form instructions to support specific lines (such as, ItemizedOtherIncomeSchedule, DualConsolidatedLossesStatement, etc.).

In some cases, the schema provides specific data elements and in other cases the schema allows for entry of a specific number of characters or text to provide an explanation or description.

- Information requested by regulations or publications, which is not specified in form instructions and IRS has not provided a predefined schema.

In this case, and for all other information requested that does not have a specified schema, use the General Dependency schema, GeneralDependencyMedium, or

GeneralDependencySmall schema. The type of General Dependency you use should be determined by the parent form schema and the amount of data included in the respective schema.

A list of supporting information required by form or form instructions is provided for all supporting MeF forms. This list includes the XML document name and location reference to assist the software developer in programming this functionality. These listings can be found on the respective forms schema pages and the [MeF User Guide and Publications page](#).

See [Section 2.7 Special Instructions for Consolidated Returns](#) for information on attaching data to consolidated returns.

2.1.10 General Dependency

As explained above, the General Dependency was created to allow for the submission of information that is not specified in a predefined schema. IN Processing Year 2010, MeF implemented three General Dependencies.

- “GeneralDependency”, available for Forms 1120, 1065 and 1065-B, is attached at the parent form level and allows for an explanation of up to 1 million characters (efile type is LongExplanationType).
- “GeneralDependencyMedium”, available for Forms 1040 family, 1120-F, 1120S, 720, 2290 and 8849, is attached at the parent form level and allows for an explanation of up to 100,000 characters (efile type is MediumExplanationType).
- “GeneralDependencySmall” is attached at the form or schedule level and allows for an explanation of up to 5,000 characters (efile type is TextType with maximum length 5,000 characters). The General DependencySmall is available for:

Form 851	``	Form 4562
Form 926		Form 4684
Form 1118		Form 5471
Form 1118AMT		Form 5713
Schedule M-3 (Form 1120)		Form 6765
Schedule M-3 (Form 1120L)		Form 8586
Schedule M-3 (Form 1120PC)		Form 8834
Schedule M-3 (Form 1120S)		Form 8865
Schedule M-3 (Form 1065)		Form 8886
Schedule K-1 (Form 1065)		
Form 3800		
Form 4136		

Data elements for all three General Dependency schemas are:

- Name – choice between business name or person name

- TaxpayerIdentificationNumber – choice between EIN or SSN or MissingEIN
- FormLineOrInstructionReference –the form and/or line number to which the attachment belongs
- RegulationsReference – the regulation and/or publication reference
- Description – provide a meaningful title or explanation for the attachment
- AttachmentInformation – explanation regarding the attachment

IRS uses the Description as the title of the General Dependency when viewing the return. Below are some tips for composing the Description for any of the General Dependencies:

- The Description should be meaningful to the information provided.
- If the General Dependency is an Election, the Description should start with the word “Election”. For Example:
 - “Election to Amortize a Bond Premium”
 - “Election for 100% Dividends Received Deduction.”
- If multiple General Dependencies (of any size) are in one submission, the Description for each General Dependency should be unique.

If the data requested for either election or other information requires “columnar format,” these documents may be submitted in PDF format until the IRS provides a structure to support columnar format.

2.1.11 XML Character Representation

When entering character data into an XML document, it is important to ensure that the specified encoding supports the characters provided. By design, Modernized e-File uses Unicode Transformation Format-8 (UTF-8). MeF does not support any other encoding scheme (for example, UTF-16 and UTF-32).

2.2 Binary Attachments (PDF files)

The tax return may also include non-XML documents, known as “binary attachments,” submitted in PDF format. (Note: Currently, IRS only supports PDF format.) This allows taxpayers to provide requested documentation that may include required signatures and/or third party documents, such as Form 8453 series signature document, signed copy of lease, signed appraisal statement, etc. The Form 7004 allows binary attachments except for Form 8453. Binary attachments cannot be attached to Form 2350, 4868, 56 or 9465.

Note: In this section the signature document for business returns (8453-C, 8453-PE, etc) will be referred to as Form 8453 series. There is no signature document for individual returns and Form 8453 for individuals was redesigned as a transmittal document. Form 8453 for individuals should not be attached to the electronic submission.

2.2.1 Attach a PDF File

To attach a PDF file, perform the following steps:

1. **Create the PDF file** using any available tool. In creating a PDF file for the submission, it is important to adhere to the following guidance:
 - Do not password protect or encrypt PDF attachments submitted through MeF.
 - Keep binary attachments as small as possible. By exporting a document to create the PDF, it makes for a much smaller file than scanning one in. The IRS needs a readable PDF using any compatible software that creates a PDF file. If using Adobe Acrobat:
 - Avoid requiring compatibility with Adobe Acrobat versions earlier than version 8. Making the PDF file compatible with earlier versions will increase the size of the file.
 - Move the compression/quality slider on the “Create PDF From Scanner” to higher compression to lower the size of the file when the source document is of adequate quality and from scanner input.
 - Each individual PDF cannot exceed 60 megabytes uncompressed.
 - Each PDF must start with %pdf- and end with %%EOF. The return will reject if the PDF is not properly formatted. (All software that creates PDFs will automatically start a PDF with %pdf- and end the PDF with %%EOF. This error condition will only occur if action is taken by the submitter to alter a PDF outside of the product that creates the PDF)

You can download the most recent free version of Adobe Reader PDF using the following link: <http://www.adobe.com/products/acrobat/readstep2.html> - *Please note* that by clicking on this link, you will leave the IRS Web site and enter a privately owned Web site created, operated and maintained by a private business. The information that this private business collects and maintains as a result of your visit to its Web site may differ from the information that the IRS collects and maintains. (Please see the IRS Web site privacy and security notice for privacy protections IRS provides to Web site visitors.) By linking to this private business, the IRS is not endorsing its products, services, or privacy or security policies. We recommend you review the business's information collection policy or terms and conditions to fully understand what information is collected by this private business.

- The name of each PDF file cannot exceed 64 characters and should not include non-ASCII characters. If the PDF file name contains non-ASCII characters, the processing of the return is delayed.
2. **Create a “Binary Attachment XML document”** in the Submission data that describes the PDF file. One Binary Attachment XML document must be created for each binary attachment. There is a one-to-one relationship between the PDF file and the Binary Attachment XML document that describes it.

To create the Binary Attachment XML document, provide the PDF file with a name,

including the extension, in the “AttachmentLocation” element and a brief meaningful and unique description of the contents of the file in the “Description” element.

a. PDF File Name

The name of the PDF file must EXACTLY match the name provided in the “AttachmentLocation” element and is case sensitive. The schema for the Binary Attachment document is defined in the file named “BinaryAttachment.xsd”.

b. “Description” element in the Binary Attachment XML document

The “Description” element in the BinaryAttachment.xsd cannot exceed 128 characters. It is important to make this as meaningful as possible because the Description is what is displayed to the IRS User to identify the contents of the binary file.

Examples of meaningful descriptions for the “Description” element:

- Police Report
- Calculation Of Section 367 Tax And Interest

Examples of descriptions that aren’t meaningful for the “Description element”:

- Other
- Miscellaneous
- Form Attachment

Note: While it is possible that one PDF may be attached in more than one location, that condition is very rare. Do not simply attach a PDF to every location that allows a PDF. Attach a PDF only where it is needed as an attachment. There have been problems with the same binary files being attached at every location where a binary file can be attached. This causes virtual documents that can delay processing.

3. **Create references**, if any, from the element(s) to which the PDF file is “attached” to the “Binary Attachment XML document.”
 - If the PDF file is to be attached to an element for a line, form, or schedule, create a reference from the element to the Binary Attachment XML document.

We recommend that PDF files be attached at the top-level return unless there is a reason it needs to be attached at a form level or to one of the GeneralDependency schemas. The reference is created from the element to the Binary Attachment XML document, not to the PDF file. If no reference is created to the Binary Attachment XML document, then the PDF file is considered to be “attached” to the Submission. Creating reference(s) to PDF files is needed when the IRS specifies the conditions under which the reference must

be created, and the reference locations within return data where the reference must exist.

4. **Include the number of binary attachments in the submission** in the `binaryAttachmentCount` attribute, which is used to indicate the number of binary attachments in the return, of element `ReturnHeader`.

5. **Include the PDF file in the attachment folder** in the submission zip.

Like-kind binary attachments should be placed adjacent to each other in the submission data XML.

2.2.2 A Sample non-XML document attached to the Submission

Below is an example of a binary attachment, 8453 Signature Document, with a file name “8453SignatureDoc.pdf”, “attached” to a submission. To attach the document to a submission:

- include the PDF file in the Submission Zip Archive
- create a Binary Attachment XML Document that describes it in the Submission data
- do not reference the Binary Attachment XML Document within the Submission data

The `Description` element of the Binary Attachment XML document contains the description of the file while the `AttachmentLocation` element contains the name of the file. The file itself is packaged along with other files in the attachment folder in the submission zip.

```
<ReturnData>...
<BinaryAttachment DocumentId="SignatureDoc8453" softwareId="00000000" softwareVersion="String">
  <DocumentType>PDF</DocumentType>
  <Description>8453 Signature Document</Description>
  <AttachmentLocation>8453SignatureDoc.pdf</AttachmentLocation>
</BinaryAttachment>...
</ReturnData>
</Return>
```

Figure 2-13: Binary Attachment XML Document

2.2.3 A Sample non-XML document attached to a form

Below is an example of a PDF file that is attached to a submission. The attachment described as “Historic Structures circa 1880” is named “HistoricStruct1880.pdf” and attached to Form 1120.

When a PDF file needs to be attached to a submission, the `BinaryAttachmentDocumentId` created in the Binary Attachment XML Document

(BinaryAttachmentDocumentId="PDFAttachment01", that describes the physical file) is also referenced within the submission using the referenceDocumentId attribute (**referenceDocumentId="PDFAttachment01"**). Only one instance of the physical PDF file is included in the Submission zip file.

```
<Return>
...
<ReturnData>
...
<IRS1120 DocumentId="DOC0001" referenceDocumentId="PDFAttachment01">
...
</IRS1120>
...
<BinaryAttachment DocumentId="PDFAttachment01" softwareId="00000000" softwareVersion="String">
  <DocumentType>PDF</DocumentType>
  <Description> Historic Structures circa 1880 </Description>
  <AttachmentLocation> HistoricStruct1880.pdf</AttachmentLocation>
</BinaryAttachment>
...
</ReturnData>
</Return>
```

← Reference to the Binary Attachment XML Document

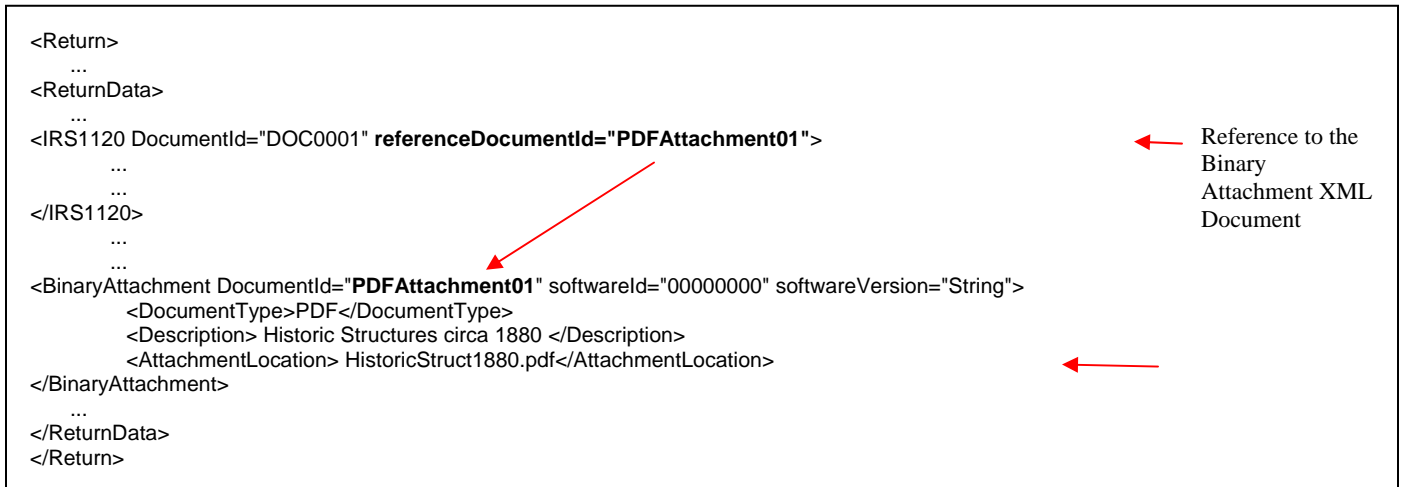

Figure 2-14: PDF attached to top level of return

2.2.4 Names and Descriptions for PDFs

When naming certain PDF attachments, tax preparation software must use the following names because they will be validated by business rules.

CONDITION	Description
If you attach a scanned 8453, the Description must be	8453 Signature Document
If you attach a scanned 8838, the Description must be	8838 Signature Document
If you attach a scanned 2553, the Description must be	Form 2553
If you attach a scanned Contemporaneous Written Acknowledgment Statement, the Description must be	Donee Organization Contemporaneous Written Acknowledgment
If you attach an art appraisal to Form 8283 and are filing an individual tax return (Form 1040), the Description must begin with	Art Appraisal
If you attach a scanned Form 1098-C, the Description must be	Form 1098-C
If you attach Appendix A, Statement by Taxpayer Using the Procedures in Rev. Proc. 2009-20 to Determine a Theft Loss Deduction Related to a Fraudulent Investment Arrangement, the Description must be	Revenue Procedure 2009-20

For all other PDF attachments, the tax preparation software must provide the taxpayer the ability to enter a meaningful description. [Exhibit 9 Recommended Names and Descriptions for PDFs](#) provides a table with recommendations of names and descriptions for PDFs . This table will be posted on IRS.gov on the [MeF User Guides and Publication](#) page and updated throughout the year.

When multiple forms or attachments are required, the taxpayer has the option to put all like-kind statements or forms in one PDF file or create a separate PDF file for each statement or form. For example, if three Section 351 statements are needed, they may all be included in one PDF file or each separate Section 351 statement may be in a separate PDF file.

When a PDF is associated with an entity, the name (or part of the name if limited by the total number of characters) should appear at the end of the suggested Description field. For example:

If attaching an organizational chart to Form 5471 of a foreign corporation, use the Description “Form 5471 Schedule O - Org Chart Foreign Corp 123” in the BinaryAttachment.xsd.

2.2.5 Form 1040 Paper Document Indicator

The Paper Document Indicator in the Form 1040 Return Header is checked when a taxpayer elects to send certain forms to IRS by mail using Form 8453, U.S. Individual Income Tax Transmittal for an IRS e-file Return.

1040 MeF filers have the option of:

- attaching the forms listed below as a PDF to the electronic submission.
- mailing the forms listed below to IRS with the Form 8453 transmittal. If the form is mailed to IRS, the Paper Document Indicator in the Return Header should be checked.

The Form 1040 Return Header has paper document indicators for:

- Form 8283, Noncash Charitable Contribution
- Form 8332, Release of Claim to Exemption for Child of Divorced or Separated Parents
- 3468, Investment Credit
- 5713, International Boycott Report
- 8885, Health Coverage Tax Credit
- 8864, Biodiesel and Renewable Diesel Fuels Credit
- 4136, Credit for Federal Tax Paid on Fuels
- Form 3115, Application for Change in Accounting Method
- Form 1098-C, Contributions of Motor Vehicles, Boats, and Airplanes
- Form 8858, Information Return of U.S. Persons With Respect To Foreign Disregarded Entities (FDE)
- Power of Attorney
- Appendix A, Statement by Taxpayer Using the Procedure in Rev. Proc. 2009-20 to Determine a Theft Loss Deduction Related to a Fraudulent Investment Arrangement

The Form 8283 data must be included as XML in the electronic submission. When a signature is required, a signed copy of Form 8283 can either be:

- included in the submission file as a binary attachment (PDF) or
- mailed to the IRS with Form 8453 transmittal and checking the Form 8283 Paper Document Indicator.

The Form 8453 transmittal lists additional forms, which are not included in the 1040 MeF program for processing. Filers who need to attach a form not listed above to the transmittal should not file through MeF.

The Declaration Control Number (DCN) is not used by MeF; therefore, these boxes can remain blank on Form 8453 and any other form that has a DCN (such as Forms 8878, 8879 or 9325). MeF uses a Submission ID instead of a DCN and does not require the

Submission ID to be reported on these forms.

2.3 Special Instructions for “schedule” attachments to Form 8865

In many instances information from various Form 1065 schedules (Schedule B, D, K, K-1, L, M-1, M-2) will be the same required to be filed with the Form 8865 schedules. Do NOT attach the Form 1065 schedules to the return; instead, the data from the Form 1065 schedules should be formatted into the corresponding Form 8865 schedules.

2.4 Special instructions for Form 4466

If applicable, Form 4466, Corporation Application for Quick Refund of Overpayment of Estimated Tax, should be filed on paper at the appropriate IRS Center listed on the form instructions. The Form 4466 attached to the e-filed return is only a copy and will not be processed.

2.5 Special instructions for other forms and attachments that require signatures

IRS Counsel issued special instructions to facilitate electronic filing. Regulation T.D. 9300 contains amendments to the Income Tax Regulations (26 CFR Part 1) and Procedure and Administration Regulations (26 CFR Part 301) eliminates some of the requirements considered impediments to the electronic submission of tax returns. T.D. 9300 eliminates the impediments for taxable years beginning after December 31, 2002. The regulations generally affect taxpayers who are required to file any of the following forms: 926, 972, 973, 982, 1120, 1120S, 1122, 5471 or 8832. In addition, effective May 30, 2006, T.D. 9264 also eliminated signature impediments by stating that by signing the return, a taxpayer is attesting to the validity of the Form 1120 as well as all of the attachments. Generally, the signature of Forms 1120/1120-S covers all forms, schedules and accompanying statements, with the exception of Form 8838 and Form 7004. Review TD9300 and 9264 for specifics.

2.5.1 Form 8838

Form 8838 data must be sent to the IRS using the XML Schema and a signed copy submitted as a binary attachment with the Description “8838 signature document.”

2.5.2 Form 7004

There is no signature requirement on the Form 7004, unless there is a payment made with the Form 7004. If you are using an ERO, then use Practitioner PIN to sign the extension and authorize the payment. If you are not using an ERO, the ACH Debit Agreement Indicator must be included in the XML to authorize the payment that is attached to the Form 7004.

Although Form 7004 MeF has binary attachment capability, such attachments are for information purposes only and will not be processed. Therefore, a Power of Attorney (POA), Form 1128, Form 1138 and other documents requiring action by IRS should not be sent with the Form 7004.

2.5.3 Form 8868

A signature is required for Forms 8868 Part I only if a payment record is attached. A signature is required for all Forms 8868 Part II regardless of whether a payment record is attached.

If a payment record is attached to this form, a signature is required for the Electronic Funds Withdrawal (EFW) authorization. A Practitioner PIN (using Form 8879-EO) or Form 8453-EO may be used for this authorization. Form 8453-EO is the only attachment/binary file that will be accepted.

2.6 Exempt Organization Return Attachments

For Exempt Organization returns, filers occasionally must attach an IRS form, schedule or other piece of information. For Forms 990, 990-EZ, 990-PF, 1120-POL, and 8868, these “attachments” will normally be submitted electronically as XML documents. Usually, the only binary file is Form 8453-EO except for Final Returns where third party documents are allowed to be attached as binary attachments. Other binary files may be submitted as attachments if permitted as part of a form or schedule shared with Forms 1120/1120-F/1120S. A Form 8453-EO is the only attachment permitted with Form 8868.

2.6.1 General Explanation Attachment

The General Explanation attachment is an XML schema used for Forms:

- 990-EZ
- 990-PF
- 1120-POL
- 990

The Schedule O (Form 990), Supplemental Information to Form 990, replaces the General Explanation Attachment for TY2008 and later Forms 990.

The General Explanation attachment, which allows for optional information to be provided that is not otherwise covered in another permitted schema, has three elements:

- Identifier, which is a single line description of the information being provided
- Return Reference, which is a single line description of the return item, if any, to which the information relates
- Explanation, which is a brief text section where the additional information the filer wishes to convey is contained

These fields may be repeated up to ten times.

One General Explanation Attachment may be optionally attached to each return. It is intended to be used to provide supplementary information, and may not be used in lieu of an existing schema.

Note: The General Dependency schemas available with other MeF forms may not be substituted for the General Explanation Attachment schema.

2.6.2 Binary Attachments for Exempt Organization returns

When submitting a binary attachment of Form 8453-EO, the name “8453 Signature Document” must be included in the submission Zip Archive. For specific information, please refer to the MeF Submission Composition Guide found at <http://www.irs.gov/efile/article/0,,id=171946,00.html>.

All attachments (except for the signature document, Form 8453-EO) to Forms 990, 990-EZ, 990-PF, 1120-POL, and 8868 must use the prescribed XML schema. Binary documents will be permitted for these forms if they are necessary as part of submitting a shared Form 1120/1120-F/1120S form or schedule. Refer to Section 2.2 for specific guidance concerning the name, description and AttachmentLocation of binary attachments. Since a signature is required for electronic payments submitted with Form 8868, Form 8453-EO is the only binary attachment permitted with the extension.

2.7 Special Instructions for Consolidated Returns

MeF requires tax preparation software approved for electronic filing to use IRS forms for reporting data for each subsidiary return. In addition to the consolidated return, tax preparation software approved for electronic filing must allow taxpayers to create a separate “stacked return” for the parent and each subsidiary return. Tax preparation software must allow taxpayers to report Eliminations and Adjustments at each level when applicable. Tax preparation software may also allow taxpayers to use spreadsheets for the internal review of the return, but IRS requires all subsidiary data to be formatted, transmitted and viewed by IRS as “stacked returns”.

MeF requires supporting data to be included in tax preparation software or attached as scanned PDF files. IRS reviewed all of the forms (and instructions for those forms) that may be attached to the corporate forms and identified every instance where taxpayers are required to attach supporting data. IRS provided structured formats to software developers or provided instructions to enter supporting data as PDF files (in instances where IRS has not defined a format).

When IRS has defined structured formats, software developers are required to use these formats for developing tax preparation software approved by IRS for electronic filing. It is the responsibility of software developers to provide appropriate instructions for taxpayers to enter supporting data to meet the IRS guidelines. Most software developers will allow taxpayers to

import/export data from other sources. Taxpayers are encouraged to discuss available options with their software developers early to determine how to prepare supporting data for their electronic returns.

When submitting a consolidated return, the software **must** provide the detail for each entity at the entity level then roll that data up to the consolidated return. At a minimum, this roll-up information must be provided on any line where the form requires a statement or schedule to be attached (e.g., Form 1120, Line 10, Other Income (attach schedule), Line 26, Other Deductions (attach schedule), etc.). However, there are forms and schedules that are transactional or informational in nature and cannot be mathematically consolidated or reported on the consolidated return. The transactional data flows to the consolidated return via a different form or schedule and the informational data is simply attached to the consolidated return. For example, the Form 6252, Installment Sale Income, results for each transaction flow to the Form 4797, Sales of Business Property, and subsequently, the data on the Form 4797 flows to the consolidated return. The Form 8883, Asset Allocation Statement, provides informational data only and does not flow to any other schedule, form or a consolidated return.

Here is an example based on the data provided in prior year Form 1120ATS Scenario 2 which is a consolidated return.

Attachment 1, F1120, line 10, Other Income (ItemizedOtherIncomeSchedule)				
Consolidated Schedules	TOTAL	Hide 'N Seek Foods, Inc.	The Greek Playhouse	Acme Food Corp.
Sales	217,441	208,671		8,770
Exchange Gain/Loss Realized	-2,321,468	-2,229,104		-92,364
Partnership Income/Loss	50,559,438	-59,869	220,747	50,398,560
Miscellaneous Income	149,354	156,146		-6,792
Interco Consulting Fees	1,448,935	1,448,935		
TOTAL	50,053,700	-475,221	220,747	50,308,174

The first subsidiary (Hide 'N Seek Foods, Inc) will provide the following data on the *ItemizedOtherIncomeSchedule*:

Corporation Name	Corporation EIN	Other Income Type	Other Income Amount
Hide 'N Seek Foods, Inc.	11-0000002	Sales	208,671
Hide 'N Seek Foods	11-0000002	Exchange Gain/Loss realized	-2,229,104
Hide 'N Seek Foods	11-0000002	Partnership Income/Loss	-59,869

Hide 'N Seek Foods	11-0000002	Miscellaneous Income	156,146
Hide 'N Seek Foods	11-0000002	Interco Consulting Fees	1,448,935
Hide 'N Seek Foods	11-0000002	Total	-475,221

The second subsidiary (The Greek Playhouse) would provide the following data on the *ItemizedOtherIncomeSchedule*:

Corporation Name	Corporation EIN	Other Income Type	Other Income Amount
The Greek Playhouse	11-0000012	Partnership Income/Loss	220,747
The Greek Playhouse	11-0000012	Total	220,747

The third subsidiary (Acme Food Corp) will provide the following data on the *ItemizedOtherIncomeSchedule*:

Corporation Name	Corporation EIN	Other Income Type	Other Income Amount
Acme Food Corp	11-0000013	Sales	8,770
Acme Food Corp	11-0000013	Exchange Gain/Loss realized	-92,364
Acme Food Corp	11-0000013	Partnership Income/Loss	50,398,560
Acme Food Corp	11-0000013	Miscellaneous Income	-6,792
Acme Food Corp	11-0000013	Total	50,308,174

The consolidated return should have an attachment for Other Income and the following data must be provided in one of the following formats:

Format 1 - The *ItemizedOtherIncomeSchedule* for the consolidated return contains a roll-up of the detail for each entity.

Corporation Name	Corporation EIN	Other Income Type	Other Income Amount
Hide 'N Seek Foods	11-0000002	Sales	208,671
Hide 'N Seek Foods	11-0000002	Exchange Gain/Loss realized	-2,229,104

Hide 'N Seek Foods	11-0000002	Partnership Income/Loss	-59,869
Hide 'N Seek Foods	11-0000002	Miscellaneous Income	156,146
Hide 'N Seek Foods	11-0000002	Interco Consulting Fees	1,448,935
The Greek Playhouse	11-0000012	Partnership Income/Loss	220,747
Acme Food Corp	11-0000013	Sales	8,770
Acme Food Corp	11-0000013	Exchange Gain/Loss realized	-92,364
Acme Food Corp	11-0000013	Partnership Income/Loss	50,398,560
Acme Food Corp	11-0000013	Miscellaneous Income	-6,792
Hide 'N Seek Foods, Inc.	11-0000002	Total	50,053,700

Note: Dependencies should be attached at the entity level and also rolled up to the consolidated return.

Format 2 - The *ItemizedOtherIncomeSchedule* for the consolidated return contains a roll-up of the total from each entity.

Corporation Name	Corporation EIN	Other Income Type	Other Income Amount
Hide 'N Seek Foods, Inc.	11-0000002	Total Other Income	-475,221
The Greek Playhouse	11-0000012	Total Other Income	220,747
Acme Food Corp	11-0000013	Total Other Income	50,308,174
Hide 'N Seek Foods, Inc.	11-0000002	Consolidated Total	50,053,700

Note: Dependencies should be attached at the entity level and also rolled up to the consolidated return.

Format 3 - The *ItemizedOtherIncomeSchedule* for the consolidated return contains a total of all subsidiaries by category.

Corporation Name	Corporation EIN	Other Income Type	Other Income Amount
Hide 'N Seek Foods, Inc.	11-0000002	Sales	217,441
Hide 'N Seek	11-0000002	Exchange Gain/Loss realized	-2,321,468

Foods			
Hide 'N Seek Foods	11-0000002	Partnership Income/Loss	50,559,438
Hide 'N Seek Foods	11-0000002	Miscellaneous Income	149,354
Hide 'N Seek Foods	11-0000002	Interco Consulting Fees	1,448,935

Note: Dependencies should be attached at the entity level and also rolled up to the consolidated return.

2.8 MeF Transmission and Submission File Structures for Internet Filing Application (IFA) and Application-to-Application (A2A)

This section describes the transmission and submission file structures for the IFA and Application-to-Application channels. Both channels use SOAP (Simple Object Access Protocol) with attachments.

For more specific information on creating a transmission file for IFA, refer to the MeF Submission Composition Guide posted to <http://www.irs.gov/efile/article/0,,id=171946,00.html>. For specific information on creating Application-to-Application Messages, refer to the ISS MeF State and Trading Partners Reference Guide posted along with the MeF Submission Composition Guide.

2.8.1 MeF Transmission File Structures for IFA

The number of submissions in the transmission file is limited to 100.

The transmission file for the IFA channel is a MIME (Multipurpose Internet Mail Extensions) multipart document that contains two parts and conforms to “SOAP 1.1 with attachments” standard. The first part of the multi-part document is the SOAP envelope and the second part is a SOAP attachment. The SOAP envelope contains transmission-level information, and the SOAP attachment contains submissions. MIME boundaries separate the parts in the multi-part document.

The SOAP envelope consists of a SOAP header which contains the MeF header and security sections. The SOAP body is also referred to as the *transmission manifest*. Please refer to Figure 2-15 below.

The SOAP attachment in the transmission file is a ZIP file. This ZIP file, also referred to as Attachment ZIP file, is not compressed; it is simply ZIP archived (compression is turned off when this file is created). This Attachment ZIP file contains one or more submissions that are themselves ZIP Archive files. These ZIP files, also referred to as Submission ZIP files, are compressed.

MeF incoming submission data is encapsulated in SOAP 1.1 with a single attachment. This single attachment will be an uncompressed zip container file. The single uncompressed zip container file may contain any number up to 100 compressed zip submission files, which is one level of nesting. No more than one level of nesting is

allowed. Each compressed zip submission file consists of one submission (return) and may not contain another zip file. The files in the zip archive can only be compressed a maximum of 250 times. Any zip archive file compressed more than 250 times the original file will trigger a virus error and the transmission will be rejected as a potential virus.

Each submission zip file may contain ONE of the following: a federal return, a state return, or a request for extension. The SOAP message (header and body) or a request for extension (with or without PDF attachments) The attachment is a zip archive containing from 1 to 100 zipped submission.

The SOAP message (header and body) is never zipped. The attachment is zipped.

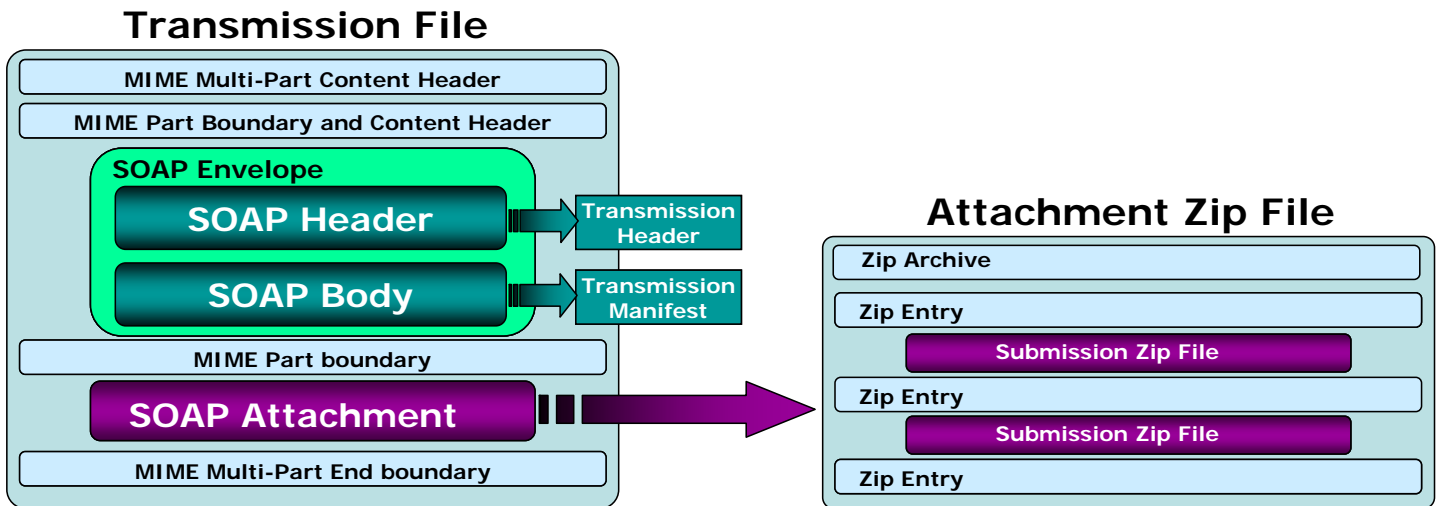

Figure 2-15: MeF Transmission File structure for the IFA Channel

2.8.2 Submission File Structure for the IFA Channel

The IFA and A2A channels support transmission of both federal and state returns. An IRS submission consists of XML data and optional binary attachments (PDF Files), which are packaged and compressed into a zip file. The Zip file is also referred to as the Zip Archive; each entry in the file is referred to as the Zip Entry. Each IRS Submission ZIP file contains the following folders (directories), which are then packaged and compressed into a Zip file:

- **/manifest.** The *manifest* folder (archive directory) contains a *manifest.xml* file, which provides information about the Submission. This information includes, but is not limited to the ERO who composed the Submission, the Tax Year for which the IRS Submission is being filed, etc. The manifest directory must be present along with the file that contains data for this directory. The */manifest/manifest.xml* is required in the submission. Please refer to the *MeF*

State and Trading Partners Reference Guide for the structure of a State Submission and contents of the *manifest.xml* file.

- **/xml**. The *xml* file (archive directory) contains the *submission.xml* file with the submission data in XML format. The *xml* archive directory must be present along with the files that contain data for this directory. The */xml/submission.xml* is required.
- **/attachment**. The *attachment* directory contains binary attachment files. This directory is required only if there are binary attachments in the Submission. The attachment folder is an optional folder in a submission zip file.

The leading slash, “/” is optional. The submission will be accepted with or without the leading slash.

The structure of an IRS submission file for the IFA channel is depicted below.

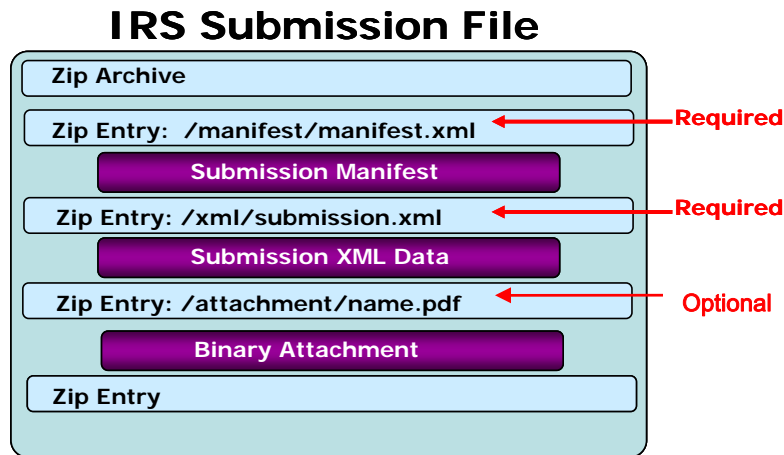

Figure 2-16: IRS Submission File structure for the IFA Channel

For detailed information regarding the IRS submission file structure, refer to the MeF Submission Composition Guide.

2.8.3 Creating an MeF Attachment

The steps below document how to create a SubmissionZip Archive. The MeF Submission Composition Guide for the Modernized e-File System, Section 4.1, describes the logical structure of attachments. The guide is posted to <http://www.irs.gov/efile/article/0,,id=171946,00.html> located just below the Publication 4164 link. This example uses the WinZip tool to generate an attachment containing one or more submissions.

2.8.3.1 Create Individual SubmissionZip Archive(s)

1. Choose a local drive such as C:\ and create three folders: the first one should be named “manifest”, the second named “xml”, and the third named “attachment”.

2. Generate the submission manifest and name it “manifest.xml”. This should be copied to the C:\manifest\ directory. **There must be a single manifest for each submission.**
3. Generate the submission XML and copy it to the C:\xml\ directory. **There must be only one XML file here.**
4. Copy any PDF submission attachments into the C:\attachment\ directory. There can be zero or multiple PDF attachments in the directory.
5. Open the WinZip tool, and select “New”

6. Browse to the **root of the local drive C:** and type in the name of the submission archive. NOTE: **The name of the submission archive must match the SubmissionId.** If the SubmissionId in the manifest generated in Step 2 is 00123420120351234567, then the file name used for the archive here should be 00123420120351234567.zip

7. Now add files to the archive using the WinZip Add dialog. First, browse to C:\manifest\ and select the manifest.xml file. NOTE: **The “Save full path info” option must be selected.**
8. Next, browse to C:\xml\ and select the submission xml file. Again, ensure that the full path info is saved.
9. Lastly, browse to C:\attachment\. This is an optional folder so there may not be any PDF attachments in the return. If there are any PDF attachments, select all of them. Again, ensure that the full path info is saved.
10. Close WinZip and verify that the submission archive 00123420110351234567.zip has been saved to the root of the C:\ drive and contains the files just added.
11. Delete the files in C:\manifest\, C:\xml\, and C:\attachment\
12. Repeat Steps 2 – 11 for all the submissions to be sent to MeF.

2.8.3.2 Generate the MeF Attachment

The individual submission zip archives generated in the previous section must now be compiled into a single MeF attachment for the send submissions message. Again, the WinZip tool will be used to do this.

1. Open WinZip and select “New”
2. Browse to a location on the local drive to save the MeF attachment, then type in a file name for the MeF attachment
3. Now add files to the archive using the WinZip Add dialog. Browse to the root of the local drive C:\ and select all the individual submission archives that were generated in the previous section. Choose Compression option “None”, and then click on “Add”.
4. Close WinZip and attach the ZIP file generated here to the MeF SendSubmissions message.

NOTE: The submission IDs in the Send Submissions SOAP message must match the submission IDs in the file names for the individual submission archives. And as indicated earlier, each submission archive name must match the submission ID in its manifest file. Refer to the diagrams below for an example:

```
**Please refer to sample MeF attachment included which contains three submissions –  
SendSubmissions.P20101214111809.0500.00027.zip ***  
SOAP Request Message contains:  
<SendSubmissionsRequest  
xmlns="http://www.irs.gov/a2a/mef/MeFTransmitterService.xsd">  
<SubmissionDataList>  
  <Count>3</Count>  
  <SubmissionData>  
    <SubmissionId>000075201030880015684</SubmissionId>  
    <ElectronicPostmark>2011-04-02T09:42:09-05:00</ElectronicPostmark>  
  </SubmissionData>  
  <SubmissionData>  
    <SubmissionId>00007520100080015685</SubmissionId>  
    <ElectronicPostmark>2011-04-02T09:53:09-05:00</ElectronicPostmark>  
  </SubmissionData>  
  <SubmissionData>  
    <SubmissionId>00007520100080015686</SubmissionId>  
    <ElectronicPostmark>2011-04-02T10:11:09-05:00</ElectronicPostmark>  
  </SubmissionData>  
</SubmissionDataList>  
</SendSubmissionsRequest>
```

Figure 2-17: SOAP Request Message with 3 submissions

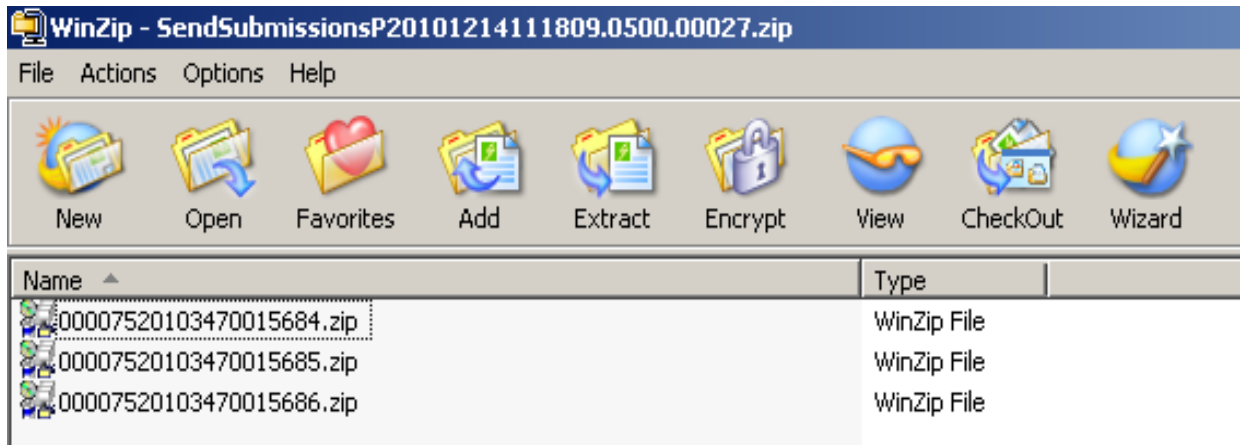

Figure 2-18: MeF attachment

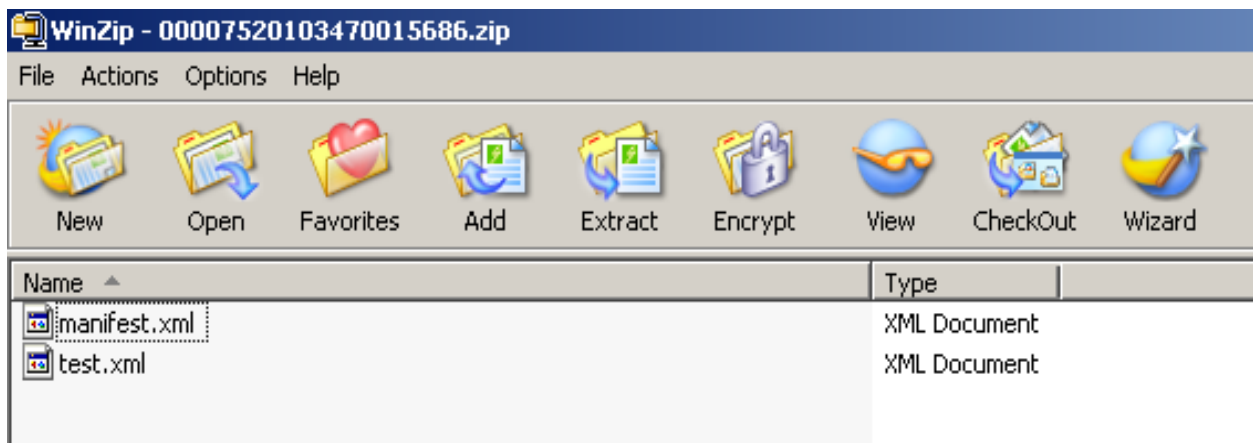

Figure 2-19: Third submission archive entry - 00007520103470015686.zip

```
<IRSSubmissionManifest xmlns="http://www.irs.gov/efile"
  xmlns:efile="http://www.irs.gov/efile">
  <SubmissionId>00007520103470015686</SubmissionId>
  <EFIN>000075</EFIN>
```

```

<GovernmentCode>IRS</GovernmentCode>
<SubmissionType>1120</SubmissionType>
<TaxYear>2010</TaxYear>
<TaxPeriodBeginDate>2010-01-01</TaxPeriodBeginDate>
<TaxPeriodEndDate>2010-12-31</TaxPeriodEndDate>
<EIN>000000001</EIN>
</IRSSubmissionManifest>

```

Figure 2-20: Manifest.xml for third submission archive – 00007520103470015686.zip

2.8.4 MeF Transmission File Structures for Application-to-Application (A2A)

A2A uses SOAP with Hypertext Transfer Protocol (HTTP) binding for the transmission file, which are SOAP messages that are transported using HTTPS. All service requests are SOAP Messages. A service request (message) or its response may or may not have an attachment. For detailed information about SOAP messages, refer to the MeF State and Trading Partners Reference Guide. MIME, DIME and MTOM encoding are used for A2A. (DIME support will end in September of 2012)

2.8.4.1 SOAP Message without Attachments.

This Web Service SOAP message contains the following:

- HTTP Headers
- A SOAP Envelope containing the following:
 - a SOAP header containing the following elements:
 - A MeF header that contains message and transmitter identifying information. This header must be included in each message.
 - A WS Security Header that contains security related information. This header must be included in each message.
 - a SOAP body that includes the message elements.

SOAP Message

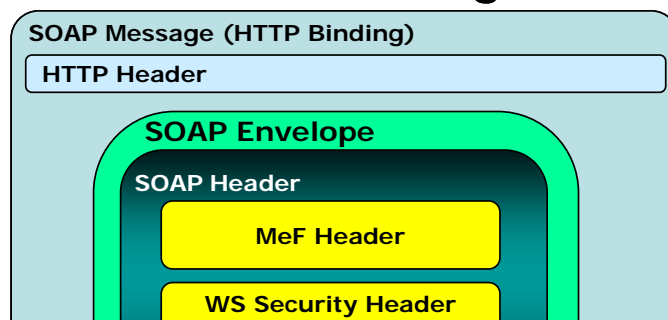

Figure 2–21: Basic SOAP Message Structure for HTTP Binding

2.8.4.2 Messages with Attachments

The SendSubmission service request is used to transmit submissions. It can have one and only one attachment. This attachment must be an uncompressed zip file called the container zip file. The container zip file can contain from 1 to 100 compressed zip files. Each compressed zip file contains one federal or state submission.

The GetNewSubmissions service request is used by state agencies to retrieve state returns. The responses to the GetNewSubmission series of service requests have the same attachment structure. Each submission is in its own compressed zip file and these zip files are attached to the response in one uncompressed container zip file.

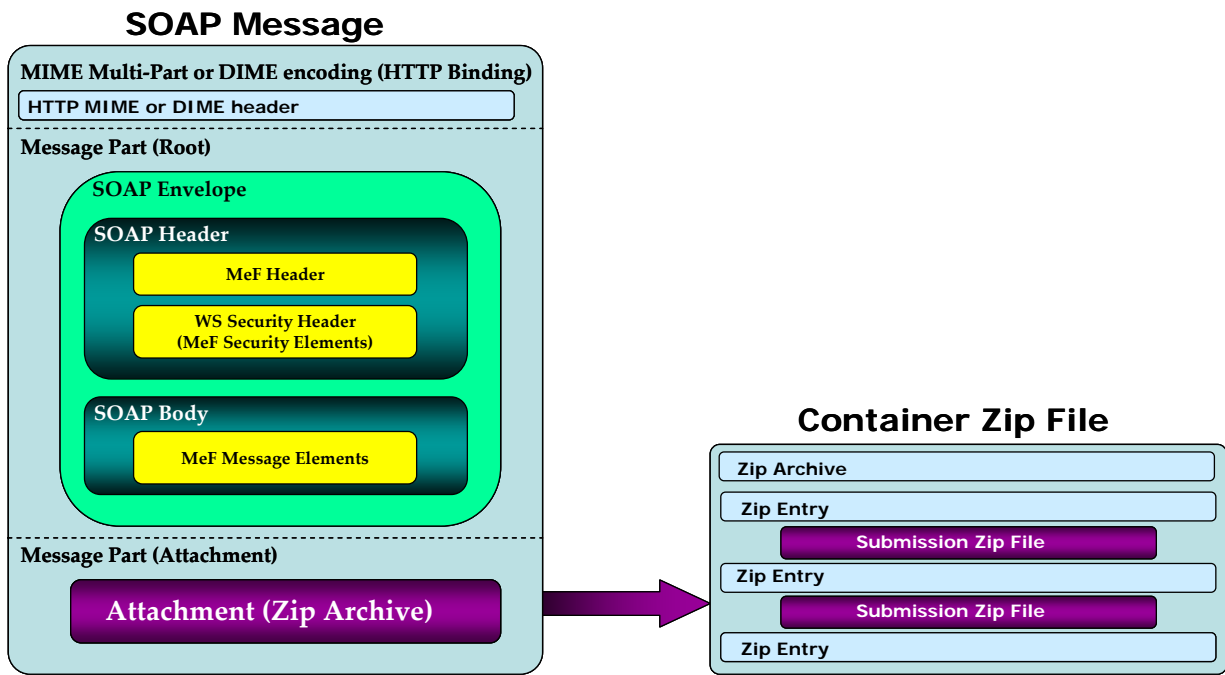

Figure 2-22: MeF Transmission File structure for the A2A Channel

2.8.5 MeF State Submission File Structure for Application-to-Application

Transmitters can transmit federal and state submissions using Web Services. A state submission contains XML data and optional binary attachments. The state return may also contain a copy of part or all of the taxpayer's federal return. The state determines what part of the federal return the taxpayer should include in the state submission. Like a federal submission, the state submission must be zipped into its own file and then placed into the container zip file. The container zip file is then attached to the SendSubmissions service request. Federal and state submissions can be included in the same attachment (container zip file) each in their own zip file.

Each submission contains the following folders (directories), which are then packaged and compressed into a zip file:

- **/manifest.** The *manifest* folder (directory) contains a *manifest.xml* file, which provides information about the state submission. This information includes, but is not limited to, the ERO who composed the Submission, the Tax Year for which the IRS Submission is being filed, etc. The manifest directory must be present along with the files that contain data for this directory. The */manifest/manifest.xml* is required in the submission. Please refer to the *MeF State and Trading Partners Reference Guide* for the structure of a State Submission and contents of the *manifest.xml* file.
- **/xml.** The *xml* directory contains the *submission.xml* file with the state submission data in XML format. The *xml* directory must be present along with the files that contain data for this directory. The */xml/submission.xml* is required in the submission.
- **/attachment.** The *attachment* directory contains binary attachment files. This directory is required only if there are binary attachments in the Submission. The attachment folder is an optional folder in a submission zip file
- **/irs/xml.** An optional archive directory. If it exists it contains all or part of the federal submission, whichever the state requires.
- **/irs/attachment.** Another optional directory. If it exists it contains any PDF documents attached to the federal submission.

The leading slash, “/” is optional. The submission will be accepted with or without the leading slash.

Note: A federal or State submission must include the */manifest* and */xml* archive directories and may include an optional */attachment* directory. If the submission is a federal submission the manifest will contain a federal submission manifest, the */xml* archive directory will contain the federal submission, and the */attachment* directory will contain PDF documents attached to the federal submission, if there are any. If the submission is a state submission, the same archive directories will contain the state submission manifest, state submission, and PDF documents attached to state submission respectively. In addition to these archive directories, a state submission may also include optional */irs/xml* and */irs/attachment* archive directories. If present they contain the federal submission and PDF documents attached to the federal submission.

Refer to [Section 2.8.3 Creating an MeF Attachment](#), for additional guidance. For more information on the transmission and submission file structure, refer to the MeF State and Trading Partners Reference Guide and the MeF Submission Composition Guide.

2.9 Version Control for MeF Schemas and Business Rules

IRS created a set of XML schemas for different types of tax returns, (Forms 1040, 1040A, 1040EZ, 1040-SS(PR), 1120, 1120-F, 1120S, 1120-POL, 1065, 1065-B, 990, 990-EZ, 990-N, 990-PF, 720, 2290, and 8849), extensions (Forms 4868, 2350 7004 and 8868), miscellaneous forms (Forms 56 and 9465), transmission file, and acknowledgement file. Each schema version also has a respective set of business rules that are used during MeF validation.

2.9.1 Schema and Business Rules Updates

Each year, new tax legislation and/or improvements to IRS programs impact the IRS forms and processing procedures. The IRS evaluates these changes to determine if updates to the XML schemas and business rules are necessary. Once the changes have been incorporated, the IRS uses the following timeline to publish the XML schemas and business rules changes:

- **August** – The IRS issues the initial version of the Tax Year XML schemas and business rules to enable software developers to begin development of the new Tax Year tax preparation software.
- **September/October/November** – The IRS issues updated versions of Tax Year XML schemas and business rules.

When schemas are posted to IRS.gov, IRS will identify when the schemas are available in the Assurance Testing System (ATS) and Production environments. Software developers are not required to retest when new schemas (minor or major) are posted. However, we **strongly** recommend the use of ATS to retest when you update your software with new schema changes.

Note: If there are critical changes required due to late legislation changes, national disasters, or errors identified during testing or production, the IRS may issue updated XML schemas and business rules after December and during the Processing Year.

2.9.2 General Information about Version Numbers

Each version of the XML schemas and the corresponding business rules has a unique version number. It is important to note the following principles regarding version numbers:

- Each tax return's schema version has an associated set of business rules with the same number. This ensures that each updated schema version includes an updated set of business rules.

- The "returnVersion" attribute of the "Return" element (the root element) identifies the version of the schema for each return type. For example, the "returnVersion" from the 1120.xsd file shown below identifies the schema version as 2011v1.0.

```

<xsd:element name="Return">
  (Note: information removed for formatting purposes only)
  <xsd:complexType>
    <xsd:sequence>
      (Note: information removed for formatting purposes only)
      <xsd:attribute name="returnVersion" type="StringType" use="required" fixed="2011v1.0">
        <xsd:annotation>
          <xsd:documentation>Return Version</xsd:documentation>
        </xsd:annotation>
      </xsd:attribute>
    
```

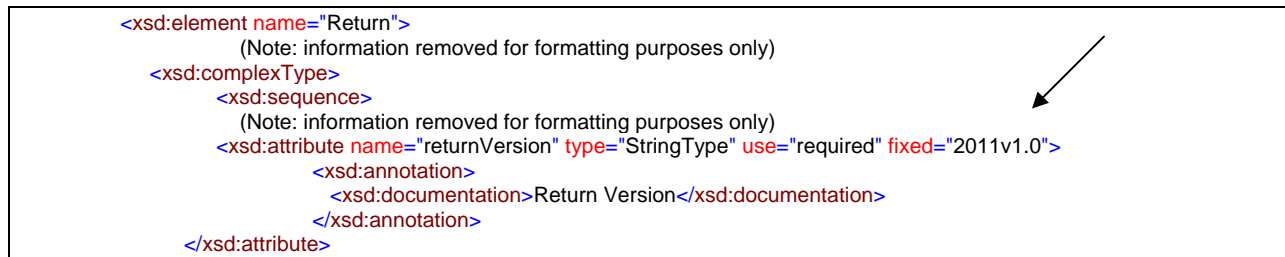

Figure 2-23: Partial "Return" element from 1120.xsd file

- Each business rule document's version number identifies the version of the business rule.
- The "Active Validating Schema Version" specifies the business rules and schema version that will be used to validate a tax return that has been received by the IRS during a timeframe. This provides a mechanism for different versions to be accepted at the same time. It also enables an older version to be validated against a newer version's set of schemas and business rules. The IRS will publish all valid schema/business rule versions.

The active validating schema version will be the most recent schema version posted to IRS.gov. IRS will provide the "Start" dates when schemas are available in Production and ATS. These "Start" dates also represent when the latest schema posted becomes the active validating schema.

Note: In rare circumstances, there may be more than one active validating schema version. In this instance, the validation may occur on either the most recent schema version or a designated earlier version. IRS will identify multiple active validating schema versions on the schema Web pages.

2.9.3 Version Numbering Scheme

The version number includes:

- the Tax Year for which the schema and business rule document applies (YYYY)
- the lower-case version initial (v)
- the two-digit version number (N.N)

When the version number reaches 10 or more in a given Processing Year, the number will include two-digits to the right and to the left of the decimal as needed (NN.NN).

The version number of MeF business rules that are invoked for the MeF XML schemas will always have the same version number as the schema version, thereby, providing a mechanism that aligns the various versions of schemas with their applicable business rules. Figure 2-20 below is an example of the structure used for version numbers for yearly returns:

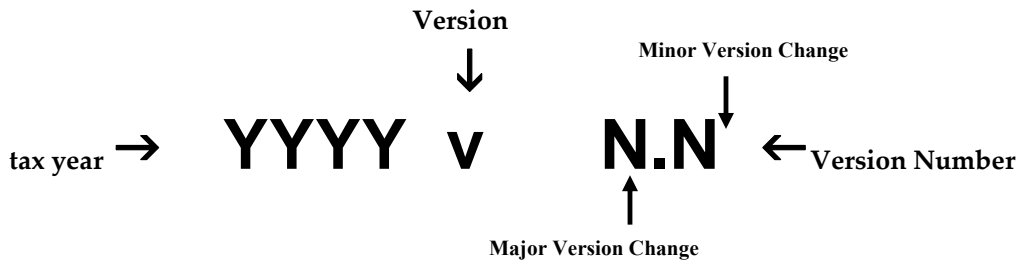

Figure 2-24: MeF Version Number Diagram

The above diagram is for yearly returns. Version numbers for quarterly returns will include “Q” and the quarter number after the Tax Year. For example:

A 3rd quarter return for Form 720 TY2011 will be shown as 2011Q3v2.0.

The examples below illustrate how the version number changes every Tax Year. New versions are generated when changes are necessary to the tax return’s XML schema structure, content, and business rules. Each change increases the version number when the new version is published. Major changes increase the left digit and minor changes increase the right digit.

Note: If only minor changes occur, software developers are not required to use the new version. If the major number changes, all software must reflect the new version. For example:

- **A new Tax Year:** The Tax Year part of the version number will change with each subsequent Tax Year and the version number is usually reset to 1.0. This is a major version change.
- **Additions, deletions and/or changes to a schema’s data elements:** This includes any schema modification to a form and/or attachment. Even if the tax return’s business rules were not affected by the additions, deletions and changes to the tax return’s schemas, the business rule’s version number will be changed to maintain the alignment between the schemas and the applicable business rules.
- **Form family:** If the 1120 version number changes, then the 1120-F and 1120S version number will also change unless otherwise noted on IRS.gov.
- **Additions, deletions and/or changes to the business rules:** Even if the business rule change(s) did not affect the tax return’s schema, the tax return’s schema version will be changed to maintain the alignment between the tax return’s schema and the applicable business rules.

2.9.3.1 Forms 56 and 9465

Forms 56 and 9465 are continuous use forms and are not associated with pre-defined tax years as tax returns and extensions are. The schema versioning for these forms will be CUv1.0. "CU" = Continuous Use. The major and minor pieces of the schema versioning are the same as tax returns and extensions. In general, there will only be one schema version for the Form 56 and 9465. When the form or schema changes, the next version will be a major version.

2.9.4 Validating Schema Versions

Throughout the year, multiple versions of XML schemas and business rules are posted to IRS.gov. Depending on if the schema change is major or minor; MeF may not require the schema version found in the return data to match the schema version used by MeF during validation. In general, there is always one active validating schema version for each return type in a Tax Year. In rare circumstances, there may be more than one active validating schema version.

- **Minor Schema Changes** - When IRS issues revised schemas for a return type and changes the increment for the minor number, MeF will continue to accept returns composed using previous schema versions. When the minor number is changed, IRS allows software developers to decide for themselves whether they need to use the new version or not based on what is included in their tax preparation software and what changes were made to the schemas. For example:

If the change affects a form or field you do not support, then you may elect not to use the newest version.

Returns may be composed using previous published schema versions but IRS will only validate against the "active validating schema version" when the return is processed. For example:

If the current schema version is 2011v1.0 and the schema change is minor, IRS will assign the new number 2011v1.1. The active validating schema version is 2011v1.1. MeF will continue to accept returns composed using version 2011v1.0. However, all returns (whether composed with version 2011v1.0 or 2011v1.1) will be validated with the new version, 2011v1.1.

- **Major Schema Change** - When IRS issues revised schemas for a return type and changes the increment for the major number, all returns must be composed using the new version number. If returns are composed using previously published schema versions, they will not validate against the active validating schema version when the return is processed.

For example, if the current version is 2011v1.1 and the IRS decides it can no longer accept returns composed using schema version 2011v1.1 (or 2011v1.0), it will assign

the new number 2011v2.0. The active validating schema version is 2011v2.0. Returns submitted with 2011v1.1 (or 2011v1.0) will be rejected for using an unsupported schema version.

Software developers and transmitters should select the applicable form type on the [MeF Schemas and Business Rules webpage](#) to get information about all active and prior year schemas and business rules used by the MeF Production and Assurance Testing Systems (ATS).

2.9.5 Example of Schema Versioning

Figure 2-21 below is a sample table of schemas posted to IRS.gov. The schema/business rules tables will include the Start dates and End dates, if applicable, for ATS and Production.

	Version	Date Posted	ATS Dates	Production Dates
Add'l Minor Version →	2010v3.4	08/09/2011	Start Date: 08/21/2011	Start Date: 08/21/2011
Minor Version →	2010v3.3	05/17/2011	Start Date: 06/12/2011	Start Date: 06/26/2011
Minor Version →	2010v3.2	02/15/2011	Start Date: 02/27/2011	Start Date: 03/06/2011
Minor Version →	2010v3.1	12/07/2010	Start Date: 12/27/2010	Start Date: 01/03/2011
New Major Version →	2010v3.0	10/26/2010	Start Date: 12/20/2010	Start Date: 01/03/2011
Initial Version →	2010v2.0	09/29/2010	Start Date: 12/06/2010 End Date: 12/19/2010	"Not Valid for Production"

Figure 2-25: Schemas and Business Rules Versions for Forms 1065/1065-B TY2010

- **Initial Version** – On 09/29/2010 IRS issued the initial schema version, 2010v2.0.
- **New Major Version** – On 10/26/2010, IRS issued an updated version, 2010v3.0, due to significant changes that affected the 1065/1065-B XML schemas and business rules. The table shows the schema version 2010v2.0 end date was 12/19/2010. As of December 21, 2010, schema version 2010v3.0 was the only active schema version and must be used for testing after this date.
- **Additional New Major Version** – IRS can issue an updated major version due to significant changes that affect the 1065/1065-B XML schemas and business rules.
- **Minor Version update** – On 12/7/2010, IRS issued updated 1065/1065-B schemas. It is up to the software developer to determine if their software needs to be updated based on changes made and the forms the software developer supports.
- **Additional Minor Version Update** - On 08/09/2011, IRS issued an updated 1065/1065-B schema and business rule version 2010v3.4. This version was available in Production on 08/21/2011 and became the active validating schema on that date. Because there are no end dates for schema versions 2010v3.0, 2010v3.1, 2010v3.2, 2010v3.3, and 200v3.4 they were all available in Production.

After Production opens, IRS strives to limit the number of schema and/or business rule revisions.

2.10 MeF XML Schema File Structures

This section describes the MeF XML Schema file structure and how the schemas will be packaged as of the date this publication was issued. Each program has its own file structure and is packaged separately. You should check for periodic updates at the Web sites shown in [Section 2.9.4 Validating Schema Versions](#).

Schemas for a given return family are bundled into one package; likewise, schemas for each extension are bundled into separate packages.

There are 15 **separate schema** packages:

- one package for Form 1040, 1040A, 1040EZ, and 1040SS(PR)
- one package for Form 4868
- one package for Form 56
- one package for Forms 1120, 1120-F, and 1120S
- one package for Forms 990, 990-EZ, and 990-PF
- one package for Form 990-N
- one package for Form 1120-POL
- one package for Form 7004
- one package for Form 8868
- one package for Forms 1065 and 1065-B
- one package for Form 720
- one package for Form 2290
- one package for Form 2350

- one package for Form 8849
- one package for Form 9465

There are 26 business rules files:

- A business rules file accompanies each parent form listed above
- A separate subset of business rules were developed for Forms 1120, 1120-F and 1120S amended returns.

The following pages provide a diagram of the schema structures for some of the forms listed above.

Note: Form 1040 XML Schema File Structure has been truncated to fit a single page. Both Common and IND1040 folders content have been reduced due to size.

2.10.1 Form 1040 XML Schema File Structure

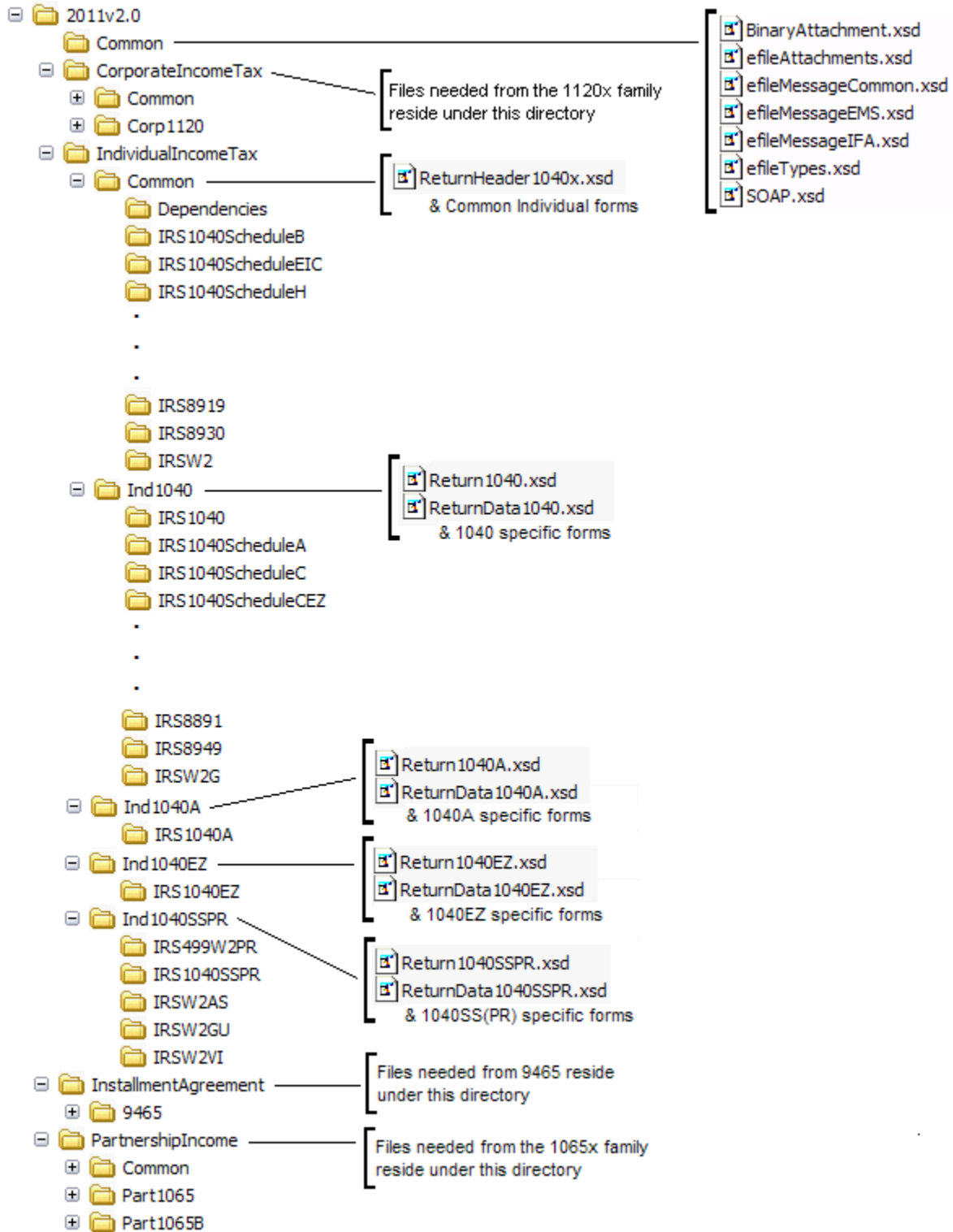

Figure 2-26 Form 1040 Package

2011vN.N is the top-level directory of the schemas for the Tax Year 2011, where N.N is

the two-digit version number. It contains the following folders:

Common contains the XML schemas that are common to all MeF return/extension types. It contains the following XML schemas:

- **SOAP.xsd** defines the XML structure of the SOAP envelope, SOAP header and the SOAP.
- **efileMessageCommon.xsd**, **efileMessageEMS.xsd**, **efileMessageIFA.xsd**, and **efileAttachments.xsd** define the transmission header, transmission manifest and the acknowledgement XML structures.
- **efileTypes.xsd** defines the global data types for MeF schemas.
- **BinaryAttachment.xsd** defines the content model for the binary attachment XML Document.
- **IndividualIncomeTax** is the top-level directory of the 1040 Individual Filer schema. It contains the following folder:
 - **Common** (truncated above) is a top-level directory for schemas for all attachments and forms shared among 1040 (supported and future) return types. It contains the following:
 - **Dependencies**, which contain schemas for the supporting XML documents/attachments common to 1040 return types.
 - **Various Shared Form directories**, which each contain the schemas for the shared forms and supporting XML documents/attachment between 1040 return types.
- **IND1040** (truncated above) is a directory for Form 1040 specific schemas not included in the above directories. It contains the following:
 - **Return1040.xsd** defines the XML structure for the return and wraps around the ReturnHeader1040 and ReturnData1040 XML documents in a transmission file.
 - **ReturnData1040.xsd** defines the content model for a Form 1040 return. This includes defining all XML forms and schedules in the return.
 - **ReturnHeader1040x.xsd** defines the structure and global data elements for the Form 1040 return.

CorporateIncomeTax, is a hierarchy of Corporate (1120x) schemas used by Individual Filer schemas.

2.10.2 Form 4868 XML Schema File Structure

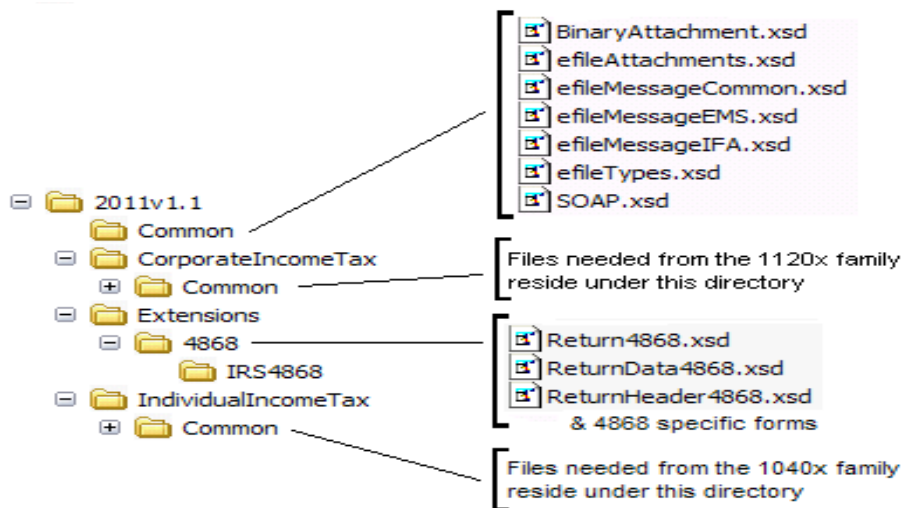

Figure 2-27 4868 Package

2011vN.N is the top-level directory of the schemas for the Tax Year 2011, where N.N is the two-digit version number. It contains the following folders:

Common contains the XML schemas that are common to all MeF return/extension types. It contains the following XML schemas:

- **SOAP.xsd** defines the XML structure of the SOAP envelope, SOAP header and the SOAP.
- **efileMessageCommon.xsd**, **efileMessageEMS.xsd**, **efileMessageIFA.xsd**, and **efileAttachments.xsd** define the transmission header, transmission manifest and the acknowledgement XML structures.
- **efileTypes.xsd** defines the global data types for MeF schemas.
- **BinaryAttachment.xsd** defines the content model for the binary attachment XML Document.

Extensions are the top-level directory of the Individual Extension Filer schemas. It contains the following folder:

- **4868** is a directory for Form 4868 specific schemas. It contains the following:
 - **Return4868.xsd** defines the XML structure for the return and wraps around the ReturnHeader4868 and ReturnData4868 XML documents in a transmission file.
 - **ReturnData4868.xsd** defines the content model for a Form 4868 return. This includes defining all XML forms and schedules in the return.
 - **ReturnHeader4868.xsd** defines the structure and global data elements for the Form 4868 return.

CorporateIncomeTax, is a hierarchy of Corporate (1120x) schemas used by Individual Extension Filer schemas.

IndividualIncomeTax, is a hierarchy of Individual (1040) schemas used by Individual Extension Filer schemas.

2.10.3 Form 2350 XML Schema File Structure

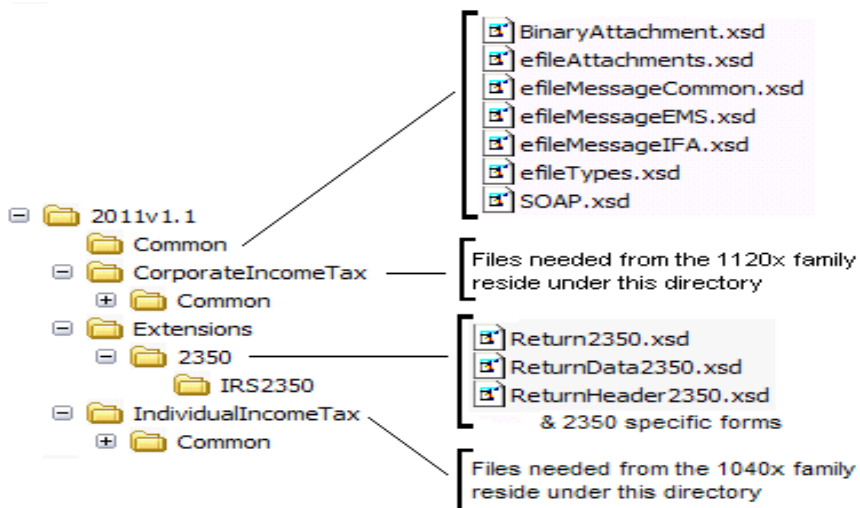

Figure 2-28 2350 Package

2011vN.N is the top-level directory of the schemas for the Tax Year 2011, where N.N is the two-digit version number. It contains the following folders:

Common contains the XML schemas that are common to all MeF return/extension types. It contains the following XML schemas:

- **SOAP.xsd** defines the XML structure of the SOAP envelope, SOAP header and the SOAP.
- **efileMessageCommon.xsd**, **efileMessageEMS.xsd**, **efileMessageIFA.xsd**, and **efileAttachments.xsd** define the transmission header, transmission manifest and the acknowledgement XML structures.
- **efileTypes.xsd** defines the global data types for MeF schemas.
- **BinaryAttachment.xsd** defines the content model for the binary attachment XML Document.

Extensions are the top-level directory of the Individual Extension Filer schemas. It contains the following folder:

- **2350** is a directory for Form 2350 specific schemas. It contains the following:
 - **Return2350.xsd** defines the XML structure for the return and wraps around the ReturnHeader2350 and ReturnData2350 XML documents in a transmission file.
 - **ReturnData2350.xsd** defines the content model for a Form 2350 return. This includes defining all XML forms and schedules in the return.
 - **ReturnHeader2350.xsd** defines the structure and global data elements for the Form 2350 return.

CorporateIncomeTax, is a hierarchy of Corporate (1120x) schemas used by Individual Extension Filer schemas.

IndividualIncomeTax, is a hierarchy of Individual (1040) schemas used by Individual Extension Filer schemas.

2.10.4 Form 56 Schema File Structure

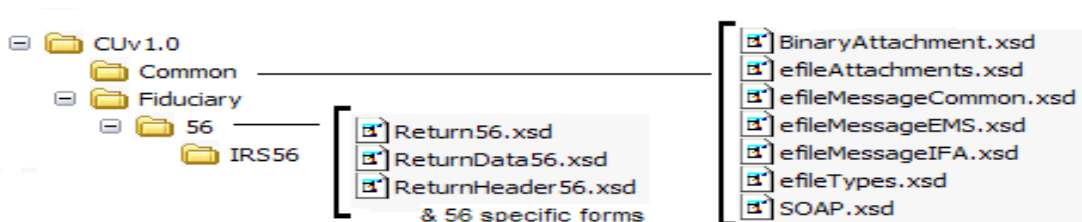

Figure 2-29 2350 Package

CUvN.N is the top-level directory of the schemas for the Tax Year 2011, where CU is Continuous Use and N.N is the two-digit version number. It contains the following folders:

Common contains the XML schemas that are common to all MeF return/extension types. It contains the following XML schemas:

- **SOAP.xsd** defines the XML structure of the SOAP envelope, SOAP header and the SOAP.
- **efileMessageCommon.xsd**, **efileMessageEMS.xsd**, **efileMessageIFA.xsd**, and **efileAttachments.xsd** define the transmission header, transmission manifest and the acknowledgement XML structures.

- **efileTypes.xsd** defines the global data types for MeF schemas.
- **BinaryAttachment.xsd** defines the content model for the binary attachment XML Document.
- **56** is a directory for Form 56 specific schemas. It contains the following:
 - **Return56.xsd** defines the XML structure for the return and wraps around the ReturnHeader56 and ReturnData56 XML documents in a transmission file.
 - **ReturnData56.xsd** defines the content model for a Form 56 return. This includes defining all XML forms and schedules in the return.
 - **ReturnHeader56.xsd** defines the structure and global data elements for the Form 56 return.

2.10.5 Form 9465 XML Schema File Structure

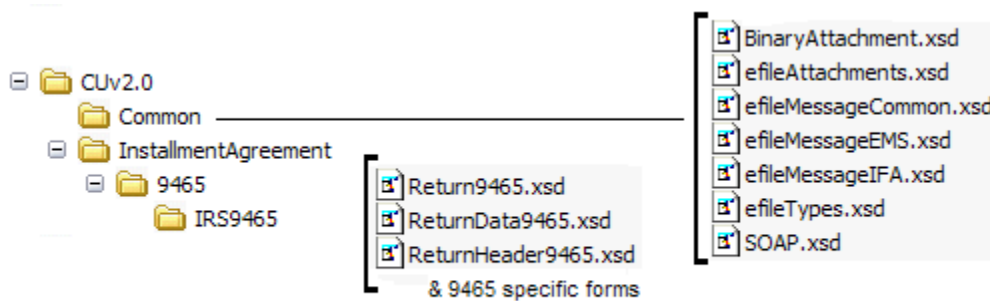

Figure 2-30 2350 Package

CUvN.N is the top-level directory of the schemas for the Tax Year 2011, where CU is Continuous Use and N.N is the two-digit version number. It contains the following folders:

Common contains the XML schemas that are common to all MeF return/extension types. It contains the following XML schemas:

- **SOAP.xsd** defines the XML structure of the SOAP envelope, SOAP header and the SOAP.
- **efileMessageCommon.xsd**, **efileMessageEMS.xsd**, **efileMessageIFA.xsd**, and **efileAttachments.xsd** define the transmission header, transmission manifest and the acknowledgement XML structures.
- **efileTypes.xsd** defines the global data types for MeF schemas.
- **BinaryAttachment.xsd** defines the content model for the binary attachment XML Document.
- **9465** is a directory for Form 9465 specific schemas. It contains the following:
 - **Return9465.xsd** defines the XML structure for the return and wraps around the ReturnHeader9465 and ReturnData9465 XML documents in a transmission file.
 - **ReturnData9465.xsd** defines the content model for a Form 9465 return. This includes defining all XML forms and schedules in the return.
 - **ReturnHeader9465.xsd** defines the structure and global data elements for the Form 9465 return.

2.10.6 1120/1120-F/1120S XML Schema File Structure

The explanation for the 1120 form family XML schema structure is on the next page.

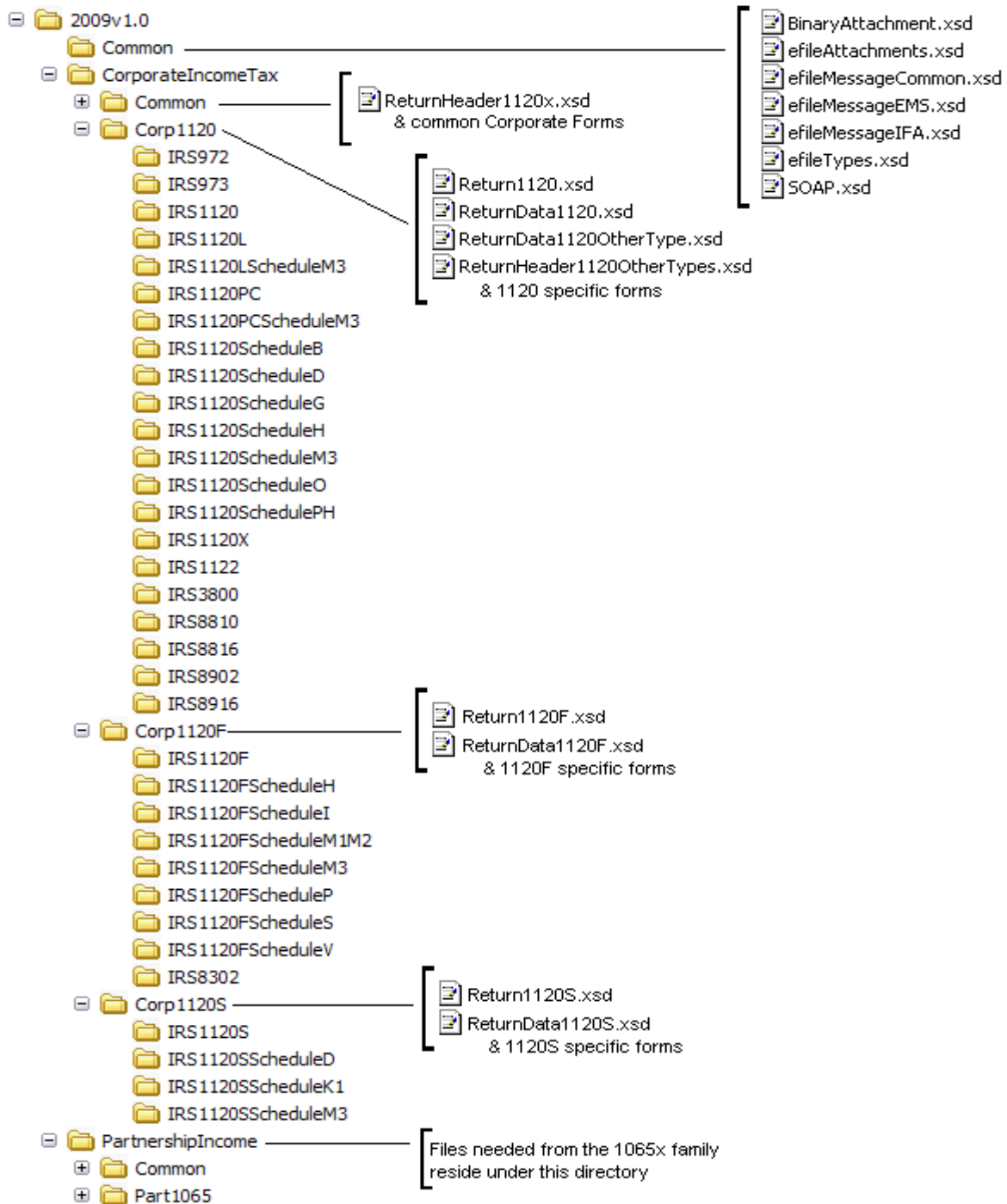

Figure 2-31: 1120/1120-F/1120S Package

The following describes the MeF Schema File Structure for Form 1120/1120-F/1120S (Figure 2-31 on the previous page):

2009v1.0 is the top-level directory of the schemas for the Tax Year 2009, version “1.0”. It contains the following folders:

- **Common**, which contains the XML schemas that are common to all MeF return and extension types. It contains the following:
 - **BinaryAttachment.xsd**, which defines the binary attachment document XML structure
 - **efileAttachments.xsd**, which defines the attachment document XML structure
 - **efileMessageCommon.xsd**, which defines the transmission header, transmission manifest, and acknowledgement XML structures for the basic message.
 - **efileMessageIFA.xsd**, which defines the transmission header, transmission manifest, and acknowledgement XML structures for the IFA channel.
 - **efileTypes.xsd**, which defines the global data types for MeF schemas.
 - **SOAP.xsd**, which defines the XML structure of the SOAP envelope, SOAP header and the SOAP.

- **CorporateIncomeTax**, which is a directory for corporate income related (1120/1120-F/1120S) schemas. It contains the following folders:
 - **Common**, which is a top-level directory for schemas for all attachments and forms shared among forms 1120, 1120-F and 1120S return types. It contains the following:
 - **ReturnHeader1120x.xsd**, which defines the structure and global data elements for the 1120, 1120-F, and 1120S tax returns.
 - **Dependencies**, which contain schemas for the supporting XML documents/attachments common to 1120, 1120-F, and 1120S return types.
 - **Various Shared Form directories**, which each contain the schemas for the shared forms and supporting XML documents/attachments between 1120, 1120-F, and 1120S return types.
 - **Corp1120**, which contains schemas specific to the 1120 return type. It contains the following:
 - **Return1120.xsd**, which defines the XML structure for the tax return and wraps around the ReturnHeader1120x, ReturnData1120, ReturnData1120OtherType, and ReturnHeader1120OtherTypes XML documents in a transmission file.
 - **ReturnData1120.xsd**, which defines the content model for an 1120 or an 1120 consolidated tax return. This includes defining all XML forms and schedules in the tax return.
 - **ReturnData1120OtherType.xsd**, which defines the content model for an 1120 parent; 1120, 1120L, and 1120PC subsidiary; 1120, 1120L, and 1120PC sub-consolidated; 1120, 1120L, and 1120PC eliminations; and 1120, 1120L, and 1120PC adjustments tax returns. This includes defining all XML forms and schedules in the tax return.

 - **ReturnHeader1120OtherTypes.xsd**, which defines the content of the ReturnHeader element for the 1120 parent; 1120, 1120L, and 1120PC subsidiary; 1120, 1120L, and 1120PC sub-consolidated; 1120, 1120L, and 1120PC eliminations; and 1120, 1120L, and 1120PC adjustments tax returns.

- **List of all form folders not shared with the 1120-F and 1120S**, which contain the schemas for the forms and supporting XML documents/attachments that are specific for the 1120 return type.
- **Corp1120-F**, which contains schemas specific to the 1120-F return type. It contains the following folders:
 - **Return1120F.xsd**, which defines the XML structure for the 1120-F tax return and wraps around the ReturnHeader1120x and ReturnData1120-F XML documents in a transmission file.
 - **ReturnData1120F.xsd**, which defines the content model for an 1120-F tax return. This includes defining all XML forms and schedules in the tax return.
 - **List of all form folders not shared with the 1120 and 1120-S**, which contain the schemas for the forms and supporting XML documents/attachments that are specific for the 1120-F return type.
- **Corp1120S**, which contains schemas specific to the 1120S return type. It contains the following folders:
 - **Return1120S.xsd**, which defines the XML structure for the 1120S tax return and wraps around the ReturnHeader1120x and ReturnData1120S XML documents in a transmission file.
 - **ReturnData1120S.xsd**, which defines the content model for an 1120S tax return. This includes defining all XML forms and schedules in the tax return.
 - **List of all form folders not shared with the 1120 and 1120-F**, which contain the schemas for the forms and supporting XML documents/attachments that are specific for the 1120S return type.
- **PartnershipIncome**, which is a directory for partnership income related (1065/1065-B) schemas. It contains the following folders that contain common forms shared with 1120/1120-F/1120S:
 - **Common**, which is a top-level directory for schemas for all attachments and forms that are shared among forms common to 1120/1120-F/1120S and 1065/1065-B return types. It contains the following:
 - **Various Shared Form directories**, which each contain the schemas for the shared forms and supporting XML documents/attachments between 1120/1120-F/1120S and 1065/1065-B return types.

2.10.7 7004 XML Schema File Structure

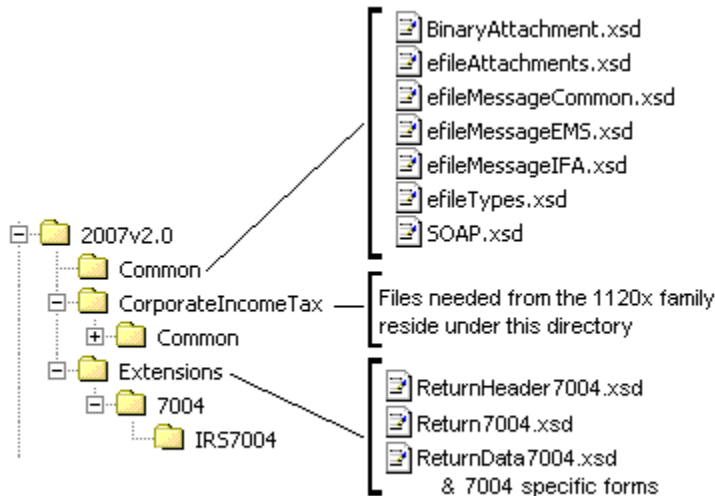

Figure 2-32: 7004 Package

The following describes the MeF Schema File Structure for Form 7004 (Figure 2-32):

2007v2.0 is the top-level directory of the schemas for the Tax Year 2007, version “2.0”. Note that reference to Tax Year is a means of controlling version releases each Processing Year. Form 7004 is not issued each Tax Year and, therefore, does not have a Tax Year.

2007v2.0 contains the following folders:

- **Common**, that contains the XML schemas that are common to all MeF return and extension types. It contains the following:
 - **BinaryAttachment.xsd**, which defines the binary attachment document XML structure
 - **efileAttachments.xsd**, which defines the attachment document XML structure
 - **efileMessageCommon.xsd**, which defines the transmission header, transmission manifest, and acknowledgement XML structures for the basic message.
 - **efileMessageIFA.xsd**, which defines the transmission header, transmission manifest, and acknowledgement XML structures for the IFA channel.
 - **efileMessage.xsd**, which defines the transmission header, transmission manifest and the acknowledgement XML structures.
 - **efileTypes.xsd**, which defines the global data types for MeF schemas.

- **SOAP.xsd**, which defines the XML structure of the SOAP envelope, SOAP header and the SOAP.
- **CorporateIncomeTax**, which is a directory for corporate income related (1120/1120-F/1120S) schemas and shared payment schemas. It contains the following folders:
 1. **Common**, which is a top-level directory for schemas for all attachments shared among forms common to 1120, 1120-F, 1120S, and 7004 return types. It contains the following folder:
 - **Dependencies**, which contain schemas for the supporting XML documents/attachments common to 7004 and/or the 1120/1120-F/1120S return types. It includes the following:
 - **IRSPayment.xsd**, which defines the XML structure of payments.
 - **MixedStraddleAccountElectionStatement**, which defines XML schema for extension type elections.
- **Extensions**, which is a directory for extension forms (7004/8868) schemas and contains the following:
 1. **7004**, which is a top-level directory for schemas for all forms and attachments shared among forms common to 7004 return types. It contains the following:
 - **ReturnHeader7004.xsd**, which defines the structure and global data elements for the 7004 return.
 - **ReturnData7004.xsd**, which defines the common content of the ReturnHeader element for the 7004 return.
 - **Return7004.xsd**, which defines the XML structure for the 7004 return and wraps around the ReturnHeader and ReturnData7004 XML documents in a transmission file.
 2. **IRS7004**, which contains schemas specific to the 7004 return type. It contains the following:
 - **ConsolidatedGroupMemberSchedule**, which defines the XML structure of the Consolidated Group Member Schedule.
 - **IRS7004.xsd**, which defines the XML structure of the 7004 return.

2.10.8 Exempt Organization Forms XML Schema File Structures

990/990-EZ/990-PF package



Figure 2-33: 990/990-EZ/990-PF Package

The following section describes the MeF Schema File Structures for Exempt Organization Filings for the 990, 990-EZ, and 990-PF package shown in Figure 2-33.

2008vN.N is the top-level directory of the schemas for Tax Year 2008, version not specified. It contains the following folders:

Common contains the XML schemas that are common to all MeF return/extension types:

- **SOAP.xsd** defines the XML structure of the SOAP envelope, SOAP header and the SOAP.

- **efileMessageCommon.xsd**, **efileMessageIFA.xsd**, and **efileAttachments.xsd** define the transmission header, transmission manifest and the acknowledgement XML structures.
- **efileTypes.xsd** defines the global data types for MeF schemas.
- **BinaryAttachment.xsd** defines the content model for the binary attachment XML Document.

CorporateIncomeTax is a hierarchy of Corporate (1120x) schemas used by Exempt Organization schemas.

PartnershipIncome is a hierarchy of Partnership (1065x) schemas used by Exempt Organization schemas.

TEGE is the top-level directory of the 990/990-EZ/990-PF Exempt Organization schemas. It contains the following folders:

Common is a directory for schemas for all attachments and dependencies shared between Exempt Organization Forms 990, 990-PF and 990-EZ. It contains the following:

- **ReturnHeader990x.xsd** defines the structure and global data elements for the Forms 990 and 990-EZ returns.
- **Dependencies** contain schemas for the supporting XML documents/attachments common to Forms 990, 990-EZ and 990-PF.

TEGE990 is a directory for Form 990 related schemas not included in the above directories. It contains the following:

- **Return990.xsd** defines the XML structure for the return and wraps around the ReturnHeader990x and ReturnData990 XML documents in a transmission file.
- **ReturnData990.xsd** defines the content model for a Form 990 return. This includes defining all XML forms and schedules in the return.

TEGE990EZ is a directory for Form 990-EZ related schemas not included in the above directories. It contains the following:

- **Return990EZ.xsd** defines the XML structure for the return and wraps around the ReturnHeader990x and ReturnData990EZ XML documents in a transmission file.
- **ReturnData990EZ** defines the content model for a Form 990-EZ return. This includes defining all XML forms and schedules in the return.

TEGE990PF is a directory for Form 990-PF related schemas not included in the above directories. It contains the following:

- **Return990PF.xsd** defines the XML structure for the return and wraps around the ReturnHeader990x and ReturnData990PF XML documents in a transmission file.
- **ReturnData990PF** defines the content model for a Form 990-PF return. This includes defining all XML forms and schedules in the return.

2.10.9 990-N Package

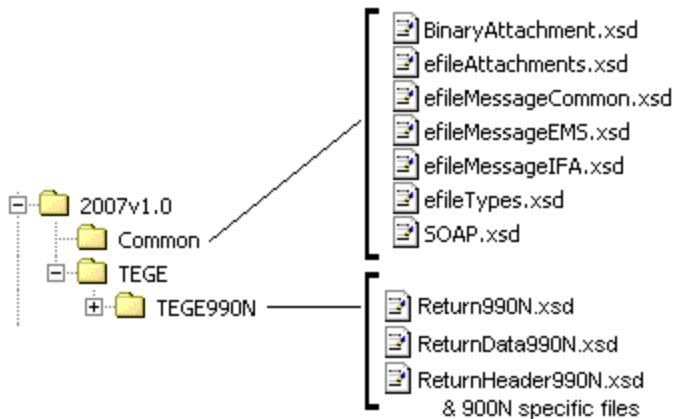

Figure 2-34: 990-N Package

2007v1.0 is the top-level directory of the schemas for the Tax Year 2007, version 1.0. It contains the following folders:

Common contains the XML schemas that are common to all MeF return/extension types. It contains the following XML schemas:

- **SOAP.xsd** defines the XML structure of the SOAP envelope, SOAP header and the SOAP.
- **efileMessageCommon.xsd**, **efileMessageEMS.xsd**, **efileMessageIFA.xsd**, and **efileAttachments.xsd** define the transmission header, transmission manifest and the acknowledgement XML structures.
- **efileTypes.xsd** defines the global data types for MeF schemas.
- **BinaryAttachment.xsd** defines the content model for the binary attachment XML Document.

TEGE is the top-level directory of the 990/990-EZ/990-PF/990-N Exempt Organization schema. It contains the following folder:

TEGE990N is a directory for Form 990-N specific schemas not included in the above directories. It contains the following:

- **Return990N.xsd** defines the XML structure for the return and wraps around the ReturnHeader990N and ReturnData990N XML documents in a transmission file.
- **ReturnData990N.xsd** defines the content model for a Form 990-N return. This includes defining all XML forms and schedules in the return.
- **ReturnHeader990N.xsd** defines the structure and global data elements for the Form 990-N return.

2.1.10 8868 XML Schema File Structure

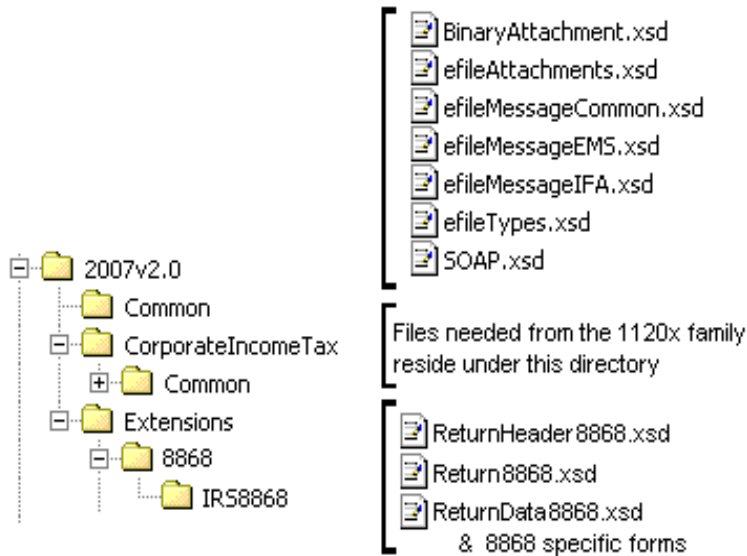

Figure 2-35: 8868 Package

The following section describes the MeF Schema File Structures for Exempt Organization Filings for the 8868 package shown in Figure 2-35 above.

Extensions are the top-level directory of the 8868 extension schemas. It contains the following:

8868 is a directory for Forms 8868 related schemas. It contains the following:

- **Return8868.xsd** defines the XML structure for the extension and wraps around the ReturnHeader8868 and ReturnData8868 XML documents in a transmission file.
- **ReturnHeader8868.xsd** defines the structure and global data elements for the Form 8868 extension.
- **ReturnData8868** defines the content model for the Form 8868 extension.

2.10.11 1120-POL XML Schema File Structure

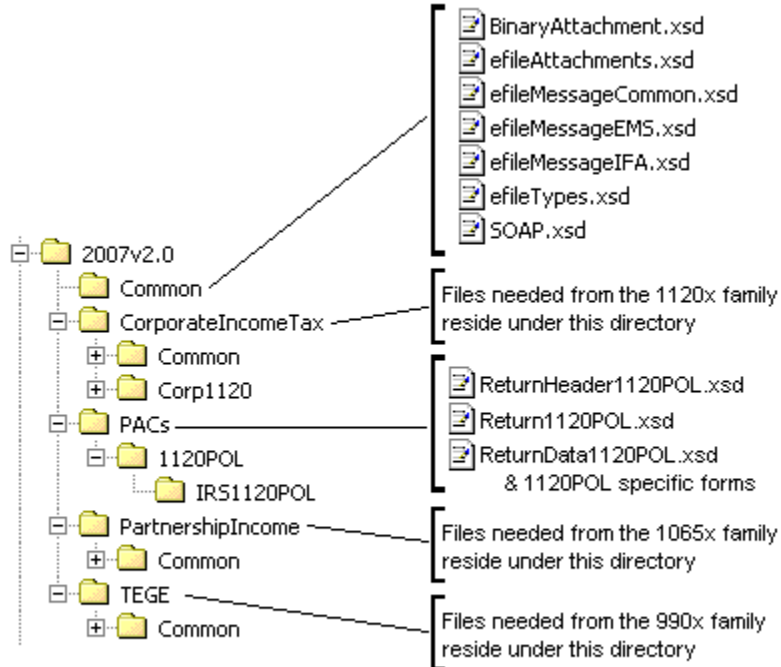

Figure 2-36: 1120-POL Package

The following section describes the MeF Schema File Structures for Exempt Organization Filings for the 1120-POL package shown in Figure 2-36 above.

PACs is the top-level directory of the 1120-POL schemas. It contains the following:

1120POL is a directory for Forms 1120-POL related schemas not included in the above directories. It contains the following:

- **Return1120POL.xsd** defines the XML structure for the tax return and wraps around the ReturnHeader1120POL and ReturnData1120POL XML documents in a transmission file.
- **ReturnHeader1120POL.xsd** defines the structure and global data elements for the Form 1120-POL tax return.
- **ReturnData1120POL** defines the content model for a Form 1120-POL tax return. This includes defining all XML forms and schedules in the tax return.

The schemas for the Exempt Organization forms may be found on IRS.gov at <http://www.irs.gov/charities/article/0,,id=129364,00.html>.

2.10.12 1065/1065-B XML Schema File Structure



Figure 2-37: 1065/1065-B Package

The following describes the MeF Schema File Structure for Form 1065/1065-B (Figure 2-34 above):

2009v1.0 is the top-level directory of the schemas for the Tax Year 2009, version 1.0.

The version above contains the following folders:

- **Common**, which contains the XML schemas that are common to all MeF returns and extension types. It contains the following:
 - **BinaryAttachment.xsd**, which defines the binary attachment document XML structure
 - **efileAttachments.xsd**, which defines the attachment document XML structure
 - **efileMessageCommon.xsd**, which defines the transmission header, transmission manifest, and acknowledgement XML structures for the basic message.
 - **efileMessageIFA.xsd**, which defines the transmission header, transmission manifest, and acknowledgement XML structures for the IFA channel.
 - **efileTypes.xsd**, which defines the global data types for MeF schemas.

- **SOAP.xsd**, which defines the XML structure of the SOAP envelope, SOAP header and the SOAP.
- **CorporateIncomeTax**, which is a directory for corporate income related (1120/1120-F/1120S) schemas. It contains the following folders that contain common forms shared with 1065/1065-B:
 - **Common**, which is a top-level directory for schemas for all attachments and forms that are shared among forms common to 1120/1120-F/1120S and 1065/1065-B return types. It contains the following:
 - **Dependencies**, which contain schemas for the supporting XML documents/attachments common to 1120/1120-F/1120S and 1065/1065-B return types.
 - **Various Shared Form directories**, which each contain the schemas for the shared forms and supporting XML documents/attachments between 1120/1120-F/1120S and 1065/1065-B return types.
 - **Corp1120**, which contains schemas specific to the 1120 return type. It also contains the following folder which contains common forms shared with 1065/1065-B:
 - **IRS8902**, which contains the schemas for the shared form, IRS8902, and supporting XML documents/attachments common to 1120/1120-F/1120S and 1065/1065-B return types.
- **PartnershipIncome**, which is a directory for partnership income related (1065/1065-B) schemas. It contains the following folders:
 - **Common**, which is a top-level directory for schemas for all attachments and forms shared among forms 1065 and 1065-B return types. It contains the following:
 - **ReturnHeader1065x.xsd**, which defines the structure and global data elements for the 1065 and 1065-B tax returns.
 - **Dependencies**, which contain schemas for the supporting XML documents/attachments common to 1065 and 1065-B return types.
 - **Various Shared Form directories**, which each contain the schemas for the shared forms and supporting XML documents/attachments between 1065 and 1065-B return types.
 - **Part1065**, which contains schemas specific to the 1065 return type. It contains the following:
 - **Return1065.xsd**, which defines the XML structure for the tax return and wraps around the ReturnHeader1065x and ReturnData1065 XML documents in a transmission file.
 - **ReturnData1065.xsd**, which defines the content model for a 1065 tax return. This includes defining all XML forms and schedules in the tax return.
 - **List of all form folders not shared with the 1065-B**, which contain the schemas for the forms and supporting XML documents/attachments that are specific for the 1065 return type.
 - **Part1065B**, which contains schemas specific to the 1065-B return type. It contains the following folders:
 - **Return1065B.xsd**, which defines the XML structure for the tax return and wraps around the ReturnHeader1065x and ReturnData1065B XML documents in a transmission file.

- **ReturnData1065B.xsd**, which defines the content model for a 1065-B tax return. This includes defining all XML forms and schedules in the tax return.
- **List of all form folders not shared with the 1065**, which contain the schemas for the forms and supporting XML documents/attachments that are specific for the 1065-B return type.

2.10.13 Excise Tax Forms 720/2290/8849 XML Schema File Structure

720 Package

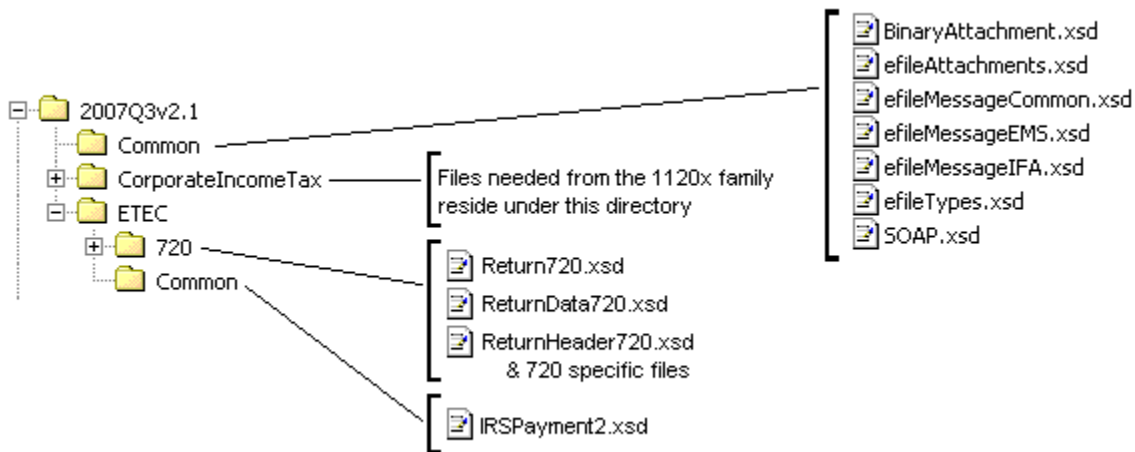

Figure 2-38: 720 Package

2007Q3v2.1 is the top-level directory of the schemas for the Tax Year 2007, 3rd Quarter, version 2.1. It contains the following folders:

- **Common**, that contains the XML schemas that are common to all MeF return/extension types. It contains the following XML schemas:
 - **SOAP.xsd** defines the XML structure of the SOAP envelope, SOAP header and the SOAP.
 - **efileMessageCommon.xsd**, **efileMessageEMS.xsd**, **efileMessageIFA.xsd**, and **efileAttachments.xsd** define the transmission header, transmission manifest and the acknowledgement XML structures.
 - **efileTypes.xsd** defines the global data types for MeF schemas.
 - **BinaryAttachment.xsd** defines the content model for the binary attachment XML Document.

CorporateIncomeTax, is a hierarchy of Corporate (1120x) schemas used by Form 720.

ETEC, is the top-level directory of the 2290/720/8849 Excise Tax e-Filing and Compliance schemas. It contains the following:

Common, which is a directory for schemas for all attachments and dependencies shared between Excise Tax e-Filing and Compliance Forms 2290 and 720. It contains the following:

- **IRSPayment2.xsd**, which defines the XML structure of payments for Forms 2290 and 720. This file is identical to the IRSPayment.xsd used by other tax types with the exception of including cents in the payment element.

720, which is a directory for Form 720 specific schemas not included in the above directories. It contains the following:

- **Return720.xsd**, which defines the XML structure for the extension and wraps around the ReturnHeader720 and ReturnData720 XML documents in a transmission file.
- **ReturnHeader720.xsd**, which defines the structure and global data elements for the Form 720 return.
- **ReturnData720.xsd**, which defines the content model for the Form 720. This includes defining all XML forms and schedules in the return.

2290 Package

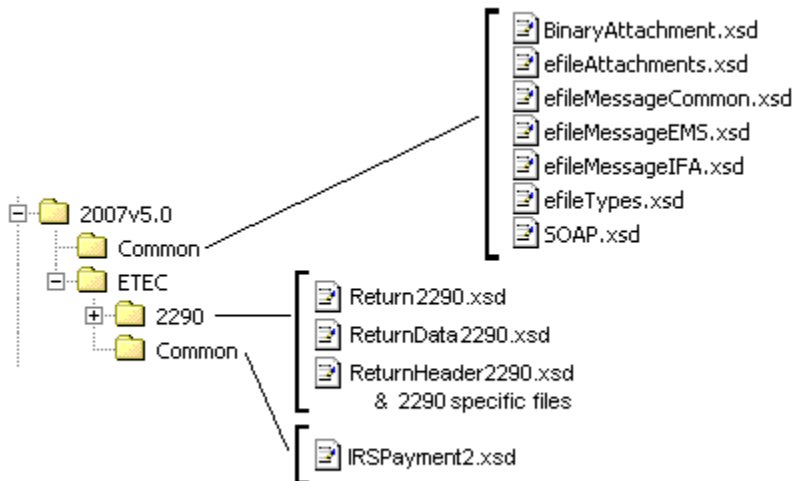

Figure 2-39: 2290 Package

2007v5.0 is the top-level directory of the schemas for the Tax Year 2007, version 5.0. It contains the following folders:

Common, this contains the XML schemas that are common to all MeF return/extension types. It contains the following XML schemas:

- **SOAP.xsd**, which defines the XML structure of the SOAP envelope, SOAP header and the SOAP.
- **efileMessageCommon.xsd**, **efileMessageEMS.xsd**, **efileMessageIFA.xsd**, and **efileAttachments.xsd**, which defines the transmission header, transmission manifest and the acknowledgement XML structures.
- **efileTypes.xsd**, which defines the global data types for MeF schemas.
- **BinaryAttachment.xsd**, which defines the content model for the binary attachment XML Document.

ETEC, is the top-level directory of the 2290/720/8849 Excise Tax e-Filing and Compliance schemas. It contains the following:

Common, which is a directory for schemas for all attachments and dependencies shared between Excise Tax e-Filing and Compliance Forms 2290 and 720. It contains the following:

- **IRSPayment2.xsd**, which defines the XML structure of payments for Forms 2290 and 720. This file is identical to the IRSPayment.xsd used by other tax types with the exception of including cents in the payment element.

2290 is a directory for Form 2290 specific schemas not included in the above directories. It contains the following:

- **Return2290.xsd**, which defines the XML structure for the extension and wraps around the ReturnHeader2290 and ReturnData2290 XML documents in a transmission file.
- **ReturnHeader2290.xsd**, which defines the structure and global data elements for the Form 2290 return.
- **ReturnData2290.xsd**, which defines the content model for the Form 2290. This includes defining all XML forms and schedules in the return.

8849 Package

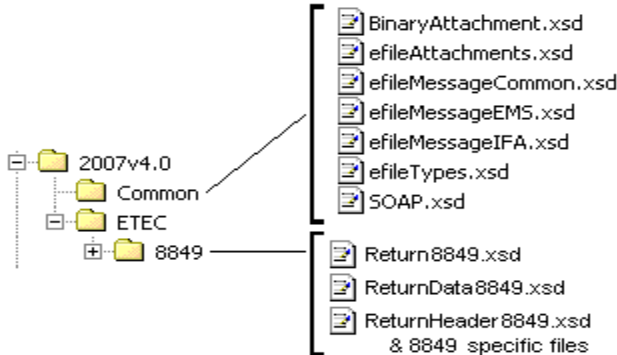

Figure 2-40: Form 8849 Package

2007v4.0 is the top-level directory of the schemas for the Tax Year 2007, version 4.0. It contains the following folders:

Common, this contains the XML schemas that are common to all MeF return/extension types. It contains the following XML schemas:

- **SOAP.xsd**, which defines the XML structure of the SOAP envelope, SOAP header and the SOAP.
- **eFileMessageCommon.xsd**, **eFileMessageEMS.xsd**, **eFileMessageIFA.xsd**, and

efileAttachments.xsd, which defines the transmission header, transmission manifest and the acknowledgement XML structures.

- **efileTypes.xsd**, which defines the global data types for MeF schemas.
- **BinaryAttachment.xsd**, which defines the content model for the binary attachment XML Document.

ETEC, is the top-level directory of the 2290/720/8849 Excise Tax e-Filing and Compliance schemas. It contains the following:

8849, which is a directory for Form 8849 specific schemas not included in the above directories. It contains the following:

- **Return8849.xsd**, which defines the XML structure for the extension and wraps around the ReturnHeader8849 and ReturnData8849 XML documents in a transmission file.
- **ReturnHeader8849.xsd**, which defines the structure and global data elements for the Form 8849 return.
- **ReturnData8849.xsd**, which defines the content model for the Form 8849. This includes defining all XML forms and schedules in the return.

3 MeF Fed/State Program

MeF implemented the following Fed/State Programs:

- Forms 990 and 1120 Fed/State Programs in January of 2006
- Form 1065 Fed/State Program in January 2007
- Form 1040 Fed/State Program in February 2010

The central feature of the MeF Fed/State program is the single point of submission and retrieval for all registered transmitters and State agencies. Federal and state submissions can be transmitted through Internet Filing Application (IFA) or Application-to-Application (A2A). States may retrieve state returns only through A2A.

The IRS and States agree to maintain open lines of communication between designated staff on both managerial and technical levels to ensure successful management and operation of the MeF Fed/State program.

The IRS role in the Fed/State program is to receive the state return and perform the minimal validation/workflow as explained in Section 3.4. MeF only validates the state submission manifest. MeF never validates the submission in the xml directory. Transmitters should work with the states directly on state return requirements, issues, questions, etc.

MeF will accept two kinds of submissions (1) IRS (federal) submissions and (2) State submissions. Each return/extension must be enclosed in a separate submission, but multiple submissions may be contained in a single message. The IRS and State submissions do not have to be transmitted to MeF together.

Both Federal and State returns must be in XML format. The federal returns must conform to the IRS valid schema versions. You can access the individual, corporate and partnership State Master Schemas at <http://www.statemef.com/>. For more information, contact the State e-File Coordinator. A current list of State Coordinators is available on the [Federal/State e-file for Tax Professionals](#) page on IRS.gov.

3.1 State Acknowledgements and State Submission Manifest

States must use the MeF acknowledgement schema for creating their acknowledgement instances. MeF performs schema validation on the state acknowledgement list. If there is an error anywhere in the list, all acknowledgements are rejected back to the state and none are made available to the transmitter. The state must correct the problem and resubmit the entire list.

Transmitters must use the IRS State Submission Manifest for state returns.

The IRS State Submission Manifest has an optional schema version element length of “12” that is not compatible with the schema version element in the State Return Header, which is required and has length of “20”.

3.2 Linked Returns (Fed/State returns)

A State submission can be linked to the IRS submission by including the Submission ID element of the federal return in the IRS SubmissionId in the State manifest. If the State submission is linked to an IRS submission (also referred to as a Fed/State return), the IRS will check to see if there is an accepted IRS submission under that Submission Id. If there is not an accepted federal return for that tax type, the IRS will deny the State submission and an acknowledgement will be sent to the transmitter. The state has no knowledge that the state return was denied (rejected) by the IRS.

Note: If you are going to link a State submission to an IRS submission, send in the IRS submission first and, after it has been accepted, send in the State submission.

If there is an accepted return under that Submission Id, then MeF will do minimal validation on the State submission that includes verifying that the State indicated in the State manifest is a participating state in the applicable 990, 1040, 1065 or 1120 Fed/State Program. MeF will then pass along to the State what the ERO/taxpayer sends in the State submission.

3.3 Unlinked State Returns (State Standalone returns)

If the ERO does not link the State return to a previously accepted federal return (also referred to as State Standalone return), then MeF will perform minimal validation as stated above that will include verifying that the State allows State Standalone returns and then will pass along to the State the entire State submission that was sent in by the ERO/taxpayer.

Note: The state return is made up of a state and a federal portion. The taxpayer provides both components based on what is required by the state. The IRS passes to the state just the information that has been provided by the taxpayer.

3.4 Workflow for Individual, Corporate, Partnership and Exempt Organization State Returns

- 1) Transmitter sends state return to IRS
- 2) IRS performs minimal validation:
 - a) If the state return is linked to the federal return, IRS will check:
 - i) the IRS SubmissionId in the State Submission Manifest matches an accepted federal submission for that Tax Year and submission type
 - ii) the State participates in the Fed/State Program for that return type and Tax Year and:
 - iii) **For Business returns:** the Filer EIN is a valid number in the IRS database and the name control matches the IRS database. MeF does not reject the state submission if there is a mismatch in this instance, but does forward the results to the state.
 - iv) **For individual returns:** the Primary SSN is a valid number in the IRS database (for joint returns, either the Primary SSN or the Spouse SSN must match the IRS database). MeF will check the SSN against the federal return and reject if it doesn't match. If the state return is not rejected, MeF forwards the SSN and name control match to the state
 - b) If the state return is unlinked, IRS will check that the State participates in the Fed/State Program.
- 3) If the state return passes the validation above, MeF makes the state return available to the state
- 4) State retrieves state returns from MeF
- 5) State sends receipt for state return to MeF

- 6) State processes state return and sends state acknowledgement to MeF
- 7) Transmitter retrieves state acknowledgement from MeF
- 8) State retrieves Acknowledgement Notification (status that transmitter retrieved the state acknowledgement)

3.4.1 Exempt Organization Fed/State Program – Providing Copy of IRS Return to State

For Forms 990/990-EZ/990-N/990-PF, a filer can request that a copy of the IRS return be provided to one or more participating States. Upon receipt of the request, IRS will validate that the State(s) is participating in the Fed/State program. If it is, then IRS will send a redacted copy of the accepted return to the State agency(s). Items that are always redacted from the state copy include, but are not limited to, the PIN or Form 8453-EO, the request for the copy and any payment information included with Form 990-PF. In addition, depending on the state, the IRS may also redact the Schedule B if the state does not require it. MeF will process the IRS submission and will generate an acknowledgement for every IRS submission and copy of IRS Forms 990/990-EZ/990-N/990-PF forwarded to a State. Each State is responsible for validating its State submissions and for generating a State acknowledgement for each State submission, which will be returned to the IRS for retrieval by the transmitter. If the Federal 990X return is rejected, no copies will be forwarded to the State.

3.4.2 Status Record for State Returns

While the state return is being processed, the transmitter can request the status of the submission. In A2A, the Status Record is retrieved by service requests Get New Submission Status, Get Submission Status or Get Submissions Status. In IFA, the Status Record is retrieved by selecting the Retrieve (Production or Test) Submission Status Records option.

Status Record Definitions

Status Name	Description
RECEIVED	The state submission was received by MeF
READY FOR PICKUP	The state submission passed MeF validation and has been made available for the state to retrieve.
SENT TO STATE	The state made a request to retrieve state submissions. The MeF system has marked this state submission as being retrieved by the state. Note: If the state lost connection when trying to retrieve this submission, MeF may have marked it as being retrieved but the state has not gotten the submission yet and it will not be returned in a subsequent Get New Submissions request.
RECEIVED BY STATE	The state sent MeF a receipt that they retrieved the state submission.
ACKNOWLEDGEMENT RECEIVED FROM STATE	The state sent MeF a state acknowledgement for this submission.
ACKNOWLEDGEMENT RETRIEVED	The acknowledgement for the state submission has been retrieved by the transmitter.
NOTIFIED	The state has been notified that the state acknowledgement has been retrieved by the transmitter.
DENIED BY IRS	The state submission did not pass MeF validations. The return was rejected back to the transmitter. The state does not receive any status from MeF on this return.

[See Section 5.4 Status Record for Federal Returns](#) for additional information

Example of the statuses provided for a state return that passed Fed/State validation:

Submission Status History:

Submission Status	Status Date ▼	Status Record Retrieval Date
Notified	2009-09-16	2009-09-16
Acknowledgement Retrieved	2009-09-16	2009-09-16
Acknowledgement Received from State	2009-09-16	2009-09-16
Received by State	2009-09-16	2009-09-16
Sent to State	2009-09-16	2009-09-16
Ready for Pick-Up	2009-09-16	2009-09-16
Received	2009-09-16	2009-09-16

Example of the statuses provided for a state return that did not pass Fed/State validation:

Submission Status History:

Submission Status	Status Date ▼	Status Record Retrieval Date
Acknowledgement Retrieved	2009-09-17	2009-09-17
Denied by IRS <input type="text"/>	2009-09-17	2009-09-17
Received	2009-09-17	2009-09-17

The Status Record is not proof a return was accepted or rejected and includes the following statement:

“This status record provides information about what step in the process the return has completed. It is not proof that the return was Accepted or Rejected. You must retrieve the Acknowledgement File and keep with the return records to prove the return was Accepted or Rejected.”

When a state submission is sent to the state agency, IRS provides additional data based on its processing of the state return. The IRS data for business and individual returns can be found in the MeF State and Trading Partners Reference Guide.

4 Transmission Methods for MeF

The MeF system allows you to transmit tax returns and extensions to the IRS through two channels: MeF Internet Filing Application (IFA), and MeF Application-to-Application (A2A).

4.1 Transmitting Through Application-to-Application (A2A)

The following section describes how to transmit a file using A2A and information regarding A2A security.

4.1.1 Security Directive Rules of Behavior for Access to IRS Business Systems

The following is provided as official guidance to manage system security for systems using the Application-to-Application (A2A) interface to IRS Systems. It is provided for software developers, operational managers, Third Party Transmitters, States, system administrators, etc...

Internal Revenue Service (IRS) Third Party Transmitters and State Trading Partners shall carry out their respective responsibilities for ensuring information systems security and taxpayer privacy commensurate with the sensitivity of the information under their control. This publication provides policies and guidance to be followed by registered organizations to carry out their respective responsibilities in information systems security. Third party transmitters must further establish a security policy and implement automated mechanisms, which can uniquely identify, authenticate, authorize and track all individual users of the applications and machines that use MeF Web services. The third party and its principal will be held responsible for any violation of security conditions identified in Publication 4164 by or through their system regardless of what individual might have been directly responsible, whether an employee of the third party organization, an authorized external user of its system, or an unauthorized external user of that system.

IRS e-services registered users must provide true, accurate, current and complete information. IRS sensitive information used to access the IRS Registered User Portal (RUP) including e-services passwords, System IDs, usernames and PINs must be protected and comply with the requirements set forth and agreed to by responsible parties as part of the IRS e-services registration process.

Users shall immediately notify the IRS at 1-866-255-0654 (international callers use 512-416-7750) of any unauthorized use of passwords or accounts, or any other breach of security. In the event that the user experiences a Login failure that leads them to believe that their account has been compromised, the registered user should immediately contact the IRS at the numbers provided above.

4.1.1.1 Penalty for Non-Compliance

A2A users are using an Official United States Government System, which may be used only for authorized purposes. The Government will monitor and audit the usage of this system, and all persons are hereby notified that the use of this system constitutes consent to such monitoring and auditing. Unauthorized attempts to upload information and/or change information on these Web sites, and any attempts to defraud the government are strictly prohibited and subject to prosecution under the Computer Fraud and Abuse Act of 1986 and Title 18 U.S.C. Sec. 1001 and 1030. Termination of the user's privileges to conduct business with the IRS and other penalties may apply.

4.1.1.2 Compliance with U.S. Internet Cryptographic Standards

All transmitters are advised to use software that supports the U.S. Internet Standards for A2A or Browser-based access. The software needs to comply with U.S. Internet Standards for use of Cryptography in accordance with guidance from the Bureau of Industry and Security, U.S. Department of Commerce (www.bis.doc.gov).

4.1.1.3 Compliance Enforcement

The IRS retains the right to conduct random, unannounced and unscheduled onsite inspections of any facility using the A2A functionality. These visits will be solely for ensuring compliance with the IRS Security policies specified in section 4, especially the encrypted storage of at rest passwords and the implementation of automated mechanisms which can uniquely identify, authenticate, authorize, and track all individual users of the applications and machines. Any non-compliance will result in immediate termination of the A2A connection privileges until such time the third party can demonstrate compliance. Repeated instances of non-compliance will result in permanent removal of permissions to utilize the A2A functionality of the MeF system.

4.1.1.4 Data Removal

The IRS requires removal of taxpayer data from systems that are no longer used for the purpose of processing and transmitting taxpayer data. On systems running any Windows operating system, an Administrator should reduce the size of all Windows page files (pagefile.sys) by at least one megabyte on each available hard drive containing a page file. Administrators should also clear all \temp directories and, if using a Web browser for processing or transmitting, clear all temporary files and caches. If the system hard drives will not be sanitized by degaussing, then files containing taxpayer data must be wiped using a file erasure program that performs at least three file overwrites or that meets NIST standards for file data destruction. If a “slack space” data destruction utility is available, it should also be used. After making the above changes, the system should be rebooted. Systems utilizing any other operating systems should be sanitized using methods similar to those described above.

4.1.2 Registration for A2A credentials

The A2A registration and enrollment process for both Transmitters and State Trading Partners and their respective application systems is an automated process.

The Automated Enrollment (AE) application was developed to replace the manual enrollment of application systems for A2A Web Services. The AE application will provide a user interface for enrolling and maintaining application systems.

Transmitters must apply to become an Authorized IRS e-file Provider by filling out an IRS e-file application online, if they have not previously completed the e-file application process. State Trading Partners will need to complete a new IRS e-file application to participate in the Modernized e-File Programs, even if they have a previous application for their other e-file programs. The IRS e-file application must indicate the form types submitted (such as 990, 1040/A/EZ/SSPR, 1120, 1120-POL, 1065, 720, 2290, 4868, 2350, 56, 9465 or 8849) and it must indicate the transmission method of *MeF Internet*, *XML*.

The Principal or Responsible Official who is completing or revising the IRS e-file application must also delegate one or more persons to access the AE application and enroll application systems for their organization. This is done by accessing the IRS e-file application and adding the delegated users with the authority of *MeF System Enroller*. Each of the MeF System Enrollers will need to complete the e-services registration process, which includes confirming their registration with a token they receive through the mail after they have successfully completed their initial registration. Once the MeF System Enrollers have confirmed their registration, they will be able to log into the existing RUP and access the AE application to enroll and maintain their application systems. The authorized delegated user can:

- Enroll, un-enroll, deactivate, inactivate, and update Application System IDs (ASIDs) for their organization
- Replace the certificate of a previously enrolled ASID
- Select “Password” or approved X509 “Certificate” as the Credential Type for an ASID
- Change the credential type from “Password” to “Certificate” or “Certificate to Password”
- Reset the password for a previously enrolled ASID

The Automated Enrollment (AE) External User Guide describes the User Interface for the AE application and can be found on IRS.gov at:

<http://www.irs.gov/efile/article/0,,id=171946,00.html>.

4.1.3 Strong Authentication

The IRS is offering strong authentication, which will affect authentication techniques for all A2A Web services. The strong authentication certificate will replace the password and will require a modification to the WSDLs. Each Transmitter and State will be required to register their certificate with MeF through the AE application. You must use the set of files sent to you to build your application so that it can use strong authentication (IRS WSDL version MeF 6.2 WSDLs IBM..zip or later, or MeF Header.xsd file containing the string 'AppSysID').

Strong Authentication is the preferred method of authentication, but has not been made mandatory at this time, however users need to prepare as the IRS will require Strong Authentication in the near future. It is strongly suggested that you start testing and using certificates as soon as possible. It is recommended that a new ATS client be added for developing and testing digital signature code for MeF processing prior to converting existing client applications over to use strong authentication.

A guide is also available that explains the integration and uses of this IRS-provided client code sample to support certificate-based authentication for MeF A2A Web services. In

addition to the code itself, this guide provides necessary information for developers to use when integrating the new feature into client software that communicates with the IRS A2A Web services. This guidance is relevant both to client code that will be developed in the future and to pre-existing client code not currently using digital signatures to sign Simple Object Access Protocol (SOAP) messages. If interested in obtaining the Strong Authentication User Guide, please contact the e-help Desk at 1-866-255-0654.

4.1.4 Certificate Management

A2A Transmitters and States may use digital certificates (X.509) versus passwords upon proper enrollment and registration of the certificate. Encryption of the signing key is important on your system. **Do not store an unencrypted copy of the signing key on your system.** The signing key should be stored in a standard encrypted key store. The IRS will provide Transmitters and States with a pair of libraries to perform signing. These libraries are detailed in Appendix A of the Strong Authentication User Guide. One library is for .NET support and the other code uses the Java support for Web Services. Each of these libraries will use the standard key storage for their environment, whether Windows' certificate store, PKCS#12 (for .NET), or a standard Java key store such as JCEKS or JKS (for Java). Always protect key store passwords used to encrypt signing keys. For problems associated with certificate management, please contact the e-help Desk at 1-866-255-0654 for assistance.

4.1.5 Transmitting through MeF Application-to-Application (A2A)

Transmitters and States communicate with the MeF system using a series of service requests that are accomplished using messages. The service requests include:

MeF Application-to-Application		
SERVICE REQUEST	TRANSMITTER	STATE AGENCY
Send Submissions	X	
Get New Acknowledgements	X	
Get Acknowledgements	X	
Get Acknowledgement	X	
Get Acknowledgements by Message ID	X	
Get New Submission Status	X	
Get Submissions Status	X	
Get Submissions Status	X	
Get New 2290 Schedule 1s	X	
Get 2290 Schedule 1s by Message ID	X	
Get 2290 Schedule 1s	X	
Get 2290 Schedule 1	X	
Get New Submissions		X
Get Submissions		X
Get Submission		X
Get Submissions by Message ID		X
Send Submission Receipts		X
Send Acknowledgements		X
Get New Acknowledgement Notifications		X
Get Acknowledgement Notifications		X
Get Acknowledgement Notification		X
Get Submission Reconciliation List		X
Initial Login (Password only)	X	X
Login	X	X
Logout	X	X
Change Password (Password only)	X	X
Request ETIN Status	X	X
Request ETIN Retrieval	X	X
Request List of State Participants	X	X

} Fed/ State

All service requests are synchronous. The request is not complete until the originating system receives a response from MeF. The response contains the information requested, a confirmation, or an error. An error indicates a problem was encountered while processing the request.

Use `GetSubmissionsByMsgID` and `GetAcknowledgementsByMsgID` to retrieve submissions or acknowledgements previously retrieved with a `GetNewSubmissions` or `GetNewAcknowledgements` service request. You must pass the message ID used in the original `GetNewSubmissions` or `GetNewAcknowledgements` request as a parameter to the `GetSubmissionsByMsgID` and `GetAcknowledgementsByMsgID` request. These two services are often used to retrieve submissions or acknowledgements previously retrieved but lost due to a timeout.

4.1.6 Password Management

MeF was scheduled to stop supporting passwords after December 2008 and require all A2A systems use certificates for authentication in January 2009. This change was not implemented. Passwords will continue to be accepted until IRS notifies transmitters that certificates must be used.

If the current password is stored in a sequential file, the Windows Registry or a relational database, it should be stored using triple Data Encryption Standard (DES) or Advanced Encryption Standard (AES). The application may also prompt the user for the password at startup. Transmission will be encrypted at the transport layer using encryption software containing a NIST-certified FIPS 140-2 compliant encryption module. Use the IFA option for communications with the IRS Systems, rather than storing an unencrypted copy of the password. **Do not use a script of clear text passwords in storage for authenticated transactions with the IRS.**

Password Criteria:

- **Length** – a minimum of 8 and a maximum of 30 alphanumeric characters
- **Complexity** – Use a minimum of one uppercase alpha, one lowercase alpha, one numeric and one special character. Please use at least one of each class of characters. Please use one of the following special characters that has been tested for use in passwords and tokens, Please use these special characters: period, comma, colon, semicolon, question mark, exclamation point, dollar sign, plus sign, equal sign, hyphen, underscore, asterisk, left parenthesis, right parenthesis, at sign (@), tilde (~), octothorpe (#), and caret (^).

Do not use single quote ('), double quote ("), ampersand (&), left brace (<), right brace (>), or percent (%).

- **Age** – do not reuse passwords (20% of password must change, random character changes, no incrementing). Passwords must be changed no less than every 30 days, but cannot be changed more than once every 24 hours. Password reset may be performed by a delegated user with the authority for MeF System Enroller. Change Password cannot be used after the password has expired.

When 15 days have expired since your last password change, you will receive a password change reminder as part of the Login response.

Note: If you are caching, it is recommended that you clear the cache after changing your password. This will eliminate any possibility of accidentally submitting the old password.

Failures during a password change are possible. After such a failure, a program cannot be sure whether the system considers it has the new password or the old password. After a failure during the password change, make sure the rejection of the change was not because the new password is invalid.

The next login should typically use the new password. If it fails, log in using the old password. If this also fails, do not try any further. The authorized delegated user should reset the password.

Transmitters and States must immediately inform the IRS of any suspected breach of passwords associated with the MeF processing by contacting the e-help Desk at 1-866-255-0654. Encryption and decryption of passwords will typically be performed in memory; unless you are using relational database software with built-in encryption. Standard facilities for encryption are available, and you must use a standardized encryption algorithm compliant with triple Data Encryption Standard (DES) or Advanced Encryption Standard (AES). Remember, you will be encrypting very small amounts of data. An example of .NET encryption of data to go into a registry can be found at <http://msdn2.microsoft.com/en-us/library/k62k71x0.aspx>. To store encrypted information, refer to: [http://msdn.microsoft.com/en-us/library/aa972236\(v=SQL.80\).aspx](http://msdn.microsoft.com/en-us/library/aa972236(v=SQL.80).aspx).

To use the built-in Triple-DES support in Java (J2SE 1.4.2 and later, existing as an extension in earlier versions), applications should use the Cipher class. This API is found at <http://java.sun.com/j2se/1.4.2/docs/api/javax/crypto/Cipher.html>. To encrypt or decrypt a single password using “Cipher”, called the init method, and then the do Final method with your data (the password for encrypt, the binary version of the stored data for decrypt). Creating your object of the Cipher class involves using the Cipher.getInstance method (Cipher.getInstance (“DESede/CBC/PKCS5Padding”) for Triple-DES in version 1.4.2). The cipher key must be the correct size (112 or 168 bits for Triple-DES, 128 bits for AES).

Note: By clicking on any of the links in this section, you will leave the IRS Web site and enter a privately owned Web site created, operated and maintained by a private business. The information that this private business collects and maintains as a result of your visit to its Web site may differ from the information that the IRS collects and maintains. (Please see the IRS Web site privacy and security notice for privacy protections IRS provides to Web site visitors). By linking to this private business, the IRS is not endorsing its products, services, or privacy or security policies. We recommend you review the business's information collection policy or terms and conditions to fully understand what information is collected by this private business.

Password Reset –Automated Enrollment provides authorized delegated users the ability to reset the password for a previously enrolled Application System IDs (ASIDs)

For more information about A2A, refer to the MeF State and Trading Partners Reference Guide and the MeF Submission Composition Guide.

4.1.7 General Information and Lessons Learned

- **A2A SSL Certificates**

Before any system can transact A2A business with MeF, the appropriate certificates must be loaded onto your system. The certificates are the same for Multipurpose Internet Mail Extension (MIME), Direct Internet Message Encapsulation (DIME) users and Message Transmission Optimization Mechanism (MTOM) users. There are five certificates, and all five are provided to you by the IRS in a single zip file. These certificates must be used for strong authentication services. To obtain the certificates, contact the e-help Desk at 1-866-255-0654.

- **Log in**

A separate Application System ID must be used for testing digital certificates. You must also upload your digital certificate to the IRS while enrolling your new system using Automated Enrollment. You must also rebuild your services using the 6.2 or later Web Services Description Language (WSDLs) because of changes made to some of the services. Once you have enrolled a system, uploaded your certificate you can test digital certificates. There are several things to keep in mind during this testing:

- There is no Initial Login service associated with strong authentication like there is for login/password. Begin testing using the login service. Only the login service should contain the binary signature. When your binary signature (login) has been authenticated, a login response will be returned to you. This response will contain a Security Assertion Markup Language (SAML). Use the SAML (not the binary signature) in all subsequent services in that session.
- If you are using a “Single Step” service, instead of login, then the Single Step service must contain the binary signature.
- Once you have successfully tested all services using digital certificates, you should convert all your Application System IDs to strong authentication (Digital Certificates).

- **System ID**

If certificates are used, the System ID is put in the AppSysID in the MeF Header for the first service in session only (usually login). AppSysID is put in the User Name Token in the Security Section of the Simple Object Access Protocol (SOAP) Header for all subsequent services in same session. The ID Element links the MeF Header and the Security Section and the SOAP Body for the initial service only. The ID is not needed in subsequent services in the same session.

If passwords are used, put the System ID in the User Name Token in the Security Section for initial and subsequent service.

- **Service Request Encoding**

DO NOT USE base 64 encoding. All requests encoded in base 64 will be rejected.

- **.NET WSE Libraries**

.NET users should use Web Services Enhancements (WSE) 2.0 and 3.0. MeF supports DIME and MIME, and Message Transmission Optimization Mechanism (MTOM). WSE 2.0

contains the DIME classes. WSE 3.0 supports MTOM only. The DIME classes have been removed from 3.0. IRS is now supporting DIME, MIME and MTOM.

- **Attachment Encoding**

Each return is contained in its own zip file, and all return zip files must be placed into a container zip file. The container zip file is attached to the SendSubmissions service request. If a SendSubmissions service contains more than one attachment, the service will be rejected. The attachment must be MIME, DIME or MTOM encoded. (DIME support will end in September of 2012)

- **Attachment Content Type**

Whether using IFA or A2A, “attachment content type” should be set to application/octet-stream, not application/zip.

- **2290 Schedule 1 Services**

Even though the Schedule 1 services are listed as Transmitter services, only 2290 Transmitters have authorized access to them.

- **State Communication Testing**

We provide generic state returns for states to test the GetSubmission portfolio of service requests. When ready to test these services, the state should e-mail the MeF mailbox requesting generic returns be loaded for your state. (Approximately 10 returns are loaded per request.)

Beginning with 1040 MeF Phase 1 (January 2010), the IRS allowed states to become their own transmitters. The state must apply separately as a software developer, receive software developer ETINS and EFINS, and enroll additional system ids to transmit their own returns. We recommend states take advantage of this option. By becoming its own transmitter, the state no longer has to rely on IRS or software developers to transmit test returns to MeF. The state becomes self-sufficient. It should be noted that these software developer accounts can be used in ATS only and not in production. However, the regular state accounts can be used in both. If you would like to become your own software developer/transmitter, please send an email to the MeF mailbox requesting access.

The Get New Submissions service requested functions differently starting in January 2010. Up until that time, a state declared the number of submissions it wanted to retrieve, up to a maximum of 100, in the MaxResults element in the SOAP Body of the request.

The MaxResults element was longer functional as of January 2010. Instead the IRS pre-builds files of state submissions. This was done to improve performance and response times. Now a file is created for each submission category ahead of time. The default number of submissions and file size are 100 and 100 MB respectively. If the state wishes to change

the default settings, it can do so by sending a request to the MeF mailbox. The request must contain the number of submissions and file size for each submission category in which it participates. The maximum number of submissions allowed in any one file is 100. The maximum file size is 4 GB (although the IRS discourages requesting such large file sizes. Please send any changes to IRS at least two weeks prior to wanting the change to take effect.

Pre-built files will be generated once an hour. Files will be created until no more submissions exist. If a file is being created when a Get New Submissions request is received for that submission category, the file will be closed and sent to the requester containing what submissions were in the file at the time of the request. The file schedule is available upon request. Send the request to the MeF mailbox.

Finally, a state should retrieve all submissions. This can be done by keying off the MoreAvailable flag in the SOAP Body of the Get New Submissions Response. Until the flag is set to FALSE, loop back and call New Submissions. Do this for all submission categories (unless using all). When all submissions have been retrieved for all categories, no more submissions will be available until the next hour.

- **Clock Synchronization**

Make sure your system clock is accurately set. Failure to do so may cause a synchronization failure between your system and MeF. A synchronization failure will result in denial of access until you synchronize your clock. The two standard web sites for time are www.nist.gov or www.usno.navy.mil/USNO/time.

We recommend that you do not transmit between 1:59am and 6:00am when clocks are changed for Daylight Savings time in the fall.

- **URLs**

A2A users are instructed to use 'la' ONLY, not 'la1' or 'la2' for ATS and Production unless instructed to do so by MeF.

4.2 Transmitting Through the Internet Filing Application (IFA)

4.2.1 Applying to Submit Returns through the Internet

This section describes the e-services registration and IRS e-file application process for transmitters who wish to transmit MeF returns through the Internet.

Transmitters who plan to transmit the forms through the Internet must complete the IRS e-file application. If your firm is not currently an Authorized IRS e-file Provider, a Principal or Responsible Official of your firm must register and complete the IRS e-file application. If you have previously submitted an IRS e-file application and are currently an authorized Transmitter, you will only need to revise your application to identify one or more of the MeF return form types and to indicate that you wish to transmit returns through the Internet. You will be required to identify an individual or individuals who are authorized to transmit returns for your firm through the Internet.

To register and complete the IRS e-file application, access IRS.gov and complete the following processes:

Registration:

You must register to gain access to the e-services products, including the IRS e-file application. Any Principals or Responsible Officials of the firm who are listed on the application and any individuals who have been delegated to transmit MeF returns through the Internet must register.

During registration, you will be required to enter the following information:

- Name
- Tax Identification Number (Social Security Number)
- Date of Birth
- Adjusted Gross Income (AGI) from either your current year or prior year tax return. This will be verified from IRS records.

You will be authenticated through these “shared secrets.” You will also be required to select a:

- Username
- Password
- PIN
- Reminder question to recover a forgotten user name

The IRS will then mail you a letter containing a confirmation code and instructions for completing the e-services confirmation process. IRS will mail the letter to the last address you provided the IRS on your individual tax return (1040 family) or Form 8822, Change of Address. You will have 28 days from the date of the letter to complete the confirmation process. If you do not confirm your registration within 28 days, your password will expire. You must then use the Forgotten Password or PIN option to set a new password (which will also generate a new confirmation code).

Application:

After registering, you will need to apply to become an Authorized IRS e-file Provider or you will need to revise your existing IRS e-file application. In completing the application to apply to be an Internet Transmitter, be sure to check:

- the appropriate return form type box: (See chart below for return form type to use)
- the provider option of Transmitter
- the transmission method of MeF Internet, XML for the Form Types 1040 family, 1120, 990, 1120-POL, and 1065. MeF Internet, XML is an automatic default for Forms 720, 2290, 2350, 4868, 8849, and 9465.

You will also be required to delegate one or more individuals who are authorized to transmit MeF returns for your firm over the Internet.

Form you wish to transmit	Return Form Type Box to check on application
1040	1040
1040A	1040
1040EZ	1040
1040SS or 1040PR	1040
56	1040
2350	1040
4868	1040
9465	1040
1120	1120
1120S	1120
1120-F	1120
7004*	1120
990	990
990-EZ	990
990-N	990
990-PF	990
8868	990
1120-POL	1120-POL
1065	1065
1065-B	1065
7004*	1065
720	720
2290	2290
8849	8849

***To develop software for or transmit Form 7004 for any form that can be extended by Form 7004, check the 1120 or 1065 box on the IRS e-File Application.**

Delegation:

The person identified to transmit over the Internet must be given this authority. This

is done by accessing the IRS e-file application and updating the delegated user section with the MeF Internet Transmitter option checked. Once this role is added to their profile, the authorized delegated user can log into the existing RUP Portal and transmit returns through IFA for the organization.

To obtain additional information regarding the e-services registration and IRS e-file application, go to <http://www.irs.gov/taxpros/article/0,,id=109646,00.html> .

4.2.2 Accessing and Logging into MeF IFA

You must be authorized to submit transmissions or retrieve acknowledgements through IFA. To access and log into MeF Internet Filing complete the following steps:

Step 1: Click the *e-file* logo on the irs.gov Web site

Step 2: Click the More Topics link

Step 3 Click Modernized e-File (MeF) Program Information

Step 4: Click Modernized e-File (MeF) Internet Filing

Step 5: Click the MeF Internet Filing link to login

Step 6: Read the Security Alert and click the OK button

Step 7: Enter your e-services Username and Password to receive authentication as an authorized Transmitter

Step 8: Select the organization you will represent in the session

The MeF IFA Web pages supporting these steps are shown in the following pages.

Step 1: Click the *e-file* logo on IRS.gov. Home Page.



Figure 4-1: IRS.gov Web Site

Step 2: Click the **More Topics** link in the left hand column under e-file Topics.

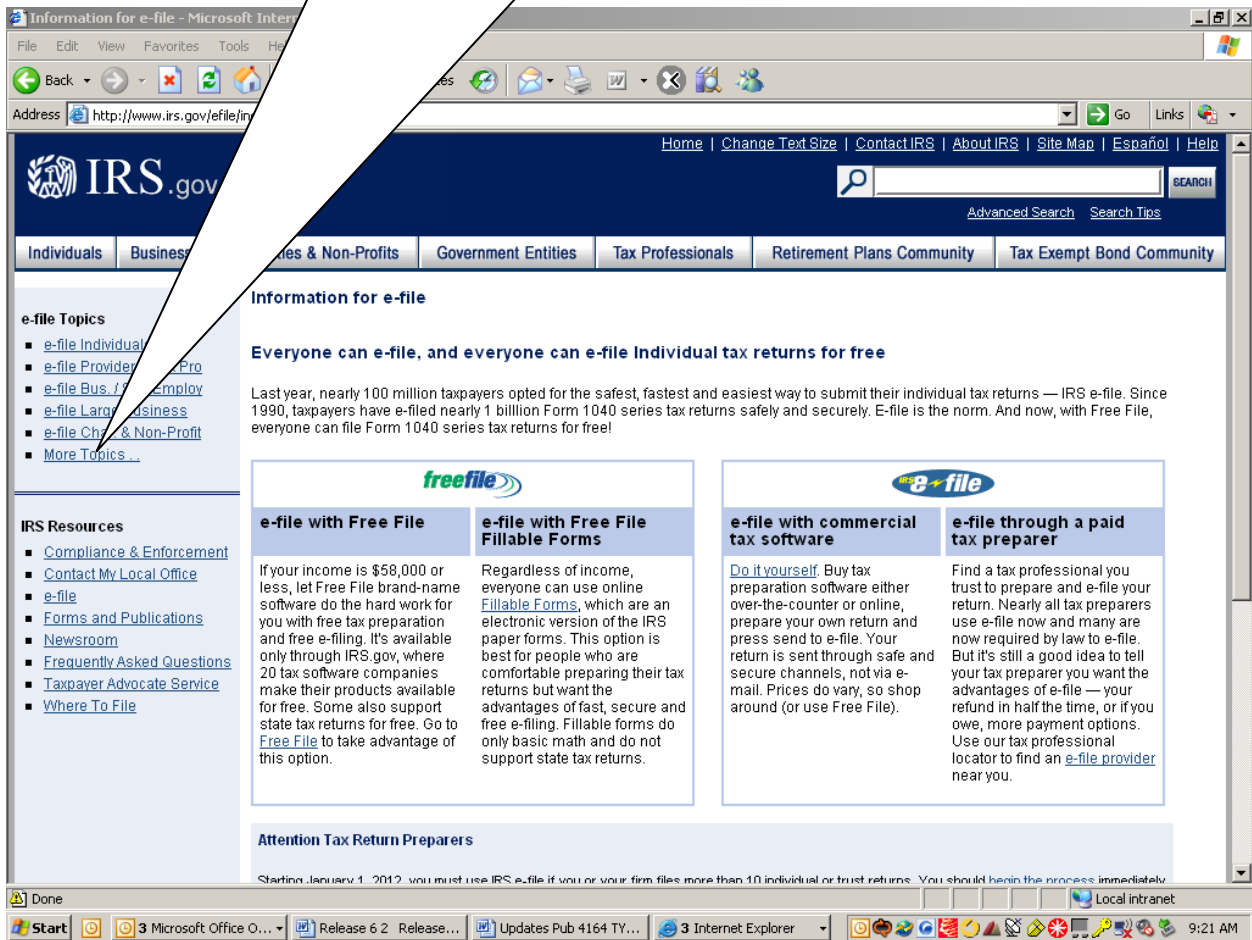

Figure 4-2: Information for e-file Page

Step 3: Click the **Modernized e-File (MeF) Program Information** link under Topics for e-file.

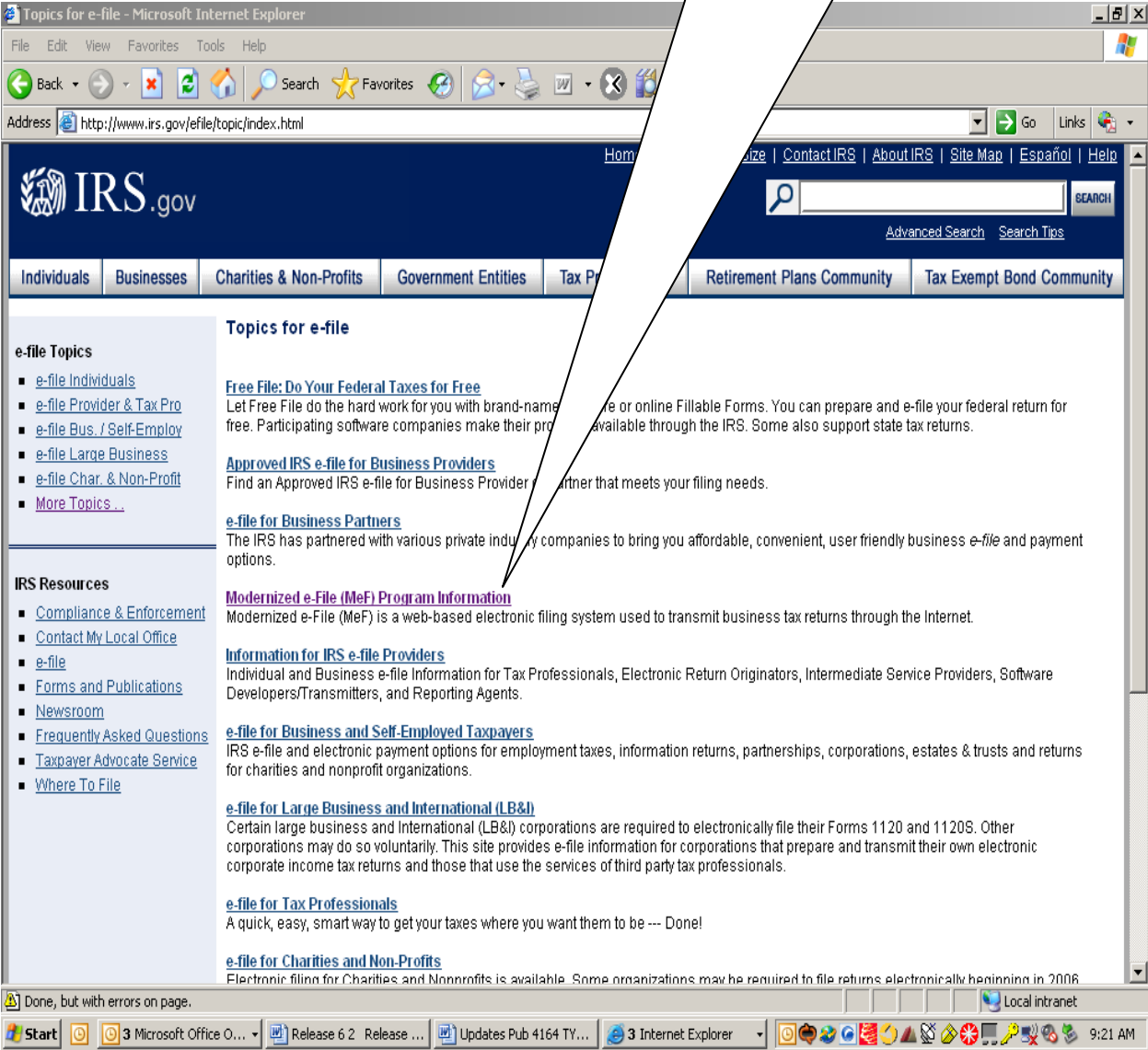

Figure 4-3: Topics for e-file Page

Step 4: Click the Modernized e-File (MeF) Internet Filing link

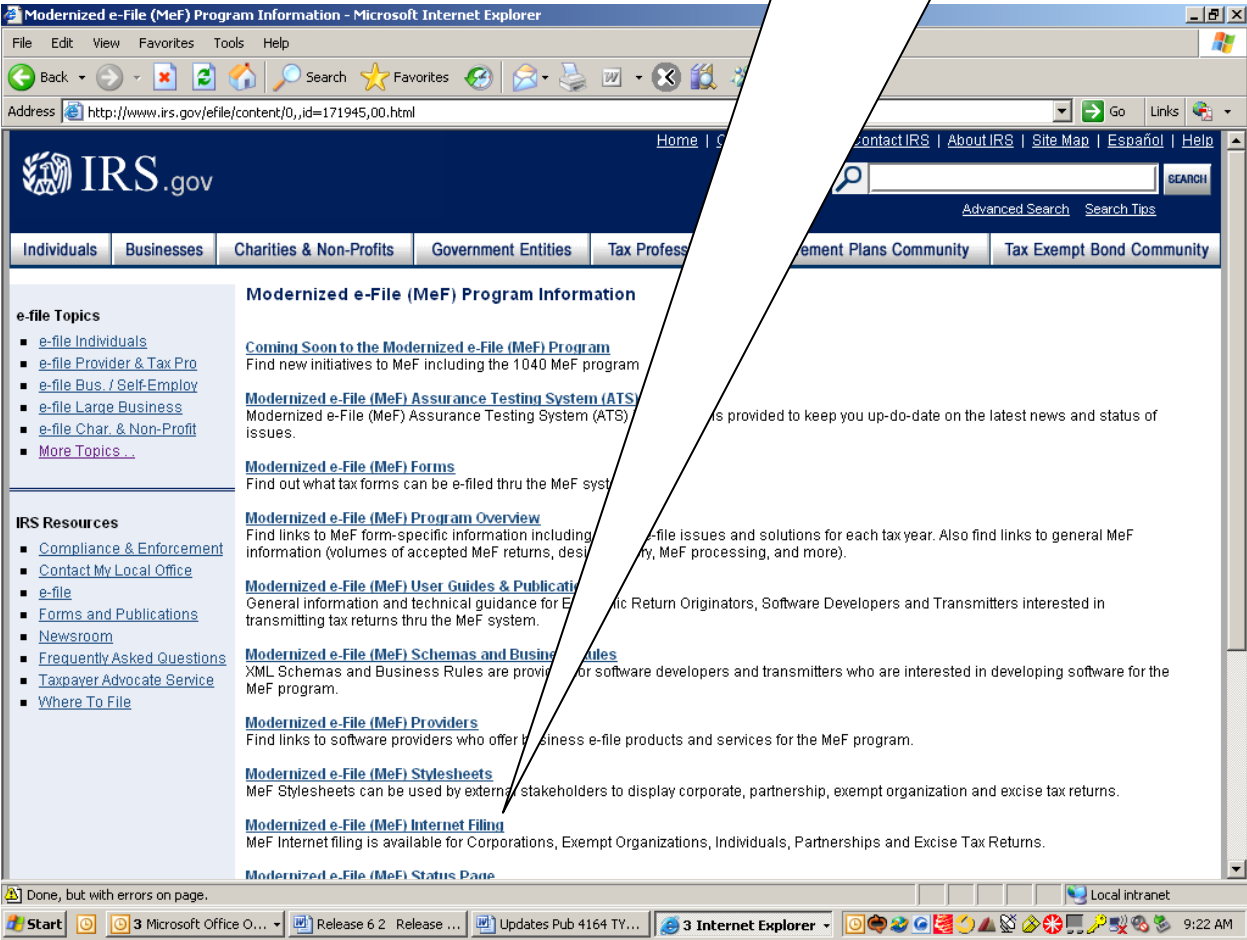

Figure 4-4: Modernized e-File (MeF) Program Information Page

Step 5: Click the **MeF Internet Filing** link

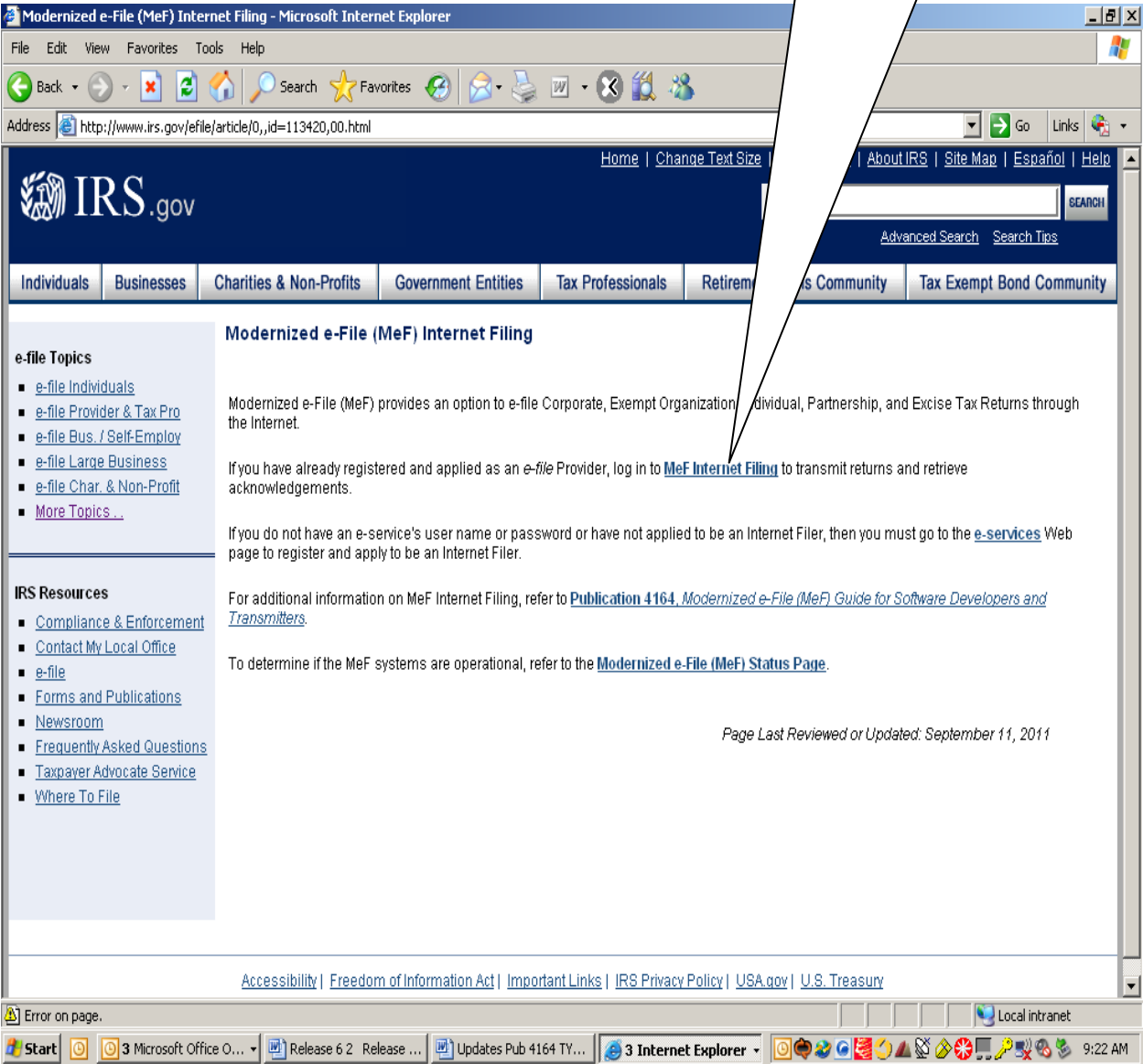

Figure 4-5: MeF Internet Filing Page

Step 6: Read the Security Alert and click the OK button to access the MeF Internet Filing Login screen.

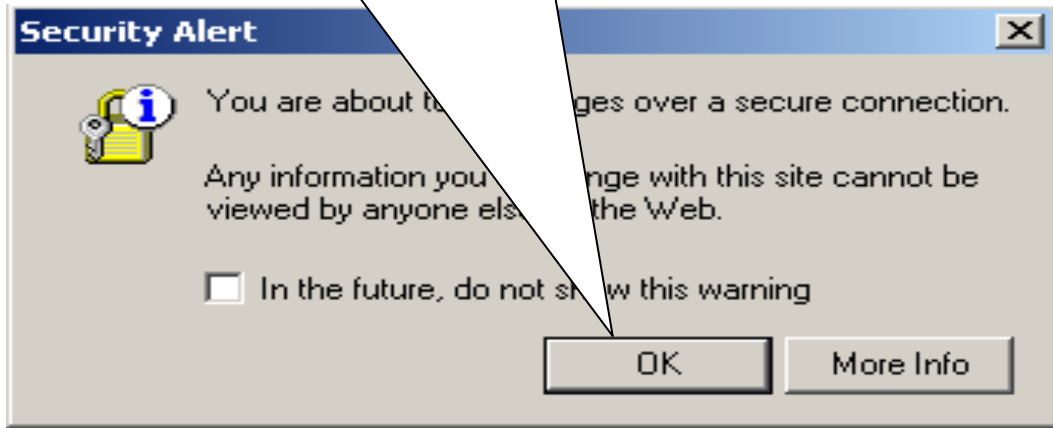

Figure 4-6: IRS.gov Security Alert

Step 7: Enter your e-services Username and Password to receive authentication as an authorized Transmitter.

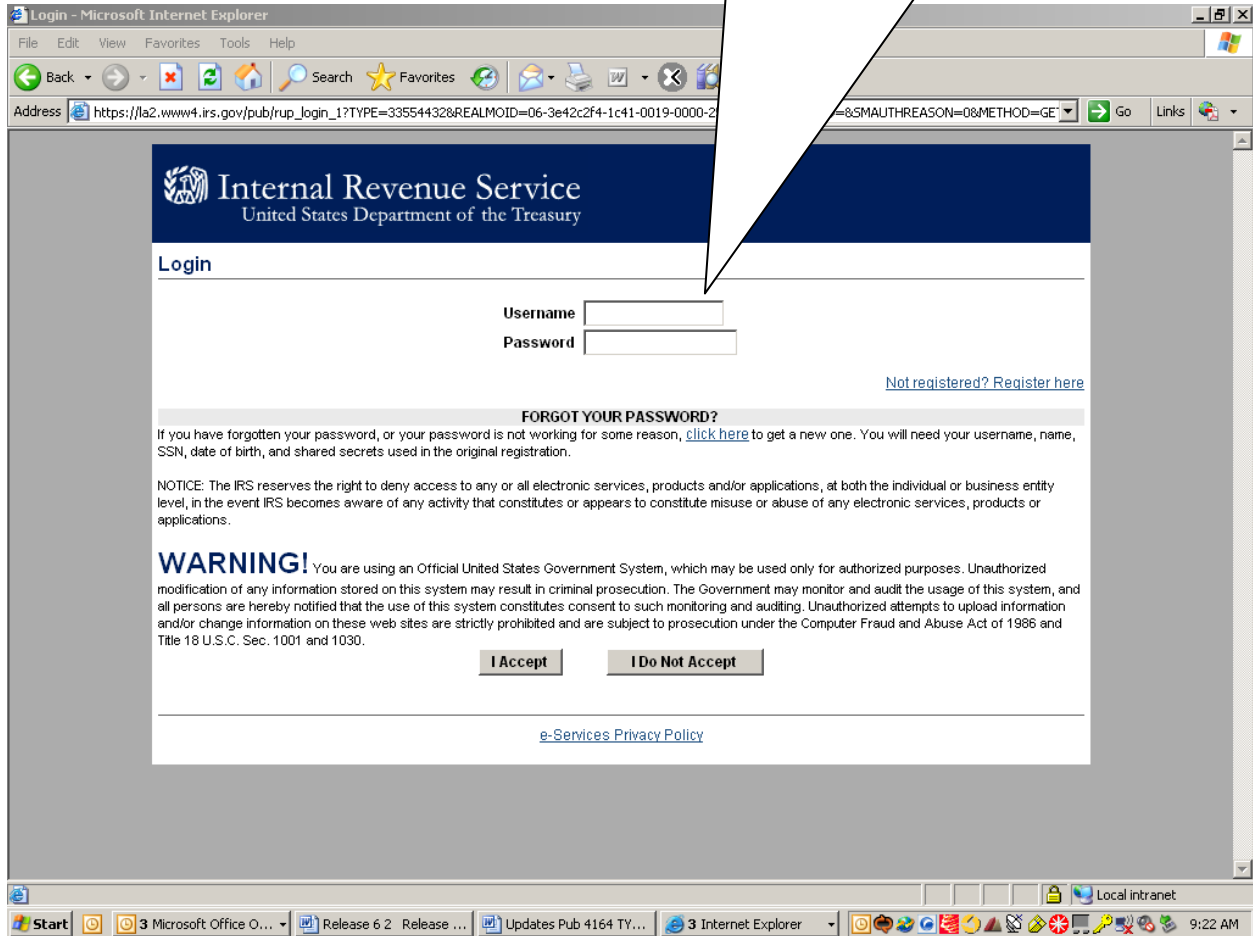

Figure 4-7: e-services Login Screen

Step 8: Select the organization you will represent in the session

Select Organization

Select the organization you will represent in this session:

Each item below represents an organization for which you are authorized to perform work. By selecting an organization, you are logging in as an authorized user of that organization. You will be able to perform work for only that organization.

- Individual**
- BALANCE PERFECTORS INC.** 2821 Duke Street . ALEXANDRIA . VA . 22314
ABC Organization

Submit Selected Organization

[e-Services Privacy Policy](#)

Figure 4-8: Select Organization Screen

After being authenticated, select the organization you will represent in the session from the list of companies that have authorized you to transmit returns on their behalf.

4.2.3 Submitting a Transmission File

After you select the organization you will represent in this session, the MeF Internet Filing Home Page displays. On this page, you can select to:

- Transmit production and test files
- Retrieve production and test acknowledgements
- Retrieve production and test submission status records
- Retrieve production and test 2290 Schedule 1s
- View a list of participating states in the Fed/State program

All tax returns and/or extensions in a transmission file must either be production files or test files. To transmit production or test files complete the following steps:

[Step 1: Select either Transmit Production File link or Transmit Test File link from the MeF Internet Filing Home Page](#)

[Step 2: Select the ETIN](#)

[Step 3: Upload file](#)

[Step 4: View Upload Status Screen Then Close Window](#)

[Step 5: Print or Save Transmission Receipt \(GTX Key\)](#)

[Step 6: Logout of MeF IFA](#)

Step 1: Select either **Transmit Production File** link or **Transmit Test File** link from the MeF Internet Filing Home Page

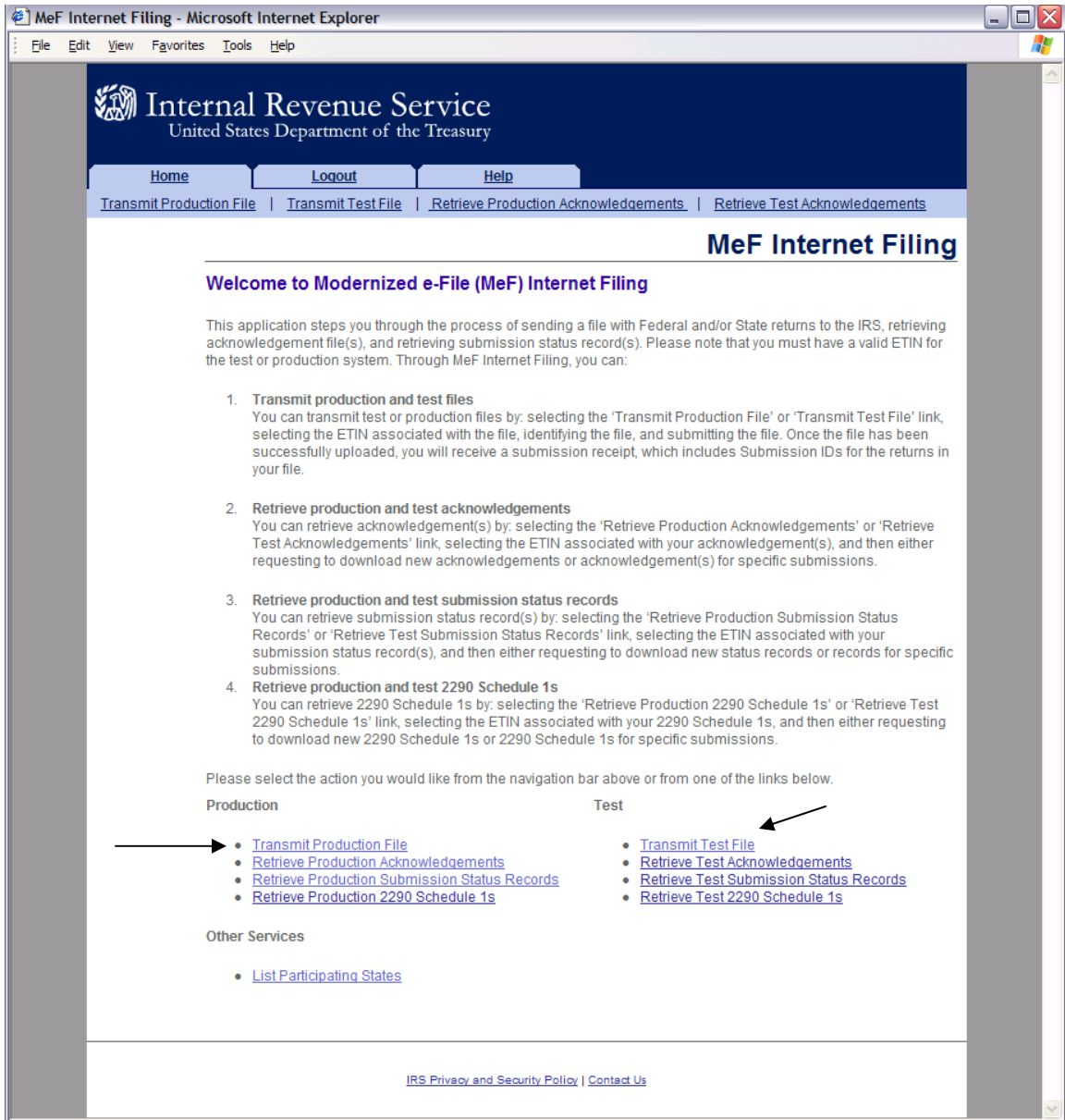
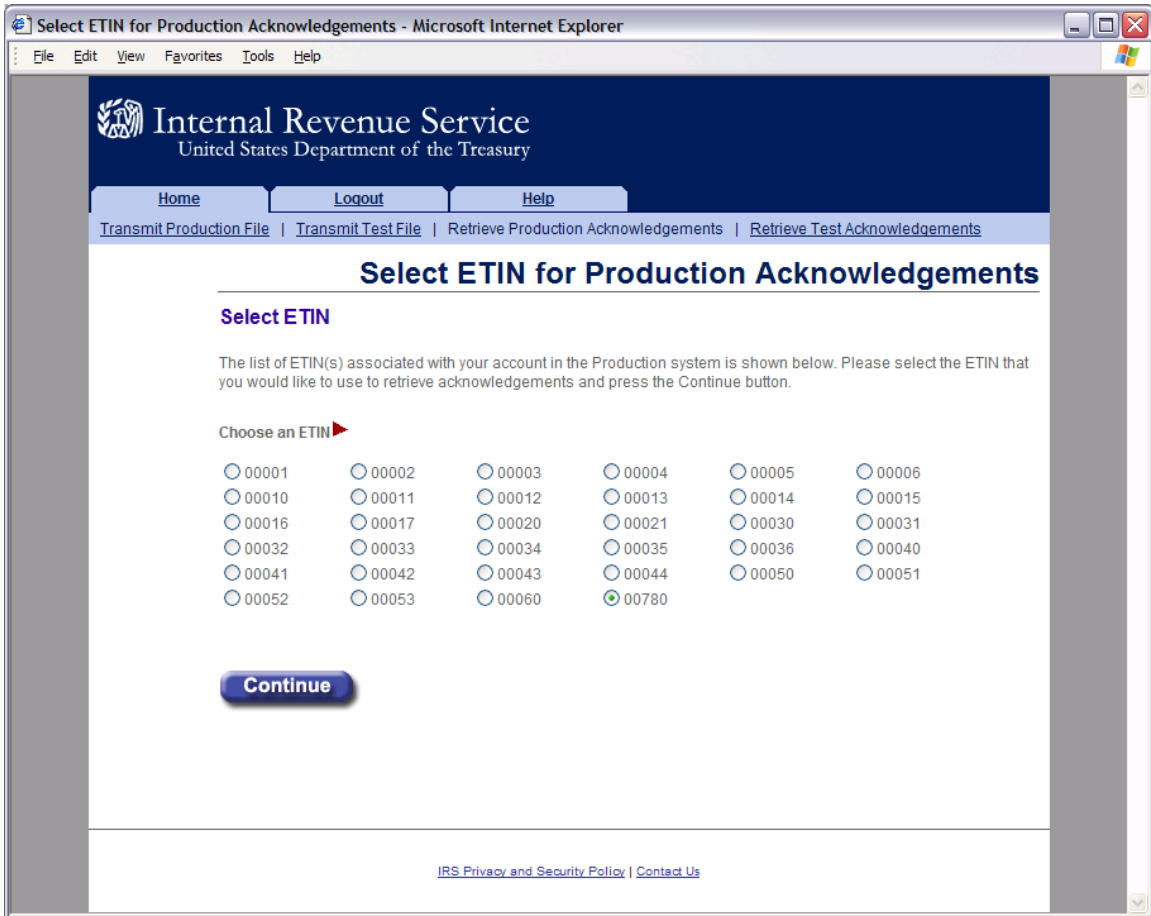

Figure 4-9: MeF Internet Filing Home Page

Step 2: Select the ETIN

The organization for which you are transmitting may have multiple ETINs. Select the ETIN that applies to this transmission. The screen below will display when you select “Transmit a Production File”.



The screenshot shows a web browser window titled "Select ETIN for Production Acknowledgements - Microsoft Internet Explorer". The page header includes the Internal Revenue Service logo and the text "Internal Revenue Service United States Department of the Treasury". Below the header are navigation links: "Home", "Logout", and "Help". A secondary navigation bar contains links: "Transmit Production File", "Transmit Test File", "Retrieve Production Acknowledgements", and "Retrieve Test Acknowledgements".

Select ETIN for Production Acknowledgements

Select ETIN

The list of ETIN(s) associated with your account in the Production system is shown below. Please select the ETIN that you would like to use to retrieve acknowledgements and press the Continue button.

Choose an ETIN ▶

<input type="radio"/> 00001	<input type="radio"/> 00002	<input type="radio"/> 00003	<input type="radio"/> 00004	<input type="radio"/> 00005	<input type="radio"/> 00006
<input type="radio"/> 00010	<input type="radio"/> 00011	<input type="radio"/> 00012	<input type="radio"/> 00013	<input type="radio"/> 00014	<input type="radio"/> 00015
<input type="radio"/> 00016	<input type="radio"/> 00017	<input type="radio"/> 00020	<input type="radio"/> 00021	<input type="radio"/> 00030	<input type="radio"/> 00031
<input type="radio"/> 00032	<input type="radio"/> 00033	<input type="radio"/> 00034	<input type="radio"/> 00035	<input type="radio"/> 00036	<input type="radio"/> 00040
<input type="radio"/> 00041	<input type="radio"/> 00042	<input type="radio"/> 00043	<input type="radio"/> 00044	<input type="radio"/> 00050	<input type="radio"/> 00051
<input type="radio"/> 00052	<input type="radio"/> 00053	<input type="radio"/> 00060	<input checked="" type="radio"/> 00780		

Continue

[IRS Privacy and Security Policy](#) | [Contact Us](#)

Figure 4-10: Select ETIN for Production Transmission File Page

Step 3: Upload file

- (1) Find the file that you want to upload by clicking the Browse button and selecting the appropriate file or by typing in the file name.
- (2) Click the submit button

NOTE: The transmission file is posted using HTTP SSL.

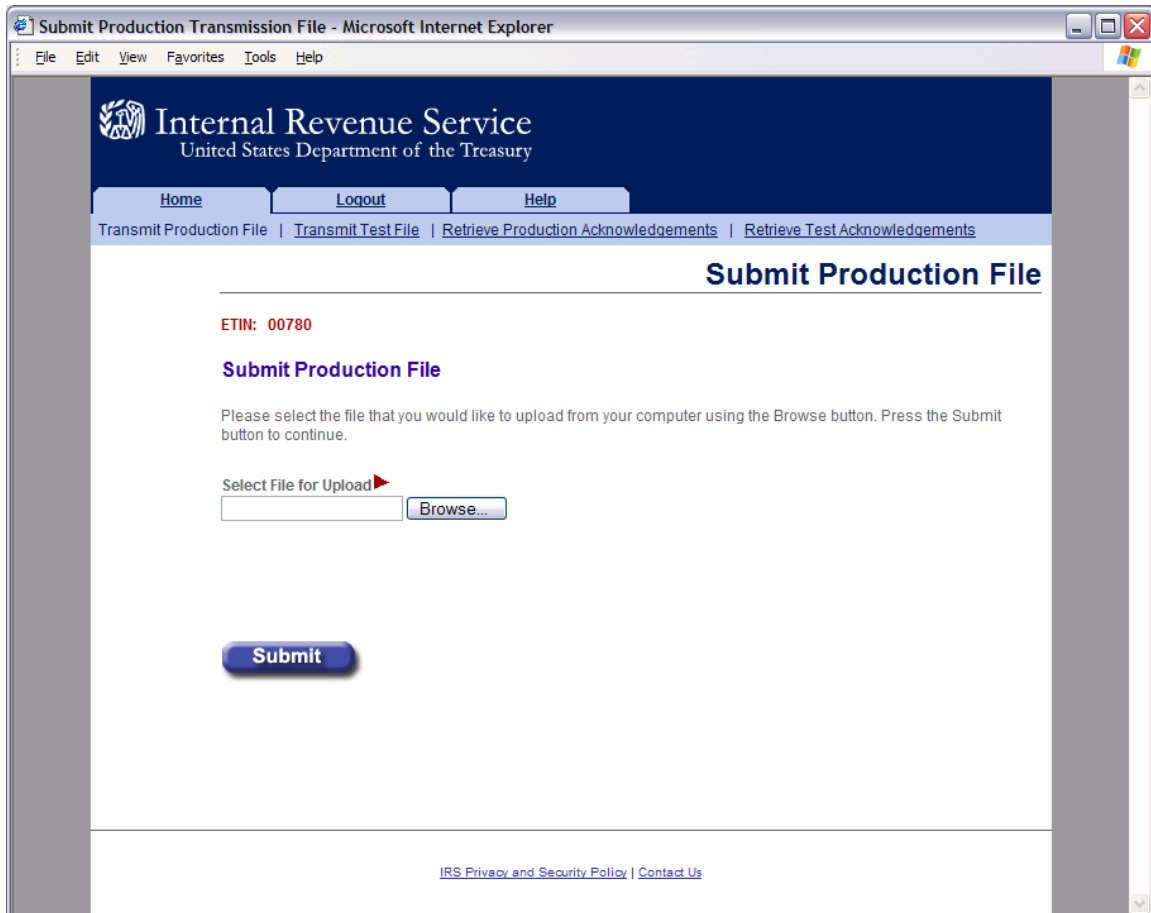

Figure 4-11: Submit Production Message File Page

Step 4: View Upload Status Screen Then Close Window

The system provides you with an upload status page that monitors the progress of the transmission. The window also displays server-side processing steps, which are updated and checked once the processing has been completed: File Upload, Virus Check, and Preliminary Validation.

Three checks are done during Preliminary Validation:

- the ETIN selected matches the ETIN in the transmission header
- the production/test type selected matches the production/test transmission type in the file
- the number of submissions does not exceed the maximum allowed (which is 100).

Once the transmission has finished, the system prompts you to close the window. It is important to note that the browser that generates this pop-up window is locked, preventing you from navigating to other Web pages until the download is complete.

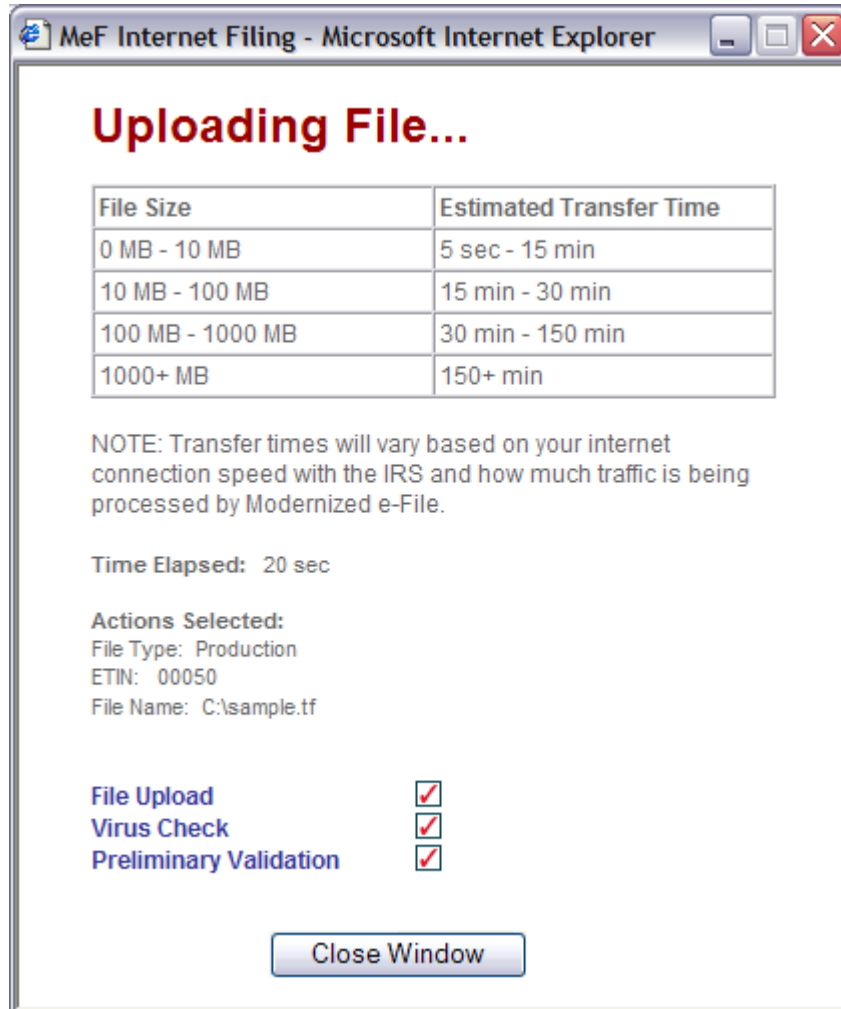

Figure 4-12: Upload Status Screen

Step 5: Print or Save Transmission Receipt (GTX key)

If the file uploads successfully, IFA displays a Transmission Receipt (also known as a GTX Key) containing the Submission IDs for each return in the file. It is highly recommended that you print and retain a copy of this receipt page. This page just indicates that the IRS received the file.

You must wait for the Acknowledgement to determine if the return was actually accepted or rejected. The system completes validation of the file and then generates an Acknowledgement. The size and complexity of the file you submitted, as well as the load on the system, will determine how long it takes for the Acknowledgement to be generated. For information on retrieving your Acknowledgement, go to [Section 6.1](#) of this publication.

Click the Home tab on the navigation bar or click Back to MeF Internet Filing Home to return to the MeF Internet Filing Home page.



Figure 4-13: Submission Receipt Page

Step 6: Logging Out of MeF IFA

To logout of MeF IFA, click the **Logout tab** followed by the Logout button.

Click Home on the navigation bar or click Back to MeF Internet Filing Home to return to the MeF Internet Filing Home page.

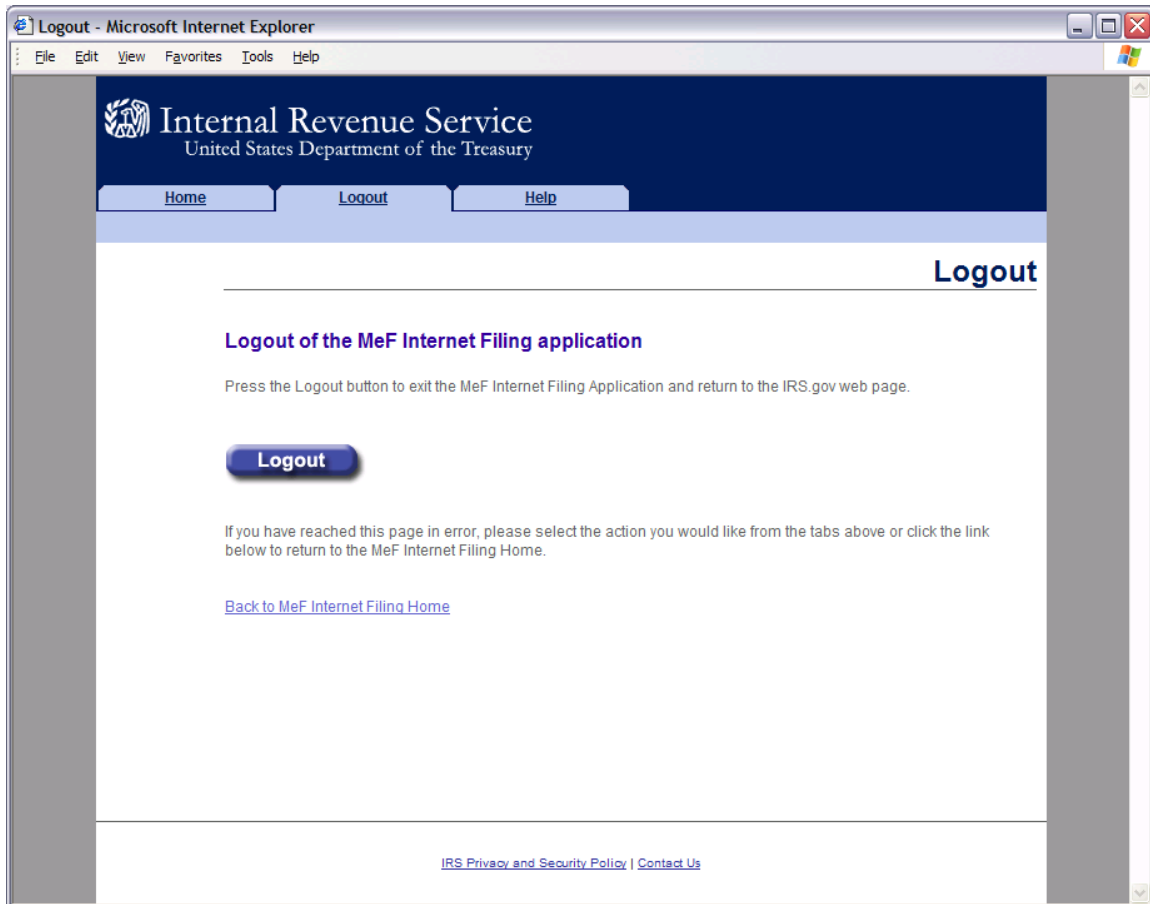

Figure 4-14: MeF Internet Filing Application Logout Page

4.2.4 MeF IFA Error Conditions When Uploading a File

During the process of uploading a file, the transmitter may encounter an error. You may want to print the error page(s) encountered.

The error messages you may encounter are:

- [No ETIN Found](#)
- [Virus Detected](#)
- [File Upload Failed](#)
- [File Error \(Unable to Process XML\)](#)
- [ETIN Mismatch](#)
- [Number of Submissions Exceeds Maximum](#)
- [System Error - Error Not Identified](#)
- [System Error – Error Identified](#)

The MeF IFA Web pages for these error messages are shown in the following pages.

No ETIN Found

If the system does not find an associated ETIN for the status you selected, then the following error message displays. Check that you selected the appropriate link – you may have selected “Production” and only have test ETINs. You may go back to the MeF Internet Filing Home Page or terminate the session.

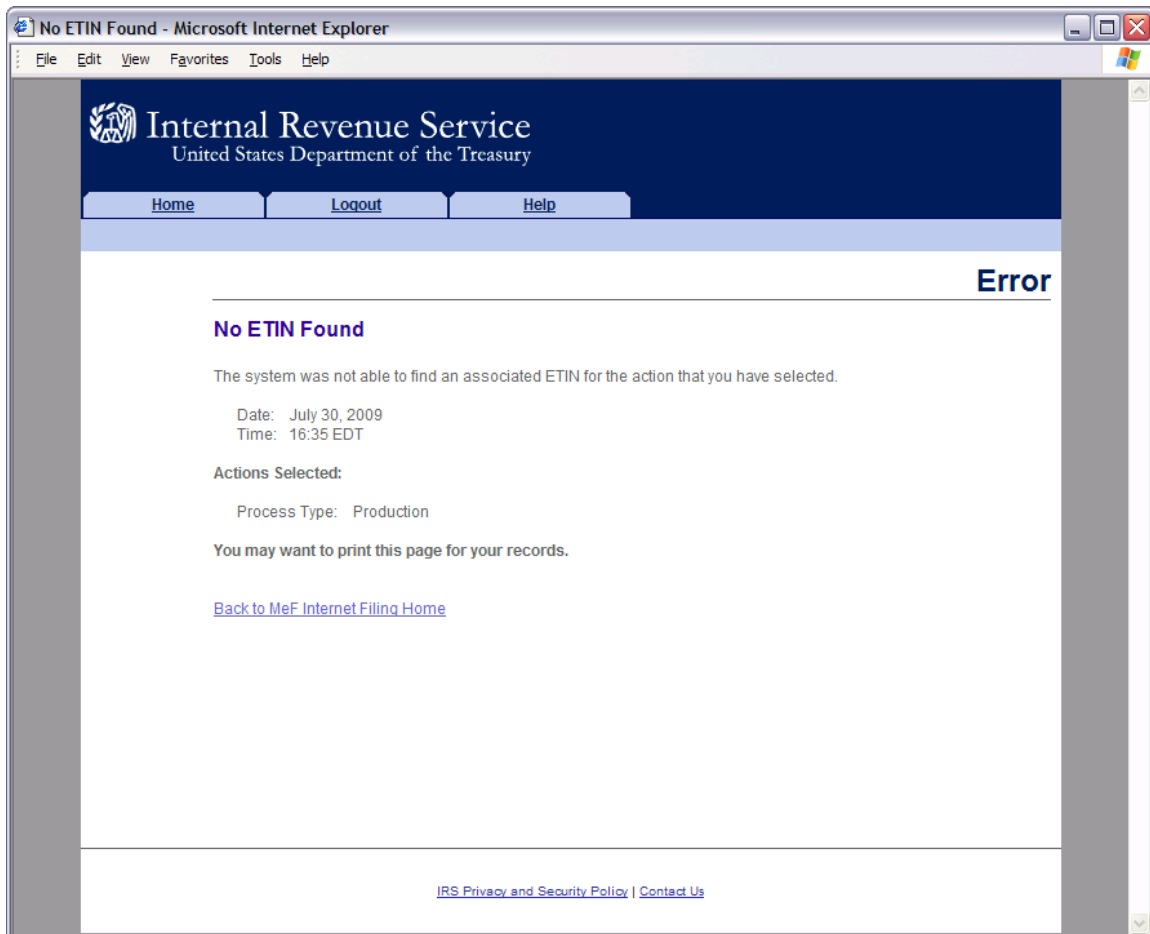

Figure 4-15: No ETIN Found Error Page

Virus Detected

If a virus is detected in the file, the system deletes the file and displays an error screen, which will include the name of the virus. You may go back to the MeF Internet Filing Home Page or terminate the session. (See [Section 4.3](#) for more information on virus detection).

Click the Home tab on the navigation bar or click Back to MeF Internet Filing Home to return to the MeF Internet Filing Home page.

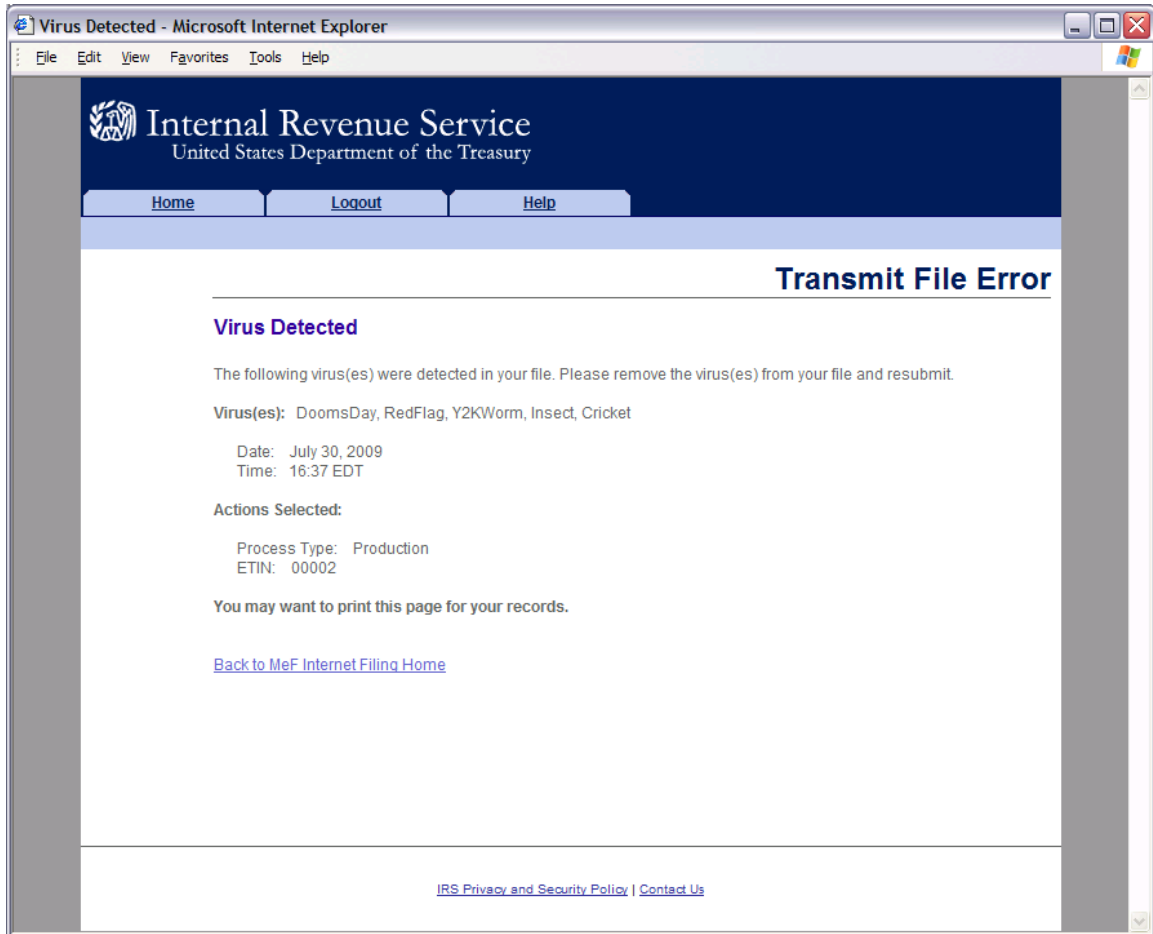

Figure 4-16: Virus Detected Page

File Upload Error Pages

If an “X” is displayed during the file upload process, you will receive an error page. (If a check mark (✓) displays then the upload was successful)

File Upload Failed

When the file upload can't be completed, IFA rejects the file and automatically displays an error page indicating the type of problem encountered.

Click the Home tab on the navigation bar or click Back to MeF Internet Filing Home to return to the MeF Internet Filing Home page.

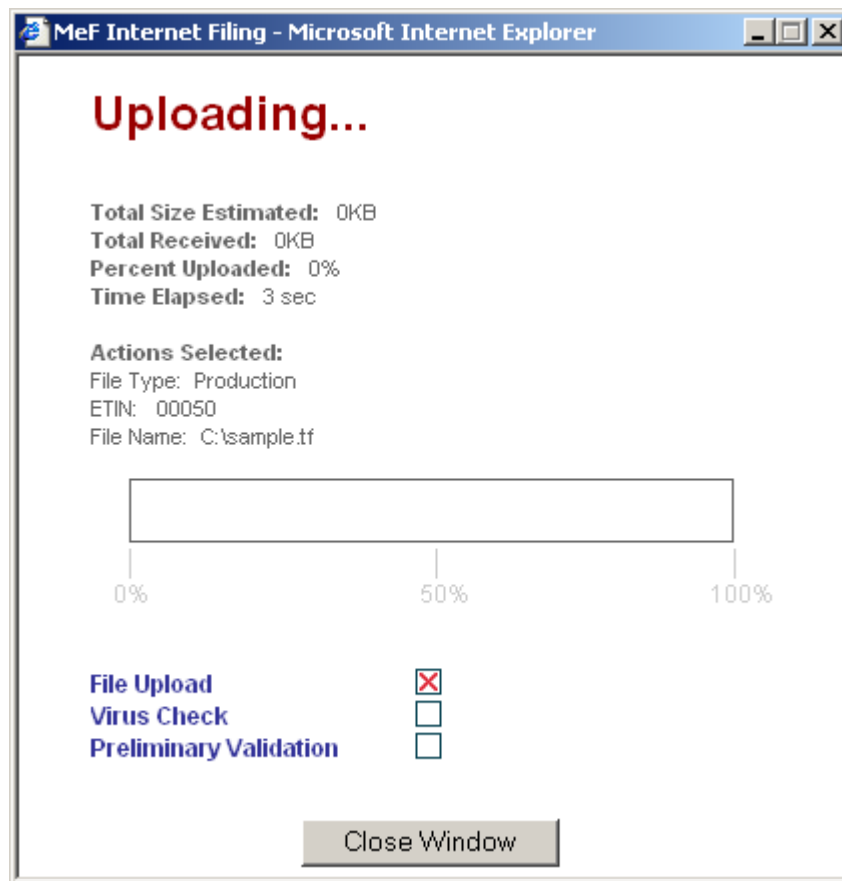

Figure 4-17: Upload Status Pop-up – Unsuccessful File Upload

File Error (Unable to Process XML)

If a successfully uploaded file contains malformed XML (for example, a bracket may be missing, an element may be missing, etc.), the system rejects the file and displays the following error page.

Click the Home tab on the navigation bar or click Back to MeF Internet Filing Home to return to the MeF Internet Filing Home page.



Figure 4-18: File Error Page – Unable to Process XML

ETIN Mismatch

If the user selected ETIN does not match the ETIN in the file, IFA rejects the file and displays the following error message. Check the value for the Selected ETIN and Transmission ETIN to see if there is a mismatch. In the example shown below, the Selected ETIN is 00780 but the Transmission ETIN is 00021 so the transmission was rejected.

Click the Home tab on the navigation bar or click Back to MeF Internet Filing Home to return to the MeF Internet Filing Home page.

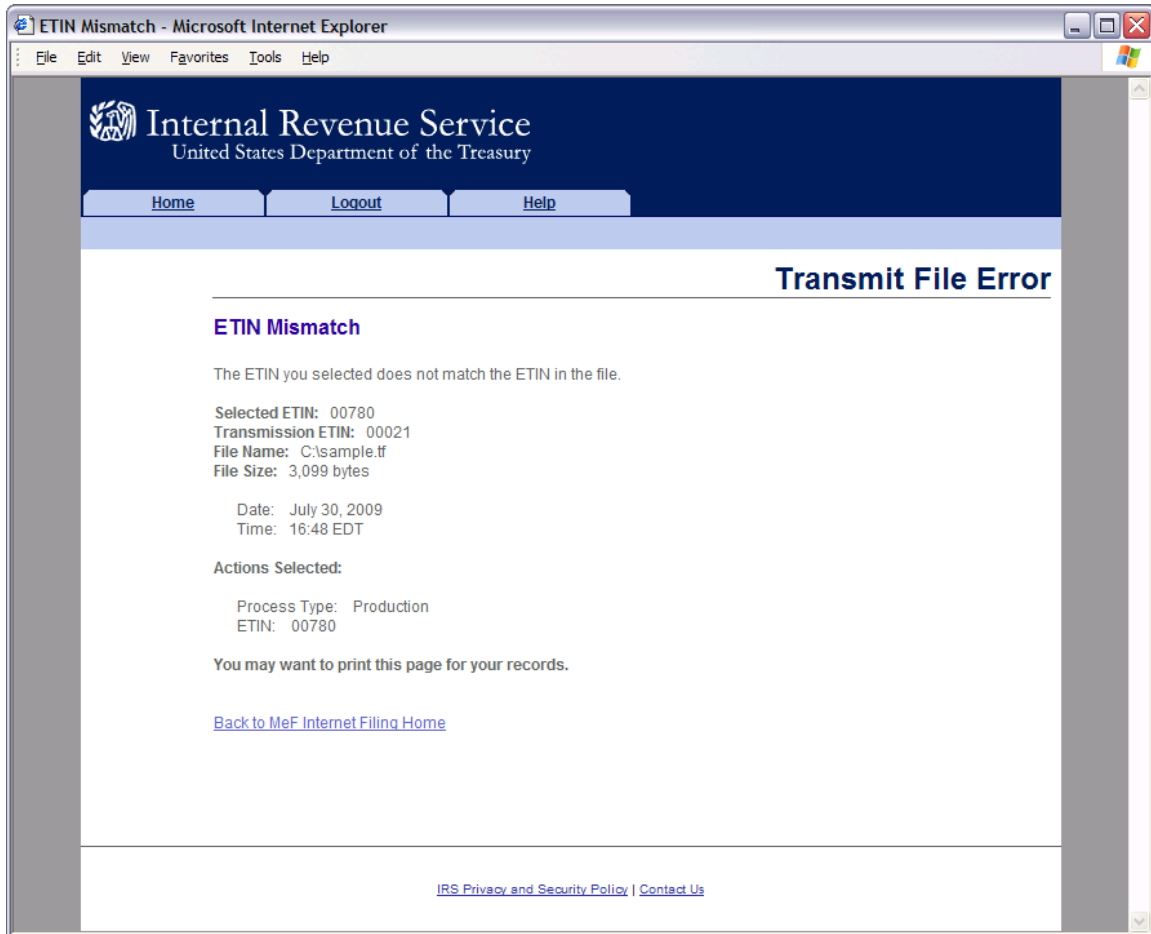

Figure 4-19: Transmit File Error Page – ETIN Mismatch

Number of Submissions Submitted Exceeds Maximum

If the number of submissions within the file exceeds the configurable limit, which is currently set to 100, IFA responds with a SOAP fault indicating that the file exceeded the max number of submissions allowed by the system (100) as shown below.

A SOAP fault indicates an error. The user can rectify a SOAP fault when the SOAP fault is caused by a user action.

Click the Home tab on the navigation bar or click Back to MeF Internet Filing Home to return to the MeF Internet Filing Home page.

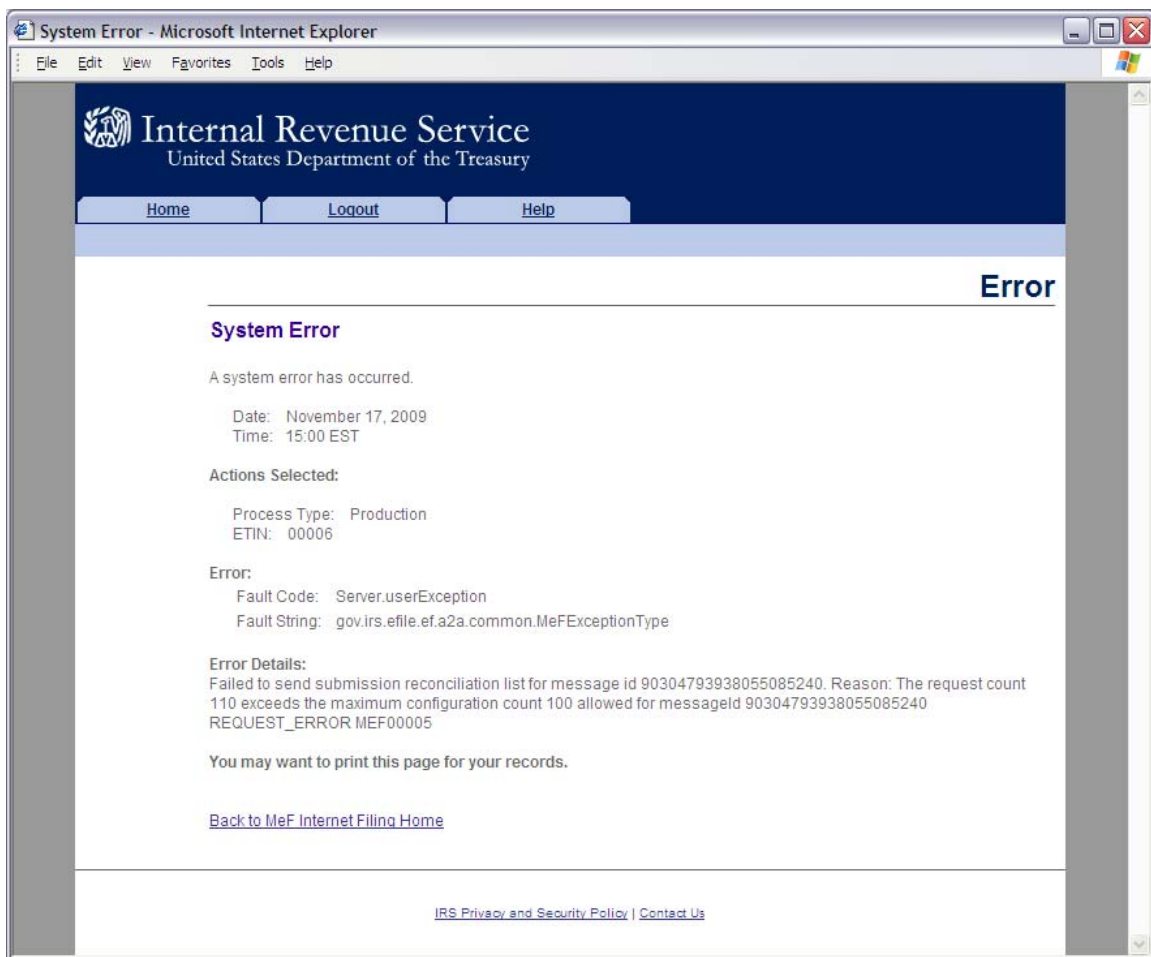

Figure 4-20: Transmit File Error Page – Number of Submissions Exceeds Maximum

System Error (Transmit) – Error Not Identified

If the system encounters a problem and cannot transfer and store the file, the system displays the following error message and asks the transmitter to resubmit the transmission file. Call the e-help Desk (1-866-255-0654) if you continue to receive this message. You may want to print this page for reference.

Click the Home tab on the navigation bar or click Back to MeF Internet Filing Home to return to the MeF Internet Filing Home page.

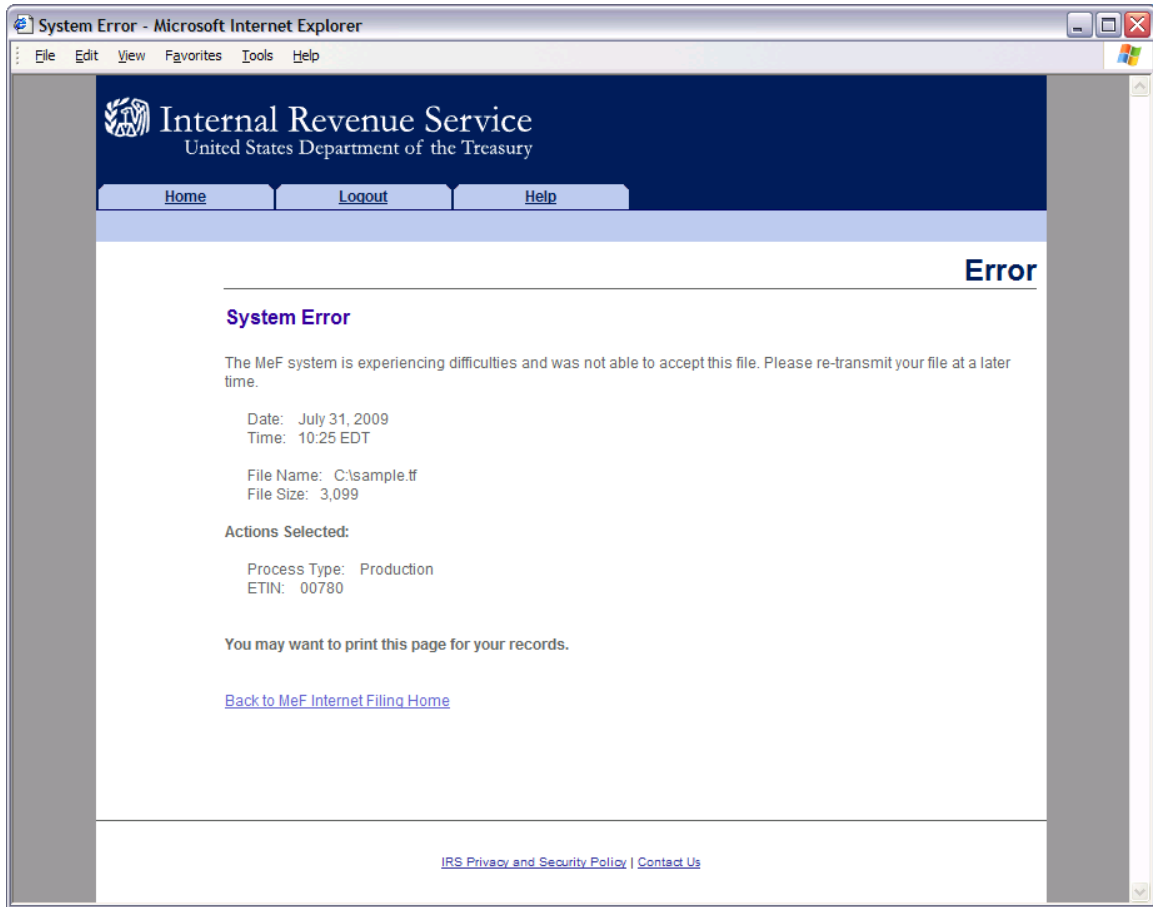

Figure 4-21: Error Not Identified

System Error (Transmit) – Error Identified

The error page below displays errors that occur when a file has been transmitted and the system is able to specify the error that occurred.

Click the Home tab on the navigation bar or click Back to MeF Internet Filing Home to return to the MeF Internet Filing Home page.

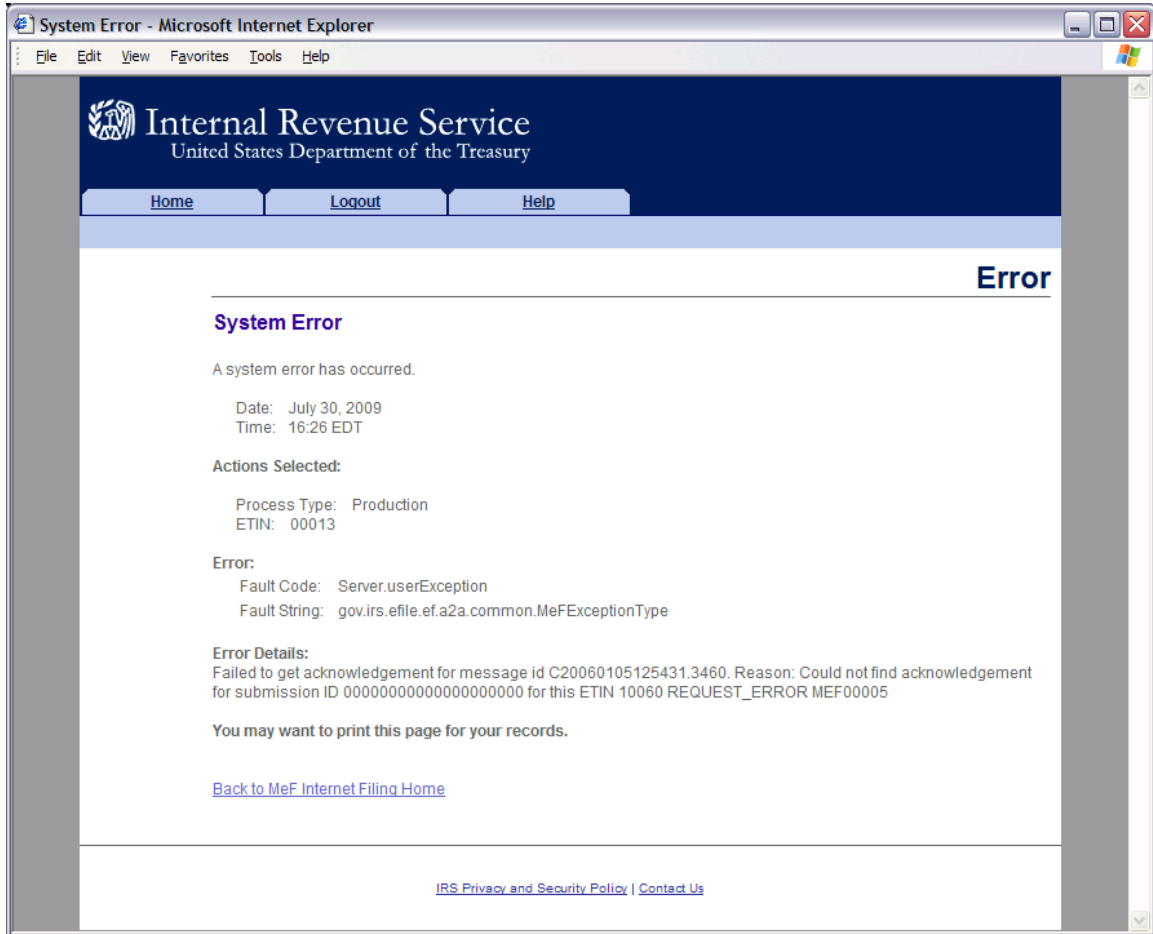

Figure 4-22: System Error Page with Error Specified

4.2.5 Help Tab

Click the Help tab to access the MeF Internet Filing Help page. This page provides the phone numbers to call if you are experiencing problems. It also lists the names of all of the MeF publications.

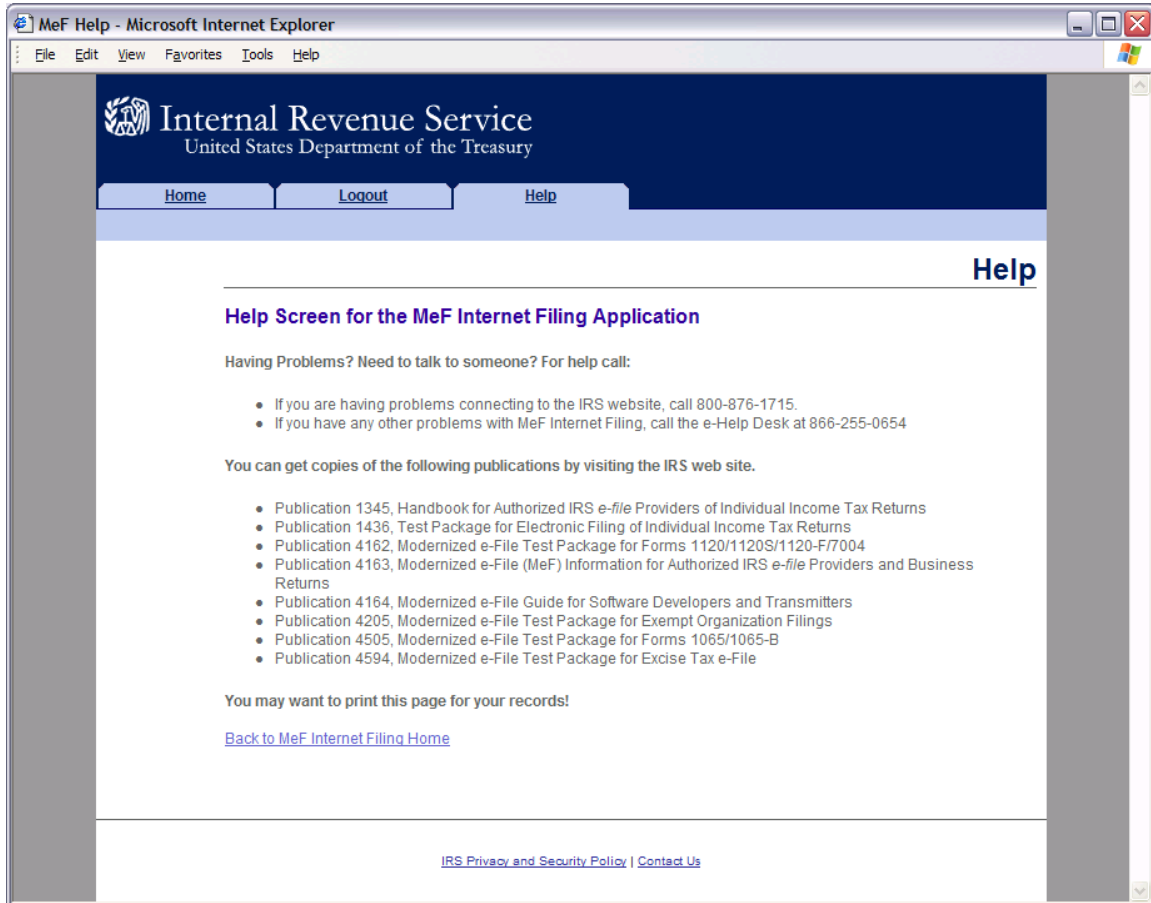

Figure 4-23: Help Screen for the MeF Internet Filing Application

4.2.6 Browsers and Operating Systems

The client-side browsers and operating systems that will be supported are listed in the following table.

BROWSER/PLATFORM	Windows XP Professional	Windows 2000 Professional
IE 8.0	Yes	Yes
Netscape 8.0	Yes	Yes
Mozilla 1.7	Yes	Yes
Firefox 5.x	Yes	Yes

4.3 Detecting Viruses in MeF Transmissions

4.3.1 Through Internet Filing

All files being transmitted through IFA will be scanned for viruses. In the event the system detects a virus in the transmission file, the following steps will be taken:

- The transmission will be rejected and an error screen with the message “Virus Detected” will be displayed.
- The session will be terminated.
- The Transmitter must remove the infected data and then call the IRS e-help Desk at 1-866-255-0654 when they are ready to retransmit.

Please refer to Section 4.2.4, Figure 4-16, which shows the error screen that will be displayed.

4.3.2 Through Application-to-Application (A2A)

All files being transmitted through A2A will be scanned for viruses. In the event the system detects a virus in the transmission file, the following steps will be taken:

- The transmission will be rejected and an error response will be returned.
- The Transmitter must remove the infected data and then retransmit the file.

5 Validating the Transmission and Return Data

This section explains how MeF will perform validations of the transmission and return data through business rules, schema validations, SOAP envelope validation and Transmission Header and Manifest validation.

5.1 Business Rules (Categories/Severity)

The following section describes the business rules used in MeF. To the extent possible, the MeF business rules have been standardized across all tax returns currently available in MeF. As additional tax returns migrate to the modernized architecture, the associated business rules for those returns will be rewritten to maintain the standardization across all form types.

Business rules for the MeF forms will be posted to the IRS.gov. You can access these business rules by selecting the appropriate form type on IRS.gov at:

<http://www.irs.gov/efile/article/0,,id=171950,00.html>.

The MeF business rules were written to be atomic; that is, they focus on one condition rather than more than one. They also do not reference legacy e-file sequence numbers, but reference form and line numbers and element names. A crosswalk of the legacy e-file error reject codes to the MeF business rule numbers was developed for the Form 1040 family returns and a crosswalk was developed for all ETD forms. The crosswalks can be found by selecting the appropriate Tax Year on IRS.gov at: <http://www.irs.gov/efile/article/0,,id=209615,00.html>

The following error information will be provided in your business rule acknowledgement file:

1. **Rule Number** - Each MeF business rule has a number that uniquely identifies the business rule within the MeF system. The rule number consists of a letter identifying the type of return document the rule applies (form, return, transmission, schema, schedule, payment), the form number that owns the rule, followed by the number of the rule within the form.

<i>Identifier</i>	<i>Rule Type</i>
FPYMT	Payment
F	Form
IND	Individual
R	Return
STATE	State
S	Schedule
T	Transmission
X	XML

2. **Error Message** - This element provides the description of the rule.

3. **Error Category** - All MeF business rules are divided into 12 error categories. The following eight categories validate the XML data:

- **Multiple Document** – more than the required number of documents are included in the tax return. The maxOccurs attribute in the ReturnData restricts the allowable number of the XML document within the tax return. In the cases where the number of documents is restricted by form and/or line, the number of times the XML document can occur will be restricted by a business rule and the maxOccurs in the ReturnData will be set to ‘unbounded’.
 - For example, only one Form 3468 can be attached to each 1120 and 8865. Since more than one 8865 can be attached to the tax return, more than one 3468 may exist in the tax return. Therefore, in the ReturnData1120, maxOccurs=”unbounded” and a business rule for each form will exist restricting the number of 3468s that can be attached to each form.
- **Missing Document** – a tax return document is required but was not included in the tax return.
- **Data Mismatch** – the data in two fields should be the same but is not. For example, if Form 1120, Line D does not equal Form 1120, Schedule L, Line 15d, then you will receive error F1120-258:
 - If Form 1120, Schedule L is present, Form 1120, Item D “Total Assets” must equal Form 1120, Schedule L, Line 15d.
- **Duplicate Condition** – the tax return or the transmission file was previously received and accepted by the IRS.
- **Math Error** – the result of a computation is incorrect.
- **Incorrect Data** – data violates a business rule even though it is syntactically correct. That is, the data values for elements must conform to the format specified and the data type. Also, the data values for elements must contain only values allowed for them in the schema. For example:

If a payment is submitted with the return, and the IRS Payment record indicates the Taxpayer’s Daytime phone number is 0000000000, then you will receive error FPYMT-018:

Taxpayer’s Day Time Phone Number in IRS Payment Record cannot equal all zeros.

- **Missing Data** – data is not provided for a required field.
- **Database Validation Error** – data provided does not match the IRS database or the data provided should be present in the IRS database but is not. For example, the Electronic Filer Identification Number (EFIN) in the Return Header must be listed in the MeF database and in accepted status.

The following are the remaining three categories for all return types:

- **XML Error** – the data violates Schema specification. The return and transmission documents must conform to the version of the XML schema they specify.
- **System Error** – a return encounters a problem with the IRS systems that prevents the return from being processed electronically.
- **Unsupported** – a submitted item(s) is sent to a location that does not accept it or an unusual condition is encountered in the data.

The following apply to extension Forms 2350, 4868, 7004 and Form 8868:

- **Not On Time** – a document is received after the due date.

4. **Severity** - When a business rule is violated, one of the following severity levels will be issued:

- **Reject** – the tax return is rejected; however, MeF will continue processing the tax return until 100 errors have occurred. You will need to send the tax return again with the errors corrected.
- **Reject and Stop** – this severity type will stop processing the return when this reject is encountered.
- **Alert** - This severity does not cause the return to reject. Information is being provided to the taxpayer about a condition in the return but the return does not reject because of that condition.

5. **Data Value** - Data value causing the violation - when appropriate.

Business Rules for Consolidated Returns

Conformance with XML schemas (format checks) will be performed at all levels of a consolidated return: top-level consolidation, parent return and all subsidiary returns. However, business rules are enforced only at the top level consolidated return. As an example, business rule SN-F1120-001 states “If Schedule N (Form 1120), Line 4a, has a choice of ‘Yes’ indicated, then Form 5471 must be attached.” MeF will look for the Form 5471 to be attached to the top-level consolidated 1120. If Form 5471 is attached to a Parent or Subsidiary return, the validation will not pass, and a reject with rule SN-F1120-001 will be returned in the acknowledgement file.

5.2 Validating Transmission File

Once the transmission file is received from IFA or A2A, the MeF system must validate the transmission header before it validates the returns inside. Transmission validation consists of two parts:

- **SOAP envelope validation.** SOAP envelope validation ensures transmission file format integrity and that the SOAP header, body, and MIME segments exist and are located in the proper place. If transmission file fails SOAP envelope validation, the entire transmission, including all returns, is rejected.
- **Transmission/Message Header and Manifest validation.** The transmission/message header provides some summary information about the file, such as Transmission ID, Message ID, ETIN, and timestamp.

Note: The time zone component of the timestamp element is a required data element in the Transmission Manifest. Where there is a timestamp element there must be a time zone component included.

The SOAP header and transmission manifest in the SOAP body are constructed correctly based on the A2A WSDL definition. For IFA, it's the structure contained in the MeF Submission Composition Guide.

The manifest contains the submission count and SubmissionId of each submission in the transmission file. The Submission ID:

- should not be a duplicate of another SubmissionId
- should contain the Electronic Return Originator's EFIN
- EFIN should be the same as the EFIN in the return header.
- YYYY in the SubmissionId must be the current Processing Year. Any submission sent to the IRS in 2012 must have "2012" in the "YYYY" value of the SubmissionId.

Note - When a transmission is rejected, you will not receive an acknowledgement for individual submissions within the transmission. All submissions must be resubmitted.

MeF validates the transmission header against business rules. Below are samples of transmission validation business rules. The complete list of business rules is found on each form's respective IRS.gov Web site shown below.

Transmission Validation Business Rules

***Note:** The Tax Type includes all MeF forms (720, 2290, 8849, 1040, 4868, 1120, 1120-F, 1120S, 990, 990-EZ, 990-N, 990-PF, 1120-POL, 8868, 7004, 1065, 1065-B)

Rule Number	Rule Text	Error Category	Severity	Tax Type
T0000-014	The Submission ID must be globally unique.	Incorrect Data	Reject And Stop	*See Note
T0000-900	Transmission can not be a duplicate of a previously accepted transmission.	Duplicate Condition	Reject and Stop	*See Note

You can access the complete list of validation rules for the transmission header and manifest for each form on IRS.gov at: <http://www.irs.gov/efile/article/0,,id=171950,00.html>.

If the transmission file (SOAP envelope, header and manifest) passes the validation check, the transmission is accepted and the system begins validating the returns contained in the transmission.

It is important that you run your transmission file through a validating parser to find any errors before transmitting.

5.3 Validating Tax Returns

Once the transmission file passes validation, the MeF system validates the submissions contained in the file. Submission validation consists of two parts: schema validation and business rule validation.

5.3.1 Schema Validation

IRS recommends each return be run against a validating parser prior to being submitted to IRS. This pre-validation is intended to identify the majority of potential error conditions and minimize the chance of receiving errors. A parser compares the XML document to the defined elements and attributes of the schemas to ensure a well-formed document is transmitted. Schemas provide the basic definition for elements –field length, data type, allowable values, etc. Data integrity depends on each data element complying with the data format specifications. If the tax preparation software uses the IRS-defined XML schemas to create the XML tax return, there should be no data format errors in the return. The MeF system verifies this by validating each return in the transmission file against the schemas.

Note: When an error is found during schema validation, processing stops once schema validation completes. No Business rules will be applied to the submission, and if the error is found in the manifest, the submission (xml archive) will not be schema validated either.

Below are samples of schema validation business rules. The complete list of business rules is found on each form’s respective IRS.gov Web site shown below.

Note: The Tax Type includes all MeF Forms (720, 2290, 2350, 56, 8849, 1040, 1040A, 1040EZ, 1040-SS, 1040-PR, 4868, 1120, 1120-F, 1120S, 990, 990-EZ, 990-N, 990-PF, 1120-POL, 8868, 7004, 1065, 1065-B), 9465

Schema Validation Business Rules

Rule Number	Rule Text	Error Category	Severity	Tax Type
X0000-005	The XML data has failed schema validation.	XML Error	Reject And Stop	*See Note above
X0000-010	For each SubmissionId provided in the transmission manifest there must be a submission zip archive entry present in the Attachment Zip file whose name (without the “.zip” extension) matches the SubmissionId.	Incorrect Data	Reject And Stop	*See Note above
X0000-029	A binary attachment submitted in the PDF format must begin with the file header “%PDF-“.	Incorrect Data	Reject and Stop	*All MeF Forms except 990-N , 2350, 4868, 56, 9465
X0000-030	The size and CRC32 checksum value must be provided for the submission XML file (i.e. xml data file that starts with “xml/” or “/xml/”	Incorrect Data	Reject and Stop	*See Note above

You can access the schema validation business rules on IRS.gov at:
<http://www.irs.gov/efile/article/0,,id=171950,00.html>.

For more information regarding validation of the return against the XML schemas, refer to Appendix A of the MeF Submission Composition Guide.

5.3.2 Business Rule Validation

The MeF system uses a business rule engine to validate returns against the rules. When a rule with severity “reject and stop”, or “reject” is violated, an error is generated. Errors result in a rejected return. As submissions are validated, the acknowledgements are made available to the transmitter for retrieval.

When a rule with severity "reject and stop" is violated, processing is stopped so there may be additional errors in the file that have not been identified. The return acknowledgement contains an element called "CompletedValidation". If a rule with severity "reject and stop" is violated, then the value in this field of the acknowledgement file will be "No".

Below are samples of return validation business rules. The complete listing of business rules can be found by selecting the appropriate form type on IRS.gov:

<http://www.irs.gov/efile/article/0,,id=243254,00.html>

Note: Rules that begin with STATE are rules that support the Fed/State submission.

Return Validation Business Rules

Rule Number	Rule Text	Error Category	Severity	Tax Type
R0000-075	The Routing Transit Number (RTN) must conform to the banking industry RTN algorithm.	Incorrect Data	Reject	720, 2290, 990-PF, 1120-POL, 1040, 1040A, 1040EZ, 1040SS, 1040PR, 2350, 4868, 1065, 1065-B, 1120, 1120-F, 1120S, 4868, 7004, 8868,
R0000-904	Software ID in the Return Header must have passed testing for the form family and Tax Year.	Database Validation Error	Reject And Stop	720, 2290, 990, 990-EZ, 990-N, 990-PF, 1120- POL, 1040, , 1040A, 1040EZ, 1040SS, 1040PR, 2350, 4868, 1065, 1065-B, 1120, 1120-F, 1120S, 4868, 7004, 8868
STATE-007	The IRS Submission ID referenced in the State Submission must be that of an IRS Return.	Incorrect Data	Reject	1040, , 1040A, 1040EZ, 1040SS, 1040PR, 990, 990-EZ, 990-PF, 1065, 1065-B, 1120, 1120-F, 1120S

5.3.3 Checksum and Data Values Returned in the Acknowledgement File

When a zip archive tool compresses files and directories into a zip file, it computes a checksum for each zip entry and includes it in the zip file. It is important to note that the checksum of a file zip entry is the checksum of the file before it is compressed. The IRS will use the 32-bit Cyclic Redundancy Code (CRC32) checksum algorithm, as supported by WinZip, PKZIP, PKWare3.0 and GZIP.

This example illustrates where the CRC32 value can be found in the zip archive file. The zip archive tool compresses the following files and directories into a *sample1.zip* file using WinZip:

- /manifest/
 - manifest.xml
- /xml/
 - 1120S.xml
- /attachment/
 - 8453 Signature Document .pdf
 - CertifiedHistoricStructuresSch.pdf

The CRC32 values for the *1120S.xml* file can be found:
WinZip Classic → File → Properties → Details

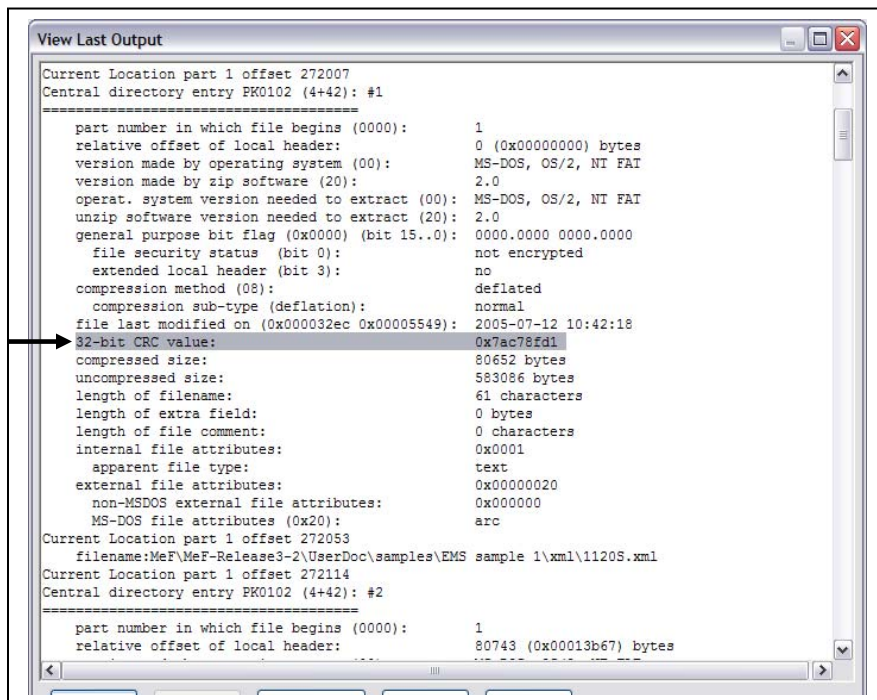

Figure 5-1: CRC Value in the Zip Archive File

The value “0x7ac78fd1” is a hexadecimal number of 32 bits long (the corresponding decimal integer is 2059898833).

The MeF system will only compute the checksum in the XML submission archive file. The checksums of the other zip entries such as the *manifest.xml* file and PDF binary attachments will not be computed and reported.

1. The MeF system will retrieve the CRC32 checksum value of the submission XML file zip entry and return it in the acknowledgement file as the <EmbeddedCRC32>.
2. The MeF system will compute the CRC32 checksum value of the submission XML file to verify that the computed value is the same as the one embedded in the zip file.

The taxpayer compares the <EmbeddedCRC32> element with the <ComputedCRC32> element to ensure that the file the IRS received is the same size as the file the taxpayer sent. If there are any discrepancies, the taxpayer needs to contact the transmitter to see if the file was changed before transmission.

5.4 Status Record for Federal Returns

While the federal return is being processed, the transmitter can request the status of the submission. In A2A, the Status Record is retrieved by service requests Get New Submission Status, Get Submission Status or Get Submissions Status. In IFA, the Status Record is retrieved by selecting the Retrieve (Production or Test) Submission Status Records option.

Below are the values and their descriptions included in the Status Record for federal returns. See Section 3.4.2 Status Record for State Returns for additional information.

Status Name	Description
ACKNOWLEDGED	The MeF system has created an acknowledgement for the federal submission.
ACKNOWLEDGEMENT RETRIEVED	The acknowledgement for the federal submission has been retrieved by the transmitter.
RECEIVED	The MeF System has received the federal submission.

Here is an example of the statuses provided for a federal return:

Submission Status History:

Submission Status	Status Date ▼	Status Record Retrieval Date
Acknowledgement Retrieved	2009-11-03	2009-11-03
Acknowledged <input type="text"/>	2009-11-03	2009-11-03
Received	2009-11-02	2009-11-03

The Status Record is not proof a return was accepted or rejected. The Status Record above only indicates a submission was received and an acknowledgement was generated and retrieved. The following statement has been added to the Status Record:

This status record provides information about what step in the process the return has completed. It is not proof that the return was Accepted or Rejected. You must retrieve the Acknowledgement File and keep with the return records to prove the return was Accepted or Rejected.”

5.5 Acknowledgement Schema

The acknowledgement schema is shared among all MeF forms and extensions; however, certain elements are form-specific and will not be generated in every instance. The table below explains some of the elements in the acknowledgement and the MeF forms to which they apply:

Element Name	Form	Explanation
AcceptanceStatus	All	<p>1) The value returned for all business returns, business extensions and Form 4868 is “Accepted” or “Rejected.”</p> <p>2) The value returned for Form 1040 family is “Accepted”, “Rejected” or “Exception”</p> <p>a) The “Exception” status indicates the return has:</p> <ul style="list-style-type: none"> • rejected previously with either Business Rule SEIC-F1040-501 and/or R0000-504 • invalid data based on these business rules in the subsequent submission • the ImperfectReturnInd checked on the subsequent submission <p>IRS will continue to process this return, and a math notice error will be sent to the taxpayer advising of any changes made as a result of this exception processing. These returns will be processed in 4 to 6 weeks from the date of acceptance.</p> <p>DO NOT RESUBMIT THE TAX RETURN or FILE ON PAPER</p> <p>b) For all MeF returns, the value of “Accepted” indicates the return is accepted as a filed tax return and will be processed. This does not mean the return will pass all validity checks or post to IRS Master File without delays.</p>
TIN/Temp ID	All	<p>“TIN” = Taxpayer Identification Number. TIN represents both “SSN” (Social Security Number) and “EIN” (Employer Identification Number)</p> <p>“Temp ID”= Alphanumeric element. The Temp ID is used by some states.</p>
ReservedIPAddressCd	Form 1040	<p>The value “R” is returned when a reserved IP address is present in the return. The Transmitter should take steps to understand why a reserved IP address was captured and what can be done to prevent this in the future.</p>

Element Name	Form	Explanation
DateOfBirthValidityCd	Form 1040 and 4868	The date of birth validity code is only returned when the PIN Type code = Self-Select Practitioner. The values are: <ul style="list-style-type: none"> • "0" = Date of Birth Validation Not Required • "1" = All Dates of Birth Valid • "2" = Primary Date of Birth Mismatch • "3" = Spouse Date of Birth Mismatch • "4" = Both Dates of Birth Mismatch
PINPresenceCd	Form 1040	The PIN presence code is returned for accepted or exception returns. The values are: <ul style="list-style-type: none"> • "Practitioner" • "Self-Select Practitioner" • "Self-Select On-line"
ITINMismatchCd	Form 1040	The value "M" is returned if the primary taxpayer has an Individual Taxpayer Identification Number (ITIN) and there is a valid SSN on a Form W-2.
CompletedValidation	All	The completed validation codes returned are: <ul style="list-style-type: none"> • "Yes" if the validation completed successfully • "No" if the validation failed with a Reject-Stop error.

To provide taxpayers with the assurance that the return the IRS received is the same return as the one the taxpayer believes was sent to IRS, the MeF system will report certain form entries in the acknowledgement: taxable income, total tax, net income (loss), balance, expected refund or balance due. This data will only be returned on the acknowledgement of the applicable form type. The taxpayer will need to check the data in the acknowledgement file against what they think was sent to the IRS to ensure that the file the IRS received is correct.

Element Name	Form	Explanation
TaxableIncome	Form 1120, 1120S and 1120-F	The taxable income from Form 1120 and 1120-F will be returned. The data from Form 1120S, Line 6 (Total income (loss)) will be returned as taxable income for Form 1120S.
TotalTax	Form 1120, 1120S and 1120-F	The total tax from Form 1120 and 1120-F will be returned. The data from Form 1120S, Line 22c will be returned as total tax for Form 1120S.
NetIncomeLoss	Form 1065 and 1065-B	The data from the NetIncomeLoss field of the AnalysisOfNetIncome LossType will be returned for both Forms 1065 and 1065-B
ExpectedRefund Or BalanceDue	Form 1040	If the return contains an expected refund, the ExpectedRefund element and amount will be returned. If the return contains a balance due, then the BalanceDue element and amount will be returned. If the return has zero or no entry for these fields, then neither element is included. Note: The amount returned as the "expected refund" does not mean this is the refund amount IRS is issuing to the taxpayer. The return will go through further processing after the acknowledgment is issued and the refund may be adjusted. The taxpayer will be notified if the refund has been adjusted.

The return acknowledgement will include the submission ID, return TIN (Taxpayer Identification Number), return type (since a transmission can include a combination of any of the MeF return types), and the acceptance status (see table on previous page). If the return is rejected, it will include the first 100 errors that were found. Each error generated contains the following information:

DocumentId – identifies in which form/schedule within the return the error occurs

Path - (Xpath) to the data element causing the violation, when available

Error Category - Errors are grouped into a small number of categories

Error Message - Rule text or XML validator message

Rule Number - Each rule is identified by a unique rule number

Severity - 'Reject And Stop' or 'Reject'

Data value - Data value causing the violation - when appropriate

MeF will generate “Alerts” when there is an issue that needs to be brought to the attention of the taxpayer. Alerts will be included in the acknowledgement file of accepted returns or rejected returns.

5.6 Generating Acknowledgement Files

Once the transmission is received, the MeF system responds within seven minutes with a receipt for the submissions contained in the transmission or an error explaining what was wrong with the transmission. For receipted messages (no transmission error), acknowledgements for the submissions will be returned within 24 hours. However, in previous filing seasons many acknowledgements were returned within 7-12 minutes. Acknowledgement turnaround times are dependent on size of submission, number of schedules and forms attached to the return, and load on the system. During peak periods acknowledgements may take two hours or more.

The transmission response indicates the transmission errors that were found during validation. The transmission acknowledgement will include:

- the transmission ID
- timestamp
- transmission status: “A” for Accepted or “R” for Rejected
- errors (if applicable)
- GTX Key

If the transmission is rejected, there will only be a transmission acknowledgement. If the transmission is accepted, the MeF system continues to validate the returns within the file. One acknowledgement is generated for each return in the file.

Refer to the items in the Acknowledgement Schema (in the efileAttachments.xsd file), for all of the items that can be included in the return acknowledgement.

6 Retrieval Methods for MeF

This section describes:

- What transmitters and state agencies retrieve
- How they retrieve messages from the IRS
- How MeF generates acknowledgements for messages (transmissions) and returns (submissions) transmitted to the IRS
- How to retrieve acknowledgements through IFA and Application-to-Application

Transmitters can retrieve Acknowledgements and Status Records. States can retrieve Submissions and Acknowledgement Notifications.

- The Acknowledgement includes the Acceptance Status, “Accepted” or “Rejected”, of a return or extension. An Acknowledgement with “Accepted” is the proof that a federal return/extension has been accepted for processing by IRS. Form 1040 has an additional acceptance status of “Exception”. [See Section 5.5 Acknowledgement Schema](#) for more information on “Exception” status.
- The Status Record provides the status of the submission. The value “ACKNOWLEDGED” is not proof the return was accepted. It means an acknowledgement was generated, but does not prove the return was accepted or rejected.

If the message rejects, the system stops validating the submissions and generates a reject acknowledgement. If the message is accepted, MeF continues validating the submissions and generates an acknowledgement for each submission.

If a submission is transmitted through IFA, the subsequent acknowledgement generated will only be available through IFA. If a submission is transmitted through A2A, the subsequent acknowledgement generated will only be available through A2A.

The Acknowledgement Notification is generated for the State when the transmitter has retrieved the state acknowledgement. It includes the SubmissionId of the acknowledgement retrieved by the transmitter and the date and time (timestamp) the acknowledgement was retrieved by the transmitter. IRS does not create an acknowledgement notification when a federal return acknowledgement is retrieved or when a State submission has been denied.

6.1 Retrieving the Acknowledgement through Internet Filing

The following section describes the procedure for retrieving an acknowledgement through the Internet Filing Application.

As submissions are validated, the acknowledgements are made available to the transmitter for retrieval. When the transmitter requests New Acknowledgements, he/she indicates how many acknowledgements he/she wants to download (up to the maximum of 100). The system will make available to the transmitter as many new (not previously retrieved) acknowledgements as are available, up to the count he/she requested. If there are additional new acknowledgements available, the screen will provide the following statement: "There are additional acknowledgements available for retrieval."

You do not have to pick up acknowledgement files before transmitting. However, you will need to pick up your acknowledgement as soon as possible to provide the taxpayer with their acknowledgement. MeF stores the acknowledgement file for one year from the date the acknowledgement was first created. You may re-retrieve an acknowledgement by following the steps in Section 6.1.1. They cannot be retrieved after one year.

6.1.1 Retrieving an Acknowledgement File

Refer to [Section 4.2.2](#) for Accessing and Logging into MeF IFA.

Acknowledgement Records for both Accepted and Rejected MeF Returns may contain Alerts. Alerts contain information to inform the customer that there may be a delay in the processing of the tax return, or that the tax return meets criteria that may reject in future processing years. A software developer/transmitter may choose to relay Alert information to EROs, Preparers, and taxpayers at their own discretion.

After the transmitter has logged in and selected the organization they will represent in this session, the MeF Internet Filing Home Page is displayed horizontally.

The transmitter may then retrieve a production or test acknowledgements file by selecting the corresponding link. Retrieving submission acknowledgements involves the following steps:

- [Step 1: Request Retrieval of the Acknowledgements](#)
- [Step 2: Select the ETIN Associated with the Acknowledgements](#)
- [Step 3: Select the Type of Acknowledgements for Download](#)
- [Step 4: Download the Acknowledgement\(s\)](#)

The MeF IFA Web pages supporting these steps are shown in the following pages. In addition, the [Download Popups](#) seen while downloading acknowledgements is included after Step 4.

Step 1: Request Retrieval of the Acknowledgements

Select the “Retrieve Production Acknowledgements” or “Retrieve Test Acknowledgements” file link/navigation tab, as appropriate.

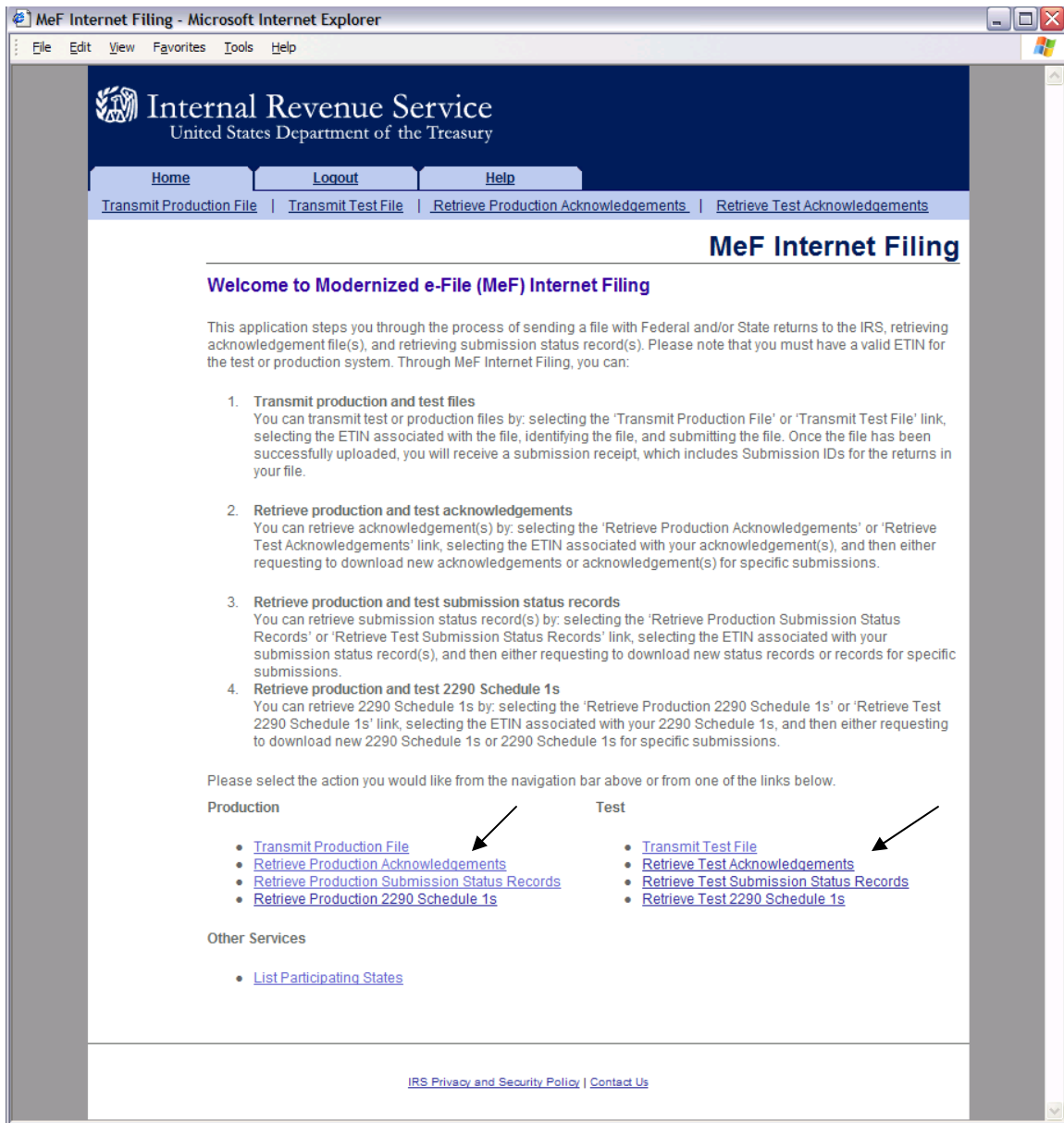

Figure 6-1: MeF Internet Filing Home Page

Step 2: Select the ETIN Associated with the Acknowledgements

The Select ETIN for Production Acknowledgements page displays the ETINs authorized for the transmitter's use, in sorted order.

Select ETIN for Production Acknowledgements - Microsoft Internet Explorer

Internal Revenue Service
United States Department of the Treasury

Home Logout Help

[Transmit Production File](#) | [Transmit Test File](#) | [Retrieve Production Acknowledgements](#) | [Retrieve Test Acknowledgements](#)

Select ETIN for Production Acknowledgements

Select ETIN

The list of ETIN(s) associated with your account in the Production system is shown below. Please select the ETIN that you would like to use to retrieve acknowledgements and press the Continue button.

Choose an ETIN ▶

<input type="radio"/> 00001	<input type="radio"/> 00002	<input type="radio"/> 00003	<input type="radio"/> 00004	<input type="radio"/> 00005	<input type="radio"/> 00006
<input type="radio"/> 00010	<input type="radio"/> 00011	<input type="radio"/> 00012	<input type="radio"/> 00013	<input type="radio"/> 00014	<input type="radio"/> 00015
<input type="radio"/> 00016	<input type="radio"/> 00017	<input type="radio"/> 00020	<input type="radio"/> 00021	<input type="radio"/> 00030	<input type="radio"/> 00031
<input type="radio"/> 00032	<input type="radio"/> 00033	<input type="radio"/> 00034	<input type="radio"/> 00035	<input type="radio"/> 00036	<input type="radio"/> 00040
<input type="radio"/> 00041	<input type="radio"/> 00042	<input type="radio"/> 00043	<input type="radio"/> 00044	<input type="radio"/> 00050	<input type="radio"/> 00051
<input type="radio"/> 00052	<input type="radio"/> 00053	<input type="radio"/> 00060	<input checked="" type="radio"/> 00780		

Continue

[IRS Privacy and Security Policy](#) | [Contact Us](#)

Figure 6-2: Select ETIN for Production Acknowledgement File Page

Step 3: Select the Type of Acknowledgements for Download

The Retrieve Submission Acknowledgements screen allows the transmitter to retrieve either specific previously downloaded acknowledgements or all new acknowledgements (that is, not previously downloaded). The maximum number of acknowledgements you can retrieve at one time is 100. Select one of the following:

- **Retrieve new acknowledgements** radio button (selected by default). Normally the transmitter sends one return at a time through IFA and wants to retrieve the acknowledgement for that return. The default values "ALL:" can be used in this case. The user can limit the acknowledgements to types of returns (corporate, partnership, etc) or agency type (Federal or State) by selecting the appropriate values from the respective drop down boxes. The user can also select the number of new Acknowledgements to retrieve, up to the maximum of 100.
- **Retrieve previously downloaded acknowledgements based on Submission ID(s)** radio button. Enter the Submission ID(s) into the text box labeled "Enter Submission ID(s)". Each Submission ID should be separated by a comma, followed by a space. The Submission IDs are listed in the Transmission Receipt you received after your message successfully transmitted.

After selecting one of the radio buttons above, click the **Submit** button.

The screenshot shows the 'Retrieve Submission Acknowledgements' page from the Internal Revenue Service. The page title is 'Retrieve Submission Acknowledgements' and the user's ETIN is 00780. There are two radio button options: 'Retrieve new acknowledgements' (selected) and 'Retrieve previously downloaded acknowledgements based on Submission ID(s)'. A callout box points to the second option with the text: 'Note: To download based on Submission ID(s), the "Retrieve previously downloaded acknowledgements" button must be selected; otherwise, the system will try to retrieve new acknowledgements even if a Submission ID is entered in this box.' The page also includes fields for 'Submission Category', 'Agency Type', and 'Enter Number of Acknowledgements' (set to 100). A 'Submit' button is at the bottom.

Figure 6-3: Retrieve Submission Acknowledgement

Step 4: Download Acknowledgements

The Download Acknowledgements screen displays the Submission IDs for acknowledgements for the associated ETIN.

- Acknowledgements that can be included in the zip file are marked “Yes” in the **Include in File** column. Click the **Download** button to retrieve the acknowledgements.
- Acknowledgements that will not be included in the zip file are marked “No” in the **Include in File** column. The reason for not including the acknowledgement is supplied in the **Notes** column.

Figure 6-4 below displays the results when “Retrieve New Acknowledgements” is selected.

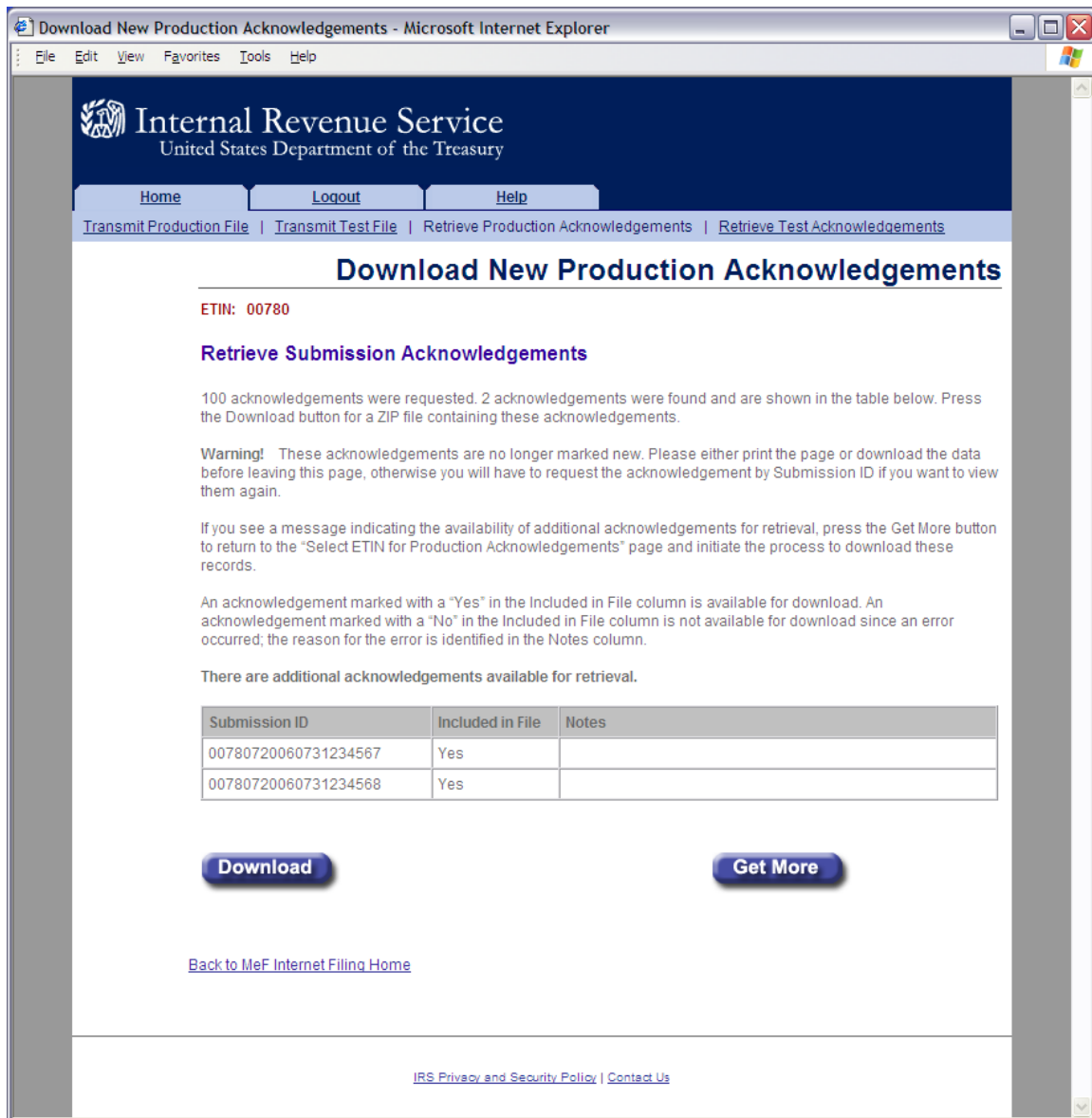

Download New Production Acknowledgements - Microsoft Internet Explorer

Internal Revenue Service
United States Department of the Treasury

Home Logout Help

Transmit Production File | Transmit Test File | Retrieve Production Acknowledgements | Retrieve Test Acknowledgements

Download New Production Acknowledgements

ETIN: 00780

Retrieve Submission Acknowledgements

100 acknowledgements were requested. 2 acknowledgements were found and are shown in the table below. Press the Download button for a ZIP file containing these acknowledgements.

Warning! These acknowledgements are no longer marked new. Please either print the page or download the data before leaving this page, otherwise you will have to request the acknowledgement by Submission ID if you want to view them again.

If you see a message indicating the availability of additional acknowledgements for retrieval, press the Get More button to return to the “Select ETIN for Production Acknowledgements” page and initiate the process to download these records.

An acknowledgement marked with a “Yes” in the Included in File column is available for download. An acknowledgement marked with a “No” in the Included in File column is not available for download since an error occurred; the reason for the error is identified in the Notes column.

There are additional acknowledgements available for retrieval.

Submission ID	Included in File	Notes
00780720060731234567	Yes	
00780720060731234568	Yes	

[Download](#) [Get More](#)

[Back to MeF Internet Filing Home](#)

[IRS Privacy and Security Policy](#) | [Contact Us](#)

Figure 6-4: Download New Production Acknowledgements Page

Figure 6-5 below displays the results when “Retrieve previously downloaded acknowledgements based on Submission ID(s)” is selected. The “Notes” column explains why the acknowledgments are not available to be downloaded.

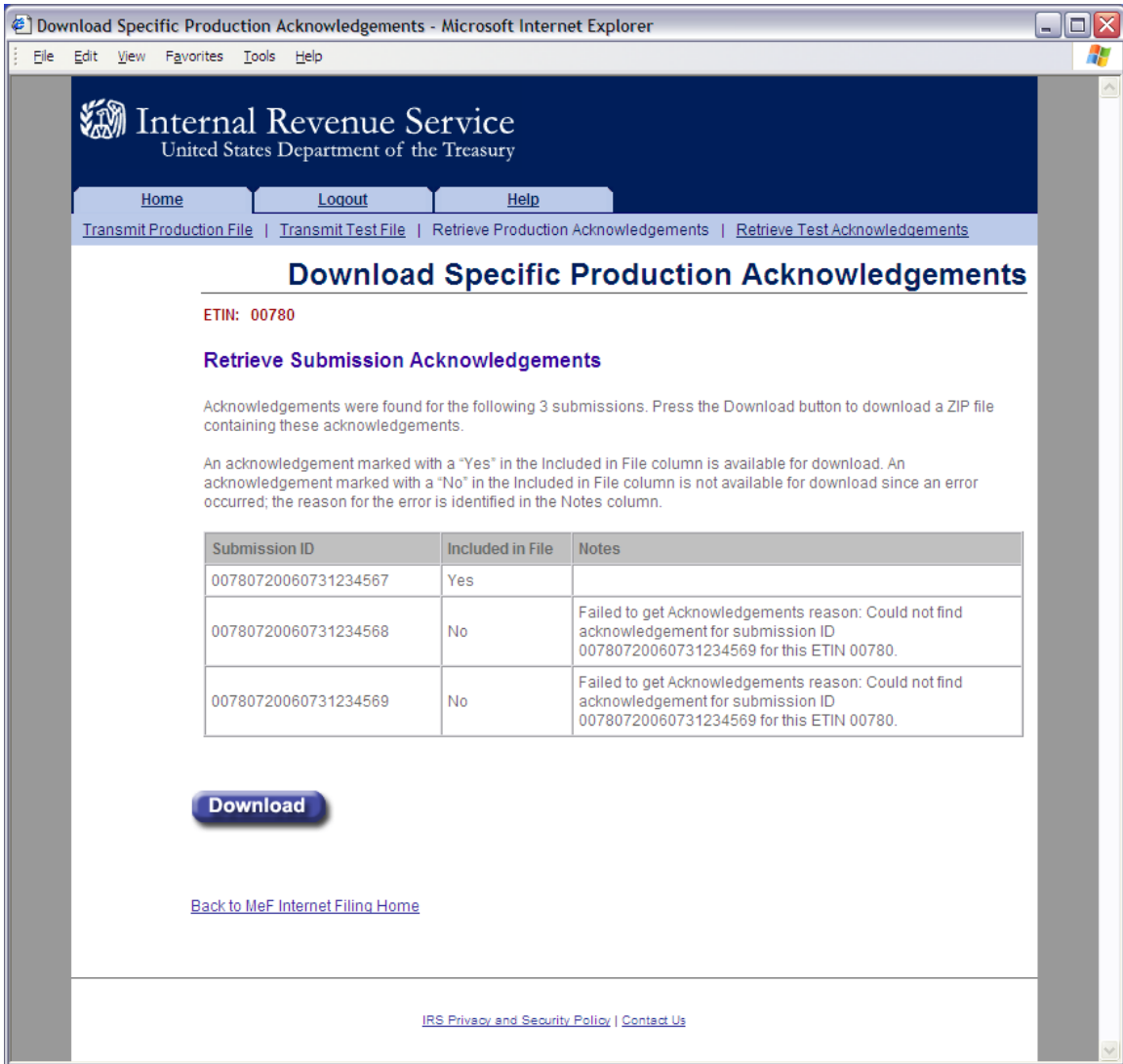

Figure 6-5: Download Specific Production Acknowledgments Page

Download Popups

During the download process, the following screens will display; screens will vary based on the configuration and version of the transmitter's operating system and browser. The following screens are from Internet Explorer 8.0 running on Windows 2000.

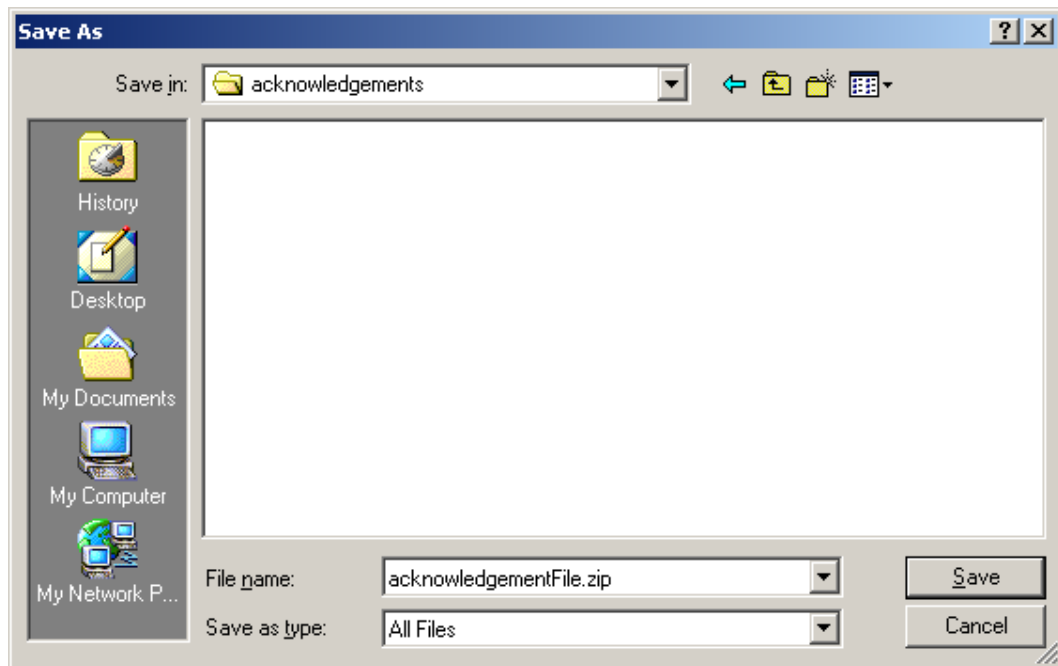
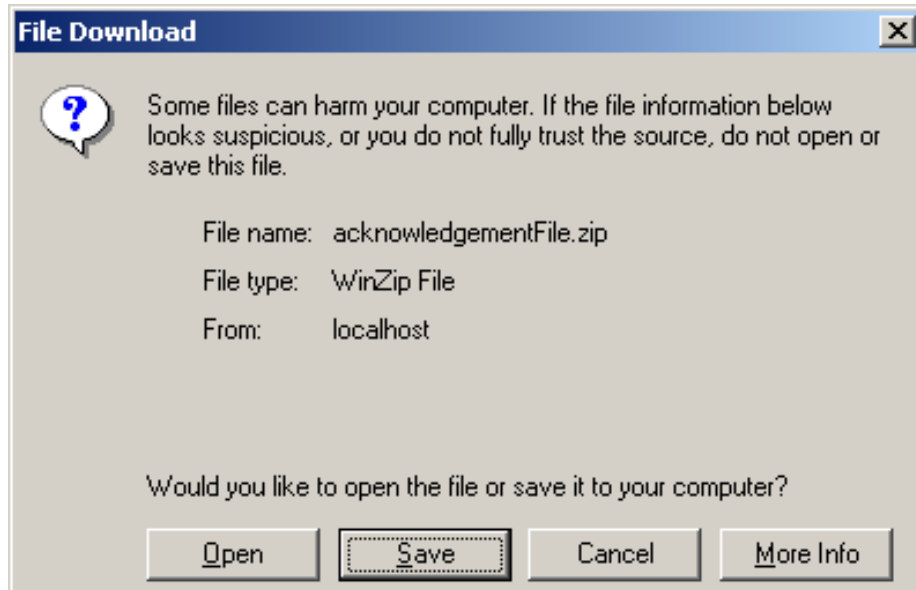

Figure 6-6: File Download and File Destination Windows

6.1.2 MeF Error Messages When Retrieving Acknowledgments

The following error messages may occur when attempting to retrieve acknowledgements:

- [No ETIN found](#)
- [Number of Acknowledgements Requested Exceeds Maximum](#)
- [Input Error \(Number of Acknowledgements\)](#)
- [Input Error \(Submission ID List\)](#)
- [Acknowledgements Not Found Error](#)
- [Not Processed by IFA Error](#)
- [System Error \(Retrieve\) – Error Not Identified](#)
- [System Error \(Retrieve\) – Error Identified](#)

The MeF IFA Web pages for these error messages are shown in the following pages.

No ETIN Found

If the system does not find any associated ETINs for the user ID and customer ID, then the following error message displays. Check to ensure that you selected the appropriate link – you may have selected “Production” and only have test ETINs. You may go back to the MeF Internet Filing Home Page or terminate the session.

Click the Home tab on the navigation bar or click Back to MeF Internet Filing Home to return to the MeF Internet Filing Home page.



Figure 6-7: No ETIN Found Error Page

Number of Acknowledgements Requested Exceeds Maximum

The error page below displays when the transmitter attempts to retrieve more acknowledgements than the maximum allowed, which is currently 100.

Click the Home tab on the navigation bar or click Back to MeF Internet Filing Home to return to the MeF Internet Filing Home page.

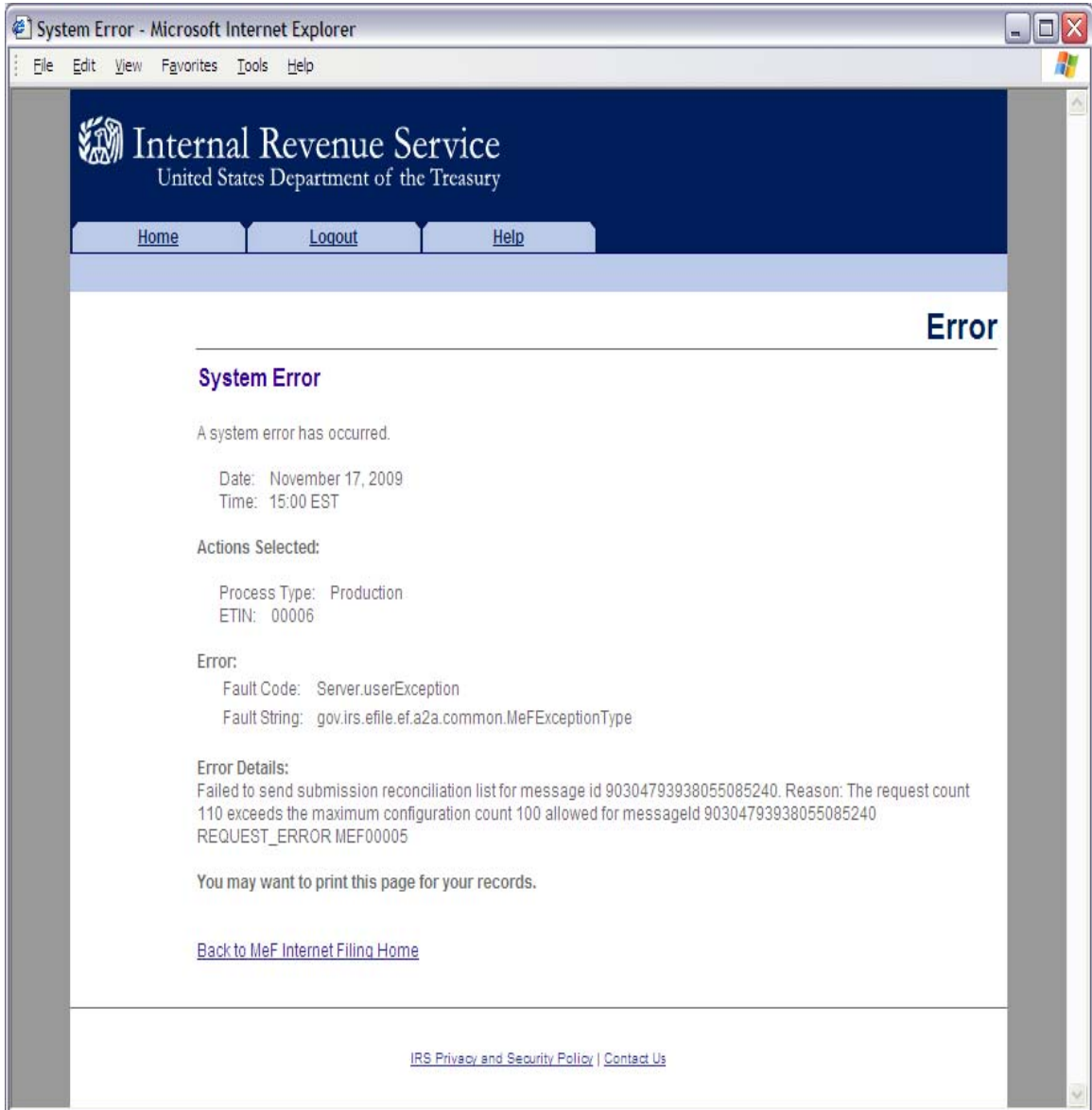

Figure 6-8: Number of Acknowledgements Exceeds Maximum Error Page

Input Error (Number of Acknowledgements)

This error page displays when the number of acknowledgements, submission status records or 2290 Schedule 1s entered to retrieve new acknowledgements is not in the correct numeric format.

Click the Home tab on the navigation bar or click Back to MeF Internet Filing Home to return to the MeF Internet Filing Home page.

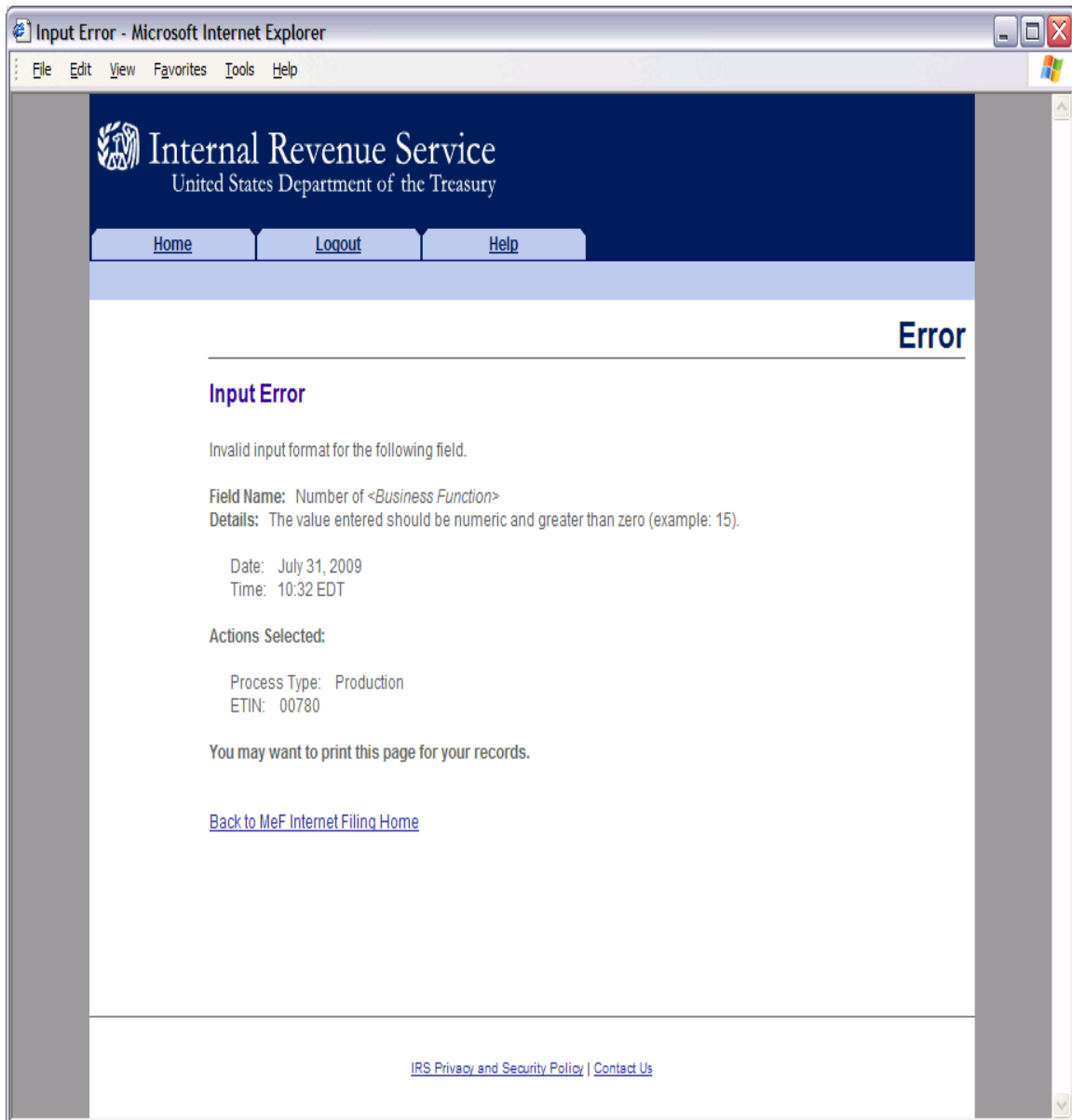

Figure 6-9: Input Error (Number of Acknowledgements)

Input Error (Submission ID List)

This error page displays when the Submission ID list entered to retrieve specific acknowledgements is not in the correct format.

Click the **Home** tab on the navigation bar or click **Back to MeF Internet Filing Home** to return to the MeF Internet Filing Home page.

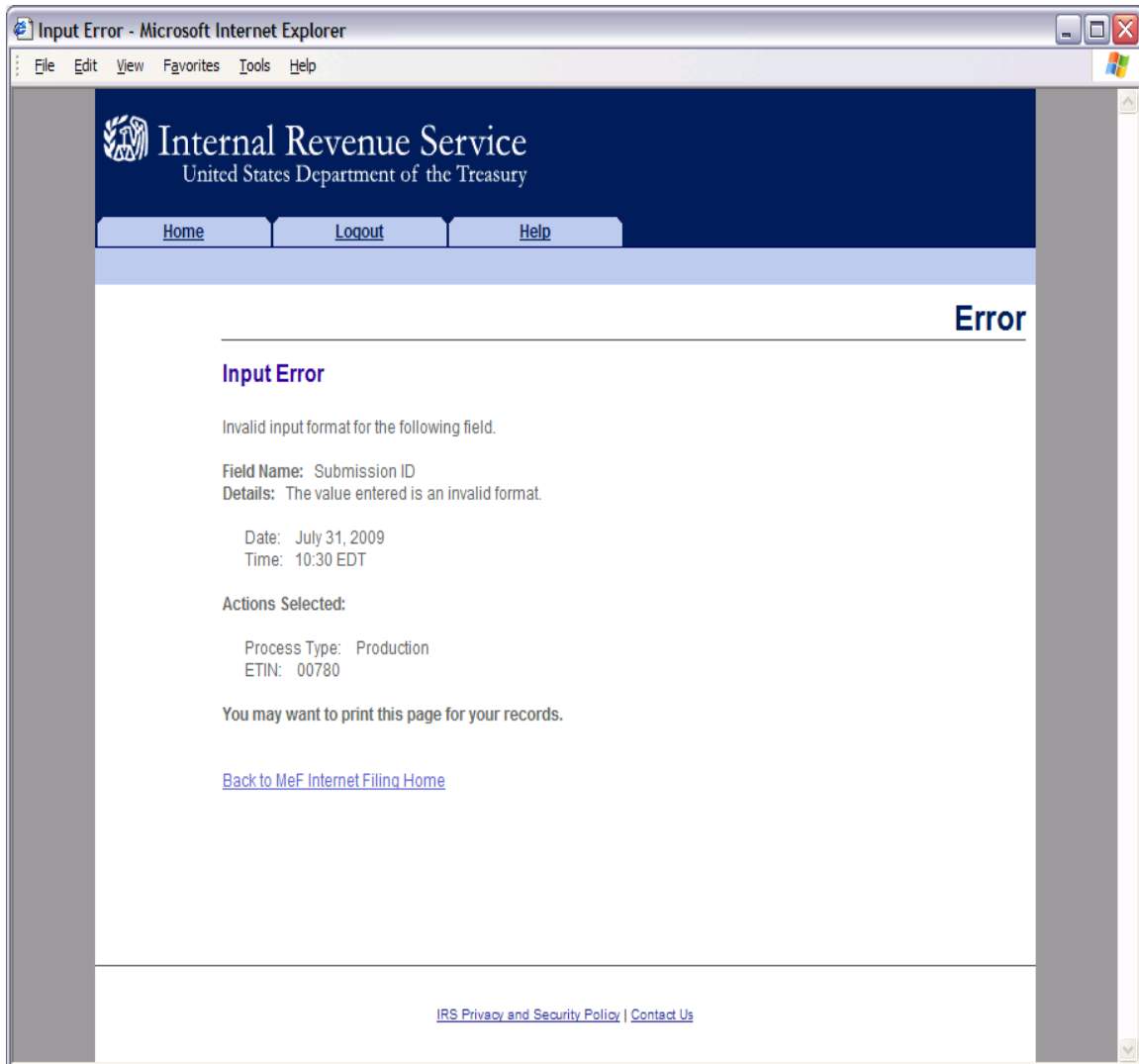

Figure 6-10: Input Error (Submission ID List)

Acknowledgements Not Found Error

This error page displays under any of the following circumstances:

- No acknowledgements are found, and the user has selected “New Acknowledgements” or has requested one or more acknowledgement(s) by entering a Submission ID.
- The return did not come in through Internet Filing (IFA).
- The system has not completed processing the submission and an acknowledgement is not available yet.

Note: This last circumstance is a common reason that the user will see this screen. It is not really an error. The user just needs to wait a little more time to allow the system to complete processing and try to retrieve the acknowledgement again.

Click the Home tab on the navigation bar or click Back to MeF Internet Filing Home to return to the MeF Internet Filing Home page.

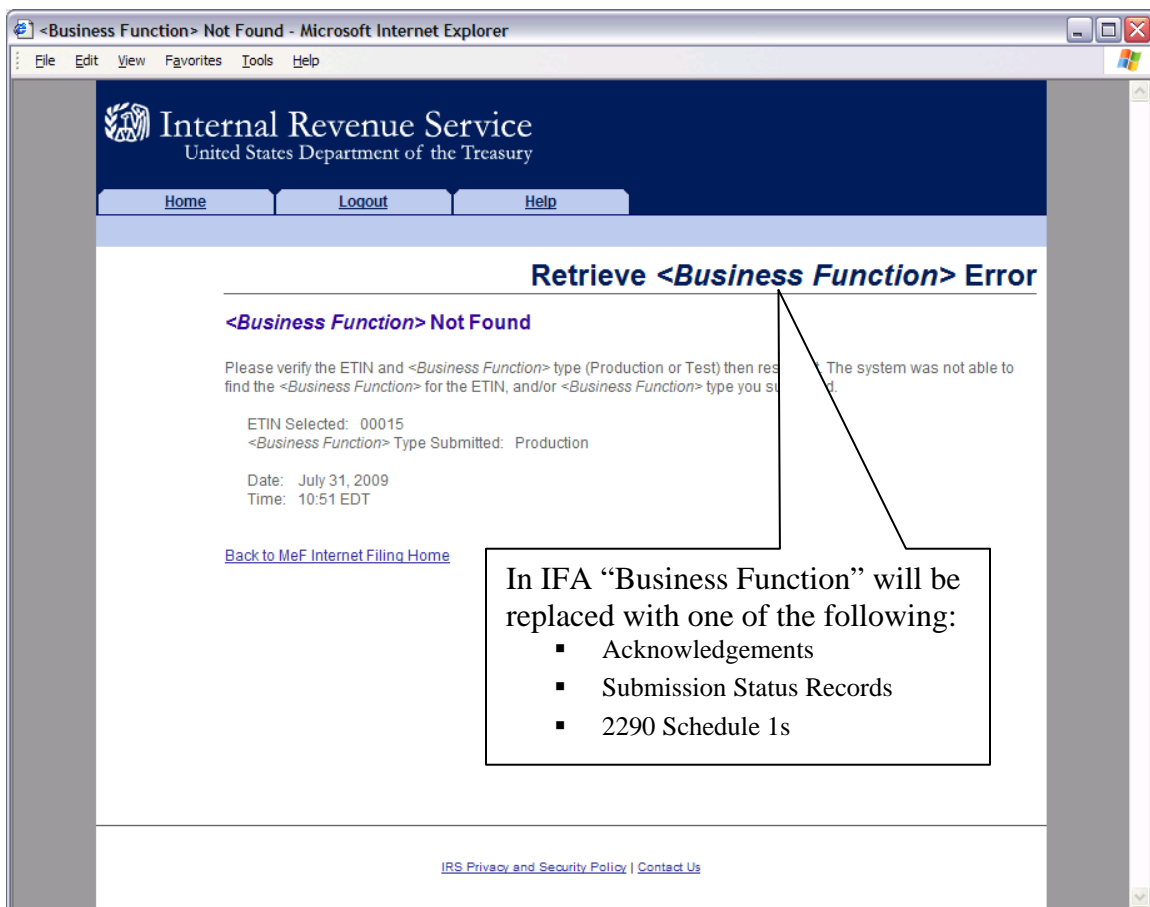

Figure 6-11: Retrieve Acknowledgement Error Page – Acknowledgements Not Found

Not Processed by IFA Error

This error page displays when the user has requested an acknowledgement that was not processed by IFA.

Click the Home tab on the navigation bar or click Back to MeF Internet Filing Home to return to the MeF Internet Filing Home

In IFA “Business Function” will be replaced with one of the following:

- Acknowledgements
- Submission Status Records
- 2290 Schedule 1s

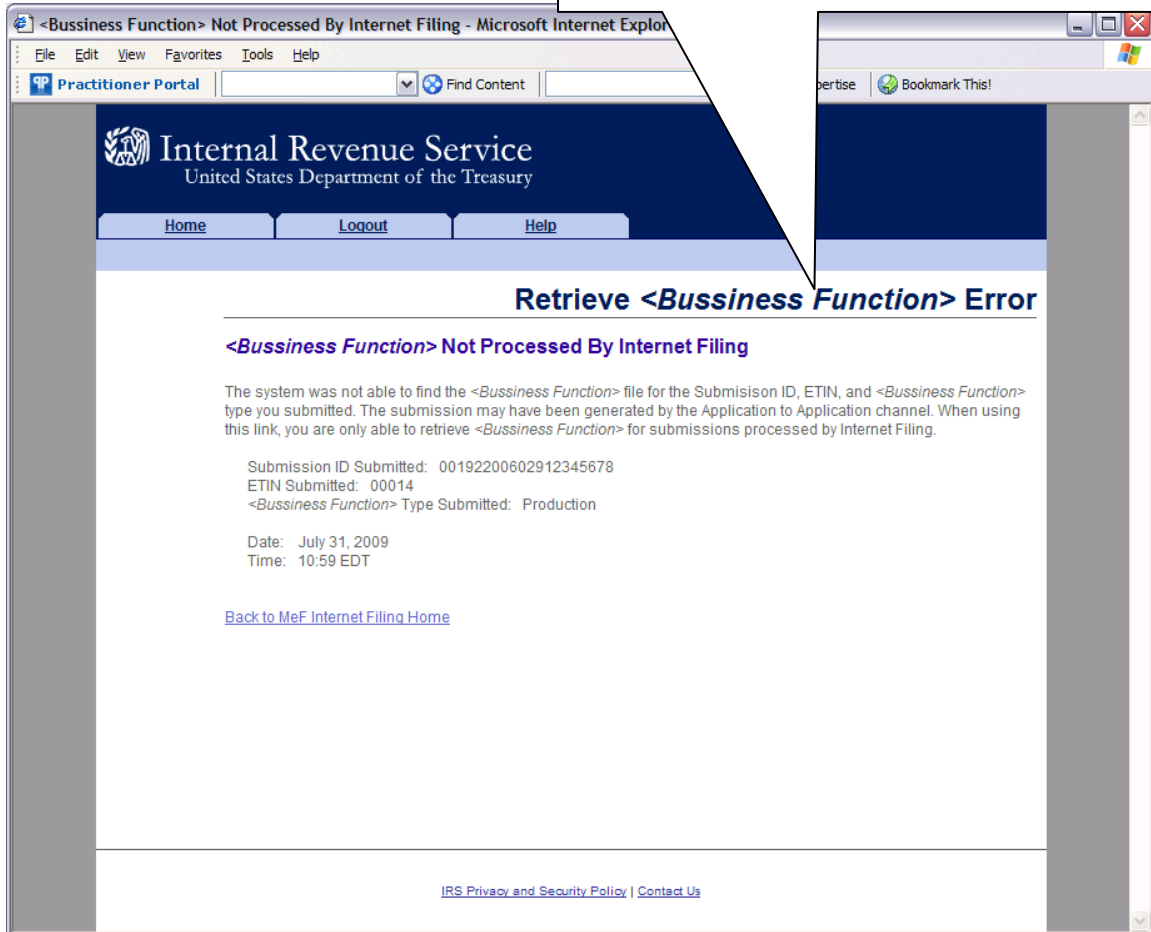

**Figure 6-12: Retrieve Acknowledgement Error Page –
Acknowledgements Not Processed by Internet Filing**

System Error Retrieve

This error page displays when a system error has occurred while trying to retrieve an acknowledgement. Call the e-help Desk (1-866-255-0654) if you continue to receive this message.

Click the Home tab on the navigation bar or click Back to MeF Internet Filing Home to return to the MeF Internet Filing Home page.

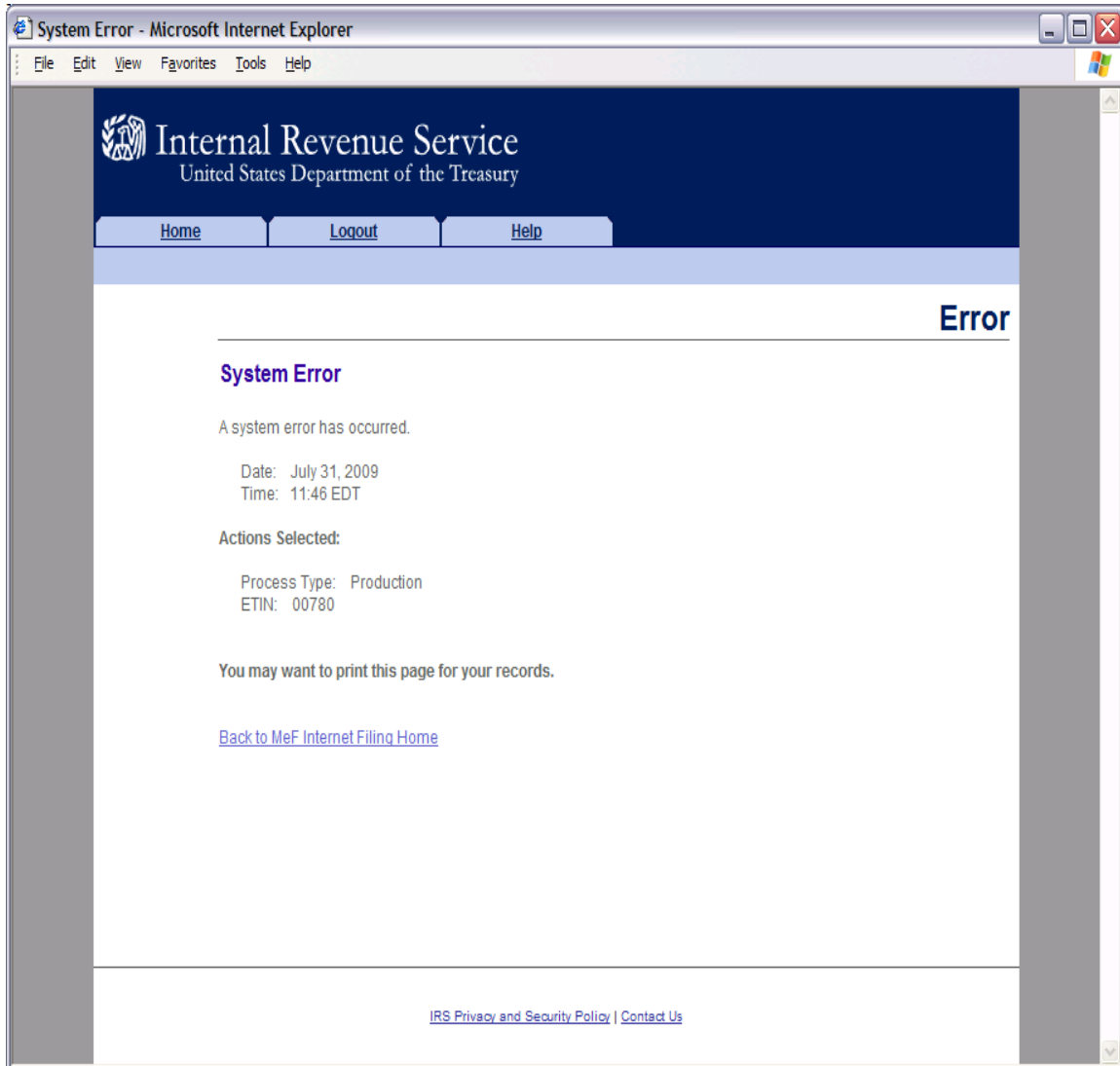

Figure 6-13: System Error Page – System Error Page – Back-end Error

System Error (Retrieve) Error Identified

This error page displays for errors occurring when retrieving acknowledgements and the system was able to specify the error that occurred.

Click the Home tab on the navigation bar or click Back to MeF Internet Filing Home to return to the MeF Internet Filing Home page.

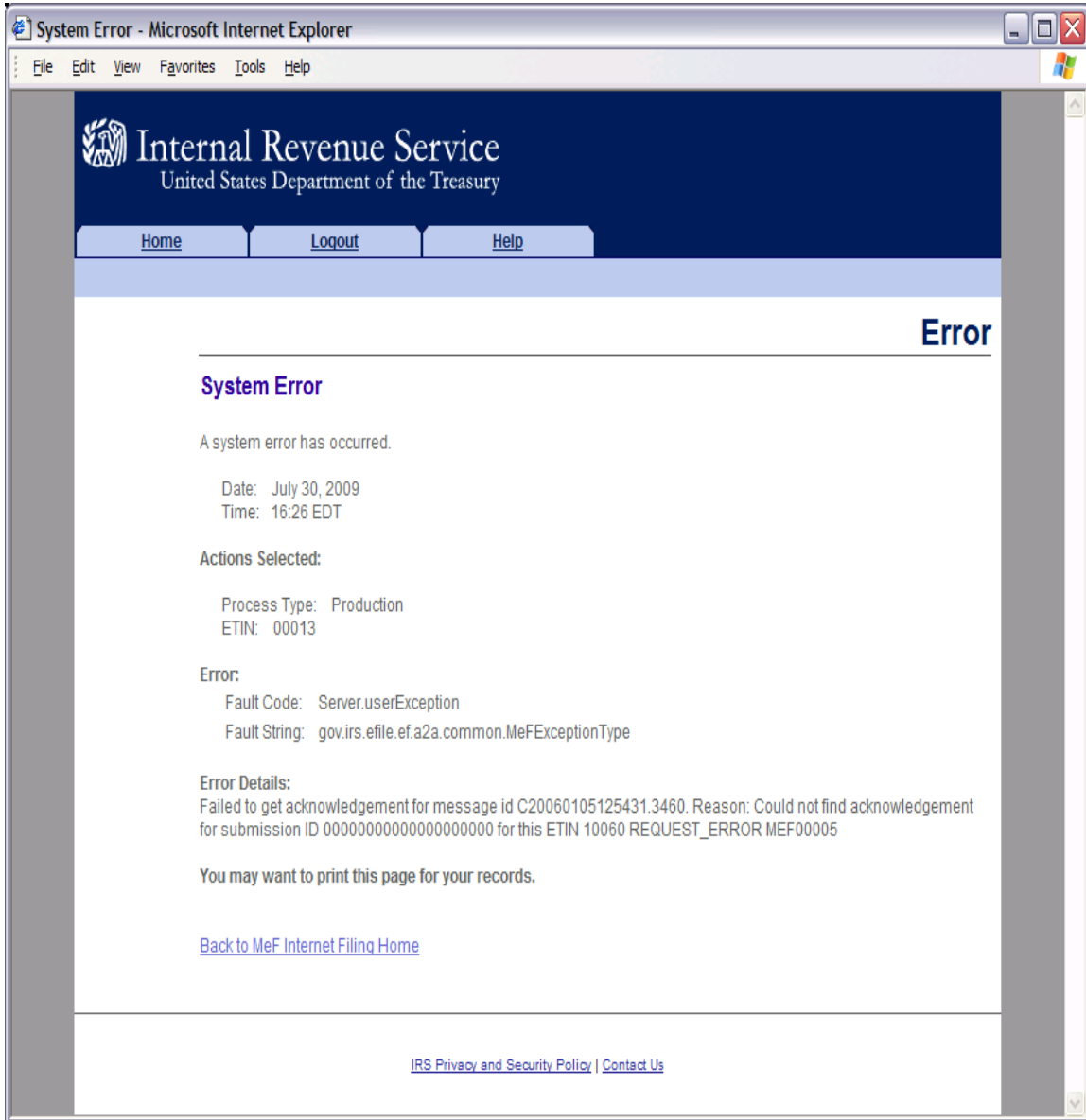

Figure 6-14: System Error Page with Error Identified

6.2 Viewing a List of Participating States in the Fed/State Program

Refer to [Section 4.2.2](#) for Accessing and Logging into MeF IFA.

After the transmitter has logged in and selected the organization they will represent in this session, the MeF Internet Filing Home Page is displayed. A transmitter then performs the following steps to view a list of participating states in the Fed/State program:

[Step 1: Select List Participating States under Other Services.](#)

[Step 2: Select an ETIN to associate with the Production list of Participating States.](#)

The list of participating states will then display; an example is provided after Step 2.

Step 1: Select List Participating States under Other Services.

Click the List of Participating States link at the bottom of the page.

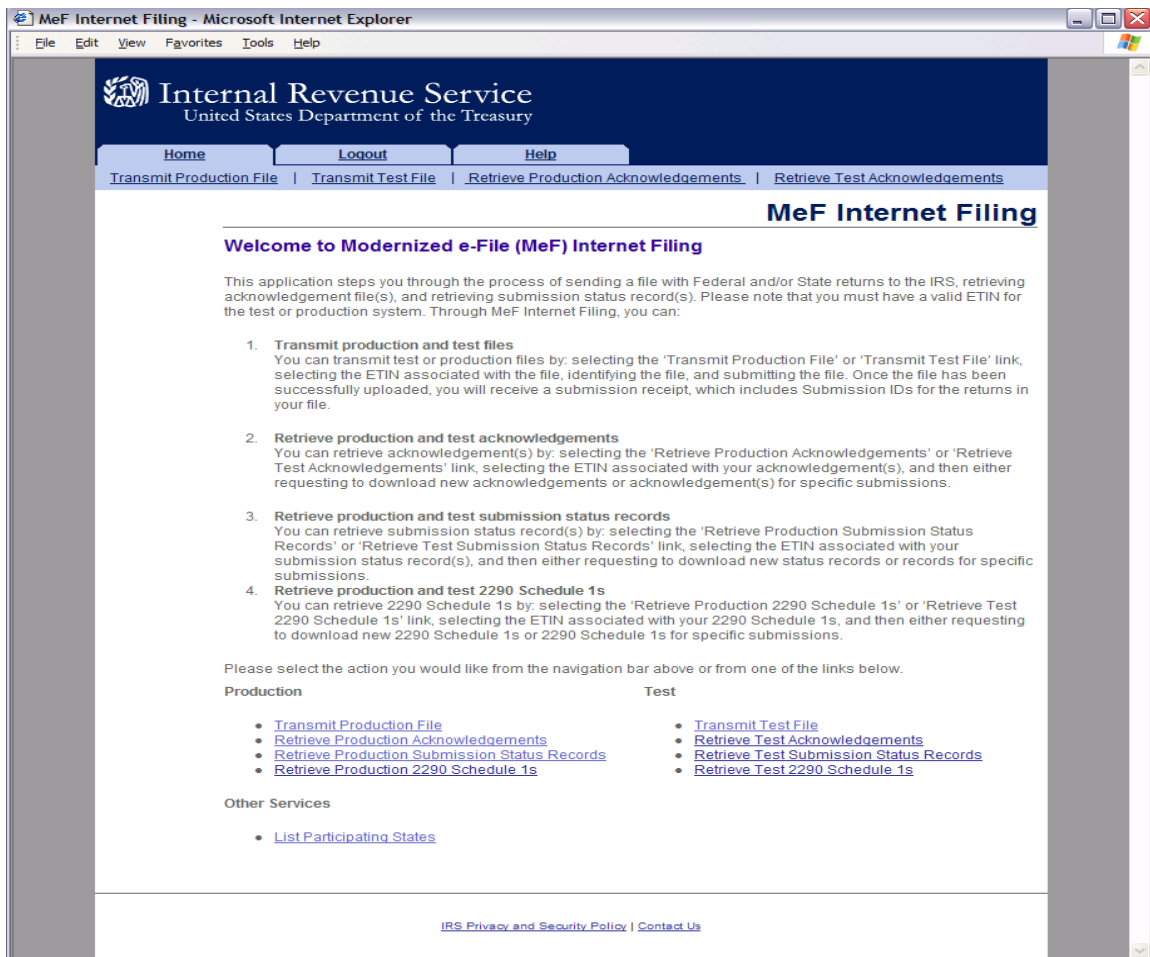

Figure 6-15: Select List Participating States

Step 2: Select an ETIN to associate with the Production list of Participating States.

Click the radio button of the ETIN to be associated with the Production list of participating states. Then click Continue.

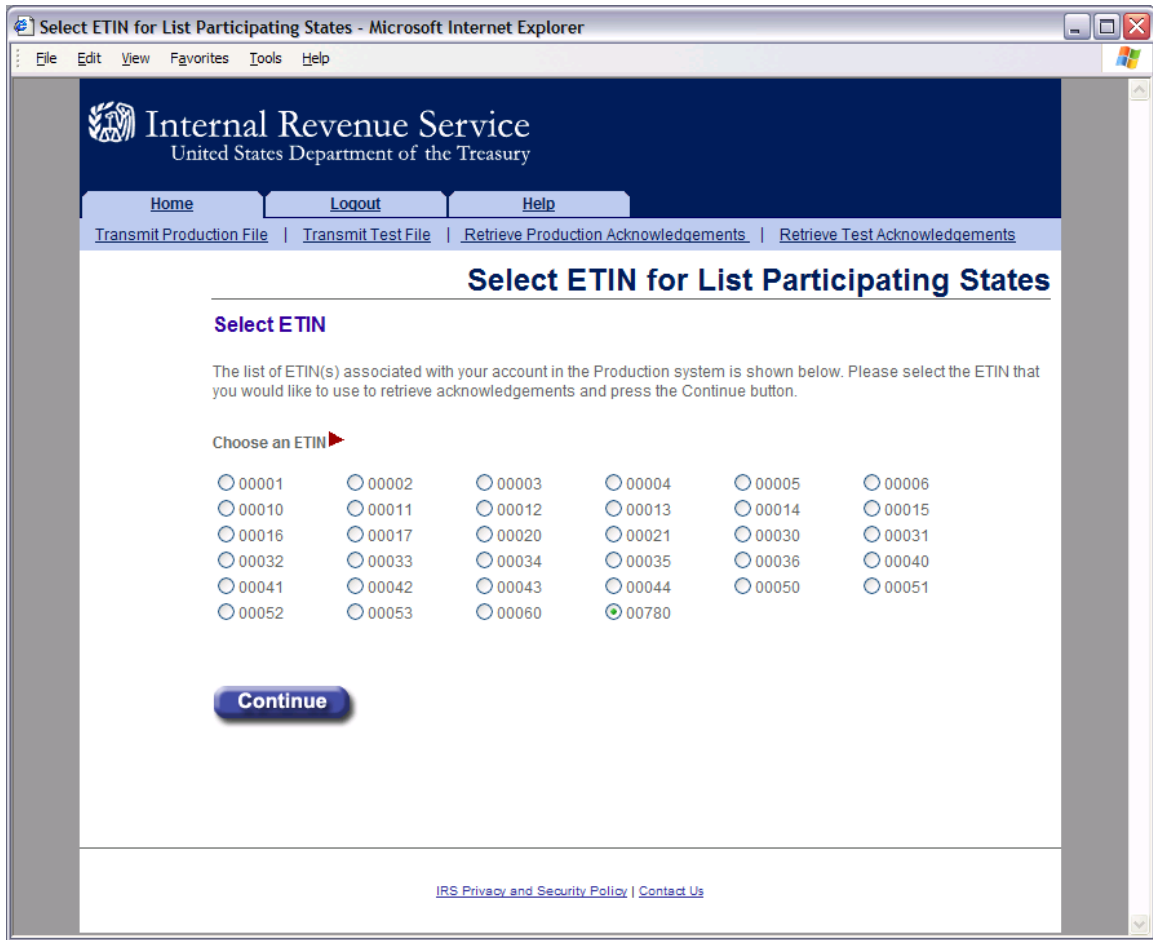

Figure 6-16 Select ETIN for List of Participating States

After the ETIN is selected, the list of participating states in the Fed/State program displays:

Internal Revenue Service
United States Department of the Treasury

Home Logout Help

[Transmit Production File](#) | [Transmit Test File](#) | [Retrieve Production Acknowledgements](#) | [Retrieve Test Acknowledgements](#)

List Participating States

State Participation Results

The following states have indicated that they are participating in the MeF Fed/State program. Please contact each state to determine when it will begin accepting returns.

State	Category	Fed/State	Standalone
Maryland	CORP	Yes	No
	EO	Yes	No
	IND	Yes	No
	PART	Yes	Yes
New York	CORP	Yes	No
	EO	Yes	Yes
	IND	No	No
	PART	Yes	No
New York City	CORP	Yes	Yes
	EO	No	No
	IND	Yes	Yes
	PART	No	No

[Back to MeF Internet Filing Home](#)

[IRS Privacy and Security Policy](#) | [Contact Us](#)

Figure 6-17: List Participating States Page

6.3 Retrieving Production Federal and/or State Submission Status Records

Refer to [Section 4.2.2](#) for Accessing and Logging into MeF IFA.

After the transmitter has logged in and selected the organization they will represent in this session, the MeF Internet Filing Home Page is displayed. A transmitter then performs the following steps to retrieve Production/Test submission status records:

- Step 1: [Select an option to retrieve either Production or Test submission status records](#)
- Step 2: [Select an ETIN to associate with the Production/Test submission status records](#)
- Step 3: [Submit a request to retrieve the Production/Test submission status records](#)
- Step 4: [Download new Production submission status records](#)
- Step 5: [Download specific Production submission status records based on Submission ID](#)

Step 1: Select an Option to Retrieve Either Production or Test Submission Status Records.

Click either the Retrieve Production Submission Status Records or Retrieve Test Submission Status Records at the bottom of the page.



Figure 6-18: Select an Option to Retrieve Either Production or Test Submission Status Records

Step 2: Select an ETIN To Associate with the Production/Test Submission Status Records

After selecting the **Retrieve Production (or Test) Submission Status Record link**, the Select ETIN for Production Submission Status Records page displays. This page shows all unique ETINs authorized for the transmitter's use, sorted in order horizontally.

Click the radio button of the ETIN to be associated with the Production list of participating states.

Click the Continue button.

Select ETIN for Production Submission Status Records - Microsoft Internet Explorer

File Edit View Favorites Tools Help

Internal Revenue Service
United States Department of the Treasury

Home Logout Help

[Transmit Production File](#) | [Transmit Test File](#) | [Retrieve Production Acknowledgements](#) | [Retrieve Test Acknowledgements](#)

Select ETIN for Production Submission Status Records

Select ETIN

The list of ETIN(s) associated with your account in the Production system is shown below. Please select the ETIN that you would like to use to retrieve submission status records and press the Continue button.

Choose an ETIN ▶

<input type="radio"/> 00001	<input type="radio"/> 00002	<input type="radio"/> 00003	<input type="radio"/> 00004	<input type="radio"/> 00005	<input type="radio"/> 00006
<input type="radio"/> 00010	<input type="radio"/> 00011	<input type="radio"/> 00012	<input type="radio"/> 00013	<input type="radio"/> 00014	<input type="radio"/> 00015
<input type="radio"/> 00016	<input type="radio"/> 00017	<input type="radio"/> 00020	<input type="radio"/> 00021	<input type="radio"/> 00030	<input type="radio"/> 00031
<input type="radio"/> 00032	<input type="radio"/> 00033	<input type="radio"/> 00034	<input type="radio"/> 00035	<input type="radio"/> 00036	<input type="radio"/> 00040
<input type="radio"/> 00041	<input type="radio"/> 00042	<input type="radio"/> 00043	<input type="radio"/> 00044	<input type="radio"/> 00050	<input type="radio"/> 00051
<input type="radio"/> 00052	<input type="radio"/> 00053	<input type="radio"/> 00060	<input checked="" type="radio"/> 00780		

[IRS Privacy and Security Policy](#) | [Contact Us](#)

Figure 6-19: Select ETIN for Production Submission Status Records Page

Step 3: Submit a Request to Retrieve Production Submission Status Records

The Retrieve Production Submission Status Records page allows the transmitter to retrieve either specific previously downloaded submission status records, or all new submission status records (that is, not previously downloaded).

To retrieve new submission status records:

- Click the “Retrieve new submission status records” radio button (set as default).
- Enter a number between 1 and 100 (the current maximum) in the “Enter Number of Submission Status Records” text box, to specify the number of submission status records to retrieve at one time.

Note: The maximum number of submission status records a transmitter can submit for retrieval is configurable. If the transmitter doesn’t specify a number, then the default maximum number 100 will be used.

To retrieve previously downloaded submission status records based on Submission ID(s):

- Click the “Retrieve previously downloaded submission status records based on Submission ID(s)” radio button
- Enter the Submission ID(s) to be retrieved in the Enter Submission ID(s) text box.

Note: Each Submission ID should be separated by a comma, followed by a space. Submission IDs are listed on Submission Receipts, reporting the successful transmission of a message.

Click the Submit button

Internal Revenue Service
United States Department of the Treasury

Home Logout Help
Transmit Production File | Transmit Test File | Retrieve Production Acknowledgements | Retrieve Test Acknowledgements

Retrieve Production Submission Status Records

ETIN: 00780

Retrieve Submission Status Records

Please select "Retrieve new submission status records" to download submission status records that have not been downloaded previously. Or, select "Retrieve previously downloaded submission status records based on Submission ID(s)". Press the Submit button to continue.

Retrieve new submission status records

Enter Number of Submission Status Records

Note: If no value is entered, the default maximum (100)

Retrieve previously downloaded submission status records based on Submission ID(s)
Submission ID with a comma followed by a space (i.e. 00349720060731234560, 00349720060731234501)

Enter Submission ID(s)

Submit

Note: To download based on SubmissionId(s), select the “Retrieve previously downloaded acknowledgments” button. If this button is not checked, the system will try to retrieve new acknowledgements even if you enter a SubmissionId in the box

Figure 6-20: Retrieve Production Submission Status Records Page

Step 4: Download New Production Submission Status Records

If the transmitter elects to retrieve new submission status records on the Retrieve Production Submission Status Records page (see Figure 6-20), the Download New Production Submission Status Records page displays, showing any new status records found. Click the **Download** button for a ZIP file containing the submission status records shown in the table.

Important! Since these records will no longer be marked new, you should either download the records before leaving this page or print this page for future reference. To view any additional status records you don't download now, you will have to request the records by Submission ID.

If you see the message "There are additional new submission status records available for retrieval." click the "Get More" button to return to the Select ETIN for Production Submission Status Records page (see Figure 6-19).

United States Department of the Treasury

Home Logout Help

Transmit Production File | Transmit Test File | Retrieve Production Acknowledgements | Retrieve Test Acknowledgements

Download New Production Submission Status Records

ETIN: 00780

Retrieve Submission Status Records

100 submission status records were requested. 9 submission status records were found and are shown in the table below. Press the Download button for a ZIP file containing these records.

If you see a message indicating the availability of additional status records for retrieval, press the Get More button to download these records.

Warning! These status records are no longer marked new. Please either print the page or download the data before leaving this page, otherwise you will have to request the status records by Submission ID if you want to view them again.

There are additional status records available for retrieval.

Submission ID	Status Record
00780720060731234566	Received
	Acknowledged
	Rejected
00780720060731234567	Received
	Denied by IRS
00780720060731234568	Received
	Acknowledged
00780720060731234569	Received
	Ready for Pickup

Download Get More

Figure 6-21 Download New Production Submission Status Records Page

Step 5: Download Specific Production Status Records based on Submission ID

If the transmitter elects to retrieve previously downloaded submission status records (based on Submission ID) on the Retrieve Production Submission Status Records page (see [Figure 6-20](#)), the Download Specific Production Submission Status Records page displays, showing the previously downloaded status records.

Click the **Download** button for a ZIP file containing the submission status records shown in the table.

Click the Home tab on the navigation bar or the Back to MeF Internet Filing Home link to return to the MeF Internet Filing Home page.

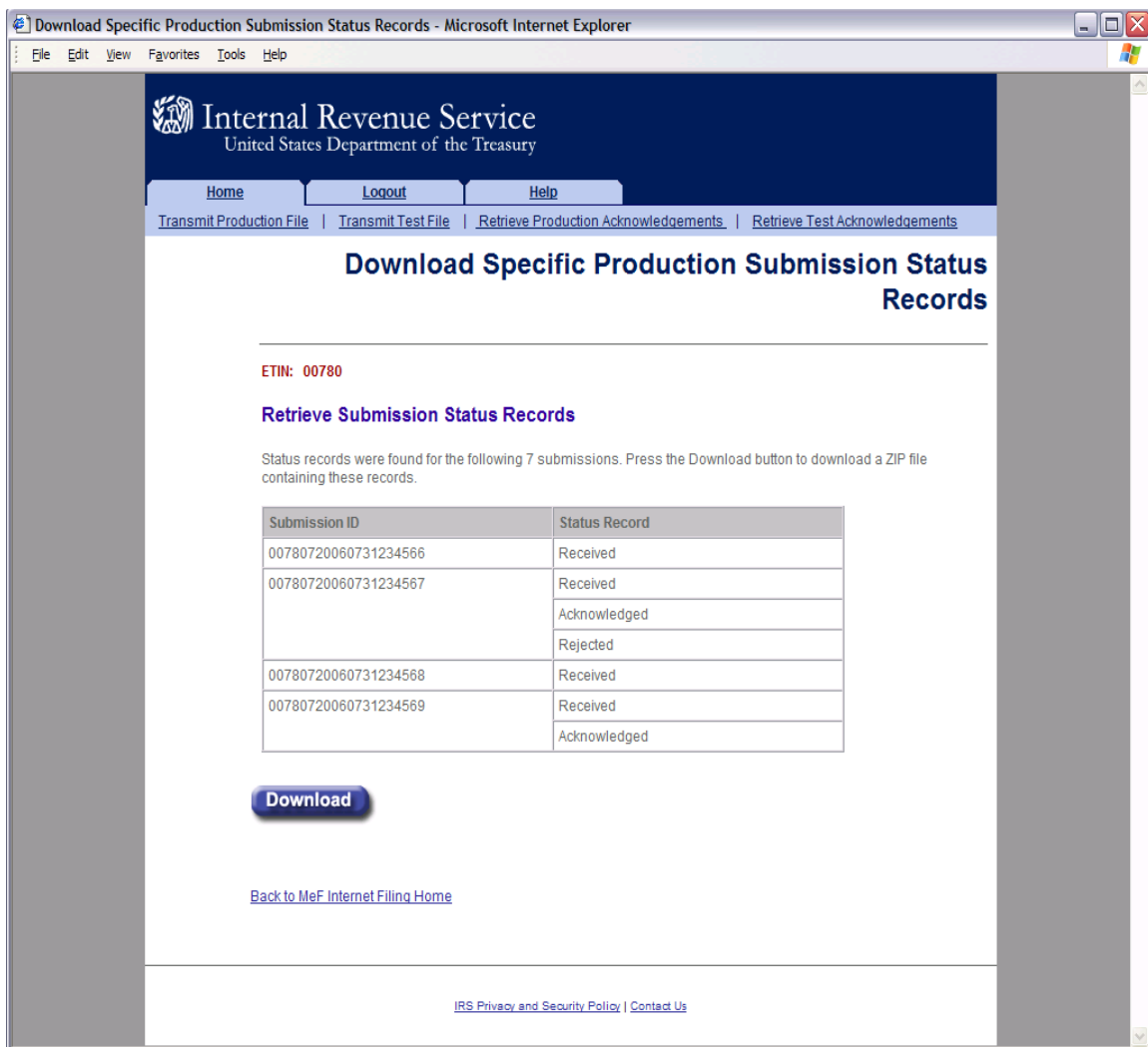

Download Specific Production Submission Status Records - Microsoft Internet Explorer

Internal Revenue Service
United States Department of the Treasury

Home Logout Help

Transmit Production File | Transmit Test File | Retrieve Production Acknowledgements | Retrieve Test Acknowledgements

Download Specific Production Submission Status Records

ETIN: 00780

Retrieve Submission Status Records

Status records were found for the following 7 submissions. Press the Download button to download a ZIP file containing these records.

Submission ID	Status Record
00780720060731234566	Received
00780720060731234567	Received
	Acknowledged
	Rejected
00780720060731234568	Received
00780720060731234569	Received
	Acknowledged

[Download](#)

[Back to MeF Internet Filing Home](#)

[IRS Privacy and Security Policy](#) | [Contact Us](#)

Figure 6-22: Download Specific Production Submission Status Records Page

6.4 Retrieving Form 2290 Schedule 1s

Refer to [Section 4.2.2](#) for Accessing and Logging into MeF IFA.

After the transmitter has logged in and selected the organization they will represent in this session, the MeF Internet Filing Home Page is displayed. A transmitter then performs the following steps to retrieve Production Form 2290 Schedule 1s:

[Step 1: Request Retrieval of the Form 2290 Schedule 1s](#)

[Step 2: Select the ETIN associated with the Form 2290 Schedule 1s](#)

[Step 3: Select the Type of Form 2290 Schedule 1s to Retrieve](#)

[Step 4: Download new Form 2290 Schedule 1s](#)

[Step 5: Download Specific Form 2290 Schedule 1s based on Submission ID](#)

The MeF IFA Web pages supporting these activities are shown in the following pages.

Step 1: Request Retrieval of the Form 2290 Schedule 1s

Click on either the **Retrieve Production 2290 Schedule 1s** link or the **Retrieve Test 2290 Schedule 1s** link at the bottom of the page.

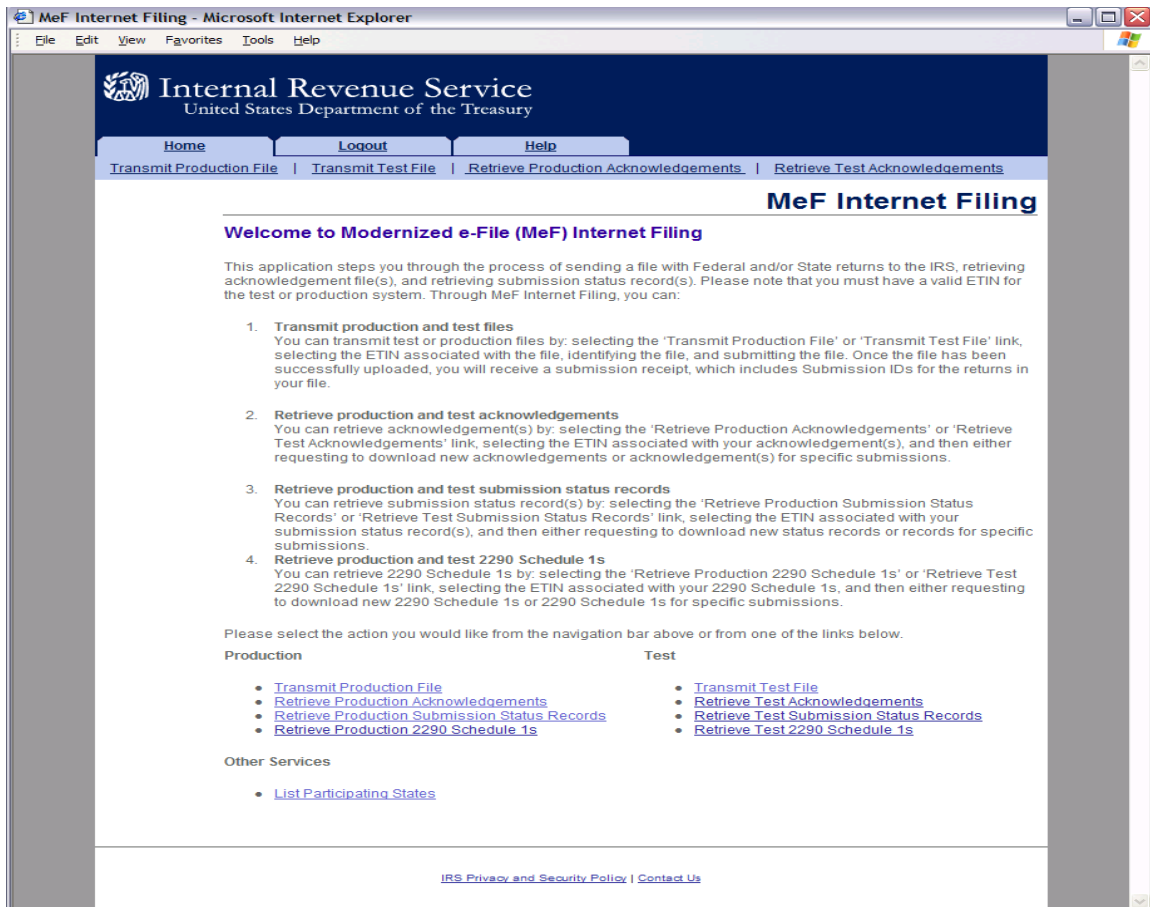

Figure 6-23: Retrieve Production or Test Form 2290 Schedule 1s

Step 2: Select the ETIN associated with the Form 2290 Schedule 1s

After selecting the Retrieve Production (or Test) 2290 Schedule 1s link, the Select ETIN for Production 2290 Schedule 1s page displays. This page shows all ETINs (unique) authorized for the transmitter's use, in order sorted horizontally.

Click the radio button of the ETIN to be associated with the Production list of participating states.

Click the Continue button.

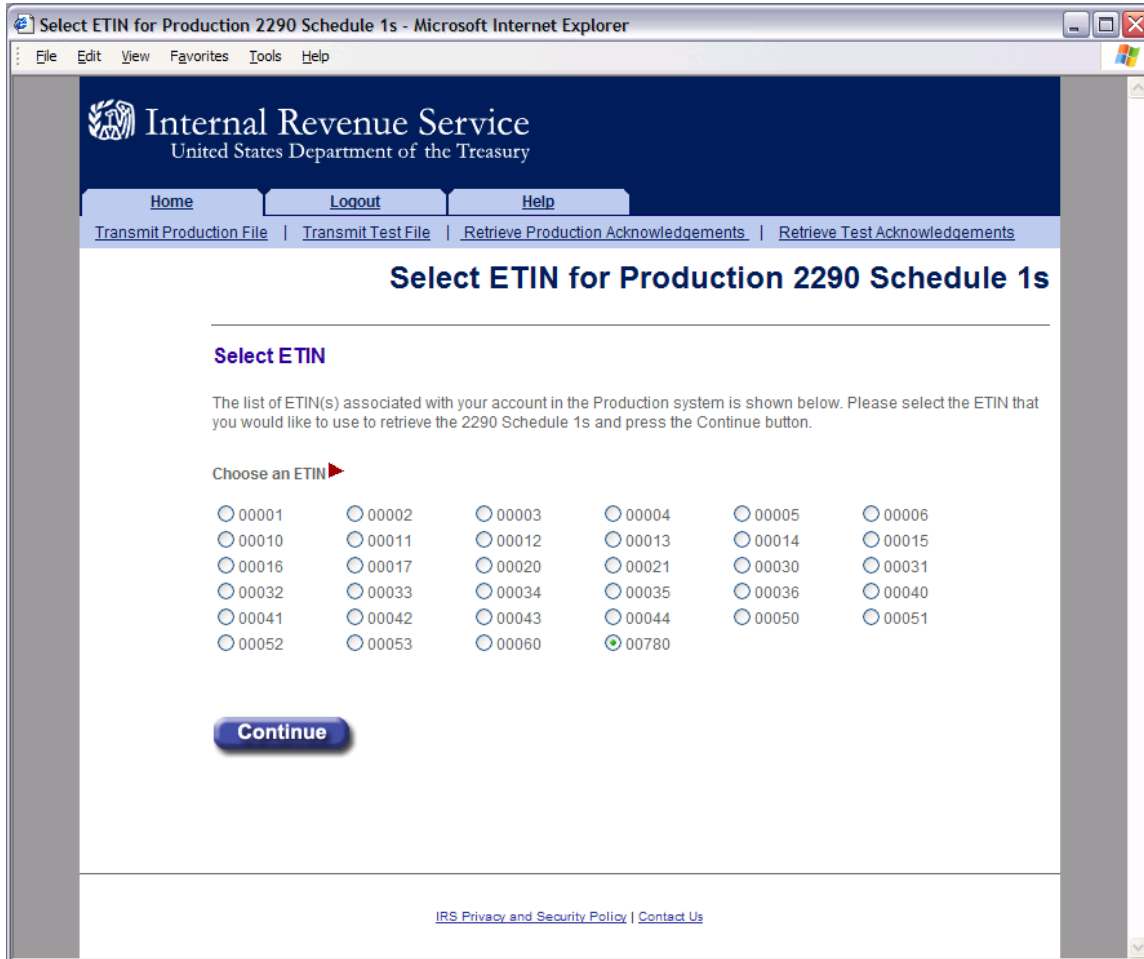

The screenshot shows a web browser window titled "Select ETIN for Production 2290 Schedule 1s - Microsoft Internet Explorer". The page header includes the Internal Revenue Service logo and the text "Internal Revenue Service United States Department of the Treasury". Below the header are navigation links: "Home", "Logout", and "Help". A secondary navigation bar contains links: "Transmit Production File", "Transmit Test File", "Retrieve Production Acknowledgements", and "Retrieve Test Acknowledgements". The main heading is "Select ETIN for Production 2290 Schedule 1s".

Select ETIN

The list of ETIN(s) associated with your account in the Production system is shown below. Please select the ETIN that you would like to use to retrieve the 2290 Schedule 1s and press the Continue button.

Choose an ETIN ▶

<input type="radio"/> 00001	<input type="radio"/> 00002	<input type="radio"/> 00003	<input type="radio"/> 00004	<input type="radio"/> 00005	<input type="radio"/> 00006
<input type="radio"/> 00010	<input type="radio"/> 00011	<input type="radio"/> 00012	<input type="radio"/> 00013	<input type="radio"/> 00014	<input type="radio"/> 00015
<input type="radio"/> 00016	<input type="radio"/> 00017	<input type="radio"/> 00020	<input type="radio"/> 00021	<input type="radio"/> 00030	<input type="radio"/> 00031
<input type="radio"/> 00032	<input type="radio"/> 00033	<input type="radio"/> 00034	<input type="radio"/> 00035	<input type="radio"/> 00036	<input type="radio"/> 00040
<input type="radio"/> 00041	<input type="radio"/> 00042	<input type="radio"/> 00043	<input type="radio"/> 00044	<input type="radio"/> 00050	<input type="radio"/> 00051
<input type="radio"/> 00052	<input type="radio"/> 00053	<input type="radio"/> 00060	<input checked="" type="radio"/> 00780		

Continue

[IRS Privacy and Security Policy](#) | [Contact Us](#)

Figure 6-24: Select ETIN for Production 2290 Schedule 1s Page

Step 3: Select the Type of Form 2290 Schedule 1s to Retrieve

The Retrieve Production 2290 Schedule 1s page allows the transmitter to retrieve either specific previously downloaded 2290 Schedule 1s, or new 2290 Schedule 1s (that is, not previously downloaded).

To retrieve new 2290 Schedule 1s:

- 1) Click the Retrieve new 2290 Schedule 1s radio button (selected by default).
- 2) Enter a number between 1 and the configurable maximum, currently 100, in the “Enter Number of 2290 Schedule 1s” text box, to specify the number of 2290 Schedule 1s to retrieve at one time.
Note: If the transmitter doesn’t specify a number, the default maximum number, currently 100, will be used.
- 3) Click the Submit button

To retrieve previously downloaded 2290 Schedule 1s:

- 1) Click the Retrieve previously downloaded 2290 Schedule 1s based on Submission ID(s) radio button.
- 2) Enter the Submission ID(s) to be retrieved in the Enter Submission ID(s) text box.
Note: Each Submission ID should be separated by a comma, followed by a space. (Submission IDs are listed on Submission Receipts, reporting the successful transmission of a message.)
- 3) Click the Submit button.

Internal Revenue Service
United States Department of the Treasury

Home | Logout | Help

Transmit Production File | Transmit Test File | Retrieve Production Acknowledgements | Retrieve Test Acknowledgements

Retrieve Production 2290 Schedule 1s

ETIN: 00780

Retrieve 2290 Schedule 1s

Please select "Retrieve new 2290 Schedule 1s" to download 2290 Schedule 1s that have not been downloaded previously. Or, select "Retrieve previously downloaded 2290 Schedule 1s based on Submission ID(s)". Press the Submit button to continue.

Retrieve new 2290 Schedule 1s

Enter Number of 2290 Schedule 1s

Note: If no value is entered, the default maximum (100) will be retrieved.

Retrieve previously downloaded 2290 Schedule 1s based on Submission ID(s). Separate each Submission ID with a comma followed by a space (i.e. 00192200602912345678, 00193200607287654321)

Enter Submission ID(s)

Submit

Note: To download based on SubmissionId(s), select the “Retrieve previously downloaded acknowledgements” button. If this button is not checked, the system will try to retrieve new acknowledgements even if you enter a SubmissionId in the box

Figure 6-25: Retrieve Production 2290 Schedule 1s Page

Step 4: Download New Form 2290 Schedule 1s

If the transmitter elects to retrieve new Form 2290 Schedule 1s on the Retrieve Production 2290 Schedule 1s page, the Download New Production 2290 Schedule 1s page displays, showing any new Form 2290 Schedule 1s found.

Click the Download button for a ZIP file containing the Form 2290 Schedule 1s shown in the table.

Important! Since these records will no longer be marked new, you should either download the records before leaving this page or print this page for future reference. To view any additional status records you don't download now, you will have to request the records by Submission ID.

If you see the message "There are additional new 2290 Schedule 1s available for retrieval." click the Get More button to return to the Select ETIN for Production 2290 Schedule 1s page (Figure 6-25) to begin the process for downloading these additional records.

Click either the Home tab on the navigation bar or the Back to MeF Internet Filing Home link to return to the MeF Internet Filing Home page.

Internal Revenue Service
United States Department of the Treasury

Home Logout Help

Transmit Production File | Transmit Test File | Retrieve Production Acknowledgements | Retrieve Test Acknowledgements

Download New Production 2290 Schedule 1s

ETIN: 00780

Retrieve 2290 Schedule 1s

100 2290 Schedule 1s were requested, 3 2290 Schedule 1s were found and are shown in the table below. Press the Download button for a ZIP file containing these 2290 Schedule 1s.

Warning! These 2290 Schedule 1s are no longer marked new. Please either print the page or download the data before leaving this page, otherwise you will have to request the 2290 Schedule 1s by Submission ID if you want to view them again.

If you see a message indicating the availability of additional 2290 Schedule 1s for retrieval, press the Get More button to return to the "Select ETIN for Production 2290 Schedule 1s" page and initiate the process to download these records.

A 2290 Schedule 1 marked with a "Yes" in the Included in File column is available for download. A 2290 Schedule 1 marked with a "No" in the Included in File column is not available for download since an error occurred; the reason for the error is identified in the Notes column.

There are additional 2290 Schedule 1s available for retrieval.

Submission ID	Included in File	Notes
00780720060731234566	Yes	
00780720060731234578	Yes	
00780720060731234568	Yes	

Download Get More

Figure 6-26: Download New Production 2290 Schedule 1s Page

Step 5: Download Specific Form 2290 Schedule 1s Based on Submission ID

If the transmitter elects to retrieve previously downloaded submission status records (based on Submission ID) on the Retrieve Production 2290 Schedule 1s page (see Figure 6-26), the Download Specific Production 2290 Schedule 1s page displays, showing the previously downloaded 2290 Schedule 1s.

Click the Download button for a ZIP file containing the 2290 Schedule 1s shown in the table. Click either the Home tab on the navigation bar or the Back to MeF Internet Filing Home link to return to the MeF Internet Filing Home page.

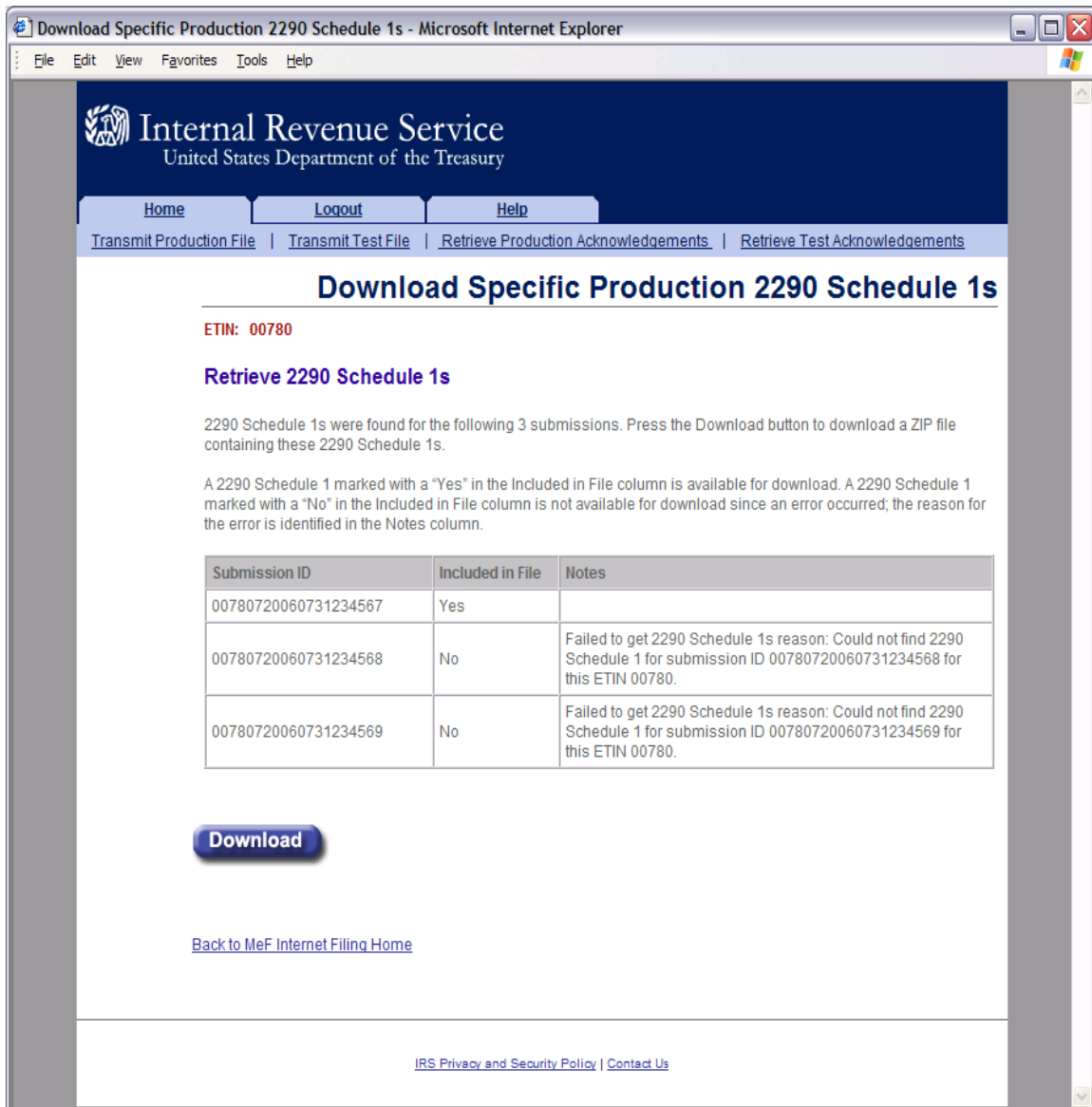

Download Specific Production 2290 Schedule 1s

ETIN: 00780

Retrieve 2290 Schedule 1s

2290 Schedule 1s were found for the following 3 submissions. Press the Download button to download a ZIP file containing these 2290 Schedule 1s.

A 2290 Schedule 1 marked with a "Yes" in the Included in File column is available for download. A 2290 Schedule 1 marked with a "No" in the Included in File column is not available for download since an error occurred; the reason for the error is identified in the Notes column.

Submission ID	Included in File	Notes
00780720060731234567	Yes	
00780720060731234568	No	Failed to get 2290 Schedule 1s reason: Could not find 2290 Schedule 1 for submission ID 00780720060731234568 for this ETIN 00780.
00780720060731234569	No	Failed to get 2290 Schedule 1s reason: Could not find 2290 Schedule 1 for submission ID 00780720060731234569 for this ETIN 00780.

Download

[Back to MeF Internet Filing Home](#)

[IRS Privacy and Security Policy](#) | [Contact Us](#)

Figure 6-27: Download Specific Production 2290 Schedule 1s Page

6.5 Retrieving Acknowledgements through Application-to-Application (A2A)

Transmitters communicate with the MeF system using a series of service requests that are accomplished using messages. The service requests include:

MeF Application-to-Application		
SERVICE REQUEST	TRANSMITTER	STATE AGENCY
Get New Acknowledgements	X	
Get Acknowledgements	X	
Get Acknowledgement	X	
Get Acknowledgements by Message ID	X	

As submissions are validated, the acknowledgements are generated and made available to the transmitter for retrieval. All the submissions in the originating SendSubmissions request do not have to process before acknowledgements become available to the transmitter. When the transmitter requests GetNewAcknowledgements, he/she indicates how many acknowledgements he/she wants to download, (up to the current maximum of 100). The transmitter can retrieve as many acknowledgements that are available, up to the number he/she requested.

The response message provides information in the MoreAvailable field. If the value in that field is "false" then there are no more acknowledgements ready to retrieve. If the value in that field is "true", then there are more acknowledgements available to download. It is important to note that these acknowledgements can be for submissions from different SendSubmissions messages sent by the transmitter.

A2A does not have a transmission acknowledgement. There is a response that contains a receipt. If errors are found in the message, the message service response indicates the error with the letter 'E' appended to the end of the message ID, and the response itself contains the specific error. These are not retrieved through the GetNewAcknowledgements service request. The service request response handles all this.

There are four Get Acknowledgement types:

- **GetNewAcknowledgements** - This request retrieves acknowledgements not previously retrieved by another GetNewAcknowledgements.
- **GetAcknowledgements up to max count** - This request requires the submission IDs of the submissions for which the acknowledgements are being requested.
- **GetAcknowledgement** - This request requires the submission ID of the submission for the acknowledgement being requested.
- **GetAcknowledgementsByMsgId** – This request requires the Message ID of the original GetNewAcknowledgement for the acknowledgements being requested. The MessageId of the GetNewAcknowledgement goes in the SOAP body of this request.

For more information about A2A, refer to the MeF State and Trading Partners ICD and the MeF Submission Composition Guide.

6.6 Retrieving State Submissions through Application-to-Application (A2A)

State agencies communicate with the MeF system using a series of service requests that are accomplished using messages. The service requests include:

MeF Application-to-Application		
SERVICE REQUEST	TRANSMITTER	STATE AGENCY
Get New Submissions		X
Get Submission		X
Get Submissions		X
Get Submissions by Message ID		X

The State applications have authorization to programmatically request a Web Service to retrieve submissions. Each State is responsible for validating their State submissions, and for generating a State acknowledgement for each State submission, which will be returned to the IRS for retrieval by the transmitter. Both Federal and State returns must be in XML format, with optional PDF, when allowed by the state.

There are four Get Submission types:

1. **GetNewSubmissions** - This request retrieves submissions not previously retrieved, up to max count. The default setting is up to 100 submissions and 2GB per filer. The state can request IRS change the default count and size.
2. **GetSubmission** - This request requires the submission ID of the submission requested.
3. **GetSubmissions** - This request requires the submission IDs of the submissions requested.
4. **GetSubmissionsByMsgID** - This request requires the message ID of the submissions requested.

For more information about A2A, refer to the MeF State and Trading Partners Reference Guide and the MeF Submission Composition Guide.

7 Payment Options

7.1 Electronic Funds Withdrawal

The MeF Program will allow a taxpayer to pay the balance due on Form 1040 family/1120/1120-F/1120S/1120-C/1120-POL/990-PF/1065/1065-B/720/2290 tax returns or the 2350/4868/7004/8868 extension forms by authorizing an electronic funds withdrawal. A taxpayer filing an individual return or extension can also include up to four Form 1040ES quarterly estimated tax payments (IRSESPayment Tax Record), with either the Form 1040, 2350 or Form 4868.

If the taxpayer chooses this payment method, they may authorize the entire payment (no greater than 200% of the balance shown on the return) or a partial payment be made at the time that their tax return/extension form is electronically filed.

Note: For extension Form(s) 7004 and 8868, the payment must equal the amount shown as the balance due. For extension Form 4868, the payment must equal the amount shown on Form 4868, Line 7 (amount you are paying). For extension Form 2350, the payment must equal the amount shown on Form 2350, Line 5 (amount you are paying).

The taxpayer must specify the bank account from which they wish to have the payment withdrawn and the date on which the withdrawal will be made. This allows the taxpayer to pay the balance due when the tax return or form is processed or schedule the payment for withdrawal on a future date, not later than the return's due date. For returns transmitted after the due date, the payment date must be the same as the date the return is transmitted or within the previous five days.

Note: Forms 720 and 2290 are to be paid when the return is filed.

Form 7004 does not extend the time to pay tax. If the entity is a corporation or affiliated group of corporations filing a consolidated return, the corporation must remit the amount of the unpaid tax liability shown on line 8 on or before the due date of the return. The Electronic Funds Withdrawal (EFW) payment option can be used for making Form 7004 payments when Form 7004 is filed electronically. Refer to Form 8878-A. A trust (Form 1041), electing large partnership (Form 1065-B), or REMIC (Form 1066) will be granted an extension even if it cannot pay the full amount shown on line 8. But it should pay as much as it can to limit the amount of penalties and interest it will owe. Foreign corporations that maintain an office or place of business in the United States should pay their tax as described below for domestic corporations. If you are requesting an extension of time to file Form 1042, see the deposit rules in the instructions for the form to determine how payment must be made.

If the EFW is authorized, an IRS Payment Record, or IRSESPayment Tax Record(s) (Note: 1-4 IRSESPayment Tax Record(s) must be attached to the electronic return and an EFW consent statement must be signed as described in [Section 9, Electronic Signature Specifications](#).

Domestic corporations must deposit all income tax payments by using the Electronic Federal Tax Payment System (EFTPS) by the due date of the return. If the corporation expects to have a net operating loss carryback, the corporation can reduce the amount to be deposited to the extent of the overpayment resulting from the carryback, provided all other prior year tax liabilities have been fully paid and Form 1138, Extension of Time for Payment of Taxes by a Corporation Expecting a Net Operating Loss Carryback, is filed with Form 7004. Additional EFTPS information is posted to <http://www.irs.gov/efile/article/0,,id=98005,00.html> and www.eftps.gov.

Entities that do not bank in the United States that need to make a payment cannot pay using EFW or EFTPS. On all checks or money orders, write the entity's taxpayer identification number (TIN), the type of tax return, and the Tax Year to which the payment applies. Make the check or money order payable to "United States Treasury" and mail to the address shown in the specific form's instruction.

Note: The payment record can only be attached at the top-level return. Any payment attached elsewhere will not be processed.

The following information is required in the payment record:

- Routing Transit Number
- Bank Account Number
- Account Type
- Payment Amount
- Requested Payment Date
- Taxpayer's Daytime Phone Number

7.1.1 EFW Payment When Return is Rejected

EFW payments are only processed with accepted returns or accepted extensions. If the return and payment cannot be submitted by the due date, taxpayers should consider submitting their payment by other means to avoid assessment of late fees. Other electronic payment options include EFTPS (requires enrollment), credit/debit card, and Same-Day (Fedwire®) payment (primarily used for business payments). For information on electronic payment options, visit www.irs.gov/e-pay. Another option is to pay by check or money order.

The "10-Day Rule" for business returns, allowing for additional days to perfect a return (explained in Section 1.4.2) does not apply to payments.

7.1.2 EFW Payment Cancellation and Payment Inquiry

To revoke or cancel any EFW payment, contact the U.S. Treasury Financial Agent, toll-free, at 1-888-353-4537. Please wait at least ten (10) days from when your IRS e-file return was accepted before calling to inquire about the status of your payment. When calling, please be prepared to provide the Taxpayer Identification Number (TIN), exact payment amount, and bank account number entered in your payment record.

The following is a sample of business rules associated with the Routing Transit Number entered on the payment record. The complete list of business rules is found on each form's respective IRS.gov web site shown below.

***Note:** Business Rules apply to Form(s) 720, 2290, 1040 family, 1040ES, 2350, 4868, 1120, 1120-F, 1120S, 1120-POL, 990-PF, 8868, 7004, 1065 and 1065-B.

IND-003	'BankAccountNumber' in IRS Payment Record must not equal all zeros.	Incorrect Data	Reject	1040 family, 4868
R0000-049	Bank Account Number (in Direct Deposit and IRS Payment Record) must not equal all zero(s).	Incorrect Data	Reject	720, 2290, 1120, 1120-C, 1120-F, 1120S, 1120-POL, 990-PF, 8868, 7004
R0000-050	Bank Account Number in IRS Payment Record must not equal all zeros or all blanks.	Incorrect Data	Reject	1120-POL, 990-PF, 8868, 1065, 1065-B
R0000-075	The Routing Transit Number (RTN) must conform to the banking industry RTN algorithm.	Incorrect Data	Reject	See *Note above
R0000-906	Routing Transit Number (RTN) included in the return must be present in the e-File database.	Database Validation Error	Reject	See *Note above

The complete listing of business rules can be found by selecting the appropriate form type on IRS.gov: <http://www.irs.gov/efile/article/0.,id=171950.00.html>

The following is a sample of business rules associated with the IRS Payment record. The complete list of business rules is found on each form's respective IRS.gov Web site shown below.

Rule Number	Rule Text	Error Category	Severity	Tax Type
FPYMT-018	Tax payer's Day Time Phone Number in IRS Payment Record cannot equal all zeros.	Incorrect Data	Reject	720 2290 1120 1120-C 1120S 1120-F 1120-POL 990-PF 8868, 7004, 1065, 1065-B
FPYMT-040	Taxpayer's Day Time Phone Number in IRS Payment Record or IRS ES Payment Record cannot equal all zeros.	Incorrect Data	Reject	1040 4868
FPYMT—27	If the timestamp (in the GTX key or Response to Send Submissions Request) is on or before the due date of the return (three and one half months after the "TaxPeriodEndDate" in the Return Header), then the "RequestedPaymentDate" in the IRS Payment Record must be on the due date or before the due date but not more than five days prior to the received date.	Incorrect Data	Reject	1065 1065-B
FPYMT-029	If the timestamp is on or before the due date of the return (two months and 15 days after the "TaxPeriodEndDate" in the Return Header), then the "RequestedPaymentDate" in the IRS Payment Record must be on the due date or before the due date but not more than five days prior to the received date.	Incorrect Data	Reject	1120 1120-F 1120S 1120-POL
FPYMT-050	If IRS Payment Record is present, then the "Requested Payment Date" in the IRS Payment Record must be on or before the due date but not more than 5 days prior to the received date, unless Form 4868 Line 8 checkbox or Line 9 checkbox is checked.	Incorrect Data	Reject	4868
FPYMT-054	If the timestamp (in the GTX key or Response to Send Submissions Request) is on or before the due date of the return, then the "RequestedPaymentDate" in the IRS Payment Record must be on the due date or before the due date but not more than five days prior to the received date.	Incorrect Data	Reject	1040

The complete listing of business rules can be found by selecting the appropriate form type on IRS.gov: <http://www.irs.gov/efile/article/0.,id=171950,00.html>.

8 MeF Alternative Signatures

8.1 Electronic Signature Requirement for Corporations, Partnerships, Exempt Organization Returns (except Form 990-N), Forms 720 and 8849

For corporations, partnerships, exempt organization returns (except Form 990-N) and Forms 720 and 8849, the MeF system requires taxpayers and Electronic Return Originators (EROs) to use one of the following two alternative signature options for signing electronic returns

- Practitioner PIN method
- Scanned Form 8453

A Large Taxpayer or a taxpayer filing through an on-line provider must use the scanned Form 8453 signature method when filing returns for corporations, partnerships, exempt organizations (except Form 990-N), Forms 720 and 8849. Publication 4163 has detailed information about Large Taxpayers.

The selected signature option must be identified in the Return Header. MeF validates that a signature exists for each return. If the taxpayer uses a PIN to sign the return, all the appropriate PIN information must be present in the return header. If the electronic return does not contain the required signatures, it will be rejected.

8.2 Electronic Signature Requirement for Form 2290

The Form 2290 Return Header schema includes the Form 2290 signature and the Schedule 1 (Form 2290) Consent to Disclosure of Tax Information signature. The Schedule 1 (Form 2290) signature is optional and used when the taxpayer consents to disclose information about the taxpayer's payment of the Heavy Highway Vehicle Use Tax (HVUT) to the federal Department of Transportation (DOT), U.S. Customs and Border Protection (CBP), and to state Departments of Motor Vehicles (DMV)

The table below identifies the signature options for Form 2290 and Schedule 1 (Form 2290) Consent to Disclosure of Tax Information:

Signature Option	Available for Form 2290?	Available for Schedule 1 (Form 2290) Consent to Disclosure?
Self-Select PIN	Yes (on-line filers only)	Yes (on-line filers only)
Practitioner PIN	Yes	No
Scanned Signed Form	Yes	Yes

8.2.1 Alternate Signature Requirements for Form 2290 online filers only

Taxpayers who complete Form 2290 using commercially available software are allowed to:

- sign the return by creating and entering a 5 digit self-select PIN number as the TaxpayerPIN in the Return Header.
- sign Schedule 1 (Form 2290) Consent to Disclosure of Tax Information by creating and entering a 5 digit self-select PIN number as the Consent to VIN Data Disclosure (ConsentToVINDataDisclosure) in the Return Header. This PIN is not required to be the same PIN used for the Form 2290 signature above.

Under this exception, the taxpayer will sign, date and enter the PIN on Form 8453-EX and/or Schedule 1 (Form 2290) Consent to Disclosure. These documents will be retained by the taxpayer and provided to IRS if requested. This method is not available to taxpayers who use the services of an ERO.

If the taxpayer is not submitting Form 8453-EX as a PDF file in the electronic submission, the signature option “Binary Attachment 8453 Signature Document” should NOT be selected.

If the taxpayer is not submitting the Schedule 1 (Form 2290) Consent to Disclosure Tax Information as a PDF file in the electronic submission, the signature option “Binary Attachment VIN Disclosure Statement” should NOT be selected.

8.3 Electronic Signature Requirement for Extension Forms 4868, 7004 and 8868

Extension Forms 4868, 7004 and 8868 only require a signature if there is a payment attached. EXCEPTION: Forms 8868 Part II ALWAYS requires a signature whether or not a payment is attached. If providing a payment with:

- Form 4868, the Practitioner PIN, Self-Select PIN or Electronic Filing PIN method may be used.
- Form 8868, the Practitioner PIN or scanned 8453 method may be used (See [Section 11.1](#)).
- Form 7004, the Practitioner PIN method or ACHDebitAgreementIndicator must be used to sign the extension application and payment.

8.4 Electronic Signature Requirement for Form 990-N

There is no signature requirement for the electronically filed Form 990-N.

8.5 Electronic Signature Requirement for Forms 1040 Series

For Form 1040, the MeF electronic signature options are:

- Self-Select PIN
- Practitioner PIN

IRS does not provide a Form 8453 signature option for Forms 1040, 1040A, 1040EZ, or 1040-SS. Questions and Answers on the Form 1040 and 4868 PIN options can be found on IRS.gov:

- [Practitioner PIN Method for Forms 1040 Family and 4868 MeF](#)
- [Self-Select PIN Method for Forms 1040 Family and 4868 MeF](#)

8.6 Electronic Signature Methods

This section provides information on electronic signature methods:

- Practitioner PIN Option
- Self-Select PIN Option
- Form 8453 Signature Document

Sections 8.1 through 8.5 explain which signature options are available for each form that can be filed through MeF.

8.6.1 Practitioner PIN Option

Taxpayers who use an ERO to e-file their return may use the Practitioner PIN signature option. If the signature option of “PIN Number” is chosen, the taxpayer and ERO will be required to sign the return with a personal identification number (PIN). The Practitioner PIN may only be used by a taxpayer using an ERO. The Practitioner PIN option consists of two PINs – one for the taxpayer and one for the Practitioner.

1) Taxpayer PIN --The taxpayer chooses the PIN that they wish to use to sign their return. The Taxpayer’s PIN must be 5 numeric characters and cannot contain all zeros.

2) Practitioner PIN --The ERO selects an eleven position PIN to sign the return. The first 6 positions of the Practitioner PIN will be made up of the EFIN of the ERO and the next 5 positions will be made up of 5 numeric characters that the ERO will select.

The taxpayer must decide whether they want to enter their own PIN or whether they authorize the ERO to enter the PIN they choose as their signature. This authorization is made on the following Forms 8879 (Forms can be found on IRS.gov at <http://www.irs.gov/app/picklist/list/formsInstructions.html>)

- Form 8879 for Form 1040, 1040A, 1040EZ, and 1040-SS (PR)
- Form 8879-C for Form 1120
- Form 8879-I for Form 1120-F
- Form 8879-S for Form 1120S
- Form 8879-EO for Exempt Organization returns
- Form 8879-PE for Form 1065
- Form 8879-B for Form 1065-B
- Form 8879-EX for Forms 720, 2290, and 8849

Do not send Form 8879 to IRS in the electronic submission or by paper. The taxpayer should give the Form 8879 to the ERO. See Form 8879 instructions for details.

The required PIN information is placed in the Return Header. The following fields are required for the Practitioner PIN or the return will reject:

Corporate Returns & Exempt Organization Returns (except 990-N)	Partnership Returns	Forms 720, 2290 & 8849
Practitioner PIN	Practitioner PIN	Practitioner PIN
PIN Entered by Indicator	PIN Entered by Indicator	
Taxpayer PIN	Taxpayer PIN	
Date Signed	Date Signed	
Name of Officer	Name of Partner	
Title of Officer	Title of Partner	

Form 1040 Family Not Joint Filing Status Self-Select Practitioner	Form 1040 Family Joint Filing Status Self-Select Practitioner	Form 1040 Family Not Joint Filing Status Practitioner	Form 1040 Family Joint Filing Status Practitioner
Primary Date of Birth	Primary Date of Birth	Primary Signature	Primary Signature
Primary Prior Year AGI/Prior Year PIN/Electronic Filing PIN	Primary Prior Year AGI/Prior Year PIN/Electronic Filing PIN	Taxpayer Signature Date	Taxpayer Signature Date
Primary Signature	Primary Signature	Jurat Disclosure Code	Jurat Disclosure Code
	Spouse Date of Birth	Primary PIN Entered By Indicator	Primary PIN Entered By Indicator
	Spouse Prior Year AGI/Prior Year PIN/Electronic Filing PIN		Spouse Signature
	Spouse Signature		Spouse Signature Date
			Spouse PIN Entered By Indicator

The Practitioner PIN requirements for Form 1040 business rules include exceptions for deceased taxpayers: F1040-670, F1040-671, F1040-697, and F1040-698.

The business rules in the table below are associated with the Practitioner PIN.

Rule Number	Rule Text	Error Category	Severity	Forms
F1040-120	If Form 1040 Line 2 checkbox "Married filing jointly" is checked (element 'IndividualReturnFilingStatusCd' has the value 2) and the 'PINTypeCode' in the Return Header has a value, then the following fields in the Return Header must have a value: 'PrimarySignatureDate', 'JuratDisclosureCode', 'PrimaryPINEnteredBy', and 'SpousePINEnteredBy'.	Missing Data	Reject	1040
F1040-121	If Form 1040 Line 2 checkbox "Married filing jointly" is not checked (element 'IndividualReturnFilingStatusCd' does not have the value 2) and the 'PINTypeCode' in the Return Header has a value, then the following fields in the Return Header must have a value: 'PrimarySignatureDate', 'JuratDisclosureCode', 'PrimaryPINEnteredBy'.	Missing Data	Reject	1040
R0000-029	If the Signature Option "PIN Number" is selected (the element "SignatureOption" in the Return Header has a value of "PIN Number") then the following fields must have a value in the Return Header: "PractitionerPIN", "TaxpayerPIN", "Name" of the "Officer", "Title" of the "Officer", "DateSigned" and "PINEnteredBy" Indicator.	Missing Data	Reject	1120, 1120-F, 1120S, 990, 990-EZ 990-PF 1120- POL, 8868
R0000-030	In the Return Header, if the Practitioner PIN is provided then the EFIN in the PractitionerPIN must be the same as the EFIN of the Originator.	Data Mismatch	Reject	All MeF Forms except 990-N
R0000-031	Taxpayer PIN in the Return Header cannot equal all zeros.	Incorrect Data	Reject	All MeF Forms except 990-N
R0000-032	Signature Option in the Return Header is a required field and must have either the value "Binary Attachment 8453 Signature Document" or "PIN Number".	Missing Data	Reject	1120, 1120S, 990, 990-EZ, 990-PF 1120- POL
R0000-068	If the Signature Option "PIN Number" is selected (the element "SignatureOption" in the Return Header has a value of "PIN Number") then the following fields must have a value in the Return Header: "PractitionerPIN", "TaxpayerPIN", "Name" of the "Partner", "Title" of the "Partner",	Missing Data	Reject	1065 1065-B
R0000-085	If the signature option "PIN Number" is selected (the element "SignatureOption" in the Return Header has a value of "PIN Number") and the PIN entered by option "ERO" is selected (the element "PINEnteredBy" in the Return Header has a value of "ERO"), then the PractitionerPIN field must have a value in the Return Header and this value cannot equal all zeros.	Incorrect Data	Reject	720 2290 8849

All MeF business rules can be found on IRS.gov [Modernized e-File Schemas and Business Rules](#) Web page.

8.6.2 Self-Select PIN option

The self-select PIN option is available for Forms 1040, 1040A, 1040EZ, 1040-SS(PR), 2350, 4868 and 2290. The PIN is any five numbers except all zeros the taxpayer chooses to enter as the electronic signature. Guidance for Form 2290 is provided in [Section 8.2 Electronic Signature Requirement for Form 2290](#).

The Data Validation for these forms is:

Primary Taxpayer

- Social Security Number
- Name Control
- Date of Birth
- Prior Year Adjusted Gross Income and/or Prior Year PIN and/or Prior Year Electronic Filing PIN.

Spouse, When Married Filing Jointly

- Spouse Social Security Number
- Spouse Name Control
- Spouse Date of Birth
- Prior Year Adjusted Gross Income and/or Prior Year PIN and/or Prior Year Electronic Filing PIN.

Taxpayers filing a joint return each need a PIN and each may choose any five numbers. As part of the authentication process, each taxpayer enters their date of birth, and either their original prior year adjusted gross income (AGI) or their prior year PIN/Electronic Filing PIN.

If the taxpayer agrees, it is acceptable for an ERO and/or software program to generate or assign the taxpayer PIN. The taxpayer consents to the ERO's choice by completing and signing the signature authorization form (Form 8879 for Form 1040 family and Form 8878 for Form 4868 and Form 2350) containing the intended taxpayer PIN. The taxpayer PIN can be systemically generated or manually assigned into the electronic format and/or the Form 8879/8878. However, the ERO must receive the taxpayer-signed signature authorization before the return is transmitted or is released for transmission to the IRS.

If both the AGI and prior year PIN are included in the electronic submission, only one of the entries must match the IRS database for the return to pass this validation.

The Electronic Filing PIN was implemented in January 2010 and can be used by filers who cannot locate their prior year AGI or prior year PIN. Taxpayers can access the Electronic Filing PIN (Help) application on IRS.gov and receive a 5 digit PIN to electronically file their return or extension after providing the following information as shown on their 2010 tax return:

- Social Security Number (or Individual Taxpayer Identification Number)
- First and Last Name
- Date of Birth
- Filing Status
- Complete mailing address

If the information entered does not match IRS records, taxpayers can contact IRS at 1-866-704-7388 to receive their Electronic Filing PIN.

8.6.3 Scanned Form 8453 Option

The scanned Form 8453 signature option is available for Forms 720, 2290, 8849, 1120, 1120-F, 1120S, 1065, 1065-B, 990, 990-EZ, 990-PF, and 1120-POL. The scanned Form 8453 must be used if the taxpayer decides not to use, or is prohibited from using, the Practitioner PIN option. If the scanned Form 8453 signature option is used:

- the taxpayer and ERO (if applicable) must sign the paper Form 8453.
- the signed Form 8453 must be scanned into a PDF document and inserted into the electronic return as a binary attachment.
- the signature option “Binary Attachment 8453 Signature Document” must be identified in the Return Header.
- the Description in the binary attachment must be “8453 Signature Document”.

For more information about binary attachments, refer to [Section 2.2](#). The following business rule is associated with the Scanned Form 8453 option.

Rule Number	Rule Text	Error Category	Severity	Tax Type
R0000-032	Signature Option in the Return Header is a required field and must have either the value "Binary Attachment 8453 Signature Document" or "PIN Number".	Missing Data	Reject	720, 2290, 8849, 1120, 1120-F, 1120S, 990, 990-EZ, 990-PF 1120- POL, 1065, 1065-B

Business rules for the MeF forms will be posted to the IRS.gov Web pages found in the

Current Valid Schema Page for each form type. You can access these business rules by selecting the appropriate form type on IRS.gov at:

<http://www.irs.gov/efile/article/0,,id=171950,00.html>

PDF files of the Forms 8453, which will be used for each of the programs shown below, can be accessed from the IRS.gov Web site at

<http://www.irs.gov/app/picklist/list/formsInstructions.html>.

- Form 8453-C for Form 1120
- Form 8453-S for Form 1120-C
- Form 8453-EO for Exempt Organization returns
- Form 8453-PE for Form 1065
- Form 8453-B for Form 1065-B
- Form 8453-I for Form 1120-F
- Form 8453-EX for Forms 720/2290/8849

8.7 Elections That Require Separate Signatures

IRS Counsel reviewed Treasury Regulations to identify elections that require a signature to determine if the requirements can be changed. IRS published the results of this review on IRS.gov on the e-file for Large Business and International Web page. Elections that require a separate signature may be submitted in PDF format.

8.8 Forms Attached to 1120/1120S with Separate Signatures

Many forms that may be attached to Forms 1120 and 1120S have separate signature lines. During the development of MeF, IRS identified the forms with separate signature lines and requested IRS Counsel issue special instructions to facilitate electronic filing. Regulation T.D. 9300 contains amendments to the Income Tax Regulations (26 CFR Part 1) and Procedure and Administration Regulations (26 CFR part 301) and eliminates some regulatory requirements considered to have been impediments to the electronic submission of tax returns and other forms filed by corporations, partnerships and other businesses with regard to third party signature requirements. These regulations impeded electronic filing by

- 1) requiring taxpayers to include third party signatures on their tax returns;
- 2) requiring taxpayers to attach documents or statements generated by third parties; or
- 3) requiring a taxpayer to sign an IRS form and file it as an attachment to their income tax return.

T.D. 9300 eliminates the impediments for taxable years beginning after December 31, 2002. The regulations generally affect taxpayers who are required to file any of the following forms: 926, 973, 982, 1120, 1120S, 1122, 5471, 5712-A, 8832. See T.D. 9300 for a complete list. In addition, effective May 30, 2006, T.D. 9264 also eliminated signature impediments by stating that by signing the return, a taxpayer is attesting to the validity of the Form 1120 as well as all of the attachments.

9 Electronic Signature Specifications

9.1 Jurat/Disclosure Guidelines

This section provides guidelines for the jurat/disclosure language to be included in software packages for electronically filed returns and extensions.

In all instances, the appropriate jurat/disclosure text must be provided to the officer of the corporation or exempt organization prior to the presentation of fields used to enter signature(s) (PIN).

A filer requesting a copy of an Exempt Organization return be sent to a state charity regulating agency(s) must have a separate screen or screens for the disclosure consent allowing disclosure to the state agency and a separate screen or screens for the signature jurat and disclosure consents permitting disclosure to the ERO.

4. It is imperative that all taxpayers who use the Electronic Funds Withdrawal feature are provided with the appropriate Electronic Funds Withdrawal (EFW) text for their review. Only the approved EFW text displayed in this publication is to be used.

5. Software products intended for use by tax professionals may also provide functionality to print a graphic equivalent of the jurat/disclosure statements for the officer of the corporation or exempt organization to sign as an alternative to viewing and signing the statement on the input screen. A graphic equivalent may be appropriate when the officer of the corporation will not be present to review the completed return in the presence of the ERO, and has elected to authorize the ERO to enter the officer's PIN that they selected.

9.2 Jurat Language Text Selections

This section identifies the Perjury, Consent to Disclosure and Electronic Funds Withdrawal text selections (components) used to develop jurat language statements for electronic filing tax preparation software where the Practitioner PIN method is selected. The software must provide the capability to incorporate these into the appropriate text for presentation to a taxpayer for their review.

9.2.1 Form 1040, 1040A, 1040EZ, 1040SS, and 1040 PR Jurat

The Jurat Disclosure Code options in the Form 1040, 1040A, 1040EZ, 1040SS or 1040PR Return Header are:

- Online Self Select PIN
- Self Select PIN by ERO
- Practitioner PIN

The perjury statement and consent to disclosure are required on all Form 1040, 1040A, 1040EZ, or 1040-SS(PR) electronic returns.

The Perjury Statement

Under penalties of perjury, I declare that I have examined this return including any accompanying statements and schedules and, to the best of my knowledge and belief, it is true, correct, and complete.

Consent to Disclosure

I consent to allow my Intermediate Service Provider, transmitter, or Electronic Return Originator (ERO) to send my return to IRS and to receive the following information from IRS: a) an acknowledgement of receipt or reason for rejection of transmission; b) the reason for any delay in processing or refund; and, c) the date of any refund.

The following consent should only be presented when the taxpayer has selected the Electronic Funds Withdrawal option:

Electronic Funds Withdrawal Consent

If applicable, I authorize the U.S. Treasury and its designated Financial Agent to initiate an ACH electronic funds withdrawal (direct debit) entry to the financial institution account indicated in the tax preparation software for payment of my Federal taxes owed on this return and/or a payment of estimated tax, and the financial institution to debit the entry to this account. I further understand that this authorization may apply to future Federal tax payments that I direct to be debited through the Electronic Federal Tax Payment System (EFTPS). In order for me to initiate future payments, I request that the IRS send me a personal identification number (PIN) to access EFTPS. This authorization is to remain in full force and effect until I notify the U.S. Treasury Financial Agent to terminate the authorization. To revoke a payment, I must contact the U.S. Treasury Financial Agent at 1-888-353-4537 no later than 2 business days prior to the payment (settlement) date. I also authorize the financial institutions involved in the processing of the electronic payment of taxes to receive confidential information necessary to answer inquiries and resolve issues related to the payment.

Taxpayer Signature when Self-Select PIN (Online Self-Select PIN or Self-Select by ERO) will be used to sign the return:

I am signing this Tax Return/Form and Electronic Funds Withdrawal Consent, if applicable, by entering my PIN below.

Taxpayer's PIN: _____ Date: _____
Taxpayer's Date of Birth: _____
Taxpayer's Prior Year Adjusted Gross Income : _____ *
Taxpayer's Prior Year PIN/Electronic Filing PIN: _____ *
Spouse's PIN: _____
Spouse's Date of Birth: _____
Spouse's Prior Year Adjusted Gross Income : _____ *
Spouse's Prior Year PIN/Electronic Filing PIN: _____ *

***NOTE: Taxpayers may use either the Prior Year AGI or Prior Year PIN/Electronic Filing PIN for authentication. If both are included in the record only one has to match IRS records.**

Taxpayer Signature when Practitioner PIN method will be used to sign the return.

I am signing this Tax Return and Electronic Funds Withdrawal Consent, if applicable, by entering my PIN below.

Taxpayer's PIN: _____ Date _____
Spouse's PIN: _____ Date _____

Use the ERO Declaration and Signature for Self-Select and Practitioner PIN when the return is transmitted by an Electronic Return Originator (ERO).

ERO Declaration

I declare that the information contained in this electronic tax return is the information furnished to me by the taxpayer. If the taxpayer furnished me a completed tax return, I declare that the information contained in this electronic tax return is identical to that contained in the return provided by the taxpayer. If the furnished return was signed by a paid preparer, I declare I have entered the paid preparer's identifying information in the appropriate portion of this electronic return. If I am the paid preparer, under the penalties of perjury I declare that I have examined this electronic return, and to the best of my knowledge and belief, it is true, correct, and complete. This declaration is based on all information of which I have any knowledge.

ERO Signature

I am signing this Tax Return by entering my PIN below.

ERO's PIN _____
(enter EFIN plus 5 Self-Selected numeric)

Decedent Returns only with Form 1310 attached (1040/1040EZ/1040A)

Use this selection only for Form 1040, 1040A, or 1040EZ Decedent returns that are filed with a Form 1310, Statement of Person Claiming Refund Due a Deceased Taxpayer. If both taxpayers are shown as decedents on this return, two Forms 1310 are required, and T8 information must be completed for each decedent.

Form 1310 Signature and Verification

Completion of this section indicates that I am requesting a refund of taxes overpaid by or on behalf of the decedent. Under penalties of perjury, I declare that I have examined this Form 1310 claim, and to the best of my knowledge and belief, it is true, correct, and complete.

Signature of person claiming refund (35 character limit) Date

9.2.2 Form 2350 Jurat

All electronic Form 2350 submissions must be signed.

The signature statement, perjury statement, and consent to disclosure are required on all Form 2350 electronic returns.

The Electronic Funds Withdrawal Consent is required whenever there is an electronic funds withdrawal.

Signature Statements

Use the following when signed by the Taxpayer or Taxpayer spouse:

Taxpayer Signature Statement

I am signing this Tax Return/Form and Electronic Funds Withdrawal Consent, if applicable, by entering my Self Select PIN below.

Taxpayer's PIN: _ _ _ _ _ Date: _ _ _ _ _
Taxpayer's Date of Birth: _ _ _ _ _
Taxpayer's Prior Year Adjusted Gross Income: _ _ _ _ _ *
Taxpayer's Prior Year PIN - - - - -
Electronic Filing PIN _ _ _ _ _ *
Spouse's PIN: _ _ _ _ _
Spouse's Date of Birth: _ _ _ _ _
Spouse's Prior Year Adjusted Gross Income: _ _ _ _ _ *
Spouse's Prior Year PIN/Electronic Filing PIN _ _ _ _ _ *

*NOTE: Taxpayers may use either the Prior year AGI or Prior year PIN or Electronic Filing PIN for authentication. If all three are included in the record only one has to match IRS records.

Preparer Other Than the Taxpayer signature Statement

Use this signature selection when filing a Form 2350 signed by a Preparer Other Than the Taxpayer

I am signing this Form by entering my name and date below.

Name of Preparer Other Than Taxpayer (35 character limit)

Date

The Perjury Statement

Perjury Statement – use this selection when electronically filing Form 2350

Under penalties of perjury, I declare that, 1) I have examined this form, including any accompanying statements and schedules and, to the best of my knowledge and belief, it is true, correct, and complete; and if prepared by someone other than the taxpayer, 2) I am authorized to prepare this form.

Consent to Disclosure Statement

I consent to allow my Intermediate Service Provider, transmitter, or Electronic Return Originator (ERO) to send this form to IRS and to receive the following information from IRS:

(a) Acknowledgment of receipt or reason for rejection of transmission, and (b) if delayed, reason for any delay in processing the form.

Electronic Funds Withdrawal Consent

The following consent should only be presented when the taxpayer or a third party has selected the Electronic Funds Withdrawal option:

I authorize the U.S. Treasury and its designated Financial Agent to initiate an ACH electronic funds withdrawal (direct debit) entry to the financial institution account indicated in the tax preparation software for payment of my Federal taxes owed, and the financial institution to debit the entry to this account. This authorization is to remain in full force and effect until I notify the U.S. Treasury Financial Agent to terminate the authorization. To revoke a payment, I must contact the U.S. Treasury Financial Agent at 1-888-353-4537 no later than 2 business days prior to the payment (settlement) date. I also authorize the financial institutions involved in the processing of the electronic payment of taxes to receive confidential information necessary to answer inquiries and resolve issues related to the payment.

9.2.3 Form 4868 Jurat

The consent to disclosure is required on all Form 4868 electronic submissions.

Consent to Disclosure

I consent to allow my Intermediate Service Provider, transmitter, or Electronic Return Originator (ERO) to send this form to IRS and to receive the following information from IRS

- (a) Acknowledgment of receipt or reason for rejection of transmission, and
- (b) if delayed, reason for any delay in processing the form.

The following Electronic Funds Withdrawal Consent and taxpayer signature should only be presented when the taxpayer has selected the Electronic Funds Withdrawal option and the Self-Select PIN option is used.

Electronic Funds Withdrawal Consent

I authorize the U.S. Treasury and its designated Financial Agent to initiate an ACH electronic funds withdrawal (direct debit) entry to the financial institution account indicated in the tax preparation software for payment of my Federal taxes owed, and the financial institution to debit the entry to this account. This authorization is to remain in full force and effect until I notify the U.S. Treasury Financial Agent to terminate the authorization. To revoke a payment, I must contact the U.S. Treasury Financial Agent at 1-888-353-4537 no later than 2 business days prior to the payment (settlement) date. I also authorize the financial institutions involved in the processing of the electronic payment of taxes to receive confidential information necessary to answer inquiries and resolve issues related to the payment.

Taxpayer Signature for Self-Select PIN

I am signing this Tax Return/Form and Electronic Funds Withdrawal Consent, if applicable, by entering my Self Select PIN below.

Taxpayer's PIN: _____ Date: _____
Taxpayer's Date of Birth: _____
Taxpayer's Prior Year Adjusted Gross Income _____ *
Taxpayer's Prior Year PIN/Electronic Filing PIN _____ *
Spouse's PIN: _____
Spouse's Date of Birth: _____
Spouse's Prior Year Adjusted Gross Income: _____ *
Spouse's Prior Year PIN/Electronic Filing PIN _____ *

***NOTE: Taxpayers may use either the prior year AGI or PIN for authentication. If both are included in the record only one has to match IRS records.**

The following taxpayer signature for EFW is required when Practitioner PIN signature method is used.

Electronic Funds Withdrawal Consent

I am signing this Electronic Funds Withdrawal Consent by entering my PIN below.

Taxpayer's PIN: _____ Date: _____
Spouse's PIN: _____ Date: _____

There is no signature requirement for the Form 4868 itself. A taxpayer signature is only required to authorize the withdrawal.

9.2.4 Forms 56 Jurat

The consent to disclosure is required on all Form 56 electronic submissions.

The Form 56 electronic return signed by the Fiduciary method must contain the following text.

Consent to Disclosure

I consent to allow my Intermediate Service Provider, transmitter, or Electronic Return Originator (ERO) to send this form to IRS and to receive the following information from IRS: (a) acknowledgment of receipt or reason for rejection of transmission, and (b) if delayed, reason for any delay in processing the form.

Fiduciary Certification and Signature

I certify that I have the authority to execute this notice concerning fiduciary relationship on behalf of the taxpayer identified on this form. I agree to retain a copy of any evidence required authorizing me to serve in this fiduciary capacity and to provide such evidence upon request.

Fiduciary Signature

I am signing this notice by entering my name and date below.

Fiduciary PIN _____ **Date** _____

9.2.5 Form 9465 (Standalone) Jurat

The consent to disclosure is required on all standalone Form 9465 electronic submissions.

Consent to Disclosure

I consent to allow my Intermediate Service Provider, transmitter, or Electronic Return Originator (ERO) to send this form to IRS and to receive the following information from IRS:

(a) Acknowledgment of receipt or reason for rejection of transmission, and (b) if delayed, reason for any delay in processing the form.

The following Electronic Funds Withdrawal Consent and taxpayer signature must be presented when the taxpayer has selected the Electronic Funds Withdrawal option to establish a Direct Debit Installment Agreement, (Include statement only with Electronic Funds Withdrawal EFW. Statement in Form 8878 does not apply), and the Self-Select PIN option is used.

Electronic Funds Withdrawal Consent

I authorize the U.S. Treasury and its designated Financial Agent to initiate a monthly ACH debit (electronic withdrawal) entry to the financial institution account indicated for payments of my federal taxes owed, and the financial institution to debit the entry to this account. This authorization is to remain in full force and effect until I notify the U.S. Treasury Financial Agent to terminate the authorization. To revoke payment, I must contact the U.S. Treasury Financial Agent at 1-800-829-1040 no later than 14 business days prior to the payment (settlement) date. I also authorize the financial institutions involved in the processing of the electronic payments of taxes to receive confidential information necessary to answer inquiries and resolve issues related to the payments.

The taxpayer signature must be present on all standalone Form 9465s.

I am signing this Tax Return/Form and Electronic Funds Withdrawal Consent, if applicable, by entering my Self Select PIN below.

Taxpayer's PIN: _____ Date: _ _ _ _ _
Taxpayer's Date of Birth: _ _ _ _ _
Taxpayer's Prior Year Adjusted Gross Income: _____ *
Taxpayer's Prior Year PIN - - - - - *
Electronic Filing PIN _____ *
Spouse's PIN: _ _ _ _ _
Spouse's Date of Birth: _ _ _ _ _
Spouse's Prior Year Adjusted Gross Income: _____ *
Spouse's Prior Year PIN/Electronic Filing PIN _ _ _ _ _ *

***NOTE:** Taxpayers may use either the Prior year AGI or Prior year PIN or Electronic Filing PIN for authentication. If all three are included in the record only one has to match IRS records.

9.2.6 Form 1120, 1120-F and 1120S Jurat

The Form 1120, Form 1120-F, or Form 1120S electronic return signed by the Practitioner PIN method must contain the following text.

Perjury Statement

Under penalties of perjury, I declare that I am an officer of the above corporation and that I have examined a copy of the corporation's 2011 electronic income tax return and accompanying schedules and statements and to the best of my knowledge and belief, it is true, correct, and complete.

Consent to Disclosure

I consent to allow my electronic return originator (ERO), transmitter, or intermediate service provider to send the corporation's return to the IRS and to receive from the IRS (a) an acknowledgement of receipt or reason for rejection of the transmission, (b) an indication of any refund offset, (c) the reason for any delay in processing the return or refund, and (d) the date of any refund.

The following Electronic Funds Withdrawal Consent should only be presented when the taxpayer has selected the Electronic Funds Withdrawal option.

Electronic Funds Withdrawal Consent

I authorize the U.S. Treasury and its designated Financial Agent to initiate an electronic funds withdrawal (direct debit) entry to the financial institution account indicated in the tax preparation software for payment of the corporation's Federal taxes owed on this return, and the financial institution to debit the entry to this account. To revoke a payment, I must contact the U.S. Treasury Financial Agent at 1-888-353-4537 no later than 2 business days prior to the payment (settlement) date. I also authorize the financial institution involved in the processing of the electronic payment of taxes to receive confidential information necessary to answer inquiries and resolve issues related to the payment.

Officer's Signature

I am signing this Tax Return and Electronic Funds Withdrawal Consent, if applicable, by entering my self selected PIN below.

Officer's PIN _ _ _ _ _

Date: _ _ _ _ _

ERO Declaration

I declare that the information contained in this electronic tax return is the information furnished to me by the corporation. If the corporation furnished me a completed tax return, I declare that the information contained in this electronic tax return is identical to that contained in the return provided by the corporation. If the furnished return was signed by a paid preparer, I declare I have entered the paid preparer's identifying information in the appropriate portion of this electronic return. If I am the paid preparer, under the penalties of perjury, I declare that I have examined this electronic return, and to the best of my knowledge and belief, it is true, correct, and complete. This declaration is based on all information of which I have any knowledge

9.2.7 Form 7004 Jurat

No signature is required on the Form 7004 unless the taxpayer has selected the Electronic Funds Withdrawal option. If selected, the Form 7004 electronic extension signed by the Practitioner PIN method must contain the following text.

9.2.7 Form 7004 Jurat

Perjury Statement

Under penalties of perjury, I declare that I have been authorized by the above taxpayer to make this authorization and that I have examined a copy of the taxpayer's electronic extension (Form 7004) for the tax period indicated above and to the best of my knowledge and belief, it is true, correct, and complete.

Consent to Disclosure

I consent to allow my electronic return originator (ERO), transmitter, or intermediate service provider to send the corporation's return to the IRS and to receive from the IRS (a) an acknowledgement of receipt or reason for rejection of the transmission, (b) an indication of any refund offset, (c) the reason for any delay in processing the return or refund, and (d) the date of any refund.

Electronic Funds Withdrawal Consent

I authorize the U.S. Treasury and its designated Financial Agent to initiate an electronic funds withdrawal (direct debit) entry to the financial institution account indicated in the tax preparation software for payment of the taxpayer's balance due on Form 7004, and the financial institution to debit the entry to this account. To revoke a payment, I must contact the U.S. Treasury Financial Agent at 1-888-353-4537 no later than 2 business days prior to the payment (settlement) date. I also authorize the financial institution involved in the processing of the electronic payment of taxes to receive confidential information necessary to answer inquiries and resolve issues related to the payment.

Officer's Signature

I certify that I have the authority to execute this consent on behalf of the organization. I am signing this Disclosure Consent by entering my self-selected PIN below.

Officer's PIN _ _ _ _ _

Date: _ _ _ _ _

ERO Declaration

ERO's EFIN/PIN. Enter your six-digit EFIN followed by your five-digit self-selected PIN.

do not enter all zeros

I certify that the above numeric entry is my PIN, which is my signature to authorize submission of the electronic application for extension and electronic funds withdrawal for the corporation indicated above. I confirm that I am submitting application for extension in accordance with the requirements of the Practitioner PIN method and Publications 4163, Modernized e-File Information for Authorized IRS e-file Providers, and 3112, IRS e-file Application and Participation.

9.2.8 Forms 1065 and 1065-B Jurat

The Form 1065 electronic return signed by the Practitioner PIN method must contain the following text.

Perjury Statement

Under penalties of perjury, I declare that I am a general partner or limited liability company member manager of the above partnership and that I have examined a copy of the partnership's 2011 electronic return of partnership income and accompanying schedules and statements and to the best of my knowledge and belief, it is true, correct, and complete.

Consent to Disclosure

I consent to allow my electronic return originator (ERO), transmitter or intermediate service provider to send the partnership's return to the IRS and to receive from the IRS (a) an acknowledgement of receipt or reason for rejection of the transmission, and (b) the reason for any delay in processing the return.

Signature of General Partner or Limited Liability Company Member Manager

I certify that I have the authority to execute this consent on behalf of the partnership as general partner or limited liability company member manager of the partnership. I am signing this Disclosure Consent by entering my self-selected PIN below.

General Partner or Limited Liability Company Member Manager's PIN _ _ _ _ _
Date: _ _ _ _ _

ERO Declaration

I declare that the information contained in this electronic return is the information furnished to me by the partnership. If the partnership furnished me a completed return, I declare that the information contained in this electronic return is identical to that contained in the return provided by the partnership. If the furnished return was signed by a paid preparer, I declare I have entered the paid preparer's identifying information in the appropriate portion of this electronic return. If I am the paid preparer, under the penalties of perjury, I declare that I have examined this electronic return, and to the best of my knowledge and belief, it is true, correct, and complete.

This declaration is based on all information of which I have any knowledge.

ERO Signature

I am signing this tax return by entering my PIN below:

ERO's PIN _____

(Enter EFIN plus 5 self-selected numerals)

The Form 1065-B electronic return signed by the Practitioner PIN method must contain the following text.

The Perjury Statement, Officer's Signature and ERO Declaration for the Form 1065-B is the same as the Form 1065. The Consent to Disclosure and Electronic Funds Withdrawal Consent for the Form 1065-B are shown below:

Consent to Disclosure

I consent to allow my electronic return originator (ERO), transmitter, or intermediate service provider to send the partnership's return to the IRS and to receive from the IRS **(a)** an acknowledgement of receipt or reason for rejection of the transmission, **(b)** an indication of any refund offset, **(c)** the reason for any delay in processing the return or refund, and **(d)** the date of any refund.

The following Electronic Funds Withdrawal Consent should only be presented when the taxpayer has selected the Electronic Funds Withdrawal option.

Electronic Funds Withdrawal Consent

If applicable, I authorize the U.S. Treasury and its designated Financial Agent to initiate an electronic funds withdrawal (direct debit) entry to the financial institution account indicated in the tax preparation software for payment of the partnership's federal taxes owed on this return, and the financial institution to debit the entry to this account. To revoke a payment, I must contact the U.S. Treasury Financial Agent at 1-888-353-4537 no later than 2 business days prior to the payment (settlement) date. I also authorize the financial institutions involved in the processing of the electronic payment of taxes to receive confidential information necessary to answer inquiries and resolve issues related to the payment.

9.2.9 Forms 990, 990-EZ, 990-PF, 1120-POL and 8868 Jurat

A signature is required on ALL Forms 8868, Part II. A signature is required on the Form 8868, Part I only if the taxpayer has selected the Electronic Funds Withdrawal option. A signature IS required on ALL Forms 8868 Part II. If the Practitioner PIN method is selected it must contain the text shown below. The Form 990, Form 990-EZ, 990-PF or Form 1120-POL electronic return signed by the Practitioner PIN method must contain the following text:

Perjury Statement

Under penalties of perjury, I declare that I am an officer of the above exempt organization and that I have examined a copy of the exempt organization's 2011 electronic return and accompanying schedules and statements and to the best of my knowledge and belief, it is true, correct, and complete.

Consent to Disclosure

I consent to allow my electronic return originator (ERO), transmitter, or intermediate service provider to send the exempt organization's return to the IRS and to receive from the IRS (a) an acknowledgement of receipt or reason for rejection of the transmission, (b) an indication of any refund offset, (c) the reason for any delay in processing the return or refund, and (d) the date of any refund.

The following Electronic Funds Withdrawal Consent should only be presented when the Form 1120-POL or Form 8868 filer has selected the Electronic Funds Withdrawal option:

Electronic Funds Withdrawal Consent

I authorize the U.S. Treasury and its designated Financial Agent to initiate an electronic funds withdrawal (direct debit) entry to the financial institution account indicated in the tax preparation software for payment of the exempt organization's Federal taxes owed on this return, and the financial institution to debit the entry to this account. To revoke a payment, I must contact the U.S. Treasury Financial Agent at 1-888-353-4537 no later than 2 business days prior to the payment (settlement) date. I also authorize the financial institution involved in the processing of the electronic payment of taxes to receive confidential information necessary to answer inquiries and resolve issues related to the payment.

Officer's Signature

I am signing this Tax Return and Electronic Funds Withdrawal Consent, if applicable, by entering my self-selected PIN below.

Officer's PIN _ _ _ _ _

Date: _ _ _ _ _

ERO Declaration

I declare that the information contained in this electronic return is the information furnished to me by the corporation. If the exempt organization furnished me a completed return, I declare that the information contained in this electronic return is identical to that contained in the return provided by the exempt organization. If the furnished return was signed by a paid preparer, I declare I have entered the paid preparer's identifying information in the appropriate portion of this electronic return. If I am the paid preparer, under the penalties of perjury, I declare that I have examined this electronic return, and to the best of my knowledge and belief, it is true, correct, and complete. This declaration is based on all information of which I have any knowledge.

ERO Signature

I am signing this tax return by entering my PIN below:

ERO's PIN

(Enter FEIN plus 5 self-selected numerics)

9.2.10 Forms 720, 2290 and Form 8849 Jurat

The Form 720, Form 2290, or Form 8849 electronic return signed by the Practitioner PIN method must contain the following text.

The beginning and ending dates of the period must be included in the Perjury Statement.

Perjury Statement

Under penalties of perjury, I declare that I have examined a copy of my electronic return and accompanying schedules and statements for the period beginning _____ and ending _____ and to the best of my knowledge and belief, they are true, correct, and complete.

Consent to Disclosure

I consent to allow my electronic return originator (ERO), transmitter, or intermediate service provider to send my return to the IRS and to receive from the IRS (a) an acknowledgement of receipt or reason for rejection of the transmission, (b) an indication of any refund offset, (c) the reason for any delay in processing the return or refund, and (d) the date of any refund.

The following Electronic Funds Withdrawal Consent should only be presented when the taxpayer has selected the Electronic Funds Withdrawal option.

Electronic Funds Withdrawal Consent

I authorize the U.S. Treasury and its designated Financial Agent to initiate an electronic funds withdrawal (direct debit) entry to the financial institution account indicated in the tax preparation software for payment of the federal taxes owed on this return, and the financial institution to debit the entry to this account. To revoke a payment, I must contact the U.S. Treasury FinancialAgent at 1-888-353-4537 no later than 2 business days before the payment (settlement) date. I also authorize the financial institution involved in the processing of the electronic payment of taxes to receive confidential information necessary to answer inquiries and resolve issues related to the payment.

Taxpayer's Signature

I am signing this Tax Return and Electronic Funds Withdrawal Consent, if applicable, by entering my self selected PIN below.

Officer's PIN _ _ _ _ _

Date: _ _ _ _ _

ERO Declaration

I declare that the information contained in this electronic return is the information furnished to me by the taxpayer. If the taxpayer furnished me a completed return, I declare that the information contained in this electronic return is identical to that contained in the return provided by the taxpayer. If the furnished return was signed by a paid preparer, I declare I have entered the paid preparer's identifying information in the appropriate portion of this electronic return. If I am the paid preparer, under the penalties of perjury, I declare that I have examined this electronic return, and to the best of my knowledge and belief, it is true, correct, and complete. This declaration is based on all information of which I have any knowledge.

ERO Signature

I am signing this tax return by entering my PIN below:

ERO's PIN _____

(Enter EFIN plus 5 self-selected numerics)

The following additional Consent to Disclosure and Signature must also be presented when the Schedule 1 (Form 2290) is signed using the Practitioner PIN method:

Consent to Disclosure

By entering my PIN, I hereby consent to the Internal Revenue Service (IRS) disclosing information about my payment of the Heavy Highway Vehicle Use Tax (HVUT) for the tax period beginning July 1, 2011, and ending June 30, 2012, to the federal Department of Transportation (DOT), U.S. Customs and Border Protection (CBP), and to state Departments of Motor Vehicles (DMV). The information disclosed to the DOT, CBP, and the state DMVs will be my Vehicle Identification Number (VIN) and verification that I have paid the HVUT. The IRS may disclose the information to the DOT, CBP, and to the DMVs of the 50 states and the District of Columbia who have other taxing, registration, or information collecting authority.

I understand that the information to be disclosed is generally confidential under the laws applicable to the IRS and that the agency receiving the HVUT information is not bound by these laws and may use the information for any purposes as permitted by other federal laws and/or state law. To be effective, this consent must be submitted to the IRS within 60 days of the date this return is signed.

If signed by a corporate officer or party other than the taxpayer, I certify that I have the authority to execute this consent to disclosure of tax information.

Taxpayer's Signature

I am signing this Consent to Disclosure of Tax Information by entering my self selected PIN below.

Taxpayer's PIN _____ Date: _____
Employer Identification Number _____

10 Form 7004, Automatic Extension of Time to File Certain Business

Income Tax, Information and Other Returns

- Only one extension form will need to be e-filed on or before the due date of the appropriate return type.
- A separate Form 7004 will need to be e-filed for each return.
- Form 7004 may be filed electronically except for specifically identified returns (see 7004 Instructions).
- Although binary files, other than Form 8453, can be attached to Form 7004, the binary file documents will not be processed. Do not attach any document that needs IRS attention or approval.
 - Power of Attorney (POA) documents should be submitted separately.
 - Form 1138 for Net Operating Loss Carryback should be submitted separately to IRS. Do not attach Form 1138 to the Form 7004.

See Form 7004 Instructions for information regarding filing for an extension.

10.1 Types of Returns and Conditions for Which Form 7004 May Be Used to Request Extension of Time to File

The revised Form 7004 (December 2008) must be used for any return with a Tax Year that ends on or after December 31, 2008. The automatic extension for certain business returns has changed from 6 months to 5 months:

Automatic 6 month extension	Automatic 5 month extension
1041-N, 1041-QFT	1041
1042	1065
1065-B	8804
1066	
1120, 1120-C, 1120-F, 1120-FSC,	
1120-H, 1120-L, 1120-ND,	
1120-PC, 1120-POL, 1120-REIT,	
1120-RIC, 1120S, 1120-SF	
3520-A	
706-GST	

10.2 Data Entry for Form 7004

Enter the extension date based upon the tax period and the type of return for which an extension is being requested. The extension date is the 15th day of the 5th month or 6th month following the applicable due date.

Note: the due dates vary depending not only on the type of return but also on different conditions, as listed in the charts. The due date charts are found on IRS.gov at:

<http://www.irs.gov/efile/article/0,,id=171946,00.html>.

For calendar year and fiscal year filers, the tax period end date month must match the month that

was approved by IRS as the tax period for this EIN.

If the change in accounting period is checked, you must have applied for approval to change your Tax Year prior to filing the application. Short Tax Year applications must check at least one of four reasons for short Tax Year. Refer to Publication 538, Accounting Periods and Methods, for details.

For a consolidated return (consolidated group), enter the name, address and EIN of each member of the group. If the member does not have an EIN, you may enter one of the following: “PENDING”, “APPLIED FOR” or “NONE”.

All monetary amounts are positive amounts. Tentative Tax, Total Payments and Refundable Credits, and Balance Due amounts are required. If Electronic Funds Withdrawal payment is attached, the payment amount must be for the entire balance due. Partial payments are not accepted.

10.3 Timely Filing of Form 7004

An extension will be rejected if it is not received by the IRS due date of the applicable return.

Note: For purposes of determining timeliness of the extension, the received date is the electronic postmark, if present, or the IRS received date in the GTX Key. To avoid rejecting extensions from filers or transmitters in a different time zone from the IRS system, the time zone differences are taken into consideration. Five days are allotted to fix and resubmit rejected extensions.

An accepted acknowledgement of the electronic Form 7004 serves as IRS approval of the extension.

11 Exempt Organization Section

11.1 Form 8868, Application for Extension of Time to File an Exempt Organization Return

In January 2011, Form 8868, Part II, Additional not Automatic 3-month Extension was added to the MeF platform. Additionally, MeF now accepts all Forms 8868, Application for Extension of

Time to File an Exempt Organization return, with no exclusions. This includes Part I, Automatic 3-month Extension and Part II, Additional not Automatic 3-month Extension.

Forms 8868 for Forms 8870 must be mailed in paper format to:

Department of the Treasury
Internal Revenue Service Center
Mail Stop 1112
Ogden, UT 84201-0045

11.2 Reasonable Cause for Late Filing of Form 990, 990-EZ, 990-PF or 1120-POL

On occasion, an organization may have a reasonable cause for late filing of an Exempt Organization return. In order to expedite the process and avoid assertion of Failure to File Delinquency penalties, a filer may attach a reasonable cause explanation using the “ReasonableCauseExplanation.xsd” schema. Acceptance of the return through MeF does NOT mean that the explanation was accepted and the penalty will not be assessed. If the explanation is not accepted, the taxpayer will be contacted as appropriate using existing IRS procedures.

12 Excise Tax Section

When Schedule 1 (Form 2290) is electronically filed, the IRS will provide stamped copies of the form to the transmitter or software provider. The electronic Schedule 1 (Form 2290) will contain a watermark and can be printed for use as proof of payment:

Schedule of Heavy Highway Vehicles

For the period July 1, 2007, through June 30, 2008

OMB No. 1545-0143

This copy will be stamped and returned to you for use as proof of payment when registering vehicle(s) with a state.

Type or Print	Name as shown on Form 2290 String String	Employer identification number 69:000001
	Address (number, street, and room or suite no.) String String	
	City, state, and ZIP code (for Canadian or Mexican address, see page 4 of the instructions.) String, AL 20872	

Caution. You must list all vehicles. Attach a separate list if needed.

Part I Vehicles on Which You Are Reporting Tax. See page 6 of the instructions.

	Vehicle Identification Number	Category		Vehicle Identification Number	Category
1	AAAAAAAAAAAAAAAAAAAA	S	7		
2			8		
3			9		
4			10		
5			11		
6			12		

Part II Vehicles for Which Tax Is Suspended—5,000 Miles or Less (7,500 Miles or Less for Agricultural Vehicles). See page 6 of the instructions.

	Vehicle Identification Number	Category		Vehicle Identification Number	Category
1	AAAAAAAAAAAAAAAAAAB	W	2		W

Part III Summary of Reported Vehicles

a	Enter the number of taxable vehicles from Form 2290, page 2, column 3, Totals	a	1
b	Enter the total number of taxable vehicles on which the tax is suspended from Form 2290, page 2, column 3 (category W)	b	2

For Privacy Act and Paperwork Reduction Act Notice, see page 8 of the instructions.

Schedule 1 (Form 2290) (Rev. 7-2007)

Form 2290 schemas include:

- An element for Consent to VIN Data Disclosure to indicate whether the taxpayer consents to disclosure of tax information
- EIN, Name and Date of the disclosure form when the taxpayer chooses to disclose
- A choice of PIN or binary attachment that will serve as the signature for the disclosure consent when the taxpayer chooses to disclose.

13 Individual Return/Extension Section

In Processing Year 2012, MeF will be accepting Forms 1040, 1040A, 1040EZ, 1040SS, 1040PR, 56, 2350, 4868, and 9465.

13.1 Foreign Employer Compensation (FEC) Record

The FECRecord.xsd file supports entries on Form 1040, Line 7 for Foreign Employer Compensation (FEC) received from non-U.S. employers who do not have EINs or issue Form W-2s. The FEC Record:

- Must be attached when the “FEC” literal is included in the Wages Not Shown Schedule.
- Is limited to a maximum of 10 per return.

- Requires the U.S. address or foreign address where the wage-recipient resided when the services for the foreign employer were performed.

If the services for the foreign employer were performed in the U.S., enter “US” in CountryCd; otherwise, enter the appropriate foreign country code found in the efileTypes.xsd file.

13.2 New field “Purpose” in Form 1040/4868 Attachments

A Purpose tag has been included in some Form 1040 attachments to explain when the statement, schedule, etc. should be attached to the return and the information that IRS is requesting.

13.3 Conditions Which May Affect Refund

The following conditions may delay the refund and/or change the refund amount:

- The taxpayer owes back taxes, either individual or business (refund offset)
- The taxpayer owes delinquent child support (refund offset)
- The taxpayer has certain delinquent federal debit, such as student loans, etc (refund offset)
- The estimated tax payments reported on the return do not match the estimated tax payments recorded on the IRS Master File. This generally occurs when:
 - The spouse made separate estimated tax payments and filed a joint return, or vice versa
 - The return was filed before the last estimated tax payment was credited to the account
- The taxpayer has a Schedule E claiming a deduction for a questionable tax shelter
- The taxpayer is claiming a blatantly unallowable deduction
- The taxpayer is considered to be a first-time filer. A first-time filer is defined as a taxpayer who has not filed a tax return as a primary or secondary taxpayer during the previous ten years.

13.4 Extensions

An extension will be rejected if it is not received by the IRS due date of the applicable return.

For purposes of determining timeliness of the extension, the received date is the electronic postmark, if present, or the IRS received date in the GTX Key. To avoid rejecting extensions from filers or transmitters in a different time zone from the IRS system, the time zone differences are taken into consideration. Five days are allotted to fix and resubmit rejected extensions.

Note: An accepted acknowledgement of the electronic Forms 4868, 2350, 7004 or 8868 serves as IRS approval of the extension.

13.5 Filer Name Format

The Form 1040, 1040A, 1040EZ, 1040-SS(PR), and 4868 Return Header Filer name has e-fileType NameLine1Type, which can have no leading or consecutive embedded spaces. The following is guidance for populating the Filer name information:

1. The only characters allowed are alpha, ampersand (&), hyphen (-), less-than sign (<), and space. The left-most position must be an alpha character. The less-than sign replaces the intervening space to identify the primary taxpayer's last name. It cannot be preceded by or followed by a space.
2. All apostrophes (') and any other punctuation characters, except the hyphen (-), must be omitted from names and the alphabetic characters shifted to the left in their place. For example: O'Shea = OSHEA.
3. Numeric characters in name components must be replaced by alphabetic Roman Numerals. For example: Charles 3rd = CHARLES III.
4. When a suffix such as "JR" or "III" is part of the name, enter a less-than sign (<) between the suffix and the last name. Do not enter a space before or after any less-than sign; the less-than sign takes the place of a space. Titles such as "M.D." or "Ph. D.", which are not part of a given name, may be omitted.
5. NameLine1Type CANNOT CONTAIN MORE THAN 35 CHARACTERS. If the information exceeds 35 characters, truncate using the following priority:
 - a. Substitute the initial for the second given name.
 - b. Omit the second initial of the secondary taxpayer, if necessary.
 - c. Omit the second initial of the primary taxpayer, if necessary.
 - d. Substitute initials for the secondary taxpayer's given name.
 - e. Substitute initials for the primary taxpayer's given name.
6. Enter taxpayer names as follows:
 - a. For one taxpayer: Enter first name, a space, middle name or middle initial, a less-than sign (<), last name. (The last name of the individual must be contained within this name line field.) If there is a suffix, enter a less-than sign (<) between the last name and the suffix.
 - b. For two taxpayers with same last name: Joint returns must contain one ampersand (&)

between taxpayers' first names. The taxpayer whose first name is associated with the Primary SSN used on the return must be entered first, and the last name of that taxpayer must be identified by a preceding less-than sign (<).

- c. For two taxpayers with different last names: If the spouse uses a different last name, enter the primary taxpayer's first and last names as above for one taxpayer's name, but after the last name, add another less-than sign (<) followed by an ampersand and the full name of the spouse. A maximum of two less-than signs are permitted. Any suffixes should follow the primary taxpayer's last name only.

Examples:*

Enter as:

John C. (Brown), III	JOHN C<BROWN<III
John M. (Brown), M.D.	JOHN M<BROWN
Henry A. (Carter)	HENRY A<CARTER
Frank N. (De Porta)	FRANK N<DE PORTA
Timothy (Jackson), 2nd	TIMOTHY<JACKSON<II
Carl A. (Jones) & Angie Myer	CARL A<JONES<& ANGIE MYER
Charles (Jones) & Diane D. Jones, M.D.	CHARLES & DIANE D<JONES
Florence E. (Jones) MD	FLORENCE E<JONES
Alfred (Newman), Minor	ALFRED<NEWMAN<MINOR
James R. (O'Donnell)	JAMES R<ODONNELL
James (Oliver-Keogh), 3rd	JAMES<OLIVER-KEOGH<III
Lillie B. (Owen-Smith)	LILLIE B<OWEN-SMITH
J. B. (Smith) Jr. & Ann Trent	J B<SMITH<JR & ANN TRENT
John A. (Smith), III & Ann Smith, M.D.	JOHN A & ANN<SMITH<III
John A. and Jane B. (Smith)	JOHN A & JANE B<SMITH

*Parentheses indicate the last name of the taxpayer with the Primary SSN.

- d. For other than Joint Return and deceased taxpayer: Enter the literal "DECD" after the surname of the deceased taxpayer. For example:

John A<Doe<DECD
John A<Doe<JR DECD.

- e. For a Joint Return with the same last name and Primary taxpayer is deceased: Enter the literal "DECD" after the first name and/or initial of the deceased taxpayer. For example:

John A DECD & Jane B<Doe
John A DECD & Jane B<Doe<JR

- f. For a Joint Return with the same last name and Secondary taxpayer is deceased: Enter the literal "DECD" after the first name and/or initial of the deceased taxpayer. For example:

John A & Jane B DECD<Doe
John A & Jane B DECD<Doe<SR

- g. For a Joint Return with different last names and either the Primary OR the Secondary

taxpayer is deceased: Enter the Literal "DECD" after the surname of the deceased taxpayer. For example:

John A<Doe<DECD & Jane B Smith
John A<Doe<III DECD & Jane B Smith
John A<Doe<& Jane B Smith DECD
John A<Doe<JR & Jane B Smith DECD)

- h. F
or a Joint Return with the same last name and both taxpayers are deceased: Enter the literal "DECD" after the first name and/or initial of the deceased taxpayer. For example:

John A DECD & Jane B DECD<Doe
John A DECD & Jane B DECD<Doe<JR

- i. For a Joint Return with different last name and both taxpayers are deceased: Enter the literal "DECD" after the surname of the deceased taxpayer. For Example:

John A<Doe<DECD & Jane B Smith DECD
John A<Doe<SR DECD & J B Smith DECD

13.6 Form 1040 Address Format

- 1 The Street Address (SEQ 0080) of Form 1040 contains the house number and street, route number, post office box, or box number. Enter college, building, or post office branch as the address if no other mailing address is given.
- 2 Do not use the "#" symbol, "No.", or "Number" as a prefix to an apartment, house, P.O. Box, or route.
- 3 Always add "ST", "ND", "RD", "TH" to a numbered street or avenue. For example:

1 = 1ST; 2 = 2ND; 3 = 3RD, etc.

- 4 Enter one-half as 1/2 (no spaces).
- 5 Plurals for apartment, avenue, road, street, etc., are entered as APTS, AVES, RDS, STS, etc.
- 6 Replace a period with a space.
- 7 For military overseas addresses, enter the letters "APO" or "FPO" or "DPO" in the first three left-most positions of the City field.
- 8 Words may be abbreviated unless the word is a proper name. For example:

Examples:

Enter as:

3 Ave.
Circle Drive
Lane Building

3RD AVE
CIRCLE DR
LANE BLDG

Northeast Street
South Court Street
Third Street

NORTHEAST ST
S COURT ST
THIRD ST

Exhibits

Exhibit 1 - Business Name Control

To aid in validating the Employer Identification Number (EIN), the “Name Control” must be provided. The Name Control consists of up to four alpha and/or numeric characters.

The Name Control should be determined from the information specified on the first name line. Generally, the Name Control is derived from the first four characters of the corporation. The ampersand (&) and hyphen (-) are the only special characters allowed in the Name Control. The Name Control can have less, but no more than four characters. Blanks may be present only at the end of the Name Control.

Note: Do not include "dba" as part of the Name Control. The initials stand for "doing business as".

Business Name Control Valid Characters:

Numeric (0- 9)

Alpha (A-Z)

Hyphen (-),

Ampersand (&)

Special Business Name Control Rule:

If an invalid character is used in the name line, drop the special character from the taxpayer's name. Example: Jon.com should be considered as “Joncom” so the Name Control should be “Jonc”. Another example is 4U.com. The Name Control should be “4UCO”.

Examples

Name Control Underlined	Name Control	Rule
<u>S</u> umac Field Plow Inc. <u>11</u> th Street Inc. <u>P & P</u> Company <u>Y-Z</u> Drive Co <u>ZZZ</u> Club <u>Palm</u> Catalpa Ltd. <u>Fir</u> Homeowners Assn.	SUMA 11TH P&PC Y-ZD ZZZC PALM FIRH	a. Derive the Name Control from the first four significant characters of the corporation name.
The <u>W</u> illow Co. The <u>H</u> awthorn	WILL THEH	When determining a corporation name control, omit “The” when it is followed by more than one word. Include the word “The” when it is followed by only one word.
<u>J</u> ohn Hackberry PA <u>S</u> am Sycamore SC <u>C</u> arl Eucalyptus M.D.P.A.	JOHN SAMS CARL	If an individual name contains any of the following abbreviations, treat as the business name of a corporation: PC – Professional Corporation SC – Small Corporation PA –Professional Association PS --Professional Service
The <u>J</u> oseph Holly Foundation	JOSE	Apply Corporate Name Control rules when the organization name contains “Fund”,
<u>K</u> athryn Fir Memorial Fdn.	KATH	“Foundation”, or “Fdn”.
<u>C</u> ity of Fort Hickory Board <u>W</u> alnut County Employees Association <u>R</u> ho Alpha Chapter Alpha <u>T</u> au Fraternity <u>H</u> ouse Assn. of Beta XI Chapter of Omicron Delta <u>K</u> appa	CITY WALN RHOA HOUS	Apply the corporate Name Control rules to chapter names of national fraternal

Exhibit 2 - Individual Name Control

The Primary SSN, Primary Name Control, State Abbreviation and Zip Code should be key

verified to avoid lengthy delays caused by mismatches with existing taxpayer information in IRS records.

The individual name controls for the Primary and Spouse in the Form 1040 Return Header, Form 1040 Dependent and Spouse Exemption, Schedule EIC Qualifying Child, Form 2441 Qualifying Person, and all Form 8863 students, must equal the first four significant characters of the primary taxpayer's last name. No leading or embedded spaces are allowed. The first left-most position must contain an alpha character. Only alpha, hyphen, and space are allowed. Omit punctuation marks, titles and suffixes

The hyphen (-) is the only special character allowed for the PersonNameControlType.

Individual Name	Name Control	General Rule
John <u>B</u> rown	BROW	a. The name control generally consists of the first four characters of the individual's last name.
Mary <u>S</u> mith & John Jones	SMIT	
Ralph <u>T</u> eak	TEAK	
Dorothy <u>W</u> illow	WILL	
Joe <u>M</u> ccedar	MCCE	
Joe <u>M</u> ccarty	MCCA	
Torn <u>M</u> acDouglas	MACD	
Joseph <u>M</u> acTitus	MACT	
John <u>H</u> ardy, Minor	HARD	
April May <u>J</u> ordan	JORD	
John <u>L</u> ea-Smith	LEA-	b. The hyphen (-) is the only special character allowed in the PersonNameControlType. Note: When a taxpayer's last name contains an apostrophe ('), ignore/disregard the apostrophe when establishing the Name Control.
Thomas A. <u>E</u> l-Oak	EL-O	
Rana <u>A</u> l-Smadi	AL-S	
John <u>O</u> 'Neil	ONEI	
Ann <u>O</u> 'Spruce	OSPR	
Mark <u>D</u> 'Magnolia	DMAG	
John <u>O</u> 'Willow	OWIL	
Danette <u>B</u>	B	c. The Name Control may be less than four characters (if applicable). Note: The first character must be an alpha character. Blanks are not needed as filler.
James P. <u>A</u> i	AI	
John A. <u>F</u> ir	FIR	
John <u>A</u> o, Sr.	AO	
John <u>E</u> n, Sr.	EN	

Individual Name	Name Control	General Rule
Daniel P. <u>Di Almond</u>	DIAL	d. Taxpayer names such as “Van”, “Von”, “Vander”, “Al”, “El”, “Abu” and “Di” are considered part of the individual name control. Note: See the Asian Pacific Names for exceptions to this rule.
Mary J. <u>Van Elm</u>	VANE	
Susan L. <u>Von Birch</u>	VONB	
Aya <u>Abu Sham</u>	ABUS	
Donald <u>Vander Oak</u>	VAND	
Otto <u>Von Hickory</u>	VONH	
Nabil <u>Al Feyez</u>	ALFE	
Amr <u>El Bayoumi</u>	ELBA	
Janet C. Redbud <u>Laurel</u>	LAUR	e. When two last names are shown for an individual, derive the name control from the second last name of the individual. Note: see exceptions to this rule for Hispanic names, Asian-Pacific names, Native American names and Islamic & Arab names.
Dee (Plum) <u>Birch</u>	BIRC	
Mary Johnson <u>Garcia</u>	GARC	
Joan <u>Hickory-Hawthorn</u>	HICK	f. When two last names are connected by a hyphen, derive the name control from the first last name.
Dale <u>Redwood-Cedar</u>	REDW	
John <u>Lea-Wren</u>	LEA-	
Dell <u>Ash & Linda Birch</u>	ASH	g. On a joint return, whether the taxpayers use the same or different last name, derive the name control from the Primary taxpayer’s last name.
Trey & Joan <u>Eucalyptus</u>	EUCA	
Linda <u>Birch & Dell Ash</u>	BIRC	
Mary <u>Smith & Mike Best</u>	SMITH	

Consider certain foreign suffixes as part of the last name (for example, Armah-Bey, Pax-Ayala and Allar-Sid). Particular attention must be given to those names that incorporate a mother’s maiden name as a suffix to the last name. This practice is common in Hispanic names. Consider the mother’s maiden name as part of the surname for Name Control purposes.

Individual Name	Name Control	General Rule
Abdullah <u>Allar-Sid</u>	ALLA	a. When “del”, “de” or “de la” appears with a Hispanic name, include it as part of the name control.
Jose Alvarado Nogales	ALVA	
Juan <u>de la Rosa Y Obregon</u>	DELA	
Pedro <u>Paz-Ayala</u>	PAZ-	
Donald <u>Vander Neut</u>	VAND	
Otto <u>Von Wodtke</u>	VONW	
John Smith <u>Gonzalez</u>	GONZ	
Maria Acevedo <u>Smith</u>	SMIT	
John Garcia <u>Garza Hernandez</u>	GARZ	
Elena <u>del Valle</u>	DELV	
Eduardo <u>de la Rosa</u>	DELA	

Individual Name	Name Control	General Rule
Pablo <u>De</u> <u>Martinez</u>	DEMA	
Miguel <u>de</u> <u>Torres</u>	DETO	
Juanita <u>de</u> <u>la Fuente</u>	DELA	
B.A. <u>De</u> <u>Rodriguez</u>	DERO	
M.D. <u>de</u> <u>Garcia</u>	DEGA	
Juan <u>Garza</u> <u>Morales</u>	GARZ	b. When two Hispanic names are shown for an individual, derive the name control from first last name. Note: This rule may not accurately identify all Hispanic last names, but it does provide consistency in IRS Hispanic name controls.
Maria <u>Lopez</u> <u>y</u> <u>Moreno</u>	LOPE	
Sylvia <u>Juarez</u> <u>de</u> <u>Garcia</u>	JUAR	

Below are examples of Asian-Pacific last names and the derivative name control. Some Indo-Chinese names have only two characters.

Individual Name	Name Control	General Rule
Binh <u>To</u> <u>La</u>	LA	
Nam Quoc <u>Tran</u> & <u>Thuy</u> <u>Thanh</u> <u>Vo</u>	TRAN	
Dang Van <u>Le</u> <u>Nhat</u> <u>Thi</u> <u>Pham</u>	LE PHAM	a. When “Van” (male) or “Thi” (female) appears with an Asian-Pacific name, do not include it as part of the name control.
Kim Van <u>Nguyen</u> & <u>Thi</u> <u>Tran</u>	NGUY	
<u>Kwan</u> <u>Kim</u> <u>Van</u> & <u>Yue</u> <u>Le</u>	KWAN	b. When the last name appears first, derive the name control from that name.
Yen-Yin <u>Chiu</u> <u>Jin-Zhang</u> <u>Qui</u>	CHIU QUI	

Below are examples of name controls for Native Americans:

Individual Name	Name Control	General Rule
Earline <u>Old</u> <u>Person</u>	OLDP	a. Native American surnames may contain several words.
Spike <u>Big</u> <u>Horn</u>	BIGH	Note: Begin the name control with the surname (unless the taxpayer is already established with a different name control)
Spike <u>Bighorn</u>	BIGH	
Mary <u>Between</u> <u>Lodges</u>	BETW	
Gail <u>George</u> <u>Moonface</u>	GEOR	

Individual Name	Name Control	General Rule
Night & James Lou Mary <u>Her</u> <u>Many</u> Horses	HERM	

Exhibit 3 – Exempt Organization Name Control

Exempt Organization Name Control (Underlined)	Name Control	Rule
Local 210 <u>I</u> nternational Post 3120, <u>V</u> eterans of Wars AFL-CIO <u>L</u> aborer's Union BPOE <u>B</u> enevolent Order of Elks AMVETS <u>A</u> merican Veterans Southbend <u>A</u> merican Legion <u>B</u> oy <u>S</u> couts of America (BSA)	INTE VETE LABO BENE AMER AMER BOYS	The Name Control is the first four characters of the national title.
<u>P</u> arent <u>T</u> eacher's <u>A</u> ssociation of <u>V</u> ermont <u>P</u> T <u>A</u> of <u>G</u> eorgia	PTAV PATG	The Name Control is "PTA" plus the first letter of the state, whether or not the state name is present as part of the name of the organization.
Diocese of Kansas <u>S</u> T. <u>R</u> ose's Hospital <u>S</u> T. <u>S</u> ilver's Church Diocese of Lani Building Fund, <u>S</u> T. <u>B</u> ernard's Church	STRO STSI STBE	For churches and their subordinates, (i.e., nursing homes, hospitals) derive the Name Control from the legal name of the church.
Committee to elect <u>J</u> ohn Smith Citizens for <u>J</u> ohn Doe Friends of <u>J</u> anice Doe	JOHN JOHN JANI	Derive the Name Control of Political Organizations from the first four characters of the individual's name.

Exhibit 4 - Identifiers

This section describes the identifiers used within the MeF system. Identifying numbers are defined at the transmission, return and form levels and uniquely identify these entities.

1. Transmission Level Identifying Numbers

- **GTX Key** - The format of the GTX Key, used in IFA only, is as follows:

SYYYMMDDhhmmss.nnnn

- S = “A”, “B”, “C”, etc. =the IFA server site.
- YYYMMDD = received date (4 digit year, 2 digit month, 2 digit day)
- hhmmss.nnnn = received time (2 digit hour, 2 digit minutes, 2 digit seconds, 4 digit nano-second)

- **Transmission ID.** This number, which exists in the transmission header, uniquely identifies a transmission for the Tax Year. It is created by the transmitter. The IRS will return this number in the transmission acknowledgement to uniquely identify the transmission that is being acknowledged. It can be up to 30 digits in length, is alphanumeric, and can contain characters “:”, “.”, and “-“. A timestamp may be used as an ID as long as it is unique within the filing season. Up to 4-decimal fractional digits may be used for the second in a timestamp to ensure its uniqueness. The transmission id is used in IFA transmissions.

- **MessageID.** This number, which exists in the transmission header, uniquely identifies a message. The MessageID element is mandatory. All request and response messages must have a globally unique MessageID provided by the message source and is a 20 digits number with following format: (ETIN + ccyddd + 8-character alphanumeric). The message id (request and response) is used in A2A transmissions.

- **Request Message ID**

To ensure the global uniqueness of a message ID, the following format is adopted for the request messages sent to the MeF system:

ETIN + ccyddd + xxxxxxxx

For example:

Request message ID: 00130201107312345678

The first five digits (00130) contain the ETIN, the next four digits (2011) contain the year, the next three digits (073) contain the Julian date and the last eight digits (12345678) contain a sequence number to uniquely identify messages sent within a day with the given ETIN. The total number of characters of the request message ID is twenty.

- **Response Message ID**

For response messages sent from the MeF system, the following format is adopted for the message ID:

Request Message ID + “R”

For example:

Response message ID: 00130201107312345678R

The total number of characters of the response message ID is twenty-one.

- **Error Message ID**

For error messages sent from the MeF system, the following format is adopted for the message ID:

Request Message ID + “E”

For example:

Response message ID: 00130201107312345678E

The total number of characters of the error message ID is twenty-one.

- **Error ID** – This number, which is located in the acknowledgement file, uniquely identifies each error in the acknowledgement file. It can be up to 6 digits in length.
- **Transmitter’s ETIN**. This number, which exists in the transmission header, uniquely identifies the electronic transmitter. It’s a 5-digit number assigned by the IRS.

2. Return Level Identifying Numbers

- **Submission ID** - This number, which exists in the submission header, is a globally unique 20 digit number with the following format: (EFIN + ccyddd + 7-digit alphanumeric sequence number). There is a business rule validation that the Year in the Submission ID must be the current Processing Year.
- **Software ID** – This number, which exists in the return header or as a top level element within each schema, identifies the software used to build the return, form, or schedule XML instance. It’s an 8-digit ASCII character field assigned by the IRS. The first two positions identify the Tax Year.

The software id in the ReturnHeader is a required field. If the return was created using just one software package, the SoftwareId in the ReturnHeader should be the only SoftwareId transmitted. If the return is created using more than one software package, the SoftwareId in the other Return Documents must indicate which software package was used for each form.

- **Originator’s EFIN** – This number, which exists in the <ReturnHeader> element definition and the submission manifest, is the originator’s Electronic Filing Identification Number. It’s a 6 digit numeric field, where the first 2 digits represent a pre-defined IRS district office code. This identifier is assigned by the IRS.
- **Business EIN** – This number, which exists in the <ReturnHeader> element definition, is the Employer Identification Number of the business for which the return is being filed. This is a 9 digit numeric field, where the first 2 digits represent a pre-defined IRS district office code. This identifier is assigned by the IRS.
- **Preparer’s PTIN** – This number, which exists in the <ReturnHeader> element definition is a Preparer’s Tax Identification Number. PTIN is 9 digits, beginning with the letter ‘P’ followed by 8 numeric digits. The PTIN is assigned by the IRS. Tax returns may be rejected if an SSN, or any number that is not a PTIN, is included in this field.
- **Preparer Firm’s EIN** – This number, which exists in the <ReturnHeader> element definition, is the Employer Identification Number of the firm which prepared the return (if applicable). It is a 9 digit numeric field, where the first 2 digits represent a pre-defined IRS district office code. The EIN is assigned by the IRS.
- **STIN** – This number, which exists in the Form 1040 <ReturnHeader>, is the site identification number VITA and Tax Counseling for the Elderly Non-Paid Preparer IRS-Sponsored Programs. The composition of the “STIN” is “S” followed by 8 digits.

3. Form Level Identifying Numbers

- **Document ID** – This number uniquely identifies a single form/schedule XML instance within the return. The attribute DocumentId exists in every top level element in the form/schedule schemas. It can be up to 30 positions in length, and is alphanumeric, plus can contain characters “:”, “.”, and “-“. This pattern allows for a timestamp to be used within the field. This identifier is assigned by the ERO’s software.
- **Reference Document ID** – This number refers to a unique form/schedule XML instance (identified by its DocumentId attribute) within the return attribute referenceDocumentId. It is found where attachments to the tax return, form, and/or lines are made. Thus, this attribute’s structure is identical to the structure of the DocumentId attribute.

Exhibit 5 - Standard Postal Service State Abbreviations and ZIP Codes

The Standard Postal Service State Abbreviations and Zip code list can be found on IRS.gov at: http://www.irs.gov/pub/irs-utl/zip_code_and_state_abbreviations.pdf

Exhibit 6 - Foreign Country Codes

The Foreign Country Code list can be found on IRS.gov at: <http://www.irs.gov/efile/article/0,,id=175595,00.html>

Exhibit 7 - Forms and Attachment Listing

The Forms and Attachments listing for Forms 1120/1120-F/1120S/7004 and 1040 is located on IRS.gov at: <http://www.irs.gov/efile/article/0,,id=171946,00.html>.

Exhibit 8 - Return Due Dates Tables

The return due date and extended due date tables for each MeF form can be found on IRS.gov at: <http://www.irs.gov/efile/article/0,,id=250477,00.html>

Exhibit 9 – Recommended Names and Descriptions for PDFs

As explained in Section [2.2.4 Names and Descriptions for PDFs](#), IRS recommends using specific names and descriptions when attaching certain PDFs to the MeF submission. This provides consistency in what the IRS users are seeing and helps to expedite processing of these returns.

The table below has the information listed by Regulatory Requirement and can also be found on IRS.gov on the [MeF User Guides and Publication](#) page. Updates during the year will be included

on the document posted on IRS.gov. Two additional tables will be provided on IRS.gov:

- Recommended Names and Descriptions for PDFs based on Forms for Business Returns
- Recommended Names and Descriptions for PDFs based on Forms for Individual Returns

Recommended Names and Descriptions for PDFs based on Regulatory Requirements

Title of Disclosure/Agreement/Statement	Regulatory Requirement to Be Attached to Return	PDF File Name (limited to 64 characters)	Description to be used in Binary Attachment.xsd (limited to 128 characters)
IRC § 367 - Foreign Restructuring Transactions			
§ 367 Interest	Prior §1.367(a)-8(b)(3)(iii)	Section367Interest	Section 367 Interest
Gain Recognition Agreement Under § 1.367(a)-8	§ 1.367(a)-8(c)(2) and (d)(1)	GainRecognitionAgreement-1.367(a)-8	Gain Recognition Agreement 1.367(a)-8
Calculation of Section 367 Tax and Interest	§ 1.367(a)-8(c)(1)(v)	CalculationOfSection367TaxAndInterest	Calculation of Sec 367 Tax and Interest
Annual Certification for Gain Recognition Agreement Under § 1.367(a)-8	§ 1.367(a)-8(g)	AnnualCertificationForGainRecognitionAgreement-1.367(a)-8	Annual Certification for Gain Recognition Agreement 1.367(a)-8
Election to Reduce Stock Basis Under § 1.367(a)-8(o)(1)(iii)	§ 1.367(a)-8(o)(1)(iii)	ElectionToReduceStockBasis-1.367(a)-8(o)(1)(iii)	Election to Reduce Stock Basis 1.367(a)-8(o)(1)(iii)
Election to Reduce Stock Basis Under § 1.367(a)-8(o)(5)(iii)(B)	§ 1.367(a)-8(o)(5)(iii)(B)	ElectionToReduceStockBasis-1.367(a)-8(o)(5)(iii)(B)	Election to Reduce Stock Basis 1.367(a)-8(o)(5)(iii)(B)
Section 367(a) - Reporting of Cross-Border Transfer Under Reg. § 1.367(a)-3(c)(6)	§ 1.367(a)-3(c)(6)	Sec367(a)ReportingCrossBorderTransfer-1.367(a)-3(c)(6)	367(a) - Reporting of Cross-Border Transfer 1.367(a)-3(c)(6)

Title of Disclosure/Agreement/Statement	Regulatory Requirement to Be Attached to Return	PDF File Name (limited to 64 characters)	Description to be used in Binary Attachment.xsd (limited to 128 characters)
Section 367(a) - Compilation of Ownership Statements under Reg. § 1.367(a)-3(c)	§ 1.367(a)-3(c)(7)	Sec367(a)CompilationOfOwnershipStmts-1.367(a)-3(c)	367(a) - Compilation of Ownership Stmt-1.367(a)-3(c)
Notice Statement Under § 1.367(b)-1(c)	§ 1.367(b)-1(c)	NoticeStatement-1.367(b)-1(c)	1.367(b)-1(c) Notice Stmt
Required Statement under § 1.367(e)-2(b)(2)(i)	§ 1.367(e)-2(b)(2)(i)	RequiredStatement-1.367(e)-2(b)(2)(i)	1.367(e)-2(b)(2)(i) Required Stmt
Required Statement under § 1.367(e)-2(c)(2)(i)	§ 1.367(e)-2(c)(2)(i)	RequiredStatement-1.367(e)-2(c)(2)(i)	1.367(e)-2(c)(2)(i) Required Stmt
Specific Form Attachments			
Form 5471, Schedule O - Section F - Required Organizational Chart	§ 6038B	Form5471ScheduleO-OrgChart	Form 5471 Schedule O - Org Chart
Form 8858, Item 5 - Required Organizational Chart	As instructed by Form 8858 and Instructions to Form 8858	Form8858-OrgChart	Form 8858, Item 5 - Org Chart
Detailed Attachment to Form 926	§ 1.6038B-1(b); § 1.6038B-1T(c) & (d)	Form926DetailedAttachment	Form 926 Detailed Attachment
Corporate Nonrecognition Provisions			
Statement Pursuant to Section 332 by [Insert Name and Employer Identification Number (if any) of Taxpayer], a Corporation Receiving a Liquidation Distribution	§ 1.332-6(a)	332Stmt	Sec 332 Stmt

Title of Disclosure/Agreement/Statement	Regulatory Requirement to Be Attached to Return	PDF File Name (limited to 64 characters)	Description to be used in Binary Attachment.xsd (limited to 128 characters)
Statement Pursuant to § 1.351-3(a) by [Insert Name and Taxpayer Identification Number (if any) of Taxpayer], a Significant Transferor	§ 1.351-3(a)	1.351-3(a)Stmt	1.351-3(a) Stmt
Statement Pursuant to § 1.361-5(a) by [Insert Name and Taxpayer Identification Number (if any) of Taxpayer], a Distributing Corporation	§ 1.351-3(b)	1.361-3(b)Stmt	1.361-3(b) Stmt
Statement Pursuant to § 1.355-5(b) by [Insert Name and Taxpayer Identification Number (if any) of Taxpayer], a Significant Distributee	§ 1.355-5(a)	1.355-5(a)Stmt	1.355-5(a) Stmt
Statement Pursuant to § 1.355-5(b) by [Insert Name and Taxpayer Identification Number (if any) of Taxpayer], a Significant Distributee	§ 1.355-5(b)	1.355-5(b)Stmt	1.355-5(b) Stmt
Statement Pursuant to § 1.368-3(a) by [Insert Name and Employer Identification Number (if any) of Taxpayer], a Corporation a Party to a Reorganization	§ 1.368-3(a)	1.368-3(a)Stmt	1.368-3(a) Stmt
Statement Pursuant to § 1.368-3(b) by [Insert Name and Employer Identification Number (if any) of Taxpayer], a Significant Holder	§ 1.368-3(b)	1.368-3(b)Stmt	1.368-3(b) Stmt
Election of Date of Distribution or Transfer Pursuant to § 1.381(b)-1(b)(2)	§ 1.381(b)-1(b)(2)	ElectionOfDateOfDistbut nOrTransfer-1.381(b)- 1(b)(2)	Election of Date of Distribution or Transfer 1.381(b)- 1(b)(2)

Title of Disclosure/Agreement/Statement	Regulatory Requirement to Be Attached to Return	PDF File Name (limited to 64 characters)	Description to be used in Binary Attachment.xsd (limited to 128 characters)
IRC § 1503(d) - Dual Consolidated Loss			
Domestic Use Election and Agreement	§ 1.1503(d)-6(d)	1503(d)DomesticUseElection	1503(d) Domestic Use Election
No Possibility of Foreign Use of Dual Consolidated Loss Statement	§ 1.1503(d)-6(c)(2)	1503(d)NoPossibilityOfForeignUseOfDualConsolidatedLossStatement	1503(d) No Possibility of Foreign Use of Dual Consolidated Loss Statement
New Domestic Use Agreement	§ 1.1503(d)-6(f)(2)(iii)(A)	1503(d)NewDomesticUseAgreement	1503(d) New Domestic Use Agreement
Original Elector Statement	§ 1.1503(d)-6(f)(2)(iii)(B)	1503(d)OriginalElectorStatement	1503(d) Original Elector Statement
Certification of Dual Consolidated Loss	§ 1.1503(d)-6(g)	1503(d)CertificationOfDualConsolidatedLoss	1503(d) Annual Certification of Dual Consolidated Loss
Reduction of Recapture Amount	§ 1.1503(d)-6(h)(2)(i)	1503(d)ReductionOfRecaptureAmount	1503(d) Reduction of Recapture Amount
Reduction of Interest Charge	§ 1.1503(d)-6(h)(2)(ii)	1503(d)ReductionOfInterestCharge	1503(d) Reduction of Interest Charge
Statement Identifying Liability	§ 1.1503(d)-6(h)(3)(iii)(A)	1503(d)StatementIdentifyingLiability	1503(d) Statement Identifying Liability
Termination of Ability for Foreign Use	§ 1.1503(d)-6(j)(2)	1503(d)TerminationOfAbilityForForeignUse	1503(d) Termination of Ability for Foreign Use
IRC § 482 - Transfer Pricing			

Title of Disclosure/Agreement/Statement	Regulatory Requirement to Be Attached to Return	PDF File Name (limited to 64 characters)	Description to be used in Binary Attachment.xsd (limited to 128 characters)
Statement of Controlled Participant to § 1.482-7T Cost Sharing Arrangement	§ 1.482-7T(k)(4)(iii)(B)	1.482-7TCostSharingArrangementStmt	1.482-7T Stmt - Cost Sharing Arrangement
American Recovery and Reinvestment Tax Act of 2009 Issues			
Carryback Based on Section 1211	§ 1211	ARRA-RevProc2009-26.pdf	ARRA - Rev Proc 2009-26
Losses in Certain Investment Arrangements		RevenueProcedure2009-20.pdf	Revenue Procedure 2009-20

