

**AIRCRAFT  
ACCIDENT INVESTIGATION BOARD  
REPORT**

**US ARMY UH-60  
BLACK HAWK HELICOPTERS  
87-26000 AND 88-26060**

**VOLUME 21**

**TAB AC**

**AIRCRAFT  
ACCIDENT INVESTIGATION BOARD  
REPORT**

**US ARMY UH-60  
BLACK HAWK HELICOPTERS  
87-26000 AND 88-26060**

**VOLUME 2  
SUMMARY OF FACTS**

**AIRCRAFT  
ACCIDENT INVESTIGATION BOARD  
REPORT**

**COPY**

15

**OF**

14

## TABLE OF CONTENTS

Table of Contents	i
1. Authority and Purpose	1
a. Authority	1
b. Purpose	2
c. Circumstances	2
2. Summary of Facts	3
a. Mission	3
(1) Command and Control Structure	5
(2) E-3B AWACS Mission	8
(3) F-15C Mission	10
(4) UH-60 Black Hawk Mission	10
b. Summary of Events	10
(1) Command and Control	10
(2) E-3B AWACS	13
(3) F-15C	19
(4) UH-60 Black Hawk	23
c. Search and Rescue	27
d. Maintenance	28
(1) E-3B AWACS	28
(2) F-15C	29
(3) UH-60 Black Hawk	32
e. Summary of AAI and IFF Anamolies	34
f. Crew Qualifications	35
(1) AWACS Crew Qualifications	35
(2) F-15C Crew Qualifications	39
(3) UH-60 Black Hawk Crew Qualifications	40



g. Medical	40
(1) AWACS	40
(2) F-15C	41
(3) UH-60 Black Hawk	41
h. Human Factors	42
(1) E-3B AWACS	42
(2) F-15C	42
(3) UH-60	43
i. Nav aids and Facilities	43
j. Weather	43
k. News media	44
l. Directives and Publications	44
(1) Command and Control Directives and Publications	44
(2) AWACS Directives and Publications	45
(3) F-15 Directives and Publications	45
(4) Black Hawk Directives and Publications	45
3. Statement of Opinion	46

27 May 1994

AFR 110-14  
AIRCRAFT ACCIDENT INVESTIGATION  
REPORT OF INVESTIGATION

1. AUTHORITY AND PURPOSE.

a. **Authority:** On 14 April 1994, the Secretary of Defense directed the United States Commander in Chief, Europe (USCINCEUR) to conduct an investigation into the facts and circumstances of the 14 April 1994 crash of two United States Army UH-60 Black Hawk helicopters in northern Iraq, and the possible involvement of United States Air Force F-15C aircraft. Accordingly, USCINCEUR directed the Commander in Chief, United States Air Forces in Europe (CINCUSAFE) to order the investigation. Under this delegated authority, and in accordance with Air Force Regulation 110-14, CINCUSAFE appointed Major General James G. Andrus and other accident board members to conduct the investigation. The appointments were made by HQ USAFE memorandum dated 15 April 1994 and HQ USAFE special order M-02 dated 20 May 94.<sup>1</sup> The individuals appointed were:

BOARD PRESIDENT

MAJOR GENERAL JAMES G. ANDRUS

Board President

BOARD MEMBERS

COLONEL PATRICK J. BENNETT  
COLONEL MICHAEL E. FAIN  
LT COL WAYNE I. MUDGE  
LT COL RAY B. SHEPHERD  
MAJOR AARON D. BYAS  
MAJOR CHRISTOPHER J. LISANTI  
MAJOR JEFFREY M. SNYDER  
1LT GREG A. BROWN  
CW5 STEVE A. MELINE  
CW4 DOUGLAS C. SOUSA

Deputy Board President  
Chief Investigator  
F-15 Pilot  
Public Affairs  
AWACS Crew Member  
Flight Surgeon  
F-15 Maintenance  
Board Recorder  
UH-60 Pilot  
UH-60 Maintenance

ASSOCIATE BOARD MEMBERS

COLONEL REMZI ARMEN  
GROUP CAPTAIN BARRY P. DOGGETT  
LT COL CHRISTIAN VELLUZ

Associate Member (Turkey)  
Associate Member (United Kingdom)  
Associate Member (France)

LEGAL ADVISORS

COLONEL WILLIAM K. AT LEE, JR.  
COLONEL CHARLES H. WILCOX, II  
LTC SCOTT C. BLACK  
LT COL BRYAN T. LAWLER

Legal Advisor  
Legal Advisor  
Legal Advisor  
Legal Advisor

### TECHNICAL ADVISORS

GS-15 DONALD NORRIS  
LT COL BERTRAM H. PRYOR, JR.  
LTC LENEAR ROYER III  
LT COL JOYCE E. TETERS  
MAJOR JAMES R. LITTLE  
CAPT MICHAEL E. TURNER  
1LT KELLY J. SCOTT  
CW5 DANIEL W. MEDINA  
CW2 JOHN B. HALL  
SSG FREDDIE L. HOLMES  
GS-11 CAROLE M. PYLES  
GS-11 GERALD D. SILVIUS  
MR DAVID BRUMMELL

Declassifier  
AWACS Systems  
Helicopter Systems  
Medical  
Medical  
AWACS Data Analysis  
AWACS Maintenance  
Helicopter Systems  
Helicopter Aircraft Survivability  
UH-60 Avionics  
Foreign Disclosure  
F-15 Maintenance  
Legal (United Kingdom)

**b. Purpose:** This was an investigation into the circumstances surrounding the 14 April 1994 accidental shoot-down of two United States Army Black Hawk helicopters in northern Iraq, by two United States Air Force F-15 fighter aircraft, participating in Operation PROVIDE COMFORT (OPC). The accident occurred at approximately 0730Z hours while the aircraft were engaged in missions to protect the Kurdish population in the area of Iraq designated as a security zone (SZ). The purpose of the investigation was to determine the relevant facts and circumstances of the accident and, if possible, to determine the cause or causes. The investigation obtained and preserved evidence for claims, litigation, disciplinary and administrative action, and for all other purposes deemed appropriate by competent authority.

**c. Circumstances:** Since the beginning of Operation PROVIDE COMFORT, coalition aircrews have flown daily missions over active Iraqi air defenses to guard the 500,000 Kurdish refugees within the United Nations-designated security zone. Iraqi forces have tested coalition resolve by probing the no-fly zone with Iraqi aircraft, illuminating coalition aircraft with "fire control" radars, and firing on friendly forces. Coalition forces have responded by shooting down an Iraqi Mig-23 and bombing of Iraqi anti-aircraft artillery and surface-to-air-missile sites. Kurdish refugees within the security zone have been harassed and UN relief trucks have been sabotaged by Iraqis. On 21 December 1993, a small contingent of coalition personnel were attacked within the security zone. Coalition liaison personnel were fired upon as they left their support base in Zakhu, Iraq. In March 1994, Saddam Hussein publicly stated that he would be "forced to take other means" in response to renewed United Nations sanctions. Non-government organization personnel have had bounties placed on their heads.<sup>2</sup> On 3 April 1994, a female civilian journalist employed by a French news agency was murdered in northern Iraq by unknown assailants.<sup>3</sup> Iraqi forces have maintained a capability to attack coalition personnel and the local Kurdish population. Tensions have remained strong in the area and coalition aircrews and ground personnel have operated at a high state of readiness.<sup>4</sup>

On 14 April 1994, the Turkish and US co-commanders of the Military Coordination Center (MCC), a component of the Operation PROVIDE COMFORT Combined Task Forces (CTF) and

other staff officers were scheduled to meet with UN representatives and officials of the Kurdish Democratic Party. Two Black Hawk helicopters transporting the group from MCC (Forward) headquarters in Zakhu, to Irbil and Salah ad Din, Iraq, were shot down by US F-15C fighter aircraft patrolling the no-fly zone. All individuals on board the two helicopters were killed. The individuals who died in the accident are listed below:<sup>5</sup>

<u>RANK/NAME</u>	<u>NATIONALITY</u>	<u>POSITION/REASON</u>
COL HIKMET ALP	TURKISH	MCC CO-COMMANDER
MR ABDULSATUR ARAB	KURDISH	MISSION SECURITY
SSGT PAUL N. BARCLAY	US	COMMUNICATIONS NCO
SPC CORNELIUS A. BASS	US	UH-60 CREW CHIEF
1LT CEYHUN CIVAS	TURKISH	TU LIAISON OFFICER
SPC JEFFREY C. COLBERT	US	UH-60 CREW CHIEF
LT COL GUY DEMETZ	FRENCH	SENIOR FRENCH REP
PFC MARK A. ELLNER	US	UH-60 CREW CHIEF
W01 JOHN W. GARRETT, JR.	US	UH-60 PILOT
1LT M. BARLAS GULTEPE	TURKISH	TU LIAISON OFFICER
CW2 MICHAEL A. HALL	US	UH-60 PILOT
SFC BENJAMIN T. HODGE	US	TRANSLATOR
MR GHANDI HUSSEIN	KURDISH	MISSION SECURITY
CPT PATRICK M. MCKENNA	US	UH-60 PILOT
MR BADER MIKHO	KURDISH	MISSION SECURITY
MR AHMAD MOHAMMAD	KURDISH	MISSION SECURITY
W01 ERIK S. MOUNSEY	US	UH-60 PILOT
COL RICHARD A. MULHERN	US	NEW MCC CO-COMMANDER
1LT LAURA A. PIPER	US	IRAQI AIR ANALYST C2
SPC MICHAEL S. ROBINSON	US	U-60 CREW CHIEF
SSGT RICKY L. ROBINSON	US	MEDIC
MR SALID SAID	KURDISH	INTERPRETER
MS BARBARA L. SCHELL	US	POLITICAL ADVISOR
MAJ HARRY C. SHAPLAND	BRITISH	SECURITY OFFICER
LT COL JONATHAN C. SWANN	BRITISH	SENIOR UK REPRESENTATIVE
COL JERALD L. THOMPSON	US	MCC CO-COMMANDER

## 2. SUMMARY OF FACTS.

a. **Mission:** In April 1991, the US National Command Authority directed US forces to conduct Operation PROVIDE COMFORT. Under his authority, the USCINCEUR directed the creation of a Combined Task Forces to conduct operations in northern Iraq. Coalition air forces from Turkey, France, the United Kingdom and the United States were assembled to conduct frequent air operations, including reconnaissance and surveillance, in the Tactical Area of Responsibility (TAOR) north of 36 degrees north latitude in Iraq. These air operations served as a symbol of coalition resolve and as a deterrent to Iraqi military encroachment into the United Nations-established security zone (SZ) in northern Iraq. CTF ground forces included a Battalion Task Force consisting of a reinforced coalition infantry battalion, a lift helicopter task force, an

attack helicopter battalion, and a Military Coordination Center. The coalition ground forces were tasked to monitor Iraqi compliance with the United Nations Security Council Resolution 688 that established the SZ and to maintain contact and coordination with Kurdish civil and military authorities in the area.<sup>6</sup>

## OPERATION PROVIDE COMFORT Tactical Area of Responsibility

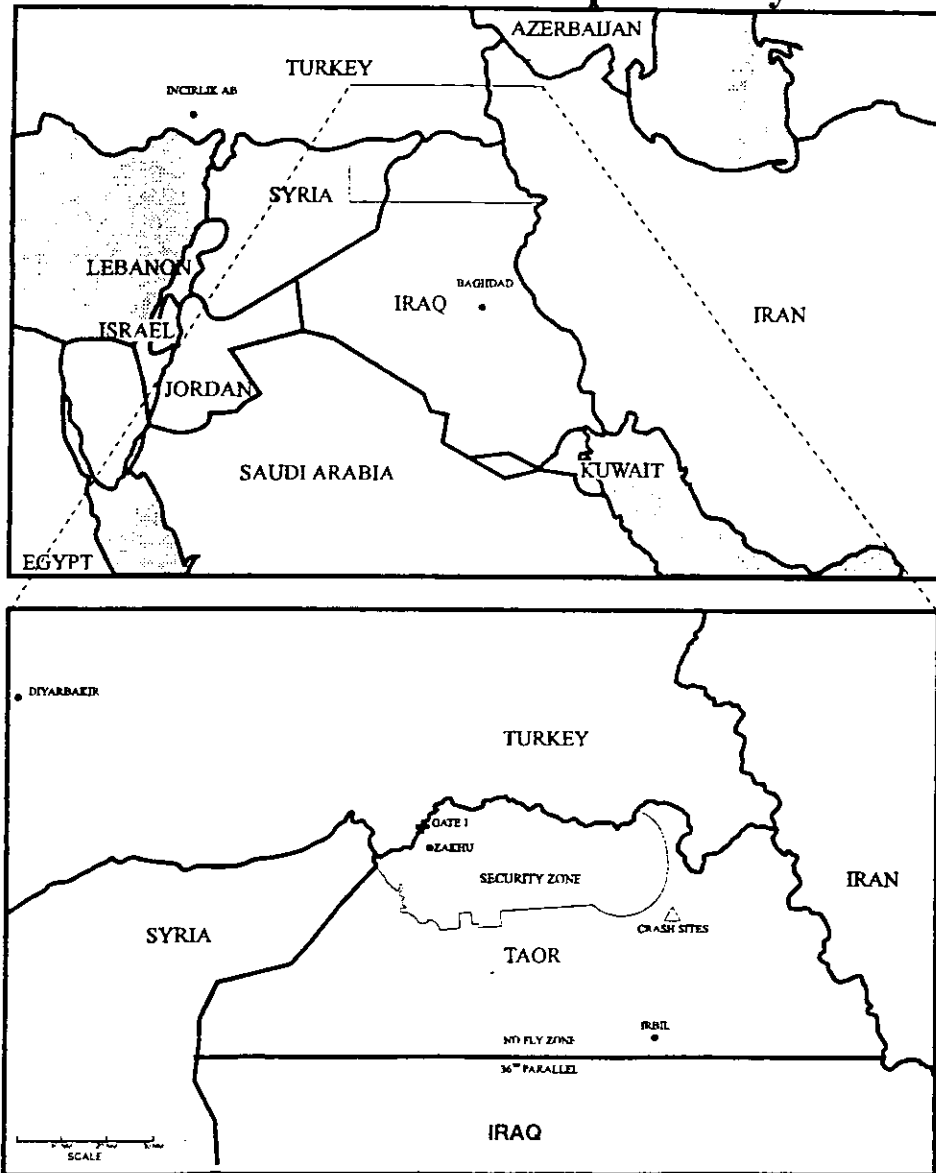

(Figure 1 - Map)

In order to satisfy the requirements of the CTF mission, specific organizations and aircraft were tasked as follows:

**(1) Command and Control Structure:** USCINCEUR Operations Orders (OPORDs) 002 and 003 defined the command and control of the CTF forces, as exercised by USCINCEUR, through the Commanding General of the CTF (CTF CG). USCINCEUR delegated operational control (OPCON) of the assigned US Army ground and air units to the CTF CG.<sup>7</sup> (OPCON is the authority to command subordinate forces, assign tasks, designate objectives and give authoritative direction necessary to accomplish the mission.)<sup>8</sup> OPCON of other coalition nations' forces was retained by their respective parent commands. The CTF CG was given tactical control (TACON) of participating US Navy, Turkish, French and British forces.<sup>9</sup> (TACON is the detailed, and usually local, direction and control of movements and maneuvers necessary to accomplish the assigned mission. TACON also provides the authority to direct military operations and control designated forces.)<sup>10</sup> Tactical aircraft and US Joint Special Operations Task Force (JSOTF) helicopters were co-located with CTF Headquarters at Incirlik Air Base (AB), Turkey. Other US Army helicopters and coalition ground forces established operations at sites in eastern Turkey and northern Iraq.<sup>11</sup> The CTF CG retained authority for all cross-border operations, both air and ground, into Iraq.<sup>12</sup>

USCINCEUR OPORD 003 directed the CTF CG to develop an operation plan (OPLAN) to govern the conduct of the OPC mission.<sup>13</sup> OPLAN 91-7, dated 20 July 1991, was developed and implemented to delineate the command relationships and organizational responsibilities within CTF PROVIDE COMFORT.<sup>14</sup> USCINCEUR OPORD 004, 14 September 1991, directed the withdrawal of the OPC Battalion Task Force. OPORD 004 further directed an increase in the size of CTF air forces and the retention of the JSOTF at Incirlik AB. The MCC and its supporting helicopter assets remained under the OPCON of the CTF and consolidated operations at Diyarbakir, Turkey.<sup>15</sup> The MCC later established a forward operating location at Zakhu, in the extreme northwestern corner of Iraq. OPLAN 91-7 provided comprehensive guidance for the OPC mission as it existed in July 1991. With the redeployment of the Battalion Task Force beginning in September 1991, the MCC and its supporting helicopter detachment were all that remained of the original CTF ground component.<sup>16</sup> OPORD 004 requested the CTF provide a supporting plan to implement provisions of OPORD 004.<sup>17</sup> However, although an effort was begun in 1991 to revise OPLAN 91-7, no evidence could be found to indicate that OPLAN 91-7 was actually updated to reflect the change in command and control relationships and responsibilities that resulted from the departure of the previously designated CTF Ground Component Commander and his forces.<sup>18</sup> OPLAN 91-7 remained in effect at the time of the accident.<sup>19</sup>

Under OPLAN 91-7, CTF PROVIDE COMFORT was organized using a modified joint task force (JTF) structure. (A CTF is a JTF which incorporates forces of other nations).<sup>20</sup> The OPC CTF organizational structure consists of a command element (US and Turkish co-commanders), a staff, a Combined Forces Air Component (CFAC), the JSOTF, and the MCC.<sup>21</sup> The CTF Chief of Staff serves as the CTF CGs' deputy and is responsible for supervising the functions of the staff. The CTF staff includes personnel (C1), intelligence (C2), operations (C3), logistics (C4), and communications (C6).<sup>22</sup> (The planning responsibilities normally executed by the plans staff

officer (C5) had been absorbed by the CTF C3.)<sup>23</sup> JSOTF forces provide special operations support and search and rescue.<sup>24</sup> The CFAC Commander (CFACC) is responsible for coordinating the employment of air forces to accomplish the OPC mission. He is delegated OPCON of the Airborne Warning and Control System (AWACS), USAF airlift, and fighter forces, and has TACON of the MCC, JSOTF, and US Navy, Turkish, French, and British fixed-wing and helicopter assets.<sup>25</sup>

CFAC responsibilities are assigned to personnel in the 39th Wing (USAF) at Incirlik AB, augmented with temporary duty personnel. The 39th Wing Commander also functions as both the Commander, 7440th Composite Wing (Provisional) and as the CFACC.<sup>26</sup> As the Commander of the 7440th Composite Wing, he exercises OPCON of US forces deployed to Incirlik AB, through the individual units' detachment commanders (DETCOs).<sup>27</sup> As the CFACC, he exercises TACON over forces participating in the daily OPC flying operation through a ground-based mission director, positioned in the command post at Incirlik AB and an airborne command element (ACE) on board the AWACS.<sup>28</sup>

The 39th Wing Operations Group Commander serves as the 7440th Composite Wing Deputy Commander for Operations (DO) and as the CFAC DO.<sup>29</sup> The CFAC DO is responsible for ensuring aircrews are informed of all unique aspects of the OPC mission upon their arrival in theater.<sup>30</sup> He is also responsible for publishing an Aircrew Read File (ARF).<sup>31</sup> The ARF includes the Rules of Engagement (ROE) for OPC and is mandatory reading for each assigned aircrew member.<sup>32</sup>

ROE are policies and procedures developed by National Command Authority (NCA) and subordinate military commanders, governing actions of US military forces to protect themselves, the United States, its possessions, bases and other property and personnel, against attack or hostile incursion. They are based upon legal, political and military considerations and are intended to provide for adequate self defense and to ensure that military activities are consistent with current national objectives. Unified combatant commanders establish ROE for their areas of responsibilities that are consistent with Joint Chiefs of Staff (JCS) guidelines. These may be modified for specified operations and for changing conditions. ROE are not designed to be specific operational orders; they are intended to describe clear circumstances and limitations under which US forces--from senior commanders to individual airman--may take necessary actions, consistent with legal, political and military requirements.<sup>33</sup> The OPC ROE are the peacetime ROE for the United States European Command, with modifications approved by National Command Authority for OPC.<sup>34</sup>

In addition to his responsibilities to incoming crew members, the CFAC DO is also responsible for publishing an Airspace Control Order (ACO), a daily Air Tasking Order (ATO) and mission-related special instructions (SPINS).<sup>35</sup> The ACO provides general guidance regarding the conduct of OPC missions, and is directive to all OPC aircrews. It provides rules and procedures that govern OPC flight operations.<sup>36</sup>

The ATO includes the daily flight schedule and provides authority for over-flight of northern Iraq.<sup>37</sup> All flights, both rotary and fixed-wing, will be in accordance with the CTF Air Component

Commander's ATO, as approved and promulgated by Headquarters, 2d Turkish Air Force.<sup>38</sup> The ATO lists radio frequencies, Identification Friend or Foe (IFF) codes, and other information pertinent to each day's mission.<sup>39</sup> Both the ACO and ATO are developed with consideration given to inputs from other CTF organizations. The CTF C2 is responsible for providing reconnaissance targeting information. Individual flying units input data such as aircraft availability and special training requests.<sup>40</sup> OPLAN 91-7 directs that the Combined Forces Ground Component Commander will coordinate rotary wing sorties in Iraq within the fighter flying window.<sup>41</sup> With the departure of the Combined Forces Ground Component Commander, no individual was assigned to coordinate rotary wing sorties.<sup>42</sup> OPLAN 91-7 specifies that the CTF C3, through the CFAC scheduling office, is the focal point for coordination of Army rotary wing flights with available fighter assets.<sup>43</sup>

The Joint Operations and Intelligence Center (JOIC), responsible to the C3, provides a 24 hour point of contact for communications within the CTF. When tasked, the JOIC receives, delivers, and transmits communications up, down, and across the CTF command and control structure. An Army Liaison Officer is available to provide liaison between the MCC helicopter detachment and its parent unit. He is not assigned to the JOIC, but is available to provide liaison between the MCC helicopter detachment and the CTF staff, on request.<sup>44</sup>

OPC daily flight operations are scheduled as mission packages. A typical package consists of a wide variety of aircraft with specific mission capabilities. When combined, these aircraft form a complex package capable of meeting OPC tactical objectives. A mission AWACS aircraft provides the airborne force with flight following, to and from the TAOR, as well as threat warning and fighter control within the TAOR. Six to seven air refueling aircraft [KC-135, F-135 (French Air Force), VC-10 (Royal Air Force)] provide inflight refueling for the AWACS and fighter aircraft. As many as 30 to 40 fighter aircraft [F-15, F-16, F-4G, F-15E, EF-111, Jaguar (FAF), Harrier (RAF)], flying two-ship and four-ship formations, provide visual and sensor reconnaissance of military targets, defensive counter air (DCA) capability, suppression of enemy air defense (SEAD) capability, and an on-call precision-guided munitions (PGM) capability. In addition, MCC Black Hawk helicopters maintain a visible presence in the security zone through air patrols and visits to Kurdish villages, and conduct transport and search and rescue (SAR) missions.<sup>45</sup>

The OPC aircraft normally remain on station in the TAOR 6 to 8 hours daily.<sup>46</sup> The flying "window" is randomly selected to avoid predictability.<sup>47</sup> The AWACS typically takes off from Incirlik AB approximately 2 hours before the first air-refueling and fighter aircraft.<sup>48</sup> Once the AWACS is airborne, the AWACS' systems are brought on-line and a Joint Tactical Information Distribution System (JTIDS) link is established with a Turkish Sector Operations Center (radar site). After the JTIDS link is confirmed, the CFAC airborne command element (ACE) initiates the planned launch sequence for the rest of the force.<sup>49</sup> Normally, within a one hour period, tanker and fighter aircraft takeoff and proceed to the TAOR in a carefully orchestrated flow.<sup>50</sup> Fighters may not cross the political border into Iraq without AWACS coverage.<sup>51</sup> No aircraft may enter the TAOR until fighters with airborne intercept (AI) radars have searched the TAOR for Iraqi aircraft.<sup>52</sup> Once the AI radar equipped fighters have "sanitized" the TAOR, they establish an orbit and continue their search for Iraqi aircraft.<sup>53</sup>



Additional fighters and tankers flow to and from the TAOR throughout the flying period. Air-to-air fighters fly combat air patrol. "Wild Weasels" and EF-111 electronic jamming aircraft maintain a watch for Iraqi surface-to-air missile activity, and the remaining aircraft conduct aerial reconnaissance of Iraqi military activity and provide a visible presence in the area. The MCC Black Hawk helicopters fly between their main base at Diyarbakir, Turkey, and Zakhu, Iraq, to resupply the MCC (Forward) operating location and to stage for missions into the TAOR. At the end of the flying window, the OPC aircraft return to their home bases, as scheduled. Air-to-air fighter aircraft equipped with AI radars leave the TAOR last to protect the package from Iraqi fighters.<sup>54</sup>

**(2) E-3B AWACS Mission.** The AWACS OPC mission is to control aircraft enroute to the TAOR, coordinate air refueling, and provide airborne threat warning and control for all OPC aircraft operating inside the TAOR. The AWACS also provides surveillance, detection and identification of all unknown aircraft.<sup>55</sup>

In order to fulfill its mission, the AWACS carries a large component consisting of a flight crew and a mission crew. The flight crew (a pilot, copilot, navigator and flight engineer) is responsible for the safe ground and flight operation of the aircraft. The mission crew has overall responsibility for command, control, surveillance, communications and sensor systems of the AWACS. The mission crew is made up of approximately 19 personnel and is divided into weapons and surveillance sections. The mission crew commander has overall responsibility for the AWACS mission. He is responsible for the management, supervision and training of the mission crew. The senior director (SD) supervises and directs the activities of the assigned weapons directors (WDs) and conducts the air battle.<sup>56</sup>

The WDs are responsible for locating, identifying, tracking and controlling all friendly aircraft, and regulating air traffic in the AWACS' area of responsibility. In addition to their normal duties, each WD has specific responsibilities for OPC aircraft. One WD acts as an enroute controller, responsible for controlling the flow of aircraft to and from the TAOR. This person also conducts IFF and radio checks on all OPC aircraft.<sup>57</sup> A second WD, the tanker controller, is responsible for controlling air-refueling operations.<sup>58</sup> A third WD, the TAOR controller, is assigned to provide threat warning, and tactical control for all OPC aircraft operating in the TAOR.<sup>59</sup> The Air Surveillance Officer (ASO) and up to four technicians are responsible for the detection, tracking, and identification of non-OPC aircraft.<sup>60</sup>

The airborne command element (ACE) is also on board. He is the CFACC's representative and works directly with the mission crew commander and SD. CTF PROVIDE COMFORT OPLAN 91-7 provides that, "An airborne command element (ACE) will be aboard [AWACS] to serve as the representative of the CFACC for time critical decisions."<sup>61</sup> CFAC operating instructions for the ACE provide that the ACE will act as the "eyes and ears" of the CFAC DO in the execution of the combat operations. They provide that the ACE has primary responsibility for the mission outside of a 50 NM circle of Incirlik, but emphasize that reference should be made to the CFAC DO. They imply that actions required for emergency or unsafe conditions can be taken by the ACE, who would then contact the CFAC DO as soon as possible.<sup>62</sup> The CFACC, in his testimony, stated that the ACE had no decision-making authority.<sup>63</sup>

# E-3B AWACS

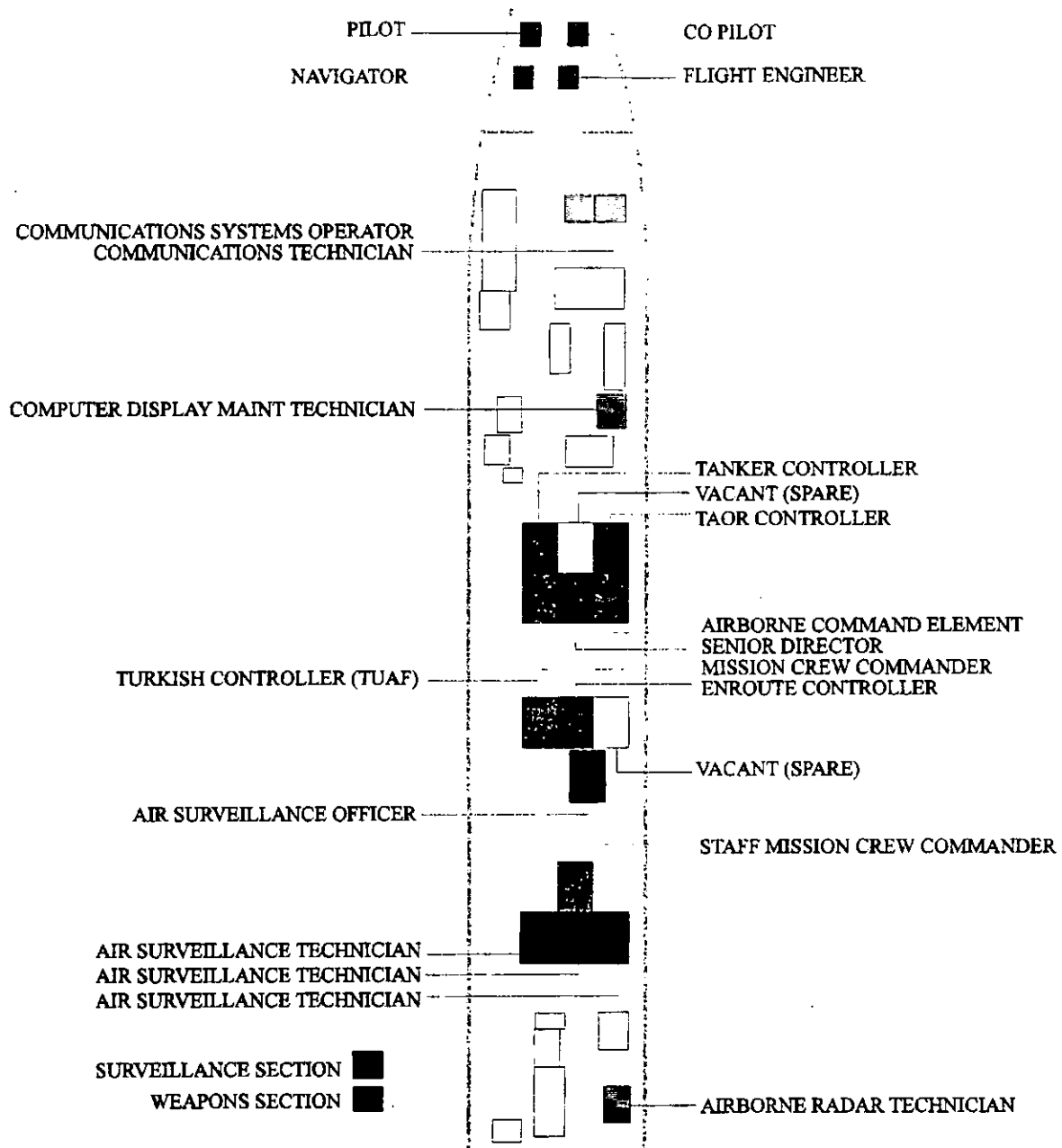

Figure 2 (AWACS Layout)

On 14 April 1994, an AWACS aircraft was tasked to provide airborne threat warning, command, control and communication in the TAOR from 0730Z to 1330Z for a mission package of 52 OPC aircraft, of which 28 were to be airborne by 0800Z.<sup>64</sup> After takeoff from Incirlik AB, the AWACS proceeded to an orbit area located 50 miles north of Incirlik, in order to allow its systems to "warm up" before beginning its task. After completion of system checks (radar, IFF and data link), AWACS proceeded to its assigned orbit area in a restricted operating area north of the TAOR.<sup>65</sup>

**(3) F-15C Mission.** As a part of the OPC coalition air forces, USAF F-15C fighter aircraft operating from Incirlik AB conduct missions in the TAOR in accordance with the standing ACO, SPINS and daily ATO.<sup>66</sup> The F-15s are tasked to protect friendly forces from enemy attack.<sup>67</sup> When the F-15s first enter the TAOR, they conduct a thorough radar search of the area to ensure the TAOR is clear of hostile aircraft ("sanitize" the airspace.)<sup>68</sup> After "sanitizing" the airspace, the F-15Cs fly an orbit, designed to provide Defensive Counter Air (DCA) cover. When necessary, they intercept, identify, and take appropriate action, as prescribed by the ROE.<sup>69</sup> On 14 April 1994, the two F-15Cs involved in the accident were tasked to depart from Incirlik AB at 0635Z to conduct a DCA combat air patrol (CAP) mission in the TAOR.<sup>70</sup>

**(4) UH-60 Black Hawk Mission.** US Army Black Hawk helicopters provide air transportation for the MCC liaison team and conduct resupply missions as required. The helicopters also have a secondary search and rescue (SAR) mission.<sup>71</sup> On 14 April 1994, the two accident helicopters were tasked to support the MCC by transporting passengers and cargo from the Turkish Air Base at Diyarbakir to the MCC Headquarters at Zakhu. From Zakhu, their mission was to transport the co-commanders of the MCC and other staff officers to the Kurdish towns of Irbil and Salah ad Din, Iraq, and return.<sup>72</sup>

## **b. Summary of Events:**

### **(1) Command and Control.**

**Aircrew Preparation.** Aircrews flying OPC missions are responsible for understanding the directives governing the air operations. These directives include the ACO, ATO, SPINS, and ARF. The CFAC DO is responsible for ensuring arriving aircrews are briefed on all aspects of the OPC flying mission. Prior to the time of the accident, the CFAC DO provided ROE briefings for change-outs of complete flying units. However, there was no arrangement to ensure that individual replacement pilots coming to OPC were centrally briefed. Briefings for these personnel were left as an individual squadron responsibility.<sup>73</sup> The two F-15 accident pilots came to OPC on temporary duty assignment rotations. They had both read the ARF and had received a squadron briefing on the ROE.<sup>74</sup>

The ROE as provided by USEUCOM were reduced, in briefings and in individual crew members' understandings, to a simplified form.<sup>75</sup> This simplification of the ROE resulted in some crew members not being aware of specific considerations required prior to engagement. These considerations included identification difficulties, the need to give defectors safe conduct, and the possibility of an aircraft being in distress and the crew being unaware of their position.<sup>76</sup>

[Classified portion deleted 145 words-ROE]<sup>77 78</sup>

**Directives.** Contents of the ACO, dated 12 December 1993, largely reflect the guidance given in the OPC Operations Orders and OPLAN 91-7. However, key CTF personnel at the time of the 14 April 1994 accident were either unaware of the existence of OPLAN 91-7 or considered it too outdated to be applicable.<sup>79</sup> No updated supporting plan or comprehensive alternative guidance regarding component responsibilities was issued by CTF.<sup>80</sup> Most key personnel within the CFAC and the CTF staff did not consider coordination of MCC helicopter activities to be part of their respective CFAC/CTF responsibilities.<sup>81</sup> The last CTF staff member who appears to have actively coordinated rotary-wing flying activities with the CFAC organization departed in January 1994.<sup>82</sup> No representative of the MCC was specifically assigned to the CFAC for coordination purposes.<sup>83</sup> Since December 1993, no MCC helicopter detachment representative had attended the CFAC weekly DETCO scheduling meetings.<sup>84</sup> The Army Liaison Officer (LNO), attached to the MCC helicopter detachment at Zakhu and assigned to Incirlik AB, was new on station (arrived April 1994) and was not fully aware of the relationship of the MCC to the OPC mission.<sup>85</sup> The CFACC, through the CFAC DO, did not, in fact, exercise TACON of MCC helicopter operations with respect to planning and scheduling.<sup>86</sup> Specific helicopter flight information was not included in the daily ATO, and no helicopter data was provided to OPC aircrews on the scheduling flow sheet, their principal planning tool.<sup>87</sup> Although the ACE had primary responsibility for the OPC mission outside of a 50 NM circle of Incirlik,<sup>88</sup> his knowledge of MCC helicopter flight activity was dependent on AWACS radar, IFF, and radio contacts, as the helicopters entered and worked within the TAOR.<sup>89</sup>

CTF CG policy letter (Subject: UH-60 Flight Policy), September 1993, implemented the following policy for UH-60 helicopter flights supporting the MCC: "All UH-60 flights into Iraq outside of the security zone require AWACS coverage."<sup>90</sup> Helicopter flights had routinely been flown within the TAOR security zone without AWACS or fighter coverage and CTF personnel at various levels were aware of this.<sup>91</sup> MCC personnel were aware of the requirement to have AWACS coverage for flights outside the security zone and complied with that requirement.<sup>92</sup> However, the accident F-15C pilots, relying on the written guidance in the ACO, believed that no OPC aircraft, fixed or rotary wing, were allowed to enter the TAOR prior to a fighter sweep.<sup>93</sup>

**Scheduling.** Since the MCC daily mission requirements were generally based on the events of the previous day, the MCC exercised flexibility in scheduling supporting helicopter flights. A weekly flight schedule was developed and provided to CTF C3, but a firm itinerary was usually not available until after the next day's ATO was published.<sup>94</sup> The weekly schedule was briefed in both the C3 and CTF CG staff meetings on Mondays, Wednesdays, and Fridays; however, the information was neither detailed nor firm enough for effective rotary-wing and fixed-wing coordination and scheduling purposes.<sup>95</sup>

The MCC provided a SITREP to the JOIC each evening that listed the helicopter flights for the following day, but the information was usually general in nature. Information in the SITREP

was received too late to be included in the daily ATO.<sup>96</sup> Each daily ATO was published showing several Black Hawk helicopter lines. Of these, two helicopter lines (two flights of two helicopters each) were listed with call signs (Eagle 01/02, and Eagle 03/04), mission numbers, IFF Mode II codes, and a route of flight described only as LLTC (the identifier for Diyarbakir) to TAOR to LLTC. No information regarding route or duration of flight within the TAOR was given on the ATO. Information concerning takeoff time and entry time into the TAOR was listed as "A/R" (as required).<sup>97</sup> The MCC would call the JOIC the night prior to the scheduled mission to "activate" the ATO line.<sup>98</sup> The takeoff times and the times the helicopters would enter northern Iraq ("gate" times) were passed by the JOIC duty officer to the Turkish C3 for approval. No procedures existed for passing this information from the JOIC to the CFAC who had TACON responsibility for the helicopters.<sup>99</sup>

A CTF C2 representative obtained available MCC helicopter information from the JOIC. This information, consisting of the MCC weekly schedule and the daily MCC SITREP, was passed from the C2 to individual units at Incirlik AB through a mail pickup point in the command post.<sup>100</sup>

On 8 April 1994, the MCC weekly schedule was provided to CTF C3 through the JOIC. That schedule showed a two-ship, MCC helicopter "administrative flight" on 14 April.<sup>101</sup> On 12 April, the MCC Commander requested approval for a 14 April flight outside the SZ. The requested flight of two helicopters was to proceed from Zakhu to the towns of Irbil and Salah ad Din, Iraq. The CTF CG approved the written request on 13 April, and the JOIC transmitted the approval to the MCC.<sup>102</sup> The 13 April MCC SITREP listed the 14 April flight as "mission support", but contained no other details. The MCC weekly schedule update, received by the JOIC on the evening of 13 April with the MCC SITREP, gave the destinations for the mission as Salah ad Din and Irbil.<sup>103</sup> This information was not passed to the CFAC.<sup>104</sup> At 1538Z on 13 April, the MCC contacted the JOIC duty officer and activated the ATO line for the accident mission. A takeoff time from Diyarbakir of 0520Z and a "gate" time of 0635Z were requested. No takeoff time or route of flight beyond Zakhu was specified. The 13 April SITREP, weekly flying schedule update, and ATO line-activation request were received by the JOIC too late to be briefed during the Wednesday (13 April) C3 and CTF CG staff meetings. None of the information was passed to the CFAC scheduling shop, the ground-based mission director, or the ACE on board the AWACS.<sup>105</sup>

An MCC schedule giving some information regarding the MCC helicopter flight, received through the C2 channels, was posted on the intelligence briefing board at the F-15 squadron operation center, but the information was not briefed to the air crews.<sup>106</sup> When the F-15 pilots departed Incirlik AB at 0635Z on 14 April, they were unaware that the MCC helicopters would be operating east of Zakhu in the TAOR.<sup>107</sup>

**Control.** When the F-15s arrived on station in the TAOR at 0720Z, they were not informed that the Black Hawk helicopters had already entered the TAOR, by either the AWACS controllers or the ACE on board the AWACS. The ACE did not consider it his responsibility to monitor the helicopters.<sup>108</sup> Neither the ACE nor the AWACS controllers gave any direction to either the helicopters or the fighters throughout the intercept and engagement.<sup>109</sup>

## (2) E-3B AWACS

**AWACS Flight Authorization:** The AWACS detachment at Incirlik AB was tasked by the CFAC DO through the ATO (ATO, PC1103, 14 April 1994) to provide airborne warning and control in the TAOR on 14 April 1994.<sup>110</sup> The accident flight was the AWACS crew's first OPC mission as a crew.<sup>111</sup> The AWACS DETCO authorized the crew to fly the tasked mission in accordance with appropriate directives.<sup>112</sup>

**AWACS Flight Plan.** The OPC ACO, the ATO for 14 April 1994, and one change to the daily ATO, Battle Staff Directive (BSD) #1, provided direction and guidance for the flight.<sup>113</sup> The planned route of flight was from Incirlik AB to an orbit in Restricted Operations Zone 1 (ROZ 1) near the northern border of Iraq. The aircraft was to remain in orbit from 0730Z to 1330Z in support of aircraft operations in the TAOR, and return to Incirlik AB.<sup>114</sup> In accordance with established Air Force procedures, each crew member initialed the flight authorization form, accepting responsibility for executing the ATO-tasked mission.<sup>115</sup>

**AWACS Communications.** The crew did not encounter any communication equipment malfunctions during the flight.<sup>116</sup> The only communication limitation which may have been experienced by the crew was a problem in maintaining line-of-sight with the helicopters.<sup>117</sup> The effect may have been intermittent loss of radio contact with the helicopters. This was a regularly encountered situation with low flying aircraft.<sup>118</sup> The AWACS crew monitored the prebriefed aircraft radio control frequencies. These included VHF and UHF guard, enroute control, TAOR "Have Quick II" (jamming resistant radio), and TAOR clear (non-secure tactical radio) frequencies.<sup>119</sup> The enroute controller received check-in calls on the enroute frequency.<sup>120</sup> The ACO required aircraft in the TAOR to monitor the TAOR tactical frequency;<sup>121</sup> however, the normal practice by the OPC helicopter crews was to remain on the enroute frequency and report to the enroute controller, unless directed to change frequencies by the enroute controller.<sup>122</sup> The last radio transmission received from the UH-60 Black Hawk helicopters was at 0654Z when they reported departing Zakhu for Irbil. This transmission was made on the enroute controller's frequency. There is no indication that communications equipment serviceability was related to the accident.<sup>123</sup>

**AWACS Navigation.** No navigational difficulties were encountered by the aircrew during the flight. There is no indication that navigation was a factor in the accident. The weather was clear.<sup>124</sup>

**AWACS Briefing and Preflight:** The crew conducted the required briefings and pre-mission planning on 12 April 1994 in preparation for the mission on 14 April 1994.<sup>125</sup> On the afternoon of 13 April 1994, the mission crew commander, and the surveillance section and weapons section personnel conducted additional specialized mission planning.<sup>126</sup> Pre-mission and specialized mission planning items required by regulations and directives were covered.<sup>127</sup>

The crew members went to bed on 13 April between approximately 1700Z and 2000Z and awoke between approximately 0100Z and 0230Z on 14 April 1994.<sup>128</sup> All crew-rest requirements

as specified by Air Force regulations were met.<sup>129</sup> The flight and mission crews arrived at the AWACS squadron operations building at approximately 0310Z.<sup>130</sup>

The aircrew, including the ACE and a Turkish controller, attended a preflight briefing at AWACS operations at approximately 0330Z.<sup>131</sup> The aircraft commander and mission crew commander conducted the briefing, addressing their respective mission areas.<sup>132</sup> The detachment staff mission crew commander and the staff weapons director attended the entire briefing.<sup>133</sup> The Detachment Commander attended the portion of the briefing covering flight operations.<sup>134</sup> The briefing was conducted using the standard squadron briefing guide for the OPC theater of operations.<sup>135</sup>

The aircraft commander briefed the forecast weather, crew manifest, aircraft status, mission timing, safety considerations, emergency procedures, elements of basic airmanship, and the wing operations security policy.<sup>136</sup>

The AWACS staff intelligence representative briefed escape and evasion procedures, the previous day's Iraqi air activity, and threat capabilities. He also briefed a United Nations support mission scheduled to take place on 14 April.<sup>137</sup> There is no evidence that the briefing included any mention of the UH-60 Black Hawk helicopter mission. AWACS technician topics were briefed which included the JTIDS and maintenance debriefing requirements.<sup>138</sup>

After the aircraft commander, intelligence, and technician briefings were completed, the AWACS technicians and flight engineer departed for the aircraft to begin preflight inspections.<sup>139</sup> The mission crew commander then briefed mission crew topics which included the weapons plan for the mission and the activity flow sheet provided by the CTF.<sup>140</sup> The activity flow sheet, which is derived from the ATO, listed the F-15C flight (call sign Tiger). The MCC helicopter flight (call sign Eagle) was not listed on the flow sheet. The preflight briefing did not address the OPC Air Tasking Order.<sup>141</sup> The mission crew commander also covered lessons learned from previous missions and special notes for the mission.<sup>142</sup>

Technician and flight engineer preflight checks were accomplished and indicated no previously undocumented equipment discrepancies.<sup>143</sup>

**AWACS Sequence of Flight Events.** At 0436Z, the AWACS took off from Incirlik AB, Turkey.<sup>144</sup> The AWACS established an initial orbit approximately 50 miles north of Incirlik AB.<sup>145</sup> While holding in the initial orbit, the mission crew began conducting mission systems (communications, computers, radar, IFF) "power-up" checks and establishing the required JTIDS communication and data link with the Turkish ground radar sites.<sup>146</sup>

At 0545Z, the mission crew commander declared "on station,"<sup>147</sup> indicating the AWACS' mission systems were powered up, required checks with ground stations had been accomplished, and the AWACS was ready and prepared to accomplish its assigned missions.<sup>148</sup> At this time, the AWACS departed the initial orbit and proceeded to its operational orbit in ROZ 1, at 32,000 feet pressure altitude.<sup>149</sup> The AWACS scheduled time for arrival at the operational orbit in ROZ 1 was 0730Z.<sup>150</sup>

Shortly after 0545Z, the AWACS surveillance section began tracking aircraft in southeast Turkey and northern Iraq.<sup>151</sup> (The AWACS tracks aircraft by radar returns and/or Identification Friend or Foe (IFF) transponder returns.)

NOTE: The IFF system is an electronic means of identifying friendly aircraft. Each friendly aircraft is equipped with an electronic device (transponder) that transmits a coded reply when the transponder is electronically "queried" by an aircraft or ground-based interrogator. Specific codes are listed in the ATO to be set into each OPC aircraft's transponder. AWACS and F-15 aircraft have the capability to electronically interrogate transponder systems of other aircraft to detect correct, friendly codes. Mode I codes are used tactically to confirm the friendly status of aircraft. Different Mode I codes are listed for OPC fixed-wing and rotary-wing aircraft operating outside the TAOR. A single Mode I code is listed in the ATO for all OPC aircraft flying inside the TAOR. Mode II codes are used to determine the identity of a known friendly aircraft. Each OPC aircraft is assigned its own distinct Mode II code for each mission. Mode II is used by AWACS to identify and flight follow individual, friendly aircraft, but is not practical for tactical use by F-15s to differentiate between "friend and foe." Mode III is an air traffic control mode that is turned off when entering the TAOR, in order to avoid detection by Iraqi radar. Mode IV is used to differentiate between friend and foe. Mode IV uses an encrypted code that is changed daily and requires special equipment, encrypting codes, and loading procedures for both the IFF transponders and the AWACS and F-15 interrogation systems. IFF signals are not continuously transmitted by aircraft transponders. Each mode/code must be specifically interrogated to activate and identify the signal.<sup>152</sup>

The MCC Black Hawk helicopters, which were enroute from Diyarbakir, Turkey, to Zakhu, Iraq, were detected by the AWACS shortly after the AWACS onboard systems reached operational status. The surveillance section assigned the Black Hawk flight a "friendly general" track symbology and a track designator of "TY06."<sup>153</sup> At 0613Z, the senior director requested display of a track tabular display (TD) on track "TY06."<sup>154</sup> The track TD included IFF Mode II, and III codes.<sup>155</sup> At 0616Z, an "H" character was programmed to appear at the Black Hawk flight's location on the senior director's radar scope whenever any IFF Mode I, Code 42 reply (squawk) from the helicopters was detected by the AWACS.<sup>156</sup>

At 0621Z, AWACS received a "check-in" radio call on the enroute UHF radio frequency from the MCC Black Hawk helicopters.<sup>157</sup> This call was made just prior to the helicopters entering the TAOR entry point (Gate 1).<sup>158</sup> The enroute controller acknowledged the helicopters' entry into the TAOR, and observed their Mode I and Mode II IFF codes.<sup>159</sup> The senior director changed the Black Hawk helicopter "friendly general" symbology to a "friendly helicopter" symbology.<sup>160</sup> The enroute controller changed the helicopter track designator from "TY06" to "EE01" (call sign Eagle 01).<sup>161</sup> There is no evidence to indicate that the enroute controller attempted to perform a Mode IV check on the Black Hawk helicopters.<sup>162</sup> The AWACS Mode IV interrogator was functioning correctly.<sup>163</sup> The ACO implies that the AWACS



crew will conduct a Mode IV check on each aircraft but does not direct that it be accomplished. The ACO states that, "On initial check-in with AWACS, ...Mode IV is 'sweet' (operational) unless AWACS tells you otherwise."<sup>164</sup> The enroute controller monitored the Black Hawk helicopters until the IFF returns faded from AWACS coverage at approximately 0624Z.<sup>165</sup> The helicopters landed at Zakhu shortly thereafter.<sup>166</sup> The helicopters' symbology was then suspended, an action that maintained the symbology in the vicinity of Zakhu.<sup>167</sup>

At 0635Z, the F-15Cs launched from Incirlik AB.<sup>168</sup> The AWACS enroute controller identified the F-15Cs and maintained radar contact with them as they proceeded to the TAOR.<sup>169</sup>

The Black Hawk helicopters contacted AWACS at 0654Z and reported that they were enroute from "Whiskey to Lima" (Whiskey was a codeword for Zakhu and Lima was a codeword for Irbil). The AWACS enroute controller received their call.<sup>170</sup> He was not familiar with the location of "Lima" and did not look it up, although materials to do so were available.<sup>171</sup> At that time, the AWACS enroute controller reinitiated the helicopter track designator (EE01).<sup>172</sup>

The enroute controller was responsible for controlling OPC aircraft in Turkish airspace west of Gate 1.<sup>173</sup> The TAOR controller was responsible for controlling aircraft inside the TAOR, east of Gate 1.<sup>174</sup> Neither the enroute controller nor the senior director instructed the Black Hawk helicopters to change from the enroute radio frequency to the TAOR clear frequency that was being monitored by the TAOR controller.<sup>175</sup> However, the TAOR controller had the capability to monitor the enroute frequency.<sup>176</sup> The Black Hawks were squawking the wrong Mode I code; there is no evidence that either the enroute controller or the senior director told the helicopters that they were still "squawking" the Mode I code for outside the TAOR.<sup>177</sup>

From 0655Z until 0711Z, the "H" character assigned to the Black Hawk flight was regularly displayed on the senior director's radar scope.<sup>178</sup> At 0711Z, the F-15Cs were heading east, approximately 100 NM west of the Black Hawk helicopters.<sup>179</sup> At that same time, the helicopter flight entered mountainous terrain at low altitude and faded from AWACS radar and IFF coverage.<sup>180</sup> After losing IFF and radar contact with the Black Hawk helicopters at 0712Z, no AWACS controller suspended (stopped at one location) the helicopters' track symbology.<sup>181</sup> As a result, the AWACS computer continued to move the symbology based on the last available heading and airspeed information from the helicopters.<sup>182</sup> The enroute controller, who had not transferred control of the Black Hawk flight to the TAOR controller, did not note the heading and speed the helicopters were flying to get to point Lima, nor did he identify the flight path the helicopters reported they would follow.<sup>183</sup>

At 0713Z, the air surveillance officer designated the Black Hawk flight's last known location on the senior director's radar scope, by placing a computer-generated "attention arrow" (used to point out an area of interest.) The attention arrow is accompanied by a blinking alert light.<sup>184</sup> The senior director did not acknowledge the arrow or the blinking alert light on his console.<sup>185</sup> The arrow and light were automatically dropped after 60 seconds.<sup>186</sup> At 0715Z, the air surveillance officer directed that the AWACS radar be adjusted to low velocity detection settings which improved the capability of the radar to detect slow-moving targets.<sup>187</sup> At

approximately the same time, the F-15s checked in with the ACE and received "...negative words," (indicating no changes in previously briefed information).<sup>188</sup>

At 0720Z, the F-15C flight arrived at Gate 1 and entered the TAOR to "sanitize" the area.<sup>189</sup> They contacted the AWACS TAOR controller on the "Have Quick II" TAOR frequency.<sup>190</sup> The TAOR controller did not pass a "picture" call (situation update giving air activity) to the F-15C flight when they entered the TAOR.<sup>191</sup> At this time, the AWACS mission crew did not have radar or IFF contact with the Black Hawk helicopters, although the Black Hawk track symbology continued to appear on the AWACS radar scopes moving on a computer-generated southeasterly path.<sup>192</sup> No one on board the AWACS informed the F-15 pilots of the friendly Black Hawk helicopters in the TAOR, their last known position, or their route of flight.<sup>193</sup>

At 0721Z, the enroute controller dropped the symbology for the Black Hawk helicopters from the radar scopes.<sup>194</sup> The track symbology was the only visual reminder to the AWACS crew that the helicopters were inside the TAOR, after the radar contact and IFF signals had faded.<sup>195</sup>

At approximately 0722Z, the F-15 flight lead reported to the TAOR controller that he had a radar contact approximately 40 NM to the southeast, in the TAOR.<sup>196</sup> The TAOR controller reported, "Clean there," meaning AWACS had no radar returns or IFF replies from that location. (AWACS magnetic tapes indicate there were none at that time.)<sup>197</sup> When the F-15C flight lead made his first "contact" call, the mission crew commander and senior director did not take any action to direct the weapons or surveillance sections to locate and identify the F-15C's reported contact.<sup>198</sup>

At approximately 0723Z, intermittent IFF signals were received by the AWACS from the helicopters, in the area where the F-15 pilot had called his contact.<sup>199</sup> These IFF signals would have appeared on every AWACS radar scope that had the "IFF feature select switch" turned on, except seat 10, which was inoperative and not manned.<sup>200</sup> All six radar and IFF/SIF switches at each weapons section's manned positions should have been on, in accordance with AWACS training guides.<sup>201</sup> Testimony by the senior director, the enroute controller, the air surveillance officer and technicians, and the tanker controller indicates that they had both radar and IFF switches on.<sup>202</sup> The TAOR controller and the mission crew commander declined to testify, through counsel, and the position of their switches could not be confirmed by other means.

The "H" character also reappeared on the senior director's radar scope at approximately 0723Z.<sup>203</sup> The Black Hawk helicopters were squawking the same IFF Mode I and II codes that they were squawking before the AWACS lost IFF and radar contact at 0712Z.<sup>204</sup> No radio calls regarding the IFF returns were made from AWACS to the fighters.<sup>205</sup> The intermittent IFF returns, which had begun at 0723Z, increased in frequency until 0726Z.<sup>206</sup> They then remained on display, without interruption, from 0726Z to just before 0728Z.<sup>207</sup>

At approximately 0725Z, the F-15 flight lead made another "contact" call at about 20 NM range from the helicopters. The TAOR controller acknowledged the radio call and responded that he had "Hits there," which implied that he had radar returns on his radar scope corresponding to the F-15Cs' contact.<sup>208</sup> However, the AWACS magnetic tape recordings (replayed through a

radar console with a "IFF feature select switch" in the on position), clearly show "IFF paints" at the reported location. (A "hit" is a term to describe a radar return. A "paint" is a term to describe an IFF reply.)<sup>209</sup>

At 0726Z, the Black Hawk helicopters' IFF returns were clearly visible, along with intermittent radar returns, on the AWACS radar scopes. The returns were at the same location as the radar contact identified by the F-15 flight.<sup>210</sup> The AWACS crew did not advise the F-15C flight of the presence of IFF data in the target area.<sup>211</sup>

NOTE: The AWACS crew had some confusion regarding tracking responsibilities of unknown aircraft in the TAOR. The air surveillance technicians believed their tracking responsibility was south of the 36th parallel and the weapons section was responsible for tracking all aircraft north of the 36th parallel. In contrast, the weapons section believed the surveillance section was responsible for tracking and identifying all unknown aircraft, regardless of location.<sup>212</sup> The applicable Air Force regulations state the surveillance section had tracking responsibility for unknown and unidentified tracks throughout the TAOR.<sup>213</sup> The mission crew commander is tasked with coordinating and directing the activities of both the surveillance and the weapons sections.<sup>214</sup> The Black Hawk helicopters were initially identified and tracked by the enroute controller, a member of the weapons section.<sup>215</sup> At approximately 0642Z, a member of the surveillance section asked the identity of the Eagle Flight track, and the senior director said it was Eagle Flight; a member of the weapons section said they were tracking it.<sup>216</sup>

At 0727Z, the enroute controller initiated an "Unknown, Pending, Unevaluated" track symbology in the area of the helicopters' radar and IFF returns and attempted an IFF identification.<sup>217</sup> During the F-15 flight's intercept of the helicopters, no one else on board the AWACS attempted to determine specific IFF aircraft identification, or to do a Mode IV check on the helicopters.<sup>218</sup> The "H" character previously attached to the helicopters' IFF return was still present on the senior director's radar scope.<sup>219</sup>

At approximately 0728Z, the F-15 flight lead transmitted to the TAOR controller that he saw "...a Hind" (NATO designation) followed by "no, Hip" (NATO designation). He then made a correction and reported a Hind helicopter.<sup>220</sup> At this time, the AWACS track symbology for the F-15s and the Black Hawk helicopters' radar and IFF data were too close together for the AWACS crew to identify the Black Hawk helicopters.<sup>221</sup> (Analysis of an AWACS audio tape indicates that, at approximately this time (0728Z), the ACE said, "Eagle One," on internal AWACS intercom; but, there is no further information available because of a blocking radio transmission.)<sup>222</sup> The F-15 flight lead again reported "...two Hinds" and the TAOR controller responded, "Copy Hinds."<sup>223</sup> The F-15 flight lead reported that he was "Engaged".<sup>224</sup> At 0730Z the F-15 flight lead reported they had "splashed" (shot down) two Hind helicopters.<sup>225</sup> There is no indication that the AWACS senior director, the mission crew commander, and/or the ACE made any radio calls throughout the intercept, or that they issued any guidance to either the AWACS crew or the F-15 pilots.<sup>226</sup>

**AWACS flight activity following the accident:** At approximately 0831Z, the CFAC ground-based mission director called the ACE and indicated that the Black Hawk helicopters were unaccounted for.<sup>227</sup> At 0914Z, the CFAC ground-based mission director instructed the ACE to find the Black Hawk helicopters and confirm good radar contact with them.<sup>228</sup> Attempts by AWACS crew members and the ACE to locate the Black Hawk helicopters by radar and/or radio, to include calls on UHF and VHF "guard" were unsuccessful. At 0926Z, AWACS placed its radar and IFF sensors to stand-by in preparation for air refueling.<sup>229</sup> At approximately 1010Z, the AWACS resumed actions to locate the Black Hawk helicopters.<sup>230</sup> The AWACS continued to support search and rescue/crash-response activities until reaching fuel minimums. The aircraft departed the TAOR at 1520Z and landed at Incirlik AB at 1615Z.<sup>231</sup> A second AWACS supported the remainder of the search and rescue activity.<sup>232</sup>

### **(3) F-15C**

**F-15C Flight Authorization:** On 14 April 1994, the F-15C fighter squadron was tasked to provide a flight of two F-15Cs to fly a DCA mission in the TAOR.<sup>233</sup> The squadron commander authorized the F-15 pilots to fly the tasked mission.<sup>234</sup>

**F-15C Flight Plan:** The ACO, the ATO for 14 Apr 94 and one change to the daily ATO, (Battle Staff Directive #1), provided the operating instructions and procedures for the F-15C flight (call signs Tiger 1 and Tiger 2).<sup>235</sup> The F-15s were the first OPC aircraft scheduled into the TAOR by the ATO.<sup>236</sup> Their planned route of flight was to proceed from Incirlik AB to the TAOR, and return.<sup>237</sup> In accordance with established Air Force procedures, the F-15 pilots signed a flight authorization form accepting responsibility for executing the ATO-tasked mission.<sup>238</sup>

**F-15C Communications:** The main and auxiliary radios, "Have Quick II" and the secure voice communications systems in the aircraft flown by the two F-15 pilots operated normally throughout the flight. No communications equipment serviceability difficulties with any ground or airborne agencies were experienced by either aircraft.<sup>239</sup>

**F-15C Navigation:** No navigation difficulties were experienced by either F-15C aircraft during the flight.<sup>240</sup>

**F-15C Briefing and Preflight:** The two F-15 pilots involved in the accident, call signs Tiger 1 (flight lead) and Tiger 2 (wingman), left the Squadron Operations Building (SOC I) before 1230Z on 13 April and went to bed at approximately 2030Z.<sup>241</sup> They awoke at approximately 0330Z on 14 April,<sup>242</sup> departed their quarters at 0420Z and arrived at SOC I at approximately 0430Z.<sup>243</sup> All crew rest requirements specified by Air Force regulations, were met.<sup>244</sup>

The F-15 flight lead prepared the flight briefing materials while the wingman checked the forecast weather and Notices to Airmen (NOTAMS). The squadron duty supervisor and the flight lead then reviewed the flight's tasking in the ATO. They modified the mission flow sheet and the flight's line-up cards to reflect a change to the ATO made by BSD #1.<sup>245</sup> (The BSD

changed the number of KC-135 air-refueling tanker aircraft available for the day's mission). Both pilots completed the flight authorization form and received a briefing from the squadron intelligence officer.<sup>246</sup> The briefing included a summary of the previous day's Iraqi air activity, information concerning the movement of an Iraqi surface-to-air missile site, search and rescue procedures, and current intelligence regarding the situation in Rwanda.<sup>247</sup> The intelligence officer made no reference to either friendly or Iraqi helicopter activity in or near the TAOR.<sup>248</sup> The intelligence officer had posted the limited available information about Eagle 01 and 02 on the intelligence situation map in SOC I. Based on the MCC (Forward) SITREP he received from CTF C-2, the intelligence officer had posted the Black Hawk helicopters' mission as "two-ship admin" which was understood to mean the helicopters would fly from Diyarbakir to Zakhu and return.<sup>249</sup>

The F-15 flight lead started the mission briefing at 0445Z using the standard squadron briefing guide.<sup>250</sup> All briefing items required by regulations and directives were covered.<sup>251</sup> During the tactical portion of the mission briefing, the flight lead discussed the OPC ROE, radar search responsibilities, intercept and visual identification procedures.<sup>252</sup> The flight lead briefed electronic identification (EID) procedures that could be used on the mission. This included a discussion on the use of the Air-to-Air Interrogation (AAI) systems to attempt to identify any unknown aircraft. The flight lead specified that IFF Modes I and IV codes would both be interrogated in the identification process.<sup>253</sup> He also briefed that the aircraft video tape recorder (VTR) would be turned on when the decision was made to "commit" (to engage or intercept.)<sup>254</sup>

Following the mission briefing, the F-15 pilots picked up their required flying equipment and inflight publications. At 0540Z, the pilots signed for their weapons, ammunition, and other controlled combat equipment and departed SOC I for their assigned aircraft.<sup>255</sup> Both pilots conducted standard aircraft preflights of their respective aircraft, which included a review of the aircraft's maintenance history forms.<sup>256</sup> The aircraft forms reflected that the correct Mode IV codes had been loaded into the aircraft transponders.<sup>257</sup> No discrepancies were recorded in the aircraft maintenance forms that would have apparently affected either aircraft's capability to perform the tasked mission.<sup>258</sup> During the preflight inspections, the pilots confirmed that the AAI system switches in the nose of each aircraft (inaccessible in flight) were set to allow continuous Mode IV interrogation when the cockpit AAI switches were activated in the Auto position.<sup>259</sup> No aircraft discrepancies were noted during the preflights.<sup>260</sup>

**F-15C Sequence of Flight Events:** At 0600Z the F-15 pilots started their aircraft engines. After engine start, the flight lead called the ground-based CFAC mission director to get any additional information pertaining to the mission. The mission director informed the F-15 flight lead that there were no changes to the tasking, or to the ATO. The mission director made no mention of any helicopter flight activity.<sup>261</sup> The pilots completed their normal ground checks as prescribed in the F-15 preflight checklist. This included accomplishing built-in-tests (BIT) of the AAI system and the IFF system. The AAI and IFF systems on both aircraft were checked and determined to be operational.<sup>262</sup> The F-15s took off at 0635Z.<sup>263</sup>

Both pilots reported conducting successful weapons systems checks after takeoff. These included checks of each aircraft's capability to respond to Mode I, II and Mode IV IFF

interrogations, and each aircraft's AAI system's ability to detect correct responses from other aircraft.<sup>264</sup>

The F-15s checked in with the AWACS enroute controller on the enroute frequency at the first checkpoint (K-Town) and proceeded toward the second checkpoint (Derik) at Flight Level (FL) 270 (27,000 feet above mean sea level). While enroute to Derik, the F-15 pilots checked their "Have Quick II" and the secure voice radio systems (KY-58) with AWACS. At the third enroute checkpoint (Jump), the F-15 flight checked in with the ACE on board the AWACS aircraft who did not report any changes to their tasking or to the ATO. The ACE made no mention of any helicopter flights, friendly traffic, or Iraqi threats in the TAOR. At 0720Z, the F-15 pilots checked in with the TAOR controller on the TAOR "Have Quick II" frequency, as they entered the TAOR. The TAOR controller acknowledged the radio call from the F-15s and made no mention of any other aircraft in the TAOR.<sup>265</sup>

The F-15s remained at FL 270 and headed southeast. The flight lead used his radar to search the airspace from ground elevation to 25,000 feet. The wingman set his radar to search the airspace above 20,000 feet.<sup>266</sup> Shortly after entering the TAOR, the flight lead detected a radar contact in the TAOR approximately 52 NM north of the 36th degree latitude. The contact was 40 NM to the southeast of his position. The flight lead relayed this information to his wingman on the auxiliary radio.<sup>267</sup> The flight lead then selected a radar mode that electronically captured ("locked on") and evaluated the radar contact to provide detailed flight information. The radar contact was heading approximately east (100 degrees) at 130 knots, very close to the ground. After "locking-on" to the radar contact, the flight lead attempted an electronic identification of the aircraft. He used the AAI system to interrogate IFF Mode I, code 52, (the correct Mode I code for OPC aircraft operating in the TAOR) and Mode IV. The flight lead received no response to the Mode I interrogation. He did receive a momentary Mode IV response.<sup>268</sup> The flight lead continued to interrogate the contact's IFF Mode IV for another 4 to 5 seconds, but received no further responses. The flight lead believed the momentary Mode IV positive response was due to a possible anomaly in the F-15 AAI system.<sup>269</sup>

At approximately 0722Z, the F-15 flight lead relayed to the TAOR controller the contact's position in relation to a predetermined, common point.<sup>270</sup> The TAOR controller acknowledged the call, transmitting, "Clean there," meaning AWACS had no radar returns or IFF replies from that location.<sup>271</sup> The F-15 flight lead then switched his radar to a search mode and began looking for additional aircraft. The flight lead thought his radar might have detected road vehicle traffic due to the proximity of the radar contact to a road. Using his AAI system, with his radar in the search mode, the flight lead again interrogated the radar contact for IFF Mode I and Mode IV codes. No response was received.<sup>272</sup> Simultaneously, the wingman lowered his radar search pattern to locate the radar contact that his flight lead had reported. The wingman detected the contact at the reported location and initiated a radar lock-on. He then interrogated the radar contact for IFF Mode I and Mode IV codes, with no response. The wingman informed the flight lead that the contact he had locked-on to was traveling at 130 knots. The wingman returned his radar to a search mode and began looking for other aircraft in the TAOR.<sup>273</sup>

At a range of approximately 20 NM from the radar contact, the flight lead began to descend from FL 270, locked-on to the radar contact, and reported the contact to AWACS on the TAOR "Have Quick II" frequency (not being used by the Black Hawk helicopter flight).<sup>274</sup> At approximately 0725Z, the TAOR controller acknowledged the call and transmitted, "Hits there", indicating that AWACS had a radar contact at the same location.<sup>275</sup> During the descent, the F-15 wingman maneuvered to a position approximately 3 NM behind the flight lead. The wingman at this time observed two radar contacts displayed on his radar scope. The contacts were his flight lead and an unidentified radar contact in front of the lead F-15. The wingman again initiated an AAI Mode I interrogation and received a reply from his flight lead, indicating the flight lead's IFF Mode I was set to Code 52 and that his IFF transponder was replying correctly. The wingman received no Mode I reply from the unidentified radar contact. (The Black Hawks' Mode I code was set on 42 - the code for OPC aircraft operating outside of the TAOR).<sup>276</sup> Because the flight lead had not been able to get an IFF Mode I or a Mode IV reply from the radar contact, he closed to conduct a visual identification (VID) pass.<sup>277</sup>

At approximately 0727Z, as the flight lead approached within 5 NM of the unidentified aircraft, he saw a single helicopter flying at a very low altitude. The flight lead began his VID pass at approximately 450 knots indicated airspeed. The helicopter was flying down the middle of a valley, approximately 120 to 200 feet above the ground.<sup>278</sup> The valley was oriented northwest-southeast and was approximately 2.5 NM wide at the elevation and position where the flight lead approached the helicopter.<sup>279</sup> The hills on either side of the valley were between 1,500 and 3,000 feet above the valley floor. Additionally, the valley narrowed from approximately 2.5 NM wide where the VID pass was made to approximately 1 NM at the eastern end (4 to 5 NM to the east).<sup>280</sup> In an attempt to make a visual identification, the flight lead descended below the tops of the hills and flew to a position reported by the pilot to be 1000 feet left and 500 feet above the helicopter's flight path. At approximately 0728Z, the flight lead observed what he thought was a helicopter with a sloped vertical tail, sponsons (wings) on the fuselage, ordnance, and a dark green camouflage paint scheme.<sup>281</sup> He transmitted on the "Have Quick II" radio frequency that he saw a "Hind" (NATO designation). He then changed the call to "No, Hip" (NATO designation).<sup>282</sup> As the flight lead started a right hand climbing turn to set up an oval racetrack pattern behind the helicopter, he saw a second helicopter in trail. As the flight lead passed above the helicopter in the climbing right turn, he referred to his inflight visual recognition guide and determined that the helicopters were "Hinds," as he had first reported. He transmitted "VID Hind, Tally Two, lead-trail."<sup>283</sup> The flight lead then transmitted, "Tiger 2, confirm Hinds?" The F-15 wingman replied, "Standby."<sup>284</sup> The wingman conducted a VID pass (approximately 2000 ft right) of the trailing helicopter, but did not confirm the identification. In response to the flight lead's radio call, the wingman responded "Tally 2." The wingman testified that he intended this call to indicate he saw two helicopters.<sup>285</sup> The F-15 flight lead understood his wingman's transmission to mean that he confirmed the identification.<sup>286</sup> The AWACS TAOR controller said, "Copy Hinds."<sup>287</sup>

The F-15 flight lead flew to a position approximately 5-10 NM behind the helicopters and called, "Engaged" to AWACS, indicating he intended to attack the helicopters. He also told his wingman to "Arm hot" (arm the missiles in preparation for launch). The F-15 flight lead advised his wingman that he, the flight lead, would shoot the trailing helicopter and that the wingman was

to shoot the lead helicopter.<sup>288</sup> At approximately 0730Z, the flight lead turned to the southeast, locked his radar on to the trailing helicopter, and attempted a final Mode I interrogation of the helicopter's transponder and received no reply. When the flight lead had closed to approximately 4 NM behind the trailing helicopter, he fired an AIM-120, radar-guided missile.<sup>289</sup> Fragments from the missile's warhead hit the helicopter approximately 7 seconds later. The helicopter burst into flames and crashed.<sup>290</sup> Moments later, the F-15 wingman, having flown to a position approximately 2 NM behind the flight lead, locked-on to the remaining helicopter, selected an AIM-9 heat-seeking missile, and fired at a range of approximately 9,000 feet. The missile hit the helicopter and detonated. The helicopter burst into flames and crashed.<sup>291</sup>

Although the flight lead had briefed that the flight would turn on the aircraft VTR system at the "commit" point, he testified that he forgot to turn on his VTR system.<sup>292</sup> The wingman turned his VTR system on as he turned to engage the helicopters after the VID pass.<sup>293</sup>

The F-15 pilots flew two visual reconnaissance passes over the helicopter crash sites. One pass was flown from west to east, and one pass was flown from east to west.<sup>294</sup> The pilots could not identify anything other than burning debris.<sup>295</sup> The F-15 flight then climbed back to altitude and began searching the TAOR airspace for Iraqi aircraft. The F-15 flight refueled with a KC-135 tanker aircraft and resumed the tasked defensive counter air mission for approximately another 1.5 hours.<sup>296</sup> During this time, both the F-15 flight lead and the wingman had numerous radar contacts that they interrogated with their AAI systems. Both reported receiving Mode I and Mode IV responses from those contacts.<sup>297</sup> The F-15 pilots completed their mission and landed at Incirlik AB at 1000Z.<sup>298</sup>

#### **(4) UH-60 Black Hawk**

**UH-60 Flight Authorization:** On 13 April 1994, the Military Coordination Center Commander tasked the Black Hawk helicopter detachment at Diyarbakir AB to provide two UH-60 Black Hawk helicopters to fly a support mission in the TAOR on 14 April 1994.<sup>299</sup> This mission had been specifically authorized by the CTF CG, since the mission involved flight outside the security zone to the Kurdish cities of Irbil and Salah ad Din, Iraq.<sup>300</sup>

**UH-60 Flight Plans:** A flight plan for the flight of two UH-60 Black Hawk helicopters, (call signs Eagle 1 and Eagle 2) was completed using a joint, preprinted Turkish/US form. The flight plan was filed with Diyarbakir AB Base Operations Section. From Base Operations, the flight plan was sent to Diyarbakir AB Sector Operations (equivalent to US departure control). Sector Operations relayed the flight plan information to Turkish air defense radar installations.<sup>301</sup> The flight plan listed the published Low Level Transit Routes from Diyarbakir AB to Zakhu, Iraq, continuing on into the TAOR. Departure and return times at Zakhu and route of flight and destinations within the TAOR were not listed.<sup>302</sup> The return leg of the flight from Zakhu listed the Low Level Transit Route to Diyarbakir AB.<sup>303</sup> The flight plan was signed by the pilot in command and filed in accordance with Turkish regulations, flight information publications, and the OPC Airspace Control Order (ACO).<sup>304</sup>



**UH-60 Communications:** The Black Hawk helicopter crews reported no radio communications discrepancies to helicopter maintenance personnel, prior to takeoff from Diyarbakir AB.<sup>305</sup> All required radio transmissions to Eagle Operations, AWACS, and the MCC (Forward) were accomplished. No indications of any radio malfunctions were noted.<sup>306</sup> All helicopter radios received extensive damage from the crash and post-crash fires, precluding conclusive analysis of their operational status.<sup>307</sup>

NOTE: One Black Hawk helicopter was equipped with a "Have Quick I" (HQI), UHF radio; the other was equipped with a "Have Quick II" radio. The radios provide UHF air-to-air and air-to-ground radio communications capability. The "Have Quick" Mode provides anti-jam capabilities using a frequency hopping method which changes the frequency many times a second.<sup>308</sup> The F-15C's are equipped with an ARC-164 "Have Quick II" UHF radio, and the AWACS is equipped with an ARC-204 "Have Quick II" UHF radio.<sup>309</sup> The "Have Quick II" radios are an updated version of the "Have Quick I" radio. "Have Quick I" operation is not compatible with "Have Quick II" operation. "Have Quick II" radios can, with difficulty, be set up to communicate with "Have Quick I" radios. The Black Hawks therefore would be limited to flight operations on "Have Quick I," if they used it at all. There is no evidence that "Have Quick" was used by the unit, generally, or by this flight.<sup>310</sup>

There is no indication that communication equipment serviceability was related to the accident.

**UH-60 Navigation:** Interviews with other pilots and maintenance personnel from the Black Hawk unit revealed no known problems or discrepancies with the navigation equipment on board the two accident Black Hawk helicopters.<sup>311</sup> All navigation equipment received extensive damage from the crash and post-crash fires, precluding conclusive analysis of their operational status.<sup>312</sup> There is no evidence that navigation was a factor in the accident. There is no evidence that weather hampered navigation or was a factor in the accident.<sup>313</sup>

**UH-60 Black Hawk Briefing and Preflight.** On 13 April, the helicopter flight assistant operations officer confirmed the next day's mission with the operations officer at MCC (Forward) at Zaku.<sup>314</sup> The helicopter flight assistant operations officer prepared the mission schedule, requested the weather briefing, and called the CTF Joint Operations Intelligence Center (JOIC) at Incirlik AB, activating the ATO line numbers. (Activating the ATO line number identified what type of mission would be conducted and started a process to notify Turkish controllers for the portions of the flight to occur in Turkey.)<sup>315</sup> The noncommissioned officer in charge also assembled required mission documents and survival gear for the crew members.<sup>316</sup>

The helicopter aircrews, call signs Eagle 1 (flight lead) and Eagle 2 (wingman), completed their assigned duties at approximately 1430Z on 13 April and went to bed at approximately 1830Z.<sup>317</sup> On 14 April, the aircrews awoke at approximately 0215Z and departed their quarters at 0310Z, arriving at the Black Hawk helicopter flight operations building at 0315Z.<sup>318</sup> All crew rest requirements specified by Army regulations were met.<sup>319</sup>

On 14 April, the air mission commander (the Black Hawk flight lead) conducted the flight mission briefing using the preprinted mission briefing form from Army regulations.<sup>320</sup> All required briefing items were covered. The Eagle Flight Detachment Aircrew Mission Briefing form requires Identification Friend or Foe (IFF) to be briefed.<sup>321</sup> All published unencrypted IFF codes and radio frequencies were photocopied from the Air Tasking Order (ATO) and were provided to the Pilot in Command of each aircraft in accordance with the Black Hawk detachment procedures.<sup>322</sup> Encrypted IFF codes were loaded by operations personnel in the KYK 13 encoding device, which was then given to the helicopter crews to load each aircraft's IFF transponder.<sup>323</sup>

Helicopter pilots assigned to the Black Hawk unit were not aware that the ATO specified separate transponder Mode I codes for operating inside and outside of the TAOR. The unit had routinely flown in the TAOR using the Mode I code designated for use outside the TAOR. On previous missions, AWACS had not pointed out the incorrect Mode I code to the helicopter crews. There is nothing to indicate that the pilots who flew the 14 April mission were briefed on, or were aware of, the correct Mode I code specified for use in the TAOR.<sup>324</sup> AWACS interrogation of the accident helicopters' Mode I IFF codes showed that the helicopters' transponders were transmitting on Mode I, Code 42 (the code for operations outside the TAOR.)<sup>325</sup>

After the mission briefing, the helicopter aircrews began their mission planning. They received intelligence and weather briefings, and completed their flight plan. The pilots signed for and were issued the ATO, night vision goggles, survival radios, authentication tables, and weapons.<sup>326</sup>

The helicopter crews departed Pirinlik AB, Turkey at approximately 0335Z, arrived at Diyarbakir base operations at approximately 0400Z, and passed their flight plan to the Turkish Air Traffic Control Section.<sup>327</sup> The aircrews then departed Diyarbakir base operations and drove to the US flight line area.<sup>328</sup>

The helicopter crews conducted preflight checks of the Black Hawk helicopters. (Aircraft serial numbers 87-26000 and 87-26001). The helicopter detachment's standard practice was to conduct all aircraft preflight checks in accordance with the aircraft operator's manual, the aircraft checklist and Army regulations.<sup>329</sup> When the lead aircrew performed their aircraft run-up checks on aircraft 87-26001, they discovered an electrical problem which required an aircraft change.<sup>330</sup> The lead aircrew changed to aircraft 88-26060, and after a normal preflight and engine run-up, both Black Hawk helicopters departed as a flight of two at 0522Z for Zakhu, Iraq.<sup>331</sup> No maintenance discrepancies on the two accident aircraft were reported to maintenance personnel at Diyarbakir AB.<sup>332</sup> As they entered the TAOR, the helicopter flight contacted AWACS at 0621Z and landed at Zakhu shortly thereafter.<sup>333</sup>

NOTE: The initial plan for the next flight had been for the helicopters to fly to a village which was just within the security zone to wait until AWACS was on station, before proceeding outside the security zone.<sup>334</sup> The US co-commander had requested permission from the CTF CG for an early departure from Zakhu. The proposed departure time would

have meant that the helicopters would have flown outside the SZ before the AWACS was scheduled to be on station. The CTF CG had denied the request.<sup>335</sup> There is no indication that any of the MCC or helicopter personnel were aware of the ACO requirement for fighter aircraft to "sanitize" the TAOR before any OPC aircraft could enter the area.<sup>336</sup>

At 0536Z, the radio operator at MCC (Forward) received word that AWACS was flying and JTIDS was operational.<sup>337</sup> When the helicopters arrived at Zakhu, the air mission commander confirmed AWACS was airborne and operational.<sup>338</sup> The MCC (Forward) operations officer conducted a mission briefing for the helicopter aircrews, MCC co-commanders, and the accompanying staff officers. The briefing covered the passenger manifest, seating, and the route of flight from Zakhu to Irbil to Salah ad Din, and return to Zakhu.<sup>339</sup> Army procedures require an aircraft thru-flight inspection (check that the aircraft is functioning properly) be performed prior to each takeoff.<sup>340</sup> Although there is no evidence to indicate whether or not the required inspection was complied with on this flight, normal practice by the unit's helicopter pilots was to conduct a thorough thru-flight in accordance with the aircraft operator's checklist.<sup>341</sup> At 0650Z, following the briefing, the helicopters were loaded and prepared to depart from Zakhu.<sup>342</sup>

**UH-60 Sequence of Flight Events:** The Black Hawk helicopters departed Zakhu, and at 0654Z, the pilots contacted the AWACS enroute controller and reported that they had departed Zakhu and were enroute to Irbil, using code words for the locations.<sup>343</sup> They proceeded at low altitude to the southeast through a valley between mountainous ridge lines.<sup>344</sup> The Airspace Coordination Order requires helicopters to remain below 400 feet above ground level (AGL) to provide deconfliction from jet aircraft.<sup>345</sup> An April 1993 helicopter detachment memorandum for flight crews states that flights in the TAOR will be straight line from point to point.<sup>346</sup> However, helicopter routes of flight within the TAOR were selected to use the most favorable terrain to avoid Iraqi air defense locations.<sup>347</sup> The route from Zakhu to Irbil which avoided the Iraqi air defenses took the helicopters on a dogleg approximately 26 NM to the northeast of the straight line route.<sup>348</sup>

The helicopters' transponders were operational and transmitting Mode I, code 42 after departing Zakhu, inside the TAOR.<sup>349</sup> This was the Mode I code for operations outside the TAOR. Mode I, code 52 was specified in the ATO for all aircraft operating inside the TAOR.<sup>350</sup> Additionally, the lead helicopter's transponder transmitted Mode II, code 5530 and the wingman's transponder transmitted Mode II, code 5531, both as specified in the ATO.<sup>351</sup> A Mode III code was not required in the TAOR.<sup>352</sup> There is no evidence to indicate that AWACS attempted to interrogate either of the helicopters' Mode IV codes on this flight either.<sup>353</sup>

The Black Hawk helicopters were engaged by the F-15 flight at a location 71 NM southeast of Zakhu.<sup>354</sup> They were between 120 feet and 200 feet above the ground in a staggered left trail formation.<sup>355</sup>

At approximately 0730Z, the trail Black Hawk, (serial number 87-26000) was flying approximately 120 feet above the ground on a heading between 100 and 120 degrees, when it was hit in the left rear fuselage by warhead fragments from the AIM-120, radar-guided missile.<sup>356</sup>

Kurdish witnesses reported fire behind the rotor mast and on top of the aircraft (in the area of the auxiliary power unit) following warhead detonation. Fire was also reported inside the cabin area.<sup>357</sup> The Black Hawk began to break up in the air, with pieces of the aircraft landing approximately 1,320 feet short of the main impact point. The helicopter impacted on the valley floor. Impact was estimated to be at an angle of 8 degrees nose low at approximately 72 knots airspeed.<sup>358</sup> The aircraft was destroyed by fire after impact with the ground.<sup>359</sup>

The lead Black Hawk, (serial number 88-26060) continued flying up the valley on a heading of approximately 100 degrees at an undetermined airspeed and at a low altitude.<sup>360</sup> Just after the trailing Black Hawk crashed, the lead helicopter made a series of rapid left and right banking maneuvers, finally turning left and entering a narrow, steep valley running generally on a heading of 040 degrees.<sup>361</sup> The lead Black Hawk was struck by the heat-seeking AIM 9 missile.<sup>362</sup> Kurdish witnesses reported an explosion with a fireball after missile impact.<sup>363</sup> The Black Hawk began to break up in the air with pieces of wreckage landing 2,118 feet short of the main impact point. At least one main rotor blade and one tail rotor paddle landed 900 feet short of the main impact point.<sup>364</sup> At approximately 0730Z, the helicopter impacted on a 45 degree mountain slope. Impact was estimated to be at an angle of 56 degrees nose low at an undetermined airspeed.<sup>365</sup> The aircraft was destroyed by fire after impact with the ground.<sup>366</sup>

### **c. Search and Rescue:**

Each of the two cockpit doors on the Black Hawk helicopters was equipped with a jettison system for emergency release of the door assembly. The two windows on each helicopter cabin door (a total of four door windows per aircraft) were equipped with a jettison system.<sup>367</sup> Aircraft emergency equipment consisted of two hand-held fire extinguishers, one crash axe, and three first aid kits.<sup>368</sup> Black Hawk helicopters are not equipped with inflight emergency ejection/egress systems. No evidence was found to indicate that egress was attempted from either aircraft or that any emergency equipment was used.<sup>369</sup>

Each Black Hawk crew member had been issued and was wearing the approved flight uniform, combat boots, flight gear, and survival vest (SRU 21P) with standard issue survival gear.<sup>370</sup> The US military passengers were all wearing the standard battle dress uniform (BDU) and combat boots. Civilian passengers wore appropriate civilian clothing. The civilian Kurdish guards wore civilian clothing and flak vests.<sup>371</sup> Minor discrepancies in aircrew member aviation and life support equipment were noted, but were not related to the accident.<sup>372</sup> There is no indication that any survival equipment was used.<sup>373</sup>

At 0806Z, the JSOTF operations office at Incirlik AB received initial notification from CTF C2 of an accident allegedly involving Hind helicopters and that the location of the Black Hawk helicopter flight was unknown.<sup>374</sup> At 0915Z, the JSOTF directed their response force at the MCC (Forward), to prepare to dispatch a ground search and rescue (SAR) team.<sup>375</sup>

At 1015Z, Kurdish civilians notified MCC (Forward) that two US helicopters had been shot down and gave them the location of the crash sites.<sup>376</sup> At 1052Z, the CTF gave authorization to launch the SAR force from Incirlik AB.<sup>377</sup> The SAR team that was assembled included an

AWACS aircraft for command and control, fighters for air cover, MH-60G Pave Hawk helicopters to carry the SAR force, and HC-130 Hercules aircraft to provide inflight refueling for the helicopters.<sup>378</sup> The MH-60 helicopter crews prepared the aircraft for the mission while the Turkish liaison officers were notified and clearance from the Turkish authorities was obtained.<sup>379</sup> JSOTF SAR forces departed Incirlik AB in MH-60 Pave Hawk helicopters at approximately 1200Z, and the HC-130 departed Incirlik AB at 1302Z. The AWACS and supporting fighters were already airborne. At 1315Z, a team of Special Forces personnel and civilian interpreters departed MCC (Forward) at Zakhu, by ground transportation, enroute to the crash site.<sup>380</sup>

The Pave Hawk helicopters arrived at the two crash sites at approximately 1615Z.<sup>381</sup> At approximately 1650Z, the MCC (Forward) ground team arrived at the crash sites.<sup>382</sup> At 1715Z, the JSOTF on-scene commander reported to the CTF commander that the helicopter wreckage was from the two US Black Hawk helicopters. He confirmed that there were 26 casualties, and no survivors.<sup>383</sup> Recovery and transport of the remains began immediately and continued throughout the night.

A medical/mortuary affairs team from Incirlik AB set up operations at Diyarbakir AB to receive and prepare the remains for transport to Rhein Main AB, Germany. Several helicopter flights were required to transport the remains and SAR personnel, first to Zakhu and then on to Diyarbakir AB. The last helicopter flight landed at Diyarbakir AB at approximately 0330Z, 15 April 1994.<sup>384</sup> At 1831Z, on 15 April 1994, a C-141 carrying the remains departed Diyarbakir AB for Rhein Main AB.<sup>385</sup>

#### **d. Maintenance:**

##### **(1) E-3B AWACS.**

**Maintenance Documentation.** Aircraft maintenance records, airborne radar technician logs, sortie debrief reports, maintenance log books, and the equipment review report for aircraft 77-0351 were reviewed. There were no documented maintenance discrepancies which appeared to be related to the accident.

**Maintenance Personnel and Supervision.** The aircraft was serviced for flight in accordance with Air Force directives, and the appropriate documentation was accomplished.<sup>386</sup> Squadron maintenance personnel were experienced, and were trained in accordance with Air Force standards to maintain the aircraft and mission systems.<sup>387</sup>

**Engine, Fuel, Hydraulic, and Oil Inspection Analysis.** With the exception of minor engine discrepancies which were unrelated to the accident, all engine, flight control, and aircraft accessory systems functioned normally during the mission. Post-flight fuel, oil, and hydraulic samples and a post-flight engine inspection were not required.<sup>388</sup>

**Airframe and Aircraft Systems.** Aircraft airframe and systems, including hydraulic, electric, mechanical, avionics, and power plant, were reviewed. Two AWACS aircraft systems, the mission crew commander's console monitor and one Magnetic Tape Transport, had

discrepancies which were reviewed during the accident investigation. Additionally, the aircraft was equipped with a commercial VHS video camera to record video/audio from a specific scope display. The video camera recorded information related to the accident, and was the only device on board which had audio recording capability.

**Video Camera.** The onboard VHS video camera was installed to provide an additional record of any flight safety problems or significant events in flight.<sup>389</sup> It recorded the scope display from a spare monitor during the F-15C intercept of the Black Hawk helicopters. According to crew members' testimony, the tape was rewound so a crew member could view the intercept. It was turned back on, after it was rewound, to record Iraqi air activity south of the no-fly zone after the accident, and a portion of the tape was recorded over. Approximately four minutes were lost--from 0728Z to 0732Z.<sup>390</sup> Extensive reconstruction efforts on the audio segment did not recover any of the lost data. However, expert analysis of the portions of the tape that were not recorded over disclosed audio material not otherwise available.<sup>391</sup>

**Magnetic Tape Transports.** One of the three Magnetic Tape Transports (MTT) was inoperable. The unit is used to record mission data or load mission programs. With one Magnetic Tape Transport (MTT) inoperable, the onboard computer technician was required to manually rewind and reload the magnetic recording tapes. Although this caused three to five minute gaps in the recorded data, video recording capability during the F-15 intercept was not affected.<sup>392</sup>

**Mission Crew Commander Radar Scope.** The mission crew commander's radar scope experienced "ballooning" problems during the mission. Every five to ten minutes, displayed images would expand, then blank out for about 20 seconds. The inflight technician assessed the problem as not serious. A fully functional spare monitor was available; however, the mission crew commander did not deem it necessary to change monitors.<sup>393</sup>

## (2) F-15C.

**Maintenance Documentation.** Aircraft maintenance records, maintenance forms, sortie debrief reports, and the equipment review report for 84-0025 (lead's aircraft) and 79-0025 (wingman's aircraft) were reviewed.

**Serial number 84-0025.** The aircraft (84-0025) had no grounding discrepancies or overdue Time Compliance Technical Orders (TCTO), (aircraft/engine modifications) or engine inspections in the aircraft status, maintenance and inspection records. Additionally, the aircraft had no abnormal trends in either engine's oil analysis records. The aircraft's historical flight records indicated no recurring maintenance problems with engine, airframe, or avionics systems (except as noted below.) Aircraft maintenance records showed that the aircraft had experienced four Air-to-Air Interrogation (AAI) system discrepancies in the 90 days prior to the accident. All four discrepancies had been documented as corrected by maintenance personnel.<sup>394</sup> It cannot be determined if they were related to the accident.

**Serial number 79-0025.** The aircraft (79-0025) had no grounding discrepancies or overdue TCTOs (aircraft/engine modifications) or engine inspections in the aircraft status, maintenance and inspection records. Additionally, the aircraft had no abnormal trends in either engine's oil analysis records. The aircraft's historical flight records indicated no recurring maintenance problems with engine, airframe, or avionics systems. The aircraft had not experienced any AAI system discrepancies since 28 February 1994.<sup>395</sup>

**Maintenance Personnel and Supervision.** Both aircraft were serviced for flight on 13 April in accordance with applicable technical directives and the appropriate documentation was accomplished. On the morning of 14 April, a qualified squadron avionics technician loaded the Mode IV codes for 14 April (Mode IVA) and 15 April (Mode IVB) into both aircraft's IFF and AAI systems. Both accident aircraft's IFF systems were electronically checked prior to flight, by a second avionics technician using an IFF ground test set. Both aircraft passed this check confirming that valid Mode IV codes were loaded in each aircraft. The training records of the second avionics technician did not reflect that he had completed training on the use of the test set. He was subsequently tested and found qualified to perform the task.<sup>396</sup> Other squadron maintenance personnel records were not reviewed.

**Engine, Fuel, Hydraulic, and Oil Inspection Analysis.** All engine, flight control, and aircraft accessory systems functioned normally during the accident sortie.<sup>397</sup> Post-flight fuel and hydraulic samples and post-flight engine inspections were not required.

**Airframe and Aircraft Systems.** The status of aircraft airframe and aircraft systems, including hydraulic, electrical, mechanical, avionics and power plant, was reviewed. Aircraft canopy and windscreen condition and the AAI/IFF systems for both F-15C aircraft were identified as components/systems requiring detailed evaluation.

**Canopy and windscreen.** Both aircrafts' (79-0025 and 84-0025) canopies and windscreens were inspected and met all technical data requirements for optical clarity.<sup>398</sup>

**Serial number 84-0025.**

The aircraft's AAI system was reported to have been successfully checked against airborne targets by the accident pilot and by the pilots on the sorties immediately prior to and after the accident sortie.<sup>399</sup> The aircraft had experienced no AAI malfunctions between 1 December 1993 and 9 March 1994. Since 9 March 1994, the aircraft had experienced four problems with its AAI/interference blanking systems. One of these problems involved an AAI Built In Test (BIT) light illuminating in flight. On another flight, the AAI was inoperative in all modes. The two other problems involved the interference blanking system. In addition, there was one interference blanking system discrepancy on the sortie following the accident flight.<sup>400</sup>

NOTE: AAI/IFF System. When interrogated, the F-15 aircraft IFF system transmits a coded response to identify itself as a "friendly" aircraft. The F-15 aircraft AAI system transmits interrogation signals, evaluates coded IFF replies, and displays symbology in the cockpit to tell the pilot if the interrogated IFF signal

is from a friendly aircraft. The F-15 aircraft interference blanking system prevents interference between an aircraft's own internal systems that use radio frequency transmitters and receivers. For example, when an F-15 aircraft's AAI system interrogates a target, the interference blanker prevents that same interrogation from being received by the F-15's own IFF system. Without the interference blanker, the interrogating aircraft's own IFF system would reply. That reply would be picked up by the F-15's own AAI system and displayed as an erroneous target on the cockpit display. (See paragraph 2i of this report for a discussion of AAI/IFF anomalies, and Tab O4b for additional discussion of the interference blanker.)

The aircraft's AAI system was ground-tested on 21/22 April 1994 by an F-15 technical advisor using an AAI ground test set and the applicable F-15 technical data. The test indicated the aircraft's AAI system was capable of interrogating, receiving replies, evaluating, and displaying Mode I, II, III, and IV targets generated by the ground test set. However, the aircraft failed the Mode IV loop check, an internal self-test of the Mode IV system. In the loop test, the aircraft's interference blanking system is disabled, allowing the AAI transmitter to send a signal to the aircraft's own IFF transponder. The IFF transponder's reply to that interrogation is received by the AAI system's receiver. Failure of the loop test indicated that the continuity of the internal test circuit was not complete. The technical advisor suspected, but was unable to positively confirm, that the interference blanking system problems and the failure of the Mode IV loop check were related. Even though the AAI had been unable to interrogate the F-15's own IFF during the loop test, it had successfully interrogated the external AAI ground test set in the previously mentioned test. The wiring between the interference blanker, IFF system, and AAI system was tested for continuity with no defects noted.<sup>401</sup>

The IFF reply evaluator and AAI receiver/transmitter from the aircraft's AAI system were then sent to Warner Robins Air Logistics Center at Robins AFB, Georgia, for tear-down analysis. The interrogator computer was also sent to the Air Force Cryptologic Support Center, Kelly AFB, Texas, for tear-down analysis. The tear-down analysis revealed no discrepancies in any of the components that would have adversely affected system performance on the aircraft. The interference blanker and AAI cockpit control panel from aircraft 84-0025 were sent to Warner Robins Air Logistics Center at Robins AFB, Georgia, for tear-down analysis. The analysis revealed each component passed all test requirements.<sup>402</sup> The successful AAI interrogations by pilots on sorties before, during and after the accident, and the lack of deficiencies noted during the tear-down analysis indicate the AAI system was functioning normally. However, because the AAI failed the Mode IV loop check and had a history of AAI write ups, the possibility of intermittent failure of the AAI system could not be ruled out. A malfunction of the F-15 interference blanking system normally does not interfere with the receipt of another aircraft's IFF transponder reply.<sup>403</sup>

#### **Serial number 79-0025.**

The aircraft's AAI system was reported to have been successfully checked against airborne targets by the pilots on the sorties before, during, and after the accident sortie.<sup>404</sup> The aircraft had experienced two AAI malfunctions in the last 90 days. Both malfunctions (December 1993 and



January 1994) involved the Mode IV portion of the AAI system. There were no pilot-reported AAI discrepancies in the 45 days prior to the accident.<sup>405</sup>

The aircraft's AAI system was ground-tested on 21/22 April 1994 by an F-15 technical advisor, using an AAI ground test set and the applicable F-15 technical data. The aircraft passed all of the test, except the Mode IV portion. When the aircraft's AAI system interrogated the test set, it failed to display Mode IV returns in the cockpit, indicating it had not successfully received/evaluated the reply from the test set. The test set indicated it had received an interrogation from the aircraft and had sent a reply. The test set had been used on aircraft 84-0025 just prior to being used on aircraft 79-0025 and the Mode IV portion of the test had worked correctly. The test set also passed a built-in self-test prior to the test on aircraft 79-0025.<sup>406</sup>

The IFF reply evaluator and the AAI receiver/transmitter from the aircraft's AAI system were then sent to the Warner Robins Air Logistics Center at Robins AFB, Georgia, for tear-down analysis. The interrogator computer from the aircraft was sent to the Air Force Cryptologic Support Center, Kelly AFB, Texas, for tear-down analysis. The tear-down analysis revealed no discrepancies in any of the components that would have adversely affected system performance on the aircraft. The interference blanker and AAI cockpit control panel from 79-0025 were sent to the test facilities at Warner Robins Air Logistics Center at Robins AFB, Georgia, for tear-down analysis. Each of these components passed all test requirements.<sup>407</sup> The lack of a history of AAI write ups, the reported successful AAI interrogations by the pilots on the sorties before, during, and after the accident sortie, and the lack of deficiencies noted during the tear-down analysis indicate the AAI system was functioning normally. However, because the AAI failed the Mode IV portion of the ground test, the possibility of an intermittent failure of the AAI system in flight could not be ruled out.

### **(3) UH-60 Black Hawks.**

**Maintenance Documentation.** Historical aircraft maintenance records and forms for helicopters 88-26060 and 87-26000 were reviewed. Available documentation indicates that maintenance procedures and practices were in accordance with applicable directives. Daily maintenance forms carried on board the accident helicopters in accordance with Army directives, could not be reviewed. The documents were destroyed when the helicopters crashed and burned. There were no known, uncorrected maintenance discrepancies on either helicopter that appear to have been related to the accident.<sup>408</sup>

**Serial number 88-26060.** Historical maintenance records revealed that all aircraft modification work orders had been completed.<sup>409</sup> There were no abnormal trends in the oil analysis records. No oil samples were overdue.<sup>410</sup> The records showed that the aircraft had 17 non-grounding discrepancies that would have been carried forward in the aircraft forms that were destroyed in the crash.<sup>411</sup>

Aircraft maintenance records for 88-26060 showed that there were six IFF system (transponder and KIT 1C) discrepancies in the 210 days prior to the accident. These included a failed Mode IV check, two transponder self-test failures, an incorrect knob installation, an IFF

caution light illuminated in flight, and a Mode II button stuck. All writeups had been documented as repaired or checked and found to be functioning properly.<sup>412</sup> It cannot be determined whether these corrected discrepancies were related to the accident.

**Serial number 87-26000.** Historical maintenance records revealed that all modification work orders had been completed.<sup>413</sup> There were no abnormal trends in the oil analysis records. No oil samples were overdue.<sup>414</sup> The records showed that the aircraft had seven non-grounding discrepancies that would have been carried forward to the aircraft forms that were destroyed in the crash. None of these discrepancies appear to have been related to the accident.<sup>415</sup>

Aircraft maintenance records for 87-26000 showed that there was one IFF system (transponder and KIT 1C) discrepancy in the 210 days prior to the accident. The records indicated that the transponder would not hold the Mode IV code. The corrective action taken was to replace the KIT 1C battery.<sup>416</sup> It cannot be determined whether this corrected discrepancy was related to the accident.

**Maintenance Personnel and Supervision.** The aircraft were serviced for flight in accordance with Army directives. Preflight servicing of the aircraft was conducted by the accident flight crew chiefs.<sup>417</sup> Servicing records, including refueling, replenishing component fluid levels, and the completion of daily scheduled inspections for the 14 April 1994 flight, were carried in the logbooks. The logbooks were destroyed in the accident.<sup>418</sup> Training records revealed that the servicing personnel (crew chiefs) were experienced and qualified.<sup>419</sup> Contractor maintenance personnel were also experienced and qualified.<sup>420</sup>

The servicing personnel (crew chiefs) were responsible for loading (keying) the encrypted Mode IV code into the aircraft transponders.<sup>421</sup> The Army has no requirement to document the keying process. A representative of the US Army Aviation Electronic Combat Project Manager's Office evaluated all Black Hawk crew chiefs at Diyarbakir on 28 April 94 and determined that keying of Mode IV of the transponders was being accomplished in accordance with applicable technical manuals.<sup>422</sup>

**Engine, Fuel, Hydraulic, and Oil Inspection Analysis.** Available information indicates that the engine, fuel, hydraulic, and lubrication systems were functioning properly prior to the accident. Post-crash fuel, hydraulic fluid, and oil samples were not taken from either Black Hawk helicopter due to the extensive destruction of the components caused by impact forces and post-crash fires.<sup>423</sup>

**Airframe and Aircraft Systems.** Records and recovered components from the helicopter wreckage were examined. The IFF transponders were the only Black Hawk systems recovered from the crash sites whose operation may have been related to the accident. Tear-down analysis was conducted on the two IFF transponders and one cryptographic computer (KIT 1C).<sup>424</sup>

**Serial number 88-26060.** The AN/APX-100 (Transponder) was recovered and shipped to the Naval Air Warfare Center, Indianapolis, Indiana, for tear-down analysis.<sup>425</sup> Tear-down

analysis indicated that, due to the damage to the AN/APX-100 (transponder), it was not possible to ascertain the operational condition of the unit, or if the Mode IV control switch was activated (on) at the time of the accident.<sup>426</sup> The KIT 1C was recovered and sent to the Air Force Cryptologic Support Center, Kelly AFB, Texas, for tear-down analysis.<sup>427</sup> Tear-down analysis of the KIT 1C indicated that, due to extensive damage to the component, no determination could be made about the condition of the component prior to the accident, or whether or not the unit was turned on at the time of the accident.<sup>428</sup>

**Serial number 87-26000.** The AN/APX-100 (Transponder) was recovered and sent to the Naval Air Warfare Center, Indianapolis, Indiana, for tear-down analysis.<sup>429</sup> Tear-down analysis showed that transponder power was on at the time of the accident.<sup>430</sup> The KIT 1C of this aircraft was not recovered. Observations made during the tear down analysis which relate to possible transponder switch positions and the operational status of the Mode IV function are discussed below.

**e. Summary of AAI and IFF Anomalies.**

The following areas have been identified as possible reasons for the lack of Mode IV IFF indications received by the F-15s during the intercept.

**Terrain masking.** The signals between aircraft AAI systems and transponders require line-of-sight in order to be effectively received.<sup>431</sup> The intercept's parameters raise the possibility that terrain masking may have intermittently interrupted the signals, preventing a valid Mode IV identification.<sup>432</sup>

**Signal interference by proximity.** The F-15C manufacturer, McDonnell Douglas Aircraft Corporation, and the Department of Defense's IFF Program Office indicate the theoretical possibility that an F-15 aircraft, electronically interrogating two other aircraft flying in close proximity to each other, could experience difficulty receiving the IFF reply from those aircraft. The close proximity of two aircraft could result in a situation where neither aircraft's transponder signal would be received by an AAI system.<sup>433</sup> On the other hand, an independent input by the Naval Air Warfare Center, Aircraft Division at Indianapolis, Indiana, indicated that the AAI interrogator should have seen, as a minimum, one valid Mode IV response.<sup>434</sup>

Computer simulation testing by the Theater Air Command and Control Simulation Facility (TACCSF) at Kirtland Air Force Base, New Mexico, revealed that, using certain interrogation modes, the F-15 AAI system would not consistently get successful interrogations of two UH-60s flying in close proximity.<sup>435</sup> Subsequent flight tests at Nellis AFB, Nevada, using F-15Cs and MH-60 helicopters indicated a very high success rate in interrogations of two helicopters flying in close proximity. Interrogation failures observed during the flight test were attributed to terrain masking and a lack of the required radar contacts during some interrogations.<sup>436</sup>

**Insufficient AAI interrogation time.** TACCSF simulator results indicated that the probability of an IFF response being received by the F-15 AAI system was "largely determined by the amount of time the 'coolie switch' was held in position during any particular interrogation

request." (The "coolie switch" is a multi-function switch which includes the AAI function.) The TACCSF report also stated, "It was often necessary to hold the coolie switch in the interrogate position for several seconds to obtain a response while in 'Track-While-Scan' or 'Search' modes". The probability of a positive IFF response is dependent on the number of times the transponder is "swept" by the interrogator. Depending on the radar antenna scan pattern, several sweeps of the radar (several seconds of sweep time) may be required to get a successful response.<sup>437</sup>

**Interrogator and Receiver Side Lobe Suppression (ISLS and RSLs).** The interrogator and receiver side lobe suppression systems are designed to reduce the interrogating pilot's screen "clutter" caused by multiple, excessive replies to an interrogation. Indications are that it is possible that the relative angles of intercept between the F-15Cs and the Black Hawk helicopters could have produced a condition where either of these suppression functions may have prevented a transponder reply by the helicopters.<sup>438</sup>

**Effect of helicopter low level flight profile on the correlation between the F-15 Fire Control Computer and AAI interrogator.** The F-15's fire control radar (FCR) uses a target's "doppler shift" to track the target and direct the interrogator. The FCR computer may have difficulty tracking a low altitude, slow moving target. Without a reliable radar lock, the F-15's interrogator might not present a response to the pilot, even though a valid reply was transmitted by the transponder.<sup>439</sup>

**Possible Black Hawk Crew Actions.** Potential problems could arise as a result of mistakes during the Mode IV keying process. They include issue/receipt of an incorrect Mode IV code, equipment malfunctions, and errors by personnel conducting the loading process. However, the available evidence indicates that the keying of 88-26060 and 87-26000 on 14 April 1994 was done with the correct code for the day and that the loading procedures were accomplished in accordance with applicable directives and technical manuals.<sup>440</sup> The detachments KYK 13s were determined to be fully operational by Tobyhanna Army Depot.<sup>441</sup>

Improper helicopter engine shut-down procedures could result in the loss of the Mode IV code from the transponder's memory. The board could not determine whether this occurred following the shut down of the Black Hawks at Zakhu on 14 April 1994.<sup>442</sup>

It is possible that the Mode IV switches were turned off during flight; however, there is no evidence indicating that the Black Hawk pilots deliberately turned off the Mode IV switch on both helicopters while in flight.<sup>443</sup>

The accident board was unable to determine from the information available why the F-15 AAI's did not receive a Mode IV response from the Black Hawk helicopters' transponders.

#### **f. Crew Qualifications:**

**(1) AWACS Crew Qualifications.** The Individual Training Records and Flight Evaluation Folders (FEF) for each member of the AWACS crew were reviewed. Except for the mission crew commander, all of the AWACS crew members were qualified and mission ready.<sup>444</sup>

Except for the instructor computer display maintenance technician, all crew members were current in OPC theater certification.<sup>445</sup> Upon arrival at Incirlik AB each crew member received additional theater-specialized training for OPC and a local orientation briefing.<sup>446</sup> Several members had participated in previous deployments to OPC.<sup>447</sup>

**Mission Crew Commander.** The accident mission crew commander, who had a total of 518 total hours of flying time, completed initial qualification training (IQT) on 3 February 1993 with a "Qualified" rating.<sup>448</sup> No evaluation discrepancies were noted and no additional training was recommended.<sup>449</sup> He completed mission qualification training (MQT) within the prescribed time and was certified as mission ready (MR) in March 1993.<sup>450</sup> To maintain MR status, the mission crew commander was required to fly at least one sortie per month, or at least three sorties within the previous three month period.<sup>451</sup> On 22 December 1993, he was placed in a "duty-not-involving-flying" (DNIF) status. Subsequently, the mission crew commander underwent a hearing evaluation that required a waiver prior to his return to flying status. The waiver was effective beginning 14 February 1994.<sup>452</sup> Because he had not flown since 22 December 1993, his MR status was downgraded to basic qualified (BQ) supervised status.<sup>453</sup> In BQ status, the mission crew commander was ineligible to fly without the supervision of an instructor, and was not certified to perform those duties required in contingency or wartime operations.<sup>454</sup> He flew an instructor supervised sortie on 23 February 1994, and was returned to MR status.<sup>455</sup> The mission crew commander was again placed in DNIF status on 29 March 1994, but was returned to flying status on 8 April 1994.<sup>456</sup> However, because he flew no sorties in March and had flown only one sortie in the first three months of 1994, he did not meet the minimum sortie requirements for being MR. The mission crew commander had flown only the one 8.3 hour sortie in the last 90 days.<sup>457</sup> He was incorrectly left in MR status, and was deployed to OPC on 9 April 1994.<sup>458</sup> Since he was incorrectly designated MR on the flight authorization orders for 14 April 94, he was not placed under the supervision of an instructor.<sup>459</sup> An instructor mission crew commander (the AWACS staff mission crew commander) flew on the 14 April 94 mission, but was not designated for, and did not perform, instructor duties on 14 April 1994.<sup>460</sup> The AWACS accident mission crew commander, who had flown only one sortie in the previous three months, was not currently qualified on 14 April 1994, in accordance with Air Force regulations.

**Senior Director.** The accident senior director (SD), who had 2383.7 total hours of flying time, completed weapons director (WD) initial qualification training on 5 July 1989, with a "Qualified" rating.<sup>461</sup> In October 1990, he was rated "Unsatisfactory" on the simulator portion of his first checkride with discrepancies noted for not properly positioning aircraft under his control. After additional training, he successfully completed the checkride on 6 November 1990.<sup>462</sup> In January 1992, he received another "Unsatisfactory" on a simulator checkride, again for poor aircraft positioning. After additional training, the checkride was successfully reaccomplished.<sup>463</sup> The senior director completed the Senior Director Upgrade Training course on 6 October 1992, receiving a "Qualified" rating. Additional training was recommended to improve his ability to prioritize mission radios during periods of heavy radio use.<sup>464</sup> During his senior director upgrade training, he had one "Unsatisfactory" mission on 12 August 1992 (Student Non-Progress [SNP] report for safety) in the flying training phase. The SNP for safety was because he had fallen asleep while the WDs under his supervision were controlling fighters.<sup>465</sup> Normal progress and instructor comments were evident on the remainder of his senior director upgrade training

missions. The senior director's mission qualification training simulator record noted several areas for improvement, including the need to be more familiar with the skill levels of the WDs under his supervision, the need to insure that both he and the WDs he supervised understood the ROE, and the need to insure WDs under his supervision totally understood their various responsibilities.<sup>466</sup> Mission Qualification training comments during the flying training phase were positive and indicated no problems.<sup>467</sup> A review of the Deployment Training Feedback form for a previous deployment to Saudi Arabia (November through December 1992), indicated that he demonstrated strong leadership and aggressive attributes during the deployment.<sup>468</sup> On 15 April 93, the SD successfully completed his mission qualification evaluation with one discrepancy and no additional training recommended.<sup>469</sup> A review of the flight training data for the SD indicated that he had completed all flying, ground, and simulator requirements. His flight training sortie accomplishments as an SD were well above Air Force requirements. The accident SD was current and mission ready to perform his assigned duties on 14 April 1994.<sup>470</sup>

**Enroute Controller.** The accident enroute controller, who had 1109 total hours of flying time, received an "Unsatisfactory" rating on his first simulator check ride on 21 February 1992. The "Unsatisfactory" rating was for safety, and additional training was recommended prior to his simulator re-evaluation.<sup>471</sup> He completed WD initial qualification training on 14 April 1992 with a "Qualified" rating.<sup>472</sup> However, once the enroute controller began MQT, he required additional sorties to complete training objectives. His MQT was extended an additional 30 days to accomplish the required training.<sup>473</sup> Prior to 18 March 1993, the enroute controller's status was downgraded from MR to BQ when he did not fly an effective weapons sortie for more than 60 days. On 18 March 1993, he was returned to MR status after flying a sortie under an instructor's supervision.<sup>474</sup> On 14 June 1993, the enroute controller failed his annual simulator evaluation with "Unsatisfactory" ratings for safety and airspace coordination. As a result, he was downgraded to an "Unqualified" (UQ) status. His squadron operations officer stated that the UQ evaluation was "...as much a reflection of the high out of CONUS TDY load/lack of home station flying training for our WDs, as it is an indication of (his) failure to prepare himself for this evaluation."<sup>475</sup> Eight additional simulator training sessions were conducted prior to his re-evaluation.<sup>476</sup> The re-evaluation was conducted on 13 August 1993 with an overall "Qualified" rating, although an "Unsatisfactory" grade was given for improper aircraft positioning.<sup>477</sup> Deployment Training Feedback forms were reviewed for a November-December 1992 OPC deployment and a March 1993 GREEN FLAG training exercise. Both indicated that the enroute controller performed well and was motivated and hard working.<sup>478</sup> A review of flight training data indicated that he had completed all of his semi-annual aircraft control requirements. The enroute controller was current and mission ready to perform his assigned duties on 14 April 1994.<sup>479</sup>

**TAOR Controller.** The accident TAOR controller, who had 161.5 total hours of flying time, completed WD initial qualification training on 5 January 1994 with a "Qualified" rating. No additional training was recommended.<sup>480</sup> His training summary report indicates that he displayed "impeccable officership" and "professional qualities" through all phases of training, but that he needed time and practice to develop more self-confidence.<sup>481</sup> His initial qualification training Individual Mission Grade Sheets indicated no problems in training. The TAOR controller completed MQT within syllabus guidelines, and instructor comments on the MQT Individual

Mission Grade Sheets were positive. They indicated that he controlled his missions well, demonstrated knowledge of the ROE, and showed good situational awareness. However, one instructor commented that he needed to "...know his limits and communicate to SD/WDs when he needs help."<sup>482</sup> A review of flight training data indicated that the TAOR controller had met all applicable training requirements. The accident TAOR controller was current and mission ready to perform his assigned duties on 14 April 1994.<sup>483</sup>

**Instructor Computer Display Maintenance Technician.** The instructor computer display maintenance technician's (ICDMT) flight training data indicated that his theater certification for the OPC area of responsibility had expired on 11 December 1993.<sup>484</sup> Theater training is required prior to aircrew members assuming duties within the OPC theater.<sup>485</sup> A review of the ICDMT's flight evaluation folder and individual training records indicated no other discrepancies. The instructor computer display maintenance technician, who had 3515 total hours of flying time, was current and mission ready in his crew position.<sup>486</sup> However, due to his expired theater certification, he was not currently qualified to perform duties in OPC on 14 April 1994.<sup>487</sup>

**Staff Mission Crew Commander.** The detachment staff mission crew commander who was on board the accident AWACS had 2527.7 total flying hours. He completed initial mission crew commander qualification training on 10 February 1993 with a "Qualified" rating. No discrepancies were noted.<sup>488</sup> His upgrade training to instructor mission crew commander was completed with a "Qualified" rating on 15 March 1994. No discrepancies were noted. The end-of-course summary report for his instructor mission crew commander course indicated that he excelled during the flying phase and was an effective leader and instructor.<sup>489</sup> On 14 April 1994, the staff mission crew commander was tasked to fly with the AWACS accident mission crew commander to provide assistance if required.<sup>490</sup> The staff mission crew commander logged primary flight time (not instructor time) on the AF Form 781, and the flight orders indicate he was not flying as an instructor.<sup>491</sup> He logged an instructor sortie on the AF Form 3526 Event Accomplishment Report.<sup>492</sup> The staff mission crew commander on board the accident AWACS aircraft was current and mission ready on 14 April 1994.<sup>493</sup>

**Qualification and Training Course Materials.** A review of the mission crew training process was conducted by the AWACS technical advisor. Initial upgrade and mission qualification training syllabi and course materials addressed those tasks required to attain mission ready qualification in the AWACS.<sup>494</sup> Continuation training materials and requirements were designed to maintain or improve capabilities needed to perform AWACS roles and missions.<sup>495</sup> Pre-deployment training materials covered the OPC theater of operations and AWACS responsibilities.<sup>496</sup> However, theater certification material was based on USCENTCOM Southwest Asia plans rather than OPC plans.<sup>497</sup> The OPC simulator training materials stressed the importance of AWACS support to MCC helicopter operations.<sup>498</sup> In-theater briefing materials did not address AWACS support to MCC helicopter operations.<sup>499</sup> The AWACS in-theater weapons training book contained conflicting, unit-generated ROE guidance.<sup>500</sup>

## **(2) F-15C Crew Qualifications.**

**F-15C Flight Lead.** The flight lead, who had 1561.9 total hours of flying time (656.1 hours in the F-15) completed initial qualification training in the F-15, on 28 January 1991, with a "Qualified" rating. No discrepancies were noted.<sup>501</sup> He completed mission qualification training on 12 July 1991 with a "Qualified" rating. No major discrepancies were noted.<sup>502</sup> The F-15 flight lead was qualified as a two-ship flight lead on 30 November 1992.<sup>503</sup> He was qualified as a four-ship flight lead on 22 October 1993.<sup>504</sup> A review of his training records revealed no problem areas. The F-15 flight lead completed his low altitude training requirements and was certified to fly operational missions as a flight lead as low as 500 ft AGL, on 19 April 1993.<sup>505</sup> During the time he was qualified as an F-15 pilot (3 years and 3 months), he had flown a total of two air-to-air training sorties below 1,000 ft AGL.<sup>506</sup> The F-15 flight lead had flown 26 sorties and 77.7 hours in the 90 days through 14 April 1994.<sup>507</sup> He was current and mission ready to perform his assigned duties on 14 April 1994.<sup>508</sup>

**F-15C Wingman.** The wingman, who had 3009.6 total hours of flying time (1126.3 hours in the F-15), completed initial qualification training in the F-15 on 21 November 1983 with a "Qualified" rating. No discrepancies were noted.<sup>509</sup> By 12 February 1985, he was mission ready, and two-ship flight lead, four-ship flight lead, and instructor pilot qualified.<sup>510</sup> After four years of non-flying duties, he completed initial requalification training in the F-15 on 11 June 1990, with a "Qualified" rating. No discrepancies were noted.<sup>511</sup> By 22 March 1991, the wingman had completed mission requalification training, two-ship flight lead and four-ship requalification training, low altitude step down training, and instructor pilot requalification training.<sup>512</sup> The wingman was again assigned to non-flying duties from 24 June 1992 until 1 June 1993.<sup>513</sup> He completed requalification training in the F-15 on 2 August 1993 with a "Qualified" rating. No discrepancies were noted.<sup>514</sup> The wingman requalified as a two-ship flight lead on 14 January 1994.<sup>515</sup> He requalified as a four-ship flight lead on 8 February 1994.<sup>516</sup> He completed instructor pilot requalification training on 10 March 1994.<sup>517</sup> Based on the wingman's previous low altitude qualification, the wingman's previous squadron commander had certified the wingman to fly operational missions as low as 500 feet AGL.<sup>518</sup> Because he had not flown a low-altitude sortie since 18 November 1993, he was currently qualified to perform missions down to 1000 feet AGL.<sup>519</sup> He had flown 18 sorties and 34.5 hours in the 90 days through 14 April 1994.<sup>520</sup> The F-15C wingman was current and mission-ready to perform his assigned duties on 14 April 1994.<sup>521</sup>

**F-15C Visual Recognition Training.** The Air Force threat recognition training program "...stresses crew members' ability to identify...operational air, naval, ground, missile and electronic equipment of any nation which could threaten US and allied forces. Aircrews must be able to identify both friendly and enemy equipment..."<sup>522</sup> USAFE regulations give responsibility for establishing an intelligence program, to include visual recognition training, to wing commanders.<sup>523</sup> The parent fighter wing of the accident pilots further delegated that responsibility to each fighter squadron commander.<sup>524</sup>

The accident pilots' fighter squadron last conducted formal, visual recognition training in December 1993.<sup>525</sup> The training in 1993 included viewing 35 mm slides of friendly and enemy



helicopters.<sup>526</sup> The accident pilots stated that the majority of the helicopter slides used in their training were from ground level looking up, and showed either the front or side of the helicopter.<sup>527</sup> Differences between friendly and hostile helicopter camouflage and color schemes were not discussed during the squadron's training.<sup>528</sup> The accident pilots may not have been aware that Iraqi Hind helicopters had a different color scheme (light tan and brown camouflage) from that of the US Black Hawk helicopters (dark green and black camouflage).<sup>529</sup> The lead pilot stated he had never seen a Black Hawk helicopter with the wings and auxilliary tanks attached.<sup>530</sup> The wingman stated that he had never seen a photo of a Black Hawk with the wings and auxillary tanks attached.<sup>531</sup> One of the squadron's visual training slides at home station depicts a Black Hawk helicopter with the wings and auxillary tanks attached.<sup>532</sup> It could not be determined if either of the accident pilots had ever viewed that slide.

**(3) UH-60 Black Hawk Crew Qualifications.** The individual training records and flight evaluation folders for each of the accident Black Hawk helicopters crew members were reviewed. All Black Hawk helicopter crew members were qualified, current, and mission ready. Each crew member had completed all training appropriate for the mission prior to deployment to Turkey and had received theater specific training upon arrival at Diyarbikir AB. There were no training deficiencies noted.<sup>533</sup>

**g. Medical:**

**(1) AWACS.** A review of all the medical and dental records of the accident crew members was accomplished. No disqualifying conditions were documented in any of the medical or dental records. All personnel had current flying class physicals and were medically qualified for flying duties at the time of the accident. Their flying experience is summarized at Tab T1a.<sup>534</sup>

Complete physical examinations were performed on all crew members, including full eye and hearing tests.<sup>535</sup> Full dental exams were not performed since no crew member reported any dental problems and no dental abnormalities were detected. There were no defects noted that were related to the accident.<sup>536</sup>

Body fluids from the staff mission crew commander and the TAOR controller for blood alcohol and urine toxicologic screenings were taken on 14 April 1994. All tests were negative. When the accident board learned that screenings had not been accomplished on all AWACS crew members,<sup>537</sup> all required screenings were directed and conducted. All additional screenings were accomplished on 17 April 1994.<sup>538</sup> The body fluid tests disclosed nothing which appeared related to the circumstances of the accident.<sup>539</sup> There were no illegal drugs detected. No crew member had a carbon monoxide level above normal limits. Complete blood counts and blood glucose levels were within normal limits for all crew members.<sup>540</sup>

Complete psychosocial interviews, including 72-hour and 14-day histories, were conducted with each crew member except the mission crew commander, the enroute controller, the TAOR controller, and the ACE on board the AWACS. These individuals declined the interviews on the advice of defense counsel. The ACE, through counsel, provided a limited 24-hour history which revealed adequate crew rest and poor nutrition. Associates were interviewed regarding the

72-hour and psychosocial backgrounds on the mission crew commander, the enroute controller, the ACE, and the TAOR controller. All crew rest requirements were reportedly met.<sup>541</sup>

**(2) F-15C:** A review of all the medical and dental records of the accident pilots was accomplished. No disqualifying conditions were documented in any of the medical or dental records. The records indicated that both pilots had current flying physicals and were medically qualified for flying duties.<sup>542</sup>

Complete physical examinations were performed on both F-15C pilots, including full eye and hearing tests. Full dental exams were not performed, since neither F-15C pilot reported any dental problems and no dental abnormalities were detected. Both pilots were given full optometric examinations.<sup>543</sup> The wingman had previously been fully qualified for flying duties. However, he had a condition that resulted in a slowly progressive eyelid droop. The wingman was evaluated by an ophthalmologist on 7 April 1993, and was given the option of corrective surgery, which he declined. At that time, the condition was not severe enough to medically disqualify the pilot from flying duties. The wingman's flight physical on 17 May 1993 noted "mild eyelid ptosis (droop) bilaterally (both eyes)." His most recent routine flight physical, performed on 14 February 1994, made no comment regarding the eyelid droop, and noted that he had 20/20 visual acuity in both eyes, near and far, without correction. A full optometric examination on 24 April 1994 found the wingman to have minimal upper/outer visual field loss in his right eye due to the eyelid droop. All other tests of his eyes and vision were normal. He was evaluated by an ophthalmologist on 5 May 1994 who confirmed the visual field loss, characterizing it as "visually significant right brow (eyelid) ptosis." This visual field loss, which on 5 May 1994 exceeded Air Force standards, did not affect his central vision which is the source of sharp visual acuity. Central vision with its sharp acuity is the type of vision normally used to attempt specific recognition of an object such as an aircraft. However it could have affected his peripheral vision on the upper right side at the time of the accident.<sup>544</sup>

Body fluids from both F-15C pilots, for blood alcohol and urine toxicologic screenings, were taken on 14 April 1994. All tests were negative. Neither pilot had a carbon monoxide level above normal limits. Complete blood counts and blood glucose levels were within normal limits for both pilots.<sup>545</sup>

Complete psychosocial interviews, including 72-hour and 14-day histories, were conducted with both the F-15C pilots. All crew rest requirements were met.<sup>546</sup>

**(3) UH-60 Black Hawk:** A review of all the medical and dental records of the accident Black Hawk crew members was accomplished. No disqualifying conditions were documented in any of the medical or dental records. All personnel had current flying class physicals and were qualified for flying duties at the time of the accident.<sup>547</sup>

Complete autopsies including microscopic and toxicological evaluations were performed on all casualties. There were no pre-existing medical abnormalities found in the helicopter crew members. Several passengers had minor pre-existing medical abnormalities at the time of death.

Toxicological screens and blood alcohol levels were negative for all casualties. The cause of death for all casualties was multiple blunt force injuries.<sup>548</sup>

Associates were interviewed regarding the 72-hour and psychosocial backgrounds on the eight helicopter crew members. All crew rest requirements were reportedly met.<sup>549</sup>

**Medical Summary:** A review of medical records, physical examination results, toxicological reports, autopsy findings and interviews, disclosed no pre-existent mental or physical defects, other than those noted above, that were relevant to this accident.<sup>550</sup>

#### **h. Human Factors:**

##### **(1) E-3B AWACS.**

**Crew-Mindset.** Some of the accident crew members indicated they were not responsible for controlling Black Hawk helicopters.<sup>551</sup> This perception was compounded by the seemingly separate nature of the Black Hawk operations.<sup>552</sup> Additionally, there was confusion within the crew regarding who was responsible for tracking helicopters in the TAOR.<sup>553</sup> The crew members also indicated they lacked adequate control authority over fighter aircraft.<sup>554</sup> On 14 April 94, the Black Hawk helicopters entered the TAOR prior to the fighters. The AWACS crew members did not acknowledge responsibility for tracking or predicting the Black Hawks' flight path enroute to their announced destination when the Black Hawk flight faded from the AWACS radar scope. They assumed that the helicopter track had faded from radar because the helicopters had landed at an intermediate stop. AWACS crew members did not try to validate this assumption.<sup>555</sup>

**Crew-Circadian Rhythm.** Low grade circadian rhythm desynchrony (commonly referred to as "jet lag") was present in all crew members except the staff mission crew commander, staff weapons director, air surveillance officer, computer technician and the ACE. With the exception of the individuals noted, the crew departed Oklahoma City, Oklahoma, on 10 April at 1300Z, and arrived at Incirlik AB on 11 April at 1100Z. The crew members appeared to adjust fairly rapidly to the time changes, considering they had traveled eastbound through 8 time zones in 24 hours. No crew member complained of fatigue on the morning of 14 April. The International Civil Aviation Organization formula for recommended rest time indicates a need for 1.8 days of rest before performing flight duties after such a trip.<sup>556</sup> The accident crew flew their first mission on this rotation at Operation PROVIDE COMFORT on day four in country; this was standard for AWACS crews operating in the OPC theater.<sup>557</sup> The accident crew reported no ill effects from circadian rhythm desynchrony, and had the required crew rest to fly this mission.<sup>558</sup>

##### **(2) F-15C.**

**Pilots-Mindset.** Based on the Airspace Control Order requirement for a fighter sweep to "sanitize" the area before other OPC aircraft could enter the TAOR, and the Air Tasking Order (ATO) of 14 April 1994 which did not show any OPC aircraft scheduled into the TAOR before the first F-15C flight, the accident pilots believed there would be no friendly aircraft in the area.<sup>559</sup> This mindset was reinforced when the F-15C pilots acquired the Black Hawk helicopters on radar,

but received no valid friendly indications by electronic interrogation.<sup>560</sup> This mindset was further reinforced when AWACS transmitted to the F-15C flight "Clean there," meaning AWACS had no contacts at the reported location.<sup>561</sup> The F-15C pilots may have begun the visual intercept with a mindset that the unknown aircraft were probably not "friendly."<sup>562</sup>

**Aircraft Visual Identification.** Both pilots had received only limited visual recognition training in the previous four months.<sup>563</sup> The process of identifying the two "unknown" helicopters was complicated by the presence of wings (sponsons) and external fuel tanks, giving an appearance, from the high aft quadrant, similar to a Hind helicopter with sponsons and weapons.<sup>564</sup> There were US flags painted on the bottom of the fuselage, the external fuel tanks and the side doors of the Black Hawk helicopters.<sup>565</sup> However, calculations based on the size of the flags relative to the reported slant range distances between the fighters and the helicopters indicate that the flags were most likely indiscernible.<sup>566</sup> At the slant ranges reported, the flags would have appeared as bright spots.<sup>567</sup> However, the surrounding terrain was dotted with light gray rocks which could have minimized this feature.<sup>568</sup> The F-15C flight lead wore an authorized high contrast yellow visor.<sup>569</sup> This visor blocks out blue colors, functionally reducing the visible portions of the flag against a dark green/black background.<sup>570</sup> The relatively low contrast between the dark green/black camouflaged Black Hawks and the green terrain, compounded visual recognition problems, making identification more difficult.<sup>571</sup>

In the accident sequence, available visual recognition time was most likely divided between the attempted identification of the helicopters, terrain avoidance, and flying the aircraft.<sup>572</sup> The over-take time between the accident F-15Cs and the Black Hawk helicopters limited the time during which the F-15s would have been close enough to make an accurate visual identification. Finally, the F-15C pilots had limited low altitude experience, which may have increased the stress of operating in a low altitude environment.<sup>573</sup>

### **(3) UH-60 Black Hawk.**

**Crew-Mindset.** Although no Black Hawk crew members survived the accident, testimony from other Black Hawk pilots from their unit indicated that they did not believe that AWACS coverage or a fighter sweep was required before helicopters could fly within the security zone of the TAOR. However, they stated that AWACS coverage was required for flights outside the security zone.<sup>574</sup> The Black Hawk unit pilots also testified that they usually had limited communication with AWACS in the TAOR, due to the mountainous terrain.<sup>575</sup> Finally, one of the helicopter pilots testified that he assumed that if the AWACS crew wanted him to leave the enroute frequency, they would tell him.<sup>576</sup>

**i. Nav aids and Facilities.** There were no Notices to Airmen (NOTAMS) that affected the accident missions. All navigational aids and facilities required to perform the mission were fully operational.<sup>577</sup>

**j. Weather.** The forecast weather in the TAOR on 14 April 1994 was for clear skies with unlimited visibility. The forecast winds were variable at 5 knots and the altimeter setting was 29.75 inches of mercury. No hazards to flight (turbulence, icing, hail, etc.) were forecast. The

maximum forecast temperature in the TAOR was 26 degrees Celsius. The forecast sunrise was 0236Z, and sunset was forecast for 1540Z.<sup>578</sup>

The Surface Weather Observation at Zakhu at 0345Z reported the skies were clear and the visibility was unlimited. The winds were from 090 degrees at 5 knots. The temperature was 20 degrees Celsius.<sup>579</sup>

At approximately 0715Z, the F-15 flight lead reported to the ACE on board the AWACS that the weather in the TAOR was "clear" and the contrail level was 31,000 to 35,000 feet.<sup>580</sup> Weather was not related to the accident.

**k. News media:** There was extensive media coverage of the initial events surrounding the accident. Press releases were managed by USEUCOM/PA and OATSD/PA.<sup>581</sup>

**l. Directives and Publications.** The following directives and publications were relevant to the accident:

**(1) Command and Control Directives and Publications.**

(a) USEUCOM Directive (ED) 55-47, 22 May 1989, Appendix A, Peacetime ROE, (SECRET)

(b) USCINCEUR 062043Z Apr 91. OPOD Ser 001, Humanitarian Relief Operations (SECRET)

(c) USCINCEUR 162230Z Apr 91. OPOD Ser 002, Temporary Refugee Shelters (SECRET)

(d) USCINCEUR 040900Z Jul 91. OPOD Ser 003, Residual Forces (SECRET)

(e) USCINCEUR 141333Z Sep 91. OPOD Ser 004, Redeployment of Ground Forces (SECRET)

(f) USCINCEUR 141609Z Aug 92. ROE Review for OPC (SECRET)

(g) USCINCEUR 151203Z Oct 92. ROE Request (SECRET)

(h) CTF Provide Comfort/CS 2041-15Z Jul 91, CTF Provide Comfort OPLAN 91-7, Residual Force (SECRET)

(i) PROVIDE COMFORT Airspace Control Order (ACO) and Standing Special Instructions (SPINS), Volume I, Volume II, dated 12 Dec 93.

(j) CFAC/DO letter, undated, Rules of Engagement, (SECRET), with one attached, Aircrew Read File (ARF) 183, ROE/Procedures for Provide Comfort Aircraft (SECRET)

(k) 7440CWP 131400Z Apr 94, Air Tasking Order (ATO), 14 Apr 94 (SECRET)

(l) Battle Staff Directive #1, Change to PC ATO #1103, 14 Apr 94 (SECRET)

**(2) AWACS Directives and Publications.**

(a) AFR 60-1, Flight Management, Feb 90

(b) MCR 55-33, E-3 Operating Procedures - Aircrews, 3 May 93

(c) ACC Reg 51-60 Vol 2, E-3 Aircrew Training, 1 Jun 92

(d) 522 Operations Group Operating Instruction 60-2, Flying 522 ACW (Deployed) Turkey Operating Procedures, 7 Sep 93

**(3) F-15 Directives and Publications.**

(a) USAFER 51-50, Vol 7, Tactical Pilot Training F-15, Jun 91

(b) USAFER 60-2, Vol 1, Aircrew Standardization/Evaluation Program Organization and Administration, Jun 89

(c) USAFER 55-115, USAFE 1-15 Pilot Operational Procedures, Jan 87

(d) AFR 160-43, Medical Examinations and Standards, 16 Feb 93

(e) AFR 60-16, General Flight Rules, Jan 92

**(4) Black Hawk Directives and Publications**

(a) FM 1-302 Aviation Life Support Equipment (ALSE) for Army Aircrews, dated 30 September 1983.

(b) MCC SOPs (Standard Operating Procedures) dated 6 Apr 93, incorporating change dated 19 May 93

(c) Eagle Flight Detachment SOPs, dated 18 Mar 94

### **3. Statement of Opinion**

---

Under 10 U.S.C. 2254 (D) any opinion of accident investigators as to the cause of, or the factors contributing to the accident set forth in the accident investigation report, may not be considered as evidence in any civil or criminal proceeding arising from an aircraft accident, nor may such information be considered an admission of liability by the United States or by any person referred to in those conclusions or statements.

---

Operation PROVIDE COMFORT has been a successful coalition effort in response to human rights abuses against the Kurdish population in northern Iraq. The operation has effectively deterred Iraq from disrupting peace and order in the UN-established security zone.

The 14 April 1994 shoot-down of two US Black Hawk helicopters by two US F-15C aircraft in northern Iraq was caused by a chain of events which began with the breakdown of clear guidance from the Combined Task Force to its component organizations. This resulted in the lack of a clear understanding among the components of their respective responsibilities. Consequently, CTF component organizations did not fully integrate Military Coordination Center helicopter activities with other OPC air operations in the Tactical Area of Responsibility. Additionally, OPC personnel did not receive consistent, comprehensive training to ensure they had a thorough understanding of the USEUCOM-directed ROE. As a result, some aircrews' understanding of how the approved ROE should be applied, became over-simplified.

MCC personnel were given a high degree of independence in helicopter operations, without an adequate consideration for the threat of engagement from other OPC aircraft. Neither the CTF staff nor the Combined Forces Air Component staff requested or received timely, detailed flight information on planned MCC helicopter activities in the TAOR. Consequently, the OPC daily Air Tasking Order was published with little detailed information regarding US helicopter flight activities over northern Iraq. Specific information on routes of flights and times of MCC helicopter activity in the TAOR was normally available to the other OPC participants only when AWACS received it from the helicopter crews by radio and relayed the information on.

The AWACS mission crew commander on 14 April 1994, who had flown only one sortie in the previous three months, was not currently qualified in accordance with Air Force regulations. The AWACS weapons controllers, under his supervision, did not have a clear understanding of their individual responsibilities to provide support to MCC helicopters. They shared the common view, along with the CFAC airborne command element officer, that MCC helicopter activities were not an integral part of OPC air operations. There was general misunderstanding throughout OPC organizations regarding the extent to which the provisions of the Airspace Control Order applied to MCC helicopter activities. AWACS personnel did not routinely monitor the Black

Hawk helicopter flights or pass information on those flights to other OPC aircraft. The result was that there was no effective coordination of OPC fixed-wing and helicopter operations within the TAOR.

On 14 April 1994, AWACS controllers were aware that the Black Hawk helicopters had departed Zakhu, and were proceeding east into the TAOR. The F-15 pilots were not aware of the Black Hawk helicopters already in the area. The fighters twice informed AWACS that they had unknown radar contacts in the TAOR. The AWACS mission crew commander, senior weapons director, enroute controller and TAOR controller had access to electronic information regarding the presence of friendly aircraft in the vicinity of the F-15s' reported radar contacts. However, there is no evidence that they were aware of, recognized, or responded to this information. They did not advise the F-15 pilots of the presence of friendly aircraft. The helicopters were unable to hear the radio transmissions between the F-15 flight and AWACS because they were on a different radio frequency.

The F-15 pilots attempted to electronically identify the radar contacts by interrogating the ATO-designated IFF Mode I and Mode IV aircraft codes. The helicopter crew members were apparently not aware of the correct Mode I code specified for use within the TAOR and had the Mode I code specified for use outside the TAOR in their IFF transponders. The result was that the F-15s did not receive a Mode I response. When the lead F-15 pilot interrogated the IFF Mode IV code, he received a momentary friendly response. However, on two subsequent attempts, no Mode IV response was received. The F-15 wingman attempted one Mode IV interrogation and received no response.

The reason for the unsuccessful Mode IV interrogation attempts cannot be established, but was probably attributable to one or more of the following factors: both F-15 pilots may have selected the incorrect interrogation mode; both F-15 Air-to-Air Interrogators (AAIs) may have incorrectly processed the Black Hawks' transponder signals; both helicopter IFF transponder codes may have been loaded incorrectly; there may have been "garbling" of the friendly Black Hawks' IFF responses, produced by two helicopters using the same code in close proximity to each other; there may have been intermittent loss of line-of-sight radar contact between the F-15s and the helicopters, due to mountainous terrain and the Black Hawks' low-altitude, which could have precluded a successful Mode IV interrogation.

When the F-15 pilots were unable to get positive/consistent IFF responses they performed an intercept in order to visually identify the "unknown" aircraft. They each made a single identification pass on the Black Hawks. However, the identification passes were accomplished at speeds, altitudes and distances where it was unlikely that the pilots would have been able to detect the Black Hawks' markings. Neither F-15 pilot had received recent, adequate visual recognition training. The pilots did not recognize the differences between the US Black Hawk helicopters with wing-mounted fuel tanks and Hind helicopters with wing-mounted weapons. The F-15 flight lead misidentified the US Black Hawks as Iraqi Hind helicopters. Following his identification pass, he asked his wingman to confirm the identification. The wingman, who was a senior squadron supervisor and instructor pilot, saw two helicopters, but did not positively identify them as Hinds. The wingman did not notify the flight lead that he had been unable to make a positive



identification, and allowed the engagement to continue. The flight lead, acting within the specified ROE, fired a single missile and shot down the trail Black Hawk helicopter. At flight lead's direction, the F-15 wingman also fired a single missile and shot down the lead Black Hawk helicopter.

  
JAMES G. ANDRUS  
Maj Gen, USAF  
Board President

---

FOOTNOTES

- 1 TAB Y1; Y2
- 2 TAB AC8i
- 3 TAB AC8j
- 4 TAB AC8i; V92/Q92
- 5 TAB AC8d
- 6 TAB AA9
- 7 TAB AA9/p2, para 5A1 (compare AA24, Annex F, para 2E)
- 8 JCS Pub 02, 21 Apr 89/p3-9
- 9 TAB AA9/tab14; V92/Q8
- 10 JCS Pub 02, 21 Apr 89, p3-17, para 3-16
- 11 TAB AA9/tab7, para 1A1
- 12 TAB AA9/p3, para 4D4
- 13 TAB AA9/p2, para 3H, 3Q2
- 14 TAB AA9/tab14
- 15 TAB AA9/tab8, para 1A1 ,3H5
- 16 TAB V33/Q11; V100A/Q8
- 17 TAB AA9/tab8, para 3P2
- 18 TAB V116/p1-3
- 19 TAB V116/p1, para 4
- 20 JCS Pub 02, 21 Apr 1989
- 21 TAB V33/Q8,9
- 22 TAB V33/Q9
- 23 TAB V97/Q6
- 24 TAB AA9/tab3, para 3G5
- 25 TAB AA9/p5, para 2E; V34/Q11,12
- 26 TAB V34/Q6,11,20
- 27 TAB V34/Q47,50,51; V32/Q10,12
- 28 TAB V34/Q54
- 29 TAB V32/Q7,31,32
- 30 TAB V32/Q21; V80/Q58; V92/Q23
- 31 TAB V80/Q22
- 32 TAB V32/Q26,67; AA3
- 33 See TAB AA29
- 34 TAB AA25; AA29
- 35 TAB V34/Q20; V80/Q25
- 36 TAB AA1
- 37 TAB AA9/p3, para 4D4; p4, para 2D; K3a
- 38 TAB AA9/p3, para 4D3
- 39 TAB K3a
- 40 TAB V109/Q17; AA18/p1-2
- 41 TAB AA9/p4, para 2C
- 42 TAB V100A/Q43,45-47,53
- 43 TAB AA9/p4, para 2C
- 44 TAB V95/p1, para 2; V97/Q11
- 45 TAB K3a; AA1; AA9
- 46 TAB K3a; AA9

- 
- 47 TAB AA9/tab14, Annex F, para 2b
  - 48 TAB K3a; V92/Q10,13
  - 49 TAB V26/Q49,64; O3D, Atch 8
  - 50 TAB K3a; K3d
  - 51 TAB AA9/p5, para 2G1
  - 52 TAB AA1/Vol II/p8, para 16C
  - 53 TAB AA1; V29/Q45; V28/Q13
  - 54 TAB K3a; K3d
  - 55 TAB O3d, Atch 6; AA9/p5, para 2K
  - 56 TAB AA4/para 5-3; V14/Q43
  - 57 TAB O3d, Atch 6,8
  - 58 TAB O3d, Atch 6,8
  - 59 TAB O3d, Atch 6,8
  - 60 TAB AA4/para5-3b; V18/Q8; V21/Q69
  - 61 TAB AA9/p6, para 2K
  - 62 TAB AA19/OG OI 55-7
  - 63 TAB V92/Q16,17,18
  - 64 TAB K3a; K3d
  - 65 TAB K3a; K3d; AC3e
  - 66 TAB K3a; AA1
  - 67 TAB K3a; K3b; MCM 3-1, Vol IV, para 1-1
  - 68 TAB V29/Q29; AA1/p8, para 16C; AC4h
  - 69 TAB AA-24, Annex F, para 2J2
  - 70 TAB K3a; K3b
  - 71 TAB AA12/p1, para 1; p2, para 2
  - 72 TAB V69/p1, para 3
  - 73 TAB V32/Q21,67-68; V62/Q274; V34/Q24-25; V92/Q23; AA1; K3a; AA3; V80/Q58
  - 74 TAB V28/Q200; V29/Q165
  - 75 TAB V80/Q107-109,176,188-193; V30/Q22-40; V62/Q102
  - 76 TAB AA3; V80/Q188-193; V30/Q37; V62/Q110-112
  - 77 TAB AA3
  - 78 See V30/Q21-40(interview continuation); V31/Q22-25,28-29,39,41,47,66-68, 86-91; V80/Q176, 183-193; V62/Q102-103, 107-111, 128; V28/Q204/223; V29/Q181-190
  - 79 TAB V33/Q11; V34/Q90-93; V97A/Q54; V108/Q27; V116/p1-2; V112/Q63-66; V100A/Q29-30
  - 80 TAB V33/Q216-221
  - 81 TAB V92/Q10,13,29-30,121
  - 82 TAB V97/Q5; V97A/Q79,81; V106/Q7,18
  - 83 TAB V34/Q30; V80/Q83; V92/Q12; V117/Q27
  - 84 TAB V80/Q83; V96/Q86-93; V109/Q18
  - 85 TAB V95/p1, para 2
  - 86 TAB V32/Q53,54,63; V92/Q10
  - 87 TAB K3a; K3d
  - 88 TAB AA19/p2, para2C(3)
  - 89 TAB V26/Q31,35
  - 90 TAB AA16
  - 91 TAB V117/Q64,71-73; V96/Q49
  - 92 TAB V69/p2, para 2; V100/Q11; V117/Q34,60; V33/Q41
  - 93 TAB V28/Q13,77; V29/Q84
  - 94 TAB V97/Q17,24; V96/Q18,23-24; V100A/Q25,67
  - 95 TAB V97/Q17,20-21,24
  - 96 TAB V97/Q24,25; V96/Q30-31; V109/Q19
  - 97 TAB K3a

- 
- 98 TAB V58/p3, para2; V97/Q27; AC8f
  - 99 TAB V32/Q46; V97A/Q10; V97/Q27
  - 100 TAB V2B/Q18; V111/p2, para2
  - 101 TAB AC1e
  - 102 TAB V69B/item 69b
  - 103 TAB AC1e
  - 104 TAB V109/Q26
  - 105 TAB AC8f; K1; K3a; V110/Q140; V26/Q31; V76/Q71-73
  - 106 TAB V2B/Q13; V2A/Q52,55
  - 107 TAB V28/Q226; V29/Q24,25,32
  - 108 TAB V26/p 35-38; V29/Q32-33; V28/Q226
  - 109 TAB V26/Q84-86; V28/Q76-77; V29/Q110-111
  - 110 TAB K3a
  - 111 TAB V93/Q24; V14/Q67
  - 112 TAB K3c
  - 113 TAB AA1; K3a; K3b
  - 114 TAB AC3e
  - 115 TAB K3c
  - 116 TAB V10/Q12-13; V14/Q116; V16/Q59; V11/p1, para 5
  - 117 TAB V14/Q357; V48/p10, para 2
  - 118 TAB V14/Q357; V48/p10, para 2
  - 119 TAB AC3b; AC3e
  - 120 TAB V16/Q135-136; AC3b
  - 121 TAB AA1, Vol II, para 16f
  - 122 TAB V48/p9, para 4-5; V14A/Q15-16, 58; V50A/Q43-44
  - 123 TAB V16A/Q18-21; N3,p9; V69/p2, para 5
  - 124 TAB V9/p1, para 4; W3
  - 125 TAB O3d,para IVc; V13/Q40
  - 126 TAB O3d,para IVc; V93/Q17; V19/p3, para 3; V14/Q61-64; V13/Q40
  - 127 TAB AA4; V13A/Q68-74
  - 128 TAB O7a
  - 129 AFR 60-1
  - 130 TAB O7a
  - 131 TAB V13/Q70-73; V93/Q68; K6
  - 132 TAB V93/Q68; V14A/Q2; AC3i
  - 133 TAB V13/Q70; K6
  - 134 TAB V93/Q67-68
  - 135 TAB V13A/Q3-4
  - 136 TAB AC3i; V13A/Q3
  - 137 TAB AC3f; V93/Q68-69
  - 138 TAB V13A/Q4; V93/Q70
  - 139 TAB AC3i; V93/Q68
  - 140 TAB AC3i; V93/Q68; K3d
  - 141 TAB AC3i; K3a; K3b; K3d
  - 142 TAB AC3i; V13A/Q3-4
  - 143 TAB H3a; V6/p1, para 4
  - 144 TAB AC3e
  - 145 TAB AC3d
  - 146 TAB AA23/p7; AC3e; AC3g/p1
  - 147 TAB AC3e
  - 148 TAB AA4/para5-3a(2)(d)
  - 149 TAB AC3d

150 TAB AC3e  
151 TAB V18/Q34,41; O3f/p12  
152 TAB O10  
153 TAB O3f/p6  
154 TAB O3f/p9  
155 TAB O3f/p5  
156 TAB O3f/p5; Z4a  
157 TAB V16/Q72-73,142; VZ4B1-2; N3; V16A/Q17  
158 TAB V16/Q72  
159 TAB V16/Q81  
160 TAB O3f/p6  
161 TAB O3f/p6  
162 TAB O3f/p6; V16/Q74  
163 TAB V24/p1, para 4; O3f/p7  
164 TAB AA1, Vol II, para 30  
165 TAB O3f/p8, Atch 5; Z4b2; V16/Q72-82,147  
166 TAB V16A/Q15; V14/Q117  
167 TAB O3f/p7; V14/Q109  
168 TAB AC4e  
169 TAB O3f/p7  
170 TAB N3/p9; V14/Q113-114; V16A/Q16-18; V16/Q142  
171 TAB V16A/Q18-19  
172 TAB O3f/p7; V16A/Q16; V114/Q118  
173 TAB V16A/Q7-8; V14/Q72-75  
174 TAB V16A/Q7-8; V14/Q72, 74  
175 TAB V14A/Q16,58,61  
176 TAB AC3b; V14A/Q18  
177 TAB N3/p6-15  
178 TAB Z4c1-9  
179 TAB Z4c9; R2  
180 TAB R1; Z4c10; V16/Q187  
181 TAB O3f/p10-11  
182 TAB O3f/p10-11  
183 TAB V16A/Q18-22  
184 TAB Z4d1-2; O3f/p8  
185 TAB O3f/p10  
186 TAB O3f/p8  
187 TAB N3/p12  
188 TAB V29/Q33  
189 TAB N3/p13; V29/Q33; V28/Q13; Z4e  
190 TAB V28/Q13; V29/Q33; V14/Q204  
191 TAB V29/Q33; V16/Q9  
192 TAB O3f,p10-11  
193 TAB V28/Q13,61; V29/Q33; V14/Q108,113,134,184  
194 TAB O3f/p8; V14/Q88-89  
195 TAB O3f/p8; Z4f1-4  
196 TAB V29/Q34-37; R2  
197 TAB V28/Q13,76; V17/Q170; V14/Q209-210  
198 TAB N3,p13-15; V21/Q44  
199 TAB Z4g1-7  
200 TAB V23/p1, para 4; O3e/p2  
201 TAB AA31

202 TAB V14/Q221,285; V16/Q172; V18/Q19,20,22-24,26,29,53; V19/p1, para 6; V20/p1, para 5; V21/Q28;  
V17/Q170,188  
203 TAB Z4g4-7; V14/Q317,318,321,329  
204 TAB O3f/p8,11  
205 TAB N3,p6-15; V28/Q13,76; V29/Q33-37; V16/Q174, 213  
206 TAB Z4g1-6  
207 TAB Z4g6; Z4h1-3  
208 TAB V17/Q170; V29/Q37-38; R2  
209 MCM Vol I/pA1-6, A1-8  
210 TAB Z4g6  
211 TAB V28/Q13; V29/Q37; N3/p13-15  
212 TAB V19/p2, para 3; V20/p2, para 1; V21/Q24-25; V16/Q118; V17/Q74  
213 TAB AA4 (MCR 55-33, para 5-3b(3)(a))  
214 TAB AA4 (MCR 55-33, para 5-3a(2))  
215 TAB V16/Q86; AA4 (MCR 55-33, para 5-2c(2))  
216 TAB V21/Q39; V22/p1, para 4  
217 TAB O3f/p9; Z4h2  
218 TAB O3f/p10-11  
219 TAB Z4h2  
220 TAB V29/Q38; N3/p15  
221 TAB Z4h3-7  
222 TAB N3/Ltr 25 May 94, para 5a and Appendix A, Time Point 0728Z  
223 TAB V28/Q137  
224 TAB V29/Q42  
225 TAB V28/Q155; V29/Q45; AC3c  
226 TAB V28/Q66,76,157  
227 TAB AC3a/p2-3  
228 TAB AC3a  
229 TAB AC3g  
230 TAB AC3e  
231 TAB AC3e  
232 TAB AC3a/p6  
233 TAB K3a  
234 TAB AC4d  
235 TAB K3a; K3b; K3d; AA1  
236 TAB K3a  
237 TAB K3a; K3b; K3d  
238 TAB AC4d, AFR 60-16  
239 TAB AC4g; V28/Q192, V29/Q158  
240 TAB V28/Q186,197; V29/Q159,164  
241 TAB O7a, Atch 4  
242 TAB O7a, Atch 4  
243 TAB V29/Q23; O7a, Atch 4  
244 AFR 60-1, para 7-6  
245 TAB V28/Q13; V29/Q23  
246 TAB AC4d; V28/Q13; V29/Q23  
247 TAB V28/Q13; V29/Q23; V2A/Q4  
248 TAB V28/Q13; V29/Q24; V2A/Q52  
249 TAB V2A/Q52,56-57; V2B/Q5,18; V62/Q264  
250 TAB V28/Q13,23; V29/Q24  
251 TAB V29/Q90; MCR 55-115; V28/Q13  
252 TAB V28/Q13; V29/Q30

---

253 TAB V28/Q25-26; V29/Q25  
254 MCM 3-1, Vol I  
255 TAB V28/Q40; V29/Q30  
256 TAB V28/Q13; V29/Q30; V36/Q28; V41/p2, para4,5  
257 TAB H4b; H5b  
258 TAB H4a; H5a; V36/Q28; V41/p2, para4,5  
259 TAB V28/Q49; V29/Q32  
260 TAB V28/Q48; V36/Q28; V41/p2, para 4-6; V29/Q30  
261 TAB V29/Q32  
262 TAB V28/Q13,53; V29/Q32  
263 TAB AC4e  
264 TAB V28/Q13; V29/Q32  
265 TAB V28/Q13; V29/Q32-33  
266 TAB V28/Q13; V29/Q34  
267 TAB V29/Q34; R2  
268 TAB V29/Q35  
269 TAB V29/Q35  
270 TAB V29/Q35; R2  
271 TAB V28/Q13; V29/Q37  
272 TAB V29/Q37  
273 TAB V28/Q13  
274 TAB V28/Q13; V29/Q37-38  
275 TAB V28/Q13; V29/Q37-38; R2  
276 TAB V28/Q13,78  
277 TAB V29/Q38  
278 TAB V29/Q38; O9/p1,4; R2  
279 TAB R2  
280 TAB R3  
281 TAB V29/Q38  
282 TAB V29/Q38,41; R2  
283 TAB V28/Q13; V29/Q38  
284 TAB V28/Q13; V29/Q41  
285 TAB V28/Q13,120  
286 TAB V29/Q41  
287 TAB V28/Q13,137; V29/Q135  
288 TAB V28/Q13; V29/Q42  
289 TAB V29/Q42,45; R2  
290 TAB V28/Q13; V29/Q45; V65/p1, para 5  
291 TAB V28/Q13; V65/p1, para 6; R7; R8  
292 TAB V28/Q28; V29/Q53  
293 TAB V28/Q13  
294 TAB V28/Q13; V29/Q45  
295 TAB V28/Q178; V29/Q153  
296 TAB V28/Q13; V29/Q45  
297 TAB V28/Q13; V29/Q157  
298 TAB V28/Q188; V29/Q46; AC4e  
299 TAB AC11  
300 TAB AC8  
301 TAB K1; V51/p1, para 6  
302 TAB K1; AA1, Vol II, para 14A/B  
303 TAB K1  
304 TAB K1; AA1

305 TAB V59/p2, para 2  
306 TAB N3; AC1c; AC8c/p1; V74/p2, para 2  
307 TAB J1c; J2c  
308 TAB AA10/p3-18.1.2.3  
309 TAB AA26/p1-50  
310 TAB AA26/p1-50; J3b; V50B/p1, para 4; V46/p5, para 1  
311 TAB V59/p1, para 4; V49/p2, para 2  
312 TAB J1c; J2c  
313 TAB W1; W2  
314 TAB V50/p1, para 3  
315 TAB V58/p3, para 2; V50A/Q32  
316 TAB V58/p2, para 6, p3, para 2-3; T1e  
317 TAB O7a  
318 TAB 07a; AC1d  
319 AR40-1  
320 TAB AA15/p1; AC1b  
321 TAB AC1b  
322 TAB AA8; V74/p1 para 2-3  
323 TAB AA8; AC1b; V58/p3, para 1  
324 TAB V50/p2, para 7; V48/p6, para 5; V104/p7 para 6; V104A/p2 para 1  
325 TAB Z4b  
326 TAB AA8; T1e; K1; W2; V51/p1, para 6  
327 TAB K1; AC1d; V51/p1, para 6  
328 TAB V55/p2, para 3; V56/p2, para 2  
329 TAB V104/p5, para 7  
330 TAB V55/p2, para 2  
331 TAB K1; AC1c; V59/p1, para 4  
332 TAB V60/p4, para 4; V59/p1, para 4  
333 TAB V16/Q72-73,142, 147; N3; O3f/p8, Atch 5; V69/p2, para 3-5  
334 TAB V69/p2, para 2,3  
335 TAB V33/Q142  
336 TAB V48/p9, para 3; V50A/Q54,56  
337 TAB V69/p2, para 3; AC8c/p1  
338 TAB V69/p2, para 3  
339 TAB V69/p2, para4; AC1a  
340 TAB AA10/p 8-2,8-9  
341 TAB V48/p15, para 2; V104/p8, para 4,6; p9, para 5  
342 TAB V69/p2, para 5  
343 TAB N3, p8-9; V14/Q113,184; V16A/Q18-21; V69/p2, para 5; AC1f  
344 TAB V100/Q16  
345 TAB AA1, Vol II, para 16I  
346 TAB AC1f  
347 TAB V100/Q16  
348 TAB R1  
349 TAB Z4b  
350 TAB K3a  
351 TAB O3f/p8; K3a  
352 TAB AA1/p2, para 30  
353 TAB O3f/p6  
354 TAB AC3c/p1; O9/p1,3  
355 TAB O9/p1; V65/p1, para 5; V66/p1, para 5  
356 TAB O9/p1; V29/Q45; AC3c



357 TAB V65/p1, para 5; V66/p1, para 5  
358 TAB O9 (Crash Site #1)  
359 TAB O9 (Crash Site #1); R7  
360 TAB O9 (Crash Site #2)  
361 TAB O9 (Crash Site #2); V65/p2, para 1  
362 TAB V28/Q13; AC3c  
363 TAB V65/p1, para 6  
364 TAB O9 (Crash Site #2)  
365 TAB O9 (Crash Site #2)  
366 TAB O9 (Crash Site #2); R8  
367 TAB AA10/p9-3  
368 TAB AA10/9-3  
369 TAB O7a; X  
370 TAB T1d  
371 TAB V69B/p1  
372 TAB T1c; T1d  
373 TAB O7a; X  
374 TAB AC8b  
375 TAB AC8g  
376 TAB AC8c/p3  
377 TAB AC8b/p3  
378 TAB V78/p3, para 4; AC8b/p4,6  
379 TAB V78/p3, para 2  
380 TAB AC8b/p4-5; AC8g; AC3e; V62/Q230-231  
381 TAB AC8b/p6  
382 TAB AC8c/p4  
383 TAB AC8g  
384 TAB AC8g; V42/p4, para 2  
385 TAB AC8h  
386 TAB O3e/p5, para 3  
387 TAB O3e/p5, para 3  
388 TAB O3e,p5, para 2  
389 TAB AC3h  
390 TAB V16/Q196-198; V17/Q196-197; V14/Q270,277-280,283  
391 TAB N3  
392 TAB O3e/p4, para 3  
393 TAB O3e/p4, para 6  
394 TAB O5a/p2; O5b/p3  
395 TAB O4a/p2; O4b/p3  
396 TAB O4b/p5; O5b/p5; O4a/p2; O5a/p2  
397 TAB V28/Q195,197; V29/Q154,159,164  
398 TAB O4a/p2, para 3; O5a/p2, para 3  
399 TAB V30/Q20-22; V29/Q32; V31/Q16  
400 TAB O5b/p3  
401 TAB O5b/p3  
402 TAB O5b/p4  
403 TAB O5b/p3  
404 TAB V3B/p1, para 5,6; V28/Q13; V62/Q54  
405 TAB O4b/p3  
406 TAB O4b/p3  
407 TAB O4b/p4  
408 TAB H1; H2

---

409 TAB H1c  
410 TAB H1d  
411 TAB H1b  
412 TAB H1b  
413 TAB H2c  
414 TAB H2d  
415 TAB H2b  
416 TAB H2b  
417 TAB V54/p3, para 1; V56/p1, para 2-3  
418 TAB O1a/p2; O2a/p2  
419 TAB T1b; T2b  
420 TAB V59/p1, para 2-3; V60/p1, para 2-3; V61/p1, para 2-3  
421 TAB V48/p7, para2  
422 TAB O1a, Atch 2  
423 TAB O1a/p4; O2a/p4  
424 TAB O1a/p5; O2a/p5  
425 TAB O1a, Atch 1  
426 TAB J1e  
427 TAB O1a, Atch 1  
428 TAB J1d  
429 TAB O2a, Atch 1  
430 TAB J2e  
431 TAB O11/p18, para 2  
432 TAB O11/p18, para 4  
433 TAB O10, Atch 2,3  
434 TAB O11, Atch 2  
435 TAB O10/p2, para 2  
436 TAB O10/p2, para 4  
437 TAB O10/p21-22  
438 TAB O11/p21, para 2-3  
439 TAB O11/p19, para 1  
440 TAB O11/p9, para 4  
441 TAB J2g  
442 TAB O11/p11, para 2  
443 TAB O11/p14, para 4  
444 TAB T3a; T3b; AA5/p8, table 1-1  
445 TAB T3a; T3f  
446 TAB V93/Q16  
447 TAB V14/Q66,69; V16/Q29; V17/Q31; V18/Q17; V21/Q66  
448 TAB T3a/p4; T3b/p1  
449 TAB T3b/p2  
450 TAB T3a/p4  
451 TAB AA5/p8, para 1-8f  
452 TAB T3b/p4  
453 TAB AA5/p19, para4-12a(4); T3b/p5,11  
454 TAB AA5/p29, para A2-9/p30, para A2-21  
455 TAB T3b/p5,11  
456 TAB T3b/p5  
457 TAB T3b/p5,6,11,13; AA5/p8, table 1-1  
458 TAB T3b/p5  
459 TAB K3c  
460 TAB K3c; V13/Q5,13-14

---

461 TAB T3a/p4; T3c/p1  
462 TAB T3c/p4-5  
463 TAB T3c/p6-7  
464 TAB T3c/p8-9  
465 TAB T3c/p10-11  
466 TAB T3c/p11-12  
467 TAB T3c/p13-15  
468 TAB T3c/p16-17  
469 TAB T3c/p18-19  
470 TAB T3c/p20-22  
471 TAB T3a/p5; T3d/p1-2  
472 TAB T3d/p3  
473 TAB T3d/p4  
474 TAB T3d/p5-8  
475 TAB T3d/p9-10  
476 TAB T3d/p11-20  
477 TAB T3d/p21-22  
478 TAB T3d/p23-26  
479 TAB T3d/p27-29  
480 TAB T3a/p5; T3e/p1,2  
481 TAB T3e/p3  
482 TAB T3e/p4-13  
483 TAB T3e/p14-16  
484 TAB T3f/p1  
485 TAB AA5/p13, para 4-5a(4)(a)  
486 TAB T3a/p8  
487 TAB T3f/p1; AA5/p13, para 4-5a(4)(a); p19, para 4-12a(3)(a)  
488 TAB K3c; V13/Q5; T3a/p4; T3g/p2-3  
489 TAB T3g/p4-5  
490 TAB K3c; V13/Q5  
491 TAB T3g/p6-7; K3c  
492 TAB T3g/p8  
493 TAB T3g/p1  
494 TAB O3a; O3b  
495 TAB O3c  
496 TAB O3d/p1-2  
497 TAB O3d/p1  
498 TAB O3d, Atch 6  
499 TAB O3d/p3, Atch 8,9  
500 TAB O3d/p3, Atch 11  
501 TAB T4a/p1; T5e  
502 TAB T5h/p3-4  
503 TAB T5f/p1  
504 TAB T5f/p1  
505 TAB T5f/p1  
506 TAB T5b/p1; V29/Q127  
507 TAB T4a/p1  
508 TAB T4a; MCR 51-50, Chap 4, 1 Jun 93; USAFER 51-50, Vol XXX, 15 Nov 91  
509 TAB T4a/p1; T4h/p1-2  
510 TAB T4h/p3-10; T4e  
511 TAB T4h/p11-12  
512 TAB T4e; T4f/p1,2

---

513 TAB T4a  
514 TAB T4h/p13,14  
515 TAB T4f/p1  
516 TAB T4i/p1  
517 TAB T4f/p2  
518 TAB T4f/p1  
519 TAB T4a/p2; MCR 51-50, Chap 4, 1 Jun 93; USAFER 51-50, Vol XXX, 15 Nov 91  
520 TAB T4a/p2  
521 TAB T4a/p2; MCR 51-50, Chap 4, 1 Jun 93; USAFER 51-50, Vol XXX, 15 Nov 91  
522 TAB AA27/p1  
523 TAB AA28/p2  
524 TAB AA22/p2  
525 TAB V28/Q263; V29/Q234  
526 TAB V28/Q263; V29/Q234  
527 TAB V28/Q265; V29/Q235-236; V63/p1; V71/p1  
528 TAB V118/p2, para 5-6  
529 TAB V28/Q215,217; AC6c  
530 TAB V29/Q141  
531 TAB V28/Q270  
532 TAB AC7c  
533 TAB O7a/p1  
534 TAB O7a/p1  
535 TAB O7a/p1  
536 TAB O7a/p1, Atch 1  
537 TAB V37  
538 TAB O7a/p1  
539 TAB O7a, Atch 7  
540 TAB O7a/p1  
541 TAB O7a/p1  
542 TAB O7a/p1  
543 TAB O7a/p1  
544 TAB O7a, Atch 3  
545 TAB O7a/p1  
546 TAB O7a/p1, Atch 4  
547 TAB O7a/p12  
548 TAB X  
549 TAB O7a/p12-13; AR95-1; AR40-1  
550 TAB O7a/p1,12  
551 TAB O6/p2-3  
552 TAB V13/Q324,328-330; V14/Q188; V16/Q96-98,143,145  
553 TAB O6/p3-4  
554 TAB O6/p4  
555 TAB V14/Q185-187; V16/Q201; V16A/Q18-20; V17/Q130-131  
556 TAB O7a, Atch 9  
557 TAB V93/Q16  
558 TAB O7a/p1  
559 TAB O6/p4-5  
560 TAB O6/p5-7  
561 TAB V28/Q66,76; V29/Q33  
562 TAB V29/Q122; V28/Q13  
563 TAB O6/p5  
564 TAB V28/Q13,122-123; V29/Q141; V48/p3 para4; V50/Q22

---

565 TAB V48/p4, para 3; V49/p4, para 6  
566 TAB O8/p14-15  
567 TAB O8/p14-15, Atch 1  
568 TAB O8/p14-15, Atch 1; R7-8  
569 TAB V29/Q99-100; O8/p10  
570 TAB O8/p10,16  
571 TAB O8/p8-10,16; V29/Q38  
572 TAB O8/p4, 12-13  
573 TAB O6/p5  
574 TAB V48/p4, para 4/p9, para 2; V50/Q51,54; V51/p2, para 7  
575 TAB V46/p3 para5; V48/p10 para3; V50/Q29,72,74; V51/p2 para9  
576 TAB V50/Q103  
577 TAB AC8a  
578 TAB W3  
579 TAB W1  
580 TAB V28/Q13; K3a  
581 TAB AB4

**AIRCRAFT  
ACCIDENT INVESTIGATION BOARD  
REPORT**

**US ARMY UH-60  
BLACK HAWK HELICOPTERS  
87-26000 AND 88-26060**

**VOLUME 3**

**TABS A thru H**

**AIRCRAFT  
ACCIDENT INVESTIGATION BOARD  
REPORT**

**COPY**

15

**OF**

16

**AFR 110-14 AIRCRAFT ACCIDENT BOARD  
INDEX OF TABS**

- A AF Form 711 - USAF Mishap Report**
- B AF Form 711a - Ground Mishap Report (Not Applicable)**
- C AF Form 711b - Aircraft Flight Mishap Report**
- D AF Form 711c - Aircraft Maintenance and Materiel Report**
- E AF Form 711d - Missile or Space Vehicle Mishap Report (Not Applicable)**
- F AF Form 711e - Explosives Mishap Report (Not Applicable)**
- G Flight and Personnel Records (Not Applicable)**
- H AFTO Forms 781 and DA Forms 2408**
- I Materiel Deficiency Report (Not Applicable)**
- J Technical or Engineering Evaluations**
- K Military Flight Plans**
- L DD Form 365-4, Weight and Balance Clearance Forms**
- M Certificate of Damage**
- N Transcripts of Recorded Communications**

**A**



**USAF MISHAP REPORT**

*(Fill in all spaces applicable. If additional space is needed, use additional sheet(s).)*

<b>1. DATE OF OCCURRENCE (Day, Month and Year)</b>  14 April 1994	<b>2. VEHICLE(S) OR MATERIEL INVOLVED (Model designation and serial no. if applicable)</b> F-15C/84-0025      UH-60A/87-26000 F-15C/79-0025      E-3B/77-0351 UH-60A/88-02060	<b>3. FOR GROUND ACCIDENTS ONLY (Base Code and Report Serial No.)</b>
---	--	---

<b>4. PLACE OF OCCURRENCE, STATE, COUNTY, DISTANCE AND DIRECTION FROM NEAREST TOWN, IF ON BASE, IDENTIFY. IF OFF BASE GIVE DISTANCE FROM NEAREST BASE.</b>  3646.1N 4405.3E	<b>5. HOUR AND TIME ZONE LOCAL</b>  0730Z	<b>6.</b> <input checked="" type="checkbox"/> DAY <input type="checkbox"/> NIGHT <input type="checkbox"/> DAWN <input type="checkbox"/> DUSK
---	---	--

7. ORGANIZATION POSSESSING OR OWNING VEHICLE OR MATERIEL AT TIME OF MISHAP						
MAJOR COMMAND	SUBCOMD OR AF	AIR DIVISION	WING	GROUP	SQ OR UNIT	NAME & BASE CODE
USAFE	17AF		52FW		53 FS	Spangdahlem
USAREUR	V Corps	159 Avn Regt	6th BN		C CO	Giebelstadt

*(List organizations of second vehicle, if they differ from Item 7 above)*

ACC	12 AF		552ACW		963 AWACS	Tinker AFB
-----	-------	--	--------	--	-----------	------------

**8. ORGANIZATION AND BASE SUBMITTING REPORT (Do not abbreviate)**

Incirlik Air Base, Turkey

**10. LIST OF PERSONNEL DIRECTLY INVOLVED**  
*(See AFR 127-2 for specific instructions)*

LAST NAME, FIRST NAME, MIDDLE INITIAL	GRADE	SSAN	ASSIGNED DUTY	AERO RATING	DEGREE INJURY <sup>1</sup> <i>(Use Abbr)</i>	DAYS LOST ON TT ONLY
Control Witness #25		Data Masked	Pilot, F-15C	P	N	
Control Witness #26		Data Masked	Pilot, F-15C	P	N	
McKenna, Patrick M.	Capt		Pilot, UH60A	P	F	
Garrett, John W.	CW2		Pilot, UH60A	P	F	
Hall, Michael A.	CW2		Pilot, UH60A	P	F	
Mounsey, Erik S.	WO1		Pilot, UH60A	P	F	
Bass, Cornelius A.	SPC		Crew, UH60A	G	F	
Colbert, Jeffrey C.	SPC		Crew, UH60A	CC	F	

<sup>1</sup> (Enter applicable letter(s) in DEGREE INJURY column. None-N; Temporary Total-TT; Permanent Partial-PP; Permanent Total-PT; Fatal-F; Missing-M)

**11. FACTUAL SUMMARY OF CIRCUMSTANCES. GIVE A DETAILED HISTORY OF FLIGHT OR CHRONOLOGICAL ORDER OF FACTS AND CIRCUMSTANCES LEADING TO THE MISHAP. THE RESULTS OF INVESTIGATION WILL BE CONTAINED IN THE "ANALYSIS PART" OF THE REPORT. ANALYSIS OF AND CONCLUSIONS DRAWN FROM ORAL OR WRITTEN STATEMENTS OBTAINED ONLY IN THE INTEREST OF MISHAP PREVENTION WILL NOT BE INCLUDED IN THIS SUMMARY.**

See attached summary of circumstances.

Item 10. (cont.)

Robinson, Michael S.	SPC		Crew, UH60A	CC	F
Ellner, Mark A.	PFC		Crew, UH60A	G	F
Normal E-3B--See Crew Orders					N

12. AUTHENTICATION			
CERTIFICATION BY (Title)	TYPED NAME AND GRADE	SIGNATURE	DATE

## **Item 11. Factual Summary of Circumstances**

On 14 April 1994, two US Army UH-60 Black Hawk helicopters assigned to Operation PROVIDE COMFORT (OPC) were tasked to support the Combined Task Force, Military Coordination Center (MCC). The helicopters were to transport the US and Turkish co-commanders of the MCC and other staff officers to the Kurdish towns of Irbil and Salah ad Din, Iraq, both of which are in the OPC Tactical Area of Responsibility (TAOR) in northern Iraq. Concurrently, a USAF E-3B Airborne Warning and Control Systems (AWACS) aircraft was tasked to provide airborne threat warning and control for OPC aircraft in the TAOR.

Additionally, two F-15C fighter aircraft were tasked to conduct a defensive counter air mission in the TAOR. Shortly after entering the TAOR, the F-15s detected the two Black Hawk helicopters on radar, but were unable to determine the identity of the helicopters through electronic means. The F-15s performed an intercept and each fighter made a visual identification pass to determine the helicopters' identity. The Black Hawk helicopters were misidentified as Iraqi Hind, (NATO designation) attack helicopters. Based on the misidentification, the F-15 pilots engaged and shot down the two Black Hawk helicopters with air-to-air missiles. The helicopters were destroyed and all personnel on-board were killed.

**AFR 110-14 AIRCRAFT ACCIDENT BOARD  
INDEX OF TABS**

- A AF Form 711 - USAF Mishap Report**
- B AF Form 711a - Ground Mishap Report (Not Applicable)**
- C AF Form 711b - Aircraft Flight Mishap Report**
- D AF Form 711c - Aircraft Maintenance and Materiel Report**
- E AF Form 711d - Missile or Space Vehicle Mishap Report (Not Applicable)**
- F AF Form 711e - Explosives Mishap Report (Not Applicable)**
- G Flight and Personnel Records (Not Applicable)**
- H AFTO Forms 781 and DA Forms 2408**
- I Materiel Deficiency Report (Not Applicable)**
- J Technical or Engineering Evaluations**
- K Military Flight Plans**
- L DD Form 365-4, Weight and Balance Clearance Forms**
- M Certificate of Damage**
- N Transcripts of Recorded Communications**

A

E

**AFR 110-14 AIRCRAFT ACCIDENT BOARD  
INDEX OF TABS**

- A AF Form 711 - USAF Mishap Report**
- B AF Form 711a - Ground Mishap Report (Not Applicable)**
- C AF Form 711b - Aircraft Flight Mishap Report**
- D AF Form 711c - Aircraft Maintenance and Materiel Report**
- E AF Form 711d - Missile or Space Vehicle Mishap Report (Not Applicable)**
- F AF Form 711e - Explosives Mishap Report (Not Applicable)**
- G Flight and Personnel Records (Not Applicable)**
- H AFTO Forms 781 and DA Forms 2408**
- I Materiel Deficiency Report (Not Applicable)**
- J Technical or Engineering Evaluations**
- K Military Flight Plans** **A**
- L DD Form 365-4, Weight and Balance Clearance Forms** **B**
- M Certificate of Damage** **C**
- N Transcripts of Recorded Communications**

**TAB C**

**AF FORM 711b**

**AIRCRAFT FLIGHT MISHAP REPORT**

**C-1 UH-60 Black Hawk 88-26060**

**C-2 UH-60 Black Hawk 87-26000**

**C-3 E-3B AWACS**

**C-4 F-15C 79-0025**

**C-5 F-15C 84-0025**

**C-1**

### AIRCRAFT FLIGHT MISHAP REPORT

(To be filled out for principal aircraft involved. Appropriate items only should be filled out on secondary aircraft.)

1. MISHAP CLASS <input checked="" type="checkbox"/> A <input type="checkbox"/> B <input type="checkbox"/> C <input type="checkbox"/> DEST	2. ACFT MDS & SERIAL NO. UH-60A 88-26060	3. DATE 14 Apr 94	4. UNIT CONTROL NO.	5. ACFT ASSIGNMENT/STATUS CODE USAREUR(Not Applicable)
PILOT(S) INVOLVED (FLIGHT CREW) <sup>1</sup>				
OPERATOR AT CONTROLS				
A. LAST NAME, INITIALS McKenna, P.		B. COMPONENT U.S. Army		
C. Unknown POSITION IN AIRCRAFT AT TIME OF MISHAP		D. NATIONALITY		E. AGE
<input type="checkbox"/> FRONT SEAT	<input type="checkbox"/> LEFT SEAT	<input type="checkbox"/> REAR SEAT	<input type="checkbox"/> RIGHT SEAT	<input type="checkbox"/> JUMP SEAT
F. MAJCOM, NAF, DIV, WG, SQ ASSIGNED USAREUR, V Corps 159th Avn Regt, 6th BN, C CO		G. MAJCOM, NAF, DIV, WG, SQ ATTACHED FOR FLYING OPC, CTF, Eagle Flight Det		
OTHER PILOT				
A. LAST NAME, INITIALS Garrett, J.		B. COMPONENT U.S. Army		
C. Unknown POSITION IN AIRCRAFT AT TIME OF MISHAP		D. NATIONALITY		E. AGE
<input type="checkbox"/> FRONT SEAT	<input type="checkbox"/> LEFT SEAT	<input type="checkbox"/> REAR SEAT	<input type="checkbox"/> RIGHT SEAT	<input type="checkbox"/> JUMP SEAT
F. MAJCOM, NAF, DIV, WG, SQ ASSIGNED USAREUR, V Corps 159th Avn Regt, 6th BN, C CO		G. MAJCOM, NAF, DIV, WG, SQ ATTACHED FOR FLYING OPC, CTF, Eagle Flight Det		
OTHER PILOT				
A. LAST NAME, INITIALS		B. COMPONENT		
C. POSITION IN AIRCRAFT AT TIME OF MISHAP		D. NATIONALITY		E. AGE
<input type="checkbox"/> FRONT SEAT	<input type="checkbox"/> LEFT SEAT	<input type="checkbox"/> REAR SEAT	<input type="checkbox"/> RIGHT SEAT	<input type="checkbox"/> JUMP SEAT
F. MAJCOM, NAF, DIV, WG, SQ ASSIGNED		G. MAJCOM, NAF, DIV, WG, SQ ATTACHED FOR FLYING		
OTHER PILOT				
A. LAST NAME, INITIALS		B. COMPONENT		
C. POSITION IN AIRCRAFT AT TIME OF MISHAP		D. NATIONALITY		E. AGE
<input type="checkbox"/> FRONT SEAT	<input type="checkbox"/> LEFT SEAT	<input type="checkbox"/> REAR SEAT	<input type="checkbox"/> RIGHT SEAT	<input type="checkbox"/> JUMP SEAT
F. MAJCOM, NAF, DIV, WG, SQ ASSIGNED		G. MAJCOM, NAF, DIV, WG, SQ ATTACHED FOR FLYING		
CLEARANCE				
FROM Diyarbakir Turkey to Zacho			TO TAOR and Return	
<input type="checkbox"/> VFR	<input type="checkbox"/> IFR	<input type="checkbox"/> LOCAL	<input checked="" type="checkbox"/> FT TO FT	<input type="checkbox"/> DIRECT
<input type="checkbox"/> AIRWAYS		<input type="checkbox"/> NO CLEARANCE		<input type="checkbox"/> NA
11. DURATION OF FLIGHT		12. TYPE OF MISSION		13. ALTITUDE/ELEVATION
HOURS 1	TENTHS 9	Operation PROVIDE COMFORT Support Mission (Passengers)		Contour Altitudes
14. PHASE OF OPERATION In-flight--low level		15. TYPE OF MISHAP Inadvertent shoot-down of friendly helicopters		
16. METEOROLOGICAL CONDITIONS <input checked="" type="checkbox"/> VMC <input type="checkbox"/> SIMULATED IMC <input type="checkbox"/> TRANSITION <input type="checkbox"/> IMC <input type="checkbox"/> ON TOP <input type="checkbox"/> VFR IN IMC CONDITIONS				
17. N/A AIRFIELD DATA APPLICABLE TO TAKEOFF AND LANDING MISHAPS OCCURRING WITHIN 2 MILES OF AIRFIELD				
A. FIELD ELEVATION (Feet)		B. COMPOSITION OF RUNWAY <input type="checkbox"/> ASPHALT <input type="checkbox"/> CONCRETE <input type="checkbox"/> OTHER (Specify)		
C. LENGTH OF RUNWAY (Feet)	D. RUNWAY HEADING	E. DISTANCE OF TOUCHDOWN FROM RUNWAY (Feet)	F. SURFACE CONDITION <input type="checkbox"/> DRY <input type="checkbox"/> WET <input type="checkbox"/> OTHER (Specify)	
G. LENGTH OF OVERRUN	H. COMPOSITION OF OVERRUN (Specify)	I. BARRIER TYPE   USED   LOCATION <input type="checkbox"/> YES <input type="checkbox"/> NO		
J. CONDITIONS AFFECTING OCCURENCE (For example, type of instrument or lighting approach used, obstructions, barrier, airspeed, gross weight, forced landing)				

<sup>1</sup> If more than four pilots are involved (Flight Crew) report same information required on additional sheet for each

**TAB C**

**AF FORM 711b**

**AIRCRAFT FLIGHT MISHAP REPORT**

**C-1 UH-60 Black Hawk 88-26060**

**C-2 UH-60 Black Hawk 87-26000**

**C-3 E-3B AWACS**

**C-4 F-15C 79-0025**

**C-5 F-15C 84-0025**

**C-1**

**C-2**

### AIRCRAFT FLIGHT MISHAP REPORT

*(To be filled out for principal aircraft involved. Appropriate items only should be filled out on secondary aircraft.)*

1. MISHAP CLASS <input checked="" type="checkbox"/> A <input type="checkbox"/> B <input type="checkbox"/> C <input type="checkbox"/> DEST		2. ACFT MOS & SERIAL NO. UH-60A 87-26000		3. DATE 14 Apr 94		4. UNIT CONTROL NO.		5. ACFT ASSIGNMENT/STATUS CODE USAREUR(Not Applicable)	
PILOT(S) INVOLVED (FLIGHT CREW) <sup>1</sup>									
OPERATOR AT CONTROLS									
A. LAST NAME, INITIALS Hall, M.					B. COMPONENT U.S. Army				
C. Unknown POSITION IN AIRCRAFT AT TIME OF MISHAP					D. NATIONALITY		E. AGE		
FRONT SEAT		LEFT SEAT		REAR SEAT		RIGHT SEAT		JUMP SEAT	
F. MAJCOM, NAF, DIV, WG, SQ ASSIGNED USAREUR, V Corps 159th Avn Regt, 6th BN, C CO					G. MAJCOM, NAF, DIV, WG, SQ ATTACHED FOR FLYING OPC, CTF, Eagle Flight Det				
OTHER PILOT									
A. LAST NAME, INITIALS Mounsey, E.					B. COMPONENT U.S. Army				
C. Unknown POSITION IN AIRCRAFT AT TIME OF MISHAP					D. NATIONALITY		E. AGE		
FRONT SEAT		LEFT SEAT		REAR SEAT		RIGHT SEAT		JUMP SEAT	
F. MAJCOM, NAF, DIV, WG, SQ ASSIGNED USAREUR, V Corps 159th Avn Regt, 6th BN, C CO					G. MAJCOM, NAF, DIV, WG, SQ ATTACHED FOR FLYING OPC, CTF, Eagle Flight Det				
OTHER PILOT									
A. LAST NAME, INITIALS					B. COMPONENT				
C. POSITION IN AIRCRAFT AT TIME OF MISHAP					D. NATIONALITY		E. AGE		
FRONT SEAT		LEFT SEAT		REAR SEAT		RIGHT SEAT		JUMP SEAT	
F. MAJCOM, NAF, DIV, WG, SQ ASSIGNED					G. MAJCOM, NAF, DIV, WG, SQ ATTACHED FOR FLYING				
OTHER PILOT									
A. LAST NAME, INITIALS					B. COMPONENT				
C. POSITION IN AIRCRAFT AT TIME OF MISHAP					D. NATIONALITY		E. AGE		
FRONT SEAT		LEFT SEAT		REAR SEAT		RIGHT SEAT		JUMP SEAT	
F. MAJCOM, NAF, DIV, WG, SQ ASSIGNED					G. MAJCOM, NAF, DIV, WG, SQ ATTACHED FOR FLYING				
CLEARANCE									
FROM Diyarbakir, Turkey to Zacho					TO TAOR and Return				
<input checked="" type="checkbox"/> VFR		<input type="checkbox"/> IFR		<input type="checkbox"/> LOCAL		<input checked="" type="checkbox"/> FT TO FT		<input type="checkbox"/> DIRECT	
<input type="checkbox"/> AIRWAYS		<input type="checkbox"/> NO CLEARANCE		<input type="checkbox"/> NA					
11. DURATION OF FLIGHT				12. TYPE OF MISSION			13. ALTITUDE/ELEVATION		
HOURS 1		TENTHS 9		Operation PROVIDE COMFORT Support Mission (Passengers)			Contour Altitudes		
14. PHASE OF OPERATION In-flight--low level					15. TYPE OF MISHAP Inadvertent shoot-down of friendly helicopter				
16. METEOROLOGICAL CONDITIONS <input checked="" type="checkbox"/> VMC <input type="checkbox"/> SIMULATED IMC <input type="checkbox"/> TRANSITION <input type="checkbox"/> IMC <input type="checkbox"/> ON TOP <input type="checkbox"/> VFR IN IMC CONDITIONS									
17. N/A AIRFIELD DATA APPLICABLE TO TAKEOFF AND LANDING MISHAPS OCCURRING WITHIN 2 MILES OF AIRFIELD									
A. FIELD ELEVATION (Feet)				B. COMPOSITION OF RUNWAY <input type="checkbox"/> ASPHALT <input type="checkbox"/> CONCRETE <input type="checkbox"/> OTHER (Specify)					
C. LENGTH OF RUNWAY (Feet)		D. RUNWAY HEADING		E. DISTANCE OF TOUCHDOWN FROM RUNWAY (Feet)		F. SURFACE CONDITION <input type="checkbox"/> DRY <input type="checkbox"/> WET <input type="checkbox"/> OTHER (Specify)			
G. LENGTH OF OVERRUN		H. COMPOSITION OF OVERRUN (Specify)			I. BARRIER TYPE   USED   LOCATION <input type="checkbox"/> YES <input type="checkbox"/> NO				
J. CONDITIONS AFFECTING OCCURENCE (For example, type of instrument or lighting approach used, obstructions, barrier, airspeed, gross weight, forced landing)									

<sup>1</sup>If more than four pilots are involved (Flight Crew) report same information required on additional sheet for each



**TAB C**

**AF FORM 711b**

**AIRCRAFT FLIGHT MISHAP REPORT**

**C-1 UH-60 Black Hawk 88-26060**

**C-2 UH-60 Black Hawk 87-26000**

**C-3 E-3B AWACS**

**C-4 F-15C 79-0025**

**C-5 F-15C 84-0025**

**C-1**

**C-2**

**C-3**

## AIRCRAFT FLIGHT MISHAP REPORT

(To be filled out for principal aircraft involved. Appropriate items only should be filled out on secondary aircraft.)

1. MISHAP CLASS <input checked="" type="checkbox"/> A <input type="checkbox"/> B <input type="checkbox"/> C <input type="checkbox"/> DEST		2. ACFT MOD & SERIAL NO. E-3B 77-0351		3. DATE 94-04-14		4. UNIT CONTROL NO.		5. ACFT ASSIGNMENT/STATUS CODE ACC/12AF/CC			
PILOT(S) INVOLVED (FLIGHT CREW) <sup>1</sup>											
OPERATOR AT CONTROLS											
A. LAST NAME, INITIALS Control Witness #09					B. COMPONENT REG AF						
C. POSITION IN AIRCRAFT AT TIME OF MISHAP								D. NATIONALITY		E. AGE	
FRONT SEAT		LEFT SEAT		REAR SEAT		RIGHT SEAT		JUMP SEAT			
F. MAJCOM, NAF, DIV, WG, SQ ASSIGNED ACC, 12AF, 552ACW, 963rd AWACS					G. MAJCOM, NAF, DIV, WG, SQ ATTACHED FOR FLYING						
OTHER PILOT											
A. LAST NAME, INITIALS Control Witness #005					B. COMPONENT REG AF						
C. POSITION IN AIRCRAFT AT TIME OF MISHAP								D. NATIONALITY		E. AGE	
FRONT SEAT		LEFT SEAT		REAR SEAT		RIGHT SEAT		JUMP SEAT			
F. MAJCOM, NAF, DIV, WG, SQ ASSIGNED ACC, 12AF, 552ACW, 963rd AWACS					G. MAJCOM, NAF, DIV, WG, SQ ATTACHED FOR FLYING						
OTHER PILOT											
A. LAST NAME, INITIALS					B. COMPONENT						
C. POSITION IN AIRCRAFT AT TIME OF MISHAP								D. NATIONALITY		E. AGE	
FRONT SEAT		LEFT SEAT		REAR SEAT		RIGHT SEAT		JUMP SEAT			
F. MAJCOM, NAF, DIV, WG, SQ ASSIGNED					G. MAJCOM, NAF, DIV, WG, SQ ATTACHED FOR FLYING						
OTHER PILOT											
A. LAST NAME, INITIALS					B. COMPONENT						
C. POSITION IN AIRCRAFT AT TIME OF MISHAP								D. NATIONALITY		E. AGE	
FRONT SEAT		LEFT SEAT		REAR SEAT		RIGHT SEAT		JUMP SEAT			
F. MAJCOM, NAF, DIV, WG, SQ ASSIGNED					G. MAJCOM, NAF, DIV, WG, SQ ATTACHED FOR FLYING						
CLEARANCE											
10. FROM Incirlik AB, Turkey					TO Incirlik AB, Turkey						
VFR		IFR		LOCAL		<input checked="" type="checkbox"/> FT TO FT		DIRECT		AIRWAYS	
								<input type="checkbox"/> NO CLEARANCE		<input type="checkbox"/> NA	
11. DURATION OF FLIGHT				12. TYPE OF MISSION				13. ALTITUDE/ELEVATION			
HOURS 9		TENTHS 7		Airborne Warning and Control in support of Operation PROVIDE COMFORT				31,000 MSL			
14. PHASE OF OPERATION In-flight--Normal						15. TYPE OF MISHAP Inadvertent shoot-down of friendly helicopter					
16. METEOROLOGICAL CONDITIONS						<input checked="" type="checkbox"/> VMC <input type="checkbox"/> SIMULATED IMC <input type="checkbox"/> TRANSITION <input type="checkbox"/> IMC <input type="checkbox"/> ON TOP <input type="checkbox"/> VFR IN IMC CONDITIONS					
17. AIRFIELD DATA APPLICABLE TO TAKEOFF AND LANDING MISHAPS OCCURRING WITHIN 2 MILES OF AIRFIELD											
A. FIELD ELEVATION (Feet) N/A				B. COMPOSITION OF RUNWAY <input type="checkbox"/> ASPHALT <input type="checkbox"/> CONCRETE <input type="checkbox"/> OTHER (Specify)							
C. LENGTH OF RUNWAY (Feet)			D. RUNWAY HEADING			E. DISTANCE OF TOUCHDOWN FROM RUNWAY (Feet)			F. SURFACE CONDITION <input type="checkbox"/> DRY <input type="checkbox"/> WET <input type="checkbox"/> OTHER (Specify)		
G. LENGTH OF OVERRUN			H. COMPOSITION OF OVERRUN (Specify)			I. BARRIER TYPE			J. USED <input type="checkbox"/> YES <input type="checkbox"/> NO   LOCATION		
J. CONDITIONS AFFECTING OCCURENCE (For example, type of instrument or lighting approach used, obstructions, barrier, airspeed, gross weight, forced landing)											

<sup>1</sup> If more than four pilots are involved (Flight Crew) report same information required on additional sheet for each

**TAB C**

**AF FORM 711b**

**AIRCRAFT FLIGHT MISHAP REPORT**

**C-1 UH-60 Black Hawk 88-26060**

**C-2 UH-60 Black Hawk 87-26000**

**C-3 E-3B AWACS**

**C-4 F-15C 79-0025**

**C-5 F-15C 84-0025**

**C-1**

**C-2**

**C-3**

**C-4**

FOR OFFICIAL USE ONLY (When filled in)

**AIRCRAFT FLIGHT MISHAP REPORT**

(To be filled out for principal aircraft involved. Appropriate items only should be filled out on secondary aircraft.)

<b>1. MISHAP CLASS</b> <input checked="" type="checkbox"/> A <input type="checkbox"/> B <input type="checkbox"/> C <input type="checkbox"/> DEST	<b>2. ACFT MDS &amp; SERIAL NO.</b> F15C 79-0025	<b>3. DATE</b> 94-04-14	<b>4. UNIT CONTROL NO.</b>	<b>5. ACFT ASSIGNMENT/STATUS CODE</b> USAF/CG
<b>PILOT(S) INVOLVED (FLIGHT CREW)<sup>1</sup></b>				
<b>6. OPERATOR AT CONTROLS</b>				
<b>A. LAST NAME, INITIALS</b> Control Witness #25			<b>B. COMPONENT</b> REG AF	
<b>C. POSITION IN AIRCRAFT AT TIME OF MISHAP</b> <input checked="" type="checkbox"/> FRONT SEAT <input type="checkbox"/> LEFT SEAT <input type="checkbox"/> REAR SEAT <input type="checkbox"/> RIGHT SEAT <input type="checkbox"/> JUMP SEAT				<b>D. NATIONALITY</b> US
<b>F. MAJCOM, NAF, DIV, WG, SQ ASSIGNED</b> IISAFE, 17AF, 52FW, 53FS			<b>G. MAJCOM, NAF, DIV, WG, SQ ATTACHED FOR FLYING</b>	
<b>7. OTHER PILOT</b>				
<b>A. LAST NAME, INITIALS</b>			<b>B. COMPONENT</b>	
<b>C. POSITION IN AIRCRAFT AT TIME OF MISHAP</b> <input type="checkbox"/> FRONT SEAT <input type="checkbox"/> LEFT SEAT <input type="checkbox"/> REAR SEAT <input type="checkbox"/> RIGHT SEAT <input type="checkbox"/> JUMP SEAT				<b>D. NATIONALITY</b>
<b>F. MAJCOM, NAF, DIV, WG, SQ ASSIGNED</b>			<b>G. MAJCOM, NAF, DIV, WG, SQ ATTACHED FOR FLYING</b>	
<b>8. OTHER PILOT</b>				
<b>A. LAST NAME, INITIALS</b>			<b>B. COMPONENT</b>	
<b>C. POSITION IN AIRCRAFT AT TIME OF MISHAP</b> <input type="checkbox"/> FRONT SEAT <input type="checkbox"/> LEFT SEAT <input type="checkbox"/> REAR SEAT <input type="checkbox"/> RIGHT SEAT <input type="checkbox"/> JUMP SEAT				<b>D. NATIONALITY</b>
<b>F. MAJCOM, NAF, DIV, WG, SQ ASSIGNED</b>			<b>G. MAJCOM, NAF, DIV, WG, SQ ATTACHED FOR FLYING</b>	
<b>9. OTHER PILOT</b>				
<b>A. LAST NAME, INITIALS</b>			<b>B. COMPONENT</b>	
<b>C. POSITION IN AIRCRAFT AT TIME OF MISHAP</b> <input type="checkbox"/> FRONT SEAT <input type="checkbox"/> LEFT SEAT <input type="checkbox"/> REAR SEAT <input type="checkbox"/> RIGHT SEAT <input type="checkbox"/> JUMP SEAT				<b>D. NATIONALITY</b>
<b>F. MAJCOM, NAF, DIV, WG, SQ ASSIGNED</b>			<b>G. MAJCOM, NAF, DIV, WG, SQ ATTACHED FOR FLYING</b>	
<b>10. CLEARANCE</b>				
<b>FROM</b> Incirlik AB, Turkey		<b>TO</b> Incirlik AB, Turkey		
<input type="checkbox"/> VFR	<input type="checkbox"/> IFR	<input type="checkbox"/> LOCAL	<input checked="" type="checkbox"/> PT TO PT	<input type="checkbox"/> DIRECT
<input type="checkbox"/> AIRWAYS		<input type="checkbox"/> NO CLEARANCE		<input type="checkbox"/> NA
<b>11. DURATION OF FLIGHT</b> HOURS: 3   TENTHS: 4		<b>12. TYPE OF MISSION</b> Defensive Counter Air in support of Operation PROVIDE COMFORT		<b>13. ALTITUDE/ELEVATION</b> 4,000ft MSL
<b>14. PHASE OF OPERATION</b> Inflight-Air-to-Air Gunnery			<b>15. TYPE OF MISHAP</b> Inadvertent shoot-down of friendly helicopter	
<b>16. METEOROLOGICAL CONDITIONS</b> <input checked="" type="checkbox"/> VMC <input type="checkbox"/> SIMULATED IMC <input type="checkbox"/> TRANSITION <input type="checkbox"/> IMC <input type="checkbox"/> ON TOP <input type="checkbox"/> VFR IN IMC CONDITIONS				
<b>17. AIRFIELD DATA APPLICABLE TO TAKEOFF AND LANDING MISHAPS OCCURRING WITHIN 2 MILES OF AIRFIELD</b>				
<b>A. FIELD ELEVATION (Feet)</b>		<b>B. COMPOSITION OF RUNWAY</b> <input type="checkbox"/> ASPHALT <input type="checkbox"/> CONCRETE <input type="checkbox"/> OTHER (Specify)		
<b>C. LENGTH OF RUNWAY (Feet)</b>	<b>D. RUNWAY HEADING</b>	<b>E. DISTANCE OF TOUCHDOWN FROM RUNWAY (Feet)</b>	<b>F. SURFACE CONDITION</b> <input type="checkbox"/> DRY <input type="checkbox"/> WET <input type="checkbox"/> OTHER (Specify)	
<b>G. LENGTH OF OVERRUN</b>	<b>H. COMPOSITION OF OVERRUN (Specify)</b>		<b>I. BARRIER</b> TYPE:   USED: <input type="checkbox"/> YES <input type="checkbox"/> NO   LOCATION:	
<b>J. CONDITIONS AFFECTING OCCURENCE (For example, type of instrument or lighting approach used, obstructions, barrier, airspeed, gross weight, forced landing)</b>				

<sup>1</sup>If more than four pilots are involved (Flight Crew) report same information required on additional sheet for each.

**TAB C**

**AF FORM 711b**

**AIRCRAFT FLIGHT MISHAP REPORT**

**C-1 UH-60 Black Hawk 88-26060**

**C-2 UH-60 Black Hawk 87-26000**

**C-3 E-3B AWACS**

**C-4 F-15C 79-0025**

**C-5 F-15C 84-0025**

**C-1**

**C-2**

**C-3**

**C-4**

**C-5**

## AIRCRAFT FLIGHT MISHAP REPORT

(To be filled out for principal aircraft involved. Appropriate items only should be filled out on secondary aircraft.)

1. MISHAP CLASS <input checked="" type="checkbox"/> A <input type="checkbox"/> B <input type="checkbox"/> C <input type="checkbox"/> DEST		2. ACFT MDS & SERIAL NO. F15C 84-0025		3. DATE 94-04-14		4. UNIT CONTROL NO.		5. ACFT ASSIGNMENT/STATUS CODE USAFE/CC							
PILOT(S) INVOLVED (FLIGHT CREW)															
6. OPERATOR AT CONTROLS															
A. LAST NAME, INITIALS Control Witness #26					B. COMPONENT REG AF										
C. POSITION IN AIRCRAFT AT TIME OF MISHAP								D. NATIONALITY		E. AGE					
<input checked="" type="checkbox"/> FRONT SEAT	<input type="checkbox"/> LEFT SEAT		<input type="checkbox"/> REAR SEAT		<input type="checkbox"/> RIGHT SEAT		<input type="checkbox"/> JUMP SEAT								
F. MAJCOM, NAF, DIV, WG, SQ ASSIGNED USAFE, 17AF, 52FW, 53FS					G. MAJCOM, NAF, DIV, WG, SQ ATTACHED FOR FLYING										
7. OTHER PILOT															
A. LAST NAME, INITIALS					B. COMPONENT										
C. POSITION IN AIRCRAFT AT TIME OF MISHAP								D. NATIONALITY		E. AGE					
<input type="checkbox"/> FRONT SEAT	<input type="checkbox"/> LEFT SEAT		<input type="checkbox"/> REAR SEAT		<input type="checkbox"/> RIGHT SEAT		<input type="checkbox"/> JUMP SEAT								
F. MAJCOM, NAF, DIV, WG, SQ ASSIGNED					G. MAJCOM, NAF, DIV, WG, SQ ATTACHED FOR FLYING										
8. OTHER PILOT															
A. LAST NAME, INITIALS					B. COMPONENT										
C. POSITION IN AIRCRAFT AT TIME OF MISHAP								D. NATIONALITY		E. AGE					
<input type="checkbox"/> FRONT SEAT	<input type="checkbox"/> LEFT SEAT		<input type="checkbox"/> REAR SEAT		<input type="checkbox"/> RIGHT SEAT		<input type="checkbox"/> JUMP SEAT								
F. MAJCOM, NAF, DIV, WG, SQ ASSIGNED					G. MAJCOM, NAF, DIV, WG, SQ ATTACHED FOR FLYING										
9. OTHER PILOT															
A. LAST NAME, INITIALS					B. COMPONENT										
C. POSITION IN AIRCRAFT AT TIME OF MISHAP								D. NATIONALITY		E. AGE					
<input type="checkbox"/> FRONT SEAT	<input type="checkbox"/> LEFT SEAT		<input type="checkbox"/> REAR SEAT		<input type="checkbox"/> RIGHT SEAT		<input type="checkbox"/> JUMP SEAT								
F. MAJCOM, NAF, DIV, WG, SQ ASSIGNED					G. MAJCOM, NAF, DIV, WG, SQ ATTACHED FOR FLYING										
10. CLEARANCE															
FROM Incirlik AB, Turkey					TO Incirlik AB, Turkey										
<input type="checkbox"/> VFR	<input type="checkbox"/> IFR		<input type="checkbox"/> LOCAL		<input checked="" type="checkbox"/> PT TO PT		<input type="checkbox"/> DIRECT		<input type="checkbox"/> AIRWAYS	<input type="checkbox"/> NO CLEARANCE	<input type="checkbox"/> NA				
11. DURATION OF FLIGHT				12. TYPE OF MISSION				13. ALTITUDE/ELEVATION							
HOURS 3		TENTHS 4		Defense Counter Air in support of Operations PROVIDE COMFORT				4,000ft MSL							
14. PHASE OF OPERATION Inflight-Air-to-Air Gunnery						15. TYPE OF MISHAP Inadvertent shoot-down of friendly helicopter									
16. METEOROLOGICAL CONDITIONS										<input type="checkbox"/> VMC		<input type="checkbox"/> SIMULATED IMC		<input type="checkbox"/> TRANSITION	
										<input type="checkbox"/> IMC		<input type="checkbox"/> ON TOP		<input type="checkbox"/> VFR IN IMC CONDITIONS	
17. AIRFIELD DATA APPLICABLE TO TAKEOFF AND LANDING MISHAPS OCCURRING WITHIN 2 MILES OF AIRFIELD															
A. FIELD ELEVATION (Feet)					B. COMPOSITION OF RUNWAY										
					<input type="checkbox"/> ASPHALT <input type="checkbox"/> CONCRETE <input type="checkbox"/> OTHER (Specify)										
C. LENGTH OF RUNWAY (Feet)			D. RUNWAY HEADING		E. DISTANCE OF TOUCHDOWN FROM RUNWAY (Feet)			F. SURFACE CONDITION							
								<input type="checkbox"/> DRY <input type="checkbox"/> WET <input type="checkbox"/> OTHER (Specify)							
G. LENGTH OF OVERRUN			H. COMPOSITION OF OVERRUN (Specify)			I. BARRIER									
						TYPE		USED		LOCATION					
								<input type="checkbox"/> YES <input type="checkbox"/> NO							
J. CONDITIONS AFFECTING OCCURENCE (For example, type of instrument or lighting approach used, obstructions, barrier, airspeed, gross weight, forced landing)															

If more than four pilots are involved (Flight Crew) report same information required on additional sheet for each

**AFR 110-14 AIRCRAFT ACCIDENT BOARD  
INDEX OF TABS**

- A AF Form 711 - USAF Mishap Report**
- B AF Form 711a - Ground Mishap Report (Not Applicable)**
- C AF Form 711b - Aircraft Flight Mishap Report**
- D AF Form 711c - Aircraft Maintenance and Materiel Report**
- E AF Form 711d - Missile or Space Vehicle Mishap Report (Not Applicable)**
- F AF Form 711e - Explosives Mishap Report (Not Applicable)**
- G Flight and Personnel Records (Not Applicable)**
- H AFTO Forms 781 and DA Forms 2408**
- I Materiel Deficiency Report (Not Applicable)**
- J Technical or Engineering Evaluations**
- K Military Flight Plans** **A**
- L DD Form 365-4, Weight and Balance Clearance Forms** **B**
- M Certificate of Damage** **C**
- N Transcripts of Recorded Communications** **D**

**TAB D**

**AF FORM 711c**

**AIRCRAFT MAINTENANCE AND MATERIEL REPORT**

**D-1 UH-60 Black Hawk 88-26060**

**D-2 UH-60 Black Hawk 87-26000**

**D-3 E-3B AWACS**

**D-4 F-15C 79-0025**

**D-5 F-15C 84-0025**

**D-1**





**TAB D**

**AF FORM 711c**

**AIRCRAFT MAINTENANCE AND MATERIEL REPORT**

**D-1 UH-60 Black Hawk 88-26060**

**D-2 UH-60 Black Hawk 87-26000**

**D-3 E-3B AWACS**

**D-4 F-15C 79-0025**

**D-5 F-15C 84-0025**

**D-1**

**D-2**



**TAB D**

**AF FORM 711c**

**AIRCRAFT MAINTENANCE AND MATERIEL REPORT**

**D-1 UH-60 Black Hawk 88-26060**

**D-2 UH-60 Black Hawk 87-26000**

**D-3 E-3B AWACS**

**D-4 F-15C 79-0025**

**D-5 F-15C 84-0025**

**D-1**

**D-2**

**D-3**

(When filled in)

### AIRCRAFT MAINTENANCE AND MATERIEL REPORT

1. AIRCRAFT SERIAL NUMBER 77-0351		2. MISSION DESIGN AND SERIES (MDS) E-3B	
3. HISTORICAL DATA			
AIRCRAFT		DEFICIENT PART COMPONENT OR ACCESSORY	
AIR FORCE ACCEPTANCE DATE	3 Oct 78	NOUN	
TOTAL FLIGHT HOURS	13,265.6	PART NUMBER	
LAST OVERHAUL DATE (PDM)	9 Apr 90	T.O. REFERENCE	
OVERHAULING ACTIVITY (Name & Loc)	OC/ALC TAFB, OK	FIGURE	
HOURS SINCE OVERHAUL	3,593.4	INDEX	N/A
HOURS SINCE LAST SCHEDULED INSP.	204.8	WORK UNIT CODE	N/A
DATE OF LAST SCHEDULED INSPECTION	20 Aug 93	TDP REQUESTED	YES <input type="checkbox"/> NC <input type="checkbox"/> YES <input type="checkbox"/> NO <input type="checkbox"/>
TYPE OF LAST SCHEDULED INSPECTION	-6, Phase #3	MDR SUBMITTED	YES <input type="checkbox"/> NC <input type="checkbox"/> YES <input type="checkbox"/> NO <input type="checkbox"/>
DATE ASSIGNED PRESENT ORGN.	3 Sep 93	MDR NUMBER	
ORGN. TRANSFERRED FROM	062 AWACS/PACAF	WIP NUMBER	

ENGINE (Complete a Column for each Engine)				
INSTALLED POSITION	#1	#2	#3	#4
ENGINE MODEL AND SERIES	TF-33-P100A	TF33-P100A	TF33-P100A	TF33-P100A
ENGINE SERIAL NUMBER	P696843	P660116	P659990	P696816
TOTAL ENGINE HOURS	11,971.7	19,046.7	16,758.1	11,181.1
NUMBER OF MAJOR OVERHAULS	1	1	1	0
HRS SINCE LAST MAJOR OVERHAUL	517.7	9,873.7	7,693.1	N/A
DATE OF LAST OVERHAUL	22 Dec 92	5 May 76	11 Jun 75	N/A
OVERHAUL ACTIVITY	OC/ALC	OC/ALC	OC/ALC	OC/ALC
DATE LAST INSTALLED	7 Jun 93	21 Mar 94	13 May 92	14 Jan 94
HOURS SINCE LAST INSTALLED	418.3	47.3	1540.4	169.7
DATE OF LAST SCHEDULED INSPECTION	9 Mar 93	14 Feb 89	14 Nov 89	19 Oct 93
TYPE OF LAST SCHEDULED INSPECTION	Overhaul	6000HR HSI/-9PE	6000HR HSI/-9PE	6000HR HSI/-9PE
FUEL (Type & Octane Rating)	JP-4	JP-4	JP-4	JP-4
TDR REQUESTED	No	No	No	No

4. N/A SOAP SAMPLES (Engine, CSD, Gearbox or APU failure of which occurred or was suspected) N/A

ITEM AND SERIAL NUMBER																			
HOURS SINCE		FE	CR	AG	AL	CU	SN	MG	TI	HOURS SINCE		FE	CR	AG	AL	CU	SN	MG	TI
O/H	OIL CHANGE									O/H	OIL CHANGE								

5. DAMAGED AIRCRAFT (Furnish complete damage information under Tab "L". See AF Form 711h)

DAMAGE TO AIRCRAFT	MANHOURS TO REPAIR	COST (ESTIMATE)
<input type="checkbox"/> DESTROYED OR DAMAGED BEYOND ECONOMIC REPAIR		
<input type="checkbox"/> SUBSTANTIAL <input type="checkbox"/> MINOR <input checked="" type="checkbox"/> LESS THAN MINOR OR NONE		

6. N/A (To be completed when fire or chemical explosion occurs, not resulting from ground impact. Indicate: P - Probable or K - Known, in squares)

A. MATERIEL FAILURE CAUSING THE FIRE		B. IGNITION SOURCE		C. COMBUSTIBLE MATERIAL	
ELECTRICAL SYSTEM	PROPULSION SYSTEM	ELECTRICAL SYSTEM	STATIC ELECTRICITY/LIGHTNING	CARGO	HYDRAULIC FLUID
FUEL SYSTEM	BLEED AIR SYSTEM	PNEUMATIC SYSTEM	OTHER (Specify)	ELECTRICAL INSULATION	LUBRICATING OIL
HYDRAULIC SYSTEM	OTHER (Specify)	PROPULSION SYSTEM		EXPLOSIVES	OTHER (Specify)
PNEUMATIC SYSTEM	UNKNOWN	BLEED AIR	UNKNOWN	FUEL	UNKNOWN

7. N/A LOCATION OF INITIAL FIRE

KNOWN		PROBABLE		KNOWN		PROBABLE	
BAGGAGE COMPARTMENT						WHEEL WELL	
BOMB BAY				FORWARD OF FIREWALL		CARGO-PASSENGER COMPARTMT.	
COCKPIT OR CREW QUARTERS				ROCKET POD		OTHER (Specify)	
ENGINE SECTION				TIRE, WHEEL OR BRAKE		UNKNOWN	

8. N/A MISCELLANEOUS CHEMICAL EXPLOSION DATA

KNOWN		PROBABLE		KNOWN		PROBABLE	
INITIAL IGNITION OCCURRED IN AN EXPLOSIVE MANNER PRIOR TO GROUND IMPACT.				INTENSITY OF EXPLOSION WAS SUFFICIENT TO CAUSE OR APPRECIABLY CONTRIBUTE TO IN-FLIGHT AIRFRAME BREAK-UP.			
EXPLOSION OCCURRED AFTER FIRE BEFORE GRD IMPACT.				OTHER SIGNIFICANT DATA (Specify)			
EXPLOSION OCCURRED SUBSEQUENT TO GROUND IMPACT.				UNKNOWN OR NOT AVAILABLE			

34

**TAB D**

**AF FORM 711c**

**AIRCRAFT MAINTENANCE AND MATERIEL REPORT**

**D-1 UH-60 Black Hawk 88-26060**

**D-2 UH-60 Black Hawk 87-26000**

**D-3 E-3B AWACS**

**D-4 F-15C 79-0025**

**D-5 F-15C 84-0025**

**D-1**

**D-2**

**D-3**

**D-4**



**TAB D**

**AF FORM 711c**

**AIRCRAFT MAINTENANCE AND MATERIEL REPORT**

**D-1 UH-60 Black Hawk 88-26060**

**D-2 UH-60 Black Hawk 87-26000**

**D-3 E-3B AWACS**

**D-4 F-15C 79-0025**

**D-5 F-15C 84-0025**

**D-1**

**D-2**

**D-3**

**D-4**

**D-5**



(When filled)

# AIRCRAFT MAINTENANCE AND MATERIEL REPORT

1. AIRCRAFT SERIAL NUMBER 79-0025	2. MISSION DESIGN AND SERIES (MDS) F-15C
--------------------------------------	---

3. HISTORICAL DATA	
AIRCRAFT	DEFICIENT PART COMPONENT OR ACCESSORY
AIR FORCE ACCEPTANCE DATE Aug 80	NOVA
TOTAL FLIGHT HOURS 3600	PART NUMBER
LAST OVERHAUL DATE 07/29/93	T.O. REFERENCE N/A
OVERHAULING ACTIVITY (Name & Loc) IAI (Ben Gurion A)	FIGURE N/A
HOURS SINCE OVERHAUL 290.6	INDEX
HOURS SINCE LAST SCHEDULED INSP. 116.1	WORK UNIT CODE
DATE OF LAST SCHEDULED INSPECTION 01/28/94	TDR REQUESTED YES <input type="checkbox"/> NO <input type="checkbox"/>
TYPE OF LAST SCHEDULED INSPECTION #1 HPO	MDR SUBMITTED YES <input type="checkbox"/> NO <input type="checkbox"/>
DATE ASSIGNED PRESENT ORGN. 25 FEB 94	MDR NUMBER
ORGN. TRANSFERRED FROM 36 FW	MIP NUMBER

ENGINE (Complete a Column for each Engine)	
INSTALLED POSITION #1	#2
ENGINE MODEL AND SERIES PW100-100	PW100-100
ENGINE SERIAL NUMBER P68-1412	P68-1901
TOTAL ENGINE HOURS Flt Time 3039	2682
NUMBER OF MAJOR OVERHAULS	
HRS SINCE LAST MAJOR OVERHAUL	
DATE OF LAST OVERHAUL N/A	N/A
OVERHAUL ACTIVITY	
DATE LAST INSTALLED	
HOURS SINCE LAST INSTALLED	
DATE OF LAST SCHEDULED INSPECTION	
TYPE OF LAST SCHEDULED INSPECTION	
FUEL (Type & Octane Rating) JP4/JP8	JP4/JP8
TDR REQUESTED NO	NO

4. N/A SOAP SAMPLES (Engine, CSD, Gearbox or APU failure of which occurred or was suspected) N/A

ITEM AND SERIAL NUMBER																				
HOURS SINCE							HOURS SINCE													
O/H	OIL CHANGE	FE	CR	AG	AL	CU	SN	MG	TI	O/H	OIL CHANGE	FE	CR	AG	AL	CU	SN	MG	TI	

5. DAMAGED AIRCRAFT (Furnish complete damage information under Tab "L". See AF Form 711h)

DAMAGE TO AIRCRAFT <input type="checkbox"/> DESTROYED OR DAMAGED BEYOND ECONOMICAL REPAIR <input type="checkbox"/> SUBSTANTIAL <input type="checkbox"/> MINOR <input checked="" type="checkbox"/> LESS THAN MINOR OR NONE	MANHOURS TO REPAIR	COST (ESTIMATE)
---	--------------------	-----------------

6. N/A (To be completed when fire or chemical explosion occurs, not resulting from ground impact. Indicate: P - Probable or K - Known, in squares)

A. MATERIEL FAILURE CAUSING THE FIRE		B. IGNITION SOURCE		C. COMBUSTIBLE MATERIAL	
ELECTRICAL SYSTEM	PROPULSION SYSTEM	ELECTRICAL SYSTEM	STATIC ELECTRICITY/LIGHTNING	CARGO	HYDRAULIC FLUID
FUEL SYSTEM	BLEED AIR SYSTEM	PNEUMATIC SYSTEM	OTHER (Specify)	ELECTRICAL INSULATION	LUBRICATING OIL
HYDRAULIC SYSTEM	OTHER (Specify)	PROPULSION SYSTEM		EXPLOSIVES	OTHER (Specify)
PNEUMATIC SYSTEM	UNKNOWN	BLEED AIR	UNKNOWN	FUEL	UNKNOWN

7. N/A LOCATION OF INITIAL FIRE

	KNOWN	PROBABLE		KNOWN	PROBABLE		KNOWN	PROBABLE
BAGGAGE COMPARTMENT			AFT OF FIREWALL			WHEEL WELL		
BOMB BAY			FORWARD OF FIREWALL			CARGO-PASSENGER COMPARTMT.		
COCKPIT OR CREW QUARTERS			ROCKET POD			OTHER (Specify)		
ENGINE SECTION			TIRE, WHEEL OR BRAKE			UNKNOWN ( )		

8. N/A MISCELLANEOUS CHEMICAL EXPLOSION DATA

	KNOWN	PROBABLE		KNOWN	PROBABLE
INITIAL IGNITION OCCURRED IN AN EXPLOSIVE MANNER PRIOR TO GROUND IMPACT.			INTENSITY OF EXPLOSION WAS SUFFICIENT TO CAUSE OR APPRECIABLY CONTRIBUTE TO IN-FLIGHT AIRFRAME BREAK-UP.		
EXPLOSION OCCURRED AFTER FIRE & BEFORE GRD IMPACT.			OTHER SIGNIFICANT DATA (Specify)		
EXPLOSION OCCURRED SUBSEQUENT TO GROUND IMPACT.			UNKNOWN OR NOT AVAILABLE		

**AFR 110-14 AIRCRAFT ACCIDENT BOARD  
INDEX OF TABS**

- A AF Form 711 - USAF Mishap Report**
- B AF Form 711a - Ground Mishap Report (Not Applicable)**
- C AF Form 711b - Aircraft Flight Mishap Report**
- D AF Form 711c - Aircraft Maintenance and Materiel Report**
- E AF Form 711d - Missile or Space Vehicle Mishap Report (Not Applicable)**
- F AF Form 711e - Explosives Mishap Report (Not Applicable)**
- G Flight and Personnel Records (Not Applicable)**
- H AFTO Forms 781 and DA Forms 2408**
- I Materiel Deficiency Report (Not Applicable)**
- J Technical or Engineering Evaluations**
- K Military Flight Plans**
- L DD Form 365-4, Weight and Balance Clearance Forms**
- M Certificate of Damage**
- N Transcripts of Recorded Communications**

**A  
B  
C  
D  
E**

**AFR 110-14 AIRCRAFT ACCIDENT BOARD  
INDEX OF TABS**

- A AF Form 711 - USAF Mishap Report**
  - B AF Form 711a - Ground Mishap Report (Not Applicable)**
  - C AF Form 711b - Aircraft Flight Mishap Report**
  - D AF Form 711c - Aircraft Maintenance and Materiel Report**
  - E AF Form 711d - Missile or Space Vehicle Mishap Report (Not Applicable)**
  - F AF Form 711e - Explosives Mishap Report (Not Applicable)**
  - G Flight and Personnel Records (Not Applicable)**
  - H AFTO Forms 781 and DA Forms 2408**
  - I Materiel Deficiency Report (Not Applicable)**
  - J Technical or Engineering Evaluations**
  - K Military Flight Plans** **A**
  - L DD Form 365-4, Weight and Balance Clearance Forms** **B**
  - M Certificate of Damage** **C**
  - N Transcripts of Recorded Communications** **D**
- E**  
**F**

**AFR 110-14 AIRCRAFT ACCIDENT BOARD  
INDEX OF TABS**

- A AF Form 711 - USAF Mishap Report**
  - B AF Form 711a - Ground Mishap Report (Not Applicable)**
  - C AF Form 711b - Aircraft Flight Mishap Report**
  - D AF Form 711c - Aircraft Maintenance and Materiel Report**
  - E AF Form 711d - Missile or Space Vehicle Mishap Report (Not Applicable)**
  - F AF Form 711e - Explosives Mishap Report (Not Applicable)**
  - G Flight and Personnel Records (Not Applicable)**
  - H AFTO Forms 781 and DA Forms 2408**
  - I Materiel Deficiency Report (Not Applicable)**
  - J Technical or Engineering Evaluations**
  - K Military Flight Plans** **A**
  - L DD Form 365-4, Weight and Balance Clearance Forms** **B**
  - M Certificate of Damage** **C**
  - N Transcripts of Recorded Communications** **D**
- E**  
**F**  
**G**

**AFR 110-14 AIRCRAFT ACCIDENT BOARD  
INDEX OF TABS**

- A AF Form 711 - USAF Mishap Report**
  - B AF Form 711a - Ground Mishap Report (Not Applicable)**
  - C AF Form 711b - Aircraft Flight Mishap Report**
  - D AF Form 711c - Aircraft Maintenance and Materiel Report**
  - E AF Form 711d - Missile or Space Vehicle Mishap Report (Not Applicable)**
  - F AF Form 711e - Explosives Mishap Report (Not Applicable)**
  - G Flight and Personnel Records (Not Applicable)**
  - H AFTO Forms 781 and DA Forms 2408**
  - I Materiel Deficiency Report (Not Applicable)**
  - J Technical or Engineering Evaluations**
  - K Military Flight Plans** **A**
  - L DD Form 365-4, Weight and Balance Clearance Forms** **B**
  - M Certificate of Damage** **C**
  - N Transcripts of Recorded Communications** **D**
- E**  
**F**  
**G**  
**H**

**TAB H**

**AFTO FORMS 781 AND DA FORMS 2408**

**H-1 UH-60 Black Hawk 88-26060**

**H-2 UH-60 Black Hawk 87-26000**

**H-3 E-3B AWACS**

**H-4 F-15C 79-0025**

**H-5 F-15C 84-0025**

**H-1**

**TAB H-1**

**UH-60 BLACK HAWK 88-26060**

**H-1a DA Form 2408-13, Aircraft Status Information Record, 13 April 1994**

**H-1b DA Form 2408-13-1, Extracts from the 30 Day Maintenance Record**

**H-1c DA Form 2408-5, Equipment Modification Record**

**H-1a**

**H-1d DA Form 2408-20, Oil Analysis Record**

**H-1e DA Form 2408-17, Aircraft Inventory Record**

DATE

13 APR 94

NUMBER OF PAGES IN FLIGHT PACK

1. AIRCRAFT SERIAL NUMBER 8826060		2. MODEL UH60A		3. UIC W0V27A		4. STATION FDEU		5. NAME OF CE/MECH SPC Robinson		
6. ENGINE HIT READINGS			7. APU HISTORY				8. ROUNDS FIRED AIR-FRAME		9. ENGINE STARTS	
DATE	NO. 1	NO. 2		HOURS	STARTS	HR METER		NO. 1	NO. 2	
			CURRENT	1528.2	2092					
			TODAY	1.0	10					
			TOTAL	1529.2	2102					
10. SYSTEM STATUS					11. FLIGHT DATA					
ACFT						AIRCRAFT HOURS	LANDINGS		HSF/ CYCLES	
							STD	AUTO		
						CURRENT	1217.7	93	0	
ARM						TODAY	4.3	5	0	
ELECT						TOTAL	1222.0	98	0	
OTHER										
12. SCHEDULED INSPECTION INFORMATION										
a. HOURS OF OPERATION SINCE LAST GENERATION	b. NEXT PHASE/SCHEDULED INSP (NO)			d. HOURS OF OPERATION TO NEXT PHASE/SCHEDULED INSPECTION			e. PMD DUE			
	PMS II						DATE COMPLETED			
	c. NEXT PHASE/SCHEDULED INSP DUE AT						PID			
	1462.4									
13. LOCAL USE										
3/7										

DA FORM 2408-13, OCT 91

EDITION OF DEC 66 IS OBSOLETE

## AIRCRAFT STATUS INFORMATION RECORD

For use of this form, see DA PAM 738-751; the proponent agency is DCSLOG

## EXTRACT

I certify that I am the Records Custodian for the Accident Investigation Board convened to investigate the crash of two U.S. Army Black Hawk helicopters in the no fly zone in northern Iraq on 14 April 1994, and that this is a true and accurate extract from DA Form 2408-13, DTD 13 APR 94 rec'd from 6 month Maintenance File, ACFT # 88-26060 which is kept in my records system.

7 May 94  
Date

WILLIAM L. HARRIS, Capt, USAF, MSC  
Evidence Custodian, Incirlik Air Base, Turkey



**TAB H-1**

**UH-60 BLACK HAWK 88-26060**

**H-1a DA Form 2408-13, Aircraft Status Information Record, 13 April 1994**

**H-1b DA Form 2408-13-1, Extracts from the 30 Day Maintenance Record**

**H-1c DA Form 2408-5, Equipment Modification Record**

**H-1a**

**H-1d DA Form 2408-20, Oil Analysis Record**

**H-1e DA Form 2408-17, Aircraft Inventory Record**

**H-1b**

1. AIRCRAFT SERIAL NUMBER <b>8826060</b>				2. MODEL <b>UH60A</b>		3. DATE <b>28 MAR 94</b>		4. PAGE <b>1</b>	
PART I - FAULT INFORMATION						PART II - CORRECTING INFORMATION			
STATUS	SYS	DATE	NO.	TIME	PID	DATE	TIME	HRS	
	<b>A</b>	<b>13 OCT 93</b>				<b>10 APR 94</b>			
FAULT/REMARKS <b>COP CENTER MAP LIGHT INOP (61620-01-253-0143)</b>						ROUNDS	ACTION CODE	WUC	
						ACTION	<b>C/F G/C</b>		
						PID	HOURS	PID	HOURS
AC HRS <b>1054.8</b>		WHEN DISC	HOW REC	MAL EFF	WUC	CMH	OMH	FMH	DMH
W.O.		REQ	OTHER			TI PID	TI MAN-HOURS		
STATUS	SYS	DATE	NO.	TIME	PID	DATE	TIME	HRS	
	<b>H</b>	<b>09 OCT 93</b>				<b>10 APR 94</b>			
FAULT/REMARKS <b>#1 ENG ECU V/N NOT INSTALLED ON ENG. 2408-12-1</b>						ROUNDS	ACTION CODE	WUC	
						ACTION	<b>C/F G/C</b>		
						PID	HOURS	PID	HOURS
AC HRS <b>1054.8</b>		WHEN DISC	HOW REC	MAL EFF	WUC	CMH	OMH	FMH	DMH
W.O.		REQ	OTHER			TI PID	TI MAN-HOURS		
STATUS	SYS	DATE	NO.	TIME	PID	DATE	TIME	HRS	
	<b>H</b>	<b>10 NOV 93</b>				<b>10 APR 94</b>			
FAULT/REMARKS <b>4th (UH60A) DOOR WINDOW USED Pressure Valve</b>						ROUNDS	ACTION CODE	WUC	
						ACTION	<b>C/F G/C</b>		
						PID	HOURS	PID	HOURS
AC HRS <b>1054.5</b>		WHEN DISC	HOW REC	MAL EFF	WUC	CMH	OMH	FMH	DMH
W.O.		REQ	OTHER			TI PID	TI MAN-HOURS		

DA FORM 2006-13-1; OCT 91

AIRCRAFT INSPECTION AND MAINTENANCE RECORD  
For use of this form, see DA PAM 738-751, the proponent agency is OCSLOG

**EXTRACT**

I certify that I am the Records Custodian for the Accident Investigation Board convened to investigate the crash of two U.S. Army Black Hawk helicopters in the fly zone in northern Iraq on 14 April 1994, and that this is a true and accurate extract from

**30 day Maintenance Record, 88-26060**

which is kept in the records system.

**23 May 94**  
Date

**WILLIAM L. HARRIS, Capt, USAF, MSC**  
Evidence Custodian, Incirlik Air Base, Turk

PART I - FAULT INFORMATION							PART II - CORRECTING INFORMATION								
STATUS	SYS	DATE	NO	TIME	PID	DATE	TIME	HRS	ROUNDS	ACTION CODE	WUC				
/	H	10 NOV 93				10 APR 94									
FAULT/REMARKS							ACTION								
H CARGO DOOR WINDOW WELD BUSTING WOP							C/F G/C								
AVC HRS	WHEN DISC	HOW REC	MAL EFF	WUC	CMH	OMH	FMH	DMH	TIPID	TI MAN-HOURS					
1054.8															
W O	REQ	OTHER													
		03 F 4405-0528													
STATUS	SYS	DATE	NO	TIME	PID	DATE	TIME	HRS	ROUNDS	ACTION CODE	WUC				
/	A	10 NOV 93				10 APR 94									
FAULT/REMARKS							ACTION								
GUARDERS WINDOW VENT LEVER NOT INSTALLED							C/F G/C								
AVC HRS	WHEN DISC	HOW REC	MAL EFF	WUC	CMH	OMH	FMH	DMH	TIPID	TI MAN-HOURS					
154.8															
W O	REQ	OTHER													
STATUS	SYS	DATE	NO	TIME	PID	DATE	TIME	HRS	ROUNDS	ACTION CODE	WUC				
/	H	10 NOV 93				10 APR 94									
FAULT/REMARKS							ACTION								
E/ENG BUSTING Nylon BUMBERS CRACKED							C/F G/C								
AVC HRS	WHEN DISC	HOW REC	MAL EFF	WUC	CMH	OMH	FMH	DMH	TIPID	TI MAN-HOURS					
1054.8															
W O	REQ	OTHER													

1. AIRCRAFT SERIAL NUMBER 8826002				2. MODEL UH60A		3. DATE 28 MAR 94		4. PAGE 2	
PART I - FAULT INFORMATION						PART II - CORRECTING INFORMATION			
STATUS	SYS	DATE	NO.	TIME	PID	DATE	TIME	HRS	
	A	10 NOV 93				10 APR 94			
FAULT/REMARKS #2 ENG COUPLING ALONG BUZZERS OBTAINED						ROUNDS	ACTION CODE	WUC	
						ACTION	C/F C/S		
						PID	HOURS	PID	HOURS
A/C HRS	WHEN DISC	HOW REC	MAL EFF	WUC		CMH	OMH	FMH	DMH
109.48									
W.O.	REQ	OTHER				TI PID	TI MAN-HOURS		
STATUS	SYS	DATE	NO.	TIME	PID	DATE	TIME	HRS	
	A	1 DEC 93				10 APR 94			
FAULT/REMARKS LOWER TAILBOOM STEP ROTATES FORWARD						ROUNDS	ACTION CODE	WUC	
						ACTION	C/F C/S		
						PID	HOURS	PID	HOURS
A/C HRS	WHEN DISC	HOW REC	MAL EFF	WUC		CMH	OMH	FMH	DMH
109.2									
W.O.	REQ	OTHER				TI PID	TI MAN-HOURS		
STATUS	SYS	DATE	NO.	TIME	PID	DATE	TIME	HRS	
	A	21 JAN 94				23 MAR 94	1620	1187.8	
FAULT/REMARKS 111-10-94 ASR11-05 REPLACEMENT OF RH MR SPINDLE DUE AT THE NEXT PMIS-2						ROUNDS	ACTION CODE	WUC	
						ACTION	ENTIRE ENTIRE INSPECTION UG. 4000 2408-141 W		
						PID	HOURS	PID	HOURS
A/C HRS	WHEN DISC	HOW REC	MAL EFF	WUC		CMH	OMH	FMH	DMH
1124.5									
W.O.	REQ	OTHER				TI PID	TI MAN-HOURS		

1. AIRCRAFT SERIAL NUMBER 8026060		2. MODEL UH60A		3. DATE 28 MAR 94		4. PAGE 3					
PART I - FAULT INFORMATION						PART II - CORRECTING INFORMATION					
STATUS	SYS A	DATE 12 FEB 94	NO	TIME	PID	DATE 10 APR 94	TIME	HRS	ROUNDS	ACTION CODE	WUC
FAULT/REMARKS 4th REFIN PANEL NOT EME MODIFIED WALW MWO 1-1520-237-50-59						ACTION C/F G/L					
A/C HRS 1142.4	WHEN DISC	HOW REC	MAL EFF	WUC	CMH	OMH	FMH	DMH	TI TIPIID	TI MAN-HOURS	
W.O.	REQ	OTHER									
STATUS	SYS A	DATE 12 FEB 94	NO	TIME	PID	DATE 10 APR 94	TIME	HRS	ROUNDS	ACTION CODE	WUC
FAULT/REMARKS PIN FILTER HEADERS REMD FROM FAULT/ADVISORY PANEL SYSTEM NO LONGER EME MODIFIED WALW MWO 1-1520-237-50-59						ACTION C/F G/L					
A/C HRS 1142.4	WHEN DISC	HOW REC	MAL EFF	WUC	CMH	OMH	FMH	DMH	TI TIPIID	TI MAN-HOURS	
W.O.	REQ	OTHER									
STATUS	SYS A	DATE 22 FEB 94	NO	TIME	PID	DATE 10 APR 94	TIME	HRS	ROUNDS	ACTION CODE	WUC
FAULT/REMARKS OPERATE WITHIN THE LIMITATIONS AND RESTRICTIONS SPECIFIED IN THE ENCLOSED AWR DATED 1 DEC 93						ACTION C/F G/L					
A/C HRS 1147.6	WHEN DISC	HOW REC	MAL EFF	WUC	CMH	OMH	FMH	DMH	TI TIPIID	TI MAN-HOURS	
W.O.	REQ	OTHER									



1 AIRCRAFT SERIAL NUMBER 5826060				2. MODEL 4116DA			3 DATE 25 MAR 94		4. PAGE 4	
PART I - FAULT INFORMATION						PART II - CORRECTING INFORMATION				
M	STATUS	SYS A	DATE 26 MAR 94	NO.	TIME 1623	PID	DATE 28 MAR 94	TIME 0745	HRS 1189.8	
FAULT/REMARKS Visual Insp of GPS RGD BEFORE REFIT						ACTION INSP COMPLETE P177				
A/C HRS 1189.8						WHEN DISC	HOW REC	MAL EFF	WUC	
W.O.						REQ	OTHER			
	STATUS	SYS A	DATE 28 MAR 94	NO.	TIME 1630	PID	DATE 10 APR 94	TIME	HRS	
FAULT/REMARKS Mode 4 chk DUE 1189.1 ACFT HRS M						ACTION CIFCS				
A/C HRS 1189.8						WHEN DISC	HOW REC	MAL EFF	WUC	
W.O.						REQ	OTHER			
R	STATUS	SYS A	DATE 28 MAR 94	NO.	TIME 1656	PID	DATE 30 MAR 94	TIME 1100	HRS 1195.4	
FAULT/REMARKS FLT 1 COPILOT'S DEDON NEEDS ADJUSTMENT P177						ACTION ADJUSTED DEDON				
A/C HRS 1195.9						WHEN DISC	HOW REC	MAL EFF	WUC	
W.O.						REQ	OTHER			

1. AIRCRAFT SERIAL NUMBER 8826060		2. MODEL UH60A		3. DATE 19 MAR 94		4. PAGE 9					
PART I - FAULT INFORMATION						PART II - CORRECTING INFORMATION					
STATUS	SYS	DATE	NO.	TIME	PID	DATE	TIME	HRS	ROUNDS	ACTION CODE	WUC
A	A	17 MAR 94		1600		19 MAR 94	0630	1169.7			
FAULT/REMARKS collar new boost servo INSP due 16						ACTION Completed w. flying					
A/C HRS 1169.7						CMH					
W.O.						TIPIID					
WHEN DISC						TI MAN-HOURS					
HOW REC						DATE 19 MAR 94					
MAL EFF						TIME 0645					
WUC						HRS 1169.7					
W.O.						ROUNDS					
REQ						ACTION CODE					
OTHER						WUC					
STATUS	SYS	DATE	NO.	TIME	PID	DATE	TIME	HRS	ROUNDS	ACTION CODE	WUC
A	A	17 MAR 94		1600		19 MAR 94	0645	1169.7			
FAULT/REMARKS visual INSP of AFMS INSP due before first flight						ACTION Completed w. flying					
A/C HRS 1169.7						CMH					
W.O.						TIPIID					
WHEN DISC						TI MAN-HOURS					
HOW REC						DATE 17 MAR 94					
MAL EFF						TIME 0645					
WUC						HRS 1169.7					
W.O.						ROUNDS					
REQ						ACTION CODE					
OTHER						WUC					
STATUS	SYS	DATE	NO.	TIME	PID	DATE	TIME	HRS	ROUNDS	ACTION CODE	WUC
A	A	17 MAR 94		1600		17 MAR 94	0645	1169.7			
FAULT/REMARKS visual INSP of GPS due before first flight						ACTION Completed w. flying					
A/C HRS 1169.7						CMH					
W.O.						TIPIID					
WHEN DISC						TI MAN-HOURS					
HOW REC						DATE 17 MAR 94					
MAL EFF						TIME 0645					
WUC						HRS 1169.7					
W.O.						ROUNDS					
REQ						ACTION CODE					
OTHER						WUC					

DA FORM 2408-13-1, OCT 91

AIRCRAFT INSPECTION AND MAINTENANCE RECORD  
For use of this form, see DA PAM 738-751, the proponent agency is DCSLOG

**EXTRACT**

I certify that I am the Records Custodian for the Accident Investigation Board convened to investigate the crash of two U.S. Army Black Hawk helicopters in the no fly zone in northern Iraq on 14 April 1994, and that this is a true and accurate extract from

*30 Day Maintenance Record, 88-26060*

which is kept in my records system.

*23 Mar 94*  
Date

WILLIAM L. HARRIS, Capt. USAF, MSC  
Evidence Custodian, Incirlik Air Base, Turkey

3





1. AIRCRAFT SERIAL NUMBER <b>8826060</b>		2. MODEL <b>UH60A</b>		3. DATE <b>03 APR 94</b>		4. PAGE <b>11</b>					
PART I - FAULT INFORMATION						PART II - CORRECTING INFORMATION					
<b>R</b> STATUS	SYS	DATE	NO.	TIME	PID	DATE	TIME	HRS	ROUNDS	ACTION CODE	WUC
		<b>30 MAR 94</b>		<b>1454</b>		<b>30 MAR 94</b>	<b>1700</b>	<b>1198.2</b>			
FAULT/REMARKS <b>1000hr 1400: I NSP DUE 1199.7 ACFT HRS</b>						ACTION <b>Completed</b>					
A/C HRS <b>1198.4</b> WHEN DISC HOW REC MAL EFF WUC						CMH OMH FMH DMH					
W.O. REQ OTHER <b>2405-13-2 P9 12</b>						TI PID TI MAN-HOURS					
<b>M</b> STATUS	SYS	DATE	NO.	TIME	PID	DATE	TIME	HRS	ROUNDS	ACTION CODE	WUC
		<b>30 MAR 94</b>		<b>1607</b>		<b>30 MAR 94</b>	<b>1610</b>	<b>1198.4</b>			
FAULT/REMARKS <b>1 GA Zeus fastener on APU fuel control panel</b>						ACTION <b>Installed Zeus fastener</b>					
A/C HRS <b>1197.4</b> WHEN DISC HOW REC MAL EFF WUC						CMH OMH FMH DMH					
W.O. REQ OTHER						TI PID TI MAN-HOURS					
<b>P</b> STATUS	SYS	DATE	NO.	TIME	PID	DATE	TIME	HRS	ROUNDS	ACTION CODE	WUC
		<b>30 MAR 94</b>		<b>1100</b>		<b>30 MAR 94</b>	<b>1630</b>	<b>1198.1</b>			
FAULT/REMARKS <b>Blue TIR pic Rod Bonding Jumper Broken</b>						ACTION <b>REPLACED BONDING JUMPER</b>					
A/C HRS <b>1193.1</b> WHEN DISC HOW REC MAL EFF WUC						CMH OMH FMH DMH					
W.O. REQ OTHER <b>2405-11-2 P9 13</b>						TI PID TI MAN-HOURS					

DA FORM 2408-13-1, OCT 91

AIRCRAFT INSPECTION AND MAINTENANCE RECORD  
For use of this form, see DA PAM 738-751, the proponent agency is DCSLOG

**EXTRACT**

I certify that I am the Records Custodian for the Accident Investigation Board convened to investigate the crash of two U.S. Army Black Hawk helicopters in the no fly zone in northern Iraq on 14 April 1994, and that this is a true and accurate extract from

**30 Day Maintenance Record 88-26060**

which is kept in my records system.

**W. L. Harris**  
WILLIAM L. HARRIS, Capt, USAF, MSC  
Evidence Custodian, Incirlik Air Base, Turkey

Date \_\_\_\_\_

PART I - FAULT INFORMATION							PART II - CORRECTING INFORMATION					
<input checked="" type="checkbox"/>	STATUS	SYS	DATE	NO	TIME	PID	DATE	TIME	HRS			
		A	31MAR94		1100		5 APR 94	1430	1202.4			
FAULT/REMARKS							ROUNDS	ACTION CODE		WUC		
NIR SPAR pressure ck due APR 12 94							ACTION completed					
							PID	HOURS	PID	HOURS	PID	HOURS
A/C HRS 1198.4			WHEN DISC	HOW REC	MAL EFF	WUC	CMH	OMH	FMH	DMH		
WO			REQ	OTHER 2408-13-29523			TI PID		TI MAN-HOURS			
<input type="checkbox"/>	STATUS	SYS	DATE	NO	TIME	PID	DATE	TIME	HRS			
		A	31MAR94		1100		10 APR 94					
FAULT/REMARKS							ROUNDS	ACTION CODE		WUC		
Gyromagnetic + starob, compass swing							ACTION CFCJC					
Due Apr 1 94							PID	HOURS	PID	HOURS	PID	HOURS
A/C HRS 1198.4			WHEN DISC	HOW REC	MAL EFF	WUC	CMH	OMH	FMH	DMH		
WO			REQ	OTHER			TI PID		TI MAN-HOURS			
<input checked="" type="checkbox"/>	STATUS	SYS	DATE	NO	TIME	PID	DATE	TIME	HRS			
		A	31MAR94		0930		31 MAR 94	1000	1198.4			
FAULT/REMARKS							ROUNDS	ACTION CODE		WUC		
static grounding cable broken							ACTION Replaced cable					
							PID	HOURS	PID	HOURS	PID	HOURS
A/C HRS 1198.4			WHEN DISC	HOW REC	MAL EFF	WUC	CMH	OMH	FMH	DMH		
WO			REQ	OTHER			TI PID		TI MAN-HOURS			

REVERSE OF DA FORM 2408-13-1, OCT 91

1. AIRCRAFT SERIAL NUMBER <u>8326060</u>		2. MODEL <u>UH60A</u>		3. DATE <u>03 APR 94</u>		4. PAGE <u>17</u>					
PART I - FAULT INFORMATION				PART II - CORRECTING INFORMATION							
STATUS	SYS <u>A</u>	DATE <u>03 APR 94</u>	NO.	TIME <u>0820</u>	PID	DATE <u>10 APR 94</u>	TIME	HRS			
FAULT/REMARKS <u>Zincs (valve) not installed on 2/5 stop fitting</u>				ROUNDS				ACTION CODE	WUC		
<u>DODR</u>				ACTION <u>C/F C/S</u>							
A/C HRS <u>193.4</u>				WHEN DISC	HOW REC	MAL EFF	WUC	CMH	OMH	FMH	DMH
W.O.				REQ	OTHER	TIPIID		TI MAN-HOURS			
STATUS	SYS	DATE	NO.	TIME	PID	DATE	TIME	HRS			
FAULT/REMARKS <u>Fly #1 OIL OK</u>				ROUNDS				ACTION CODE	WUC		
A/C HRS				WHEN DISC	HOW REC	MAL EFF	WUC	CMH	OMH	FMH	DMH
W.O.				REQ	OTHER	TIPIID		TI MAN-HOURS			
STATUS	SYS	DATE	NO.	TIME	PID	DATE	TIME	HRS			
FAULT/REMARKS <u>Fly #2 OIL OK</u>				ROUNDS				ACTION CODE	WUC		
A/C HRS				WHEN DISC	HOW REC	MAL EFF	WUC	CMH	OMH	FMH	DMH
W.O.				REQ	OTHER	TIPIID		TI MAN-HOURS			

DA FORM 2408-13-1, OCT 91

AIRCRAFT INSPECTION AND MAINTENANCE RECORD  
For use of this form, see DA PAM 738-751, the proponent agency is DCSLOG

**EXTRACT**

I certify that I am the Records Custodian for the Accident Investigation Board convened to investigate the crash of two U.S. Army Black Hawk helicopters in the no fly zone in northern Iraq on 14 April 1994, and that this is a true and accurate extract from:

50 Army Maintenance Report 83-26060  
which is kept in my records system.

23 May 94  
Date

WILLIAM L. HARRIS, Capt, USAF, MSC  
Evidence Custodian, Incirlik Air Base, Turkey

1 AIRCRAFT SERIAL NUMBER 3226060		2. MODEL UH60A		3. DATE 04 APR 94		4. PAGE 18						
PART I - FAULT INFORMATION						PART II - CORRECTING INFORMATION						
#	STATUS	SYS	DATE	NO.	TIME	PID	DATE	TIME	HRS	ROUNDS	ACTION CODE	WUC
#		A	03 APR 94		1812		04 APR 94	1615	1202.0			
FAULT/REMARKS Coll 4th boost servo Insp Doc N						ACTION completed v. 4-g						
A/C HRS 1202.0						CMH						
W.O.						TI MAN-HOURS						
#	STATUS	SYS	DATE	NO.	TIME	PID	DATE	TIME	HRS	ROUNDS	ACTION CODE	WUC
#		A	03 APR 94		1814		04 APR 94	1615	1202.0			
FAULT/REMARKS Visual Insp of AMFS Before first flight						ACTION completed v. 4-g						
A/C HRS 1202.0						CMH						
W.O.						TI MAN-HOURS						
#	STATUS	SYS	DATE	NO.	TIME	PID	DATE	TIME	HRS	ROUNDS	ACTION CODE	WUC
#		A	03 APR 94		1815		04 APR 94	1615	1202.0			
FAULT/REMARKS Visual Insp of GPs before first flight						ACTION completed v. 4-g						
A/C HRS 1202.0						CMH						
W.O.						TI MAN-HOURS						

DA FORM 2408-13-1, OCT 91

AIRCRAFT INSPECTION AND MAINTENANCE RECORD  
For use of this form, see DA PAM 738-751, the proponent agency is DCSLOG

**EXTRACT**

I certify that I am the Records Custodian for the Accident Investigation Board convened to investigate the crash of two U.S. Army Black Hawk helicopters in the no fly zone in northern Iraq on 14 April 1994, and that this is a true and accurate extract from

30 Day Maintenance Record, 88-26060  
which is kept in my records system.

23 May 94  
Date

WILLIAM L. HARRIS, Capt, USAF, MSC  
Evidence Custodian, Incirlik Air Base, Turkey

PART I - FAULT INFORMATION							PART II - CORRECTING INFORMATION					
STATUS	SYS	DATE	NO	TIME	PID	DATE	TIME	HRS				
	A	04 APR 94		C.930		10 APR 94	1					
FAULT/REMARKS							ROUNDS	ACTION CODE	WUC			
25 HR Oil Samples 1 up 12 13.4 RC + MRS M							ACTION C.F.G.C.					
							PID	HOURS	PID	HOURS	PID	HOURS
							CMH	OMH	FMH	DMH		
A/C HRS	WHEN DISC	HOW REC	MAL EFF	WUC			TIPID	TI MAN-HOURS				
1202.0												
W.O	REQ	OTHER					DATE	TIME	HRS			
							04 APR 94	1540	1202.0			
STATUS	SYS	DATE	NO	TIME	PID	ROUNDS	ACTION CODE	WUC				
X	A	04 APR 94		1420			Replaced Bearing	7024				
FAULT/REMARKS							PID	HOURS	PID	HOURS	PID	HOURS
Blue M/R PIC upper Rod Bearing excessive Limitation I/A/W 55-1520-237-23.3 M												
							CMH	OMH	FMH	DMH		
A/C HRS	WHEN DISC	HOW REC	MAL EFF	WUC			TIPID	TI MAN-HOURS				
1202.0												
W.O	REQ	OTHER					DATE	TIME	HRS			
		2408-18-2920					04 APR 94	1635	1202.0			
STATUS	SYS	DATE	NO	TIME	PID	ROUNDS	ACTION CODE	WUC				
X	A	04 APR 94		1450			Completed w. Rng					
FAULT/REMARKS							PID	HOURS	PID	HOURS	PID	HOURS
MTF Repairs for Removal + Reinstallation of Blue M/R PIC Rod												
							CMH	OMH	FMH	DMH		
A/C HRS	WHEN DISC	HOW REC	MAL EFF	WUC			TIPID	TI MAN-HOURS				
1202.0												
W.O	REQ	OTHER										

REVERSE OF DA FORM 2408-13-1, OCT 91

1. AIRCRAFT SERIAL NUMBER 8826060		2. MODEL UH60A		3. DATE 04 APR 94		4. PAGE 21					
PART I - FAULT INFORMATION						PART II - CORRECTING INFORMATION					
STATUS	SYS	DATE	NO.	TIME	PID	DATE	TIME	HRS	ROUNDS	ACTION CODE	WUC
	A	04 APR 94		1540		10 APR 94					
FAULT/REMARKS 250 HR STAB Insp Due 1212.4 ACFT HRS						ACTION C/E 90					
A/C HRS / 1202.0		WHEN DISC	HOW REC	MAL EFF	WUC	CMH	OMH	FMH	DMH	TI MAN-HOURS	
W/O		REQ	OTHER			TIPIID					
STATUS	SYS	DATE	NO.	TIME	PID	DATE	TIME	HRS	ROUNDS	ACTION CODE	WUC
#	A	04 APR 94		1450		04 APR 94	1500	1202.0			
FAULT/REMARKS Mod Required For Removal + Reinstall of Blue M/R p/c Rod						ACTION mod OK w/ [initials]					
A/C HRS / 1202.0		WHEN DISC	HOW REC	MAL EFF	WUC	CMH	OMH	FMH	DMH	TI MAN-HOURS	
W/O		REQ	OTHER			TIPIID					
<del>STATUS SYS DATE NO TIME PID</del>						<del>DATE TIME HRS</del>					
<del>FAULT/REMARKS</del>						<del>ROUNDS ACTION CODE WUC</del>					
<del>A/C HRS WHEN DISC HOW REC MAL EFF WUC</del>						<del>CMH OMH FMH DMH</del>					
<del>W/O REQ OTHER</del>						<del>TIPIID TI MAN-HOURS</del>					
<del>STATUS SYS DATE NO TIME PID</del>						<del>DATE TIME HRS</del>					
<del>FAULT/REMARKS</del>						<del>ROUNDS ACTION CODE WUC</del>					
<del>A/C HRS</del>		<del>WHEN DISC</del>	<del>HOW REC</del>	<del>MAL EFF</del>	<del>WUC</del>	<del>CMH</del>	<del>OMH</del>	<del>FMH</del>	<del>DMH</del>	<del>TI MAN-HOURS</del>	
<del>W/O</del>		<del>REQ</del>	<del>OTHER</del>			<del>TIPIID</del>		<del></del>			

DA FORM 2408-13-1, OCT 91

AIRCRAFT INSPECTION AND MAINTENANCE RECORD  
For use of this form, see DA PAM 738-751, the proponent agency is DCSLOG

**EXTRACT**

I certify that I am the Records Custodian for the Accident Investigation Board convened to investigate the crash of two U.S. Army Black Hawk helicopters in the no fly zone in northern Iraq on 14 April 1994, and that this is a true and accurate extract from

30 Day Maintenance Record; 88-26060  
which is kept in my records system.

23 May 94  
Date

WILLIAM L. HARRIS, Capt, USAF, MSC  
Evidence Custodian, Incirlik Air Base, Turkey

1. AIRCRAFT SERIAL NUMBER <b>8826060</b>		2. MODEL <b>UH60A</b>		3. DATE <b>08 APRIL 94</b>		4. PAGE <b>24</b>						
PART I - FAULT INFORMATION						PART II - CORRECTING INFORMATION						
<b>11</b>	STATUS	SYS <b>A</b>	DATE <b>05 APR 94</b>	NO	TIME <b>1920</b>	PID	DATE <b>08 APR 94</b>	TIME <b>1300</b>	HRS <b>1202.8</b>	ROUNDS	ACTION CODE	WUC
FAULT/REMARKS <b>Coll + Yaw Boost Servo Easy Disc Before 1st FH</b>						ACTION <b>INSP COMPLETE</b>						
A/C HRS <b>1202.8</b> WHEN DISC HOW REC MAL EFF WUC						CMH. OMH FMH DMH						
W.O. REQ OTHER						TIPIID TI MAN-HOURS						
<b>11</b>	STATUS	SYS <b>A</b>	DATE <b>05 APR 94</b>	NO	TIME <b>1920</b>	PID	DATE <b>08 APR 94</b>	TIME <b>1300</b>	HRS <b>1202.8</b>	ROUNDS	ACTION CODE	WUC
FAULT/REMARKS <b>Visual Insp of AFMS Required Before 1st FH</b>						ACTION <b>INSP COMPLETE</b>						
A/C HRS <b>1202.8</b> WHEN DISC HOW REC MAL EFF WUC						CMH. OMH FMH DMH						
W.O. REQ OTHER						TIPIID TI MAN-HOURS						
<b>11</b>	STATUS	SYS <b>A</b>	DATE <b>05 APR 94</b>	NO	TIME <b>1920</b>	PID	DATE <b>08 APR 94</b>	TIME <b>1300</b>	HRS <b>1202.8</b>	ROUNDS	ACTION CODE	WUC
FAULT/REMARKS <b>Visual Insp of GPS Required Before 1st FH</b>						ACTION <b>INSP COMPLETE</b>						
A/C HRS <b>1202.8</b> WHEN DISC HOW REC MAL EFF WUC						CMH. OMH FMH DMH						
W.O. REQ OTHER						TIPIID TI MAN-HOURS						

DA FORM 2408-13-1, OCT 91

AIRCRAFT INSPECTION AND MAINTENANCE RECORD  
For use of this form, see DA PAM 738-751, the proponent agency is DCSLOG

**EXTRACT**

I certify that I am the Records Custodian for the Accident Investigation Board convened to investigate the crash of two U.S. Army Black Hawk helicopters in the no fly zone in northern Iraq on 14 April 1994, and that this is a true and accurate extract from

**30 Day Maintenance Record, 88-26060**  
which is kept in my records system.

**23 May 94**  
1213

**W. L. Harris**  
WILLIAM L. HARRIS, Capt. USAF, MSC  
Evidence Custodian, Incirlik Air Base, Turkey



PART I - FAULT INFORMATION							PART II - CORRECTING INFORMATION																		
STATUS	SYS	DATE	NO	TIME	PID	DATE	TIME	HRS	ROUNDS	ACTION CODE	WUC														
FAULT/REMARKS <u>FLT 1 OK W. H. G.</u>							ACTION _____																		
							<table border="1"> <tr> <td>PID</td><td>HOURS</td><td>PID</td><td>HOURS</td><td>PID</td><td>HOURS</td> </tr> <tr> <td></td><td></td><td></td><td></td><td></td><td></td> </tr> </table>							PID	HOURS	PID	HOURS	PID	HOURS						
PID	HOURS	PID	HOURS	PID	HOURS																				
A/C HRS		WHEN DISC	HOW REC	MAL EFF	WUC	CMH	OMH	FMH	DMH																
W O		REQ	OTHER			TIPID	TI MAN-HOURS																		
STATUS	SYS	DATE	NO	TIME	PID	DATE	TIME	HRS	ROUNDS	ACTION CODE	WUC														
FAULT/REMARKS <u>FLT 2 OK W. H. G.</u>							ACTION _____																		
							<table border="1"> <tr> <td>PID</td><td>HOURS</td><td>PID</td><td>HOURS</td><td>PID</td><td>HOURS</td> </tr> <tr> <td></td><td></td><td></td><td></td><td></td><td></td> </tr> </table>							PID	HOURS	PID	HOURS	PID	HOURS						
PID	HOURS	PID	HOURS	PID	HOURS																				
A/C HRS		WHEN DISC	HOW REC	MAL EFF	WUC	CMH	OMH	FMH	DMH																
W O		REQ	OTHER			TIPID	TI MAN-HOURS																		
STATUS	SYS	DATE	NO	TIME	PID	DATE	TIME	HRS	ROUNDS	ACTION CODE	WUC														
FAULT/REMARKS <u>FLT 3 PLS UHF Radio T. mod</u> <u>W. H. G.</u>							ACTION <u>C/F G/C</u>																		
							<table border="1"> <tr> <td>PID</td><td>HOURS</td><td>PID</td><td>HOURS</td><td>PID</td><td>HOURS</td> </tr> <tr> <td></td><td></td><td></td><td></td><td></td><td></td> </tr> </table>							PID	HOURS	PID	HOURS	PID	HOURS						
PID	HOURS	PID	HOURS	PID	HOURS																				
A/C HRS <u>1206.7</u>		WHEN DISC	HOW REC	MAL EFF	WUC	CMH	OMH	FMH	DMH																
W O		REQ	OTHER			TIPID	TI MAN-HOURS																		

1. AIRCRAFT SERIAL NUMBER 8826060				2. MODEL UH60A		3. DATE 28 MAR 94		4. PAGE 4											
PART I - FAULT INFORMATION						PART II - CORRECTING INFORMATION													
M	STATUS	SYS A	DATE 26 MAR 94	NO.	TIME 1623	PID	DATE 28 MAR 94	TIME 0745	HRS 1187.8										
FAULT/REMARKS Visual INSPECTION OF GPS READ BEFORE 151 FH						ACTION INSPECTION COMPLETE													
A/C HRS 1189.8						WHEN DISC		HOW REC		MAL EFF		WUC							
W.O.						REQ		OTHER				CMH		OMH		FMH		DMH	
W.O.						REQ		OTHER				TIPIID		TI MAN-HOURS					
---	STATUS	SYS A	DATE 28 MAR 94	NO.	TIME 1630	PID	DATE 10 APR 94	TIME	HRS										
FAULT/REMARKS Mode 4 chk DUE 1189.1 ACFT HRS M						ACTION C/F C/L C/S													
A/C HRS 1189.8						WHEN DISC		HOW REC		MAL EFF		WUC							
W.O.						REQ		OTHER				CMH		OMH		FMH		DMH	
W.O.						REQ		OTHER				TIPIID		TI MAN-HOURS					
K	STATUS	SYS A	DATE 28 MAR 94	NO.	TIME 1656	PID	DATE 30 MAR 94	TIME 1106	HRS 1193.4										
FAULT/REMARKS FLT 1 COPILOTS DOOR NEEDS ADJUSTMENT						ACTION ADJUST DOOR													
A/C HRS 1193.9						WHEN DISC		HOW REC		MAL EFF		WUC							
W.O.						REQ		OTHER				CMH		OMH		FMH		DMH	
W.O.						REQ		OTHER				TIPIID		TI MAN-HOURS					

DA FORM 2409-13-1, OCT 91

AIRCRAFT INSPECTION AND MAINTENANCE RECORD

For use of this form, see DA PAM 738-751, the proponent agency is OCSLOG

EXTRACT

I certify that I am the Records Custodian for the Accident Investigation Board convened to investigate the crash of two U.S. Army Black Hawk helicopters in the fly zone in northern Iraq on 14 April 1994, and that this is a true and accurate extract from

30 Day Maintenance Record, 88-26060  
which is kept in my records system.

23 May 94  
Date

WILLIAM L. HARRIS, Capt. USAF, MSC  
Evidence Custodian, Incirlik Air Base, Turk

PART I - FAULT INFORMATION							PART II - CORRECTING INFORMATION																		
STATUS	SYS	DATE	NO	TIME	PID	DATE	TIME	HRS	ROUNDS	ACTION CODE	WUC														
<i>A</i>	<i>A</i>	<i>28 MAR 94</i>		<i>1657</i>		<i>3 April 94</i>	<i>10 00</i>	<i>1202.0</i>		<i>1</i>															
FAULT/REMARKS <i>TRANSPONDER INOP ACFT Restricted from I MC III</i>							ACTION <i>REPAIR WIRING TO TRANSPONDER CONTROL HEAD T. SE</i>																		
							<table border="1"> <tr> <th>PID</th> <th>HOURS</th> <th>PID</th> <th>HOURS</th> <th>PID</th> <th>HOURS</th> </tr> <tr> <td></td> <td></td> <td></td> <td></td> <td></td> <td></td> </tr> </table>							PID	HOURS	PID	HOURS	PID	HOURS						
PID	HOURS	PID	HOURS	PID	HOURS																				
AC HRS <i>1193.9</i> WHEN DISC HOW REC MAL EFF WUC							CMH OMH FMH DMH																		
WO REQ OTHER							TIPID TI MAN-HOURS																		
STATUS	SYS	DATE	NO	TIME	PID	DATE	TIME	HRS	ROUNDS	ACTION CODE	WUC														
<i>H</i>	<i>A</i>	<i>28 Mar 94</i>		<i>1700</i>		<i>4 Apr 94</i>	<i>1100</i>	<i>1202.4</i>																	
FAULT/REMARKS <i>Red #112 blade has a 1/2" crack on the leading edge near tip cap J. Haskins</i>							ACTION <i>Repaired I/A/W TMSS-1520-237-23 paragraph 5-21 J. Haskins</i>																		
							<table border="1"> <tr> <th>PID</th> <th>HOURS</th> <th>PID</th> <th>HOURS</th> <th>PID</th> <th>HOURS</th> </tr> <tr> <td></td> <td></td> <td></td> <td></td> <td></td> <td></td> </tr> </table>							PID	HOURS	PID	HOURS	PID	HOURS						
PID	HOURS	PID	HOURS	PID	HOURS																				
AC HRS <i>1193.9</i> WHEN DISC HOW REC MAL EFF WUC							CMH OMH FMH DMH																		
WO REQ OTHER							TIPID TI MAN-HOURS																		
STATUS	SYS	DATE	NO	TIME	PID	DATE	TIME	HRS	ROUNDS	ACTION CODE	WUC														
FAULT/REMARKS							ACTION																		
							<table border="1"> <tr> <th>PID</th> <th>HOURS</th> <th>PID</th> <th>HOURS</th> <th>PID</th> <th>HOURS</th> </tr> <tr> <td></td> <td></td> <td></td> <td></td> <td></td> <td></td> </tr> </table>							PID	HOURS	PID	HOURS	PID	HOURS						
PID	HOURS	PID	HOURS	PID	HOURS																				
AC HRS WHEN DISC HOW REC MAL EFF WUC							CMH OMH FMH DMH																		
WO REQ OTHER							TIPID TI MAN-HOURS																		

1. AIRCRAFT SERIAL NUMBER 88-26060		2. MODEL UH-60A		3. DATE 20 JAN 94		4. PAGE 6							
PART I - FAULT INFORMATION						PART II - CORRECTING INFORMATION							
<input checked="" type="checkbox"/> STATUS	SYS A	DATE 20 JAN 94	NO.	TIME 0900	PID	DATE 20 JAN 94	TIME 0930	HRS 1120.3		ROUNDS		ACTION CODE	WUC
FAULT/REMARKS 1/4 MAIN LANDING GEAR JIRE LEAKING AIR 5.4025						ACTION REPAIRED LANDING GEAR ASSEMBLY 5.4025							
A/C HRS 1120.3		WHEN DISC	HOW REC	MAL EFF	WUC	CMH	OMH	FMH	DMH	TI PID		TI MAN-HOURS	
W.O.		REQ		OTHER 2408-13297		DATE 2 Feb 94		TIME	HRS	ROUNDS		ACTION CODE	WUC
<input type="checkbox"/> STATUS	SYS A	DATE 21 JAN 94	NO.	TIME 1515	PID	ACTION CIF - Kowalew							
FAULT/REMARKS UH-60-94-ASAM-03, REPLACEMENT OF ALL M/R SPINDLE DUE AT THE NEXT PMS-2 MTRAM ✓						PID HOURS PID HOURS PID HOURS							
A/C HRS 1124.5		WHEN DISC	HOW REC	MAL EFF	WUC	CMH	OMH	FMH	DMH	TI PID		TI MAN-HOURS	
W.O.		REQ		OTHER		DATE 26 JAN 94		TIME 1200	HRS	ROUNDS		ACTION CODE	WUC
<input checked="" type="checkbox"/> STATUS	SYS A	DATE 26 JAN 94	NO.	TIME 1600	PID	ACTION Cleaned Set Button CMA							
FAULT/REMARKS FLT 1 XPDR MODE 2 set button #4 is stuck in down position. MM add.						PID HOURS PID HOURS PID HOURS							
A/C HRS 1134.5		WHEN DISC	HOW REC	MAL EFF	WUC	CMH	OMH	FMH	DMH	TI PID		TI MAN-HOURS	
W.O.		REQ		OTHER		DATE		TIME	HRS	ROUNDS		ACTION CODE	WUC

DA FORM 2408-13-1, OCT 91

AIRCRAFT INSPECTION AND MAINTENANCE RECORD  
For use of this form, see DA PAM 738-751, the proponent agency is DCSLOG

**EXTRACT**

I certify that I am the Records Custodian for the Accident Investigation Board convened to investigate the crash of two U.S. Army Black Hawk helicopters in the no fly zone in northern Iraq on 14 April 1994, and that this is a true and accurate extract from

Historical Records 88-26060  
which is kept in my records system!

23 May 94  
Date

William L. Harris  
WILLIAM L. HARRIS, Capt, USAF, MSC  
Evidence Custodian, Incirlik Air Base, Turkey

1. AIRCRAFT SERIAL NUMBER 88-26060		2. MODEL UH-60A		3. DATE 14 Dec 93		4. PAGE 16							
PART I - FAULT INFORMATION						PART II - CORRECTING INFORMATION							
<input checked="" type="checkbox"/> STATUS	SYS A	DATE 14 DEC 93	NO.	TIME 0700	PID	DATE 14 DEC 93	TIME 0710	HRS 1093.4	ROUNDS	ACTION CODE	WUC		
FAULT/REMARKS XPANDER FAILS SELF TEST WITH TOP ANT SELECTED, LEFT REST FROM IFR CRASH						ACTION REPLACED XPANDER ANT. CONNECTORS IN 40 AL. STATE							
A/C HRS 1093.4						WHEN DISC		HOW REC		MAL EFF		WUC	
W.O.						REQ		OTHER 2408-13-2 Pg 17					
<input checked="" type="checkbox"/> STATUS	SYS A	DATE 14 DEC 93	NO.	TIME 0715	PID	DATE 14 DEC 93	TIME 0800	HRS 1093.4	ROUNDS	ACTION CODE	WUC		
FAULT/REMARKS M/C REQ FOR REPLACEMENT OF XPANDER ANT CONNECTORS						ACTION Failed Secondary Release							
A/C HRS 1093.4						WHEN DISC		HOW REC		MAL EFF		WUC	
W.O.						REQ		OTHER					
<input checked="" type="checkbox"/> STATUS	SYS A	DATE 14 DEC 93	NO.	TIME 0800	PID	DATE 14 DEC 93	TIME 0830	HRS 1093.4	ROUNDS	ACTION CODE	WUC		
FAULT/REMARKS XPANDER FAILS SELF TEST WITH TOP ANT SELECTED, LEFT REST FROM IFR CRASH						ACTION Replaced XPANDER							
A/C HRS 1093.4						WHEN DISC		HOW REC		MAL EFF		WUC	
W.O.						REQ		OTHER 2409-13-2 Pg 17					

DA FORM 2408-13-1, OCT 91

AIRCRAFT INSPECTION AND MAINTENANCE RECORD

**EXTRACT**

I certify that I am the Records Custodian for the Accident Investigation Board convened to investigate the crash of two U.S. Army Black Hawk helicopters in the no fly zone in northern Iraq on 14 April 1994, and that this is a true and accurate extract from

*Historical Records, 88-26060*

which is kept in my records system.

23 May 94  
Date

WILLIAM L. HARRIS, Capt, USAF, MSC  
Evidence Custodian, Incirlik Air Base, Turkey



1. AIRCRAFT SERIAL NUMBER 88260600		2. MODEL UH-60A		3. DATE 13 Nov 93		4. PAGE 24						
PART I - FAULT INFORMATION						PART II - CORRECTING INFORMATION						
#7	STATUS	SYS	DATE	NO.	TIME	PID	DATE	TIME	HRS	ROUNDS	ACTION CODE	WUC
		A	12 NOV 93		1408		13 NOV 93	0800	1060.7			
FAULT/REMARKS Coll + yaw burst seen insp DUE. <i>TR</i>						ACTION Completed <i>TR</i>						
AC HRS 10100.7 WHEN DISC HOW REC MAL EFF WUC						CMH OMH FMH DMH						
W.O. REQ OTHER						TIPIID TI MAN-HOURS						
#7	STATUS	SYS	DATE	NO.	TIME	PID	DATE	TIME	HRS	ROUNDS	ACTION CODE	WUC
		A	12 NOV 93		1409		13 NOV 93	0800	1060.7			
FAULT/REMARKS Prior to 1st FLT. insp of MR B: Filer for cracks =/A/W ATCOM UH60-93281-11000 memo <i>TR</i>						ACTION Completed <i>TR</i>						
AC HRS 1060.7 WHEN DISC HOW REC MAL EFF WUC						CMH OMH FMH DMH						
W.O. REQ OTHER						TIPIID TI MAN-HOURS						
#5	STATUS	SYS	DATE	NO.	TIME	PID	DATE	TIME	HRS	ROUNDS	ACTION CODE	WUC
		A	12 NOV 93		1410		12 NOV 93	1630	1060.7			
FAULT/REMARKS 100 HR Insp. Due 10624 ACH HRS <i>TR</i>						ACTION Completed <i>TR</i>						
AC HRS 1060.7 WHEN DISC HOW REC MAL EFF WUC						CMH OMH FMH DMH						
W.O. REQ OTHER 2408-13-7 p 25						TIPIID TI MAN-HOURS						

DA FORM 2408-13-1 OCT 91

AIRCRAFT INSPECTION AND MAINTNANCE RECORD

<b>EXTRACT</b>	
I certify that I am the Records Custodian for the Accident Investigation Board convened to investigate the crash of two U.S. Army Black Hawk helicopters in the no fly zone in northern Iraq on 14 April 1994, and that this is a true and accurate extract from	
<i>Historical Records 88-26060</i>	
which is kept in my records system.	
<i>23 Nov 94</i> Date	<i>W. L. Harris</i> WILLIAM L. HARRIS, Capt, USAF, MSC Evidence Custodian, Incirlik Air Base, Turkey

**TAB H-1**

**UH-60 BLACK HAWK 88-26060**

**H-1a DA Form 2408-13, Aircraft Status Information Record, 13 April 1994**

**H-1b DA Form 2408-13-1, Extracts from the 30 Day Maintenance Record**

**H-1c DA Form 2408-5, Equipment Modification Record**

**H-1a**

**H-1d DA Form 2408-20, Oil Analysis Record**

**H-1e DA Form 2408-17, Aircraft Inventory Record**

**H-1b**

**H-1c**



1. NOMENCLATURE					2. REGISTRATION NUMBER		3. SERIAL NUMBER	
HELICOPTER UH-60A							88-26060	
4. MODIFICATIONS REQUIRED					5. MODIFICATIONS COMPLETED			
MWO NUMBER	DATE OF MWO (Day/Mo/Yr)	PRI-ORITY	ECN	MWO TITLE AND KIT NUMBER(S)	DATE MWO APPLIED (Day/Mo/Yr)	MAN HRS	ORGANIZATION APPLYING MWO	SIGNATURE (Certification of MWO Application)
a	b	c	d	e	f	g	h	i
MWO 55-2840-248-50-28	19 JAN 89	N	D	SELF SEALING ADAPTER (OIL CAP REPLACEMENT)	12 JAN 89	1	DYNCORP	Jay Pugh (CIV)
MWO 1-5945-237-50-1	15 JAN 89	N	D	Electromagnetic Inter. Protection (EMI)	19 JUL 89	12	DYNCORP-E	J Pugh (CIV)
MWO 55-1520-237-50-54	10-7 89	N	D	INCOOP STAIR ALTIMETER GROUNDING TRAP	16 JUL 90	3.0	DYNCORP-E	[Signature]
MWO 55-1520-237-50-83	3 MAR 90	N	D	Improved Tiedown Fittings	31 Aug 90	5	DYNCORP-E	T. Klumb
MWO 01-1520-237-50-01	15 NOV 90	N	D	Installation of Improved Tiedown Ring Eyebolt	27 Aug 91	4.0	DynCorp-E	S. Daley CIV Contr.
MWO 55-1570-237-50-58	15 JAN 91	N	D	Incorporation of Engine Drive Shaft Balancing Procedure	13 SEPT 91	8.0	DynCorp-E	S. Daley CIV Contr.
MWO I- 1520-237-50-59	22 FEB 91	N	D	Electromagnetic Environment Protection	21 DEC 92	850	DynCorp-E	K. Stivers (CIV)
MWO I- 1520-237-50-64	1 SEP 91	N	D	Instl. of improved engine cowling release handle assy	6 JAN 93	2.0	DynCorp-E	K. Stivers (CIV)
MWO 55-4030-237-50-1				IMPROVED CAB ON THE CARGO DOOR ASSY	P/C/W	.1	DYNCORP-E	E. Wane (CIV)
MWO 55-1520-237-50-47				IMPROVED WIRE STRAPS SYSTEM	P/C/W	.1	DYNCORP-E	E. Wane (CIV)
MWO LEX-2561	8 NOV 93			ANX. FUEL QUANTITY Indicating System (ESSS)	6 DEC 93	80.0	SERV-AIR	L. Patis SSG TI

DA FORM 2408-5, 1 JAN 64

EQUIPMENT MODIFICATION RECORD

For use of this form, see TM 38-750; the procuring agency is Office of The Deputy Chief of Staff for Logistics

## EXTRACT

I certify that I am the Records Custodian for the Accident Investigation Board convened to investigate the crash of two U.S. Army Black Hawk helicopters in the fly zone in northern Iraq on 14 April 1994, and that this is a true and accurate extract from the Historical Flight Record Equipment Modification Record 88-26060 which is kept in my records system.

23 May 94  
Date

WILLIAM L. HARRIS, Capt, USAF, MSF  
Evidence Custodian, Incirlik Air Base, Tur































**AIRCRAFT  
ACCIDENT INVESTIGATION BOARD  
REPORT**

**COPY**

15

**OF**

14



**AFR 110-14 AIRCRAFT ACCIDENT BOARD  
INDEX OF TABS**

- O Additional Substantiating Data Reports**
- P Statement of Damage to Private Property**
- Q Documents Appointing Safety Board (Not Applicable)**
- R Diagrams**
- S Photographs from Safety Report (Not Applicable)**
- T Individual Flight Records/Personnel Records**
- U Aircraft Maintenance Records**
- V Testimony and Statements of Witnesses**
- W Weather Observations**
- X Statements of Death**
- Y Appointment Documents**
- Z Photographs**
- AA Regulations and Directives**
- AB Administration and Glossaries**
- AC Other Documents**

- O**
- P**
- Q**
- R**
- S**
- T**
- U**
- V**
- W**
- X**
- Y**
- Z**
- AA**
- AB**
- AC**

**TAB AC**

**OTHER DOCUMENTS**

**AC-1 UH-60 Black Hawk 88-26060**

**AC-2 UH-60 Black Hawk 87-26000**

**(See Tabs AC-1a thru AC-1f)**

**AC-3 E-3B AWACS**

**AC-4 F-15C 79-0025**

**AC-5 F-15C 84-0025**

**AC-6 Command and Control**

**AC-7 Visual Recognition Guides**

**AC-8 Miscellaneous**

**TAB AC-1**

**UH-60 BLACK HAWK 88-26060**

**AC-1a Black Hawk Load Plan and Pre-mission Brief**

**AC-1b UH-60 Crew Member Briefing/Risk Assessment**

**AC-1c AE Form 1010, Army Aircraft Traffic Log**

**AC-1d Eagle Flight Detachment Mission Schedule**

**AC-1a**

**AC-1e MCC Situation Reports and Operations Schedule**

**(See also Classified Addendum)**

**AC-1f Eagle Flight Following Schedule**

11045

216

DATE: 14 APR 94

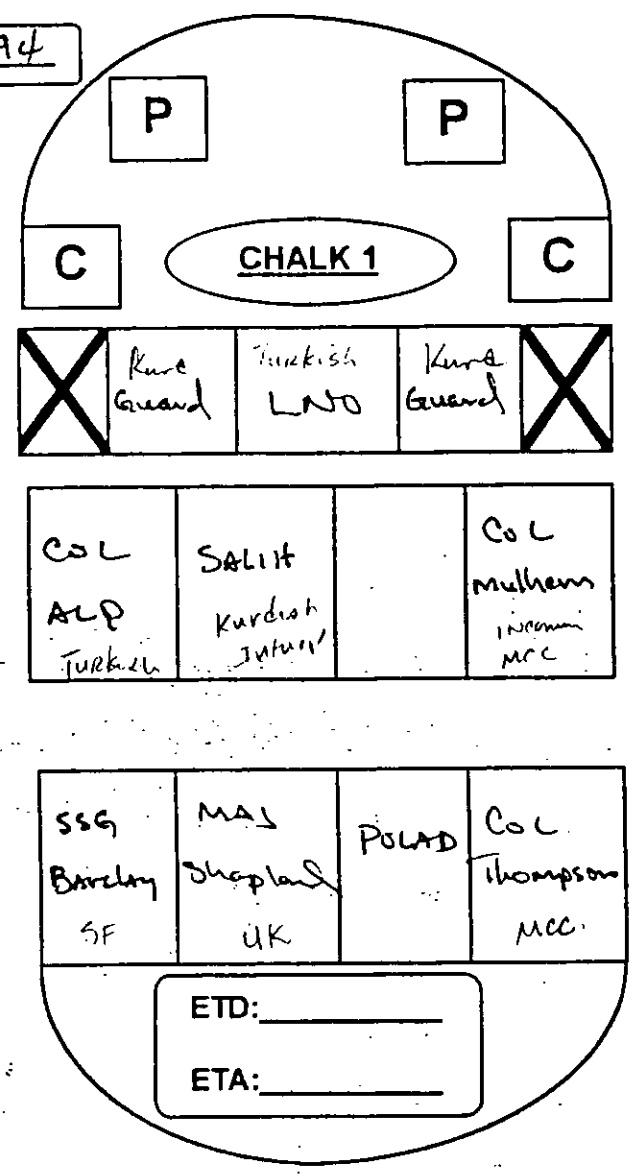
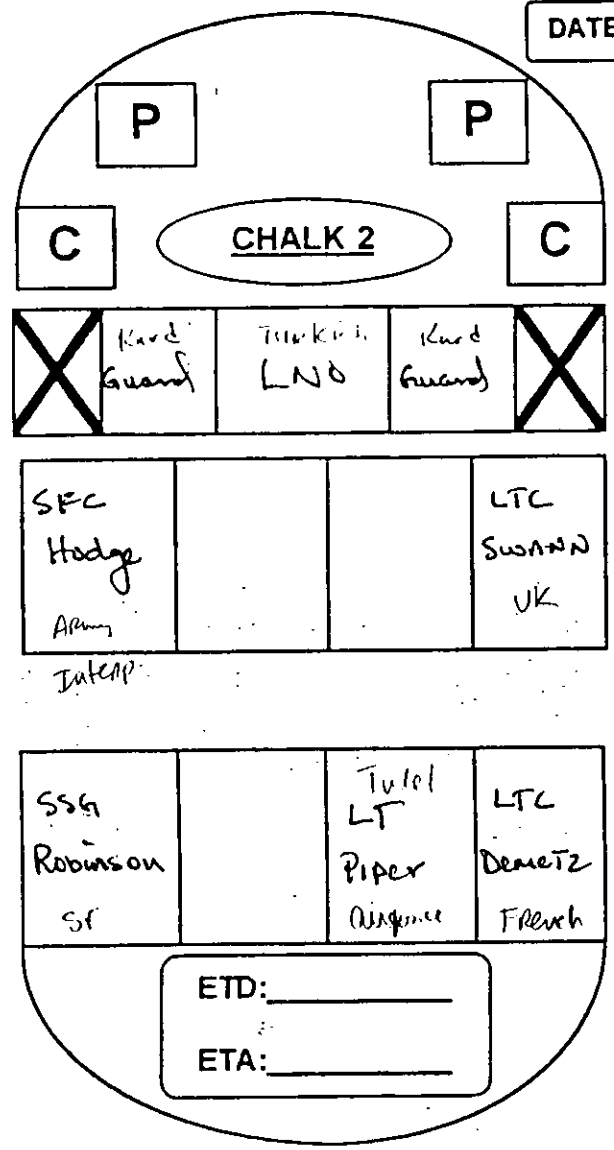

ROW 1

ROW 2

ROW 3

**CERTIFICATE**  
 I certify that I am the Records Custodian for the Accident Investigation Board convened to investigate the crash of two U.S. Army Black Hawk helicopters in the no-fly zone in northern Iraq on 14 April 1994, and that this is a true and accurate copy of the record which is kept in my records system.

15 May 94  
 Date

WILLIAM L. HARRIS, Capt USAF, MSC  
 Evidence Custodian, Inct Base, Tur

MILITARY COORDINATION CENTRE

Combined Task Force  
Operation Provide Comfort  
Zakho, N. Iraq

Thursday

Irbil (MF 0709)

SALAH ad Din (MF 2829)

Date: 14 APR 94

0930 - EMD + STAFF  
1015 - SP - CP  
1030 - ACFT Arrive  
1050 - T/O  
1130 - Arrive - BAVZAN  
(MAKE RADIO CONTACT  
w/ BAFS)  
~~1155 T/O~~  
1145 - Arrive Irbil  
1215 Depart "  
1230 Arrive Salahad Din  
1430 Depart " "  
1530 Arrive ZAKHO

Remarks:

- Need to work A plan  
to send

- Send msg to P.O.  
requesting specific of  
INB

- what, when

(Priority power + P.O.  
office)

Hail + Jewell → 1800h →

WX:

AWAC - 1130 - 1730 Local

HUM  
- Maj Shapland  
SFC Hodge

#6 COL Thompson  
COL ALP  
COL Mulhorn  
SALIH

#1 LTC SWANN  
LTC DEMETZ  
LT PIPER

TUM  
- SSG BAVCLAY  
- SSG ROBINSON

IN:

- SSG Parks  
- TSG BADMAN  
- Mr DABNEY  
- TSG Hamlett  
- TSG  
- LT PIPER

OUT:

- SSG PARKS  
- TSGT BADMAN  
- Mr Dabney  
- Mr STRZOK  
- LT STRZOK

**TAB AC-1**

**UH-60 BLACK HAWK 88-26060**

**AC-1a Black Hawk Load Plan and Pre-mission Brief**

**AC-1b UH-60 Crew Member Briefing/Risk Assessment**

**AC-1c AE Form 1010, Army Aircraft Traffic Log**

**AC-1d Eagle Flight Detachment Mission Schedule**

**AC-1a**

**AC-1e MCC Situation Reports and Operations Schedule**

**(See also Classified Addendum)**

**AC-1b**

**AC-1f Eagle Flight Following Schedule**

EAGLE FLIGHT DETACHMENT  
AIRCREW MISSION BRIEF

MISSION BRIEF-BACK

\*1. MISSION:

- a.  Mission can be accomplished as briefed.  
b. Identify required deviations from mission: NONE

2. PERMISSION PLANNING:

- \*a.  WEATHER (-1 REQD IF NOT LOCAL) e.  IFF KEYED  
\*b.  PERFORMANCE PLANNING f.  NOISE ABATEMENT  
\*c.  NOTAMS g.  ALSE  
\*d.  CREW STATUS  
(1)  Crew Endurance  
(2)  Qualified and current

3. PASSENGERS/CARGO/AMMUNITION:

- a. \_\_\_ Loads planned per briefing.  
b. \_\_\_ Passenger manifest on file.

\*4. FLIGHT ROUTE: AS BRIEFED

5. REFUELING ARRANGEMENTS: \_\_\_\_\_

6. REMARKS/SAFETY: \_\_\_\_\_

7. WEATHER UPDATE EACH STOP:

8. SAFETY CONSIDERATIONS:

- \*\*a. NA Snow Ops \*\*b.  Mountain Ops  
\*\*b.  Formation Flight \*\*d. NA NVG Ops

[Signature]  
(PIC/Air Mission Commander's Signature)

POST-MISSION DEBRIEF

\*1. MISSION STATUS:

- \_\_\_ Completed as briefed \_\_\_ Not Completed (See remarks)  
\_\_\_ Cancelled (See remarks) \_\_\_ Changed (See remarks)

2. PIREPS: \_\_\_\_\_

\*3. CREW ENDURANCE STATUS: \_\_\_\_\_

4. AIRCRAFT STATUS:

- \*a. Maintenance \_\_\_\_\_ \*c. Fuel \_\_\_\_\_  
\*b. Avionics \_\_\_\_\_ d. Ammunition \_\_\_\_\_

5. REMARKS: \_\_\_\_\_

6. HOURS FLOWN: \_\_\_\_\_

\_\_\_\_\_  
(PIC/AIR MISSION COMMANDER'S SIGNATURE)

\* Mandatory for all flights.

\*\* Mandatory if flight conditions will be performed or exist.

MCKENNA / GARRETT

Enclosure 2 (Risk Assessment Sheet) to  
 Appendix 6 (Mission Briefing) to  
 ANNEX B (Operation, Training and Standardization) to Co C, 6th Bn 159th  
 Avn SOP

SUPERVISION	3
Parent	1
Attached	3
Unsupervised	5

CONDITION	1
Day	1
IMC	2
Night	3
NVG	3

COMPELXITY	6
Terrain Flight	1
Multiaircraft Ops	1
External Loads	1
Overwater Ops	1
Rappel/STABO/Paradrop/Helicast	1
Millilux (2.5)	2
Mountain Ops	2
Snow Ops	2
Emergency Procedures (IP/SP)	2
MTF (Power On)	2
MTF (Power Off)	3

MISSION PLANNING	1
Detailed	1
Adequate	3
Minimal	5

WEATHER	1		
>1000/5	<1000/5	<500/800	
Day	1	2	4
Night	2	4	6

CREW SELECTION	PC 2	PI 4	
Total	>1000	>500	<500
NVG	>100	<100	<50
	1	2	4

CREW ENDURANCE	PC	PI
	Garrison	Field
Optimum	1	2
Adequate	3	4
Minimal	5	6

CREW ENDURANCE PARAMETERS:

Optimum: 12+ hrs uninterrupted rest last 24 hrs or <8 hrr duty day  
 Adequate: 8-12 hrs uninterrupted rest last 24 hrs or a 8-12 hr duty day  
 Minimal: <8 hrs uninterrupted rest last 24 hrs

RISK ASSESSMENT COMPUTATIONS:			
CATEGORY:	RISK VALUE	CATEGORY:	RISK VALUE
SUPERVISION	3	WEATHER	1
CONDITION	1	CREW SELECTION	PC 2 PI 4
COMPLEXITY	6	CREW ENDURANCE	PC 1 PI 1
MISSION PLANNING	1	TOTAL RISK ASSESSED	20
		LOW RISK 08 - 20	
		MEDIUM RISK 21 - 30	
		HIGH RISK 31 +	

APPROVAL AUTHORITY:

Low Risk Missions - Briefing Officer [Signature] signature  
 Medium Risk Missions - Company Commander \_\_\_\_\_ signature  
 High Risk Missions - 1st LTC in COC \_\_\_\_\_ signature



WAGLE FLIGHT DETACHMENT  
AIRCREW MISSION BRIEF

\*UNIT: E.F.D.  
\*DATE: 14 APR 94  
\*MSN NO: A1470

BRIEFING

1. SITUATION:

- a. Threat: Iraq, PKK
- b. Friendly Forces: USAF, Air Cap
- c. Attachments/Detachments: MCC
- d. Weather: 175-1 attached

\*2. MISSION: Support MCC as directed (transport pax/cargo to Zakhu/TAOR).

3. EXECUTION:

- \*a. Mission Type: TAC C F S T X D
- \*b. Authorized Conditions: AA D DG DS H N NG TR W
- \*c. Authorized Flight Modes: Multi-ship: yes/no
- d. Movement Techniques: \_\_\_\_\_

\*e. Aircraft/Crews:

	TYPE/TAIL #	PC/SEAT	PI/SEAT	CE	OR
(1)	UH60/ <u>001</u>	<u>McKENNA</u>	<u>GARRETT</u>	<u>COLDSPR</u>	<u>ELLNER</u>
(2)	UH60/ <u>000</u>	<u>HALL</u>	<u>MOUNSEY</u>	<u>ROBINSON</u>	<u>RAIS</u>
(3)	UH60/ _____	_____	_____	_____	_____
(4)	UH60/ _____	_____	_____	_____	_____

- \*f. Special Mission Equipment: ERFs, Cold Wx Kits, TACSAT, Water & MRES
- \*g. Authorized Loads: Pax: Yes/No Cargo: Yes/No Ammunition: Yes/No
- h. Flight Route: LTCC > LLTR 1234 > ZAKHU > TAOR > ZAKHU > LLTR 1234 > LTCC
- i. Mission Restrictions: No flight after official sunset, no single ship beyond Zakhu without CO's approval.
- j. Additional Remarks: Flying above or below the established altitude is authorized (IAW ACO). Contact AWACS with intentions. \_\_\_\_\_

- \*\* (1) Snow Operations (Associated Hazards): Yes/No
- \*\* (2) Formation Flight (AMC Briefed): Yes/No
- \*\* (3) All Requirements Of AVN MSG 93-04 On Use Of ERFs Complied With: Yes/No
- \*k. Noise Abatement (Briefed on USAREUR and local procedures): Yes/No
- l. ALSE Requirements: SRU-21P, PRC-90, PRC-112

4. SERVICE SUPPORT:

- a. Refuel/Rearm Location: LTCC, Zakhu
- b. Ration Support: LTCC, Zakhu
- c. RON Support: LTCC, Zakhu
- d. Maintenance Support: LTCC

5. COMMAND AND SIGNAL:

- \*a. Command: (1) Air Mission Commander: McKENNA
- (2) Supported unit and command relationship: MCC
- b. Signal: IFF Keyed: Yes/No COMSEC Operations: Yes/No
- Other: \_\_\_\_\_

6. SAFETY CONSIDERATIONS:

- a. Wx, Wires, Birds, Mtn & Snow Ops, Flt Following
- b. Risk Assessment: 20
- c. Conduct Mode IV/IFF and APR 39 checks, if msn allows

[Signature]  
(Briefing Officer's Signature)

\* Mandatory for all flights.

**CERTIFICATE**  
 I certify that I am the Records Custodian for the Accident Investigation Board convened to investigate the crash of two U.S. Army Black Hawk helicopters in the northern Iraq on 14 April 1994, and that this is a true and accurate copy of the record which is kept in my records system.  
15 May 94 Date  
W. L. Harris  
 WILLIAM L. HARRIS, Capt, USAF, MSC  
 Evidence Custodian, Incirlik Air Base, Turkey

**TAB AC-1**

**UH-60 BLACK HAWK 88-26060**

**AC-1a Black Hawk Load Plan and Pre-mission Brief**

**AC-1b UH-60 Crew Member Briefing/Risk Assessment**

**AC-1c AE Form 1010, Army Aircraft Traffic Log**

**AC-1d Eagle Flight Detachment Mission Schedule**

**AC-1a**

**AC-1e MCC Situation Reports and Operations Schedule**

**(See also Classified Addendum)**

**AC-1b**

**AC-1f Eagle Flight Following Schedule**

**AC-1c**

21-12

ARMY AIRCRAFT TRAFFIC LOG (USAREUR Reg 95-40)					AIRFIELD								
AIRCRAFT NO 1	IFR/VFR 2	TYPE 3	POINT OF DEPARTURE 4	ROUTE 5	TIME					CODE 11	REFUEL 12	POI 13	
					ETD 6	ATD 7	ETE 8	ETA 9	ATA 10				
<u>12 APR 94</u>													
060	V	UH60	LTCC	→ TAOR → LTCC	0520	0520			1210				
056	V	UH60	LTCC	→ TAOR → LTCC	0520	0520			1210				
<u>13 APR 94</u>													
656	V	UH60	LTCC	→ TAOR → LTCC	0520	0525							
060	V	UH60	LTCC	→ TAOR → LTCC	0520	0525			1316				
<u>14 APR 94</u>													
060	V	UH60	LTCC	→ TAOR → LTCC	0520	0522							
060	V	UH60	LTCC	→ TAOR → LTCC	0520	0522							
634	V	UH60	LTCC	→ LTAG	0730	0730			1410				
634	V	UH60	LTAG	→ LTCC	1240	1240			1450				

**CERTIFICATE**

I certify that I am the Records Custodian for the Accident Investigation Board convened to investigate the crash of two U.S. Army Black Hawk helicopters in the no fly zone in northern Iraq on 14 April 1994, and that this is a true and accurate copy of the record which is kept in my records system.

  
 WILLIAM L. HARRIS, Capt, USAF, MSC  
 Evidence Custodian, Incirlik Air Base, Turkey

7 May 94  
 Date



**TAB AC-1**

**UH-60 BLACK HAWK 88-26060**

**AC-1a Black Hawk Load Plan and Pre-mission Brief**

**AC-1b UH-60 Crew Member Briefing/Risk Assessment**

**AC-1c AE Form 1010, Army Aircraft Traffic Log**

**AC-1d Eagle Flight Detachment Mission Schedule**

**AC-1e MCC Situation Reports and Operations Schedule**

**(See also Classified Addendum)**

**AC-1f Eagle Flight Following Schedule**

**AC-1a**

**AC-1b**

**AC-1c**

**AC-1d**

EAGLE FLIGHT DETACHMENT  
 \*\*MISSION SCHEDULE\*\*  
 THURSDAY, 14 APRIL 1994

MSN#	TAIL#	CALLSIGN	-- FC/PI----CE/GUNNER--	REMARKS/DESTINATION
A1470	001	EAGLE 01	McKENNA/GARRETT COLBERT/ELLNER	2 SHIP TAOR
A1470	000	EAGLE 02	HALL/MOUNSEY ROBINSON/BASS	
A1477	060	EAGLE 10	HOLDEN/MENARD McCARTHY	1 SHIP INCIRLIK WX CALL 0745
AIRCREWS * SHOWTIME AT OPS: 0615 * ETD TO AIRFIELD: 0635 * PREFLIGHT TIME : 0700 * ETD FOR MISSION: 0820 * ETA BACK TO LTCC: ???? * READ POST MISSION SHEET IN OPS AFTER MISSION. * PERFORM COM CHECK ON FM. * CALL AIRCRAFT DEPARTURE, 30 MINUTES OUT, LANDING LTCC. * AMC/PIC RETURN EQUIPMENT, FILL OUT BRAIN BOOK, FILL OUT DEBRIEF.				MAINTENANCE WEAPONS DRAW: 0605 1) Bowen 2) Ellner

**CERTIFICATE**

I certify that I am the Records Custodian for the Accident Investigation Board convened to investigate the crash of two U.S. Army Black Hawk helicopters in the no fly zone in northern Iraq on 14 April 1994, and that this is a true and accurate copy of the record which is kept in my records system.

*15 May 94*  
Date

*W. L. Harris*  
WILLIAM L. HARRIS, Capt, USAF, MSC  
Evidence Custodian, Incirlik Air Base, Turkey

**TAB AC-1**

**UH-60 BLACK HAWK 88-26060**

**AC-1a Black Hawk Load Plan and Pre-mission Brief**

**AC-1b UH-60 Crew Member Briefing/Risk Assessment**

**AC-1c AE Form 1010, Army Aircraft Traffic Log**

**AC-1d Eagle Flight Detachment Mission Schedule**

**AC-1e MCC Situation Reports and Operations Schedule**

**(See also Classified Addendum)**

**AC-1f Eagle Flight Following Schedule**

**AC-1a**

**AC-1b**

**AC-1c**

**AC-1d**

**AC-1e**

MCC OPERATIONS SCHEDULE

WEEK OF 10 - 17 APR 94

AS OF: 08 APR 94

10 APR MCC:0530Z KEMAKA (LF 2691)/BESHINGI (LF 2495)/  
SUNDAY ALOKA CP/FAYDAH O-LOOK

EAGLE:0520-0630Z 2 X ADMIN

IN:

OUT:

11 APR MCC:0615Z DERGINI (LG 7510)/PEPIRKA (MG 0107)  
MONDAY

EAGLE:0520-0630Z 4 X MCC SPT MSN

IN:

OUT:

12 APR MCC:0530Z SORIYA (LF 2822)/AVLENE (LG 1722)  
TUESDAY

EAGLE:0520-0630Z 2 X TAOR

IN: COL MULHERN

OUT:

13 APR MCC:0615Z SURI (LF 9597)/KHALILAN (LF 8480)  
WEDNESDAY

EAGLE:0520-0630Z 2 X MCC SPT MSN

IN:

OUT:

14 APR MCC:0530Z SUMMAYL (LF 0881)/SADDAM LAKE RECON  
THURSDAY

EAGLE:0520-0630Z 2 X ADMIN

IN:

OUT:

EXTRACT

... the Records Custodian for the Accident Investigation Team of ...  
... investigate the crash of two U.S. Army Black Hawk helicopters ...  
... in northern Iraq on 14 April 1994, and that this is ...

MCC Ops Schedule 10-17 Apr 94

20 May 94

WILLIAM L. HERRING, Captain  
Evidence Custodian  
Incirlik Air Base, Turkey



MCC OPERATIONS SCHEDULE

WEEK OF 10 - 17 APR 94

AS OF: 13 APR 94

10 APR MCC:0530Z KEMAKA (LF 2691)/BESHINGI (LF 2495)/  
SUNDAY ALOKA CP/FAYDAH O-LOOK

EAGLE:0520-0630Z 2 X ADMIN

IN:COL HUNT

OUT:WO1 COFFMAN

---

11 APR MCC:0615Z DERGINI (LG 7510)/PEPIRKA (MG 0107)  
MONDAY

EAGLE:0520-0630Z 4 X MCC SPT MSN

IN:

OUT:

---

12 APR MCC:0530Z SORIYA (LF 2822)/ALOKA CP/FAYDAH O-LOOK  
TUESDAY

EAGLE:0520-0630Z 2 X MCC SPT MSN

IN:COL MULHERN/MAJ MAILHES

OUT:COL HUNT/MAJ SHAW

---

13 APR MCC:0615Z KHALILAN (LF 8480)/ALOKA CP/FAYDAH O-LOOK  
WEDNESDAY

EAGLE:0520-0630Z 2 X MCC SPT MSN

IN:MAJ REMMEY/SGM McDANIELS/

OUT:MAJ REMMEY/SGM McDANIELS/  
MAJ ROSENGARD/SGT CHAFFELL

---

14 APR MCC:0615Z IRBIL (MF 0709)/SALAH AD DIN (MF 2826)  
THURSDAY

EAGLE:0520-0630Z 2 X MCC SPT MSN

IN:SSG PARKS/TSG BADMAN/MR DABNEY

OUT:SSG PARKS/TSG BADMAN/  
MR DABNEY

EXTRACT

... was Custodian for the Accident Investigation ...  
... of two U.S. Army Black Hawk Helicopters ...  
... on 12 April 1994, and that the ...

*MCC Ops Schedule 10-17 Apr 94*

*20 May 94*

*W. H. H.*  
WILLIAM H. HARRIS  
Evidence Custodian  
Incident # 10-17 Apr 94

1. ~~(S)~~ <sup>U</sup> SIGNIFICANT EVENTS:

SUMMARY: - POWER CUT/PARTIAL SUPPLY FROM TURKEY.  
- GOI ACTIVITY: NSTR.  
- JSOTF REACTION FORCE.

A. (U) POWER CUT: AS OF 1900 HRS LOCAL ON 08 APR 94, THE ELECTRICITY FROM GOI HAS STILL NOT BEEN RESTORED TO THE DAHUK GOVERNORATE. IT IS NOW 248 DAYS SINCE IT WAS CUT ON 5 AUG 93. WORK CONTINUES ON THE DISTRIBUTION OF THE PARTIAL SUPPLY FROM TURKEY. IT IS REPORTED THAT LIMITED POWER IS NOW AVAILABLE TO THE THREE URBAN AREAS OF DAHUK, SUMMAYL (LF0881), AND ZAKHO.

B. ~~(S)~~ <sup>U</sup> GOI ACTIVITIES: NSTR

C. ~~(S)~~ <sup>U</sup> TRUCK TRAFFIC: TRUCK TRAFFIC FOR 7 APR 94 - NOT AVAILABLE.

D. (U) VISITORS TO ZAKHO HOUSE: 6.

2. ~~(S)~~ <sup>U</sup> COMMUNICATIONS: NTR

3. ~~(S)~~ <sup>U</sup>

{CLASSIFIED PORTION DELETED (138 WORDS)!}

4. ~~(S)~~ <sup>U</sup> LOGISTICS AS OF 08 APR 94:

JP-4 STATUS 15,149/20,000 GALLONS  
MOGAS STATUS 20,140/50,000 LITRES  
DIESEL STATUS 3,940/50,000 LITRES

5. PUBLIC AFFAIRS: NTR

~~CONFIDENTIAL/RMNF~~  
UNCLAS

**EXTRACT**  
I certify that I am the Records Custodian for the Accident Investigation Board convened to investigate the crash of two U.S. Army Black Hawk helicopters in the no fly zone in northern Iraq on 14 April 1994, and that this is a true and accurate extract from  
*MCC SITREP - 098, 8 APR 94, except for Deleted Classified*  
which is kept in my records system. *Portions*  
*W. H.*  
WILLIAM L. HARRIS, Capt. USAF, MSC  
Evidence Custodian, Incirlik Air Base, Turkey  
Date *20 May 94*

**CERTIFICATE OF DECLASSIFICATION**  
I certify that the information contained in this document has been declassified from  
~~CONFIDENTIAL/RMNF~~ to UNCLASSIFIED.  
*Donald G. Norris*  
DONALD G. NORRIS, GS-15, DAC  
Declassification Team Chief, HQ USEUCOM  
Date *20 May 94*

MCC HELICOPTERS MISSIONS:

- APR - 1 SHIP ADMIN
- 10 APR 94 - 2 SHIP ADMIN
- 11 APR 94 - 4 SHIP MCC SUPPORT MISSION
- 12 APR 94 - 2 SHIP TAOR
- 13 APR 94 - 2 SHIP MCC SUPPORT MISSION
- 14 APR 94 - 2 SHIP ADMIN
- 15 APR 94 - 2 SHIP ADMIN
- 16 APR 94 - 2 SHIP MCC SUPPORT MISSION

AIRCRAFT STATUS: 5 FMC, 1 NMC (AUX POWER UNIT INOPERATIVE).

7. <sup>U</sup>~~(C)~~ TRANSPORT STATUS: MCC VEHICLES STATUS: FOUR TOYOTAS - FMC, FOUR HMMWV - 3 FMC, 1 NMC (BLOWN ENGINE), 4 CUCV - 4 FMC

- 8. (U) PLAQUES: NTR
- 9. (U) CCMCC COMMENTS: NTR

MULTIPLE SOURCES

DECLASSIFY ON: OADR

~~CONFIDENTIAL/RYNF~~  
UNCLAS

SUBJECT: <sup>U</sup>/<sub>(C)</sub> MCC ZAKHO SITREP # 103 - 13 APR 94

1. <sup>U</sup>/<sub>(C)</sub> SIGNIFICANT EVENTS:

SUMMARY: - POWER CUT/PARTIAL SUPPLY FROM TURKEY.  
 - AIR/ROAD PATROL.  
 - FAYDAH OVERFLIGHTS.  
 - VILLAGE VISIT: ROUTINE REPORT.  
 - VISIT TO ALOKA CHECKPOINT: REACTION TO FAYDAH OVERFLIGHTS, CONSCRIPTION DEFERRED, FIGHTING IN RAMADI, BENZINE AND PROPANE, DEATH OF OPPOSITION LEADER, HARASSMENT.  
 - GOI ACTIVITY: NSTR.

A. (U) POWER CUT: AS OF 1900 HRS LOCAL ON 13 APR 94, THE ELECTRICITY FROM GOI HAS STILL NOT BEEN RESTORED TO THE DAHUK GOVERNORATE. IT IS NOW 253 DAYS SINCE IT WAS CUT ON 5 AUG 93. DISTRIBUTION OF THE PARTIAL SUPPLY FROM TURKEY HAS BEEN INTERRUPTED. LOCAL REPORTING INDICATES PKK CUT LINES IN TURKEY.

[CLASSIFIED PORTION DELETED (72 WORDS)]

C. <sup>U</sup>/<sub>(C)</sub> FAYDAH OVERFLIGHTS: ON 13 APR 94 MCC WAS PRESENT ON THE FAYDAH OVERLOOK DURING CTF OVERFLIGHTS OF THE FAYDAH AREA. THE ONLY OBSERVABLE REACTION TO THE COALITION AIRCRAFT FROM TROOPS IN THE FAYDAH COMPLEX WAS BY TWO MEN FROM THE MACHINE GUN POSITION AT OP11 (LF144729), WHO AFTER THE FIRST PASS APPEARED TO QUIT THEIR POST AND MOVE QUICKLY ACROSS THE FIELD ON FOOT TO THE CONCRETE BUILDING AT THE ENTRANCE TO FAYDAH CAMP (LF147736). A NUMBER OF MEN IN OTHER POSITIONS REMAINED IN FULL VIEW THROUGHOUT THE SEQUENCE OF PASSES; CIVILIAN TRAFFIC ON THE MAIN NORTH/SOUTH ROAD CONTINUED NORMALLY; MOVEMENT OF VEHICLES AND PEDESTRIANS WAS SEEN ON THE GIREPAN ROAD TO SHARIYAH (LF1973).

D. <sup>U</sup>/<sub>(C)</sub> VILLAGE VISIT - ZHULE (LF846812): ON 13 APR 94 MCC MADE ITS FIRST VISIT TO THE ASSYRIAN CHRISTIAN VILLAGE OF ZHULE OF THE TIARI TRIBE. THE PEOPLE CAME FROM THE MARDIN AREA OF TURKEY TO SETTLE THE VILLAGE IN 1927. THE VILLAGE WAS ATTACKED AND DESTROYED FIVE TIMES IN THE PERIOD FROM THE MID 1960S TO 1985 WHEN ALL THE PEOPLE WERE FINALLY DEPORTED TO AQRAN (MF0169). AT THAT TIME THERE HAD BEEN 133 FAMILIES IN THE GROUP OF VILLAGES IN THE AREA. ZHULE ITSELF HAD CONSISTED OF 12 FAMILIES. IN 1991 6 FAMILIES HAD RETURNED TO REBUILD THE VILLAGE ON THE ORIGINAL SITE WITH THE HELP OF CARITAS. THERE WAS ONE MUKHTAR FOR THE WHOLE GROUP OF VILLAGES. THERE WAS NO CLINIC, SCHOOL, OR CHURCH IN THE VILLAGE OR IN THE IMMEDIATE AREA. THE JOURNEY TO AQRAN TOOK SEVEN HOURS ON FOOT BUT THEY COULD USUALLY

~~CONFIDENTIAL/RMNF~~

**EXTRACT**

I certify that I am the Records Custodian for the Accident Investigation Board convened to investigate the crash of two U.S. Army Black Hawk helicopters in the no fly zone in northern Iraq on 14 April 1994, and that this is a true and accurate extract from MCC SITREP 103, 13 Apr 94, except for *Redacted classified portions* which is kept in my records system.

*William L. Harris*  
 20 May 94  
 Date

WILLIAM L. HARRIS, Capt, USAF, MSC  
 Evidence Custodian, Incirlik Air Base, Turkey

**CERTIFICATE OF DECLASSIFICATION**

I certify that the information contained in this document has been declassified from

~~CONFIDENTIAL/RMNF~~ to UNCLASSIFIED.

*Donald G. Norris*  
 20 May 94  
 Date

DONALD G. NORRIS, GS-13, DAC  
 Declassification Team Chief, HQ USEUCOM

GET TRANSPORT (20 DINARS PER PERSON ONE WAY) FROM BAKIRMAN (LF8276) ABOUT 8 KM AWAY. THEY HAD ENOUGH LAND AND DID NOT SUFFER FROM LAND DISPUTES LIKE THE PEOPLE OF RIBATE (LF7681) (SEE SITRP # 88 DATED 29 MAR 94). THEIR MAIN CROPS WERE RICE AND SESAME. THEIR WATER CAME FROM THE NEARBY RIVER KHAZIR BUT HAD NOT BEEN TESTED. THEY SAID THAT IRRIGATION WAS A PROBLEM AND A GERMAN NGO HAD MADE AN INSPECTION OF THE SYSTEM 3 MONTHS AGO BUT HAD NOT BEEN BACK SINCE. THEY HAD BEEN GIVEN SMALL NUMBERS OF SHEEP DEPENDING ON FAMILY SIZE. NO-ONE IN ZHULE OWNED A TRACTOR AND A HIRED ONE COST 140 DINARS TO PLOUGH 1 DONUM (0.25 HECTARES). THERE WERE DIFFERENT OPINIONS OVER WHETHER THEY HAD RECEIVED SEED OR FERTILISERS. THE WHEAT HAD BEEN BADLY AFFECTED BY SUNNAPEST IN 1993 WHICH WAS ALREADY ATTACKING THIS YEAR'S CROP. THEY HAD NOT YET PRODUCED SUFFICIENT SURPLUS TO SELL ANY OF THE HARVESTS. THEY WERE DISAPPOINTED WITH THE AMOUNT OF ASSISTANCE THEY HAD RECEIVED FROM NGOS OVER THE LAST TWO YEARS AND EXPRESSED THE VIEW THAT SOME AID FROM UN AND CONTRIBUTING NATIONS WAS DIVERTED BEFORE IT REACHED THE VILLAGES IN NEED. THEY WERE PARTICULARLY CONCERNED ABOUT THE HIGH PRICE OF FOODSTUFFS SUCH AS 17 TO 18 DINARS FOR A KILO OF FLOUR AND 50 DINARS FOR A CAN OF COOKING OIL. THEY SAID THEY HAD NOT BEEN VISITED BY ANY OFFICIALS EXCEPT FROM THE ASSYRIAN DEMOCRATIC MOVEMENT (ADM). THEIR MAIN POINT OF CONTACT FOR PROBLEMS HOWEVER

[CLASSIFIED PORTION DELETED (33 WORDS)]

U  
D. ~~(C)~~ VISIT TO ALOKA CHECKPOINT: ON 13 APR 94 FOLLOWING THE LOW-LEVEL CTF FLIGHTS OVER FAYDAH, MCC VISITED THE ALOKA CHECKPOINT AND WERE TOLD THAT:

(1) THEY HAD NOT YET HEARD OF THE REACTION IN THE GOI AREA TO THE FLIGHTS. HOWEVER TWO TRUCK DRIVERS WHO HAD JUST COME FROM FAYDAH SAID PEOPLE WERE ASKING WHY THE AIRCRAFT WERE FLYING SO LOW. THE DRIVERS HAD SEEN TWO SOLDIERS IN A FORT HEADING FOR THEIR BOMB SHELTER.

(2) GOI HAD DEFERRED CONSCRIPTION TO THE FORCES FOR PEOPLE LIVING IN N.IRAQ BORN BETWEEN 1970 AND 1976, ALTHOUGH THEY WERE NOW ELIGIBLE. SUCH PEOPLE WERE THEREFORE ABLE TO TRAVEL FREELY TO THE GOI AREA. NO TIME LIMIT HAD BEEN GIVEN.

(3) A MAN FROM THE RAMADI GOVERNORATE (BASIN OF RIVER EUPHRATES, WEST OF BAGHDAD) HAD SAID THERE HAD BEEN FIGHTING IN A VILLAGE CALLED ABUL ALGHANIM (NOT LOCATED) IN WHICH SEVEN GOI TROOPS AND TWO VILLAGERS HAD BEEN KILLED.

(4) THERE WAS STILL NO MOVEMENT OF BENZINE OR PROPANE FROM GOI AREA. THE MERCHANTS HAD BEEN PROMISED SUPPLIES ON 13 OR 14 APR 94. GOI OFFICIALS WERE APPARENTLY ASKING TRAVELLERS WHY THE ELECTRICITY IN N.IRAQ HAD BEEN CUT OFF AND WHEN IT WOULD COME BACK ON.

(5) GOI OFFICIALS WERE SAID TO BE VERY HAPPY AT THE

DEATH OF OPPOSITION LEADER GHARBI HADIDI IN QASROK (REPORTED BY MCC IN SITREP # 102 DATED 12 APR 94, IN WHICH THE NAME WAS GIVEN AS ABUL HADIDI).

(6) HARASSMENT OF TRAVELLERS AT JANBUR CHECKPOINT (LF1765) CONTINUED AS BEFORE.

E. ~~(S)~~ GOI ACTIVITIES: FOLLOW UP OF ASSASSINATION OF LISSY SCHMIDT: ON 13 APR 94 MCC RECEIVED THE FOLLOWING MESSAGE DATED 12 APR 94 FROM THE MAYOR OF ZAKHO: (QUOTE) SUBJECT: ASSASSINATION OF THE GERMAN JOURNALIST LISSY SCHMIDT. THE DAHUK GOVERNORATE INFORMED US THIS EVENING IN A MESSAGE FROM THE MINISTRY OF INTERIOR OF THE KURDISTAN REGION THAT THREE PEOPLE PARTICIPATED IN THE INCIDENT OF THE GERMAN JOURNALIST LISSY SCHMIDT'S MARTYRDOM. TWO OF THEM WERE ARRESTED WHILE THE THIRD IS UNDER THE PROTECTION OF THE CENTRAL AUTHORITY [MCC COMMENT: TAKEN TO IMPLY GOI]. THE TWO THAT WERE CAPTURED CONFESSED TO THE PERPETRATION OF THE KILLING. WE WILL PROVIDE YOU WITH THE DETAILS AS SOON AS THEY ARRIVE. (END QUOTE)

F. ~~(S)~~ TRUCK TRAFFIC: TRUCK TRAFFIC FOR 12 APR 94 - NOT AVAILABLE.

G. (U) VISITORS TO ZAKHO HOUSE: 9.

2. ~~(S)~~ COMMUNICATIONS: NTR

3. ~~(S)~~

[CLASSIFIED PORTION DELETED (73 WORDS)]

4. ~~(S)~~ LOGISTICS AS OF 13 APR 94:

JP-4 STATUS 11,863/20,000 GALLONS

MOGAS STATUS 19,240/50,000 LITRES

DIESEL STATUS 2,940/50,000 LITRES

5. PUBLIC AFFAIRS: NTR

6. ~~(S)~~ MCC HELICOPTERS MISSIONS:

14 APR 94 - 2 SHIP SUPPORT MISSION

15 APR 94 - 2 SHIP ADMIN  
16 APR 94 - 3 SHIP ADMIN  
17 APR 94 - DOWN DAY  
18 APR 94 - 2 SHIP TAOR  
19 APR 94 - 2 SHIP MCC SUPPORT MISSION  
20 APR 94 - 2 SHIP ADMIN  
21 APR 94 - 2 SHIP ADMIN

AIRCRAFT STATUS: 6 FMC

7. <sup>U</sup>~~(C)~~ TRANSPORT STATUS: MCC VEHICLE STATUS: FOUR TOYOTAS -  
FMC, FOUR HMMWV - 3 FMC, 1 NMC (BLOWN ENGINE), 4 CUCV - 4 FMC

8. (U) PLAQUES: NTR

9. (U) CCMCC COMMENTS: NTR

MULTIPLE SOURCES

DECLASSIFY ON: OADR

**TAB AC-1**

**UH-60 BLACK HAWK 88-26060**

<b>AC-1a</b>	<b>Black Hawk Load Plan and Pre-mission Brief</b>	
<b>AC-1b</b>	<b>UH-60 Crew Member Briefing/Risk Assessment</b>	
<b>AC-1c</b>	<b>AE Form 1010, Army Aircraft Traffic Log</b>	
<b>AC-1d</b>	<b>Eagle Flight Detachment Mission Schedule</b>	<b>AC-1a</b>
<b>AC-1e</b>	<b>MCC Situation Reports and Operations Schedule</b>	
	<b>(See also Classified Addendum)</b>	<b>AC-1b</b>
<b>AC-1f</b>	<b>Eagle Flight Following Schedule</b>	
		<b>AC-1c</b>
		<b>AC-1d</b>
		<b>AC-1e</b>
		<b>AC-1f</b>



DEPARTMENT OF THE ARMY  
EAGLE FLIGHT DETACHMENT, 12th AVIATION BRIGADE  
PIRINCLIK, TURKEY, APO AE 09825

AETV-AVA-EAGLE

1 APR 93

MEMORANDUM FOR FLIGHT CREWS

SUBJECT: Eagle Flight Coordinates

1. The attached sheet contains the destination coordinates with coordinating letter designations. These letter designations will be used to transmit the locations and destination to AWACS (Cougar).
2. The route of flight will be straight line from point to point unless otherwise indicated. In the event of a "round robin" or to a destination that does not have a letter designation notify AWACS appropriately. i.e. "Eagle 1 will be enroute to vicinity Delta".
3. The following CFAC units should receive the coordinates and designated locations.  

CFAC OPNS	Rec'd 31 Dec 92
C-3 CTF HQ'S	Rec'd 31 Dec 92
MAD DOG OPNS	Rec'd 30 Dec 92
4. If there are any questions, contact the detachment IP at DSN 676-7085

  
KENNETH J. KOCH  
CW2, AV  
Detachment IP

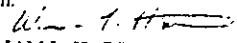
CERTIFICATE	
I certify that I am the Records Custodian for the Accident Investigation Board convened to investigate the crash of two U.S. Army Black Hawk helicopters in the no fly zone in northern Iraq on 14 April 1994, and that this is a true and accurate copy of the record which is kept in my records system.	
<u>7 May 94</u> Date	 WILLIAM L. HARRIS, Capt, USAF, MSC Evidence Custodian, Incirlik Air Base, Turkey

EAGLE FLIGHT CHECKPOINT DESTINATION COORDINATES

A = AL AMADIYA	N37'05.6	E043'28.8	38S	LG 6555	0645
B = BARUSHKI	N37'04.1	E043'04.5	38S	LG 2900	0410
C = BARZAN	N36'55.5	E044'02.7	38S	MF 1500	8700
D = BATUPAH	N37'10.7	E043'00.7	38S	LG 2350	1650
E = AQURAH	N36'45.5	E043'54.0	38S	MF 0145	6905
F = BASHUR AFLD	N36'32.0	E044'20.5	38S	MF 4100	4335
G = DAHUK	N36'51.5	E043'00.0	38S	LP 2220	8070
H = DIYANAH	N36'39.8	E044'32.7	38S	MF 5934	5769
I = PIDAH	N36'48.9	E042'54.6	38S	LP 1350	7650
J = QAL'AH CHIN	N36'38.6	E044'19.4	38S	MF 3920	5410
K = HARIK	N37'02.5	E043'40.1	38S	LG 8176	0041
L = IRBIL	N36'13.0	E043'58.5	38S	MF 0800	0862
M = KANI MASI	N37'13.8	E043'26.5	38S	LG 6180	2165
N = MANGESH	N37'02.5	E043'08.0	38S	LG 3096	0065
O = SALAH A DIN	N36'21.3	E043'16.0	38S	MF 3420	2350
P = SHALADIZA	N37'02.3	E043'48.1	38S	LP 9345	9995
Q = SHAQLAWA	N36'23.5	E044'19.9	38S	MF 2875	2689
R = SURI	N37'01.1	E043'49.7	38S	LP 9575	9770
S = SARSENK	N37'02.4	E043'20.7	38S	LG 5275	0065
T = SIRSENK AFLD	N37'06.0	E043'16.2	38S	LG 4636	0735
U = SPINDAR	N36'58.4	E043'19.1	38S	LP 5100	9310
V = DAM (BEKMA)	N36'40.4	E044'14.1	38S	MF 3380	6030
W = ZAKHU	N37'08.5	E042'40.7	38S	KG 9331	1353
X = ZAWITA	N36'54.2	E043'08.2	38S	LP 3394	8588

EAGLE FLIGHT INTERNAL FREQUENCIES (Secure capable UHF/PM)  
 FM #1 41.45 UHF 300.000 VHF 141.800 PM #2 30.30

LLTR COORDINATES

DIYARBAKIR	N37'53.8	E040'11.6	37S	FB 0502	9518
TURN POINT # 1	N37'43.5	E041'47.5	37S	GB 4602	7918
TURN POINT # 2	N37'25.5	E041'51.8	37S	GB 5350	4600
TURN POINT # 3	N37'25.1	E041'13.1	38S	KG 5382	4498
GATE # 1	N37'12.1	E042'36.8	38S	KG 8815	1998

LTCC FREQUENCIES VHF 122.100 UHF 257.800 VOR 110.0

**TAB AC**

**OTHER DOCUMENTS**

**AC-1 UH-60 Black Hawk 88-26060**

**AC-2 UH-60 Black Hawk 87-26000**

**(See Tabs AC-1a thru AC-1f)**

**AC-3 E-3B AWACS**

**AC-4 F-15C 79-0025**

**AC-5 F-15C 84-0025**

**AC-6 Command and Control**

**AC-7 Visual Recognition Guides**

**AC-8 Miscellaneous**

**AC-1**

**AC-2**

**TAB AC**

**OTHER DOCUMENTS**

**AC-1 UH-60 Black Hawk 88-26060**

**AC-2 UH-60 Black Hawk 87-26000**

**(See Tabs AC-1a thru AC-1f)**

**AC-3 E-3B AWACS**

**AC-4 F-15C 79-0025**

**AC-5 F-15C 84-0025**

**AC-6 Command and Control**

**AC-7 Visual Recognition Guides**

**AC-8 Miscellaneous**

**AC-1**

**AC-2**

**AC-3**

**TAB AC-3**

**E-3B AWACS**

**AC-3a**

**AC-3a Extract from AWACS Log Book**

**AC-3b 552nd ACW Form 32, CSO Communication Configuration Worksheet**

**AC-3c Extract from AWACS Senior Director Log**

**AC-3d AWACS In-flight Log**

**AC-3e 552nd ACW Form 49, AWACS Mission Summary**

**AC-3f Intelligence Brief - UN Flight Information**

**AC-3g 28 AD Form 67, ASO Log Continuation Sheet**

**AC-3h Statement on AWACS Video Camera**

**AC-3i AWACS Pre-mission Brief**

RECORD  
AWACS  
LOG  
BOOK

<b>CERTIFICATE OF DECLASSIFICATION</b>	
I certify that the information contained in this document has been declassified from	
<del>SECRET</del>	to UNCLASSIFIED
26 May 94	<i>Ronald G. Norris</i> RONALD G. NORRIS, GS-15, DAC Declassification Team Chief, HQ USEUCOM
Date	

**CERTIFICATE OF DECLASSIFICATION**  
 I certify that the information contained in this document has been declassified from  
 SECRET to UNCLASSIFIED  
 16 MAY 94  
 Date

Donald G. Norris  
 DONALD G. NORRIS, GS-15, DAC  
 Declassification Team Chief, HQ USEUCOM

I certify that I am the Records Custodian for the Accident Investigation Board convened to investigate the crash of two Army Black Hawk helicopters in the no-fly zone in northern Iraq on 14 April 1991 and that this is a true and accurate extract from the AWACS Log Book, interview for 14-15 Apr 91 which is kept in the records system.  
 16 May 97  
 Date  
 WILLIAM L. HARRIS, Capt, USAF, MSC  
 Evidence Custodian, Incirlik Air Base, Turkey

3  
 // LRW 0814 GOOD LINK & PIC  
 FOCY//

1  
 D/MD 0818 PUMA 44 NO COOL STAY TILL BINGO OUT BECAUSE  
 NO GAS FOR YOU//

NK//  
 D/MD 0821 1815Z BINGO FOR COUGAR/ROGER  
 MD/D 0825 LOOKING FOR EVERYBODY TO BE FULL AFTER  
 P94 1215Z BINGO FOR CLAW & COUGAR//

350Z  
 MD/D 0920 CLAW ABOUT 20 MIN LATE//  
 SIC 0922 ROGER WE WILL HAVE TAPES UPON RTN/TURKS  
 RUNNING SPECIAL MEN HAVE TAPES//

MD/C 0925 WHATS INFO IN PROVIDE CONFIDENT FLTS/ARE  
 THEY INTERFERING, WHAT ALT, TYPE ACFT/  
 NIG/R4 ELEMENTS BELOW ROT 3 STAYING  
 LOW//

MD/D 0958 2 SPEC MSN JUST INSIDE TANK 1 & LIOLE ORPINANCE  
 ON BOARD

MD/D 1018 NEEDS 1315 WX OUT. BACK//  
 14 APR 94 14 APR 94  
 QUARTZ / 32 / T ETD 0450Z

MD/C 0530 JTIDS W INDIA//  
 SC/SD 0540 RDOCK LC / GO MIKE 17//  
 MD/SD 0741 RDOCK LC//  
 C/MD/SD 0742 TIGER JUST SHOT DOWN 2 HIND  
 HELICOPTERS N 36'46".9 E 44'04".3  
 AT 0730Z N 36'45".1 E 44'05".2  
 // KING HD COPY AND V. DEO//  
 C/SD 0745 WE DO HAVE HD COPY//

~~DAD~~ DMD 0745 WHAT KIND OF MUNITIONS USED/  
STANDBY/TIGER IS ON TANKER  
WILL BE A FEW BEFORE WE  
GET INFO //

MD/D 0755 DO YOU WANT THE RECCE TO TAKE  
PICTURES OF AREA / ROGER TAKE  
PICTURES OF AREA AND CHK FOR  
SURVIVORS //

MD/D 0807 HOW DID WE GET ID / VISUAL ID  
AND AWACS ID / WAS AWACS TRACKING  
PRIOR TO ENGAGEMENT? / MEG IT  
HAPPENED SO QUICKLY AND THEY  
WERE AT LOW ALT IN THE CLUTTERED  
AREA

MD/D 0810 TIGER 1 USED A SLAMMER ~~AND~~  
AIM9 MIKE # FOR TIGER 2 //

MD/D 0812 WHO'S FLYING IN RAIDER?  
FALCON IS # 2 GUY / I'LL  
LET HIM FLY OVER

DMD 0815 WRITE DWN THE SQNC OF EVNTS //

DMD 0817 GIVE ME A CALL WHEN YOU SEND  
TIGERS HOME / ~~ETD~~ ETD 0845Z  
ETA 0930Z

D/MD 0929Z THE HARRIERS SHOULD HAVE RECCE CREW

D/MD 0931 ASK AWACS WHAT KIND OF ID THEY  
/ ASK AWACS WHAT KIND OF ID  
THEY HAD / JUST A RADAR NO ~~SQU~~ SQU  
KS NO CONF BY AWACS # IF HOSTILE OR NOT



WERE THEY TRACKING EAGLE & FLT AT  
ALL NEED POSITIVE CONF OF THEIR PSN

D/MD 0941 NO SURVIVORS / WERE THEY CARRYING  
ORDINANCE / THEY WERE CARRYING  
SOME KIND OF ~~ORDINAL~~ ORDINANCE ON PYLONS  
BUT UNSURE OF WHAT KIND //

C/MD 0945 LIKE YOU TO EST VOX CONTACT / WE'VE  
BEEN TRYING //

SO/CM 65.000 AOR OR EXTEND TO ~~45~~ 1735z - 1835z  
IS OUR MAX DUTY DAY //

D/MD 0906 HAS TIGER GONE YET / NO //

D/MD 0909 HAVE THE HARRIERS FLOWN OVER TARGET /  
ROGER HURRICANE JUST FLEW OVER AND  
TOOK PICTURES / SPITFIRE FLYING  
OVER ATT

D/MD 0914 CONFIRM GOOD RADAR ON EAGLE FLT /  
FIND THEM AND ~~KEEP~~ KEEP THEM GET  
GOOD COORDINATES //

D/MD 0915 AWAC GUY SAYS WHENEVER EAGLE FLY FLIES  
THEY ALWAYS SQUAWK / HE SAYS THEY ARE  
DOWN RIGHT NOW //

D/MD 0916 CONFIRM W/AWACS IF THEY DID HAVE  
A GOOD SQUAWK BECAUSE EAGLE FLY CAME  
WITHIN 10 MILES OF SHOOT DOWN //

WS11:

D/MD 0918 CONF IF EAGLE WAS A SINGLE OR DOUBLE //

D/MD 0921 TIGERS JUMPED //

NAV D/MD 0925 EAGLE WAS A 2 SHIP MSN //

DTA

DMD 0926 HURRICANE SAID HE FLEW OVER  
BOTH CRASH SITES / SPITFIRE ONE  
SITE ATT //

DMD 0929 WHAT WAS HDING OF TARGET AT  
TIME OF INCIDENT / UNKNOWN //

DMD 0930 CONFIRMED A VALID SQUAWK WELL  
AFTER INCIDENT WITH HINDS //

SO/CM 0931 ON TANK ATT / COPY //

D/MD 0932 ARE THEY STILL TALKING TO  
TIGER / NEG WERE GETTING GAS

D/MD 0937 HAVE YOU HAD ANY LUCK REACHING  
EAGLE / NEG / DID YOU COPY THAT  
THEY HAVE A CONFIRMED AFTER  
THE INCIDENT //

D/MD 0945 ARE YOU STILL ON TANKER ? /  
JUST GOT OFF / GET BACK ON  
AND GET 30000 MORE //

C/SO 0947 WHAT IS YOUR TOTAL FUEL ONLOAD /  
WE'RE STILL COORDINATING THROUGH  
D/MD //

MD/D 0952 GOING TO TAKE ON 30000 / GET  
30000 AND TIGER GETS THE REST /  
YOU GUYS MAY BE OUT AWHILE / I  
GIVE TIGER THE REST BUT I MEAN  
GIVE CLAW THE REST / ROGER //

MD/D 1007 WX RPT //

D/MD 1026 HAS TIGER LANDED AND HAVE  
THEY LOOKED AT THE VIDEO /

1026 CONT NEG HE JUST LANDED / GET VIDEO  
ASAP //

D/MO 1028 D.D THEY GET CONFIRMATION ON THE PARKING LOT/  
THEY FLEW OVER BUT ARE NOT SURE  
IF THEY WERE ON RIGHT VECTOR

D/MO 1045 HAVE CLAW MAKE SOME NOISE OVER THE  
CRASH SITE / I DON'T THINK IT'S SMART  
BUT I'LL DO IT //

MD/D 1102 CLAW SAW SITE 1, MADE NOISE, NO ONE WILL GAS  
EXCEPT TIGER OFF OF PUMA 55 //

D/MO 1110 UNTIL POSITIVE ID ON EAGLE WE ARE GOING TO STAY  
IN AREA UNTIL 1730Z //

~~S/C~~ S/C 1115 NEED COMSEC GUY TO COME OVER TO RADIO / ROGER /  
ABOUT KICK 13

D/MO 1123 DID ANYBODY HAVE CT WITH EAGLE FLT TODAY / YES  
WHEN THEY CAME INTO AOR / LAST CT WAS AT ZACKO  
@ 0650Z //

S/C 1125 SINGLE CK / 1/2 HOUR ME / 1/2 ALSO //

D/MO 1129 HAS ANY ONE HAD CT WITH EAGLE FLT / APPROX  
TIME WAS 0600Z WHEN ~~THEY~~ THEY WERE LEAVING  
ZACKO TO POINT (D) / WAS ALO AWARE THAT  
THEY WERE COMING INTO AOR / ~~AFFIRM~~ AFFIRMATIVE)  
DID ALO KNOW OF THEIR TIMES TO DIFF PLACES  
NEG //

S/C 1135 BAM ROD VP / ROGER / COPY BINGO TIMES / FUEL BINGO  
1735Z / 1810Z BINGO / WILL EXTEND DUTY DAY 1 HR /  
ROGER //

D/MD 1149 SPIDER & VIKING WILL NOT MAKE IT OUT/ANY  
WORD ON TIGER DEBRIEF YET/NEG//

D/MD 1232 DUKE, TIGER & PUMA 55 REMAIN ON STN UNTIL  
1730Z/SAUY 2 TAKE OFF 1545Z/PUMA 11 T/O 1610Z/  
CLAW T/O 1615Z//

S/L 1238 BTB 1730Z/SAUY 02 1530Z T/O/WHEN DO HAVE  
THEM ABOUT THE WESTERN LONG @ 32,000 & WE WILL BE  
@ 23,000/ROGER//

S/L 1244 ON FALY MIT & NLS/THEIR P.O. WILL BE 75/ROGER//

MD/C 1403 GHOST 31 & PONY WANTS OVERLAND REFUELING/ROGER  
A.R. IS URGENT DUE TO LACK OF FUEL//

MD/C 1406 EAGLE 14 ETA 1500Z//

MD/C 1411 GHOST WANT TO AB, PONY OVER 1 AB & IN ROZ 2//

C/MD 1415 UNDER STAND THAT YOU WANT GHOST TO RE FUEL  
WHEREVER EVER POSS TO ACCOMP. MSN/ROGER//

C/MD 1428 SAUY 02 UP ATT/NEED YOUR PLANE BACK ASAP//

S/CZ 1440 ADD CK/1/2 PWYS//

D/MD 1932 PONY 22 ADV TRAILER JUST OUTSIDE  
ZAKHU WHEN ON WAY BACK TO CRASH  
SITE//

D/MD 1935 YOUR TANKER AIRBORNE//

D/MD 1940 GHOST 31 WANTS GHOST 32 TO PICK THEM  
UP ON WAY TO DIX//

15 APR 94

MD/P 0032 PONY 23 ON PECK @ PIX (DIX) ATT//

MD/D 0038 PONY 21 HEADING INBOUND/PONY 22 LEFT AT  
FAR SITE THEN BACK TO AB WITH LAST REMAIN  
BNL//

MD/P 0046 GHOST 32 ON DECK @ PIX ATT//

1  
 MD/D 0055 2 HELI LEFT FOR PIR / 1 HELI BTWN SITE 1  
 & AB & 1 Q AB TO GET PSNL //

2/ MD/D 0000 W/ UPDATE //

3/ 4/C 0101 SINGLE CK / NEG RTT //

MD/D 0108 HEADING OUTSIDE ROZ L ATT //

MD/D 0117 PONY 22 ON DECK @ CRASH SITE ATT //

MD/D 0119 EST FLT TIME BTWN PIR & AB 45  
 MIN //

4/ MD/D 0121 PONY 21 ETA @ PIR 0230Z / COPY //

4/C 0126 OFF STN 0125Z / COPY //

MD/D 0132 PONY 22 MAY OR MAY NOT BE AIRBORNE  
 (HOST 32 STILL ON DECK / GOING OFF STN ATT //

15 APR 94 15 APR 94

1/ UNIFORM / 05 / D ETO ~~0250Z~~ 0600Z

SO/C 0617 RDO CK LC //

MD/D 0623 RDOCK / 5 BY / ALL F16'S INDEFINITE ROLEX //

SO/C 0625 RDO CK LC BWYS //

4/ C/SO 0721 JTIDS W/INDIA AND DADDY //

SO/R/C 0 RECOMMEND KICK TO MIKE 18 //

D/M/D 1005 ANSTE ANOTHER PACKAGE ENTERING THE ROZ //

D/M/D 1025 40 MILES W ROZ L 2 IN IRAQ / A  
 4TH SPECIAL MISSION OF HELI IN IRAQ

D/M/D 1034 1ST ACFT LEFT IRAQ / 2ND LEAVING / THIRD  
 AB STILL IN IRAQ / FOURTH W/ HELI STILL THERE //

W/MD 1050 DO YOU WANT THIS INFO ON ACFT? / 6 PACKAGE  
 OF FIGHTERS HEADED TOWARD IRQ IRAQ /  
 ALREADY WITHIN 25 MILES

C/SO 1050 D: PHASE PROB / ON UHF RDO SYSTEM //

**TAB AC-3**

**E-3B AWACS**

		<b>AC-3a</b>
<b>AC-3a</b>	<b>Extract from AWACS Log Book</b>	
<b>AC-3b</b>	<b>552nd ACW Form 32, CSO Communication Configuration Worksheet</b>	<b>AC-3b</b>
<b>AC-3c</b>	<b>Extract from AWACS Senior Director Log</b>	
<b>AC-3d</b>	<b>AWACS In-flight Log</b>	
<b>AC-3e</b>	<b>552nd ACW Form 49, AWACS Mission Summary</b>	
<b>AC-3f</b>	<b>Intelligence Brief - UN Flight Information</b>	
<b>AC-3g</b>	<b>28 AD Form 67, ASO Log Continuation Sheet</b>	
<b>AC-3h</b>	<b>Statement on AWACS Video Camera</b>	
<b>AC-3i</b>	<b>AWACS Pre-mission Brief</b>	

~~SECRET~~

MISSION:		CSO COMMUNICATIONS CONFIGURATION WORKSHEET								DATE:													
POSITION	GD	A	B	C	D	RADIO	DA	FREQ(P)	FREQ(S)	USE													
31		2	10	17	23	21	T1R2	16															
27	AST	2	10	05	23	21	T3R4	17															
23	AST	2	10	05	23	21	T5R6	20															
05	WD SD	1	22	24	23/2	21	RT7	21		TSAT													
30	TC <sup>NO GNET</sup> <sub>3</sub>	1	22	04	05	17	RT8	22		ENROUTE													
04	WD SD	1	22	24	23/2	21	RT9	23		FOR HB													
06	DUKE	1	14/6	12/4	23/2	21	RT10	24		TANK													
11	AAS	2	17	05	14/6	21	RT11	25		FOR													
07	ASO	2	17	05	03	21	RT12	GD-1		GUARD													
14	AST	2	10	05	23/2	21	R13	GD-3		ADF													
25	CAP	1	22	24	23/2	25	TR14	03		SSAT													
21	Check in	1	22	24	23/2	12/4	RT15	12		HB													
02	CT						RT16	14		DUKE													
22	CSO						RT17	05		INDIA													
26	ART						RT18	06		OB													
33	CDMT						RT20	N/A		HO													
13							ERV1	04		TIMING													
10	TANK	1	22	24	23	14/6	HF1	10															
24	MCC	1	05	24	23	21	HF2																
01	SD	1	22	24	23	21	HF3	71															
FLT DECK		NET:		HF:		VHF:		UHF:		VHF-1	21												
										VHF-2	15												
										VHF-FM	13												
RT08				RT09				RT10				RT11											
CN	DA	A	B	C	D	CN	DA	A	B	C	D	CN	DA	A	B	C	D	CN	DA	A	B	C	D
F1						F1						F1						F1					
F2						F2						F2						F2					
F3						F3						F3						F3					
F4						F4						F4						F4					
F5						F5						F5						F5					
F6						F6						F6						F6					
RT15				RT16				RT17				RT18											
CN	DA	A	B	C	D	CN	DA	A	B	C	D	CN	DA	A	B	C	D	CN	DA	A	B	C	D
F1						F1						F1						F1					
F2						F2						F2						F2					
F3						F3						F3						F3					
F4						F4						F4						F4					
F5						F5						F5						F5					
F6						F6						F6						F6					

552 ACW Form 32, Oct 92

~~SECRET~~

**CERTIFICATE OF DECLASSIFICATION**

I certify that the information contained in this document has been declassified from

~~SECRET~~ to UNCLASSIFIED

14 May 1994

Date

DONALD G. NORRIS, GS-15, SAC  
Declassification Team Chief, HQ USEUCOM

**CERTIFICATE**

I certify that I am the Records Custodian for the Accident Investigation Board convened to investigate the crash of two U.S. Army Black Hawk helicopters in the no fly zone in northern Iraq on 14 April 1994, and that this is a true and accurate copy of the record which is kept in my records system.

14 MAY 94  
Date

W. L. HARRIS  
WILLIAM L. HARRIS, Capt, USAF, MSC  
Evidence Custodian, Incirlik Air Base, Turkey

**TAB AC-3**

**E-3B AWACS**

	<b>AC-3a</b>	
<b>AC-3a</b>	<b>Extract from AWACS Log Book</b>	
<b>AC-3b</b>	<b>552nd ACW Form 32, CSO Communication Configuration Worksheet</b>	<b>AC-3b</b>
<b>AC-3c</b>	<b>Extract from AWACS Senior Director Log</b>	
<b>AC-3d</b>	<b>AWACS In-flight Log</b>	<b>AC-3c</b>
<b>AC-3e</b>	<b>552nd ACW Form 49, AWACS Mission Summary</b>	
<b>AC-3f</b>	<b>Intelligence Brief - UN Flight Information</b>	
<b>AC-3g</b>	<b>28 AD Form 67, ASO Log Continuation Sheet</b>	
<b>AC-3h</b>	<b>Statement on AWACS Video Camera</b>	
<b>AC-3i</b>	<b>AWACS Pre-mission Brief</b>	



~~SECRET~~

Br 10 R1 RS  
R7

CONTINUATION SHEET FOR 28 AD FORMS 36, 42, 48, AND 49				
NAME	MISSION	ACFT TAIL NO.	DATE	PAGE
[REDACTED] SD			14 APR 94	1 OF
TIME (Z)	CHRONOLOGICAL NARRATIVE / REMARKS (CONTINUED)			
0458	Wpm consoles assigned area altimeter 29.75 1007			
0521	RCFMU RT7 <sup>not</sup> SATCOM RT9 RT15			
0727	Engaged 3646.9 N 3645.1 N #C157 TRO1 4404.3E 4405.2E			
0730	Splash 1 Hind <sup>40100</sup> Splash 2 3647 N below 500' 4407 E			
0744	passed to MD TRO1 AMRAM TRO2 AIM-9M VID			
0754	Cyrano 4 #C175 #5534 1/4200			
0812	Height Finder HE 340/20			
1013	Halo sighted by Bronco			
1026	Bronco @ site 7 <sup>parking</sup> 3623.0 4412.0			
1052	CW11 over splash site "broken-up and charred"			
1100	Cycb through PRC-112 Progr. 253.25 26430			
1259	R/D Pony <sup>21</sup> 22 on Satcom Ghost 31			
1320	Comm set <sup>23</sup> for SAR			
1428	Tiger <sup>at</sup> Puma Tiger bracketed 28K alt 20K @ 1500Z			
1457	SAR package through gate			
1519				
1522	Friendly shoot down confirmed			
1523	Radios released			
1520	Off-station			

28 AD FORM 67 APR 89

(PREVIOUS EDITIONS WILL BE USED)

~~SECRET~~

**CERTIFICATE OF DECLASSIFICATION**  
 I certify that the information contained in this document has been declassified from  
~~SECRET~~ to UNCLASSIFIED.  
 15 May 94  
 Date  
 Donald G. Norris  
 DONALD G. NORRIS, GS-15, DAC  
 Declassification Team Chief, HQ USEUCOM

**CERTIFICATE**  
 I certify that I am the Records Custodian for the Accident Investigation Board convened to investigate the crash of two U.S. Army Black Hawk helicopters in the no fly zone in northern Iraq on 14 April 1994, and that this is a true and accurate copy of the record which is kept in my records system.  
 15 May 94  
 Date  
 WILLIAM L. HARRIS, Capt, USAF, MSC  
 Evidence Custodian, Incirlik Air Base, Turkey

**TAB AC-3**

**E-3B AWACS**

	<b>AC-3a</b>	
<b>AC-3a</b>	<b>Extract from AWACS Log Book</b>	
<b>AC-3b</b>	<b>552nd ACW Form 32, CSO Communication Configuration Worksheet</b>	<b>AC-3b</b>
<b>AC-3c</b>	<b>Extract from AWACS Senior Director Log</b>	
<b>AC-3d</b>	<b>AWACS In-flight Log</b>	<b>AC-3c</b>
<b>AC-3e</b>	<b>552nd ACW Form 49, AWACS Mission Summary</b>	
<b>AC-3f</b>	<b>Intelligence Brief - UN Flight Information</b>	<b>AC-3d</b>
<b>AC-3g</b>	<b>28 AD Form 67, ASO Log Continuation Sheet</b>	
<b>AC-3h</b>	<b>Statement on AWACS Video Camera</b>	
<b>AC-3i</b>	<b>AWACS Pre-mission Brief</b>	







**NARRATIVE - COMMENTS & PROBLEM AREAS**

**TACTICS LESSONS LEARNED**

MCC:

SD:

ASO:

TECHS:

FAA/AIRSPACE:

ARE THERE ADDITIONAL SHEETS ATTACHED? YES/NO      HOW MANY? \_\_\_\_\_

**TAB AC-3**

**E-3B AWACS**

	<b>AC-3a</b>
<b>AC-3a</b>	<b>Extract from AWACS Log Book</b>
<b>AC-3b</b>	<b>552nd ACW Form 32, CSO Communication Configuration Worksheet</b>
<b>AC-3c</b>	<b>Extract from AWACS Senior Director Log</b>
<b>AC-3d</b>	<b>AWACS In-flight Log</b>
<b>AC-3e</b>	<b>552nd ACW Form 49, AWACS Mission Summary</b>
<b>AC-3f</b>	<b>Intelligence Brief - UN Flight Information</b>
<b>AC-3g</b>	<b>28 AD Form 67, ASO Log Continuation Sheet</b>
<b>AC-3h</b>	<b>Statement on AWACS Video Camera</b>
<b>AC-3i</b>	<b>AWACS Pre-mission Brief</b>

Full-up / DOP - 00 R

AWACS INFLIGHT LOG		NAVIGATOR	PROT	DATE	CALL SIGN/TAIL NO.								
CLEARANCE				DESTINATION	BLOCK TIME								
CAF VFR 232.0				LTA5	1615Z								
V. 12) V101 145 40164				DEPARTURE	T.O. TIME								
ILS 05 - DH 496				LTA5	0436Z (0736L)								
				MISSION NUMBER	TOTAL TIME								
				DPC-084	11.6								
TIME	AID	R P I	POSITION		STA 1	STA 2	ALT	TAS GS	W	V	NEXT CK POINT		REMARKS
			LATITUDE	LONGITUDE	DME	DME					TEMP	TC	
0501	INS 1	18	-24.0	-50.9	412	344	32.0	375	224	28	WAU-UP	0444	
	INS 2	✓	37-24.0	035-50.9	2	2	48	5					0.109 (C.S)
0547	INS 1	40	-32.1	-03.4	842	844	✓	372	286	9	KTAWN	0525	0545 ON STATION
	INS 2	✓	37-32.4	039-03.7	2	6	49	5			JTIDS	0531	0351 (C.S)
0617	INS 1	18	-20.2	-02.0	✓	✓	✓	385	276	19	JTIDS	0531	
	INS 2	✓	37-20.5	039-01.9	✓	✓	✓	5					0.134 (C.S)
0647	INS 1	16	-32.4	-01.3	✓	✓	✓	288	184	5	ARCT	0930	
	INS 2	✓	37-32.5	039-01.5	✓	✓	✓	5			JTIDS	0930	0.049 (C.S)
0730	INS 1	20	-55.5	-02.4	842	844	✓	380	267	31	Der:K	0715	0730 - KILL 2 HIND HELOS.
	INS 2	✓	37-55.9	042-02.6	4	5	48	5			SUNP	0726	0.875 (C.S)
0810	INS 1	✓	-44.4	-24.4	✓	✓	✓	370	309	20	G FOR	0730	0.900 (C.S)
	INS 2	✓	37-44.8	043-24.3	✓	✓	✓	49					0.900 (C.S)
0900	INS 1	22	-59.2	-25.9	✓	✓	✓	376	308	26			0.886 (C.S)
	INS 2	✓	37-59.5	043-25.9	✓	✓	✓	4					0.886 (C.S)
0940	INS 1	18	-44.7	-14.1	✓	✓	✓	393	125	01	ARL		0.811 (C.S)
	INS 2	✓	37-44.9	043-13.9	✓	✓	✓	34					0.811 (C.S)
1027	INS 1	✓	-01.4	-24.4	✓	✓	✓	310	263	208	31	ROZ1	
	INS 2	✓	38-01.6	043-24.2	✓	✓	✓	4					0.929 (C.S)
1115	INS 1	20	-06.7	-12.0	✓	✓	✓	392	246	18			1056 - TONE UNFLIGHTED
	INS 2	✓	38-06.9	043-12.0	✓	✓	✓	5					0.983 (C.S)
1200	INS 1	18	-38.2	-09.4	✓	✓	✓	384	323	13			1735 FUEL 1310 OLEW
	INS 2	✓	37-38.0	043-09.4	✓	✓	✓	4					0.996 (C.S)
1300	INS 1	✓	-42.3	-58.5	✓	✓	✓	376	328	14	OFF STATION	1730	1530 TIO SAVVYZ
	INS 2	✓	37-42.5	042-58.5	✓	✓	✓	5					1.117 (C.S)
1400	INS 1	✓	-39.2	-07.8	✓	✓	✓	355	348	13			D-100000 (C.S)
	INS 2	✓	37-39.4	043-07.7	✓	✓	✓	4					1.401 (C.S)
1448	INS 1	20	-36.6	-36.0	✓	✓	✓	32.0	303	04	SUNO	1453	0 DLY NAT
	INS 2	✓	37-36.9	042-35.8	✓	✓	✓	344			Der:K	1504	1.52 (C.S)
1510	INS 1	✓	-30.7	-57.0	842	844	✓	32.0	306	14	KTAWN	1528	Vref=133 1520 AFST
	INS 2	✓	37-30.6	037-57.5	2	1	4A	276			LUGAR	1530	1548Z 2128Z

552 ACW Form 34, Sep 92

(Previous Edition Will Be Used)

(See Reverse)

0730 - HIND (2) KILLED.  
Probable IIS/UN Blackbirds.

AC = 1-605  
15452 Y18.0

This Page  
Reduced  
with

**CERTIFICATE**

I certify that I am the Records Custodian for the Accident Investigation Board convened to investigate the crash of two U.S. Army Black Hawk helicopters in the no fly zone in northern Iraq on 14 April 1994, and that this is a true and accurate copy of the record which is kept in my records system.

WILLIAM L. HARRIS, Capt, USAF, MSC  
Evidence Custodian Incirlik Air Base, Turkey



N37-27.0      N37-25.5  
 E038-53.0      E039-17.5  
 CW, 6.0 Nm Rad.

TIME	AID	R P I	POSITION		STA 1	STA 2	ALT	TAS	W	V	NEXT CK POINT		REMARKS
			LATITUDE	LONGITUDE	RAD	RAD		GS			TC	DC	
1600	INS 1	24	20.3	-33.8	014	014	18.0	528	200	15	424.14	1532	NO VID Rad/Dm 6 Δ
	INS 2		37-20.2	03-33.1	2	014	-	5			424.14	1540	
	Δ		-19.5	-25.0		25							
1610	INS 1		LND	LTAC	LOC	9650							
	INS 2												
	Δ												
1615	INS 1		-00.3	-23.7									
	INS 2		-00.8	-23.0									
	Δ		37-00.0	035-29.7									
	INS 1												
	INS 2												
	Δ												
	INS 1												
	INS 2												
	Δ												
	INS 1												
	INS 2												
	Δ												
	INS 1												
	INS 2												
	Δ												
	INS 1												
	INS 2												
	Δ												

CELESTIAL HEADING FORM				DEVIATION DATA		REFUELING INFORMATION	
TIME				CEL TH	-	FINAL DISCONNECT TIME	POSITION 37-44.9
BODY				TH INS 1 P	02.0	0948	043-13.9
GHA				TH INS 2 N	093.0	INITIAL CONTACT TIME	POSITION 37-31.9
CORR				VAR	-3	0936	042-47.3
TOTAL GHA				MH	090	TOTAL TIME +10	ONLOAD 45M
LONG -W + E				DEC CORR 1	-L	CLEARANCE	
* LHA				AHRS 1 N	098	REFUELING INFORMATION	
* DEC				DEC CORR 2	30	FINAL DISCONNECT TIME	POSITION 3743.9
* LAT				AHRS 2 P	090	1013	042-55.8
HC				DEV CORR STBY	±0	INITIAL CONTACT TIME	POSITION 37-39.2
ZN				CH STBY P	090	1009 Z	043-33.8
IRB				ZN + IRB = TH		TOTAL TIME +04	ONLOAD 24M
TH				* APPLY 15/45 RULE		CLEARANCE	

*This page reduced - will*

**TAB AC-3**

**E-3B AWACS**

	<b>AC-3a</b>
<b>AC-3a</b>	<b>Extract from AWACS Log Book</b>
<b>AC-3b</b>	<b>552nd ACW Form 32, CSO Communication Configuration Worksheet</b>
<b>AC-3c</b>	<b>Extract from AWACS Senior Director Log</b>
<b>AC-3d</b>	<b>AWACS In-flight Log</b>
<b>AC-3e</b>	<b>552nd ACW Form 49, AWACS Mission Summary</b>
<b>AC-3f</b>	<b>Intelligence Brief - UN Flight Information</b>
<b>AC-3g</b>	<b>28 AD Form 67, ASO Log Continuation Sheet</b>
<b>AC-3h</b>	<b>Statement on AWACS Video Camera</b>
<b>AC-3i</b>	<b>AWACS Pre-mission Brief</b>
	<b>AC-3f</b>

~~SECRET~~

RELEASABLE TO MULTINATIONAL FORCES

INTELLIGENCE BRIEF

BRIEFER: MSGT Newhall

<b>CERTIFICATE OF DECLASSIFICATION</b>	
I certify that the information contained in this document has been declassified from	
<u>SECRET</u>	to UNCLASSIFIED.
<u>26 May 94</u>	<u>Donald G. Norris</u> DONALD G. NORRIS, GS-15, DAC Declassification Team Chief, IIQ USEUCOM
Date	

RELEASABLE TO MULTINATIONAL FORCES

~~SECRET~~

~~SECRET REL MNE~~

# IRAQ AIR SUMMARY

TOTAL SORTIES: 135

FIXED WING: 132

HELICOPTER: 3

LOCAL TRACKS: 15  
(PREVIOUS MISSION)

## HIGHLIGHTS

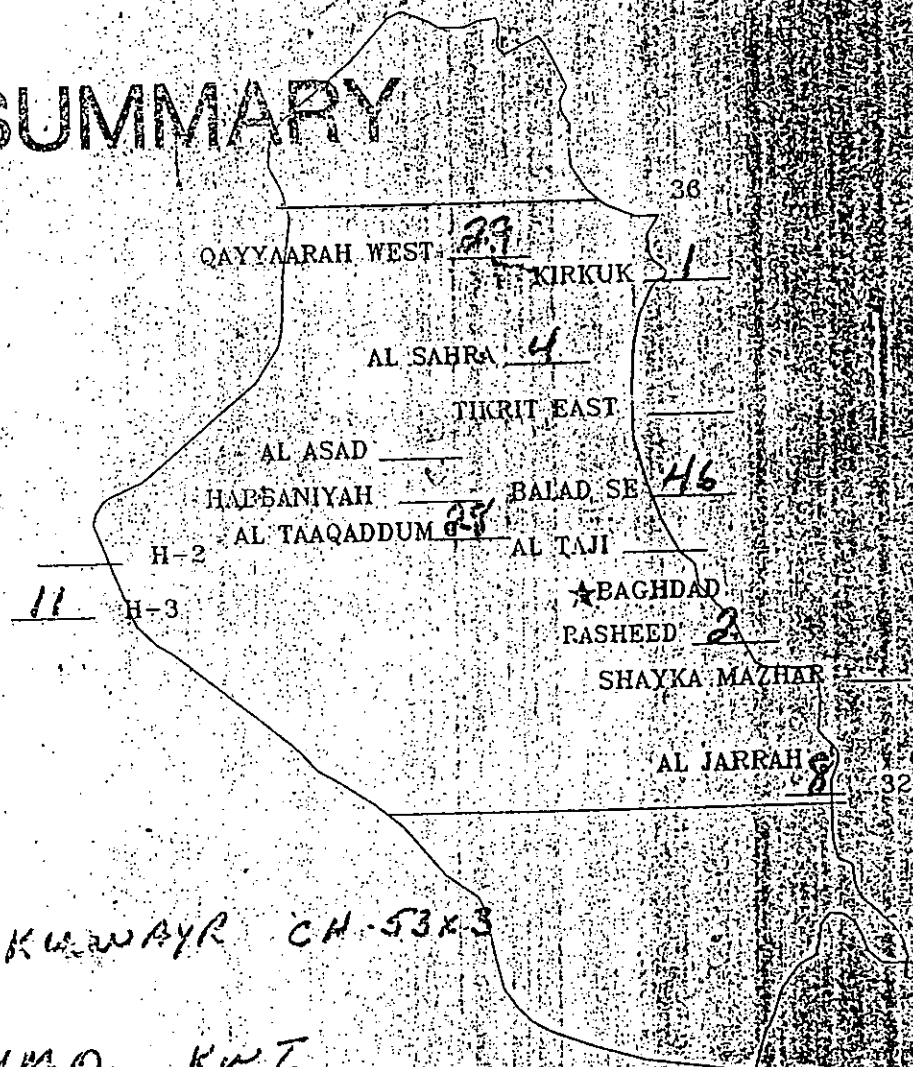

Helo to BAGHDAD TO AL KUWAYR CH-53K3

UNO 700	LCA	HAB	UMQ	KWI
	0700Z	1000Z	1230Z	1250Z

UNO 566/7	BAH	HAB	BAH
	0600Z	0900Z	1130Z

~~SECRET REL MNE~~

### CERTIFICATE OF DECLASSIFICATION

I certify that the information contained in this document has been declassified from

SECRET REL MNE to UNCLASSIFIED

Date 10 May 94

By Donald J Harris  
Declassification Team Chief, HQ USEUCOM

### CERTIFICATE

I certify that I am the Records Custodian for the Accident Investigation Board convened to investigate the crash of two U.S. Army Black Hawk helicopters in the no fly zone in northern Iraq on 14 April 1994, and that this is a true and accurate copy of the record which is kept in my records system.

Date 14 May 94

By Liam L. Harris  
Evidence Custodian, Inerlik Air Base, Turkey

**TAB AC-3**

**E-3B AWACS**

	<b>AC-3a</b>	
<b>AC-3a</b>	<b>Extract from AWACS Log Book</b>	
<b>AC-3b</b>	<b>552nd ACW Form 32, CSO Communication Configuration Worksheet</b>	<b>AC-3b</b>
<b>AC-3c</b>	<b>Extract from AWACS Senior Director Log</b>	
<b>AC-3d</b>	<b>AWACS In-flight Log</b>	<b>AC-3c</b>
<b>AC-3e</b>	<b>552nd ACW Form 49, AWACS Mission Summary</b>	
<b>AC-3f</b>	<b>Intelligence Brief - UN Flight Information</b>	<b>AC-3d</b>
<b>AC-3g</b>	<b>28 AD Form 67, ASO Log Continuation Sheet</b>	
<b>AC-3h</b>	<b>Statement on AWACS Video Camera</b>	<b>AC-3e</b>
<b>AC-3i</b>	<b>AWACS Pre-mission Brief</b>	
		<b>AC-3f</b>
		<b>AC-3g</b>

PU 75

3CA

M17

CONTINUATION SHEET FOR 28 AD FORMS 36, 42, 48, AND 49

NAME	Capt [REDACTED]	MISSION	DPC084	ACFT TAIL NO.	0351	DATE	14 MAR 94	PAGE	1 OF 1
------	-----------------	---------	--------	---------------	------	------	-----------	------	--------

TIME (Z)	CHRONOLOGICAL NARRATIVE / REMARKS (CONTINUED)								
0449	IFF T.O.	Z/Z							3623N441ZE
0452	Cleared S/A								KK466/KK777
0456	IFF TFRD								KE056
0503	Cleared TSat cam								6A064
0505	IFF ops								
0512	Radar TFRD	AZ	108/104/306			BZ	109/103/311		
0513	JTIDS	↑ w/ XRAY							
0517	Radar ops	- minor ringing	AZ checked						
0520	Ops	normal							
0520	Released radios								EM25/6
0526	Radar ops	both chains							
0527	JTIDS	↑ w/ India							
0537	JTIDS	↑ w/ Dabney							
0540	TA	ops							
0545	On	station							
0600	Z011 = Spec	msn	2/1661	3/3600		1/23	in Iraq	≈ 12	1500
0617	Z001 = spec	msn	3722N	04305E		into Iraq	1/33	2/2255	3/07 00
0633	Z063 =	"	2/2255	3/1100		1/41			140000 110000 120000
0700	TA	↑ w/ RW							1200
0708	Z011	land at	LTAT	3824N03806E		(ERHAC?)			
0715	Z001	"	"	"		"			
0730	Z063	"	"	"		"			
0730	Splash	Z 4ink helos	500K	1 AMKRAM		AIM 9M			
				L 3646N04404E		3645N04405E			
0900	AlR	↓ list							
0926	Sensors	TFRD	FOR	AlR		4.1 + 5.0			
1019	Sensors	TFRD	Back	to me.					
1020	Sensors	ops	normal	post	AlR.	CG ops	normal.		
1124	Both	SATCOMs	work						

**EXTRACT**  
 I certify that I am the Records Custodian for the Accident Investigation Board convened to investigate the crash of two U.S. Army Black Hawk helicopters in the no fly zone in northern Iraq on 14 April 1994, and that this is a true and accurate extract from AWACS Cover Log, ASU, DPC 084, 1404174 which is kept in my records system.  
 WILLIAM L. HARRIS, Capt, USAF, MSC  
 Evidence Custodian, Incirlik Air Base, Turkey  
 16 May 94  
 Date

TIME (Z)	CHRONOLOGICAL NARRATIVE/REM	5 (CONTINUED)
1505	3646.11N 04404.40E from Dictate confirmed crash site	
1509	Cougar 2 ops normal minus JTIDS	
1520	Sensors TFR	
1525	Links terminated.	Total TA 9.7
1528	Pwr down. ans 1s	Total JT 10.2
1528	Log closed.	Total Radar 9.1
	SAR phase	
	G1. ST 31 1300Z To	
	Pg 31-3	
	TE PASS 1330	
	class 1515	
	PD 11 1410	
	SY 2 1545	

**TAB AC-3**

**E-3B AWACS**

	<b>AC-3a</b>
<b>AC-3a</b>	<b>Extract from AWACS Log Book</b>
<b>AC-3b</b>	<b>552nd ACW Form 32, CSO Communication Configuration Worksheet</b>
<b>AC-3c</b>	<b>Extract from AWACS Senior Director Log</b>
<b>AC-3d</b>	<b>AWACS In-flight Log</b>
<b>AC-3e</b>	<b>552nd ACW Form 49, AWACS Mission Summary</b>
<b>AC-3f</b>	<b>Intelligence Brief - UN Flight Information</b>
<b>AC-3g</b>	<b>28 AD Form 67, ASO Log Continuation Sheet</b>
<b>AC-3h</b>	<b>Statement on AWACS Video Camera</b>
<b>AC-3i</b>	<b>AWACS Pre-mission Brief</b>
	<b>AC-3f</b>
	<b>AC-3g</b>
	<b>AC-3h</b>



## STATEMENT

7 May 94

1. A VHS video camera was purchased in early March 1994 for the purpose of video taping unusual air activity in the Operation Provide Comfort Tactical area of responsibility (TAOR). The primary reason was to document airspace conflicts between OPC missions and Turkish Air Force anti-PKK operations. By early March a significant safety and political issue had evolved that obtained higher headquarters attention. To support a tasking to record these events, I requested approval from CTF/CG (Brig Gen Pilkington) to purchase a video camera.

2. I obtained CG approval and C4 coordination on the same day. Money was authorized and Lt Col Jeffcoat (AWACS DETCO) purchased the camera at the Incirlik Base Exchange.

3. Lt Col Jeffcoat signed for the camera and assumed responsibility for deciding which crew members would store, maintain and operate the equipment. He stated he had people who were very familiar with this as the 552nd Wing at Tinker AFB, OK often tapes portions of missions for training.

4. In our discussion, I explained in detail what EUCOM and CTF was interested in, and that he should focus on Turkish activity that conflicted with OPC traffic. I concluded by stating that AWACS crews were now required to present the tapes to CTF/C3 and verbally debrief these missions only if Turkish activity conflicted with OPC operations.

*James R O'Brien*  
JAMES R. O'BRIEN  
Colonel, USAF  
Director of Operations

## CERTIFICATE

I certify that I am the Records Custodian for the Accident Investigation Board convened to investigate the crash of two U.S. Army Black Hawk helicopters in the no fly zone in northern Iraq on 14 April 1994, and that this is a true and accurate copy of the record which is kept in my records system.

*18 May 94*  
Day

*W. L. Harris*  
WILLIAM L. HARRIS, Capt, USAF, MSC  
Evidence Custodian, Incirlik Air Base, Turkey

**TAB AC-3**

**E-3B AWACS**

	<b>AC-3a</b>	
<b>AC-3a</b>	<b>Extract from AWACS Log Book</b>	
<b>AC-3b</b>	<b>552nd ACW Form 32, CSO Communication Configuration Worksheet</b>	<b>AC-3b</b>
<b>AC-3c</b>	<b>Extract from AWACS Senior Director Log</b>	
<b>AC-3d</b>	<b>AWACS In-flight Log</b>	<b>AC-3c</b>
<b>AC-3e</b>	<b>552nd ACW Form 49, AWACS Mission Summary</b>	
<b>AC-3f</b>	<b>Intelligence Brief - UN Flight Information</b>	<b>AC-3d</b>
<b>AC-3g</b>	<b>28 AD Form 67, ASO Log Continuation Sheet</b>	
<b>AC-3h</b>	<b>Statement on AWACS Video Camera</b>	<b>AC-3e</b>
<b>AC-3i</b>	<b>AWACS Pre-mission Brief</b>	
		<b>AC-3f</b>
		<b>AC-3g</b>
		<b>AC-3h</b>
		<b>AC-3i</b>

THIS BRIEFING IS CLASSIFIED SECRET

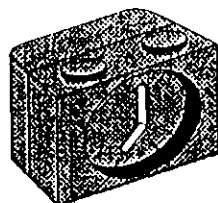

TIME HACK



WEATHER

**CERTIFICATE OF DECLASSIFICATION**

I certify that the information contained in this document has been declassified from

~~SECRET~~ to UNCLASSIFIED.

10 MAY 1994  
Date

*Donald G. Norris*  
DONALD G. NORRIS, GS-15, DAC  
Declassification Team Chief, HQ USEUCOM

**CERTIFICATE**

I certify that I am the Records Custodian for the Accident Investigation Board convened to investigate the crash of two U.S. Army Black Hawk helicopters in the no fly zone in northern Iraq on 14 April 1994, and that this is a true and accurate copy of the record which is kept in my records system.

*W. L. Harris*  
14 May 94  
Date

WILLIAM L. HARRIS, Capt, USAF, MSC  
Evidence Custodian, Incirlik Air Base, Turkey

THIS BRIEFING IS CLASSIFIED SECRET

**WEATHER:**

**LTAG:** \_\_\_\_\_

**ROZ I:** \_\_\_\_\_

**ALTN:** \_\_\_\_\_

# ON BOARD PERSONNEL

- DISTINGUISHED VISITOR(S)

- PAX

- DUKE(S)

- TURKISH CONTROLLER(S)

- TOTAL ON BOARD - \_\_\_\_\_

# Aircraft Status

TAIL NUMBER: \_\_\_\_\_

STATUS:

AIRCRAFT SYSTEMS: \_\_\_\_\_

MISSION SYSTEMS: \_\_\_\_\_

REMARKS: \_\_\_\_\_

# E-3 TIMELINE

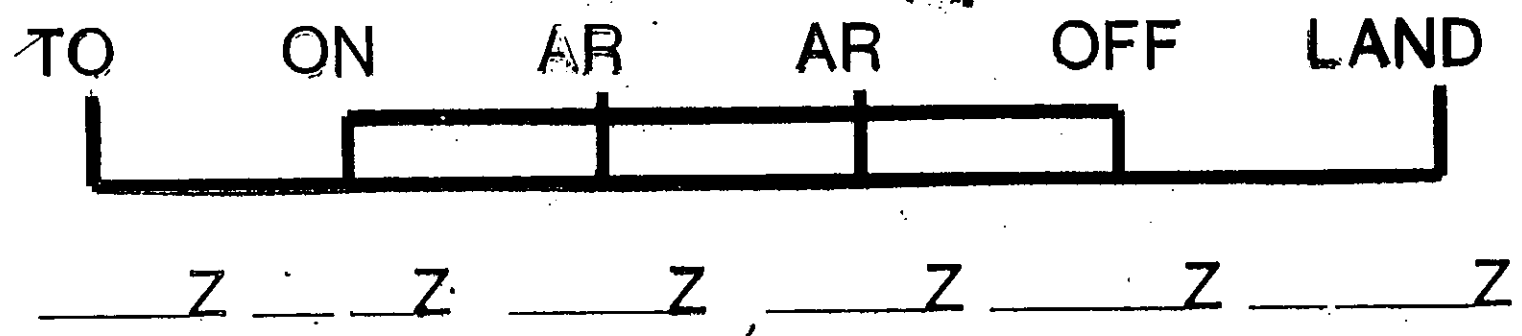

MSN NBR: \_\_\_\_\_  
TAIL NBR: \_\_\_\_\_  
CALL SIGN: \_\_\_\_\_  
ENGINE START: \_\_\_\_\_  
FIRST ACTIVITY: \_\_\_\_\_  
LAST ACTIVITY: \_\_\_\_\_



# ARCT TIMING/INFORMATION

21

	<u>A/R#1</u>	<u>A/R#2</u>
ARCT:	_____	_____
TANKER C/S:	_____	_____
ONLOAD:	_____	_____



# **SAFETY CONSIDERATIONS**

- \* NO SMOKING ON BUS OR IN RAMP AREA**
- \* REMOVE ALL RINGS PRIOR TO BOARDING BUS**
- \* EAR PROTECTION REQUIRED ON FLIGHT LINE**
- \* WEAR REFLECTIVE BELT ON RAMP WHEN WALKING TO/FROM AIRCRAFT IN THE DARK**
- \* DO NOT CROSS RED LINE ON RAMP**
- \* BOARDING STAND IS STEEP - MAXIMUM TWO PEOPLE ON STAND AT A TIME**
- \* REMOVE SCARVES AFTER BOARDING AIRCRAFT**
- \* EYEGLASSES (IF REQUIRED) WILL BE WORN INFLIGHT**

# EMERGENCY SIGNALS

## ON GROUND

ALARM BELL ON 5 TO 10  
SECONDS - EVACUATE AIRCRAFT

## CRASH LANDING

ANNOUNCE OVER PA & ILLUMINATE  
CRASH LANDING SIGNS "PREPARE FOR  
CRASH LANDING (OR DITCHING)

ALARM BELL ON 5 TO 10 SECONDS  
CRASH LANDING SIGNS ILLUMINATED -  
BRACE FOR CRASH LANDING OR DITCHING

# GROUND EVACUATION

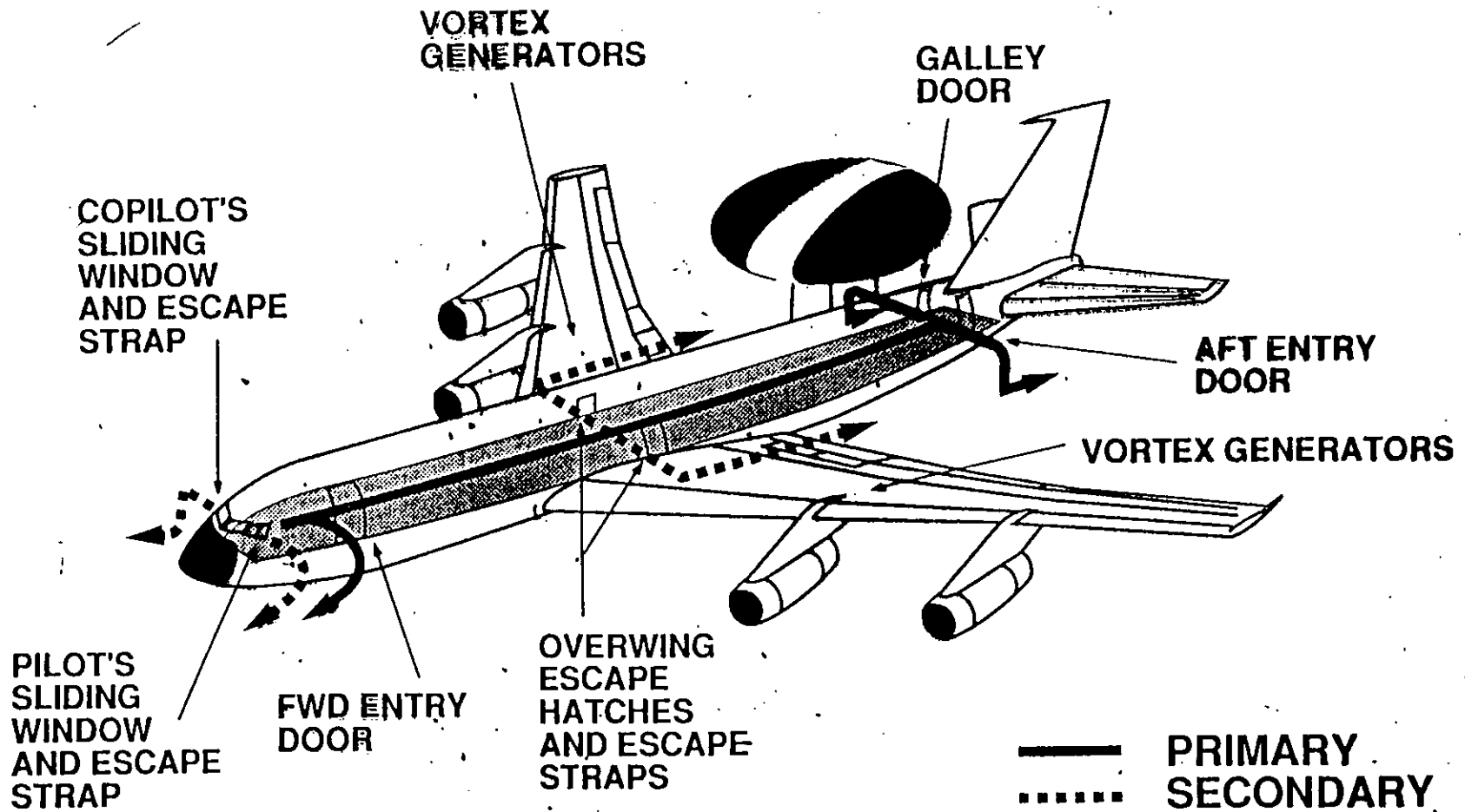

# FUNDAMENTAL ELEMENTS OF BASIC AIRMANSHIP

- \* THOROUGHLY BRIEF MISSION
- \* EVALUATE FLIGHT ACTIVITY
- \* CRITIQUE MISSION
- \* AIRCREW DISCIPLINE
  - CREW COORDINATION - CREW RESOURCE MANAGEMENT
  - SOUND JUDGEMENT
  - IF IT DOESN'T LOOK OR FEEL RIGHT-DCN'T DO IT!
  - ADDRESS BREACHES IMMEDIATELY
  - INFORM SUPERVISORS
- \* STRICT COMPLIANCE WITH T.O.s AND DIRECTIVES
- \* KNOW YOUR LIMITS

# WING POLICY ON OPERATIONAL SECURITY

- \* DO NOT DISCUSS DETAILS OF HOW WE ACCOMPLISH OUR MISSION, WHAT EQUIPMENT WE DO IT WITH, AND HOW THAT EQUIPMENT WORKS THIS INFORMATION IS CLASSIFIED AND ONLY RELEASABLE ON A STRICT NEED TO KNOW BASIS
- \* DO NOT JEOPARDIZE THE MISSION BY ASKING QUESTIONS SPECULATING, OR DRAWING ATTENTION TO EQUIPMENT PROCEDURES ON WHICH YOU HAVE NOT BEEN BRIEFED
- \* IF QUFSTIONED BY UNAUTHORIZED PERSONNEL < "I'M SORRY, I CANNOT ANSWER YOUR QUESTION" IS THE APPROPRIATE RESPONSE. IF THE INDIVIDUAL PERSISTS, DEFER TO AC/MCC

**INTEL**

# TECH AREAS TO EXEL

- JTIDS: DIRECT LOAD MAY FIX THE PROBLEM
  - DO NOT RUN MONITOR LOOP-BACK MESSAGE TEST - FREEZES TERMINAL
- SUPERIOR MAINTENANCE DEBRIEFS HAVE KEPT AIRCRAFT IN GREAT SHAPE
- DDs ON THE RISE: READ FORMS CAREFULLY CONTINUE WITH PROFESSIONAL DEBRIEFS

**TECHS AND FE**

**RELEASED**



# **WEAPONS "GAME PLAN"**

- **OBJECTIVES**
  
- **TASKINGS**
  - **ENROUTE**
  
  - **TANKER**
  
  - **TAOR**

# STANDING NOTES

*NEW LIFE SUPPORT HEADSET PROCEDURES:  
MCCs ARE RESPONSIBLE FOR SIGNING OUT  
THE HEADSET BAG FROM OPS WITH THEIR MISSION  
KITS. MCCs WILL ENSURE THEY ARE RETURNED  
AT THE END OF THE MISSION WITH THE  
MISSION KITS.*

*- Document Headset problems & return  
broken headsets to Life Support*

# DAILY NOTES

- KEEP ACCURATE LOGS OF ANY UNUSUAL ACTIVITY
  - TIME HDG ALT SPD POSITION & WHAT IT'S DOING
- Don't Forget VCR + VIDEOTAPE
  - \* BRACKET ATTACHES TO BACK OF MISSION CREW SEAT!

# **SURVEILLANCE**

## **"GAME PLAN"**

- **OBJECTIVES**

- **TASKINGS**

- **TRACKING**

- **LOGS**

- **LINKS**

# STANDING NOTES

## MISSION CREW COMMANDER

- DURING SYSTEMS WAKE-UP PASS STATUS TO SAVVY OPS EVERY 15 MINUTES
- PRIOR TO HEADING EAST IN THE CORRIDOR CALL "OPS NORMAL MINUS JTIDS"
- ONCE IFF/RADAR ARE OPERATIONAL - PROCEED EAST ON COURSE TO LINK WITH DADDY AND INDIA
- IF NO COMMUNICATIONS WITH SAVVY/MADDOG - USE HF PHONE PATCH THRU INCIRLIK AIRWAYS TO SAVVY OPS ON THE HOUR +05 AND +35
- COMPLETE MISSION SYSTEMS POWER DOWN AFTER LAST FIGHTER COMES UNDER ATC CONTROL (K-TOWN)
- FILL OUT/TURN IN DAILY DEBRIEFING QUESTIONNAIRE TO INTEL

**TAB AC**

**OTHER DOCUMENTS**

**AC-1 UH-60 Black Hawk 88-26060**

**AC-2 UH-60 Black Hawk 87-26000**

**(See Tabs AC-1a thru AC-1f)**

**AC-3 E-3B AWACS**

**AC-4 F-15C 79-0025**

**AC-5 F-15C 84-0025**

**AC-6 Command and Control**

**AC-7 Visual Recognition Guides**

**AC-8 Miscellaneous**

**AC-1**

**AC-2**

**AC-3**

**AC-4**

**TAB AC-4**

**F-15C 79-0025**

**AC-4a F-15 Emergency Procedures, Cockpit Training Review Logs**

**AC-4b Tiger 02 Notes, 14 April 1994**

**AC-4c Weapons/GPS Issued Log**

**AC-4a**

**AC-4d USAFE Form 406, Consolidated Flight Authorization**

**AC-4e Control Tower Flight Data Strips**

**AC-4f Tiger Flight Line Up Card, Mission Numbers 1410/1411**

**AC-4g Squadron Sign-out Log**

**AC-4h Squadron Operation PROVIDE COMFORT Briefing Guide**

**(See also Classified Addendum)**

DATE OF REVIEW (Cont'd)	UNIT	GRADE	NAME (Last, First & MI)
6 APR 94			
GENERATOR FAILURE			
DOUBLE GENERATOR FAILURE			
AMAD FAILURE			
RUNAWAY TRIM			
FLIGHT CONTROL SYSTEM MALF			
SPEED BRAKE FAILURE			
INLET LIGHT ON			
BOARDING STEPS INFLIGHT			
ATTITUDE FAILURE			
HEADING ERROR			
INS FAILURE			
CONTROLLABILITY CHECK			
FLAP MALFUNCTIONS			
BLOWN TIRE ON LANDING			
HYDRAULIC FAILURE			
LANDING GEAR UNSAFE			
LANDING GEAR EMERGENCY EXT			
APPROACH END ARREST			
DEPARTURE END ARREST			
AIR REFUELING MALFUNCTIONS			
RADAR MALFUNCTIONS			
CONDUCTED IN CPT OR SIM			
PILOTS CONDUCTING THE EMERGENCY PROCEDURES COCKPIT TRAINING ENTER LAST NAME TO THE RIGHT	BONG		

F-15 EMERGENCY PROCEDURES COCKPIT TRAINING REVIEW LOG	DATE OF REVIEW		UNIT	GRADE	NAME (Last, First & MI)
INSTRUCTIONS: (X) Check block to right of emerg if reviewed during the EPCT.	6 APR 94				
AMAD FIRE/OVERHEAT - START					
JFS READY LITE - NOT ON					
JFS - ABNORMAL START					
EMERGENCY GENERATOR NOT ON					
ABNORMAL ENGINE START					
ECS LITE ON					
INS PROBLEMS					
ANTI - SKID MALFUNCTIONS					
LOSS OF BRAKES					
LOSS OF DIRECTIONAL CONTROL					
GROUND EGRESS					
ABORT					
EXTERNAL STORES JETTISON					
ENGINE FAILURE ON TAKEOFF					
AFTER BURNER FAILURE					
ENGINE FIRE/OVERHEAT - TAKEOFF					
PITCH RATIO FAIL					
TIRE FAILURE - TAKEOFF					
LANDING GEAR FAILS TO RETRACT					
OUT - OF - CONTROL RECOVERY					
EJECTION					
ENGINE STALL/STAGNATION					
SINGLE ENGINE OPERATION					
DOUBLE ENGINE STALL/STAGNATION					
RESTART/JFS ASSIST					
EEC MALFUNCTIONS					
NOZZLE FAILURE					
ENGINE FIRE/OVERHEAT INFLIGHT					
AMAD FIRE/OVERHEAT INFLIGHT					
SMOKE/FUMES/FIRE - COCKPIT					
CANOPY LOSS					
EXTREME COCKPIT TEMPERATURE					
BLEED AIR MALFUNCTIONS					
ECS MALFUNCTIONS					
OIL SYSTEMS MALFUNCTIONS					
EMERG BST ON/BST SYS MALF LITE					
FUEL BOOST PUMP INOP					
FUEL TRANSFER SYSTEM MALF					
UNCOMMANDED FUEL VENTING					
INFLIGHT FUEL LEAK					

**CERTIFICATE**

I certify that I am the Records Custodian for the Accident Investigation Board convened to investigate the crash of two U.S. Army Black Hawk helicopters in the no fly zone in northern Iraq on 14 April 1994, and that this is a true and accurate copy of the record which is kept in my records system.

11 May 94  
Date

W. L. HARRIS  
WILLIAM L. HARRIS, Capt, USAF, MSC  
Evidence Custodian, Incirlik Air Base, Turkey

NAME (Last, First & MI)



**TAB AC-4**

**F-15C 79-0025**

**AC-4a F-15 Emergency Procedures, Cockpit Training Review Logs**

**AC-4b Tiger 02 Notes, 14 April 1994**

**AC-4c Weapons/GPS Issued Log**

**AC-4a**

**AC-4d USAFE Form 406, Consolidated Flight Authorization**

**AC-4e Control Tower Flight Data Strips**

**AC-4b**

**AC-4f Tiger Flight Line Up Card, Mission Numbers 1410/1411**

**AC-4g Squadron Sign-out Log**

**AC-4h Squadron Operation PROVIDE COMFORT Briefing Guide**

**(See also Classified Addendum)**

Tiger 02

Upon entering AOR Tiger 1 reported radar contact at 30 miles low/slow. Cougar reported "clean there". I found contact on my scope locked it, attempted ID - Mode 1 and Mode 4 with no friendly reply. Contact was tail aspect, heading southeast (110 hdg) at 130 knots.

Tiger 1 reported "possible road traffic" I responded "Tiger 2 shows 130 knots." I broke lock and continued to sanitize the area. Tiger 1 reported the contact again to Cougar, and began to ramp down to perform VID. I performed "S Turn" behind Tiger 1 to achieve 3 NM trail position (briefed intercept option to low/slow contact).

Tiger 1 flew down valley low altitude and performed VID as "HIND". Upon repositioning in vertical he called "correction HIP; tally 2 lead/trail." I was approaching contacts from the stern offset right. I picked up the shadows of the helos against the river bed. I passed the trail helo at approx 3-4,000' lateral on the right side. The helo was camouflaged, appeared to have wings, with no fin flashes or tail markings.

As I repositioned to the North, Tiger 1 called Cougar and stated we had 2 hinds at our position, Cougar "rogered" the call. Tiger 1 called for the flight to arm hot, I acknowledged and he called in.

I watched a missile launch from his left wing, make a bee-line for the target and observed a fireball. Tiger 1 called "off, 2 you are cleared-in; lead bandit is on my nose 2 miles."

I replied "I have him on radar," closed inside 2NM, selected heat uncaged the Sidewinder and fired an AIM-9M at 9,000'. The target was banking hard left towards high terrain. The missile grabbed a large amount of lead (left turn), then corrected back to the target. The fireball engulfed the aircraft and wreckage fell along the north side of the valley.

We safed up switches, made two RECCE passes across top of wreckage site, then manned the Eastern cap.

**CERTIFICATE**

I am the Records Custodian for the Accident Investigation Board concerning the crash of two U.S. Army Black Hawk helicopters in the area of ... on 14 April 1994, and that this is a true and accurate copy of the original file.

15 May 94

Photo

*W. L. Hantes*  
**WILLIAM L. HANTES, Capt. USAF USAF**  
Evidence Custodian  
Incident # 94-100-100

Signature *Musked-W. L. Hantes*, 15 May 94

*Signature of  
Tiger 02 Deleted  
to Protect Identity  
by: Col AFTR lag/Alk  
14 APR 94  
1553L*

**TAB AC-4**

**F-15C 79-0025**

**AC-4a F-15 Emergency Procedures, Cockpit Training Review Logs**

**AC-4b Tiger 02 Notes, 14 April 1994**

**AC-4c Weapons/GPS Issued Log**

**AC-4a**

**AC-4d USAFE Form 406, Consolidated Flight Authorization**

**AC-4e Control Tower Flight Data Strips**

**AC-4b**

**AC-4f Tiger Flight Line Up Card, Mission Numbers 1410/1411**

**AC-4g Squadron Sign-out Log**

**AC-4c**

**AC-4h Squadron Operation PROVIDE COMFORT Briefing Guide**

**(See also Classified Addendum)**

GPS (DEPLOYED)  
OPERATIONS PROVIDE COMFORT

Everyone must sign this form before  
you are issued a gun!

WEAPON / GPS ISSUE LOG

ISSUING/RECEIVING PERSON Kenneth S. Cunn  
SHIFT TRANSFERRED TO B. McDaniel

DATE 13-4-94  
WEAPON/GPS ACCOUNTABILITY  
BEGIN SHIFT 10 END SHIFT 6  
6

WEAPON S/N	GPS S/N	ASSIGNED GPS #	RNDS	ISSUED TO / SIGNATURE	RECEIVED BY/ TIME
1072394	0010001C0H	01	30	[REDACTED]	B. McDaniel
1071500	0010001E22	02	30	[REDACTED]	B. McDaniel
1073460	0010001CE6	03	30	cap Wyrick	B. McDaniel
1071497	0010001E32	04	30	cap. Roth	J. McDaniel
1072354	0010001E37	05	30	cap. schulz	B. McDaniel
1073463	0010001E4Y	06	30	cap. Neuser	B. McDaniel
1073472					
1073465					
1071499					
1073464					

**CERTIFICATE**  
I certify that I am the Records Custodian for the Accident Investigation Board convened to investigate the crash of two U.S Army Black Hawk helicopters in the no fly zone in northern Iraq on 14 April 1994, and that this is a true and accurate copy of the record which is kept in my records system.  
18 May 94  
Date  
W. L. H.  
WILLIAM L. HARRIS, Capt, USAF, MSC  
Evidence Custodian, Incirlik Air Base, Turkey

**TAB AC-4**

**F-15C 79-0025**

**AC-4a F-15 Emergency Procedures, Cockpit Training Review Logs**

**AC-4b Tiger 02 Notes, 14 April 1994**

**AC-4c Weapons/GPS Issued Log**

**AC-4a**

**AC-4d USAFE Form 406, Consolidated Flight Authorization**

**AC-4e Control Tower Flight Data Strips**

**AC-4b**

**AC-4f Tiger Flight Line Up Card, Mission Numbers 1410/1411**

**AC-4g Squadron Sign-out Log**

**AC-4c**

**AC-4h Squadron Operation PROVIDE COMFORT Briefing Guide**

**(See also Classified Addendum)**

**AC-4d**

CONSOLIDATED FLIGHT AUTHORIZATION/APPROVAL

52 fw [redacted] 515C [redacted] 11 APR 94 PAGE 1 OF 1 PAGE

AUTHORITY TO U.S.C. 8012 and E.O. 9397. PRINCIPAL PURPOSE: To identify crewmembers authorized/approved to perform specified duties on a specified flight. The SSN is necessary to identify the individual. ROUTINE USES: Used as a flight order to designate crewmembers for a given flight and to prepare AFTO 781, Aerospace Vehicle Flight Data Document. Information contained in this flight authorization may be disclosed to any DOD component including the Department of the Air Force, and, upon request, to other Federal, State, and local agencies in the pursuit of their official duties. It may be used for other lawful purposes including law enforcement and litigation. DISCLOSURE IS MANDATORY. Failure to provide information, including the SSN, would prevent personnel from acquiring access to USAF aircraft, prevent performance of the mission, and result in administrative/disciplinary action.

CREWMEMBERS LISTED BELOW WILL DEPART FROM INCIRLIK (CT/G) ON/ABOUT 11 APR 94 IN THE AIRCRAFT INDICATED AND RETURN TO DEPARTURE BASE ON/ABOUT 11 APR 94. VARIATIONS IN ITINERARY AUTHORIZED FOR FLIGHTS TO OTHER THAN DEPARTURE BASE. USE USAF FORM 618.

LINE NO	TAIL NO	CALL SIGN	NAME OF ACFT COMMANDER (Last, first and second initials) & GRADE <sup>1</sup>	CREW MEMBER	SSN	CREW POSN	TYPE MSN <sup>2</sup>	MSN SYM	ETD	ETA	ATE	ALT	E/NE	REMARKS/A/C INITIALS
									ATD	ATA				
1	4085	1	[redacted]	[redacted]	[redacted]	PI	RA	0-1	0635	0930	3.5			[redacted]
2	4085	2	[redacted]	[redacted]	[redacted]	PI			1	1	3.5			[redacted]
3	4085	1	SEPP, DAVID	OT	[redacted]				0805	1240	5.1			DATA
4	4085	2	SMYK, LAINE	OT	[redacted]				0808	1313	5.1			DATA
5	4085	1	SMYK, SCOTT	OT	[redacted]				1130	1715	6.4			SCA
6	4085	2	SMYK, [redacted]	OT	[redacted]				1125	1746	6.4			William
7	4085	1	SMYK, SCOTT	OT	[redacted]				1500	1600	0.6			SCA
									1500	1535	0.6			

7/30.6

**CERTIFICATE**  
 I certify that I am the Records Custodian for the Accident Investigation Board convened to investigate the crash of two U.S. Army Black Hawk helicopters in the no fly zone in northern Iraq on 14 April 1994, and that this is a true and accurate copy of the record which is kept in my records system.  
 18 May 94  
 Date  
 WILLIAM L. HARRIS, Capt, USAF, MSC  
 Evidence Custodian, Incirlik Air Base, Turkey

<sup>1</sup> Designate \* = Flt Lead \*\* = Dep Flt Lead.  
<sup>2</sup> List primary and alternate mission, e.g. ACT, A/G, DACT, LLN, MAV, WW

MISSION CONTROL/MISSION CLEARANCE/APPROVAL AUTHORITY'S SIGNATURE [redacted]

**TAB AC-4**

**F-15C 79-0025**

**AC-4a F-15 Emergency Procedures, Cockpit Training Review Logs**

**AC-4b Tiger 02 Notes, 14 April 1994**

**AC-4c Weapons/GPS Issued Log**

**AC-4a**

**AC-4d USAFE Form 406, Consolidated Flight Authorization**

**AC-4e Control Tower Flight Data Strips**

**AC-4b**

**AC-4f Tiger Flight Line Up Card, Mission Numbers 1410/1411**

**AC-4g Squadron Sign-out Log**

**AC-4c**

**AC-4h Squadron Operation PROVIDE COMFORT Briefing Guide**

**(See also Classified Addendum)**

**AC-4d**

**AC-4e**

Control Tower Flight Data Strip

TIGER  
2/F-15

2410	0635
0635	0930
	0950

R |

~~R~~ R

I	F	1000
		42

CERTIFICATE

I certify that I am the Records Custodian for the Accident Investigation Board convened to investigate the crash of two U.S. Army Black Hawk helicopters in the no fly zone in northern Iraq on 14 April 1994, and that this is a true and accurate copy of the record which is kept in my records system.

7 May 94  
Date

W. L. Harve  
WILLIAM L. HARVE, Capt. USAF MED  
Evidence Custodian  
Incirlik Air Base, Turkey



**TAB AC-4**

**F-15C 79-0025**

**AC-4a F-15 Emergency Procedures, Cockpit Training Review Logs**

**AC-4b Tiger 02 Notes, 14 April 1994**

**AC-4c Weapons/GPS Issued Log**

**AC-4a**

**AC-4d USAFE Form 406, Consolidated Flight Authorization**

**AC-4e Control Tower Flight Data Strips**

**AC-4b**

**AC-4f Tiger Flight Line Up Card, Mission Numbers 1410/1411**

**AC-4g Squadron Sign-out Log**

**AC-4c**

**AC-4h Squadron Operation PROVIDE COMFORT Briefing Guide**

**(See also Classified Addendum)**

**AC-4d**

**AC-4e**

**AC-4f**



**TAB AC-4**

**F-15C 79-0025**

**AC-4a F-15 Emergency Procedures, Cockpit Training Review Logs**

**AC-4b Tiger 02 Notes, 14 April 1994**

**AC-4c Weapons/GPS Issued Log**

**AC-4a**

**AC-4d USAFE Form 406, Consolidated Flight Authorization**

**AC-4e Control Tower Flight Data Strips**

**AC-4b**

**AC-4f Tiger Flight Line Up Card, Mission Numbers 1410/1411**

**AC-4g Squadron Sign-out Log**

**AC-4c**

**AC-4h Squadron Operation PROVIDE COMFORT Briefing Guide**

**(See also Classified Addendum)**

**AC-4d**

**AC-4e**

**AC-4f**

**AC-4g**

# THE [REDACTED] "NATO TIGERS"

NAME	ACFT	LOC	CODE	BLOODCHIT	COMSEC	7SI	120	TAPE	PILOT AID	SIGNATURE
[REDACTED]	400S	5A	I	1 3.5	3109	0135	1005	1B	1	[REDACTED]
[REDACTED]	900S	8A	II ROR	2 3.5	3110	?	?	2B	2	[REDACTED]
RETH	401S	6	I	3 5.1	3111	0805	1310	3B	3	[Signature]
WIRICK	0012	8	II ROR	4 5.1	3112	0808	1313	6.0	4	[Signature]
RETH-(OCF)	0011	6A	I	0.6		1500	1535			
SCHULE	4006	8	I	5	3113	1105	1546	9.0	5	[Signature]
NEUSER	9006	8A	II ROR INTERIM LITE	6	3114	6	6	103	6	[Signature]

DATE: 14 APR 94

SPARE ACFT: 401S / TIGER 1st GO

SORTIES FLOWN: 7

TOTAL HOURS: 30.6

**CERTIFICATE**

I certify that I am the Records Custodian for the Accident Investigation Board convened to investigate the crash of two U.S. Army Black Hawk helicopters in the no fly zone in northern Iraq on 14 April 1994, and that this is a true and accurate copy of the record which is kept in my records system.

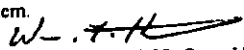
  
 WILLIAM L. HARRIS, Capt, USAF, MSC  
 Evidence Custodian, Incirlik Air Base, Turkey

13 May 94  
 Date

**TAB AC-4**

**F-15C 79-0025**

**AC-4a F-15 Emergency Procedures, Cockpit Training Review Logs**

**AC-4b Tiger 02 Notes, 14 April 1994**

**AC-4c Weapons/GPS Issued Log**

**AC-4a**

**AC-4d USAFE Form 406, Consolidated Flight Authorization**

**AC-4e Control Tower Flight Data Strips**

**AC-4b**

**AC-4f Tiger Flight Line Up Card, Mission Numbers 1410/1411**

**AC-4g Squadron Sign-out Log**

**AC-4c**

**AC-4h Squadron Operation PROVIDE COMFORT Briefing Guide**

**(See also Classified Addendum)**

**AC-4d**

**AC-4e**

**AC-4f**

**AC-4g**

**AC-4h**

TIME HACK

INTEL

OBJECTIVE  
WX/NOTAMS

- LTAG
- ALTERNATES
- AOR/AAR TRACK

PERSONAL EQUIPMENT / MAPS / FCIF / SIGNOUT

- SANITIZE
- GPS
- 9 MM / AMMO
- E/E KIT
- VTR TAPE
- CLASSIFIED PILOT AID
- COMBAT WALLET
- DTM

DATA CARD

- TIMES
- JOKER / BINGO
- ADMIN vs TACTICAL FUELS
- CODEWORDS

GROUND OPS

- PREFLIGHT
- S1S2 SWITCHES
- AIM-120 BIT
- START
- "ROLEX" vs "SLIP"
- RADIOS - 2 / 1 AUX
- REDBALLS ON 1 AUX

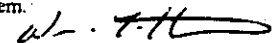
CERTIFICATE	
I certify that I am the Records Custodian for the Accident Investigation Board convened to investigate the crash of two U.S. Army Black Hawk helicopters in the no fly zone in northern Iraq on 14 April 1994, and that this is a true and accurate copy of the record which is kept in my records system.	
<u>23 May 94</u> Date	 WILLIAM L. HARRIS, Capt, USAF, MSC Evidence Custodian, Incirlik Air Base, Turkey

CERTIFICATE OF DECLASSIFICATION	
I certify that the information contained in this document has been declassified from	
<u>SECRET</u> to UNCLASSIFIED <u>23 MAY 94</u> Date	 DONALD G. NORRIS, GS-15, DAC Declassification Team Chief, HQ USEUCOM

Classified by: TAC/DO  
Declassify on: OADR

DO NOT REMOVE

GO-NO-GO SYSTEMS

- RADAR
- IFF MODES
- AAI
- CC/ADC/PACS
- INS
- RWR
- AAR SYSTEM
- WEAPON MINIMUMS
- VTR DRILL
  - HUD, BOTH, VSD & VOICE TITLE
- CHECK IN
  - HQ NET / 1 AUX
    - UNABLE TOD, PASS FROM LEAD
- TAXI / RWR CHECK / ARMING FLOW
  - LANDING LIGHT ON WHEN COMPLETE
- PRIOR TO TAKEOFF
  - RADIOS - SWITCH 3 / AUTO SWITCH TIGER/CLAW AUX

DEPARTURE

- TAKEOFF (VMC/IMC)
- RADIOS - 4 / TIGER/CLAW AUX ONCE AIRBORNE
- REJOIN
- SYSTEMS CHECK
  - MSTR ARM SAFE
  - AIM-9s, RADAR, AAI, RWR
    - DESELECT COOL
  - T/A/TACAN ON = SYSTEMS CHECK COMPLETE
- ALIBIS
  - REQUEST "GREEN AUX" - GO SECURE AUX

ENROUTE

- FORMATION VMC - SPREAD = 2000-3000'; 0-30° AFT
- IMC - 2 NM TRAIL
- CONS CHECK

AOR ENTRY

- RADIOS - COLIGAR (CH8) > DUKE (CH9) > HQ NET
- 10 AUX IF GOING TO TANKER

?? QUESTIONS GOING OUT ??

~~SECRET~~

RTB

- REJOIN
- FENCE OUT
- BDA CHECK
- ENROUTE FORMATION
- K-TOWN
- RADIOS - 14 ; 1 AUX (CALL IN CODES)
- APPROACH INTENTIONS
- INITIAL vs STRAIGHT IN
- DE-ARM

### ABNORMAL PROCEDURES / SPECIAL SUBJECTS

- ABORTS
- LANDING IMMEDIATELY AFTER TAKEOFF
- RADAR / VISUAL SEARCH RESPONSIBILITIES
- MID-AIR COLLISION AVOIDANCE

### TANKER OPS -

- ARCT TIMES
- TANKER CALL SIGNS / ALTITUDES
- OFF-LOADS
- RENDEZVOUS FORMATION
- BRITTS CHECK; GMD OFF
- REFUELING ORDER
- "QUICK FLOW"
- POST REFUELING FLOW

?? ADMIN QUESTIONS ??

### TACTICAL BRIEF

### AOR FLOW (ON CARD)

### FACTORS IMPACTING MISSION -

- ENVIRONMENT
- SUN/CONS/CLOUDS/HAZE/WINDS
- AOR LAYOUT
- OTHER PLAYER LOCATIONS



- AVIACS
- BLIND ZONES - RADAR and RADIOS
- THREATS
  - AIR-to-AIR
  - ORDNANCE
  - ECM
  - RWR
  - SAM/AAA

AVIONICS

- FENCE CHECK
  - MSTR ARM - SAFE
  - PACS
- [REDACTED]
- ICS/RWR - AUTO / COMBAT
- MODES - 1,2,4A
- AAI - CC/MODE 1 \_\_\_\_\_
- RWR/SRM - VOLUME UP
- CMD - MAN / BOTH
- INS - PP/ STEER TO ▲ & ○

RADAR SET-UP

- [REDACTED]
- RADAR LOOKS (ON CARD)
- ACQ SYMBOL PLACEMENT

CAPS

- LOCATION / HEADINGS / LEGS
- ALTITUDE
- FORMATION
- AIRSPEED
- TURNS
  
- COUNTER-ROTATING RESPONSIBILITIES
- CAP MANNING PRIORITIES / FALLOUT

[REDACTED]

[REDACTED]

[REDACTED]

CAP RADAR

[REDACTED]

COMM PLAN

- MAIN - HAVE QUICK PRIMARY
- UHF CLEAR BACK-UP
- PRIORITY TALKERS: PRIMARY DCA (CAP MSN CC) & AWACS
- USE: - "BIG PICTURE" IN DIGITAL B/E
  - CORE INFO
  - NUMBER OF GROUPS
  - LOCATION OFF B/E
  - ALTITUDES
- "HOT" & "COLD" CALLS BY CAP MSN CC
- COMMITS
- TARGETING
- INTERCEPT DIRECTIVES
- SPIKE COMM (FRIENDLY OR HOSTILE)

NOTE: MAX USE OF CODEWORDS AND MIN COMM

- AUX - TIGER AUX (19A) (F-15Es WILL MONITOR WHILE IN DCA ROLE)
- USE - INTRA DCA FREQ
  - CAP COORDINATION
  - FUELS
  - "FENCE IN/OUT" CALLS
  - SORTING
  - F-15 SPECIFIC DIRECTIVES OR FILLINS



INTERCEPT CONTINGENCIES

-- HI-FAST

[REDACTED]

-- LOW/SLOW/VID

- FORMATION
- HOT PASS / MARK / RE-ATTACK
- SAM AWARENESS

[REDACTED]

- FUEL AWARENESS

RADAR EMPLOYMENT

> MELD

[REDACTED]

MELD

[REDACTED]

CONFIDENTIAL

TARGETING

PHILOSOPHY:

[REDACTED]

WEAPONS EMPLOYMENT

ID

- ALL IDs FROM STT
- CC / MODE 1
- AUTO for MODE 4

[REDACTED]

- AWACS "BANDIT" CALL NOT REQUIRED TO SHOOT
- CONFIRM IF FRIENDLIES IN SAME AREA
- COMM
- "PAINTS" = MODE 1 OR 4 REPLY
- "SPADES" = NO FRIENDLY AAI REPLIES
- CHALLENGE AND RESPONSE CALL
- "Xs" or "PRINT" for POSITIVE HOSTILE
- FRENCH F-1 AMBIGUITY CAVEAT

SHOTS

[REDACTED]

RADAR MISSILE DEFENSE

- WINNING / LOSING / EQUAL - DACT STANDARD
- BANDIT WEZ CONSIDERATIONS FOR DECISION RANGE AND MIN ABORT
- FOXBAT/FULCRUM THREAT vs F-1
- MIN NOTCH RANGE

[REDACTED]

10/25/78

MERGE CONSIDERATION:

- POWER / CMD / IRMD - DACT STANDARD
- TURN DECISION:

[REDACTED]

POST MERGE

- SHORT RANGE RADAR
- ISOLATE THREAT HIGH OR LOW
  - SAM THREAT
- FLOW POST MERGE

[REDACTED]

DEFENSIVE RESPONSE

- FRIENDLY SPIKE COMM - STANDARD
- ELEMENT REACTIONS TO HOSTILE AIR-TO-AIR SPIKES
  - NOTCH DIRECTIONS
  - CMD USE
  - SAM AVOIDANCE
- SAM REACTIONS

[REDACTED]

- VISUAL LOOKOUT & MUTUAL SUPPORT

*[Handwritten signature]*

CONTINGENCIES

- DEGRADED OPS
  - AAI INOP
  - INS
  - RWR
  - RADAR
  - WEAPONS
- EPs / WOUNDED BIRD
- NORDO IN AOR
- RESCAP

SECRET

21-105

**TAB AC**

**OTHER DOCUMENTS**

**AC-1 UH-60 Black Hawk 88-26060**

**AC-2 UH-60 Black Hawk 87-26000**

**(See Tabs AC-1a thru AC-1f)**

**AC-3 E-3B AWACS**

**AC-4 F-15C 79-0025**

**AC-5 F-15C 84-0025**

**AC-6 Command and Control**

**AC-7 Visual Recognition Guides**

**AC-8 Miscellaneous**

**AC-1**

**AC-2**

**AC-3**

**AC-4**

**AC-5**



**TAB AC-5**

**F-15C 84-0025**

**AC-5a F-15 Emergency Procedures Cockpit Training Review Logs**

**AC-5b Tiger 01 Notes, 14 April 1994**

**(See Classified Addendum)**

**(See also Tabs AC-4c thru i)**

**AC-5a**

F-15 EMERGENCY PROCEDURES COCKPIT TRAINING REVIEW LOG	DATE OF REVIEW			
	16 Dec 93	10 Jan 94	14 Mar 94	15 Apr 94
INSTRUCTIONS: (X) Check block to right of emerg if reviewed during the EPCT.				
AMAD FIRE/OVERHEAT - START *	X			
JFS READY LITE - NOT ON				
JFS - ABNORMAL START				
EMERGENCY GENERATOR NOT ON	X	X		
ABNORMAL ENGINE START	X	X		
ECS LITE ON	X	X		
INS PROBLEMS				
ANTI - SKID MALFUNCTIONS				
LOSS OF BRAKES				
LOSS OF DIRECTIONAL CONTROL	X	X		
GROUND EGRESS				
ABORT	X			
EXTERNAL STORES JETTISON				
ENGINE FAILURE ON TAKEOFF	X	X		
AFTER BURNER FAILURE				
ENGINE FIRE/OVERHEAT - TAKEOFF	X	X		
PITCH RATIO FAIL				
TIRE FAILURE - TAKEOFF	X	X		
LANDING GEAR FAILS TO RETRACT	X	X		
OUT - OF - CONTROL RECOVERY				
EJECTION				
ENGINE STALL/STAGNATION	X	X		
SINGLE ENGINE OPERATION				
DOUBLE ENGINE STALL/STAGNATION				
START/JFS ASSIST				
C MALFUNCTIONS				
NOZZLE FAILURE				
ENGINE FIRE/OVERHEAT INFLIGHT				
AMAD FIRE/OVERHEAT INFLIGHT				
MOKE/FUMES/FIRE - COCKPIT	X			
CANOPY LOSS				
EXTREME COCKPIT TEMPERATURE				
BLEED AIR MALFUNCTIONS				
ECS MALFUNCTIONS	X	X		
OIL SYSTEMS MALFUNCTIONS	X	X		
EMERG BST ON/BST SYS MALF LITE				
FUEL BOOST PUMP INOP				
FUEL TRANSFER SYSTEM MALF	X	X		
UNCOMMANDED FUEL VENTING				
INFLIGHT FUEL LEAK	X			

UNIT: [REDACTED]

GRADE: CAPT

NAME (Last, First & MI): [REDACTED]

DATE: 16 Dec 93  
10 Jan 94  
14 Mar 94  
15 Apr 94

AT SPARE

F15 C/D

F-15 EMERGENCY PROCEDURES COCKPIT TRAINING REVIEW LOG	DATE OF REVIEW (Cont'd)			
	16 Dec 93	10 Jan 94	14 Mar 94	15 Mar 94
GENERATOR FAILURE				
DOUBLE GENERATOR FAILURE				
AMAD FAILURE				
RUNAWAY TRIM	X			
FLIGHT CONTROL SYSTEM MALF				
SPEED BRAKE FAILURE				
INLET LIGHT ON				
BOARDING STEPS INFLIGHT	X	X		
ATTITUDE FAILURE				
HEADING ERROR				
INS FAILURE				
CONTROLLABILITY CHECK				
FLAP MALFUNCTIONS	X	X		
BLOWN TIRE ON LANDING				
HYDRAULIC FAILURE	X	X		
LANDING GEAR UNSAFE	X	X		
LANDING GEAR EMERGENCY EXT	X	X		
APPROACH END ARREST				
DEPARTURE END ARREST				
AIR REFUELING MALFUNCTIONS				
RADAR MALFUNCTIONS				
CONDUCTED IN CPT OR SIM				
PILOTS CONDUCTING THE EMERGENCY PROCEDURES COCKPIT TRAINING ENTER LAST NAME TO THE RIGHT	Neuser D	Richardson		

UNIT: [REDACTED]

GRADE: CAPT

NAME (Last, First & MI): [REDACTED]

DATE: 16 Dec 93  
10 Jan 94  
14 Mar 94  
15 Mar 94

AT SPARE

F-15C/D

**CERTIFICATE**

I certify that I am the Records Custodian for the Accident Investigation Board convened to investigate the crash of two U.S. Army Black Hawk helicopters in the no-fly zone in northern Iraq on 14 April 1994, and that this is a true and accurate copy of the record which is kept in my records system.

11 Mar 94  
Date

W. L. HARRIS, Capt, USAF, MSC  
Evidence Custodian, Incirlik Air Base, Turkey

**TAB AC-5**

**F-15C 84-0025**

**AC-5a F-15 Emergency Procedures Cockpit Training Review Logs**

**AC-5b Tiger 01 Notes, 14 April 1994**

**(See Classified Addendum)**

**(See also Tabs AC-4c thru i)**



*NO TAB AC-4i*

*only thru AC-4h*

*Jw  
6/24/94 -*

**AC-5a**

**AC-5b**

TIGER 01

0720 Z TIGER 1 & 2 SWITCHED TO AOR HQ AND ENTERED GATE 1  
TIGER 1 GOT LOW/SLOW HITS ON THE NOSE (ABOUT 100 DEG) FOR  
40 MILES. I WAS AT FL 270

LOCKED THE HITS AND GOT A LOW/SLOW TGT  
THE TGT WAS < 500 FEET, 130 KTS, HEADING 090-100 DEG  
I GOT A NEG M1 INTERROGATION  
POS M4 INTERROGATION  
NEG [REDACTED] ALL IN STT

I BROKE LOCK AND CHECKED MY MAP. I FOUND A ROAD AT THAT  
LOCATION AND INITIALLY THOUGHT IT WAS ROAD TRAFFIC.

I CONTINUED TO SWEEP, PAINTING THE TGT AND GETTING  
NEG M1, NEG M4 AND NEG [REDACTED] IN SWEEP.

I RELOCKED THE TARGET AND BEGAN A DESCENT TO VID  
I INTERROGATED M1, M4, AND [REDACTED] IN STT AGAIN AND GOT NO  
REPLY.

I CONTINUED THE DESCENT AND AT ABOUT 10 NM THE TD BOX LEFT  
ROAD. AT 5-7 NM I SAW A HELICOPTOR IN THE TD BOX AND  
CALLED FOR A VID. I PASSED ON THE LEFT SIDE 1000-3000  
FEET. I SAW A CAMO GREEN HIND WITH NO MARKINGS. I PULLED  
OFF HIGH AND RIGHT AND SAID VID HIND. I SAID HIP ON THE  
RADIO AND THEN CONFIRMED HIND AFTER CHECKING OUR VID GUIDE  
WE CARRY. I ASKED 2 TO CONFIRM THIS AND AT THIS POINT  
NOTICED A SECOND HELICOPTOR IN TRAIL. TIGER 2 VIDed HIND.  
UP TO THIS POINT AWACS HAS ONLY SAID HIT THERE.

WE SET UP A RACETRACK PATTERN AND CAME BACK IN 3-4 MILE  
LEAD TRAIL BETWEEN TIGER 1 AND 2 AND 7NM BEHIND THE HINDS.

I FIRED AN AIM-120 AT ABOUT 4 NM FOR ABOUT A 7 SEC TIME OF  
FLIGHT SPLASH AT 0728. I PULLED OFF RIGHT AND CALLED  
TIGER 2 IN ON THE LEAD HELICOPTER.

HE SHOT THE LEAD HELICOPTER WITH A 9000 FOOT AIM 9 AT  
0729.

WE DID 2 PASSES OVER THE SIGHTS AND ONLY SAW WRECKAGE AND  
THEN RESET TO THE EAST CAP.

THE HELICOPTER WAS CAMO GREEN  
NO MARKINGS  
5 BLADES  
SPONSONS ON THE SIDE

COORD # 1 N4404.3 E3645.1  
COORD # 2 N4412.0 E3646.0

Name and signature  
of Tiger 01  
added to protect  
identity [REDACTED]  
WHLK

UNCLAS

72 MAR 94  
SECRET NOFORN to UNCLASSIFIED  
CERIFICATE OF DECLASSIFICATION  
I certify that the information contained in this document has been declassified from  
Donald G. Norris, GS-15, DAC

CERTIFICATE  
I certify that I am the Records Custodian for the Accident Investigation Board  
convened to investigate the crash of two U.S. Army Black Hawk helicopters in the no  
fly zone in northern Iraq on 14 April 1994, and that this is a true and accurate copy of  
the record which is kept in my records system.  
20 May 94  
Date  
WILLIAM L. HARRIS, Capt, USAF, MSC  
Evidence Custodian, Incirlik Air Base, Turkey

**TAB AC**

**OTHER DOCUMENTS**

**AC-1 UH-60 Black Hawk 88-26060**

**AC-2 UH-60 Black Hawk 87-26000**

**(See Tabs AC-1a thru AC-1f)**

**AC-3 E-3B AWACS**

**AC-4 F-15C 79-0025**

**AC-5 F-15C 84-0025**

**AC-6 Command and Control**

**AC-7 Visual Recognition Guides**

**AC-8 Miscellaneous**

**AC-1**

**AC-2**

**AC-3**

**AC-4**

**AC-5**

**AC-6**

**TAB AC-6**

**COMMAND AND CONTROL**

**AC-6a Approval to Travel Outside the Security Zone**

**AC-6b Colonel G.B. Thompson, Memorandum, OPLAN 91-7**

**AC-6c U.S. EUCOM Joint Analysis Center, Iraq Working Group Memorandum,  
Iraqi Helicopter Identification**

**AC-6d Col Maher Memorandum, C2 Support to Special Investigation**

**AC-6a**

71 112

100/03

100/03

100/03

100/03

100/03

100/03

100/03

100/03

100/03

100/03

100/03

CERTIFICATE

I certify that I am the Records Custodian for the Accident Investigation Board convened to investigate the crash of two U.S. Army Black Hawk helicopters in the no fly zone in northern Iraq on 14 April 1991, and that this is a true and accurate copy of the record which is kept in my records system.

7 May 94  
Date:

William L. Hamme, Capt, USAF MSC  
Evidence Custodian  
Incirlik Air Base, Turkey

THIS REPRODUCES THE TYPED PORTIONS  
OF THE ATTACHED ITEM "69b"  
FOR EASE OF READING

CMCC/US

22 Apr 94

MEMORANDUM FOR CTF/CG

THRU CTF/DC

SUBJECT: REQUEST FOR TRAVEL OUTSIDE THE SECURITY ZONE

1. Co-Commanders, MCC, Zakho request authorization to travel outside the security zone via MCC Helicopter on 14 Apr 94. Destination will be Irbil (MF 0709) and Salah Ad Din (MF 2826)
2. Purpose of travel is to introduce the new US CCMC to the head people of the US agencies (Irbil) and to Mr Barzani (Salah Ad Din).
3. This travel is in accordance with current CTF policy governing travel outside the security zone as outlined in Tab J, MCC SOP. your authority to approve this travel is found in DOD 4515 13R Ch 6 and ECIC 190720Z Aug 92 msg. This air travel is deemed necessary to execute the OPC mission.
4. Recommend approval

DONALD L. SANDERS  
Maj  
Opns Off

CTF/CG or DC Approve \_\_\_\_\_ Disapprove \_\_\_\_\_

21-114  
Item 69b



**TAB AC-6**

**COMMAND AND CONTROL**

**AC-6a Approval to Travel Outside the Security Zone**

**AC-6b Colonel G.B. Thompson, Memorandum, OPLAN 91-7**

**AC-6c U.S. EUCOM Joint Analysis Center, Iraq Working Group Memorandum,  
Iraqi Helicopter Identification**

**AC-6d Col Maher Memorandum, C2 Support to Special Investigation**

**AC-6a**

**AC-6b**

08 May 1994

MEMORANDUM FOR RECORD

SUBJECT: OPLAN 91-7

1. During my 29 April interview with the Accident Review Board investigating the accidental shoot down of Eagle Flight on 14 April, I was asked whether I was familiar with OPLAN 91-7. I replied that I was not familiar with the plan, did not recall having been briefed on the plan and that the plan was not one of the contingency plans stored at the Military Coordination Center (MCC) in Zakho during my tenure as CCMCC/US from May-November 1993.

2. On this date, while reviewing the OPLAN files with the incoming CCMCC/US, COL Jim Williams, I found that a copy of OPLAN 91-7 is now included among the OPLANS available at MCC. The complete OPLAN files have been extensively reorganized and show evidence of having been worked with a great deal. I surmise from the presence of OPLAN 91-7 in the MCC files and the condition of the files that it is probable that COL Jerald L. Thompson, CCMCC/US at the time of the accident, was familiar with the contents of OPLAN 91-7.

3. In any case, it is clear that my response with regard to OPLAN 91-7 cannot be taken to infer that COL Jerald L. Thompson was also not familiar with the plan. The evidence here indicates the opposite to be the case.



GERALD B. THOMPSON  
Colonel, U.S. Army  
Acting CCMCC/US

CERTIFICATE

I, William J. Harris, Evidence Custodian for the Accident Investigation Board, do hereby certify that the crash of two U.S. Army Black Hawk helicopters in the mountains of Iraq on 14 April 1994, and that this is a true and accurate copy of the original as kept in my records system.

15 May 94  
WJH

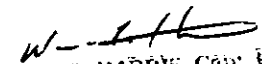
  
WILLIAM J. HARRIS, Capt. USAF Ret.  
Evidence Custodian  
Incirlik Air Base, Turkey

**TAB AC-6**

**COMMAND AND CONTROL**

**AC-6a Approval to Travel Outside the Security Zone**

**AC-6b Colonel G.B. Thompson, Memorandum, OPLAN 91-7**

**AC-6c U.S. EUCOM Joint Analysis Center, Iraq Working Group Memorandum,  
Iraqi Helicopter Identification**

**AC-6d Col Maher Memorandum, C2 Support to Special Investigation**

**AC-6a**

**AC-6b**

**AC-6c**

OVERALL CLASSIFICATION: UNCLASSIFIED

MEMORANDUM FOR: Major General Andrus

4 May 1994

FROM: U.S. EUCOM Joint Analysis Center, Iraq Working Group

SUBJECT: Iraqi Helicopter Identification

SOURCE: Joint Analysis Center Iraq Working Group, Multiple Sources

1. (U) Following extensive research, the Iraq Working Group has developed the following assessments concerning the way in which the Iraqi armed forces mark their helicopters.

a. (U) The camouflage used for the Iraqi Mi-25 Hind (Export version of the Mi-24), consists of a two or possibly three-tone mottled brown color scheme. The underside of the aircraft is usually painted gray.

b. (U) The Iraqi Armed forces generally use standard utility helicopters for medical evacuation missions. Because of this, they do not have any sort of symbol which would distinguish them as medical evacuation aircraft. Additionally, there is a possibility that Iraq bought some helicopters specifically for medevac purposes. If these are marked, they would have a red crescent insignia on them, signifying the fact that they are medical aircraft.

c. (U) The current publication which addresses Iraqi aircraft recognition is DIAM 57-25-136, *Desert Shield Adversary Recognition Guide*, dated 3 December 1990. This publication does not contain information concerning aircraft color schemes, nor does it contain information about Iraqi medical aircraft markings.

2. (U) POC for this issue is Major Mark F. Supko, DSN 268-4933.

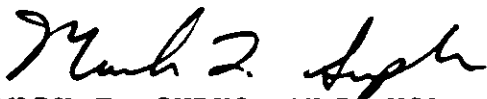

MARK F. SUPKO, MAJ, USA  
Chief, Iraq Working Group

**CERTIFICATE**

I certify that I am the Records Custodian for the Accident Investigation Board convened to investigate the crash of two U.S. Army Black Hawk helicopters in the no fly zone in northern Iraq on 14 April 1994, and that this is a true and accurate copy of the record which is kept in my records system.

*18 May 94*  
Date

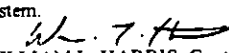
  
WILLIAM L. HARRIS, Capt, USAF, MSC  
Evidence Custodian, Incirlik Air Base, Turkey

**TAB AC-6**

**COMMAND AND CONTROL**

**AC-6a Approval to Travel Outside the Security Zone**

**AC-6b Colonel G.B. Thompson, Memorandum, OPLAN 91-7**

**AC-6c U.S. EUCOM Joint Analysis Center, Iraq Working Group Memorandum,  
Iraqi Helicopter Identification**

**AC-6d Col Maher Memorandum, C2 Support to Special Investigation**

**AC-6a**

**AC-6b**

**AC-6c**

**AC-6d**

9 MAY 1994

SUBJECT: C2 Support to Special Investigation

1. The following information is provided per an 8 May request of the investigation team to forward an affidavit from the CTF/C2 Directorate regarding the availability of visual identification material at C2 prior to 14 April 1994, and subsequent to requests by the team during the course of the investigation.

2. Prior to 14 April 1994 the following material was available at CTF/C2 that could be utilized for visual recognition of HIND or BLACKHAWK helicopters:

- a. Pictures from the 1990-1991 "Jane's All the Worlds Aircraft", pages 508 and 509, and pages 266-268.
- b. DIA Fact Book, USSR and Eastern Europe Communist Forces (U), DST-2660Z-013-91(N), Feb 1991, pages 3-81 and 3-82.
- c. MCM/ACCMK/PACAFMK/USAFEM 3-1, Vol II, 9 Oct 1992, pages 8-1 to 8-4.
- d. CFE Equipment Handbook, DST-1120H-277-91, 18 Oct 1991, pages 7-1 to 7-14.
- e. OPERATION GRANBY Recognition Guide to Iraq, Kuwait Aircraft, JARIC, Dec 1990.

3. Subsequent to requests from the investigation team, the following materials were obtained via the Joint Analysis Center from CONUS sources:

- Written responses describing the color scheme of Iraqi HIND helicopters and medical markings found on Iraqi medical helicopters.

4. It is important to reiterate that all visual identification training for pilots is accomplished at squadron level. It would be standard procedure for this training to have occurred prior to deployment to OPERATION PROVIDE COMFORT.

5. The following information is provided per request:

- SSAN: [REDACTED]
- Home Unit: HQ NORAD/USSPACECOM, Peterson AFB CO
- Position: Dep Director of Intelligence, Plans and Programs.

If any further support is required, I can be contacted at 676-3978.

**CERTIFICATE**

I certify that I am the Records Custodian for the Accident Investigation Board convened to investigate the crash of two U.S. Army Black Hawk helicopters in the no fly zone in northern Iraq on 14 April 1994, and that this is a true and accurate copy of the record which is kept in my records system.

19 May 94  
Date

*W. L. Harris*  
WILLIAM L. HARRIS, Capt, USAF, MSC  
Evidence Custodian, Incirlik Air Base, Turkey

*Roger D. Maher*  
COLONEL ROGER D. MAHER, USAF  
Director of Intelligence

**TAB AC**

**OTHER DOCUMENTS**

- AC-1 UH-60 Black Hawk 88-26060**
- AC-2 UH-60 Black Hawk 87-26000**  
**(See Tabs AC-1a thru AC-1f)**
- AC-3 E-3B AWACS**
- AC-4 F-15C 79-0025**
- AC-5 F-15C 84-0025**
- AC-6 Command and Control**
- AC-7 Visual Recognition Guides**
- AC-8 Miscellaneous**

- AC-1**
- AC-2**
- AC-3**
- AC-4**
- AC-5**
- AC-6**
- AC-7**

**TAB AC-7**

**VISUAL RECOGNITION GUIDES**

**AC-7a Extracts from Operation PROVIDE COMFORT Eagle Aid 1**

**(See also Classified Addendum)**

**AC-7b Hind VID Materials**

**AC-7c Black Hawk VID Materials**

**AC-7a**



# 53 "NATO TIGERS"



## OPERATION PROVIDE COMFORT

### EAGLE AID

# 1

\*\*\* [REDACTED] \*\*\*

#### EXTRACT

I certify that I am the Records Custodian for the Accident Investigation Board convened to investigate the crash of two U.S. Army Black Hawk helicopters in the no fly zone in northern Iraq on 14 April 1994, and that this is a true and accurate extract from

*Eagle Aid #1*

which is kept in my records system

*15 May 94*

Date

*W. L. Harris*  
WILLIAM L. HARRIS, Capt, USAF, MSC  
Evidence Custodian, Incirlik Air Base, Turkey

**CERTIFICATE OF DECLASSIFICATION**  
I certify that the information contained in this document has been declassified from  
*Donald G. Norris*  
DONALD G. NORRIS, GS-15, PAC  
Declassification Team Chief, HQ USAF/COM  
**SECRET REMOVE TO UNCLASSIFIED**  
*15 MAY 94*  
Date

21-123

PUMA



HIND



HIP

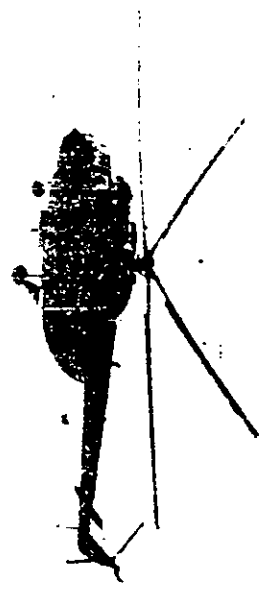

MD 500

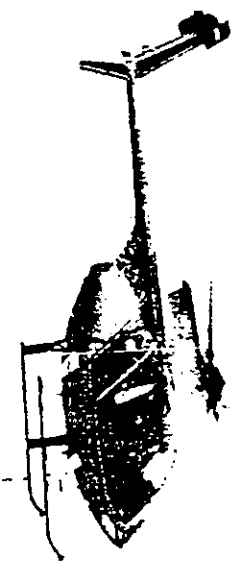

GAZELLE



BO-105

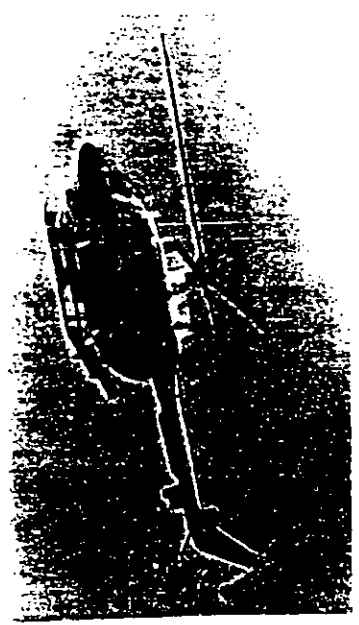

UNITED STATES  
NAVY



1954

BELL 214

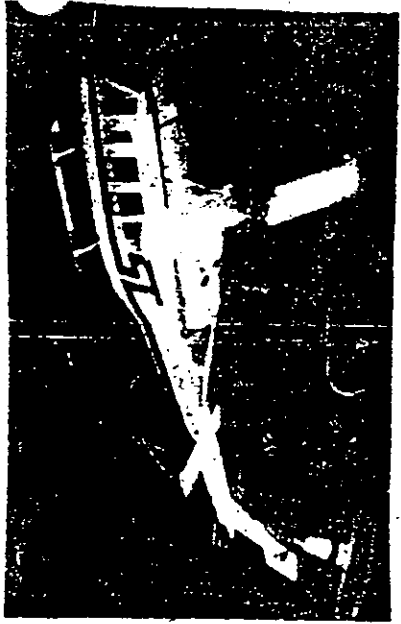

ALLOUETTE III

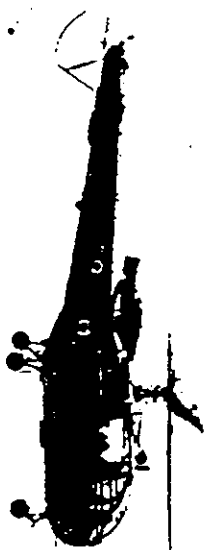

UH-53  
(FLOWN BY THE UN)

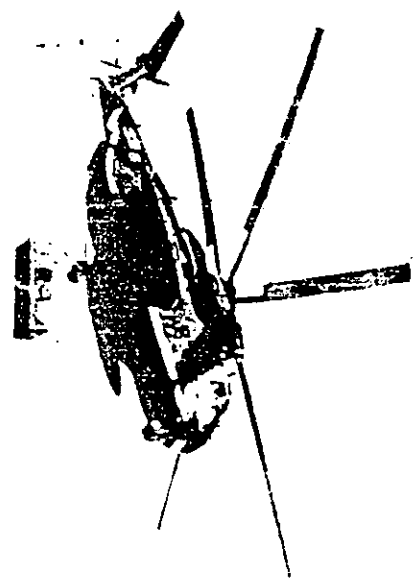

HOPLITE

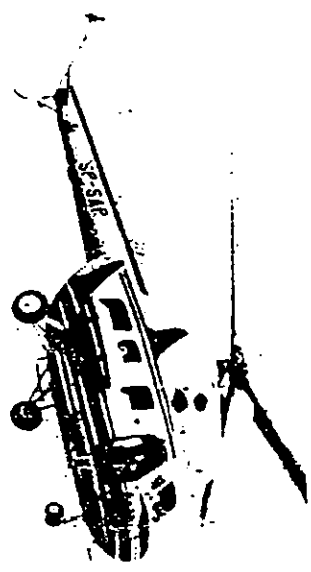

HOOK

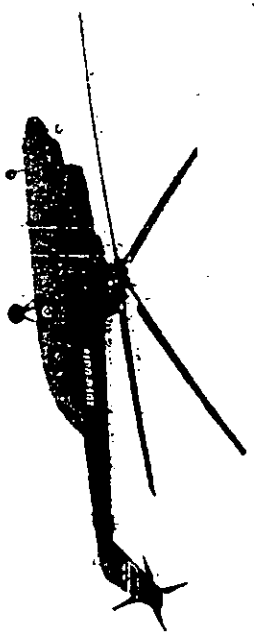

**TAB AC-7**

**VISUAL RECOGNITION GUIDES**

**AC-7a Extracts from Operation PROVIDE COMFORT Eagle Aid 1**

**(See also Classified Addendum)**

**AC-7b Hind VID Materials**

**AC-7c Black Hawk VID Materials**

**AC-7a**

**AC-7b**

78 TRS / INTER



**EXTRACT**

I certify that I am the Records Custodian for the Accident Investigation Board convened to investigate the crash of two U.S. Army Black Hawk helicopters in the no fly zone in northern Iraq on 14 April 1994, and that this is a true and accurate extract from

7 THMS7-25-136, 3 Dec 90, OY 1.73-178  
7 May 94  
Date

WILLIAM L. HARRIS, Capt, USAF, MSC  
Evidence Custodian, Inertik Air Base, Turkey

NAME: Mi-25 HIND (Export model of the Mi-24)

DIAM 57-25-134  
3 DECEMBER 1990

MISSION: ASSAULT  
ROTOR DIAMETER: 56.0 Feet -- 17.0 Meters  
LENGTH: 55.6 Feet -- 16.9 Meters

ROTORS: Five-bladed main rotor. Three-bladed left-mounted tail rotor.  
ENGINES: Two turboshafts mounted in fuselage.  
FUSELAGE: Tapers into thick tail boom. Stub wings may be seen with stepped cockpit.  
TAIL: Vertical stabilizer is swept. Horizontal stabilizer is tapered-tapered and mounted on rear of tail boom.

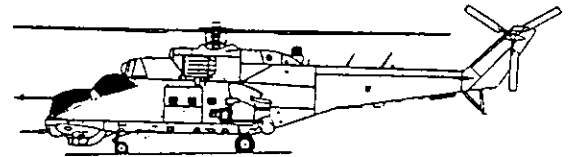
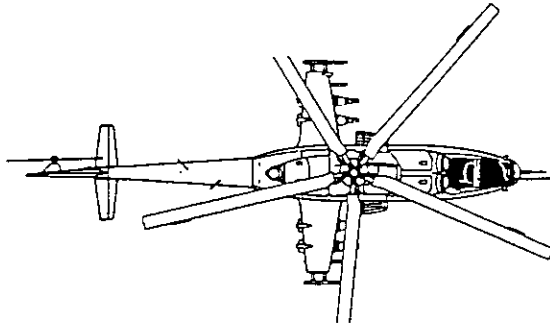

1.77

DIAM 57-25-136  
3 December 1990



I certify that I am the Records Custodian for the Accident Investigation Board convened to investigate the crash of two U.S. Army Black Hawk helicopters in the no fly zone in northern Iraq on 14 April 1994, and that this is a true and accurate extract from

DHH-5725-131 / 54188

which is kept in my records system

7 May 94

Date

WILLIAM L. HARRIS, Capt, USAF, MSC  
Evidence Custodian, Incirlik Air Base, Turkey

**EXTRACT**

NAME: Mi-24 HIND

DIAM 57-25-131  
1 JULY 1988

MISSION: ASSAULT  
ROTOR DIAMETER: 56.0 Feet -- 17.0 Meters  
LENGTH: 55.6 Feet -- 16.9 Meters

ROTORS: Five-bladed main rotor. Three-bladed left-mounted tail rotor.  
ENGINES: Two turboshafts mounted in fuselage.  
FUSELAGE: Tapers into thick tail boom. Stub wings may be seen with stepped cockpit.  
TAIL: Vertical stabilizer is swept. Horizontal stabilizer is tapered-tapered and mounted on rear of tail boom.

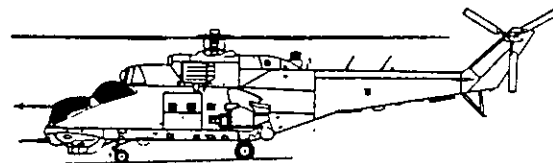
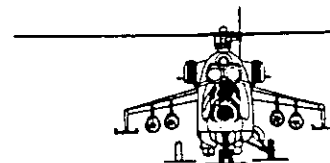
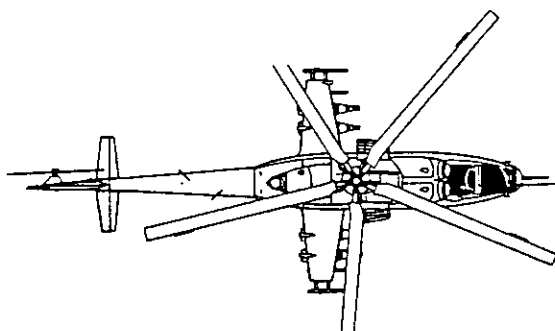

244

DIAM 57-25-131  
1 JULY 1988



21 50



# AVIATOR'S RECOGNITION MANUAL

FM 1-402

~~RESTRICTION: This publication contains technical or operational information that is for official Government use only. Distribution is limited to Government agencies. Requests from outside the Government for release of this publication under the Freedom of Information Act or the Foreign Military Sales Program must be made to HQ TRADOC, Ft Monroe, VA 23651~~

RETURN TO

510



### EXTRACT

I certify that I am the Records Custodian for the Accident Investigation Board convened to investigate the crash of two U.S. Army Black Hawk helicopters in the no fly zone in northern Iraq on 14 April 1994, and that this is a true and accurate extract from

FM 1-402, Aug 84

which is kept in my records system.

7 May 94  
Date

W-7H  
WILLIAM L. HARRIS, Capt, USAF, MSC  
Evidence Custodian, Incirlik Air Base, Turkey

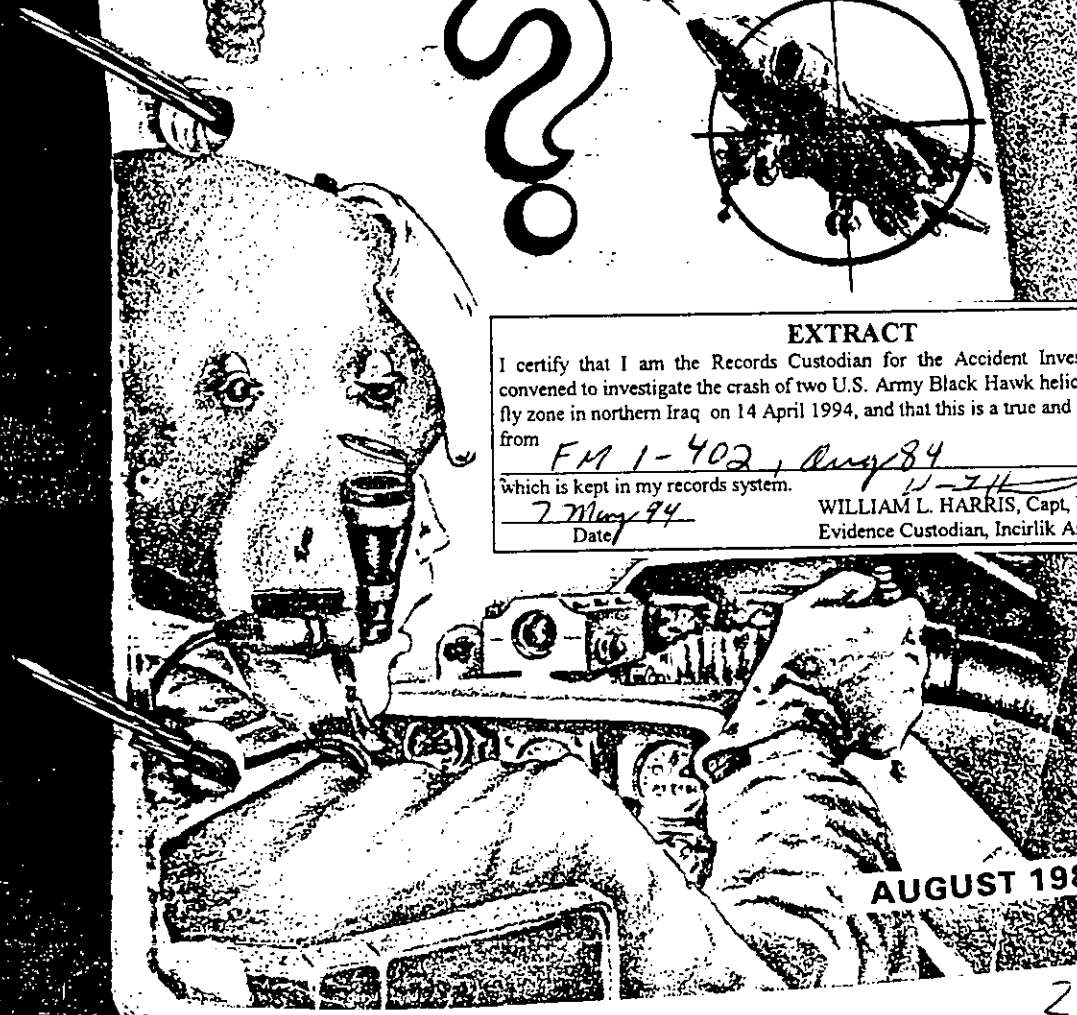

AUGUST 1984

21

FM 1-402

## Mi-24 HIND D and E

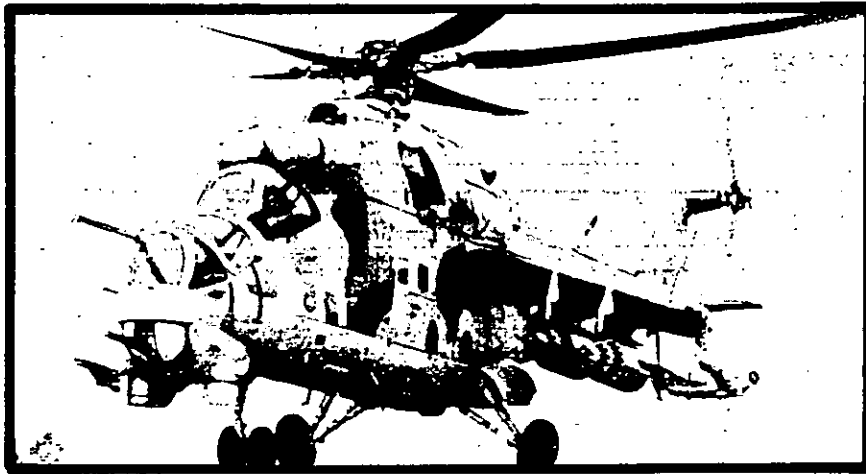

### RECOGNITION FEATURES

- Five-bladed main rotor; three-bladed tail rotor
- Two tandem-bubble canopies
- Short, stubby weapons-carrying wings mounted at mid-fuselage
- Retractable tricycle landing gear

The HIND is a multipurpose helicopter capable of carrying eight fully equipped combat troops besides a complete external armament load. Besides the standard pylon armament, the HIND D incorporates a turret which houses a four-barrel, 12.7mm Gatling-type gun. The sensor pack under the nose of the HIND D probably carries an optical sight system. The HIND E carries four AT-6 ATGMs (radio linked) which travel at 500 meters per second. It may have a FLIR or low-light level TV sight system.

### USERS

Algeria, Czechoslovakia, Iraq, Libya, Peru, Syria, USSR, numerous Warsaw Pact countries

ROTARY WING

1-48

21-

**WARSAW PACT**

**SPEED:** 182 knots

**RANGE:** 455 km

**ARMAMENT:** One 12.7mm machine gun  
 Four 32-shot, 57mm rocket pods  
 Four AT-2 ATGMs (HIND D)  
 Four AT-6 ATGMs (HIND E)  
 HIND D variant carries a twin-barrel, 23mm cannon

**MAXIMUM EFFECTIVE RANGE:** 57mm rocket—1,500 meters  
 12.7mm machine gun—1,500 meters  
 AT-2 ATGM—4,000 meters  
 AT-6 ATGM—5,000 meters

**ORIGIN:** USSR

**EMPLOYMENT:** Support of military units as a combat assault, scout, and armed gunship. Also used in close air support, antiarmor, and antihelicopter operations. May be found in the independent attack helicopter regiment of a frontal Tactical Air Army, Combined Arms Army, and in the helicopter squadrons of motorized rifle and tank divisions.

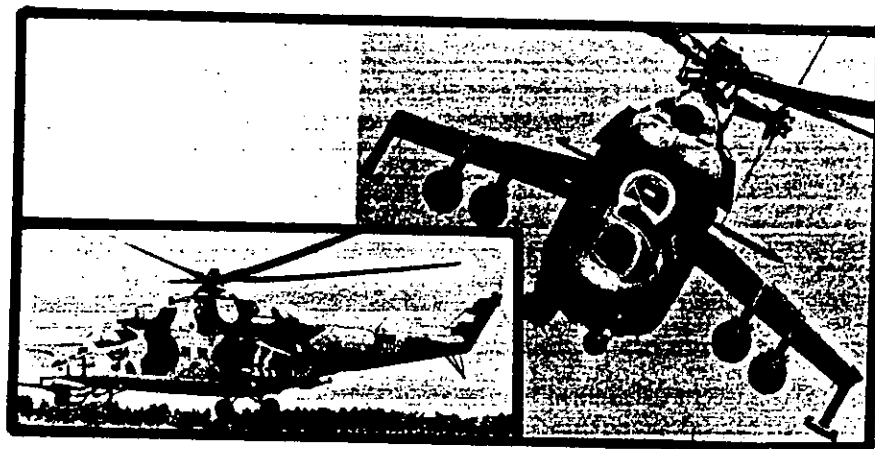

**TAB AC-7**

**VISUAL RECOGNITION GUIDES**

**AC-7a Extracts from Operation PROVIDE COMFORT Eagle Aid 1**

**(See also Classified Addendum)**

**AC-7b Hind VID Materials**

**AC-7c Black Hawk VID Materials**

**AC-7a**

**AC-7b**

**AC-7c**



REPRODUCTION OF 35MM SLIDE FROM TIGER 01  
AND TIGER 02 HOME SQUADRON VISUAL  
IDENTIFICATION TRAINING SLIDES

INTELLIGENCE  
MIDDLE EAST  
AND AFRICA  
THEATER  
RECOGNITION  
GUIDE

PARTIAL  
AFRICA

EXTRACT

I certify that I am the Records Custodian for the Accident Investigation Board convened to investigate the crash of two U.S. Army Black Hawk helicopters in the no-fly zone in northern Iraq on 14 April 1994, and that this is a true and accurate extract from DHHR-57-25-131, 1 Jul 88 to 20 Aug 97 which is kept in my records system.

2 May 97  
Date

WILLIAM L. HARRIS, Capt, USAF, MSC  
Evidence Custodian, Incirlik Air Base, Turkey

NAME: S-70/UH-60 BLACKHAWK

DIAM 57-25-131  
1 JULY 1988

MISSION: GENERAL PURPOSE/TRANSPORT

ROTOR DIAMETER: 53.7 Feet -- 16.4 Meters

LENGTH: 50.0 Feet -- 15.2 Meters

ROTORS: Four-bladed main rotor. Four-bladed right-mounted tail rotor.

ENGINES: Two turboshafts mounted in fuselage.

FUSELAGE: Fuselage tapers to tail. Fixed main and tail landing gear. External fuel tanks may be mounted on upper sides of fuselage.

TAIL: Vertical stabilizer is swept. Horizontal stabilizer is tapered-tapered and low-mounted on vertical stabilizer.

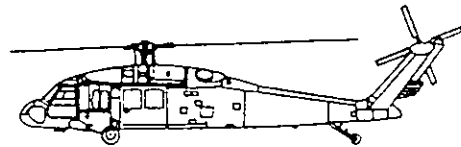
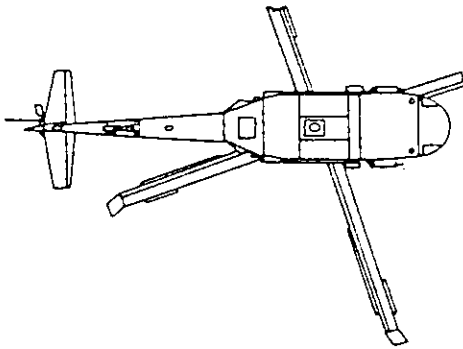

246

DIAM 57-25-131  
1 JULY 1988

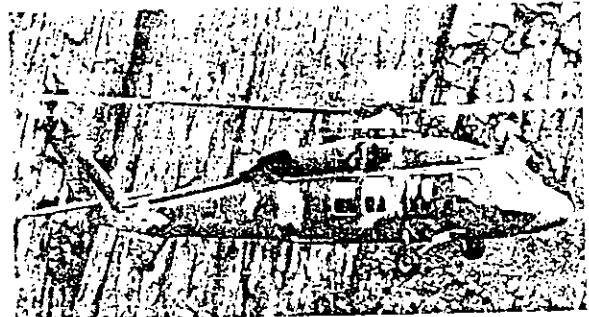
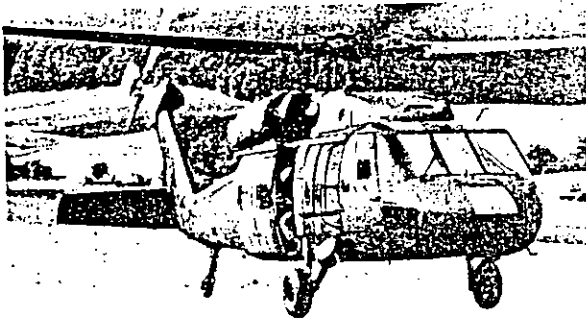
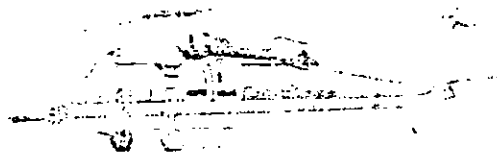

21-137  
247

# AVIATOR'S RECOGNITION MANUAL

M 1-4

**DISTRIBUTION RESTRICTION:** This publication contains technical or operational information that is for official Government use only. Distribution is limited to US Government agencies. Requests from outside the US Government for release of this publication under the Freedom of Information Act or the Foreign Military Sales Program must be made to HQ TRADOC, Ft Monroe, VA 23651

FM 1-402

RETURN TO

510 BUNTE



### EXTRACT

I certify that I am the Records Custodian for the Accident Investigation Board convened to investigate the crash of two U.S. Army Black Hawk helicopters in the no fly zone in northern Iraq on 14 April 1994, and that this is a true and accurate extract from

*FM 1-402, Aug 84*

which is kept in my records system.

*7 May 94*  
Date

*W. L. Harris*  
WILLIAM L. HARRIS, Capt, USAF, MSC  
Evidence Custodian, Incirlik Air Base, Turkey

AUGUST 1984

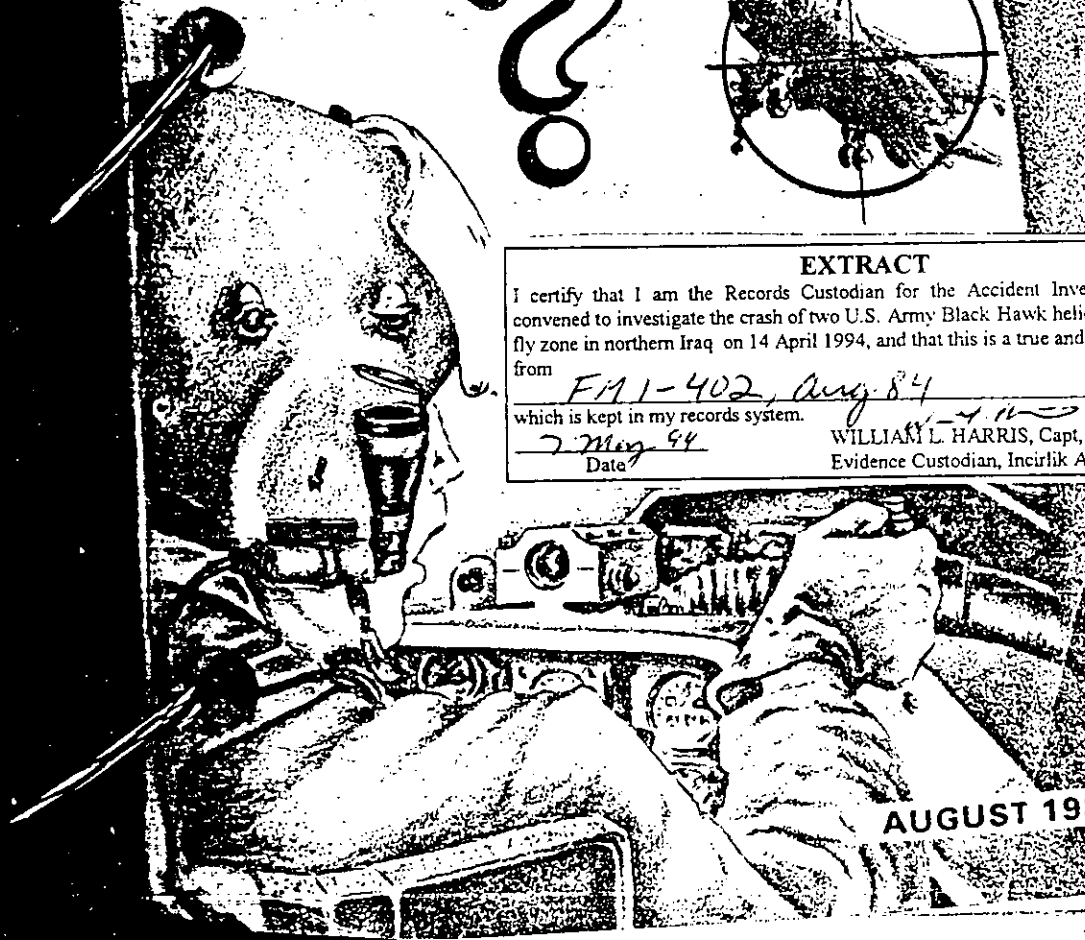



FM 1-402

## UH-60A BLACK HAWK

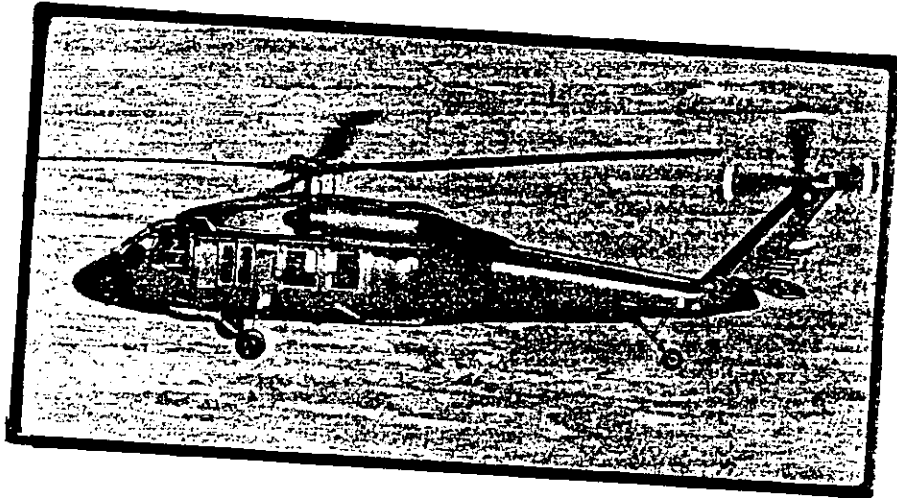

### RECOGNITION FEATURES

- Four-bladed main rotor; four-bladed tail rotor
- Twin turbine engines
- Rectangular-shaped fuselage
- Tapered horizontal stabilizer
- Swept-back vertical stabilizer
- Tricycle landing gear (one aft and two fore)
- Seating capacity of 14 to 17

### USERS

United States



FM 1-402

## ALLIED

**SPEED:** 142 knots  
**RANGE:** 578 km  
**ARMAMENT:** Two M60D, 7.62mm machine guns  
**WEAPON RANGE:** 1,100 meters  
**ORIGIN:** United States  
**EMPLOYMENT:** Troop movement and resupply (internal and external cargo) and medical evacuation

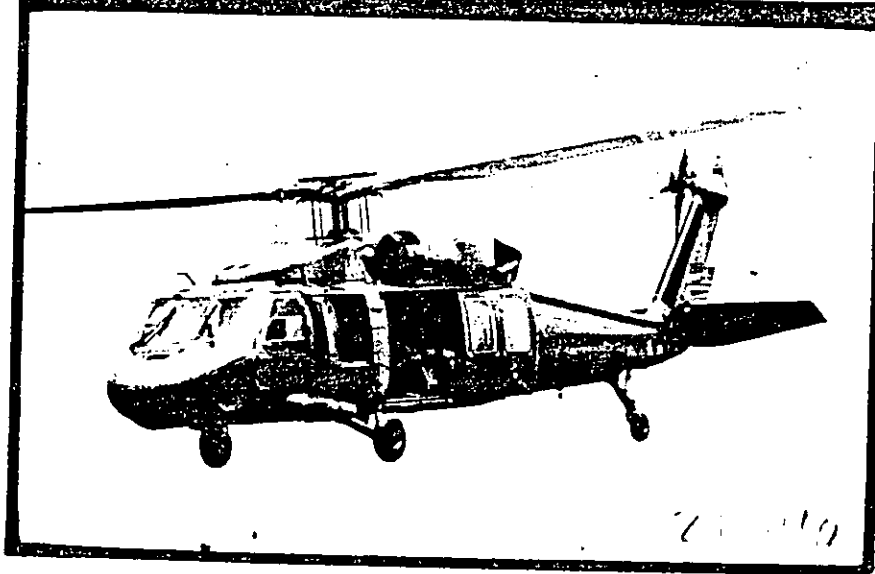
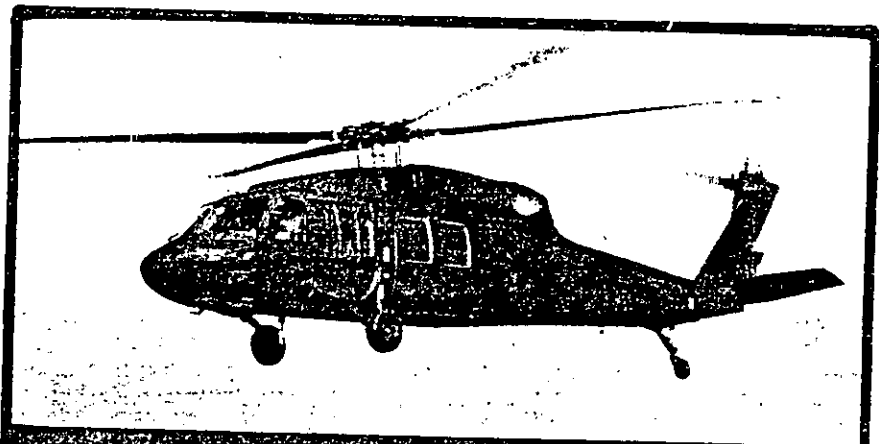

**TAB AC**

**OTHER DOCUMENTS**

- AC-1 UH-60 Black Hawk 88-26060**
- AC-2 UH-60 Black Hawk 87-26000**  
**(See Tabs AC-1a thru AC-1f)**
- AC-3 E-3B AWACS**
- AC-4 F-15C 79-0025**
- AC-5 F-15C 84-0025**
- AC-6 Command and Control**
- AC-7 Visual Recognition Guides**
- AC-8 Miscellaneous**

- AC-1**
- AC-2**
- AC-3**
- AC-4**
- AC-5**
- AC-6**
- AC-7**
- AC-8**

**TAB AC-8**

**MISCELLANEOUS**

**AC-8a NOTAMs**

**AC-8b SAR Daily Log, 14-17 April 1994**

**AC-8c MCC Operations Log, 14-18 April 1994 and Note from Zakhu,  
Kurdistan Democratic Party**

**AC-8d Headquarters, Combined Task Force, Operation PROVIDE COMFORT,  
Memorandum for Record, 14 May 1994**

**AC-8e Headquarters Operation PROVIDE COMFORT II,  
Combined Task Force/C2 Log, 14 April 1994**

**AC-8f Extract of Joint Operations Center Log, 13-14 April 1994**

**AC-8g Extract from JSOTF-J3 After Action Report, Eagle Flight Incident**

**AC-8h 39 Support Group Memorandum, Lessons Learned,  
SAR Operations on Helicopter Incident**

**AC-8a**

**AC-8i Memorandum USAFE/XO, OPC Assessment**

**AC-8j MCC SITREP, 3 April 1994**

**AC-8k Senate Armed Services Committee  
Request for Inquiry**

# AUTHENTICATION

I am SHEDRICK B. WILLIAMS, assigned to 53FS  
(Name) (Organization)

My duty section is OPERATIONS SYS MGMT (DOTF). I am the records custodian of my duty section.

I recognize NOTM 16 KDZZ AS THE DAILY AIRCREW NOTAMS FOR  
INCIRLIK AB DATED 04/14 APR 94.

(Fully describe the record collected)

Evidenced Tag Number # 92

I certify that (it is a record taken from my duty section) ~~(it is a true and accurate copy of a record kept in my duty section)~~ NSW

Shedrick B. Williams  
(Signature)

SHEDRICK B. WILLIAMS  
(Printed Name)

53FS / DOTF  
(Organization/Duty Section)

(Date)

Subscribed to and sworn before me this 1 day of MAY 1994.

William H. [Signature]

UNKEY

LTAA ANKARA ACC

- 5) 9404110600 C) 9404201500 E) DISTANT THUNDER-94 IS SMALL SCALE NATO SOUTHERN REGION LIVE EXERCISE WITHIN ANKARA, ISTANBUL, ATHINAI FIR, S BTN 11-20 APRIL 1994 AIP SUPPLEMENT FOR THOSE EXERCISE AREAS WITHIN ANKARA AND ISTANBUL FIRS IN COURSE OF DISTRIBUTION.
- 2) 9404150001 C) 9404152359 E) TOP ATISLARI YAPILACAKTIR, SAHA:4045N4222E 4045N4250E 4033N4222E 4033N4250E AFFECTED AWY W85D, W27D F)MSL G)21000FT.
- 5) 9404110200 C) 9404141400 D) APR 11,12,13,14 0500/1000 AND 1100/1400 E) GUN FIRING WILL TAKE PLACE. AREA:3952N4039E 3956N4039E 3956N4046E 3952N4048E AFFECTED ERZURUM CTR AND AWY VA4. F)MSL G)19500FT
- 5) 9404100400 C) 9404201700 D) FM 10 TILL 20 APR, 0400/1700 E) GUN FIRING WILL TAKE PLACE. WI 4003N4126E 4002N4129E 4001N4123E 4001N4127E WITHIN ERZURUM CTR. F) MSL G) 18000FT.
- 2) 9403262201 C) 9410292200 E) AERODROME OPERATING HOURS ARE AS FOLLOWS. ALL TIMES ARE UTC. BTN 27.05.1994/24.09.1994 0500/1400 MON-TUE-WED-FRI 0530/1830 THU (SAT-SUN CLOSED). BTN 25.09.1994/29.10.1994 0600/1500 MON-TUE-WED-FRI 0630/1930 THU (SAT-SUN CLOSED).

LTAC ESENBOGA

- 5) 9402240824 C) PERM E) BETWEEN ANKARA NDB AND BAKIR INTERSECTION DIST AMEND TO READ 39 NM INSTEAD OF 43 NM.
- 5) 9404121300 C) 9406302359 E) RWY 03R/21L CLOSED

LTAG INCIRLIK AB

- 5) WIE C) UFN E) 05/23 PAPI NOT AVBL
- 5) WIE C) UFN E) DISREGARD RUNWAY MARKINGS ON NORTH PARALLEL TAXIWAY, TAXIWAY IS MARKED FOR FUTURE USE AS ACTIVE RUNWAY DURING MAIN RUNWAY RECONSTRUCTION, AS OF YET IS NOT AN ACTIVE RUNWAY

LTAN KONYA

- 5) WIE C) UFN E) ALL INST APCH PROC CHANGED TO PROCEDURES AUTHORIZED FOR USAF AIRCREWS ONLY. LIMITED TO VMC ONLY.

LTBA ATATURK

- 5) 9312311500 C) 9406301500 E) RWY 06/24 CENTERLINE LIGHTS OUT OF SERVICE.

- 5) 9404011600 C) 9404221200 E) RWY 18 ILS OUT OF SERVICE.

END OF PART 07C

### EXTRACT

I certify that I am the Reason Custodian for the Accident Investigation Board convened to investigate the crash of two U.S. Army Black Hawk helicopters in the no fly zone in northern Iraq on 14 April 1994, and that this is a true and accurate extract from:

Incirlik AB Daily NOTAMS for 14 Apr 94

which is kept in my records system.

W.L.H.  
Date

W.L.H.  
WILLIAM L. HARRIS, Capt, USAF MEG  
Evidence Custodian  
Incirlik Air Base, Turkey

LTSS ISTANBUL ACC

- 5) 9307151230 C) 9407152359 EST E) NEW TEMPORARY ATS ROUTE W340 BETWEEN IZMIR VOR (IMR) AND KAVAK INTERSECTION IS ESTABLISHED AS FOLLOWS. 1-SIGNIFICANT POINT: IZMIR VOR (IMR) :381906N 270028E KAVAK INTERSECTION :372130N 294400E 2-MAG TRACK: 125 3-01ST NM: 100 4-UPPER/LOWER LIMITS: FL460/FL235 5-MNM IFR EN-ROUTE FL (FT) : FL240 6-CRUISE LEVEL: ODD 7-REMARKS: FLIGHTS DEPARTING ANY AERODROME WITHIN IZMIR TMA DESTINED TO DALAMAN AIRPORT ARE NOT AUTHORIZED TO FLY VIA THIS ROUTE.
- 5) 9401280530 C) 9412311430 D) DAILY 0530/1430 E) TRAINING EXERCISE AREA AS FOLLOWS: COOR:3745N2724E 3736N2727E 3742N2733E 3746N2742E 3751N2744E 3751N2733E 3754N2730E. EFFECTED IZMIR TMA. F) MSL. G) 5000FT
- 5) 9403260500 C) 9404281500 D) FEB 28 AND MAR 01,02,03,04,07,08,09,10,29,30,31 AND APR 13,26,27,28 0500/1500 E) GUN FIRING WILL TAKE PLACE:4147N2634E 4147N2700E 4132N2634E 4132N2700E AFFECTED AWAY VAA F) MSL G) 15000FT
- 5) 9403220500 C) 9404292200 D) MARCH 22,23,24,25. APRIL 12,13,19,20,21,22,28,29. 0500/2200 E) GUN FIRING WILL TAKE PLACE: 4147N2634E 4147N2700E 4132N2634E 4132N2700E. EFFECTED AWAY VAA. F)MSL G)15000FT
- 5) 9403110630 C) 9404251530 D) FM 11 TILL 31 MAR AND FM 11 TILL 25 APR 0630/1530 E) GUN FIRING WILL TAKE PLACE: 3840N2647E 3840N2644E 3839N2644E 3839N2646E WITHIN IZMIR TMA F)MSL G)10.000 FT
- 5) 9404110700 C) 9404151300 D) APR 11,12,13,14,15. 0700/1500 E) GUN FIRING WILL TAKE PLACE:1ST AREA:3840N2634E 3840N2644E 3857N2646E 3833N2632E 2ND AREA:384030N263400E 355100N263606E 385115N264615E 384430N264530E 384000N264430E WITHIN IZMIR TMA F)MSL G)10000FT
- 5) 9404130700 C) 9404141500 D) APR 13 14,0700/1500 E) GUN FIRING WILL TAKE PLACE.WI 4016N2926E 4016N2928E 4014N2926E 4014N2926E WITHIN ISTANBUL TMA. F)MSL G)6500FT.
- 5) 9404030700 C) 9405161200 D) AS ITEM E E) TURKISH NAVY AND AIRFORCE SHALL MAKE A WITHOUT FIRING TASMO CEVIK FENCE-2 EXERCISE IN INTERNATIONAL WATERS AND AIRSPACE OF MEDITERRANEAN AND AEGEAN SEA. FIRST AREA:3552N2649E 3851N2636E 3851N2619E 3842N2619E 3840N2640E AFFECTED IZMIR TMA. DATE AND TIMES:APR 05 0700/0900 MAY 15 0600/0900 AND 1000/1200 SECOND AREA:3942N2608E 3943N2543E 3923N2513E 3915N2538E 3929N2553E 3929N2604E DATE AND TIMES:APR 06 0600/0600 AND 1200/1400 MAY 11 0800/1000 AND 1100/1400 THIRD AREA:3630N2834E 3625N2910E 3600N2919E 3621N2834E AFFECTED DALAMAN TMA DATE AND TIMES:APR 28 1000/1400) END PART 1 OF 2
- 5) 9404110400 C) 9406171600 D) AS ITEM E E) GUN FIRING WILL TAKE PLACE: AREA:3630N2834E 3623N2834E 3609N2919E 3625N2919E AFFECTED DALAMAN TMA. DATE AND TIME:APR FM 11 TILL 17 AND 26,27,28. MAY 25,26,27 JUN 14,15,16,17 0400/1600 F) MSL G) 35000FT
- 5) 9404110700 C) 9404161230 D) AS ITEM E E) NAVIGATIONAL WARNING TO ALL CONCERNED REF(A)CLASS ONE NOTAM A0391/94 FROMULGATED BY GREECE ON 01 APRIL 1994 FOR NATO EXERCISE DISTANT THUNDER-94 REF(B) AIP SUPPLEMENT ISSUED BY TURKISH CAA DATED 10 APRIL 1994 NUMBER SUP 1/94 CONCERNING DISTANT THUNDER -94 1-THE PARAGRAPH 4.B(FOUR BRAVO),4.D(FOUR DELTA) OF REF (A) (ALPHA) ARE NOT VALID FOR MILITARY AIRCRAFT FLYING OVER HIGH SEAS WITHIN ATHENS FIR DUE TO THE FACT THAT THESE ITEMS ARE ARBITRARILY INJECTED TO THE ORIGINAL NOTAM TEXT. FURTNER MORE MILITARY AIRCRAFT FLYING OVER THE HIGH SEAS ARE NOT BOUND BY THE ICAO RULES AND PROCEDURES AS DEDETAILED IN AIP GREECE. 2.DISTANT(THUNDER-94 EXERCISE AIRCRAFT WILL OPERATE WITHIN THE AIRSPACE OVER THE AEGEAN HIGH SEAS IN ACCORDANCE WITH ARTICLE 3 (THREE) OF CHICAGO

DALAMAN TMA DATE AND TIMES: APR 28 1000/1400) END PART 1 OF 2  
E) 9404110400 C) 9404171600 D) AS ITEM E E) GUN FIRING WILL  
TAKE PLACE: AREA: 3630N2834E 3623N2834E 3609N2919E 3623N2919E  
AFFECTED DALAMAN TMA. DATE AND TIME: APR FM 11 TILL 17 AND  
26, 27, 28. MAY 25, 26, 27 JUN 14, 15, 16, 17 0400/1600 F) MSL G)  
35000FT

E) 9404110700 C) 9404161230 D) AS ITEM E E) NAVIGATIONAL  
WARNING TO ALL CONCERNED REF(A) CLASS ONE NOTAM A0391/94  
PROMULGATED BY GREECE ON 01 APRIL 1994 FOR NATO EXERCISE  
DISTANT THUNDER-94 REF(B) AIP SUPPLEMENT ISSUED BY TURKISH  
CAA DATED 10 APRIL 1994 NUMBER SUP 1/94 CONCERNING DISTANT  
THUNDER -94 1-THE PARAGRAPH 4.B(FOUR BRAVO). 4.D(FOUR DELTA)  
OF REF (A) (ALPHA) ARE NOT VALID FOR MILITARY AIRCRAFT  
FLYING OVER HIGH SEAS WITHIN ATHENS FIR DUE TO THE FACT THAT  
THESE ITEMS ARE ARBITRARILY INSERTED TO THE ORIGINAL NOTAM  
TEXT. FURTHER MORE MILITARY AIRCRAFT FLYING OVER THE HIGH  
SEAS ARE NOT BOUND BY THE ICAO RULES AND PROCEDURES AS  
DETAILED IN AIP GREECE. 2. DISTANT(THUNDER-94 EXERCISE  
AIRCRAFT WILL OPERATE WITHIN THE AIRSPACE OVER THE AEGEAN  
HIGH SEAS IN ACCORDANCE WITH ARTICLE 3 (THREE) OF CHICAGO  
CONVENTION AND PARAGRAPH 4(FOUR) OF REF B (BRAVO) AIP  
SUPPLEMENT.

E) 9404140600 C) 9404221000 D) 14, 15, 22 APRIL 0500/1000 E) GUN  
FIRING WILL TAKE PLACE: WI 4125N2829E 4124N2829E 4116N2834E  
4116N2832E WITHIN TMA ISTANBUL. F) MSL G) 15000

E) 9404110600 C) 9404151400 E) NAVIGATIONAL WARNING TO ALL  
CONCERNED 1. THIS NTM IS ISSUED TO CLARIFY THE STATEMENT  
MADE CONCERNING THE WIDTH OF GREEK NATIONAL AIRSPACE IN ITEM  
2 OF NTM A0429/94 DATED 07 APR 1994 ISSUED BY HELLENIC CAA.  
2. THE EXTENSION OF GREEK NATIONAL AIRSPACE BEYOND SIX  
NAUTICAL MILES IS CONTRARY TO INTERNATIONAL LAW AND  
CONVENTIONS AND IS THEREFORE NOT RECOGNIZED BY TURKEY.  
FIRING ACTIVITY WILL TAKE PLACE IN WHOLE EXERCISE AREA AS  
DESCRIBED IN ITEM 1 OF GREEK NTM A0429/94.

E) 9404140600 C) 9405061000 D) APR 14, 15 AND MAY 06 0500/1000  
E) GUN FIRING WILL TAKE PLACE. 4125N2829E 4124N2829E  
4116N2834E 4116N2832E AFFECTED ISTANBUL TMA. F) MSL  
G) 15000FT.

E) 9404130735 C) 9404131400 E) NAVIGATIONAL WARNING TO ALL  
CONCERNED. TURKISH NAVY FIRING EXERCISE REMAIN UNCHANGED.

LTSS DALAMAN

E) 9403262201 C) 9410292200 E) AERODROME OPERATING HOUR IS H24.

E) 9404071200 C) FERM E) TURKEY AGA 2-6-1 ITEM 7 AMEND TO READ  
TRANSITION ALTITUDE 4500 FT INSTEAD OF 4600 FT.

D OF PART 07D

D OF PART 07



**TAB AC-8**

**MISCELLANEOUS**

**AC-8a NOTAMs**

**AC-8b SAR Daily Log, 14-17 April 1994**

**AC-8c MCC Operations Log, 14-18 April 1994 and Note from Zakhu,  
Kurdistan Democratic Party**

**AC-8d Headquarters, Combined Task Force, Operation PROVIDE COMFORT,  
Memorandum for Record, 14 May 1994**

**AC-8e Headquarters Operation PROVIDE COMFORT II,  
Combined Task Force/C2 Log, 14 April 1994**

**AC-8f Extract of Joint Operations Center Log, 13-14 April 1994**

**AC-8g Extract from JSOTF-J3 After Action Report, Eagle Flight Incident**

**AC-8h 39 Support Group Memorandum, Lessons Learned,  
SAR Operations on Helicopter Incident**

**AC-8a**

**AC-8b**

**AC-8i Memorandum USAFE/XO, OPC Assessment**

**AC-8j MCC SITREP, 3 April 1994**

**AC-8k Senate Armed Services Committee  
Request for Inquiry**

140500Z APR 94 TSGT LIDER ON DUTY

140515Z APR 94 CALLED THE FRAG SHOP, MSGT TOMLINSON (6-3938), REGARDS  
PC LOG ENTRY 131130Z APR 94.

140535Z APR 94 REGARDS 132140Z APR 94 RED CROSS PC LOG ENTRY - PASSED  
INFORMATION TO THE FIRST SGT. ASKED FIRST SGT TO RELAY  
SAME TO COL HUNT.

140545Z APR 94 REGARDS SAT., 16 APR 94 HC-130 MISSION - PASSED INFORMATI-  
ON CONTAINED IN PC LOG ENTRY 131615Z TO CAPT  
LEFEBVRE.

140556Z APR 94 SOC3/LT CRAIG CALLED. TOWER REPORTED IT HAD NO FLIGHT  
PLAN FILED FOR ROTOR 05 (0600Z T/O). CALLED C-3 JOC/LT  
ALLEN. LT ALLEN SAID HE WOULD CHECK ON IT.

140610Z APR 94 SOC3/LT CRAIG CALLED. ROTOR 05 HAS MX PROBLEMS AND  
WILL NOT GET OFF ON TIME. SOC3 WILL ADVISE ON OPENING  
A NEW LINE. LT CRAIG REPORTED TOWER WAS INCORRECT -  
FCF'S DON'T NEED TO FILE A FLIGHT PLAN.

140620Z APR 94 LTC SPENCE CALLED ASKING TO SPEAK WITH COL HUNT ASAP  
ON A SECURE LINE. CAPT LEFEBVRE PASSED THIS MESSAGE TO  
COL HUNT'S BEEPER NUMBER.

140650Z APR 94 SOC3/MAJ LIEBOCK CALLED. ROTOR 05 READY FOR T/O ASAP.

140651Z APR 94 CALLED C-3 JOC/MAJ WIGGINS. C-3 JOC WILL TRY TO GET  
ROTOR 05 T/O APPROVAL FOR 0700Z. MAJ WIGGINS BELIEVES  
CALLSIGN FOR FCF CAN REMAIN ROTOR 05.

140658Z APR 94 CALLED C-3 JOC/MAJ WIGGINS. 0700Z T/O APPROVAL CONFIRMED  
FOR ROTOR 05. RELAYED APPROVAL TO SOC3/LT CRAIG.

140713Z APR 94 CALLED SOC3/SRA WAID. ROTOR 05: ATD - 0700Z, ATA - 0710Z.

140714Z APR 94 SPEC BUDGET/J1 CALLED REGARDS A SITREP NUMBER ERROR.  
SHE SAID YESTERDAY'S NUMBER WAS SHOWING 189 AND IT  
SHOULD HAVE BEEN 190.

140805Z APR 94 MAJ BECKIT CALLED ASKING TO SPEAK TO COL HUNT ON A  
SECURE LINE. MAJ ROSENGARD SPOKE SECURE WITH MAJ  
BECKIT.

**CERTIFICATE**

I certify that I am the Records Custodian for the Accident Investigation Board convened to investigate the crash of two U.S. Army Black Hawk helicopters in the no fly zone in northern Iraq on 14 April 1994, and that this is a true and accurate copy of the record which is kept in my records system.

15 May 94  
Date

W. L. Harris  
WILLIAM L. HARRIS, Capt, USAF, MSC  
Evidence Custodian, Incirlik Air Base, Turkey

140806Z APR 94 MAJ ROSENGARD AND CAPT VANDER LEY CALLED C2 RECEIVED  
INITIAL INFORMATION ON HIND HELICOPTER INCIDENT

140808Z APR 94 LTC ZAHRT CALLED ASKING TO SPEAK TO COL HUNT ON A  
SECURE LINE GAVE LTC ZAHRT COL HUNT'S BEEPER NUMBER

140809Z APR 94 MAJ LIEBOCK CALLED AND TALKED TO MAJ ROSENGARD

140810Z APR 94 J2 HAS ALSO BEEPED COL HUNT

140815Z APR 94 COL HUNT CALLED AND SPOKE BRIEFLY WITH MAJ ROSENGARD

140825Z APR 94 SOC3/LT CRAIG CALLED. REQUEST OPEN A LINE FOR AN FCF -  
ROTOR 06, T/O ASAP, MSN DUR 2 HRS., MSN #T14321.

140826Z APR 94 CALLED C-3 JOC/LT ALLEN. C-3 JOC WILL TRY TO ARRANGE FOR  
A ROTOR 06 T/O TIME OF 0835Z.

140833Z APR 94 LTC ZAHRT CALLED AND SPOKE WITH COL HUNT SECURE.

140845Z APR 94 CALLED C-3 JOC/MAJ WIGGINS. APPROVAL FOR ROTOR 06  
CONFIRMED. ROTOR 06 WILL T/O ASAP FOR A 2 HR DURATION

140846Z APR 94 SOC3/LT CRAIG CALLED. INFORMED HIM OF ROTOR 06 T/O  
APPROVAL CONFIRMATION.

140853Z APR 94 CALLED SOC3/SRA WAID. ROTOR 06 ATD - 0840Z. ASSUME  
ROTOR 06 AC RECEIVED T/O CLEARANCE FROM TOWER  
BEFORE J3 VERIFIED APPROVAL CONFIRMATION FROM C-3 JOC.

140909Z APR 94 COL HUNT HAS DIRECTED JSOTF TO MOVE THE AOB ALERT SAR  
PACKAGE TO SOC3.

140914Z APR 94 SOC3/SRA WAID CALLED. ROTOR 06 ATA - 0855Z.

140930Z APR 94 PER MAJ ROSENGARD - POSSIBLE SATCOM MISSION WITH COL  
HUNT. J6 INFORMED.

140933Z APR 94 CAPT LEFEBVRE CALLED AND SPOKE SECURE WITH  
MAJ ROSENGARD.

141000Z APR 94 [CLASSIFIED PORTION DELETED (6 WORDS)]

141010Z APR 94 CALLED SOC3/LT CRAIG. ALL JSOTF TRAINING LINES CNX

(SHADOW 01/02, HAWK 21/22)

141020Z APR 94 CALLED CAPT LEFEBVRE SECURE. ASKED ABOUT JSOTF LNO'S  
LTC ZAHRT GOT ON THE LINE WITH CAPT LEFEBVRE AND  
TOLD HIM THERE IS NO ROOM ON THE AIRCRAFT FOR LNO'S.

141025Z APR 94 INFORMED SOC3/SRA WAID NO ROOM FOR LNO'S

141027Z APR 94 CAPT VANDER LEY GIVES COL HUNT AN ISOPREP CARD  
INTERVIEW

141029Z APR 94 PER MAJ ROSENGARD - "COUGAR" THE AWACS ACFT IS  
AIRBORNE CTF (MAJ WIGGINS) WILL MAKE ARRANGEMENTS  
TO KEEP AWACS AIRBORNE FOR DURATION OF MISSION.

141050Z APR 94 LT ALLEN C-3 JOC CALLED SAID FCF APPROVED FOR ROTOR  
07, T/O TIME IN APX. 5 MINUTES. RECEIVED NO PRIOR  
PHONE CALL FROM SOC3.

141052Z APR 94 PERMISSION FROM CTF TO LAUNCH. IF REFUEL NECESSARY  
ENROUTE TO ZAKHO MUST DO SO AT DIYARBAKIR.

141057Z APR 94 COL HUNT HAS DEPARTED THE BLDG.

141100Z APR 94 SOC3/SGT MONEY CALLED. ROTOR 07 ATD - 1055Z

141108Z APR 94 [CLASSIFIED PORTION DELETED (32 WORDS)]

141134Z APR 94 COL RACE - DCO SOCEUR CALLED. HE STATED GEN KELLOG  
NEEDS TO KNOW IF JSOTF CC HAS A GOOD ACCOUNTABILITY  
OF ALL PERSONNEL AT ZAKHO. MAJ ROSENGARD BRIEFED  
COL RACE ON THIS SUBJECT.

141201Z APR 94 LT CRAIG/SOC3 CALLED.

[CLASSIFIED PORTION DELETED (16 WORDS)] CALLED  
MAJ WIGGINS/C-3 JOC AND PASSED THIS INFO TO HIM. MAJ  
WIGGINS STATED APPROVAL FOR PONY 21-23 HAD BEEN  
GRANTED BUT DIFFICULTY EXISTS IN GAINING APPROVAL  
FOR THE HC-130 SAR LINES.

141225Z APR 94 CAPT CLARK CALLED MAJ BETHEL, MCC REAR IN DIYARBAKIR.

REF. MH-60 REFUEL MAJ BETHEL WILL COORDINATE WITH  
TURKS. NO PROBLEMS ANTICIPATED.

141230Z APR 94 CALLED SOC3/LT CRAIG. ASKED FOR T/O TIMES.  
PONY 21 ATD - 1200Z  
PONY 22 ATD - 1208Z  
PONY 23 ATD - 1210Z

141234Z APR 94 CALLED SOC3/LT CRAIG. ROTOR 07 ATA - 1115Z.

141237Z APR 94 MAJ BETHEL CALLED CAPT CLARK BACK. SHE STATED THE  
REFUELER WOULD BE STANDING BY.

141238Z APR 94 C-3 JOC/MAJ WIGGINS CALLED. APPROVAL GRANTED FOR THE  
LAUNCH OF THE [CLASSIFIED PORTION DELETED (7 WORDS)]

141250Z APR 94 CAPT LEFEBVRE'S CURRENT LOCATION IS C-1 JOC, 6-3001.

141253Z APR 94 CALLED SOC3/SGT MONEY. INFORMED HIM GHOST 31/32  
APPROVED FOR T/O.

141255Z APR 94 MAJ ROSENGARD SPOKE TO CPT LITTLE AT ZAKHO. CPT KENT  
WILL LEAD 8 MAN ELEMENT (6 US, 2 RCC INTERP'S) TO CRASH  
SITE. WILL USE GROUND TRANSPORTATION. WILL LEAVE  
WITHIN THE HOUR. WILL NEED APPROX 3-HRS TO GET THERE.  
WILL LINK-UP WITH FORCE SECURING THE CRASH SITE (PESH ??)  
DURING DAY-LITE HRS TO PRECLUDE FORCE TRAVELING FROM  
INCIRLIK HAVING TO POTENTIALLY LINK UP WITH THIS FORCE  
AT NIGHT. MAJ SANDERS IS SENIOR AMERICAN AT ZAKHO. CPT  
LITTLE IS NOW SENIOR AMERICAN SF AT ZAKHO. MAJ  
ROSENGARD WILL GET WORD OF ALL OF THIS COL HUNT VIA  
SOCIII.

141257Z APR 94 SGM GANN (SOCEUR) CALLED FOR COORDINATES OF CRASH  
SITE. SGM HALTERMAN GAVE SGM GANN THE DATA HE  
NEEDED.

141259Z APR 94 COL HASSLE CALLED FOR MAJ ROSENGARD. WILL INFORM THE  
MAJ TO CALL WHEN HE IS FINISHED IN J2.

141301Z APR 94 MAJ ROSENGARD RETURNS COL HASSLE'S CALL.

141303Z APR 94 LT CRAIG/SOC3 CALLED. ASKED FOR THE TOTAL NUMBER OF  
PERSONNEL ON EACH OF THE PONY HELICOPTERS. THE MOST  
CURRENT INFORMATION AVAILABLE TO MAJ ROSENGARD IS A

TOTAL BODY COUNT OF 24 (INCLUDING CREW).

141310Z APR 94 LTC RIVERA CALLED ASKING FOR INFORMATION REGARDS THE HIND HELICOPTER INCIDENT. LTC RIVERA IS THE EXEC FOR THE CC OF AMERICAN FORCES IN TURKEY, MAJ GEN STOKES. MAJ ROSENGARD TALKED TO LTC RIVERA.

141317Z APR 94 CALLED SOC3/LT CRAIG. AS OF THIS TIME SOC3 HAS NO ATD FOR GHOST 31. THEY WILL CHECK AND CALL BACK.

141319Z APR 94 LT CRAIG/SOC3 CALLED. GHOST 31 ATD - 1302Z.

141331Z APR 94 MAJ SHAW CALLED FROM SOC3 REGARDS SAR HC-130 AIR REFUELING COORDINATION. HE SPOKE SECURE WITH CAPT CLARK.

141340Z APR 94 39TH WING CC, COL KULA, RELAYED A MESSAGE (TO CAPT CLARK) FROM BGEN PILKINGTON. MSG IS AS FOLLOWS:  
--- NO CASUALTIES WILL BE BROUGHT BACK TO INCIRLIK AB.  
--- TOMORROW, 15 APR, WILL BE A NO FLY DAY.

141341Z APR 94 CAPT LEFEBVRE CALLED FROM C-1 JOC (6-3001) AND TALKED TO CAPT CLARK. CAPT LEFEBVRE ASKED FOR A SEQUENCE OF INFORMATION:  
--- TIMELINE IT WILL TAKE TO GET THE MH-60'S FROM ZAKHO TO THE SITE.  
--- TIME NEEDED ON STATION.  
--- TIME DATA REQUIRED FOR CAS COORDINATION.  
CAPT CLARK PASSED THIS REQUEST FOR INFORMATION TO MAJ ROSENGARD.

141343Z APR 94 CAPT CLARK LEARNED AWACS WILL STAY AIRBORNE AS LONG AS THEY ARE NEEDED.

141350Z APR 94 J2 RELATES THE OFFICIAL SHOOTDOWN TIME OF HELICOPTERS WAS 0730Z. POSSIBLY EAGLE FLIGHT UH-60s vs. HINDs.

141420Z APR 94 CPT LEFEBVRE CALLED FROM WOC. WE HAVE PREMISSION TO PERFORM AERIAL REFUELING. GRID COORD OF RECEIVED IMAGERY - MF 177698. AWACS WILL STAY ON STATION. FIGHTERS WILL BE ON STRIP ALERT AT INCIRLIK. BG P SAYS NO NEED TO KEEP FIGHTERS UP, NO IRAQIS FLY AT NIGHT. MAJ ROSENGARD TOLD CPT L TO GO BACK AND ARGUE THAT AIR THREAT IS NOT OUR CONCERN, GOI GROUND THREAT IS !!! WE

STILL NEED RESCAP IN THE AIR TONIGHT FOR THE DURAITION  
OF OPS AT CRASH SITE. SSG TOBIA PASSED INFO REGARDING  
OUR ASSESMENT OF PROBABLE GROUND TARGETS AND ROUTES  
OF MOVEMENT.

- 141425Z APR 94 SOC3/LT CRAIG CALLED. ETD FOR GHOST 32 IS 1700Z. RELAYED  
SAME TO MAJ WIGGINS/C-3 JOC.
- 141433Z APR 94 CAPT CLARK PASSED MH-60 FREQUENCIES TO MAJ SANDERS/  
MCC.
- 141553Z APR 94 COL HUNT AND CREW CROSSED THE BORDER AT 1515Z.
- 141554Z APR 94 PER CAPT VANDER LEY - SOC3 INTEL RELATES GROUND TIME  
AT THE CRASH SITE OF 1615Z.
- 141619Z APR 94 CAPT LEFEBVRE CALLED FROM THE WOC. THE FIRST HC-130  
(GHOST 31) CAN ONLY TALK TO AWACS. HC-130 IS POSSIBLY  
HAVING FLIGHT PROBLEMS. TENATIVE PLAN IS TO FLY TO  
DIYARBAKIR, DROP OFF MEDICAL TEAM, AND RETURN TO  
INCIRLIK AB. THE SECOND HC-130 WILL P/U THE MEDICAL  
TEAM AT DIYARBAKIR ENROUTE TO TAOR.
- 141620Z APR 94 CAPT LEFEBVRE CALLED. SAR TEAM IS ON THE GROUND AT  
THE CRASH SITE.
- 141644Z APR 94 CAPT LEFEBVRE CALLED. 2 F-15'S ARE ON-STATION OVER THE  
AREA. THE F-15'S ONLY HAVE AIR-TO-AIR CAPABILITY.
- 141700Z APR 94 TSGT SMITH ON DUTY.
- 141715Z APR 94 RECEIVED CALL FROM CPT LEFEBVRE FROM COMMUNICATIONS  
WITH JSOTF COMMANDER ROUGHLY 26 BODIES/ NO SURVIVORS  
TAKING BODIES TO DIYARBAKIR/ EQUIPMENT TAKING TO A  
SAFE AREA. HES AT 6-3001 PASSED INFO TO MAJ ROSENGARD.
- 141730Z APR 94 CPT LEFEBVRE CALLED CRASHED HELICOPTERS ARE  
CONFIRMED US UH-60'S. 26 DECEASED CONFIRMED.
- 141758Z APR 94 PONY 21/23 ENROUTE TO DIYARBAKIR WITH 26 BODIES. PONY 22  
STILL AT CRASH SITE.
- 141815Z APR 94 RECEIVED CALL FROM CPT LEFEVBRE: PONY 22 ENROUTE TO

ZAHKO WITH 9 BODIES ON BOARD. WILL THEN CONTINUE TO DIYARBAKIR. CORRECTION ON BODY COUNT IN PONY 21/23: 17 BODIES ON BOARD. PONY 21/23 HAVE FINISHED AIREAL REFUEL AND ARE CIRCLING THE CRASH SITE. THEY HAVE NOT OFF-LOADED BODIES YET.

- 141930Z APR 94 CPT LEFEVBRE CALLED: 1 HC-130 WITH MEDICAL PERSONNEL ON BAORD HAS LOST 1 ENGINE HAS REQUESTED TO RETURN TO INCIRLIK . REQUEST DENIED BY CTF. MUST LAND AT DIYARBAKIR TO OFF-LOAD MED PERSONNEL. CTF RESEARCHING WHETHER HC-130 CAN TAKEOFF FROM DIYARBAKIR WITHOUT ONE ENGINE.
- 141932Z APR 94 CPT LEFEBVRE CALLED PONY 22 OBSERVING TRACER FIRE NORTH OF ZAHKO NOT SURE IF DIRECTED TOWARD THEM.
- 142000Z APR 94 RECEIVED CALL FROM CPT LEFEBVRE GHOST 31 LANDED AT DIYARBAKIR WITH MEDICAL PERSONNEL CANNOT TAKE-OFF. NEEDS TO KNOW WHEN HELICOPTERS WILL BE OUT OF AOR. TIME CRITICAL: MAY NEED TO LAUNCH ANOTHER AWACS. WILL GET INFORMATION FROM SOC3.
- 142025Z APR 94 MAJ ROSENGARD IS UPDATING SOCEUR OF AOR " STATUS".
- 142032Z APR 94 MAJ ROSENGARD IS CALLING COL SPENCE AT ETTIC WITH UPDATE OF AOR.
- 142034A APR 94 RECEIVED CALL FROM CPT LEFEBVRE GHOST 32 LANDED AT DIYARBAKIR TO PICKUP PERSONNEL AND CREW FROM GHOST31 MAINTENACE PERSONNEL AND EQUIPMENT WILL BE LOADED ON A C-141 THIS EVENING HEADED TO DIYARBAKIR SHOOTING FOR A 0200Z TAKEOFF. VERY FLEXIBLE TIME.
- 142110Z APR 94 PER COMMUNICATIONS FROM CPT LITTLE FROM ZAHKO THE FOLLOWING GRID COORDINATES OF CRASH SITES.  
# 1 MF 176698  
# 2 MF 190695
- 142145Z APR 94 GHOST 31 HAS 6 BODIES ON SITE 2. EIGHT BODIES ARE 50MIN. OUT OF ZAHKO. ONCE ALL BODIES ARE AT DIYARBAKIR . TERMINATION OF FLIGHT UNTIL TOMORROW, TIME UNKNOWN.
- 142259Z APR 94 PONY23 HAS LEFT TO DIYARBAKIR. ETA 1H15MIN.
- 142331Z APR 94 ALL PONYS ARE AIRBORNE HEADED TO DIYARBAKIR.



150055Z APR 94 MONITORING COMUNICATIONS ONCE ALL BODIES GET TO ZAHKO THEY WILL TRANSPORTED TO THE C-130 AND WILL FLY TO DIYARBAKIR. PERSONNEL WILL STAY AT ZAHKO.

150105Z APR 94 TEAM AT SITE IS BREAKING DOWN AWATING PICKUP IN 15MIN. PONY22 WILL DO PICK-UP.

150115Z APR 94 PONY 21 T/O HEADED TOWARD DIYARBAKIR. PONY 22 IS NOW AT SITE FOR PICK-UP SILVER BULLET TEAM.

150430Z APR 94 GHOST 32 HAS LANDED AT INCIRLICK.

150430Z APR 94 NOTIFIED BY CAPT BOLGER AT DIYARBAKIR THAT ALL HELO CREWS HAVE ENTERED CREW REST AT 0330Z. ALL HELOS ARE MISSION CAPABLE.

150500Z APR 94 TSGT LIDER ON DUTY.

150518Z APR 94 SOC3/LT CRAIG CALLED. HE ASKED IF FLYING OPERATIONS WOULD COMMENCE AGAIN TOMORROW. CALLED C3 JOC/ LT ALLEN. ASKED HIM IF THAT QUESTION WAS LOW ON THE PECKING ORDER OF THINGS TO THINK ABOUT. HE CONCURRED. LT ALLEN SAID BY 1200 OR 1300L TODAY IT MIGHT BE KNOWN IF THERE WILL BE A FLYING SCHEDULE FOR SAT., 16 APR.

150553Z APR 94 CALLED SOC3/LT CRAIG. INQUIRED ON THE STATUS OF THE CREWS AT DIYARBAKIR. CREW REST TIMES:  
MH-060'S (PONY 21-23) - START 0330Z / STOP 1530Z  
HC-130'S (GHOST 31/32) - START 0600Z / STOP 1800Z

150603Z APR 94 SGT ATKINS CALLED FROM BGEN PILKINGTON'S OFFICE. HE SAID THERE IS A PERSONAL MSG FROM BGEN P TO COL HUNT WHICH NEEDS TO BE PICKED UP. SGT PRATTIS WENT TO GO GET IT.

150607Z APR 94 LT CRAIG/SOC3 CALLED. THE CC OF THE PJ'S AT HURLBURT FIELD, FL WANTED TO KNOW IF ANY OF HIS PJ'S WERE ON THE HELICOPTERS DOWNED AT THE CRASH SITE.

150609Z APR 94 CAPT VANDER LEY TALKED TO LT CRAIG. ANSWER - NO.

150614Z APR 94 SGM HALTERMAN CALLED CTF C1 REQUESTING MEDICAL RECORDS FOR DNA IDENTIFICATION. C1 WILL CALL BACK.

TONIGHT'S FLIGHT.

- 150815Z APR 94 CAPT VANDER LEY CALLED MAJ WIGGINS C3/JOC - REF. ESCORTS FOR BODIES OF COL THOMPSON, SSG BARCLAY, AND SSG ROBINSON. MAJ WIGGINS STATED ESCORT DUTIES PROBABLY WOULD NOT BEGIN UNTIL THE BODIES LEFT FRANKFURT. HE WOULD PASS ON THE REQUEST FOR ESCORTS TO BGEN PILKINGTON. HE WILL LET US KNOW THE TIME SCHEDULE TO ENSURE THE ESCORTS ARRIVE AT FRANKFURT ON TIME. ALSO REQ. GUIDANCE ON THE RELEASE OF MISREPS OF SOC 3 MISSIONS TO HOME STATION. CTF GUIDANCE HC-130 MISREPS CAN BE RELEASED. HELO MISREPS MUST BE IN LINE WITH CURRENT EUCOM SITREP INFORMATION. INFO PASSED TO SOC3 INTEL.
- 150816Z APR 94 AT APX. 0812Z SGM HALTERMAN WAS BEEPED REGARDS ATTENDING THE 1ST SGT'S MTG IN THE CTF CONF RM. PER HIS REQUEST AOB AND SOC3 1ST SGT'S WERE ALSO NOTIFIED.
- 150909Z APR 94 PER CAPT VANDER LEY - INITIAL TIMELINE FOR TONIGHT'S MISSIONS RECEIVED FROM LTC ZAHRT.
- 150945Z APR 94 LTC HOOVER AND SGM HITCHO WILL ACCOMPANY THE HC-130 DEPARTING DIYARBAKIR TOMORROW.
- 150946Z APR 94 CAPT CLARK ARRANGED FOR MEDICAL RECORDS AND 10TH SF ESCORT BACK TO FRANKFURT.
- 151019Z APR 94 PER CAPT LEFEBVRE - C-141 ITINERARY CHANGE. STOP AT INCIRLIK AB DELETED. DIRECT DIYARBAKIR TO FRANKFURT. REASON UNKNOWN AS OF THIS TIME.
- 151305Z APR 94 MAJ ROSENGARD RECEIVED FROM MAJ BECKIT/C3 JOC THE DISPOSITION OF JSOTF AIR FORCES FOR THE NEXT 72 HRS.
- 151347Z APR 94 EAGLE IS STANDING DOWN FOR THE NEXT 48 HRS. JSOTF MH-60G'S WILL TAKEOVER THE EAGLE MISSION OUT OF DIYARBAKIR. JSOTF HELICOPTERS WILL RUN SHUTTLE MISSIONS BACK AND FORTH FROM ZAKHO AND THE CRASH SITE. HC-130 PRESENTLY AT DIYARBAKIR IS REPAIRED. THE HC-130 POSITIONED AT INCIRLIK WILL FLY TO DIYARBAKIR ON 16 APR TO ASSIST IN THE REDEPLOYMENT OF JSOTF GROUND PERSONNEL.

-----  
COL HUNT REMAINS IN ZAKHO FOR APPROXIMATELY  
2 OR 3 DAYS. WILL HAVE 1 CAPT AND 1 E-6 TBD TO  
REMAIN AS S3 CELL.

- 151446Z APR 94 FIRST SGT JOSEPH CALLED REFERENCE ESCORT DETAIL WILL  
COME FROM THE AOB.
- 151455Z APR 94 SOC3/LT CRAIG CALLED. REQUEST OPEN A LINE FOR AN HC-130.  
GHOST 31, ETD - 160600Z, INCIRLIK TO DIYARBAKIR, MSN #A1680.  
GHOST 31 WILL ASSIST THE THREE PONY HELOS WITH AERIAL  
REFUELING AND COMM. GHOST 31 ETD OUT OF DIYARBAKIR  
IS 161345Z. GHOST 32 WILL FOLLOW GHOST 31 AND DEPART  
DIYARBAKIR AT APX. THE SAME. MSN # FOR GHOST 32 IS  
A1681. ETA FOR GHOST 31/32 BACK TO INCIRLIK - 161500Z.
- 151457Z APR 94 CALLED C3 JOC/LTC WITCHER SEEKING APPROVAL FOR THE  
TWO HC-130 LINES, MSN #'S: A1680/1
- 151500Z APR 94 TSGT SMITH ON DUTY.
- 151545Z APR 94 RECEIVED CALL FROM LTCOL WITCHER GHOST 31 FOR 16APR IS  
APPROVED. PASSED ON TO SOC3/MAJ SHAW.
- 151555Z APR 94 RECEIVED FAX FOR SCHEDULE OF EVENTS AND FLIGHTS FROM  
ZAHKO AND SHUFFLE TO AND FROM AOR AREA.
- 151610Z APR 94 RECEIVED CALL LT CMDR BREMSETH WILL BE ARRIVING 1430L  
NEEDS TO BRIEF C-3 AND CTF COMMANDER.
- 151625Z APR 94 RECEIVED CALL FROM MAJ LIBACK REQUESTING TO OPEN 3  
LINES W/CALL SIGN EAGLE 01/02/03 FOR A 0530Z WITH A  
0635Z GATE. PASSED ON TO JOC LTCOL WITCHER. HE  
INSTRUCTED WE WOULD HAVE TO ACTIVATE PONY LINES.  
AWAITING CONFIRMED POSSIBLE HAVE TO WAIT TILL 0700L  
TURKS APPROVAL.
- 152020Z APR 94 RECEIVED CALL FROM JOC/MAJ BICKET EAGLE CALL SIGN FOR  
HELOS WILL PROBABLY GO BUT NEEDS APPROVAL FROM  
TURKS WILL FOLLOW IN MORNING.

160245Z APR 94 RECEIVED CALL FROM CPT BOINGER ZAKHO CONCERNING LINES FOR THIS MORNING EAGLE CALL SIGNS. RELAYED JOC WILL WORK ON THIS WITH TURKS TO GET APPROVAL. HE WILL CALL BACK LATER TO CONFIRM.

160255Z APR 94 CAPT BOINGER CALLED, STATED THEY HAD SLIP THEIR T/O TILL 1100L TALKED TO MAJ WIGGINS HE CANNOT CONFIRM SLIP T/O. ???

160300Z APR 94 TSGT LIDER ON DUTY.

160413Z APR 94 SOC3/LT CRAIG CALLED. ASKED FOR COORDINATION ON LNO'S FOR GHOST 31. MIGHT BE NECESSARY TO TAKE 2 LNO'S. GHOST 31 WILL HAVE 1 DEADHEAD CREW. THE DEADHEAD CREW WILL BRING GHOST 32 BACK TO INCIRLIK. MAY NEED 2ND LNO FOR GHOST 32.

160414Z APR 94 CALLED C3 JOC/MAJ WIGGINS. ADVISED HIM OF THE LNO SITUATION AS RELATED BY SOC3.

160423Z APR 94 MAJ WIGGINS/C3 JOC CALLED. HAD INFORMATION ON THE 12 MEMBER INSPECTION TEAM. 6 WILL DEPART FOR DIYARBAKIR ON GHOST 31 - 0600Z ETD. THE OTHER 6 WILL DEPART ON A C-12, SPAR 51 - 0600Z ETD. MAJ WIGGINS ADVISED EAGLE 01-03 CALLSIGNS APPROVED (VICE PONY). EAGLE FLT T/O TIME WILL HAVE TO BE 0800Z. MAJ WIGGINS SAID HE NOTIFIED THE MCC ON ALL OF THE ABOVE.

160424Z APR 94 SOC3/LT CRAIG CALLED. RELAYED THE MOST RECENT INFO, RECEIVED FROM C3 JOC, TO LT CRAIG. NO WORD YET FROM C3 JOC REGARDS THE LNO'S.

160440Z APR 94 MAJ WIGGINS/ C3 JOC CALLED. THE TURKS ONLY HAVE 1 LNO TO SEND. THE TURKS AGREED THAT AN LNO WILL NOT BE NEEDED ON GHOST 32. MAJ WIGGINS REQUESTS JSOTF ASCERTAIN THE WHEREABOUTS OF THE LNO FOR GHOST 31.

160444Z APR 94 CAPT LEFEBVRE ARRIVES. HE IS WORKING THE LNO ISSUE.

160528Z APR 94 SOC3/LT CRAIG CALLED. SOC3 ADVISES THAT ONLY 3 VICE 6 INSPECTION TEAM MEMBERS WILL BOARD GHQST 31. NO ONE FROM THE INSPECTION TEAM HAS ARRIVED AT THE AIRCRAFT AS OF THIS TIME.

160530Z APR 94 CALLED C3 JOC/MAJ WIGGINS. MAJ WIGGINS STATES HE WILL CALL LT CRAIG/SOC3 DIRECTLY. C3 JOC HAD RECEIVED NO PRIOR WORD THAT THE NUMBER OF INSPECTION TEAM PAX FOR GHOST 31 HAD BEEN REDUCED FROM 6 TO 3. C3 JOC WILL ALSO WORK ON GAINING A TALLY ON THE INSPECTION TEAM MEMBERS.

160549Z APR 94 SGT CALIBOSO, X. 3940, CALLED FOR SGM HALTERMAN. THE CHIEF OF STAFF REQUIRES JSOTF PROVIDE 1 OR 2 MEMBERS TO ACT AS ESCORTS/USHERS FOR TOMORROW'S MEMORIAL SERVICE. SHOWTIME FOR THE ESCORTS/USHERS IS 1500L AT HANGAR 3. THE MEMORIAL SERVICE STARTS AT 1600L.

160558Z APR 94 CALLED SOC3/LT CRAIG. INQUIRED ON THE STATUS OF GHOST 31. LT CRAIG SAID ALL 4 PAX (3 INSPECT. TEAM, 1 LNO) ARE ONBOARD THE ACFT.

160610Z APR 94 CAPT LEFEBVRE RETURNS FROM THE CTF. HE STATES THAT LTC HOOVER AND SGM HITCHO HAVE ALSO BEEN MANIFESTED ON GHOST 31.

160615Z APR 94 SOC3/SRA WAID CALLED. GHOST 31 ATD - 0600Z.

160633Z APR 94 CALLED THE WOC/MAJ JAMES. SPAR 51 ATD - 0608Z.

160640Z APR 94 LTC SMITH/SOCEUR J3 CALLED. INQUIRED ON THE STATUS OF TODAY'S HC-130 AND HELO MISSIONS. MAJ ROSENGARD ALSO SPOKE WITH LTC SMITH.

160705Z APR 94 SGM HALTERMAN DIRECTED THE AOB BE INFORMED OF THE 1500Z ETA FOR GHOST 31/32 OUT OF DIYARBAKIR. NO ONE ANSWERS AT THE AOB. WILL TRY AGAIN LATER.

160712Z APR 94 COL THOMPSON AND LCDR BREMSETH (SOCEUR J3) WILL BE ARRIVING INCIRLIK AB TODAY VIA C-12. ETA - 1130Z.

160717Z APR 94 CONTACTED THE AOB/SGT ROY. NOTIFIED AOB OF THE 1500Z ETA FOR GHOST 31/32.

160730Z APR 94 CALLED THE MCC/SGT SMALLEY. ASKED HER TO PASS TO JSOTF THE ATA OF GHOST 31 AT DIYARBAKIR WHEN AVAILABLE.

160745Z APR 94 SGT SMALLEY/MCC CALLED BACK. GHOST 31 HAS ARRIVED AT DIYARBAKIR. ATA NOT AVAILABLE YET.

200

160751Z APR 94 WOC/CAPT PAULEY CALLED. GHOST 31 & SPAR 51 ARE DOWN.

160755Z APR 94 CAPT LEFEBVRE CALLED. SAID HE WILL REMAIN AT C3 JOC,  
X. 3014 TO ACT AS A LIAISON BETWEEN JSOTF & CTF.

160814Z APR 94 FROM J6 - EAGLE 01 - 03 DEPARTED DIYARBAKIR AT 0812Z.

160847Z APR 94 PER CAPT LEFEBVRE:  
EAGLE FLT DEPARTED DIYARBAKIR AT APX. 0842Z.  
BY APX. 0837Z IT WAS KNOWN THAT THE AWACS RADAR WENT  
DOWN.  
AWACS IS RTB INCIRLIK.  
IT WILL TAKE APX. 2 1/2 HRS. FOR THE 2ND AWACS TO BE ON  
STATION.  
MCC HAS BEEN INSTRUCTED THAT EAGLE FLT WILL NOT BE  
FORWARDED UNTIL THE 2ND AWACS IS ON STATION.

160848Z APR 94 ATD OF EAGLE FLT RECEIVED FROM J6 AND CAPT LEFEBVRE  
DON'T MATCH (0812Z & 0842Z RESPECTIVELY). WILL ASSUME  
FOR NOW J6 HAS THE MORE ACCURATE ATD.

160947Z APR 94 AWACS AIRBORNE.

161120Z APR 94 GIVEN POSSESSION OF A BROWN ENVELOPE AND A BRICK.  
HANDLED OFF BY CAPT VANDER LEY. RETURN TO LTC ZAHRT  
WHEN HE RTB'S INCIRLIK TONIGHT.

161124Z APR 94 CALLED THE MCC/MAJ BETHEL. AWACS PROBLEM WILL CAUSE  
SLIPPAGE IN GHOST AND EAGLE ETD'S. MAJ BETHEL WILL CALL  
JSOTF WHEN THE NEW SCHEDULING IS FIRMED UP.

161145Z APR 94 CAPT LEFEBVRE CALLED FROM CTF. EAGLE FLT ATD FROM  
ZAKHO - 1120Z. WILL BE LANDING AT THE CRASH SITE  
SOON. THEY WILL BE SETTING UP SATCOM. MAJ ROSENGARD  
AND J6 HAVE BEEN INFORMED OF SAME.

161147Z APR 94 SOC3/LT RAMSEY CALLED. THE PHONE LINES FOR SOC3 ARE ALL  
DOWN. UFN ANY TELECOM WITH SOC3 - DIAL 8171.

161150Z APR 94 MAJ ROSENGARD HAD TELECOM W/COL HUNT & LTC HOOVER.  
COL HUNT VERY BUSY WITH THE INVESTIGATION TEAM. MH-60  
SPACE PROBLEM WILL LIMIT ABILITY TO REDEPLOY SECURITY  
TEAM. PLAN NOW IS TO SEND 4 - 6 BACK TO INCIRLIK TONIGHT.  
PRIORITY IS TO PEOPLE WITH ESCORT DUTY.

- 161220Z APR 94 FROM SGM HALTERMAN - CALLED LTC HOOVER AT DIYARBAKIR. EXPECTING CALL BACK REGARDS LIST OF NAMES FOR PEOPLE RETURNING TO INCIRLIK TONIGHT. AWAITING INFO ON WHETHER THE EQUIPMENT PACKAGE WILL BE COMING OUT WHOLE OR PIECEMEAL.
- 161313Z APR 94 FINALLY GOT THROUGH TO THE MCC/SGT SMALLEY. ESTIMATES GHOST 31 T/O FROM DIYARBAKIR ON-TIME AT 1345Z. SGT SMALLEY REPORTS HAVING DIFFICULTY IN COMMUNICATING WITH HER FLIGHTLINE TO GET INFORMATION. NO PAX MANIFEST INFO AVAILABLE FOR GHOST 31.
- 161314Z APR 94 C3 JOC/LTC WITCHER CALLED. NEEDS TO KNOW WHO IS ON GHOST 31. WHO WILL BE ON THE EAGLE MH-60'S. WHO WILL HAVE TO RON DIYARBAKIR. WHEN AND HOW THE PEOPLE LEFT BEHIND WILL BE PICKED UP. CURRENTLY - NO ANSWERS TO ANY OF THOSE QUESTIONS. LTC HOOVER HASN'T RETURNED SGM HALTERMAN'S 1220Z PHONE CALL YET. SGT SMALLEY DOESN'T KNOW HOW TO REACH SGM HITCHO. MAJ BETHEL IS TEMPORARILY OUT OF THE OFFICE, ETR 20 MIN. FROM NOW.
- 161327Z APR 94 PER SGM HALTERMAN'S REQUEST - TRYING TO REARRANGE TMO ITINERARY FOR LTC HOOVER & SGM HITCHO. CHANGE ISTANBUL - AMSTERDAM FROM SUN. TO MON., 18 APR 94. HAD TO CALL THE WOC/SRA WILLIAMS (X. 3001). SHE WILL CALL THE WEEKEND TMO STANDBY NUMBER. EXPECTING TMO TO CALL ME IN APX. 15 MINUTES.
- 161347Z APR 94 MAJ BETHEL/MCC CALLS. MORE INTENSIVE COORDINATION ON GHOST 31 PAX MANIFEST LIST BEGINS. MAJ ROSENGARD TALKS TO MAJ BETHEL REGARDS BEYANAMME TRANSPORTATION. MAJ ROSENGARD IS CONNECTED TO SGM HITCHO. BRIEFS HIM ON BEYANAMME ACTION ITEMS TO BE ACCOMPLISHED ON HIS END. AFTER CALL MAJ ROSENGARD BRIEFS SGM HALTERMAN.
- 161350Z APR 94 ADVISED BY MAJ BETHEL ETD OF GHOST 32 FROM DIYARBAKIR IS APX. 4 OR 4 1/2 HRS. FROM NOW (1800 OR 1830Z).
- 161400Z APR 94 AMN LOWRY FROM TMO CALLS. STATES FLIGHT RESERVATIONS FOR LTC HOOVER AND SGM HITCHO CAN'T BE CHANGED UNTIL MON., 18 APR. REASON - SINCE IT'S A COMMERCIAL FLIGHT THERE'S NO WAY TO GET IN TOUCH WITH A DELTA REP. UNTIL MONDAY.

161420Z APR 94 GHOST 31 ATD - 1400Z. ETA INCIRLIK - 1515Z. RELAYED SAME TO C3 JOC/LTC WITCHER, SOC3/LT RAMSEY, WOC/SRA WILLIAMS.

161440Z APR 94 CALLED MCC. TALKED TO SRA KINNEY WHO IS WORKING THE GHOST 31 PAX MANIFEST. TOTAL # OF PAX - 18. GAVE THIS INFO TO C3 JOC/LTC WITCHER, SOC3/LT RAMSEY. LTC WITCHER ONLY NEEDED TOTAL # OF PAX. LT RAMSEY WANTS AN ITEMIZED LIST OF NAMES. TOLD SRA KINNEY TO SECURE FAX GHOST 31 PAX MANIFEST LIST TO C3 JOC. ADVISED LT RAMSEY TO CALL C3 JOC.

161500Z APR 94 MCC/MAJ BETHEL CALLS. EAGLE FLT ETA ZAKHO - 1530Z  
ETA DIYARBAKIR - 1655Z.

161503Z APR 94 CALLED C3 JOC/LTC WITCHER, SOC3/LT RAMSEY WITH EAGLE FLT ETA'S. C3 JOC NEEDS EAGLE GATE TIME.

161508Z APR 94 SOC3/LT RAMSEY CALLS. TOWER IS SENDING GHOST 31 TO PARKING SPOT B-1. GHOST 31 NEEDS TO PARK BY THE SOC3 HARDSTAND FOR OFFLOAD. CALLED C3 JOC/LTC WITCHER TO WORK PARKING PROBLEM.

161511Z APR 94 PARKING PROBLEM RESOLVED.

161527Z APR 94 C3 JOC/LTC WITCHER. NEEDS TO KNOW TOTAL NUMBER OF PAX ON GHOST 32.

161532Z APR 94 EAGLE FLT RADIOS IN GATE TIME TO C3 JOC.

161705Z APR 94 MSGT LEE ON DUTY.

161722Z APR 94 CREWS RETURNING FROM DIYARBAKIR TONIGHT ARE: 9 ON C-12 AND 16 ON 16 HC 130.

161910Z APR 94 SOC3/LT RAMSEY CALLED. GHOST 32 AIRBORNE EXITING DIYARBAKIR.

161945Z APR 94 C-3 JOC/MAJ SHAW CALLED. HC 130 IS SCHEDULE TO LEAVE INCIRLIK 171300Z APR 94 TO DIYARBAKIR, TRANLOAD 1430Z AND RETURN 1600Z.

162007Z APR 94 SOC3/LT RAMSEY CALLED. GHOST 32 LANDED AT 2000Z. UNLOADING EQUIPMENT AT FOX RAMP.

162045Z APR 94 SOC3/LT RAMSEY CALLED. PUTTING CREWS ON CREW REST TO HANDLE AUTHORIZED PLAN THEY OUTLINE FOR 17 APR 94.



162200Z APR 94 MAJ ROSENGARD REVIEWED AND SIGNED SITREP.

170500Z APR 94 TSGT LIDER ON DUTY.

170630Z APR 94 SRA WAID FROM SOC3 DROPS OFF THE NEW ROE FOR OPC.

170640Z APR 94 CALLED C3 JOC/LT ALLEN. EAGLES 01 - 03 ETD  
DIYARBAKIR 0700Z, ETA ZAKHO 0800Z. ONE MH-60  
WILL DO AN OUT & BACK. THE OTHER TWO WILL  
OFFLOAD AND GO BACK TO DIYARBAKIR. LT ALLEN  
WAS TOLD BY CAPT STEIN IT'S PLANNED FOR EACH OF  
THE THREE HELOS TO DO AT LEAST 2 SHUTTLES TODAY  
BETWEEN DIYARBAKIR AND ZAKHO.  
REGARDS THE INSPECTION TEAM - C3 JOC SHOWS THEM  
ALL RETURNED TO INCIRLIK. ONLY GENERAL INFO IS  
KNOWN ABOUT THEIR SCHEDULE I.E. ON MON., 18 APR  
THEY WILL GO BACK TO ZAKHO FOR INTERVIEWS. WED.,  
20 APR THEY PLAN TO RETURN TO THE CRASH SITE.

170645Z APR 94 IT'S UNKNOWN WHAT THE INSPECTION TEAM PLANS TO  
DO TODAY.

170715Z APR 94 LT CRAIG/SOC3 VISITS JSOTF. REQUEST NEW ETD FOR  
GHOST 31 - 1200Z. RELAY THIS TO C3 JOC/LT ALLEN.  
LT ALLEN STRESSES GETTING PAX INFO SO NO ONE  
MISSES EARLIER T/O. LT CRAIG WORKING TO GET A  
PAX LIST. COL O'BRIEN NEEDS TO KNOW PAX INFO,  
UNIT / QTY.

170737Z APR 94 CALLED C3 JOC/LT ALLEN. EAGLE 01 - 03, ATD DIYARBAKIR  
0720Z, ETA ZAKHO 0820Z.  
LT ALLEN STATES MAJ SHAW CALLED C3 JOC FROM ZAKHO.  
MAJ SHAW REQUESTS 1300Z ETA AT DIYARBAKIR FOR  
GHOST 31.

170811Z APR 94 CALLED MCC REAR. LEFT MSG WITH A MR. HALUN. HAVE  
MAJ BETHEL OR SHAW CALL JSOTF REGARDS PAX LIST. PLAN  
IS TO HAVE MAJ SHAW SECURE FAX ZAKHO PAX LIST TO  
JSOTF. MCC REAR MEMORIAL CHURCH SERVICE STARTED  
AT 1030L.

170834Z APR 94 SOC3/LT CRAIG CALLED. REGARDS PAX HE STATES CTF IS  
CONTROLLING TODAY'S GHOST 31 DIYARBAKIR MISSION.  
SOC3 HAS ONLY BEEN TOLD WHEN TO PROVIDE THE ACFT.

171415Z APR 94 SFC PRATTIS CALLS ZAHKO VIA COMM. LANDLINE # PROVIDED BY MCC REAR/TSGT SMALLEY. HE RECEIVES A SECURE FAX OF A PAX MANIFEST LIST FOR 18 APR ZAHKO - DIYAR. PERSONNEL.

171418Z APR 94 MAJ ROSENGARD RECEIVES CALL FROM ZAKHO. ALL 3 EAGLES DEPARTED ZAKHO AT 1322Z HEADED FOR DIYARBAKIR.

171452Z APR 94 CALLED C3 JOC/MAJ HOIDA. CHG 1 FOR 18 APR HC-130 LINE ....  
CALLSIGN: GHOST 31            MISSION NO: A1880.  
ETD INCIRLIK ----- 1100Z    ETA DIYARBAKIR - 1215Z  
ETD DIYARBAKIR - 1300Z    ETA INCIRLIK ----- 1415Z

171453Z APR 94 SAME PHONE CALL WITH MAJ HOIDA - HE SAYS THE PLANNED ETD FOR EAGLE FLT OUT OF DIYARBAKIR ON MON., 18 APR IS 1245Z, ETA INCIRLIK - 1400Z.

171509Z APR 94 CALLED MCC REAR (DIYAR.)/TSGT SMALLEY. PASSED INFO REGARDING TOMORROW'S HC-130 MISSION. MCC REAR ADVISED ON ATD FOR GHOST 31 17/1500Z, ETA INCIRLIK - 1600Z. MCC REAR GAVE JSOTF THE FOLLOWING PAX MANIFEST LIST:

LTC ZAHRT	SFC FREEMAN
MAJ SHAW	SFC RAMSDALL
CPT KENT	SFC TRAMELL
MSG FERGUSON	SSG ELIZDALE
SFC DOLAN	SRA MCCURE
SFC FAY	

171515Z APR 94 CALLED SOC3/LT RAMSEY. NOTIFIED SOC3 OF HC-130 INBOUND AND PASSENGER LIST. LT RAMSEY'S INTEL IS THAT MAJ SHAW SHOULDN'T BE ONE OF TONIGHT'S PAX. LT RAMSEY HEARD MAJ SHAW WILL RTB INCIRLIK TOMORROW. ASKED SOC3 FOR ACFT PARKING SPOT TO EXPEDITE PAX P/U ----- HARDSTAND 5 OR 6.

171522Z APR 94 PER SGM HALTERMAN - CALLED MOTOR POOL VEHICLE DISPATCHER/MR. CENAT (X. 6756). MADE ARRANGEMENTS FOR A BUS TO P/U THE HC-130 PASSENGERS.

171551Z APR 94 SOC3/LT RAMSEY CALLED. REQUEST EOD MEET HC-130 AT FOX TO DOWNLOAD EXPLOSIVES.

171553Z APR 94 CALLED C3 JOC/MAJ HOIDA. PASSED TO C3 JOC SOC3'S EOD REQUEST.

171558Z APR 94 PER SSG TOBIA/J2 - J1 REPORTS NO CHANGE IN PERSONNEL STATUS.

171602Z APR 94 AOB/SGT WALSH CALLED. REPORTS GHOST 31 HAS LANDED. A FEW MINUTES LATER SOC3/SGT FIELDS DOES SAME.

171611Z APR 94 COL HUNT CALLED. SAID HIS RUCKSACK, LB, & HELMET SHOULD BE ON THE HC-130. HE REQUESTED THOSE ITEMS BE TAKEN OFF THE ACFT AND BROUGHT TO HQ JSOTF. BEEPED THE J2 & J3 BEEPERS REGARDS SAME. BELIEVE MAJ ROSENGARD WENT TO MEET THE HC-130.

171719Z APR 94 CALLED C3 JOC/MAJ HOIDA. ASKED ABOUT APPROVAL FOR TOMORROW'S HC-130 GHOST 31 MISSION. MAJ HOIDA STATED THE TURKS SAID THEY WON'T BEGIN TO LOOK AT THAT LINE UNTIL ROUGHLY 18 APR/0800L.

171741Z APR 94 SOC3 SITREP DROPPED OFF BY 1LT RAMSEY.

171745Z APR 94 NOTE FOR NEXT DAYSHIFT CONTROLLER. CALL FRAG SHOP. WHEN THE 17 APR CFAC BSD IS RECEIVED THEY HAVE A CORRECTED PAGE TO SWAP OUT WITH US.

171800Z APR 94 MSGT LEE ON DUTY.

171825Z APR 94 HOSP/ SRA STEVENS CALLED. SPC BUDGET HAS BEEN ADMITTED TO HOSPITAL. PASSED TO CPT CLARK.

172005Z APR 94 CPT LEFEBVRE REVIEWED AND SIGNED SITREP.

**TAB AC-8**

**MISCELLANEOUS**

**AC-8a NOTAMs**

**AC-8b SAR Daily Log, 14-17 April 1994**

**AC-8c MCC Operations Log, 14-18 April 1994 and Note from Zakhu,  
Kurdistan Democratic Party**

**AC-8d Headquarters, Combined Task Force, Operation PROVIDE COMFORT,  
Memorandum for Record, 14 May 1994**

**AC-8e Headquarters Operation PROVIDE COMFORT II,  
Combined Task Force/C2 Log, 14 April 1994**

**AC-8f Extract of Joint Operations Center Log, 13-14 April 1994**

**AC-8g Extract from JSOTF-J3 After Action Report, Eagle Flight Incident**

**AC-8h 39 Support Group Memorandum, Lessons Learned,  
SAR Operations on Helicopter Incident**

**AC-8a**

**AC-8b**

**AC-8i Memorandum USAFE/XO, OPC Assessment**

**AC-8c**

**AC-8j MCC SITREP, 3 April 1994**

**AC-8k Senate Armed Services Committee  
Request for Inquiry**

AUTHENTICATION

122 Donald L. SANDERS, MCC No. CTF OTC, ZACHA W. BRAD

My duty station is OPERATIONS

Location Home # 262, MCC operations log, Room

From 14-18 APR, 24 A. N. L. Room KDFV

(Fully describe the record preserved)

Reference Tag Number # 262

I certify that (it is a record taken from my duty station) (it is a true and accurate copy of a record kept in my duty station).

Donald L. Sanders  
(Signature)

Donald L. Sanders  
(Printed Name)

MCC No. CTF, OTC, ZACHA W. BRAD  
(Printed Name)

10 APR 61  
(Date)

Subscribed to and sworn before on this 10TH day of May 1961.

John H. Brad  
(Signature)

DAILY STAFF JOURNAL OR DUTY OFFICER'S LOG  
 For use of this form see AR 250-18; the proponent agency  
 is Office of The Deputy Chief of Staff for Operations & Plans.

PAGE NO. NO. OF PAGES

ORGANIZATION OR INSTALLATION	LOCATION	PERIOD COVERED			
		FROM		TO	
		HOUR	DATE	HOUR	DATE

ITEM NO	TIME		INCIDENTS, MESSAGES, ORDERS, ETC.	ACTION TAKEN	INL
	IN	OUT			
36	1626		RECD TRC FROM <sup>(CTF)</sup> SECURITY <del>FOR</del>		AB
37	1637		RECD INVENTORY FOR COMPUTERS		CB
38	1718		Eagle Ops reported that Eagle 1 & 2 landed at 1316 Z.		DCS
39	1848		RECD. SITREP FROM CTF		FB
40	1942		RECD. PIRINCIRLIK SITREP		PR
41	2210		INTRCP 889 RG'D		CB
42	<del>2355</del>		sent SITREP 103		
43		0004	CLOSED OPS 14 APR 93		
1	0730		OPENED OPS		DA
2	0900		RECD C-2 Highlights		DA
3		0905	SENT CALID APR TO CTF		DA
4		0925	SENT CALID APR TO PIRINCIRLIK		DA
5	0930		DELAYED ENTRY AWACS TOOK OFF ON TIME CALLED IN 0900		DA
6	0936		AWACS IS FLYING AND THEY HAVE GOOD J-TIDS		DA
7	0940		RECD 3 DAY FORECAST Fm CTF		DA
8	0942		EAGLES DEPARTED 0520Z Fm DIYARBIKIR		DA
9	1003		EAGLES 27 MIKES Fm TEXACO		DA
10		1050	EAGLES DEPARTED FOR MISSION		DA
11		1040	MOBILE DEPARTING FOR DL		DA

I certify that I am the Records Custodian for the Accident Investigation Board  
 convened to investigate the crash of two U.S. Army Black Hawk helicopters in the no  
 fly zone in northern Iraq on 14 April 1994, and that this is a true and accurate copy of  
 the record which is kept in my records system.  
 WILLIAM L. HARRIS, Capt, USAF, MSC  
 Evidence Custodian, Incirlik Air Base, Turkey  
 15 May 94  
 Date

TYPEN NAME AND GRADE OF OFFICER OR OFFICIAL ON DUTY	SIGNATURE
---	-----------

DAILY STAFF JOURNAL OR DUTY OFFICER'S LOG <small>For use of this form, see AF 220-18; the proponent agency is Office of The Deputy Chief of Staff for Operations &amp; Plans.</small>				PAGE NO.	NO. OF PAGES	
ORGANIZATION OR INSTALLATION		LOCATION	PERIOD COVERED			
			FROM		TO	
			HOUR	DATE	HOUR	DATE
ITEM NO.	TIME		INCIDENTS, MESSAGES, ORDERS, ETC.	ACTION TAKEN	INL	
	IN	OUT				
12	1155		MOBILE AT CP D-9		DA	
13	1207		MOBILE AT CP M-3		DA	
14	1225		MOBILE AT CP V-1		DA	
15	1315		DELAYED ENTRY COL HASSEL CALLED CWZ CARLSON GAVE HIM MSG ABOUT 2 HELOS. MSG CAME APPROX 1210-1215L		DA	
16	1305		APPROX THIS TIME 2 AIRCRAFT FLY BY ZAKHO HOUSE FLYING EAST TO WEST DID NOT KNOW WHAT KIND		DA	
17	1320		HAVE TRIED CONSTANTLY TO CONTACT MOBILE 1 & STOPPERS BUT NEG-CONTACT. HAVE BEEN TRYING SINCE APPROX 1200L.		DA	
18	1325		MOBILE & BREAKING DOWN IN OL COMING BACK TO HOUSE		DA	
19	1328		HAVE TRIED TO CONTACT EAGLES ON FRC 113 - NEG CONTACT HAVE TRIED SEVERAL TIMES		DA	
20	1343		MOBILE DEPARTING V-1		DA	
21	1352		MOBILE AT CP F-6		DA	
22	1400		MOBILE AT CP M-3		DA	
23	1409		MOBILE AT CP D-9		DA	

TYPE NAME AND GRADE OF OFFICER OR OFFICIAL ON DUTY

SIGNATURE

DAILY STAFF JOURNAL OR DUTY OFFICER'S LOG

For use of this form, see AFI 220-14; the proponent agency is the Office of the Deputy Chief of Staff for Operations & Plans

PAGE NO. NO. OF PAGES

ORGANIZATION OR INSTALLATION

LOCATION

PERIOD COVERED

FROM TO  
HOUR DATE HOUR DATE

ITEM NO	TIME		INCIDENTS, MESSAGES, ORDERS, ETC.	ACTION TAKEN	INITIALS
	IN	OUT			
24	1415		RCUD MSG FM LOCAL ZAKHO KDP OFFICE ABOUT CHOPPERS		
25	1420		SENT CTF MSG THAT WE RECEIVED FM KDP OFFICE ALSO SENT LIST OF NAMES ON UH-606		
26	1525		SENT CTF UPDATED LIST FM CHOPPERS		DSH
27	1645		SENT CTF QTC SWANNS NOK BIRDS TO OFF FM INCIRLIK TO ZAKHO AT 1225Z		DSH
28	1650	1	UN Community notified to increase local security ALL NGO'S		DSH
29	1700		SENT CTF UPDATED PERSONNEL ROSTER FM EAGLES & ALSO MAS SHARANI NOK		DSH
30	1710		MAS SANDERS TALKED TO CG TO CONFIRM HE GAVE OK TO LAUNCH GROUND MISSION FOR LZ		DSH
31	1740		LATE ENTRY GROUND PATROL LEFT FOR LZ APPROX 1645-1650L		DSH
32	1845		Mr Mohammed Selavani representative of Prime Minister extends		DSH

TYPE NAME AND GRADE OF OFFICER OR OFFICIAL ON DUTY

SIGNATURE



DAILY STAFF JOURNAL OR DUTY OFFICER'S LOG

For use of this form, see AFI 210-18: the proponent agency  
 is Office of The Deputy Chief of Staff for Operations & Plans

PAGE NO.

NO. OF PAGES

ORGANIZATION OR INSTALLATION

LOCATION

PERIOD COVERED

FROM  
 HOUR DATE

TO  
 HOUR DATE

ITEM NO.

TIME

IN

OUT

INCIDENTS, MESSAGES, ORDERS, ETC.

ACTION TAKEN

INL

deepest regrets. Also, stands ready to do anything ~~we~~ we may ask. The prime minister also reported that everything is quiet in the Area.

33 1900

3 MH-60's FLEW OVER HOUSE ON THEIR WAY TO LZ NONE STOPPED

DLR

34 2005

RCL (MC) ARRIVED AQRAH WITH JOSTF

DLR  
 B

35 2030

John Cooley & JSOTF PERSONNEL WERE NEAR VILLAGE

DLR

36 2050

MSC & JSOTF ARRIVED AT LOCATION.

DLR

37 2107

MADE COMMO VIA TAC SAT WITH JSOTF AT SITE THEY ARE LINKING UP W/CHOPPERS

DLR

38 2305

1 BIRD LANDED AT CP WITH (9) BODIES

DLR

39 2315

Pony 22 DEPARTED CP FOR CRASH SITE.

DLR

40 2317

PERSONNEL AT CP ARE TRYING TO IDENTIFY BODIES

DLR

41 2326

WAS INFORMED JOHN COOLEY

TYPED NAME AND GRADE OF OFFICER OR OFFICIAL ON DUTY

SIGNATURE

DAILY STAFF JOURNAL OR DUTY OFFICER'S LOG

For use of this form, see AFI 220-18, the proponent agency.  
 Is Office of The Deputy Chief of Staff for Operations & Plans.

PAGE NO.

NO. OF PAGES

ORGANIZATION OR INSTALLATION

LOCATION

PERIOD COVERED

FROM		TO	
HOUR	DATE	HOUR	DATE

ITEM NO	TIME		INCIDENTS, MESSAGES, ORDERS, ETC.	ACTION TAKEN	INL
	IN	OUT			
41	2326		WAS GOING TO STAY AT THE CRASH SITE		PSA
42	2327		CTF INFORMED US NOT TO TRY AND IDENTIFY THE BODIES		PSA
43	2332		Body punch is LEAVING CRASH SITE 1 & GOING TO CRASH SITE 2		PSA
44	2355		SILVER BULLET & Body punch ARE AT 2 <sup>ND</sup> CRASH SITE. MENTIONING DIFFICULT TERRAIN		PSA
45	0010		ALL AIRCRAFT ARE NOW AT SITE 2		PSA
46	0020		SECOND CRASH SITE LOCATED AT GRID MF 1901169551		PSA
47	0040		CPL Hicks went on rest		SWC
48	0115		Relayed RFI from Silver Bullet to <del>AF</del> on Iraqi force movement.		SWC
49	0123		CTF reported no new movements		SWC
50	0130		JC called to say they would RON on site and they were almost finished there. Requested we inform RCC to monitor the net all night & he would use the same freq tomorrow		SWC

TYPED NAME AND GRADE OF OFFICER OR OFFICIAL ON DUTY

SIGNATURE

DAILY STAFF JOURNAL OR DUTY OFFICER'S LOG

For use of this form, see AFI 220-18, the proponent agency  
 is Office of The Deputy Chief of Staff for Operations & Plans.

PAGE NO.

NO. OF PAGES

ORGANIZATION OR INSTALLATION

LOCATION

PERIOD COVERED

FROM

TO

HOUR

DATE

HOUR

DATE

ITEM NO	TIME		INCIDENTS, MESSAGES, ORDERS, ETC.	ACTION TAKEN	INL
	IN	OUT			
51	0140		Silver Bullet reports 1 bird w- 8 PAX inbound ETA 50 minutes		None
52	0200		Silver Bullet reports 2 hoists to complete and 26 confirmed dead	passed to CTF	None
53	0205		Eagle DPS called requesting call when birds are inbound to Diabakur		None
54	0230		ALL BODIES HAVE BEEN EVACUATED fm CRASH SITE NO ETA YET		None
55	0240		Pony 21 10 miles fm CP		None
56	0255		Pony 21 LANDED CP w/ 8 PAX		None
57	0300		Pony 23 DEPARTED SITE 2 & HEADING STRAIGHT TO DIARBAKUR APPROX 1 hr 50 min		None
58	0310		ALL US PERSONNEL ARE LINKING UP AT SITE 1		None
59	0320		Pony 21 CONTACTED HOUSE & HEADING STRAIGHT TO DIARBAKUR		None
60	0322		ONE BIRD LEFT CP TO SITE 1 TO PICK UP RESCUE PERSONNEL		None
61	0418		Pony 21 DEPARTED CRASH SITE 1 w/ 4 PASSENGERS FOR ZAKAO. WILL LOAD UP BODIES & Fly to DIARBAKUR.		None

TYPE NAME AND GRADE OF OFFICER OR OFFICIAL ON DUTY

SIGNATURE

DAILY STAFF JOURNAL OR DUTY OFFICER'S LOG

For use of this form, see AFI 250-18, the proponent agency  
 is Office of The Deputy Chief of Staff for Operations & Plans

PAGE NO.

NO. OF PAGES

ORGANIZATION OR INSTALLATION

LOCATION

PERIOD COVERED

FROM

TO

HOOR

DATE

HOOR

DATE

ITEM NO.

TIME

IN

OUT

INCIDENTS, MESSAGES, ORDERS, ETC.

ACTION TAKEN

INL

62

0424

Pony 22 SMIKES fm CP going to offload 7 PASSENGERS THEN DEPART BACK TO CRASH SITE.

63

0438

Pony 22 DEPARTED BACK TO CRASH SITE 1

64

0440

INFORMED SILVER BULLET PONY 22 HEADED BACK TO CRASH SITE 1

65

0450

Pony 23 ARRIVED 0440Z AT DIYARBAKIR w/ 8 bodies

66

0500

Pony 21 LANDED CP OFFLOADING PASSENGERS & LOADING ON CASUALTIES.

67

0505

Relayed to CP GHOST 32 IS AT DIYARBAKIR & COMING TO ZAKO FOR AIR SUPPORT OF PONY 21 & PONY 22 FOR THEIR FLIGHT BACK TO DIYARBAKIR

68

0515

Pony 21 DEPARTED CP TO DIYARBAKIR w/ 9 CASUALTIES

69

0555

Pony 22 SMIKES fm CP will require fuel

70

0601

Pony 22 ON FINAL APPROACH AT TEXACO

71

0610

Pony 22 DEPARTED TEXACO

TYPE NAME AND GRADE OF OFFICER OR OFFICIAL ON DUTY

SIGNATURE

DAILY STAFF JOURNAL OR DUTY OFFICER'S LOG

For use of this form, see AFI 220-18; the proponent agency is Office of The Deputy Chief of Staff for Operations & Plans.

PAGE NO.

NO. OF PAGES

ORGANIZATION OR INSTALLATION

LOCATION

PERIOD COVERED

FROM TO  
HOUR DATE HOUR DATE

ITEM NO.	TIME		INCIDENTS, MESSAGES, ORDERS, ETC.	ACTION TAKEN	INL
	IN	OUT			
71	0610		w/ 7 CASUALTIES 4 CREW & 1 LNO INFORMED CTF OF THIS		
72	0615		INFORMED EAGLE OPS OF POUY 22 DEPARTURE		DA
			15 APR 94		DA
1	0730		GHOST 32 DEPARTED <del>1800Z</del> 0320Z		OS
2	0738		1st GROUP AT PRINCLIK 2ND & 3RD GROUP DUE IN 15 MIN Received Short Wave msg to contact John C. on Channel #1 He has people at both sites and he is at Site #2	could not contact John	OS
3	0745		SITREP MCL#103 RECEIVED		OS
4	0830		PRINCLIK REPORTED 3 M160 GOLF ALL Landed SAFELY, ALL FULLY SERVICEABLE AND CREW REST COMMENCED 0330Z		OS
5	0831		EAGLE OPS CONFIRMED DEPARTURE THIS LOCATION ETA 0910Z		OS
6	0930		TACFAX PROPOSED PRESS RELEASE R/C		OS
7	0930		FORECAST FOR AOR R/C		OS
8	0932		CTF REQUEST INFO REGARDING AFFILIATION OF KURDS ON DOWNED BIRDS		OS
9	1050		ROOD TGS ROSTER Am CTF		DA
10	1249		EAGLES 1+2 DEPARTED DILBAR 0845Z		DA

PRINTED NAME AND GRADE OF OFFICER OR OFFICIAL ON DUTY

SIGNATURE

DAILY STAFF JOURNAL OR DUTY OFFICER'S LOG

For use of this form, see AA 230-18, the proponent agency is Office of The Deputy Chief of Staff for Operations & Plans.

PAGE NO. NO. OF PAGES

ORGANIZATION OR INSTALLATION: LOCATION: PERIOD COVERED: FROM: TO: HOUR: DATE: HOUR: DATE:

ITEM NO	TIME		INCIDENTS, MESSAGES, ORDERS, ETC.	ACTION TAKEN	INITIALS
	IN	OUT			
11	1317		EAGLES APPROX 30 MIKES OUT		DA
12	1330		EAGLE 20 MIKES FM CP		DA
13	1350		EAGLE LANDED CP		DA
14		1435	EAGLES DEPARTED CP FOR CRASH SITE		DA
15		1440	DELAYED EAGLES DEPARTURE TO J.C. AT CRASH SITE		DA
16		1440	INFORMED EAGLES J.C. WOULD MEET THEM AT CRASH SITE 1		DA
17		1525	WAS HEARD ACROSS THE HF RADIO MR B. AGREED TO GIVE D.N. THE TAPE. THEY NEED HER TO GO TO LOCATION. THIS IS NOT CONFIRMED		DA
18		1530	MOBILE STATED 1 EAGLE AT CRASH SITE 1 & 1 EAGLE AT CRASH SITE 2		DA
19		1550	DELAYED ENTRY BODY PUNCH AT SITE 2		DA
20		1640	WAS INFORMED BY GROUND UNIT APPROX ETA 1830H		DA
21		1730	BODY PUNCH & EAGLES WILL BE LEAVING SITES APPROX 15 MINUTES INFORMED CTF OF THIS		DA
22		1740	J. COOLEY ENROUTE BACK TO HOUSE		DA
23		1741	EAGLES DEPARTING SITES		DA

TYPED NAME AND GRADE OF OFFICER OR OFFICIAL ON DUTY: SIGNATURE:

DAILY STAFF JOURNAL OR DUTY OFFICER'S LOG  
 For use of this form, see AN 230-18, the proponent agency  
 in Office of The Deputy Chief of Staff for Operations & Plans.

FORM NO. NO. OF PAGES

ORGANIZATION OR INSTALLATION LOCATION PERIOD COVERED  
 FROM HOUR DATE TO HOUR DATE

ITEM NO	TIME		INCIDENTS, MESSAGES, ORDERS, ETC.	ACTION TAKEN	INL
	IN	OUT			
24		1820	REQUESTED RTN GATE 1445Z		DA
25		1825	GATE APPROVED		DA
26	1830		RCUD LEADERS Agenda for 17 APR & CTF		DA
27	1840		EAGLE 5 MIKES fm TEXACO		DA
28	1848		EAGLE flight LANDING AT CP THEY WERE REQUESTING RTN GATE 1500Z THROUGH COUGAR		DA
29	1855		RTN GATE 1500Z APPROVED		DA
30	1900		EAGLES DEPARTED TEXACO INFORMED EAGLE OPS & CTF		DA
31	2005		EAGLES ARRIVED Pirinlik 1600Z		DA
32	2125		RCUD Airlift Schedule fm CTF	SENT CTF SATREP 104 & 105 2330	DA
16 APR 94					
1	0730		OPENED OPS		DA
2	0930		RCUD - 3 DAY FORECAST fm CTF		DA
3	1040		RCUD SAM UPDATE fm CTF		DA
4		1105	MOBILE DEPARTING TEXACO FOR MISSION		DA
5	1123		MOBILE AT CP D-9		DA
6	1139		MOBILE AT M-3		DA
7	1149		MOBILE AT F-6		RS
8	1157		MOBILE at V-1		DA
9	1200		RCUD C-2 Highlights fm CTF		DA
10	1215		EAGLES 12 & 13 DEPARTED Pirin 0811Z		DA

TYPE NAME AND GRADE OF OFFICER OR OFFICIAL ON DUTY SIGNATURE

DAILY STAFF JOURNAL, OR DUTY OFFICER'S LOG

For use of this form, see AFM 220-18; the proponent agency is Office of The Deputy Chief of Staff for Operations & Plans.

PAGE NO.

NO. OF PAGES

ORGANIZATION OR INSTALLATION

LOCATION

PERIOD COVERED

FROM

HOUR

DATE

TO

HOUR

DATE

ITEM NO.

TIME

IN

OUT

INCIDENTS, MESSAGES, ORDERS, ETC.

ACTION TAKEN

INITIALS

11	1220		MOBILE AT <del>ALTA</del> FAYDAH OL.		DA
12	1240		RCVD MSG fm SOC COUGAR HAD TO GO BACK TO INJIRLIK DUE TO PROBLEMS, THERE WOULD BE APPROX 2 1/2 3 HRS DELAY IN COVERAGE. BIRDS WERE NOT TO FLY FORWARD fm THIS LOCATION.		
13	1310		MOBILE AT F-6		DA
14	1320		ALL 3 EAGLES INBOUND TO CP		DA
15	1325		INFORMED EAGLES 3 TO SHUT DOWN CP TOLD HIM TO RELAY TO 14Z		
16	1335		MOBILE AT D-9		R
17	1337		AT 1320 HRS CTF CALLED SAID AWACS WOULD POSSIBLY BE UP IN 12 MINS. WOULD CALL WHEN THEY ARE CONFIRMED AIRBORNE & OPERATIONAL		DA
18	1345		CTF CALLED INFORMED US AWACS WAS AIRBORNE AT 0930Z		DA
19	1346		MOBILE AT CP TEXACO		DA
20	1350		INFORMED CTF THAT Insp. TEAM WANTED TO TAKE COMMO ITEMS THAT WERE RECOVERED BACK TO SITES		DA
21	1355		RCVD FAX fm CTF Summary Count Checklist		DA

TYPE NAME AND GRADE OF OFFICER OR OFFICIAL ON DUTY

SIGNATURE



DAILY STAFF JOURNAL OR DUTY OFFICER'S LOG

For use of this form, see AA 220-18; the proponent agency is Office of The Deputy Chief of Staff for Operations & Plans.

PAGE NO. NO. OF PAGES

ORGANIZATION OR INSTALLATION	LOCATION	PERIOD COVERED			
		FROM		TO	
		HOUR	DATE	HOUR	DATE

ITEM NO.	TIME		INCIDENTS, MESSAGES, ORDERS, ETC.	ACTION TAKEN	INITIAL
	IN	OUT			
22	1430		CTF INFORMED US AWACS IS UP BIRDS CAN FLY		
23	1520		EAGLE 1 DEPARTING CP		DA
24	1524		ALL EAGLES HAVE DEPARTED CP		DA
25	1617		ALL 3 BIRDS ARE ON LOCATION SITE 1		DA
26	1740		FIRST SHUTTLE COMP. 2ND SHUTTLE STARTING IN 10 MIKES & DEPART LOCATION IN ONE HOUR. EAGLE 3 HAS APU PROBLEMS. HAVE TO KEEP AIRCRAFT RUNNING AT SITE 1		DA
27	1749		BOTH SHUTTLES COMPLETE TO SITE 2		DA
28	1810		RCUD INTREP 894, MCC104 & MCC105 Fm CTF		DA
29	1815	10	Body punch CALLED ARE BREAKING DOWN & DEPARTING IN 10 MIKES APPROX 1825L		DA
30	1817		SENT COL HASSEL FAX FOR CHAP BURNING		DA
31	1828		SENT CTF JOC CHIEF NAMES OF GUARDS N.O.K.		DA
32	1840		RCUD TGS ROSTER Fm CTF		DA
33	1915		EAGLES 4 MIKES Fm CP		DA
34	1922		EAGLES LANDING AT CP		DA

TYPED NAME AND GRADE OF OFFICER OR OFFICIAL ON DUTY	SIGNATURE
---	-----------

**DAILY STAFF JOURNAL OR DUTY OFFICER'S LOG**  
 For use of this form, see AFM 220-18, the proponent agency  
 Office of the Deputy Chief of Staff for Operations & Plans

FORM NO. \_\_\_\_\_ NO OF PAGES \_\_\_\_\_

ORGANIZATION OR INSTALLATION \_\_\_\_\_ LOCATION \_\_\_\_\_  
 PERIOD COVERED  
 FROM \_\_\_\_\_ TO \_\_\_\_\_  
 HOUR DATE HOUR DATE

ITEM NO	TIME		INCIDENTS, MESSAGES, ORDERS, ETC.	ACTION TAKEN	INL
	IN	OUT			
35		1931	REQUESTED RTN GATE 1600Z FOR EAGLES 1, 2 & 3		
36	1937		RCUD COALITION LEADERS AGENDA CHG 2 fm CTF		DSH
37	1957		EAGLE (PARTE)		DSH
38	2125		Eagle OPNS reported that Eagles 2, 2, & 3 arrived at 1720Z		DSH
39	2210		RCV TACFAX WITH DRAWINGS SENT SITREP 106		DSH
40					
41		2315	CLOSED OPS		DSH
17 APR 94					
1	0730		OPENED OPS		DSH
2	0833		John Cooley informed locals to keep guarding sites at 0730L		DSH
3	0910		RCUD C-2 Highlights		DSH
4	0920		RCUD 3 DAY FORECAST fm CTF		DSH
5	0925		RCUD SAM UPDATE fm CTF		DSH
6	0	0950	F2 GOING TO BORDER CROSSING		DSH
8	1148		COALITION LEADERS AGENDA		DSH
9	1200		EAGLE flight CALLED 20 MIKES OUT		DSH
10	1222		EAGLE flight 1 MIKE OUT		DSH
11	1254		EAGLE 03 DEPARTED CP w/0845Z GATE TO DIYARBARIR		DSH

TYPED NAME AND GRADE OF OFFICER OR OFFICIAL ON DUTY \_\_\_\_\_

SIGNATURE \_\_\_\_\_

DAILY STAFF JOURNAL OR DUTY OFFICER'S LOG

For use of this form, see AIR 230-18; the proponent agency is Office of The Deputy Chief of Staff for Operations & Plans.

PAGE NO.

NO. OF PAGES

ORGANIZATION OR INSTALLATION

LOCATION

PERIOD COVERED

FROM

TO

HOUR

DATE

HOUR

DATE

ITEM NO.

TIME

IN

OUT

INCIDENTS, MESSAGES, ORDERS, ETC.

ACTION TAKEN

INL

12		1350	REQUESTED 1015Z RTN GATE FOR EAGLE 1 & 2		
13	1355		RTN GATE 1015Z APPROVED		
14		1422	EAGLE 1 DEPARTED CP		
15		1433	EAGLE 2 DEPARTED CP		
16	1530		GATE APPROVED FOR RETURN GATE AT 1215Z		
17			Eagle 4 DEPARTED CP		
18			EAGLE 5 15 MINS OUT		
19	1703		EAGLE 5 1 MIKE OUT		
20	1718		SENT CTF RATIONS REQUEST		
21	1720		SENT CTF Commo DESTROYED TO Col BENNET		
22	1722		EAGLES SW6 DEPARTED CP FOR DYAR		
23	1724		RCUD PROPOSED FLIGHT PLAN Am CTF		
24		1810	SENT SEOTF 3-2 COPY FAX LIST		
25	1839		FAX OF NAMES OF INVESTIGATION TM		
26	1900		RCUD INTREP 17 Am CTF		
27	2048		RCUD SITRP107 Am Pirinichk		
28	2301		MCC EVAC CONSIDERATIONS		
29		2310	SENT CTF SITRP 107		
			CLOSED OPS		
			18 APR 94		
1	0745		OPENED OPS		

TYPED NAME AND GRADE OF OFFICER OR OFFICIAL ON DUTY

SIGNATURE

DAILY STAFF JOURNAL OR DUTY OFFICER'S LOG

For use of this form, see AR 230-18; the proponent agency is Office of The Deputy Chief of Staff for Operations & Plans.

PAGE NO.

NO. OF PAGES

ORGANIZATION OR INSTALLATION		LOCATION		PERIOD COVERED			
				FROM		TO	
				HOUR	DATE	HOUR	DATE
ITEM NO.	TIME		INCIDENTS, MESSAGES, ORDERS, ETC.	ACTION TAKEN	INITIALS		
	IN	OUT					
19	1410		SAID would try AND GET AN ETA		DA		
20	1430		Requested complete inventory that we should have at Zack's MCC from C-6.		DA		
21			Mobil will return est 1530Z Relayed to CTF		DA		
22			Mobil called again we be leaving in 5m.				
23	1654		Eagles landed MCC		DA		
24	1705		Contact CTF requested 1315Z gate, relayed to Arrow 3.		DA		
25	1720						
26	1720		Eagle 1-2 depart notify CTF		DA		
27	1730		Next of Kin for Kurdish sent to JOC Chief		DA		
28	1732		Subsistence request list		DA		
29			Incoming personnel roster		DA		
30	1806		Commo equip list from C-6		DA		
31	<del>1835</del>		RCVD NEW FILL		DA		
32	2040		RCVD JINTREP 896 Sin CTF		DA		
33	2047		RCVD SATEP 108 for Pirandik		DA		
34	2145		RCVD MCC 107		DA		

TYPE NAME AND GRADE OF OFFICER OR OFFICIAL ON DUTY

SIGNATURE

K.D.P.  
KURDISTAN DEMOCRATIC PARTY / IRAQ  
Public Relation Office

٣٢٢ / ١٤

بروتيه قائمقام قضاء عفره  
اليوم وفي الساعة ١١ دعتنا اللجنة  
خاتمة هيليتويتر من قبل خاتمة هيليتويتر  
وبالصباح في مهنه (تويشكه)  
التابعة لقضاء عفره واستدعيتنا  
بالتفصيل حال ورودها اليها

With Compliments

To The MCC

Message of the Mayor of AQRAH :

At 11.45 Today two helicopters were shot down  
by two Jet fighters in Twashka area which is  
within AQRAH'S Territory. We will provide you  
further details as soon as we get them.

P.R.O

~~TOT/25~~  
~~#25/141420~~

**TAB AC-8**

**MISCELLANEOUS**

**AC-8a NOTAMs**

**AC-8b SAR Daily Log, 14-17 April 1994**

**AC-8c MCC Operations Log, 14-18 April 1994 and Note from Zakhu,  
Kurdistan Democratic Party**

**AC-8d Headquarters, Combined Task Force, Operation PROVIDE COMFORT,  
Memorandum for Record, 14 May 1994**

**AC-8e Headquarters Operation PROVIDE COMFORT II,  
Combined Task Force/C2 Log, 14 April 1994**

**AC-8f Extract of Joint Operations Center Log, 13-14 April 1994**

**AC-8g Extract from JSOTF-J3 After Action Report, Eagle Flight Incident**

**AC-8h 39 Support Group Memorandum, Lessons Learned, AC-8a  
SAR Operations on Helicopter Incident AC-8b**

**AC-8i Memorandum USAFE/XO, OPC Assessment AC-8c**

**AC-8j MCC SITREP, 3 April 1994 AC-8d**

**AC-8k Senate Armed Services Committee  
Request for Inquiry**

**HEADQUARTERS  
COMBINED TASK FORCE, OPERATION PROVIDE COMFORT  
INCIRLIK AIR BASE, TURKEY  
APO AE 09396**

14 May 94

**MEMORANDUM FOR MG Andrus, Accident Investigation Board President**

**FROM: HQ CTF/CG**

**SUBJECT: Memorandum for Record**

1. Reference your request of 13 May 1994 for a list of individuals on board the helicopters involved in the accident over Northern Iraq on 14 April 1994 and their reason for being aboard, the following is provided:

<u>RANK/NAME</u>	<u>NATIONALITY</u>	<u>POSITION/REASON</u>
COL JERALD L. THOMPSON	US	MCC CO-CMDR
COL HIKMET ALP	TU	MCC CO-CMDR
LT COL JONATHAN C. SWANN	UK	SENIOR UK REP
LT COL GUY DEMETZ	FR	SENIOR FRENCH REP
COL RICHARD A. MULHERN	US	NEW MCC CO-CMDR
MAJ HARRY C. SHAPLAND	UK	SECURITY OFFICER
1 LT LAURA A. PIPER	US	IRAQI AIR ANALYST (C-2)
MS BARBARA L. SCHELL	US	POLITICAL ADVISOR
MR SALID SAID	KURD	INTERPRETER
SSG RICKY L. ROBINSON	US	MEDIC
SSG PAUL N. BARCLAY	US	COMM NCO
SFC BENJAMIN T. HODGE	US	TRANSLATOR
MR. AHMAD MOHAMMAD	KURD	MISSION SECURITY
MR. BADER MIKHO	KURD	MISSION SECURITY
MR. GHANDI HUSSEIN	KURD	MISSION SECURITY
MR. ABDULSATUR ARAB	KURD	MISSION SECURITY
CAPT PATRICK M. McKENNA	US	H-60 PILOT
W01 JOHN W. GARRETT JR.	US	H-60 PILOT
W01 ERIK S. MOUNSEY	US	H-60 PILOT
CW2 MICHAEL A. HALL	US	H-60 PILOT
SPC JEFFREY C. COLBERT	US	H-60 CREW CHIEF
PFC MARK A. ELLNER	US	H-60 CREW CHIEF
SPC MICHAEL S. ROBINSON	US	H-60 CREW CHIEF
SPC CORNELIUS A. BASS	US	H-60 CREW CHIEF

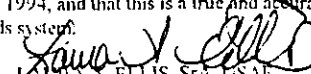
<b>CERTIFICATE</b>	
I certify that I am the Records Custodian for the Accident Investigation Board convened to investigate the crash of two U.S. Army Black Hawk helicopters in the no fly zone in northern Iraq on 14 April 1994, and that this is a true and accurate copy of the record which is kept in my records system.	
25 May 94 Date	 LAURA A. ELLIS, SFC USAF Evidence Custodian, Incirlik Air Base, Turkey



<u>RANK/NAME</u>	<u>NATIONALITY</u>	<u>POSITION/REASON</u>
1LT M. BARLAS GULTEPE	TU	TU LIAISON OFFICER
1LT CEYHUN CIVAS	TU	TU LIAISON OFFICER

2. The mission was being conducted to introduce the new U.S. and Turkish MCC Co-Commanders to various dignitaries in Northern Iraq. The approved mission was conducted in the line of duty, for official purposes, and essential to Operation PROVIDE COMFORT.

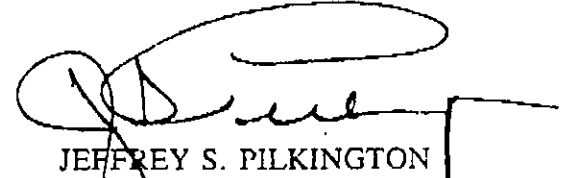

JEFFREY S. PILKINGTON  
Brigadier General, USAF  
Commanding General  
Combined Task Force

**TAB AC-8**

**MISCELLANEOUS**

**AC-8a NOTAMs**

**AC-8b SAR Daily Log, 14-17 April 1994**

**AC-8c MCC Operations Log, 14-18 April 1994 and Note from Zakhu,  
Kurdistan Democratic Party**

**AC-8d Headquarters, Combined Task Force, Operation PROVIDE COMFORT,  
Memorandum for Record, 14 May 1994**

**AC-8e Headquarters Operation PROVIDE COMFORT II,  
Combined Task Force/C2 Log, 14 April 1994**

**AC-8f Extract of Joint Operations Center Log, 13-14 April 1994**

**AC-8g Extract from JSOTF-J3 After Action Report, Eagle Flight Incident**

**AC-8h 39 Support Group Memorandum, Lessons Learned,  
SAR Operations on Helicopter Incident**

**AC-8a**

**AC-8b**

**AC-8i Memorandum USAFE/XO, OPC Assessment**

**AC-8c**

**AC-8j MCC SITREP, 3 April 1994**

**AC-8d**

**AC-8k Senate Armed Services Committee  
Request for Inquiry**

**AC-8e**

DAILY STAFF JOURNAL OR DUTY OFFICER'S LOG				PAGE NO.	NO. OF PAGES
ORGANIZATION OR INSTALLATION		LOCATION		PERIOD COVERED	
CTF-C2		HQ OPC II Incirlik AB, TU		FROM	TO
				HOUR DATE	HOUR DATE
				0001 14 Apr 94	2400 14 Apr 94
ITEM NO.	TIME		INCIDENTS, MESSAGES, ORDERS, ETC.	ACTION TAKEN	INITIALS
	IN	OUT			
01	0001		Log opened		AD
02	0030		SAM AB		AB
03	0645		CFAC Sum		AB
04	0200		Com Check		AB
05	0230		(2 Highlight)		AB
06	0400		BCC Run		AB
07	0830		WATCH CHANGE		Tm
08	0942		BCC Run		Tm
09	0730Z (10:45)		2 Prob Hind Helos shot down		Tm
10	1135 L		CTF-C-3 CONTACTS EAGLE FLIGHT		Tm
11	1135 L		ALWAYS - DOES NOT HAVE A PAINT ON EAGLE FLIGHT		Tm

ENTER NAME AND GRADE OF OFFICER ON OFFICIAL ON DUTY  
 Todd C. Miller, 1LT USAF

SIGNATURE  
 Todd Miller

DA FORM 1584

PREVIOUS EDITION OF THIS FORM IS OBSOLETE.

U.S. GOVERNMENT PRINTING OFFICE: 1984-411-001/3141

Page Redundant 32% add

NOTE: HE CHANGES TIME FROM Z TO L  
 AT ENTRY #10, THEN AT #11 STARTS  
 A NEW PAGE (TITLED "SPECIAL LOG")  
 ON PAGE 2, HE THEN GOES BACK TO ZULU TIME  
 AT ENTRY #10  
 ON PAGE 3, BACK TO LOCAL TIME

CERTIFICATE	
I certify that I am the Records Custodian for the Accident Investigation Board convened to investigate the crash of two U.S. Army Black Hawk helicopters in the no fly zone in northern Iraq on 14 April 1994, and that this is a true and accurate copy of the record which is kept in my records system.	
Date: 9 May 94	WILLIAM L. HARRIS, Capt, USAF, MSC Evidence Custodian, Incirlik Air Base, Turkey

2

DAILY STAFF JOURNAL OR DUTY OFFICER'S LOG

PAGE NO. 01

NO. OF PAGES

For use of this form, see AFM 23-10, the proponent agency  
 In Office of The Deputy Chief of Staff for Operations & Plans

ORGANIZATION OR INSTALLATION

LOCATION

PERIOD COVERED

CTF-C2

HQ OPC II  
 Incirlik AB, TU :

FROM  
 HOUR DATE

TO  
 HOUR DATE

1132 4-14-94

ITEM NO.	TIME		INCIDENTS, MESSAGES, ORDERS, ETC.	ACTION TAKEN	INL
	IN	OUT			
01	1134		SPECIAL Log OPENED	---	n
02	1134		NO MODES FROM TARGETS	---	m
03	11:36		AWACS got PAINT AFTER TIGER POINTED THEM OUT, NO IFF.	---	
04	11:46		CTF <sup>ATTEMPS</sup> CONTACTS Eagle Flight NO CONTACT ON EAGLE 1		m
05	11:47		NO SURVIVORS FOR Duke MAD dog.		
06	11:48		-ORDINANCE ON PYLONS - EAGLE 1 WAS 2 SHIP		
07			ASKED FOR EAGLE Flight PLAN.		
08			EAGLE Flight <del>PLAN</del> HARRIERS OVER-FLEW CRASH SITE, HURRICANE SPITEFIRE.		
09	909Z		EAGLE 1 NOT SQUAWKING ASSUMED to be landed		
10	911Z		(MAD dog)!! Confirm EAGLE I WAS SINGLE SHIP - (duke)	Negative 2 ship	m
11	915Z		ASKING FOR INFLIGHT REPORT FROM SPITEFIRE'S HURRICANE		m

TYPE NAME AND GRADE OF OFFICER OR OFFICIAL ON DUTY

SIGNATURE

DAILY STAFF JOURNAL OR DUTY OFFICER'S LOG

PAGE NO. 02 NO. OF PAGES

For use of this form, see AFM 230-10, the proponent agency, or the Office of The Deputy Chief of Staff for Operations & Plans.

ORGANIZATION OR INSTALLATION <b>CTF-C2</b>	LOCATION <b>HQ OPC II Incirlik AB, TU</b>	PERIOD COVERED	
		FROM HOUR DATE <b>1130 414-94</b>	TO HOUR DATE

ITEM NO.	TIME		INCIDENTS, MESSAGES, ORDERS, ETC.	ACTION TAKEN	INL
	IN	OUT			
14	1227	L	Eagle 1 - Two Ship Helos Confirmed From MAD dog		7m
15			SPIT FIRE OVER TARGET Now confirms 2 splash.		
16			"Heading OF TARGET during INCIDENT" - (NEGATIVE)		7m
17			MANIFEST FOR Eagle 2 Received.		7m
18	1242	L	"Confirmed Squawk with Eagle After Incident" (AWACS)		
19	1243	L	MANIFEST'S CREW for Both Flights Requested by C-3 From ZALIKAH or PRINCERLICH.		7m
20			1 CREW AT PRINCERLICH ready. Weather Good		7m
21	116	L	HARRIERs getting GAS - TO VISUAL ID. POSSIBLE - BLACK HAWK helos on - A parking lot AT 36 23 0 N 4412" E //		
22	126	L	"Tiger Flight Landed Reviewing video ASAP		7m

Typed Name and Grade of Officer on Official on Duty	Signature
---	-----------

DA FORM 1594

PREVIOUS EDITION OF THIS FORM IS OBSOLETE.

U.S. GPO: 1985-421-001/12103

Page Rechecked 4/4/94

DAILY STAFF JOURNAL OR DUTY OFFICER'S LOG  
For use of this form, see AFM 230-10, the appropriate agency  
 in Office of The Deputy Chief of Staff for Operations & Plans

PAGE NO. 83

NO. OF PAGES

ORGANIZATION OR INSTALLATION

LOCATION

PERIOD COVERED

CTF-C2

HQ OPC II  
 Incirlik AB, TU

FROM  
 HOUR DATE

TO  
 HOUR DATE

ITEM NO.	TIME		INCIDENTS, MESSAGES, ORDERS, ETC.	ACTION TAKEN	INITIALS
	IN	OUT			
23	129	L	mad dog to Duke "Do we have A VISUAL OVER PARKING lot" NR. CHAVING TROUBLE with VECTOZ OVER Irbil parking lot.		M
24	143	L	JSOTF MCC TEAM TO Luanch A RECCE TEAM TO CRASH SITE		
25	143	L	- HARRIS handed		
26	146	L	JSOTF HAS CLEARANCE TO LUANCH. IN CAB TO TO AOR. 14.45 LUNCH		
27	320	L	- CNN REPORTS 2 IRAQI WINGLANES shoot down 2 BLACK HAWK helos		
28	0330		- PHOTOS ARRIVED - OF FIRST CRASH SITE NO POSITIVE ID.		
29	334	L	3 MA-60S AIRBORNE AT 3:15 LOCAL + 1 MC-130		M
30	432	L	H-60 90% PROBABLE FROM PHOTO INTEL.		M
31	506	L	CAPT VANDERWHITE CALLED - FACREC		Z

TYPE NAME AND GRADE OF OFFICER OR OFFICIAL ON DUTY

SIGNATURE

page reduced 44% - call

**TAB AC-8**

**MISCELLANEOUS**

**AC-8a NOTAMs**

**AC-8b SAR Daily Log, 14-17 April 1994**

**AC-8c MCC Operations Log, 14-18 April 1994 and Note from Zakhu,  
Kurdistan Democratic Party**

**AC-8d Headquarters, Combined Task Force, Operation PROVIDE COMFORT,  
Memorandum for Record, 14 May 1994**

**AC-8e Headquarters Operation PROVIDE COMFORT II,  
Combined Task Force/C2 Log, 14 April 1994**

**AC-8f Extract of Joint Operations Center Log, 13-14 April 1994**

**AC-8g Extract from JSOTF-J3 After Action Report, Eagle Flight Incident**

**AC-8h 39 Support Group Memorandum, Lessons Learned,  
SAR Operations on Helicopter Incident**

**AC-8a**

**AC-8b**

**AC-8i Memorandum USAFE/XO, OPC Assessment**

**AC-8c**

**AC-8j MCC SITREP, 3 April 1994**

**AC-8d**

**AC-8k Senate Armed Services Committee  
Request for Inquiry**

**AC-8e**

**AC-8f**

100-106

# RECORD

#13

CERTIFICATE OF DECLASSIFICATION	
I certify that the information contained in this document has been declassified from	
<del>SECRET</del> <i>NSA</i> to UNCLASSIFIED	<i>Donald G. Norris</i>
24 MAY 94	DONALD G. NORRIS, GS-15, DAC
Date	Declassification Team Chief, HQ USEUCOM

EXTRACT	
I certify that I am the Records Custodian for the Accident Investigation Board convened to investigate the crash of two U.S. Army Black Hawk helicopters in the no fly zone in northern Iraq on 14 April 1994, and that this is a true and accurate extract from	
Doc Log ref #13 CTF/C3 DPC	<i>Donald G. Norris</i>
24 May 94	DONALD G. NORRIS, SFC, USAF
Date	Evidence Custodian, Incirlik Air Base, Turkey

CTF/C3

OPERATION



13 APR 1994

21-0323

-PT 50

0600 LT ALLEN ON DUTY WITH SGT HARRIS, SPEC HENRY, SRA ROBINSON

0650 INDEF HOLD, AWACS RETURNING WITH HYD LEAK.

0735 AWACS ON DECK

0743 AWACS REQ T/O 0515Z, TURKS APPROVED OVER PHONE

(0830) ROLEX 1+30

0838 #2087, #2088 ROTOR T/O + 1+30 ROLEX

0845 #2089 SAVVY T/O 0525

0911 #2090 ZUR ROLEX, DETON T/O 0700Z, DEVIL T/O 1030Z

0914 LINK WITH X-RAY MINUS RADAR

0926 AWACS TROUBLE SHOWING RADAR PROBLEM

0930 JTIDS WITH INDEF

0946 JTIDS WITH DADDY

0949 #2091 DEMON T/O 0800Z, DEVIL T/O 1100Z

0955 #2092 ROTOR 05 T/O 0715Z

CONTINUED ON LUNCH  
0732Z

1048 #2093 DEMON T/O 1100Z, DEVIL T/O 1230Z

1115 TURKS CMA KAPLAN, #2094 WIKING T/O 0920Z

1132 #2095 ROTOR 06 T/O 0400Z

1136 #2096 PUMA 44 CNX

1206 #2097 CHG - DEMON 10Z

(1219) TURK A/C ON AOR -

1225 APPROX # A/C NO CONTACTS SO FAR STAYING LOW IN ROE 3  
PASSES TO C3, C2

13 APR 94

WEDNESDAY

1238 #2098 CLAW T/O 0935Z, DEVIL T/O 1130Z

(1240) SPECIAL MISSIONS IN AOR, TNKR OBSERVED LIVE ORDNANCE ON BOARD

1302 SPECIAL MISSIONS AIRCRAFT ARE BEING RELIEVED ON STATION. INDIA SAYS ONCOMING A/C WILL REMAIN BELOW 25,000'

1310 SPECIAL MISSIONS ARE OUT OF AREA

1315 LT COL SHUK FROM ETCC CALLED WITH QUESTIONS ON THE SPECIAL MISSIONS. SAID HE WOULD CALL BACK LATER.

1321 #2099 ROTOR 06 T/O 1030Z

REFER TO 10.3

1400 (L) Bicket on duty

1425(L) SPAR 53 1100Z SLIPPING TO 1145Z BECAUSE OF TWR DELAYS

1445(L) #~~3000~~<sup>3100</sup> ROTOR 06 T/O 1245 ACTIVE

1445(L) TU AIRCRAFT IN R02 - CLOSE TO 6:00 PM SO CTF WILL RETROGRADE A/C

1452(L) #~~3000~~<sup>3100</sup> EAGLE 01/02 RER 1215Z RETURN GATE

1504(L) Secret immediate message at com center

1505(L) Requested MADDOG CALL JOE TO PASS INFO ABOUT SPECIAL AIRCRAFT IN R02 - Reported the MD is on other line - will call

ALT'S

#'S

IMPACT

Times

Did they interfere?? NO

1542(L)

1536 "FORD"

1545(L) Secret immediate com center

1610(L) ROTOR 06 CAME UP WITH CALL SIGN REPLICATION PLEASE USE ROTOR 07 TO AVOID CONFUSION PER CTTULND - LANDING TIME??

1616(L) 2102' FOR OPEN SPAR 51 0330Z to 0700Z  
SPAR 53 1100Z to 1430Z

1638(L) CANX ROTOR 07 INFORMED TUB

1640 LTC WILFRED ON DUTY

1751 # 2103 Activate Route #5 FCF

1820 BIC 1513111

1838 # 2104 <sup>14</sup> APR EAGLE 1/2 T/O 0520Z GI 0625  
EAGLE 10 T/O 0630Z (LTAG)

1903 STU Keys removed from C-3; C-3DO OFFICES AND  
PUT ON KEY HOOD IN JOL

1930 RECD MSG DTG 130740Z APR 94; OLIVE COMFORT  
" " " 130630Z APR 94; IRISH EMERALD  
" " " 130620Z APR 94; OLIVE COMFORT  
" " " 131208Z APR 94; IRISH EMERALD  
" " " 131239Z APR 94; IRISH EMERALD  
" " " 131323Z APR 94; USECOM RECON SCHEDULE

2000 RCVD B5ID#1 Need copy to go down to  
the C3 TU office

2100 Pentagon called to get a question from the fused slide  
squeezed away - How come 23 scheduled and 23 flown  
but 2 curx? ANSWER - One curx was an Air Abort so it  
flew - It was ANAS so the spare flew (added a sortie)  
that made up for the ground abort KC 135

2200 Bullet to quarter 6 3117 or page #191

14 APR

0200 RECD MSG DTG 131730Z APR 94; UNIKOM DAILY FLT SCHEDULE

0400 SWA NTR

0405 NO G/C OR O/B MISSIONS TODAY

0600 Maj Wiggins on duty with Spl Hency, Ann Nichols & Ann Robinson  
Night reports person gone when I arrived. No Chg over bnf.  
UN CH-53 scheduled north of 36th parallel at 0515Z. LV  
0555Z. Inform MadDog

0650 Intel informed me that Iraqi's flew many sorties last

night. It was the normal Iraqi night fly day.

0743 Rumor of a Tu F-4 and a Tu Helicopter going down yesterday P.M.

0800 AWACS off on time. Verified by radio checks.

0825 JTIDS is good.

0845 AWACS on station

0950 Chg Rotor 05 to 0700Z T/O Activate Hornet 01 for a 0730Z T/O

1000 CNX Hornet 01. Aircraft broke

1015 Chg Eagle 10's t/o to 0730Z

1045  
0745 2 Hind Helicopters shot down by Tiger N3646.9  
E 44° 04.3. #2 3645.1 4405.2 less than 500'  
Hard copy available. 0745Z

1050 Maj Wilmet from Eucom ref Demarche to Iraq. Has not been delivered to Iraq as far as Eucom can determine.

1053 Tiger on tanker

1100 Cmd post called. Requested Col O'Brien at battle cab.

1105 Duke reported a VID, followed by AWACS ID.

Tiger one used on AAMRAM, Tiger 2 used a AIM-9M.

1115 CG went to call Eucom & inform the Turks.

1128 AWACS had a rdr paint in the clutter with no squawks.

1130 Chg Claw T/O to 0815Z

Activate Rotor 06 T/O 0835Z

1135 Eagle f/t launched at 0650Z Destination Irbil

1140 Tiger saw no survivors on over f/t. AWACS reported Eagle f/t located Turk/Iraq border NE ROZ 2 at 0738Z.

1148 (?) MADDOX SAID "Do we know of anyone that has talked to Eagle Eight

? NO Have you contacted their ops center? YES - we are waiting

for them to <sup>fax</sup> flight plan to us. we will pass on anything we find out.

Duke has them painted on the radar with IFF code

1205 Spitfire over splash area. Taking pictures. Tiger RTB.

1215 request Hurr & Spit give in f/t mis reps. □

1215 No outgoing phone calls. All incoming calls refer to Col O'Brien.

- 1220 Centcom called looking for details. Still armed for now.
- 1222 Hurricane photoed both sites. Spittie over sites now.
- 1228 AWACS confirmed valid squawk for Eagle FT ~~FT~~ after shutdown.
- 1236 AWACS on tanker getting gas.
- 1238 Passed Pinnacle inputs to command post.
- 1240/1316 Harrier FT flew over parking lot outside Mr Barzen's HQ's and reported 2 helicopters there. They are refueling to fly back to site to verify.
- 1320 Tiger FT is down.
- 1340 Passed coords of shoot down to MCC.
- 1345 Activated Rotor 07 for a 1050Z T/O.
- 1347 Permission to launch JSOTF for Reserve mission. <sup>no AAR over Turkey</sup>
- 1350 Extended AWACS til 1730Z. Tiger will provide JCA. Second AWACS will launch at 1545Z along with claw.
- 1351 Activated Pony 21, 22, 23, + Ghost for 115Z for helicopters + 1145Z for Ghost.
- 1352 Nobody except Tiger getting gas from Puma 55.
- 1400 LTC WITHEER on Duty
- 1409 Intel reports 92 Harrier Recce observes 1 red car 2 white vans site MF176698 No Helix observes.
- 1436 # 2112 Activate claws/Puma 11
- 1506 PSA call CPT Peterson, EUCCOM PAT
- 1511 Passed to C3 call from EUCCOM REF
- 1515 Call from BAE CAR 12 AVAL BDE - Col Hayes
- 1534 C3 passes to MCC-7 launch program team - 6 PAX 2 vehicles to beach site.
- 1542 # 2113 Activate Eagle 17 remains to DIT # 2114 Activate Ghost 31
- 1550 Call from USARPAC Com CAR max rates
- 1552 Call from USAF CAT - <sup>(detected)</sup>
- 1602 Call from CPT Kelly, EUCCOM <sup>views can RPTs</sup>
- 1612 Call names pilots + crews Eagle FT.
- 1619 Award to P/U names secret specat to CAR.
- 1647 C2 Rep Reports Pentagon info release US Helos shot down - unconfirmed by whom C3 internal cc

- 1651 MSGC Cans Post 1st Point all OK  
Signal Fxi CX - except local & distant  
Thunder
- 1701-08 MSGC from Ghost 31 to actual  
Pony overland due to high density  
altitude than Silver Bullet / 1758  
Air Refuel by Soc II / MIA 106 cases EO
- 1740 # 2119 Advance Ghost 32 2nd HC120
- 1747 - Eagle 14 Arr Pirinlike
- 1805 - 3 Helos will go direct to crash site
- 1819 - C3 passes press into to Evcon of S  
CBS News Release on President Press Conf
- 1820 - MLC-2 Rpt GND Team site of all  
in 30 min ie 1850-1800 L
- 1850 # 2120 Ghost 32 1630Z
- 1831 Pass to Cans Post - for battle staff  
GND Team 5 km out; Helos circling; attempting  
to communicate area back; will pass into
- 1940 Pass to Cans Post - Pony has 2 CRASH  
sites in view, good Comms
- 1958 Call from WOC Lt Ramsey - Req  
for LND Ghost 32 / Req for info SOC III  
via 8177/8173 - (IN) C3 say LND not missed
- 2000  
2006 PERS on ground attempting to confirm  
# BODIES  
- Call from Cans Post - MIA NEES cor on ENGL  
Sp for EOD mentions and d/c? ?
- 2016 - Per CG - BODIES to be Recovered to  
Diyarbakir - passed to <sup>Ghost 31 1930Z</sup> MLC-R <sup>MIA BIRTH</sup> RECEIVE MIA return <sup>106</sup> 2055  
<sup>LTC ERVINS 238 2800 JAF</sup>
- 2019 - MSGC Cans Post MIA Andrews to all  
1620L Inca. msg given to Lt Brewster
- 2028 - Pass to Cans Post - MIA NEES / EOD  
mentions on Eagle 142 - <sup>2020</sup> <sup>MIA 100 Hares</sup> <sup>CHAFF</sup>  
- survival three
- 2032 MSGC from Hospital - no special considerations  
for BODIES; ~~not~~ clear to move BODIES  
to Diyarbakir; then on to GE; 4 slots  
here - Col Greeby at Diyarbakir - Col ORCES -
- 2042 MSGC from (MIA) Youngs - Evcon  
initiated Nonrec'd Next of Kin - Call from <sup>MIA</sup> R
- 2048 BODIES <sup>Point 21423</sup> Evconite to Diyarbakir - passed to <sup>STAY</sup> MLC-R

EXTRACT  
OF  
JOC LOG #13 CTF/C3  
OPERATION PROVIDE COMFORT  
5 APRIL 1994  
\* \* \*

1605 Were informed of an injured person at Erbil hospital requesting air evoc to Diyabakir. recalled Maj Bicket.

1710 Received more info. Patient at Erbil Hospital stomach wound, critical, from Denmark, Un passport [REDACTED] Neis Jensen. Evacuate to ~~Erbil~~ Diyabakir with doctor, Khatri B Chetri, Nepal, passport [REDACTED]. Tasking Eagle flight. Estimated T/O 1600Z. Arrive Erbil 1830Z.

1715 - Notified C3 (Tu) of diplomatic info.

1735 Received coordinates + conditions of landing area in Erbil.

1810 Activated 3+4 Eagle to extricate patient T/O 1515Z.

1815 notified E-TCC of operation.

1835 Recalled Eagle flight. Adm Lear at EUCom/J3. directed no night flight to Erbil.

1915 Got a phone call from Southern Watch. UN helicopter airborne to Erbil at 1606Z. The UN is affecting the airlift.

1920 Notified MCC, Zakho, Eagle flight, + CFAcc (woc) that UN was doing the airlift. Our help is not needed at this time.

1925 Got a call from the embassy at Ankara. Called on behalf of the Danish Embassy. Passed on info about UN helicopter.

CERTIFICATE OF DECLASSIFICATION

I certify that the information contained in this document has been declassified from

SECRET No FORN to UNCLASSIFIED

24 MAY 94  
Date

Donald G. Norris  
DONALD G. NORRIS, GS-15, PAC  
Declassification Team Chief, HQ USPT/COM

EXTRACT

I certify that I am the Records Custodian for the Accident Investigation Board convened to investigate the crash of two U.S. Army Black Hawk helicopters in the no fly zone in northern Iraq on 14 April 1994, and that this is a true and accurate extract from

JOC Log #13 UN/CF 300  
which is kept in my records system.

24 May 94  
Date

Laura A. Hill, PAC  
Evidence Custodian, In Chrg. of the Task

**TAB AC-8**

**MISCELLANEOUS**

**AC-8a NOTAMs**

**AC-8b SAR Daily Log, 14-17 April 1994**

**AC-8c MCC Operations Log, 14-18 April 1994 and Note from Zakhu,  
Kurdistan Democratic Party**

**AC-8d Headquarters, Combined Task Force, Operation PROVIDE COMFORT,  
Memorandum for Record, 14 May 1994**

**AC-8e Headquarters Operation PROVIDE COMFORT II,  
Combined Task Force/C2 Log, 14 April 1994**

**AC-8f Extract of Joint Operations Center Log, 13-14 April 1994**

**AC-8g Extract from JSOTF-J3 After Action Report, Eagle Flight Incident**

**AC-8h 39 Support Group Memorandum, Lessons Learned,  
SAR Operations on Helicopter Incident**

**AC-8i Memorandum USAFE/XO, OPC Assessment**

**AC-8j MCC SITREP, 3 April 1994**

**AC-8k Senate Armed Services Committee  
Request for Inquiry**

**AC-8a**

**AC-8b**

**AC-8c**

**AC-8d**

**AC-8e**

**AC-8f**

**AC-8g**



HEADQUARTERS  
JOINT SPECIAL OPERATIONS TASK FORCE  
COMBINED TASK FORCE PROVIDE COMFORT II  
INCIRLIK AIR BASE, TURKEY  
APO AE 09396

JSOTF-J3

30 April 1994

MEMORANDUM FOR: CTF CG, CTF CofS, CTF C3

SUBJECT: Letter of Transmittal - Executive Summary - After Action Report  
JSOTF Participation in Recovery Operation: MCC-Eagle Flight Incident - 14 April 1994

140915Z APR 94 JSOTF Response Force at MCC prepares to launch ground team, on order.

141315Z APR 94 Ground team departs MCC Zakho for crash site.

141644Z APR 94 From JSOTF LNO at CTF: 2 F-15'S are on-station over the TAOR. The F-15's only have air-to-air capability. JSOTF restates requirement for air-to-ground capability.

141700Z APR 94 HC-130 (Ghost 32) departs Incirlik to assume Aerial Refueling mission.

141715Z APR 94 Initial report received from COMJSOTF at crash site: confirmed US helicopters, confirmed no survivors, and confirmed 26 deceased personnel. COMJSOTF received CTF/CG direction to 1) exfil bodies to Diyarbakir and 2) to exfil as much equipment as possible to a secure place. Recovery begins.

150331Z APR 94 Pony 22 arrives Diyarbakir. All JSOTF rotary wing assets now at Diyarbakir. All recovered remains at Diyarbakir; 26 sets accounted for.

**CERTIFICATE OF DECLASSIFICATION**

I certify that the information contained in this document has been declassified from

SECRET to UNCLASSIFIED.

*Donald G. Norris*  
DONALD G. NORRIS, GS-15, DAC  
Declassification Team Chief, HQ USEUCOM

21 MAY 94  
Date

**EXTRACT**

I certify that I am the Records Custodian for the Accident Investigation Board convened to investigate the crash of two U.S. Army Black Hawk helicopters in the no fly zone in northern Iraq on 14 April 1994, and that this is a true and accurate extract from

JSOTF-J3 Memo, 30 Apr 94, After Action  
which is kept in my records system.

21 May 94  
Date

*W. L. Harris*  
WILLIAM L. HARRIS, Capt, USAF, MSC  
Evidence Custodian, Incirlik Air Base, Turkey

**TAB AC-8**

**MISCELLANEOUS**

**AC-8a NOTAMs**

**AC-8b SAR Daily Log, 14-17 April 1994**

**AC-8c MCC Operations Log, 14-18 April 1994 and Note from Zakhu,  
Kurdistan Democratic Party**

**AC-8d Headquarters, Combined Task Force, Operation PROVIDE COMFORT,  
Memorandum for Record, 14 May 1994**

**AC-8e Headquarters Operation PROVIDE COMFORT II,  
Combined Task Force/C2 Log, 14 April 1994**

**AC-8f Extract of Joint Operations Center Log, 13-14 April 1994**

**AC-8g Extract from JSOTF-J3 After Action Report, Eagle Flight Incident**

**AC-8h 39 Support Group Memorandum, Lessons Learned,  
SAR Operations on Helicopter Incident**

**AC-8a**

**AC-8b**

**AC-8i Memorandum USAFE/XO, OPC Assessment**

**AC-8c**

**AC-8j MCC SITREP, 3 April 1994**

**AC-8d**

**AC-8k Senate Armed Services Committee  
Request for Inquiry**

**AC-8e**

**AC-8f**

**AC-8g**

**AC-8h**

*Z*

18 April 1994

FROM: 39TH SPTG/CD (SAR Incident Team Chief)

SUBJECT: Lessons Learned, SAR Operations on Helicopter Incident

1. SUMMARY: I was tasked to lead two groups of mortuary search and recovery personnel into Northern Iraq on 15 April. The team consisted of 21 personnel which were split into Team 1 and Team 2 which departed Incirlik, flew to Diyarbakar on a C141, changed onto blackhawk helicopters and flew into Bazan Province (via Zakhu). The two teams searched the wreckage area and located several body items, personal effects, and weapons which were properly tagged and brought back to Diyarbakar. The teams were on the ground for approximately four hours, and were extracted via chopper to Diyarbakar Air Base. At the base the personnel then prepared remains for shipment to Frankfurt FRG on a C141, which was loaded and took off at about 2130L. I coordinated with Col Bonfiglio from Princilik and our personnel were transported to the base and remained over night in the gym (except the officers and the one female member--housed in the BOQ). We set up to keep the dining hall open and personnel did get chow--had to pay for their meals to include surcharge. On 16 April, I worked with the MCC to get transport for our personnel back to Incirlik which happened to be on a C130 and my personnel departed at about 1700L. I remained behind to meet with MGen Andres to discuss matters pertaining to the crash sites. I returned to Incirlik via C12 with MGen Andres the evening of 16 April, arriving at 2245 hours.

2. The following bullets are items of concern or "lessons learned" to be used for planning for future incidents.

- Identify now those personnel who should be on a SAR team of this sort. The initial cut should be 30 folks and the teams broken into 10 man increments. That way we could handle smaller incidents as well as be prepared for the larger ones.

- Set up training for the SAR teams. Demand that they be kept up to date and refresher training be conducted continuously. Prepare the folks for what they will see involving death and exposed human remains.

- Prepackage the equipment needed for a SAR operation and have an up-to-date inventory of the packages. Missing items could then be rapidly obtained to put in the package. Items missing in this instance were: Ice coolers, "Vicks" rub to kill smells, inventory sheets, and basic pads and pencils.

- Establish, in writing, a predeployment brief outline. Include the medics, EOD, Intel, and Chaplain, and have the brief in place so it can be given without running all over the place to get it set up properly--fill in the blanks checklist would be a good

**EXTRACT**

I certify that I am the Records Custodian for the Accident Investigation Board convened to investigate the crash of two U.S. Army Black Hawk helicopters in the no fly zone in northern Iraq on 14 April 1994, and that this is a true and accurate extract from

39TH SPTG/CD, 18 Apr 94, Lessons Learned, SAR  
 which is kept in my records system.  
 20 May 94  
 Date

W. L. Harris  
 WILLIAM L. HARRIS, Capt. USAF, MSC  
 Evidence Custodian, Incirlik Air Base, Turkey

start for the drawn of the brief.

- Limit the items to be taken to the site. Several folks showed up with extra bags, "carry on" things, etc. I had these things put in a hold area at Diyarbikar as we did not have the room to take the stuff on the choppers.

- Require Comm Sq to have a communications package readily available for deployment with the SAR team/s. It must be light weight and easy to use.

- Ensure there are always two people on the team who are trained in pallet build up. This eliminates big problems when trying to get things on airplanes--especially personal and "B" bags, plus boxes of equipment and transfer cases.

- The expectation to search and take care of the two sites in four hours or less could have been a very difficult mission because of the terrain and limited number of folks available to search. We did get, what we felt was all, of the body parts. Senior personnel need to decide when we will terminate searching as we did in this instance--I was seconded guessed by several folks who wanted total assurances we had located every piece of remains at the crash sites. Of course, this expectation is an impossibility.

- Because of the press and news personnel always attempting to get into sites and gather info from our troops, we need to ensure the SAR troops are briefed in detail about how to handle situations with folks like CNN reps. We did give a short overview brief to our team members, and they did well, but there was too much potential for our SAR people to be confronted at the scene and inadvertently make some comment or statement. I felt we were very weak in this area on this particular situation.

- Ensure there is a Lt Col or above to lead the teams into a remote place where political overtones are involved. I feel we made a very excellent decision in this case, because of the local political figures that came to express sorrow, etc., to the US and the fact the security was under the command of a Peshmerga general officer and in their culture, a senior representative was needed. A lower rank would have sent an inappropriate signal that we were not that concerned (personal opinion).

  
RUSSELL L. DAISLEY, Lt Col, USAF  
Deputy Commander 39th Support Group

8 Attachments

1. After Actions (Capt Snyder)
2. Mortuary Affairs Log (1-6)
3. SAR Log (1-2)
4. Diyarbikar Mortuary Log (1-2)
5. Property Receipt from scene

**TAB AC-8**

**MISCELLANEOUS**

**AC-8a NOTAMs**

**AC-8b SAR Daily Log, 14-17 April 1994**

**AC-8c MCC Operations Log, 14-18 April 1994 and Note from Zakhu,  
Kurdistan Democratic Party**

**AC-8d Headquarters, Combined Task Force, Operation PROVIDE COMFORT,  
Memorandum for Record, 14 May 1994**

**AC-8e Headquarters Operation PROVIDE COMFORT II,  
Combined Task Force/C2 Log, 14 April 1994**

**AC-8f Extract of Joint Operations Center Log, 13-14 April 1994**

**AC-8g Extract from JSOTF-J3 After Action Report, Eagle Flight Incident**

**AC-8h 39 Support Group Memorandum, Lessons Learned,  
SAR Operations on Helicopter Incident**

**AC-8i Memorandum USAFE/XO, OPC Assessment**

**AC-8j MCC SITREP, 3 April 1994**

**AC-8k Senate Armed Services Committee  
Request for Inquiry**

**AC-8a**

**AC-8b**

**AC-8c**

**AC-8d**

**AC-8e**

**AC-8f**

**AC-8g**

**AC-8h**

**AC-8i**

DEPARTMENT OF THE AIR FORCE  
UNITED STATES AIR FORCES IN EUROPE

MEMORANDUM FOR ACCIDENT INVESTIGATION BOARD PRESIDENT, MAJOR  
GENERAL ANDRUS

FROM: MAJOR GENERAL LEE A. DOWNER  
HQ USAFE/XO  
UNIT 3050 BOX 15  
APO AE 09094-5015

SUBJ: OPERATION PROVIDE COMFORT ASSESSMENT

1. In the past sixteen months Operation PROVIDE COMFORT forces have been engaged several times both in the air and on the ground by Iraqi forces. The incidents are as follows:

- 17 Jan 93: US F-16 shot down Iraqi MiG-23 that violated the no-fly zone.
- 9 Apr 93: F-16s dropped cluster bombs after being fired at by anti-aircraft artillery.
- 18 Apr 93: F-4Gs fired HARMs after being tracked by SA-2 surface-to-air missile system radar.
- 19 Aug 93: F-16s and F-15s dropped CBU's and GBU's on SA-3 site near Mosul after F-16 pilot claimed he saw a plume of smoke, possibly indicating a shoulder-launched SAM.
- 19 Dec 93: Coalition representatives from the Military Coordination Center in Zakhu were fired on at the Faidah Camp along the security zone. Iraqi forces continued small arms fire as the convoy drove north toward Dahuk.

2. Since the incident at Faidah there have been no direct confrontations between the Iraqi military and coalition forces. This is consistent with the fact that while Iraq still maintains the capability to engage coalition aircraft both in the air and with ground based air defense assets, activity in the past four months has been relatively low.

3. Air activity remained moderately low, accented by the fact that the Iraqis have not been able to sustain the same levels of flight activity noted during this period last year, probably due to the effect sanctions have on maintenance and spare parts. Air defense assets have remained stagnant since September, with the only movement being conducted by tactical SAMs. Ground force movement activity levels have been high, with additional Republican Guard units moving into the Mosul area, and a large unit swap-out between two major divisions. Despite this activity, there is no increased threat to Kurdish populations by

**CERTIFICATE**

I certify that I am the Records Custodian for the Accident Investigation Board convened to investigate the crash of two U.S. Army Black Hawk helicopters in the no fly zone in northern Iraq on 14 April 1994, and that this is a true and accurate copy of the record which is kept in my records system.

*L. A. Lillis*  
Date: \_\_\_\_\_

*Laura A. Lillis*  
LAURA A. LILLIS, SFA, USAF  
Evidence Custodian, Incirlik Air Base, Turkey

Iraqi forces; they maintain the same capability to move against Kurdish cities with little or no warning.

4. While there have been no hostile confrontations between coalition and Iraqi forces in the last four months, Husayn has continued his policy of persistent low-level harassment against the Kurdish populations in northern Iraq. These include extended power outages, security checkpoints, roadblocks, infrequent shelling of villages by both Iraqi and Iranian forces, and an occasional attack against UNGCI personnel. Bounties remained in effect for non-government organization personnel. In a similar way, Saddam Husayn continued to threaten coalition pilots. It is common knowledge that Husayn would like nothing better than to shoot down a coalition plane. Although Husayn's rhetoric became increasingly hostile in March right before the UN sanctions vote, no provocative actions occurred as a result.

5. Although there has been no evidence of an increased threat over the past year, coalition forces continue to fly daily missions in a politically and diplomatically charged environment with the potential for hostile engagement. Given the unpredictable nature of the environment, the coalition presence saves hundreds of thousands of lives. Without the security zone and the no-fly zone enforcement, the Kurdish population in northern Iraq would have no hope for a stable future.

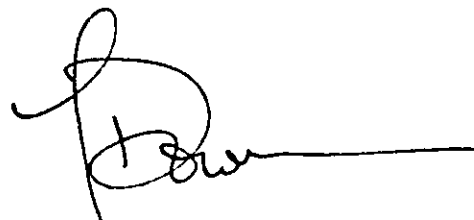
A handwritten signature in black ink, appearing to read 'L. Downer', with a long horizontal line extending to the right.

LEE A. DOWNER, Maj Gen, USAF  
Director of Operations, Plans,  
and Intelligence

**TAB AC-8**

**MISCELLANEOUS**

- AC-8a** NOTAMs
- AC-8b** SAR Daily Log, 14-17 April 1994
- AC-8c** MCC Operations Log, 14-18 April 1994 and Note from Zakhu,  
Kurdistan Democratic Party
- AC-8d** Headquarters, Combined Task Force, Operation PROVIDE COMFORT,  
Memorandum for Record, 14 May 1994
- AC-8e** Headquarters Operation PROVIDE COMFORT II,  
Combined Task Force/C2 Log, 14 April 1994
- AC-8f** Extract of Joint Operations Center Log, 13-14 April 1994
- AC-8g** Extract from JSOTF-J3 After Action Report, Eagle Flight Incident
- AC-8h** 39 Support Group Memorandum, Lessons Learned, AC-8a  
SAR Operations on Helicopter Incident AC-8b
- AC-8i** Memorandum USAFE/XO, OPC Assessment AC-8c
- AC-8j** MCC SITREP, 3 April 1994 AC-8d
- AC-8k** Senate Armed Services Committee AC-8e  
Request for Inquiry AC-8f  
AC-8g  
AC-8h  
AC-8i  
AC-8j



EXTRACT

I certify that I am the Records Custodian for the Accident Investigation Board created to investigate the crash of two U.S. Army Black Hawk helicopters in the no man's land in northern Iraq on 14 April 1994, and that this is a true and accurate extract

MCC Zakho Sitrep  
Date: 3 May 94  
File # 1000  
Laura A. Ellis, SFA USAF  
Evidence Custodian, Incirlik Air Base, Turkey

~~CONFIDENTIAL/RMNF~~  
UNCLAS

CERTIFICATE OF DECLASSIFICATION

I certify that the information contained in this document has been declassified from:

~~CONFIDENTIAL/RMNF~~ to UNCLASSIFIED  
Date: 25 MAY 94  
Donald G. Norris  
DONALD G. NORRIS, GS-15, D-AC  
Declassification Team Chief, HQ USEUCO

SUBJECT: (U) MCC ZAKHO SITREP # 093 - 03 APR 94

1. (U) SIGNIFICANT EVENTS:

- SUMMARY: - POWER CUT/PARTIAL SUPPLY FROM TURKEY.
- MAINTENANCE DAY.
- GOI ACTIVITY.

A. (U) POWER CUT: AS OF 1900 HRS LOCAL ON 03 APR 94, THE ELECTRICITY FROM GOI HAS STILL NOT BEEN RESTORED TO THE DAHUK GOVERNORATE. IT IS NOW 243 DAYS SINCE IT WAS CUT ON 5 AUG 93. WORK CONTINUES ON THE DISTRIBUTION OF THE PARTIAL SUPPLY FROM TURKEY.

B. (C) MAINTENANCE DAY: ON 3 APR 94 MCC HAD A MAINTENANCE DAY

C. (U) GOI ACTIVITY: ON 3 APR 94 MCC RECEIVED AN INFORMATION COPY OF THE FOLLOWING MESSAGE DATED 31 MAR 94 FROM DAHUK ASSAYESH TO THE GENERAL DIRECTORATE OF ASSAYESH IN ERBIL: (QUOTE) WE HAVE RECEIVED RELIABLE INFORMATION FROM RELIABLE SOURCES (AND FROM SEVERAL OTHER SOURCES OVER A PERIOD OF TIME) THAT THE REGIME IS INTENT ON ATTACKING THE HQS OF HUMANITARIAN ORGANIZATIONS AND THE UN IN THE KURDISTAN REGION. THE REGIME TOLD ITS REPRESSIVE ORGANIZATIONS AND AGENTS THAT ANYONE WHO CARRIED OUT AN ASSASSINATION OF ONE OF THE FOREIGNERS IN THE KUDISTAN REGION WOULD BE GIVEN A CASH REWARD OF ONE MILLION IRAQI DINARS. THE INFORMATION FROM THE REGIME WAS THAT THE PURPOSE OF COMMITTING THESE CRIMES WAS TO GET THE FOREIGNERS OUT OF KURDISTAN (END QUOTE).

D. (U) ASSASSINATION OF GERMAN CIVILIAN: ON 3 APR 94 MR STEVE ALLEN, SENIOR UN COORDINATOR FOR N.IRAQ, REPORTED TO MCC THAT MS LISSY SCHMIDT, A GERMAN CITIZEN AND CORRESPONDENT FOR AGENCE FRANCE PRESSE, HAD BEEN SHOT DEAD WHILST TRAVELLING BY CAR FROM SAYYID SADIQ (NE7813) TO SULAYMANIYAH (NE4035). HER CAR HAD BEEN DISCOVERED ABOUT 30 KM EAST OF SULAYMANIYAH BY A WORLD FOOD PROGRAMME STAFF MEMBER AT APPROX 1400 HRS ON 3 APR 94. BOTH MS SCHMIDT AND HER DRIVER HAD APPARENTLY DIED FROM MULTIPLE GUNSHOT WOUNDS TO THE HEAD. A MORE DETAILED REPORT FROM UN WILL BE PROVIDED AS SOON AS POSSIBLE. UN REQUEST ASSISTANCE IN EVACUATION OF THE BODY OF MS SCHMIDT FROM IRAQ.

D. (U) TRUCK TRAFFIC: TRUCK TRAFFIC FOR 02 APR 94 - NOT AVAILABLE.

F. (U) VISITORS TO ZAKHO HOUSE: 8.

(U) COMMUNICATIONS: NTR

(U) PERSONNEL TOTAL: 62.

~~CONFIDENTIAL/RMNF~~

UNCLAS

7

**TAB AC-8**

**MISCELLANEOUS**

- AC-8a NOTAMs**
- AC-8b SAR Daily Log, 14-17 April 1994**
- AC-8c MCC Operations Log, 14-18 April 1994 and Note from Zakhu,  
Kurdistan Democratic Party**
- AC-8d Headquarters, Combined Task Force, Operation PROVIDE COMFORT,  
Memorandum for Record, 14 May 1994**
- AC-8e Headquarters Operation PROVIDE COMFORT II,  
Combined Task Force/C2 Log, 14 April 1994**
- AC-8f Extract of Joint Operations Center Log, 13-14 April 1994**
- AC-8g Extract from JSOTF-J3 After Action Report, Eagle Flight Incident**
- AC-8h 39 Support Group Memorandum, Lessons Learned, AC-8a  
SAR Operations on Helicopter Incident AC-8b**
- AC-8i Memorandum USAFE/XO, OPC Assessment AC-8c**
- AC-8j MCC SITREP, 3 April 1994 AC-8d**
- AC-8k Senate Armed Services Committee AC-8e  
Request for Inquiry AC-8f  
AC-8g  
AC-8h  
AC-8i  
AC-8j  
AC-8k**

SAM NUNN, CHAIRMAN

J. JAMES EPPH, NEBRASKA  
CARL LEVIN, MICHIGAN  
EDWARD M. KENNEDY, MASSACHUSETTS  
JEEF PINGAMAN, NEW MEXICO  
JOHN GLENN, OHIO  
RICHARD C. SHELBY, ALABAMA  
ROBERT C. BYRD, WEST VIRGINIA  
ROY GRAHAM, FLORIDA  
CHARLES S. ROSS, VIRGINIA  
JOSEPH I. LIEBERMAN, CONNECTICUT  
RICHARD M. BRYAN, NEVADA

STROM THURMOND, SOUTH CAROLINA  
JOHN W. WARNER, VIRGINIA  
WILLIAM S. COHEN, MAINE  
JOHN MCCAIN, ARIZONA  
TRENT LOTT, MISSISSIPPI  
DAN COATS, INDIANA  
BOB SMITH, NEW HAMPSHIRE  
DIRK KEMPTORNE, IDAHO  
LAUCH FAIRCLOTH, NORTH CAROLINA  
KAY BAKER, MICHIGAN, TEXAS

ARNOLD L. PUNARO, STATE DIRECTOR  
RICHARD L. REYNARD, STATE DIRECTOR FOR THE MINORITY

United States Senate OFFICE OF THE CLERK

COMMITTEE ON ARMED SERVICES 94 MAY 23 PII 1:45  
WASHINGTON, DC 20510-6056

May 16, 1994

Honorable William J. Perry  
Secretary  
Department of Defense  
The Pentagon  
Washington, D.C. 20301-1155

Dear Mr. Secretary:

The Committee has received information from an individual who wishes to remain anonymous concerning one of the pilots allegedly involved in the recent destruction of two U.S. Army helicopters by U.S. Air Force aircraft over Iraq. According to the information provided to the Committee, an Air Force colonel named Sonderheim, who is currently stationed in SOUTHCOM, has allegedly made a number of comments concerning one of the pilots:

1. Col. Sonderheim served as squadron commander of one of the pilots, and that pilot is now squadron commander of a unit in Turkey.

2. Col. Sonderheim found it necessary to rate this pilot very poorly and recommended that he be separated from the Air Force for dangerous flying and lack of judgment. This was the only time that he had ever rated a pilot so harshly.

3. The damaging OER was "pulled" because the pilot was a favorite of some senior officers. In its place, a favorable OER written by the Wing Commander was sent forward and placed in the pilot's record.

4. Col. Sonderheim characterized the pilot as "trigger happy."

The credibility of this information is unknown, and is forwarded to you for appropriate consideration in view of the ongoing investigation of the incident over Iraq.

Sincerely,

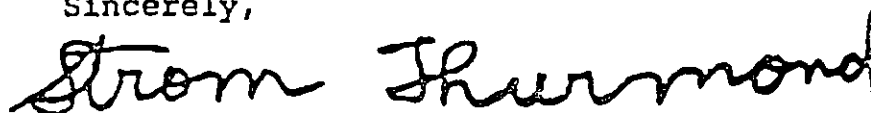

Strom Thurmond  
Ranking Republican Member

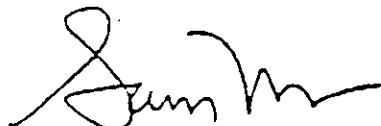

Sam Nunn  
Chairman

10721