

**AIRCRAFT  
ACCIDENT INVESTIGATION BOARD  
REPORT**

**US ARMY UH-60  
BLACK HAWK HELICOPTERS  
87-26000 AND 88-26060**

**VOLUME 19**

**TAB AA**

**AIRCRAFT  
ACCIDENT INVESTIGATION BOARD  
REPORT**

**COPY**

15

**OF**

14

**AFR 110-14 AIRCRAFT ACCIDENT BOARD  
INDEX OF TABS**

- O Additional Substantiating Data Reports**
- P Statement of Damage to Private Property**
- Q Documents Appointing Safety Board (Not Applicable)**
- R Diagrams**
- S Photographs from Safety Report (Not Applicable)**
- T Individual Flight Records/Personnel Records**
- U Aircraft Maintenance Records**
- V Testimony and Statements of Witnesses**
- W Weather Observations**
- X Statements of Death**
- Y Appointment Documents**
- Z Photographs**
- AA Regulations and Directives**
- AB Administration and Glossaries**
- AC Other Documents**

**O  
P  
Q  
R  
S  
T  
U  
V  
W  
X  
Y  
Z  
AA**

**TAB AA**

**REGULATIONS AND DIRECTIVES**

**AA-1 OPC Airspace Control Order and SPINS, 12 December 1993**

**AA-2 Extracts from MCM 3-1**

**(See Classified Addendum)**

**AA-3 Extract from Aircrew Read File 183**

**(See also Classified Addendum)**

**AA-4 Multi-Command Regulation 55-33, E-3 Operating Procedures  
with 552 ACW Supp 1**

**AA-5 Air Combat Command Regulation 51-60, Training Management  
for Command and Control Aircrews**

**AA-6 Extracts from DA Pamphlet 738-751, Functional User's Manual  
for the Army Maintenance Management System**

**AA-7 552nd Operations Group Operating Instruction 60-2,  
552nd (Deployed) Turkey Operating Procedures**

**AA-1**

**AA-8 Extract from Eagle Detachment Read File, Annex A, Daily  
Requirements**

OPERATION PROVIDE COMFORT  
 AIRSPACE CONTROL ORDER  
 AND  
 STANDING SPECIAL INSTRUCTIONS  
 VOLUME I  
 VOLUME II  
 EFFECTIVE 12 DEC 93

CERTIFICATE

I certify that I am the Records Custodian for the Accident Investigation Board concerned to investigate the crash of two U.S. Army Black Hawk Helicopters in the no fly zone in northern Iraq on 14 April 1994, and that this is a true and accurate copy of the records which are kept in my records system.

*J. M. [Signature]*  
 11/94

*W. J. [Signature]*  
 WILLIAM J. BARRY, CAPT USAF MCC  
 Records Custodian  
 Office of the Inspector General

VOL I  
PROVIDE COMFORT AIRSPACE CONTROL ORDER and STANDING SPINS  
EFFECTIVE DATE: 12 DEC 93

1. AIRSPACE CONTROL ORDER (ACO) PROCEDURES:

Aircrews are responsible for reviewing all information in VOL I & II. Nothing in this ACO releases the DETCO/flight lead of ensuring safe tactical execution. The ATO will be executed as published unless change is coordinated & approved by CFAC. Additional information/restrictions are written in Air Tasking Orders (ATO), Aircrew Read Files (ARF), and/or directed by Mission Directors/Airborne Control Element (MAD DOG/DUKE). All times will be in Zulu. Changes to ACO are noted by a vertical line in left margin.

2. Mission Directors (MAD DOG/DUKE):

Direction from MAD DOG/DUKE is final (RTBs, retrograde, etc); Confirm, authenticate (if required), then execute. Aircrews experiencing unusual circumstances/occurrences will pass details to DUKE or COUGAR. DUKE will work through MAD DOG to pass info to CFAC/DO. (Let DETCOs know ASAP.)

SOF - Works airfield/safety concerns within 50 nm LTAG (Incirlik);

MAD DOG - Works mission elements within 50 nm LTAG

DUKE - C2 link to CFACC/CTF (On AWACS)

COUGAR - AWACS Crew... Provides radar picture, comm and ATC.

3. Comm:

- Contact MAD DOG CH-7 (or via maintenance expediter) prior to start (don't start until cleared.)
- Call MAD DOG prior to takeoff for update
- Load HQ, get Mickey (338.025) and check before take-off
- Take off on CH-3/4 and proceed VFR/IFR as required. Contact Departure (CH-4) leaving control zone
- Check in with COUGAR on enroute freq at 50 NM from Incirlik with enroute altitude
- Check HQ with COUGAR approaching DERIK (auto-TOD available on 399.0)
- Check in with DUKE (CH-9) approaching JUMP PT and receive words
- Switch to tanker primary (CH-10) entering ROZ 2 or 3 (if AAR)
- Switch to TAOR primary (CH-5)/HQ after tanking/before entry in TAOR
- Check in with COUGAR on enroute frequency with recovery altitude
- Check out with DUKE (CH-9) approaching JUMP PT
- Check out with COUGAR at K-Town
- Contact approach (CH-14) entering 50 NM circle, state: VFR/IFR intentions
- Contact Tower (CH-3) for landing instructions
- Squawk IAW ATO, modes and codes are "sweet" unless reported otherwise
- Call signs are 1,2,3,4 (not 31,32 etc...).
- COUGAR will give a "Heads up" call when approaching within 5 NM of SYRIA, IRAN or 36 degrees north. Acknowledge and check position.

4. ALTITUDES & ROUTES - (Fighters):

- For all operations use altimeter setting 29.92 in/1013 mb when above 5000 AGL (or specified transition altitude). The local (TAOR) altimeter setting will be provided by DUKE on initial check-in for low level operations. (Recce may use AOR altimeter for target runs, when required)
- Special Corridors (SCs) are 10NM wide (centerline +/- 5 nm); don't deviate without approval or unless emergency is declared with AWACS
- SC are blocked FL 180<sup>2</sup>- FL 400 (IFR, east-odd, west-even). Avoid blocks FL 210-230 and FLs 290-350 from 50 NM circle to 70 NM east of K-Town. Formations remain within 2 nm.
- Gate 1, FL 200-400. Avoid ROZ 3 (FL 150-FL 190) approaching or departing gate 1. Tankers are not required to use gates

- Low Level Transit Routes (LLTRs) for helicopters and other SC information located in ACO VOL II
- If not VMC by JUMP point, contact DUKE for instructions
- Turkish training area overlaps SC 15-35 nm east of K-Town. A potential conflict exists here - HEADS UP!
- Do NOT overfly known friendly populated areas (i.e., K-town/Irbil) with free fall munitions.

#### 5. Air Refueling:

a. Unless coordinated, fighters will plan to be at Sirsenk (ARCP) at ARCT (within 2 minutes). Use radio silent operations to the maximum extent possible when on tankers. Tankers will have A/A TACAN/MODE II on. AAR refueling is not authorized outside of ROZs unless for emergency.

b. State all altitudes in the clear for refueling, do not use base plus (i.e., state FL230 vice "base plus XX"). Use 29.92"/1013mb for refueling and squawk Mode C.

c. AAR will be conducted VMC unless IMC ops are approved. Tankers will coordinate altitude/track changes to remain VMC with COUGAR/DUKE. Weather permitting, fighters descend to 1000' below fragged tanker altitudes entering ROZ 2. Climb to refueling altitude IAW appropriate AAR T.O.s/regs, clear your flight path! Depart ROZ 2 at tanker altitude unless refueling from highest tanker, in which case, departure from above the tanker is approved. Avoid AAR departure point N36-52.5 E043-00.3 (Dahuk Dam - a common use INS update point) entering ROZ 2.

d. If IFR AAR is approved, DUKE/COUGAR will increase tanker separation by 3000' minimum to provide 1000' altitude blocks above and below tankers for IFR separation. Expect to RTB unless mission critical.

#### 6. Recovery:

- Enroute: Formations will establish 10 nm spacing by K-town (DAN 060/80). If daytime and Incirlik VFR overhead is open (wx > 2500/5 km), 2-ship formations may request to join another 2-ship (4-ship max) to expedite recovery/VMC split-up. Otherwise, recover/penetrate 2-ship maximum.

- Letdown: Establish 300 KIAS from K-town to 50 NM circle, contact approach control, re-check weather, and state intentions (i.e., IFR/VFR (as req'd) to VFR entry point, straight-in, or published approach). Hold 300 KIAS until split-up, or until 15 DME (heavy).

- Split-up for VFR Straight-In: RWY 23: Split/drag inside 10 DME (2 ship) or 17 DME (4-ship). RWY 05: Split/drag as above or during turn to base/final. Maintain visual separation. Fighters should be 1500' MSL at 5 DME (RWY 23) or 7 DME (RWY 05) to deconflict overheads.

- Split-up for IFR/Night Approaches: Expect/request ATC to split/drag #2 at 17 DME (RWY 23). Lead holds 300 KIAS until 12 DME. Request separate approaches/maintain radar separation. For RWY 05, split IAW above or before turn to base/final.

- VFR Overhead Patterns: 2000' MSL, 350-400 KIAS. Do not overfly WSA. No overheads on Sunday, Turkish holidays, or with freefall munitions. Sunday is designated IFR/Instrument recovery day.

#### 7. REQUIRED FUEL RESERVES:

- VFR: Land with normal VFR fuel reserve plus fuel to allow for 15 minutes of holding (Ref OPC ACO Vol I, Atch 1, until incorporated into OPC Inflight Guide).

- IFR/NIGHT: Land with divert fuel for KONYA or designated divert base. Plus fuel to allow for 15 minutes of holding (Ref OPC ACO Vol I; Atch 1, until incorporated into OPC Inflight Guide).

8. Airspace Deconfliction in Tactical Area of Responsibility (TAOR) (excluding low fly areas (LFAs)):

a. Aircrews must always be ready to defend against Iraqi threats, particularly tactical SAMs/AAA fire. Aircraft will fly at tactical airspeeds. Transonic or supersonic airspeeds are prohibited unless required for safety. Should ground fire be noted, aircraft will abort low altitude operations, climb above 4500' AGL, and either engage, or retrograde IAW ROE. Contact DUKE via HAVE QUICK or KY-58 and have area restricted from further low altitude overflight.

b. ATO will designate a General CW/CCW flow plan (for non air-to-air DCA) to minimize 180-out passes (even-day=CW, odd-day=CCW). Flight leads coordinate with DUKE/other players for block swaps, changes, or deconfliction in event of fallout/weather. Check ATO for mission, i.e., primary/secondary air-to-air, SEAD, swing, etc. This general flow does not restrict recce tactics. Plan and fly smart.

- Air-to-air mission commander directs position of CAPs based on threat and assets (default plan: first players enter east CAP; follow on players then enter west CAP). Altitude Blocks as follows:

Pri A/A (F-15C)	FL270 and above	Swing (F-15E)	FL160-180
Sec A/A (F-16C)	FL230-260	Recce	FL100-150
SEAD (F-4G/F-16, EF-111)	FL190-220		

Above altitude guidance is in lieu of a coordination brief (i.e., CFM). Any other pre-coordinated plan must conform to CTF/CG tactical guidance, and be coordinated with CFAC/DO and/or DUKE.

c. Special Emphasis Targets (SETs) are identified in ATO – DON'T CHANGE. Minimum altitude is 10,000' MSL. Deconflict prior to simulated attacks and ensure SEAD coverage if in SAM rings. Do not squeeze trigger, pickle button, or enter LFA (unless fragged).

9. AUTHENTICATION: OPC uses two letter authentication procedures. The first letter will be the row: the second letter, the column. The response will be the non-boldface letter below the intersection of the row and column. If the last row is used, the proper response lies in the first row (e.g. wrap-around from bottom to top).

10. Operations in Low Fly Areas (LFAs) (At or below FL090):

- The two operational reasons for aircraft to fly low are: 1) the requirement for coalition presence, and 2) to maintain low-altitude proficiency for specific attack profiles. Coalition aircraft will adhere to the following procedures:

a. Check-in with Cougar on AOR primary before entering scheduled low fly areas for words/deconfliction with Eagle flights (UH-60s)

b. LFAs are over generally low threat areas. Do not fly over populated areas. If ground fire is noted, aircraft will abort low altitude operations, climb above 4500' AGL and retrograde from the area. Contact DUKE via HAVE QUICK or KY-58 and have the area restricted from further low altitude overflight. DO NOT ATTACK UNLESS DIRECTED.

c. Low fly airspace will be scheduled by CFAC/DO and published in the ATO. Only those flights scheduled/tasked will enter the low fly areas. Minimum altitude is current guidance in Operation PROVIDE COMFORT Aircrew Read File (ARF) or National Directives, whichever is higher. Avoid populated areas.

11. Weather Requirements:

- Above a cloud deck - 5000'/5 NM clear of clouds
- No IMC operation in TAOR south of security zone



12. Emergency Jettison:

- Avoid jettison over any populated area, in or out of Iraq.
- AOR : 2 NM NW of Saddam Dam (N36-39 E042-47), in lake
- Local : DAN (Incirlik TACAN CH 21) R-185/038, in ocean

13. BINGO:

- Fuel required to return to Incirlik with either VFR/IFR fuel reserve, as appropriate
- Combat/SAR bingo:
  - With Tanker available: Fuel to Batman or Diyarbakir (as specified by DUKE)
  - Without tanker: Fuel to Incirlik (unless directed by DUKE to use Batman/Diyarbakir fuels)

14. Runway Separation:

- Full Stop - 3000' similar aircraft, 6000' dissimilar or night, full rwy behind EF-111/KC-135, and 7500' behind Turkish fighters
- Drag Chutes - when TAF jets deploy drag chutes on or near the runway, ATC will issue an advisory to the pilot as to its position. If aircrew cannot taxi or land/turn-off safely, go around or stop.

15. Rules of Engagement:

- Classified ROE and SPINS, as published in Aircrew Read File (ARF).
- No intercepts or radar locks of known friendly aircraft within the (TAOR).
- No intercepts conducted on any aircraft in Turkish airspace unless approved by AWACS; however, during CFM, Turkish OPC fighters may conduct intercepts IAW HQ USAF PLAN 4636 (FIGHTING EDGE)

16. Standard terms:

- "SPIKE" - RWR indicates AI radar
- "BUDDY SPIKE" - RWR indicates friendly radar; should be followed by reply from the aircraft with the radar lock
- "RAYGUN" - Your radar is locked onto an unknown aircraft - Call "BUDDY SPIKE" if it's on you
- "ROLEX" - delay entire ATO for stated amount (entire flow stays intact), (usually occurs in 30 minute increments)
- "SLIP" - delay launch (readjust to regain original flow ASAP) but usually ARCT's, AOR, Area, landing times stay same unless specifically changed. Contact MAD DOG/DUKE for any changes to ARCT.

17. SAR:

- Ensure proper pre-flight of survival equipment and set emergency beacon on seat (if applicable)
- Review ISOPREP, evasion plan of action (EPA), and daily SAR codes
- During SAR, attempt contact on Guard or Alpha frequency IAW SAR spins

PROVIDE COMFORT AIRSPACE CONTROL ORDER VOL 1, ATCH 1

OPC FUEL REQUIREMENTS

(Supercedes OPC Aircrew Read File #196, 15 Jul 93)

This page will remain in effect until incorporated into new OPC Inflight Guide

Aircraft Type	OPC Combat Drag Index	Initial or FAF*	Konya Divert**
F-16C	196	2000 LBS	3300 LBS
F-15C	49	3300 LBS	5500 LBS
F-15E	100	4000 LBS	7000 LBS
F-111F	50	5000 LBS	7500 LBS
EF-111	0	6000 LBS ***	6800 LBS
F-4G	50	3700 LBS	6000 LBS
A-10	60	1800 LBS	3600 LBS
F-1	46	2310 LBS	2600 LBS
JAG	48	1200 KG	1800 KG
HARR	35	2200 LBS	3100 LBS
KC-135 FR	0	20,000 LBS	20,000 LBS
KC-135 US	0	25,000 LBS	30,000 LBS
VC-10	0	22,000 LBS	28,600 LBS
AWACS	0	25,000 LBS	30,000 LBS

\* Minimum VFR fuel plus 15 minutes of reserve for holding (10,000 MSL, max endurance at listed OPC drag index)

\*\* Fuel for Bravo penetration at Incirlik, climb to optimum altitude, max cruise, penetration/approach at Konya, land with VFR fuel reserve (computed at listed OPC drag index)

\*\*\* Uses Cannon AFB 55-111 Ch. 8 fuel requirements for single runway ops plus holding reserve



VOL II  
PROVIDE COMFORT AIRSPACE CONTROL ORDER/STANDING SPINS  
12 DEC 93

1. AIRSPACE CONTROL ORDER (ACO) PROCEDURES: Aircrews are responsible for reviewing all information in VOL I & II. Nothing in this ACO releases the DETCO/flight lead of ensuring safe tactical execution. The ATO will be executed as published unless change is coordinated & approved by CFAC. Additional information/restrictions are written in Air Tasking Orders (ATO), Aircrew Read Files (ARF), and/or directed by Mission Directors (MAD DOG/DUKE). All times will be in Zulu.
  
2. ALERT CREW PROCEDURES:
  - A. All unit DETCOs will furnish building and room number along with a phone number where they can be reached 24 hours a day. When these individuals cannot be reached at the number(s) provided, the Command Post (6-3100) must be kept informed of their location or designated representative and his location.
  - B. DETCOs will ensure that enough crews to cover the "A" mission numbers on the down day printed schedule are available if needed. Designated alert crews without pagers will remain on base. Alert crews with pagers may go off base, but no further than the "Alley".
  
3. GENERAL RULES:
  - A. All aircraft flying missions in support of PC will contact the Mission Director ("MAD DOG") on UHF 315.4 prior to start and take-off.
  - B. Cougar (AWACS) provides flight following to and from the TAOR (except when not capable of radar surveillance ("Midnight")) and in ROZ 01, 02 and 03. The actual control of the airspace is maintained by Turkish ARTCC (INDIA/MARDIN).
  - C. If aircrews are unable to comply with published ACO procedures (i.e. emergency or thunderstorms), a request for deviations must be made from Mardin through AWACS or an emergency declared.
  - D. If safety of flight (fuel state) is jeopardized by communication delays, squawk 7700, declare an emergency, and RTB.
  - E. Deviations will be recorded in a written report to DETCOs, then CFAC OG/CC ASAP after landing.
  - F. Transition Altitude (TA) for Turkey is 5,000 MSL (individual airfields could be higher, e.g. LTCC IS 7,000 MSL). An altimeter setting of 29.92 will be used above TA.
  - G. Aircrews will use the 29.92"/1013mb altimeter setting whenever operating above 5000 ft AGL, to include the special corridors; ROZ 1, 2, and 3; and the TAOR. Aircrews will use local altimeter setting when operating below 5000 feet AGL.
  - H. Encoded Altitudes: The base number published in the ATO is to be used in the TAOR to encode altitudes ("Altitude is base plus..."). Aircraft in transit to/from the TAOR or operating in ROZ 1, 2, and 3, and all aircraft refueling, will report altitudes in the clear (Flight Level XX).
  - I. All altitudes are above ground level (AGL) unless otherwise stated.
  - J. Formations will be flown with a maximum spacing of 12,000 feet while transiting from Incirlik to the gates and from the gates returning to Incirlik.
  - K. All Special Corridors (SC)/Low Level Transit Routes (LLTR) will be flown in VMC to the max extent possible within the corridor altitude blocks, except as noted in Para 12 in the ACO.
  - L. Maintain VMC if possible and fly IFR hemispheric altitudes in special corridors. Deviations from these altitudes may be approved/ directed by AWACS or Mardin Radar.

OPERATION PROVIDE COMFORT ACO - 12 DEC 93

M. VFR hemispheric altitudes of odd plus 500 feet MSL and even plus 500 feet MSL will be used when transiting LLTRs. Attempt to fly as close as possible to 6,000 feet, (8,000 MSL) (e.g. 7,500 MSL and 8,500 MSL), weather permitting.

N. AWACS Procedures: All missions will be planned with AWACS working in Restricted Operating Zone (ROZ) 01, unless under contingency ops (see Para 18, Contingency Operations With Degraded AWACS on station). Contingency ops must be approved by the CFACC.

(1) Aircraft will be advised when AWACS is not capable of radar surveillance of the TAOR or when AWACS depart station for RTB.

(2) If unable to contact INDIA and AWACS is "Midnight", all aircraft will make procedural position reports on enroute frequency when over Kahramanmaras ("K-TOWN") and Derik. Format will be: Callsign, Position, and Altitude. See Para 18 for additional guidance when AWACS is not on station.

O. IFF/SIF will be used during the entire flight. On initial check-in with AWACS, your MODE-IV is sweet unless AWACS tells you otherwise. Primary identification will be modes II and IV. Turn your Mode III and C to standby or off upon entering the TAOR. Squawk all modes and codes after exiting. Wingmem will squawk Mode III/C standby the entire sortie unless requested by ATC/AWACS or until separated from the lead aircraft.

P. Avoid overflying all populated areas in Turkey by 2 nm laterally. Do not overfly known friendly populated areas (i.e., K-town/Irbil) with free fall munitions.

4. LOCAL AIR TRAFFIC CONTROL (ATC) PROCEDURES:

A. Climbout Terminology: Controllers will use the terminology "Climbout as Published" for multiple radar/instrument approaches. This procedure, published in IABR 60-4, is -- "Maintain 1500 ft MSL until departure end, fly heading 140, climb and maintain 4000 feet MSL." Do not overfly the weapons storage area (WSA) unless an emergency exists.

B. VFR Entry Altitudes, (Pad, Snake, Warehouse): In accordance with OPC Aircrew Aid, all aircraft will be at 3000' MSL at these VFR entry point and descend to 2000 ft MSL at 5 NM (7 DME RWY 05, 5 DME RWY 23) if going to initial. Straight-in's will be at 2000 MSL at the VFR entry point and then descend to 1500 MSL at 5 NM.

C. No-Fly Area: Unless departing, recovering, or flying instrument approaches at Incirlik, avoid the airspace within 10 NM and 10,000 ft MSL of the airfield unless in radio contact with the control tower or RAPCON.

D. Incirlik GOOSE ONE and GOLD/RED/BLUE ONE STEREO Departures: These are not standard instrument departures (SIDs). The procedures allow aircraft to depart on an IFR clearance when the ASR radar is available. All stereo departures are short range clearances designed to terminate at a designated clearance limit before aircraft leave approach control airspace. When able to maintain VMC conditions or upon reaching the clearance limit, aircrews will cancel IFR, at which point IFR service will be discontinued and service will consist of traffic advisories only.

E. On Sundays and Turkish Holidays, aircraft will recover via a straight-in full stop (i.e. no overhead patterns).

F. All PROVIDE COMFORT aircraft will report 50 nm from the base with intentions (IFR/VFR, Stage 2, TACAN, ILS, straight-in, overhead). VFR overhead pattern is 2000' MSL at 350-400 KCAS and VFR straight-in pattern altitude is 1500' MSL. All aircraft will be at 1500' by 5 DME (Rwy 23) or 7 DME (Rwy 05). All aircraft will recover with VFR fuel reserve plus 15 min (VFR conditions) or with Konya divert fuel (IFR conditions) +15 Min!

G. Aircraft carrying live air-to-air or live air-to-ground missiles only may return to the overhead pattern. Aircraft loaded with free-fall munitions will return to straight-in patterns.

OPERATION PROVIDE COMFORT ACO - 12 DEC 93

H. Emergency Runway: In the event the main runway is closed/anticipated closed for emergency, all aircraft will plan to land on the north parallel. The SOF and DUKE will ensure that ATC/COUGAR transmit advisories on Guard and have crews conserve fuel on recovery.

5. NIGHT OPS INCIRLIK MTCA:

- A. Aircraft will not perform night overhead patterns.
- B. Between local sunset and sunrise, aircraft in the Incirlik MTCA will request an IFR clearance when ready for recovery. Night VFR in the MTCA is not authorized unless on an approved training route.
- C. The Bravo recovery is a published enroute descent to an approved ASLAR approach, and may be flown at night with ATC approval.
- D. FLIP published approaches are also available, if approved.
- E. For operations after sunset the North parallel taxiway is not suitable for an emergency landing. If landing after sunset, aircrews will plan on landing with divert fuel plus 15 minutes reserve for holding.
- F. On weekends there are no suitable divert airfields open after sunset therefore all aircrews will plan on landing before official sunset.

6. AIRCREW/SOF COORDINATION:

- A. All aircrews experiencing difficulty and/or an IFE will contact the SOF and relay all pertinent information. The SOF will have an appropriate squadron representative come up on the SOF frequency, CH 6, 262.625, to assist in working the problem.
- B. The SOF will "stay in the loop" and coordinate sequencing in the event of multiple IFE'S. The AWACS or Tanker SOF will notify the Tower SOF when working an AWACS or Tanker IFE.

7. EMERGENCY JETTISON PROCEDURES:

- A. Local Area:
  - (1) If able, aircrews will attempt to jettison munitions IAW the 39 TACG Aircrew Aid on the DAN R-185/038.
  - (2) If unable to get to the DAN R-185/038 for any reason, attempt jettison over water in the Mediterranean and inform SOF and Mad Dog.
- B. TAOR:
  - (1) If able, pilots will jettison ordnance/stores in the lake jettison area. If unable to reach the lake jettison area, jettison in an unpopulated area.
  - (2) The lake jettison area is defined as 2 NM northwest of the Saddam Dam (N36-39 E042-47, Q West R-343/55) in the middle of the lake. Jettison altitude will not be lower than 3000 feet. If a high altitude/IFR jettison is needed, aircrew will ensure munitions/stores land in the lake north of the dam.
- C. Avoid jettison over any populated area, in or out of Iraq.

8. INCIRLIK REDUCED RUNWAY SEPARATION:

A. Reduced runway separation is approved for all OPC fighter aircraft. This reduced separation criteria is a guide and does not relieve pilots of the responsibility to exercise good judgment when landing behind heavier aircraft. The following reduced runway separation will be used until dissolution of PROVIDE COMFORT.

OPERATION PROVIDE COMFORT ACO - 12 DEC 93

(1) Day Operations:

- a Similar full stop landings 3000 feet
- b Dissimilar full stop landings 6000 feet
- c Landing behind a form. landing 6000 feet
- d Touch-and-go behind full stop Full runway
- e Full stop behind F/EF-111 Full runway
- f ASLAR 4000', except faster following A-10/OA-37 6000'
- g Behind Turkis fighters 7500 feet

(2) Night/Wet Runway Operations:

- a Similar full stop landings 6000 feet
- b Dissimilar full stop landings Full runway
- c ASLAR 6000 ft

(3) Tower will attempt to sequence Turkish F-5 aircraft a full runway length behind full-stop CFAC Fighters. When TAF jets deploy drag chutes at end of runway, ATC will issue an advisory to the pilot as to its position. If aircrew cannot taxi or land/turn off safely, go around or stop.

9. WEATHER CRITERIA:

A. Approach criteria for all PC fighter aircraft are as follows:

(1) <u>WX CAT</u>	<u>CEIL/VIS</u>	<u>NATO WX CODE</u>
	UNUSABLE	Black
	200/.9KM OR GCA Min	Red
A	Published Mins	Amber
B	300/1.6KM	Yellow
C	500/2.4KM	

(2) All PC fighter aircraft will use CAT B as local minimums/ lowest pilot weather category (PWC).

(3) TAKEOFF MINIMUMS: Local minimums for a compatible, available approach or PWC, whichever is higher.

(4) WEATHER REQUIRED TO START APPROACH:

(a) At Incirlik:  
Published MINS or PWC, whichever is higher. ONCE STARTED - Descend no lower than published MINS or PWC, whichever is higher.

(b) At Turkish Bases with US published approaches: 500/2.4 KM, published MINS, or PWC, whichever is higher.

(c) At Turkish Bases Without US published Approaches: TO BEGIN - 1500/5KM.

B. TAOR Weather Requirements:

(1) The first aircraft in the TAOR will conduct a weather check on the air refueling frequency.

(2) Aircraft must have 5000 feet clearance above/below cloud decks and 5NM visibility.

OPERATION PROVIDE COMFORT ACO - 12 DEC 93

10. NAVIGATION POINTS:

<u>DESIGNATION</u>	<u>LAT/LONG</u>	<u>DESCRIPTION</u>
SC-1/2 POINTS:		
K-TOWN	N3734/E3658	WAY POINT
DERIK	N3721/E4017	WAY POINT
JUMP PT.	N3732/E4153	WAY POINT, (LV/JOIN SC-1/SC-2)
LLTR AND SC-1A/SC-2A POINTS:		
ALPHA	N3717/E3648	WAY POINT
BRAVO	N3720/E3753	WAY POINT
CHARLIE	N3714/E3914	WAY POINT
DELTA	N3729/E4050	WAY POINT
ECHO	N3727/E4152	WAY POINT
GATES:		
GATE 01	N3715/E4239	TAOR ENTRY/EXIT
GATE 02	N3722/E4310	TAOR ENTRY/EXIT
GATE 03	N3714/E4347	TAOR ENTRY/EXIT
REFUELING ANCHOR POINTS:		
EXXON	N3730/E4330	ROZ 02 NORTH RENDEZVOUS PT.
SIRSENK	N3705/E4316	ROZ 02 SOUTH RENDEZVOUS PT.

11. TAOR GATES:

Three gates are located on the Turkish/Iraq border for purposes of entry/exit into the TAOR. No other entry/exit points are authorized. The gates are 10NM wide. Every attempt will be made to use GATE 01 to minimize conflicts with Turkish Army helicopter traffic operating from surface to 1500 feet along the Turkish/Iraqi border.

GATE 01: Entry/Exit Altitudes for GATE 01:  
 Helicopters: 8000 feet MSL  $\pm$ 500' (7500 eastbound, 8500 westbound)  
 Transport A/C: FLO70-140  
 ALL Other A/C: FL200 -400. Avoid ROZ 3 (FL150-190).  
 GATE 02: Entry/Exit AT FL180-200  
 GATE 03: Entry/Exit AT FL180-200  
 NOTE: Tankers are not required to use the gates.

12. SPECIAL CORRIDOR (SC) ROUTES: SC routes have been established for enroute travel to/from the TAOR and/or refueling tracks. SC routes are 10NM wide unless noted otherwise.

- A. SC-1: Eastbound traffic will fly block FL180-400.
- (1) Incirlik to ROZ 02 North: Incirlik, K-Town, Derik, JUMP PT, EXXON, ROZ 02 North. Prior to entering ROZ 02 North, coordinate with AWACS to deconflict with refueling traffic and be on the local altimeter setting.
  - (2) Incirlik to ROZ 02 South: Incirlik, K-TOWN, Derik, JUMP PT, GATE 01, Sirsenk, ROZ 02 South. Prior to entering ROZ 02 South be at FL200, or coordinate with AWACS to deconflict with refueling traffic.
  - (3) Incirlik to TAOR: Incirlik, K-Town, Derik, JUMP PT, GATE 01, TAOR. Enter GATE 01 at FL190, or deconflict with AWACS, and avoid ROZ 02 South.
  - (4) Incirlik to ROZ 02 North/South (Tankers only): Incirlik, K-Town, Derik, JUMP PT, direct ROZ 02 North/South.
  - (5) Incirlik to ROZ 01 (AWACS): Incirlik, DAN 010/035, K-Town, ROZ



OPERATION PROVIDE COMFORT ACO - 12 DEC 93

01 AT FL320.

(6) Avoid blocks FL210-230 and FL 290-350 from 50NM circle to 70NM east of K-town. Fly IFR hemispheric (East - odd, West - even) on the SC.

B. SC-2: Westbound aircraft on SC-2 will fly in the block FL180-400. A-10 aircraft may fly block FL150-200 Westbound only when approved by MARDIN radar via AWACS if required.

(1) ROZ 02 North to Incirlik: ROZ 02 North, GATE 01, JUMP PT, Derik, K-Town, Incirlik.

(2) ROZ 02 South to Incirlik: ROZ 02 South, GATE 01, JUMP PT, Derik, K-Town, Incirlik. Exit ROZ 02 South at FL180 or deconflict with AWACS and maintain until GATE 01. After GATE 01 coordinate with AWACS for RTB flight level.

(3) TAOR TO Incirlik: Exit via GATE 01 FL150 or above FL200, JUMP PT, Derik, K-Town, Incirlik. After GATE 01 coordinate with AWACS for RTB flight level.

(4) ROZ 01 to Incirlik (AWACS): ROZ 01, K-Town AT FL320.

(5) Avoid blocks FL210-230 and FL 290-350 from 50NM circle to 70NM east of K-town. Fly IFR hemispheric (East - odd, West - even) on the SC.

C. SC-1A: Incirlik, ALPHA, BRAVO, CHARLIE, DELTA, ECHO, GATE 01. (Primary departure for airlift missions)

D. SC-2A: GATE 1, ECHO, DELTA, CHARLIE, BRAVO, ALPHA, Incirlik. (Primary recovery for airlift missions). Flight altitudes for aircraft on SC-1A and SC-2A: helicopters will fly at 6,000 feet AGL (8,000 MSL  $\pm$ 500', 7500 MSL eastbound and 8500 MSL westbound). Fixed wing aircraft will fly in the block FLO70-140.

E. SC-4: N36-35 E36-11 (Iskenderun) to Incirlik at 1,000 feet Corridor is 5NM wide.

F. SC-5: N36-50 E34-40, N36-55 E35-27, Incirlik at 1,000 feet Corridor is 10NM wide.

NOTE FOR ROUTES SC-4 AND SC-5: All helos which will fly in these corridors will send their flight plans to FAX number 9-8891-1338 or telephone number 9-8891-2235, one hour prior to flight. They will also maintain contact with Incirlik Approach Control during all flights.

G. See ACQ (GENERAL FLIGHT RULES) for additional information regarding altitude deconfliction procedures while flying on SC routes.

13. RESTRICTED OPERATING ZONES:

A. ROZ 01: N3815 E4200 - N3815 E4300 - N3753 E4400 - N3725 E4400 N3725 E4200. Altitudes are from FL250-310. Turkish fighters and AWACS will refuel in ROZ 01. AWACS will contact Diyarbakir control tower or Mardin Radar on 364.2 when entering and exiting ROZ 1. Local traffic and test flights between FL250-310 will be to Mardin Radar by Diyarbakir control tower. Mardin will transmit this information to AWACS. All flights between FL 250-310 in ROZ 1 will be under control of AWACS.

B. ROZ 02 NORTH: N3735 E4248 - N3735 E4400 - N3720 E4400 - N3722 E4248. ROZ 02 North, southern boundary follows the Turkey/Iraq border between N3720 E4400 and N3722 E4248. Altitudes are from 17,000-29,000 ft. ROZ 02 North tanker rendezvous point is EXXON. If required for Turkish National Interest, the floor altitude may be raised from FL 170 to FL 200 by Sector Operating Center 2 (SOC

OPERATION PROVIDE COMFORT ACO - 12 DEC 93

2, Turkish Air Force)

C. ROZ 02 SOUTH: N3722 E4248 - N3720 E4400 - N3655 E4400 - N3655 E4248. ROZ 02 South, northern boundary follows the Turkey/Iraq border between N3720 E4400 and N3722 E4248. Minimum altitude is 15,000 ft. ROZ 02 South tanker rendezvous point is SIRSENK.

D. ROZ 03: (AAR Area for Jaguar and Mirage aircraft only) N37-40 E41-50, N37-20 E41-50, N37-21 E42-12, N37-12 E42-36, N37-23 E 42-47, and then back to beginning. Altitudes are FL 150-190.

14. LOW-LEVEL TRANSIT ROUTES (LLTR):

A. LLTRs are two-way corridors limited in length and altitudes. These routes are 10NM wide. Aircraft will operate right of center-line and remain VMC. Altitude is 8,000 MSL  $\pm$ 500' (7500 MSL eastbound and 8500 MSL westbound) on the LLTRs. If aircraft weight or IMC conditions require a lower/higher altitude, contact India or Mardin Radar (Contact AWACS on ATO enroute freq) if Mardin does not respond).

B. LLTR DESCRIPTION:

LLTR 01 N37-54 E40-12, N37-48 E41-08  
LLTR 02 N37-48 E41-08; N37-43 E41-48  
LLTR 03 N37-43 E41-48, N37-27 E41-52,  
LLTR 04 N37-27 E41-52, N37-26 E42-12, SILOPI (N37-15 E42-30)  
LLTR 06 N37-18 E39-41, DIYARBAKIR (WILL JOIN SC-1A, SC-2A)

15. RESTRICTIONS:

A. General:

- (1) Fighter/Tanker Enroute Procedures:
  - (a) Cross Air Routes UA17, VB36 and UVW701D at FL200, FL240-280, or above FL350.
  - (b) Prior to hand-off from Incirlik Departure to AWACS at 50 NM, level off at FL200, FL240-280, or above FL350 to avoid the Airways.
  - (c) Coordinate a higher/lower cruise altitude through AWACS when clear of airways.
  - (d) Flying above or below the established SC-1/SC-2 altitude blocks must be approved by Mardin Radar through AWACS.
- (2) Incirlik to TAOR (AWACS "MIDNIGHT"):
  - (a) IMC - Make position report at K-Town. If unable to achieve VMC by JUMP PT, contact DUKE to request instructions.
  - (b) VMC - Proceed to JUMP PT. Make position reports at K-Town, Derik, and JUMP PT. At JUMP PT, DUKE will advise if cleared into the TAOR or will provide other direction.
- (3) Incirlik to TAOR (AWACS radar operating):
  - (a) IMC - If not VMC at JUMP PT, RTB. Coordinate even flight level with AWACS for west bound return.
  - (b) VMC - If VMC at JUMP PT enter TAOR for normal operations.
- (4) TAOR/ROZ to Incirlik:
  - (a) Overfly K-Town. This applies even if BRAVO recovery procedure is used.
  - (b) Contact approach control by K-Town but no later than the 50NM circle.
- (5) IMC Transit Altitudes for SCs: Due to the altitude restrictions crossing the airways UA17, VB36 and UVW701D, the following altitudes will be used when AWACS radar is not operating and all altitudes are IMC:

OPERATION PROVIDE COMFORT ACO - 12 DEC 93

<u>AIRCRAFT</u>	<u>EASTBOUND</u>	<u>WESTBOUND</u>
FRENCH	FL 190 (Ensure contact with Mardin radar if below FL 180)	FL 240
VC-10	FL 250	FL 240
HARRIER	FL 250	FL 340
US TANKERS	FL 250	FL 260
F-15E/EF-111*	FL 270	FL 280
AWACS	FL 320	FL 320
F-16/F-4	FL 270	FL 340
F-15C	FL 270	FL 360

16. TACTICAL AREA OF RESPONSIBILITY (TAOR):

A. The TAOR is defined as the area north of 36-00N latitude within the borders of Iraq, exclusive of ROZ 2. The security zone (SZ) is that area free of all Iraqi military, paramilitary, police, and security forces as defined in UNSCR 688. The Low Fly Zone is that area defined at the map at Atch-1.

B. No aircraft will normally fly south of 36-00N.

C. No aircraft will enter the TAOR until fighters with AI radars have sanitized the TAOR.

D. All fighters will contact "DUKE" prior to entering the TAOR for latest guidance. On RTB, when established on SC-2 and at enroute altitude, fighters will contact "DUKE" and report mission results. Coordinate frequency changes with AWACS. Use Have Quick or KY-58 (secure) to pass mission results. If unable to use one of these modes, file mission reports immediately after landing, unless the situation dictates an urgent real-time response by CFAC forces.

(1) Aircrews experiencing any unusual circumstances/occurrences while flying PC missions will report the incident ASAP to "DUKE" or "COUGAR" if "DUKE" is unavailable. "DUKE" will contact "MAD DOG" who will then pass the information to the CFAC/DO.

(2) During RTB, aircrews should confirm with Mad Dog, details of unusual circumstances/occurrences. These include but are not limited to:

- (a) Being intercepted by Turkish fighters.
- (b) Any intercept run on an "Unidentified aircraft".
- (c) Ground or air fire or acquisition/TTR spikes.
- (d) Any hostile acts in the TAOR.
- (e) Bogie/bandits north of 36-00N.
- (f) Near misses

E. RWR procedures. The standard brevity codes to be used to describe RWR AI indications while in the AOR are:

(1) "SPIKED": RWR indication of AI threat is displayed.  
Example: "STING 1, SPIKED SOUTHWEST", BIRDIE 350/30, BASE PLUS 8"

(2) "BUDDY SPIKE": Receiving friendly AI RWR. Should be followed by a reply from the aircraft who has the radar lock.  
Example: "STING 1, BUDDY SPIKE, BIRDIE 350/30, BASE PLUS 5"  
Reply: "ADLER 2"

(3) "RAYGUN": Your radar is locked onto an unknown aircraft. Request BUDDY SPIKE reply.  
Example: "STING 1, RAYGUN, BIRDIE 020/15, BASE PLUS 10"  
Reply: "HURRICANE 1, BUDDY SPIKE"

OPERATION PROVIDE COMFORT ACO - 12 DEC 93

F. Communications (Comm):

(1) Comm discipline is a must with both A/G and A/A players using the same frequency. Assume any comm over a clear frequency is compromised. Use the appropriate frequencies and codewords that are published in the daily ATO.

(2) All HAVE QUICK II (HQ-II) capable aircraft will operate in the "non-training" mode while working in the TAOR. Non HQ-II capable aircraft will use ATO Tactical freqs in the TAOR. Except for initial radio checks with COUGAR, HQ will not be used for enroute and AAR. Comm HQ-II Active Net will be published in the daily ATO.

(3) Contacts will be labeled "slow" if they are below 300 KTAS.

(4) AWACS will call when a Bandit track is "faded".

(5) Comm Format: Exact bullseye (B/E) of bearing, range, and altitude off primary bullseye will be used to identify all aircraft.  
Example: Cougar contact 2 groups; 1st group B/E (using ATC codeword) 180/10/2,000'; 2nd group B/E 270/20/10,000'.

(6) Frequency setup when F-1s are in TAOR (without HAVE QUICK):

(a) F-1s - Clear UHF TAOR freq.

(b) Wws - Clear UHF TAOR freq.

(c) F-15s - Clear UHF TAOR freq. and HQ TAOR freq.

(d) All others - HQ TAOR freq.

(7) Frequency setup when F-1s are in the TAOR and there are no F-15s: All players on clear UHF TAOR freq.

G. PC missions flown in the TAOR will avoid flying within 500 feet of any habitation. In heavily populated areas, PC aircraft tasked to fly low altitude will fly 1,000 feet above the highest obstacle within 2,000 feet horizontally of their flight path.

H. Supersonic Flight: No supersonic flight is authorized over Iraq unless specifically required for operational necessity (E.G. intercepts on a track believed to be of a hostile nature).

I. Rotary Wing Procedures:

(1) All helicopter flights will be accomplished between sunrise and sunset. This restriction does not apply to training flights in the Incirlik MTCA.

(2) Max altitude of 400 feet. Do not exit assigned block altitude unless positively cleared by AWACS.

(3) Unless operational requirements do not allow compliance, all rotary wing aircraft will operate at night with normal position lighting.

(4) Unless mission requirements will not allow compliance, all rotary wing aircraft should avoid known AAA sites and small arms ranges by the required distances.

(5) All known AAA sites and small arms ranges will be posted in Unit Operations and transferred to operational charts required.

17. AIRSPACE DECONFLICTION IN TACTICAL AREA OF RESPONSIBILITY (TAOR):

A. Aircrews must always be ready to defend against Iraqi threats, particularly tactical SAMs/AAA fire. Should ground fire be noted, aircraft will abort low altitude operations, climb above 4500' AGL, and either engage, or retrograde IAW ROE. Contact DUKE via HAVE QUICK or KY-58 and have area restricted from further low altitude overflight.

B. Aircraft will fly at tactical airspeeds. Transonic or supersonic airspeeds are prohibited unless required for safety.

C. A general CW/CCW flow plan will be implemented to maximize deconfliction

OPERATION PROVIDE COMFORT ACO - 12 DEC 93

and minimize 180-out passes. Direction will be published in ATO (ie. morning CW, afternoon CCW). The general flow does not restrict Recce tactics. Plan and fly smart. Minimum altitude guidance still applies. Flight leads will coordinate with other players/COUGAR for weather deconfliction. RECCE flights will plan routes accordingly.

- Primary /secondary air-to-air players are identified in the ATO  
- Air-to-air mission commander directs the position of CAPs based on the threat and assets (default plan: first players enter east CAP, follow-on players enter west CAP)

Pri A/A (F-15C)	FL270 and above	Swing (F-15E)	FL160-180
Sec A/A (F-16C)	FL230-260	Recce	FL100-150
SEAD (F-4G/F-16, EF-111)	FL190-220		

Above altitude guidance is in lieu of a coordination brief (i.e., CFM). Any other pre-coordinated plan must conform to CTF/CG tactical guidance, and be coordinated with CFAC/DO and/or DUKE.

D. Special Emphasis Targets (SETs) are identified in ATO and will not be changed w/o CFAC approval. Minimum altitude is 10,000' MSL. Deconflict prior to simulated attacks and ensure SEAD coverage if in SAM rings. (Do not squeeze trigger/pickle button. Do not enter LFA unless fragged).

E. Altimeter setting in the SC, all ROZs, and the TAOR is 29.92"/1013mb when above 5000 ft AGL and local altimeter when below 5000 ft AGL. The TAOR local altimeter setting will be provided by DUKE on initial check-in. Refer to all friendly aircraft altitudes in Iraq as "Base plus" and refer to all refueling flight level altitudes in the clear.

F. Authentication: OPC uses two letter authentication procedures. The first letter will be the row: the second letter, column. The response will be the letter below the intersection of the row and column. If the last row is used, the proper response lies in the first row (e.g. Wrap-around from bottom to top).

G. Low Altitude Operation in Low Fly Areas (At or below 9000' MSL:  
(1) If ground fire is noted, aircraft will abort low altitude operations, climb above 4500' AGL and retrograde from the area. Contact DUKE via HAVE QUICK or KY-58 and have the area restricted from further low altitude overflight.

(2) Coalition aircraft may use the designated low fly area IAW national guidance but fly no lower than the altitude specified in ARF.

(3) Low fly aircraft will be scheduled by CFAC/DO and published in the ATO. Only those flights scheduled/tasked will enter the low fly areas.

(4) Fighters operating in the low altitude environment confirm with Cougar deconfliction with Eagle flights (UH-60's) or contact Eagle on AOR primary.

18. CONTINGENCY OPERATIONS WITH DEGRADED AWACS ON STATION: (Performed with CFAC/DO Approval only.)

A. In cases when aircraft are in the TAOR without AWACS radar coverage, the following procedures will apply:

- (1) The DUKE remains the mission commander
- (2) The DUKE will direct all aircraft to single frequency (Have

OPERATION PROVIDE COMFORT ACO - 12 DEC 93

Quick if all fighters are capable, UHF if any fighters are not HQ capable).

(3) DCA aircraft pick-up responsibility for making all threat calls reference the appropriate bullseye.

(4) All aircraft continue with fragg mission.

(5) If unidentified tracks are observed north of 36-00N, all non-DCA/non-SEAD aircraft will retrograde north to security zone to orbit. Recces will be directed to RTB.

(6) DCA aircraft will take action IAW classified ROE or as directed by CFAC/DO through the DUKE.

(7) If AWACS radar comes back, AWACS will resume threat call responsibility and all aircraft will be cleared back to normal AOR frequencies.

19. CONTINGENCY OPERATIONS WITHOUT AWACS COVERAGE ON STATION: (Performed with CFAC/DO approval only)

A. In cases when aircraft are in the TAOR without AWACS, the following procedures will be used:

(1) The DUKE (back-up is tanker relay) will designate an air-to-air flight lead as mission commander. The mission commander will designate a single frequency for use and will be the on-scene commander; he will make decisions regarding retrograding, changing refueling altitudes/airspace, etc. He will coordinate with the tanker for additional support such as SAR (if required), and contact MADDOG for guidance. An alternate package commander will also be designated and will assume on-scene commander duties if the primary package commander is unable (aborts, RTB, etc.).

(2) If no F-15/16/WW aircraft are available as package commander and air cover, aircraft must relay the situation through the on-station tanker to MADDOG for a risk assessment, and decision to continue TAOR ops.

B. Communications:

(1) All PC missions will be flown under positive radar/radio control of Mardin Radar (callsign "INDIA"). If unable to contact India directly, contact the tanker designated as radio relay.

(2) All aircraft will be on enroute frequency from K-Town to abeam Diyarbakir. Abeam Diyarbakir switch to tanker refueling frequency for inflight refueling.

(3) After refueling, switch to Mission frequency prior to entering the TAOR and inform the package commander. The TAOR frequency may be monitored by the non-refueling fighter on the wing.

(4) When departing the TAOR for RTB, inform the Package Commander and stay on the Mission frequency until abeam Diyarbakir and then switch to enroute frequency.

(a) The primary mission frequency will be the ATO Have Quick (HQ) frequency when all fighters in TAOR are HQ capable.

(b) The primary mission frequency will be the ATO UHF frequency when non-HQ capable fighters are in the TAOR.

(5) If post-mission refueling; upon entering the ROZ, inform the package commander you are leaving the mission frequency and switch to tanker refueling frequency. After refueling, switch to mission frequency until abeam Diyarbakir and then switch to enroute frequency.

(6) The tanker with the longest On-Station time remaining will be the designated radio relay aircraft and will maintain "LISTENING WATCH" on mission frequency. An "OPS NORMAL" call to Mad Dog via Incirlik Airways will be made on the hour/half hour on one of the following HF frequencies:

OPERATION PROVIDE COMFORT ACO - 12 DEC 93

Primary - 11176, Secondary - 13214, Tertiary - 6738, and back-up freqs OF 3137, 6738, and 15015.

(7) For aircraft not equipped with secure (KY-58) communications, use the following procedure when there is a requirement to discuss sensitive, yet unclassified information between flight members:

(a) Inform AWACS (F-15/16 during contingency operations) you will be off frequency.

(b) Push to active back-up frequency A00.350.

(c) Limit operations on this frequency to 1-2 minutes.

(d) Report back on mission frequency.

C. F-15/F-16/F-4 Mixed Force Fighter Operations (MFFO): F-15/F-16 and F-4/F-16 aircraft may fly together when briefed.

(1) When both F-15s and F-16s are manning CAPs, the F-15 flight lead is air-to-air mission commander and should normally coordinate the air-to-air plan.

D. Weather:

(1) If weather precludes reconnaissance, F-15s/ F-16s will fly CAP and F-4/F-16 will provide SEAD; reconnaissance aircraft will RTB.

(2) The package commander in coordination with DUKE, will designate refueling altitudes and airspace for tankers if weather precludes refueling at ATO assigned altitudes/ airspaces.

E. Unknown Targets: ALL CFAC aircraft will retrograde north, or as directed if unknown confirmed targets are in the TAOR. Air-to-air fighters will take action as directed and IAW classified air-to-air ROE.

20. AWACS PROCEDURES:

A. ROUTING: AWACS will takeoff from Incirlik and fly north to the DAN 010/035 and hold in the block FL310-320 until the system is operational. Proceed direct to "K-Town", then direct Special Corridor 1 to ROZ 01. Return routing to Incirlik is via Special Corridor 2.

B. Duke will advise Mad Dog once AWACS radar checks good and leaving the 50 NM circle.

C. AWACS aircraft will contact Diyarbakir Control Tower and Mardin Radar on 364.2 when outside the Incirlik MTCAs.

D. AWACS will advise all aircraft in the TAOR and upon initial check-in when AWACS is "Midnight".

21. REFUELING PROCEDURES:

A. General:

(1) Refueling operations in ROZ 02 north and south and ROZ 03 will be IAW EMCON 3 "Smooth Flow" procedures (Navy-"ZIP LIP"). Refueling operations in ROZ 01 will be IAW EMCON 1 "Normal" procedures using AAR primary and boom frequencies as published in the daily ATO. Tankers should use air-to-air TACAN and IFF Mode II to facilitate intercepts.

(2) QUICK FLOW Refueling Procedures: The following procedures are for Quick Flow refueling in USAFE. "Quick Flow" is an expedited air refueling procedure for use in day VMC only, in which the "On-Deck" receiver flies loose fingertip (right wing) formation with the receiver on the boom. As the refueling receiver is disconnected, he slides to the tanker's left wing and the on-deck receiver slides directly into a close pre-contact position. The next (new) "on-deck" receiver moves to the refueling receiver's wing (loose fingertip) when he feels the receiver is about to complete his offload and the process continues, creating a counter-clockwise flow right to left across the boom. The right-to-left direction is driven by F-111 type receivers cross-cockpit limitation in left

OPERATION PROVIDE COMFORT ACO - 12 DEC 93

wing formations, and it is important all receivers adhere to the same flow. After refueling, all receivers will join to an echelon formation on their flight lead in the observation position on the tankers left wing. If a subsequent refueling of the flight is required or for continuous top-off of multiple receiver flights per tanker, the completed flight departs the tanker left wing slightly high by drifting back, maintaining visual on all players and in turn, returning to the tanker's right wing -- hence the counter-clockwise flow. As number four of the first flight moves to the boom, lead of the following flight will slide to loose fingertip on his right wing and thus continue the flow unimpeded. For breakaways, the refueling receiver and the On-Deck receiver on his right wing will be tied in taking appropriate action, while remaining receivers on both wings will remain with the tanker. These procedures are verbatim from Hq USAFE msg DTG 081310Z DEC 89.

(3) Every effort should be made to conduct air refueling in VMC conditions. After the weather check/update is passed on AAR freq., the Duke will coordinate to get all tankers VMC. All refueling will occur on 29.92"/1013mb altimeter setting and all altitudes will be passed as flight levels in the clear. If receivers are not VMC for refueling, then discontinue "Quick Flow" procedures until VMC can be attained

B. Refueling Operations:

(1) ROZ 02 NORTH - ROZ 02 North extends from FL170-FL290. All operations will be accomplished within these altitudes. If unable, move to ROZ 02 South using FL210 and above to refuel. Deconflict altitudes of other tankers with AWACs.

(2) ROZ 02 SOUTH - Refueling operations in ROZ 02 South will be conducted no lower than FL150. There is no max altitude in ROZ 02 South. For normal operations, FL190 and above will be used to refuel. When weather is a factor, tankers/fighters will coordinate with AWACs to refuel higher, if able.

NOTE: During refueling operations, consider ROZ 02 North/South as one big ROZ for airspace deconfliction purposes. All ROZ 02 North/South entry/exit procedures remain the same. Be extremely cautious rejoining/departing tankers; there is no room for mistakes in ROZ 2--plain and simple.

(3) Post TAOR Refueling:

(a) For ROZ 02 North, climb to FL210. Be above FL200 prior to transiting ROZ 02 South. Proceed direct GATE 2 or 3, whichever is closer. Contact AWACs for tanker information.

(b) FOR ROZ 02 South, climb to FL160, direct Sirsenk. Be above FL150 prior to entering ROZ 02 South. Contact AWACs for tanker information.

(4) ENTERING THE TAOR:

(a) From ROZ 02 North, proceed to gate 2 or 3, whichever is more convenient, then direct to ATO tasking.

(b) From ROZ 02 South, Proceed direct to ATO tasking. Descend VMC to FL150. Once South of the ROZ 02 southern border fly at altitudes consistent with ATO tasking.

(5) RTB Routing (POST AAR):

(a) From ROZ 02 North, proceed direct JUMP PT, intercept SC-2, Incirlik.

(b) From ROZ 02 South, proceed direct GATE 1, direct JUMP PT, SC-2, Incirlik. Exit ROZ 02 South at FL180 or coordinate with AWACs, and maintain until GATE 1. After GATE 1 coordinate with AWACs, for climb to RTB flight level.

C. Night Tanker Lighting.

(1) Tanker standard for Night refueling will be:



OPERATION PROVIDE COMFORT ACO - 12 DEC 93

- (a) Beacon off, unless requested for rendezvous, then off after fighters rejoin.
- (b) Nacelle lights off.
- (c) Position lights "On-bright", unless fighters rejoined, then "On-dim".

22. EMERGENCY DIVERT BASES:

- A. Batman, Erhac, & Konya airfields are available 24 hours, 7 days a week.
- B. Diyarbakir is fully operational. The base hosts the MCC UH-60 unit.
- C. Operating hrs for Van AB are: Weekdays - 0530Z-1430Z, and Weekends - 0530Z-1130Z. This is a civilian field with no crash equipment.
- D. Operating hours for Mus AB are: Weekdays - 0530Z - 1430Z; Saturday closed; and Sunday - 1230Z -1500Z.
- E. With an emergency, do not overfly potential recovery bases because of concern for maintenance impact or local terrorist threat.

23. SEARCH AND RESCUE:

- A. Due to the extended range of the TAOR from SAR capable assets, downed aircrews must be prepared to survive and evade for an extended time. Prior to each TAOR sortie, crews should review their ISOPREP data and ensure they have a good evasion plan of action (EPA).
- B. Peacetime procedures will be utilized to the maximum extent possible.
- C. Specific SAR procedures are outlined in the Operation PROVIDE COMFORT SAR SPINS published separately in the ARF.
- D. All aircrews flying in the TAOR will know how to use the GPS receiver.

24. CLOUD BREAK PROCEDURES: (Requires CFAC/DO approval)

- A. If not VMC +/- 5000' by the TAOR, RTB unless directed by the CFACC, through DUKE to remain.
  - B. Considerations/Procedures: If a cloud break is required, the following priorities and limitations on aircraft and crew to penetrate are:
    - (1) F/EF-111, A-6, EA-6: day or night.
    - (2) F-16, A-10, F-14, F-18: day only.
    - (3) F-1/Jag/Harrier: day only when optical photo is required.
    - (4) C-130: day only.
    - (5) Limit of 4 aircraft maximum of any type in the TAOR below the weather at any one time.
  - C. Requirements:
    - (1) Weather required for operations below a deck is 10,000 feet and 5NM visibility. Weather conditions below these minimums require aircraft to exit the TAOR unless given further clearance from the CFAC Commander.
    - (2) Operational Equipment Required:
      - (a) Solid INS (or position fixed by AWACs)
      - (b) Ground map radar
      - (c) TACAN (Except F-111)
- NOTE: Two of the three methods of on-board navigation are required.
- (d) Positive radar contact by AWACs.
  - (3) AWACs controllers must use corridor displays on their scopes, and provide position verification and separation from other aircraft. The corridors allow aircrews to legally descend in uncontrolled airspace, utilizing On-board equipment (INS and/or TACAN), backed up with position reporting by AWACs, to a minimum descent altitude (MDA).
    - (a) The AWACs position controlling the descent corridors will provide

OPERATION PROVIDE COMFORT ACO - 12 DEC 93

position reports for entry, mid-point and exit points to ensure aircraft remain within corridors until VMC. In addition, AWACs will provide traffic advisories to ensure at least 5NM separation between flights. Ensure corridor overlay displays contain the following points:

	<u>TACO</u>		<u>BURRITO</u>	
EXXON	N3730	E4330	N3730	E4330
TEXICO	N3722	E4320	N3722	E4320
SIRSENK	N3705	E4316	N3705	E4316
ENTRY POINT	N3644	E4306	N3709	E4241
MID-POINT	N3635	E4329	N3651	E4230
EXIT POINT	N3626	E4350	N3635.5	E4223.5
PEAKS W/I 25NM	N3658.5	E4329 (7,267)	N3716	E4251 (6,588)
CLIMB POINT	N3720	E4350 (BRAVO)	N3700	E4300 (DELTA)

(b) Each corridor is 5 NM wide either side of centerline between entry/exit points.

E. Descent Corridor Descriptions:

(1) "BURRITO":

(a) Corridor is 10NM wide (5NM either side of centerline) with entry point directly overhead town of Zakhu (N3709 E4241), 115/81, CH 53, and exit point overhead village of Baghdad (N3635.5 E4223.5).

(b) Outbound heading is 199 degrees mag for 36NM.

(c) MDA IS 6,500 feet MSL on local altimeter (QNH). MDA provides at least 2,300 feet terrain clearance north of the Tigris river and 4,800 feet south.

(d) If not VMC below by MDA, missed approach is a climbing left turn to point "DELTA" (N3700 E4300) to 22,000 ft or above then direct to ROZ 2 and RTB.

(e) Highest terrain within 25NM is 6,588 feet peak at N3716 E4251.

(2) "TACO":

(a) Corridor is 10NM wide (5NM each side of centerline) with entry point directly overhead the town Alqosh (N3644 E4306), 120/120, CH 53 and exit point over the great Zab River (N3626 E4350).

(b) Outbound heading from entry point is 113 Degrees mag for 40 NM.

(c) MDA in corridor is 8,000 feet MSL west of mid-point and 6,500 feet MSL east of mid-point on local altimeter. MDA provides at least 4,000 feet terrain clearance within corridor west of mid-point and 3,000 feet east.

(d) If not VMC below the cloud by MDA, missed approach is a climbing left turn to point "BRAVO" (N3720 E4350) to 22,000 ft or above.

(e) Highest terrain within 25NM is 7,267 feet peak at N3658 E4329.

(3) Aircrew Procedures:

(a) AWACs must be airborne and able to provide traffic and position advisories at all times during the cloudbreak operations. Aircrews are responsible for maintaining terrain clearance since AWACs cannot accept this responsibility.

(b) Remain VMC at or above 16,000 ft enroute from TEXICO to entry point. At entry point verify position with INS, Radar, TACAN, if able, and AWACs. If unable to verify position, RTB.

(c) Once position is verified, fly outbound on centerline heading and descend in the corridor to no lower than MDA until VMC below. The first aircraft penetrating will give a PIREP to AWACs on minimum ceiling.

(d) If unable to break out by exit point, execute appropriate

OPERATION PROVIDE COMFORT ACO - 12 DEC 93

climb out procedure and RTB.

(e) Aircraft with operable air-to-air radar are authorized radar trail descents with 2NM separation, otherwise, wingman must be in close formation or at least 5NM trail.

(4) IMC Flight From ROZ 2: (i.e. AAR)

(a) Proceed at 20,000 ft to point TEXICO (N3722 E4320) then direct to entry point (offset as required to roll-out HDG 199/113 on centerline) and then same procedure as described in Para 3 above.

(b) If not VMC below by MDA, missed approach is a climbing left turn to BRAVO or DELTA to ROZ 2, then RTB. Flights must remain in contact with AWACs for position verification and flight separation at all times.

(5) Special Instructions:

(a) The letdown procedure allows for positive position verification and update, and a conservative letdown to low terrain and away from known ground-based defensive systems.

(b) At no time proceed below MDA in corridor unless VMC below. (Exception F-111).

(c) Qualified TFR F-111 aircrews may descend on approved TFR routes to the pilots' TFR minimum altitude or breaking out VFR.

(d) Should aircrews become disoriented, attempt a wings-level climb straight ahead while performing spatial disorientation recovery procedures. Once recovery is complete, turn left to exit points BRAVO or DELTA as required and RTB. Minimum Safe Altitude (MSA) within 100NM is 16,000 ft.

(e) Do not descend below 16,000 ft until established in corridor. (Exception, F-111)

(f) A-10s are authorized to proceed into area C during cloud break procedures using descent corridor "TACO". Once VMC below, maneuver as required toward area B as soon as feasible.

(6) Climbing Cloud Break: To recover when working below an overcast in the TAOR, contact COUGAR and advise them you would like to proceed to point DELTA (N3700 E4300) with climbing cloud break to VMC on top. COUGAR will advise of potential conflicts with other aircraft.

SAMPLE: "COUGAR, LUCKY 01. Request aircraft advisories for cloud break climb to DELTA". "LUCKY 01, COUGAR. traffic 360 degrees, 5 MILES, 20,000 ft. climb at your discretion".

## 25. PRC-112 Radio Procedures

A. Each squadron maintains control of their own PRC-112 radios. They are responsible for properly loading frequencies and codes, and order any needed support equipment. The following procedures are amplified for clarification.

B. FREQUENCIES: The current PRC-112 "ALPHA" and "BRAVO" frequencies are in the daily Air Tasking Order (ATO). These frequencies change once a quarter (Sep/Dec/Mar/Jun). When the frequencies are changed, the Search and Rescue Liaison Officer (SARLO) will contact the units ahead of time, and the ATO will reflect the changes. Squadron life support sections have the coding equipment necessary to load these frequencies.

C. IDENTIFICATION CODES: Each PRC-112 radio is loaded with a six-digit identification code unique to that particular radio. Squadron life support sections load these codes into the radios per EUCOM OPORD 003. Each squadron must track which PRC-112 radio the individual crew member has, and what code is loaded into that radio. This six-digit code is used in conjunction with the personnel locator system (PLS) by rescue aircraft as a means of authentication and location of a downed crew member. In the event an aircraft goes down, the SARLO (or representative) will contact the squadron to obtain the crew member's PRC-112 code so it can be passed on the rescue forces.

OPERATION PROVIDE COMFORT ACO - 12 DEC 93

D. TESTING: When the PRC-112 radios are loaded with the frequencies, the "coder" automatically conducts an internal self-test of the radio. In addition, a digital readout shows the frequencies that are being loaded, and shows the identification code loaded into that radio.

E. SPARE BATTERIES: Individual units can order spare batteries through their normal supply channels using a "9BY" project code.

26. DEPLOYMENT/REDEPLOYMENT PROCEDURES:

A. Base operations must have flight plans 24-hours prior to take-off for any flight transiting French airspace.

B. Many PC aircraft have experienced trouble in talking to Athinia ATC. The following guidance and frequencies are meant to help if aircrews cannot talk to Athinia.

(1) Aircraft entering OLULU or flying in the southwest part of the Athinia FIR/UIR: Contact Athinia ACC - UHF 353.8 - VHF 124.9, 128.07 or Kalamata APP - 362.3, Andravida APP - 362.3, Souda APP - 382.6 to relay to Athinia FIR/UIR.

(2) Aircraft entering TOSKA or flying in southeast part of Athinia FIR/UIR: Contact Athinia ACC - UHF 325.7 - VHF 125.2, 126.12 or Rodos APP - 244.4 to relay to Athinia ACC.

(3) Aircraft operating in the north part of Athinia FIR/UIR: Contact Athinia ACC - UHF 230.5 - VHF 131.32, 134.15 or Linnos APP - 257.8 to relay to Athinia ACC.

C. If aircraft are unable to do as described above, the message must be transmitted through any military aircraft in flight equipped with VHF.

D. Departures/arrivals follow normal ATC noise abatement procedures published in FLIP and this ACO.

27. UNITED NATIONS (UN) HELICOPTER FLIGHTS IN IRAQ:

A. UN helicopter flights will be published in the ATO on the last page in plain language.

B. Special Handling: If UN helicopter flight information is passed to late too be included into the ATO, verbal notification will be passed from CTF C-3/JOC to Mad Dog to DUKE to AWACS and fighters.

28. NAVAL AVIATION ROUTING/COMMUNICATIONS PROCEDURES: Navy procedures have been temporarily suspended. All information concerning Navy procedures are for reference only.

A. For times when the carrier is outside of the Ankara FIR, there will be two FIR crossing points. For operations east of Cyprus, the crossing point will be N35-55 E35-15. For operations north of Cyprus, the crossing point will be N35-55 E34-20. From either of these points, all aircraft will fly to N36-11 E35-23 for entry into Incirlik's airspace (50NM circle). When the carrier is inside the Ankara FIR, aircraft will fly directly to the Incirlik CTR entry point. From this point aircraft going east bound will continue as in Para B OR C (below). Aircraft going to Incirlik will fly to N36-28 E35-34, maintaining altitude and adhering to the avoidance restrictions in Para D (below).

B. Fixed wing aircraft will enter/exit the Turkish coastline via N36- 53 E36-07 eastbound; proceed direct to "K-Town" to join SC-1 IAW SC procedures above. Returning aircraft westbound on SC-2 proceed to K-Town then to N36-53 E36-07 IAW Special Corridor procedures.

C. Helicopters going to/from the TAOR will enter/exit the Turkish coastline via N36-54 E36-05, proceed to N37-09 E36-07, and join SC-1A IAW SC

OPERATION PROVIDE COMFORT ACO - 12 DEC 93

procedures above. Returning helicopters westbound on SC-2A proceed to N37- 09 E36-07 then N36-54 E36-05 IAW SC procedures above.

D. Helicopters from Iskenderun to Incirlik will join SC-4, then fly direct Incirlik. Contact Incirlik Rapcon (385.4) AT 50NM. Maintain 1,000 feet or above over land, and avoid all populated areas until cleared by Rapcon or established on SC-1A routing. Helicopters returning via SC-2A or from Incirlik will maintain 1,000 feet until over water. Call Rapcon prior to turning south off SC-2A. Maintain 1,000 feet until crossing the coastline, then fly direct to the ship. Avoid LTD 13 and LTD 19. All A/C will avoid Dortyol airport by 5NM/3,000 feet.

E. Communication Plan For Naval Aircraft:

(1) Eastbound: at 100NM from Incirlik, contact Mission Director (MAD DOG) for mission updates. At 50NM from Incirlik, contact Incirlik approach for normal ATC services through their airspace. At 50NM east of Incirlik, contact on (COUGAR/E2C) enroute freq for mission information such as terminal or tgt area wx, tanker status, etc., and for enroute deconfliction. Approaching the ARCP, contact COUGAR/E2C on ROZ O2 AAR primary for tanker rendezvous coordination. Coming off the tanker, contact fighter Airborne Control Element (ACE), callsign "DUKE" for specific tasking and target area information. After receiving tasking, monitor MSN primary (COUGAR/E2C) on while in the target area. If off MSN primary in the target area (talking to a FAC, etc.) aircraft with VHF should monitor VHF MSN primary in place of UHF MSN primary.

(2) Westbound: When leaving the target area, contact DUKE to pass on time critical information, and to let DUKE know that you are leaving. Then contact COUGAR/E2C on AAR primary or MSN enroute as applicable. At 100NM east of Incirlik westbound, Contact MAD DOG to pass on your INFLTRPT. At 50NM east, contact Incirlik approach. At 50NM outbound, contact STRIKE, Button 1.

28. OPR:

POC for any questions or suggested corrections is 39 OSS/OCS, 6-3902.

**TAB AA**

**REGULATIONS AND DIRECTIVES**

**AA-1 OPC Airspace Control Order and SPINS, 12 December 1993**

**AA-2 Extracts from MCM 3-1**

**(See Classified Addendum)**

**AA-3 Extract from Aircrew Read File 183**

**(See also Classified Addendum)**

**AA-4 Multi-Command Regulation 55-33, E-3 Operating Procedures  
with 552 ACW Supp 1**

**AA-5 Air Combat Command Regulation 51-60, Training Management  
for Command and Control Aircrews**

**AA-6 Extracts from DA Pamphlet 738-751, Functional User's Manual  
for the Army Maintenance Management System**

**AA-7 552nd Operations Group Operating Instruction 60-2,  
552nd (Deployed) Turkey Operating Procedures**

**AA-1**

**AA-8 Extract from Eagle Detachment Read File, Annex A, Daily  
Requirements**

**AA-2**

**TAB AA**

**REGULATIONS AND DIRECTIVES**

**AA-1 OPC Airspace Control Order and SPINS, 12 December 1993**

**AA-2 Extracts from MCM 3-1**

**(See Classified Addendum)**

**AA-3 Extract from Aircrew Read File 183**

**(See also Classified Addendum)**

**AA-4 Multi-Command Regulation 55-33, E-3 Operating Procedures  
with 552 ACW Supp 1**

**AA-5 Air Combat Command Regulation 51-60, Training Management  
for Command and Control Aircrews**

**AA-6 Extracts from DA Pamphlet 738-751, Functional User's Manual  
for the Army Maintenance Management System**

**AA-7 552nd Operations Group Operating Instruction 60-2,  
552nd (Deployed) Turkey Operating Procedures**

**AA-1**

**AA-8 Extract from Eagle Detachment Read File, Annex A, Daily  
Requirements**

**AA-2**

**AA-3**

ARF 183

FROM: CFAC/DO

SUBJ: Rules of Engagement

TO: All CFAC Aircrew

1. The attached document supplements Annex A, Rules of Engagement (ROE), to CTF PROVIDE COMFORT OPLAN 91-7.
2. The content of this supplement does not add or detract from current guidance contained in the USEUCOM Directive 55-47, Peacetime ROE (ED-55-47) or USCINCEUR OPOD Serial 003 for PROVIDE COMFORT. Nor is it an interpretation. It is a compilation of information from both documents as amended by guidance from USCINCEUR that is pertinent to aircrews flying in the Tactical Area of Responsibility (TAOR).
3. Changes have been highlighted by placing an asterisk (\*) in the column next to affected text.

Deputy Commander for Operations

CERTIFICATION OF EXTRACT	
I reviewed <u>ARF 183</u>	
From that source document, I extracted the information contained in this extract. I certify the information contained herein is a true and accurate extract of that source document. <u>except as noted.</u>	
<u>18 MAY 94</u>	<u>Donald G. Norris</u> Signature
Date	Name/Organization/Section <u>DONALD G. NORRIS, HQ USEUCOM/ESJ2-P</u>

CERTIFICATE OF DECLASSIFICATION	
I certify that the information contained in this document has been declassified from	
<u>SECRET</u>	to UNCLASSIFIED.
<u>18 MAY 94</u>	<u>Donald G. Norris</u> DONALD G. NORRIS, GS-15, DAC Declassification Team Chief, HQ USEUCOM
Date	



Title: ROE/Procedures for Provide Comfort Aircraft

1. (U) Purpose. This supplement to Annex A, Provide Comfort Oplan 91-7 establishes policies and procedures governing the interception, identification, intervention, and engagement of aircraft by U.S. air forces not operating as, or in support of, U.S. seaborne forces. It is a single source document containing pertinent ROE from USEUCOM Directive 55-47 (ED 55-47), CINCEUR OPOD SERIAL 003, and USCINCEUR ROE change message (DTG 231043Z NOV 92).

2. (U) 1. Policy. NOTHING IN THESE RULES NEGATES A COMMANDER'S OBLIGATION TO TAKE ALL NECESSARY AND APPROPRIATE ACTION FOR HIS UNIT'S SELF-DEFENSE.

a. (U) Defensive action taken will be in consonance with U.S. and international law and the right to take action as set forth in ED 55-47.

b. (U) Before exercising the right to use force under peacetime ROE, careful consideration will be given to:

(1) (U) Identification difficulties.

(2) (U) The presence of civil aircraft and the special treatment afforded such aircraft under international law and these ROE.

(3) (U) The need to give defectors safe conduct.

(4) (U) Possible instance of aircraft being in distress and the crew being unaware of their position.

(5) (U) The possibility of errors in the air defense systems.

c. (U) Action to engage and destroy airborne objects can be justified if one of the following pertains.

[Classified portion deleted (59 words)]

[Classified portion deleted (97 words)]

(5) (U) Additionally:

[Classified portion deleted (25 words)]

3. (U) Interception and Identification of Unidentified Airborne Objects

a. (U) Any unidentified airborne object in or approaching airspace within a U.S. air defense area of responsibility will be identified by any means available, including visual recognition, flight plan correlation, electronic interrogation, and track analysis.

b. (U) When feasible, airborne objects in or approaching the airspace within a U.S. area of responsibility that have not been satisfactorily identified by communications, electronics, or any other means will be intercepted for visual identification purposes.

(1) (U) Upon request, the pilot making identification, or another member of the intercept force, will report available information about quantity, type, nationality, ownership, serial number or registration letters, and any unusual behavior of the intercepted airborne object (or leader of an unidentified formation) to the appropriate authority.

a. (U) The intercepting pilot will take every precaution to avoid startling the intercepted aircrew or passengers. The desired effect is to assure personnel in the intercepted airborne object that the interceptor is making a routine investigation.

b. (U) If the intercepted airborne object is positively identified as friendly and is not in distress, the interceptors will withdraw immediately.

(2) (U) The intercepting pilot will keep the controller advised of marginal conditions or visibility. If weather does not permit visual identification, radar monitoring will be maintained until identification is possible, the unknown departs the U.S. area of responsibility, or proper authority directs the intercept be terminated.

[Classified portion deleted (29words)]

(4) (U) The intercepting pilot will, upon interception of an unidentified or suspected hostile airborne object, report his observations to the controller. The controller will, with minimum delay, instruct the pilot whether the identification procedure is to continue.

a. (U) If an intercepted airborne object enters the airspace of a U.S. area of responsibility, is unidentified, and radio contact cannot be established, International Civil Aviation Organization (ICAO) visual signals will be employed. If a response is received and the airborne object is identified as a civil or military airborne object of a friendly nation, or it is otherwise clear that the airborne object poses no hostile threat, visual signals will be used to inform the airborne object that it is free to proceed. The identifying markers of the airborne object will be reported to the controller.

b. (U) If the intercepted airborne object enters the airspace of a U.S. area of responsibility and is not identified as friendly, the interceptor will order it to land at a suitable airport by using (ICAO) visual signals. Civil airborne objects will not be ordered to land unless the appropriate air defense commander determines that such landing is the only means available to ensure the security of the air defense area of responsibility. U.S. forces will engage civil airborne objects only when clear evidence of a hostile act or hostile intent exists and there is no alternative course of action. Overflight of a restricted or prohibited area by civil airborne objects, without committing a hostile act or clearly

manifesting hostile intent, does not constitute grounds for engagement of such airborne objects.

[Classified portion deleted (155 words)]

3. (U) Responsibility for Engagement.

[Classifier portion deleted (39 words)]

b. (U) Specifically:

(1) (U) The commander of a unit having an air defense capability, a flight leader, or a pilot will engage and/or intervene when:

[Classified portion deleted (74 words)]

(2) (U) An appropriate air defense commander will direct engagement when:

[Classified portion deleted (123 words)]

(U) Definitions:

(U) Airborne Object. This term includes aircraft, missiles, and remotely piloted vehicles.

(U) Hostile Act. A hostile act is an attack or other use of armed force by a foreign force or terrorist unit(s) against the United States, U.S. forces, U.S. citizens or their property, or U.S. commercial assets, or armed force used directly to preclude or impede the mission and/or duties of U.S. forces. Examples of hostile acts are:

[Classified portion deleted (111 words)]

[Classified portion deleted (16 words)]

*Paragraph classification marking added 2/17*

(U) The commission of a hostile act gives rise to the right to respond with the use of proportionate force in self-defense by all authorized means available.

[Classified portion deleted (74 words)]

(U) Self-Defense. Self-defense includes any action of a unit of U.S. forces in defending itself, subunits, or when appropriate, U.S. citizens, their property, or U.S. commercial assets in it's vicinity, against a hostile act or hostile intent. As to both unit and national self-defense, the right to use armed force in self-defense depends upon two elements: necessity and proportionality. The requirement of necessity, or present danger, obviously arises when a hostile act occurs. The right of self-defense may also involve using armed force against hostile intent. In either case, proportionality requires that the use of force be limited in intensity, duration, and magnitude to what is reasonably required to counter the hostile act or hostile intent. Under the concept of self-defense in peacetime, force may not be used with view to inflicting reprisal or retaliation for acts already

committed. National self-defense within the AOR may be authorized by USCINCEUR or higher authority.

**TAB AA**

**REGULATIONS AND DIRECTIVES**

**AA-1 OPC Airspace Control Order and SPINS, 12 December 1993**

**AA-2 Extracts from MCM 3-1**

**(See Classified Addendum)**

**AA-3 Extract from Aircrew Read File 183**

**(See also Classified Addendum)**

**AA-4 Multi-Command Regulation 55-33, E-3 Operating Procedures  
with 552 ACW Supp 1**

**AA-5 Air Combat Command Regulation 51-60, Training Management  
for Command and Control Aircrews**

**AA-6 Extracts from DA Pamphlet 738-751, Functional User's Manual  
for the Army Maintenance Management System**

**AA-7 552nd Operations Group Operating Instruction 60-2,  
552nd (Deployed) Turkey Operating Procedures**

**AA-1**

**AA-8 Extract from Eagle Detachment Read File, Annex A, Daily  
Requirements**

**AA-2**

**AA-3**

**AA-4**

Operations

E-3 OPERATING PROCEDURES—AIRCREW

This regulation prescribes the operating policies, procedures, and restrictions for Air Combat Command and Pacific Air Forces aircrew members operating the E-3 aircraft and mission equipment. This publication does not apply to Air National Guard (ANG) or United States Air Force Reserve (USAFR) members or units.

SUMMARY OF CHANGES

References to Tactical Air Command (TAC) have been changed to ACC; PACAF has been scripted into the text as a separate and distinct owner of USAF E-3s; references to AWACS units have been changed to reflect the reorganization of the 28 AD into an objective wing. Redundent information and information covered in other regulations have been deleted.

	Paragraph	Page
<b>Chapter 1—INTRODUCTION</b>		
General .....	1-1	4
Waivers .....	1-2	4
Recommended Changes .....	1-3	4
Distribution .....	1-4	4
Explanation of Terms .....	1-5	4
<b>Chapter 2—MISSION PLANNING</b>		
Responsibilities .....	2-1	6
Forms and Logs .....	2-2	3
Navigational Charts .....	2-3	6
Briefings/Debriefings .....	2-4	6
Mission Planning Requirements .....	2-5	6
Local Checklists/Aircrew Aids .....	2-6	7
Theater Procedures Aircrew Aids .....	2-7	7
<b>Chapter 3—AIRCREW OPERATING PROCEDURES</b>		
General .....	3-1	8
Minimum Crew Manning .....	3-2	8
Aircrew Duty Period/Augmentation .....	3-3	8
Pre-mission Duties .....	3-4	8
Minimum Equipment .....	3-5	8
Communications .....	3-6	8
Weapons Director Assisted Rendezvous .....	3-7	9

Supersedes TACR 55-3, 5 November 1990.  
 No. of Printed Pages: 33  
 OPR: HQ ACC/DOYA (Lt Col John Newsom)  
 Approved By: Col Jack P. Shafer  
 Edited by: Marty Muir  
 Distributed to: E-3 HQ USAF/XOOI . . . 1

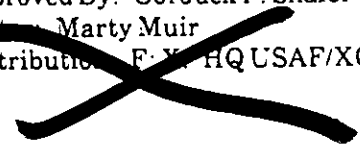

<b>EXTRACT</b>	
I certify that I am the Records Custodian for the Accident Investigation Board convened to investigate the crash of two U.S. Army Black Hawk helicopters in the flight zone in northern Iraq on 14 April 1994, and that this is a true and accurate extract from	
<i>MC Reg 55-33, 3 May 93</i>	
which is kept in my records system.	
<i>13 May 94</i> Date	<i>W. L. Harris</i> WILLIAM L. HARRIS, Capt, USAF, MSC Evidence Custodian, Incirlik Air Base, Turkey

## Chapter 2

## MISSION PLANNING

2-1. **Responsibilities.** The responsibility for mission planning rests with the aircraft commander (AC) and mission crew commander (MCC) with support from the operations and intelligence functions of the unit. Under normal circumstances a crew scheduled for a mission will complete their own planning and briefing under the supervision of the AC and MCC on the working day prior to the flight. Applicable aircrew members will participate as directed. During circumstances that require accelerated response, the crew scheduled to perform the mission may be placed in crew rest and a group of qualified individuals will be designated to perform mission planning and/or briefings. Units will develop specific procedures to ensure all aircrew members are thoroughly familiar with and prepared for each flight.

2-2. **Forms and Logs.** Specific flight plans, logs, and mission forms will be developed/specified by the appropriate OG/CC. Maximum use of existing AF and MAJCOM forms should be made.

2-3. **Navigational Charts.** Navigational charts will be annotated to reflect:

a. Special use airspace within the altitude structure and within 50 nautical miles of the planned route of flight. Those portions of the route that are conducted on established airways by reference to FLIP en route charts and pilot's radio navigation instruments need not be annotated. On airways, the navigator may correlate special use airspace directly from the FLIP charts. Restricted and warning areas adjacent to coastal operating areas will be annotated on the navigator's chart.

**NOTE:** Units will, if necessary, specify flight plan requirements and procedures in their local chapters to meet specialized mission requirements.

b. **Emergency Airfields.** Sufficient to cover area of flight.

c. **High Terrain.** Within 50 nautical miles of planned route of flight and 25 nautical miles of the departure/arrival base.

d. **Local Area.** A chart of ONC or larger scale to sufficiently cover the planned departure/arrival, and will include highest terrain or obstacle within 25 nautical miles.

e. **Mission Airspace.** Boundaries of assigned mission airspace and E-3 orbit airspace.

2-4. **Briefings/Debriefings.** The AC/MCC will brief/debrief all crewmembers to ensure safe/effective mission accomplishment. Locally developed briefing guides will be used to provide a reference list of items which apply to a particular mission. Items may be briefed in any logical sequence, and those items understood by all participants may be briefed as Standard. Specific items not pertinent should not be covered. All aircrew members will attend these briefings unless excused by the AC/MCC.

2-5. **Mission Planning Requirements.** Requirements contained in this paragraph may be waived by appropriate wing commander if deemed necessary to accomplish a specific mission.

a. **Aircrew Planning.**

(1) Locally developed briefing guides will be used as the basis for mission planning and briefing actions.

(2) Normally the planning/briefing sequence will be: pre-mission planning; mission planning summary; and specialized briefings, all taking place on the duty day prior to the flight. The pre-mission briefing will take place (with slides) after the crew reports on the day of the flight. For proficiency sorties (P-sorties), the crew may plan and brief on the day of the flight. In this instance, the crew will perform those items listed in locally developed Same Day Mission Planning Procedures for P-sorties.

(3) Crew duty day planning. Missions will not be planned to exceed a 14 hour crew duty day without approval of the appropriate operations group commander; see Aircrew Duty Period/Augmentation in Chapter 3 of this regulation for additional guidance.

(4) Passengers. The AC/MCC will assign a crew member to be responsible for passengers or distinguished visitors; see Transportation of Passengers in Chapter 3 of this regulation for minimum responsibilities.

(5) Weapons Director **W**sted Rendezvous. The AC, Nav, and WD will thoroughly discuss the rendezvous procedures and techniques to be used. The Nav will supply the WD with the following information.

(a) ARIP and ARCP coordinates in degrees LAT/LONG.

(b) Air refueling primary and secondary frequencies.

(c) Desired tanker offset and range.

(d) Range and offset calls desired during the rendezvous.

(e) Any other pertinent information.

**b. Formation Planning.** The Formation Briefing Guide (attachment 2) will be used when planning/briefing sorties involving two or more aircraft in an en route formation.

**c. Mission Crew Planning.**

(1) The MCC will ensure Weapons and Surveillance personnel will plan mission activities according to applicable checklists and guides.

(2) MCC, SD, ASO, CSO, and Battle Staff will develop and coordinate a communication plan to ensure mission requirements are met.

(3) Log Book Review/Mission Equipment Status.

(a) Log Book Review: The ART, CDMT, and CT will review the mission systems history log book if available. They will note equipment configurations used on previous flights, recurring equipment malfunctions, and previous/new equipment malfunctions. The CDMT will also review the software versions used on past flights.

(b) Mission Equipment Status: The ART, CDMT, and CT will obtain their respective systems status from the appropriate squadron maintenance unit (SMU). Open AFTO 781 discrepancies will be noted. If possible, a face to

face brief with : respect mission specialists will be accomplished and the Computer Automated Maintenance System (CAMS) will be used to determine open AFTO Form 781 discrepancies.

(c) The ART, CDMT, and CT will brief the status to the MCC. The CT will also brief the CSO.

(4) The CDMT will prepare, coordinate and deliver a list of tape requirements. Minimum tape requirements will be according to local operating procedures.

(5) The MCC will assess impact of equipment limitations and adjust tasking as necessary. A final review of weapons and surveillance planning will be conducted.

**2-6. Local Checklists/Aircrew Aids.** Locally produced checklists and aircrew aids will include as a minimum:

a. Mission Planning Checklists (as required).

b. Briefing Guides.

c. Other information deemed necessary by the unit.

**2-7. Theater Procedures Aircrew Aids.** These aids (classified/unclassified) will be developed by the unit specifically tasked to support the area of operations and made available to the crews upon implementation of a contingency OPLAN for deployment to the theater. As a minimum, these aids will include:

a. Communications plans.

b. Mission crew positional actions/ procedures.

c. Rules of Engagement.

d. Other information deemed necessary by the unit.



## Chapter 3

## AIRCREW OPERATING PROCEDURES

**3-1. General.** The AC is responsible for the safe, effective conduct of flight operations and the safety of the aircrew and passengers. The aircrew is responsible to the AC for the safe, successful accomplishment of all flight activities. That portion of the flight directly affecting the accomplishment of the E-3 mission will be coordinated with the MCC/Battle Staff. This chapter contains operating procedures that are applied to the entire aircrew.

**3-2. Minimum Crew Manning.**

a. Minimum flight crew manning specified is the pilot, copilot, navigator and flight engineer. The applicable wing commander will determine conditions that warrant minimum flight crew manning on a case-by-case basis.

b. P-sorties will be flown with a minimum of five crewmembers; pilot, copilot, navigator, flight engineer, and one additional crewmember to act as safety observer (not applicable for B-707 operations).

c. Minimum mission crew manning to power up the mission systems will include MCC, ASO, ART, CDMT, and CT. Mission crew manning may vary by the type mission flown.

**3-3. Aircrew Duty Period/Augmentation.**

a. Normal aircrew duty period is 16 hours. Augmented aircrew duty period is 24 hours. With any axis of the autopilot inoperative, the normal aircrew duty period will be limited to 12 hours and the augmented aircrew duty period will be limited to 16 hours. Missions will be planned according to paragraph 2-5a(4). The applicable wing commander waiver authority under AFR 60-1, is limited to a 1-hour extension of the normal aircrew duty period. Augmented aircrew duty period may not be extended.

b. When airborne, the AC may extend missions planned for a 14 hour crew duty day to a 16 hour day, but will notify the applicable operations group commander or deployed commander (DETCO) of the decision and the reasons for it.

c. An augmented flight crew will consist of a qualified pilot, navigator, and flight engineer in addition to the normal flight crew. Crews will not be augmented after the first takeoff in a crew duty period.

d. The augmented mission crew composition will be as determined by the applicable operations group commander depending upon mission requirements.

e. Crew Rest for Deploying/Redeploying Aircrews. Due to the long flights and numerous time zone changes involved in flying to and from overseas deployed locations, unless waived by applicable operations group commander, ground time between landing and subsequent takeoff will not be planned for less than 18 hours. Ops stops made within an aircrew duty period do not apply.

f. Crewmembers will be afforded 12 hours of non-duty time after a flight before reporting for normal non-flight duties, unless waived by the squadron commander or operations officer.

**3-4. Pre-mission Duties.** Crew report times will allow sufficient time to accomplish all preflight activities (normally 2.25 hours prior to takeoff). For P-sorties that are planned and flown on the same day, a 3.5 hour show time will normally be used. The FE and technicians should arrive at the aircraft 1.5 hours prior to the scheduled takeoff time. Crew show at the aircraft for all other crew members will normally be no later than 1 hour prior to the scheduled takeoff time. Squadron commanders may adjust crew report times to meet mission requirements.

**3-5. Minimum Equipment.** 552 OG/LG will develop a Minimum Equipment Subsystem Listing (MESL) for use by all AWACS crews as a guide to determine operable equipment required for safe flight.

**3-6. Communications.**

a. The HF back-up air refueling frequency is 6761 USB.

b. Radio Calls.

(1) The following radio calls to the applicable command post are required unless local directives specify otherwise.

(a) Engine start time (at least 10 minutes prior to engine start to allow notification of Central Security Control (CSC)).(AC/CP)

(b) Actual takeoff time. (Nav)

(c) Significant changes (approximately 5 minutes in ETAs to the ARCP, orbit, or destination). (Nav)

(d) Post-air refueling report. (CSO/CT)

(e) On station/Ops Normal time (NLT 15 minutes after arriving on station). (CSO)

(f) Time off station and ETA (NLT 15 minutes after departing station). (CSO)

(g) Maintenance Codes and revised ETA (NLT one hour prior to final landing). (CSO)

(h) ETA (if changed) when in UHF contact. (Nav)

(i) Anytime a major change is made in the Flight Plan or a malfunction or incident occurs that will adversely affect mission accomplishment. (AC/MCC)

(2) Maintenance Codes (Aircraft Landing Status and System Capability Codes). The MCC is responsible for providing the maintenance codes to the CSO for transmission prior to landing. Aircraft Landing Status and System Capability Codes as defined in ACCR 66-36, Aircrew/Maintenance Debriefing, will be used and should be included in applicable aircrew aids.

### 3-7. Weapons Director Assisted Rendezvous.

a. **Communications.** Coordination between the NAV and WD during the rendezvous will normally be over maintenance net unless using secure voice. When using secure voice, coordination will be over Net 1. The designated net will not be used by other crewmembers for 30 minutes before the ARCT until after the rendezvous is complete. The net will be selected, interphone contact established, and the MCC will ensure appropriate crewmembers have the air refueling frequency on direct access not later than 30 minutes prior to the ARCT.

b. **Procedures.** The WD will use Order of Battle or Special Points to identify the ARIP and ARCP Points, and connect them with a pooled line. The WD will measure the actual tanker offset perpendicular to the ARIP/ARCP line and pass this distance to the Nav as tanker offset \_\_\_\_ NM left. All the ranges prior to the tanker turn will be slant ranges. After the tanker begins the turn to refueling heading, the range will be forward range. The navigator will advise the WD/MCC when visual contact with the tanker is established and when mission crew assistance can be terminated.

### 3-8. On-Station Procedures.

a. Mission orbits will normally be flown at best endurance speed.

b. Aircraft position will be coordinated with the MCC/Battle Staff.

c. The AC/MCC will ensure crewmembers do not wear lightweight headsets when entering the lower compartments.

3-9. **Radar Radiation Restrictions.** The mission radar will not be radiated at or below FL 180 due to the potential for conflict with VFR traffic which may pass closer than 650 feet vertically and 1300 feet horizontally. However, during contingency operations, emergency situations, and special operations, the mission radar may be radiated at or below FL 180 within equipment limitations.

3-10. **Aircraft Position Monitoring.** Aircraft position relative to a preplanned track is the responsibility of both the flight and mission crews. Applicable wing commander may waive these requirements if deemed necessary to accomplish a specific mission.

a. During flights within 25 NM of an established prohibited area or within 50 NM of a potentially hostile border, the pilot, co-pilot and navigator positions will be occupied continuously until a fall back orbit location is assumed.

#### (1) Flight Crew Procedures:

(a) Both pilots will continuously monitor the E-3 position via radio navigational aids and INS.

(b) The navigator, in coordination with the pilot, will establish a radio navigation fix or line of position between the closest point of the E-3 orbit and the threat area as a no fly beyond line for all E-3 orbits.

#### (2) Mission Crew Procedures:

(a) The MCC must have at least a stand-behind position at an operational console when a dedicated console is not available.

(b) The AWACS TADIL-A LINK 11 net participant symbol and E-3 track TD must be displayed on the AWACS monitor's and MCC's consoles. If the accuracy of the E-3 symbol is in doubt, consideration should be given to the worst case location, and coordination with the flight deck will be taken immediately to reposition the aircraft from prohibited areas.

b. An E-3 is operating under Military Assumes Responsibility for Separation of Aircraft (MARSA) conditions when flying in Warning

INS. The INS heading will be used to compute the heading deviation of the magnetic heading systems. If the difference between INS No. 1 and INS No. 2 is 1 degree or greater, a celestial heading check is required. This deviation check (either by use of INS or celestial information) will be entered in the appropriate portion of the inflight log. The complete heading check will be done as soon as practical after level off.

f. One flight crew member will monitor the mission crew interphone (Net 1) at all times.

#### 4-8. On-Station.

a. HF and VHF seize precautions. The flight crew will normally use VHF No.1 as a primary flight crew radio. If its use is required by the mission crew, the CSO/MCC will coordinate with the AC.

b. Full line entry position checks are not required while on-station. Entries will include adequate information for crosscheck of the navigation equipment. Prior to updating the NCS/INS, notify the pilot and MCC, when in mission orbit or actively controlling aircraft, to preclude bank angle upset of the radar picture.

c. On missions where the orbit is out of radio aid range, split mode operation of the NCS is required. During an orbit in this situation, position checks may be made by comparing the NCS tied-in INS position with the free running INS position.

d. The AC has the responsibility and final authority for determining when the aircraft should depart station. ACs will consider forecast enroute and destination weather, enroute winds, icing, mission requirements, fuel requirements, training requirements, etc.

(1) Within 1 hour after assuming station, the flight crew will compute Bingo fuel. If air refueling (AR) is planned after orbit, a similar computation will be made allowing enough fuel so that in the event of a missed AR, the aircraft can land at the destination or a preplanned alternate with the required fuel minimums. Bingo fuel computations will not include center wing tank fuel used as ballast to maintain c.g. forward of 35% M.A.C.

(2) Coordinate with the MCC if fuel requirements necessitate a modification to on-station duration, pattern, or altitude.

(3) A weather check will be made no later than 2 hours prior to ETD from the orbit area. This check will include enroute, refueling track, and landing base weather. Crews will use all

available weather sources to keep abreast of changes.

(4) Should an equipment malfunction or an inability to complete an assigned mission occur, the crew should fly an alternate mission in lieu of dumping fuel to reduce weight. Alternate missions should be planned and briefed during mission planning day.

#### 4-9. Arrival and Approach.

a. Approach Briefing. Prior to starting descent from cruise altitude the pilot flying the approach will brief the crew in accordance with Technical Order and AFM 51-37 requirements. Three complete sets of the appropriate Terminal Approach Procedures and STAR booklets will be in the cockpit to be used by the pilot, copilot, and navigator. The pilot not flying the approach and the navigator will monitor their respective instruments and all radio transmissions by the controlling agency, and advise the pilot making the approach when noting any deviation from the prescribed procedures or instructions.

(1) The pilot not flying the approach will make the following advisory calls:

(a) Non-precision approaches:

1. 100 feet above minimum descent altitude (MDA).

2. "Minimums" at MDA.

3. Runway in sight. Make this call when the runway environment is in sight. Do not call too soon when obstructions to vision such as fog, haze, low stratus clouds, etc., are present.

4. VDP.

5. Missed Approach Point, if applicable.

(b) Precision approaches:

1. 100 feet above decision height (DH).

2. Runway in sight. Make this call when the runway environment is in sight. Do not call too soon when obstructions to vision such as fog, haze, low stratus clouds, etc., are present.

3. Decision height.

(2) The navigator will back up the pilots in monitoring these calls and reporting deviations.

(3) The pilot flying the aircraft will:

(a) Acknowledge all advisory calls.

(b) Announce intentions over interphone at the appropriate decision point for both

## MISSION CREW OPERATING PROCEDURES

5-1. **General.** This chapter contains operating procedures applicable to the mission crew only.

5-2. **E-3 Missions.**

a. **E-3 Tactical Mission.**

(1) When augmenting Theater Air Control System (TACS) elements the E-3 will provide an airborne extension of the ground TACS radar and provide coverage in areas when TACS elements are lost or degraded. The E-3 may function as a Control and Reporting Center (CRC) or Control and Reporting Post (CRP) as directed by the Air Force Component Commander (AFCC). The E-3 may be responsible for:

(a) Identification of traffic when operating in an area without existing ground identification authority already established, or when ground identification facilities are degraded and not capable of providing the identification function.

(b) Airspace regulation and control within an assigned control area.

(c) Surveillance within its assigned area of responsibility.

(d) Issuing of scramble orders or airborne orders in the absence of ground TACS or when authority is delegated by the Tactical Air Control Center (TACC).

(e) Maintaining status of available weapons and equipment.

(f) Forwarding accurate and timely surveillance data to the CRC/TACC and crosstell appropriate surveillance data to adjacent command and control facilities.

(g) Maintaining continuous communications with other airspace control agencies.

(h) Relay of instructions from the TACC, CRC, and other elements of the TACS to airborne aircraft.

(i) Commitment of defensive counterair weapons. This may be self-initiated or directed by a TACC/CRC.

(2) When the primary or alternate TACC is rendered inoperative, the AFCC may direct an E-3 to continue to manage tactical air operations until the TACC becomes operational. Under this condition, additional E-3 responsibilities may include voice coordination with Army

units and Air Support Operations Centers (ASOCs).

b. **E-3 Missions.**

(1) The NORAD/1 AF strategic air defense mission is composed of three roles: air sovereignty, tactical warning, and atmospheric defense. Air sovereignty is the peacetime policing of the combined US/Canadian sovereign airspaces to ensure that all air traffic using the airspace complies with national regulations. The second role of tactical warning includes detecting, characterizing and assessing the potential threat. The third role is the wartime role of atmospheric air defense against an enemy threat or attack. NORAD performs these roles by integrating a variety of sensor equipment, communications, aircraft and facilities.

(2) E-3 counterdrug (CD) mission is to assist national agencies in interdiction of suspected drug traffic IAW command directives.

5-3. **Responsibilities.**

a. **Battle Management.** E-3 battle management is performed by the onboard battle staff in conjunction with the E-3 MCC.

(1) **Battle Staff/ACE Team.** The Battle Staff/ACE Team is responsible for the total assigned battle management function and will:

(a) Determine priorities and authorize the reallocation/distribution of the assets assigned.

(b) Establish/maintain contact and coordinate with appropriate commanders.

(c) Recommend changes to the mission as necessary to maintain continuous coverage of the assigned AOR.

(d) Receive, interpret, and disseminate information to appropriate battle staff and region personnel.

(2) **Mission Crew Commander.** The MCC is responsible to the appropriate commander (whether on board as part of the battle staff or on the ground) for the E-3 mission and performs all applicable duties to support the assigned task. The MCC is responsible for the management, supervision and training of the mission crew. The MCC will:

(a) Coordinate the preparation of required mission equipment, data, and displays

prior to takeoff to ensure the mission crew is prepared to meet mission tasking.

(b) Perform battle staff duties as required/directed.

(c) Ensure that data base information is current and correct.

(d) Manage the orderly transfer of data base information and station responsibility. Declare on-station/ops normal when mission systems are operating as required to accomplish the mission, and surveillance and weapons sections have completed their station assumption requirements. Ensure ground monitor/control authority is notified of on-station time and equipment status within COMSEC constraints. Notify ground monitor/controlling agency of adjustments to operations when the E-3 is only partially able to accomplish the mission. Declare off-station and coordinate with command agencies as required when the E-3 is unable to accomplish the mission. Ensure ground agencies are debriefed and notified of off-station.

(e) Supervise the SD and ASO to ensure effective management of the weapons and surveillance functions. Monitor and provide guidance to weapons and surveillance sections to accomplish the mission.

(f) Supervise the communications, data processing and display, and sensor system functions to ensure effective support of mission objectives. Thoroughly assess equipment malfunctions to determine impact on mission accomplishment. If the malfunction cannot be corrected, ensure coordination with ground maintenance is initiated. Notify and coordinate with the E-3 squadron operations officer, through the appropriate command post when possible, of any limitations to operations and to determine further action. This notification should be initiated as soon as it becomes apparent the mission will be adversely affected.

(g) Disseminate changes in states of alert.

(h) Approve/coordinate downtime for unscheduled maintenance.

(i) Receive and authenticate messages.

(j) Advise the pilot of situations which could affect safety of flight operations or mission accomplishment.

(k) Approve/coordinate all orbit changes.

**b. Surveillance.** The surveillance function is performed by the Air Surveillance Officer, the Advanced Air Surveillance Technician, and

the Air Surveillance Technicians. They are responsible for the detection, tracking, identification, height measurement, display, telling, and recording/documenting surveillance data.

(1) Air Surveillance Officer. The ASO is responsible to the MCC for the functions of the surveillance section. The ASO will:

(a) Monitor and direct the accurate collection, display, and dissemination of surveillance data.

(b) Direct and/or coordinate the identification of all observed activity within designated areas.

(c) Analyze the surveillance situation and advise the MCC of surveillance capabilities.

(d) Notify the MCC whenever Electronic Countermeasures (ECM) are experienced and coordinate Electronic Counter Countermeasures (ECCM) actions.

(e) Notify the MCC of any suspected emergency IFF/SIF returns or triangular distress patterns.

(f) Forward Electronic Countermeasures reports.

(g) Coordinate with external agencies to ensure that accurate active and passive tracking, and track tell are performed.

(h) Assign and supervise AAST and AST responsibilities.

(i) Monitor and manage sensor data to ensure that the optimum sensor quality is maintained.

(2) Advanced Air Surveillance Technician. The AAST is a supervisory position responsible to the ASO and will provide assistance as required. The AAST will:

(a) Supervise the detection, tracking, reporting, identification, and recording of surveillance data.

(b) Assign and ensure the completion of AST duties.

(c) Monitor sensors in the assigned areas, notify the ASO of any unusual presentations, and assist the ASO in correcting problems.

(d) Coordinate with the ASO/CT/CSO in the establishment and operation of data links.

(e) Notify the ASO of any suspected emergency IFF/SIF returns or triangular distress patterns.

(3) Airborne Air Surveillance Technician. The AST is responsible for surveillance func-

tions as directed by the ASO/AAST. The AST or ASOP will:

- (a) Initiate on all suspected data trails appearing within the assigned AOR and ensure continuity of tracking.
- (b) Upon receipt of voice told tracks, monitor telling source and ensure that the track data is entered into the computer. On such tracks, monitor sensor data which may correlate and take appropriate action to effect correlation.
- (c) Tell tracks.
- (d) Notify the ASO/AAST of all unusual console presentations (ECM, electro magnetic interference (EMI), erroneous computer generated data, etc.), and take appropriate actions when directed by the ASO/AAST, to obtain the best possible presentation.
- (e) Notify the ASO/AAST of any suspected emergency IFF/SIF returns or triangular distress patterns.
- (f) Coordinate with the ASO/AAST to ensure passive tracking is maintained.
- (g) Assist the ASO/AAST with flight plans and other identification functions.

**c. Weapons.** The weapons function is performed by the Senior Director and Weapons Directors.

(1) Senior Director. The SD is responsible to the MCC for conduct of the air battle and for the control of all assigned aircraft and weapons systems in the E-3 area of responsibility. The SD will:

- (a) Supervise all WD activities.
- (b) Maintain data on friendly and enemy orders of battle.
- (c) Estimate and/or predict the capabilities of hostile forces and organize friendly counter forces.
- (d) Maintain current and accurate tactical situation, weapons, weather, airbase status, and other situational information.
- (e) Coordinate the air battle with appropriate agencies.
- (f) Direct the pairing of weapons against hostile targets.
- (g) Coordinate directly with the ASO to obtain surveillance support and optimum sensor quality.
- (h) Coordinate with other agencies to ensure the accomplishment of all assigned weapons missions.

(i) Notify the MCC of any suspected emergency IFF/SIF returns or triangular distress patterns.

(j) Ensure weapons team members receive maximum training from available resources (including SIM).

(2) Weapons Director. The WD is responsible to the SD for the control and regulation of air traffic for all assigned missions. The WD will:

- (a) Locate, identify and track aircraft assigned for control.
- (b) Control weapons against assigned targets.
- (c) Ensure orderly and expeditious recovery of assigned aircraft.
- (d) Coordinate with internal and external agencies, as applicable, on matters pertaining to flight safety/mission accomplishment.
- (e) Notify the SD of any suspected emergency IFF/SIF returns or triangular distress patterns.

**d. Communications.** The communications function is performed by the Airborne Avionics Communications Technician and the Airborne Communications Systems Operator.

(1) Airborne Avionics Communications Technician. The CT is responsible to the AC/MCC for the proper maintenance and operation of flight and mission crew communications and related equipment. The CT will:

- (a) Evaluate equipment status of the Communications Functional Group (CFG) and advise the MCC of its capabilities to support mission requirements.
- (b) During deployment or dispersed base operations, the CT will assist ground based personnel with maintenance activities when required or requested. When ground based maintenance personnel are not available, the CT is responsible for organizational level maintenance on the communications group and its related subsystems utilizing the available technical data, and the Mobility Readiness Spares Package (MRSP) as applicable.

(2) Communications Systems Operator. The CSO is responsible to the AC/MCC for proper programming and operation of flight and mission crew communications systems. The CSO will:

- (a) Tune, configure, and operate clear and secure voice communications systems and communications nets to support mission requirements.

(b) Configure and operate data link equipment and software.

(c) Perform frequency management; recommend and make required communications changes.

(d) Compile and transmit required in-flight and position reports to appropriate facilities.

(e) Coordinate, obtain, use, and control COMSEC material.

**e. Data Processing and Display.** The data processing and display function is performed by the Airborne Computer Display Maintenance Technician. The CDMT is responsible to the MCC for the operation, monitoring, and limited inflight maintenance of the Data Processing, Data Display, and Onboard Test Monitor and Maintenance functional groups. The CDMT will:

(1) Perform loading of the Data Processing System, auxiliary system(s), and monitor the performance of the Data Processing System, Data Display System, auxiliary system(s), Onboard Test Monitor and Maintenance Groups using fault indications and software messages displayed at the Computer Technician console.

(2) Monitor the status of mission avionics equipment tested by the computer for efficient operation.

(3) Service the Data Processing peripheral equipment.

(4) Perform diagnostic programs.

(5) Perform inflight troubleshooting and fault isolation.

(6) Perform replacement of modules, parts, and inflight maintenance repairs as required.

(7) Perform utilities programs.

(8) During deployment or dispersed base operations, the CDMT will assist ground based personnel with maintenance activities when required or requested. When ground based personnel are not available, the CDMT is responsible for organizational level maintenance on the Data Processing Functional Group, Data Display functional Group, Onboard Test-Monitor Group and the Interface Adaptor Unit (IAU) and its related subsystems using the available technical data and MRSP as applicable.

**f. Sensor System.** The ART is responsible to the MCC for the operation and maintenance of the radar and IF systems and their subsystems. The ART will:

(1) Initiate and monitor the Surveillance Radar Functional Systems and Identification Functional Systems.

(2) Perform radar equipment test (Fault Isolation) routines and other checkouts.

(3) Troubleshoot malfunctions in sensor systems and repair or replace equipment as required.

(4) Monitor surveillance equipment operating performance levels.

(5) Initiate and monitor associated test equipment to optimize performance of sensor systems.

(6) During deployment or dispersed base operations, the ART will assist ground based personnel with maintenance activities when required or requested. When ground based maintenance personnel are not available, the ART is responsible for organizational level maintenance on the radar and IFF systems and their related subsystems utilizing the available technical data and MRSP as applicable.

#### 5-4. Operational Procedures.

**a. Aircraft Mission Systems History Log Book.** A history log book will be maintained for each aircraft. Units will develop history log book procedures and ensure log books are readily available.

**b. Equipment Malfunctions.** MCC approval is required for continued operations of malfunctioning equipment that would affect the mission. The MCC must carefully evaluate the potential loss of equipment against the potential failure to accomplish the mission.

#### **c. Air Surveillance.**

(1) The ASO will coordinate with the SD and MCC to ensure all activity is conducted on an appropriate map. Coordinate Command and Control Coordinate System (CCCS) origin changes with the MCC and CDMT prior to taking the switch action.

(2) The ASO/AAST will ensure a surveillance briefing is accomplished prior to assuming station, normally during mission planning. As a minimum, the briefing will include surveillance information and individual task assignments.

(3) **Sensor Management/Procedures.** Prior to assuming station the ASO will perform sensor checks to determine the optimum radar/IFF settings for the mission. Results of the checks and the final radar setup will be briefed to the MCC. Sensor check procedures include:

(a) IFF Sensor Check. Perform a systematic checkout of the IFF as soon as it becomes available and prior to declaring it operational. The ASO will ensure an additional check is accomplished if equipment malfunctions are suspected or a previously unchecked R/T unit comes on line. As a minimum, the ASO will check:

1. Maximum Range: Maximum range of the IFF will be measured by determining the range of an IFF sensor return with a consistent data trail.

2. IFF Jitter: IFF jitter will be checked in all quadrants out to 250 NM from the E-3. Jitter will be measured as sideway displacement or returns from a straight-line path. Normally, 2-5 NM jitter is acceptable.

3. Quality: Overall quality of the IFF will be addressed by checking consistency of data trails and when radar becomes available, the mileage difference between the IFF and radar sensor returns. Normally, 1-2 NM is acceptable. This check will be accomplished within a radius of 250 miles from the E-3.

4. Loop Test: Perform a loop test prior to declaring the IFF operational.

5. Resolution of IFF Overloads: The ASO will frequently monitor the overload condition and make the necessary adjustments to minimize the loss of IFF data.

(b) Radar Sensor Check. Time permitting, the ASO will check as many frequencies as possible, and select a primary and secondary frequency (preferably not in the same RF chain). If checkout was accomplished prior to arrival to the orbit area, a sensor quality check must be made when established in the orbit area. The radar check will include:

1. Doppler/BTH Maximum Range: Determine the maximum doppler range from the SID presentation using data trails with a minimum 40% blip-scan ratio (3 out of 7 scans have radar returns). Determine the maximum BTH range from the SID presentation.

2. Quality: Radar quality is assessed by determining the percentage of all IFF returns within a 250 NM radius of the E-3 which have consistent discernible radar data trails. In addition, overall consistency of the radar presentation should be considered. The following criteria will be used to assess the overall quality of the radar:

GOOD = GREATER THAN 50%  
FAIR = BETWEEN 30 to 50%  
POOR = LESS THAN 30%

3. System Counts: Log on 28 AD Form 11; Doppler, BTH and Mode 3 counts for comparison of radar frequencies. Time of day, operating location, traffic density areas, and radar mode of operation may significantly affect the ratio of these figures.

(c) Radar Setup. The ASO must consider the effects of the E-3 flight parameters on sensor performance and attempt to optimize checkout within these restraints. The assessment of overall air picture quality will be the primary factor in determining the optimum frequency.

1. After selecting the optimum frequency, the ASO will declare the radar operational.

2. When multiple E-3 flights to an area are planned, the ASO will ensure that any frequency change will not produce interference with adjacent E-3s.

(4) Assuming Station: The following requirements will be met prior to assuming station. If station assumption is required prior to these requirements being met, the MCC will be informed of items not yet completed.

(a) Conduct data base checks as appropriate.

(b) IFF interface configured for mission use.

(c) Configure the radar settings based on mission requirements and optimize sensors for maximum detection while maintaining air picture quality.

(d) Track initiation on all data trails appearing within the assigned area(s) of responsibility.

(e) Initial contact with ground control agencies as required.

(f) Operational data links(s) if feasible.

(g) ESS placed in the mission mode.

(5) ASO, ART, and CDMT coordination will be accomplished on Maintenance Net. If the subject is classified, Net 3 will be used.

(6) Data Link Procedures and Operation. Data link is the primary means of passing E-3 information. Datalinks will be established according to JCS Pub 3-56.23 for TADIL-A and JTIDS Network Design Library for JTIDS during CONUS operations. For operations outside the CONUS, data links will be established according to local theater directives.



(7) Voice Tell and Recording Procedures. When the E-3 is in an environment with units not capable of data link interface, the following voice tell and recording procedures will be used:

(a) The E-3 will voice tell priority one, two, and three tracks unless the receiving agency directs cease tell. All other priorities will be told on request only. For this purpose the following priorities have been established:

1. Priority One--Hostile/Faker.
2. Priority Two--Unknown/Pending.
3. Priority Three--Emergencies.
4. Priority Four--Defensive Counter

Air.

5. Priority Five--VIP Flights.
6. Priority Six--Special Missions.
7. Priority Seven--Other tracks as directed by the receiving agency, (for example, Neutralized Fakers). Live tracks have priority over simulated tracks.

(b) Voice tell will be according to formats listed in attachment 11 (Voice Tell Formats). Prior to starting voice tell, the format to be used will be coordinated with and agreed upon by both agencies. When it is impossible for the receiving agency to accept tell according to attachment 11, a format agreed upon by both agencies will be used.

(8) ECM/ECCM Procedures: The ASO will monitor/coordinate ECCM actions. The following procedures will be used:

(a) Any unusual sensor activity should be coordinated by the ASO and ART to determine whether the source is external or internal to E-3 sensor systems. If no explanation can be determined and the source is external, a MIJI report will be submitted.

(b) In an ECM environment every effort will be made to obtain active data on all ECM targets. Cooperative passive tracking will be used whenever possible; self-passive tracking will be used whenever cooperative support is not available.

(c) When self-triangulating, to determine if one of several previously active tracking returns is a suspected ECM emitter, the AST will extrapolate the suspected track on its last known heading, speed and altitude, before initiating a passive track. If two tracks are used, the ASO will coordinate with the MCC and SD to ensure proper weapons commitment.

(d) The ASO will keep the MCC and SD advised on status of passive tracks. When the ASO is confident that the passive track has cor-

related with the jammer's location, notify the SD that the track has stabilized.

(9) Identification: When the E-3 is granted ID authority, the crew will use all available capabilities and resources to ID tracks within its area of responsibility according to the local operating theater ID regulations.

#### d. Weapons Procedures.

(1) Station Assumption: Prior to assuming station, the SD will:

(a) Contact FAA/ARTCC or ground monitor/control authority, as applicable.

(b) Initiate and complete a sensor correlation check when the E-3 is scheduled to be a control facility. To ensure correct positioning of sensor data, the correlation procedures will be reaccomplished periodically if mission computer or inertial navigation computer problems are encountered.

(c) Ensure that all weapons assigned radio frequencies are checked for usability.

(d) Check data base accuracy.

(e) If no ARTCC or ground monitor capability exists for the area of responsibility, a correlation check with a controlled aircraft position from a TACAN will be used if possible.

(2) On-Station Procedures: Procedures will be according to the operational procedures contained in this regulation and specific mission directives.

(3) Off-Station Procedures: The SD will compile controlled aircraft mission totals and furnish this data to the MCC. The SD will pass totals to the ground monitor if requested/directed.

(4) SD Control Procedures. The SD may control aircraft during a mission after coordination with the MCC and when simultaneous missions are not in progress.

(5) Handoff procedures will be according to applicable FAA Letters of Agreement. The SD or a designated WD will monitor the handoff frequency at all times when performing station assumption duties and while on station.

(6) Controlled Aircraft Emergency Procedures. For aircraft with in-flight emergencies, the SD/WD performing the handoff will use the word Emergency at the beginning and ending of transmissions to the recovery agency. In the event of an emergency being declared by an aircraft under control, the WD will refer to their Aircrew Aids Controlled Aircraft Emergency Procedures.

(7) On-station control procedures will be according to AFR 55-79.

(8) Use of airspace will be according to Air Traffic Control Management/Airspace Control directives.

(9) Report any suspected or triangular distress patterns to the SD.

(10) During all operations, WDs will ensure that symbology and sensor data of controlled aircraft are within 2 NM of each other. WDs ensure that pairings to Combat Air Patrol (CAP), Air-to-Air Intercept and ground targets can be passed to net participants over data link.

**e. Communications.**

(1) Radio procedures. Communications discipline will be adhered to at all times. Proper ICAO phrases, phonetic alphabet and R/T procedures outlined in ACP 121, US Sup 2 (Communications Instructions, General-Air-Ground) will be used by all crewmembers.

(2) Priority of Message Transmissions. The E-3 aircrew, while in flight, will transmit messages according to the following priority:

- (a) Flight Safety.
- (b) Command and Control Information.
- (c) Flight Regularity.

(3) Phone Patches. Units will establish phone patch procedures in their local chapter.

(4) Dispersal Word/Base. The CSO will obtain the dispersal word and base and inform the MCC and pilot during mission planning.

(5) Mode 2 IFF/SIF Procedures. The CSO will obtain the Mode 2 code settings and Mode 4 key list when receipting for the classified documents. The CT will be responsible for inserting, verifying and zeroizing the Mode 2 setting and Mode 4 as required by local procedures.

(6) Call Signs. The aircraft call sign will always be used when transmitting messages of Flight Safety, aircraft movement, and radio calls required by this regulation. The mission crew call sign will be used by mission crewmembers when communicating with the respective controlling/monitoring agency, aircraft under their control or as fragged/briefed. The CSO will brief crewmembers on call signs to be used when providing alternate communications.

(7) UHF/VHF Guard Monitoring Procedures. The MCC will ensure that VHF and UHF guard frequencies are monitored by the mission crew. The MCC, SD, and WDs will have UHF guard receiver/transmitter programmed to their consoles. While aircraft are under control by the mission crew, the SD will designate

at least one weapons crewmember to monitor UHF guard. The ASO, AAST, and ASTs will have VHF guard programmed to their consoles. The ASO will designate one surveillance crewmember to monitor VHF guard while the E-3 is on station.

**f. Mission Crew Intercom Procedures.**

(1) The primary means of coordination for the mission crew will be via the programmed mission nets.

(a) Net assignments/deviations will be coordinated through the MCC.

(b) Net discipline will be strictly maintained. Conversations will be limited to operational matters.

(2) The ADS selective intercom system will be used for unclassified person-to-person conversations or information that is lengthy in nature.

(3) The PA system is for use in emergencies and practice emergencies. Except for emergency checklist items, use of the PA by mission crew is restricted to the MCC.

**g. Special Interest Track Procedures.**

(1) A special interest track is any track that requires priority handling by the mission crew.

(2) The E-3 will not depart orbit or working area to continue monitoring the special interest track unless directed by the command authority exercising E-3 OPCON. Any instructions that are directive for the E-3 (i.e. leave/move orbit, changes in level of decentralization, etc.) will be authenticated by the MCC/BDT.

(3) The MCC will:

(a) Direct the ASO to assign tracking responsibilities for the special interest track.

(b) Direct the SD to monitor the special interest track for possible intercept actions.

(c) Coordinate with the flight crew to maintain the special interest track within the E-3 surveillance limits (orbit location).

(d) Coordinate E-3 airspace changes (orbit location) with the ground monitor or ATC, as required.

(4) The ASO will:

(a) Give priority attention to the special interest track and assign it to an AST as a specific responsibility.

(b) Ensure the track TD is hardcopied and logged, listing the time; track number, and ID.

(5) The ASTs will maintain tracking and perform tell according to the procedures in this regulation.

(6) The SD will:

(a) Monitor the progress of the special interest track and conduct any intercept operations of the track as directed.

(b) Scramble and/or direct aircraft for interception as directed/necessary.

(c) Inform the MCC/ground monitor facility of any required information after intercept has been accomplished.

(d) Coordinate with the proper ground unit for recovery of the interceptors.

#### h. Sensor Correlation.

(1) If control of aircraft is anticipated, a weapons correlation check will be accomplished normally prior to assuming station. If the E-3 mission is surveillance only, the surveillance section will perform the check with the appropriate automated/manual tell agency/agencies.

(2) An IFF only correlation check can be performed if:

(a) The ASO subsequently correlates IFF to radar sensor returns, or;

(b) IFF only on-station operations are authorized according to this regulation and theater operating instructions.

(3) When operating as an MRU in CONUS and control of aircraft is anticipated, correla-

tion procedures will be according to FAA Handbook 7610.4F, Special Military Operations.

(4) When operating as an ARU, procedures will be coordinated with the responsible MRU prior to assuming station.

(5) When operating in Canada, the E-3 will comply with the DOT/DND agreement (short title, AWACS Agreement) between Director General Air Doctrine and Operations Department National Defense, and Director Air Traffic Services Department of Transportation.

(6) The following procedures apply to sensor correlation checks required by surveillance:

(a) Minimum of two tracks within the ADIZ preferably in a non-congested area (tracks should be mutually agreed on by both agencies).

(b) Voice tell format will include the track number, coordinates, and Mode 3 squawk (if possible). Tracks used must be within 3 nautical miles, plus or minus, to be considered as good sensor correlation.

(c) Successful data link correlation checks could be used in lieu of voice tell checks due to accurate real time data being passed between both agencies.

i. **Mission Crew Commander Reports.** MCC reports will be compiled according to MCC Aircrew Aid. Information will be collected by the MCC and passed to the CSO for transmission.

DEPARTMENT OF THE AIR FORCE  
Headquarters 552d Air Control Wing (ACC)  
Tinker Air Force Base, Oklahoma 73145-90123

552 ACW SUPPLEMENT 1  
MCR 55-33  
15 July 1993

Operations

552 ACW LOCAL OPERATING PROCEDURES

MCR 55-33, 3 May 1993, is supplemented as follows:

1. Insert this supplement as Chapter 6 of the basic publication.
2. This transmittal page will be filed in back of the basic publication.

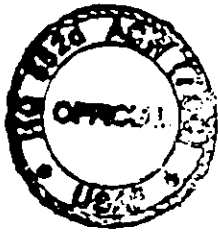

DAVID OAKES, Brig Gen, USAF  
Commander

BERNITA M. DAVIS, MSgt, USAF  
Acting, Chief of Information Management

Supersedes TACR 55-3/552 AWACW Sup 1, 10 Dec 90

No. of Printed Pages: 49

OPR: 552 OG/OGV (Maj T. L. Johnson)

Approved By: Colonel C. L. Davis

Editor: SSgt R. Leverett

Distribution: ~~XXXX~~ (HQ ACC/DOYA)

## DEPLOYMENT ACTIONS

1. This attachment establishes procedures for deployment and redeployment to forward operating locations.

2. Currency requirements: Squadrons will establish procedures to ensure crewmembers scheduled for deployments will not become delinquent in flying/ground training requirements during the period of TDY.

a. Squadron flight managers will review the following currency requirements on all crewmembers scheduled for deployment prior to publishing flight orders:

- (1) Life support training
- (2) Flight physical
- (3) Physiological training
- (4) Evaluations required by AFR 60-1
- (5) Instrument refresher training (Pilots/Navigators only)
- (6) All currency requirements
- (7) Required additional training complete
- (8) Periodic (180 day) testing complete
- (9) Any other training requirements which may preclude an individual from

deploying.

b. Crewmembers scheduled for deployment who may become delinquent during the deployment period will be replaced or will accomplish the item(s) in which they may become delinquent prior to deployment.

3. Outprocessing: Deploying crewmembers will report to their squadron mobility section prior to deployment for out processing instructions. Squadron mobility personnel will provide checklists for out processing through MPF and Accounting and Finance when a mobility processing line has not been arranged.

4. Mission planning: Deployment mission planning normally will be conducted the last duty day prior to deployment. 552 OSS/OSO will provide a computer flight plan (CFP) on mission planning day and ensure a current CFP is in the squadron ORC two and one half hours prior to scheduled takeoff time.

5. Crew baggage loading: All non-crew baggage and cargo on board will be manifested. The deploying squadron will arrange for the high-lift truck to be available two and one half hours prior to scheduled takeoff time. The driver will be provided by the squadron or the

**TAB AA**

**REGULATIONS AND DIRECTIVES**

**AA-1 OPC Airspace Control Order and SPINS, 12 December 1993**

**AA-2 Extracts from MCM 3-1  
(See Classified Addendum)**

**AA-3 Extract from Aircrew Read File 183  
(See also Classified Addendum)**

**AA-4 Multi-Command Regulation 55-33, E-3 Operating Procedures  
with 552 ACW Supp 1**

**AA-5 Air Combat Command Regulation 51-60, Training Management  
for Command and Control Aircrews**

**AA-6 Extracts from DA Pamphlet 738-751, Functional User's Manual  
for the Army Maintenance Management System**

**AA-7 552nd Operations Group Operating Instruction 60-2,  
552nd (Deployed) Turkey Operating Procedures**

**AA-8 Extract from Eagle Detachment Read File, Annex A, Daily  
Requirements**

**AA-1**

**AA-2**

**AA-3**

**AA-4**

**AA-5**

Chg 1 - APC

DEPARTMENT OF THE AIR FORCE  
Headquarters Air Combat Command  
Langley Air Force Base, Virginia 23665-2788  
Headquarters Pacific Air Forces  
Hickam Air Force Base, Hawaii 96853-5001

ACC REGULATION 51-60  
PACAF REGULATION 51-60  
Volume 2

1 June 1992

**Flying Training**

**TRAINING MANAGEMENT FOR COMMAND AND CONTROL AIRCREWS**

**E-3 Aircrew Training**

This volume in conjunction with volume 1 establishes Air Combat Command (ACC) and Pacific Air Forces (PACAF) standards for training and qualifying personnel performing aircrew duties in E-3 aircraft. It should be used with AFR 50-5 and AFR 60-1. This publication does not apply to Air National Guard (ANG) or US Air Force Reserve (USAFR) units and members. See attachment 6 for list of acronyms/abbreviations used in this publication.

This publication is affected by the Privacy Act of 1974. The information required to be collected and maintained is covered by Privacy Act System Number F060 AF A, Air Force Operations Resource Management Systems (AFORMS). The authority for maintenance of the system is 37 U.S.C. 301a and 301b, Public Law 92-204, Section 715; Public Law 93-570 and Public Law 93-294; and Executive Order 9397.

**SUMMARY OF CHANGES**

References to Tactical Air Command (TAC) have been changed to ACC; PACAF has been scripted into the text as a separate and distinct owner of USAF E-3s; references to AWACS units have been changed to reflect the reorganization of the 28 AD into an objective wing; a Graduated Combat Capability (GCC) training concept for each AWACS aircrew position has been established; training is divided into three levels (A,B,C) with each level containing requirements for experienced and inexperienced aircrew members; monthly training rates, a 3-month lookback, and semiannual training requirements are also included; weapons director (WD) training requirements have been streamlined, simplified, and standardized to parallel WD training programs at other command and control units; the term Mission Capable (MC) has been changed to Mission Support (MS) to parallel 51-50-series training regulations; squadron commanders have been given the authority to grant 30-day extensions in training; a second 30-day extension may be granted by 552 OG/CC and 5 AF/DO; this revision places several specific training events within an overall systems operations training event specific to each aircrew position; a counterdrug operations training requirement has been established; the term pilot has been changed to aircraft commander; more realistic prerequisites have been established for upgrade to instructor and positions of greater responsibility, i.e. weapons director to senior director.

**EXTRACT**

I certify that I am the Records Custodian for the Accident Investigation Board convened to investigate the crash of two U.S. Army Black Hawk helicopters in the no fly zone in northern Iraq on 14 April 1994, and that this is a true and accurate extract from

ACC Reg 51-60, Vol 2, 1 June 92  
which is kept in my records system.  
15 May 94 Date  
W. L. Harris  
WILLIAM L. HARRIS, Capt, USAF, MSC  
Evidence Custodian, Incirlik Air Base, Turkey

Supersedes TACM 51-60 Volume 2, 30 December 1988.

No. of Printed Pages: 36

OPR: HQ ACC/DOYA (Maj Bill Karr) and HQ PACAF/DOC (Maj Les Ferguson)

OPDR: 552 OG/DOT (Capt Roy Hosenin)

Approved by: Major General Lawrence E. Boese

Editor: Marty Mun...

Distribution: ACC: HQ USAF/XOOI... 1; PACAF: F

and proficiencies of assigned/attached aircrew members.

(4) Will certify aircrew members as Mission Ready (MR) when appropriate training requirements are met.

(5) Will report end-of-cycle training deficiencies through channels to MAJCOM/DO.

h. Flight Commanders will manage individual assigned/attached aircrew member currencies and requirements.

i. Supervisors will:

(1) Identify areas where additional training is needed and direct training accordingly.

(2) Ensure mission objectives are prebriefed, debriefed, and evaluated to determine successful accomplishments.

(3) Request waivers of training requirements through appropriate channels as required.

j. Individual Aircrew Members:

(1) Are responsible for completion of training requirements and currencies within the guidelines of this volume.

(2) Will ensure they are neither scheduled for nor participate in flying activities for which they are not qualified or current unless under the supervision of a qualified instructor.

### 1-3. Volume Administration.

a. This volume will be maintained in all E-3 squadrons where it will be readily accessible to operations staff and aircrew personnel.

b. MAJCOMs may use chapter 6 of this volume for unique requirements and restrictions and to establish individual unit taskings as required.

c. The 552 ACW/5 AF and/or 552 OG/18 OG/961 AWACS may supplement this volume and will forward a copy through channels to the appropriate MAJCOM DOC/DOY for approval.

d. Proposed changes to this volume will be submitted IAW AFR 60-9, *Aircrew Flight Manual Programs*. Use AF Form 847, Recommendation for Change of Publications (Flight Publication), to submit recommended changes. Time sensitive changes will be addressed by immediate action message that will be

filed in the Flight Crew Information File (FCIF) and will be followed up with a remove/insert page change.

e. Additional guidance, requirements or restrictions levied by subordinate units to training addressed in this volume will be forwarded through channels to MAJCOM for review and approval.

f. Changes to the multi-command section of this volume require coordination by both ACC and PACAF OPRs. HQ ACC will process all changes to this regulation.

1-4. **Aircrew Experience Levels.** Aircrew experience levels will be used locally in assigning aircrew members to best balance the crew force IAW the Graduated Combat Capability (GCC) training levels established in paragraph 1-8. They may also be used to direct training for those who most need it. Experience levels are defined as follows:

a. **Experienced Aircraft Commander:** A pilot with 3,000 hours total rated pilot time with 200 hours E-3 time; or 2,000 hours total rated flying time with 300 hours E-3 time; or 1,500 hours total rated flying time with 500 hours E-3 time. In addition, an aircraft commander must have been MR in the E-3 for 1 year.

\*b. **Experienced Copilot:** 200 hours E-3 time, qualified to land with passengers onboard, must be MR.

c. **Experienced Navigator:** 2,000 hours total rated flying time with 200 hours E-3 time; or 1,000 hours total rated flying time with 300 hours E-3 time; or 600 hours E-3 time. In addition, a navigator must have been MR in the E-3 for 1 year.

d. **Experienced MCC/SD/ASO/AAS/AST/BDT/FE:** 400 hours total E-3 time in the primary crew position. In addition, these crew members must have 2 years in their primary career field.

e. **Experienced WD:** An experienced controller must hold a 1745 AFSC and have controlled a minimum of 125 generic and 25 specific live missions as an MR controller. Generic missions are any/all MR missions accomplished during a career regardless of the system. Specific missions are those accomplished in the sys-



tem to which a controller is currently assigned. An experienced controller must also have 2 years in the career field beginning upon graduation from basic weapons controller school. In addition, a controller must have been MR in the E-3 for 1 year.

f. Experienced CDMT/ART/CT/CSO. 500 hours total E-3 time in their primary career field. CDMO and ARO are inexperienced by definition.

1-5. **Training Concept.** The E-3 aircrew training program is designed to achieve the highest degree of mission readiness possible within the peacetime constraints of safety, resource availability, and aircrew capabilities. Personnel are stepped through a logical training sequence starting with simple, non-tactical duties and progress upward through several phases of training to become qualified to perform tactical duties in support of E-3 roles and missions as defined in MCM 3-1. A balanced mixture of flying, aircrew training device (ATD), and academic training is used to prepare qualified aircrew members for each successive level of required proficiency. Each phase of training and proficiency level is defined in terms of crewmember readiness to allow commanders and operations officers the ability to balance their force experience and proficiency throughout the unit, allocate training resources effectively, and maximize unit readiness.

#### 1-6. Training Policies.

a. **Training Standards and Testing.** Criterion objectives, as described in AFM 50-2, AFR 50-8, and AFP 50-58 will be used to establish training requirements when possible. Training managers and instructors will use the Instructional System Development (ISD) process to develop formal training programs to include objectives and tests where applicable.

(1) Academic and positional testing will be used to validate the qualification of personnel to the maximum extent possible throughout the training program.

(2) Individuals who demonstrate high levels of performance may proficiency advance by successfully completing the tests prior to receiving the supporting training.

b. Training missions will be designed to achieve combat capability in E-3 roles and missions to include High Value Airborne Asset (HVAA) defense as defined in MCM 3-1. Scenar-

ios will emphasize procedures and operations based on employment plans, location, current intelligence, and threat capabilities.

c. **Downgrade/Review Policy.** The squadron commander may declare a crewmember unqualified (UQ) or basic qualified (BQ) at any time a crewmember cannot maintain the minimum level of proficiency. Squadron commanders should review GCC training levels monthly to ensure squadron members meet monthly sortie requirements. Concurrently, 552 OG/CC should review the Group's GCC training levels on a quarterly basis.

#### 1-7. Training Records.

a. **Flying Training Records** will be maintained IAW TACR 50-31 and local directives. Training records will be hand-carried by individuals to their unit. Losing units will ensure training records are complete and all appropriate OJT records are current.

b. **Training Folders.** Training folders will be maintained for all E-3 aircrew members in Initial Qualification Training (IQT) or AFR 50-5 aircrew/instructor upgrade IAW TACR 50-31. Standardized training folders will be maintained for all E-3 members in MQT, aircrew/instructor upgrade, or requalification training not under formal syllabi.

#### 1-8. GCC Policy and Management.

a. Since the training necessary to prepare aircrew members for all combat missions may exceed available resources, the CAF uses an incremental approach to training. These increments are expressed as Graduated Combat Capability (GCC) levels, each defined by a number of sorties flown within a specific time period, the number of semiannual training events accomplished, and the aircrew member's experience level. GCC levels are designed to provide unit commanders and operations officers with information to aid them in allocating training resources and flying hours to facilitate the building of a well-balanced, fully-trained combat ready unit.

b. ATD and live GCC training requirements for inexperienced and experienced E-3 aircrew members are at Tables 4-1, 4-2, 4-3, and 4-4 of this volume.

c. GCC levels provide a tool for unit commanders to flexibly manage training. They are not intended to stigmatize or categorize E-3

crewmember inherent capability or basic skill level. GCC levels are defined as follows:

(1) GCC Level A (GCC-A). Level A is the basic Mission Ready (MR) level as determined by MAJCOM. It is the minimum amount of training necessary for an E-3 crewmember to perform the unit's primary Designed Operational Capability (DOC).

(2) GCC Level B (GCC-B). Level B establishes the maximum level of training sorties and events necessary to increase proficiency and increases the unit's capability to meet its full tasking.

(3) GCC Level C (GCC-C). Level C establishes the maximum level of training sorties and events and develops maximum aircrew proficiency and unit capability to meet additional taskings.

d. The commander's first priority is to train all aircrew members to Level A. Additionally, the commander may designate an aircrew member for a higher training level as individual or unit proficiency needs dictate. For example, a crewmember completing initial qualification training may require greater than GCC Level A training opportunities to achieve proficiency. Also, a crew member returning from an extended, non-flying TDY may require training at a higher GCC level.

e. GCC levels will be determined and assigned based on the sortie rate and the number of training events currently attained.

(1) MR aircrew members must maintain a minimum of GCC Level A training requirements. Training will be documented in AFORMS (attachment 3).

(2) Administration of GCC training above level A requires performance of all events at the higher GCC level or completion of the prorated share of training events at the higher GCC level.

f. Three-Month Lookback (Table 1-1). The 3-month lookback allows commanders to better manage aircrew member training resources by examining training accomplishment on a more frequent basis.

(1) An aircrew member failing to fly the monthly Level A rate could lose MR status. The commander may keep an aircrew member MR if the 3-month GCC sortie total is above the minimum for Level A. This lookback feature can avoid unwarranted swings in status and reporting. Aircrew members without a 3-month history may be kept MR at the discretion of the

squadron commander. Training requirements are at paragraph 4-6.

(2) If the 3-month lookback is not met, the crewmember may be given one more month to fly enough sorties to make the 3-month total by the next monthly review. Unless the 3-month rate is met, the crewmember will lose MR status and will have to regain status IAW paragraph 4-12.

(3) A crewmember should be reported at the level that the crewmember's continuation training flying can support. Aircrew members less than 3 months MR must meet the 1-month lookback to maintain MR status.

Table 1-1. GCC Sortie/System Ops Requirements (Inexperienced/Experienced).

	GCC Level		
	A 1/E	B 1/E	C 1/E
Aircraft Commander/Copilot			
Monthly Sortie Requirement	2/2	3/2	4/3
3-Month Lookback	6/4	8/6	10/8
Navigator/Flight Engineer			
Monthly System Ops Sortie	1/1	2/1	2/2
3-Month Lookback	3/2	4/3	5/4
Mission Crew			
Monthly System Ops/Weapons Sortie	2/1	3/2	4/3
3-Month Lookback	6/3	9/6	12/9

g. Training requirements will be based on the aircrew member's experience level on the last day of the current training cycle.

### 1-9. Ground Training Categories.

a. Applicable aircrew ground training is outlined in the following chapters as it pertains to each phase of training. Ground training is divided into the three categories outlined below. Refer to attachment 1 for a complete list of categories I and II training.

(1) Category I (Mission Essential Ground Training). Training included in this category is designed to enable aircrew members to effectively perform their assigned combat mission. Without this training, aircrew readiness could be degraded.

(2) Category II (General Flying Related Ground Training). This training category includes flying related training applicable to aircrew members regardless of their specific mission or aircraft.

(3) Category III (Nonflying Related Ground Training). This training category in-

## Chapter 4

## CONTINUATION TRAINING (CT)

## Section A—General

**4-1. Scope.** This chapter prescribes training standards to maintain qualification, currency, and to requalify previously qualified aircrew members in the E-3.

**4-2. Definitions.**

a. Continuation Training (CT). Flying, ATD, and academic training designed to maintain or improve aircrew capabilities to perform E-3 roles and missions.

b. Weapons Systems Academic Training (WSAT). Quarterly academic training designed to provide aircrews with information on tactics, employment, training and evaluation trends, procedures, and changes to E-3 equipment and software.

**4-3. Training Period.** Each training period is 6 months long. The first semiannual period starts on 1 January and the second on 1 July. The training cycle for WSAT is quarterly.

**4-4. Prerequisites.** Aircrew members must have completed E-3 MQT and have MR/MS certification.

## Section B—Ground Training Requirements

**4-5. Ground Training.** Category I and II Ground Training applies as follows:

## a. Category I (Mission Essential).

(1) Weapons Systems Academic Training (WSAT). WSAT will be administered quarterly and implemented at the squadron level. See attachment 5 for a recommended list of WSAT training categories and topics.

(2) Aircrew Intelligence and TK/CM training. The focus and extent of intelligence training will be determined by the 552 OG/DO, or Geographically Separated Unit (GSU)/CC, as appropriate. The program will be designed around projected real world taskings and the latest threat information. Training objectives will be jointly developed by intelligence and tactics. The 552 OG/DO or GSU/CC will determine which crew positions are subject to testing. Other crew positions will receive familiarization training and not be subject to intelligence test-

ing. Crew position training requirements, overall objectives, testing/familiarization requirements and fly away threat aids will be approved by the 552 OG/DO, or GSU/CC, and reviewed annually.

(3) US/USSR Prevention of Dangerous Military Activities. An annual training requirement providing guidance on operations and communications procedures to be used when conducting activity in the vicinity of Soviet military forces.

## (4) Theater Training.

(a) As a minimum, MR/MS crewmembers will receive annual training in their applicable theater of operations. Squadron commanders may require their personnel to receive training in additional theaters to fulfill unit taskings. E-3 aircrew members must complete applicable theater training prior to assuming operational duties within that theater. Theater training will be developed for CENTCOM, LANTCOM, NORAD, PACOM, EUCOM, and SOUTHCOM. Training materials will be reviewed and updated annually by the OPR/OPDR and will consist of:

1. Geography, terrain, climatology, and recent history.
2. Command structure.
3. Intelligence.
4. Theater resources and their disposition.
5. Rules of engagement.
6. Command, control, and communications interface.
7. Local operating procedures.
8. Theater employment.

(b) Theater training will be accomplished in conjunction with Checkered Flag (CF) training whenever possible. Squadron tactics offices will maintain a theater training package for each theater listed above. If training time is not available prior to crew departure, packages will be deployed with the crew.

(5) Exercise/Deployment Spin-up Training. Academic and simulator (if available) training will be conducted prior to participation in Composite Force Training (CFT), NORAD exercises, or overseas deployments. Training will include an overview of the exercise, exercise objectives, and E-3 concept of employment.

If training time is not available prior to deployment, an exercise/deployment package will be deployed with the crew.

b. Category II (General Flying Related Ground Training). For the purposes of CT, Category II ground training consists of:

- (1) Physiological training.
- (2) Life Support training.
- (3) Chemical warfare defense training.
- (4) ATD training.

### Section C—ATD Training Requirements

#### 4-6. ATD Training Requirements.

a. Flight Crew (Table 4-1). Flight Crew semi-annual ATD training events are designed to provide training that may not be available in flight or is prohibited by flight safety guidelines. MS crewmembers will accomplish 50 percent of GCC Level A (Experienced) training requirements, but not less than one, where only one is required.

**Table 4-1. Flight Crew Semiannual ATD Training—GCC Training Levels (Inexperienced/Experienced).**

Training Event	Crew Position	Notes	Number of Training Events		
			GCC-A I/E	GCC-B I/E	GCC-C I/E
Scenario					
Sortie	AC,CP,FE	1,3,4,5	4/4	4/4	4/4
Instrument					
Sortie	AC,CP,FE	2,5	2/1	2/1	2/1

#### NOTES:

1. Flight crews stationed at GSUs require 8 simulator scenario sorties every 17 months which may be accomplished in conjunction with appropriate evaluation criteria (60-2-series publications); however, these units must comply with SEPT training requirements detailed in attachment 4.
2. Not applicable to instructors, SEFEs, or GSUs.
3. AWACS senior staff officers (0-6 and above) may complete semiannual simulator requirements by accomplishing two senior staff continuation training simulator sessions under instructor supervision.
4. Instructors, SEFEs, and MS crewmembers will be required to accomplish 50 percent of GCC Level A (experienced) training requirements. Instructors and SEFEs may count instructional/evaluation sorties toward their semiannual training requirements.
5. The flight crew training contract provides a continuation training simulator program involving no more than four

scenario sorties and two instrument sorties per flight crew member per semiannual period. This constitutes the flight crew ATD program. Therefore, the requirements for all GCC Levels are equal due to the limitation of the contract.

b. Mission Crew (Table 4-2). Mission Crew semiannual ATD training events are designed to provide specialized training that may not be available in flight. Personnel assigned to HQ ACC, HQ PACAF, GSUs, and USAFFWS are exempt from simulator requirements. MS crewmembers will accomplish 50 percent of GCC Level A (Experienced) training requirements, but not less than one, where only one is required.

**Table 4-2. Mission Crew Semiannual ATD Training Requirements—GCC Training Levels (Inexperienced/Experienced).**

Training Event	Crew Position	Notes	Number of Training Events		
			GCC-A I/E	GCC-B I/E	GCC-C I/E
Mission Scenario	MCC,SD, WD,ASO, AAST,AST, BDT	1	4/3	6/4	8/6
Air-to-Air Mission	SD WD	2,5,6	6/4 22/18	8/6 36/24	10/8 50/30
AAR Msn	SD WD	3,5,6	2/1 6/2	3/2 10/4	4/3 14/6
Air-to-Surface	SD WD	4,5,6	1/0 2/0	2/1 4/2	3/2 6/4

#### NOTES:

1. Mission Scenario. Mission scenarios will be developed to meet operational taskings. Emphasis is on crewmember performance of wartime taskings. Scenarios will emphasize current E-3 employment tactics and include ECM/ECCM and communications jamming.
2. A mission includes briefing, controlling, and debriefing. Controlling will consist of taking radio and radar control of aircraft and accomplishing one or more intercepts or engagements. Simulation drivers will attempt to make these events as realistic as possible by imitating actual radar handoffs, recoveries, tactical employment, and mission timing as closely as possible. ACT and composite force scenarios described in AFR 55-79 and ACC Supplement 1 will be used as guidelines. Aircraft other than fighters may be used as targets (e.g., bombers, jammers, transports, etc.).
3. An AAR mission will consist of the launch and recovery of at least one tanker aircraft. A minimum of four receivers must be controlled. One rendezvous must be controlled point parallel. The remaining rendezvous may be tactical or close control.

4. An Air-to-surface mission will consist of a minimum of five flights of aircraft. WDs will assist in marshaling of forces, provide threat warning; and pass in-flight, FAC, and battle damage assessment reports as needed. Mission duration is flexible but will include an ingress and egress of the target area by all applicable participants.

5. Engagements controlled during mission scenarios may be credited toward those requirements if they meet the standards listed for each mission type.

6. Flying training accomplished in excess of requirements may be credited toward simulator requirements on a one-for-one basis.

**Section D—Flying Training Requirements**

**4-7. Flying Training.**

a. Flight Crew (Table 4-3). Flying training requirements will be accomplished as outlined in the following table. MS crewmembers will accomplish 50 percent of GCC Level A (Experienced) training requirements, but not less than one, where only one is required.

**Table 4-3. Flight Crew Semiannual Flying Training Requirements—GCC Training Level (Inexperienced/Experienced).**

Training Event	Crew Position	Notes	Number of Training Events		
			GCC-A I/E	GCC-B I/E	GCC-C I/E
Sortie	AC,CP	5	12/8	16/12	20/16
Take Off	AC,CP	1	8/5	10/8	13/10
Landing	AC,CP	2,6	12/8	15/12	19/15
Night Landing	AC,CP	2,6	2/2	3/2	3/3
Pilot Proficiency Sortie	AC,CP	5,9	4/3	5/4	6/5
Instrument Departure	AC,CP	8	4/3	6/4	7/6
Precision Approach	AC,CP	3,7,8	8/5	10/8	13/10
Nonprecision Approach	AC,CP	7,8	6/4	8/6	11/8
Penetration (Published or en route)	AC,CP	8	5/4	6/5	7/6
AAR	AC	4,10	5/4	6/5	7/6

AAR (night)	AC	4,10	2/2	3/2	3/3
AAR (Tanker auto pilot off)	AC	4,10	2/2	3/2	3/3
3 Engine Approach/ Missed Approach	AC,CP	7	4/3	5/4	6/5
3 Engine Landing	AC,CP	6	4/3	5/4	6/5
Celestial LOPs	N		8/6	10/8	12/10
Inflight Alignments	N		4/3	5/4	6/5
AAR Rendezvous	N		4/3	5/4	6/5
Systems Operations	N,FE		6/4	8/6	10/8

**NOTES:**

1. Takeoffs may be logged for initial takeoffs, touch-and-go landings, and full stop taxi backs. An individual must actually control the aircraft to log a takeoff.
2. Log both landing and night landing when performing a night landing.
3. ILS and PAR approach may be substituted one for another depending on facilities available. Every attempt should be made to get an even distribution of both.
4. Log both AAR (night) and AAR (tanker autopilot off) with AAR if applicable.
5. Log both Sortie and Pilot Proficiency when flying pilot proficiency sortie.
6. Log both landing or landing (night) with three engine landing, as applicable.
7. Log both nonprecision approach or precision approach, as applicable, and three-engine approach/missed approach flown together.
8. Two each may be credited per semiannual period in conjunction with flight simulator instrument sorties.
9. Pilot Proficiency Sorties (P-sortie). To credit a P-sortie, a pilot must log 45 minutes first pilot time and accomplish the following within one crew duty day:
  - (a) AAR (if available).
  - (b) Precision Approach (PAR/ILS if available).
  - (c) Non-Precision Approach.
  - (d) Missed Approach.
  - (e) VFR Pattern.
  - (f) Emergency Procedures to include as a minimum (weather permitting):
    1. Simulated three engine approach and missed approach.
    2. Simulated three engine landing.

If items (a), (c), (e), or (f) can't be accomplished due to weather, traffic, or tanker availability, a minimum of 45 minutes of simulated or actual instrument approaches must be flown to credit a P-sortie. An instructor pilot will be scheduled for P-sorties.

10. Pilots logging AAR will perform multiple closures to contact with a minimum of 5 minutes contact time. Total AAR time must be at least 10 minutes. BQ and MS pilots are not required to maintain AAR qualification.

b. Mission Crew (Table 4-4). Flying training requirements will consist of system operations and currency requirements as listed in paragraphs 4-8 and 4-9. Additional semiannual flying training requirements will be completed for certain crew positions IAW Table 4-4. MS crewmembers will accomplish 50 percent of GCC Level A (Experienced) training requirements, but not less than one, where only one is required.

Table 4-4. Mission Crew Semiannual Flying Training Requirements—GCC Training Level (Inexperienced/Experienced).

Training Event	Crew Position	Notes	Number of Training Events		
			GCC-A 1/E	GCC-B 1/E	GCC-C 1/E
Weapons Sortie/ System Ops	All	1,3,4,5	12/6	18/12	24/18
Air-Air Missions	SD	1,2	4/3	5/4	6/5
	WD		11/9	18/12	25/15
Air Refueling	SD	1,2	1/0	2/1	3/2
	WD	1,2	3/1	5/2	7/3
Air-to-Surface	SD	1,2,6	0/0	1/0	2/1
	WD	1,2,6	1/0	2/1	3/2

**NOTES:**

1. Air to Air missions for SD/WD include ACT/DACT and Intercepts. BFM missions will not be credited toward semiannual controlling requirements. An ACT/DACT or Intercept mission should consist of one or more engagements. Credit of one or more control missions will be based on SD and MCC recommendation. AAR will consist of at least one rendezvous either tactical or point parallel. AAR may also be credited for a WD directed E-3 rendezvous. Air-to-surface consists of a minimum of three fighters and/or support aircraft. WDs will assist in marshaling forces and will provide threat warning as a minimum. During composite force exercises, SDs and MCCs will determine the actual number of control missions to be credited. WDs performing check-in (TAC scope) function will be credited with one or more control missions based on SD and MCC recommendation. Non-standard missions will be credited as one or more

based on SD and MCC recommendation. Instructors assigned to USAFFWS may credit control missions performed in conjunction with their duties at the school.

2. Flying training requirements in excess of semiannual totals may be credited toward applicable simulator training events.

3. Instructors and SEFEs may credit up to 50 percent of their semiannual systems operations/weapons sortie requirements through performance of instructor/evaluator duties.

4. Semiannual ATD training may not be credited for semiannual flying requirements except as in NOTE 6 below.

5. A weapons sortie can be any combination of weapons activity to include air-to-air, air-to-surface, and AAR missions. A WD-directed E-3 rendezvous does not by itself constitute a weapons sortie.

6. Simulated air to surface missions may be substituted for live requirements on a one-for-one basis.

4-8. Systems Operations/Weapons Sortie Requirements. Systems operation consists of the normal operation of those systems typically used on a sortie to include equipment operation and in-flight, hands-on training. A weapons sortie, applicable only to SD/WD, is the weapons equivalent of systems operations. SDs and WDs will log a weapons sortie, not a systems operation, to reflect performance of weapon-related duties. Instructors and SEFEs may credit up to 50 percent of their semiannual system operations/weapons sortie requirements through performance of instructor/evaluator duties. Systems operations/weapon sortie requirements are:

a. NAV, FE. Normal or emergency operations of systems routinely used on a sortie, to include one or more of the following: preflight, takeoff, inflight systems operation, and landing.

b. MCC. The MCC will declare Ops-Normal or On-Station and will supervise mission crew personnel throughout the sortie.

c. SD. The SD will supervise a minimum of one WD during a weapons sortie.

d. WD. The WD will control a minimum of one mission type specified in Table 4-4, NOTE 1. Neither BFM nor a WD-directed E-3 rendezvous by themselves satisfy the requirement for a weapons sortie.

e. ASO. The ASO will perform radar and/or IFF systems checks and, as a minimum, declare one or the other operational. E-3 will declare ops normal or on-station as applicable. Link man-

agement will be performed with other agencies if available.

f. AAST, AST. Radar and/or IFF must be declared operational and ops-normal or on-station declared. The AAST or AST will establish communications with an external agency if one is available.

g. CSO. The CSO will operate communications equipment to meet planned mission objectives.

h. CT. The CT will operate and maintain communications equipment to meet planned mission objectives.

i. CDMT, CDMO. The CDMT/CDMO will load and cycle the Airborne Operational Computer Program (AOCP) to support mission requirements.

j. ART, ARO. The ART; ARO will perform normal systems operation to support mission requirements.

k. MCC, BDT. The MCC or BDT will contact a NORAD agency and conduct scenario training.

4-9. Aircrew Currency Requirements. Flight and mission crew currency requirements are shown in Table 4-5.

Table 4-5. Aircrew Currency Requirements.

Training Event	Crew Position	Notes	Frequency/ Days
Landing	AC,CP	5	1/45
Touch and Go	IP	1,5	1/45
Instrument Approach	AC/CP	5	1/45
AAR	AC	5	1/45
AAR Rendezvous	N		1/90
Pilot Proficiency Training	AC/CP	6	1/90
Training Event	Crew Position	Notes	Frequency/ Days
Systems Ops/ Weapons Sortie	All (Except AC,CP)	3,4	1/60
Instructor/ Evaluator Sortie	All Instructors/ SEFEs	2,3	1/90

NOTES:

1. Dual credit with landing.
2. Instructor and SEFE currency is 1/90 days.
3. Instructors will fly in an instructor capacity and will provide training and supervision to one or more students. Students may be in IQT/MQT, or BQ/MR/MS crewmembers requiring training or recurrency/requalification. SEFEs will perform a flight evaluation. Instructors and SEFEs may credit up to 50 percent of their semiannual system operation/weapons sortie requirements through performance of instructor/evaluator duties.
4. Systems operation for each mission position is defined in paragraph 4-8.
5. One event during each semiannual period should be accomplished in an E-3 airframe.
6. A pilot proficiency sortie should be accomplished once every 90 days; however, this currency item will not prevent a pilot from deploying if directed by the 552 OG/DO or 18 WG/CC provided the pilot is current in all other events.

4-10. Proration of Requirements. Training requirements for aircrew members who are not available for duties as outlined in AFR 60-1 will be prorated.

a. The number of months an aircrew member is not available will be entered into the Air Force Operations Resource Management System (AFORMS) which will determine the prorated number of requirements remaining. If AFORMS is not available, the unit will determine the number of training requirements remaining by using Table 4-8 at the end of this chapter.

b. Crewmembers completing MQT and receiving MR certification during a given month start continuation training on the first day of the following month. Training accomplished during IQT/MQT are not counted toward continuation training requirements remaining after attainment of MR status. All requirements for aircrews departing PCS will be prorated from the last day of the month preceding the month of departure. Refer to AFR 60-1 for further guidance.

c. Flying and ATD training requirements for aircrew members who are not available for normal duties will be prorated according to the following criteria. A maximum number of 2 months' training requirements may be prorated, except in the case of newly MR aircrew members who may prorate a maximum of 6 months' training requirements.

- (1) 0-14 days (consecutive) No proration
- (2) 15-45 days " 1 month

- (3) 46-75 days " 2 months
- (4) 76-105 days " 3 months
- (5) 106-135 days " 4 months
- (6) 136-165 days " 5 months
- (7) 166 days to 6 months " Norequirements
- (8) 15 to 30 days (non-consecutive) 1 month

d. Effective Dates.

- (1) Basic Qualification. The date of successful completion of the initial evaluation criteria (60-2-series publications).
- (2) Mission Ready. The date of squadron commander certification.
- (3) Mission Support. The date assigned to the applicable MS crew/staff position.

Section E—Regression/Requalification Requirements

4-11. Recurrency/Requalification Requirements (Tables 4-6 and 4-7).

a. Crewmembers not meeting their assigned GCC training event requirements for the end of the training cycle will regress to a lower GCC level or BQ if the crewmember fails to meet GCC A requirements. Reinstatement to MR status requires a minimum of one instructor supervised flight to demonstrate proficiency in appropriate events as determined by the squadron commander or representative.

b. Flight crew:

Table 4-6. Flight Crew Recurrency/Requalification Requirements.

Length of Time Since Currency Was Lost

1-60 Days (Noncurrent)	61-180 Days (Unqualified)	181 Days-18 Months (Unqualified)
Fly at least one mission with an instructor and complete required currency events.	Fly at least one mission with an instructor and complete required currency events.	Complete IQT (see note below)
Review emergency procedures with an instructor of like crew position	Review emergency procedures with an instructor of like crew position	

1-60 Days (Noncurrent)	61-180 Days (Unqualified)	181 Days-18 Months (Unqualified)
	Complete a normal and Emergency Procedures simulator scenario with an instructor. (Except N)	
	Complete DOV written exams and 60-2-series publication ATD/flight evaluation.	

NOTE. If waiver of formal IQT is approved, pilots, navigators and flight engineers will fly a minimum of five sorties with an instructor. Copilots will fly a minimum of three sorties with an instructor. IQT syllabus standards must be achieved. Following instructor recommendation, a flight evaluation (60-2-series publications) and emergency procedures ATD evaluation will be completed.

c. Mission crew

Table 4-7. Mission Crew Recurrency/Requalification Requirements.

Length of Time Since Last Systems Operation was logged.

1-60 Days (Noncurrent)	61-180 Days (Unqualified)	181 Days-18 Months (Unqualified)
Fly one mission with an instructor and log systems operation. Complete required currency events.	Fly at least one mission with an instructor and log systems operation. Review emergency procedures with an instructor of like crew position.	Fly a minimum of two missions with an instructor. Training may be accomplished in an operational squadron or in the 966 AWACTS. IQT syllabus standards must be achieved.
Review emergency procedures with an instructor of like crew position.	Complete written DOV exams, ATD evaluation (SD/WD only), and appropriate (60-2-series publications) flight evaluation.	Review emergency procedures with an instructor of like crew position. Complete written DOV exams, simulator evaluation (SD/WD only), and appropriate flight evaluation (60-2-series publications).



**4-12. Failure to Complete Training Requirements.** Aircrew members failing to complete semiannual flying, ATD, or certain ground training requirements will be reclassified IAW the Professional Qualification Index (PQI) found in AFR 60-1.

a. Crewmembers will regress to BQ status under any of the following conditions:

(1) The crewmember's squadron commander determines that lack of semiannual training events is sufficient to justify downgrading the crewmember from MR/MS to BQ.

(2) The semiannual training waiver is disapproved.

(3) The crewmember fails to complete any of the following training.

(a) Applicable theater training.

(b) Life support chemical warfare defense training.

(c) TK/CM training (except MS crewmembers).

(d) CWDT (if applicable to unit location).

(e) WSAT (after the 45 day grace period expires).

(4) The crewmember fails to maintain:

(a) Currency (mission crew only).

(b) Event currency (flight crew only).

b. Crewmembers will regress to UQ status under the following conditions:

(1) The crewmember's squadron commander determines that lack of demonstrated ability or failure to complete required training events requires regression.

(2) The crewmember fails to successfully complete the appropriate evaluation (60-2-series publications).

c. Crewmembers will be grounded for failure to complete the following:

(1) Physiological training.

(2) Wet ditch training (refer to ACCR 55-2). For PACAF, guidance provided in PACAFR 55-7 will be followed.

(3) Land survival refresher training.

(4) Egress training.

d. At the end of each semiannual period, crew members who have not achieved GCC Level A semiannual ATD and flying training requirements are required to fly with an instructor until the semiannual training waiver is approved.

e. Aircrew members who fail to complete Categories I and II ground training requirements by the end of the training cycle will be allowed 45 days to complete delinquent items. (See attachment 1 for a listing of requirements.) If training has not been accomplished after this period, the squadron commander will review the individual's records to determine if the deficiency warrants regression from current qualification status. (Failure to complete underlined requirements at attachment 1 will cause automatic loss of current qualification status.) Unless specifically stated otherwise in this volume, squadron commanders will determine if the training requirements will be credited to the current training cycle.

f. Squadron commanders may return crewmembers to MR/MS status once the crewmember has completed the delinquent training requirement, unless prohibited by another regulation (e.g., ACCR 60-2 which requires additional training and another evaluation prior to requalification.)

**4-13. 4-13. Waivers.** The 552 ACW/CC (ACC) and 5 AF/CC (PACAF) are waiver authority for semi-annual training requirements and may delegate this authority to unit commanders.

a. Squadron commanders will compile a list of aircrew members requiring waivers.

(1) GSUs will forward waiver requests through channels to the appropriate NAF.

(2) ACC squadrons will forward waiver requests through 552 OG/CC to 552 ACW.

(3) The 961 AWACS will forward waiver requests to 5 AF/DO through 5 AF/DOY.

b. Waiver requests must arrive at 552 ACW, 5 AF/DOY not later than 10 July and 10 January for the applicable semiannual period.

c. After final review and determination of waiver requests, 552 ACW and 5 AF will notify subordinate units of the approval/disapproval of the waiver request. The 552 ACW and 5 AF will forward informational copies of the waiver request packages to HQ ACC/DOY and HQ PACAF/DOC, as appropriate, not later than 1 August and 1 February for the applicable semiannual period.

d. Semiannual training requirements, once waived, do not require make-up during the next semiannual period. Squadron commanders may require crewmembers to complete all or some of the delinquent training events within 30 days following the end of the semiannual period to ensure proficiency. Should a crewmember's semiannual requirements not be waived, the crewmember will regress to BQ status. Reinstatement to MR status requires a minimum of one instructor supervised flight to demonstrate proficiency in appropriate events as determined by the squadron commander or representative.

Table 4-8. Proration of Semiannual Training Events.

SEMIANNUAL REQUIREMENT	NUMBER OF MONTHS REMAINING AFTER PRORATION					
	5	4	3	2	1	0
	PRORATED REQUIREMENT					
1	1	1	1	0	0	0
2	2	1	1	1	0	0
3	2	2	2	1	0	0
4	3	3	2	1	1	0
5	4	3	3	2	1	0
6	5	4	3	2	1	0
7	6	5	4	2	1	0
8	7	5	4	3	1	0
9	8	6	5	3	2	0
10	8	7	5	3	2	0
11	9	7	5	4	2	0
12	10	8	6	4	2	0
14	12	9	7	5	2	0
15	13	10	8	5	3	0
16	13	11	8	5	3	0
18	15	12	9	6	3	0
20	17	13	10	7	7	0
22	18	15	11	7	4	0
24	20	16	12	8	4	0
25	21	17	12	8	4	0
30	25	20	15	10	5	0
36	30	24	18	12	6	0
50	42	33	25	17	8	0

## GLOSSARY OF TERMS

A2-1. **Aircrew.** The complete complement of flight and mission crew personnel required to fly an operational mission.

A2-2. **Flight Crew.** The pilot, copilot, navigator, and flight engineer.

A2-3. **Mission Crew.** Those individuals responsible for the command, control, surveillance, and communications/electronic/management functions to include the control and monitoring of assigned aircraft, sensor management, internal and external communications management, and onboard systems management.

A2-4. **Instructor.** An MR qualified aircrew member who has been trained to provide instruction in their crew position.

A2-5. **Unqualified (UQ).** Aircrew members who are not qualified to fly or operate E-3 systems and equipment unless they are under the supervision of a qualified instructor in the appropriate crew position.

A2-6. **System Operation Sortie.** Normal operation of flight and mission systems that provides sufficient hands-on training to maintain crewmember proficiency.

A2-7. **Mission Ready (MR).** A crewmember who has been trained and certified to perform tactical duties in support of E-3 roles and missions as defined in MCM 3-1, Volume 15.

A2-8. **Mission Support (MS).** A crewmember who requires further training prior to being certified to perform tactical duties in support of E-3 roles and missions as defined in MCM 3-1, Volume 15. MS crewmembers have completed MQT but do not maintain MR status due to staff duty assignment or other reasons as determined by the appropriate authority.

A2-9. **Basic Qualified (BQ).** A crewmember who has completed IQT and passed initial TAC/PACAFR evaluation (60-2-series publications), but is not certified to perform tactical duties in support of E-3 roles and missions as defined in MCM 3-1, Volume 15.

A2-10. **Continuation Training (CT).** Flying and ATD training designed to maintain proficiency and improve crewmember capabilities.

A2-11. **Weapons Systems Academic Training (WSAT).** Quarterly academic training designed to provide crewmembers with information on tactics, employment, training and evaluation trends, procedures, and changes to E-3 software and equipment.

A2-12. **Initial Qualification Training (IQT).** Prepares aircrew members to perform non-tactical duties in the aircraft. Training is conducted IAW approved syllabi. Graduates of IQT are awarded Basic Qualification (BQ) status after successful completion of a TACR/PACAFR evaluation (60-2-series publications).

A2-13. **Mission Qualification Training (MQT).** Prepares aircrew members to perform tactical duties in support of unit taskings. Graduates of MQT are certified MR/MS by the squadron commander.

A2-14. **Instructor Aircrew Upgrade Training.** Prepares and qualifies crewmembers for instructor duties in their assigned crew position.

A2-15. **Positional Aircrew Upgrade Training.** Prepares crewmembers to perform duties in a higher level crew position.

A2-16. **Non-tactical Duties.** Duties involving basic operation of aircraft and aircraft systems. These duties do not include tactical applications of wartime or contingency skills (e.g., non-tactical duties for pilots would include takeoff and landing, but would not include knowledge or proficiency in MCM 3-1 threat neutralization tactics).

A2-17. **Tactical Duties.** Those duties that would or may be performed in contingency or wartime operations. These duties vary by crew position, are trained during MQT, and may be performed for training purposes during peacetime CONUS or overseas sorties (e.g., performance of duties wearing CWD equipment or control of intercepts during air defense operations)

A2-18. Non-Mission Ready (NMR). This category includes those individuals who are BQ, MS, and UQ.

A2-19. Composite Force Training (CFT). Training that includes two or more aircraft types performing two or more mission roles (e.g., F-15s providing escort for F-16s performing air interdiction). CFT exercises vary in complexity and size from smaller ORE/ORIs to RED FLAG/GREEN FLAG scenarios.

A2-20. Minimum Requirements. The minimum level to which a crewmember can be trained to maintain MR/MS status.

A2-21. Supervised Status. Aircrew members who have not completed continuation training (Phase III) requirements within the specified training period; or aircrew members downgraded IAW paragraph 1-6c of this volume; or crewmembers failing to meet the appropriate requirements (60-2-series publications).

**TAB AA**

**REGULATIONS AND DIRECTIVES**

**AA-1 OPC Airspace Control Order and SPINS, 12 December 1993**

**AA-2 Extracts from MCM 3-1**

**(See Classified Addendum)**

**AA-3 Extract from Aircrew Read File 183**

**(See also Classified Addendum)**

**AA-4 Multi-Command Regulation 55-33, E-3 Operating Procedures  
with 552 ACW Supp 1**

**AA-5 Air Combat Command Regulation 51-60, Training Management  
for Command and Control Aircrews**

**AA-6 Extracts from DA Pamphlet 738-751, Functional User's Manual  
for the Army Maintenance Management System**

**AA-7 552nd Operations Group Operating Instruction 60-2,  
552nd (Deployed) Turkey Operating Procedures**

**AA-1**

**AA-8 Extract from Eagle Detachment Read File, Annex A, Daily  
Requirements**

**AA-2**

**AA-3**

**AA-4**

**AA-5**

**AA-6**

# CERTIFICATION OF EXTRACT

I reviewed DA Pam 738-751 Functional Users Manual for the Army  
(describe the original source document)

MAINTENANCE MANAGEMENT SYSTEM

From that source document, I extracted the information contained in the attached document,  
entitled DA Pam 738-751

I certify the information contained there in is a true and accurate extract of the source document.



(Signature)

STEVE MELINA

(Printed Name)

207<sup>TH</sup> AIN Co Hewlberg Garrison

(Organization/Duty Section)

13 MAY 94

(Date)

Logistics Management

**Functional Users  
Manual for the Army  
Maintenance  
Management  
System—Aviation  
(TAMMS-A)**

Headquarters  
Department of the Army  
Washington, DC  
15 June 1992

**Unclassified**

Logistics Management

Functional Users Manual for the Army Maintenance Management  
System—Aviation (TAMMS-A)

By Order of the Secretary of the Army:

GORDON R. SULLIVAN  
General, United States Army  
Chief of Staff

Official:

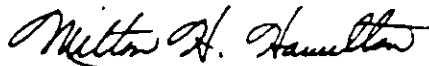

MILTON H. HAMILTON  
Administrative Assistant to the  
Secretary of the Army

**History.** This UPDATE publishes a revision of this publication. Because the publication has been extensively revised, the changed portions have not been highlighted.

**Summary.** This pamphlet covers the preparation and management of forms and records

needed to manage maintenance, control the use, and report warranty actions and deficiencies on Army aircraft and aviation associated equipment.

**Applicability.**

a. This pamphlet applies to the Active Army, Army National Guard (ARNG), Army Reserve (USAR), Department of Defense (DOD) and other Government agencies that operate and maintain Army aircraft.

b. This pamphlet also applies to all aircraft and aviation associated equipment operated, maintained, and stored by DOD contract support maintenance activities.

**Interim changes.** Interim changes to this pamphlet are not official unless they are authenticated by The Adjutant General. Users will destroy interim changes on their expiration dates unless sooner superseded or rescinded.

**Suggested improvements.** The proponent agency of this pamphlet is the Office of Deputy Chief of Staff for Logistics. Users are invited to send comments and suggested improvements on DA Form 2028 (Recommended Changes to Publications and Blank Forms) directly to Commander, U.S. Army Aviation Systems Command, ATTN: AM-SAV-MC, 4300 Goodfellow Blvd, St. Louis, MO 63120-1798.

**Distribution.** Distribution of this publication is made in accordance with the requirements on DA Form 12-09-E, block number 2374, intended for command levels A, B, C, D, and E for Active Army, Army National Guard, U.S. Army Reserve, and other Government agencies.

**Contents** (Listed by paragraph and page number)

**Chapter 1**

- Introduction, page 7
- Purpose • 1-1, page 7
- References • 1-2, page 7
- Explanation of abbreviations and terms • 1-3, page 7
- Types of records • 1-4, page 7
- Tables and appendixes • 1-5, page 7
- General Instructions • 1-6, page 8
- Responsibilities of forms • 1-7, page 9
- How to use status symbols • 1-8, page 10
- Clearing status symbols • 1-9, page 11
- Evacuation of aircraft on a Red 'X' status symbol • 1-10, page 12
- Maintenance test flight verification of aircraft on a Red 'X' status symbol • 1-11, page 12
- Safety-of-flight (SOF) messages/aviation safety action message (ASAMs) technical bulletins (TBs) • 1-12, page 12
- Safety-Of-Use (SOU) messages/urgent MWOs/TBs • 1-13, page 13
- Missing historical records or information • 1-14, page 14
- Aircraft and aviation associated equipment files content and management • 1-15, page 14
- Records to accompany aircraft • 1-16, page 15
- U.S. Army aircraft loaned or bailed • 1-17, page 16
- U.S. Army aircraft procured for other U.S. Government departments and agencies • 1-18, page 16
- Aircraft Transferred to other Government Agencies and the Military Assistance Program • 1-19, page 16
- Classifying records and reports • 1-20, page 17

- Sample data collection • 1-21, page 17
- Use of electronic forms • 1-22, page 18
- Aircraft quality control program • 1-23, page 18
- Aircraft weight and balance control • 1-24, page 18
- Aviation Night Vision Goggles Maintenance. • 1-25, page 19

**Chapter 2**

- Aircraft Logbook Forms and Records, page 32**
- General-Aircraft Logbook Forms and Records • 2-1, page 32
- Logbook Binder (NSN 7510-00-889-3494 (2 1/2-in)) • 2-2, page 32
- DA Form 2408 (Equipment Log Assembly) • 2-3, page 32
- DA Form 2408-31 (Aircraft Identification Card) • 2-4, page 32
- DA Form 2408-4-2/2408-4-2-E (Weapon Sighting Data (OH-58D)) • 2-5, page 32
- DA Form 2408-4-3/2408-4-3-E (Weapon Sighting Data (AH-64A)) • 2-6, page 32
- DA Form 2408-12 (Army Aviator's Flight Record) • 2-7, page 33
- DA Form 2408-13/2408-13-E (Aircraft Status Information Record) • 2-8, page 33
- DA Form 2408-13-1/2408-13-1-E (Aircraft Inspection and Maintenance Record) • 2-9, page 34
- DA Forms 2408-13-2/2408-13-2-E (Related Maintenance Actions Record) • 2-10, page 37
- DA Form 2408-14/2408-14-E (Uncorrected Fault Record) • 2-11, page 38
- DA Form 2408-18/2408-18-E (Equipment Inspection List) • 2-12, page 38

**Chapter 3**

- Maintenance Forms and Records, page 69**
- General-Maintenance Forms • 3-1, page 69

\*This pamphlet supersedes DA Pam 738-751, 15 January 1988.



safeguarding of forms and records at time of transfer of aircraft from one property account to another.

f. To provide aircraft logbooks contain important forms and records from being misplaced or leaving units or activities are urged to establish and adhere to a logbook control program. Currently, logbooks are filed in a maintenance, production control, quality control office, or they are kept in the aircraft. For resolution of present day logbook problems and to be in agreement with the improved processing of aircraft logbook forms and records when the STAMIS ULLS-A is fielded or extended, the following is recommended:

- (1) Establish a logbook control program, prepare and issue a standard operating procedure.
- (2) File aircraft logbooks in the flight platoon or unit or activity maintenance office when aircraft are not flying.
- (3) Place responsibility on the assigned crew chief or mechanic to maintain and file the logbook in the maintenance office when aircraft is not flying.
- (4) Place responsibility on the platoon leader or unit or activity maintenance officer, as applicable for carrying out the procedures of the logbook control program.

#### 1-8. How to use status symbols

a. Status symbols are used on forms and records to show the seriousness of faults, failures, deficiencies, related maintenance actions, and mechanical type problems and known safety hazards imposed by nuclear, biological, or chemical agents in the environment. There are five condition status symbols used: Red 'X', circled Red 'X', Red horizontal dash '—', Red diagonal '/', and last name initial. There are three status symbols used for types of contamination of the aircraft: circled Red 'N', circled Red 'B', and circled Red 'C'.

(1) *Status symbol Red 'X'.* A Red 'X' status symbol is the most serious one. You put a Red 'X' on the form or record that applies when there is a fault, deficiency, or condition that makes the aircraft unsafe to fly or aviation associated equipment is unfit for use. No one will authorize or direct aircraft to be flown until proper maintenance action has been taken, the maintenance forms are reviewed for completeness and accuracy, and the red 'X' is properly cleared. The following Red 'X' symbol policy also applies:

(a) Operation of the aircraft engines, components, and systems on the ground is allowed for maintenance and troubleshooting purposes when the aircraft condition status is a Red 'X' when the Red 'X' condition does not affect the component(s) or system being operated. An example would be to operate the installed engine, flight controls, fuel system, and so forth, or when the phase or other scheduled maintenance inspection was overdue completion. In any case, caution must be exercised to insure safety of personnel, equipment, and facilities.

(b) When an unsafe condition is discovered that the use of a Red 'X' status is called for and the same condition could reasonably be expected to occur in other aircraft, the Commander or the designated representative will immediately inspect other aircraft of the same mission, design, and series (MDS) for the unsafe condition. When the unsafe condition is found on other aircraft, the affected aircraft will be placed on a Red 'X' status symbol. Prepare and send a Category I Deficiency Report on the unsafe condition when it meets the rules in paragraph 3-4.

(c) Refer to table 1-1 for examples of other Red 'X' conditions for aircraft and aviation associated equipment.

(2) *Status symbol circled Red 'X'.* A circled Red 'X' means that the aircraft has a fault, deficiency, or condition allowing the aircraft to fly under specific limitations as specified or directed by higher authority until corrective action is taken. A circled Red 'X' status symbol applies to the following situations:

(a) When a condition is found that may be a hazard, but the aircraft may be flown with certain limitations; for example, no instrument flights due to a flight instrument being erratic, flights above a specific altitude due to oxygen system inoperative, and so forth. If this condition can be reasonably assumed to exist on other MDS aircraft, the commander or the designated representative will inspect

needed. The person finding the fault, deficiency or condition will also prepare and send a Category I Deficiency Report as per paragraph 3-4.

(b) When a SOF message, TB, MWO, airworthiness release message or other directives received that permits an aircraft to be flown within the limits stated in the publication may have an operation limitation; for example, speed limitation of the aircraft, a restricted inspection task needed that would limit the aircraft operating time. It may be a mandatory need for a maintenance action or follow-up special inspection listed in a SOF message, TB, MWO, or other directives to be done within a certain amount of flying hours, round fired, component operating hours, or calendar time.

(3) *Status symbol Red horizontal dash '—'.* A Red horizontal dash '—' symbol shows that the condition of aviation equipment is unknown. It means that a possible dangerous condition may exist and that the condition will be corrected as soon as possible. A Red horizontal dash '—' symbol applies to the following situations:

(a) A Red horizontal dash '—' symbol shows a scheduled maintenance inspection, special inspection, component/module replacement, maintenance operational check is called for and a normal MWO or ASAM/TB is overdue application, and when a maintenance test flight is needed.

(b) The Red horizontal dash '—' will also be used when maintenance actions listed above become due or when they are started early.

(4) *Status symbol Red diagonal '/'.* The Red diagonal status symbol '/' shows that a fault or deficiency exists in materiel installed on aviation equipment. It also shows that an unsatisfactory condition exists on aircraft or aviation associated equipment that is not urgent, critical, or dangerous enough to ground the aircraft. The Red diagonal '/' symbol applies to the following situations:

(a) When you find a condition that calls for a Red diagonal '/' describe the condition on the form which applies. Do this even if the fault or deficiency is corrected immediately. The entries are needed to make sure there is a complete maintenance history of all work done or needed.

(b) To prevent confusion the Red diagonal '/' will be entered on the form which applies by drawing a red line from the lower left corner to the upper right corner of the aircraft condition status symbol block.

(5) *Status symbol last name initial.* A last name initial symbol on the aircraft or aviation associated equipment condition status block shows that a completely satisfactory condition exists as determined by the individual whose last name initial is entered in the status symbol block. This symbol will remain in the status symbol block until fault, deficiency, or other unsatisfactory condition is found and recorded on the form which applies.

(6) *Status symbol circled Red 'N'.* A circled Red 'N' means that the aircraft was flown, operated, or stored in a nuclear contaminated environment. Aircraft that are contaminated will be decontaminated and needed related maintenance work done as per appendix B.

(7) *Status symbol circled Red 'B'.* A circled Red 'B' means that the aircraft was flown, operated, or stored in a biological contaminated environment, or stored in a biological contaminated environment. Aircraft that are contaminated will be decontaminated and needed related maintenance work done as per appendix B.

(8) *Status symbol circled Red 'C'.* A circled Red 'C' means that the aircraft was flown, operated, or stored in a chemical contaminated environment. Aircraft that are contaminated will be decontaminated and needed related maintenance work done as per appendix B.

b. Condition status symbols used in this pamphlet serve two purposes; which are:

(1) To promptly show the condition and status of the aircraft and aviation associated equipment aboard the aircraft.

(2) To establish the basis of a standard way of promptly identifying the seriousness of faults and conditions of aircraft and aviation associated equipment.

will never be erased, even if it is entered in error. This restriction on erasing status symbols is needed to ensure that the opinion of the person who made the entry is properly evaluated before a symbol is changed, and that even an entry made in error is properly cleared. In this way there is no doubt about the integrity and validity of the status symbol entered. Status symbols to be used and methods of clearing these symbols are listed below. More specific uses of status symbols are contained in the instructions for filling out each of the various aircraft forms and records in chapters 2 through 5.

(1) *Status symbol change.* A status symbol in a condition status block shows that the person's opinion as to how serious the fault, deficiency, or condition is. No one may direct a person to change this symbol. Status symbols entered in error will be corrected as follows:

(a) When a red dash or red diagonal symbol is entered in error on the DA Form 2408-13-1/2408-13-1-E (Aircraft Inspection and Maintenance Record), or other maintenance forms, the person who made the entry will enter the following statement in the Correcting Information block: 'Status symbol entered in error, see entry below.' Enter your signature or PID in the Correcting Information block and enter your last name initial over the status symbol in the Fault Information block. Enter the fault or deficiency and proper status symbol in the next open Fault Information block on the form.

(b) When a Red 'X' or circled Red 'X' is entered in error on the DA Form 2408-13-1/2408-13-1-E, or other maintenance forms, the person who made the entry will enter the following statement in the Correcting Information block: 'Status symbol entered in error, see entry below.' Enter your signature or PID in the Correcting Information block. Have a designated representative (usually a technical inspector) verify the incorrect status symbol by entering 'Insp OK' and signature in the Correcting Information block where the action was accomplished. The designated representative will then enter his or her last name initial over the status symbol in the Fault Information block. The fault or deficiency with the proper status symbol will be entered in the next open Fault Information block.

(c) If an error is found in the SYSTEM STATUS block on the DA Form 2408-13/2408-13-E (Aircraft Status Information Record), the person finding the error will properly explain the error in the next open Fault Information block of the DA Form 2408-13-1/2408-13-1-E. The explanation will include the aircraft or mission related equipment SYSTEM STATUS symbol and column number that is in error, followed by your signature or PID. For example, 'Red dash '-' Symbol in column 2 (aircraft) entered in error, C. Roy'. In the Correcting Information block enter a statement showing corrective action, followed by your signature or PID. For example, 'Status adjusted, C. Roy'. A status symbol is not needed in the Fault Information block for these entries. In the next open Fault Information Status block and the next column in the System Status block on the DA Form 2408-13/2408-13-E, enter the proper status symbol, if it applies. Reenter the fault in the Fault Information block followed by your signature. The fault discovery date (dd mmm yy) and aircraft hours when the fault was discovered will also be entered.

Note. These procedures also apply to the DA Form 2408-13-2/2408-13-2-E (Related Maintenance Actions Record) and DA Form 2408-13-3 (Aircraft Technical Inspection Worksheet).

(d) Any maintenance or quality assurance personnel within the Aviation Unit Maintenance (AVUM), Aviation Intermediate Maintenance (AVIM), or Depot Maintenance activities who believes that the fault, deficiency, or condition is more serious than depicted by the status symbol, may change the symbol to a more serious status symbol. This person will enter the 'Status symbol changed' on the same line in the Correcting Information block of the DA Form 2408-13-1/2408-13-1-E. Enter your signature or PID in the Correcting Information block and enter your last name initial over the status symbol in the Fault Information block. On the next open Fault Information block of 2408-13-1/2408-13-1-E enter the new status symbol. Re-enter the fault or deficiency in the first line of the Fault Information block of the DA Form

will place his or her signature or PID following the change entry in the Fault Information block of the DA Form 2408-13-1/2408-13-1-E to assume full responsibility for the status symbol change entry.

Note. These procedures also apply to the DA Form 2408-13-2/2408-13-2-E and DA Form 2408-13-3 (Aircraft Technical Inspection Worksheet).

(e) If the commander or those in equal positions in DOD contract support maintenance activities considers the condition of the aircraft or aviation associated equipment less serious than indicated by the status symbol, he or she can change the symbol. Changing status symbols to a less serious symbol will not be delegated, except during emergency evacuation covered in paragraph 1-10 below. In the Correcting Information block enter 'Status symbol changed to (enter the proper status symbol) 'see entry below' and sign your name. On the next open Fault Information block of the DA Form 2408-13-1/2408-13-1-E, re-enter the fault or deficiency and sign your name. Enter the status symbol in the Status block in the Fault Information block and update the SYSTEM STATUS block on DA Form 2408-13/2408-13-E. In the case of a fault or deficiency entered on DA Form 2408-13-2/2408-13-2-E or DA Form 2408-13-3 the same procedures apply.

(2) Not used.

### 1-9. Clearing status symbols

a. When a Red 'X' or circled Red 'X' condition is corrected, by a maintenance action the completed action must be inspected by a qualified designated representative appointed by the unit or activity commander, activity supervisor, or an equal management or supervisory personnel in a DOD contract support maintenance activity.

(1) The mechanic making the corrective action will fill out the Fault Information and Correcting Information blocks of the DA Form 2408-13-1/2408-13-1-E, including the mechanics signature or PID and maintenance manhours, however man hours will be left blank at this time.

(2) The corrective action taken will be inspected. If the action taken is found to be satisfactory, the person making the inspection will enter a statement 'Insp OK' in the Correcting Information block, of the DA Form 2408-13-1/2408-13-1-E. The inspector will also enter his or her signature or PID by using a black lead pencil or a blue or black ballpoint pen. An inspector's stamp can be used instead of the statement "Insp OK" and his or her signature. A space is provided to enter the number of work hours in hours and tenths it took to inspect the action taken on the lines marked 'TI Manhours,' but leave this block blank at this time. Note. If an inspector's stamp is used, stamp will be no larger than 1/2 inch in diameter and blue or black stamp pad ink will be used. A blue or black ballpoint pen may be used to enter the inspector's signature or PID if a stamp is not available.

(3) The person making the inspection of the corrective action will place his or her last name initial over the status symbol in the Fault Information block of the DA Form 2408-13-1/2408-13-1-E. Also, update the proper SYSTEM STATUS block of DA Form 2408-13/2408-13-E, as needed.

b. When a designated representative or an authorized technical inspector does any part of the corrective action work to clear the Red 'X' or circled Red 'X', this will call for a different designated representative or technical inspector to inspect the corrective action and sign off the inspection on the DA Form 2408-13-1/2408-13-1-E.

Note. These procedures also apply to the DA Form 2408-13-2/2408-13-2-E, and the DA Form 2408-13-3.

c. There are SOF messages, TB, MWO, and other one time inspection messages that call for a visual inspection of the aircraft or aviation associated equipment. When this type of inspection is completed and no maintenance work is needed, any designated representative can inspect and sign the inspection off. Entries on the DA Form 2408-13-1/2408-13-1-E will be done as per paragraph 1-9

**TAB AA**

**REGULATIONS AND DIRECTIVES**

**AA-1 OPC Airspace Control Order and SPINS, 12 December 1993**

**AA-2 Extracts from MCM 3-1**

**(See Classified Addendum)**

**AA-3 Extract from Aircrew Read File 183**

**(See also Classified Addendum)**

**AA-4 Multi-Command Regulation 55-33, E-3 Operating Procedures  
with 552 ACW Supp 1**

**AA-5 Air Combat Command Regulation 51-60, Training Management  
for Command and Control Aircrews**

**AA-6 Extracts from DA Pamphlet 738-751, Functional User's Manual  
for the Army Maintenance Management System**

**AA-7 552nd Operations Group Operating Instruction 60-2,  
552nd (Deployed) Turkey Operating Procedures**

**AA-1**

**AA-8 Extract from Eagle Detachment Read File, Annex A, Daily  
Requirements**

**AA-2**

**AA-3**

**AA-4**

**AA-5**

**AA-6**

**AA-7**

DEPARTMENT OF THE AIR FORCE  
552d Air Control Wing (ACC)  
Tinker AFB, Oklahoma 73145-9012

552d Operations Group  
Operating Instruction 60-2  
7 September 1993

### Flying

#### 552 ACW (DEPLOYED) TURKEY OPERATING PROCEDURES

To establish supplementary procedures to be followed while flying missions in Turkey.

1. Scope: Applicable to all E-3 crewmembers of the 552 ACW deployed to Turkey.

2. Procedures:

a. These procedures are intended to provide guidelines for safe and effective mission accomplishment.

b. These procedures supplement USAF/MAJCOM/552 ACW/squadron operational procedures and are not intended to be a single source document for procedures contained in other directives or regulations.

c. Crewmembers will become familiar with the procedures contained in this operating instruction before deploying.

d. This operating instruction will be issued to all flight crewmembers, all MCCs, SDs, and ASOs. In addition, it will be maintained in each squadrons' flight crew information file (FCIF). Ten copies will be added to each squadron's weapons and tactics library (five in the 966 AWACTS and five in 552 TS).

#### EXTRACT

I certify that I am the Records Custodian for the Accident Investigation Board convened to investigate the crash of two U.S. Army Black Hawk helicopters in the no fly zone in northern Iraq on 14 April 1994, and that this is a true and accurate extract from

552d Ops Group, OI 60-2, 7 Sep 93

which is kept in my records system.

15 May 94  
Date

W. L. Harris  
WILLIAM L. HARRIS, Capt, USAF, MSC  
Evidence Custodian, Incirlik Air Base, Turkey

~~OPR: 552 OG/ACC (Maj Johnson)  
Distribution: (5 Copies to Turkey)  
No. of Pages: 14~~

## 1. INTRODUCTION:

a. **General.** This operating instruction establishes supplementary procedures for 552 ACW E-3 crewmembers flying missions in Turkey. These procedures supplement USAF/MAJCOM/552 ACW/squadron operational procedures and are not intended to be a single source document for procedures contained in other directives or regulations. These procedures are intended to provide guidelines for safe and efficient mission accomplishment. Deviations to this directive require 552 ACW/Deployed Commander (DETCO) approval.

b. **Changes.** Recommendation for changes or improvements to this chapter will be coordinated through the deployed staff and forwarded to 552 OG/OGV for inclusion in the next revision.

c. **Command and Control.** The 552 ACW DETCO, or the deployed Operations Officer (DO) in his absence, exercises command and control of E-3 resources through AWACS operations. Manning procedures will be established by the DETCO.

d. **Scheduling Procedures.** The deployed staff will prepare and post daily schedules in AWACS Operations. The AC and MCC will ensure that all crewmembers are aware of show times. The staff will designate a DNIF cover crew and notify them of crew rest requirements. Normally, the DNIF cover crew will be released to ground duties/time off when the E-3 calls "ops normal".

e. **AF Form F.** Flight engineers should keep copies of Form Fs for all aircraft in theater. Flight kits may have extra copies. The forms will not be removed until aircraft redeploys to CONUS.

f. **Cocking Procedures.** The primary aircraft should be cocked CC III IAW T.O. 1E-3A-1 by the DNIF cover pilot and flight engineer. If conditions require, the DETCO may have the mission compartment cocked by DNIF cover aircrew members.

g. **Alert Procedures.** If a crew is needed for alert, the DETCO and deployed staff will establish procedures for alert assumption, changeover, cocking procedures and launching off alert.

h. **Maximum flying time.** The 552 ACW/CC waives flying hours to 165 hours per 30 day period for deployed crewmembers.

## 2. MISSION PLANNING:

a. **General.** Crewmembers will be familiar with the Operation Provide Comfort (OPC) concept of operations (OPLAN 91-7), Air Tasking Order (ATO), Airspace Control Order (ACO), Battlestaff Directives (BSD), Operations Read File (ORF), Aircrew Read File (ARF), and local flying procedures as appropriate.

b. **Frag/ATO.** Fragmentary orders will be issued and made available.

c. Composite Force Missions (CFM). CFMs are Red Flag-style missions and are usually flown weekly. There will usually be a 'CFM players' meeting the day prior for mission planning and coordination. CFMs will be "comm-out" unless safety is jeopardized. Terminate communication out procedures if situation warrants.

d. Mission Planning Preparation.

(1) Aircrews will be thoroughly inbriefed upon arrival in theater before flying missions. Aircrew members should ensure that they are prepared and have all questions answered by the deployed staff before flying missions or assuming duties.

(2) Mission routing, altitudes, air refueling and orbit data will be IAW deployed 552 ACW directives.

e. Mission Planning. Mission planning will use pre-planned routes and altitudes. Filing and departure procedures will be accomplished IAW local policies. Crew briefings will be conducted by the AC/MCC, and deployed staff IAW local briefing guides. Aircraft commanders will insure they have a corrected copy of the flight orders, passenger manifest, all pertinent flight information from AWACS operations.

f. Call Signs. Flight crew will be "SAVVY" and mission crew will be "COUGAR", followed by the appropriate crew number.

3. AIRCREW OPERATING PROCEDURES:

a. FCIF Go/No-Go Procedures. The 552 ACW deployed DO is responsible for maintaining the FCIF and the local read file as required.

b. Crew report. Crew report is normally one hour prior to takeoff at AWACS operations. For a crew's first flight 1+30 will be used.

c. Preflight procedures.

(1) Aircraft acceptance. The aircraft will normally be cocked. Crewmembers will ensure that all checklist items have been accomplished IAW the appropriate Tech Order.

(2) Preflight actions.

(a) Upon arriving at AWACS operations, crewmembers will review the FCIFs, BSDs, ORFs, ARFs and initial the flight orders. The Turkish Controller (TC) will be added to the passenger manifest. If the TC is not present at show time, the staff will contact the Joint Operations Command Center (JOCC).

(b) The MCC, ASO, SD, and NAV will pick up their kits prior to the brief. The NAV will also pick up two Jeppesens.

**TAB AA**

**REGULATIONS AND DIRECTIVES**

**AA-1 OPC Airspace Control Order and SPINS, 12 December 1993**

**AA-2 Extracts from MCM 3-1**

**(See Classified Addendum)**

**AA-3 Extract from Aircrew Read File 183**

**(See also Classified Addendum)**

**AA-4 Multi-Command Regulation 55-33, E-3 Operating Procedures  
with 552 ACW Supp 1**

**AA-5 Air Combat Command Regulation 51-60, Training Management  
for Command and Control Aircrews**

**AA-6 Extracts from DA Pamphlet 738-751, Functional User's Manual  
for the Army Maintenance Management System**

**AA-7 552nd Operations Group Operating Instruction 60-2,  
552nd (Deployed) Turkey Operating Procedures**

**AA-1**

**AA-8 Extract from Eagle Detachment Read File, Annex A, Daily  
Requirements**

**AA-2**

**AA-3**

**AA-4**

**AA-5**

**AA-6**

**AA-7**

**AA-8**

## DAILY REQUIREMENTS

11 FEB 94

1. Items to be prepared and accessible to aircrews prior to "show time":
  - a. ATOs(1 per Aircraft)
  - b. NVGs(2 pair per Aircraft)
  - c. PRC 112s(3 per Aircraft)
  - d. KYK-13(1 issued to chalk 1) (CHECK FOR CORRECT FILLS)
  - e. Authentication table (1 per Aircraft)
  - f. Coffee
2. Pilots arrive to begin mission planning sequence to include:
  - a. Mission Brief Sheet/Risk Assessment/Intel brief
  - b. Weather Brief(175-1) from Incirlik Weather (676-6878)
  - c. Flight plan
3. Crewchiefs/Maintenance personnel draw weapons from Arms Room and depart for airfield at scheduled show time.
4. Pilots depart for airfield with all necessary items.
5. Call MCC and inform them of any weather delays and ETD. Initial checklist on desk upon completion.
6. Call Incirlik Weather (676-6878) for 175-1 update, pass changes to aircrews prior to takeoff if any changes, otherwise at takeoff just give new void time.
7. At takeoff Eagle 1 will call at takeoff, open flight log, annotate departure. Call JOC (676-3014) to adjust gate time if requested.
8. Contact MCC (HOTLINE) and pass on aircraft departure time. Initial checklist on desk upon completion.
9. Monitor all Radio Equipment for updates on Eagle locations (LTCC Tower [VHF] until departure, AWACS Enroute [UHF] until landing, SATCOM, FM secure).
10. Destroy old COMSEC material and ensure all documentation is correct.
11. Eagle(s) will request return gate through AWACS (Cougar) or Eagle Ops. Call JOC (676-3014) to request gate time if required.
12. Call Incirlik weather (676-6878) at 1500L for 24hr outlook. Post on clipboard next to door. Initial checklist on desk upon completion.

**EXTRACT**

I certify that I am the Records Custodian for the Accident Investigation Board convened to investigate the crash of two U.S. Army Black Hawk helicopters in the no fly zone in northern Iraq on 14 April 1994, and that this is a true and accurate extract from Eagle Det Record file

which is kept in my records system.

11 Feb 94

Date

W. L. HARRIS, Capt, USAF, MSC  
Evidence Custodian, Incirlik Air Base, Turkey



13. Zakhu will advise Eagle Ops periodically of Eagle aircraft location, if not, call for status NLT 1+30 before official sunset.
14. Aircraft will call 30 minutes from landing LTCC. Call MCC (HOTLINE) and Nest (FM) to advise them of ETA. Initial checklist on desk upon completion.
15. Aircraft landing at LTCC, will call landing assured. Call MCC (HOTLINE), close flight log. Initial checklist on desk upon completion.
16. Begin CINRF and SITRF on IBM (Sarah-Lite). Aircrews return from airfield, turn-in issue items, and fill out Brain Book and debrief. PC NCOIC will give OPS aircraft status report. Commander or Ops officer confirms next day's mission at 1730 at MCC.
17. Maintenance personnel will request weapons turn-in time prior to departing airfield. Call SP's (3344) for weapons turn-in.
18. After PCNCOIC drops off aircraft status and provides aircraft and crews and CDR provides mission times, the following items need to be prepared or requested. As each item is completed, initial next to that item on the checklist on the desk.
  - A. Prepare time lines and mission board for the next days' mission(s).
  - B. Prepare mission schedule for next day (Formtool). Post on board in barracks.
  - C. Call Incirlik Weather (676-6878) to put a 175-1 on request for the next day's mission.
  - D. Call JOC (676-3014) for line numbers for next day's mission(s). If have information for next day before 1200L, call FRAGG shop (676-3959, 3938 SECURE) to open line numbers.
  - E. Put new fills in KYK-13 for next day.
  - F. Request a weapons draw from the SPs for the next day's show time.
  - G. Complete SITRF and CINRF. Put copies in the commander's box. Take the disk over to the COMM Center. Drop off the disk and pick up the ATO.
19. Make 1 copy of ATO (not addressee portion) per scheduled aircraft. Secure all classified documents in safe.

20. At each change of Operation's CO, ensure the new CO is briefed on status of assigned duties and any special instructions, ensure all COMSEC, NVGs, and PRC 112s are secure. If the new CO has a SECRET clearance, ensure they inventory the safe. If they do not have a SECRET, ensure the safe is locked before the last person cleared for access departs.

**TAB AA**

**REGULATIONS AND DIRECTIVES**

**AA-9 Extracts from OPC II Command and Control Guidance  
(USCINCEUR OPORDs 002, 003, 004, CTF OPLAN 91-7)  
(See also Classified Addendum)**

**AA-10 Extracts from DA Technical Manual 55-1520-237-10, Operator's  
Manual UH-60A and EH-60A Helicopters**

**AA-11 Eagle Flight Detachment, Standard Flight Operating Procedures**

**AA-12 Eagle Flight Detachment Operations Order 92-01**

**AA-13 Extract from AFP 110-34, Commander's Handbook on The Law  
of Armed Conflict**

**AA-14 Extract From Mission Control Center Standard Operating  
Procedures, Headquarters Combined Task Force**

**AA-15 Extract from Army Regulation 95-1, Aviation, Flight Regulation**

**AA-16 Headquarters Combined Task Force Memorandum for CFACC  
Commander, Military Coordination Center, UH-60 Flight Policy,**

**AA-9**

~~SECRET~~

EXTRACTS OF  
OPERATION PROVIDE COMFORT II  
COMMAND AND CONTROL GUIDANCE

1. USCINCEUR OPOD SERIAL 003 FOR CTF PROVIDE COMFORT MESSAGE

\*\*\*

0 040900Z JUL 91  
FM USCINCEUR VAHINGEN GE//ECJ3//

\*\*\*

\*\*\* THIS IS USCINCEUR OPOD SERIAL 003 FOR CTF PROVIDE COMFORT \*\*\*

\*\*\*

2. <sup>4</sup>(S) MISSION. DETER IRAQI BEHAVIOR THAT MAY UPSET PEACE AND ORDER TO NORTHERN IRAQ. ON ORDER, RESPOND WITH SUFFICIENT FORCE TO PROTECT NATIONS INTERESTS SHOULD DETERRENCE FAIL.

\*\*\*

3E. (U) FIRST TASKING ASSIGNMENT - CINCUSAREUR

3E8. <sup>4</sup>(S) OPCON OF FORCES PROVIDED WILL BE ASSIGNED TO CTF PROVIDE COMFORT.

\*\*\*

3F.(U) SECOND TASKING ASSIGNMENT - CINCUSNAVEUR.

\*\*\*

3F6. <sup>4</sup>(S) DURING PLANNING AND EXECUTION, OPCON FOR FORCES AFLOAT REMAINS WITH PROVIDING COMMAND. HOWEVER, ALL NAVEUR OPERATIONS WITHIN TAOR WILL BE UNDER TACON OF CTF PROVIDE COMFORT.

\*\*\*

3G. (U) THIRD TASKING ASSIGNMENT - CINCUSAFE.

**CERTIFICATE OF DECLASSIFICATION**  
I certify that the information contained in this document has been declassified from

SECRET  
Date: 16 MAY 94

to UNCLASSIFIED.

Signature: [Signature]  
DONALD G. NORRIS, GS-15, DATE  
Declassification Team Chief, HQ USFUCOM

**CERTIFICATION OF EXTRACT**  
I reviewed USFUCOM/OPD/OPAS/OPAS 91-7. From that source document, I extracted the information contained in this extract. I certify the information contained herein is a true and accurate extract of that source document.

16 MAY 94  
Date

Signature: [Signature]  
BRYAN T. LAWRENCE, LTC, 3AF/JA  
Number/Organizations/Section

~~SECRET~~

~~SECRET~~

\*\*\*

~~4~~ 3G4. (S) ALL USAFE OPERATIONS WITHIN TAOR WILL BE UNDER TACON OF CTF PROVIDE COMFORT.

\*\*\*

3H. (U) FOURTH TASKING ASSIGNMENT - CTF PROVIDE COMFORT.

\*\*\*

~~4~~ 3H5. (S) INTEGRATE SUPPORTING COMMAND AND AGENCY ASSETS INTO PROVIDE COMFORT PLANNING/EXECUTION AS REQUIRED.

\*\*\*

3Q. (U) COORDINATING INSTRUCTIONS:

~~4~~ 3Q1. (S) THIS OPORD IS EFFECTIVE FOR PLANNING AND EXECUTION UPON RECEIPT.

~~4~~ 3Q2. (S) SUPPORTING PLAN. REQ SUPPORTING PLANS BE SUBMITTED BY MSG TO USCINCEUR VAHINGEN GE//ECJ3// NLT 18 JUL 1991.

\*\*\*

5A. (U) COMMAND RELATIONSHIPS.

~~4~~ 5A1. (S) USCINCEUR IS SUPPORTED COMMANDER. USCINCEUR WILL EXERCISE OPCON OVER COMPONENT FORCES THROUGH CTF PROVIDE COMFORT. CTF PROVIDE COMFORT IS ASSIGNED OPCON OF FORCES DEPLOYED IN TURKEY TO SUPPORT OPERATIONS AS DIRECTED THIS OPORD. (...)

\*\*\*

~~SECRET~~

2. CTF PROVIDE COMFORT OPLAN 91-7 MESSAGE

01 15 201415Z JUL 91 (..)

\*\*\*

CTF PROVIDE COMFORT OPLAN 91-7, RESIDUAL FORCE

\*\*\*

4. (UNCLAS) COORDINATING INSTRUCTIONS.

\*\*\*

4D2. (~~S~~/MNF) ROUTINE OPERATIONS AND IMMEDIATE RESPONSE ACTIONS 0/0 (WITH THE EXCEPTION OF SAR AND NON-COMBAT EVACUATION) WILL BE UNDER CTF PROVIDE COMFORT AND USCINCEUR AUTHORITY. (..)

4D3. (~~S~~/MNF) ALL FLIGHTS, BOTH ROTARY AND FIXED WING, WILL BE IN ACCORDANCE WITH THE CTF AIR COMPONENT COMMANDER'S AIR TASKING ORDER (ATO) AS APPROVED AND PROMULGATED BY HQ 2TAF.

4D4. (~~S~~/MNF) CDR, CTF PROVIDE COMFORT RETAINS AUTHORITY FOR ALL CROSS BORDER OPERATIONS, BOTH AIR AND GROUND, INTO IRAQ. THE AIR TASKING ORDER/DAILY FLIGHT SCHEDULE GIVES AUTHORITY FOR OVERFLIGHT OF NORTHERN IRAQ.

4D5. (~~S~~/MNF) NO COALITION GROUND FORCES ARE ALLOWED INTO IRAQ WITHOUT APPROVAL BY CTF HEADQUARTERS, WITH THE EXCEPTION OF THE MCC.

\*\*\*

ANNEX B (INTELLIGENCE) TO CTF PROVIDE COMFORT OPLAN 91-7.

\*\*\*

2. (U) MISSION.

\*\*\*

~~SECRET~~

2A. (U) GENERAL. TO PROVIDE TIMELY, USABLE, RELEVANT INTELLIGENCE TO COALITION FORCES IN ORDER TO SUPPORT PRUDENT, EFFECTIVE COMMAND DECISIONS.

\*\*\*

3A. (S/PMNF) ~~U~~ CONCEPT OF OPERATIONS. CTF PC C2 WILL BE THE FOCAL POINT FOR ALL INTELLIGENCE DIRECTION, COLLECTION, PROCESSING/ANALYSIS, AND DISSEMINATION FOR THE OPERATION. (...)

\*\*\*

ANNEX F (AIR OPERATIONS) TO CTF -- PROVIDE COMFORT OPLAN 91-7.

\*\*\*

## 2. CONCEPT OF OPERATIONS.

A. GENERAL: ALL AIR OPERATIONS OF THE COALITION FORCES ABOVE 36-00 N WILL BE APPROVED AND PROMULGATED BY THE 2TAF VIA THE ATO AND DAILY FLYING SCHEDULE PRIOR TO EXECUTION.

B. FIGHTER: (...) ARMY ROTARY WING OPERATIONS WILL BE INTEGRATED WITH FIXED WING OPERATIONS BY THE ATO THROUGH 2TAF.

C. HELICOPTER: (...) COMBINED FORCES GROUND COMPONENT COMMANDER WILL COORDINATE ROTARY WING SORTIES IN IRAQ WITHIN THE FIGHTER FLYING WINDOW. CTF/C-3, THROUGH THE CFACC (FRAG SHOP), WILL BE THE FOCAL POINT FOR COORDINATING ARMY ROTARY WING FLYING WITH AVAILABLE FIGHTER ASSETS.

D. ATO DEVELOPMENT: ALL SORTIES FLOWN IN TURKEY AND IRAQ MUST BE FRAGGED IN THE ATO/DAILY FLYING SCHEDULE (DFS). COMBINED FORCES, AIR COMPONENT COMMANDER (CFACC) IS THE OFFICE OF PRIMARY RESPONSIBILITY FOR PREPARATION OF THE ATO/DFS, 2TAF IS THE OFFICE OF PRIMARY RESPONSIBILITY FOR APPROVAL OF THE ATO/DFS FLYING UNITS WILL SEND A REPRESENTATIVE TO THE FRAG SHOP NLT 0600Z EACH DAY TO COORDINATE THE FOLLOWING DAY'S ATO/DFS. (...)

~~SECRET~~

~~SECRET~~

**E. OPERATIONAL/TACTICAL CONTROL: OPERATIONAL CONTROL FOR USAF FIGHTER AIRLIFT AND AWACS AIRCRAFT IS MAINTAINED BY THE CFACC. SAC MAINTAINS OPERATIONAL CONTROL OF TANKER AIRCRAFT AND SUPPORTS CFACC'S REQUIREMENTS. OPERATIONAL CONTROL FOR US NAVAL AND US ARMY AIRCRAFT IS MAINTAINED BY THEIR PARENT UNIT, FLIGHT ACTIVITY IS IN SUPPORT OF COMMANDER, CTF PROVIDE COMFORT. 2TAF WILL EXERCISE POSITIVE AIRSPACE/AIR TRAFFIC CONTROL, IF NECESSARY THROUGH AWACS, WHILE CTF AIRCRAFT ARE IN TURKISH AIRSPACE. CFACC EXERCISES TACTICAL CONTROL.**

\*\*\*

**G. DAY/NIGHT PROCEDURES:**

**1. FIGHTER: EITHER E3B OR E2 AIRCRAFT WILL PROVIDE AIRBORNE THREAT WARNING AND FIGHTER CONTROL . . . FIGHTERS WILL NOT CROSS THE POLITICAL BORDER WITHOUT AWACS/AEW COVERAGE. (. . .)**

\*\*\*

**2. HELICOPTERS: EITHER E3B OR E2 AIRCRAFT WILL PROVIDE AIRBORNE THREAT WARNING \*\*\*. COMMAND AND CONTROL FOR ARMY ASSETS WILL NORMALLY BE COORDINATED THROUGH AWACS/AEW OR AIRBORNE HELICOPTER C2 ASSETS. HELICOPTER FLIGHTS WILL NOT NORMALLY BE CONDUCTED INTO IRAQ WITHOUT FIGHTER COVERAGE.**

\*\*\*

**K. COMMAND AND CONTROL: E3B OR E3 AIRCRAFT WILL PROVIDE AIR CONTROL FOR ALL FIGHTER/HELICOPTER AIRCRAFT OPERATING INSIDE THE AOR. THE FLIGHT LEAD/AIRCRAFT COMMANDER WILL CONTACT AWACS/AEW ENROUTE TO THE AOR . . . AFTER POSITIVE IDENTIFICATION AND AUTHENTICATION BY AWACS/AEW, AIRCRAFT MAY BE CLEARED TO CROSS THE POLITICAL**

~~SECRET~~



~~SECRET~~

BORDER. AN AIRBORNE COMMAND ELEMENT (ACE) WILL  
BE ABOARD TO SERVE AS THE REPRESENTATIVE OF CFACC  
FOR TIME CRITICAL DECISIONS. (...)

\*\*\*

~~SECRET~~

~~SECRET~~

3. USCINCEUR OPORD SERIAL 004 FOR CTF PROVIDE COMFORT MESSAGE

\*\*\*

141333Z SEP 91  
FM USCINCEUR VAIHINGEN GE//ECCAT//

\*\*\*

REF/A/OPORD/USCINCEUR/040900Z JUL 91//  
AMPN/USCINCEUR PROVIDE COMFORT SERIAL OPORD 003//

REF/D/RMG/CTF/ PROVIDE COMFORT/201415Z JUL 91//MPN/CTF PROVIDE  
COMFORT OPLAN 91-7, RESIDUAL FORCE//

\*\*\*

~~(S)~~ THIS IS USCINCEUR OPORD SERIAL 004 FOR REDEPLOYMENT  
OF CTF PROVIDE COMFORT BATTALION TASK FORCE FROM TURKEY.  
(...) THE MCC, CSAR, TAC AIR, SUPPORT FORCES, AND A MODIFIED  
CTF HQ WILL REMAIN IN TURKEY UNTIL FURTHER NOTICE//

\*\*\*

~~(S)~~ 2. MISSION. WHEN DIRECTED BY NCA, REDEPLOY THE PROVIDE  
COMFORT BTF, INCLUDING GROUND AND AVIATION UNITS, TO  
ORIGINALLY PROVIDING COMMANDS, HOME STATIONS, AND PORTS.  
RETAIN CTF ASSETS AS REQUIRED TO SUPPORT THE MCC.

\*\*\*

3. (U) EXECUTION

3A. (U) CONCEPT OF OPERATIONS.

~~(S)~~ 3A1. CONTINUE PRESENT OPERATIONS IAW REF A WITH USAFE  
TACTICAL AND SUPPORTING AIR BASED IN TURKEY WHILE  
REDEPLOYING BTF PERSONNEL AND EQUIPMENT. MCC  
OPERATIONS WILL CONTINUE IAW REFS A, C, AND D.

\*\*\*

3E. (U) FIRST TASKING ASSIGNMENT -- CINCUSAREUR.

~~SECRET~~

~~SECRET~~

4  
3E1. (S) PROVIDE SUPPORT FOR CTF PROVIDE COMFORT AND MCC OPERATIONS AS REQUIRED. BE PREPARED TO ACCEPT RETROGRADE FORCES.

\*\*\*

3F. (U) SECOND TASKING ASSIGNMENT -- CINCUSNAVEUR.

4  
3F1. (S) (. . .) ALL OPERATIONS IN PROVIDE COMFORT AOR WILL BE UNDER TACON OF THE COMMANDER PROVIDE COMFORT.

\*\*\*

3G. (U) THIRD TASKING ASSIGNMENT -- CINCUSAFE.

\*\*\*

4  
3G3. (S) DESIGNATE THE COMMANDER FOR COMBINED TASK FORCE PROVIDE COMFORT TO COMMAND COMBINED OPERATIONS UNDER THIS OPORD.

\*\*\*

4  
3G7. (S) CONTINUE TO COORDINATE STRIKE PLANNING/EXECUTION WITH CTF PROVIDE COMFORT.

\*\*\*

3H. (U) FOURTH TASKING ASSIGNMENT -- CTF PROVIDE COMFORT.

4  
3H1. (S) BE PREPARED TO COMMENCE REDEPLOYMENT OF THE PROVIDE COMFORT BTF AND SUPPORTING AIR ON ORDER. RETAIN THOSE CTF ASSETS REQUIRED TO SUPPORT THE CONTINUING MCC MISSION.

\*\*\*

5A. (U) COMMAND RELATIONSHIPS.

4  
5A1. (S) USCINCEUR IS SUPPORTED COMMANDER. USCINCEUR WILL EXERCISE OPCON OVER COMPONENT FORCES THROUGH CTF PROVIDE COMFORT, LESS NAVEUR FORCES. ALL NAVEUR

~~SECRET~~

~~SECRET~~

JOINT OPERATIONS WITHIN TURKEY AND/OR TAOR WILL BE COORDINATED WITH AND AT EXECUTION UNDER TACON OF CTF PROVIDE COMFORT. CTF PROVIDE COMFORT IS ASSIGNED OPCON OF FORCES DEPLOYED IN TURKEY TO SUPPORT OPERATIONS AS DIRECTED THIS OPORD. (...)

\*\*\*

~~SECRET~~

**TAB AA**

**REGULATIONS AND DIRECTIVES**

**AA-9 Extracts from OPC II Command and Control Guidance  
(USCINCEUR OPORDs 002, 003, 004, CTF OPLAN 91-7)  
(See also Classified Addendum)**

**AA-10 Extracts from DA Technical Manual 55-1520-237-10, Operator's  
Manual UH-60A and EH-60A Helicopters**

**AA-11 Eagle Flight Detachment, Standard Flight Operating Procedures**

**AA-12 Eagle Flight Detachment Operations Order 92-01**

**AA-13 Extract from AFP 110-34, Commander's Handbook on The Law  
of Armed Conflict**

**AA-14 Extract From Mission Control Center Standard Operating  
Procedures, Headquarters Combined Task Force**

**AA-15 Extract from Army Regulation 95-1, Aviation, Flight Regulation**

**AA-16 Headquarters Combined Task Force Memorandum for CFACC  
Commander, Military Coordination Center, UH-60 Flight Policy,**

**AA-9**

**AA10**

# CERTIFICATION OF EXTRACT

I reviewed TECHNICAL MANUAL TM 55-1520-237-10 OPERATORS MANUAL  
(describe the original source document)

From that source document, I extracted the information contained in the attached document,  
entitled TECHNICAL MANUAL TM 55-1520-237-10 OPERATOR MANUAL

I certify the information contained there in is a true and accurate extract of the source document.

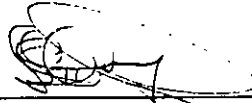

(Signature)

STEVE MELINA

(Printed Name)

201<sup>TH</sup> HW Co HEIDELBERG GERMANY

(Organization/Duty Section)

13 MAY 94

(Date)

CHANGE DATED POSTED IN

TECHNICAL MANUAL

- CHG 9 2 JUL 90 27 MAR 91
- CHG 10 24 JUL 90 27 MAR 91 (D)
- CHG 11 24 AUG 90 27 MAR 91 (D)
- CHG 12 13 FEB 91 27 MAR 91 (D)
- CHG 13 30 AUG 91 04 DEC 91 (D)
- CHG 14 11 OCT 91 10 JAN 92 (D)
- CHG 15 29 NOV 91 APR 92 (D)
- CHG 16 30 SEP 92 9 MAR 93 (D)
- CHG 17 08 SEP 92 21 APR 93 (D)
- CHG 18 15 FEB 93 21 APR 93 (D)
- CHG 19 31 JUL 93 DEC 93 (D)
- CHG 20 16 AUG 93 4 OCT 93 (D)

OPERATOR'S MANUAL

UH-60A AND EH-60A HELICOPTER

THIS MANUAL SUPERSEDES  
TM 55-1520-237-10/ TO 1H-60(U)A-1.  
21 MAY 1979, INCLUDING ALL CHANGES.

Change 10, 11, 12, 13, 14, 15, 16, 17, 18, 19, 20  
 Deleted temporary  
 applicable to UH-60A UH-60A  
 (see note on page 7)  
 10, 11, 12, 13, 14, 15, 16, 17, 18, 19, 20  
 removed temporary  
 applicable to UH-60A UH-60A  
 installed in the manual  
 10, 11, 12, 13, 14, 15, 16, 17, 18, 19, 20

"Approved for public release; distribution is unlimited."

This copy is a reprint which includes current pages from Changes 1 through 8.

Chg 15 Chap 7.1 removed  
 Chg 16 Chap 7.1 removed  
 Chg 18 Chap 7.1 removed  
 Chg 19 Chap 7.1 removed

HEADQUARTERS, DEPARTMENT OF THE ARMY

8 JANUARY 1988

c. Turn preset channel selector switch to desired channel number.

d. Press and release PRESET switch.

e. Using a soft lead (erasable) pencil, record frequency selected for channel number used on card on front panel.

### 3-58. Retransmit.

Retransmission permits the helicopter to be used as an airborne relay link. To operate as a relay unit, additional installed equipment must be used (Figure 3-8).

a. Frequency - Select.

b. RADIO TRANSMISSION selector switch - Set to radio sets to be used.

c. Establish communication between each relay radio in helicopter and its counterpart radio link terminal station by using appropriate ICS TRANS selector.

### 3-59. Guard (Emergency) Operation.

a. MANUAL-PRESET-GUARD switch to GUARD.

b. ICS transmitter selector - Position 2.

c. Radio push-to-talk switch on cyclic stick or foot-operated push-to-talk switch - Press to talk.

### 3-60. Stopping Procedure.

Mode Selector - OFF.

#### 3-60.1. Receiver-Transmitter Radio, RT-1167C/ARC-164(V).

Receiver-Transmitter Radio RT-1167C/ARC-164(V) (Figure 3-6) has the same functions and capabilities as the RT-1167/ARC-164(V) plus a HAVE QUICK mode of operation. Have QUICK is an antijamming mode which uses a frequency hopping scheme to change channels many times per second. Because the HQ mode depends on a precise time-of-day, both HQ radios must have synchronized clocks.

#### 3-60.2. HAVE QUICK (HQ) System.

The HQ system provides a jam resistant capability through a frequency hopping technique. Frequency hopping is a technique in which the frequency being used for a given channel is automatically changed at some rate common to the transmitter and receiver. The jam resistance of the system is due to the automatic frequency changing and the pseudorandom pattern of frequencies used. In order to defeat this communications system, the jammer must find the frequency being used, jam it and then predict or find the next frequency. The HAVE QUICK modification adds the frequency hopping capability, yet it does not remove any of the previous capabilities of the radio. The HQ modified radios retain the standard, single frequency UHF voice mode of operations. This is referred to as the normal mode, while frequency hopping operation is called the anti-jam (AJ) mode. Several ingredients are necessary for successful system operations. These are:

a. Common frequency.

b. Time synchronization.

c. Common hopping pattern and rate.

d. Common net number.

The common frequencies have been programmed into all HQ radios. Time synchronization is provided via UHF radio and/or hardware by external time distribution system. A time-of-day (TOD) signal must be received from the time distribution system for each time the radio is turned on. The hopping pattern and hopping rate are determined by the operator inserted word-of-day (WOD). The WOD is a multi-digit code, common worldwide to all HAVE QUICK users. In the AJ mode, a communications channel is defined by a net number instead of a signal frequency as in the normal mode. Before operating in the AJ mode, the radio must be primed. This consists of setting the WOD, TOD, and net number. The AJ mode is then selected by placing the A-3-2-T knob to A.

#### 3-60.3. A-3-2-T Knob (HQ Only).

a. A- Selects AJ mode (Figure 3-6).

b. 3- Allows manual selection of frequencies.



c. 2- Allows manual selection of frequencies

d. T- Momentary position which enables the radio to accept a new TOD for up to 60 seconds after selection. Also used in conjunction with the emergency startup of the TOD clock when TOD is not available from an external source.

#### 3-60.4. TONE Button (HQ Only).

Depressing the TONE button in normal or AJ modes interrupts reception and transmits alone signal and TOD on the selected frequency. Simultaneously pressing the TONE button in conjunction with the A-3-2-T knob in the T position starts the emergency startup of the TOD clock.

#### 3-60.5. WORD OF DAY (WOD).

The WOD entry is normally entered before flight, but it is possible to enter it in flight. WOD is entered by using one or more of the six preset channels which are 20-15. For a new WOD entry, start at channel 20 and use the same method as in entering preset frequencies in the normal mode with the frequency knobs and the PRESET button. After each entry, a single beep is heard until channel 15 entry; a double beep is heard indicating that the radio has accepted all six WOD entries.

#### 3-60.6. WOD TRANSFER.

Select the preset mode and, starting with preset channel 20, rotate the preset knob CCW. At channel 20, a single beep is heard. A single beep indicates that channel 20 data has been transferred and accepted. After the single beep is heard, select remaining channels (19-15) in the same manner until a double beep is heard indicating the WOD transfer is complete.

#### 3-60.7. TIME-OF-DAY (TOD) Transmission.

The TOD entry is normally entered before flight, but it is possible to enter it in flight. It is possible to transmit timing information in both normal and Ad modes by momentarily pressing the TONE button. In the normal mode, a complete TOD message is transmitted, while in the AJ mode, only an abbreviated time update is transmitted. A mode time transmission allows a time update if one radio has drifted out of synchronization.

#### 3-60.8. TIME-OF-DAY Reception.

Reception is possible in both normal and AJ modes. The radio automatically accepts the first TOD message

after the radio is turned on and WOD transferred. Subsequent messages are ignored unless the T position is selected with the A-3-2-T knob. The radio then accepts the next TOD update in either normal or AJ mode, provided the TOD update arrives within 60 seconds of the time the T position has been selected. To receive time in the normal mode, rotate the A-3-2-T knob to the T position and return to a normal channel in either the manual or preset mode. To receive a time update in AJ mode, rotate the A-3-2-T knob to the T position and then back to the A position. A TOD update (time tick) can be received on the selected AJ net.

#### 3-60.9. Net Numbers.

After WOD and TOD are entered, any valid AJ net number can be selected by using the manual frequency knob.

#### 3-60.10. Anti-Jamming Mode Operation.

A tone is heard in the headset if an invalid AJ net is selected, if TOD was not initially received, or if WOD was not entered. If the function knob is set to both and the AJ mode is selected, any transmission on the guard channel takes precedence over the AJ mode.

#### 3-60.11. Operational Procedures Radio Set AN/ARC-164(V).

1. Transfer WOD IAW "WOD TRANSFER" paragraph 3-60.5.

2. Setup RT to receive TOD.

a. With external TOD equipment.

(1) Select manual mode on MODE switch.

(2) Set TOD frequency in manual frequency windows.

(3) Set A-3-2-T to A, after TOD beep is heard. If tone is heard with the A-3-2-T in the A position, reinitialize radio IAW steps in "TOD TRANSMISSION" paragraph 3-60.6.

b. Without external TOD equipment: Emergency start-up of TOD clock.

(1) Set and hold A-3-2-T switch to T.

(2) Press the TONE button.

**NOTE**

When using this method, the flight commander or lead aircraft should emergency start his TOD clock. Lead aircraft would then transfer TOD to other aircraft in flight. Aircraft using this method will not be able to communicate with valid TOD signal in the AF mode. A valid TOD signal must be transferred to all aircraft that have invalid TOD time before effective AJ communications can be achieved.

3-60.12. HQ Checklist ARC-164, Loading Word-of-Day (WOD).

1. "T, 2, 3, A" switch - Not in A position.
2. Functional selector switch - Both.
3. Manual, preset, guard switch - Preset.
4. Manual frequency display - Set WOD 15.
5. Preset channel select - Set to 15.
6. Preset button (under frequency cover) - Press.
7. Manual frequency display - Set WOD 16.
8. Preset channel select - Set to 16.

9. Preset button - Press.
10. Repeat steps 7 thru 9 to store WOD 17, 19.
11. Manual frequency display - Set 300.050.
12. Preset channel select - Set to 20.
13. Preset button - Press.
14. Rotate preset select down 19, 18, 17, 16, 15. (hear 1 beep 20-16, 2 beeps on 15).

3-60.13. Receiving Time from Net Control Aircraft.

1. Manual, preset, guard switch - Manual.
2. Set to internal frequency to receive the time.
3. Hear net control aircraft state: "Standby for time".
4. Rotate "T, 2, 3, A" switch to "T" and return to established manual frequency, hear.
5. Hear net control aircraft state: "Go active 0 point one."
6. Set A00.100 in manual window and complete commo check; if loud tone is heard, repeat timing.

3-60.14. Sending Time (Net Control Aircraft).

1. Manual, preset, guard switch - Manual.
2. Set to internal frequency.
3. Rotate "T, 2, 3, A" switch to "T" and hold.
4. Press tone button and hold (hear no tone).
5. "T, 2, 3, A" to internal frequency (0.25 second beep, then tone).
6. Call other aircraft to send time.
7. Press tone button to send time.

**NOTE**

Recall today's WOD by reselecting presets 20 down thru 15, and hear beeps.

3-61. Voice Security System TSEC/KY-28.

Three TSEC/KY-28s (Figure 3-7) are used as auxiliary equipment to provide voice security (ciphony) mode. Control indicator C-8157/ARC is used by the pilot and copilot to control TSEC/KY-28 for FM-1, FM-2 and UHF-AM. The control has four switches and three indicator lamps. Power to operate the TSEC/KY-28 for the NO. 1 and NO. 2 AN/ARC-114A systems is provided from the dc essential bus through a circuit breaker, marked COMM SCTY SET NO. 1 FM, and No. 1 dc primary bus through a circuit breaker, marked NO. 2 FM COMM SCTY SET respectively. Power to operate the AN/ARC-164(V) TSEC/KY-28 is provided from the dc essential bus through a circuit breaker, marked COMM SCTY SET UHF AM. Each Control C-8157/ARC is located adjacent to the radio set it supports. Two operating modes are available when the TSEC/KY-28 is installed in the helicopter; PLAIN mode for clear voice radio transmission or reception, and CIPHER mode for secure voice radio transmission or reception.

**NOTE**

When the TSEC/KY-28s are installed in the helicopter, the TSEC/KY-28 for the intended use radio set must be ON before radio communication, plain or ciphered, is possible. Non-secure radios will not be keyed when using any secure radio or the intercom for classified communications.

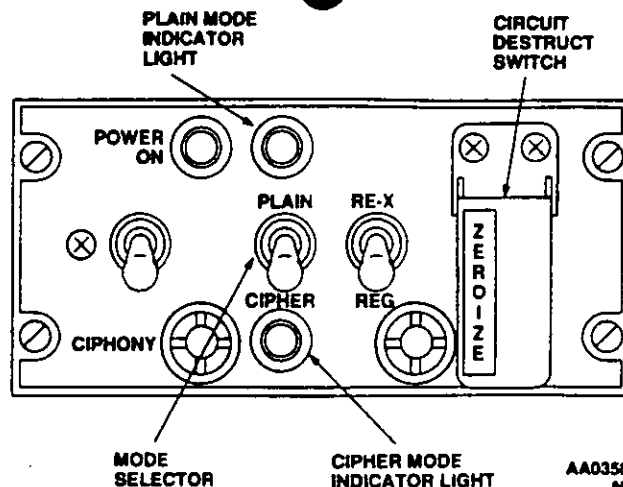

Figure 3-7. Voice Security System Control C-8157/ARC

3-62. Controls and Functions.

Controls for the TSEC/KY-28 are on the front panel of the C-8157/ARC (Figure 3-7). The function of each control is as follows:

CONTROL	FUNCTION
POWER ON	Turns set on and off. Switch must be on (up) for operation in either plain or cipher mode.
POWER ON light (amber)	Lights when POWER ON switch is placed on (up).
PLAIN-CIPHER switch	At PLAIN, permits normal communications on associated equipment. At CIPHER, permits secure voice communications on associated equipment.
Plain mode indicator light (red)	Lights when PLAIN-CIPHER switch is at PLAIN.
Cipher mode indicator light (green)	Lights when PLAIN-CIPHER switch is at CIPHER.

- (4) Movement in helicopter.
  - (5) Internal communications.
  - (6) Security of equipment.
  - (7) Smoking.
  - (8) Oxygen.
  - (9) Refueling.
  - (10) Weapons.
  - (11) Protective masks.
  - (12) Parachutes.
  - (13) Hearing protection.
  - (14) Aviation life support equipment (ALSE).
- e. Emergency procedures.
- (1) Emergency exits.
  - (2) Emergency equipment.
  - (3) Emergency landing/ditching procedures.

## Section II OPERATING PROCEDURES AND MANEUVERS

### 8-6. OPERATING PROCEDURES AND MANEUVERS.

This section deals with normal procedures and includes all steps necessary to ensure safe and efficient operation of the helicopter from the time a preflight begins until the flight is completed and the helicopter is parked and secured. Unique feel, characteristics, and reaction of the helicopter during various phases of operation and the techniques and procedures used for taxiing, takeoff, climb, etc., are described, including precautions to be observed. Your flying experience is recognized; therefore, basic flight principles are avoided. Only the duties of the minimum crew necessary for the actual operation of the helicopter are included. Additional crew duties are covered as necessary in Section I Mission Planning. Mission equipment checks are contained in Chapter 4 Mission Equipment. Procedures specifically related to instrument flight that are different from normal procedures are covered in this section, following normal procedures. Descriptions of functions, operations, and effects of controls are covered in Section IV Flight Characteristics, and are repeated in this section only when required for emphasis. Checks that must be performed under adverse environmental conditions, such as desert and cold-weather operations, supplement normal procedures checks in this section and are covered in Section V Adverse Environmental Conditions.

### 8-7. SYMBOLS DEFINITION.

Items which apply only to night or only to instrument flying shall have an N or an I, respectively, immediately preceding the check to which it is pertinent. The symbol O shall be used to indicate "if in-

stalled". Those duties which are the responsibility of the non-flying pilot, will be indicated by a circle around the step number; i.e., (4). The symbol star ★ indicates an operational check is required. Operational checks are contained in the performance section of the condensed checklist. The asterisk symbol \* indicates that performance of step is mandatory for all thru-flights. The asterisk applies only to checks performed prior to takeoff. Placarded items such as switch and control labels appear in uppercase type.

### 8-8. CHECKLIST.

Normal procedures are given primarily in checklist form, and amplified as necessary in accompanying paragraph form, when a detailed description of a procedure or maneuver is required. A condensed version of the amplified checklist, omitting all explanatory text, is contained in the operator's checklist. To provide for easier cross-referencing, the procedural steps in the checklist are numbered to coincide with the corresponding numbered steps in this manual.

### 8-9. PREFLIGHT CHECK.

The pilot's walkaround and interior checks are outlined in the following procedures. The preflight check is not intended to be a detailed mechanical inspection. The preflight order is a recommended sequence only. The expanded substeps do not need to be memorized or accomplished in order. The steps that are essential for safe helicopter operation are included. The preflight may be made as comprehensive as conditions warrant at the discretion of the pilot.

8-10. BEFORE EXTERIOR CHECK (Figure 8-1).

**WARNING**

Do not preflight until armament systems are safe, switches off, safety pins installed and locking levers in locked position.

1. Publications - Check DA Forms 2408-12, -13, -14, and -18; DD Form 365-4; required forms and publications, and availability of operator's manual(s) (-10) and checklist (-CL).

\*2. Helicopter covers, locking devices, tiedowns, and grounding cables - Removed and secured.

\*3. Fuel - Check quantity as required.

4. Fuel sample - As required. Check for contamination before first flight of the day and after adequate settling time after cold refueling, or if fuel source is suspected contaminated.

8-11. EXTERIOR CHECK:

Exterior walkaround diagram is shown in Figure 8-1.

8-12. NOSE SECTION (AREA 1).

**CAUTION**

Do not deflect main rotor blade tips more than 6 inches below normal droop position when attaching tiedowns. Do not tie down below normal droop position.

\*1. Main rotor blades - Check.

2. Fuselage - Nose area, check as follows:

a. Windshield and wipers - Check.

O b. O... sensor - Check.

c. Avionics compartment - Check equipment as required; secure door.

d. Antennas - Check.

e. Landing and search lights - Check.

8-13. COCKPIT - LEFT SIDE (AREA 2).

1. Cockpit area - Check as follows:

a. Cockpit door - Check.

b. Copilot seat, belts, and harness - Check.

c. FM and **EH** antennas - Check.

d. Landing gear support fairing and step - Check.

e. Position light - Check.

f. Main landing gear - Check.

O g. HSS, VSP, ejector rack locking levers locked, fairing, and external tanks - Check; refueling caps secure. **ES**

h. Gunner's window - Check.

i. Ambient sense port - Check.

\*2. Left engine oil level - Check.

8-14. CABIN TOP (AREA 3).

1. Cabin top - Check as follows:

a. Left engine - Check inlet.

b. Left pitot tube - Check.

## 3-162. Normal Procedures.

Completion of the starting procedure leaves the AN/APX-100(V) in operation. The following steps may be required, depending upon mission.

a. MODE 4 CODE selector switch - A or B as required.

(1) If code retention is desired, momentarily place the MODE 4 CODE selector switch to HOLD.

(2) If code retention in external computer is not desired during transponder off mode, place MODE 4 CODE selector switch to ZERO to dump external computer code setting.

b. Mode M-1, M-2, M-3/A, M-C, or MODE 4 switches - Select desired mode.

c. Identification of position (I/P) Switch - IDENT, when required, to transmit identification of position pulses or set I/P switch to MIC to transmit I/P pulse only when microphone press-to-talk switch is actuated. (I/P pulses will be for 15 - 30-second duration when activated.)

## 3-163. Emergency Operation.

During a helicopter emergency or distress condition the AN/APX-100(V) may be used to transmit specially coded emergency signals on mode 1, 2, and 3/A and 4 to all interrogating stations. Those emergency signals will be transmitted as long as the MASTER control switch on the control panel remains in EMER.

MASTER control switch - EMER.

## 3-164. Stopping Procedure.

Refer to paragraph 3-162, step a. (1) and (2) before stopping transponder.

MASTER switch - OFF.

## 3-165. Transponder Computer KIT-1A/TSEC.

The transponder computer in the nose section of the helicopter operates in conjunction with mode 4. A caution light on the caution panel, marked IFF, will go on when a malfunction occurs in mode 4 or the computer that will prevent a reply when interrogated. Mode 4 operation is selected by placing the MODE 4 switch ON, provided the MASTER switch is at STBY or NORM. Placing the

MODE 4 switch to OUT disables mode 4. MODE 4 CODE switch is placarded ZERO, B, A, and HOLD. The switch must be lifted over a detent to switch to ZERO. It is spring-loaded to return from HOLD to the A position. Position A selects the mode 4 code for the present code period and position B selects the mode 4 code for the succeeding period. Both codes are mechanically inserted by a code-changing key. The codes are mechanically held in the transponder computer, regardless of the position of the MASTER switch or the status of helicopter power, until the first time the helicopter becomes airborne. Thereafter, the mode 4 codes will automatically zeroize any time the MASTER switch or helicopter power is turned off. The code setting can be mechanically retained. With weight on the landing gear, turn the MODE 4 CODE switch to HOLD (only momentary actuation is required) and release the MASTER switch or helicopter power must be turned OFF within 15 seconds following placing MODE 4 CODE select switch to HOLD. Mode 4 codes can be zeroized any time the helicopter power is on and the MASTER switch is not in OFF, by turning the CODE switch to ZERO. Power to operate the transponder computer is provided automatically when the AN/APX-100(V) is on. The transponder computer KIT-1A/TSEC operation is classified.

## 3-165.1. Cryptographic Computer Kit-1C.

The cryptographic computer uses electronic key loading. Key loading is accomplished by use of the KYK-13 Electronic Transfer Device per TM 11-5810-389-13&P. The Cryptographic Computer Kit-1C operation is classified.

## 3-166. Altimeter Set AN/APN-209(V).

The radar altimeter system (Figure 3-27) provides instantaneous indication of actual terrain clearance height. Altitude, in feet, is displayed on two radar altimeter indicators on the instrument panel in front of the pilot and copilot. The radar altimeter indicators each contain a pointer that indicates altitude on a linear scale from 0 to 200 feet (10 feet per unit) and a second-linear scale from 200 to 1500 feet (100 feet per unit). An ON/OFF/LO altitude bug set knob, on the lower left corner of each indicator, combines functions to serve as a low level warning bug set control, and an on/OFF power switch. The system is turned on by turning the LO control knob, marked SET, of either indicator, clockwise from OFF. Continued clockwise turning of the control knob will permit either pilot to select any desired low-altitude limit, as indicated by the LO altitude bug. Whenever the altitude pointer exceeds low-altitude set limit, the LO altitude warning light will go

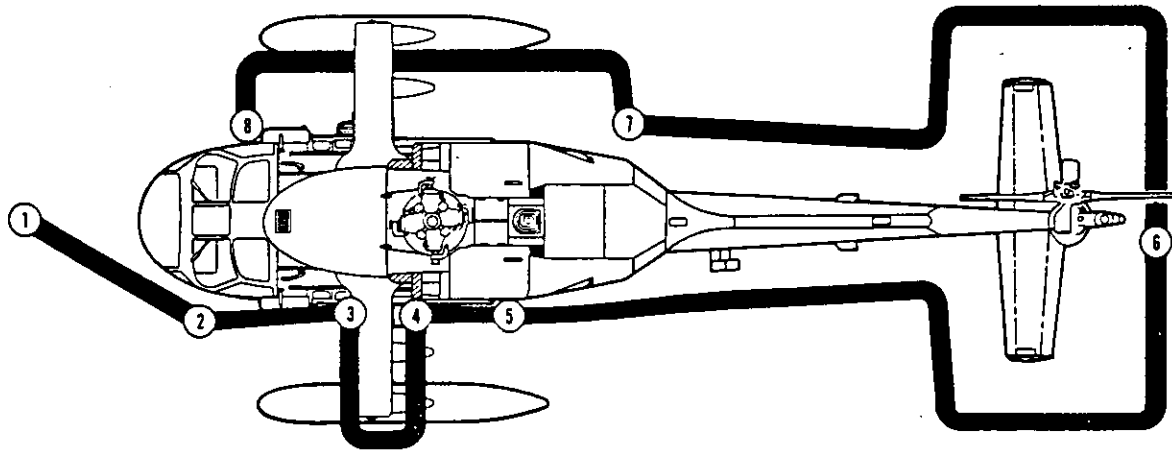

AREA 1 NOSE SECTION  
AREA 2 COCKPIT - LEFT SIDE  
AREA 3 CABIN TOP  
AREA 4 INTERIOR CABIN

AREA 5 FUSELAGE-LEFT SIDE  
AREA 6 TAIL PYLON  
AREA 7 FUSELAGE-RIGHT SIDE  
AREA 8 COCKPIT-RIGHT SIDE

S 45320 (BH2)

Figure 8-1. Exterior Check Diagram

c. Control access - Check flight controls, hydraulic reservoir, and filter indicators. Check tempilabels for safe indication and security. Check area.

d. Control access cover - Close and check secured.

e. Right pitot tube - Check.

f. Right engine - Check; inlet.

O g. IRCM - Check.

2. APU - Check; oil level, use dipstick.

O 2.1. APU IPS - Check.

3. Gust lock - Check.

4. Main transmission - Check; oil level.

\*5. Main rotor system - Check controls, dampers, head, and blades. BIM indicators - Check for safe indication (yellow color).

#### 8-15. INTERIOR CABIN (AREA 4).

1. Cabin - Check as follows:

a. Fire extinguishers - Check.

b. First aid kits - Check.

c. Pilot's and copilot's tilt-back release levers - Lock position.

d. Cabin interior - Check security of stowed equipment.

e. Cabin seats and belts - Check.

2. APU accumulator pressure gage - Check minimum 2,800 psi.

3. Transmission oil filter impending bypass indicator - Check.

4. Survival gear and mission equipment - Check as required.

#### 8-16. FUSELAGE - LEFT SIDE (AREA 5).

1. Fuselage - Check as follows:

a. Cabin door - Check.

b. Fuel tank filler ports - Check; caps secure, doors secured.

c. External pneumatic inlet port - Door secured.

d. Engine exhaust - Check.

O d.1. APU IPS exhaust - Check.

e. APU exhaust - Check.

O f. Chaff and **EH** flare dispensers - Check; number and programmer settings.

g. Lower anticollision light - Check.

h. Antennas - Check.

i. Tail landing gear - Check.

\*2. Intermediate gear box - Check; oil level.

#### 8-17. TAIL PYLON (AREA 6).

1. Tail pylon - Check as follows:

a. Tail pylon - Check.

b. Stabilator - Check.

O c. Radar detector **EH** antennas - Check.

d. Position light - Check.

e. Upper anticollision light - Check.

\*2. Tail rotor - Check.

\*3. Tail rotor gear box - Check; oil level.

#### 8-18. FUSELAGE RIGHT SIDE (AREA 7).

1. FUSELAGE - Check as follows:

a. Antennas - Check.

b. Aft avionics compartment circuit breakers and ECS fluid level - Check. **EH**

c. Fire bottles thermal plug - Check.

d. Engine exhaust - Check.

e. Fuel tank gravity filler port - Check cap secure; door secured.

f. Cabin door - Check.



**8-19. COCKPIT - RIGHT SIDE (AREA 8).**

\*1. Right engine oil level - Check.

2. Cockpit area - Check as follows:

O a. Ice detector - Check.

b. Ambient sense port - Check.

O b1. HSS, VSP, ejector rack locking levers locked, safety pins installed, fairings, and external tanks - Check; refueling caps secure. **ES**

c. Gunners window - Check.

d. External electrical power receptacle - Door secured.

e. Main landing gear - Check.

f. Position light - Check.

g. Landing gear support fairing and step - Check.

h. FM and **EH** antennas - Check.

i. Cockpit door - Check.

j. Pilot seat, belt, and harness - Check.

O k. Set switch on dimmer control box as desired. NORM for IR Dimming.

★\*3. Crew and passenger briefing - Complete as required.

**8-20. BEFORE STARTING ENGINES.**

\*1. Copilots collective - Extended and locked.

2. Shoulder harness locks - Check.

3. PARKING BRAKE - Release, then set.

★4. Circuit breakers and switches - Set as follows:

a. Circuit breakers - In.

b. Avionics - Off, frequencies set.

c. BLADE DE-ICE POWER - OFF.

d. Radar altimeter - Set. **EH** Left LO bug 200 feet.

e. Clocks - Set and running.

f. BACKUP HYD PUMP - AUTO.

**WARNING**

White strobe lights may cause a safety hazard. Personnel may be affected by the brilliance and pulse of the light.

\*g. ANTICOLLISION/POSITION LIGHTS - As required.

\*h. Q/F PWR switch - OFF. **EH**

O \*i. ECS panel switches - OFF. **EH**

j. CARGO HOOK EMER REL - OPEN, ARMING switch - SAFE.

k. APU CONTR switch - OFF; APU T-Handle - In.

l. Ground power unit - Connected if required.

\*m. AIR SOURCE HEAT/START switch - APU (OFF for external air source).

n. EMER OFF T-Handles - Full forward.

\*o. BATT switch - ON.

**8-21. COCKPIT EQUIPMENT CHECKS.**

\*1. FUEL PUMP switch - APU BOOST.

\*2. APU CONTR switch - ON.

**NOTE**

If the APU does not start and the APU ACCUM LOW advisory light is not on with the APU CONTR switch on, the manual override lever on the accumulator manifold should be pulled to attempt another start, and held until the APU has reached self-sustaining speed.

If APU fails, note and analyze BITE indications before cycling BATT switch or before attempting another APU start.

**WARNING**

Stabilator will move to full trailing edge down position upon application of AC power. Assure stabilator area is clear prior to energizing stabilator system.

\*3. APU generator - ON.

\*4. EXT PWR switch - OFF and cable disconnected.

O★5. ESSS AUXILIARY FUEL MANAGEMENT panel - TEST. **ES**

\*6. IINS system SELECT switches - DG and VG. **EH**

★\*7. IINS - Align. **EH**

8. Caution/advisory/warning panels - Check as required.

a. Caution/advisory panel BRT/DIM-TEST switch - TEST. Caution/advisory/warning, CIS/MODE SEL and VSI advisory lights on. #1 and #2 FUEL LOW caution lights flashing. On helicopters equipped with NVG lighting, AFCS FAILURE ADVISORY lights will illuminate. **EH** System select switches will illuminate. **EH** ASE advisory light - Press to test.

N b. INSTR LTS PILOT'S FLT control - ON.

N c. Caution/advisory BRT/DIM-TEST switch - BRT/DIM momentarily and then to TEST.

N d. All caution/advisory/warning panels CIS/MODE SEL and VSI advisory lights on at decreased intensity. On helicopters equipped with NVG lighting, AFCS FAILURE ADVISORY lights will not dim.

8.1. DEC engine fault indicator codes - Check for signal validation as required. **701C**

**NOTE**

If DEC signal validation codes are displayed on the % TRQ indicator, do not fly the helicopter.

N 9. Interior/exterior lighting - Set.

O★10. Mission equipment - Check.

★\*11. Cold weather control exercise - Check if temperature is below - 17°C.

\*12. AFCS FAILURE ADVISORY lights - If on, POWER ON RESET.

\*13. SAS1 off, SAS2, TRIM, FPS, and BOOST switches - Push on.

★14. Flight controls - Check first aircraft flight of day as follows:

a. Collective - Midposition, pedals centered.

b. BOOST switch - Press off. There will be a slight increase in collective and pedal forces. BOOST SERVO OFF caution light on. MASTER CAUTION light should be on.

c. Right SVO OFF switch - 1ST STG. No allowable stick jump. #1 PRI SERVO PRESS, and MASTER CAUTION light should be on.

d. Move cyclic and pedals slowly through full range. There should be no binds or restrictions. Move collective through full range in about 1 to 2 seconds. Check #2 PRI SERVO PRESS caution light does not illuminate during movement of collective.

e. Right SVO OFF switch - 2nd STG. No allowable stick jump. #2 PRI SERVO PRESS and MASTER CAUTION light should be on.

f. Repeat step d. above. Check #1 PRI SERVO PRESS caution light does not illuminate during movement of collective.

**NOTE**

If #1 PRI SERVO PRESS or #2 PRI SERVO PRESS caution light illuminates during collective movement servo bypass valve may be jammed.

g. SVO OFF switch - Center.

**NOTE**

During steps h. and i., check for not more than 1.5 inches of freeplay in control.

h. Collective - Move through full range in no less than 5 seconds. There should be no binding.

i. Pedals - Move both pedals through the full range in no less than 5 seconds. There should be no binding.

j. TAIL SERVO switch - BACKUP. #1 TAIL RTR SERVO caution and both MASTER caution lights illuminate, #2 TAIL RTR SERVO ON advisory light illuminates, move pedals through full range in no less than 5 seconds. There should be no binding.

k. TAIL SERVO switch - NORMAL. Caution and advisory lights out.

l. BOOST switch - ON. BOOST SERVO caution light should be off.

★15. Stabilator - Check.

**NOTE**

For the purpose of this check, the right STAB POS indicator shall be used. The left STAB POS indicator may vary from right indicator as much as  $\pm 2^\circ$  throughout the check.

a. STAB POS indicator should be at  $34^\circ$  to  $42^\circ$  DN.

b. TEST button - Press and hold. Check STAB POS indicator moves up  $5^\circ$  to  $12^\circ$ . MASTER CAUTION and STABILATOR caution lights on; stabilator audio heard.

c. AUTO CONTROL RESET switch - Press ON. Note that the STABILATOR caution light and audio are off, and STAB POS indicator moves to  $34^\circ$  to  $42^\circ$  down.

d. Either cyclic slew-up switch - Press and hold until STAB POS indicator moves approximately  $15^\circ$  trailing edge up, release, stabilator should stop. STABILATOR and MASTER CAUTION lights ON and beeping audible warning in pilot's and copilot's headsets. MASTER CAUTION - Press to reset audio tone.

e. Other cyclic slew-up switch - Press and hold until STAB POS indicator moves approximately  $15^\circ$  trailing edge up, release, stabilator should stop.

f. MAN SLEW switch - UP and hold until stabilator stops. STAB POS indicator should be  $6^\circ$  to  $10^\circ$  up.

g. MAN SLEW switch - DN and hold until STAB POS indicator reads  $0^\circ$ .

h. AUTO CONTROL RESET switch - Press ON. STAB POS indicator should move  $34^\circ$  to  $42^\circ$  DN. STABILATOR caution light off.

**NOTE**

If any part of stabilator check fails, do not fly helicopter.

\*16. Avionics - ON.

\*17. COMPASS switch - SLAVED. Set as required.

18. Deleted.

19. Barometric altimeters - Set.

\*20. Cyclic and pedals centered. Collective raise no more than 1 inch (to prevent droop stop pounding) and friction.

21. BACKUP HYD PUMP switch - OFF.

O★22. Blade deice system - Test as required.

**CAUTION**

Do not perform blade deice test when blade erosion kit is installed.

**NOTE**

To prevent overheating of droop stops, blade deice test shall not be done more than one time within a 30-minute period when rotor head is not turning.

a. Ice rate meter PRESS TO TEST button - Press and release.

b. Ice rate meter indicator - Moves to half scale (1.0), holds about 50 seconds; then falls to 0 or below. ICE DETECTED and MASTER caution lights on after 15 - 20 seconds into the test, and FAIL flag should not be visible in flag window. Ice rate meter should move to zero within 75 seconds after pressing PRESS TO TEST button.

#### NOTE

PWR MAIN RTR, and PWR TAIL RTR fault monitor lights may flicker during tests in steps e. through r.

c. BLADE DE-ICE TEST panel select switch - NORM.

d. BLADE DE-ICE POWER switch - TEST.

e. PWR MAIN RTR and TAIL RTR monitor lights - Check. MAIN RTR monitor light may go on for 2 - 4 seconds. If either light remains on for 10 seconds or more:

(1) BLADE DE-ICE POWER switch - OFF. If either light is still on,

(2) GENERATORS APU switch and/or EXT PWR - OFF.

f. TEST IN PROGRESS light - Check. The light should be on for 105 to 135 seconds. No other blade de-ice system lights should be on. PWR MAIN RTR and TAIL RTR monitor lights should go on for 2 - 4 seconds near end of test. The TEST IN PROGRESS light should then go off.

#### WARNING

Droop stop hinge pins and cams may become very hot during test. Use care when touching those components.

g. Crewman touch each droop stop cam - Cams should be warm to touch.

h. BLADE DE-ICE POWER switch - OFF.

i. BLADE DE-ICE TEST select switch - SYNC 1.

j. BLADE DE-ICE POWER switch - TEST. MR DE-ICE FAIL and MASTER CAUTION lights on.

k. BLADE DE-ICE POWER switch - OFF. MR DE-ICE FAIL and MASTER CAUTION lights off.

l. BLADE DE-ICE TEST panel select switch - SYNC 2.

m. BLADE DE-ICE POWER switch - TEST. MR DE-ICE FAIL and MASTER CAUTION lights on.

n. BLADE DE-ICE POWER switch - OFF. MR DE-ICE FAIL and MASTER CAUTION lights off.

o. BLADE DE-ICE TEST SELECT switch - OAT.

p. BLADE DE-ICE POWER switch - TEST. MR DE-ICE FAIL, TR DE-ICE FAIL, and MASTER CAUTION lights on.

q. BLADE DE-ICE POWER switch - OFF. MR DE-ICE FAIL, TR DE-ICE FAIL, and MASTER CAUTION lights off.

23. Avionics - Check as required.

#### 8-22. STARTING ENGINES.

\*1. ENG FUEL SYS selector(s) - XFD for first start of day.

\*2. FUEL BOOST PUMP CONTROL switch(es) - As required. (ON when operating with JP-4 fuel.)

\*3. ENGINE IGNITION switch - ON.

\*4. GUST LOCK caution light - Off.

\*5. Fire guard - Posted if available.

\*6. Rotor blades - Check clear.

★\*7. Engine(s) - Start as follows:

#### CAUTION

If start is attempted with ENGINE IGNITION switch OFF, do not place switch ON. Complete EMER ENG SHUTDOWN procedure.

a. If any of these indications occur, perform EMER ENG SHUTDOWN as required.

- (1) No TGT increase (light off) within 45 seconds.
- (2) No ENG OIL PRESS within 45 seconds.
- (3) No % RPM 1 or 2 within 45 seconds.
- (4) ENGINE STARTER caution light goes off before reaching 52% Ng SPEED.
- (5) TGT reaches 850°C before idle is attained (Ng 63%).

**CAUTION**

To avoid damage to the engine start switch actuators, do not move the ENG POWER CONT lever from IDLE to OFF while pressing the starter button.

During engine start and runup ensure that cyclic is kept in neutral, collective no more than one inch above full down, and pedals centered until % RPM R reaches 50% minimum to prevent damage to anti-flap bracket bushings.

b. Starter button(s) - Press until Ng SPEED increases; release.

**NOTE**

If an ENGINE STARTER CAUTION light goes off when the starter button is released, and the ENG POWER CONT lever is OFF, the start attempt may be continued by pressing and holding the starter button until 52% - 65% Ng SPEED is reached; then release button.

- c. TGT - Check below 150°C **700** or 80°C **701C** before advancing ENG POWER CONT levers.
- d. ENG POWER CONT lever(s) - IDLE. Start clock.
- e. System indications - Check.

f. ENGINE STARTER caution light(s). Check, OFF at 52% - 65% Ng SPEED. If ENGINE STARTER caution light remains on after 65% Ng.

(1) ENG POWER CONT lever - Pull out.

If caution light remains on:

(2) APU - OFF or engine air source remove as required.

\*8. If single-engine start was made, repeat step 7 for other engine.

\*9. Systems - Check.

- a. Ng SPEEDS 63% or more.
- b. % RPM - Check that % RPM 1 or 2 is not in the range of 20% to 40% and 60% to 90%. Advance ENG POWER CONT lever(s) as required.
- c. XMSN PRESS - Check.
- d. ENG OIL PRESS - Check.
- e. #1 and #2 HYD PUMP caution lights - Check off.

\*10. BACKUP HYD PUMP switch - AUTO.

★ 11. Hydraulic leak test system - Check as follows:

**NOTE**

It is normal for the IINS CDU screen to blank momentarily during the Hydraulic Leak Test system check. **EH**

**NOTE**

When performing the HYD LEAK TEST, all Leak detection/isolation system components are checked electrically. Manually holding the HYD LEAK TEST switch in the test position does not allow the Leak detection/isolation system to be checked automatically. It manually holds the circuits open. The switch must be placed in the TEST position and released.

a. HYD LEAK TEST switch - TEST. #1 TAIL RTR SERVO, BOOST SERVO OFF, SAS OFF, #1 and #2 RSVR LOW, BACK-UP RSVR LOW, and MASTER CAUTION lights and #2 TAIL RTR SERVO ON and BACK-UP PUMP ON advisory lights on. During this check, it is normal for the collective and pedals to move slightly.

b. HYD LEAK TEST switch - RESET. The lights in step a. should go off.

#### NOTE

If the backup pump is still running following the hydraulic leak test, cycle the BACKUP HYD PUMP switch to OFF then back to AUTO.

#### ★12. Tail Rotor Servo Transfer - Check.

a. BACKUP HYD PUMP switch - AUTO with backup pump not running.

b. TAIL SERVO - BACKUP. #1 TAIL RTR SERVO caution light on and #2 TAIL RTR SERVO ON and BACK-UP PUMP ON advisory lights on within 3 to 5 seconds.

c. TAIL SERVO switch - NORMAL. #1 TAIL RTR SERVO caution light and #2 TAIL RTR SERVO ON advisory light off. BACK-UP PUMP ON advisory light remains on for approximately 90 seconds for single accumulator and 180 seconds for dual accumulators.

#### O 13. AUX CABIN HEATER switches - Desired.

#### NOTE

Cabin temperature must be below 29°C (84°F) for heat to go on, and above 10°C (50°F) for the heater to shut off.

★14. Engine warmup - Check if temperature is below -17°C (2°F).

#### 8-23. ENGINE RUNUP.

\*1. Flight controls - Hold.

#### CAUTION

Restrict the rate of ENG POWER CONT lever's movement, when the tailwheel

lockpin is not engaged. Rapid application of ENG POWER CONT levers can result in turning the helicopter.

\*2. ENG POWER CONT lever(s) - FLY.

\*3. Droop stops - Check out 70% to 75% RPM R.

\*4. #1 and #2 GEN caution lights - Off.

#### CAUTION

During operation of the air conditioner system, the right cabin door should remain closed. If opening is required, the right cabin door should not remain open for more than 1 minute. **EH**

\*4.1. ECS Panel switches - As desired. **EH**

#### NOTE

ECS heater will operate with either backup pump or windshield anti-ice operating, but not with both at same time.

O★5. DE-ICE EOT - Check as required.

#### CAUTION

In ambient temperatures above 21°C (70°F), operate rotor at 100% RPM R for 5 minutes before doing the deice EOT check, to prevent blade overheating. Do not do the deice EOT check if FAT is above 38°C (100°F).

a. BLADE DE-ICE TEST select switch - EOT.

b. BLADE DE-ICE MODE select switch - MANUAL M.

c. BLADE DEICE POWER switch - ON.

d. TR DE-ICE FAIL and MASTER CAUTION lights on after 15 to 30 seconds, and MR DE-ICE FAIL caution light on after 50 to 70 seconds.

e. BLADE DEICE POWER switch - OFF. TR DE-ICE FAIL, MR DE-ICE FAIL, and MASTER CAUTION lights off.

f. BLADE DE-ICE TEST select switch - NORM.

**NOTE**

If helicopter engine was started using external air source and/or external ac power, the APU must be started to do APU generator backup check.

g. NO. 1 or NO. 2 GENERATORS switch - OFF. Applicable GEN and MASTER CAUTION lights on.

h. BLADE DE-ICE POWER switch - ON. Wait 30 seconds; no deice lights on.

i. GENERATORS switch(es) - ON. Applicable GEN caution light(s) off.

j. BLADE DE-ICE POWER switch - OFF.

k. BLADE DE-ICE MODE select switch - AUTO.

\*6. % TRQ 1 and 2 - Matched within 5%.

\*7. Q/F PWR switch - As desired. **EH**

\*8. FUEL PUMP switch - OFF.

\*9. APU CONTR switch - OFF.

\*10. AIR SOURCE HEAT/START switch - As required.

\*11. ENG FUEL SYS selector - As required.

\*12. SAS1 - ON.

\*13. Collective friction - As required.

**NOTE**

A slight amount of collective friction (approximately 3 pounds) should be used to prevent pilot induced collective oscillations.

O \*14. IINS NAVRDY light flashing - CDU mode select switch to NAV. **EH**

O \*15. IINS SYSTEM SELECT switches - IINS. **EH**

**WARNING**

Engine anti-ice bleed and start valve malfunction can cause engine flameout.

16. Engine Health Indicator Test (HIT)/Anti-Icing Check - Accomplish. Refer to ENGINE HEALTH INDICATOR TEST/ANTI-ICE CHECK IN HELICOPTER LOG BOOK. HIT/ANTI-ICE checks while operating in adverse conditions (e.g., dust, desert, coastal beach area, dry river beds) may be deferred (maximum of 5 flight hours) until a suitable location is reached.

O ★ 17. External extended range fuel transfer - Check. **ES**

**8-24. BEFORE TAXI.**

O \*1. Ejector rack lock levers unlocked and safety pins removed. **ES**

O \*2. Chaff, **EH** flare electronic module(s) safety pin(s) - Remove.

\*3. Chocks - Removed.

\*4. Doors - Secure.

\*5. PARKING BRAKE - Release.

\*6. TAIL WHEEL switch - As required.

**8-25. GROUND TAXI.**

**CAUTION**

When performing these maneuvers, cyclic inputs should be minimized to prevent droop-stop pounding.

Forward Taxiing. Increase collective and place cyclic forward of neutral to start forward movement. Minimize forward cyclic movement to prevent droop stop pounding. Reduce collective to minimum required to maintain forward movement. Soft or rough terrain may require additional collective pitch. The use of excessive collective pitch during taxi, especially at light gross weights, can cause the tailwheel to bounce. Regulate taxi speed with cyclic and collective and control heading with pedals. Use brakes as required.

## 8-26. HOVER CHECK.

1. Systems - Check caution/advisory panel, CDU and PDU(s) for normal indication.
2. Flight instruments - Check as required.
3. Power - Check. The power check is done by comparing the indicated torque required to hover with the predicted values from performance charts in Chapter 7.

## 8-27. BEFORE TAKEOFF.

### WARNING

Pitot heat and anti-ice will be on during operations in visible moisture with ambient temperature of 4°C and below.

- \*1. ENG POWER CONT levers - FLY.
- \*2. Systems - Check.
- \*3. Avionics - As required.
- \*4. Crew, passengers, and mission equipment - Check.

## 8-28. TAKEOFF.

### NOTE

If the stabilator has not begun trailing edge up movement by 50 KIAS, abort the takeoff.

a. Align the helicopter with the desired takeoff course at a stabilized 10-foot hover (wheel height) or, an altitude permitting safe obstacle clearance. Increase collective pitch approximately 10% above hover torque, but not to exceed aircraft limitations, and apply forward cyclic to maintain desired angle of climb. Simultaneously, adjust pedal pressure as necessary to maintain desired heading. Adjust power for desired rate of climb and trim helicopter as required.

b. Refer to the height-velocity diagram, Figure 9-2, for avoid areas. Since suitable landing areas are often not available, operating outside avoid areas during takeoff and climb will provide the highest margin of safety.

## 8-29. MAXIMUM PERFORMANCE.

A takeoff that demands maximum performance from the helicopter may be necessary because of various combinations of heavy helicopter loads, limited power and restricted performance due to high density altitudes, barriers or terrain features that must be cleared. The decision to use the following takeoff techniques must be based on an evaluation of the conditions and helicopter performance. The copilot should assist the pilot by monitoring TGT to assess proximity to TGT limits and should advise the pilot when approaching the TGT limits.

a. Coordinated climb. Align the helicopter with the desired takeoff course at a stabilized hover of about 10 feet (wheel height). Apply forward cyclic pressure smoothly and gradually, while simultaneously increasing collective pitch, begin a coordinated acceleration climb. Adjust pedal pressure as necessary to maintain the desired heading. Maximum torque available should be applied (without exceeding helicopter limits) as the helicopter attitude is established that will permit safe obstacle clearance. The climbout is continued at the attitude and power setting until the obstacle is cleared. After the obstacle is cleared, adjust helicopter attitude and collective pitch as required to establish a climb at the desired rate and airspeed. Continuous coordinated application of control pressures is necessary to maintain trim, heading, flight path, airspeed, and rate of climb. This technique is desirable when OGE hover capability exists. Takeoff may be made from the ground by positioning the cyclic slightly forward of neutral prior to increasing collective pitch.

b. Level acceleration/obstacle clearance takeoff.

(1) This procedure is intended for use when a takeoff *must* be made under conditions when hover capability is limited. Prior to attempting a level acceleration/obstacle clearance takeoff, thorough performance planning must be accomplished to ensure that adequate distance is available to clear any obstacles in the takeoff path. To ensure that a successful takeoff can be performed within the obstacle clearance distances presented in Figure 7-10, all takeoffs must be initiated from 5 feet, regardless of hover capability.

(2) Once it has been determined that a level acceleration/obstacle clearance takeoff is required and that sufficient distance is available to clear any obstacles, the following procedure shall be used.



## 8-32. LANDING.

**CAUTION**

During roll-on landing aerodynamic braking with aft cyclic is permitted with the tail wheel contacting the ground. Once the main wheels touchdown, the cyclic must be centered prior to reducing collective. Excessive aft cyclic may cause droop stop pounding and contact between main rotor blades and other portions of the aircraft. Aerodynamic braking is prohibited once the main landing gear touches down. Use brakes to stop the aircraft.

**NOTE**

Because of the flat profile of the main transmission, pitching the helicopter nose up as in hover, may cause a transient drop in indicated main transmission oil pressure, depending on degree of nose-up attitude.

a. Roll-on landing. A roll-on landing may be used when the helicopter will not sustain a hover, to avoid hovering in snow or dust, or if tail rotor control is lost.

**CAUTION**

When landing the EH-60A in a nose downslope configuration, exercise extreme caution to prevent the main rotor blades from contacting the aft DF antennas. When the main wheels contact the ground, center the cyclic prior to reducing collective. The cyclic should be centered before the collective is placed in full down to prevent possible rotor/airframe contact. If droop stop contact is felt prior to the main wheels touching the ground, abort landing attempt. **EH**

b. Slope landing. The tailwheel should be locked and the parking brake should be set. For slope landings and all ground operations, avoid using combinations of excessive cyclic and low collective settings. Where minimum collective is used, maintain cyclic near neutral position and avoid abrupt cyclic inputs. During nose-down slope landings, low-frequency oscillations may be eliminated by moving cyclic toward neutral and lowering collective.

## 8-33. AFTER LANDING CHECK.

1. TAIL WHEEL switch - As required.
2. Exterior lights - As required.
3. Avionics/mission equipment - As required.

## 8-34. PARKING AND SHUTDOWN.

1. TAIL WHEEL switch - As required.
2. PARKING BRAKE - Set.
3. Landing gear - Chocked.
- O 4. Ejector rack locking levers - Locked and safety pins installed. **ES**
- O 5. Chaff, **EH** flare electronic module safety pin(s) - Install.
- EH** 5.1. IINS SYSEM SELECT switches - DG/VG.
- O 6. IINS - OFF. **EH**
- O 7. ECS panel switches - OFF. **EH**
8. SAS 1 - Off.

9. DE-ICE, PITOT, ANTI-ICE, **EH** Q/F PWR, and HEATER switches - OFF.

10. AIR SOURCE HEAT/START switch - APU.

11. FUEL PUMP switch - APU BOOST.

12. APU CONTR switch - ON. The APU ON, BACKUP PUMP ON, and APU ACCUM LOW advisory lights - ON.

**NOTE**

If external electrical power is required for shutdown, it shall be connected and EXT PWR switch placed to reset; then ON. If external ac power is not available, complete normal shutdown on right engine before continuing.

13. Collective raise no more than 1 inch.

14. Flight controls - Hold.

**CAUTION**

During shutdown ensure that cyclic is kept in neutral or displaced slightly into prevailing wind, collective no more than one inch above full down and pedals centered.

Restrict the rate of ENG POWER CONT lever's movement, when the tailwheel lockpin is not engaged. Abrupt application of ENG POWER CONT levers can result in turning the helicopter.

15. ENG POWER CONT levers - IDLE.

16. ENGINE IGNITION switch - OFF.

17. Cyclic - As required to prevent anti-flap pounding.

18. Droop stops - Verify in, about 50% RPM R. If one or more droop stops do not go in during rotor shutdown, accelerate rotor to above 75% RPM R. Repeat rotor shutdown procedures, slightly displacing cyclic in an attempt to dislodge jammed droop stop. If droop stops still do not go in, make certain that rotor disc area is clear of personnel and proceed with normal shutdown procedures while keeping cyclic in neutral.

**CAUTION**

To prevent damage to anti-flap stops, do not increase collective pitch at any time during rotor coast-down.

19. BACKUP HYD PUMP switch - OFF.

20. Stabilator - Slew to 0° after last flight of the day.

21. BACK-UP PUMP ON advisory light - Check off.

**CAUTION**

Before moving ENG POWER CONT lever OFF, engine must be cooled for 2 minutes at an Ng SPEED of 90% or less. If an engine is shut down from a high power setting (above 90%) without being cooled for 2 minutes, and it is necessary to restart the engine, the restart should be done within 5 minutes after shutdown. If the restart can not be done within 5 minutes, the engine should be allowed to cool for 4 hours before attempting an engine restart.

22. ENG POWER CONT levers - OFF after 2 minutes at Ng speed of 90% or less.

23. ENG FUEL SYS selector - OFF.

○ 24. AUX CABIN HEATER - OFF.

25. TGT - Monitor. If TGT rises above 538°C:

a. Start button - Press.

b. ENG POWER CONT lever(s) - Pull after TGT is below 538°C.

26. DEC torque indicator fault code - CHECK.

**701C**

27. Avionics - OFF.

○ 28. FUEL BOOST NO. 1 and NO. 2 PUMP switch(es) - OFF.

29. Overhead switches - As required:

a. ANTICOLLISION/POSITION LIGHTS.

- b. Left panel light controls.
  - c. WINDSHIELD WIPER.
  - d. VENT BLOWER - OFF.
  - e. Right panel light controls.
- 30. GENERATORS APU - OFF.
  - 31. FUEL PUMP - OFF.
  - 32. APU CONTR - OFF.

33. BATT - OFF.

#### 8-35. BEFORE LEAVING HELICOPTER.

1. Walkaround - Complete; checking for damage, fluid leaks and levels.
2. Mission equipment - Secure.
3. Complete DA Form 2408-12 and -13.
4. Secure helicopter - As required.

### Section III INSTRUMENT FLIGHT

#### 8-36. INSTRUMENT FLIGHT.

Refer to FM 1-240 for instrument flying and navigation techniques.

8-37. Deleted.

### Section IV FLIGHT CHARACTERISTICS

#### 8-38. GENERAL.

Refer to FM 1-203 Fundamentals of Flight for explanation of aerodynamic flight characteristics.

The safe maximum operating airspeed range is described in Chapter 5. While hovering in high wind, sideward and rearward flight should be limited to low ground speeds. The helicopter is directionally stable in forward flight. In sideward and rearward flight, directional control is more difficult. During approach, or slow flight as the airspeed reaches about 17 to 20 KIAS, a mild vibration will be felt.

#### 8-39. GROUND RESONANCE.

Ground resonance is a self-excited vibration created when a coupling interaction occurs between the movement of the main rotor blades and the helicopter. For this to happen, there must be some abnormal lead/lag blade condition which would dynamically unbalance the rotor and a reaction between the helicopter and ground, which could aggravate and further unbalance the rotor. Ground resonance can be caused by a blade being badly out of track, a malfunctioning damper, or a peculiar set of landing conditions. Ground resonance may occur when a wheel reaction aggravates an

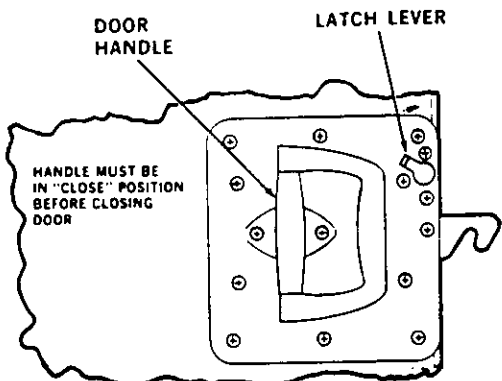

**CABIN DOOR  
INTERIOR RELEASE HANDLE**  
VIEW LOOKING OUTBOARD  
LEFT SIDE  
(SAME FOR RIGHT SIDE)

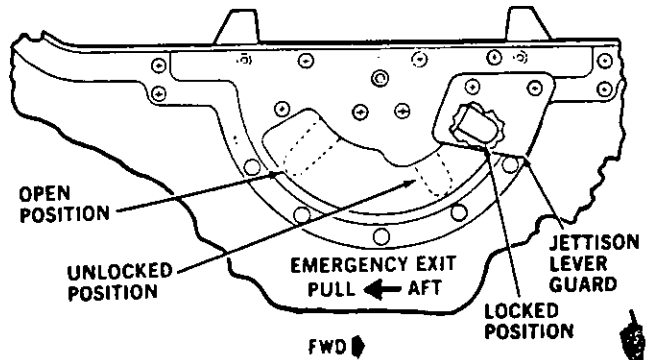

**CABIN DOOR WINDOW JETTISON LEVER**  
VIEW LOOKING OUTBOARD  
LEFT SIDE  
(RIGHT SIDE PULL → FWD)

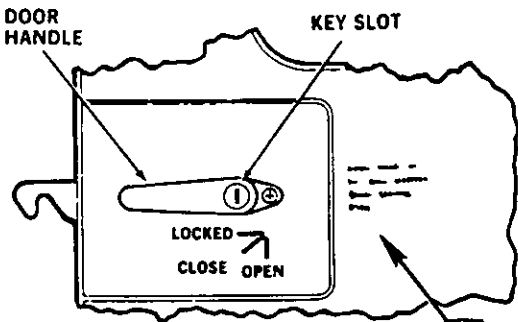

**CABIN DOOR  
EXTERIOR RELEASE HANDLE**  
VIEW LOOKING INBOARD  
LEFT SIDE  
(SAME FOR RIGHT SIDE)

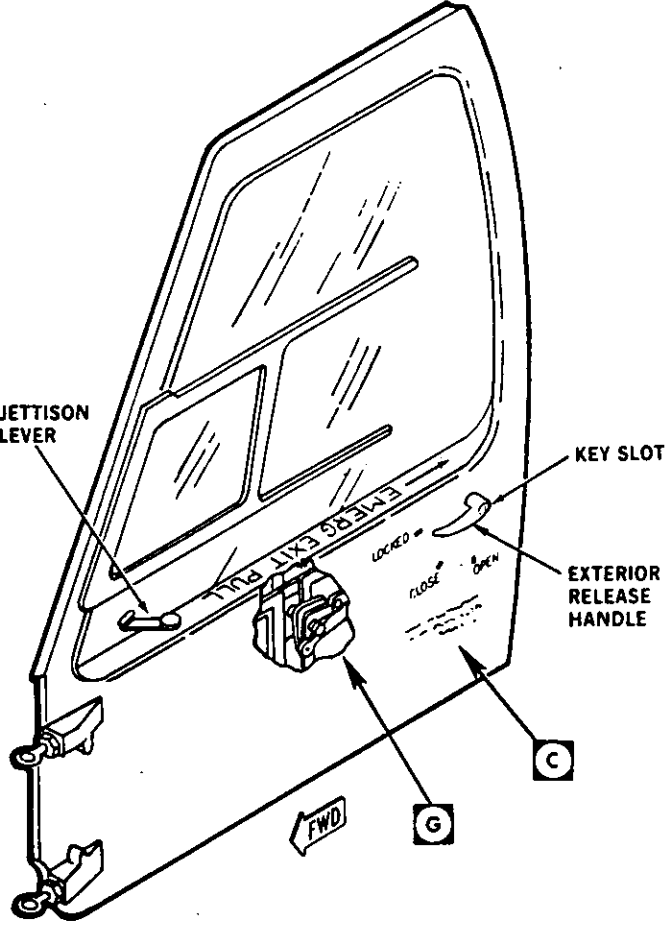

**COCKPIT DOOR  
INTERIOR JETTISON LEVER**  
VIEW LOOKING INBOARD  
LEFT SIDE  
(SAME FOR RIGHT SIDE)

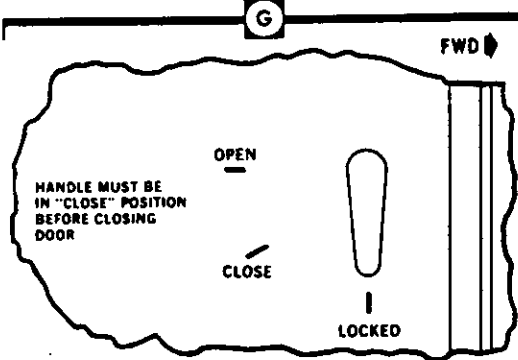

**INTERIOR COCKPIT DOOR RELEASE  
HANDLE**  
VIEW LOOKING OUTBOARD  
LEFT SIDE  
(SAME FOR RIGHT SIDE)

S 45332.2 (BH2)

Figure 9-1. Emergency Exits and Emergency Equipment Diagram (Sheet 2 of 2)

1911

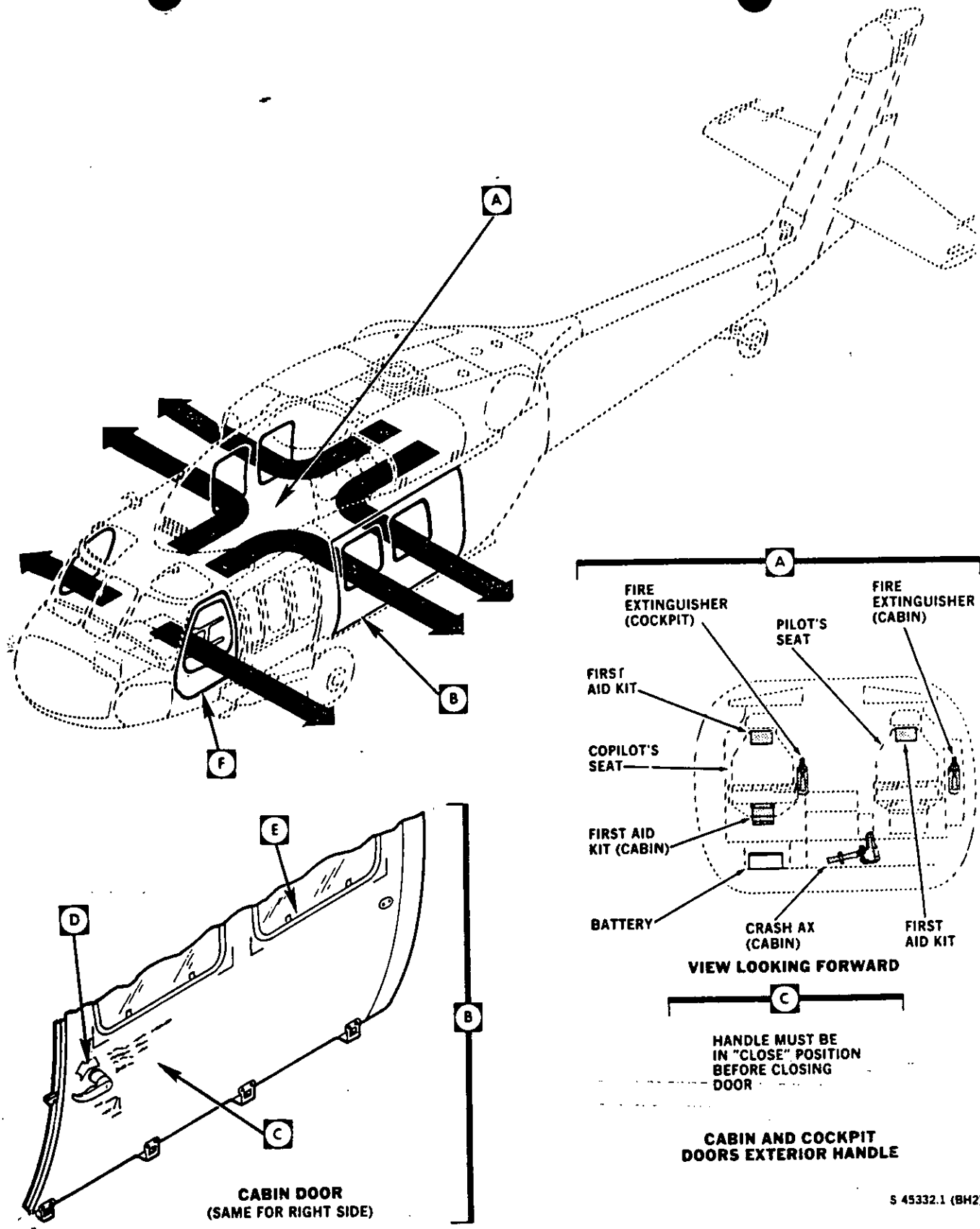

Figure 9-1. Emergency Exits and Emergency Equipment Diagram (Sheet 1 of 2)

S 45332.1 (BH2)

**TAB AA**

**REGULATIONS AND DIRECTIVES**

- AA-9 Extracts from OPC II Command and Control Guidance  
(USCINCEUR OPORDs 002, 003, 004, CTF OPLAN 91-7)  
(See also Classified Addendum)**
- AA-10 Extracts from DA Technical Manual 55-1520-237-10, Operator's  
Manual UH-60A and EH-60A Helicopters**
- AA-11 Eagle Flight Detachment, Standard Flight Operating Procedures**
- AA-12 Eagle Flight Detachment Operations Order 92-01**
- AA-13 Extract from AFP 110-34, Commander's Handbook on The Law  
of Armed Conflict**
- AA-14 Extract From Mission Control Center Standard Operating  
Procedures, Headquarters Combined Task Force**
- AA-15 Extract from Army Regulation 95-1, Aviation, Flight Regulation**
- AA-16 Headquarters Combined Task Force Memorandum for CFACC  
Commander, Military Coordination Center, UH-60 Flight Policy,**

**AA-9**

**AA10**

**AA-11**

EAGLE FLIGHT DETACHMENT  
STANDARD FLIGHT OPERATING PROCEDURES

PURPOSE: To establish an SOP for the intended use of aircrew members flying missions in support of the Combined Task Force Military Coordination Center (MCC).

REFERENCES:

- a. AR 95-1
- b. USAREUR 95-1
- c. AIRSPACE CONTROL ORDER (ACO)
- d. AIR TASKING ORDER / SPINS
- e. TC 1-201
- f. TC 1-212
- g. GENERAL PLANNING
- h. AREA PLANNING

NOTE: Nothing in these procedures will be construed as limiting the on site commander or senior individual from taking whatever actions necessary to cope with a tactical emergency, or a self defense requirement.

APPENDIX A. FLIGHT PLANS

1. Form 66 (flight plan) will be filed with the YAMAHA (FOD) guard. If takeoff is delayed for more than 15 minutes past filed takeoff time, then a new flight plan must be filed. In addition, the CTF line number must also be updated. This is done by calling Eagle Operations and having them notify the JOC of the new takeoff time.

APPENDIX B. DEPARTURE & ARRIVAL PROCEDURES FROM LTCC

1. Aircraft will contact tower on 122.1 prior to engine start. In many cases there is a "problem" with the flight plan. This may be resolved by calling Eagle's Nest and asking the Turkish LNO to call the tower or by having Eagle Ops call the JOC. A request to start your engine for maintenance checks may be granted pending approval of the flight plan.
2. Minimize hovering on the American ramp and avoid hovering over the grassy sod areas. The Turks are very sensitive about FOD being blown onto the runway or taxi-way. Utilize a steeper than normal take-off and approach angle. If the ramp is congested use the taxi-way. Use the runway only in emergency situations.

PAGE 1

**CERTIFICATE**

I certify that I am the Records Custodian for the Accident Investigation Board convened to investigate the crash of two U.S. Army Black Hawk helicopters in the no fly zone in northern Iraq on 14 April 1994, and that this is a true and accurate copy of the record which is kept in my records system.

*12 May 94*  
Date

*William L. Harris*  
WILLIAM L. HARRIS, Capt, USAF, MSC  
Evidence Custodian, Incirlik Air Base, Turkey

3. Climb to and maintain 3,000 ft MSL until 25 miles east of LTCC. Contact Eagle Ops with the take-off time. Establish initial contact with Cougar (AWACS) after departure and update gate time if necessary.
4. OUTBOUND: Contact LTCC tower for frequency change 25 miles east of LTCC. Frequency change to Batman tower and begin a climb to the appropriate cruise altitude.
5. INBOUND: Contact Batman tower 25 miles to the east at FL 085. Request a descent to arrive at 3,000 ft MSL, 25 miles east of LTCC. Contact LTCC tower 25 miles east.
6. Notify Eagle Ops 30 minutes prior to arrival.
7. Frequency change with Cougar when approximately 5 miles from LTCC.
8. Notify Eagle Ops when landing assured at LTCC.

#### APPENDIX C. FLIGHT ROUTE

1. The route LLTR 1,2,3,4, Zakhu will be flown. The route is 10 NM wide and will be flown as close to 6,000 ft AGL as possible using the semicircular altitude rule. Altitude to Zakho will be flown at FL 075, return route will be flown at FL 085. The transition altitude is 5,000 ft unless you are within 50 NM of LTCC, then it is 7,000 ft. If weather precludes flight at the published altitudes, notify AWACS or appropriate tower with intentions.
2. Try to contact Arrow Base approximately 20 minutes out on 141.8 VHF. Zakho should notify you if there are any changes or essential information. In normal operation the LZ will be Texaco.
3. All ASE equipment will be on and operational throughout all flights.
4. All aircraft in the flight except lead will place Mode 3A/C in the out position on the transponder unless separated from the flight.
5. Prior to crossing the Iraq border lead will turn off mode 3A/C on the transponder, trail will turn off the anti-collision light, and trail will contact AWACS with the code word for crossing into the TAOR. See Airspace Control Order for border crossing instructions. (ACO)



6. Upon arrival at landing site notify AWACS and request a return gate time, if applicable. If the aircraft are to be shutdown, advise AWACS that you will be on the ground for an indefinite amount of time. A return gate time may be requested through Arrow Base along with an update on weather if required.
7. Flight follow with AWACS while in the TAOR using the Eagle Flight checkpoints (Alpha through Xray). i.e. Eagle is off Whiskey enroute to Sierra.
8. Prior to departing Zakho for the return to LTCC, update your gate time and weather if applicable. Upon departure notify AWACS that you are off Whiskey enroute to LTCC, also transmit the appropriate code word when exiting the TAOR. At the border lead will turn on its mode 3A/C on the transponder, trail will turn on its anti-collision light.

#### APPENDIX D. AIRSPACE CONTROL

1. All flights will follow the procedures outlined in the most current Special Information Notices (SPINS).
2. Daily Air Tasking Order will be reviewed prior to conducting missions and changes to the weekly SPINS noted if applicable and followed.
3. Aircraft will utilize the published Low-Level Transit Routes (LLTR's) or Special Corridors (SC's) as published in the current Airspace Control Order / standing SPINS for flights into and out of the TAOR (Tactical Area Of Responsibility).
4. Mission numbers and transponder codes will be extracted from the daily ATO.
5. Low level flight on the LLTR is not authorized. Minimum enroute altitude is 4500 ft AGL in Turkey. Deviations due to weather are not authorized. If the ceiling is too low, the mission is aborted.

#### APPENDIX E. FLIGHT FOLLOWING

1. Operations will maintain a flight log and the supported unit will maintain a passenger manifest for all flights.
2. All aircraft will flight follow with one of the following:
  - a. ATC
  - b. AWACS
  - c. Another aircraft within the flight
3. When unable to flight follow because single ship operations, and no AWACS coverage:
  - a. Aircrews will follow the route filed on your flight plan in accordance with the most current ACO.
  - b. Remain within 5 (five) nautical miles right or left of the course center line.
  - c. If unable to flight follow enroute, contact Eagle Ops when in radio range. Pass them your arrival or departure time as applicable.
  - d. If you have to land enroute due to maintenance or otherwise, set up TACSAT and contact any available station.
4. No aircraft will conduct single ship operations into Iraq beyond Zakho without authorization from the Eagle Flight detachment commander.

#### APPENDIX F. WEATHER REQUIREMENTS

1. Aviators will use the VFR weather requirements contained in USAREUR 95-1. The area of operation is a designated mountainous area.
2. IFR minimums will be IAW current regulations, i.e. AR 95-1.
3. All night US Army flights, aided or unaided will use night mountainous minimums of 1000 ft ceilings and 1600 meters visibility.

4. Initial weather forecast is obtained from Incirlik (LTAG). Forecast can be put on request the night before to be ready the next morning. After the initial brief, the forecast can be updated by calling (676-6878/6880) or have Eagle Ops call and update the brief.

NOTE: USAREUR reg 95-1 weather applies to this operation. If you do not have 500 ft ceilings and 800 meters visibility, the mission is aborted or put on a weather hold. No one but DA has waiver authority for the weather minimums.

#### APPENDIX G. INADVERTENT IMC

1. Climb on the heading being flown, turning to avoid known obstacles. Turn to a heading of 300 degrees, modifying heading if necessary to avoid the Syrian border.
2. Climb to a recommended minimum altitude of 10,000 ft MSL if west of Zakho. If east of Zakhu, climb initially to a recommended minimum altitude of 12,000 ft MSL, reducing altitude to 10,000 ft MSL if desired when west of Zakho.
3. Contact AWACS on GUARD to declare an emergency. If unable, broadcast a Mayday call on GUARD (243.00) or (121.5) VHF and request assistance. Mardin Radar (India) is another option. See ATD for frequencies.
4. Set transponder Mode 3 to 7700.
5. Fuel permitting, return to LTCC and execute an authorized instrument approach.
6. Formation flights will comply with prebriefed formation breakup procedures.

#### APPENDIX H. ARRIVAL & DEPARTURE FROM PIRINCLIK HELO-PAD

1. A 3km radius has been established around Pirinclik proper. This is to be considered a "restricted" area for Eagle Flight Detachment aircraft.
2. All Eagle Flight aircraft wishing to conduct operations within this 3km area are required to receive confirmation from Eagle Flight Operations that "BETTY" is not active and will remain inactive until all aircraft operations are completed.

3. All arrival and departures will proceed to the holding area located at BG 9750 9700 5km east of Pirinclik. Aircraft arriving at this point and not yet in contact with Eagle Operations will not proceed any closer to Pirinclik until confirmation has been received that "BETTY" is not active.

#### APPENDIX I. GATE TIMES & COORDINATION ALTITUDES

1. Gate times MUST be coordinated prior to crossing the border. The initial gate time will be coordinated through Eagle Ops prior to takeoff. A return gate can be requested through AWACS or <sup>Approval</sup> ~~Maverick~~ Base. You must cross the gate 15 minutes <sup>known</sup> either side of the gate time. Give either AWACS or ~~Maverick~~ Base sufficient time to coordinate.
2. Helicopters will operate below 400 ft AGL while in the TAOR. You must coordinate with AWACS if you want higher. Jet aircraft will operate down to the coordination altitude and the possibility exists for a mid-air collision.

\*NOTE\* When crossing ridgelines and mountains you do not need approval from AWACS.

#### APPENDIX J. BUFFER ZONES

1. A 5 NM buffer zone exists between Turkey and Syria. A 10 NM buffer zone exists between Iraq and the Iranian border. A 5NM buffer zone exists between Turkey and Iraq.

#### APPENDIX K. TURKISH OFFICER REQUIREMENTS (LNO's)

1. A Turkish officer will be on board each Eagle aircraft on missions in Turkey and Iraq. (Including NVG training flights) NO Turkish officer -NO FLIGHT !!!!

#### APPENDIX L. EXTENDED RANGE FUEL SYSTEM OPNS (ERFS) (ESSS)

1. You must always know your FFC information and ESSS limitations. You are flying aircraft at maximum gross weights in mountainous terrain. DO NOT THINK you can do one FFC when you first get here and think that it will suffice for your 60 day rotation. ETF's and ATF's change with each aircraft and mission parameters change daily. KNOW YOUR LIMITATIONS !!!!!

APPENDIX M. DOWNED AIRCREW SAR PROCEDURES

1. The following information pertains to aircrew members of Eagle Flight Detachment participating in Operation Provide Comfort.
2. Special Instructions (SPINS) for downed aircrews, blood chits, downed aviator/crew pickup points, PRC-112 survival radios, NVGs, and a KYK-13 will be issued and signed for on a daily basis from Eagle Operations. The SPINS contain detailed information regarding crewmember procedures and policies from the time the aircraft lands through recovery by the appropriate Emergency Action Cell (ie. Eagle Flight, JSOTF, etc.).
3. In the event an Eagle aircraft goes down and it is deemed necessary to evade the downed aircraft position, the following items should be either taken, destroyed, or changed, time and/or situation permitting:

TAKE

DESTROY/CHANGE

- |                          |                        |
|--------------------------|------------------------|
| a. Maps                  | a. IFF/XPNDR Codes     |
| b. GPS                   | b. Radio Frequencies   |
| c. TACSAT                | c. Doppler Coordinates |
| d. SPINS/Blood Chit Pkg. | d. Zeroize KY-58s      |
| e. Survival Gear         | e. APR-39 Data Card    |
| f. Weapons               | f. ALO-144 Emitter     |

4. All detailed SAR information to include the SAR SOP is located in the Eagle Operations safe. See Eagle Flight Operations personnel for access.

BOTTOM LINE: NOTHING PRECLUDES A PILOT/CREWMEMBER FROM ABORTING THE MISSION IF CONDITIONS ARE NOT RIGHT TO SAFELY CONDUCT THE MISSION IN VMC CONDITIONS. DO NOT PRESS ANY RESTRICTIONS SINCE WE ARE IN PEACETIME CONDITIONS AND WE CAN RETURN LATER TO COMPLETE THE TASKING. IF IT DOESN'T LOOK RIGHT OR FEEL RIGHT -----ABORT THE MISSION. FLY SMART !!!!!

**TAB AA**

**REGULATIONS AND DIRECTIVES**

**AA-9 Extracts from OPC II Command and Control Guidance  
(USCINCEUR OPORDs 002, 003, 004, CTF OPLAN 91-7)  
(See also Classified Addendum)**

**AA-10 Extracts from DA Technical Manual 55-1520-237-10, Operator's  
Manual UH-60A and EH-60A Helicopters**

**AA-11 Eagle Flight Detachment, Standard Flight Operating Procedures**

**AA-12 Eagle Flight Detachment Operations Order 92-01**

**AA-13 Extract from AFP 110-34, Commander's Handbook on The Law  
of Armed Conflict**

**AA-14 Extract From Mission Control Center Standard Operating  
Procedures, Headquarters Combined Task Force**

**AA-15 Extract from Army Regulation 95-1, Aviation, Flight Regulation**

**AA-16 Headquarters Combined Task Force Memorandum for CFACC  
Commander, Military Coordination Center, UH-60 Flight Policy,**

**AA-9**

**AA10**

**AA-11**

**AA-12**

Operation Order, Eagle Flight Detachment #92-01

References:

- a. Joint Operations Graphic (Air), 1:250,000
- b. Maps NJ 37-11, NJ 37-12, NJ 38-9, NJ 38-10, NJ 38-13, NJ 38-14, NI 38-1, NI 38-2, NI 38-3

Time Zone used throughout the plan: Zulu

Task Organization

EAGLE FLIGHT DETACHMENT  
HHC (-)  
5-158 AVN (-)  
C 6-159 AVN (-)  
B 7-159 AVN (-)

EXTRACT	
I certify that I am the Records Custodian for the Accident Investigation Board convened to investigate the crash of two U.S. Army Black Hawk helicopters in the no fly zone in northern Iraq on 14 April 1994, and that this is a true and accurate extract from	
<u>12th Avn Bde (FOR), Eagle FH Det 92-01, Draft</u>	
which is kept in my records system.	
<u>15 Nov 92</u>	WILLIAM L. HARRIS, Capt, USAF, MSC
Date	Evidence Custodian, Incirlik Air Base, Turkey

1. Situation:

Operation Provide Comfort Humanitarian relief efforts have proven successful and the requirement for continued presence inside the security zone of Northern Iraq is still needed. The Military Coordination Center (MCC) will continue meetings with faction groups within Iraq for the purpose of maintaining peace and order within the region. Eagle Flight Detachment continues the mission of air transportation of the MCC Liaison team throughout the region and crucial resupply into Zakho, Iraq. Eagle Flight Detachment continues to operate the detachment from Diyarbakir Air Base.

- a. Enemy Forces: Eagle Flight Annex B (Intelligence)
- b. Friendly Forces:
  - (1) Higher: Participating Nations provide personnel, equipment, and supplies in support of Combined Task Force (CTF) Provide Comfort residual force operations.
  - (2) Supporting: USCINCENT, USCINSPACE, USCINCFOR, USCINTRANS, USCINCSOC, and USCINCLANT are supporting US Commands.
- c. Attachments and Detachments: B 7-159 AVN (-)
- d. Assumptions:
  - (1) Adequate Turkish AF support is available on site for air mission requirements; weather support, flight planning, ATC, and navigational aids.
  - (2) Close air support is available for all cross border flights.
  - (3) AWACS support is available for all cross border flights.

(4) On-site security elements are sufficient for protection of personnel and equipment.

(5) Engineer support is available for required construction for personnel and equipment needs.

(6) Mission will receive search and rescue priority.

## 2. Mission:

12th Aviation Brigade (-) assumes the mission of aerial transportation and resupply for the MCC liaison team. Eagle Flight Detachment is under the operational control of CTF and tactical operational control of MCC. Eagle Flight Detachment will maintain 29 personnel and equipment required for mission accomplishment. On order conduct search and rescue operations and non-combatant operations of United Nations, nongovernmental organization (NGO) and/or private volunteer organization (PVO) personnel in the Security Zone. On order, conduct air movement operations as directed by Commander CTF. Conducts aerial resupply to MCC element in Zakho, Iraq. (N 37 08'30" E 42 40'42")

## 3. Execution:

### a. Concept of the Operation.

Commanders Intent: My intent is for Eagle Flight Detachment to safely and rapidly conduct aerial transportation and resupply operations for the MCC liaison team in Zakho, Iraq. Additionally, conduct search and rescue (SAR) missions for CTF. This requirement is due to the large distances separating USAF assets from the area of operation and our ability to quickly react to these types of emergencies. Joint and combined training efforts emphasizing mission essential tasks and safety for all personnel are the focus of all endeavors conducted in the region.

(1) Maneuver. Commander Eagle Flight Detachment operates a three cell organization to support the MCC mission. An LNO cell of two (2) officers operates from CTF Headquarters at Incirlik. This organization will manage part distribution, rotation of personnel, and performs liaison functions with the CTF Headquarters. Cell 2 consists of 7 contract maintenance personnel composed of electricians, sheet metal, avionics, and engine technicians. Cell 3 consists of twenty five military operational section which will fly the MCC missions and maintain the aircraft from Diyarbakir Air Base (N 37 53'42" E 40 11'54"). The detachment billet is located at Prinlik AB (N 37 54'06" E 40 00'05") a USAF radar site with permanent buildings and complete life support facilities. Distances between the two sites is approximately twenty minutes by vehicle. The MCC mission requires two (2) FMC JH-60 aircraft, 5 days per week. Estimated flight duration is 5 hours per day per airframe. All missions fly during the hours of daylight. Turkish policies require VFR flights to terminate at sunset. USAF C-12s, Casa 212s, and C-130s resupply capability will utilize Diyarbakir Air Base.

(2) Fires. USAF/USN assets will continue reconnaissance and CAS missions in The Area Of Responsibility (TAOR).



**TAB AA**

**REGULATIONS AND DIRECTIVES**

**AA-9 Extracts from OPC II Command and Control Guidance  
(USCINCEUR OPORDs 002, 003, 004, CTF OPLAN 91-7)  
(See also Classified Addendum)**

**AA-10 Extracts from DA Technical Manual 55-1520-237-10, Operator's  
Manual UH-60A and EH-60A Helicopters**

**AA-11 Eagle Flight Detachment, Standard Flight Operating Procedures**

**AA-12 Eagle Flight Detachment Operations Order 92-01**

**AA-13 Extract from AFP 110-34, Commander's Handbook on The Law  
of Armed Conflict**

**AA-14 Extract From Mission Control Center Standard Operating  
Procedures, Headquarters Combined Task Force**

**AA-15 Extract from Army Regulation 95-1, Aviation, Flight Regulation**

**AA-16 Headquarters Combined Task Force Memorandum for CFACC  
Commander, Military Coordination Center, UH-60 Flight Policy,**

**AA-9**

**AA10**

**AA-11**

**AA-12**

**AA-13**

## JUDGE ADVOCATE GENERAL



# COMMANDER'S HANDBOOK ON THE LAW OF ARMED CONFLICT

25 JULY 1980

### CERTIFICATION OF EXTRACT

I reviewed AFP 110-34  
From that source document, I extracted the information contained in this extract. I  
certify the information contained herein is a true and accurate extract of that source  
document.

*Charles Wilen*

15 May 94 Charles Wilen 16AFJA  
Date Name/Organization/Section

### CERTIFICATE

I certify that I am the Records Custodian for the Accident Investigation Board  
convened to investigate the crash of two U.S. Army Black Hawk helicopters in the no  
fly zone in northern Iraq on 14 April 1994, and that this is a true and accurate copy of  
the record which is kept in my records system.

15 May 94  
Date

*W. L. Harris*  
WILLIAM L. HARRIS, Capt, USAF, MSC  
Evidence Custodian, Incirlik Air Base, Turkey

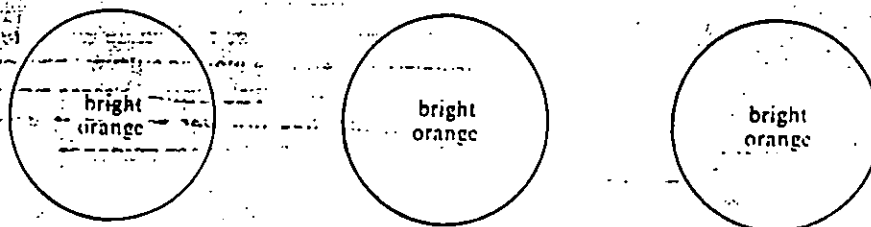

Figure A1-1. International Special Sign for Works and Installations Containing Dangerous Forces. International special sign for dams, dikes and nuclear power stations protected under Protocol I to the 1949 Geneva Conventions (1977). (Three bright orange circles of equal size on the same axis.)

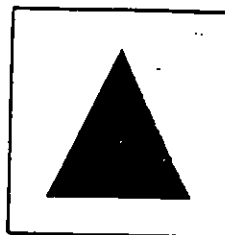

Figure A1-2. International Sign of Civil Defense. International distinctive sign of civil defense, provided for in Protocol I to the 1949 Geneva Conventions (1977). (Equilateral blue triangle on an orange background.)

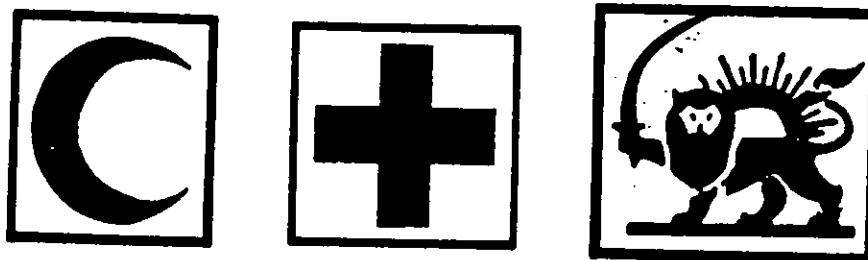

Figure A1-3. Emblems for Medical Activities. The distinctive emblems for medical activities. (Red Cross, red crescent or red lion and sun on a white background.)

**TAB AA**

**REGULATIONS AND DIRECTIVES**

**AA-9 Extracts from OPC II Command and Control Guidance  
(USCINCEUR OPORDs 002, 003, 004, CTF OPLAN 91-7)  
(See also Classified Addendum)**

**AA-10 Extracts from DA Technical Manual 55-1520-237-10, Operator's  
Manual UH-60A and EH-60A Helicopters**

**AA-11 Eagle Flight Detachment, Standard Flight Operating Procedures**

**AA-12 Eagle Flight Detachment Operations Order 92-01**

**AA-13 Extract from AFP 110-34, Commander's Handbook on The Law  
of Armed Conflict**

**AA-14 Extract From Mission Control Center Standard Operating  
Procedures, Headquarters Combined Task Force**

**AA-15 Extract from Army Regulation 95-1, Aviation, Flight Regulation**

**AA-16 Headquarters Combined Task Force Memorandum for CFACC  
Commander, Military Coordination Center, UH-60 Flight Policy,**

**AA-9**

**AA10**

**AA-11**

**AA-12**

**AA-13**

**AA-14**

UNCLASSIFIED

MCC MISSION AND TASKS

MCC MISSION

- (U) ~~Monitor Iraqi compliance with the UN Security Council Resolution 688 and applicable demarches~~ through contact and coordination with local civil and military authorities, representatives of local political factions and UN/NGO/PVO agencies involved in humanitarian relief operations in northern Iraq. Deconflict potential confrontational issues. Investigate incidents, and gather and report information.

MCC TASKS

- (U) Maintain Coalition communication channels with the indigenous population, and with the Iraqi military, should the mil-to-mil meetings resume.
- (U) Present Coalition Nations' positions on demarches to Iraqi military, should the mil-to-mil meetings resume.
- (U) Monitor Iraqi compliance with UNSCR 688 and applicable demarches and discuss, as necessary, with Iraqi military, should the mil-to-mil meetings resume.
- (U) Monitor security situation in the CTF TAOR in Iraq and provide visual reassurance to the indigenous population.
- (U) Deconflict potential confrontational issues and situations with the Iraqi military should the mil-to-mil meetings resume.
- (U) Investigate incidents, and gather and report information.
- (U) Coordinate arrangements for meetings between CG CTF and Iraqi military should the mil-to-mil meetings resume.
- (U) Where possible, monitor activities of humanitarian relief agencies.
- (U) When directed, conduct emergency humanitarian assistance.
- (U) Facilitate the implementation of the USEUCOM/CTF UN Participation Act relief operations as directed.
- (U) Coordinate, monitor, and support the mission of the Relief Coordination Center.
- (U) Conduct other tasks as directed by CG CTF.

EXTRACT

I certify that I am the Records Custodian for the Accident Investigation Board concerning the crash of two U.S. Army Black Hawk helicopters in the northern zone in northern Iraq on 14 April 1994, and that this is a true and accurate extract from

MCC SOP

which is kept in my records system.

15 May 94  
Date

W. L. HARRIS, Capt, USAF, MSC  
Evidence Custodian, Incirlik Air Base, Turkey

## MCC MISSION

MONITOR IRAQI COMPLIANCE WITH THE UN  
SECURITY COUNCIL RESOLUTION 688 AND  
APPLICABLE DEMARCHES THROUGH CONTACT AND  
COORDINATION WITH LOCAL CIVIL AND MILITARY  
AUTHORITIES, REPRESENTATIVES OF LOCAL  
POLITICAL FACTIONS AND UN/NGO/PVO AGENCIES  
INVOLVED IN HUMANITARIAN RELIEF OPERATIONS  
IN NORTHERN IRAQ. DECONFLICT POTENTIAL  
CONFRONTATIONAL ISSUES. INVESTIGATE  
INCIDENTS, GATHER AND REPORT INFORMATION,  
PREPARED TO RESUME DIRECT, FACE-TO-FACE  
COMMUNICATIONS WITH IRAQI MILITARY LIAISON  
OFFICERS.

**TAB AA**

**REGULATIONS AND DIRECTIVES**

**AA-9 Extracts from OPC II Command and Control Guidance  
(USCINCEUR OPORDs 002, 003, 004, CTF OPLAN 91-7)  
(See also Classified Addendum)**

**AA-10 Extracts from DA Technical Manual 55-1520-237-10, Operator's  
Manual UH-60A and EH-60A Helicopters**

**AA-11 Eagle Flight Detachment, Standard Flight Operating Procedures**

**AA-12 Eagle Flight Detachment Operations Order 92-01**

**AA-13 Extract from AFP 110-34, Commander's Handbook on The Law  
of Armed Conflict**

**AA-14 Extract From Mission Control Center Standard Operating  
Procedures, Headquarters Combined Task Force**

**AA-15 Extract from Army Regulation 95-1, Aviation, Flight Regulation**

**AA-16 Headquarters Combined Task Force Memorandum for CFACC  
Commander, Military Coordination Center, UH-60 Flight Policy,**

**AA-9**

**AA10**

**AA-11**

**AA-12**

**AA-13**

**AA-14**

**AA-15**

AA 15

# CERTIFICATION OF EXTRACT

I reviewed ARMY REGULATION 45-1 FLIGHT REGULATIONS  
(describe the original source document)

From that source document, I extracted the information contained in the attached document,  
entitled ARMY REGULATION 45-1 FLIGHT REGULATIONS

I certify the information contained there in is a true and accurate extract of the source document.

  
\_\_\_\_\_  
(Signature)

STEVE MELINE  
\_\_\_\_\_  
(Printed Name)

207<sup>TH</sup> AVN CO HEIDELBERG GERMANY  
\_\_\_\_\_  
(Organization/Duty Section)

13 MAY 94  
\_\_\_\_\_  
(Date)



Aviation

Flight Regulations

This UPDATE printing publishes a revision of this publication. Because the publication has been extensively revised, the changed portions have not been highlighted.

By Order of the Secretary of the Army:

CARL E. VUONO  
General, United States Army  
Chief of Staff

Official:

*Milton H. Hamilton*  
MILTON H. HAMILTON  
Administrative Assistant to the  
Secretary of the Army

**Summary.** This regulation covers aircraft operations, crew requirements, and flight rules. It also includes applicable paragraphs of Federal Aviation Regulation Parts 91 and 105.

**Applicability.** This regulation applies to all Army aircraft systems and persons involved in the operation of such aircraft and systems. This includes aircraft on loan, lease, and bailment to the Army, the Army National Guard, and the U.S. Army Reserve.

**Internal Control System.** This regulation is not subject to the requirements of AR 11-2. It does not contain internal control provisions.

**Supplementation.** Supplementation of this regulation and establishment of command and local forms are prohibited without prior approval of Headquarters, Department of the Army, (DAMO-FDV), WASH DC 20310-0460.

**Interim changes.** Interim changes to this regulation are not official unless they are authenticated by the Administrative Assistant to the Secretary of the Army. Users will destroy interim changes on their expiration date unless sooner superseded or rescinded.

**Suggested improvements.** The proponent agency of this regulation is the Office

of the Deputy Chief of Staff for Operations and Plans. Users are invited to send comments and suggested improvements on DA Form 2028 (Recommended Changes to Publications and Blank Forms) directly to Commander, U.S. Army Aviation Center, ATTN: ATZQ-ESO-L, Fort Rucker, AL 36362-5211.

**Distribution.** Distribution of this publication is made in accordance with the requirements on DA Form 12-09-E, block number 2080, intended for command level A for Active Army, the Army National Guard, and the U.S. Army Reserve.

**Contents** (Listed by paragraph number)

**Chapter 1**

**General**

- Purpose • 1-1
- References • 1-2
- Explanation of abbreviations and terms • 1-3
- Responsibilities • 1-4
- Deviations • 1-5
- Waivers and delegation of authority • 1-6

**Chapter 2**

**Flight Personnel**

- Personnel authorized to fly Army aircraft • 2-1
- Personnel authorized to run up Army aircraft • 2-2
- Aviators prohibited from performing aircrew duty • 2-3
- Aviators restricted to limited cockpit duty • 2-4
- Aircrew and maintenance checklists • 2-5
- Logging flying time • 2-6
- Computation of flying time • 2-7
- Individual flight records • 2-8

**Chapter 3**

**Operations and Safety**

*Section I*

*Use of Army Aircraft*

- General • 3-1
- Prohibited missions • 3-2
- Passenger restrictions • 3-3

*Section II*

*Safety and Aviation Life Support Equipment (ALSE)*

- Safety procedures • 3-4
- Crew endurance • 3-5
- DA Form 2696 • 3-6
- Aircraft safety equipment • 3-7
- Flight data recorders (FDRs) • 3-8
- Oxygen system • 3-9
- Parachute requirements • 3-10
- Protective clothing and equipment • 3-11
- Protective masks • 3-12
- Seat belts and restraints • 3-13
- Aviation life support equipment • 3-14
- Noise abatement • 3-15

*Section III*

*Aircraft Maintenance*

- Maintenance test flights (MTFs) • 3-16

- Maintenance operational check (MOC) • 3-17

**Chapter 4**

**Training**

*Section I*

*Training*

- Aircrew training • 4-1
- Currency • 4-2
- Similar aircraft • 4-3
- Emergency procedures training • 4-4

*Section II*

*Flight Crewmembers*

- Flight crews • 4-5
- Pilot in command (PC) • 4-6
- Air mission commander • 4-7
- Pilot (PI) • 4-8
- Copilot (CP) • 4-9
- Unit trainer (UT) • 4-10
- Instructor pilot (IP) • 4-11
- Instrument flight examiner (IE) • 4-12
- Standardization instructor pilot (SP) • 4-13
- Maintenance test pilot (MP) • 4-14
- Maintenance test flight evaluator (ME) • 4-15

\*This regulation supersedes AR 95-1, 15 September 1988.

UNIT \_\_\_\_\_

DATE \_\_\_\_\_

MSN NO. \_\_\_\_\_

**BRIEFING**

**1. SITUATION.**

- a. Threat: \_\_\_\_\_
- b. Friendly Units: \_\_\_\_\_
- c. Attachments/Detachments: \_\_\_\_\_

**\*2. MISSION.** \_\_\_\_\_  
\_\_\_\_\_

**3. EXECUTION.**

- \*a. Mission Type:  TAC  TNG  ADMIN  MAINT  MED  Other \_\_\_\_\_
- \*b. Authorized Conditions:  DAY  N  VMC  IMC  DG  NG  HOOD  Other \_\_\_\_\_
- \*c. Authorized Flight Modes:  Formation  Low-Level  Contour  NOE
- d. Movement Techniques: \_\_\_\_\_
- \*e. Aircraft/Crews:

	TYPE/TAIL #	PC/SEAT	CP	CE	
(1)	_____	_____	_____	_____	_____
(2)	_____	_____	_____	_____	_____
(3)	_____	_____	_____	_____	_____
(4)	_____	_____	_____	_____	_____

(Attach additional sheets as required.)

- \*f. Special Mission Equipment: \_\_\_\_\_
- g. Authorized Loads: Passengers \_\_\_\_\_ Cargo \_\_\_\_\_ Ammunition \_\_\_\_\_
- h. Flight Route: \_\_\_\_\_
- i. Mission Restrictions: \_\_\_\_\_
- \*j. Safety Considerations: \_\_\_\_\_

**4. SERVICE SUPPORT.**

- a. Refuel/Rearm Location: \_\_\_\_\_
- b. Ration Support: \_\_\_\_\_
- c. Assembly Area/Bivouac/Remain overnight locations: \_\_\_\_\_
- d. Maintenance Support: \_\_\_\_\_

**5. COMMAND AND SIGNAL.**

- \*a. Command: (1) Air Mission Commander \_\_\_\_\_  
(2) Command or support relationships to supported unit:  
 Attached  OPCON  DS  GS TO: \_\_\_\_\_
- b. Signal (except published frequencies): \_\_\_\_\_

**6. ADDITIONAL REMARKS.** \_\_\_\_\_  
\_\_\_\_\_

\_\_\_\_\_  
(BRIEFER'S SIGNATURE)

\*Mandatory for all flights.

**MISSION BRIEF-BAC:**

**\*1. MISSION.**

- a.  Mission can be accomplished as briefed.
- b. Identify required deviations from mission: \_\_\_\_\_

**2. PREMISSION PLANNING\***

- \*a. WEATHER.
- \*b. PERFORMANCE PLANNING.
- \*c. NOTAMS.
- \*d. CREW STATUS.
  - (1) Crew endurance.
  - (2) Qualified and current.

**3. PASSENGERS/CARGO/AMMUNITION.**

- a. Loads planned per briefing.
- b. Passenger manifest on file.

**\*4. FLIGHT ROUTES.** \_\_\_\_\_

**5. REFUELING ARRANGEMENTS.** \_\_\_\_\_

**6. REMARKS.** \_\_\_\_\_

\_\_\_\_\_  
*(PIC/AIR MISSION COMMANDER'S SIGNATURE)*

**POST-MISSION DEBRIEF**

1. \*MISSION STATUS.  Completed as briefed  Not completed (See remarks)  
 Cancelled (See remarks)  Changed (See remarks)

2. PIREPS. \_\_\_\_\_

3. \*CREW ENDURANCE STATUS. \_\_\_\_\_

4. AIRCRAFT STATUS.

- \*a. Maintenance \_\_\_\_\_
- \*b. Fuel \_\_\_\_\_
- c. Ammunition \_\_\_\_\_
- \*d. Avionics \_\_\_\_\_

5. REMARKS: \_\_\_\_\_

\_\_\_\_\_  
*(PIC/AIR MISSION COMMANDER'S SIGNATURE)*

\*Mandatory for all flights.

(d) Training involving multi-engine helicopters must be approved by the unit commander added to the appropriate ATM.

(e) Simulated single engine operations are not authorized.

#### b. Helicopters.

(1) Hydraulics-off, autorotations (except from a hover), and anti-torque touchdown emergency procedures training in single engine helicopters will be conducted only during aviator and instructor pilot qualification and transition training per formal POI at Department of the Army designated training bases. Touchdown emergency procedures are also authorized for—

(a) IPs designated to conduct touchdown emergency procedures in single engine helicopters at designated training bases.

(b) Directorate of Evaluation and Standardization (DES) IPs.

(c) Local transition training in OH-58A/C and OH-6 helicopters.

(d) IPs designated to conduct touchdown emergency procedures in OH-58A/C and OH-6 helicopters.

(2) Procedures must be conducted in designated training locations free from obstructions. There must be air-to-ground communications and crash and fire rescue equipment available. Night training areas will be designated and used. A method of opening and closing the training area will be established.

(3) Unannounced touchdown autorotations will not be made except for IP training or evaluations.

(4) No more than six practice touchdown autorotations (hovering autorotations are excluded) per pilot or student pilot will be made during any instructional period. This restriction does not apply to IPs or SPs conducting training.

(5) Practice low-level touchdown autorotations may be made at designated training locations under the following conditions:

(a) Approach zones must be clear of obstructions to permit visual contact with the point of landing from autorotation entry to termination.

(b) Entry speeds and altitudes must be as specified in the ATM for the aircraft flown.

(6) Autorotations with power recoveries and terminations with power will be conducted per the ATM.

(7) In multi-engine helicopters, practice touchdown autorotations are prohibited.

## Section II Flight Crewmembers

### 4-5. Flight crews

Flight crewmembers will be—

a. Designated in writing, by the commander, specifying the duties and flight crew stations that they are authorized to fly.

b. Selected to occupy specific flight crew stations by the aviation unit chain of command, no lower than platoon leader in table of organization and equipment (TOE) units before each flight or series of flights. In table of distribution and allowance (TDA) units, selections will be made by the chain of command or operations officer. Selections will be based on proficiency, mission complexity, crew capability, and other factors bearing on the flight.

c. At the flight crew station specified in paragraph b above.

d. Evaluated during APART in the primary aircraft and during each training year in alternate and additional aircraft in each flight crew station where they are authorized to fly.

### 4-6. Pilot in command (PIC)

a. The pilot in command will be—

(1) Responsible and have final authority for operating, servicing, and securing the aircraft he or she commands.

(2) Selected per paragraph 4-5b for each flight or series of flights.

(3) Qualified and current in the aircraft mission, type, design, and series.

(4) The UT, IP, SP, IE, or ME when instructing or evaluating at a pilot or copilot station.

(5) Listed in the flight plan or unit operations log.

(6) Responsible for crew and passenger briefings.

(7) Briefed by the commander designated briefing officer before each mission and key elements of the mission briefing. UTs, IPs, SPs, MEs, and IEs who are evaluating or instructing from other than pilot or copilot station will participate in the mission briefing and brief-back. A copy of the form used in the mission briefing will be retained in unit files for at least 30 days. DA Form 548-R (Aircrew Mission Briefing), located in the back of this regulation, may be reproduced locally on 8 1/2- by 11-inch paper.

b. RC rotary-wing aviators who have completed contact and academic training may fly as pilots in command during training missions in VFR conditions during the 1 year authorized for instrument qualifications.

### 4-7. Air mission commander

When two or more aircraft are operating as one flight, the unit commander will designate an air mission commander to be in command of all aircraft in the flight. The designation of air mission commander is an assignment of command responsibility and is not a crew duty assignment. Air mission commanders will participate in mission briefings and brief backs.

### 4-8. Pilot (PI)

a. The pilot, when designated, will be—

(1) Qualified and current in the aircraft mission, type, design, and series.

(2) Briefed by the pilot in command.

(3) Listed on the flight plan or unit operations log.

b. Flight trainees undergoing training and personnel performing limited cockpit duties per paragraph 2-4 may perform pilot duties when an IP is at one set of controls. The IP must be qualified and current in the mission, type, design, and series aircraft being flown.

c. When the operators manual requires a pilot and copilot as minimum crew, two pilots qualified and current in the mission, type, design, and series aircraft to be flown are required. When an IP qualified in the mission, type, design, and series aircraft being flown is at one set of controls, the following additional personnel meet this requirement:

(1) Persons undergoing authorized training.

(2) Personnel performing limited cockpit duties per paragraph 2-4.

(3) Aviation unit commanders, DA Regional Representatives (DARR) to the FAA, and MACOM aviation officers in the grade of O5 and above in operational aviation positions who are not qualified in the aircraft being flown.

(4) Personnel approved by a MACOM (four star level) commander, in writing, when the following conditions have been met:

(a) Flight is for determining the capabilities and/or combat effectiveness of the aircraft.

(b) NVD or NOE flight must be specifically authorized.

(c) Flight will be in VFR conditions.

(d) Simulated emergency procedures will not be conducted.

(e) Flight is approved by the MACOM commander providing the aircraft. If any of the above conditions cannot be complied with, a waiver may be requested per paragraph 1-7a.

(5) Authority granted in (3) above will not be further delayed.

### 4-9. Copilot (CP)

a. The copilot, when designated, will assist in the performance of cockpit tasks as directed by the PIC. Except as stated in b and c below, any aviator may occupy a copilot station and perform designated copilot duties in any aircraft.

b. Two aviators current in the aircraft category being flown are required for flights in forecast instrument meteorological conditions (IMC). Flight trainees meet this requirement when undergoing instrument training and an IP or IE current in the mission, type, design, and series aircraft being flown is at one set of controls. RC aviators who have not completed the required instrument training and evaluation per the ATM will not fly as a crewmember in forecast IMC except when undergoing instrument training with an IP or IE.

**TAB AA**

**REGULATIONS AND DIRECTIVES**

- AA-9 Extracts from OPC II Command and Control Guidance  
(USCINCEUR OPORDs 002, 003, 004, CTF OPLAN 91-7)  
(See also Classified Addendum)**
- AA-10 Extracts from DA Technical Manual 55-1520-237-10, Operator's  
Manual UH-60A and EH-60A Helicopters**
- AA-11 Eagle Flight Detachment, Standard Flight Operating Procedures**
- AA-12 Eagle Flight Detachment Operations Order 92-01**
- AA-13 Extract from AFP 110-34, Commander's Handbook on The Law  
of Armed Conflict**
- AA-14 Extract From Mission Control Center Standard Operating  
Procedures, Headquarters Combined Task Force**
- AA-15 Extract from Army Regulation 95-1, Aviation, Flight Regulation**
- AA-16 Headquarters Combined Task Force Memorandum for CFACC  
Commander, Military Coordination Center, UH-60 Flight Policy,**

- AA-9**
- AA10**
- AA-11**
- AA-12**
- AA-13**
- AA-14**
- AA-15**
- AA-16**

HEADQUARTERS  
COMBINED TASK FORCE PROVIDE COMFORT  
INCIRLIK AIR BASE, TURKEY  
APO AE 09396

CG

1 September '93

MEMORANDUM FOR CFACC  
Commander, Military Coordination Center (CCMCC)

SUBJECT: UH-60 Flight Policy

1. I have implemented the following policy for UH-60 flights supporting the Military Coordination Center (MCC).

a. All UH-60 flights into Iraq, outside of the security zone require AWACS coverage.

b. Designated non-flying days directed by CTF will apply to the UH-60 detachment with the exception of the administrative missions.

2. POC is the Deputy C-3, 6-3014.

CERTIFICATE

I hereby certify I am the Records Custodian for the Accident Investigation Report copy and to participate in the crash of two U.S. Army Black Hawk helicopters in the northern Iraq on 14 April 1994, and that this is a true and accurate copy of the record which is kept in my records system.

15 May 94  
Date

W. Harris  
WILLIAM L. HARRIS, Capt, USAF (M)  
Evidence Custodian  
Incirlik Air Base, Turkey

**TAB AA**

**REGULATIONS AND DIRECTIVES**

**AA-17 Combined Task Force, OPC, Combined Forces Air Component  
Mission Director/Airborne Control Element Checkout Program  
Verification/Certification**

**AA-18 39th Operations Group Operating Instruction 55-6, Schedule**

**AA-19 39th Operations Group Operating Instruction 55-7, Mission  
Director (MADDOG/DUKE)**

**AA-20 UH-60 Black Hawk Operator's Manual**

**AA-21 DOD Technical Manual 86-100, Mode 4 Handbook**

**AA-22 52nd Operations Group Operating Instruction 200-5, Intelligence**

**AA-23 Extracts from 552nd ACW (Deployed) Local Procedures for OPC**

**AA-24 Extract from Combined Task Force Provide Comfort OPLAN  
91-7 (See also Classified Addendum)**

**AA-17**

**AA-25 Chronology of Rules of Engagement for OPC  
(See Classified Addendum)**

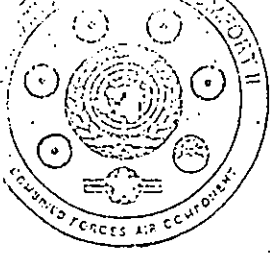

COMBINED TASK FORCE - OPERATION PROVIDE COMFORT  
COMBINED FORCES AIR COMPONENT  
Incirlik Air Base, Turkey

MISSION DIRECTOR / AIRBORNE CONTROL ELEMENT (ACE)  
CHECKOUT PROGRAM VERIFICATION / CERTIFICATION

A. INDIVIDUAL DATA:

- 1) Name, Rank, component: [REDACTED]
- 2) Home Unit/Office symbol: 2ADG LANGLEY AFB VA.
- 3) Official mailing address: 2ADG  
LANGLEY AFB, VA 23665
- 4) Date arrived OPC: 27 DEC 93
- 5) Projected Departure Date: APR 30, 94

B. CHECKOUT PROGRAM VERIFICATION:

- 1) Read ROE, ACO, ARF, SAR procedures, MD/ACE checklists Olive Branch/Olive Comfort Procedures, Pilgrim Message Procedures, Provide Noise and Provide Response MCC Support Mission procedures; Miscellaneous guidance in Mission Director and ACE (Duke) books, 552 ACW (Deployed)-procedures. [REDACTED]
- 2) MD-01, Supervised AM Mad Dog Tour 29 Dec 93 ERP
- 3) MD-02, Supervised PM Mad Dog Tour 30 Dec 93 ERP
- 4) DU-01, Supervised B-day Duke Flight 4 Jan 94 ERP
- 5) DU-02, Supervised A-day Duke Flight 6 JAN 94 RS  
"Checkride"
- 6) CFAC/DO Interview/Certification scheduled: 9 Jan 94

C. CFAC/DO INTERVIEW/CERTIFICATION:

Interview conducted this day concerning CTF/CG, CFAC/CC, and CFAC/DO guidance and policies; mission importance and significance of the role of the Mission Director and Airborne Control Element (ACE).

I certify that [REDACTED] is qualified to perform the duties of Mission Director and Airborne Control Element for the Combined Task Force, Operation Provide Comfort.

date: 7 JAN 94

signature:  
signature  
block

*[Handwritten Signature]* cc/co

12/93

CERTIFICATE	
I certify that I am the Records Custodian for the Accident Investigation Board convened to investigate the crash of two U.S. Army Black Hawk helicopters in the no fly zone in northern Iraq on 14 April 1994, and that this is a true and accurate copy of the record which is kept in my records system.	
<u>26 May 94</u> Date	<i>[Handwritten Signature]</i> Laura A. Ellis, SrA USAF Evidence Custodian, Incirlik Air Base, Turkey



**TAB AA**

**REGULATIONS AND DIRECTIVES**

- AA-17 Combined Task Force, OPC, Combined Forces Air Component  
Mission Director/Airborne Control Element Checkout Program  
Verification/Certification**
- AA-18 39th Operations Group Operating Instruction 55-6, Schedule**
- AA-19 39th Operations Group Operating Instruction 55-7, Mission  
Director (MADDOG/DUKE)**
- AA-20 UH-60 Black Hawk Operator's Manual**
- AA-21 DOD Technical Manual 86-100, Mode 4 Handbook**
- AA-22 52nd Operations Group Operating Instruction 200-5, Intelligence**
- AA-23 Extracts from 552nd ACW (Deployed) Local Procedures for OPC**
- AA-24 Extract from Combined Task Force Provide Comfort OPLAN  
91-7 (See also Classified Addendum) AA-17**
- AA-25 Chronology of Rules of Engagement for OPC AA-18  
(See Classified Addendum)**

DEPARTMENT OF THE AIR FORCE  
39th Operations Group (USAFE)  
APO AE 09824

OG Operating Instruction 55-6

Operations

SCHEDULE

The purpose of this operating instruction is to outline the procedures to be used to plan and schedule all aircraft/helicopter sorties supporting both Operation PROVIDE COMFORT and local training.

1. References: USAFER 60-5, USAFER 66-5, OG OI 55-2.

2. RESPONSIBILITIES:

a. 39 OSS/OSC will:

(1) Develop the Combined Forces Air Component (CFAC) Three-Month Schedule on a monthly basis for all OPC flying activity for signature by the 39 WG/CC (CFAC/CC)

(2) Develop the CFAC Weekly Flying and Maintenance Schedule for 39 OG/CC (CFAC/DO) signature

(3) Develops and publish the Flying Schedule, Air Tasking Order (ATO), and ATO Notes daily

b. Unit/detachment commanders (DETCOs) will:

(1) Coordinate their minimum sortie contract with 39 OG/CC

(2) Coordinate with home units and 39 OSS/OSC to schedule aircraft/personnel rotations during down days to minimize the impact on PROVIDE COMFORT operations

c. Unit/detachment schedulers will:

(1) Keep 39 OSS/OSC informed of aircraft rotations and other maintenance/operational factors affecting scheduling

(2) Schedule unit aircrews to meet tasked sorties

3. PROCEDURES: 39 OSS/OSC will ensure that by:

a. The 10th of each month: The three-month schedule will be developed with inputs from:

- (1) CTF National Representatives (desired down days)
- (2) Higher headquarters (HHQ) proposed schedules
- (3) CFAC down day guidance
- (4) CTF/CFAC mission guidance
- (5) Training requirements
- (6) Unit inputs
- (7) Military Coordination Center (MCC) EAGLE Operations
- (8) Joint Special Operations Task Force (JSOTF)

b. The 25th of each month: The proposed three-month schedules will be briefed to DETCOs; then IAW USAFER 66-5, the schedule will be coordinated with

~~No. of Printed Pages: 2  
OPR: 39 OSS/OSC (Maj White)  
Approved: 39 OG/CC (Col Richardson)  
Distribution: F~~

CERTIFICATE

I certify that I am the Records Custodian for the Accident Investigation Board convened to investigate the crash of two U.S. Army Black Hawk helicopters in the no fly zone in northern Iraq on 14 April 1994, and that this is a true and accurate copy of the record which is kept in my records system.

*W. L. Harris*  
WILLIAM L. HARRIS, Capt, USAF, MSC  
Evidence Custodian, Incirlik Air Base, Turkey

*16 May 94*  
Date

the logistics and operations groups commanders prior to being submitted to 39 WG/CC for approval. Draft coordination copies will be sent to CTF/C-3 to streamline JSOTF, MCC and CTF/CG coordination with national representatives. Before publication, the three-month schedule is briefed to CTF/CG. Atch 1 contains the a checklist to cover each step. Changes thereafter must be brought to the attention of 39 OSS/OSC for approval by 39 OG/CC and 39 WG/CC (Atch 2).

c. Each Monday: Unit schedulers provide USAFE Forms 438 to 39 OSS/OSC detailing proposed training flight schedules. These forms will contain take-off and land times, types of mission, working areas and times needed, and configuration.

d. Each Tuesday: 39 OSS/OSC will brief the upcoming week's schedule (both combat and training missions) at the DETCO meeting. This briefing will serve as the weekly schedule meeting. Any scheduling conflicts will be resolved at this time.

e. Each Wednesday: Based on the current three-month schedule, the Mission Planning Cell ATO Element will build a combined weekly flying and maintenance schedule for the following week. The weekly schedule is then approved and signed by CFAC/DO.

f. Fly day - 2: ATO Element will build projected daily flow sheets, using standard unit sortie contracts, that meet CTF/CFAC tactical guidance. Unit schedulers are encouraged to review the proposed flow sheets in the Frag Shop (Bldg 376). Deviations from the weekly schedule (numbers of aircraft/types flying) must be approved by the 39 OG/CC.

g. Fly day - 1: The daily fragger (Air Tasking Order programmer) will finalize the schedule upon receipt of the targets from CTF/C-2. Any unit updates must be received no later than 0900 hrs.

(1) CTF C-2 (ref OI 55-2) sends prioritized target lists (coordinated with C-3) to the ATO Element. The ATO Element will then match aircraft to targets, publish the ATO, ATO Notes, and the Daily Schedule.

(2) The ATO Element will distribute these documents directly to the flying units and other approved agencies; any undelivered schedules (if a unit is unmanned) will be left in the Wing Operations Center (WOC). At the same time, the ATO is transmitted by message to higher headquarters and to the host nation.

(3) If the ATO package will not reach the CTF Joint Operations and Intelligence Center (JOIC) by 1400 hrs local or the units by 1500 hrs daily, the ATO Element will notify the JOIC and flying units of the expected distribution time.

(4) After delivery of the ATO, the CTF/C-3 calls the Turkish radar sites to ensure they have the AWACS times for data link.

(5) If changes are necessary after the distribution of the ATO package, the ATO Element or 39 OSS/OSC will publish a Battle Staff Directive (BSD) to implement necessary changes. If the BSD moves the overall times for the entire package, the on-duty controller in the WOC will inform each DETCO.

h. Fly day: Each unit will stop at the WOC first thing each fly day to pick-up any distribution. Responsibility for the ATO transfers to the MADDOG/DUKE one hour prior to AWACS take-off. The MADDOG is the POC for all schedule changes after the transfer; upon notification of a change, he will coordinate with the JOIC to obtain the necessary permission from Turkish authorities. If changes are necessary on the flying day and the MADDOG can coordinate all changes verbally, no BSD is needed. If the MADDOG feels a BSD is necessary, he will contact the ATO Element for BSD completion and distribution.



DOUGLAS J. RICHARDSON, Colonel, USAF.  
Commander, 39th Operations Group

Approved.

JAMES D. KULA, Colonel, USAF  
Commander, Combined Forces Air Component

Approved.

JEFFREY S. PILKINGTON, Brig Gen, USAF  
Commanding General  
Operation Provide Comfort

- 2 Atch
1. Three-Month Schedule Checklist
  2. PROVIDE COMFORT Mission Tasking Coordination Sheet

THREE-MONTH SCHEDULE CHECKLIST

<u>Step</u>	<u>Target</u>	<u>Completed</u>
Proposed schedule developed	1st	_____
Scheduler review	1st Tues	_____
Final inputs received	10th	_____
DETCO review	2nd Tues	_____
OSS approval		_____
OG approval		_____
LG coordination		_____
CC approval	3rd Thurs	_____
Draft to CTF/C-3		_____
CTF/CG review		_____
Distributed	25th	_____

**TAB AA**

**REGULATIONS AND DIRECTIVES**

**AA-17 Combined Task Force, OPC, Combined Forces Air Component  
Mission Director/Airborne Control Element Checkout Program  
Verification/Certification**

**AA-18 39th Operations Group Operating Instruction 55-6, Schedule**

**AA-19 39th Operations Group Operating Instruction 55-7, Mission  
Director (MADDOG/DUKE)**

**AA-20 UH-60 Black Hawk Operator's Manual**

**AA-21 DOD Technical Manual 86-100, Mode 4 Handbook**

**AA-22 52nd Operations Group Operating Instruction 200-5, Intelligence**

**AA-23 Extracts from 552nd ACW (Deployed) Local Procedures for OPC**

**AA-24 Extract from Combined Task Force Provide Comfort OPLAN  
91-7 (See also Classified Addendum)**

**AA-25 Chronology of Rules of Engagement for OPC  
(See Classified Addendum)**

**AA-17**

**AA-18**

**AA-19**

16 May 94

W. H. H.  
William H. H. H.  
Evidence Custodian  
Incirlik Air Base, Turkey

DEPARTMENT OF THE AIR FORCE  
39th Operations Group (USAF)  
APO AE 09824

OG Operating Instruction 55-7

25 March 1994

Operations

MISSION DIRECTOR (MADDOG/DUKE)

The purpose of this operating instruction is to outline the responsibilities, procedures, and command relationships for the MADDOG/DUKE program for 39 OG. The MADDOG is the ground-based mission director (normally in the Wing Operations Center-WOC) whereas the DUKE is the airborne mission director (normally on-board AWACS).

1. References: EUCOM Rules-of-Engagement for Operation PROVIDE COMFORT (S). Mission Director Checkout Program and Standard Operating Procedures, with Attachments.

2. RESPONSIBILITIES:

a. 39 OSS/OSC will:

(1) Have staff responsibility for the MADDOG/DUKE program to ensure continuity and compatibility with other operations functions.

(2) Schedule a weekly meeting with CFAC/DO, MADDOG/DUKE personnel, 39 OSS/CC, 39 OSS/OSC, Mission Planning Cell personnel, and AWACS Detachment Commander (DETCO)/Operations Officer to discuss current issues and problems.

(3) Ensure the senior MADDOG/DUKE maintains current procedures, policies, and command guidance.

b. The senior deployed MADDOG/DUKE:

(1) Develops, maintains, and operates a program to train MADDOG/DUKE personnel in their duties and ensure this training is certified by 39 OG/CC prior to their performing DUKE duties "solo". Documentation will be maintained in the Mission Director book located at the MADDOG station in the Incirlik WOC.

(2) Ensures the MADDOG/DUKE continuity books and quick reaction checklists reflect the most current Operation PROVIDE COMFORT information, policies, and CTF/CG, CFAC/DO guidance.

(3) Nominate MADDOG/DUKE personnel for appropriate awards and decorations IAW current command policies and ensure their nomination packages are prepared prior to their departure. Approved packages should be forwarded to each individual's servicing CBPO for processing.

(4) Be the office of primary responsibility for the airspace coordination order (ACO-Volumes I and II) and will incorporate Aircrew Read File items as required by 39 OG/CC.

c. The on-duty MADDOG/DUKE will:

(1) Ensure operations are conducted in a safe and tactically sound manner IAW USAF, EUCOM, CTF, CFAC, and other applicable guidance and restrictions.

No. of Printed Pages: 2  
OPR: 39 OSS/CC (Maj White)  
Approved by: Col Douglas J. Richardson  
Distribution: F

(2) Act as the "eyes and ears" of the 39 OG/CC in the execution of combat operations. Call 39 OG/CC or his representative before launch with status/updates or for any significant events.

(3) Primary responsibility for the mission within the 50 nm circle of Incirlik rests with the MADDOG, outside of the 50 nm circle with the DUKE. MADDOG/DUKE will coordinate with the Supervisor of Flying (SOF) regarding any airfield/emergency aircraft problems.

(4) The MADDOG will maintain regular contact with 39 OG/CC or his designated representative regarding the status of the mission and will immediately advise him of any changes to the Tactical Area of Responsibility (TAOR) coverage, initiation of hostilities, or emergency situations in the area.

### 3. PROCEDURES:

a. Each Operation PROVIDE COMFORT mission will be under the control of a MADDOG/DUKE from AWACS take-off until the last combat aircraft is within the 50nm circle of Incirlik AB. The MADDOG will remain in the WOC until all aircraft are in the 50 nm circle. Prior to his departure he will notify DUKE, SOF, and 39 OG/CC or his representative.

b. The MADDOG/DUKE will ensure that required communications, AWACS radar/IFF/JTIDS are operational and host nation requirements are met before launch of the first fighter aircraft for each day's mission. Coordinate with 39 OG/CC or his representative prior to launch approval.

c. Ensure the tanker launches before the tasked fighter flow. An airborne tanker is required prior to launching the first fighter.

d. In the event changes to the air tasking order (ATO) are necessary, the MADDOG will brief 39 OG/CC or his designated representative and obtain approval prior to implementation. If an emergency or unsafe situation requires immediate action be taken before such coordination and approval can be obtained, the MADDOG will brief 39 OG/CC or his representative as soon as possible.

e. MADDOG/DUKE will assume responsibility for the daily Air Tasking Order (ATO) from the Mission Planning Cell (MPC) one-hour prior to the fragged AWACS take-off. If complex changes during the day require a Battle Staff Directive (BSD), the MADDOG should obtain the necessary coordination and 39 OG approval, then request the MPC prepare and distribute the BSD to all affected units.

f. If communications are lost with the chain-of-command chain, the DUKE will direct exhaustive efforts to find some means of reestablishing communication with the command structure while maintaining command and control of the on-going mission.



DOUGLAS J. RICHARDSON, Colonel, USAF  
Commander, 39th Operations Group



**OPERATION PROVIDE COMFORT -**  
**COMBINED TASK FORCE**  
**COMBINED FORCES AIR COMPONENT**  
**MISSION DIRECTOR/AIRBORNE CONTROL ELEMENT**  
**STANDARD OPERATING PROCEDURES**

---

8 December 1993

---

**JOB OVERVIEW/RESPONSIBILITIES**

- Representative of the CFAC/CC/DO and CTF/CG both on the ground and airborne
  - Keep chain of command informed
- Provide Tactical / local OPC experience aboard E-3 as ACE(Duke)
  - Provide "OPC continuity" for problem solving
  - Serve as "airborne SOF" for emergencies/diverts
- On-scene commander for SAR operations
  - Provide comm link between CFAC/CC/DO and SAR forces
- Mission Director (Mad Dog) in Command Post
  - One hour prior to first takeoff MD/ACE share responsibility for successful ATO execution
  - Coordinate all changes to daily ATO with CFAC/DO or his rep BEFORE they take place unless Emer/other situation demands immediate response then backbrief CFAC/DO immediately
  - Communicate ATO changes to all players
  - Coordinate for Duke as needed
- Ensure the OPC daily ATO is executed according to current CTF/CG and CFAC/CC/DO guidance and directives

-----  
Supersedes MD/ACE SOPs, 27 Sep 93.

No. of printed pages:

OPR: CFAC/DO-MD (DETCO, Msn Dir/ACE Det)

Approved by: Col Douglas J. Richardson, 390G/CC

Writer-Editor: Lt Col Jeffrey L. Duncan, 110G/CC

Distribution: CFAC/DO, 1- ea MD/ACE, MD bk, ACE bk, DETCO bk

## SIGNIFICANCE

- MD/ACE operations are "high threat" - Know Your 8---!
- OPC operations are conducted in unstable part of world
  - AOR is "warm" on any given day with potential to become "hot" with little, if any warning
- OPC is a "high-vis" multi-national UN operation with forces flying with "live" ordnance
  - The opportunity for fatal mistakes is prevalent
  - MD/ACE MUST be professional and stay on top of situation
  - The opportunities for international incidents also abound
- Absolutely necessary for MD/ACE to be aware of latest guidance and directives of CTF/CG and CFAC/CC/DO - MUST KNOW "THE WORD"

## MAD DOG/DUKE RESOURCES

- CFAC chain of command - ("Where's Waldo" for Mad Dogs and Dukes)
  - Refer to Attachment 1 - CTF Organizational Chart
  - Refer to CFAC/DO OI 55-11, Mission Director/Airborne Control Element Program for more info
- Squadron Operations Centers (SOCs)
  - Designed as a central point of contact for several units operating out of a central location
  - SOC I (Golf Loop) Accessed via Hotline at MD console or
    - F-15 (6-3311)
    - F-15E (6-3917)
    - EF-111
    - F-111 (6-3917)
    - French Air Force assets
  - SOC II (Golf Loop) Accessed via Hotline at MD console or
    - F-16 (6-3322)
    - F-4G (6-3321)
    - Royal Air Force assets (6-8421)
  - SOC III (India Loop) Accessed via Hotline at MD console or
    - SOW (6-8177)
  - TANKER OPS (Hangar 4)
    - US Tanker Force (6-3445)
    - French Tankers (6-3193)
    - British Tankers (6-3759)
  - AWACS OPS (QRA)
    - Hotline at MD console
  - C-12 OPS (CTF/C4) (6-3441)
  - EAGLE OPS (6-7085)

- Contact SOCs/Operations Centers to speak to appropriate aircraft Detco or duty officer to coordinate ops issues (coordinating maintenance issues is quicker/more appropriate through MOC with an info call to the SOC/Detco)
- **Joint Special Operations Task Force (JSOTF)**
  - Contact via hotline from MD console
  - OPC ATO has HC-130 and MH-60 on SAR Alert
  - Let them know immediately after CFAC/DO !
- **Other base agencies**
  - **SOF-** Hotline at MD console. Fighter SOF must be in the Tower 30 minutes before the first fighter takeoff or else SLIP the fighter takeoffs and contact CFAC/DO immediately. AWACS SOF will be in SAVVY OPS or on the flight line in SOF truck. TANKER SOF will either be in TANKER OPS or on the flightline in SOF truck.
  - **Tower-** Hotline at the MD console. Part of 39 OSS (39OSS/OSA) Tower is staffed by both US and Turkish controllers. When SOF is not in the Tower they can be your "eyes on the ramp".
  - **Base Ops-** Hotline at the MD console. Part of 39 OSS (39OSS/OSA) can provide updated airfield status or be requested to perform a runway or airfield inspection. **HOWEVER, coordinate all frag/schedule changes through JOC, and let them contact the appropriate agency.**
  - **Weather-** Part of 39 OSS (39OSS/OSW) can be contacted for weather updates/questions and for problems with the computerized weather display.
  - **Security Police-** Law Enforcement Desk 6-3200. Provides normal security services. Can be contacted to respond to security problems on airfield or SOCs.

#### CHECKOUT PROGRAM

- Checkout program designed to ensure standardization/qualification
  - MD01- Supervised AM Mad Dog tour
  - MD02- Supervised PM Mad Dog tour (A-day preferred)
  - DU01- Supervised B-day Duke flight
  - DU02- Supervised A-day Duke flight - ("CHECKRIDE")
  - **CFAC/DO interview BEFORE performing solo DUKE duties !!**
  - MD01 must be done BEFORE MD02 and DU01
  - DU01 must be done BEFORE DU02
  - MD/DU sorties should be scheduled with different IMDs and IDUs, if possible

## QUICK REACTION CHECKLISTS

(Located in MD and ACE checklists)

- JTIDS link inop
- SATCOM inop
- Frag execution problems
  - Weather homeplate/AOR/divert base
  - Slips/Rolex's/Schedule changes
  - AWACS late T/O - Late On-Station time
  - AWACS degraded operations
  - Tanker late T/O or abort
  - Tanker early RTB
  - Fighter late T/O or abort
  - Fighter prohibited/permissible single-ship options
- Aircraft emergencies/diverts
- Combat diverts
- SAR operations
- Hostile tracks / Hostile groundfire
- Unknown tracks, origin, location, direction, actions
- Unidentified potentially hostile CAPs outside AOR
- Maverick Support Missions
- Olive Comfort / Olive Branch Missions
- UN Support Missions
- Restrictions
  - Turkish imposed
  - UN / HHQ imposed
- Aircraft/Systems capabilities/limitations
  - AWACS
  - Tankers
  - Fighters/Recce/Weasel/Jammers
  - Helicopters/SAR Forces
- Ground forces capabilities/limitations
- Normal procedures
  - Mad Dog opening/closing procedures/ show/changeover times
  - Duke start-up/shut-down procedures/ show/brief times
  - AWACS console operations
  - AWACS crew coordination (AWACS "Where's Waldo" for Dukes)

OPERATION PROVIDE COMFORT COMBINED TASK FORCE / C3  
MISSION DIRECTOR / AIRBORNE CONTROL ELEMENT CHECKOUT

MD-01 SUPERVISED AM MISSION DIRECTOR TOUR

This tour is a "first look" at the Mission Director (callsign MAD DOG) opening procedures; equipment and its operation; OPSEC and COMSEC concerns and responsibilities; launch flow/problems; command post coordination (MOC, EA Cell, Intel, SRC, etc.); radio procedures; and coordination with the CFAC chain of command.

A. References

1. Mission Director Book (MDB)
2. OPC Aircrew Read File (ARF)
3. OPC Airspace Coordination Order (ACO)
4. OPC Air Tasking Order (ATO)
5. SAR Book
6. TADIL-A Link 11 book
7. MD/ACE Meeting/Notes book
8. CTF/CG, CFAC/CC, CFAC/DO guidance
9. Olive Branch/ Olive Comfort Procedures
10. OPC Rules of Engagement (ROE)

B. CHECKOUT ELEMENTS

1. Instructor Mission Director (IMD) will demonstrate use of the Mission Director Opening Checklist.
2. Upgrading Mission Director (UMD) will read:  
MDB \_\_\_\_\_; ARF \_\_\_\_\_; MD/ACE Meeting/Notes Book \_\_\_\_\_;  
ACO \_\_\_\_\_; OPC ROE \_\_\_\_\_; Intercepted Track Decision Tree \_\_\_\_\_  
and become fluent with their contents.
3. UMD will be familiar with the HAVE QUICK Radio; UHF Radio; the SATCOM Radio; the HF radio; and the STU-III. UMD will know its location, operating procedures, limitations, typical problems and their solutions, and emergency maintenance phone numbers.
4. UMD will know the contents of the Search and Rescue Book and OPC SAR Procedures.
5. UMD will know how to operate/read the TADIL-A Link 11 display unit, its symbology, and how to use the field phone to contact ROADWARRIOR if symbology or unit are inoperative or in error.

6. UMD will become familiar with the operation of the computerized weather display and the various weather display pages as well as how to get ahold of Weather on the MD console hotline for questions or updates.

7. UMD will be familiar with weather requirements/ limitations/ restrictions. Through discussion with IMD, various weather situations will be covered along with expected actions to be taken.

8. UMD will become proficient with the proper use of authenticators, as they're used in-theater, for both requesting and giving authentication.

9. UMD will become familiar with CTF/CC...CFAC/CC Daily Recap Log, OPC Sortie Log, and proper record-keeping to ensure next MD has a clear record of what has transpired before he came on duty.

10. UMD will become familiar with MD changeover procedures and briefing.

11. With IMD, UMD should visit JOC, JSOTF, Intel, EA Cell, and SAVVY OPS. Visit to SOC's good also, time permitting.

12. UMD will become familiar with French Recall Procedures, Olive Comfort/Branch Missions, and Pilgrim Messages.

13. UMD will become familiar with the MD/ACE Quick Reaction Checklists.

14. UMD will become familiar with Alternate, Emergency Divert, Combat Divert bases -- their location, characteristics, support available and limitations/concerns/policies with OPC aircraft using each.

- OPERATION PROVIDE COMFORT COMBINED TASK FORCE / C3  
MISSION DIRECTOR / AIRBORNE CONTROL ELEMENT CHECKOUT

MD-02 SUPERVISED PM MISSION DIRECTOR TOUR (A-DAY PREFERRED)

This tour is intended for the Upgrading Mission Director (UMD) (callsign MAD DOG) to demonstrate entry-level proficiency at performing Mission Director duties and for the Instructor Mission Director (IMD) to cover any topics which did not get covered on MD-01 or on which the UMD has questions.

A. REFERENCES

1. Mission Director Book (MDB)
2. OPC Aircrew Read File (ARF)
3. OPC Airspace Coordination Order (OPC)
4. OPC Air Tasking Order (ATO)
5. SAR Book
6. TADIL-A Link 11 book
7. MD/ACE Meeting/Notes book
8. CTF/CG, CFAC/CC, CFAC/DO guidance
9. Olive Branch/ Olive Comfort Procedures

B. CHECKOUT ELEMENTS

1. UMD demonstrates at least entry-level proficiency in duties/tasks/ documents identified in MD-01.
2. UMD handles all radio/telephone calls with assistance (as required) from the IMD.
3. IMD will discuss various contingency situations with the UMD, such as AWACS problems both on the ground and after airborne; Slips vs Rolex considerations; Tanker problems/dropouts; radio problems as well as previously successful solutions to these problems.
4. IMD explains MD changeover and shutdown procedures.
5. UMD completes the CFAC/CC Daily Sortie Recap Log and OPC Sortie Summary Sheet.
6. IMD shows UMD where to pick up MAD DOG mail at CTF/C3.
7. IMD shows UMD where and how to refuel the HUMVEE.

7. IAD will demonstrate how to set-up and update weather "TD" for Incirlik AB on console display.

8. When "cleared mission radios", IAD will demonstrate how to determine which frequencies are loaded into which console positions and how to change those frequencies or assignments and who "owns" which radio nets.

9. UAD will become familiar with the contents of the Duke Book and OPC Aircrew Aid.

10. IAD will demonstrate techniques on how to keep track of, and account for, all classified and COMSEC materials received on-board AWACS.

11. UAD will become fluent with the ACO; ATO; and the OPC ROE.

12. IAD will demonstrate how to ensure ACO/ATO/ROE and CTF/CG and CFAC/CC guidance are being complied with in the AOR. (ie: ensuring two air-to-air flights and a wild weasel flight are in the AOR before and during other OPC flight operations begin.)

13. IAD will review with the UAD different situations which might develop, including JTIDS link going down; AWACS radar going down before and after fighters enter the AOR; Unknown Track in the AOR; weather deteriorating in the AOR, Incirlik, Combat Divert Base; Aircraft emergencies/no-shows; partial flights arriving; Turkish-directed early RTB; chain of command coordination; enemy action in the AOR; tanker early RTB or aborts/no-shows.

14. IAD will review Provide Noise and Provide Response MCC Support Mission procedures with the UAD.

15. IAD will review A-Day, B-Day, C-day, and CFM-day differences for AWACS flight profile (ie: wake-up orbit for two hours, limited time allotted for radar wakeup/ JTIDS link establishment, etc...)



OPERATION PROVIDE COMFORT COMBINED TASK FORCE / C3  
MISSION DIRECTOR / AIRBORNE CONTROL ELEMENT CHECKOUT

DU-01 SUPERVISED B-DAY "ACE" FLIGHT

This flight is a "first-look" at the Airborne Control Element (ACE) (callsign DUKE) procedures to include preflight briefing times; the Duke Book and its contents; headsets; typical on-board console position/seat; console set-up and operation; OPC ROE; AOR Intercepted Track Decision Tree; OPSEC and COMSEC concerns/responsibilities; radio procedures; E-3 AWACS crew composition, coordination and functions; role, function and authority of the on-board Turkish Controller (TC); flight debriefing; and coordination with the CTF - CFAC chains of command.

A. REFERENCES

1. Airborne Control Element (ACE, callsign "Duke") book
2. 552ACW (Deployed) AWACS OPC Procedures
3. OPC Aircrew Read File (ARF)
4. OPC Airspace Coordination Order (ACO)
5. OPC Air Tasking Order (ATO)
6. Olive Branch/ Olive Comfort Mission Procedures
7. Provide Noise and Provide Response MCC Support Mission Procedures
8. Miscellaneous E-3 equipment documentation (as required)

B. CHECKOUT ELEMENTS

1. Instructor ACE/Duke (IAD) will demonstrate how to determine E-3 takeoff, brief, and land times, covering the rules on how to determine show time.
2. IAD will show Upgrading ACE/Duke (UAD) SAVVY OPS layout, location of Duke Book, and flight authorization sign-out procedures as well as how to get starting weather observations and forecasts off of the weather computer.
3. IAD will demonstrate and discuss normal pre-boarding ground operations.
4. After boarding the E-3, the IAD will identify the Duke console position and demonstrate proper gear storage, console preflight and strap-in procedures.
5. Seat 5 for takeoff for the UAD is an option to facilitate getting a better "lay of the land" in the Incirlik AB area. This also provides a "reprieve" from the many hours of "tubular time" which are to come.
6. Once AWACS Mission Crew Commander (MCC) identifies the crew is "cleared switches" IAD will demonstrate proper AWACS radar console setup and assignment and comm panel setup.

OPERATION PROVIDE COMFORT COMBINED TASK FORCE / C3  
MISSION DIRECTOR / AIRBORNE CONTROL ELEMENT CHECKOUT

DU-02 SUPERVISED A-DAY "ACE" FLIGHT - "CHECKRIDE"

This flight is intended for the Upgrading ACE/Duke (UAD) to demonstrate entry-level proficiency in the Airborne Control Element (ACE) duties and responsibilities observed/practiced on DU-01 and for the IAD to cover any topics which did not get covered during DU-01 or on which the UAD has questions.

A. REFERENCES

1. Airborne Command Element (ACE, callsign "Duke") book
2. 552ACW (Deployed) AWACS OPC Procedures
3. OPC Aircrew Read File (ARF)
4. OPC Airspace Coordination Order (ACO)
5. OPC Air Tasking Order (ATO)
6. Olive Branch/ Olive Comfort Mission Procedures
7. Provide Noise and Provide Response MCC Support Mission Procedures
8. Miscellaneous E-3 equipment documentation (as required)

B. CHECKRIDE ELEMENTS

1. The UAD will demonstrate, at a minimum, satisfactory entry-level proficiency with the ACE/Duke responsibilities covered in DU-01.
2. UAD will handle all radios/situations and normal ACE/Duke procedures. (Assistance from the IAD may be provided if unusual or previously unbriefed situations develop however all discrepancies will be corrected to 100% before recommending UAD for CFAC/DO interview and certification.)
3. IAD will discuss various contingency situations with the UAD to determine satisfactory knowledge of procedures/policies.
4. IAD will debrief UAD on mission performance and make known his recommendation for either another ACE/Duke Flight or CFAC/DO interview and certification.



COMBINED TASK FORCE - OPERATION PROVIDE COMFORT  
COMBINED FORCES AIR COMPONENT  
Incirlik Air Base, Turkey

MISSION DIRECTOR / AIRBORNE CONTROL ELEMENT(ACE)  
CHECKOUT PROGRAM VERIFICATION / CERTIFICATION

A. INDIVIDUAL DATA:

- 1) Name, Rank, component \_\_\_\_\_
- 2) Home Unit/Office symbol \_\_\_\_\_
- 3) Official mailing address \_\_\_\_\_  
\_\_\_\_\_
- 4) Date arrived OPC \_\_\_\_\_
- 5) Projected Departure Date \_\_\_\_\_

B. CHECKOUT PROGRAM VERIFICATION:

- 1) Read ROE, ACO, ARF, SAR procedures, MD/ACE checklists Olive Branch/Olive Comfort Procedures, Pilgrim Message Procedures, Provide Noise and Provide Response MCC Support Mission procedures; Miscellaneous guidance in Mission Director and ACE (Duke) books, 552 ACW (Deployed) procedures. \_\_\_\_\_
- 2) MD-01, Supervised AM Mad Dog Tour \_\_\_\_\_
- 3) MD-02, Supervised PM Mad Dog Tour \_\_\_\_\_
- 4) DU-01, Supervised B-day Duke Flight \_\_\_\_\_
- 5) DU-02, Supervised A-day Duke Flight \_\_\_\_\_  
"Checkride"
- 6) CFAC/DO Interview/Certification scheduled: \_\_\_\_\_

C. CFAC/DO INTERVIEW/CERTIFICATION:

Interview conducted this day concerning CTF/CG, CFAC/CC, and CFAC/DO guidance and policies; mission importance and significance of the role of the Mission Director and Airborne Control Element(ACE).

I certify that \_\_\_\_\_  
is qualified to perform the duties of Mission Director and Airborne Control Element for the Combined Task Force, Operation Provide Comfort.

date: \_\_\_\_\_

signature: \_\_\_\_\_  
signature  
block

# PROVIDE COMFORT MISSION TASKING COORDINATION

INITIATED BY (NAME, RANK, UNIT)

DATE & TIME INITIATED

## REQUESTED SORTIE CONTRACT

	A	B	C
TAOR	<u>    </u> x <u>    </u>	<u>    </u>	<u>    </u> x <u>    </u>

NO FLY/REDUCED FLY DAYS

JUSTIFICATION:

OETCO (Last, First, Mi. Rank)

Signature

OSC COMMENTS:

Initials

OSS COMMENTS:

Initials

OG COMMENTS

APPROVED/DISAPPROVED

Initials

**TAB AA**

**REGULATIONS AND DIRECTIVES**

- AA-17 Combined Task Force, OPC, Combined Forces Air Component  
Mission Director/Airborne Control Element Checkout Program  
Verification/Certification**
- AA-18 39th Operations Group Operating Instruction 55-6, Schedule**
- AA-19 39th Operations Group Operating Instruction 55-7, Mission  
Director (MADDOG/DUKE)**
- AA-20 UH-60 Black Hawk Operator's Manual**
- AA-21 DOD Technical Manual 86-100, Mode 4 Handbook**
- AA-22 52nd Operations Group Operating Instruction 200-5, Intelligence**
- AA-23 Extracts from 552nd ACW (Deployed) Local Procedures for OPC**
- AA-24 Extract from Combined Task Force Provide Comfort OPLAN  
91-7 (See also Classified Addendum) AA-17**
- AA-25 Chronology of Rules of Engagement for OPC AA-18  
(See Classified Addendum) AA-19  
AA-20**

3060A, D.  
CW4 AV  
TM 55-1520-237-10

CHANGE	DATE	POSTED	INITIALS
CHG 9	2 JUL 90	27 MAR 91	DCS
CHG 10	24 JUL 90	27 MAR 91	DCS
CHG 11	24 AUG 90	27 MAR 91	DCS
CHG 12	13 FEB 91	27 MAR 91	DCS
CHG 13	30 AUG 91	04 DEC 91	DCS
CHG 14	11 OCT 91	10 JAN 92	DCS
CHG 15	29 NOV 91	APR 92	DCS
CHG 16	30 SEP 92	9 MAR 93	DCS
CHG 17	08 SEP 92	21 APR 93	DCS
CHG 18	15 FEB 93	21 APR 93	DCS
CHG 19	31 JUL 93	DEC 93	DCS
CHG 20	16 AUG 93	4 OCT 93	DCS

TECHNICAL MANUAL

OPERATOR'S MANUAL

UH-60A AND EH-60A HELICOPTER

THIS MANUAL SUPERSEDES  
TM 55-1520-237-10/ TO 1H-60(U)A-1,  
21 MAY 1979, INCLUDING ALL CHANGES.

"Approved for public release; distribution is unlimited."

This copy is a reprint which includes current  
pages from Changes 1 through 8.

HEADQUARTERS, DEPARTMENT OF THE ARMY

8 JANUARY 1988

CONTROL/INDICATOR	FUNCTION	
MODE 4 TEST/ON/OUT	Determines whether Mode 4 is on, off, or in BIT operation.	f. MASTER switch - NORM.
MODE 4 AUDIO/LIGHT/OUT	Controls method of monitoring Mode 4 operation.	g. M-1 switch - Hold at TEST, observe that only TEST GO indicator is on.
MODE 4 REPLY	Indicates that a Mode 4 reply is generated.	h. M-1 switch - Return to ON. If modes 2, 3A or M-C are to be used, check as follows:
IDENT/OUT/MIC	Controls transmission of I/P pulse. <i>Ident. Indicator</i>	i. M-2, M-3/A and M-C switches - Repeat steps g. and h.
MODE 1 Selector buttons	Selects Mode 1 code to be transmitted.	
MODE 2 Selector buttons	Selects Mode 2 code to be transmitted.	
MODE 3/A Selector buttons	Selects Mode 3/A code to be transmitted.	

**NOTE**

Do not make any checks near a radar site or with MASTER control switch in EMER, nor with M-3/A codes 7600 or 7700, without first, obtaining authorization from the interrogating station(s).

The following steps can be done only with KIT/1A computer transponder installed.

j. MODE 4 CODE switch - A.

(1) Set assigned test code in the KIT/1A computer transponder.

(2) AUDIO-ON-OUT switch - OUT.

(3) MODE 4 TEST-ON-OUT switch - Place to TEST and hold, then release.

(4) TEST GO light - ON, MODE 4 REPLY light off, KIT STATUS light off.

k. When possible, request cooperation from interrogating station to activate radar TEST mode.

(1) Verify from interrogating station that MODE TEST reply was received.

(2) RAD TEST switch - RAD TEST and hold.

(3) Verify from interrogating station that TEST MODE reply was received.

**3-160. OPERATION.****3-161. Starting Procedure.**

If the MODE 2 code has not been set previously, loosen two screws which hold MODE 2 numeral cover, and slide this cover upward to expose numerals of MODE 2 code switches (Figure 3-26). Set these switches to code assigned to helicopter. Slide numeral cover down and tighten screws.

a. MASTER switch - STBY. NO-GO light should be on.

b. Allow 2 minutes for warmup.

c. MODES 1 and 3A CODE selector buttons - Press and release until desired code shows.

d. TEST, TEST/MON, and REPLY indicators - PRESS-TO-TEST. If MODE 1 is to be used, check as follows:

e. ANT switch - DIV.

**EXTRACT**

I certify that I am the Record's Custodian for the Accident Investigation Board convened to investigate the crash of two U.S. Army Black Hawk helicopters in the no fly zone in northern Iraq on 14 April 1986, and that this is a true and accurate extract from

T.O. 55-1520-237-10

which is kept in my records system.

23 May 86

EWB

W. L. HAWKINS  
WILLIAM L. HAWKINS, Capt, USAF MSC  
Evidence Custodian  
Incirlik Air Base, Turkey

Change 19

3-65

### 3-162. Normal Procedures.

Completion of the stopping procedure leaves the AN/APX-100(V) in operation. The following steps may be required, depending upon mission.

a. MODE 4 CODE selector switch - A or B as required.

(1) If code retention is desired, momentarily place the MODE 4 CODE selector switch to HOLD.

(2) If code retention in external computer is not desired during transponder off mode, place MODE 4 CODE selector switch to ZERO to dump external computer code setting.

b. Mode M-1, M-2, M-3/A, M-C, or MODE 4 switches - Select desired mode.

c. Identification of position (I/P) Switch - IDENT, when required, to transmit identification of position pulses or set I/P switch to MIC to transmit I/P pulse only when microphone press-to-talk switch is actuated. (I/P pulses will be for 15 - 30-second duration when activated.)

### 3-163. Emergency Operation.

During a helicopter emergency or distress condition the AN/APX-100(V) may be used to transmit specially coded emergency signals on mode 1, 2, and 3/A and 4 to all interrogating stations. Those emergency signals will be transmitted as long as the MASTER control switch on the control panel remains in EMER.

MASTER control switch - EMER.

### 3-164. Stopping Procedure.

Refer to paragraph 3-162, step a. (1) and (2) before stopping transponder.

MASTER switch - OFF.

### 3-165. Transponder Computer KIT-1A/TSEC.

The transponder computer in the nose section of the helicopter operates in conjunction with mode 4. A caution light on the caution panel, marked IFF, will go on when a malfunction occurs in mode 4 or the computer that will prevent a reply when interrogated. Mode 4 operation is selected by placing the MODE 4 switch ON, provided the MASTER switch is at STBY or NORM. Placing the

MODE 4 switch to OUT disables mode 4. MODE 4 CODE switch is placed in ZERO, A, and HOLD. The switch must be lifted a detent switch to ZERO. It is spring-loaded to return from HOLD to the A position. Position A selects the mode 4 code for the present code period and position B selects the mode 4 code for the succeeding period. Both codes are mechanically inserted by a code-changing key. The codes are mechanically held in the transponder computer, regardless of the position of the MASTER switch or the status of helicopter power, until the first time the helicopter becomes airborne. Thereafter, the mode 4 codes will automatically zeroize any time the MASTER switch or helicopter power is turned off. The code setting can be mechanically retained. With weight on the landing gear, turn the MODE 4 CODE switch to HOLD (only momentary actuation is required) and release the MASTER switch or helicopter power must be turned OFF within 15 seconds following placing MODE 4 CODE select switch to HOLD. Mode 4 codes can be zeroized any time the helicopter power is on and the MASTER switch is not in OFF, by turning the CODE switch to ZERO. Power to operate the transponder computer is provided automatically when the AN/APX-100(V) is on. The transponder computer KIT-1A/TSEC operation is classified.

### 3-165.1. Cryptographic Computer Kit-1C.

The cryptographic computer uses electronic key loading. Key loading is accomplished by use of the KYK-13 Electronic Transfer Device per TM 11-5810-389-13&P. The Cryptographic Computer Kit-1C operation is classified.

### 3-166. Altimeter Set AN/APN-209(V).

The radar altimeter system (Figure 3-27) provides instantaneous indication of actual terrain clearance height. Altitude, in feet, is displayed on two radar altimeter indicators on the instrument panel in front of the pilot and copilot. The radar altimeter indicators each contain a pointer that indicates altitude on a linear scale from 0 to 200 feet (10 feet per unit) and a second-linear scale from 200 to 1500 feet (100 feet per unit). An ON/OFF/LO altitude bug set knob, on the lower left corner of each indicator, combines functions to serve as a low level warning bug set control, and an on/OFF power switch. The system is turned on by turning the LO control knob, marked SET, of either indicator, clockwise from OFF. Continued clockwise turning of the control knob will permit either pilot to select any desired low-altitude limit, as indicated by the LO altitude



**TAB AA**

**REGULATIONS AND DIRECTIVES**

- AA-17 Combined Task Force, OPC, Combined Forces Air Component  
Mission Director/Airborne Control Element Checkout Program  
Verification/Certification**
- AA-18 39th Operations Group Operating Instruction 55-6, Schedule**
- AA-19 39th Operations Group Operating Instruction 55-7, Mission  
Director (MADDOG/DUKE)**
- AA-20 UH-60 Black Hawk Operator's Manual**
- AA-21 DOD Technical Manual 86-100, Mode 4 Handbook**
- AA-22 52nd Operations Group Operating Instruction 200-5, Intelligence**
- AA-23 Extracts from 552nd ACW (Deployed) Local Procedures for OPC**
- AA-24 Extract from Combined Task Force Provide Comfort OPLAN  
91-7 (See also Classified Addendum) AA-17**
- AA-25 Chronology of Rules of Engagement for OPC AA-18  
(See Classified Addendum) AA-19**
- AA-20 AA-20**
- AA-21 AA-21**

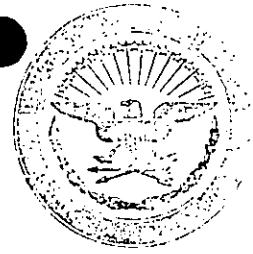

**DOD AIMS 86-100**

---

**TECHNICAL MANUAL**

**OPERATION AND MAINTENANCE OVERVIEW  
GENERAL TRI-SERVICE**

**MODE 4 HANDBOOK**

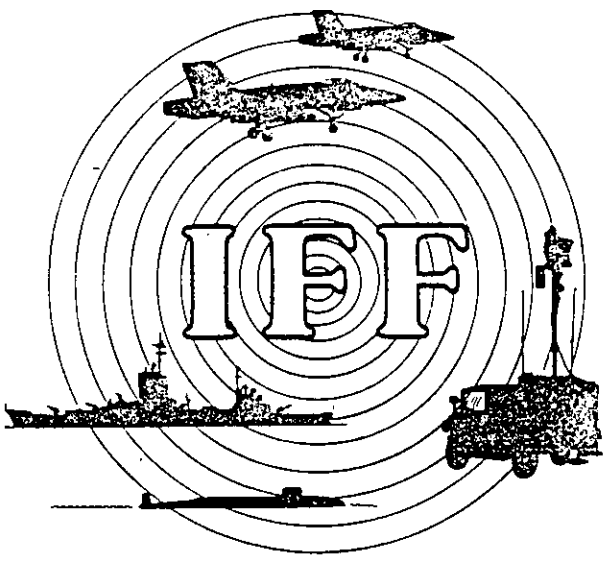

MANUAL PREPARED BY  
NAVAL ELECTRONIC SYSTEMS ENGINEERING ACTIVITY  
ST. INIGOES, MD 20684-0010

~~This document contains information that is EXEMPT FROM MANDATORY  
DISCLOSURE UNDER THE FREEDOM OF INFORMATION ACT. Exemption 3 applies.~~

PUBLISHED BY DIRECTION OF AIMS PROGRAM OFFICE.  
CHANGES TO THIS PUBLICATION MUST BE AUTHORIZED BY DOD AIMSPD.

---

**MAY 1987**



4-4.2.3 Automatic Mode 4 Override Enable. An interrogator system may be associated with an automated surveillance or weapon system. In that case, the system often has the means to remotely enable Mode 4 override. In most cases, this is in addition to and does not interfere with manual Mode 4 operation. When automatic Mode 4 enabling is used, it is typically sector enabled under computer program control. However, surveillance or weapon systems may interrogate Mode 4 automatically. The system processes replies and may or may not communicate the evaluation to the operator.

#### 4-5 TRANSPONDER SYSTEM MODE 4 CONTROLS AND INDICATORS.

The transponder system provides several controls and indicators for using and monitoring the Mode 4 function. Most of these controls and indicators are located on the transponder's control head. The remaining controls and indicators are located on special equipment enclosures or on various aircraft instrumentation panels. The following is a discussion of Mode 4 controls and indicators found on the transponder control head. Figure 4-2 shows three commonly used transponder control heads. Refer to those figures during the discussion that follows.

##### 4-5.1 Transponder Control Head Controls and Indicators.

4-5.1.1 Mode 4 Code Switch. The Mode 4 code switch provides the functions listed below.

a. It selects the A or B Mode 4 operational key. In the A or B position, this switch selects the corresponding Mode 4 operational key. A Mode 4 operational key loaded into the transponder computer consists of operational Mode 4 keys for two consecutive code periods. The B position of this switch selects the next period's Mode 4 key at the end of the current Mode 4 crypto period without rekeying the transponder computer. Refer to section 4-6 for a more complete discussion of Mode 4 key changing at the end of the crypto period.

b. It enables the Mode 4 code hold circuits. In the hold position, this switch activates the Mode 4 code hold circuits of the transponder computer. The Mode 4 code hold circuits prevent the loss of the Mode 4 key if power is removed from the transponder computer. This feature allows for a shutdown of power to the transponder system without the need to reload the transponder computer when power is restored. This switch position also enables the Mode 4 code hold circuits of the interrogator computer in some aircraft with interrogation systems installed. Refer to paragraph 4-8 for a more complete discussion of the Mode 4 code hold function.

c. It zeroizes the Mode 4 key in the transponder computer. In the zero position, the Mode 4 key is zeroized (cleared) in the transponder computer. This switch position also zeroizes the Mode 4 key in the interrogator computer in some aircraft with an interrogator system installed. Refer to paragraph 4-7 for a more complete discussion of the Mode 4 key zeroize function.

4-5.1.2 Rad Test Switch. The rad test switch serves a dual function. In Mode 4 operation, it is used to select verify bit 1. In SIF operation, it enables a mode 3 reply to a special test mode interrogation. This requires a special purpose test set. In some aircraft with an interrogator system installed, this switch also enables the interrogator system's verify bit 1 function. Refer to paragraphs 4-4.1.3 and 4-9 for a more complete discussion of the verify bit 1 function.

4-5.1.3 Mode 4 On/Out Switch. The Mode 4 on/out switch is used to enable the transponder computer to reply to compatible Mode 4 interrogations. This switch must be placed in the on position before the

Original

EXTRACT	
I certify that I am the Records Custodian for the Accident Investigation Board convened to investigate the crash of two U.S. Army Black Hawk helicopters in the no fly zone in northern Iraq on 14 April 1994, and that this is a true and accurate extract from	
<u>DoD AIMS 86-100</u>	
which is kept in my records system.	
23 May 94 Date	<u>William L. Harris</u> WILLIAM L. HARRIS, Capt. USAF, MSC Evidence Custodian, Incirlik Air Base, Turkey

4-5

transponder computer can generate Mode 4 replies. When the switch is in the out position and the Mode 4 function is otherwise operational, the transponder computer will not generate a reply if the interrogation was compatible. If no disparity pulse or reply is generated in response to an interrogation, the Mode 4 caution light will light, indicating to the transponder system operator that **the system was interrogated with a compatible key but did not reply.**

4-5.1.4 Mode 4 Audio/Out/Light Switch. This switch is used to enable the Mode 4 reply light or the Mode 4 audio tone.

- a. In the audio position, the Mode 4 reply light and Mode 4 audio tone are enabled.
- b. In the out position, both the Mode 4 reply light and Mode 4 audio tone are disabled. The press-to-test function of the Mode 4 reply light is also disabled.
- c. In the light position, the Mode 4 reply light is enabled and the Mode 4 audio tone is disabled.

4-5.1.5 Mode 4 Reply Light. The Mode 4 reply light provides a visual indication to the transponder operator that Mode 4 replies are being transmitted. For this light to function, it must be enabled by placing the Mode 4 audio/out/light switch in the light or audio position.

4-5.1.6 Mode 4 Audio Tone. Transponder operators can monitor Mode 4 function via their headset or speaker by selecting the audio position on the transponder control. With most transponders, when the operator hears a tone in the headset, this indicates that you have been interrogated by a Mode 4 key compatible with the key in your transponder computer.

**NOTE**

Remember the use of the terms compatible and valid. Compatible indicates a key which matches that of your transponder. Valid means a key that is theoretically possible but not necessarily the correct Mode 4 key for the crypto period.

Note, however, that a tone in the headset of AN/APX-100 users means that you have been interrogated by an incompatible Mode 4 key. Table 4-1 below sums up the different meanings of tones.

Table 4-1. Transponders' Use of Mode 4 Audio

	AN/APX-72	AN/APX-64	KY-532/533	AN/APX-100	AN/APX-101
Compatible Mode 4 Key Received	tone	tone	tone*		tone
Incompatible Mode 4 Key Received				tone	

\* Note: When technical improvement program modifications are complete, the KY-532 audio system will operate like an AN/APX-100.

If you're using any of the transponders that produce a tone when interrogated with a compatible key (AN/APX-72, AN/APX-64, KY-532/533, AN/APX-101), your transponder will either:

- a. Reply, indicated by a reply light on the transponder control
- b. Not reply, indicated by an IFF caution light.

One of several reasons may cause your transponder to not reply; these reasons are listed in 4-5.2.1 below. AN/APX-100 users will hear a tone if their transponder computer receives an incompatible key. Check your Mode 4 A/B switch to make sure its position corresponds to the current crypto period (see paragraph 4-6). If your A/B switch is set correctly, either your transponder or the interrogator has been loaded with an incompatible Mode 4 key. Follow your operational orders in this situation.

**4-5.2 Additional Transponder System Mode 4 Controls and Indicators.** The following Mode 4 circuits and indicators will be found on special control box enclosures or on various aircraft instrumentation panels.

**4-5.2.1 Mode 4 Caution Light.** Each transponder installation is equipped with a Mode 4 caution light to indicate one of the following conditions:

- a. The transponder computer is installed, with power applied, but is not loaded with a valid Mode 4 key or the key has been zeroized.
- b. The transponder computer has failed its self-test cycle.
- c. A compatible Mode 4 interrogation was received but no Mode 4 reply was transmitted. This condition occurs if:
  1. **The transponder system is in standby**
  2. A malfunction in the receiver-transmitter will not allow the Mode 4 reply to be transmitted or transmits the reply at very low power
  3. The Mode 4 on/out switch is in the out position.

In the case of a and b above, the Mode 4 caution light will be on steadily. In the case of c above, the Mode 4 caution light may cycle on and off depending on the recurrence of Mode 4 interrogations. In any event, the Mode 4 caution light is an indication to the transponder system operator that the Mode 4 function is not operating. In some aircraft with interrogator systems installed, the Mode 4 caution light also serves as an interrogator system general Mode 4 fault indicator.

**4-5.2.2 Code Hold Enable Switch.** Aircraft with rigid landing gear (such as some helicopters) are provided with a code hold switch. The switch is used to enable but not activate the Mode 4 code hold function. This switch serves the function of the landing gear interlock used with retractable and certain compressible landing gear aircraft. This switch must be placed in before the transponder system's code hold function can be activated. Refer to paragraph 4-8 for a more complete discussion of the Mode 4 code hold function.

#### **4-6 MODE 4 KEY CHANGING AT THE END OF THE CURRENT CRYPTO PERIOD.**

**4-6.1 The Crypto Period.** Currently, the Mode 4 crypto period is 24 hours long. Each daily Mode 4 operational key is replaced by a new operational key at the end of the crypto period. The interrogator and transponder system operators must know exactly when the end of the Mode 4 crypto period is and change to the new day's key at that time. Failure to change to the new day's key at the end of the crypto period will make the system's Mode 4 function incompatible with other Mode 4 systems. Operators must be sensitive to the fact that not all units will complete the change to the new Mode 4 key at precisely the same time.

**4-6.2 Rekeying the KIR-1 or KIT-1 Crypto Computers.** When possible, the interrogator and transponder computers should be rekeyed with the new Mode 4 operational key at the beginning of each new crypto

**TAB AA**

**REGULATIONS AND DIRECTIVES**

**AA-17 Combined Task Force, OPC, Combined Forces Air Component  
Mission Director/Airborne Control Element Checkout Program  
Verification/Certification**

**AA-18 39th Operations Group Operating Instruction 55-6, Schedule**

**AA-19 39th Operations Group Operating Instruction 55-7, Mission  
Director (MADDOG/DUKE)**

**AA-20 UH-60 Black Hawk Operator's Manual**

**AA-21 DOD Technical Manual 86-100, Mode 4 Handbook**

**AA-22 52nd Operations Group Operating Instruction 200-5, Intelligence**

**AA-23 Extracts from 552nd ACW (Deployed) Local Procedures for OPC**

**AA-24 Extract from Combined Task Force Provide Comfort OPLAN  
91-7 (See also Classified Addendum)**

**AA-17**

**AA-25 Chronology of Rules of Engagement for OPC**

**AA-18**

**(See Classified Addendum)**

**AA-19**

**AA-20**

**AA-21**

**AA-22**

29 April 1994

INTELLIGENCE

INTELLIGENCE TRAINING

This Operations Operating Instruction (OOI) outlines procedures and responsibilities for the intelligence training of all intelligence and direct support augmentee personnel and pilots within the OPG.

1.1. References:

- 1.1.1. AFR 35-45, Resource Augmentation Duty (READY) Program.
- 1.1.2. AFR 50-23, Enlisted Speciality Training.
- 1.1.3. USAFEP 200-5, USAFE Unit Intelligence Training Standards.
- 1.1.4. USAFER 51-50, Vol XXX USAFE Tactical Aircrew Training.
- 1.1.5. USAFER 200-33, USAFE Unit Intelligence Functions and Responsibilities.
- 1.1.6. OOI 200-33, Intelligence Mission, Organization, and Responsibilities.

1.2. Responsibilities:

1.2.1. As the OPG single point of contact for all intelligence related training matters, 52d Operations Support Squadron Intelligence Flight (52 OSS/INF) will:

1.2.1.1. Establish intelligence training standards and supervise the intelligence personnel training program through the fighter squadron (FS)/DOIs to ensure that assigned personnel, including augmentees, receive training in command intelligence directives, policies and procedures, unit commitments, and lateral intelligence responsibilities essential to the accomplishment of the 52 FW mission.

1.2.1.2. Conduct or monitor training in accordance with the references listed above.

1.2.1.3. Provide each fighter squadron commander (FS/CC) with recommendation prior to decisions regarding AFSC qualification for any deviations to routine USAF requirements for maintenance and upgrade of intelligence skill levels.

1.2.1.4. Make supporting documents, target materials, and personnel expertise available to each squadron's intelligence training programs (pilot and intelligence personnel). This includes coordinating OSS Weapons and Tactics Flight (DOW), US Army Ground Liaison Team (GLT), and OPG Standards and Evaluation (OPG/DOV) support and expertise.

1.2.1.5. Schedule and conduct OPG centralized intelligence training.

---

Supersedes OPG OI 200-5, 14 Sep 92

No. of Printed Pages: 5

OPR: 52 OSS/INF/S

Approved by: Colonel Baptiste

Editor: MSgt McCallister

CERTIFICATE

I hereby certify that I am the Records Custodian for the Accident Investigation Board and that I have investigated the crash of two U.S. Army Black Hawk helicopters in northern Iraq on 14 April 1994, and that this is a true and correct copy of the records maintained in my records system.

20 May 94

WILLIAM J. ...  
Executive Officer  
Intelligence Operations

1.2.2. Each FS/CC is responsible for his unit's intelligence training and will:

1.2.2.1. Incorporate semi-annual pilot intelligence training needs in six month training plan and provide a copy to 52 OSS/INF, DOW, GLT, and OPG/DOV.

1.2.2.2. Conduct training in accordance with the references listed above and conduct semi-annual testing of required intelligence knowledge at each intelligence workcenter.

1.2.2.3. Coordinate with OSS/INF prior to making a decision regarding AFSC qualifications for any deviations to routine USAF requirements for maintenance and upgrade of intelligence skill levels.

1.2.2.4. Ensure the OSS/INF is aware of current warskills training status for assigned intelligence specialists. Identify the support required from INF, DOW, or GLT to accomplish squadron intelligence training.

1.3. Goals:

1.3.1. The INF and FS/DOIs will ensure three categories of training are given to intelligence personnel:

1.3.1.1. Basic intelligence orientation training.

1.3.1.2. Contingency/warskill training.

1.3.1.3. Job qualification training.

1.3.2. The FS/CCs will ensure the intelligence training provided to pilots is directly related to squadron doctrine mission statements and tasked OPLANS.

1.4. Procedures:

1.4.1. Each intelligence workcenter will conduct and document the minimum required training contained in USAFEP 200-5 and further training they deem necessary to meet unique mission requirements. Some USAFEP 200-5 standards pertain to intelligence functions performed differently at each workcenter, others pertain to generic functions performed the same throughout the OPG. For this reason the USAFEP 200-5 training standards have been divided into those OSS/INF will be responsible for maintaining and providing training for; and those individual intelligence flights will develop their own training for. Individual training standard OPRs are responsible for developing task listings (AF Form 797) and expanding on references listed in USAFEP 200-5 as "unit developed". Development of training programs which go beyond the "minimum" USAFEP 200-5 requirements are highly encouraged. OPRs for individual USAFEP 200-5 training standards are listed below.

STANDARD	DESCRIPTION
1-1	Security Training++
1-2	Unit Personnel Training++



1-3 Unit Plans\*\*  
1-4 Self-Inspection\*\*

2-1 Wartime Order of Battle and Situation display\*\*  
2-2 Combat Intelligence System\*\*  
2-3 Battle Situation briefings\*\*  
2-4 Alternate Command Post Operations\*\*  
2-5 Intelligence Reporting\*\* Debriefing\*\*  
2-6 POW/EPW Captured Document/Equipment Exploitation\*\*  
2-7 Workcenter Changeover Procedures\*\*  
2-8 Support to Combat Mission Planning/Prep\*\*  
2-9 Law of Armed Conflict\*\*  
2-10 Peacetime Order of Battle displays\*\*  
2-11 Training Program Objectives/Requirements\*\*  
2-12 The 6-Month Training Plan\*\*  
2-13 Developing the Training Objective\*\*  
2-14 Lesson Plans (Briefing scripts)\*\*  
2-15 Developing Tests and Test Analysis\*\*  
2-16 Maintaining Training Documentation\*\*  
2-17 Understanding Unit Weapon System\*\*  
2-18 Presenting a Training Briefing\*\*  
2-19 Demonstrating Subject Knowledge\*\*  
2-20 Documenting Training\*\*  
2-21 INO Support to Target Folder Programs\*\*  
2-22 Intelligence Data Base\*\*  
2-23 Current Intelligence Briefing\*\*

3-1 Determine and Verify Tasking from Orders\*\*  
3-2 Mission planning Cell Responsibilities\*\*  
3-4 Determine Types of Target Tasking\*\*  
3-5 Targets Cycle and Mission Planning\*\*  
3-6 Construct Navigation Charts\*\*  
3-11 Target Materials\*\*  
3-12 Maps and Charts\*\*  
3-13 Geodetic Data\*\*  
3-14 Analytical Photogrametric Positioning System\*\*

#### OTHER STANDARDS

SENTINEL BYTE OPERATOR\*\*  
SENTINEL BYTE System Administrator\*\*  
IMOM Operator\*\*  
SB/IDB Operator\*\*  
Image File Server User\*\*  
CONSTANT SOURCE Analyst\*\*

\*\*OSS/INF is OPR for these training standards.

++Individual intelligence flights are OPR for these training standards.

#### 1.4.2. Pilot Intelligence Training

1.4.2.1. Each fighter squadron will develop a semi-annual pilot intelligence training plan to ensure both mission support and curricular flex-

ibility. Based on advise from squadron DOI, DOW, DOX, and GLT, squadron commanders will task their DOIs with intelligence areas of concentration. The squadron should use the following consideration when tasking:

1.4.2.1.1. Doctrinal mission(s)

1.4.2.1.2. OPLAN contingencies

1.4.2.1.3. Current "real-world" deployments

1.4.2.1.4. TDY training schedule

1.4.2.1.5. Exercise schedule

1.4.2.1.6. A standard mix of DOW/IN topics--air, SAM, AAA, EC, E&E, tactics, visual recognition, countermeasures, employment doctrine, and weapons systems of former WARPAC, US, European or Asian design.

1.4.2.2. A copy of each FS training plan will be provided to INF, DOW, GLT, and OPG/DOV (through INF) to allow them to make supporting documents, target materials, and personnel expertise available. These four organizations will also review the plans and provide observations to FS commanders on the depth and variety of the training. OPG/DOV will continue to use the USAFE MQF as a basis for NATO Tactical Evaluations.

1.4.3. Centralized Intelligence Training

1.4.3.1. This training pertains to all intelligence personnel throughout the OPG and is mandatory for those assigned. It will be held at a minimum of twice monthly.

1.4.3.2. Training will consist of USAFEP 200-5 training standards which apply to all intelligence personnel and those areas the SIO or squadron DOIs identify as deficiency items during inspections, exercises, or real-world contingencies.

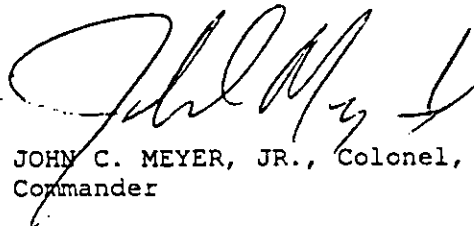

JOHN C. MEYER, JR., Colonel, USAF  
Commander

Attachment:  
Distribution List

DISTRIBUTION LIST INTERNAL

23 FS/DOI  
53 FS/DOI  
480 FS/DOI  
510 FS/DOI  
606 ACS/CC  
52 OSS/CC  
52 OSS/DOMA

**TAB AA**

**REGULATIONS AND DIRECTIVES**

- AA-17 Combined Task Force, OPC, Combined Forces Air Component  
Mission Director/Airborne Control Element Checkout Program  
Verification/Certification**
- AA-18 39th Operations Group Operating Instruction 55-6, Schedule**
- AA-19 39th Operations Group Operating Instruction 55-7, Mission  
Director (MADDOG/DUKE)**
- AA-20 UH-60 Black Hawk Operator's Manual**
- AA-21 DOD Technical Manual 86-100, Mode 4 Handbook**
- AA-22 52nd Operations Group Operating Instruction 200-5, Intelligence**
- AA-23 Extracts from 552nd ACW (Deployed) Local Procedures for OPC**
- AA-24 Extract from Combined Task Force Provide Comfort OPLAN  
91-7 (See also Classified Addendum) AA-17**
- AA-25 Chronology of Rules of Engagement for OPC AA-18  
(See Classified Addendum) AA-19**
- AA-20 AA-20**
- AA-21 AA-21**
- AA-22 AA-22**
- AA-23 AA-23**

# 552 ACW DEPLOYED



## LOCAL PROCEDURES FOR OPERATION PROVIDE COMFORT

15 MARCH 1994

### EXTRACT

I certify that I am the Records Custodian for the Accident Investigation Board convened to investigate the crash of two U.S. Army Black Hawk helicopters in the no fly zone in northern Iraq on 14 April 1994, and that this is a true and accurate extract from

552 ACW (DEPLOYED) Local Procedures for OPE

which is kept in my records system.

14 May 94  
Date

W. L. Harris  
WILLIAM L. HARRIS, Capt, USAF, MSC  
Evidence Custodian, Incirlik Air Base, Turkey

66 02 2100 12

# TABLE OF CONTENTS

TABLE OF CONTENTS .....	i
I. GENERAL OPERATIONS .....	1
1. INTRODUCTION .....	1
2. ARRIVAL/INPROCESSING/SPINUP .....	1
3. CREW REST/DNIF COVER .....	1
4. CREW DUTY DAY/MAX FLIGHT TIME.....	2
5. DEPARTURE/OUT PROCESSING.....	2
II. FLIGHT OPERATIONS .....	
1. CREW SHOW PROCEDURES.....	3
2. CALL SIGNS.....	4
3. PREFLIGHT/STARTING ENGINES/TAXI .....	4
4. LAUNCH/CLIMBOUT .....	5
5. ORBIT/ON STATION.....	7
6. RETROGRADE PROCEDURES.....	7
7. AIR REFUELING .....	7
8. 24 HOUR OPERATIONS/STATION CHANGEOVER .....	8
9. OFF STATION/RECOVERY.....	8
10. LANDING/TAXI-IN .....	9
11. DIVERT PROCEDURES .....	9
12. POST MISSION PROCEDURES.....	10
III. GROUND OPERATIONS .....	
1. AIR ABORT/QUICK TURN PROCEDURES .....	11
2. ALERT CREW PROCEDURES.....	13
3. DNIF COVER CREW PROCEDURES .....	14
4. SOF PROCEDURES .....	14
5. ORIENTATION FLIGHTS.....	15
6. VEHICLE USE .....	15
7. CHANGES.....	16
8. LIST OF ATTACHMENTS .....	16
9. DISTRIBUTION.....	17

**552 AIR CONTROL WING (DEPLOYED)  
LOCAL PROCEDURES FOR OPERATION PROVIDE COMFORT (OPC)**

**I. GENERAL OPERATIONS**

**1. INTRODUCTION**

A. These procedures supplement USAF, MAJCOM, and 552 ACW operations procedures and are in effect for normal 552 ACW OPC operations at Incirlik AB, Turkey.

B. These procedures are intended to provide guidelines and techniques for safe and efficient mission accomplishment in this theater. Changes to these procedures which improve mission effectiveness and efficiency of operations are encouraged. Changes should be coordinated through the 552 ACW Deployed Staff and then published in this document to ensure continuity.

C. Both Flight and Mission Crews must be familiar with this document as well as the daily Air Tasking Order (ATO), latest Airspace Control Order (ACO), Battle Staff Directives (BSD), Operations Read File (ORF), Aircrew Read File (ARF), Flight Crew Information File (FCIF), local flying procedures, and the weekly/daily schedule. These contain essential mission information: check for daily changes and updates. Additional detailed information can be found in the classified CTF PROVIDE COMFORT OPLAN 91-7, dated 20 Jul 91, which is stored in the Weapons and Tactics safe.

**2. ARRIVAL/INPROCESSING/SPINUP**

A. After arrival, each crew will receive a comprehensive orientation consisting of a standard agenda of briefings from the DETCO, DO, ADO-M, Intel, First Sgt/Ops Superintendent, and the 39th Operations Group. All arriving crews are in-briefed by the Combined Forces Air Component (CFAC) DO or ADO the day after arrival- usually at 1300L in the CFAC/DO conference room (duration 15-20 min). It is highly recommended that, prior to their first mission, the AC and MCC conduct a one-time summary Briefing/meeting to review/clarify responsibilities, crew show times, and crew procedures unique to Incirlik.

B. Following spinup, each crew will enter a repeating three-day cycle consisting of cocking/DNIF cover duties (DAY 1), flying crew (Day 2), and an off day (Day 3). This cycle will be modified by scheduled down days and mission lengths to ensure each crew receives equal opportunities to fly, pull alert, and have off days during their deployment. Surge (24-hr ops) will also modify this cycle.

**3. CREW REST/DNIF COVER**

A. Normal AFR 60-1/ACC Sup 1 and 552 ACW ORFs apply. Noise in the living area should be kept to a minimum since other crews in the same building may be in crew rest. Crew rest violations should be brought to the attention of the First Sergeant, ADO-M, DO, or DETCO as soon as possible to determine the best course of action.

B. The DNIF crew consists of an AC, NAV, FE, MCC, S<sup>1</sup> ASO, A<sup>1</sup> T, AST, WD, CSO, CT, CDMT, and ART. The designated DNIF crew members will meet crew rest requirements for the primary crew they are covering. Should crewmembers of the DNIF cover crew be needed, the staff will notify them in time to meet the show time. DNIF crewmembers not needed are released at the discretion of the DETCO/DO, normally about 1200L.

#### 4. CREW DUTY DAY/MAX FLIGHT TIME

AFR 60-1/ACC Sup 1 specifies that the maximum unaugmented crew duty day (scheduled crew show time until landing) is 16 hours for peacetime operations. Per authorization from the 552 ACW/CC, maximum monthly flying hours are waived to 165 hours. Individual crewmembers are expected to monitor their accumulated flying time and advise the staff if they are approaching the 165 hour limit. Per authorization from 552 OG/CC, minimum time between landing and subsequent launch is waived to 14 hours IAW MCR 55-33.

#### 5. DEPARTURE/OUTPROCESSING

A. Crewmembers will normally not fly or perform other aircrew duties on their final day at Incirlik. On the day of redeployment, departing crewmembers will be scheduled for outprocessing, baggage check-in, key turn-in, off-base pass turn-in, etc.

B. All crewmembers should provide constructive debriefing comments to the staff prior to departure. Our goal is to conduct a safe flying operations with minimal hassle for the crews.



## II. FLIGHT OPERATIONS

### 1. CREW SHOW PROCEDURES

A. Showtime for the SOF (Ramrod) is 20 minutes prior to primary crew showtime. The SOF, with the cocking crew, will proceed to the aircraft to be cocked. The SOF will get the weather and NOTAMS from base operations and pass this information to the primary crew at their briefing. The SOF will also call maintenance for the status of the primary and spare aircraft.

B. The crew's designated bus driver picks up the crew in the front of Bldg 1080, 1+30 prior to takeoff. ASTs will pick up boxes of bottled water at Savvy Ops (2 boxes for short missions, 4 boxes for long missions). Crewmembers should bring meals sufficient for the duration of the flight, since inflight meals are not available. Airborne Command Element (ACE) (call sign Duke), the Turkish controller (TC), and other passengers must also provide their own meals.

C. Crew showtime/brief time at Savvy Ops (Bldg 627) is normally 1+20 prior to takeoff. Crewmembers will review the FCIFs, BSDs, ORFs, and ARFs, then annotate flight orders with the latest ARF number and their initials. ORC will have a passenger manifest already prepared with the TC and other passengers. The Duke will be on the flight orders. If the Duke or TC are not present at briefing time, the staff will contact the Joint Operations Command Center (JOCC) at 6-3016 and await further instructions. DO NOT DELAY the briefing or pretakeoff flow if either is not present. The flight deck will contact Savvy Ops, before engine start, for status of Duke/TC. THE AIRCRAFT WILL NOT TAXI UNTIL THE DUKE AND TC ARE ABOARD.

D. The WD, ASO, and NAV will pick up their mission kits at showtime. The MCC will ensure all required material is collected and carried to the jet. These include, two Jeppesen binders (AC or NAV), proper documents to fly: ATO, ACO, latest BSD, pertinent flight/track info, other applicable documents/directives, and a copy of this document (weapons), headsets (weapons), water (ASTs), and Saudi step brief (ASO normally calls Saudi for a brief time).

E. The MCC will assign a WD to be responsible for the VHS camera, tripod, and enough video tapes to record any mission activity. Procedures for setting up the equipment and its use are contained in the camera case.

F. The CT and CDMT will obtain a good time hack from the NAV. JTIDS timing is ABSOLUTELY CRITICAL and must be accurate to within strict tolerances to establish an effective link with Turkish ground agencies.

G. The FE and Techs will preposition their equipment next to the briefing room's exit door. Upon release from the briefing, the life support representative will drive them to the flight line. The CT tool box is located in the maintenance supply van on the flight line.

H. After the FE and TECHs depart the briefing room, AC/MCC will finish the required MCR 55-33 briefing items. After the briefing, the crew will drive the bus to the aircraft and leave it parked (with the keys left in it) outside the restricted area for their use after landing. If ice is needed, it can be picked up at AWACS MX or the Sultan's Inn (enlisted dining facility) enroute to the aircraft.

## 2. CALL SIGNS

### A. Aircraft

- (1) Call signs for the flight deck and mission crew will be listed in the ATO.
  - (a) Normal call sign for the flight deck is Savvy 01.
  - (b) Normal call sign for the mission crew is Cougar.

### B. Turkish Agencies

- (1) Daddy - Turkish Control Reporting Post (CRP) at Erzurum, Turkey.
- (2) India - Turkish CRP at Mardin, Turkey.
- (3) X-ray - Turkish CRP at Sarkisla, Turkey.
- (4) Tiger - Control Reporting Center (CRC) at Diyarbakir, Turkey.

### C. U. S. Agencies

- (1) Duke - Airborne Command Element (ACE) onboard the E-3.
- (2) Maddog - Mission Director in the Joint Operations Command Center (JOCC) at Incirlik AB.
- (3) Road Warrior - Mobile, land based, USN TADIL-A unit at Incirlik AB.
- (4) Savvy Ops - 552 ACW (Deployed) Operations Center.
- (5) Magic - Mission crew call sign for NATO E-3.

D. The TC does not have a specific call sign. The TC is on board to OBSERVE. If requested, the TC has the option to assist the crew in monitoring the radar picture, talking with Turkish ATC controllers to pass requests and instructions, talking with Turkish fighters to coordinate their movements, and talking to the ground JTIDS technician to coordinate the link. However, keep in mind these additional tasks are strictly optional.

E. Call signs for the Land Mobile Radios (LMR) and frequencies for the flight deck UHF preset channels are listed in attachment 1.

## 3. PREFLIGHT/STARTING ENGINES/TAXI

A. The E-3 aircraft are parked 3 abreast near base operations on Bravo ramp. The exact locations with INS coordinates are shown in attachment 2. Because of the poor lighting on the ramp, care should be used around maintenance equipment, vehicles, and security ropes located in close proximity to the aircraft.

B. The ramp is clearly marked off with red lines showing the boundaries of the priority C restricted area. **DO NOT CROSS THIS LINE.** There are certain breaks in the line, identified with white cross-hatched zones. These zones are the normal entry/exit points for the Bravo ramp. **ENTER AND EXIT THE RESTRICTED AREA ONLY THROUGH THESE ZONES.** The only reason not to use these zones for entry/exit are situations of critical or emergency nature. Security police strictly enforce these zones. Inside these zones, the E-3 aircraft are roped off (priority B restricted areas). **DO NOT ENTER** until cleared by the sentry. The aircraft commander will take security responsibility of the flying aircraft upon arrival at the aircraft. It is critical to ensure a positive handover of security to avoid confusion or misunderstanding. The ropes will be lowered when the transfer takes place. The same principle applies at the end of a mission (maintenance usually handles the changeover).

C. The primary aircraft is normally cocked IAW CC3 (front end only). If it appears there has been unauthorized entry into the cocked aircraft, contact the SOF or the on-duty maintenance supervisor immediately to resolve the discrepancy. Personnel and equipment will normally load/unload via the aft crew entry door.

D. Start engines to i. scheduled takeoff window (normally min prior to planned takeoff). The takeoff window is plus or minus 15 minutes of the scheduled takeoff time. DO NOT TAKEOFF EARLIER THAN 0330L (quiet hours). Recommend crews attempt to take-off at the beginning of the window to give the mission crew additional troubleshooting time in the wakeup orbit. If it appears that the takeoff will be delayed beyond the takeoff window, for whatever reason, advise Savvy Ops to contact Maddog to coordinate a new takeoff time.

E. When ready for the last chance inspection, flash the landing lights to signal the SOF to begin. When completed, the SOF will give a "thumbs-up". On occasion, as circumstances warrant, the SOF may coordinate with the AC for an alternate location, probably the hammerhead for runway 23 (there is no hammerhead for runway 05). Monitor SOF primary frequency.

F. Composite Force Missions (CFM) are Red Flag-style packages days, usually twice a month. There will usually be a CFM players meeting the day prior for mission planning and coordination. When prebriefed, CFMs will be "COMM OUT" unless safety is jeopardized. COMM OUT procedures are in attachment 7.

G. The IFF codes are found in the ATO, and Mode 1 may change daily. Mode 3 is set to 240X (X is the call sign number). ATC may change the last two digits as required.

H. Sometime, either prior to or just after departure, the flight deck should receive a classified blue folder from weapons containing the ATO breakout, codeword sheet, and comm setup sheet.

#### 4. LAUNCH/CLIMBOUT

A. Takeoff and landing times are based on meeting station times established by the ATO. Fly fragged timing unless directed otherwise by CTF authority. Ensure DETCO or DO is advised of any changes to fragged timing. Pass takeoff time to SOF in the clear. If COMM OUT procedures are in effect, SOF will relay takeoff time to Savvy Ops and CSO should confirm time on secure SATCOM after radios are powered up.

B. Flight operations are conducted under VFR. Extreme vigilance must be used to prevent traffic conflicts. Climbs and descents without operational radar or not under radar advisory service from Incirlik RAPCON should be done only when absolutely necessary. IF CONDITIONS ARE IMC, ASK GROUND/RAPCON FOR AN IFR CLEARANCE TO VFR ON TOP. The Incirlik CTA runs to 50 DME and radar advisories can usually be provided out to 60 DME. Remain within radar coverage (wakeup orbit) until mission radar is operating.

C. Fly the Savvy 1 Standard Instrument Departure (SID) (see attachment 3). Since the wakeup orbit is so close to Incirlik, fly 250 KIAS up to FL 320. Use of MRT for climbout will help provide altitude and cooling air for mission systems.

D. Use HAVE SIREN on departure IAW T.O. Pass takeoff time to Savvy Ops in the clear. If comm out procedures are in effect, SOF will relay the takeoff time to Ops.

E. Monitor Incirlik Approach and remain in the wakeup orbit until radar and IFF are operational. If experiencing problems with any system, notify Savvy Ops ASAP and request maintenance assistance (SATCOM primary, VHF or UHF secondary). If unable Ops NORMAL, you may be directed to fly to the fuel dump area, adjust gross weight, land, and re-launch in the spare aircraft.

F. If fuel dumping is required, get clearance to LTD-13 (see attachment 4). Dump above 5000 AGL, if conditions permit. LTD-13 is the only authorized fuel dump area for OPC. RAPCON's second choice, if all of LTD-13 is not available, is DAN Radial 185 from 30 to 40 DME (which is in LTD-13). Amount of fuel dumped will be annotated in the 781H.

G. IMPORTANT - After arriving in the wakeup orbit, call in a PIREP to Savvy Ops/Maddog on SATCOM. Latest information on cloud decks, turbulence, thunderstorms, or icing will assist the fighter launch decision process.

## 5. ENROUTE

A. When radar, IFF, SATCOM or HF comm, and UHF or VHF comm, are operational, contact Savvy Ops with an "OPS NORMAL minus JTIDS" call. If not "OPS NORMAL", keep Savvy Ops informed of your status. Ops will pass on information to maintenance and the other players. Then proceed eastbound via Special Corridor 1 (SC-1) at FL 320 while you establish a JTIDS link with X-Ray and either India or Daddy. The JTIDS link with X-Ray proves the system is working, but only a link with India or Daddy will be effective when we are in ROZ 1. Therefore, a link with India/Daddy is necessary before Maddog launches the other OPC aircraft. Once JTIDS is established, call OPS NORMAL. Orbit in SC-1 west of Derik until the first DCA fighter goes past, then follow them down SC-1 to ROZ-1. DO NOT ENTER ROZ-1 UNTIL "ON STATION" AND THE FIGHTERS HAVE SANITIZED THE TAOR.

B. When departing the wakeup orbit, advise Incirlik Approach that you are "proceeding on course". They will advise you "radar service terminated, frequency change approved".

C. Recommend the aircrew continue to monitor Incirlik Approach and the primary enroute frequency, to monitor fighter and tanker flows out of Incirlik toward the TAOR.

D. Consider JTIDS an abort item, since Turkish authorities require JTIDS links for the AWACS to remain on station. The staff will relay JTIDS status to the JOCC. Establishing the JTIDS link between AWACS and Turkish ground units is a complicated procedure and takes good communications between the AWACS communications technician and the ground JTIDS technician. Recommend a careful evaluation be made to ensure a simple misunderstanding or miscommunication has not occurred before aborting a mission for lack of JTIDS link. The TC can be a valuable asset when coordinating with Daddy, India, or X-Ray.

E. When a NATO E-3 (Magic) flies in this area, they will contact Cougar on AICC frequency to coordinate JTIDS link information. They will assume "Master" status after joining the link if Daddy or India are not operational.

F. IMPORTANT - Pass a PIREP of weather conditions in SC-1, ROZ-1, and the TAOR to Maddog or Savvy Ops on SATCOM after arrival in ROZ-1. This is essential information to the fighter and tankers.

G. SPECIAL NOTE: Special Corridor 1 is only 10 NM wide (5 NM each side of centerline). Keep this in mind, if you need to reverse course, do a 360, or hold. Mardin Radar is the only authority for deviating outside of SC-1 or ROZ-1. Coordinate early unless the situation is time critical (weather, emergencies, etc.), then inform Mardin as soon as possible of the actions taken. Decreased airspeed and increased bank angle will be required to remain inside SC-1 during delay orbits. In case of an air abort, keep in mind that there is no established procedure to turn around large groups of aircraft within this corridor and RTB them to Incirlik in an orderly fashion. Use Caution: avoid sending aircraft into Incirlik's terminal area at the same time - forcing some to hold and run low on fuel.

## 5. ORBIT/STATI

A. When entering ROZ-1, descend to FL 310. Be on station as soon as possible to provide a deep look into Iraq. "ON STATION" is defined as OPS NORMAL (including an active JTIDS link with India or Daddy) and radar surveillance of the TAOR (usually possible at 38-00E before going into ROZ-1). Orbit at FL 310 (top of ROZ-1) and conduct air refueling (if required) between FL 250-280 IAW the ATO/ACO. Deviations outside the vertical or lateral confines of ROZ-1 require coordination with Turkish ATC through Mardin Radar or India. The TC onboard may assist in coordinating deviations. Recommend you do not exit ROZ-1 unless cleared to do so. Use EXTREME caution when Turkish aircraft are air refueling or conducting operations in ROZ-1. Altitudes are deconflicted in the ATC/ACO but, there is no guarantee that the Turkish aircraft will honor altitude restrictions.

B. Remain in the orbit area until all aircraft are about to depart the TAOR. Coordinate departure to ensure the last fighters depart ROZ-2 after the E-3 for DCA protection. The E-3 SHOULD NEVER BE INSIDE ROZ-1 WITHOUT SHOOTER COVERAGE.

## 6. RETROGRADE PROCEDURES

A. The unpredictability of hostile forces within this theater could require a crew to execute a retrograde with little notice. One of the better retrograde/survivability bases to use from the orbit area is ERZURUM airfield (ERZ CH 71 / 112.4 39-57.4N 041-12.4E). Detailed information on this airfield can be found in the Jeppesen binder.

B. A suggested retrograde checklist can be found in attachment 11.

## 7. AIR REFUELING

A. Air refueling (A/R) information will be briefed during premission briefing. All A/R info is in the ATO. E-3 refueling is in ROZ-1, normally at FL 260. Due to fighter flow, E-3 tankers may enter ROZ-1 directly from Incirlik or from ROZ-2. Check the mission flow sheet or ATO for tanker flow in ROZ-1 and ROZ-2.

B. The rendezvous is normally WD directed, with navigator assisting. Comm will be in the clear (EMCON 1), unless directed in the ATO to use secure or HQ. An alternate ARIP/ARCP point parallel track is available in the flight deck flyaway kit.

C. Stay within ROZ-1 during A/R. If weather is a problem, coordinate with ATC (Mardin or India) for deviations and advise the tanker. Prior to shutting down the radar for A/R, clear for traffic and ensure an F-15 assumes radar monitor for us while we are down. If there are tracks of interest in Iraq, you may need to coordinate with the tanker for a timing slip. DO NOT REMAIN IN ROZ-1 WITHOUT DCA FIGHTERS IN THE AOR FOR PROTECTION.

D. The tanker may request an increased offload to reduce to landing weight. Ensure increased offload does not exceed E-3 inflight or landing weight limitations. FL 280 is normally the highest altitude we can accept heavy onload. Any additional onload will require a lower altitude.

E. This is not a training mission. Get on and off tanker expeditiously. However, copilot refuelings (with an IP) are authorized.

F. Upon completion of A/R, coordinate with the tanker to ensure safe separation. Remain at post-climb altitude until radar comes up. The MCC will advise the flight deck when clear to climb. Ensure no other aircraft are transiting ROZ-1 which could conflict with the climb.

## 8. 24 HOUR OPERATIONS/STATION CHANGEOVER

A. If an E-3 is already on station, the second E-3 will bypass the wakeup orbit and proceed directly to ROZ-1 at FL 320. The relieving E-3 will contact the on station E-3, on secure SATCOM, for flight following, and changeover coordination. The relieving E-3 will enter a counter-clockwise (CCW) circle around the eastern lobe at FL 310. The off-going E-3 will be in a CCW circle around the western lobe at FL 290. Both remain at their altitudes until changeover is complete and then off-going E-3 climbs to FL 320 when exiting ROZ-1.

B. The on station E-3 will pass the relief handover information to Savvy Ops on SATCOM two hours prior to scheduled off-station time. Prepare a JTIDS free text message (FTM) for weapons/surveillance and have it ready to send as soon as the relief E-3 enters the net. Ensure all RCTs are changed to RCNs or system tracks to allow use of monitor tracks on the relieving E-3.

C. Radar frequency and link procedures will be briefed by the staff prior to departing Savvy Ops.

D. The relieving E-3 will contact the on-station E-3 using JTIDS FTM/ERV to effect station changeover. If unable via JTIDS, contact will be made over secure radios on 340.55 (Savvy Ops), or as fraged in the ATO. The SD will initiate monitor tracks on aircraft under control of the on-station E-3, ensure good radio check with on-station E-3 on all required frequencies, know which aircraft are on all frequencies and reply to JTIDS FTMS as necessary before assuming station. The ASO will initiate monitor tracks on all tracks of interest (refer to station changeover package in ASO book, section 1 for pertinent info) and coordinate via JTIDS FTM.

E. The relieving E-3 will make "OPS NORMAL" and "ON STATION" calls on SATCOM to Savvy Ops and Maddog. The relieved E-3 will make the "OFF STATION" call on SATCOM to Savvy Ops and Maddog. Both will ensure they receive acknowledgements.

F. If the relieving E-3 experiences problems going on station, the on-station aircraft will stay until bingo or expiration of crew duty day and then RTB after all players have exited the TAOR. Keep Maddog and Savvy Ops informed!

## 9. OFF STATION/RECOVERY

A. "OFF STATION" is defined as fighters have exited the TAOR and you cannot see the entire TAOR (usually at the 038-00E line when RTB).

B. Plan bingo to arrive overhead Incirlik with a minimum 24K of fuel. This allows holding for at least 30 minutes in the event the single runway at Incirlik is temporarily closed.

C. When necessary, the primary weather alternate will be Konya, but Konya can go down frequently with little notice. Other suitable divert fields are listed in attachment 5. Check current NOTAMS. Keep Adana's, Sakirpasa civil airport in mind for low fuel divert situations.

D. The [redacted] will advise Mardin radar or Diyarbakir Tower via [redacted] depart ROZ-1, and you are "OFF STATION". Pass off station report to Savvy Ops on SATCOM or HF at least one hour prior to landing. If necessary, update on 340.55 (Savvy Ops) when in range.

E. When departing ROZ-1, fly recovery via Special Corridor 1 at FL 320. Do not use another altitude without coordination between AWACS monitor and flight deck. See Atch 6 for recommended descent profile. Contact Incirlik approach at 100NM on UHF with your altitude and location, and they will give you the current weather and active runway. They will not pick you up until about 60NM, but this gives them a heads up. Plan to keep the radar up to give all returning players radar coverage until they enter the Incirlik Approach Control radar terminal airspace. Have AWACS monitor clear your descent path by briefing you on other traffic. Plan and fly a normal enroute descent. Expect holding while approach gets all the fighters recovered (tankers and AWACS usually recover last). You will be VFR until approach calls you radar contact at 50NM. In IMC, stay above FL 150 (Emergency Safe within 100NM) prior to radar contact.

F. In the event technicians require time to work on systems after the mission, the flight engineer needs additional time to dry out the forced air system, proceed from K-town to the wakeup orbit (DAN 010/35) at FL 320 or altitude coordinated with Incirlik Approach. On two-go days, remain in the JTIDS wakeup orbit with all systems up and linked with Daddy or India. When at the end of the mission, one technique is to use the wakeup orbit for holding and descent while powering down the system and waiting for the fighters to recover to avoid being directed to a holding fix by Incirlik Approach.

G. Use HAVE SIREN on descent IAW T.O.

H. Call Savvy Ops with maintenance codes and ETA when at least 80NM (UHF is usually good out to 100NM).

## 10. LANDING/TAXI-IN

A. After landing, call the SOF with landing and total flight times.

B. Taxi stripes on the parking ramps were not meant for E-3 use, so make every effort to follow the marshaller's instructions.

C. There are no ramp lights, so use extreme caution while taxiing at night.

D. After engine shutdown, SOF will position the SOF vehicle by the aft crew entry door. Tapes and selected personnel will ride back to Savvy Ops with the SOF. The remaining personnel will ride back to Ops on the crew bus. Maintenance debrief will be IAW MCM 55-33 in the aircrew debrief tent, across from Savvy Ops, as soon as possible after the flight.

## 11. DIVERT PROCEDURES

A. Read and understand ARF 121 concerning approaches into Turkish airfields. Check the NOTAMS also. Diyarbakir and Konya are two examples where there is plenty of runway, but, they are restricted to daylight VFR only. Be aware of your options at all times.

B. Detailed divert information is listed at attachment 5. Times, distances, and fuels are based on proceeding direct. Aircrews may need to increase bingo fuels to allow for indirect routing.

## 12. POST MISSION PROCEDURES

A. Conduct the post mission briefing IAW MCM 55-33, with all crewmembers, Duke, and TC attending. AC will annotate and sign the PAX manifest with takeoff, landing, and flight time and give it to the TC. The TC uses this as documentation to log flight time. Debrief the staff and INTEL with any significant problems. Each crewmember will complete a Form 326 for every mission. For a relaunch, the mission number becomes the original number plus "A". Pass completed mission packages to flight management. **BE SURE TO CLEARLY MARK CLASSIFIED DOCUMENTS.**

B. Check the schedule board for your next activity. Changes frequently occur. Even though the crew may be "OFF" or on "DNIF COVER", some crewmembers may have additional duties, such as cocking, staff, etc..



**TAB AA**

**REGULATIONS AND DIRECTIVES**

- AA-17 Combined Task Force, OPC, Combined Forces Air Component  
Mission Director/Airborne Control Element Checkout Program  
Verification/Certification**
- AA-18 39th Operations Group Operating Instruction 55-6, Schedule**
- AA-19 39th Operations Group Operating Instruction 55-7, Mission  
Director (MADDOG/DUKE)**
- AA-20 UH-60 Black Hawk Operator's Manual**
- AA-21 DOD Technical Manual 86-100, Mode 4 Handbook**
- AA-22 52nd Operations Group Operating Instruction 200-5, Intelligence**
- AA-23 Extracts from 552nd ACW (Deployed) Local Procedures for OPC**
- AA-24 Extract from Combined Task Force Provide Comfort OPLAN  
91-7 (See also Classified Addendum)** **AA-17**
- AA-25 Chronology of Rules of Engagement for OPC** **AA-18**  
**(See Classified Addendum)** **AA-19**  
**AA-20**  
**AA-21**  
**AA-22**  
**AA-23**  
**AA-24**

EXTRACT OF  
CTF PROVIDE COMFORT OPLAN 91-7

01 15 201415Z JUL 91 (...)

\*\*\*

CTF PROVIDE COMFORT OPLAN 91-7, RESIDUAL FORCES

\*\*\*

3. <sup>U</sup>~~(S/RMNF)~~ MISSION. RESIDUAL FORCES SERVE AS A SYMBOL OF COALITION RESOLVE AND AS A DETERRENT TO IRAQI MILITARY ENCROACHMENT INTO THE SECURITY ZONE IN NORTHERN IRAQ. MAINTAIN AIR PRESENCE ABOVE THE 36 N. PARALLEL AS PROVIDED BY THE DAILY ATO. BE PREPARED TO CONDUCT AIR COMBAT OPERATIONS OVER NORTHERN IRAQ AS DIRECTED. BE PREPARED TO CONDUCT SEARCH AND RESCUE OPERATIONS AND NON-COMBATANT EVACUATION OPERATIONS OF UNITED NATIONS, NON-GOVERNMENTAL ORGANIZATION (NGO) AND /OR PRIVATE VOLUNTEER ORGANIZATION (PVO) PERSONNEL PRESENT IN THE CURRENT SECURITY ZONE. ON ORDER, CONDUCT LIMITED FORCED ENTRY OPERATIONS INTO NORTHERN IRAQ TO FACILITATE ENTRY OF FOLLOW-ON FORCES.

\*\*\*

ANNEX F (AIR OPERATIONS) TO CTF -- PROVIDE COMFORT OPLAN 91-7

\*\*\*

2. CONCEPT OF OPERATIONS.

\*\*\*

2J2. AIR THREAT: [CLASSIFIED PORTION DELETED (31 WORDS)]

\*\*\*

EXTRACT	
I certify that I am the Records Custodian for the Accident Investigation Board convened to investigate the crash of two U.S. Army Black Hawk helicopters in the no-fly zone in northern Iraq on 14 April 1994, and that this is a true and accurate extract from	
<u>CTF OPLAN-91-7</u>	
which is kept in my records system.	
<u>13 May 94</u> Date	<u>W. L. Harris</u> WILLIAM L. HARRIS, Capt, USAF, MSC Evidence Custodian, Incirlik Air Base, Turkey

CERTIFICATION OF EXTRACT	
I reviewed <u>CTF PROVIDE COMFORT OPLAN 91-7</u>	
From that source document, I extracted the information contained in this extract. I certify the information contained herein is a true and accurate extract of that source document.	
<u>19 MAY 94</u> Date	<u>Bryan D. Lawlor</u> Signature BRYAN D. LAWLOR, JTC, 3AF/JA Name/Organization/Section

CERTIFICATE OF DECLASSIFICATION	
I certify that the information contained in this document has been declassified from	
<u>SECRET RMNF</u>	to UNCLASSIFIED.
<u>19 MAY 94</u> Date	<u>Donald G. Norris</u> DONALD G. NORRIS, GS-15, DAC Declassification Team Chief, HQ USEUCOM

**TAB AA**

**REGULATIONS AND DIRECTIVES**

- AA-17 Combined Task Force, OPC, Combined Forces Air Component  
Mission Director/Airborne Control Element Checkout Program  
Verification/Certification**
- AA-18 39th Operations Group Operating Instruction 55-6, Schedule**
- AA-19 39th Operations Group Operating Instruction 55-7, Mission  
Director (MADDOG/DUKE)**
- AA-20 UH-60 Black Hawk Operator's Manual**
- AA-21 DOD Technical Manual 86-100, Mode 4 Handbook**
- AA-22 52nd Operations Group Operating Instruction 200-5, Intelligence**
- AA-23 Extracts from 552nd ACW (Deployed) Local Procedures for OPC**
- AA-24 Extract from Combined Task Force Provide Comfort OPLAN  
91-7 (See also Classified Addendum) AA-17**
- AA-25 Chronology of Rules of Engagement for OPC AA-18  
(See Classified Addendum) AA-19**
- AA-20 AA-20**
- AA-21 AA-21**
- AA-22 AA-22**
- AA-23 AA-23**
- AA-24 AA-24**
- AA-25 AA-25**

**TAB AA**

**REGULATIONS AND DIRECTIVES**

**AA-26 Extracts from Technical Order 1F-15A-1, F-15 Flight Manual**

**AA-27 Air Force Instruction 14-103, Threat Recognition Training  
Program**

**AA-28 USAFE Regulation 200-33, USAFE Intelligence Functions and  
Reponsibilities**

**AA-29 Extract from European Command Directive 55-47, Peacetime  
Rules of Engagement**

**AA-30 Extract from DA Technical Manual 11-5895-1199-12, Mark XII  
IFF System**

**AA-31 Extract from Initial Qualification Training Guide, E-3 Weapons Director**

# FLIGHT MANUAL

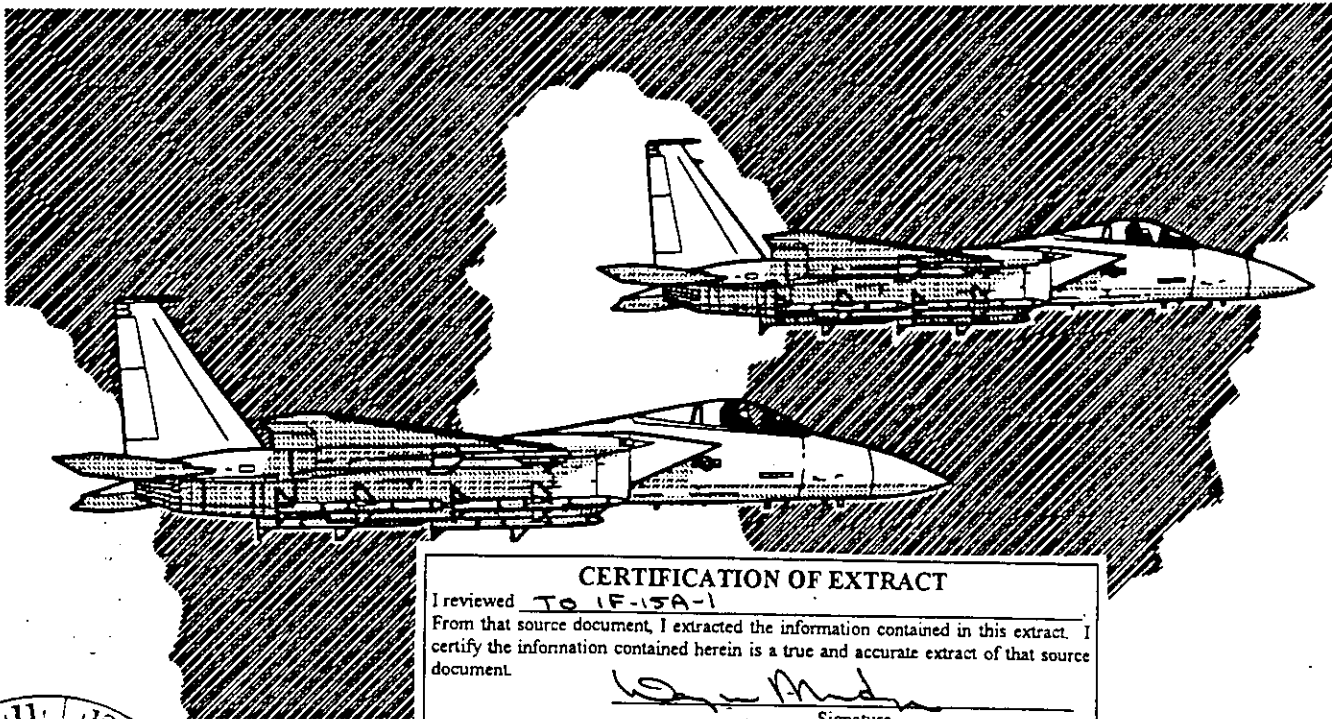

**CERTIFICATION OF EXTRACT**

I reviewed TO 1F-15A-1  
 From that source document, I extracted the information contained in this extract. I certify the information contained herein is a true and accurate extract of that source document.

*[Signature]*  
 Signature

20 May 94      Madge / 494PS / CC  
 Date                      Name/Organization/Section

15A-1-(10-1)B1-CAT

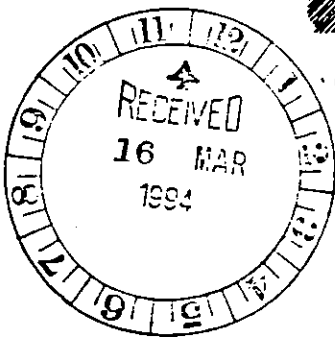

## USAF SERIES F-15A/B/C/D AIRCRAFT BLOCK 7 and up

McDonnell Douglas Aerospace  
F33657-70-C-0300  
F09603-91-D-0669 F33657-91-C-2002

~~Distribution authorized to the Department of Defense and U.S. DoD contractors only, Critical Technology, 1 May 1987. Other requests shall be referred to WR-ALC/LFL, 296 COCHRAN STREET, ROBINS AFB GA 31098-1982.~~

~~**WARNING** - This document contains technical data whose export is restricted by the ARMS Export Control Act (Title 22, U.S.C., sec. 2751 et seq.) or the Export Administration Act of 1979, as amended, Title 50, U.S.C., app. 2401 et seq. Violation of these export laws are subject to severe criminal penalties.~~

~~**HANDLING AND DESTRUCTION NOTICE** - Comply with Distribution Statement and destroy by any method that will prevent disclosure of the contents or reconstruction of the document.~~

This publication supersedes Interim Safety Supplement TO 1F-15A-1SS-126.

Commanders are responsible for bringing this publication to the attention of all affected personnel.

Published under authority of the Secretary of the Air Force.

*ISS-127 Record  
20 Mar 94*

- UHF 1** Enables the UHF 1 guard receiver.
- UHF 2** Enables the UHF 2 guard receiver.
- OFF** Disables both guard receivers.

#### ADF Selector Switch

The ADF selector switch is a three-position toggle switch that allows the relative bearing to the UHF transmitting station to be displayed on the number 1 bearing pointer of the HSI.

- UHF 1** Enables ADF operation utilizing the UHF 1 transmitter-receiver.
- UHF 2** Enables ADF operation utilizing the UHF 2 transmitter-receiver.
- OFF** Disables ADF operation.

#### ICS Volume Control Knob

The ICS volume control knob adjusts the intercom audio volume level for the pilot's headset.

#### Microphone Switch

A three-position microphone switch is on the inboard throttle control handle for UHF transmissions. Pushing the switch forward enables transmission on the UHF 1 transmitter. Pushing the switch aft enables transmission on the UHF 2 transmitter. The center position OFF disables all UHF transmission.

### WARNING

With microphone switch held or stuck in a transmit position (hot mic), communication with other cockpit (F-15B/D) or sources outside the cockpit (ATC, other aircraft) is not possible.

#### MAIN COMMUNICATIONS CONTROL PANEL (UHF 1)

The main communications control panel (UHF 1) is on the main instrument panel, just below the head-up display (HUD) and is used for operating the UHF 1 radio. The controls on the panel include the main

UHF volume control knob, main mode selector switch, main manual frequency selector knobs, and the main channel selector knob.

#### Main UHF Volume Control Knob

The main UHF volume control knob adjusts the volume level for the main transmitter-receiver and guard receiver. Turning the knob fully counterclockwise turns off the main transmitter-receiver.

#### Main Mode Selector Switch

The main mode selector switch is a three-position toggle switch which controls the mode of channel selection.

- CHAN** Permits the main transmitter-receiver to operate on pre-set channels 00-19.
- MAN** The main transmitter-receiver will operate on the manually selected frequencies.
- G** Selects the guard frequency (243.00 MHz) for UHF 1 transmitter-receiver operation.

#### Main Manual Frequency Selector Knob

The three main manual frequency selector knobs are used to insert UHF frequencies into the UHF 1 main radio.

#### Main Channel Selector Knob

The main channel selector knob selects any one of 20 preset channels. The selected channel is shown on the main channel select window.

### UHF COMMUNICATIONS SYSTEM (AIRCRAFT 80-0002 AND UP AND ALL OTHERS AFTER TO 1F-15-857)

The UHF communications system provides air-to-air and air-to-ground communications, automatic direction finding (ADF) and monitoring of guard (emergency frequency). The system consists of a control amplifier for ADF and two separate transmitter-receivers (R1 and R2) with their associated controls and indicators. Both transmitter-receivers transmit on manually selected frequencies or on 20 preset

frequency channels within the 225.000 to 399.975 MHz frequency range. The R1 transmitter-receiver may be utilized to receive ADF signals within its frequency range and display them on the horizontal situation indicator. Aircraft that contain a modified UHF radio (RT-1145A or 1145C/ARC-164) can operate in HAVE QUICK modes (anti-jam). The UHF radios can be operated from ground power without cooling air; however, transmissions should be minimized.

**NOTE**

In F-15B/D aircraft, if an annoying noise is received by one crewman whose UHF receiver is tuned to a low UHF frequency (230 to 260 MHz) while the second crewman is transmitting at a high UHF frequency on the other radio, the noise can be eliminated by placing the R1 antenna selector switch to UPPER.

**UHF CONTROLS AND INDICATORS**

The R1 and R2 radios are operated by controls on the integrated communications control panel (primarily for R2), the main communications control panel (R1), and the microphone switch.

**INTEGRATED COMMUNICATIONS CONTROL PANEL**

The integrated communications control panel (ICCP) is on the left console. The controls and indicators on the panel include the R2 mode selector knob, R2 channel selector knob, R2 channel indicator, frequency/JTIDS selector knobs, frequency/JTIDS indicators, intensity control knob, transmit selector switch, channel set switch, frequency display switch, intercom volume control knob, R2 volume control knob, R1 antenna selector switch, R2 antenna selector switch, RADIO 1 guard receiver/tone switch, and the R1 ADF switch.

**R2 Mode Selector Knob**

The R2 mode selector knob has four positions which control the mode of channel selection. The VHF/FM position is not used.

CHAN	Enables R2 preset channel frequency selection.
------	--

MAN	Enables R2 manual frequency selection.
OFF	Turns off R2 radio.
G-AM	Inoperative.
G-VHF FM	This position is redundant with a UHF radio installed in the R2 position. However, in this event, the UHF AM guard frequency will still be selected in this position.

**R2 Channel Selector Knob**

The channel selector knob selects any one of 20 preset channels for R2 (channels 00 thru 19).

**R2 Channel Indicator**

The channel selected by the channel selector knob is displayed on the channel indicator above the knob.

**Frequency/JTIDS Selector Knobs**

The frequency/JTIDS selector knobs manually select desired R2 UHF frequencies.

**Frequency/JTIDS Indicators**

The frequency JTIDS indicators display the R1 or R2 frequency selected when the frequency display switch is set to either R1 or R2 position.

**Intensity Control Knob**

This knob, labeled INT, with positions of MIN (minimum) and BRT (bright), adjusts the light intensity in the frequency/JTIDS and channel indicators. Turning the knob to MIN decreases the light intensity and turning it to BRT increases the intensity. Pushing the knob in causes the number either to appear in all windows of the indicators.

**Transmit Selector Switch**

This switch has positions of R1-R2 and NORM. Placing the switch to R1-R2 enables both R1 and R2 radios to transmit simultaneously when the microphone switch is pushed either forward or aft. With the switch to NORM, the microphone switch is used to transmit on one radio at a time. To enable the R1-R2 transmit function the KY-58 control panel C/RAD

This three-position knob has positions of C/RAD 1, PLAIN, and C/RAD 2.

- |                |   |
|----------------|---|
| <b>C/RAD 1</b> | Selects secure speech operation of R1 modulation and received audio signals by switching these signals through the KY-58 processor/adapter for encoding and decoding. |
| <b>PLAIN</b>   | Enables transmission and reception of plain audio text by R1 and R2 with the KY-58 system installed.  |
| <b>C/RAD 2</b> | Selects secure speech operation of R2 modulation and received audio signals by switching these signals through the KY-58 processor/adapter for encoding and decoding. |

#### Mode Select Knob

The mode select knob has positions of OP (operation), LD (load), and RV (receive variable).

- |           |   |
|-----------|---|
| <b>OP</b> | Places the KY-58 into operational mode.   |
| <b>LD</b> | Allows variables to be loaded into memory locations in the KY-58 processor/adapter. |
| <b>RV</b> | Places the KY-58 into receive variable mode.  |

#### Power Switch

Placing the power switch to the forward position (ON) applies operating power to the KY-58 secure speech system.

#### Fill Select Knob

This knob has positions of 1 through 6 which selects the variable memory locations.

The KY-58 processor/adapter contains controls which are set before flight and are not accessible to the pilot. The OFF, ON, TD knob must be set to the ON or TD position or the KY-58 system will be inoperative.

## HAVE QUICK SYSTEM

HAVE QUICK anti-jam (AJ) modes are available in UHF 1 only. When in the HAVE QUICK mode, the radio uses a frequency hopping method to change the channel or frequency selected many times a second. To operate in the anti-jam modes, all radios in a particular net must have the same word-of-day (WOD), time-of-day (TOD), net number, and the same frequencies stored in allocated preset channel locations. Description of the HAVE QUICK system is based on training net operation. For training nets, channel 00 is used to store WOD and channels 19 thru 15 are used to store the preset frequencies.

#### HAVE QUICK II (AFTER TO 1F-15-940)

A HAVE QUICK II radio can operate in the basic HAVE QUICK mode; however, HAVE QUICK II provides more capabilities than basic HAVE QUICK. HAVE QUICK II allows for up to six WODs or multiple word-of-day (MWOD) and all associated frequencies to be loaded at one time. When in HAVE QUICK II mode the WODs and frequencies are not stored in ICCP preset channels; these are stored in radio memory. ICCP channels 00 thru 15 are not required for WOD and preset frequency storage. Channel 00 is used for placing the radio into the proper mode. Channel 19 thru 15 are freed for use during normal operation.

#### HAVE QUICK RADIOS

The HAVE QUICK radios contain a clock, memory circuits, and a real time code generator. This added circuitry allows the radio to change frequencies many times a second. The WOD and anti-jam frequencies are sent from the ICCP to the memory. The WOD sets up the pattern for hopping the frequencies stored in the memory. A TOD signal from the anti-jam net control station synchronizes the radio clock to the other radios in the net. The clock times the operation of the real time generator. When anti-jam modes are selected, signals are sent which activate the real time code generator and the anti-jam mode is placed in operation.



## WORD-OF-DAY (WOD)

The WOD is normally entered prior to flight, but it is possible to enter it in flight. The WOD defines the frequency hopping pattern of the day for the radio.

In aircraft with the R1 radio, if the radio is switched to OFF, the R1 mode selector knob on the MCCP must be set to CHAN and the R1 channel selector knob set to 00 to transfer the WOD from the ICCP data memory to the radio. The same must be done for the 5 preset channel frequencies. At each setting of the R1 channel selector knob from 00 down thru 16 a single beep is heard in the headset. A brief pause until the beep is heard at each channel setting is required to ensure proper transfer of data to the radio. After channel 15 a double beep tone is heard which indicates that the radio has accepted the WOD and the 5 preset frequencies. The HAVE QUICK WOD and 5 preset frequencies need only be set up and stored in one cockpit ICCP. For training mode, a WOD is entered into preset channel 20 only and should be one of the following frequencies: 300.000, 300.025, 300.050, or 300.075 MHz.

## MULTIPLE WORD-OF-DAY (AFTER TO 1F-15-940)

All WODs which make up a MWOD have their own unique date code attached to them which corresponds to the day of the month the WOD is to be used. A date code can be any number between 301.000 thru 331.000, 301.000 means the first day of the month and 331.000 means the 31st day of the month. If the radio is turned off no WODs or frequencies are lost. They are permanently stored in the radio until they are intentionally erased or changed. However, it must be identified to the radio which one of the up to six WODs is to be used. This is accomplished by placing both the ICCP and MCCP in the CHAN mode and selecting channel 00 on both units. Place the ICCP CHAN SET switch to the R1 position, select an ICCP frequency of 220.025, and place the CHAN SET switch to R1. A beep tone will be heard which indicates the radio is in the load mode. Rotate the MCCP CHANNEL selector to channel 01, select MAN mode on the MCCP R1 mode selector, and select the appropriate date code on the MCCP FREQUENCY selectors. Place the ICCP R1 GUARD RECEIVE/TONE switch to the TONE position. A beep will be heard indicating the appropriate WOD has been selected. Place the MCCP R1 MODE switch to CHAN and select channel 00. Set the ICCP CHAN SET switch to R1, select an ICCP frequency of 220.000, and place the CHAN set switch to R1. A beep will be heard indicating the radio is in the verify/

operation and is ready to enter the AJ mode once a TOD is received and a valid net number is selected.

## TIME-OF-DAY (TOD)

The TOD entry is normally performed before flight, but can be done in flight after the radio is turned on. TOD synchronizes the HAVE QUICK radio to the net control station and the other radios in the net. After the radio is turned on it accepts the first TOD signal it receives on any channel or frequency in use. To ensure that the radio is operating in the correct net, request a TOD from the net control station, or request a TOD from another station in the net which has previously received TOD from the net control station.

### Time-of-Day Reception

On aircraft with an R1 radio, TOD is entered by momentarily setting the R1 mode selector knob on the MCCP to T then back to MAN or CHAN as appropriate, and requesting a TOD from the net control station. The TOD is heard in the headset as a short burst of varying tones followed by a steady tone. The steady tone lasts as long as the station keeps the sending transmitter in the tone setting. If the TOD is not received within one minute, repeat the above procedure. Do not leave the R1 mode selector knob set to T or the radio could receive false TOD signals from other sources. If anti-jam communication is attempted with an invalid TOD the received signal is not readable and it is necessary to request another TOD transmission.

### Time-of-Day Transmission

On aircraft with an R1 radio, after TOD is received it can be transmitted to other stations in the net by placing the ICCP R1 guard receiver/tone switch to the TONE position.

## TIME-OF-DAY (AFTER TO 1F-15-940)

On aircraft with an R1 radio, in an emergency when TOD is not available from an external source, selecting the T position on the MCCP R1 mode selector and simultaneously selecting TONE on the ICCP R1 GUARD RECEIVE/TONE switch initiates the radio's clock. The radio cannot properly operate with other nets when initiated in this manner. The radio acts as a TOD source for its own independent net, and any radio is able to operate on the resulting net.

## NET NUMBER

On aircraft with an R1 radio, there are five valid anti-jam training net numbers, 0 to 4, which are selected by the tenths of megahertz (first decimal position) setting of MCCP manual frequency selector knobs in the active manual mode, or the MCCP channel selector in the active channel mode.

### ACTIVE CHANNEL MODE (R1 RADIO)

The active channel (AC) mode is selected by setting the MCCP R1 mode selector knob to AC, and the MCCP R1 channel selector knob to any channel that has a proper net (frequency) stored in the R1 channel memory, except 00, which is reserved for WOD. The anti-jam frequency hopping activity then goes into operation.

### ACTIVE MANUAL MODE (R1 RADIO)

The active manual (AM) mode is selected by setting the MCCP R1 mode selector knob to AM, and the MCCP manual frequency selector knobs to the desired frequency. The anti-jam frequency hopping activity then goes into operation.

## LIGHTING EQUIPMENT

### EXTERIOR LIGHTING

Exterior lights are controlled from either the exterior lights control panel or the miscellaneous control panel, both on the left console.

#### Position Lights

The position lights include a green light on the forward edge of the right wing tip, a red light on the forward edge of the left wing tip, and a white light just below the tip of the left vertical tail fin. The position lights are controlled by a knob on the exterior lights control panel labeled POSITION. With the anti-collision lights on, the position lights automatically go to steady full brilliance, regardless of the position of the position lights knob.

OFF            Lights are off. Guide numbers for  
1 - 5            varying brightness from off to full  
                  bright.

BRT            Lights are at full brightness.

## FLASH

Lights will flash at full  
brightness.

### Anti-Collision Lights

There are three red anti-collision lights; one on the leading edge of each wing just outboard of the air intake and another just below the tip of the right vertical tail fin. The anti-collision lights are controlled by a single toggle switch on the exterior lights control panel labeled ANTI-COLLISION. The switch positions are OFF and ON.

### Formation Lights

Six green electroluminescent formation lights are provided. Two lights are on the wingtips behind the position lights, two lights are on the side of the forward fuselage just forward of the cockpit, and two lights are on the aft fuselage just aft of wing trailing edge. The formation lights are controlled by a single knob on the exterior lights control panel labeled FORMATION.

OFF            Lights are off. Guide numbers for  
1-5            varying brightness from off to full  
                  bright.

BRT            The lights are at full brightness.

### Vertical Tail Lights (After TO 1F-15-974 ).

The vertical tail lights are mounted in the aft fuselage and illuminate the outboard surface of the vertical tails. The incandescent floodlights are controlled by a three position toggle switch labeled VERT TAIL FLOOD on the exterior lights control panel. The switch positions are OFF, DIM or BRIGHT.

### Landing and Taxi Lights

The landing and taxi lights are on the nose gear strut. They are controlled by a toggle switch on the miscellaneous control panel. The lights are off, regardless of switch position, on aircraft through 73-107 when the nose wheel is not down and locked, or on aircraft 74-081 and up, when the landing gear handle is in the

All data on pages 1-53 thru 1-54 deleted.

**TAB AA**

**REGULATIONS AND DIRECTIVES**

**AA-26 Extracts from Technical Order 1F-15A-1, F-15 Flight Manual**

**AA-27 Air Force Instruction 14-103, Threat Recognition Training  
Program**

**AA-28 USAFE Regulation 200-33, USAFE Intelligence Functions and  
Reponsibilities**

**AA-29 Extract from European Command Directive 55-47, Peacetime  
Rules of Engagement**

**AA-30 Extract from DA Technical Manual 11-5895-1199-12, Mark XII  
IFF System**

**AA-31 Extract from Initial Qualification Training Guide, E-3 Weapons Director**

**AA-26**

**AA-27**



Intelligence

**THREAT RECOGNITION TRAINING PROGRAM**

This instruction implements AFPD 14-1, *Intelligence Management*, and DIAM 57-25, *Coordination, Production, and Maintenance of Joint Recognition Materials* (copy available through the Defense Intelligence Agency [DIA]). This instruction details requirements and responsibilities for the US Air Force Recognition Training Program. Send all recommended changes for this publication to the 480th Intelligence Group (IG), 27IS/INZR, 34 Elm Street, Langley AFB VA 23665-2092, with an information copy to HQ USAF/INRF, 1700 Air Force Pentagon, Washington DC 20330-1700. See attachment 1 for references, abbreviations, acronyms, and terms used.

**SUMMARY OF CHANGES**

This revision aligns the instruction with AFPD 14-1.

	Paragraph
<b>Section A--Threat Recognition Training</b>	
Objective .....	1
Concept .....	2
<b>Section B--Assigned Responsibilities</b>	
Headquarters US Air Force, Assistant Chief of Staff, Intelligence (ACS/I) .....	3
480th Intelligence Group (IG, Air Intelligence Agency) .....	4
HQ Air Combat Camera Service .....	5
National Air Intelligence Center (NAIC) .....	6
Air Education and Training Command (AETC) .....	7
Other Agencies .....	8
<b>Attachment</b>	
1. Glossary of References, Abbreviations, Acronyms, and Terms .....	Page 4

**Section A--Threat Recognition Training**

- 1. Objective.** The threat recognition training program establishes a coherent unit training program based on command and unit mission requirements. The program ensures that all aircrew and selected support personnel maintain the proper level of threat recognition proficiency.
- 2. Concept.** Threat recognition training covers visual recognition and threat knowledge.
  - 2.1.** Aircrew threat recognition training stresses crewmembers' ability to identify and understand the characteristics of operational air, naval, ground, missile, and electronic equipment of any nation which could threaten US and allied forces.
  - 2.2.** Aircrews must be able to identify both friendly and enemy equipment, recognize patterns of employment, and know equipment capabilities in order to make effective tactical decisions.
  - 2.3.** Aircrews must be able to identify deviations from known equipment characteristics in order to report these deviations through intelligence channels.

Supersedes AFR 200-10, 10 August 1992.  
OPR: NAIC/TI (Col H. Anderson)



Certified by: HQ USAF/INR (Col Richard J. L'Heureux)  
Pages: 5/Distribution: F

**CERTIFICATE**

I certify that I am the Records Custodian for the Accident Investigation Board copy of the investigation of the crash of two U.S. Army Black Hawk helicopters in the vicinity of Inirlik Air Base on 14 April 1994, and that this is a true and accurate copy of the record which is kept in my records system.

20 May 94  
Date

WILLIAM E. HAFFNER, Capt, USAF  
Evidence Custodian  
Inirlik Air Base, Turkey

3. Headquarters US Air Force, Assistant Chief of Staff, Intelligence (ACS/I). ACS/I, through HQ USAF/INRF, will:

- Supervise policy and planning of the US Air Force Threat Recognition Training Program.
- Interact with other Military Services, DIA, and foreign military organizations on threat recognition training matters.
- Follow DIAM 57-25 to ensure that the Air Force participates in the Joint Recognition Materials Committee (JRMC) and exchanges reproduced recognition materials.
- Review by 31 July each year the Air Force programmed production schedule for the upcoming fiscal year.

4. 480th Intelligence Group (IG), Air Intelligence Agency. The 480th IG is the HQ USAF-designated office of primary responsibility (OPR) for producing and distributing Air Force threat recognition materials.

4.1. Production. 480th IG will:

- Interact with Air Force major commands (MAJCOM), other Services, and DIA to develop and produce new threat recognition training materials while improving and maintaining existing materials.
- Prepare a production plan for threat recognition training materials which includes estimated completion and issuance dates and identifies materials and support needed.
- Send the plan to all MAJCOMs and HQ USAF/INRF by 1 July of each year for comments. Based on response, submit a copy of the final version of the 480th IG production plan to MAJCOM OPRs, HQ USAF/INRF, HQ Air Combat Camera Service (HQ AIRCCS), and JRMC by 1 September of each year.
- Obtain annually through HQ ACC/CVS, Product Identification Numbers (PIN) from AIRCCS for video productions.
- Produce threat recognition training publications, slides, videos, and other media for Air Force consumers and other valid requesters.

4.2. Distribution. 480th IG will:

- Distribute threat recognition training products to Air Force consumers and other valid requesters.
- Send video duplication masters to HQ AIRCCS, Norton AFB CA 92409-5439 (effective December 1993, HQ AIRCCS moves to March AFB CA 92518-5000) for archiving and to meet sister-Service reproduction requirements.
- Notify the OPRs for recognition material in other Services of the availability of new items once they are issued.
- Provide JRMC; HQ USAF/INRF; HQ AIRCCS; 310th Training Support Squadron (310TSS/DOULI), Goodfellow AFB TX 76908-4113; and each MAJCOM OPR a copy of the catalogue or index of available 480th IG-produced recognition training materials.
- Advise HQ AIRCCS when threat recognition videotape products become obsolete.

5. HQ, Air Combat Camera Service. HQ AIRCCS will:

- Interact with 480th IG and provide technical assistance in developing and producing threat recognition videotapes.
- Provide an annual copy of the PINs index to 480th IG video productions.
- Provide at 480th IG request any HQ AIRCCS imagery suitable for reproduction and use in the US Air Force Threat Recognition Training Program.

6. National Air Intelligence Center (NAIC). NAIC, as the dedicated US Air Force producer of scientific and technical analyses of foreign weapon systems, will:

- Distribute reproducible NAIC intelligence materials on weapon systems to the 480th IG to use when producing training materials. These materials include capability and performance assessments, models, photographs, videos, artistic and technical drawings.
- Assist the 480th IG in applying NAIC publications for developing threat recognition training materials.

7. Air Education and Training Command (AETC). AETC, through the 315th Technical Training Squadron, Goodfellow AFB TX 76908-4113, must include instruction in their officer and enlisted operational intelligence courses on the principles aircrews and intelligence specialists need in order to recognize those items in paragraphs 2.1, 2.2, and 2.3.

8. Other Agencies. MAJCOMs, field operating agencies (FOA), Office of Air Reserve Component (ARC), and Director of the Air National Guard (ANG) will manage threat recognition training programs and send local directives and requests to the 480th IG and the 310th TSS.

8.1. Training Program Management. MAJCOMs, FOAs, ARC, and the ANG will:

- Monitor threat recognition training programs of subordinate units according to this instruction and command requirements.
- Establish procedures to monitor the threat recognition proficiency level of designated trainees.
- Supplement centrally produced threat recognition training materials with locally developed or purchased materials; e.g., models and publications.
- Accept threat recognition training responsibilities for ARC units the command will gain on mobilization.

8.2. Local Directives and Requests. MAJCOMs, FOAs, ARC, and the ANG will:

- Send copies of command threat recognition training directives to:
  - (a) 480 IG/27IS/INZ  
34 Elm Street  
Langley AFB VA 23665-2092
  - (b) 310 TSS/DOULI  
154 Canberra Street, Suite B  
Goodfellow AFB TX 76908-4113
- Submit consolidated requests for existing products to 480th IG/INPM, using DD Form 1142, Interagency Document Request. Submit requests for new products through MAJCOM OPRs to 480th IG/INPM by message or letter. Also include an estimate of total annual command requirements for supply or resupply of existing recognition materials.
- Send one copy of each locally developed product to 480th IG and 310th TSS. Units are authorized use of unit-level operations and maintenance funds to purchase such supplemental training aids.
- Review the 480th IG annual production plan and submit comments by 31 July of each year. Provide imagery and other supplemental materials that contribute to the program.

ERVIN J. ROKKE, Maj General, USAF  
Assistant Chief of Staff, Intelligence

# GLOSSARY OF REFERENCES, ABBREVIATIONS, ACRONYMS, AND TERMS

## Section A--References

**NOTE:** If you use this instruction, you are responsible for verifying the currency of the cited documents.

DIAM 57-25, *Coordination, Production, and Maintenance of Joint Recognition Materials*, 11 April 1979

AFPD 14-1, *Intelligence Management*, 9 July 1993

## Section B--Abbreviations and Acronyms

ANG	Air National Guard
ARC	Air Reserve Component
DIA	Defense Intelligence Agency
FOA	Field Operating Agency
HQ AIRCCS	Headquarters Air Combat Camera Service
HQ USAF/IN	Headquarters US Air Force Intelligence
IG	Intelligence Group
JRMC	Joint Recognition Materials Committee
MAJCOM	Major Command
NAIC	National Air Intelligence Center
OPR	Office of Primary Responsibility
PIN	Production Identification Number
RTM	Recognition Training Material
TSS	Training Support Squadron

## Section C--Terms

**NOTE:** This glossary clarifies only the terms used in this publication. It doesn't include associated terms. Joint Publication 1-02, *Department of Defense Dictionary of Military and Associated Terms*, 1 December 1989, and AFM 11-1, *Air Force Glossary of Standard Terms*, contains standardized terms for Department of Defense and Air Force use.

**Air Combat Camera Service.** Provides a variety of services and products to include duplication, inventory, control, circulation, and distribution of Air Force visual information products.

**Defense Intelligence Agency (DIA).** A government agency charged with the responsibility of being the Department of Defense's intelligence arm. The DIA's functional responsibilities are broad in scope and nature.

**Intelligence Group.** An intelligence unit, usually composed of two or more squadrons. Squadrons are formed along different types of production lines based on common functions.

**Joint Recognition Materials Committee.** A committee chaired by the Defense Intelligence Agency with production responsibilities assigned to the three Services. The committee standardizes production of threat recognition training materials and eliminates duplicate efforts.

**National Air Intelligence Center.** Located at Wright-Patterson AFB, OH, it produces scientific and technological intelligence about foreign engineering techniques. This intelligence includes characteristics, capabilities, and limitations of foreign military systems, including data about related weapons, weapon system material, research, development, test, evaluation, and production.

**Product Identification Number (PIN).** Headquarters Air Combat Camera Service assigns PIN numbers to identify and order audiovisual products. A PIN number has six digits and two alpha letters; e.g., 604324DF.

**Recognition Training Materials (RTM).** RTMs are a family of products designed and produced for use in aircrew

training. They consist of threat and training tapes, recognition guides, the DIAM 25 series, 35mm slide kits, and wall posters. Recognition guides are widely distributed throughout the services, to selected governmental agencies, and selected Commonwealth Countries (United Kingdom, Canada, and Australia). Each Service receives master video and 35 mm slide kits, and it is the individual Service's responsibility to mass produce and distribute these products to their users.

**Visual Recognition and Threat Knowledge:** These are basic categories of information about weapons systems covered in recognition training materials. Visual recognition covers unique physical features or signatures. Threat knowledge includes system capabilities, limitations, associated tactics and countertactics, and orders-of-battle.



7 January 1993

Intelligence

USAFE INTELLIGENCE FUNCTIONS AND RESPONSIBILITIES

This regulation provides direction to ensure effective use of intelligence in the performance of peacetime, contingency and wartime tasks. It applies to US Air Forces in Europe (USAFE) personnel assigned to or working in support of intelligence activities. It does not apply to US Air Force Reserve or Air National Guard units.

SUMMARY OF CHANGES

This revision provides a thorough rewrite of the regulation to provide only broad responsibilities to the wing commander level.

1-1. **Policy.** The priority of USAFE Intelligence is to provide combat tasked units the best quality and most current intelligence products and services available for planning, training, and exercises as well as for contingency/combat operations. An effective combat intelligence system is the ultimate goal of peacetime efforts.

1-2. **Scope.** To establish requirements and guidance necessary to accomplish required peacetime/wartime functions. It covers basic management, organization, and support activities necessary to accomplish those functions. Emphasis is on providing timely, accurate intelligence to commanders, staffs, and aircrews.

1-3. **Responsibilities:**

a. HQ USAFE/DO will:

- (1) Include aircrew intelligence training guidance in the USAFE Integrated Combat Mission Training (ICMT) program.
- (2) Advise USAFE/IN on intelligence issues that affect aircrew combat capabilities.

b. HQ USAFE/IN will:

- (1) Provide all-source intelligence support required by numbered air forces (NAF) and wing commanders.
- (2) Provide target materials, map/chart, and specialized targeting support.
- (3) Provide special security office (SSO) services.
- (4) Plan, provide, and maintain intelligence distribution and data handling systems.
- (5) Establish intelligence personnel training standards and provide theater/system specific training/orientation and training aids.
- (6) Provide aircrew intelligence training guidance and briefing materials.
- (7) Establish theater evasion and escape (E&E) policy/procedures and provide E&E aids.
- (8) Establish intelligence manpower requirements, provide personnel, and arrange augmentation as required.
- (9) Monitor command tables of allowances (TA) for intelligence equipment.
- (10) Provide intelligence document manage-

Supersedes USAFER 200-33, 12 December 1988. (See summary of changes.)

No. of Printed Pages: 2

OPR: INRA (Maj Williams)

Approved by: Col James R. Martin

Editor: Jaime W. Santos

Distribution: F: X: AFIA/IMP, Norton AFB CA 92409-7001 ..... 1  
AUL/LDEA, Maxwell AFB AL 36112-5564 ..... 1  
HQ USAF/INXY, Wash DC 20330-5000 ..... 1

CERTIFICATE

Presented to the USAFE/IN for the Accident Investigation Board con-  
ducting the investigation of the crash of two USAF Army Black Hawk helicopters in the  
vicinity of the USAFE/IN on 12 April 1993, and that this is a true and accurate  
copy of the original as it appears in my records system.

WILLIAM L. GARDNER, USAF, USAF/IN  
Evidence Custodian  
In-Task Air Force, Theater

20 May 94

ment assistance.

(11) Establish mobility policy and provide specialized equipment as required.

(12) Provide HQ USAFE/DO with advice on ICMT program.

(13) Establish theater intelligence reporting policy/procedures for non-NATO tasking.

(14) Provide real world and exercise plans and exercise support as required.

(15) Provide inspection criteria and checklists.

(16) Manage Intelligence Awards Program.

(17) Provide specialized expertise to NAFs and units for staff assistance visits (SAV).

c. NAFs will:

(1) Provide advice and assistance to HQ USAFE/IN to accomplish the above tasks.

(2) Monitor status of unit intelligence resources/capabilities and forward issues beyond NAF capabilities to resolve to HHQ. Ensure intelligence products and services are readily available and used day-to-day to train and prepare for contingency operations. Assess the effectiveness of products and services during local and HHQ exercises.

(3) Monitor regional logistics (RELOG) center intelligence planning.

(4) Review and validate unit aircrew intelligence training requirements: assist units with expertise, training materials, and evaluations.

(5) Identify/validate unit intelligence requirements to HQ USAFE/IN.

(6) Support units with SAVs and exercise evaluation visits (EEV).

(7) Oversee SSO support to NAF HQ and units.

(8) Assist units in accomplishing tasks.

d. Wing/CC will:

(1) Ensure an intelligence program is established and tailored to weapon systems and tasking to include specific standards, goals, and priorities. This

program will integrate intelligence resources into daily flying training and contingency efforts. As a minimum, the commander's goal should be to ensure the following when applicable:

(a) Personnel: Intelligence staffs are sufficiently manned with proper Air Force specialty codes (AFSC), and adequately trained in wing's mission, equipment, capabilities, and tactics.

(b) Systems/Equipment: Equipment necessary to accomplish mission tasking (i.e., Constant Source (CS), Sentinel Byte (SB), Mission Support System (MSS), Analytical Photogrammetric Positioning System (APPS), secondary imagery systems, color copier, etc.) is available and sustainable.

(c) Data bases: Informational materials required to accomplish mission tasking (i.e., reference documents, regulations, software, operating instructions), are on-hand and up-to-date.

(d) Maps, charts, and target materials: Items required to support OPLAN tasking are on-hand in sufficient quantity.

(e) Mobility: Ensure intelligence resources are available, can be airlifted, and reconstituted to support unit tasking.

(2) Availability and use of intelligence. Ensure intelligence products and services are readily available and used to support day-to-day operations and are regularly used to train and prepare for contingency operations. Assess the effectiveness of products and services available for exercises.

(3) Preparedness. Ensure crews can effectively use intelligence information on possible adversary location, capabilities, and intentions in mission planning and execution. Ensure crews can accurately report mission results and intelligence as required. Ensure intelligence personnel can assess mission results and post-flight documentation.

(4) Identify requirements and issues beyond unit's capability to resolve to HHQ.

ROBERT C. OAKS, General, USAF  
Commander in Chief



CYNTHIA J. STEWART, Colonel, USAF  
Director of Information Management

**TAB AA**

**REGULATIONS AND DIRECTIVES**

**AA-26 Extracts from Technical Order 1F-15A-1, F-15 Flight Manual**

**AA-27 Air Force Instruction 14-103, Threat Recognition Training  
Program**

**AA-28 USAFE Regulation 200-33, USAFE Intelligence Functions and  
Reponsibilities**

**AA-29 Extract from European Command Directive 55-47, Peacetime  
Rules of Engagement**

**AA-30 Extract from DA Technical Manual 11-5895-1199-12, Mark XII  
IFF System**

**AA-31 Extract from Initial Qualification Training Guide, E-3 Weapons Director**

**AA-26**

**AA-27**

**AA-28**

**TAB AA**

**REGULATIONS AND DIRECTIVES**

**AA-26 Extracts from Technical Order 1F-15A-1, F-15 Flight Manual**

**AA-27 Air Force Instruction 14-103, Threat Recognition Training  
Program**

**AA-28 USAFE Regulation 200-33, USAFE Intelligence Functions and  
Reponsibilities**

**AA-29 Extract from European Command Directive 55-47, Peacetime  
Rules of Engagement**

**AA-30 Extract from DA Technical Manual 11-5895-1199-12, Mark XII  
IFF System**

**AA-31 Extract from Initial Qualification Training Guide, E-3 Weapons Director**

**AA-26**

**AA-27**

**AA-28**

**AA-29**

UNCLASSIFIED

EXTRACT

HEADQUARTERS  
UNITED STATES EUROPEAN COMMAND  
APO 09128-4209

ECJ3-OD  
ED 55-47

DIRECTIVE  
NUMBER 55-47

22 MAY 1989

OPERATIONS

Peacetime Rules of Engagement (ROE) (U)

1. (U) Purpose. To promulgate United States Commander in Chief, Europe (USCINCEUR), policies governing actions to be taken by United States (U.S.) military forces to protect themselves, the United States, its possessions, bases, and other property, and personnel against attack or hostile incursion. The intent of this Directive is to incorporate the "Peacetime Rules of Engagement for U.S. Forces" contained in the Joint Chiefs of Staff SM-846-88 (reference d) as USCINCEUR Peacetime ROE. The Peacetime Rules of Engagement contained in this Directive are effective upon receipt for all U.S. forces operating in the United States European Command (USEUCOM) Area of Responsibility (AOR) and remain in effect in all conditions short of war or prolonged conflict. Additional ROE governing specific USEUCOM missions and for U.S. forces operating as part of a multinational force (e.g., under NATO, LIVE OAK, or other multinational command) are promulgated separately. ROE contained herein do not supersede ROE previously approved by JCS for special operations/contingency operations.

\*\*\*\*\*

CERTIFICATION OF EXTRACT	
I reviewed <u>Directive 55-47</u>	
From that source document, I extracted the information contained in this extract. I certify the information contained herein is a true and accurate extract of that source document.	
<u>22 May 94</u>	<u>Grey A. Brown</u>
Date	Signature Name/Organization/Section

CERTIFICATE OF DECLASSIFICATION	
I certify that the information contained in this document has been declassified from	
<del>CONFIDENTIAL</del> to UNCLASSIFIED.	
<u>23 MAY 94</u>	<u>Donald G. Norris</u>
Date	Signature DONALD G. NORRIS, GS-15, DAC Declassification Team Chief, HQ USEUCOM

Appendix A

Peacetime Rules of Engagement - For USCINCEUR Forces (U)

A-1. (U) Purpose and Scope. This document establishes policies and procedures governing actions to be taken by U.S. force commanders during all military operations and contingencies short of war or prolonged conflict. Except as modified by separate rules for specific operations, missions, or projects (such as U.S. Coast Guard law enforcement functions), the policies and procedures established herein remain in effect until modified or rescinded by USCINCEUR or higher authority. The inherent right of self-defense is the basis for these Rules of Engagement (ROE).

A-2. (U) Modification. USCINCEUR component commanders and COMSOCEUR may modify these ROE provided such modification is compatible with the intent of these ROE, enhances the accomplishment of approved missions, results in more definitive guidance to subordinate commanders, and does not impair the commander's inherent right of self-defense. Commanders shall inform USCINCEUR of such modification.

A-3. (U) ROE.

a. (U) Are intended to provide general guidelines on unit and national self-defense and are applicable worldwide to all echelons of command.

b. (U) Are intended to ensure a full range of options consistent with the right of self-defense and U.S. policy.

\*\*\*\*\*

(U) U.S. policy, should deterrence fail, provides flexibility to respond to crises with options that:

- a. (U) Are appropriate to the provocation.
  - b. (U) Are designed to limit the scope and intensity of the conflict.
  - c. (U) Will discourage escalation.
  - d. (U) Will achieve political and military objectives.
- U.S. policy seeks to terminate hostilities quickly, decisively, and on terms favorable to the United States.

A-5. (U) The Inherent Right of Self-Defense. (See Definitions, Appendix C, paragraph C-61).

a. (U) Unit Self-Defense. The act of defending a particular unit of U.S. forces (see Definitions, Appendix C, paragraph C-77) or element thereof against a hostile act or hostile intent. The need to exercise unit self-defense may arise in situations ranging from apparently unrelated localized, low-level conflicts to prolonged engagements.

b. (U) National Self-Defense. The act of defending the United States, U.S. forces, and, in certain circumstances, U.S. citizens, their property, or U.S. commercial assets from a hostile act or hostile intent. The need to exercise national self-defense may arise in isolated or prolonged regional or global situations that are often related to unstable international tensions.

c. (U) Elements of Self-Defense. The application of armed force in self-defense depends upon two elements.

(1) (U) Necessity. The requirement that a hostile act occur or that a force or terrorist unit exhibits hostile intent. (See Definitions, Appendix C, paragraphs C-25 and C-27.)

(2) (U) Proportionality. The requirement that the force used be reasonable in intensity, duration, and magnitude, based on all facts and circumstances known to the commander at the time, to counter the hostile act or hostile intent and to ensure the continued safety of U.S. forces.

\*\*\*\*\*

A-6. (U) Action. Circumstances and limitations under which U.S. forces will engage hostile forces during peacetime conditions are as follows.

\*\*\*\*\*

**TAB AA**

**REGULATIONS AND DIRECTIVES**

**AA-26 Extracts from Technical Order 1F-15A-1, F-15 Flight Manual**

**AA-27 Air Force Instruction 14-103, Threat Recognition Training  
Program**

**AA-28 USAFE Regulation 200-33, USAFE Intelligence Functions and  
Reponsibilities**

**AA-29 Extract from European Command Directive 55-47, Peacetime  
Rules of Engagement**

**AA-30 Extract from DA Technical Manual 11-5895-1199-12, Mark XII  
IFF System**

**AA-31 Extract from Initial Qualification Training Guide, E-3 Weapons Director**

**AA-26**

**AA-27**

**AA-28**

**AA-29**

**AA-30**



TECHNICAL MANUAL  
No 11-5895-1199-12

HEADQUARTERS  
DEPARTMENT OF THE ARMY  
Washington, DC, 10 July 1984

### MARK XII IFF SYSTEM

#### REPORTING ERRORS AND RECOMMENDING IMPROVEMENTS

You can help improve this manual. If you find any mistakes or if you know of a way to improve the procedures, please let us know. Mail your letter or DA Form 2026 (Recommended Changes to Publications and Blank Forms) direct to Commander, US Army Communications Electronics Command and Fort Monmouth, ATTN: DRSEL-ME-MP, Fort Monmouth, New Jersey 07703. A reply will be furnished to you.

	Page
HOW TO USE THIS MANUAL .....	ii
GENERAL INFORMATION .....	1
EQUIPMENT DESCRIPTION .....	4
PRINCIPLES OF OPERATION .....	18
DESCRIPTION OF CONTROLS AND INDICATORS .....	28
OPERATING INSTRUCTIONS .....	36
ORGANIZATIONAL PMCS .....	54
OPERATIONAL PREFLIGHT CHECKS .....	72

### CONTENTS

**POSTED**  
JD

TM 11-5895-1199-12

25 APR 1985  
Date

### TECHNICAL MANUAL

### Operator's and Organizational Maintenance

### MARK XII IFF SYSTEM

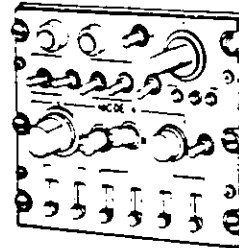

AN/APX-100

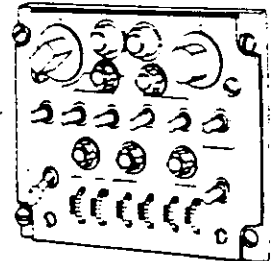

AN/APX-72

LIBRARY & INFORMATION CENTER  
HEADQUARTERS DEPARTMENT OF THE ARMY

Headquarters, Department of the Army

LIBRARY & INFORMATION CENTER JULY 1984  
COMBAT SERVICES CENTER

### CERTIFICATE

Certificate of the Economic and Social Research Institute, London, England, dated 14 April 1984, in connection with the crash of two US Army aircraft on 14 April 1984, at Fort Monmouth, New Jersey. The certificate is a copy of the original records of the investigation.

24 May 84

William L. Harris, Jr.  
Evidence Custodian  
Infield, Fort Monmouth, New Jersey

DESCRIPTION OF MAJOR COMPONENTS - CONTINUED

Transponder Control Set

IFF transponders are configured in two different ways. In the first type, the transponder is designed as a single unit with all controls and indicators integrally mounted. The second type is designed for remote mounting in the aircraft avionics bay with the controls and indicators housed in a separate control set. This control set is then installed in the aircraft in an area accessible to the operator.

The AN APX-72 is an example of the remote type of transponder as is one model of the AN APX-100. Every AN APX-72 installation utilizes an RT-859 transponder and a C-6280(P) APX Transponder Control Set. The RT-1157 APX-100(V) remote transponder must be interconnected with a C-10009, C-10532, C-10533, or C-10534 APX-100(V) Transponder Control Set.

The control sets are panel-mounted and interconnected by cable with the transponders. These sets provide the operator with all controls necessary to access and enable the IFF system features. Control capabilities exist for setting codes, selecting modes and performing system self-tests. Control set indicators permit the operator to monitor system functions.

KIT-1A TSEC Reply Computer

The on-board cryptographic equipment, utilized in the IFF systems addressed in this manual, is the KIT-1A TSEC computer. This computer insures secure IFF operation by decrypting and authenticating encrypted interrogations and generating appropriate encrypted replies when the interrogations are judged valid.

DESCRIPTION OF MAJOR COMPONENTS - CONTINUED

Transponder Tester TS-1843 APX

The TS-1843 APX Transponder Tester is an on-board test set designed to verify the operation of the AN APX-72 transponder before and during flight. This set is an optional piece of equipment and is not used in every AN APX-72 installation. When installed, the transponder tester will indicate either satisfactory or unsatisfactory performance of the overall transponder system with a GO or NO-GO indication. The transponder functions tested include the receiver frequency, sensitivity, and decoding and the transmitter frequency, power, and bracket pulse coding. In addition, the test set checks the VSWR of the antenna system and monitors transponder responses to operational interrogations. The TS-1843 APX transponder tester has no Mode 4 testing capability.

Pressure Altitude Digitizer

When installed, Pressure Altitude Digitizer CPU-66 A, or equivalent, is used in Mode C operation to generate coded signals indicating aircraft altitude in hundreds of feet. These signals are transmitted when the IFF system is interrogated in Mode C. When received by a suitably equipped ground facility, these signals result in a digital readout of the aircraft altitude being displayed next to the corresponding blip on the radar screen.

Aircraft IFF Antenna

The IFF system receives interrogations and radiates replies through the same antenna(s). Antennas may be diplexed and shared with other IFF components installed in the aircraft.



11

## Transponder - Continued

Mode 1, 2, and 3 A reply signals are generated by the encoder circuit of the transponder. If the IFF has a pressure altitude digitizer, the digitizer will generate the necessary information to enable the transponder to formulate a reply in Mode C.

When the IFF has been interrogated in Mode 4, the signals are relayed through the transponder to the KIT-1A TSEC computer. All Mode 4 reply pulse trains are under the control of the KIT-1A TSEC.

At the discretion of the operator, all the reply signals, with the exception of Mode 4, can be expanded to convey additional information. When the Emergency feature is activated, all modes are enabled regardless of transponder settings. The preset Mode 1 and 2 reply code numbers are transmitted followed by three sets of empty framing pulses. Framing pulses are the first and last pulses in every 20  $\mu$ s pulse train. Mode 3 A automatically transmits a pulse train denoting 7700, the emergency code followed by the same pattern of three empty framing pulses. No pulses are added to the Mode 4 reply when the Emergency feature is enabled.

When the operator chooses, the transponder can be set to transmit an Identification of Position signal. This I.P. signal takes the form of an additional pulse inserted after every Mode 2 or 3 A reply. If the transponder is operating in Mode 1, activation of the I.P. feature causes the Mode 1 reply to be transmitted twice in succession. I.P. is useful for enabling ground facility personnel to distinguish between aircraft that are transmitting otherwise identical transponder codes.

## SYSTEM PRINCIPLES - CONTINUED

All IFF reply codes in every mode are transmitted on 1090 MHz. Aircraft equipped with space diversity transponders will transmit the reply from the antenna which received the strongest interrogation signal.

Direction finding capabilities existing at some ground facilities enable the operator to approximate the azimuth to the aircraft.

## COMPONENT PRINCIPLES

As described in the paragraph on System Principles, IFF system operation is dependent upon the transmission and reception of pulsed rf signals. The transponder is the component responsible for both receiving and decoding interrogations and encoding and transmitting replies. Although Mode 4 signals must be decrypted and encrypted by the cryptographic equipment, they are routed through the transponder.

With the AN APX-72 transponder, an interrogation signal is received by the antenna and transponder receiver section and is forwarded to the decoder circuit for processing. The AN APX-100 transponder utilizes two antennas and a diversity processor circuit. This configuration enables the AN APX-100 to compare the strength of the incoming signals to determine which of the two antennas is oriented most favorably in relation to the interrogating station. When this is determined, the diversity processor forwards a command to the rf distribution subassembly. After the reply is prepared, the rf distribution subassembly will direct the transmission.

# CERTIFICATION OF EXTRACT

I reviewed TM 11-5895-1199-12 Operator's and organization/  
(describe the original source document)

MAINTENANCE MARK XII IFF SYSTEM ALL PAGES AND REFERENCE-72

From that source document, I extracted the information contained in the attached document,

entitled TM 11-5895-1199-12

I certify the information contained there in is a true and accurate extract of the source document.

John B Hall  
(Signature)

John B Hall  
(Printed Name)

PM AEC ST LOUIS, MO.  
(Organization/Duty Section)

24 MAY 94  
(Date)

**TAB AA**

**REGULATIONS AND DIRECTIVES**

- AA-26 Extracts from Technical Order 1F-15A-1, F-15 Flight Manual**
- AA-27 Air Force Instruction 14-103, Threat Recognition Training Program**
- AA-28 USAFE Regulation 200-33, USAFE Intelligence Functions and Reponsibilities**
- AA-29 Extract from European Command Directive 55-47, Peacetime Rules of Engagement**
- AA-30 Extract from DA Technical Manual 11-5895-1199-12, Mark XII IFF System**
- AA-31 Extract from Initial Qualification Training Guide, E-3 Weapons Director**

**AA-26**

**AA-27**

**AA-28**

**AA-29**

**AA-30**

**AA-31**

# INITIAL QUALIFICATION TRAINING

E-3 WEAPONS DIRECTOR  
(1741G)  
BLOCK I  
GENERAL PROCEDURES



SEPTEMBER 1993

AIR COMBAT COMMAND

### CERTIFICATION OF EXTRACT

I reviewed Initial Qualification Training  
From that source document, I extracted the information contained in this extract. I  
certify the information contained herein is a true and accurate extract of that source  
document.

[Signature]  
Signature

25 May 94  
Date

Arthur D. Byers  
Name/Organization/Section

~~WARNING - This document contains technical data whose export is restricted by the Arms Export Control Act (Title 22, U.S.C., Sec 2751, et seq.) or the Export Administration Act of 1979 (as amended, Title 50, U.S.C., 1701 et seq.). Violations of these export laws are subject to severe criminal penalties. Disseminate in accordance with the provisions of DOD Directive 5230.25.~~

One step which we skipped over on console checkout was number 6p which told you to set your Feature/Category Switches as required. In the chapter on these switches, you were provided with suggestions as to whether a switch might 'normally' be ON or OFF, but you weren't given definite guidance because the switch settings depend on mission requirements at a particular moment and personal preference. Since it will be a while until you have enough background to determine what you need, you can use the basic standard set up listed in the next paragraph. This should provide you with all of the information you will need for most of your simulator sessions. We will be covering those switches we missed in later chapters and you will then have a better understanding of how they interrelate to provide you the data you need. Remember - don't be afraid to 'play' with these switches as you go through the course to become familiar with the information available.

For your basic standard set up you should have at least the following switches on: Boundaries/ADIZ, Self-Generated Geography, Requested/Forced SIDs, Net Participants/Primary E-3, Special Points, Unassigned Tracks, Assigned Tracks, and all six radar and SIF/IFF switches. This is just a suggestion until you become more familiar with the switches; it is not a requirement and you will not be expected to memorize this set up for evaluation.

The final step in setting up your SDC is to assign your console to the proper function. To do this you must perform your first switch action operation. You'll recall, though, that you cannot take any switch actions until you are cleared to do so, therefore, you must now check with your instructor to ensure that you are cleared. Once you have received clearance to start, push your Test Mode switch (on the Alarms/Display Control Panel) to OFF. You will see the test pattern disappear and, if you have the Category switches set as suggested, you should see background and sensor data on your monitor.

For the rest of this chapter, we are going to walk through the Assign Console switch action (S/A). You will be introduced to some new terms and display areas, but we will not go into detail on why or how everything happens until later. Therefore, you should pay close attention to how things appear on your monitor so you'll be better able to relate it to the next chapter's text.