

26 OCT 1994

Ref: 94-F-2154

Mr. Thomas A. Trimboli  
Pyrocap International Corporation  
6551 Loisdale Court, Suite 400  
Springfield, VA 22150-1854

Dear Mr. Trimboli:

This letter and documents respond to your October 4, 1994, Freedom of Information Act (FOIA) request.

Due to the size and complexity of the Department of Defense (DoD), there is no central repository for all DoD records. This office is responsible for responding to requests for records in the Components of the Office of the Secretary of Defense (OSD) and Joint Staff (JS). The several Components of the DoD, including the Military Departments, Unified Commands and separate Defense Agencies, operate their own Freedom of Information offices to respond to requests for records for which they are responsible. These procedures are provided in DoD Regulation 5400.7-R, as published at 32 CFR 286.

For your information your request has been categorized as commercial in nature. Commercial requesters are required to pay search, review, and reproduction costs associated with their requests. Established DoD fees are: clerical search or review at \$12.00 per hour; professional search or review at \$25.00 per hour; executive review at \$45.00 per hour; computer search, varies according to the system used, billed per minute; microfiche at \$0.25 per page; office copy reproduction at \$0.15 per page; and printed publications or reports at \$0.02 per page.

Therefore, the total cost associated with processing your request is \$27.10, of which \$27.10 is assessable. Assessable fees include, 1/4 hour of professional search at \$25.00 per hour, and 139 pages of reproduction at \$.15 per copy.

Please indicate the reference number 94-F-2154 on a check or money order made payable to the U.S. Treasurer in the amount of \$27.10. Send the payment within 30 days of the date of this letter to this office at the address indicated below.

OATSD(PA)  
DFOISR  
Room 2C757  
1400 Defense Pentagon  
Washington, DC 20301-1400

#654

Please also note the billing date above since payments received later than 30 days after the billing date may incur additional interest charges.

Sincerely,

*Signed*

A. H. Passarella  
Acting Director  
Freedom of Information  
and Security Review

Enclosures:  
As stated

Prepared by VOORHIES:gjv:10/25/94:DFOI:gr<sup>o</sup>pk\_y1\_\_wh\_\_

*RR pls*  
✓



ACQUISITION AND  
TECHNOLOGY

OFFICE OF THE UNDER SECRETARY OF DEFENSE

3000 DEFENSE PENTAGON  
WASHINGTON DC 20301-3000



08 AUG 1994

(L/MDM)

MEMORANDUM FOR PRINCIPAL ASSISTANT DEPUTY UNDER SECRETARY  
OF DEFENSE (ENVIRONMENT)  
DIRECTOR, COUNTERINTELLIGENCE & SECURITY  
PROGRAMS, OFFICE OF THE ASD (C<sup>3</sup>I)

SUBJECT: Pyrocap B-136™

As the organization responsible for materiel management/supply policy, we received correspondence from Mr. Theodore Adams, President, Unified Industries, Springfield, VA. Mr. Adams explained that a product marketed by his company, Pyrocap B-136™ has been added to the GSA schedule for fire retardant/suppressant chemicals. In addition, the U.S. Forest Service has added this product to its qualified products list for certain applications.

According to Mr. Adams, and as reported by the *Wall Street Journal*, June 1, 1994, Pyrocap B-136™ is a nitrogen-based product refined from a Native American formula which originally used the nitrogen in bovine urine. Presumably because of the origin of its formula, acceptance of the product, particularly within the federal government, has been slow. Nevertheless, it appears to be gaining acceptance for use as an additive to water for a quick "knock down" of many types of fires. Several municipal fire departments have used it, reporting *significant reductions in time* to control/contain fires of various types. It bears an unqualified endorsement from the President of the International Association of Black Professional Fire Fighters (Enclosure 1). Several news articles and related materials are at Enclosure 2.

DoD has conducted a number of tests of Pyrocap B-136™. Data *do not support* the use of Pyrocap B-136™ as a substitute for AFFF foam for petroleum fire suppression (Enclosure 3). The product is also incompatible with most AFFF dispensing equipment. FAA tests (Enclosure 4) confirm that Pyrocap B-136™ is not particularly effective in suppression of petroleum fires involving high volatility products (e.g., AVGAS), although as a water additive, it helps to suppress low volatility fires--e.g., crude oil. FAA tests indicate that, at relatively high concentrations (30 percent), Pyrocap B-136™ suppressed magnesium (wheel) fires. Discussions with the vendor confirm the advantages of retaining AFFF systems where installed, particularly for fuel fire control. However Pyrocap B-136™ appears to provide added value as an AFFF supplement (e.g., via pump trucks).



776574

Given the data available on Pyrocap B-136™, we believe the DoD fire fighting community should be made aware of the potential of this product, and possibly other new products not brought to our attention, to save lives and reduce time in fighting a variety of fires, especially where AFFF systems are not installed.

One of the barriers to employing additives to water is cost. Pyrocap B-136™ presently costs about \$20 per gallon--more than AFFF. The vendor claims, with apparent validity, that the product's ability to reduce the time to achieve effective fire control and limit damage and loss need to be considered in determining cost-effectiveness.

Since this office is not responsible for occupational safety or fire fighting policy, we suggest that you determine the most appropriate guidance to the field. In the process of responding to the vendor's inquiry, we have obtained extensive data in addition to the enclosures, which is available to you through my point of contact, Mr. James N. Carnes, tel. 697-2500.

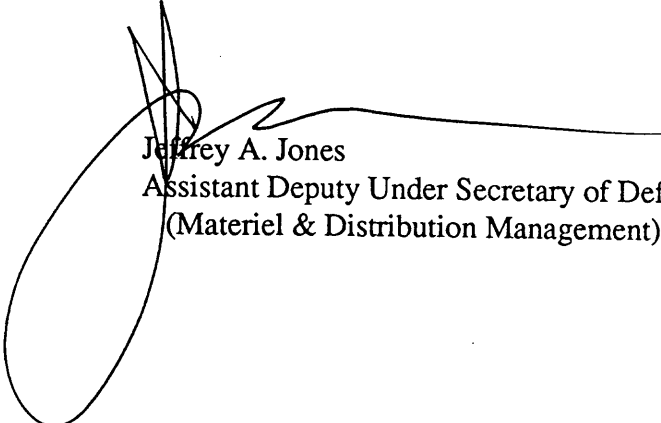

Jeffrey A. Jones  
Assistant Deputy Under Secretary of Defense  
(Materiel & Distribution Management)

Enclosures



# INTERNATIONAL ASSOCIATION OF BLACK PROFESSIONAL FIRE FIGHTERS

LIFE MEMBER

NATIONAL ASSOCIATION FOR THE ADVANCEMENT OF COLORED PEOPLE

## LETTER OF ENDORSEMENT

### OFFICERS

Romeo O. Spaulding  
President  
Washington, D.C.

Joseph Recasner  
Executive Vice President  
New Orleans, LA

Arnold Hyacinthe  
Treasurer  
Woodside, N.Y.

John R. Johnson  
Recording Secretary  
Baltimore, MD

Lindsey L. Plummer  
Coresponding Secretary  
Miami, FL

Carl Hawkins  
Financial Secretary  
Flint, MI

Edward Brown  
Sergeant-at-Arms  
Milwaukee, WI

### REGIONAL DIRECTORS

Conde Peoples  
N.E. Regional Director  
Buffalo, N.Y.

Theodore O. Holmes  
S.E. Regional Director  
Fl. Washington, MD

Charles Anderson  
N.C. Regional Director  
Toledo, OH

Jerhorne B. Randolph  
S.C. Regional Director  
Kansas City, KA

Robert Davis  
N.W. Regional Director  
Seattle, WA

Hershel Clady  
S.W. Regional Director  
Inglewood, CA

### PAST PRESIDENT

Clarence Williams

The International Association of Black Professional Fire Fighters was founded in 1970. Its goals and objectives include a call to actively seek ways to reduce the devastating impact of the destruction and injuries caused by fire throughout the United States. In our efforts to actively seek ways to reduce the hazards to life and property, we have chosen to actively focus our concentration, at this time, on the problems within minority communities.

As we have traveled to various cities participating in numerous fire service training seminars and technical trade shows, in search of new methodology and equipment, we were introduced to **Pyrocap B-136**.

**Pyrocap B-136** is a fire retardant which satisfies the physical and technical characteristics according to our standards of a qualified product. It was simple in application, yet sophisticated enough in its chemical composition to astound engineers. And above all, it works.

**Pyrocap B-136** is a wet water foam agent which is an admixture of water with air to form a cellular structure of foam. The foam breaks down rapidly into its original liquid state at temperatures below the boiling point of water, and at a rate directly related to the heat to which it is exposed in order to cool the combustible on which it is applied.

It is a chemical compound wetting agent, which when added to water in proper quantities, materially reduces surface tension, increases its penetration and spreading abilities, and may also provide emulsification and foaming characteristics.

It is also an emulsifying agent which mixes with liquid hydrocarbons and/or oil and water to reduce its ignitability.

Finally, it is a heat absorbing agent which dissipates BTU's when exposed to burning materials.

During the test that I personally observed and based on resultant test data, this product has a far reaching impact on shaping the fire suppression and mitigation strategies for the next century. Thus, we overwhelmingly endorse and encourage the use of **Pyrocap B-136**.

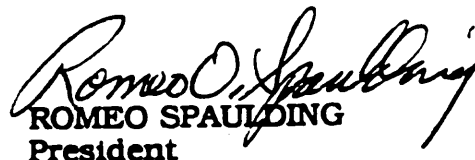
  
ROME O SPAULDING  
President

# Young Firm Sells Old Indian Formula to Fight Fires

## 'Weaned on Water,' Government Bureaucracy Frustrates Pyrocap's Efforts

By Brent Bowers  
*Staff Reporter of THE WALL STREET JOURNAL*  
 Some firefighters are raving about a new chemical weapon based on an old American Indian formula of animal urine and plants.

But despite fire professionals' warm reception for the compound, produced by tiny Pyrocap International Corp. of Springfield, Va., the substance is getting the cold shoulder from many buyers. Reauctants who do the buying.

Only a handful of U.S. cities are using the compound, called Pyrocap B-136. The company says it is even more disappointed by scant interest shown by the U.S. Forest Service, a major potential customer.

Marketing a new technology has never been easy—especially for a young, single-product company. It is much harder, however, if target buyers are tradition-bound government officials worried about costs.

### Getting Through Red Tape

Pyrocap, which is pitching its chemical mainly to municipal fire departments and federal agencies, is learning that lesson. "Firefighters tell us it will save lives," says Theodore Adams III, Pyrocap's president. "Our problem is getting through to the top administrators." Pyrocap B-136 retails for more than \$20 a gallon, compared with \$12 to \$22 a gallon for most firefighting foams, says Mr. Adams.

Pyrocap B-136 was patented by John Slates, a member of the Tuscarora Indian tribe and a co-founder of the firm. Mr. Slates's grandparents taught him the formula, which combines bovine urine and parts of alfalfa plants and eucalyptus trees, Mr. Adams says.

Pyrocap refined the formula, using alfalfa extract, oil of eucalyptus, synthetic urea and other substances. When mixed with water in concentrations of up to 6%, Mr. Adams claims, Pyrocap B-136 puts out wood and petroleum fires much faster than water, extinguishes metals fires that are supposedly impervious to water, cools fire-stricken areas faster than water, and neutralizes many toxins in smoke.

### 'Fire Disappears' In 'Seconds'

Some users swear by the product: "Flames will be coming out of three or four windows, and we'll start pumping, and in three or four seconds the fire disappears," says Cecil Shackleton, fire commissioner in Roosevelt, N.Y.

A military technician who has watched field tests of Pyrocap B-136 says, "Fires roar up and stop cold" at areas treated with it. Ray Alfred, who recently retired as fire chief in Washington, says his department's tests showed Pyrocap B-136 had quicker "knockdown" and cooling capabilities than water. Versar Inc., a Springfield, Va., engineering firm, reported that the compound reduced carbon monoxide from burning tires faster than water.

Nevertheless, Mr. Adams says that he keeps bumping into bureaucratic barriers when he tries to sell Pyrocap B-136 to Uncle Sam or city fire departments.

For example, Pyrocap B-136 has been waiting on the U.S. Forest Service's list of approved suppressants since 1991. Yet the

agency says it still buys most of its firefighting chemicals from Monsanto Co. of St. Louis and Chemonics Industries Ltd., a Canadian unit of Ercly Industries Inc. of Los Angeles.

### Interest From Washington

Agriculture Secretary Mike Espy expressed interest in November in seeing how Pyrocap B-136 works, according to Mr. Adams. Theodore Adams Jr., Pyrocap's chairman and father of its president, promised to arrange a demonstration in Washington.

Instead, the younger Mr. Adams says, the Forest Service scheduled an April test in Montana, but designed it to emphasize retardant rather than suppressant capabilities. Because Pyrocap's product is a suppressant, the company declined to participate. "It seemed like a deliberate contrivance to forestall the introduction of the product," the elder Mr. Adams says.

Forest Service officials say they didn't want to buy Pyrocap B-136 before the product was placed on the General Services Administration's "multiple awards schedule" this April.

Persuading a big city's firefighting bureaucracy to take a look at the technology also can be daunting. Pyrocap's California distributor says he got a polite brushoff from the Los Angeles Fire Department last year.

A Los Angeles fire official says anybody wishing to sell a new product to the department must submit a written request for a test. But, he adds, "We're not really in the business of testing."

Apparently, neither is any other private organization or public agency, which helps explain Pyrocap's problems. "No organization has developed any specific

tests to evaluate the performance of firefighting foams and chemicals, says Bill Carey, a senior staff engineer at Underwriters Laboratories, a Northbrook, Ill., safety-testing organization.

As a result, Mr. Carey says, "The Forest Service and municipal fire departments use foams based on their experience. Everything is by the seat of the pants."

Firefighters' conservatism creates problems for established firms, too. Steven Hansen, a researcher at Ansul Fire Protection, a Marinette, Wis., subsidiary of Tyco International Ltd., says he has "witnessed the resistance of fire departments" to some of his company's most promising firefighting products. "Most of the chiefs have been weaned on water," he says, and most are reluctant to inflate their budgets with new products.

### In About 12 U.S. Cities

But Pyrocap, which went public last year by merging into a shell corporation and raising \$4.5 million in private funding, is finally starting to make some inroads. The U.S. Army bought some of the product, though it declines to elaborate. Fire departments in about a dozen cities—include Washington; Philadelphia; Detroit; Oakland, Calif.; and New Orleans—use it.

Moreover, the relative lack of U.S. interest is offset by growing foreign demand. The company's revenue rose 44% during the first half of the fiscal year ending Aug. 31 to \$259,000 from \$180,000 a year earlier; exports accounted for more than half of the total.

Nonetheless, Mr. Adams wants to sell more at home. After all, he says, "It's an American product."

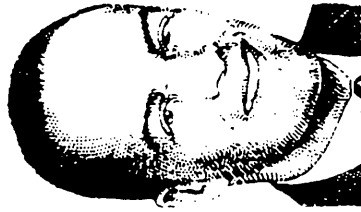

Theodore Adams III



Going to blazes: Tests found Pyrocap B-136 absorbed heat up to 20 times faster than water.

## Springfield company fights fires and bureaucracies

By JAMES WORKMAN

Pyrocap International Corp., which produces a highly touted new organic fire suppressant, is marketing its product at a trade show in France this week. The Springfield-based company has already sold it in Japan, Germany and Saudi Arabia.

Meanwhile, local fire departments and federal agencies have shown little interest.



Theodore Adams Jr.

So, what have the world's most protectionist markets seen in Pyrocap's nitrogen-based suppressant that the world's most open market hasn't?

Proponents say bureaucracy and favoritism are keeping Pyrocap out of the U.S. market.

"What Pyrocap meets here is the resistance of the existing bureaucracy," said Romeo Spaulding, head of the Landover-based International Association of Black Professional Fire Fighters.

"When Pyrocap gets into the hands of firefighters, they love it, but they aren't the ones in charge of procurement. And the ones that are don't want to upset the status quo equation."

"We've had comments from one agency that shocked us," said Theodore Adams Jr., chairman and co-founder of Pyrocap. "They saw in tests how competitive our product was in tests, but said 'We've been buddies with these guys for years, so why change it?'"

Why indeed, especially after they find out that the original formula contains cow urine, alfalfa and eucalyptus leaves.

John States, a member of the Tuscarora Indian tribe and a co-founder of the minority-owned Pyrocap, patented the formula, which he says his grandparents taught him. Then the company experimented with synthetic urea and organic extracts to produce Pyrocap B-136.

In January, Versar Inc., a Springfield-based technical consulting company, tested B-136 on fires fueled by diesel and rubber tires, two of the most difficult fires to combat.

Versar found that Pyrocap absorbs heat up to 20 times faster than water and quickly reduces toxins and smoke.

That was enough to convince the Japanese trading company Cornes & Co., which immediately placed an order.

It was also enough for Jordan, Kuwait, Abu Dhabi and Saudi Arabia, which have problems with crude oil fires.

For all of that, Pyrocap executives haven't been able to convince many U.S. agencies and local fire departments, even though people who have used Pyrocap in tests or fires will swear by it.

Former District fire chief Ray Alfred said the D.C. department's tested "Pyrocap on our trucks and based on our findings we believe it will make a real and cost-effective difference in our margin of safety."

The trouble, say observers, is that the margin of safety — knockdown of a fire in 120 seconds vs. 10 minutes — is difficult to quantify for tradition-bound, budget-constrained bureaucracies.

Pyrocap B-136 sells for \$20 per gallon, compared with \$12 to \$22 per gallon for conventional foams.

Firefighters who protect the White House and other federal buildings downtown have begun to buy Pyrocap, but only after ordered to by Congress. The rest of the D.C. department continues to test the product.

The U.S. Forest Service, a potentially huge customer, has approved Pyrocap as an effective and environmentally clean fire suppressant, but has shown little interest otherwise.

Some critics within and outside fire departments say that fire fighting technology will change only through lawsuits.

"Most people would never consider suing the fire department if a fire takes 15 minutes to put out," said one observer who asked not to be identified. "But when you find out they're using obsolete technology, you're going to see more liability."

"If I get really hurt on the job," said one D.C. firefighter, "I told my wife to get a real good lawyer, because things don't have to be the way they are."

VOLUME 13, NUMBER 4 • ONE DOLLAR

WHERE WASHINGTON CAPITALIZES ON BUSINESS

WEEK OF JUNE 10-16, 1994

# Washington BUSINESS JOURNAL

ED FASIOR  
26 DISTRICT, ARIZONA

PLEASE REPLY TO:

408 CANNON HOUSE OFFICE BUILDING  
WASHINGTON, DC 20515-0302  
(202) 225-4065

COMMITTEE ON APPROPRIATIONS



232 EAST McDOWELL BOULEVARD  
PHOENIX, AZ 85004  
(602) 258-0551

2432 E. BROADWAY  
TUCSON, AZ 85719  
(602) 624-8986

281 W. 24TH STREET, SUITE 111  
YUMA, AZ 85364  
(602) 728-2234

**Congress of the United States**  
**House of Representatives**

June 16, 1994

Hon. Julian Dixon, Chairman  
Subcommittee on the District of Columbia  
Committee on Appropriations  
U.S. House of Representatives  
H-302, The Capitol

Dear Mr. Chairman:

Your subcommittee's understanding of the plight of inner-city residents dealing with the ravages of fires has been exemplary. A recent USA Today (March 3, 1994) noted that fire primarily kills the young, the old, and minorities in cities across the country. As you must realize, it is imperative that we seek new ways to control this problem.

Last year's Conference Report for the FY 94 appropriations for the District of Columbia (Conf. Rpt. 103-303) noted that the Congress received a report from the District's Fire Department regarding a new fire safety liquid concentrate known as Pyrocap B-136. Pyrocap B-136 greatly reduces smoke and heat, and "completely relieves the problem of burnback in cases of petroleum fires." The technology evaluation that led to this report, as you are aware, was conducted at the behest of your subcommittee.

The conferees urged the Fire Department to use this technology whenever possible, and to place it on trucks that answer fire emergencies in several parts of the District, including inner-city areas that have high fire incident rates, the White House, and the Federal enclave. As we understand, this has been accomplished. However, testimony before the DC Council's Judiciary Committee, Chaired by Councilman Jim Nathanson, as well as other reports, have indicated that the District government needs funds to ensure that this new fire safety technology program continues to provide added protection not only for the city's residents, employers and government employees, but also for the city's dedicated fire service personnel.



At this time we respectfully request that your subcommittee target \$400,000 of available funds for the continued procurement of Pyrocap B-136. The inclusion of this specifically earmarked funding in the budget would go a long way towards fulfilling new Fire Chief Otis Latin's pledge that his department will utilize new fire fighting technologies and become a model high technology department for the nation.

  
Hon. Jim Moran

  
Hon. Ed Pastor

  
Hon. Martin Olav Sabo

FOLEY & CO., INC.  
GOVERNMENT RELATIONS  
POST OFFICE BOX 61303  
POTOMAC, MARYLAND 20859  
(301) 294-0937

# Memorandum

Government of the District of Columbia

TO: Linda Cheatham  
Director  
Office of the Budget

Department: Fire & EMS  
Agency, Office: OFC

FROM: R. Alfred   
Fire Chief

Date: 31 MAR 1993

SUBJECT: FY 1993 Congressional Reporting Requirement - Pyrocap

In the FY 1993 budget Senate Report 102-333, page 50 and Conference Report 102-906, page 17, the Committee and Conferees recommended that the D.C. Fire and Emergency Medical Services Department use Pyrocap B-136, a fire fighting chemical, in its training program and in a variety of fire ground situations. Since that time the department has tested and used the chemical as recommended.

The department's initial experience with Pyrocap B-136 has been thoroughly successful. The quick knock-down of fires has been consistent. Our firefighters report that the product not only rapidly extinguishes fires, but it also has a tremendous cooling effect. Cooling (taking the heat from a fire), establishes a rapid end to a fire incident, greatly enhances the ability to evacuate fire victims and prevent our firefighters from being overcome by heat exhaustion. We have also found that the product completely relieves the problem of burnback, in cases of petroleum fires, i.e., diesel fuel, gasoline fuel, fuel oil, etc., which is highly essential in allowing firefighters to enter the burning area and quickly and successfully extinguish the fire.

It is a known fact that smoke is the leading cause of death by fire. Our testing at the Training Academy have found that the product significantly reduces the toxins normally found in smoke, and it also increases the firefighter's visibility. Through our limited use of the product we have come to believe that through city wide implementation, the product will increase the efficiency of the department and create an overall reduction in total operating costs. We expect the reduction in operating cost to be the results of a reduction in the time spent at the fire incident. Time saved means less fuel used; less maintenance costs; the elimination of property loss; reduced injury to the firefighters; and increased safety for the fire victim.

The Training Academy has tested the product on several classes of fires. It was found to be most effective at a 3 percent concentration on interior fires and at 6 percent on tire fires. The product's penetrating characteristics knocked down a tire fire within seconds. In addition, the smoke and heat usually associated with this type of fire was no longer a threat. The tires were able to be touched with the bare hand and the nasal passage was not bothered by toxic smoke.

Therefore, it is my recommendation to this Committee that the product, Pyrocap B-136, be utilized within the District of Columbia as a significant contribution to our urban fire problem. The D.C. Fire and Emergency Medical Services Department has the awesome task of protecting all government facilities, the White House, including the protection of the President during take-off and landing by helicopter, and all structures within our city. Thus, it is important for us to have the latest in fire fighting tools, equipment and technology. Since using this product and becoming more knowledgeable of its qualities I feel confident it will help reduce the number of serious residential fires, and have discontinued ordering any other fire fighting agents.

We are, however, in dire need of funding to purchase this product. It will be happy to discuss this issue in more detail with the Committee at your convenience.

ESL-TR-91-09



**ARMORED PERSONNEL CARRIER  
(APC) FIREFIGHTING VEHICLE  
SYSTEM**

**M. J. WILSON, J. H. STORM, G. B. SINGH,  
C. W. RISINGER**

**APPLIED RESEARCH ASSOCIATES, INC.  
4300 SAN MATEO BLVD, N.E., SUITE A220  
ALBUQUERQUE, NM 87110**

**MARCH 1992**

**FINAL REPORT**

**FEBRUARY 1991**

**APPROVED FOR PUBLIC RELEASE:  
DISTRIBUTION UNLIMITED**



**AIR FORCE ENGINEERING & SERVICES CENTER  
ENGINEERING & SERVICES LABORATORY  
TYNDALL AIR FORCE BASE, FLORIDA 32403**

NOTICE

PLEASE DO NOT REQUEST COPIES OF THIS REPORT FROM  
HQ AFESC/RD (ENGINEERING AND SERVICES LABORATORY).

ADDITIONAL COPIES MAY BE PURCHASED FROM:

NATIONAL TECHNICAL INFORMATION SERVICE  
5285 PORT ROYAL ROAD  
SPRINGFIELD, VIRGINIA 22161

FEDERAL GOVERNMENT AGENCIES AND THEIR CONTRACTORS  
REGISTERED WITH DEFENSE TECHNICAL INFORMATION CENTER  
SHOULD DIRECT REQUESTS FOR COPIES OF THIS REPORT TO:

DEFENSE TECHNICAL INFORMATION CENTER  
CAMERON STATION  
ALEXANDRIA, VIRGINIA 22314

# REPORT DOCUMENTATION PAGE

Form Approved  
OMB No. 0704-0188

Public reporting burden for this collection of information is estimated to average 1 hour per response, including the time for reviewing instructions, searching existing data sources, gathering and maintaining the data needed, and completing and reviewing the collection of information. Send comments regarding this burden estimate or any other aspect of this collection of information, including suggestions for reducing this burden, to Washington Headquarters Services, Directorate for Information Operations and Reports, 1215 Jefferson Davis Highway, Suite 1204, Arlington, VA 22202-4302, and to the Office of Management and Budget, Paperwork Reduction Project (0704-0188), Washington, DC 20503.

1. AGENCY USE ONLY (Leave blank)	2. REPORT DATE March 1992	3. REPORT TYPE AND DATES COVERED Final 12-16 Feb 91	
4. TITLE AND SUBTITLE Armored Personnel Carrier (APC) Firefighting Vehicle System (M113a2 Firefighting System)		5. FUNDING NUMBERS C - F08635-88-C-0067	
6. AUTHOR(S) M. J. Wilson, J. H. Storm, and G. B. Singh, C. W. Risinger		8. PERFORMING ORGANIZATION REPORT NUMBER None	
7. PERFORMING ORGANIZATION NAME(S) AND ADDRESS(ES) Applied Research Associates, Inc. 4300 San Mateo Blvd, N. E., Suite A220 Albuquerque, NM 87110		10. SPONSORING/MONITORING AGENCY REPORT NUMBER ESL-TR-91-09	
9. SPONSORING/MONITORING AGENCY NAME(S) AND ADDRESS(ES) Civil Engineering Laboratory HQ Air Force Civil Engineering Support Agency Tyndall AFB, Florida 32403-6001		11. SUPPLEMENTARY NOTES Prepared in cooperation with the U.S. Army Tank and Automotive Command (TACOM) and the U.S. Army Material Command (AMC) in support of "Desert Storm" application.	
12a. DISTRIBUTION/AVAILABILITY STATEMENT Approved for public release. Distribution unlimited.		12b. DISTRIBUTION CODE	
13. ABSTRACT (Maximum 200 words)  This project evaluated the fire suppression capabilities of an M113A2 Armored Personnel Carrier (APC), modified with an internal skid-mounted fire suppression system. Six different agents were tested with the APC system to evaluate their fire extinguishing time, burnback rate, throw range, reservicing time, and ease of reser- vicing. To facilitate this test program, a 96 feet by 10 feet trench was construct- ed with a 15 inch high clay berm. JP-4 fuel (250-500 gallons) was floated on water in the trench and burned to simulate large hydrocarbon fires anticipated in combat operations during operation "Desert Storm". The M113A2 APC system, using AFFF as the superior agent, was found to be effective in combating large tactical fires.			
14. SUBJECT TERMS Hydrocarbon fuel fires, Fire extinguishing agents, AFFF, Pyrocop PVC, Phirex, Hurri-safe, Acu-lite			15. NUMBER OF PAGES 62
17. SECURITY CLASSIFICATION OF REPORT UNCLASSIFIED			16. PRICE CODE
18. SECURITY CLASSIFICATION OF THIS PAGE UNCLASSIFIED	19. SECURITY CLASSIFICATION OF ABSTRACT UNCLASSIFIED	20. LIMITATION OF ABSTRACT UL	

NSN 7540-01-280-5500

## EXECUTIVE SUMMARY

### A. OBJECTIVE

The overall objective of this test series was to demonstrate the fire suppression performance of the modified M113A2 APC in suppressing simulated trench fires. The secondary objective was to evaluate six firefighting agents for use with the modified APC in a realistic wartime scenario.

### B. BACKGROUND

The Middle-East situation (Operation Desert Storm) presented a unique petroleum warfare problem. Among potential Iraqi defenses were a number of dug-in trenches approximately one mile long, ten feet wide, and ten feet deep. These trenches could be fed crude oil and ignited should allied forces attempt to cross them. Operation Desert Storm was the first conflict to present a tactical problem of this type and consequently a military solution had not been formulated. The need was foreseen to suppress these fires, or at least create a path in the fire, so that a combat vehicle bridge could be dropped over the trench for the blue forces to pass without delay. To rapidly suppress these large hydrocarbon fuel fires from the ground with personnel protection from small arms fire, an M113A2 Armored Personnel Carrier (APC), integrated with a firefighting system, was determined to be the most viable option. This task was directed by AMC to TACOM. The goal was to design, develop, and fabricate a prototype fire suppression system, integrate it with an M113A2, and demonstrate its capability to extinguish large tactical fires with a suitable fire suppression agent. AMC requested Air Force assistance, through the Air Force Engineering Service Center, Fire Protection and Crash Rescue Research Branch (AFESC/RDCF), to conduct fire suppression performance tests of this system and several fire suppressing agents on simulated 10-foot wide trench fires.

### C. SCOPE

This project evaluated the fire suppression capabilities of an M113A2 Armored Personnel Carrier (APC), modified with an internal skid-mounted fire suppression system. The APC is a standard U.S. Army vehicle. Using the modified APC as the agent dispensing vehicle, several different fire suppressing agents were evaluated for their ability to suppress a simulated trench JP-4 fire 10 feet wide and 96 feet long. The extinguishing time, burnback rate, throw range, reservicing time, and ease of reservicing were evaluated for each agent. Three fires were planned for each test agent in the test series with initial fuel quantities of 250 gallons and a maximum of 500 gallons being burned during any single fire.

**EXECUTIVE SUMMARY**  
(Concluded)

**D. CONCLUSION**

1. The M113A2 APC, configured with the firefighting kit, as tested in this report, showed that large tactical fires can be successfully suppressed.

2. The standard military firefighting agent, Aqueous Film Forming Foam (AFFF), (MIL-F-24835C) was found to be superior to all other tested agents in extinguishing and suppressing tactical fires.

3. This system, as configured, is not only applicable to ordnance fire suppression, but (after enemy attack) it may also be used for getting firefighting equipment to off-road or debris-strewn areas that are inaccessible to standard firefighting vehicles. For example: cratered debris-strewn runways, large POL or ammunition depots, off-road aircraft crash sites, and other emergency sites inaccessible to standard wheeled firefighting vehicles. Natural disasters, such as earthquakes, hurricanes, and tornadoes are also applications for this all-terrain firefighting vehicle. A firefighting system equipped M113A2 APC can meet these exigencies.



PREFACE

This final report was prepared by the Engineering and Services Laboratory, Air Force Engineering and Services Center, Tyndall Air Force Base, Florida 32403 in conjunction with U.S. Army Tank Command (TACOM), Warren, Michigan.

Overall project management was the responsibility of Mr G.B. Singh, PM-M113/M60 FOV Office, TACOM, Warren, Michigan 48397-5000.

Mr Charles W. Risinger, AFESC/RDCF, was the Project Officer. This report presents the results of the Armored Personnel Carrier (APC) Firefighting Vehicle System tests conducted from 12-16 February 1991 at Tyndall AFB, Florida.

This Technical Report has been reviewed and is approved for publication.



CHARLES W. RISINGER  
Test Director  
AFESC/RDCF

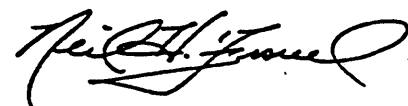

NEIL H. FRAVEL, Lt Col, USAF  
Chief, Engineering Research Division



RICHARD N. VICKERS  
Chief, Airbase Fire Protection  
and Crash Rescue Systems Branch

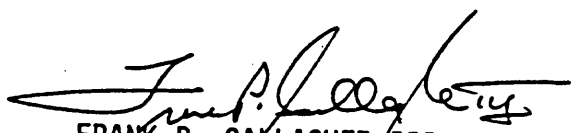

FRANK P. GALLAGHER III, Colonel USAF  
Director, Engineering and Services  
Laboratory

# TABLE OF CONTENTS

Section	Title	Page
I	INTRODUCTION.....	1
	A. TEST OBJECTIVES.....	1
	B. BACKGROUND.....	1
	C. MEASURES OF MERIT.....	2
	D. SCOPE.....	2
	E. TEST AUTHORITY.....	2
	F. M113A2 FIRE EXTINGUISHER SYSTEM DESCRIPTION.....	2
	G. AGENTS TESTED.....	4
	H. TEST SITE ACCESS.....	4
II	TEST DESCRIPTION.....	6
	A. INTRODUCTION.....	6
	B. FIRE EXTINGUISHMENT AND BURNBACK TESTS.....	8
	C. AGENT THROW RANGE TEST.....	8
	D. AGENT RESERVICING TEST.....	8
	E. APC VISUAL ACUITY TEST.....	8
	F. SPECIAL INSTRUMENTATION.....	9
	G. DATA COLLECTION.....	9
III	RESULTS AND CONCLUSIONS.....	10
	A. GENERAL.....	10
	B. APC FIREFIGHTING PERFORMANCE.....	11
	C. AGENT PERFORMANCE.....	13
	D. AGENT COMPARISONS.....	19
	E. ALTERNATE EXTINGUISHING METHODS.....	19
	F. SUMMARY BY ASSESSMENT PARAMETER.....	20
	G. CONCLUSIONS.....	22
APPENDIX		
A	PHOTOGRAPHS OF TYPICAL FIRE TEST OPERATIONS.....	23
B	MATERIAL SAFETY DATA SHEETS.....	28
C	ARMORED PERSONNEL CARRIER (APC) FIREFIGHTING VEHICLE SYSTEM TEST PLAN.....	40

SECTION I  
INTRODUCTION

A. TEST OBJECTIVES

Test objectives for this test series were as follows:

1. Demonstrate the fire suppression performance of the modified APC in suppressing simulated trench fires.
2. Demonstrate the capability of a modified APC agent delivery system to establish and maintain a 10-15 foot wide assault path through the 96 foot long simulated fire trench. The time for the fire to burnback and close the path was measured and recorded. The purpose of this objective is to provide a more realistic simulation of the wartime scenario.
3. Evaluate the capability of each firefighting agent being tested to arrest a fire and suppress burnback in conjunction with Objectives 1 and 2.
4. Evaluate the throw range of the modified APC with each agent tested.
5. Evaluate the reservicing time and ease of reservicing of the modified APC with each agent being tested.
6. Assess the visual acuity from the APC operator's position during firefighting operations. It is anticipated that during upwind operations, agent blowing back on the vision blocks of the APC may obscure the view of the fire for the APC operator.

B. BACKGROUND

The Middle-East situation (Operation Desert Storm) presented a unique petroleum warfare problem. The Iraqi Defense created several sequential obstacles. One of which was a number of dug-in trenches approximately one mile long, ten feet wide, and ten feet deep. These trenches were fed crude oil from a central outlet with six to eight pipelines buried underground. In the battlefield scenario, Iraqi forces had full intentions of setting fire to these trenches as Allied Forces attempted to cross them. Operation Desert Storm was the first conflict to present a tactical problem of this type and consequently a military solution had not been formulated. The need was foreseen to suppress these fires, or at least create a path in the fire, so that a combat vehicle bridge could be dropped over the trench for the blue forces to pass without delay. To rapidly suppress these large hydrocarbon fuel fires from the ground with personnel protection from small arms fire, an M113A2 Armored Personnel Carrier (APC), integrated with a firefighting system, was determined to be the most viable option. This task was directed by AMC to TACOM. The goal was to design, develop, and fabricate a prototype fire suppression system, integrate it with an M113A2, and demonstrate its capability to extinguish large tactical fires with a suitable fire suppression agent. AMC requested Air Force assistance, through the Air Force Engineering Service Center, Fire Protection and Crash Rescue Research Branch (AFESC/RDCF), to conduct fire suppression performance tests of this system and several fire suppressing agents on simulated 10-foot wide trench fires.

### C. MEASURES OF MERIT

The measures of merit were the capability of the modified APC and the agents being tested to rapidly suppress the fire and delay burnback for a sufficient period of time, within the limits of an on-board premixed agent supply system. The extinguishment time, quantity of agent used, burnback rates, throw range, reservicing time, and ease of reservicing were the parameters used in determining the success of the system and agents being tested. The ability of the crew to approach and extinguish the fire from an upwind position must be determined. An analysis of the success/failure of the firefighting crew, using the modified APC to combat large hydrocarbon fuel spills, must also be determined.

### D. SCOPE

This project evaluated the fire suppression capabilities of an M113A2 Armored Personnel Carrier (APC), modified with an internal skid-mounted fire suppression system. The APC is a standard U.S. Army vehicle. Using the modified APC as the agent dispensing vehicle, several different fire suppressing agents were evaluated for their ability to suppress a simulated trench JP-4 fire 10 feet wide and 96 feet long. The extinguishing time, burnback rate, throw range, reservicing time, and ease of reservicing were evaluated for each agent. Three fires were planned for each test agent in the test series with initial fuel quantities of 250 gallons and a maximum of 500 gallons being burned during any single fire.

### E. TEST AUTHORITY

This test was conducted to support a U.S. Army Materiel Command (AMC) requirement with potential "Desert Storm" application.

### F. M113A2 FIRE EXTINGUISHER SYSTEM DESCRIPTION

A standard U.S. Army M113A2 APC was modified with a fire suppression system developed by the Amerex Corporation. A diagram of the system is shown in Figure 1. The system consists of the following components:

#### 1. Tank.

- a. Agent Fill Volume - 250 gallons mixed
- b. Operating Pressure - 240 psig
- c. 4 inch ID opening in top with cap for filling agent concentrate and mixing the solution
- d. Drain valve in tank bottom which can also be used to fill tank with water
- e. Safety pressure relief valve in tank top
- f. Vent valve in tank top
- g. 2" shut-off ball valve to control agent flow from tank
- h. Tank ID coated with coal tar epoxy to prevent corrosion
- i. An agent level gauge

#### 2. Pressurizing Cylinders.

Two 220 cubic foot nitrogen or air cylinders with a nominal pressure of 2,000 psig (Standard military equipment)

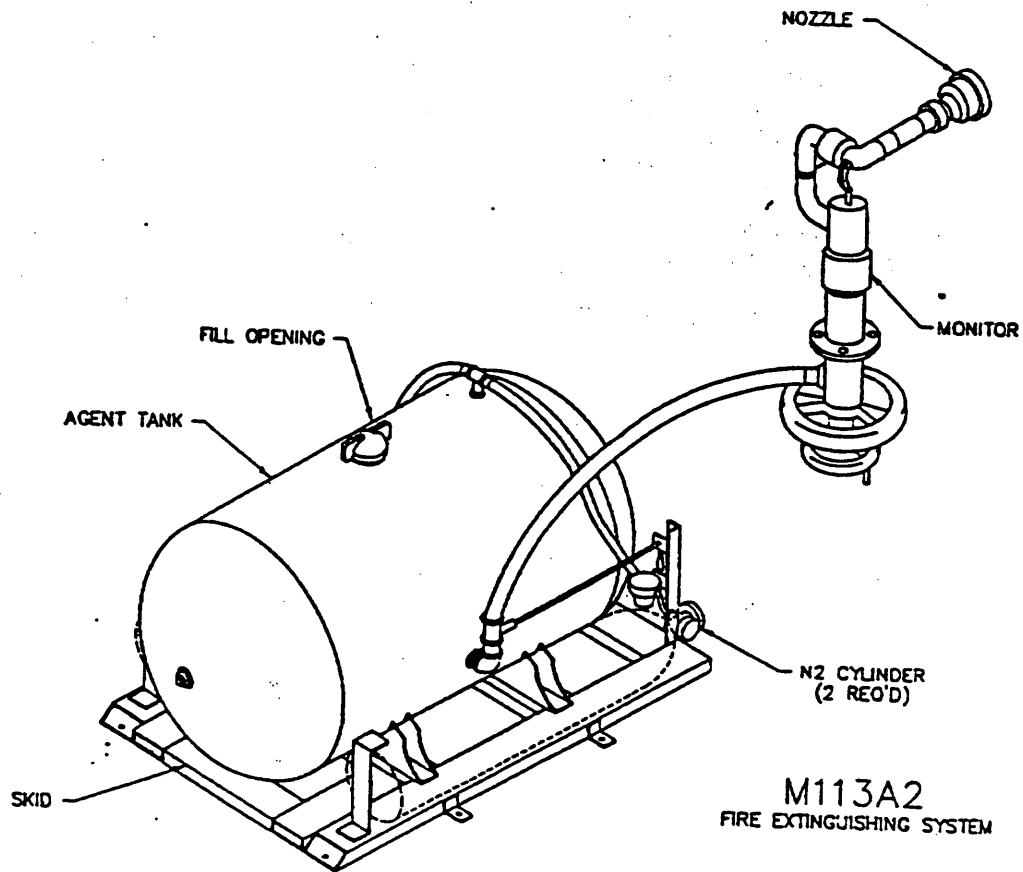

Figure 1. M113 A2 Firefighting System Diagram

### 3. Skid System.

a. Skid provides a means for quickly mounting the pressurizing cylinders (GFE). The cylinders may be slid into place or removed when a cylinder retaining bracket, held by two bolts, is removed.

b. System provides two high flow pressure regulators set to an operating pressure of 200 psig.

c. The agent tank is welded to the skid.

d. The skid system with tank and other components can be handled from the out board end and loaded into the APC with a fork-lift truck.

e. The skid system, with plumbing, weighs 1,220 pounds empty and 3,300 pounds full.

f. The skid system is bolted to the APC's floor plate, using existing holes.

g. The skid is designed to provide an even distribution of weight onto the floor support frame members.

#### 4. Tank Pressurizing System.

Pressure from each of the two 220 cubic foot cylinders is fed through a high flow pressure regulator. The regulator reduces the pressure to 200 psig. The pressure feed hoses are attached to the top of the tank.

#### 5. Agent Feed System.

A two inch ball valve is connected to the agent tank outlet. A two inch agent hose connects the ball valve to the monitor.

#### 6. Monitor.

The monitor is installed in the right forward antenna position on the M113A2. Four bolts are used to hold it in place. The agent delivery nozzle, mounted on the monitor outlet can be rotated horizontally or elevated or depressed by controls located inside the vehicle. The controls shown in Figure 1 are being replaced by a single lever system which will permit easy operation by the vehicle commander. The turret and nozzle are controllable through approximately  $+160^\circ$  horizontally and  $-15^\circ$  to  $+45^\circ$  vertically from the operator's position within the vehicle.

#### 7. Nozzle.

Various nozzle configurations are easily accommodated.

#### 8. System Installation.

To install the fire extinguishing system in an APC, the personnel heater system and the vehicle commander's seat must be removed. Six deck plate bolts are removed with their larger washers. The empty system is placed through the rear ramp door opening. The skid is bolted to the floor plate with six long bolts, provided. The right forward antenna position cover is removed and the monitor is installed in this opening. A two inch jumper hose is attached between the tank outlet valve and the monitor. Two supply pressure cylinders are installed. The tank is filled with agent and water and the fill cap installed. When the nitrogen cylinders are opened the system is pressurized and ready for use. System flow can be controlled by the single tank outlet valve, located within easy reach of the vehicle commander. The aiming of the fire extinguisher agent stream is also accomplished by the vehicle commander.

#### 9. General Reservicing Procedures.

Replacement of the two pressure supply cylinders and refilling the tank with water and the liquid agent concentrate is all that is required to reservice the system. Turn around time is approximately 7 to 10 minutes for most agents tested (see "Reservicing Procedures in Section III, Paragraph B.3.) and is somewhat contingent upon the supply water flow rate, used for refilling the tank.

G. AGENTS TESTED

1. Assessment Parameters. The six agents, listed below, were assessed for their firefighting potential against the following parameters:

ASSESSMENT PARAMETERS (descending importance)

Fire-out time	Agent Availability/
Reflash resistance	Production base
Toxicity - Neat agent	Training requirements
Salt Water requirements	Agent Data - MSDS, etc.
Agent to equipment interface	Handling residue
Pyrolysis products	Cost
Neat Agent handling	

2. Agents Tested. The following agents were evaluated:

<u>AGENT TYPE</u>	<u>MANUFACTURER</u>	<u>LOCATION</u>
Pyrocap B-136	Pyrocap Inc.	Springfield, Va.
Hurri-Safe	Hurri-Safe	Birmingham, Al.
Powdered Viscous Foam	Atlantic Rim, Inc.	Manasses, Va.
AFFF (Type 6% MIL-SPEC)	3M Company	St. Paul, Mn.
Phirex	Phirex	
Acu-Lite-F	Conrad Mikulec	Auto-X Corp.

H. TEST SITE ACCESS

During all testing activities, access to the test site and immediate area was limited to government personnel, SETA support contractor personnel, technical representatives from the agent dispensing equipment manufacturer, and test agent contractor personnel. Agent contractor personnel were permitted access to the test site only during the initial test site familiarization period and when their agent was being tested.

SECTION II  
TEST DESCRIPTION

A. INTRODUCTION

This test program was conducted by burning 250 or 500 gallons of JP-4 fuel in the AFESC 100-foot diameter fire test facility. One to four test fires were conducted for each test agent, at the request of the agent manufacturers. Prior to conducting test fires, two fires were conducted for equipment and procedure training and familiarization for the APC and reserivcing crews.

The AFESC 100-foot environmentally-safe fire test facility, located on Farmdale Road, Tyndall AFB, Florida was used for all fire tests. The facility was modified for this test series with a 15-inch high clay reinforced dam placed in the fire pit to form a rectangular bermed area 10 feet by 96 feet to simulate the trenches anticipated in the wartime scenario. A diagram of the test set-up is shown in Figure 2. Two six-foot high steel stakes were placed along the edge and centered on the trench to facilitate agent application aiming and data acquisition during the burnback portion of the test.

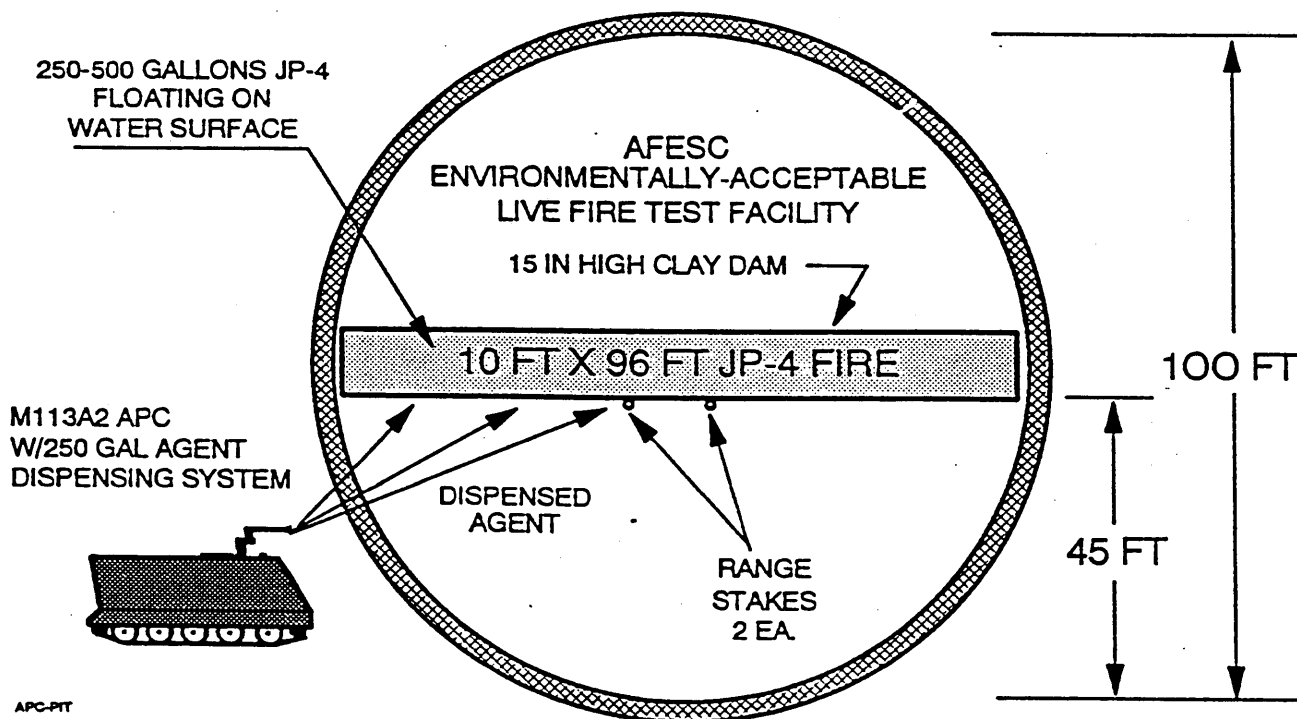

Figure 2. 100-Foot Fire Test Facility Set-Up



The modified APC was prepared before each test fire by filling the tank with 100 or 250 gallons of premixed agent, in accordance with the test matrix in Table 1. Sea water was used as the agent carrier, since this is the anticipated scenario in the operational environment. The two 220 ft<sup>3</sup> nitrogen bottles, used to propel the agent, were replaced for each fire test to ensure that the gas supply was not depleted before an individual test was completed. The pressure regulator was adjustable to obtain the appropriate flow for the particular agent being tested, as per the agent manufacturer's specifications. This turned out to be 200 psi for all agents tested. The nozzle configuration was tailored to each individual agent manufacturer's requirements.

Sea water for use throughout this test series was pumped from the Gulf of Mexico into a 5,000 gallon tank truck and placed at the test site before the test began. Water was taken from a location near the open gulf to provide salt water with high salinity. Water for all tests was taken from the same tank truck load.

For each test fire, fuel was placed in the rectangular burn area, ignited with a torch, and followed by the modified APC attacking the fire and extinguishing a 10-15 foot assault path or all except the last 10-15 feet of the trench, as determined by the test event protocol shown in Table 1. Fire tests from both upwind and downwind positions were planned, but in the interest of consistently getting the test agents on the fire so that an objective comparison could be made, only approaches from the upwind position were made.

A USAF P-19 firefighting vehicle was manned by AFESC personnel and available at the fire test facility for all fires to cover contingencies.

Table 1. Firefighting Agent Test Matrix

<u>FIRE NO.</u>	<u>AGENT GAL.</u>	<u>FUEL GAL.</u>	<u>WIND DIRECTION</u>	<u>OBJECTIVE</u>
1	100	250	UPWIND	Extinguish 90% of trench from upwind end of trench. Measure extinguishment and burnback times.
2	100	250	UPWIND	Extinguish 90% of trench from upwind end of trench. Measure extinguishment and burnback times.
3	250	500	UPWIND	Extinguish 90% of trench from upwind end of trench. Measure extinguishment and burnback times.

After each fire test was completed the fire pit was reignited, if necessary, and permitted to burn off the residual fuel to facilitate pit clean-up for the next test. The fire pit was also flushed with water before the next fire test so that agent from the previous test would not contaminate the results of following tests.

To ensure that the residue from one agent did not contaminate the test results for a follow-on agent, the entire the agent tank and dispensing system was thoroughly flushed with water and blown clean with nitrogen at the completion of the test matrix for each agent.

## B. FIRE EXTINGUISHMENT AND BURNBACK TESTS

A series of three test fires were planned for each agent being tested. Most agents were tested during three separate fires. However, at the agent manufacturer's request, some agents were tested for only one or two fires and one agent was tested during four fires. Test fires were conducted as follows.

The 10 by 96 foot trench was filled with either 250 or 50 gallons of JP-4 fuel. The Range Safety Officer then directs the ignition of the fire, observes a 30-second preburn period and commands the APC to approach the fire. The APC either approached the fire from an upwind position or was pre-positioned at the upwind end of the trench and begin dispensing agent. The objective was to extinguish all except 10-15% of the opposite end of the fire. The time to extinguish most of the trench and the burnback time were recorded. The quantity of agent used was also recorded. However, in most cases all agent on-board (100 gallons for the first fire and 250 gallons for the third fire for each agent) was used. After burnback, the fire was be permitted to burn out the remaining fuel to facilitate pit cleanup in preparation for the following test fire.

## C. AGENT THROW RANGE TEST

The purpose of this test was to evaluate the throw range of the modified APC with each agent tested. The concern was that agent viscosity may effect this critical firefighting parameter. This test was conducted in conjunction with fire extinguishment tests.

## D. AGENT RESERVICING TEST

The purpose of this test was to evaluate the reservicing time and ease of reservicing of the modified APC with each agent being tested, using the written instructions provided by the agent manufacturer. The test was conducted in conjunction with the fire tests described above for each of the test agents. The reservicing activity for each agent was timed and video taped. Subjective evaluations as to the ease of reservicing the system were made by reservicing personnel and recorded by the data recorder.

## E. APC VISUAL ACUITY TEST

The purpose of this test was to assess the visual acuity from the operator's position in the APC during firefighting operations. This test was completed in conjunction with and throughout the fire tests. Results were based on the subjective evaluation of the system operator and recorded by the data recorder.

## F. SPECIAL INSTRUMENTATION

In order to measure the maximum temperatures experienced by the APC and the occupants, the APC was instrumented with six thermocouples to measure and record temperature both inside and outside of the vehicle during firefighting operations. Two thermocouples were placed in front of the heat shield blanket, two behind the blanket, and two inside of the vehicle. An onboard recording system recorded all six channels for later data reduction and analysis. Thermocouples were also placed in and near to fire to measure maximum temperatures.

## G. DATA COLLECTION

All data were recorded on preprinted data collection sheets. One fixed and one roving video camera recorded all test activities. Still camera photographs were taken throughout the test series.

SECTION III  
RESULTS AND CONCLUSIONS

A. GENERAL

1. Data Presentation. This section includes the test results and conclusions of the test. Table 2 includes relevant data from the 17 fire tests conducted. Paragraph B presents the firefighting performance parameters of the APC that are irrespective of the agent used. Paragraph C presents the firefighting performance of the individual agents tested and their interaction with the APC. Paragraph D is a comparison of the agent performance for the agents tested. Paragraph E addresses two alternate extinguishing methods that were evaluated during this test series. Paragraph F is a summary by Assessment Parameter of all agents tested with overall test conclusions contained in paragraph G.

2. APC Position and Wind Data. The fire trench, constructed in the AFESC Environmentally-Acceptable Live Fire Test Facility, was oriented in a north-south direction as shown in Figure 3. Wind direction is given in degrees relative to a magnetic compass, with 360 meaning that wind is from 360 degrees, or North, as shown in Figure 3. Wind Speed is given in statute miles per hour (mph). A wind speed of 10G18 means 10 mph gusting to 18 mph with L-V denoting "light and variable" winds. The APC position relative to the fire trench is also given in degrees magnetic. In the example shown in Figure 3, the APC is applying agent from a position of approximately 340 degrees.

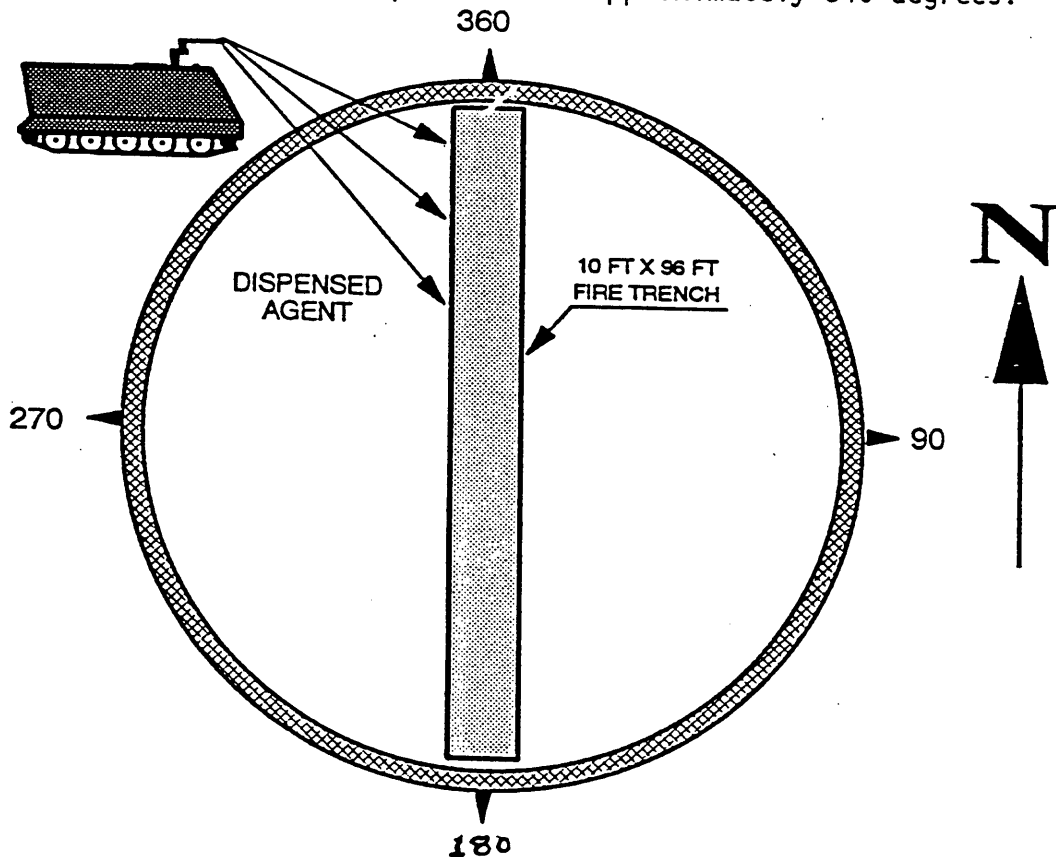

Figure 3. Fire Trench Orientation and APC Position

3. Test Data Presented in Table 2. Time data are local CDT. Agent flow rates were calculated by dividing the agent quantity used by the total dispensing time and are shown in gallons per minute (GPM). Some error exists in these rates as the total agent used was not accurately known for all tests, specifically the PVF agent where large, but unmeasured, quantities of undissolved agent remained in the APC tank after the test. The "% BURNING" column is an estimate of the percent of the trench that remained burning after all agent was expended. "EXT TIME" is the extinguishment time measured from the start of agent application until the trench was extinguished to the maximum extent obtained. "BURNBACK" time was measured from the end of agent application until the trench was fully engulfed in flames again or began burning out due to fuel exhaustion. "BURNBACK RATE" was calculated by dividing the number of feet that reignited by the time to achieve the reignition and is presented in feet per minute (ft/min). "APC MAX TEMPS" were the maximum temperatures recorded during a particular fire inside and outside of the APC.

4. Salt Water Origin and Analysis. Sea water was used as the carrier for all tested agents. Sea water for the test was taken from the Gulf of Mexico adjacent to Tyndall AFB, Florida. Water was transported from the gulf to the test site with a 5,000 gallon tank trailer. A water sample was tested at a local laboratory (The Water Spigot, Inc., Panama City, Fl) for salinity and PH factor. Following are the results of the laboratory analyses:

Salinity:	15.4 parts/thousand
pH factor:	8.0

## B. APC FIREFIGHTING PERFORMANCE

1. Overall Capability. The modified APC has a maximum capacity of 250 gallons of agent and water. Using an effective agent, this quantity is adequate to extinguish a 10 foot wide trench fire 100 feet long and prevent burnback for approximately 5-6 minutes; wind being the variable factor. Using a system pressure of 200 psi, flow rates varied from 150 to 250 GPM but averaged 200 GPM. While the data shown in Table 2 would indicate the higher flow rates (250 GPM) were a result of using PVF agent, it should be noted that when using this agent, all of the agent in the tank was not expended. A considerable amount of residue remained in the tank at the conclusion of the PVF tests. Flow rate was calculated by dividing the total quantity of agent used by the total dispensing time. It was impossible to measure the quantity of the remaining solid PVF agent, and therefore the agent used. Disregarding these data, the anticipated average flow rate will be 200 GPM. Throw range also did not appear to be a function of agent type and averaged between 70 and 80 feet to the center of the foot print in a no-wind condition. A headwind will decrease this range.

2. Operator Visibility. The APC's closed circuit television system was inoperative for this test. During the first two tests conducted on 12 and 13 February, little or no agent was put on the fire. The APC operators were attempting to operate the vehicle from inside with all hatches closed. The visibility from inside the APC through the periscopes was restricted such that the monitor operator was unable to determine the location of the agent stream, resulting in not getting the stream on the fire during these early tests. The remaining fire tests were conducted with the hatch open and the operator's upper body above the vehicle while wearing a fire protection ensemble with hood. This is the recommended mode of operation.

### 3. Reservicing Procedures and Time Required - by Agent.

Reservicing procedures were observed, video taped, and timed throughout the test series for each agent. Three people were used for each reservicing operation.

a. AFFF, Pyrocap, Hurri-Safe, and Phirex. These four agents were essentially the same, as far the reservicing aspects are concerned. These agents are supplied in five-gallon plastic cans and mixed with water in ratios between six and fifteen percent, requiring from three to eight five-gallon cans for the 250 gallon capacity of the APC. The empty APC tank was filled with water (210 gallons for a 15 percent mixture or 235 gallons for a six percent mixture) and the agent poured into the tank from the five-gallon cans. A long-spout funnel was used to introduce the agent into the bottom of the tank to enhance mixing while impeding foaming action. After the agent was added, the tank contents were manually stirred for approximately one minute using a paddle approximately five feet long and the cap secured on top of the tank. The two nitrogen bottles were exchanged for full bottles with each reservicing. Using three people, the entire process took between 7.5 and 10 minutes, as a function of the number of cans of agent required.

b. Powdered Viscous Foam (PVF). The reservicing of this agent required minor modifications to the dispensing system. The agent manufacturer provided the necessary hardware and assisted with the system modification. The change required approximately two hours to complete. The agent was supplied as a white powder in one kilogram (2.2 pound) dissolvable plastic bags. A brown liquid activating agent was included in a separate compartment with each one kilogram agent bag. Each bag containing the white powdered agent and the activating agent in a separate compartment was further packaged in a non-dissolvable plastic bag. These plastic bags were shipped in five-gallon plastic buckets. To fully charge the 250 gallon APC tank, 100 of these PVF bags were required. The bags were opened and dropped into the APC tank one by one. The agent manufacturer accomplished this task and pierced each activator section of the bag with a pocket knife as he dropped the bags into the tank. When all 100 bags were placed in the tank the cap was replaced and water added through the monitor nozzle. The nitrogen bottles were replaced as in the previous tests. The process required 40 minutes. After the reservicing operation was completed, the APC was driven around the test area to mix the agent, at the request of the agent manufacturer. Also at the request of the agent manufacturer, the agent was allowed to stand for an additional 30 minutes to permit the agent/water mixture to fully react before beginning the next fire test. Including the manufacturer's required activation time, the entire reservicing time was one hour and 20 minutes. After the completion of the test the tank was opened to begin cleaning the system for the next test. Several large chunks of solid material and several undissolved plastic bags were found inside the tank. A vacuum truck and several flushing operations of the system with water were required to clean the system for the next test. This clean-out process required one hour and 30 minutes. Including this clean-out time, the recycle time for this agent was 2 hours and 50 minutes.

c. Acu-lite-F. This agent was mixed 50/50 with AFFF (6% type) in the APC tank. No water was used. Both the Acu-lite and the AFFF were supplied in 55 gallon drums. Drums were handled with a fork-lift and lifted

above the APC fill port to permit gravity feed of the agents into the APC tank. A two-inch hose was attached to the drums to facilitate pouring the agents into the APC tank. Nitrogen bottles were replaced as in the previous tests. The entire reserVICing process required one hour and 11 minutes.

#### 4. Temperatures Encountered.

a. Maximum APC Temperatures. Throughout the test series the APC was instrumented with six thermocouples and an on-board data recording system to measure and record the temperatures encountered during firefighting operations. Table 2, APC Test Data, includes these maximum temperatures for each fire test. The symbol "N/A" under the temperature columns indicates that temperatures were not recorded during that particular fire test. The maximum temperature encountered on the outside forward section of the APC (in front of the temperature shield blanket) was 129°F. The APC was positioned 25 feet upwind (wind blowing from behind the APC and towards the fire) of the fire. Wind velocity at the time was 7 gusting to 12 MPH. Maximum temperature encountered inside of the APC was 74°F. Ambient temperature at the time was 66°F. However, it should be noted that this 8°F increase in temperature existed before the fire. No measurable increase in interior temperature resulted from bringing the APC in close proximity with the fire.

b. Maximum Fire Temperatures. During four fires, high-temperature thermocouples were placed in and near the actual fire trench and connected to a data recording system. The maximum temperature recorded in the center of the flame was 2,100°F. Maximum temperatures in close proximity to the fire were as follows:

<u>Distance from edge of fire</u>	<u>Maximum Temp (°F)</u>
25	311
50	241
75	124

#### C. AGENT PERFORMANCE

Test data for all fire tests are contained in Table 2.

##### 1. Pyrocap B-136.

###### a. Test Conditions

As called out in the test plan, three fires were initially conducted to evaluate this agent on 13 February 1991. Ambient temperatures were approximately 66°F with winds out of the south gusting 5-20 mph. The agent supplied had a bright green color and was mixed with sea water at a ratio of 15%. One hundred gallons of agent was prepared for the first two fires. However only 58 gallons was used during the second fire. For the third fire, 250 gallons was prepared (full APC tank). The first two fires burned 250 gallons of JP-4 each with 500 gallons being burned for the third fire. As specified by the agent manufacturer, a Task Force Tip H-V variable stream nozzle was used for all tests. Agent flow rate was approximately 200

TABLE 2. APC FIRE TEST DATA

TEST DATE	TEST NO.	AGENT NAME	AGENT MIX USED RATIO (gal) (%)	NOZZLE TYPE	FUEL QTY. (gal)	WIND DIR.	WIND SPEED (mph)	AMB. TEMP (deg F)	APC POS.	IGN TIME	AGENT DISPENSE		FLOW RATE (GPM)	BURN-ING (%)	EXT. TIME (sec)	BURN BACK TIME (sec)	BURN BACK RATE (ft/min)	APC MAX TEMPS		COMMENTS	
											BEGIN	END						deg F	deg F		
2/12	1	3M AFFF	247	6	4	250	270	20	75	270	15:46:45	-----	N/A	100	N/A	N/A	N/A	80	74	No agent on fire - poor APC vis.	
2/13	1	Pyrocap	100	15	1	250	200	5620	66	270	14:04:00	14:04:30	200	100	N/A	N/A	N/A	69	72	Little agent on fire - green agent	
2/13	2	Pyrocap	58	15	1	250	180	5610	66	300	14:55:30	14:56:10	174	80	19	10	115.2	89	74	Partial path cleared - green agent	
2/13	3	Pyrocap	250	15	1	500	190	5610	68	140	16:04:13	16:04:50	150	80	90	20	57.6	N/A	N/A	green agent	
2/16	2	Pyrocap	250	10	2	500	30	2-4	44	360	10:56:00	10:56:43	208	30	125	55	73.3	111	53	Rapid burnback - red agent	
2/14	1	Hurri-Safe	100	6	1	250	330	5610	65	330	09:52:00	09:52:30	187	100	N/A	N/A	N/A	112	69	No extinguishment	
2/14	2	Hurri-Safe	100	6	1	250	320	7612	66	330	10:39:45	10:40:18	162	90	32	15	38.4	129	73	Partial path cleared	
2/14	3	Hurri-Safe	250	6	1	500	330	7612	66	360	11:43:43	11:44:10	150	50	90	50	57.6	100	74	Partial path cleared	
2/15	1	PVF	250	Note 1	5	500	290	10622	57	290	10:02:21	10:03:09	246	100	N/A	N/A	N/A	N/A	N/A	No path or extinguishment	
2/15	2	PVF	250	Note 1	6	500	310	10618	57	360	12:30:55	12:31:30	250	20	60	200	23.0	N/A	N/A	N/A	
2/16	1	Phirex	250	6	1	500	360	1-3	33	360	08:49:08	08:49:54	250	20	50	25	184.3	N/A	N/A	Rapid burnback	
2/16	3	CO2/N2	Note 2	N/A	N/A	300	170	3	48	N/A	14:39:20	14:39:50	N/A	20	10	400	11.5	N/A	N/A	Rapid extinguishment	
2/16	4	3M AFFF	100	6	3	300	90	5-7	50	360	Note 3	14:59:30	15:00:00	200	0	15	N/A	N/A	119	64	Fire ext - No burnback
2/16	5	3M AFFF	160	6	3	500	90	3-5	49	360	15:33:00	15:37:43	185	0	30	N/A	N/A	94	66	Fire ext - No burnback	
2/16	5a	3M AFFF	90	6	3	Note 4	90	3-5	49	90	15:48:00	15:53:30	216	80	20	250	4.6	94	66	Path opened in center of fire.	
2/16	6	Acu-lite	250	Note 5	3	500	0	L-V	40	360	18:08:34	18:10:20	188	30	80	240	16.8	N/A	N/A	Initially fire flared up.	
2/22	1	3M AFFF	180	50	Note 6	500	110	5	60	180	09:26:13	09:26:50	270	0	12	600	8.6	N/A	N/A	Reignited for burnback test	

\* Note 1: Powered agent mixed 100 Kg to 220 gal water.

\* Note 2: Seven cardboard barrels filled with dry ice - 3 with N<sub>2</sub> Agent released by initiating detonation-chord.

\* Note 3: Fire burning from previous CO2 fire test. 300 gallons fuel added.

\* Note 4: Fuel added after Test 5 burnback and fire reattacked from the side to evaluate path cutting.

\* Note 5: Mixed agent (250 gal) consisted of 125 gal. Acuilite and 125 gal. 3M AFFF (6% type), without water.

\* Note 6: P-4 bumper turret, with flow rate similar to APC (280 GPM) used for this test - Equipment change does not effect burnback time.

NOZZLES:

- 1 Task Force Tip H-V Variable Stream
- 2 Task Force Tip H-V Variable Stream - with 2' extension
- 3 Task Force Tip F200
- 4 Straight Pipe 40" x 2" diameter
- 5 Straight Tip - 1" smooth bore nozzle
- 6 Straight Tip - 1" smooth bore nozzle with 2' ext.



GPM. The APC was positioned beside the trench for these three fire tests with the wind approximately 90 degrees to the agent stream direction. Refer to APC position and wind data in Table 2 and the pit diagram in Figure 3 for detailed APC position and wind data.

After the first three fires were completed, Pyrocap representatives requested that they be permitted to supply more agent for one additional fire test to be conducted on 16 February. The request was granted by the government. Although Pyrocap personnel stated that all tested agents were the same, the agent supplied by Pyrocap for this test had a bright red color, as opposed to the green agent supplied for the first three Pyrocap tests. As directed by Pyrocap personnel, this agent was mixed with seawater at 10%, as opposed to the 15% mixture used on the previous Pyrocap tests. Conditions for this fourth test were light winds and a temperature of 44°F. In order to get the maximum amount of agent on the fire, this test was conducted with the APC positioned directly off the north end of the trench so that the agent stream could be applied directly to the trench. As in the third test, 250 gallons of agent was applied to the fire.

#### b. Agent Performance

During the first fire very little agent reached the fire. This was a result of limited visibility from the operator's position inside the APC. As a result, no extinguishment of the fire took place. The 100 gallons of agent on-board the APC was expended.

During the second fire 58 gallons of agent was applied to the center section of the fire trench. A partial path approximately 20 feet wide was opened. Extinguishment time was rapid, 19 seconds. However, burnback time was even more rapid. Agent application was ceased when the rapid extinguishment occurred to observe burnback characteristics. The path closed completely within 10 seconds.

During the third fire 250 gallons of agent was applied to the fire with a 20 foot path extinguished in approximately 90 seconds. Again, burnback was very rapid at about 20 seconds.

During the fourth Pyrocap fire test, conducted on 16 February 1991, fire extinguishment of 70% of the trench (30% remained burning) occurred in 125 seconds. Burnback time was again rapid at 55 seconds to 100% burnback.

The extinguishment time for this agent is slightly poorer than average. Its burnback suppression performance is very poor.

## 2. Hurri-Safe.

#### a. Test Conditions

Three fires were conducted to evaluate this agent on 14 February 1991. Ambient temperatures were approximately 66°F with winds out of the northwest gusting 5-12 mph. The agent was mixed with sea water at a ratio of 6%. One hundred gallons of agent was used for the first two fires with 250 gallons used for the third fire. The first two fires burned 250 gallons of JP-4 each with 500 gallons being burned for the third fire. As specified by the agent manufacturer, a Task Force Tip H-V variable stream nozzle was used

for all tests. Agent flow rate was approximately 175 GPM. The APC was positioned off the north end of the trench or slightly to the west of the north end with the wind blowing from behind the APC. Refer to APC position and wind data in Table 2 and the pit diagram in Figure 3 for detailed APC position and wind data.

b. Agent Performance

Although agent was applied to the fire, no extinguishment occurred during the first fire. As a result no burnback test was possible.

During the second fire, 10% of the trench was extinguished in 32 seconds. Burnback was very rapid and the trench was fully 100% burning again within 15 seconds.

During the third fire 250 gallons of agent was applied from the north end of the trench. Approximately 50% of the trench was extinguished in 90 seconds. Complete burnback occurred within 50 seconds.

Both extinguishing and burnback suppression performance for this agent is poor.

3. Powdered Viscous Foam (PVF).

a. Test Conditions

At the request of Atlantic Rim, Inc. personnel, two fires were conducted to evaluate this agent on 15 February 1991. Ambient temperatures were 57°F with winds out of the northwest gusting 10-22 mph. This powdered agent was mixed 220 pounds of agent to 220 gallons of seawater to produce 250 gallons of mixed agent. Two hundred and fifty gallons of agent were used for each fire. Both fires burned 500 gallons of JP-4 each. As specified by the agent manufacturer, a straight tip one inch smooth bore nozzle was used for all tests. A two foot extension was added between the monitor and the nozzle tip for the second fire to facilitate manual operation of the nozzle by Atlantic Rim personnel. Agent flow rate was approximately 250 GPM. This flow rate may be high as a considerable amount of sludge remained in the tank after each fire test. This unmeasured quantity of agent was not considered in the flow rate calculation. The APC was positioned on the west side of the trench with the wind blowing from directly behind the vehicle for the first test. During the second test the APC was positioned directly off the north end of the trench with the wind blowing from the northwest. Refer to APC position and wind data in Table 2 and the pit diagram in Figure 3 for detailed APC position and wind data.

b. Agent Performance

Although agent was applied to the fire, no extinguishment occurred during the first fire. As a result no burnback test was possible.

During the second fire, 80% of the trench was extinguished in 60 seconds. Burnback to a fully burning trench occurred in 200 seconds.

4. Phirex.

a. Test Conditions

At the request of the Navy, a single fire was conducted to evaluate this agent on 16 February 1991. Ambient temperature was 33°F with very light (1-3 mph) north winds. The agent was mixed with sea water at a ratio of 6%. Two hundred and fifty gallons of agent was used on a 500 gallon JP-4 fire. A Task Force Tip H-V variable stream nozzle was used for the test. Agent flow rate was approximately 250 GPM. The APC was positioned off the north end of the trench. Refer to APC position and wind data in Table 2 and the pit diagram in Figure 3 for detailed APC position and wind data.

b. Agent Performance

Agent was applied in two separate intervals. At the end of the original 20 second application the fire was extinguished to 50% of the full trench length. Extinguishment was rapid. However, burnback was very rapid, returning the trench to its 100% fully burning condition within 15 seconds. The remaining agent was applied in 50 seconds, extinguishing the trench to 20% burning. Burnback was again rapid, returning the trench to 100% burning in 25 seconds. The extinguishment performance of this agent is very rapid, but its burnback suppression performance is practically non-existent.

5. Acu-lite.

a. Test Conditions

At the request of the the agent manufacturer, a single fire was conducted to evaluate this agent on 16 February 1991. Ambient temperature was 40°F with very light and variable winds. The agent was mixed 50/50 with AFFF concentrate (type 6%); 125 gallons of Acu-lite and 125 gallons of AFFF concentrate. No water was used. Two hundred and fifty gallons of agent was used on a 500 gallon JP-4 fire. A Task Force Tip F-200 nozzle was used for the test. Agent flow rate was approximately 190 GPM. The APC was positioned off the north end of the trench. Refer to APC position and wind data in Table 2 and the pit diagram in Figure 3 for detailed APC position and wind data.

b. Agent Performance

Agent was applied in two separate intervals. At the end of the original 80 second application the fire was extinguished to 30% of the full trench length. The fire burned back to 50% burning in 90 seconds. The remaining agent was applied in 10 seconds, returning the extinguishment to 30% burning. Burnback to 50% burning occurred in 90 seconds again. No further burnback occurred as fuel was exhausted. The extinguishment performance of this agent is fair. Its burnback suppression performance is also fair.

6. 3M AFFF (type 6%).

a. Test Conditions

As called out in the test plan, three fires were initially planned for the evaluation of this agent. One fire was conducted on 12 February 1991, three fires on 16 February 1991, and one fire to evaluate agent

performance when mixed at a 50% ratio with water was conducted on 22 February. Ambient temperatures were 75°F with west winds at 20 mph for the 12 February fire, 50°F and east winds at 3-7 mph for the three fires on 16 February, and 60°F and southeast winds at 5 mph for the 22 February fire. Standard 3M AFFF (type 6%) was mixed with sea water at 6% for the first four fires and 50% for the fifth fire. See Table 2 for agent and fuel quantities used for each fire. A 40 inch long by two inch diameter straight pipe nozzle was used for the 12 February test. A Task Force Tip F200 nozzle was used for the three fires conducted on 16 February. Agent flow rate was approximately 200 GPM. The APC was positioned on the north end of the trench for the first two tests on 16 February and east of the trench for the third 16 February test. Refer to APC position and wind data in Table 2 and the pit diagram in Figure 3 for detailed APC position and wind data.

The purpose of an additional AFFF test fire conducted on 22 February was to evaluate the firefighting and burnback suppression performance of AFFF when mixed at a 50% ratio with water. It was believed that this very rich mixture may provide significantly improved burnback resistance. The APC was not available on 22 February so a P-4 firefighting vehicle and its bumper turret were substituted. The flow rate of the P-4 bumper turret is approximately 280 GPM, only slightly higher than the APC system. The higher agent flow rate may have effected the extinguishment time but had no effect on burnback time, the parameter of primary concern. Two hundred and fifty gallons of premixed agent were placed in the empty main water tank of the P-4. The agent consisted of 125 gallons of water and 125 gallons of type 6% AFFF.

#### b. Agent Performance

During the 12 February fire no agent reached the fire. This was a result of limited visibility from the operator's position inside the APC. As a result, no extinguishment of the fire took place. The 247 gallons of agent on-board the APC was expended.

During the first fire conducted on 16 February the APC applied agent from the north end of the trench. The fire was totally extinguished in 15 seconds, consequently no burnback data were collected.

During the second fire on 16 February the APC also applied agent from the north end of the trench. The fire was totally extinguished in 30 seconds with no burnback test conducted.

During the third fire on 16 February the APC applied agent from the east side of the trench to the center section of the fire trench. A 20 foot wide path in the center of the trench was extinguished in 20 seconds. The time required for the path to burnback and close was 250 seconds, demonstrating excellent burnback suppression performance.

During Test conducted on 22 February the P-4, using its bumper turret and AFFF premixed at 50% was positioned on the south end of the trench and extinguished the entire pit in 12 seconds. The AFFF covered fuel was difficult to reignite, but reignition was eventually accomplished. After the trench was burning to 10% of it length, the burnback time was initiated. The time to burnback to 60% burning was 10 minutes. No additional burnback occurred as fuel was expended.

This agent, 6% AFFF, proved to be far superior to all other agents tests in both fire suppression time and burnback resistance. Mixing the agent at 50% with water was effective, but no more so than mixing at the prescribed 6% ratio. A comparison of agent performance parameters can be found in the following paragraph.

#### D. AGENT COMPARISONS

Agent reservicing times, extinguishment rates, and burnback times are shown on Table 3.

TABLE 3. AGENT COMPARISONS

AGENT	RECYCLE TIME (min)	EXTINGUISH RATE (ft/sec)	RELATIVE EXTINGUISH RATE	BURNBACK RATE (ft/min)	RELATIVE BURNBACK RATE
PYROCAP	7-10	0.59	0.13	82.0	12.42
HURRI-SAFE	7-10	0.27	0.06	48.0	7.27
PVF	170	0.64	0.14	23.0	3.48
PHIREX	7-10	1.54	0.33	184.3	27.92
ACU-LITE	70	0.84	0.18	16.8	2.55
AFFF	7-10	4.64	1.00	6.6	1.00

Times and rates are averages of all tests performed for that agent and are relative to that of AFFF. High extinguish rates and low burnback rates are desirable. As can be seen from this table, AFFF has the fastest extinguishing rate and the slowest burnback rate, by a considerable margin.

#### E. ALTERNATE EXTINGUISHING METHODS

##### 1. P-19 Firefighting Vehicle.

After several of the agents tested failed to extinguish, or in some cases even a portion of, the fire, the standby P-19 firefighting vehicle was called in to complete the extinguishment. The P-19 was dispensing 3% AFFF metered through a modified precision, positive displacement, computer controlled, metering system through the roof turret. The roof turret flow rate is approximately 460 GPM. In every case, the P-19 extinguished the fire very rapidly (10-15 seconds). The P-19 used for this test, also had a prototype hardening system installed. This armoring kit will protect the vehicle and its occupants from a STANAG 2929 small munition fragment.

##### 2. CO<sub>2</sub>/N<sub>2</sub> Explosive Fire Suppression.

###### a. Test Conditions

At the request of the Office of the Assistant Secretary of Defense, an explosive fire suppression concept was evaluated in the same 10 by 96-foot trench as the APC tests. Seven 50 gallon cardboard barrels were evenly spaced in the northern 80 feet of the trench. The southern 15 feet of the trench were left open so that the fire would remain burning to facilitate burnback testing. Approximately 80 pounds of dry ice (frozen CO<sub>2</sub>) were placed in each barrel. Liquid nitrogen (N<sub>2</sub>) was placed over the dry ice in the

northern three barrels. The top and bottom of each barrel were previously equipped with 5 turn spirals of detonation chord connected together. The seven barrels were also connected with det chord which was brought to the end of the trench and connected to a detonation device. After the barrels were filled with dry ice and liquid nitrogen, as specified above, and the barrel lids replaced, the trench was filled with 300 gallons of JP-4 and ignited. After a 30 second burn the det chord was initiated. The theory was that the explosion would blow the fire out and the CO<sub>2</sub> pellets and liquid N<sub>2</sub> would suppress burnback. Ambient temperature was 48°F with very light (1-3 mph) south winds.

#### b. Fire Suppression Performance

All personnel were cleared from the immediate area. The fire was ignited and 30 seconds later, the detonation chord was initiated. The explosive blast immediately blew out the fire in the northern 80% of the trench. The southern 20% of the trench remained burning, as anticipated. The dry ice pellets remained in the fuel emitting CO<sub>2</sub>, suppressing burnback. The time required to burnback to 100% burning was 400 seconds.

#### F. SUMMARY BY ASSESSMENT PARAMETER

The overall system evaluation was based on the following assessment parameters. These 20 parameters, along with the overall assessment for each, are listed below in descending order of importance.

1. Fire-Out Time. This parameter is a measure of the agent's capability to extinguish the fire and is measured from the beginning of agent application to the time that a predetermined portion of the fire has been extinguished. For comparative purposes, Fire extinguishment rates were calculated to give extinguishment in feet per second. AFFF was superior to all agents tested.

2. Reflash Resistance. This parameter is also called burnback time or burnback rate and is a measure of the firefighting agent's capability to prevent an extinguished fire from reigniting from an adjacent ignition source. For comparative purposes burnback rates were calculated to give burnback in feet per minute. AFFF was superior to all agents tested.

3. Toxicity - Neat Agent. This parameter was not a discriminator.

4. Heat Prostration. This was determined to be no factor in the operation of the system. In fighting 16 trench fires with the APC coming within 20 feet of the fire, the maximum temperatures encountered on the outside and inside of the vehicle, respectively, were 129°F and 74°F. A firefighters ensemble and hood will easily protect the operator from this external temperature with his upper body above the vehicle.

5. Oxygen Depravation. Due to the very limited heat build-up in and around the APC, this parameter was found to be no factor in the operation of the APC in this scenario.

6. Salt Water Requirements. All assessed/demonstrated agents appeared to be soluble in salt water. Solution composition for the agents tested varied from 6-15% agent concentrate with sea water.

7. Agent to Equipment Interface. Each agent was designed to interface with current standard firefighting equipment, with the exception that PVF required an alteration of the existing plumbing in an effort to mix the powdered agent and reduce flow restrictions. This requirement remains questionable.
8. Equipment to Vehicle Interface. Equipment to vehicle interface displayed full compatibility.
9. Force Structure Impact. This parameter was not a discriminator.
10. Throw Capability. This parameter was not a discriminator when assessing the agents under review, as it was not agent dependent. It was evaluated under APC system performance. Agent throw range for the modified APC as 70-80 feet.
11. Pyrolysis Products. This parameter was not a discriminator.
12. Neat Agent Handling. Hurri-Safe, Pyrocap, and Phirex were easily handled; no different than AFFF. However, PVF, with no clear or apparent handling and mixing instructions, appeared to be a "mix and check" procedure. Acu-lite required additional handling due to the large quantity of agent required. Acu-lite was mixed 50/50 with AFFF concentrate. With no water being used, handling 250 gallons of agent in 55 gallon barrels posed additional handling difficulties and time.
13. External Visual Acuity. This parameter was not a discriminator when assessing the agents under review, as it was not agent dependent. It was evaluated under APC system performance. Visibility from inside the APC was difficult at best. Operation of the system from the open vehicle commanders hatch corrected this problem. By wearing firefighter's ensemble and hood the otherwise exposed operator is protected from the fire.
14. Agent Availability/Production Base. With the exception of AFFF, the agents are supported by a production base. Hurri-Safe's agent is viewed as low risk, since a warm corporate production base exists for other product lines. Pyrocap is viewed as slightly higher risk; with ARI's agent being the highest risk of all. None of the agents appear to require strategic materials; however, the cryogenic manufacturing process associated with ARI is the most restrictive from both the technical and proprietary aspects.
15. Dispensing Equipment Availability/Production Base. This parameter was not a discriminator when assessing the agents, however it was evaluated with the overall system. The dispensing equipment is an assortment of commercial non-development items (NDI). There are no formal Technical Data Packages (TDP) or Technical Manuals (TM) available. However, a small quantity of systems could be assembled within 2-3 weeks without a formal TDP. If the system is adopted, the development of a formal competitive TDP will be required.
16. Training Requirements. This parameter was not a discriminator.
17. Agent Data - Material Safety Data Sheet (MSDS). This parameter was not a discriminator.

18. Handling Residue. The ARI agent, PVF, was the only agent that posed any problems with residue handling. It required special equipment and special handling after each use. This agent fouled all components of the extinguishing system and the delivery vehicle. The other agents tested, presented no additional residue handling problems as compared to AFFF.

19. RAM-D. The RAM-D of the dispensing equipment is viewed as the same for all agents except the PVF agent. In this case, the issue of residue or precipitate clogging or degrading the performance of the dispensing equipment (monitor, relief valve, control valve, and nozzle) is an issue which increases the operational risk when this agent is used.

20. Cost - (Agent and Equipment). AFFF was the lowest priced agent at \$75/250 gallon tankfull of mixed agent. Hurri-Safe was \$1,250/tankfull and Pyrocap was \$900/tankfull. ARI's agent, PVF was \$35,000/tankfull. Other agents tested were provided by their agent manufactures at no cost to the government and no cost data are available.

#### G. CONCLUSIONS

1. The M113A2 APC, configured with the firefighting kit, as tested in this report, showed that large tactical fires can be successfully suppressed.

2. The standard military firefighting agent, Aqueous Film Forming Foam (AFFF), (MIL-F-24835C) was found to be superior to all other tested agents in extinguishing and suppressing tactical fires.

3. This system, as configured, is not only applicable to ordnance fire suppression, but (after enemy attack) it may also be used for getting firefighting equipment to off-road or debris-strewn areas that are inaccessible to standard firefighting vehicles. For example: cratered debris-strewn runways, large POL or ammunition depots, off-road aircraft crash sites, and other emergency sites inaccessible to standard wheeled firefighting vehicles. Natural disasters, such as earthquakes, hurricanes, and tornadoes are also applications for this all-terrain firefighting vehicle. A firefighting system equipped M113A2 APC can meet these exigencies.



**APPENDIX A**

**PHOTOGRAPHS OF TYPICAL FIRE TEST OPERATIONS**

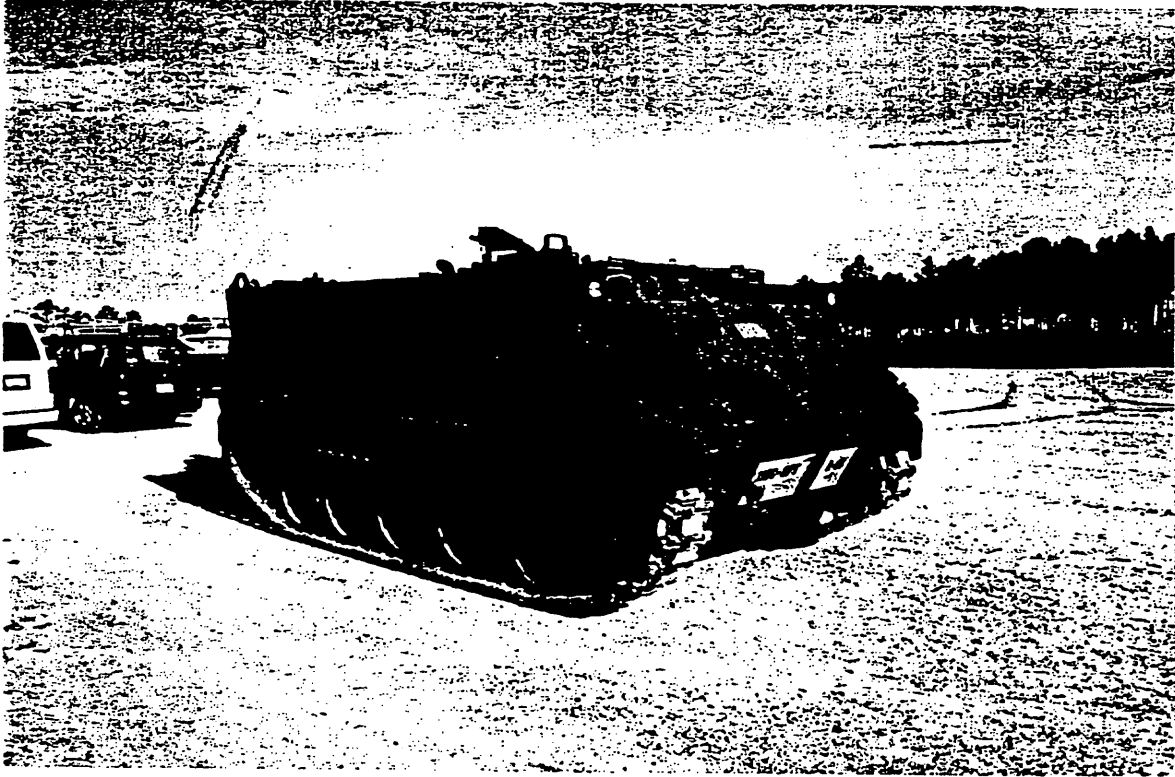

Figure A-1. Typical M113A2 Armored Personnel Carrier APC)

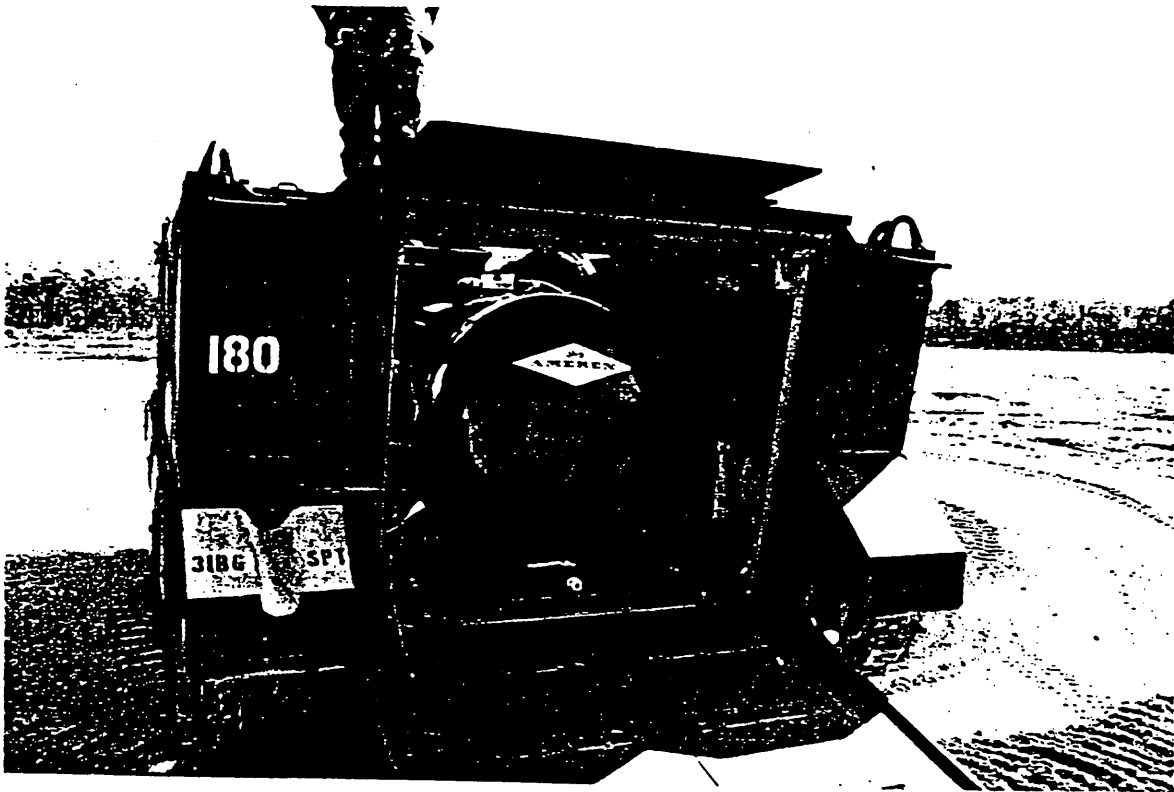

Figure A-2. M113A2 with Fire Suppression System Installed

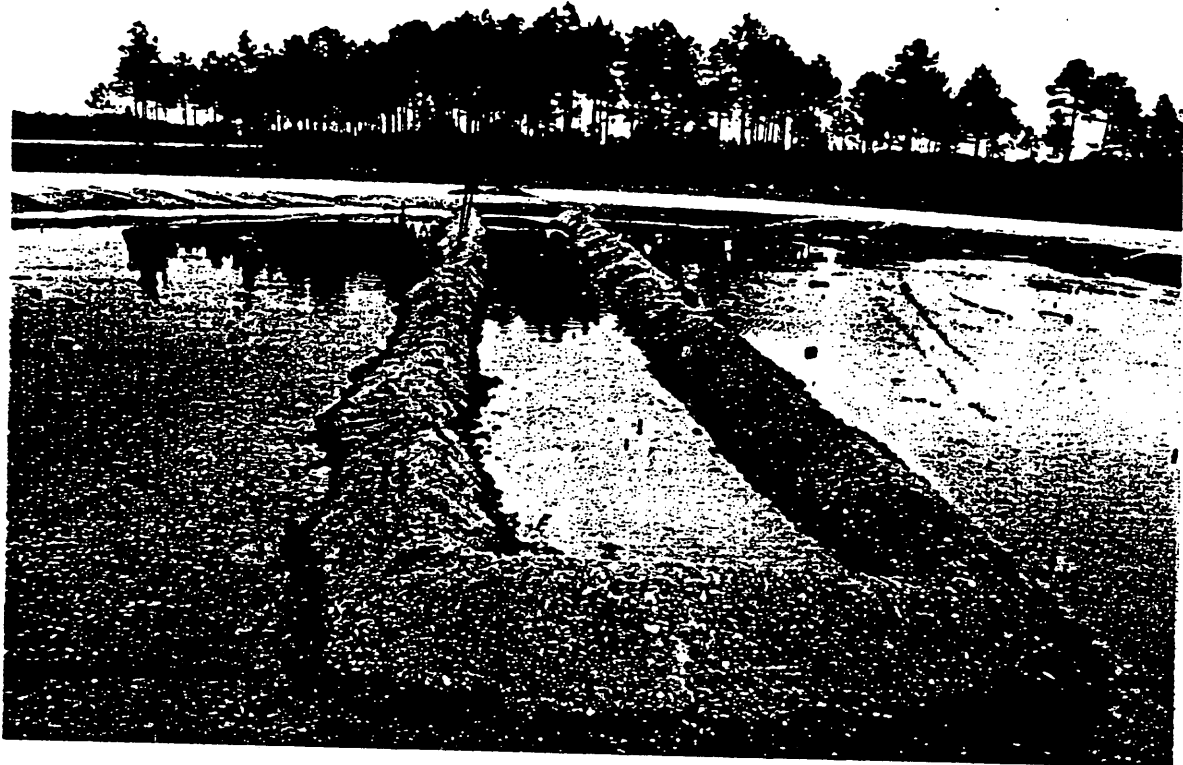

Figure A-3. Pre-fire Trench Set-up



Figure A-4. Typical Fire Test with APC Set-up



Figure A-5. APC Applying Agent to Fire



Figure A-6. Fire trench Showing Burnback



Figure A-7. Fire with Path in Center Extinguished



Figure A-8. Fire Trench After Total Extinguishment

**APPENDIX B**  
**MATERIAL SAFETY DATA SHEETS (MSDS)**

Pyrocap, Inc.

## MATERIAL SAFETY DATA SHEET

1/18/91

SECTION I	
MANUFACTURER'S NAME	Pyrocap, Inc.
ADDRESS	6551 Loisdale Ct, Suite 400, Springfield, VA 22150
EMERGENCY TELEPHONE NUMBER	(703) 922-9800 8a-5p EST. Mon-Fri except holidays
INFORMATION TELEPHONE NUMBER	(703) 922-9800 8a-5p EST. Mon-Fri except holidays
CHEMICAL NAME AND SYNONYMS	<del>Fire Suppressant-Chemical</del>
TRADE NAME AND SYNONYMS	<b>Pyrocap B-136 and Pyrocap A-500</b>
CHEMICAL FAMILY	<del>Surfactant</del>
FORMULA	

SECTION II - HAZARDOUS INGREDIENTS				
HAZARDOUS COMPONENTS	OSHA PEL	ACGIH TLV	Other Limits Recommended	% (optional)
None				

SECTION III - PHYSICAL CHEMICAL CHARACTERISTICS			
BOILING POINT (°F)	>500	SPECIFIC GRAVITY (H <sub>2</sub> O = 1)	1.03
VAPOR PRESSURE (mm H <sub>2</sub> )	-	PERCENT VOLATILE BY VOLUME (%)	30.15
VAPOR DENSITY (AIR = 1)	1	EVAPORATION RATE (Butyl Acetate = 1)	N/A
SOLUBILITY IN WATER	100%	MELTING POINT	-10°C
APPEARANCE AND ODOR	Viscose Liquid, Red, Mildly Pleasant Odor		

SECTION IV - FIRE AND EXPLOSION HAZARD DATA					
FLASH POINT (Method Used)	Unknown	FLAMMABLE LIMITS	N/A	LEL: N/A	UEL: N/A
EXTINGUISHING MEDIA	N/A				
SPECIAL FIRE FIGHTING PROCEDURES	N/A				
UNUSUAL FIRE AND EXPLOSION HAZARDS	Unknown				

**MATERIAL SAFETY DATA SHEET**

SECTION V - REACTIVITY DATA			
STABILITY	UNSTABLE		CONDITIONS TO AVOID: None known
	STABLE	X	
INCOMPATIBILITY (Materials to avoid)		Strong oxidizing agents	
HAZARDOUS DECOMPOSITION OR BYPRODUCTS		None known	
HAZARDOUS POLYMERIZATION	MAY OCCUR		CONDITIONS TO AVOID: None known
	WILL NOT OCCUR	X	

SECTION VI - HEALTH HAZARD DATA				
ROUTE(S) OF ENTRY		INHALATION? None known	SKIN? None known	INGESTION? None known
HEALTH HAZARDS (Acute and Chronic)		Will cause irritation if concentrated product comes in contact with eye		
EMERGENCY AND FIRST AID PROCEDURES		In case of contact with eyes, immediately flush eyes with copious amounts of water. If irritation persists, call a physician.		
CARCINOGENICITY:	NTP? No	IARC MONOGRAPHS? No	OSHA REGULATED? No	
SIGNS AND SYMPTOMS OF EXPOSURE		Irritation (burning/itching) of the eyes		
MEDICAL CONDITIONS GENERALLY AGGRAVATED BY EXPOSURE		None known		

SECTION VII - PRECAUTIONS FOR SAFE HANDLING AND USE	
STEPS TO BE TAKEN IN CASE MATERIAL IS RELEASED OR SPILLED	Larger amounts (more than 5 gallons) may be mopped up. Smaller amounts may be flushed away with water.
WASTE DISPOSAL METHOD	May be flushed to sewer if local ordinances do not prohibit such disposal of biodegradable detergent materials.
PRECAUTIONS TO BE TAKEN IN HANDLING AND STORING	None required
OTHER PRECAUTIONS	None

SECTION VIII - CONTROL MEASURES			
RESPIRATORY PROTECTION (Special type)		None	
VENTILATION	LOCAL EXHAUST	None	SPECIAL
	MECHANICAL (General)	None	OTHER
PROTECTIVE CLOVES	Not normally required	EYE PROTECTION	Avoid contact
OTHER PROTECTIVE CLOTHING OR EQUIPMENT		None	
WORK/HYGIENIC PRACTICES		No special practices required	





*Safer Products for a Safer World*

**FIRE KNIFE**

FIRE KNIFE IS A FULLY AQUEOUS FORMULATION THAT FORMS AS TRUE A SOLUTION AS IS POSSIBLE.

FIRE KNIFE, WHEN USED WITH THE PROPER FAN NOZZLE, CREATES A SHEETING EFFECT THAT SEPARATES THE HEAT OF THE BURNING GASSES FROM THE POTENTIAL FUEL SOURCE THUS PREVENTING PYROLYSIS (DECOMPOSITION BY HEAT). FIRE KNIFE THUS COOLS THE SURFACE AND ELIMINATES THE DANGER OF RE-IGNITION. THESE BENEFITS ARE IMMEDIATE.

FIRE KNIFE IS MUCH LESS AFFECTED BY WIND, FROM ANY DIRECTION, THAN ANY FOAM TYPE EXTINGUISHING AGENT.

FIRE KNIFE WAS FORMULATED AS AN ALTERNATIVE AND REPLACEMENT FOR FIRE FIGHTING AGENTS THAT EMIT CHLOROFLOROCARBONS.

FIRE KNIFE IS NON-HAZARDOUS, HAS NO HARMFUL FUMES, IS COMPLETELY BIODEGRADABLE AND MAY BE DILUTED WITH EITHER FRESH WATER OR SEA WATER.

**SPECIFICATIONS**

pH.....	7-8
SOLUBILITY IN WATER.....	100%
SOLUBILITY IN SEA WATER.....	100%
BIODEGRADABILITY.....	100%
TOXICITY.....	NON-TOXIC NO HARMFUL FUMES
BOILING POINT.....	212 F
SPECIFIC GRAVITY.....	1.01
VOC'S.....	0

**HURRI K 31 | CORP.**

6000 SOUTHERN INDUSTRIAL DRIVE • BIRMINGHAM ALABAMA 35235 • TELEPHONE: 205-655-8808

**HURRI  
SAFE**

*Safer Products for a Safer World*

## FIRE KNIFE

FIRE KNIFE IS FORMULATED, FOR EASE OF COMPUTATION, AS A 20% SOLUTION. IT IS ESTIMATED THAT A 1% SOLUTION IS OPTIMUM WHEN DILUTING WITH FRESH WATER; AND INCREASES UP TO 3% WHEN DILUTING WITH SALT WATER DEPENDING UPON THE SALINITY.

MIXING: FIRE KNIFE IS FORMULATED TO BE PREMIXED TO THE DESIRED DILUTION BEFORE BEING LOADED IN THE TANK; IT IS NOT TO BE USED WITH A PROPORTIONER.

THE FOLLOWING DILUTIONS ARE GIVEN FOR 100 GALLONS OF DILUTED FIRE KNIFE:

- 1%= 5-GALLONS OF FIRE KNIFE WITH 95 GALLONS OF WATER
- 2%= 5-GALLONS OF FIRE KNIFE WITH 45 GALLONS OF WATER
- 3%= 5-GALLONS OF FIRE KNIFE WITH 28.3 GALLONS OF WATER
- 4%= 5-GALLONS OF FIRE KNIFE WITH 20 GALLONS OF WATER

APPLICATION: FIRE KNIFE IS NOT A FOAM AND SHOULD NOT BE AERATED OR USED WITH FOAM GENERATING EQUIPMENT. THE NOZZLE USED FOR APPLYING FIRE KNIFE SHOULD BE A SHEET NOZZLE OF APPROXIMATELY 20 DEGREE SPREAD. IT IS BEST APPLIED AT THE BASE OF THE FLAME WITH GOOD FORCE, SO AS TO SEPARATE THE FLAME FROM THE BURNING MATERIAL ALLOWING THE FLAME AND THE HEAT OF COMBUSTION TO CONTINUE RISING WITHOUT FURTHER HEATING OF THE FUEL. IT THEN OPERATES TO ALLOW COOLING OF THE MATERIAL AT THE SAME TIME CUTTING OFF OXYGEN.

THE POINT OF IMPACT SHOULD BE CONTINUOUSLY SHIFTED AS THE FIRE IS SEPARATED FROM THE FUEL. FIRST, ACROSS THE BASE AND THEN ADVANCED FORWARD ACROSS A HORIZONTAL SURFACE OR UP ACROSS ANY COMBUSTIBLE VERTICAL SURFACE. HOSE HANDLERS SHOULD ADVANCE AS APPROPRIATE TO KEEP FIRE KNIFE IMPINGING WITH GOOD FORCE AT THE BASE OF THE FLAME. GOOD SEPARATION ACTION WITHOUT EXCESSIVE SPLATTERING IS THE OBJECTIVE. THE ANGLE OF ATTACK DOES NOT DEPEND UPON THE WIND.

CLEAN UP: FIRE KNIFE IS NON-CORROSIVE AND HENCE EQUIPMENT CAN BE STOWED AFTER EXCESS SOLUTION HAS BEEN DRAINED.

**HURRI | 32 V CORP.**

DIVISIC ITRIES, INC.

6000 SOUTHERN INDUSTRIAL DRIVE • BIRMINGHAM, ALABAMA 35235 • TELEPHONE: 205-655-8808

**HURRI KLEEN<sup>®</sup> CORP.**  
SUBSIDIARY OF SELF INDUSTRIES, INC.

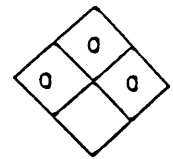

10 SOUTHERN INDUSTRIAL DRIVE  
MINGHAM, ALABAMA 35235  
PHONE: 205-655-8808 • FAX: 205-655-3288

**MATERIAL SAFETY DATA SHEET**  
**I. IDENTIFICATION**

PRODUCT NAME: FIRE KNIFE	
TECHNICAL NAME: Aqueous Formula	DATE PREPARED: 2-1-91
PERCENTAGE OF CONCENTRATION:	HAZARD CLASSIFICATION: NONE
TRANSPORTATION:	SHIPPING NAME: CLASS 55

**II. PHYSICAL DATA**

MELTING POINT, (F°)	212 F	VAPOR PRESSURE AT 20°C	NON-VOLATILE
SPECIFIC GRAVITY (H <sub>2</sub> O=1)	1.01	WATER SOLUBILITY	100%
RELATIVE DENSITY (air=1)	NON-VOLATILE	DENSITY	Not Established
PERCENT VOLATILE VOLUME (%)	NON-VOLATILE	EVAPORATION RATE WATER=1	N/A
pH of concentrate)	7-8 pH	VOC'S (%)	NONE
APPEARANCE AND ODOR	AMBER LIQUID, CONTAINING SLIGHT BUT NOT OFFENSIVE ODOR		

**III. INGREDIENTS**

INGREDIENT	%	OSHA PEL	TLV (units)	HAZARD
THIS FORMULA CONTAINS NO HAZARDOUS CHEMICALS AS LISTED IN SARA, SECTION 3, 313, and 302.				
INGREDIENT A	N/A	N/A	N/A	N/A
INGREDIENT B	N/A	N/A	N/A	N/A
INGREDIENT C	N/A	N/A	N/A	N/A

**IV. FIRE AND EXPLOSION HAZARD DATA**

FLASH POINT (test method)	NONE	FLAMMABLE LIMITS	NONE	LOWER NONE	UPPER NONE
EXTINGUISHING MEDIA	N/A				
SPECIAL FIRE FIGHTING PROCEDURES	N/A				
ADDITIONAL FIRE AND EXPLOSION HAZARDS	N/A				

**V. HEALTH HAZARD DATA**

EXPOSURE SOURCE	N/A
ACUTE EFFECTS OF EXPOSURE	N/A
CHRONIC CONTACT	N/A
IRRITATION	N/A
ADDITIONAL CONTACT	Slight irritation may be exhibited
TOXIC EFFECTS FROM OVEREXPOSURE	NONE
ADDITIONAL HEALTH HAZARDS	NONE

**EMERGENCY AND FIRST AID PROCEDURES**

ALLOWING	Induce vomiting by placing finger to throat or use ipecas.
Y	N/A
ALATION	N/A
Rinse with water for 15 minutes, if irritation occurs.	
ES TO SICIAN	This is relatively innocuous substance not expected to cause harm. Should treatment ever be required, it would be directed at control of symptoms.

**VI. REACTIVITY DATA**

STABILITY	STABLE: YES	UNSTABLE:	CONDITIONS TO AVOID:	N/A
COMPATIBILITY	N/A			
HAZARDOUS COMBUSTION OR DECOMPOSITION PRODUCTS	Under high temperatures, slight ammoniacal gas may evolve			
HAZARDOUS POLYMERIZATION	MAY OCCUR	WILL NOT OCCUR XXXXXX	CONDITIONS TO AVOID:	N/A

**VII. SPILL OR LEAK PROCEDURES**

ACTIONS TO BE TAKEN IF MATERIAL IS SPILLED	SMALL SPILLS: FLUSH WITH WATER LARGE SPILLS: ABSORB WITH SAWDUST, SAND OR EARTH.
WASTE DISPOSAL METHOD	May be disposed of in sewer system. Consult local state, county or Federal regulations for applicable laws pertaining to your areas.

**VIII. SPECIAL PROTECTION INFORMATION**

LABORATORY PROTECTION (type)	None
VENTILATION	N/A
RESPIRATORY GLOVES	N/A
FACE PROTECTION	If splashing is expected use goggles
OTHER PROTECTIVE EQUIPMENT	N/A

**IX. SPECIAL PRECAUTIONS**

PRECAUTIONS TO BE TAKEN IN HANDLING AND STORING	Keep container closed. Store in dry area
OTHER PRECAUTIONS	None



ATLANTIC RIM, Inc.  
P.O. Box 3191  
Manassas, VA 22110  
(703) 368-4024  
(703) 631-4217 FAX

MATERIAL SAFETY DATA SHEET

Product Name: POWDERED VISCOUS FOAM DS

Manufacturer:  
Atlantic Rim, Inc.  
P.O. Box 3191  
Manassas, VA 22110

Sales & Emergency Information  
(703) 368-4024  
(703) 631-4217

Effective Date: January 1991

Section I: General Information

Product Number: 704-1  
Product Class: Class B Fire Extinguishing Concentrate  
DOT Category: Non-hazardous

Section II: Hazardous Ingredients

There are no ingredients classed as hazardous in 29 CFR 1910.120 (OSHA), or Threshold Limit Value (TLV)'s for Chemical Substances and Physical Agents in the Work Environment, American Conference of Governmental and Industrial Hygienists, or the National Toxicology Program (NTP), Annual Report on Carcinogens, or the International Agency for Research on Cancer Monographs.

Section III: Physical & Chemical Characteristics

This product is used in prepackaged, water soluble bags. Each bag is preweighed and contains activators that produce fire-fighting liquid when added to water. When used as recommended, personnel are never exposed to the contents of the sealed bags.

Boiling Point: Not Applicable  
Percent (%) Volatile by Weight: < 1%  
Evaporation Rate: Not Applicable  
Vapor Density: Not Applicable

Section IV: Fire & Explosion Hazard Data

Flash Point: Not Applicable  
Explosive Limits: Not Applicable  
Extinguishing Media: Not Applicable  
Special Firefighting Procedures: Not Flammable  
Unusual Fire & Explosion Hazards: None

---

### Section V: Reactivity Data

---

Stability: Stable in closed container  
Incompatibility: None known  
Hazardous polymerization: Will not occur  
Hazardous Decomposition Products: Carbon dioxide (closed chambers), Ammonia

---

### Section VI: Health Hazard Data

---

In the event that an individual comes into contact with the contents of a bag (after an accident, or act of war) the following steps are recommended:

#### Effects of overexposure emergency and First Aid Procedures:

Eyes: Flush eyes immediately with copious quantities of water  
Skin: Flush with water.  
Inhalation: Avoid breathing mist.  
Ingestion: If swallowed consult a physician immediately. Although powdered ingredients are non-toxic allergic reactions may occur.  
Chronic Effects: None known.  
Carcinogen: No ingredient of this product is considered a carcinogen by OSHA, NTP or IARC.

---

### Section VII: Spill, Leak and Disposal Procedures

---

Recover material in accordance with all applicable Federal, State and Local regulations. Uncontaminated absorbent may be disposed of in an authorized landfill in accordance with Federal, State and Local regulations.

---

### Section VIII: Protective Measures

---

In recommended use the sealed, water soluble bags are used without opening. If there is an accidental or intentional destruction of bag integrity, the following measures are sufficient for protecting clean-up personnel.

Eye Protection: Wear goggles when product is carried by the wind.  
Gloves: Wear gloves or wash skin after contact with the product.  
Respiratory: Avoid breathing dust.  
Ventilation: Not Applicable.  
Other Protective Equipment: Wear protective clothing when involved with prolonged contact.

---

### Section IX: Special Precautions

---

Handling & Storage: Store cartons of bags of PVF-DS in accordance with good industrial hygiene and safety practices.

---

3M General Offices  
 3M Center  
 St. Paul, Minnesota 55144-1000  
 612/733-1110  
 Duns No.: 00-617-3082

00-16  
 1944

MATERIAL SAFETY  
 DATA SHEET



DIVISION: INDUSTRIAL CHEMICAL PRODUCTS DIVISION

TRADE NAME:

FC-206CE LIGHT WATER Brand Aqueous Film Forming Foam

3M I.D. NUMBER: ZF-0002-0138-2 ZF-0002-0168-9 ZF-0002-4662-7 ZF-0002-4663-5  
 98-0211-1393-5 98-0211-1417-2 98-0211-1501-3 98-0211-1502-1  
 98-0211-4829-5 98-0211-4830-3

ISSUED: DECEMBER 20, 1990  
 SUPERSEDES: NOVEMBER 29, 1989  
 DOCUMENT: 10-3020-7

1. INGREDIENT	C.A.S. NO.	PERCENT	EXPOSURE		LIMITS TYPE
			VALUE	UNIT	
Water	7732-18-5	76.0	NONE	NONE	NONE
Ethanol,2-(2-butoxyethoxy)-	112-34-5	15.0	35	ppm	TWA
Fluoroalkyl Surfactants +(5131P, 5143P)	TS	< 5.0	NONE	NONE	NONE
Synthetic Detergents +(5155P, 5038P, 5167P)	TS	< 5.0	NONE	NONE	NONE
Urea	57-13-6	4.0	NONE	NONE	NONE
1H-Benzotriazole,methyl-	29385-43-1	< 0.1	NONE	NONE	NONE

SOURCE OF EXPOSURE LIMIT DATA:

- CMRG: Chemical Manufacture Recommended Guidelines
- NONE: None Established

NOTE: New Jersey Trade Secret Registry (EIN) 04499600-+

THIS PRODUCT CONTAINS THE FOLLOWING TOXIC CHEMICAL OR CHEMICALS SUBJECT TO THE REPORTING REQUIREMENTS OF SECTION 313 OF TITLE III OF THE SUPERFUND AMENDMENTS AND REAUTHORIZATION ACT OF 1986 AND 40 CFR PART 372:

Ethanol,2-(2-butoxyethoxy)-

2. PHYSICAL DATA

BOILING POINT:..... ca. 100.00 C  
 (Initial)  
 VAPOR PRESSURE:..... ca. 30.4000 mmHg  
 Calc. @ R.T.  
 VAPOR DENSITY: ..... ca. 0.62 Air = 1  
 Calc. @ R.T.  
 EVAPORATION RATE:..... < 1.00 Butyl Acetate = 1  
 SOLUBILITY IN WATER: ..... Miscible  
 SP. GRAVITY:..... ca. 1.030 Water = 1  
 PERCENT VOLATILE: ..... ca. 90.00 %  
 VOLATILE ORGANICS: ..... N/D  
 pH: ..... ca. 7.50-8.50  
 VISCOSITY: ..... N/D  
 APPEARANCE AND ODOR: Clear, amber colored liquid.

3. FIRE AND EXPLOSION HAZARD DATA

FLASH POINT:..... None (Setaflash CC)  
 FLAMMABLE LIMITS - LEL: ..... N/A  
 FLAMMABLE LIMITS - UEL: ..... N/A  
 AUTOIGNITION TEMPERATURE: ... N/D  
 EXTINGUISHING MEDIA:  
 FC-206CE is a fire extinguishing agent.

Abbreviations: N/D - Not Determined N/A - Not Applicable

MATERIAL SAFETY  
DATA SHEET



MSDS: FC-206CE LIGHT WATER Brand Aqueous Film Forming Foam  
DECEMBER 20, 1990

PAGE: 2 of 3

**3. FIRE AND EXPLOSION HAZARD DATA (continued)**

**SPECIAL FIRE FIGHTING PROCEDURES:**

Full protective clothing including self-contained breathing apparatus, coat, pants, gloves, boots, and bands around legs, arms and waist should be provided. No skin surface should be exposed.

**UNUSUAL FIRE AND EXPLOSION HAZARDS:**

Toxic by-products, including small amounts of HF, may be formed. See Section 4.

**NFPA-HAZARD-CODES: HEALTH 3 FIRE 0 REACTIVITY 0**

**UNUSUAL REACTION HAZARD: N**

**4. REACTIVITY DATA**

**STABILITY:** Stable

**INCOMPATIBILITY - MATERIALS TO AVOID:**

Not Applicable

**HAZARDOUS POLYMERIZATION:** Will Not Occur

**HAZARDOUS DECOMPOSITION PRODUCTS:**

Thermal decomposition may produce toxic materials including HF. Decomposition of usage concentrations does not present a hazard.

**5. ENVIRONMENTAL INFORMATION**

**SPILL RESPONSE:**

Observe precautions from other sections. Cover with absorbent material. Collect spilled material. Clean up residue with water.

**RECOMMENDED DISPOSAL:**

Bleed spent solutions and small product quantities, <5 gal., to a wastewater treatment system. Reduce discharge rate if foaming occurs. Incinerate bulk product in an industrial or commercial incinerator. Combustion products will include HF. Disposal alternative: Dispose of completely absorbed waste product in a facility permitted to accept chemical wastes. Since regulations vary, consult applicable regulations or authorities before disposal. U.S. EPA Hazardous Waste No.: None

**ENVIRONMENTAL DATA:**

COD=0.40 g/g; BOD20=0.33 g/g; 96-Hr. LC50, Killifish(Fundulus heteroclitus)=>2000 mg/l; 96-Hr. LC50 Fathead minnow(Pimephales promelas)= >2000 mg/l; Concentration inhibiting growth of green algae(Selenastrum capricornutum) by 50% = 345 mg/l; FC-206CE has no acute inhibitory effect on activated sludge respiration rate at 1000 mg/l.

**SARA HAZARD CLASS:**

**FIRE HAZARD: No PRESSURE: No REACTIVITY: No ACUTE: Yes CHRONIC: Yes**

**6. SUGGESTED FIRST AID**

**EYE CONTACT:**

Immediately flush with plenty of water. Continue for 10 minutes. Call

Abbreviations: N/D - Not Determined N/A - Not Applicable



3M General Offices  
3M Center  
St. Paul, Minnesota 55144-1000  
612/733-1110  
Duns No.: 00-617-3082

00-10  
1946

MATERIAL SAFETY  
DATA SHEET

**3M**

MSDS: FC-206CE LIGHT WATER Brand Aqueous Film Forming Foam  
DECEMBER 20, 1990

PAGE: 3 of 3

**6. SUGGESTED FIRST AID (continued)**

a physician.

**SKIN CONTACT:**

Wash affected area with soap and water.

**INHALATION:**

If symptoms occur, remove person to fresh air. If symptoms continue, call a physician.

**IF SWALLOWED:**

Give two glasses of water. Call a physician or Poison Control Center.

**OTHER FIRST AID:**

NONE

**7. PRECAUTIONARY INFORMATION**

Avoid eye contact. Avoid prolonged or repeated skin contact. Use in well ventilated areas.

**SPECIAL PROTECTION:**

**EYE PROTECTION:** Safety Glasses

**SKIN PROTECTION:** Rubber Gloves

**VENTILATION:** General ventilation is adequate.

**RESPIRATORY PROTECTION:** Above component exposure limits, use organic vapor cartridge respirator.

**8. HEALTH HAZARD DATA**

**EYE CONTACT:** May cause moderate irritation of eyes on contact; corneal involvement may occur, but permanent damage is not expected.

**SKIN CONTACT:** May cause irritation of the skin on prolonged or repeated contact. 2-(2-Butoxyethoxy)ethanol may be absorbed through the skin in harmful amounts if continuous and prolonged contact occurs.

**INHALATION:** Mists or vapors may cause irritation of the respiratory system. Very high concentration of vapors may cause vomiting, nausea, diarrhea, abdominal pain, pulmonary edema and stupor. Symptoms of acute overexposure may include unconsciousness; symptoms of repeated overexposure may include nystagmus, recurrent unconsciousness, hemolysis and bone marrow depression.

**INGESTION:** The acute oral LD50 (rat) is greater than five grams per kilogram of body weight. FC-206CE is considered practically non-toxic orally.

Abbreviations: N/D - Not Determined N/A - Not Applicable

The information on this Data Sheet represents our current data and best opinion as to the proper use in handling of this material under normal conditions. Any use of the material which is not in conformance with this Data Sheet or which involves using the material in combination with any other material or any other process is the responsibility of the user.

APPENDIX C

ARMORED PERSONNEL CARRIER (APC)  
FIREFIGHTING VEHICLE SYSTEM  
TEST PLAN

AIR FORCE ENGINEERING AND SERVICES CENTER  
Tyndall Air Force Base, Florida 32403

ARMORED PERSONNEL CARRIER (APC)  
FIREFIGHTING VEHICLE SYSTEM

12 FEBRUARY 1991

TEST PLAN

This test plan has been reviewed and approved by:

  
CHARLES W. RISINGER  
Test Director

  
RICHARD REID, Capt, USAF  
AFESC/RDCS (SAFETY OFFICER)

  
RICHARD N. VICKERS  
Chief, Air Base Fire Protection  
and Crash Rescue Systems Branch

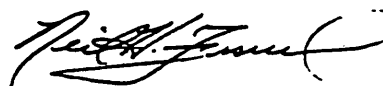
  
Neil Fravel, Lt Col, USAF  
Chief, Engineering Research Division

## TABLE OF CONTENTS

Section	Title	Page
I	INTRODUCTION.....	43
	A. SCOPE.....	43
	B. BACKGROUND.....	43
	C. AUTHORITY.....	43
	D. PURPOSE.....	43
	E. TEST ITEM DESCRIPTION.....	43
	F. TEST SITE ACCESS.....	44
II	TEST OBJECTIVES AND MEASURES OF MERIT.....	45
III	MANAGEMENT AND ORGANIZATIONAL RESPONSIBILITIES.....	46
IV	TEST EXECUTION.....	47
	A. GENERAL.....	47
	B. FIRE TEST ONE.....	49
	C. FIRE TEST TWO.....	49
	D. FIRE TEST THREE.....	50
	E. AGENT THROW RANGE TEST.....	50
	F. AGENT RESERVICING TEST.....	50
	G. APC VISUAL ACUITY TEST.....	50
	H. INSTRUMENTATION AND DATA COLLECTION.....	50
V	SAFETY.....	52
VI	ENVIRONMENTAL IMPACT.....	53
ANNEX		
1	TEST SCHEDULE.....	54
2	LOGISTICS SUPPORT.....	55
3	SAFETY .....	57
4	LARGE-SCALE FIRE TEST PIT OPERATIONAL PROCEDURES.....	61
5	DATA COLLECTION SHEET.....	62

## SECTION I

### INTRODUCTION

#### A. SCOPE

This project will evaluate the fire suppression capabilities of an M113A2 Armored Personnel Carrier (APC), modified with an internal skid-mounted fire suppression system. The APC is a standard U.S. Army vehicle. Using the modified APC as the agent dispensing vehicle, several different fire suppressing agents will be evaluated for their ability to suppress a simulated trench JP-4 fire 10 feet wide and 96 feet long. The extinguishing time, burnback rate, throw range, reservicing time, and ease of reservicing will be evaluated for each agent. A total of three fires are planned for each test agent in the test series with initial fuel quantities of 250 gallons and a maximum of 500 gallons being burned during any single fire.

#### B. BACKGROUND

The U.S. Army, through Army Materiel Command (AMC), has a requirement to rapidly suppress large hydrocarbon fuel fires. The system being tested, a standard Army APC, modified with a fire suppression system, and the fire suppressing agents being tested have potential applicability in this scenario. AMC has requested that the Air Force, through the Air Force Engineering Service Center, Fire Protection and Crash Rescue Research Branch (AFESC/RDCF) conduct an objective fire suppression performance test of this system and the four fire suppressing agents on simulated 10-foot wide trench fires.

#### C. AUTHORITY

This test is being conducted to support a U.S. Army Materiel Command (AMC) requirement with potential "Desert Storm" application.

#### D. PURPOSE

The purpose of this test series is to demonstrate the fire suppression capabilities of an APC modified with a self-contained fire suppression system. JP-4 pool fires configured to resemble a 10-foot wide trench will be extinguished using a variety of test fire suppressing agents.

#### E. TEST ITEM DESCRIPTION

A standard U.S. APC was modified with a fire suppression system developed by the Amerex Corporation. The system consists of a 250 gallon container for the premixed agent, two 220 ft<sup>3</sup> nitrogen bottles, associated manifold and regulator to provide agent propulsion, appropriate plumbing to the external monitor and nozzle, and a TV system to allow the operator to view the fire site from his position within the APC. The turret and nozzle are controllable through approximately  $\pm 160^\circ$  horizontally and  $-15^\circ$  to  $+45^\circ$  vertically from the operator's position within the vehicle. The system is skid-mounted for loading and unloading through the rear ramp door and fits completely within the vehicle.

#### F. TEST SITE ACCESS

During all testing activities, access to the test site and immediate area will be limited to government personnel, SETA support contractor personnel, technical representatives from the agent dispensing equipment manufacturer, and test agent contractor personnel. Agent contractor personnel will be permitted access to the test site only during the initial test site familiarization period and when their agent is being tested. Exceptions will be approved by the AFESC/RDCF Test Director.

## SECTION II

### TEST OBJECTIVES AND MEASURES OF MERIT

#### A. TEST OBJECTIVES

1. Demonstrate the fire suppression performance of the modified APC in suppressing simulated trench fires.
2. Demonstrate the capability of a modified APC agent delivery system to establish and maintain a 10-15 foot wide assault path through the 96 foot long simulated fire trench. The time for the fire to burnback and close the path will be measured and recorded. The purpose of this objective is to provide a more realistic simulation of the wartime scenario.
3. Evaluate the capability of each firefighting agent being tested to arrest a fire and suppress burnback in conjunction with Objectives 1 and 2.
4. Evaluate the throw range of the modified APC with each agent tested.
5. Evaluate the reservicing time and ease of reservicing of the modified APC with each agent being tested.
6. Assess the visual acuity from the operator's position in the APC during firefighting operations, especially during upwind agent dispensing operations. It is anticipated that agent blowing back on the vision blocks of the APC during upwind operations may obscure the view of the fire for the APC operator.

#### B. MEASURES OF MERIT

The measures of merit are the capability of the modified APC and the agents being tested to rapidly suppress the fire and delay burnback for a sufficient period of time, within the limits of an on-board premixed agent supply system. The extinguishment time, quantity of agent used, burnback rates, throw range, reservicing time, and ease of reservicing are the parameters to be used in determining the success of system and agents being tested. The ability of the crew to approach and extinguish the fire from an upwind position must be determined. An analysis of the success/failure of the firefighting crew, using the modified APC to combat large hydrocarbon fuel spills, must also be determined.

## SECTION III

### MANAGEMENT AND ORGANIZATIONAL RESPONSIBILITIES

#### A. MANAGEMENT

Overall test responsibility rests with the AFESC/RDCF Test Director. The Test Director will delegate authority, as necessary. Specific responsibilities for safety, instrumentation, photography, and engineering support are listed in the following paragraphs.

#### B. ORGANIZATIONAL RESPONSIBILITIES

1. HQ AFESC - The Air Force Engineering and Services Center is responsible for overall test management.
2. AFESC/RDCF will:
  - a. Develop, coordinate, and publish a test plan.
  - b. Provide the Test Director and Range Safety Officer.
  - c. Provide the necessary fire test facilities, AFFF agent, instrumentation and data collection systems.
  - d. Have overall test authority and be the final judge as to test protocol and relative merit of the test results.
  - e. Determine test protocols and outline test results.
  - f. Prepare a test report describing the method of test and test results.
3. U.S. Army AMC will:
  - a. Provide an on-site technical representative throughout the test period.
  - b. Provide the modified APC for the test.
  - c. Determine suitability of test results.
4. Agent Contractors will:
  - a. Provide an on-site representative during their portion of the test.
  - b. Provide adequate quantities of their agent to prepare up to 500 gallons of mixed firefighting agent for the test.



SECTION IV  
TEST EXECUTION

A. GENERAL

This test program will be conducted by burning 250 to 500 gallons of JP-4 fuel in the AFESC 100-foot diameter fire test facility. Three test fires are planned for each agent being tested. An additional fire may be conducted as a contingency at the discretion of the Test Director. Prior to implementing the test, two fires will be conducted for equipment and procedure training and familiarization for the APC and reservicing crews.

The AFESC 100-foot environmentally-safe fire test facility, located on Farmdale Road, Tyndall AFB, Florida will be used for all fire tests. The facility will be modified for this test series with a 15-inch high clay reinforced dam placed in the pit to form a rectangular burn area 96 feet by 10 feet to simulate a 10-foot wide trench, as shown in Figure 1. Two six-foot high steel stakes will be centered along the length of the trench to facilitate agent application and fire extinguishment in the center portion of the trench and data acquisition during the burnback portion of the test.

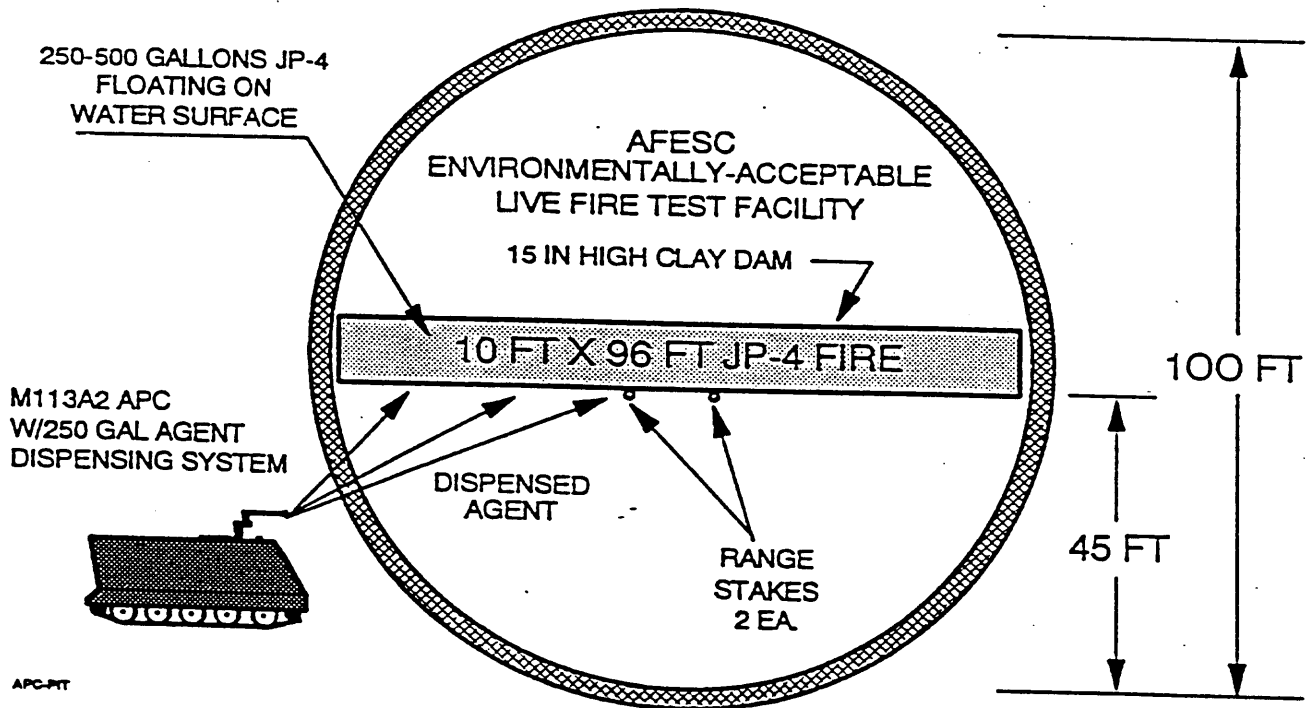

Figure 1. 100-Foot Fire Test Facility Set-Up

The modified APC will be prepared before each test fire by filling the tank with 100 or 250 gallons of premixed agent, in accordance with the test matrix in Table 1. Sea water will be used as the agent carrier, since this is the anticipated scenario in the operational environment. The two 220 ft<sup>3</sup> nitrogen bottles, used to propel the agent, will be replaced for each fire test to ensure that the gas supply is not depleted before the test is completed. The pressure regulator will be adjusted to obtain the appropriate flow for the particular agent being tested. The nozzle configuration will be tailored to each individual agent manufacturer's requirements.

For each test fire, fuel is placed in the rectangular burn area, ignited using a torch, and followed by the modified APC attacking the fire and extinguishing all except 1-15 feet at the end of the trench or a 10-15 foot assault path, as determined by the test event protocol shown in Table 1. During separate tests, fires will be attacked from both an upwind and downwind position to simulate a realistic wartime scenario. The test matrix in Table 1 will be completed for each tested agent.

A backup USAF P-19 or P-4 firefighting vehicle will be manned by AFESC personnel and available at the fire test facility for all fires to cover contingencies. The Range Safety Officer will not permit anyone to approach the fire without his expressed consent.

Table 1. Firefighting Agent Test Matrix

<u>FIRE NO.</u>	<u>AGENT GAL.</u>	<u>FUEL GAL.</u>	<u>WIND DIRECTION</u>	<u>OBJECTIVE</u>
1	100	250	UPWIND	Establish 10-foot breaching path. Measure extinguishment and burnback times.
2	100	250	DOWNWIND	Establish 10 foot breaching path. Measure extinguishment and burnback times.
3	250	500	DOWNWIND	Extinguish 90% of trench area up to approximately 10 feet from the upwind end of the trench. Measure burnback time.

Pretest briefings will be conducted before each fire to evaluate weather conditions, discuss the results of the previous test, verify that all systems are functional, and plan the next fire test. All personnel will be at their assigned locations a minimum of 1 hour before each scheduled ignition time. Individual protective equipment will be worn by all actively involved personnel and will be tested and verified as fully operational before fuel is placed in the pit. All test materials and equipment will be set up and ready for the test a minimum of 1 hour before the scheduled ignition time. At T-30 minutes (30 minutes before ignition time) the pretest checklist, included at the end of Annex 3, will be completed to ascertain the readiness of all

functions. These functions will include, but are not limited to, safety, weather, test pit readiness, and data collections readiness. When all functions are ready, the fire will be ignited. The order to ignite the fuel will be given by the AFESC Test Director.

After each fire test is completed the fire will be reignited, if necessary, and permitted to burn off the residual fuel to facilitate pit clean-up for the next test. The fire pit will also be flushed with water before the next fire test so that agent from the previous test will not contaminate the results of following tests. A detailed checklist for large-scale fire pit operations is contained in Annex 4.

To ensure that the residue from one agent does not contaminate the test results for a follow-on agent, the entire the agent tank and dispensing system will be thoroughly flushed with water and blown clean with nitrogen at the completion of the test matrix for each agent.

#### B. FIRE TEST ONE

When the Test Director confirms that all systems are ready, he will direct the filling of the test trench with 250 gallons of JP-4. After The Test Director has entered the APC, the Range Safety Officer will direct ignition of the fire, observe a 30-second preburn period and command the APC to approach the fire. The APC will approach the trench from an upwind position and begin dispensing agent. The APC will attempt to establish a 10 foot assault path using the 100 gallons of agent on-board from predetermined discharge locations. The time to establish the assault path and the burnback time will be recorded. The quantity of agent used will also be recorded. After burnback, the fire will be permitted to burn out the remaining fuel to facilitate pit cleanup in preparation for the following test fire.

#### C. FIRE TEST TWO

When the Test Director confirms that all systems are ready, he will direct the filling of the test trench with 250 gallons of JP-4. After The Test Director has entered the APC, the Range Safety Officer will direct ignition of the fire, observe a 30-second preburn period and command the APC to approach the fire. The APC will approach the trench from an downwind position and begin dispensing agent. The APC will attempt to establish a 10 foot assault path using the 100 gallons of agent on-board from predetermined discharge locations. The time to establish the assault path and the burnback time will be recorded. The quantity of agent used will also be recorded. After burnback, the fire will be permitted to burn out the remaining fuel to facilitate pit cleanup in preparation for the following test fire.

#### D. FIRE TEST THREE

When the Test Director confirms that all systems are ready, he will direct the filling of the test trench with 500 gallons of JP-4. For this test the APC will be filled with 250 gallons of agent. After The Test Director has entered the APC, the Range Safety Officer will direct ignition of the fire, observe a 30-second preburn period and command the APC to approach the fire. The modified APC will approach the trench from a downwind position and begin dispensing agent. The APC will attempt to extinguish all except approximately 10 feet of the upwind end of the fire area. The extinguishment and burnback times and quantity of agent used will be recorded. After burnback, the fire will be permitted to burn out the remaining fuel to facilitate pit cleanup in preparation for the following test fire.

#### E. AGENT THROW RANGE TEST

The purpose of this test is to evaluate the throw range of the modified APC with each agent tested. Their is concern that agent viscosity may effect this critical firefighting parameter. This test will be conducted in conjunction with Fire Test One beginning at a distance of 150 feet using a maximum turret elevation of 30°. Thereafter the vehicle will move to closer ranges and continue the fire extinguishing test.

#### F. AGENT RESERVICING TEST

The purpose of this test is to evaluate the reservicing time and ease of reservicing of the modified APC with each agent being tested, using the written instructions provided by the agent manufacturer. The test will be conducted in conjunction with the fire tests described above for each of the test agents. The last reservicing activity for each agent will be timed and video taped. Subjective evaluations as to the ease of reservicing the system will be made by reservicing personnel and recorded by the data recorder.

#### G. APC VISUAL ACUITY TEST

The purpose of this test is to assess the visual acuity from the operator's position in the APC during firefighting operations, especially during upwind agent dispensing operations. It is anticipated that agent blowing back on the vision blocks of the APC during upwind operations may obscure the view of the fire for the APC operator. This test will be completed in conjunction with and throughout the fire tests. Results will be based on the subjective evaluation of the system operator and recorded by the data collector.

#### H. INSTRUMENTATION AND DATA COLLECTION

1. Instrumentation. The APC will be instrumented with six thermocouples to measure and record temperature both inside and outside of the vehicle during firefighting operations. Two thermocouples will be placed in front of the heat shield blanket, two behind the blanket, and two inside of the vehicle. Anticipated temperature ranges are up to 2,000°F on the outside of the vehicle and up to 140°F on the inside of the vehicle. An onboard recording system will record all six channels for later data reduction and analysis.

2. Data Collection. All data will be recorded on the data collection sheet contained in this Annex 5. One fixed and one roving video camera will record all test activities. Still camera photographs will be taken of selected events. All hand-recorded data, video tapes, and 35mm exposed film will be stored in a suitable government storage facility at the completion of each test day. Test data results do not constitute approval or endorsement for use of the tested product by U.S. Army or U.S. Air Force units. No data will be distributed without direction from the U.S. Army Materiel Command.

3. Salt Water Testing. Salt water for use throughout this test series will be pumped from the Gulf of Mexico into a 5,000 gallon tank truck and placed at the test site before the test begins. Water will be taken from a location as near as possible to the open gulf to provide salt water with a salinity very close to that of the Persian Gulf. The sea water from the tank truck will be tested to determine salinity and provided in the final report. Water for all tests will be taken from the same tank truck load.

## SECTION V

### SAFETY

#### A. GENERAL

Safety is an integral part of the test. The Test Director is responsible for accident prevention. Personnel and equipment safety will take precedence over test execution at all times. Special emphasis will be placed on providing thorough supervision and guidance throughout all test phases. Pretest briefings will be conducted daily by the test director detailing the test procedures for the day and emphasizing safety in all test phases.

The AFESC Test Director is ultimately responsible for safety. However, during that portion of the test when the Test Director is occupied in the APC, the Range Safety Officer is responsible for range safety and the conduct of the fire test. However, the test may be suspended at any time by anyone if a safety hazard is observed. Identification of a potential safety hazard will result in test suspension until the hazard can be evaluated and corrected to the satisfaction of the Range Safety Officer.

#### B. IDENTIFIED HAZARD

A JP-4 open pit fire, by its very nature, is hazardous. The largest fire planned for this test series will be 96 feet by 10 feet and will burn up to 500 gallons of JP-4 for approximately 2 minutes. The approved test plan has been thoroughly examined for safety distance from surrounding objects and found to be well within safe distance limits.

#### C. SAFETY REPORTING

Accidents, incidents, and serious hazards will be reported in accordance with AFR 127-4 through AFESC/SEG and HQ USAFADWC/SEG. The Range Safety Officer is responsible for accident/incident reporting.

The Test Director and Range Safety Officer will ensure that all appropriate safety procedures are followed throughout all testing. Testing will be suspended if an event occurs contrary to this checklist. During the actual fire testing, observers will be located a minimum of 300 feet west of the edge of the fire pit.

Individual protective equipment will be worn by the test facility operators, APC crew members, and back-up firefighting vehicle operator(s). APC crew members will also wear Self-Contained Breathing Apparatus (SCBA) during the fire tests.

Direct radio contact shall be maintained at all times preceding and during each test event between the Test Director (APC commander) and the Range Safety Officer. The Range Safety Officer will position himself to be observed by the back-up firefighting crew during the test.

Additional safety procedures are contained in Annex 3.

SECTION VI  
ENVIRONMENTAL IMPACT

In accordance with AFR 19-2, Air Force Form 813 has been completed and approved. The determination has been made that this test series qualifies for a Categorical Exclusion 2y. As stated in the Form 813, it is anticipated that all evidence of visible smoke will be dispersed within two hours. Using the Air Quality Assessment Model (AQAM), initial calculations were made for the levels of particulate matter, hydrocarbons, carbon monoxide, and oxides of nitrogen for a 500 gallon fire, typical for this series. The results are contained in Table 2.

Table 2. AIR EMISSION ESTIMATES FOR LARGEST HYDROCARBON FIRES

FIRE SIZE		AIR POLLUTANTS*					TOTAL
GALLONS JP-4	POUNDS JP-4	POUNDS PM	POUNDS CO	POUNDS HC	POUNDS NOx		
500	3,250	420	184	1,048	14	1,666	

APPROXIMATE TOTAL FOR TEST SERIES

5,000	32,750	4,200	1,840	10,480	140	16,660
-------	--------	-------	-------	--------	-----	--------

- \* PM = Particulate Matter
- CO = Carbon Monoxide
- HC = Hydrocarbons
- NOx = Oxides of Nitrogen

Reference: A Generalized Air Quality Assessment Model for Air Force Operations, AFWL-TR-74-304, February 1975.

Any major fuel spills or other unplanned event that may affect the environment will immediately be reported to the AFESC and Tyndall AFB environmental offices.

ANNEX 1

TEST SCHEDULE

**12 FEB 91**

KICKOFF MTG - ALL PARTICIPANTS (9706 CONF RM)	0700
APC ARRIVES TAFB TEST SITE	0800
TEST SITE AND EQUIPMENT FAMILIARIZATION	0900
TRAINING AND TEST FIRES	1230
REVIEW DAY'S ACTIVITIES & BRIEF FIRST TEST	1530
INSTALL INSTRUMENTATION ON APC	
PIT PREPARATIONS	ALL DAY
PRE-POSITION SUPPORT MATERIALS	

**13 FEB 91**

DAILY PRETEST MEETING (9706 CONF RM)	0700
PREPARE APC & FIRE PIT	0800
BEGIN 3-FIRE SERIES - 3M AFFF	0900
COMPLETE 3M AFFF FIRE SERIES AND REVIEW RESULTS	1200
PREPARE APC & FIRE PIT	1300
BEGIN 3-FIRE SERIES - PYROCAP	1400
COMPLETE PYROCAP FIRE SERIES AND REVIEW RESULTS	1630

**14 FEB 91**

DAILY PRETEST MEETING (9706 CONF RM)	0700
PREPARE APC & FIRE PIT	0800
BEGIN 3-FIRE SERIES - FIRE KNIFE	0900
COMPLETE FIRE KNIFE FIRE SERIES AND REVIEW RESULTS	1200
PREPARE APC & FIRE PIT	1300
BEGIN 3-FIRE SERIES - PVF	1400
COMPLETE PVF FIRE SERIES AND REVIEW RESULTS	1630

**15-16 FEB 91**

CONTINUATION OF FIRE TESTS, AS REQUIRED	TBD
-----------------------------------------	-----



ANNEX 2  
LOGISTICS SUPPORT

A. FACILITY REQUIREMENTS

The test facility for this test is the 100 foot AFESC Fire Research Facility #1, located approximately 7 miles southeast of the main gate at Tyndall AFB, Florida. This test site will be used for all fires conducted in this series.

B. PERSONNEL REQUIREMENTS

Personnel to support this test will be provided by AFESC/RDCF, with on-site technical assistance provided by representatives from the Army, AMC, and the equipment and agent contractors, as required.

<u>Agency/Organization</u>	<u>Personnel Required</u>
AFESC/RDCF	Test Director Range Safety Officer Fire Pit Operator (2 ea) Data collector (1 ea) Video Operator (1 ea)
USAF HOSPITAL - TYNDALL AFB	Emergency Medical Care
AMC	APC operations personnel

C. MATERIAL REQUIREMENTS

Material requirements are as follows:

ITEM	QUANTITY	SOURCE
JP-4	5,000 gal.	AFESC/RDCF
Nitrogen bottles (220 ft <sup>3</sup> )	72 ea	AFESC/RDCF
Video tape	24 cassettes	AFESC/RDCF
35 mm film	6 rolls	AFESC/RDCF
Test Agents	As req.	Agent Contractors

D. EQUIPMENT REQUIREMENTS

ITEM	QUANTITY	
APC, modified with Agent system	1	U.S. Army AMC
P-19/P-4 Fire Fighting Vehicle	1	
Portable Fire Extinguishers	4	
Protective Clothing (sets)	5	
SCBA units	4	
First Aid Kit	1	
Hand Held Radios	2	
Electric Ignition System	1	
35mm Still Frame Cameras	2	
VHS 1/2" Video Cameras	3	
Stopwatches	2	
Wind Direction Instrument	1	

## ANNEX 3

### SAFETY

#### A. PURPOSE

This Safety Plan establishes the safety areas for the large scale fire testing of the APC Firefighting System. Fire tests will be conducted at the AFESC Fire Research Facility #1 located on Farm Dale Road, Tyndall AFB, Florida. This plan identifies the agency responsible for the test area. This document contains detailed Safety Rules which govern the conduct of this test series. The Test Director or Range Safety Officer will insure adherence to all safety policies. Before conducting any live fire tests at the Fire Research Facility, the Base Fire Department Communications Center will be notified. The following documents are applicable to this test:

AFOSH 127-11 & 50, First Aid Kits  
AFOSH 127-31, Personal Protective Clothing and Equipment  
AFR 92-1, Paragraph 4-14, Safety Equipment for Fire Fighters  
AFR 127-4, Accident Reporting

#### B. OVERALL SAFETY RESPONSIBILITY

HQ AFESC/RDCF, as Test Director, is responsible for enforcing the overall safety program for the test. The Test Director will maintain close coordination with the AFESC Safety Officer (AFESC/SE) and the Air Defense Weapons Center Ground Safety Officer (USAFADWC/SEG) on all safety matters.

#### C. GENERAL SAFETY

1. Safety Briefing. The Test Director will brief all test personnel on known safety hazards in associated with this test and test site. Supervisors will, in turn, brief their personnel on these hazards.

2. Visitors. Visitors will be permitted at the test site only with the approval of the Test Director. Visitors will be instructed on applicable safety regulations.

3. Individual Safety Responsibility. Careful attention to potential hazards associated with fire testing must be stressed at all levels of responsibility. The purpose of the safety rules outlined herein is to present the most important elements in experimenting with controlled fires. These rules do not cover all the possible hazards which may occur at the site. As new problems arise, new safety measures must be established. This Safety Plan must be strictly adhered to by all personnel. The procedures outlined in the plan shall be accepted as minimum safe conduct. Only the Test Director may authorize a deviation from this plan.

4. Vehicles. For vehicles other than fire-fighting vehicles conducting actual fire-fighting operations, speeds shall not exceed 20 mph when driving on unpaved roads. Seat belts will be used at all times while vehicles are in motion. When a vehicle is parked, the hand brake will be set and the transmission put in park or reverse. Unauthorized vehicles will not be parked in the vicinity of the fire pit during fire test operations.

5. First Aid. An adequate supply of first-aid items will be maintained at the site. These items will be properly stored and periodically inspected. All personnel will be briefed upon the locations of first aid kit/supplies. An appropriate vehicle will be designated and available to transport injured persons to the base medical center, if required.

6. Accident Reporting (Emergency).

a. Scope. The purpose of this procedure is to ensure expedient handling and care of personnel injured in an accident or disaster. All post-emergency reporting and investigation of an accident will be performed in accordance with applicable Air Force Regulations.

b. Responsibility. Each person involved in this program must be familiar with the emergency reporting procedures established by this plan and immediately implement these procedures in the event of an accident. The Test Director will insure that all personnel are familiar with this procedure.

c. Emergency Reporting Procedures. In the event of an accident at the test site, the following procedures will be followed:

(1) The Test Director will direct appropriate first aid. Caution will be exercised to prevent aggravation of an accident-related injury.

(2) Tyndall Air Force Base Hospital Ambulance Service will be notified by calling extension 911. The nature of the accident, including apparent condition of injured personnel and the location of the test site, will be reported to the medical personnel. The Test Director or the Range Safety Officer will decide whether to transfer the injured directly to a hospital or to request emergency ambulance support.

(3) The Test Director or the Range Safety Officer will determine the seriousness of the accident. If the accident is not serious enough to require emergency hospitalization or ambulance service, the injured person will be taken to a doctor or hospital by normal means of transportation.

(4) All accidents requiring emergency treatment or first aid must be reported to the AFESC Safety Officer (AFESC/SE).

D. FIRE PREVENTION, REPORTING, AND EMERGENCY PROCEDURES

This paragraph defines the responsibility for fire prevention and reporting procedures related to the test.

1. Responsibility. The Test Director will be responsible for the implementation of the procedures established by this plan. All on-site personnel must be completely familiar with these procedures to ensure proper response to an emergency.

2. Fire Prevention Procedures. The procedures listed below are to be followed in an effort to reduce chances of an uncontrolled fire. Three

portable fire extinguishers will be at the test site, and all personnel participating in the fire test will be briefed on the locations and proper use of the extinguishers.

#### E. TEST SITE LOCATIONS

All fire tests will be conducted at the 100 foot AFESC Fire Research Facility #1, located on Farm Dale Road. These tests be conducted in accordance with AFESC Office Instruction dated 7 April 1988, titled "Live Fire Demonstration/Tests."

#### F. NOTIFICATION

Before conducting a fire test, notify the Fire Department Communications Center at Extension 3-2884.

1. The Communications Center will be requested to notify the following:
  - a. Command Post - 3-2155
  - b. Air Traffic Control Tower - 3-4553
  - c. Base Hospital - 3-7514
  - d. Security Police - 3-2028
  - e. Division of Forestry - 3-2641
  - f. Base Weather - 3-2856
2. The Fire Department Communications Center will need an estimate of the duration of the live fire tests.

PRETEST CHECK LIST  
TO BE USED BEFORE CONDUCTING FIRE TESTS AT  
FIRE RESEARCH FACILITIES NO. 1

DATE: \_\_\_\_\_ TIME: \_\_\_\_\_

VERIFIED

PROCEDURES

- \_\_\_ Brief all personnel on proper safety procedures.
- \_\_\_ All personnel at the test site are required for the test or are an approved visitor?
- \_\_\_ Brief all personnel on accident and fire reporting procedures.
- \_\_\_ Radio or telephone communications available?
- \_\_\_ Post telephone numbers for the ambulance and fire department by the telephone or radio.
- \_\_\_ Ensure that adequate first aid kit is available.
- \_\_\_ Ensure that an emergency eye wash apparatus is available.
- \_\_\_ Ensure that all fuel valves are closed and that there are no fuel leaks prior to fuel ignition.
- \_\_\_ Ensure Individual Protective Equipment is fully charged and operational.
- \_\_\_ Secure area prior to igniting fire.

## ANNEX 4

### LARGE-SCALE FIRE TEST PIT OPERATIONAL PROCEDURES

The following are general procedures to be used during the operation of the 100 foot fire test pit during the APC Firefighting System Demonstration.

1. Insure all agencies are notified of test events.
2. Conduct Safety Briefing.
3. Verify all data collection equipment in place and operational.
4. Insure downrange/fire pit area clear.
5. Verify amount of fuel to be used; flow fuel in test area.
6. Start data collection.
7. Ignite fire.
8. 30-second pre-burn.
9. Conduct fire event/test.
10. Secure fire burn area/downrange.
11. Check test results.
12. Conduct post-test and facility shutdown procedures.
13. Notify all agencies that test complete & facility secure.
14. Conduct critique.
15. Document test results.

ANNEX 5

APC AND FIREFIGHTING AGENT TEST

TEST CONDUCT CHECKLIST AND DATA COLLECTION SHEET

AGENT ID: \_\_\_\_\_ MANF: \_\_\_\_\_ TEST NO: \_\_\_\_\_ DATE: \_\_\_\_\_ TIME: \_\_\_\_\_

LOT #: \_\_\_\_\_ MIXTURE RATIO: \_\_\_\_\_ INITIAL QTY: \_\_\_\_\_ gal. FINAL QTY: \_\_\_\_\_ gal.

AGENT USED: \_\_\_\_\_ gal. AGENT FLOW RATE: \_\_\_\_\_ gpm

METEOROLOGICAL DATA:

TEMPERATURE: \_\_\_\_\_ WIND: \_\_\_\_\_

TEST READINESS:

_____ Weather within limits	_____ Communications check
_____ Fire vehicles ready	_____ Ignition system ready
_____ Video cameras ready	_____ Fuel in pit
_____ Emer. Medical notified	_____ Access gate secured

CLEARANCE FOR IGNITION:

\_\_\_\_\_ Safety Officer \_\_\_\_\_ Fire Department

IGNITION TIME: \_\_\_\_\_ AGENT APPLICATION: START: \_\_\_\_\_ END: \_\_\_\_\_

INITIAL PATH CLEAR: \_\_\_\_\_ PATH BURNED CLOSED: \_\_\_\_\_ EXTINGUISH TIME: \_\_\_\_\_

90% EXTINGUISHED: \_\_\_\_\_ TOTAL BURNBACK: \_\_\_\_\_

MAXIMUM AGENT THROW RANGE: \_\_\_\_\_ WIND: DIR: \_\_\_\_\_ SPEED: \_\_\_\_\_ mph

RESERVICING TIME: \_\_\_\_\_

RESERVICING EASE - COMMENTS:

GENERAL COMMENTS:



# Tests of the General Fire Suppression Concentrate Pyrocap B-136

George B. Geyer  
Joseph A. Wright  
Dung Do  
Lawrence Hampton

August 1990

DOT/FAA/CT-TN90/21

Document is on file at the Technical Center  
Library, Atlantic City International Airport, N.J. 08405



U.S. Department of Transportation  
**Federal Aviation Administration**

Technical Center  
Atlantic City International Airport, N.J. 08405

1. Report No. DOT/FAA/CT-TN90/21		2. Government Accession No.		3. Recipient's Catalog No.	
4. Title and Subtitle TESTS OF THE GENERAL FIRE SUPPRESSION CONCENTRATE PYROCAP B-136				5. Report Date August 1990	
7. Author(s) G. B. Geyer, J. A. Wright, D. Do, and L. Hampton				6. Performing Organization Code	
9. Performing Organization Name and Address Federal Aviation Administration Technical Center Atlantic City International Airport, NJ 08405				8. Performing Organization Report No. DOT/FAA/CT-TN90/21	
12. Sponsoring Agency Name and Address U.S. Department of Transportation Federal Aviation Administration Technical Center Atlantic City International Airport, NJ 08405				10. Work Unit No. (TRAIS)	
15. Supplementary Notes				11. Contract or Grant No.	
16. Abstract  Fire extinguishing effectiveness of the general fire suppression concentrate identified as Pyrocap B-136 was determined by laboratory experiments and large-scale fire tests. This agent demonstrated strong emulsifying properties toward Jet A, kerosene fuel; JP-4, kerosene and gasoline fuel blend; and avgas, aviation gasoline fuel. At 6 percent concentration, Pyrocap B-136 extinguished large Jet A fuel fires when applied at the rate of 0.052 gallon per minute per square foot. At 30 percent concentration, the agent was effective in extinguishing magnesium aircraft wheel fires at a low application rate.				13. Type of Report and Period Covered  Technical Note	
17. Key Words Emulsifying Agent Pyrocap B-136 Jet A JP-4 Aviation Gasoline				14. Sponsoring Agency Code ACD-240	
18. Distribution Statement Document is on file at the Technical Center Library, Atlantic City International Airport, New Jersey 08405					
19. Security Classif. (of this report) Unclassified		20. Security Classif. (of this page) Unclassified		21. No. of Pages 28	22. Price

#### NOTICE

This document is disseminated under the sponsorship of the U. S. Department of Transportation in the interest of information exchange. The United States Government assumes no liability for the contents or use thereof.

The United States Government does not endorse products or manufacturers. Trade or manufacturers' names appear herein solely because they are considered essential to the objective of this report.

## PREFACE

This Technical Note was prepared at the Federal Aviation Administration (FAA) Technical Center, Atlantic City International Airport, New Jersey 08405, under FAA Project T1702F and under Project Order No. F84-80, for the Air Force Engineering and Services Center, Engineering and Services Laboratory (HQ AFESC/RDCF), Tyndall Air Force Base, Florida 32403-6001.

The report summarizes the evaluation of the general fire suppression concentrate identified as Pyrocap B-136 and manufactured by Pyrocap, Incorporated, 6551 Loisdale Court, Suite 400, Springfield, Virginia 22155-1845. This evaluation was part of an investigation of state-of-the-art and new agents for use at commercial or general aviation airports and heliports.

The Pyrocap concentrate was brought to the attention of the Department of Transportation (DOT) and the FAA by Representative Curt Weldon, Chairman of the Congressional Fire Services Caucus.

## TABLE OF CONTENTS

	Page
INTRODUCTION	1
Purpose	1
Background	1
DISCUSSION	1
Emulsification Process	1
Physiochemical Properties of Pyrocap B-136	1
Emulsification Characteristics of Pyrocap B-136	3
Fire Test Procedures	4
Fire Test Results	6
Magnesium Fire Extinguishing Experiments	9
SUMMARY OF RESULTS	13
CONCLUSIONS	13
APPENDICES	
A -- Variation of Hydrogen Ion Concentration (pH) With Solution Concentration of Pyrocap B-136	
B -- Emulsification Characteristics of Pyrocap B-136	
C -- Extinguishment of Jet A Pool Fires With Pyrocap B-136	
D -- Extinguishment of Magnesium Wheel Fires With Pyrocap B-136	

## LIST OF ILLUSTRATIONS

Figure		Page
1	Variation of the Spreading Coefficient With Solution Concentration for Pyrocap B-136 Against Jet A, JP-4, and Avgas Aviation Fuels	2
2	Average Dimension of the Ground Patterns Produced by Pyrocap B-136	5
3	Typical Distillation Curves of Aviation Fuels	8

## LIST OF TABLES

Table		Page
1	Properties of Pyrocap B-136	2
2	Summary of Fire Test Results	7
3	Magnesium Fire Extinguishing Experiment Test 1 and Test 2	11

## INTRODUCTION

### PURPOSE.

The principal objectives of this investigation were to evaluate the Pyrocap B-136 as a fire extinguishing and emulsifying agent for aviation fuels and as an extinguishing agent for magnesium metal (Class D) fires.

### BACKGROUND.

The heavy duty surface active agents have been known and employed in the petrochemical industry for many years for cleaning the holds of petroleum tanker ships and barges whenever cargos are changed. More recently, large oil spills from leaking tankers have claimed the attention of oil companies to develop economical and ecologically safe methods for minimizing these potential environmental hazards. This technology is currently being exploited in the development of a potentially new class of auxiliary firefighting agents for the control and extinguishment of fuel spill fires and magnesium wheel fires at airports.

## DISCUSSION

### EMULSIFICATION PROCESS.

There are four classes of surface active agents available for modifying the surface activity of water that are dependent upon the active moiety in the surfactant molecule. The classes are identified as anionic, cationic, nonionic, and amphoteric. Within each class, the molecular structure can be varied widely; and by proper blending, the resulting product can be tailored to meet specific chemical and physical requirements.

The preparation of an oil in water dispersion requires the input of mechanical energy into a simple mixture of oil and water. In general, the higher the shearing stress applied to the system, the smaller the oil droplets become. Regardless of their size, however, the oil droplets will rise rapidly to the water surface and coalesce to reform a homogeneous layer. Therefore, to produce stable emulsions, it is necessary to add a suitable surface active or emulsifying agent to the water phase prior to dispersing the oil. By this means, the interfacial tension between the oil and water phases is reduced to a level which permits a film of surfactant solution to form around each oil droplet, thereby retarding the coalescence of the oil droplets and subsequent vaporization of the oil or fuels, such as Jet A, JP-4, and avgas (Jet A, kerosene fuel; JP-4, kerosene and gasoline fuel blend; avgas, aviation gasoline fuel).

### PHYSIOCHEMICAL PROPERTIES OF PYROCAP B-136.

The physical and chemical properties employed to identify the Pyrocap B-136 agent were the specific gravity, viscosity, and hydrogen ion concentration (pH). These values for Pyrocap B-136, Batch No. 45 VA 299-910, are provided in table 1.

TABLE 1. PROPERTIES OF PYROCAP B-136

AGENT	SPECIFIC GRAVITY	VISCOSITY CENTIPOISE at 68 °F	CONCENTRATE pH
Pyrocap B-136	1.03	573	8.15

The variations of the hydrogen ion concentration with the solution concentration are presented in appendix A.

The degree to which the Pyrocap B-136 agent modified the physical properties of water was measured in terms of the surface tension (ST) and interfacial tension (IT) between Jet A, JP-4, and avgas fuels at various solution concentrations. The spreading coefficients (SC) calculated from these values are plotted in figure 1 as a function of solution concentration.

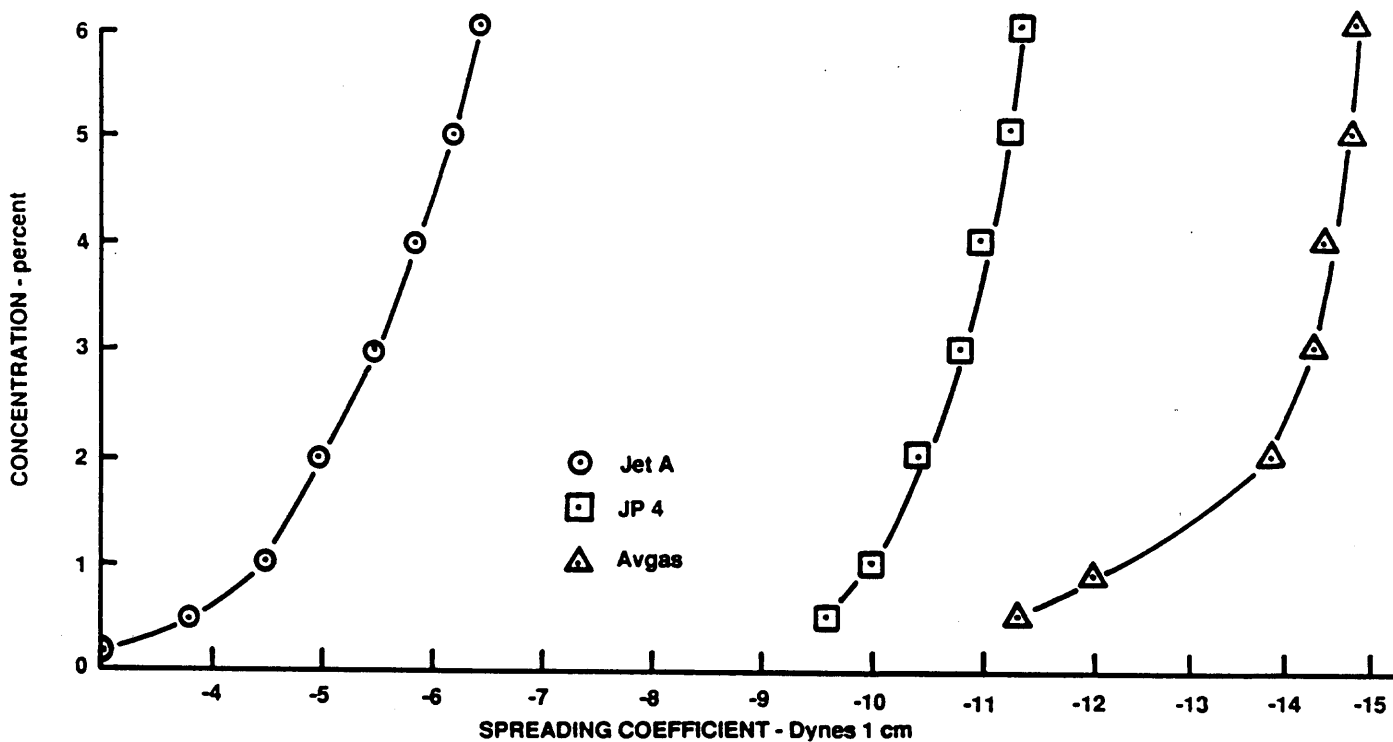

FIGURE 1. VARIANCE OF THE SPREADING COEFFICIENT WITH SOLUTION CONCENTRATION FOR PYROCAP B-136 AGAINST Jet A, JP4 AND AVGAS



According to classical theory concerning the spontaneous spreading of insoluble films on liquids, if the spreading coefficient has a value greater than zero (i.e., positive), the aqueous phase can spread spontaneously upon or "wet" the fuel. A coefficient below zero (i.e., negative) indicates that it cannot spread spontaneously. When the spreading coefficient is zero, the liquids are miscible.

All solution concentrations of Pyrocap B-136 had negative spreading coefficients against Jet A, JP-4, and avgas fuels, with avgas demonstrating the greater negativity.

#### EMULSIFICATION CHARACTERISTIC OF PYROCAP B-136.

The emulsifying capability of Pyrocap B-136 was visually assessed by blending premixed water solutions (20 milliliters, ml) of selected concentrations from 0.5 to 6 percent and at 30 percent by volume with 60 ml of Jet A, JP-4, and avgas fuels and vigorously shaking each mixture. Photographs showing the quality of the initial emulsion obtained with each fuel and the degree of phase separation with time, are presented in appendix B for Jet A (figure B-1), JP-4 (figure B-2), and avgas (figure B-3).

EMULSIFICATION OF JET A FUEL. Appendix B, figure B-1 (a) shows various solution concentrations of Pyrocap B-136 below the Jet A fuel prior to agitation. Figure B-1 (b) shows the degree of emulsification obtained 10 seconds after agitation. The photograph indicates that only a very small quantity of fuel in solution (water) emulsion appeared on the surface of the Jet A fuel at concentrations from 0.5 to 3 percent and that some floc was present at the interface between the fuel and solution. At a solution concentration of 4 percent, a visible fuel in solution emulsion developed on the fuel surface and a uniform distribution of light floc appeared throughout the fuel phase. When the concentration of surface active agent was further increased to 5 and 6 percent, the visible fuel in solution emulsion increased to 5.7 and 7.6 millimeters, respectively. Figure B-1 (c) shows the fuel and solution phase separation after 5 minutes. At surfactant concentrations from 0.5 to 3 percent, the fuel in solution emulsion was negligible. The emulsions formed at concentrations from 4 to 6 percent remained stable and increased in depth with agent concentration.

At 30 percent concentration, approximately 25 percent of the aqueous phase remained at the cylinder bottom, while the remainder appeared to be evenly distributed throughout the Jet A fuel. The mixture of Jet A fuel and water showed no tendency to form a stable emulsion.

Based upon these experiments, the 6 percent solution of Pyrocap B-136 was selected for the Jet A pool fire tests.

EMULSIFICATION OF JP-4 FUEL. Appendix B, figure B-2 (a) shows various solution concentrations of Pyrocap B-136 beneath the JP-4 fuel layer before agitation. Figure B-2 (b) shows the degree of emulsification obtained 10 seconds after agitation. Approximately 3.8 millimeters of emulsion was formed on the surface of the JP-4 fuel at Pyrocap B-136 concentrations from 0.5 to 4 percent and various quantities of white floc remained suspended within the fuel phase. The emulsions produced at solution concentration of 5 and 6 percent increased to approximately 11.4 and 22.8 millimeters, respectively, and the white floc produced remained evenly distributed within the fuel phase. The 30 percent solution of Pyrocap B-136 was distributed within the fuel phase with a large quantity of the agent settling to the bottom of the cylinder.

Figure B-2 (c) shows the phase separation after 5 minutes. Solution concentrations from 0.5 to 3 percent show well-defined emulsion layers of approximately 3.8 to 5.7 millimeters floating on the surface of the JP-4 fuel. The emulsions produced at agent concentrations of 5 and 6 percent remained stable.

At 30 percent concentration, the distribution of the Pyrocap B-136 within the fuel mixture did not appear to have changed with time. The mixture of JP-4 fuel and water showed no tendency to form a stable emulsion.

No fire tests were performed with JP-4 fuel since it was not available in the quantity required at the test site.

EMULSIFICATION OF AVIATION GASOLINE. Appendix B, figure B-3 (a) shows various solution concentrations of Pyrocap B-136 below the avgas phase before agitation. Figure B-3 (b) shows the degree of emulsification obtained 10 seconds after agitation. The quantity of emulsion produced by agent concentrations from 0.5 to 5 percent is shown as a thin white band approximately 2 to 3 millimeters thick floating on the surface of the avgas fuel. As the agent concentration was increased to 6 and 7 percent, the emulsion band increased to 5 and 6 millimeters in depth. It is also apparent that all of the aqueous agent phase between 1 and 7 percent is temporarily contained in the white floc. At 30 percent concentration, the Pyrocap B-136 agent produced a floc that was evenly distributed throughout the avgas phase.

Figure B-3 (c) shows the rapid settling of the floc at solution concentrations from 1 to 7 percent; however, at the higher concentrations the aqueous solution phase was more firmly bound into the floc during formation.

At a concentration of 30 percent, the floc was starting to show phase separation at the surface of the avgas. The mixture of avgas and water showed no tendency to form a stable emulsion when agitated.

Based upon these experiments, the 6 percent solution of Pyrocap B-136 was selected for the avgas pool fire tests.

#### FIRE TEST PROCEDURES.

THROW RANGE OF PYROCAP B-136. To establish the most effective firefighting techniques to be employed during the large-scale fire tests, it was expedient to know the effective throw range and ground area covered by the discharge. These parameters would, in part, be employed to establish the nozzle elevation and rate of traverse that the firefighter would employ during the fire control and extinguishing operations.

To establish stable fuel-in-water emulsions, the nozzle stream must be plunged directly into the fuel surface at the base of the fire plume. This procedure is in direct contrast with that required in firefighting operations employing mechanical foam agents, such as aqueous film forming foams (AFFF).

The fluid ground patterns produced by Pyrocap B-136 discharged at 100 and 230 pounds per square inch (psi) are shown in figure 2. In these experiments, the throw ranges varied from 45 to 72 feet and widths from 11 to 22 feet.

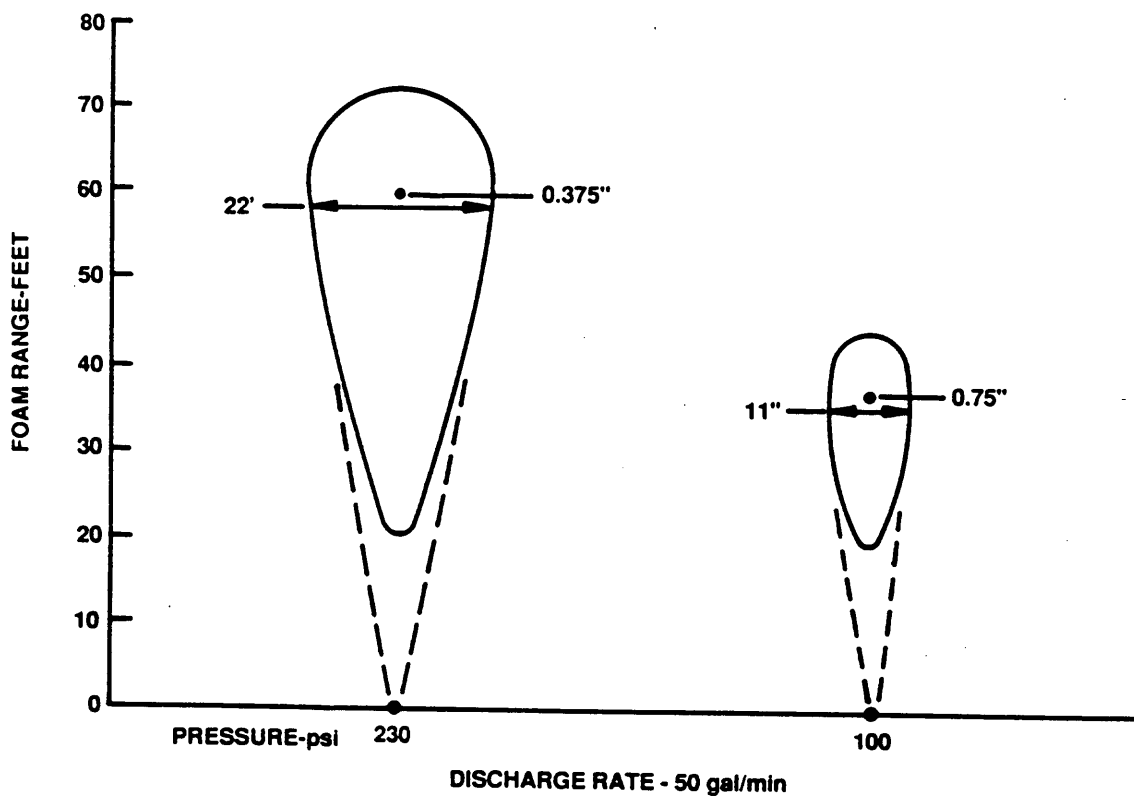

FIGURE 2. AVERAGE DIMENSIONS OF THE GROUND PATTERNS PRODUCED BY PYROCAP B-136

POOL FIRES. The first test bed was a 35-foot-diameter fire pit which contained sufficient water to provide a smooth water base upon which the Jet A fuel (335 gallons) was floated. A preburn period of 45 seconds was allowed after complete involvement of the fuel surface was obtained.

The fire was approached from the upwind side by an experienced firefighter committed to extinguishing the fire as rapidly as possible. The extinguishing fluid was applied as a 6 percent premixed solution from a 50-gallon-per-minute solid stream, air-aspirating nozzle under nitrogen pressure at 230 pounds per square inch.

Prior to conducting experiments with the emulsifying agent, a series of tests was performed using a 3 percent type aqueous film forming foam (AFFF) agent conforming with the requirements of MIL-F-24385C to establish the baseline characteristics of the procedure.

After each fire test employing the fuel-in-water emulsifying agent, the residual fuel was completely burned off the surface of the fire pit and the water was pumped out in preparation for a fresh charge of water and fuel.

SIMULATED FUEL SPILL FIRES. For the second test a Jet A fuel spill fire was simulated in a 20-foot-square banded area containing 750 gallons of fuel. The fuel was preburned for 45 seconds after full involvement of the pit was obtained. A 6 percent premixed solution of Pyrocap B-136 was plunged into the fuel surface at the rate of 50 gallons per minute and 230 pounds-per-square-inch nozzle pressure.

#### FIRE TEST RESULTS.

POOL FIRES. The 6 percent premixed solution of Pyrocap B-136 controlled and extinguished the 962-square-foot Jet A pool fire in 18 seconds and 32 seconds, respectively. The estimated depth of the Jet A emulsion layer was 1/8 inch. In this experiment, some of the emulsifying water may have been derived from the aqueous substrate beneath the fuel layer. The burnback test required 160 seconds to break the emulsion and completely involve the fuel surface. The photographs presented in appendix C show four critical phases during the fire control and extinguishing process using the Pyrocap B-136 agent.

At the conclusion of the burnback test, a second attempt was made to extinguish the fire, and control and extinguishment were accomplished in 17 seconds and 30 seconds, respectively. No burnback time was recorded for this experiment. The results of these tests are summarized in table 2.

SPILL FIRES. The 6 percent premixed solution of Pyrocap B-136 applied at 0.125 gallons per minute per square foot controlled and extinguished the 400-square-foot fire in 28 seconds and 57 seconds, respectively. The fire burnback time was 184 seconds.

At the conclusion of the burnback period, a second attempt was made to control and extinguish the fire. This was accomplished in 28 seconds and 52 seconds, respectively, followed by a burnback period of 103 seconds.

An approximation of the depth of the Jet A fuel-in-water emulsion that was formed during the fire extinguishing process was 1/8 inch for the circular pool

TABLE 2. SUMMARY OF FIRE TEST RESULTS

POOL FIRES

Agents	Solution Conc. %	Fire Area ft <sup>2</sup>	Solution Rate gpm	Application Density gpm/ft <sup>2</sup>	Control Time sec.	Extinguishing Time sec.	Burnback Time sec.	Fuel
Pyrocap B-136	6	962	50	0.052	18	32	160	Jet A
Pyrocap B-136	6	962	50	0.052	17	30	---	Jet A
SPILL FIRES								
Pyrocap B-136	6	400	50	0.125	28	57	184	Jet A
Pyrocap B-136	6	400	50	0.125	28	52	103	Jet A
Pyrocap B-136	6	400	50	0.125	none	none	---	AVGAS
*AFFF	3	962	50	0.052	9	12	MIL-F-24385C	

\*For comparison only

fire with the water substrate and 3/16 inch for the simulated fuel spill fire without the water substrate. The larger quantity of Pyrocap B-136 solution used per square foot of fire surface in the fuel spill simulation test was required to provide an adequate depth of the fuel-in-water emulsion to secure the fuel surface from vapor penetration.

In a third simulated spill fire, 500 gallons of avgas was employed in the 400-square-foot banded pit. The 6 percent premixed Pyrocap B-136 solution discharged at 50 gallons per minute and 230 pounds per square inch nozzle pressure was not able to emulsify the avgas. The solution discharge stream was varied from direct plunging to a gentle application without success, and the fuel continued to burn with undiminished intensity until it was all consumed. The results of the simulated spill fire tests are summarized in table 2.

The failure of the JP-4 fuel to produce stable fuel-in-water emulsions with Pyrocap B-136 under the established fire test conditions is attributable in part to the high volatility of the fuel. All aviation fuels are blends of many individual hydrocarbons, each of which has its own vapor pressure and boiling range. The kerosene-type fuels (Jet A) are comprised principally of the higher boiling range fractions and the gasoline types (avgas), the lower boiling range fractions. Since the military fuel (JP-4) is a blend of both the kerosene and gasoline types, the distillation curve lies somewhere between these two extremes.

An analysis of the distillation profiles for the three aviation fuels (figure 3) shows that the starting vaporization temperatures are 154 °C, 65.65 °C and 48.55 °C for Jet A, JP-4, and avgas, respectively. Since the difference in the initial distillation temperature between JP-4 and avgas is only 17.1 °C, it is speculated that the effectiveness of Pyrocap B-136 would be significantly lower against JP-4 fuel fires than Jet A fuel fires under the established fire test conditions.

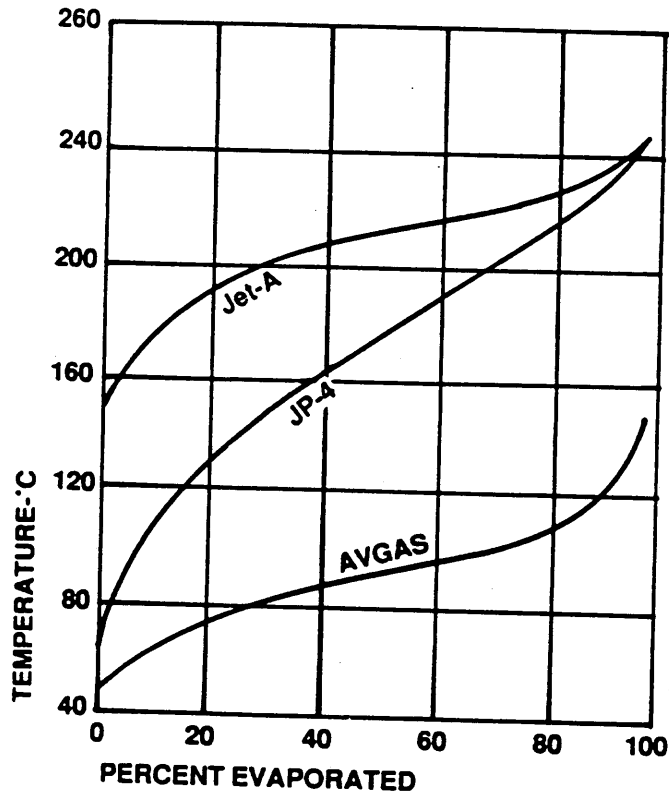

FIGURE 3. TYPICAL DISTILLATION CURVES OF AVIATION FUELS

## MAGNESIUM FIRE EXTINGUISHING EXPERIMENTS.

In addition to the aircraft fuel emulsifying properties exhibited by Pyrocap B-136, the manufacturer claimed that a 30 percent concentrate of the agent was also effective in extinguishing magnesium metal fires.

Accordingly, experiments were performed using two segments of a C-130 aircraft nose wheel assembly. The 30 percent premixed Pyrocap agent was dispensed at the rate of 2.5 gallons per minute from a 2.5-gallon portable water fire extinguisher pressurized to 90 pounds per square inch by means of an external carbon dioxide cartridge.

The results of these experiments are summarized in table 3, tests 1 and 2. Photographs showing critical phases in the extinguishment of the magnesium wheel fires are presented in appendix D.

TABLE 3. MAGNESIUM FIRE EXTINGUISHING EXPERIMENTS

TEST 1

Test Article: One-half of a C-130 magnesium nose wheel.  
Weight: 18.5 pounds  
Height: 18.5 inches  
Width: 6 inches

Fire Extinguisher: Badger 2.5 gallon water extinguisher pressurized to 90 pounds per square inch with an external carbon dioxide cartridge. Discharge rate 2.5 gallons per minute.

Extinguishing Agent: Pyrocap B-136  
Solution concentration: 30 percent by volume

Log of Events

<u>Time (min:sec)</u>	<u>Event</u>
0:00	Heat applied to wheel with acetylene torch.
4:25	Magnesium ignited at bottom of wheel.
15:37	Large area of lower wheel burning.
20:00	Initial application of Pyrocap B-136 to the burning metal caused a large flareup and a shower of sparks. Continued application of fluid, in short bursts on and around the burning metal, controlled the fire. A large quantity of molten magnesium & slag (thermo- pile) continued to burn on the ground under the wheel, which was secured by the agent.
23:15	First extinguisher emptied; no burning magnesium visible. The thermopile was glowing red in the center under the wheel.
25:00	No signs of magnesium burning, but smoke (MgO) emanated from the glowing thermopile.
32:00	Thermopile flared when probed and increased in intensity.
32:57	Second 2.5 gallon extinguisher applied on thermopile.
36:00	Second extinguisher emptied; wheel fire extinguished; some low heat emanated from the thermopile.

Quantity of agent used: 5 gallons of 30 percent Pyrocap B-136.



TABLE 3. MAGNESIUM FIRE EXTINGUISHING EXPERIMENTS

TEST 2

Test Article: One-half of a C-130 magnesium nose wheel.  
 Weight: 18.5 pounds  
 Height: 18.5 inches  
 Width: 6 inches

Fire Extinguisher: Badger 2.5 gallon water extinguisher pressurized to 90 pounds per square inch with an external carbon dioxide cartridge. Discharge rate 2.5 gallons per minute.

Extinguishing Agent: Pyrocap B-136 concentration premixed to 30 percent by volume.

Log of Events

<u>Time (min:sec)</u>	<u>Event</u>
0:00	Heat applied to wheel with acetylene torch.
4:00	Surface burning of magnesium appeared on wheel.
5:20	Major burning of wheel started.
8:10	Approximately 25 percent of wheel involved.
11:50	External heat application stopped.
12:20	Application of Pyrocap B-136 agent; started using gentle application.
14:30	Gentle application was effective in cooling non-burning magnesium metal.
14:45	Pyrocap agent coated the metal surface and boiling occurred over the thermopile, which was glowing red.
17:00	Entire rim covered with Pyrocap agent and boiling continued over the thermopile.
17:10	First 2.5 gallon extinguisher exhausted.
21:38	Second extinguisher brought into play.
26:00	Pyrocap agent covered the wheel, but the thermopile continued to boil and glow.
29:00	Second extinguisher exhausted; all burning under control.

TABLE 3. MAGNESIUM FIRE EXTINGUISHING EXPERIMENTS

TEST 2 (CONTINUED)

Log of Events

<u>Time (min:sec)</u>	<u>Event</u>
34:00	Small emission of magnesium oxide from thermopile; no other visible burning.
45:30	Minor burning of interior of the thermopile when the slag was probed.
45:45	Third extinguisher activated.
47:00	Small emanation of magnesium oxide from thermopile.
58:00	Application of Pyrocap agent stopped; complete extinguishment.

Quantity of agent used: 6.5 gallons of 30 percent Pyrocap B-136.

## SUMMARY OF RESULTS

The results obtained from laboratory experiments and large-scale fire tests employing the general fire suppression concentrate identified as Pyrocap B-136 are:

1. Aqueous solutions of Pyrocap B-136 show negative spreading coefficients when measured against Jet A, JP-4, and Avgas aviation fuels.
2. The relatively high viscosity (573 centipoise at 68 °F) of Pyrocap B-136 may require modification of some field dispensing equipment to obtain proper proportioning of the agent.
3. Pyrocap B-136 is a strong emulsifying agent toward Jet A, JP-4, and Avgas aviation fuels at ambient environmental temperatures.
4. A solution concentration of 6 percent by volume of Pyrocap B-136 controlled and extinguished a 962-square-foot Jet A pool fire at the low solution application rate of 0.052 gallons per minute per square foot.
5. Six percent concentration of Pyrocap B-136 produced stable Jet A fuel in water emulsions which resisted rapid burnback of the emulsified fuel in large-scale fire tests.
6. The 6 percent solution of Pyrocap B-136 required approximately one and one-half times longer to achieve fire control and extinguishment of the 400-square-foot simulated Jet A fuel spill fire than it did the 962-square-foot pool fire at the same discharge rate (50 gallons per minute).
7. Pyrocap B-136 was not effective in extinguishing highly volatile hydrocarbon fuel fires such as avgas.
8. Thirty percent aqueous solutions of Pyrocap B-136 demonstrated progressive control and extinguishment of aircraft magnesium wheel rim fires.

## CONCLUSIONS

Based upon the results of preliminary laboratory and large-scale fire test data, it is concluded that the general fire suppression concentrate identified as Pyrocap B-136 is worthy of continued testing and evaluation as a candidate auxiliary agent for use at airports.

**APPENDIX A**

**VARIATION OF HYDROGEN ION CONCENTRATION (pH)  
WITH SOLUTION CONCENTRATION OF PYROCAP B-136**

**Manufacturer:** Pyrocap, Inc.  
6551 Loisdale Court  
Suite 400  
Springfield, Virginia 22155-1854

General Fire Suppression Concentrate  
Batch No. 45 VA 299-910  
FAA Contract Order No. DTFA03-90-P-00479

**LAB TEST RESULTS**

<b>Pyrocap pH Level Concentration</b>	<b>Test 1</b>	<b>Test 2</b>	<b>Test 3</b>	<b>Average</b>
0.2%	7.05	7.05	7.05	7.05
0.5%	7.40	7.35	7.35	7.36
1.0%	7.45	7.45	7.50	7.46
2.0%	7.75	7.75	7.72	7.74
3.0%	7.70	7.70	7.70	7.70
4.0%	7.75	7.75	7.75	7.75
5.0%	7.75	7.75	7.75	7.75
6.0%	7.75	7.70	7.70	7.71
30.0%	7.85	7.85	7.90	7.86
100.0%	8.10	8.15	8.20	8.15

**Equipment Used:** Beckman  
Zeromatic II pH Meter  
86-R pH Electrodes

**APPENDIX B**

**EMULSIFICATION CHARACTERISTICS  
OF PYROCAP B-136**

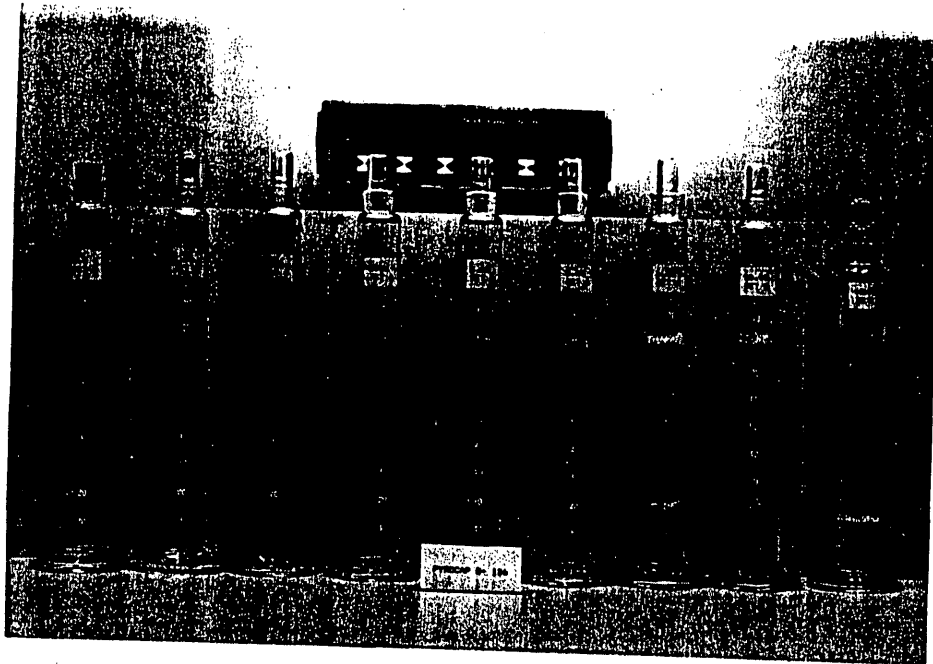

(a) Jet A and Pyrocap B-136 Solutions Before Agitation

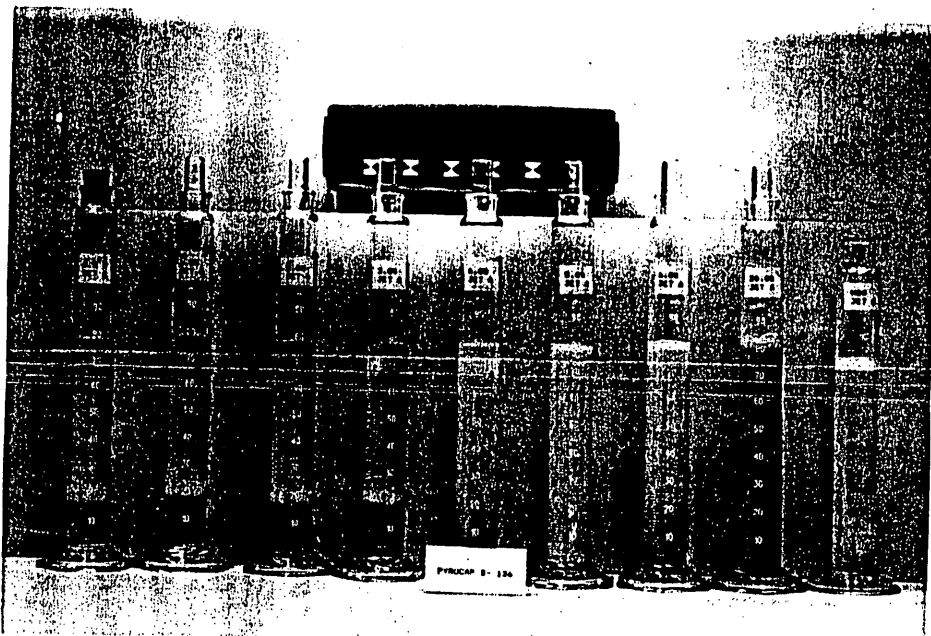

(b) Jet A and Pyrocap B-136 Solutions After Agitation

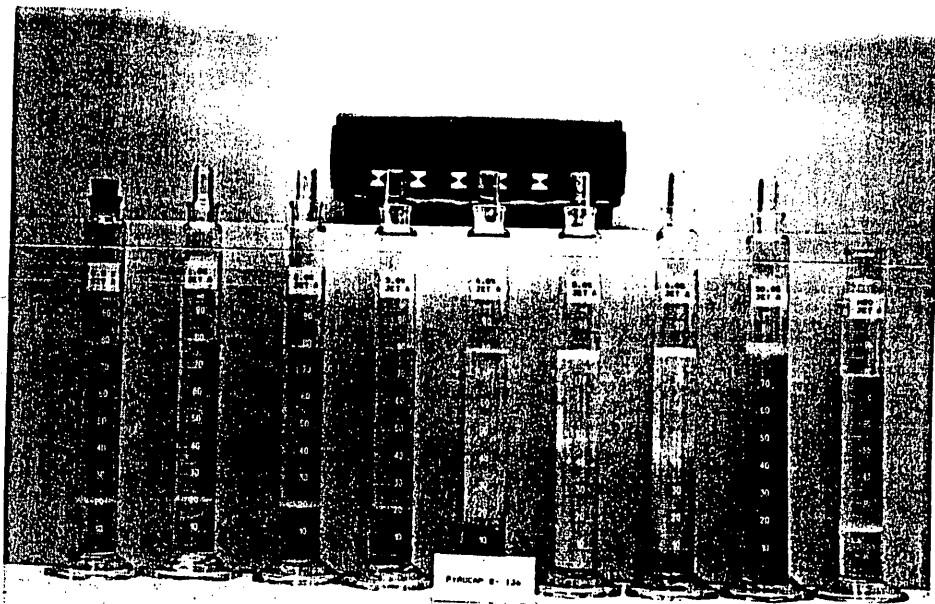

(c) Jet A and Pyrocap B-136 Solutions 5 Minutes After Agitation

FIGURE B-1. EMULSIFICATION OF JET A WITH PYROCAP B-136 SOLUTIONS



(a) JP-4 and Pyrocap B-136 Solutions Before Agitation

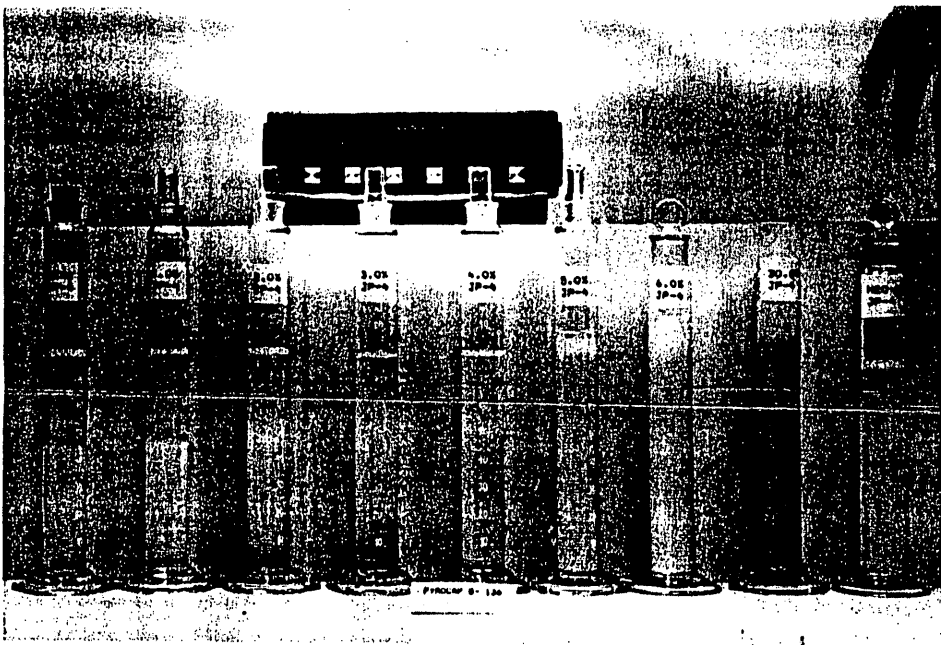

(b) JP-4 and Pyrocap B-136 Solutions After Agitation

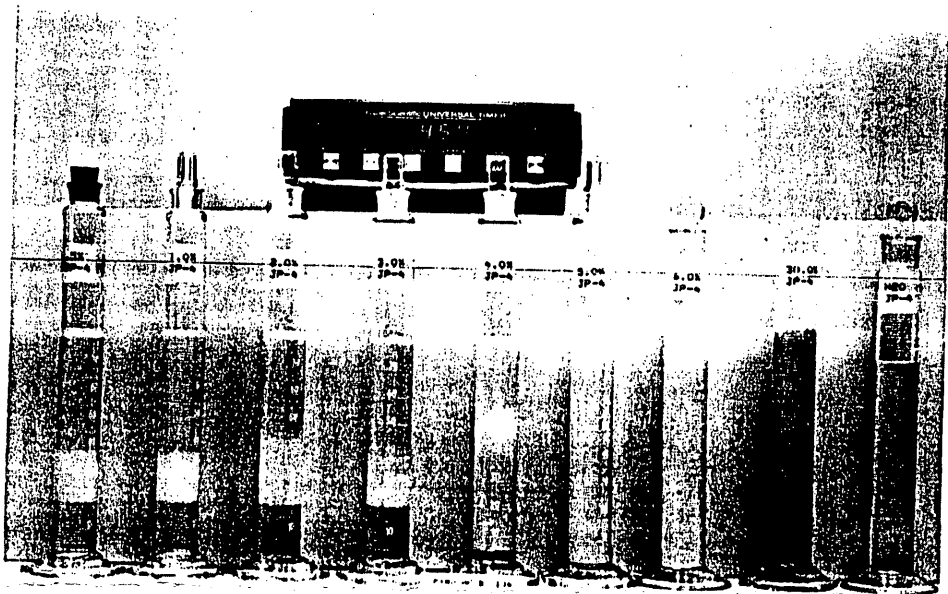

(c) JP-4 and Pyrocap B-136 Solutions 5 Minutes After Agitation

FIGURE B-2. EMULSIFICATION OF JP-4 WITH PYROCAP B-136 SOLUTIONS



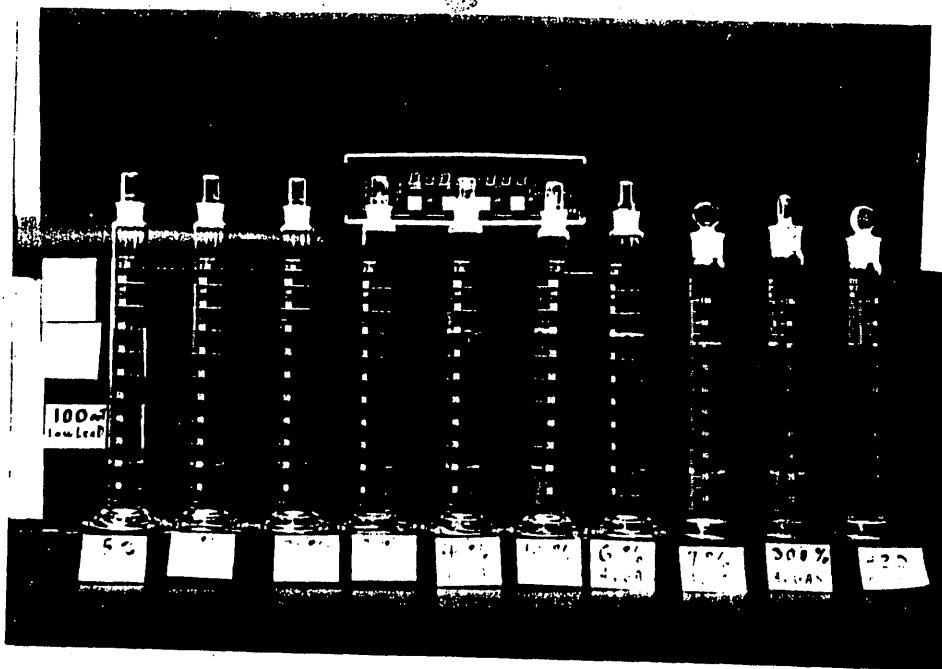

(a) Avgas and Pyrocap B-136 Solutions Before Agitation

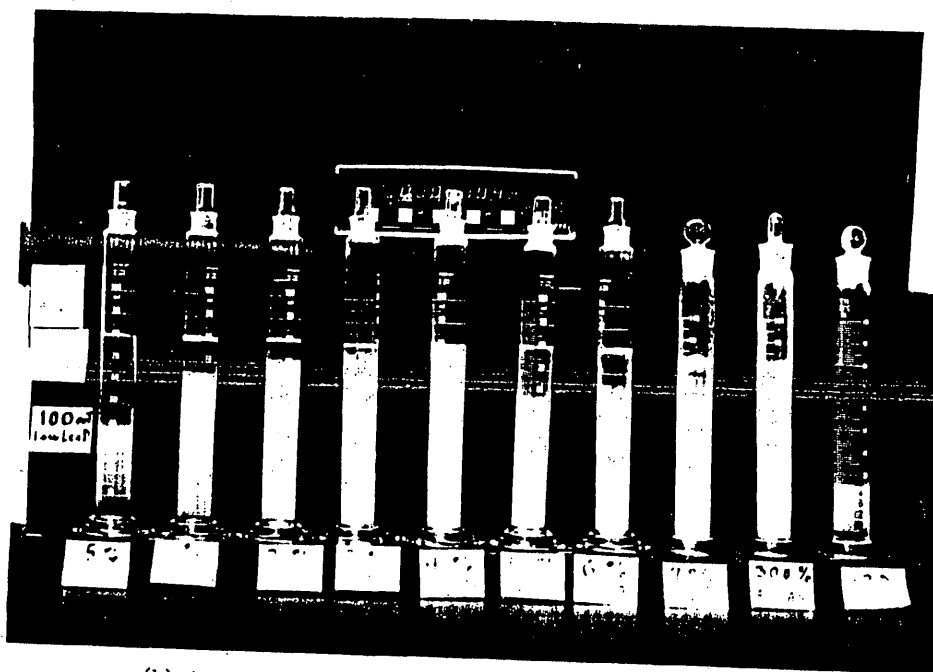

(b) Avgas and Pyrocap B-136 Solutions After Agitation

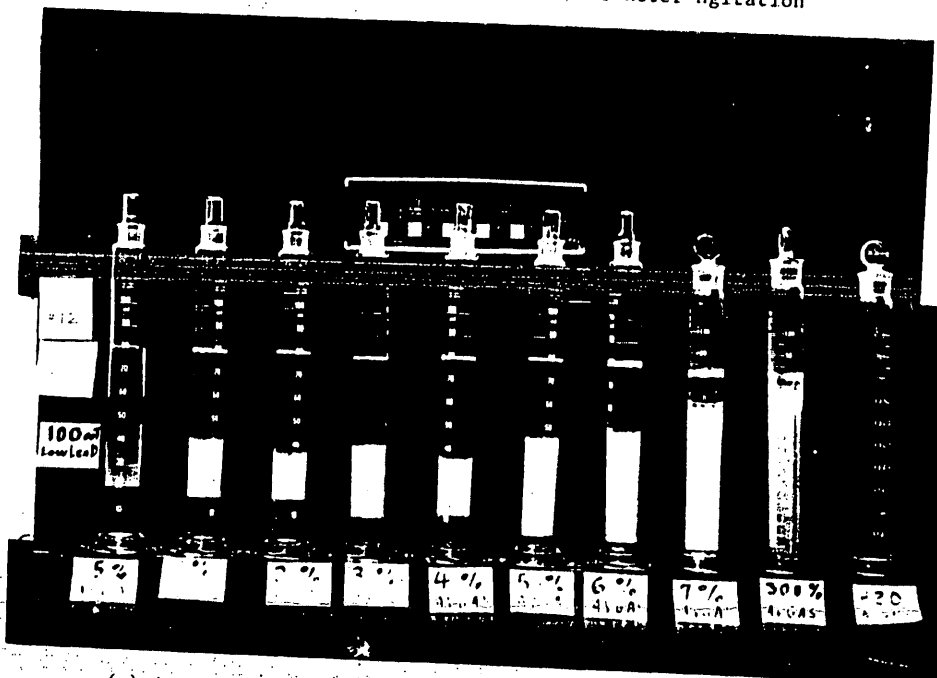

(c) Avgas and Pyrocap B-136 Solutions 5 Minutes After Agitation

FIGURE B-3. EMULSIFICATION OF AVGAS WITH PYROCAP B-136 SOLUTIONS.

B-4

APPENDIX C  
EXTINGUISHMENT OF JET A POOL FIRES WITH  
PYROCAP B-136



(a) Time of Discharge 6 Seconds



(b) Time of Discharge 10 Seconds

FIGURE C-1. FIRE EXTINGUISHING SEQUENCE (4 PHOTOGRAPHS) SHOWING THE DISCHARGE OF PYROCAP B-136 ON THE 35-FOOT DIAMETER JET A POOL FIRE (1 of 2)



(c) Time of Discharge 18 Seconds Controlled



(d) Time of Discharge 32 Seconds Extinguished

FIGURE C-1. FIRE EXTINGUISHING SEQUENCE (4 PHOTOGRAPHS) SHOWING THE DISCHARGE OF PYROCAP B-136 ON THE 35-FOOT DIAMETER JET A POOL FIRE (2 of 2)

APPENDIX D

EXTINGUISHMENT OF MAGNESIUM WHEEL  
FIRES WITH PYROCAP B-136

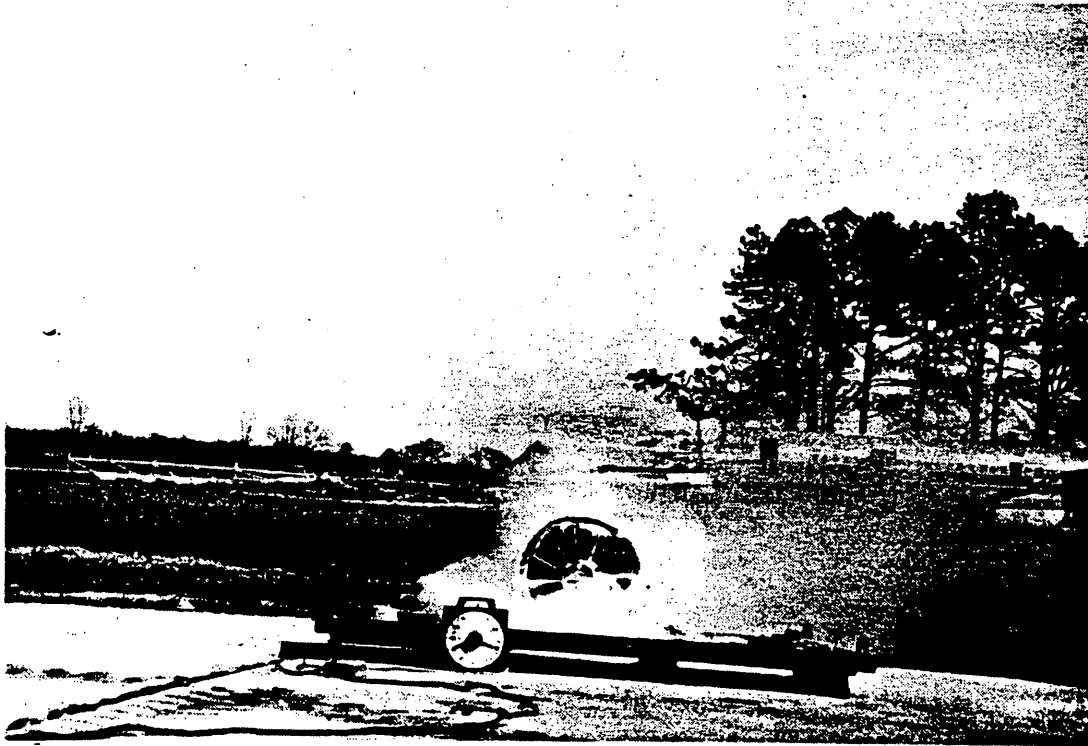

(a) Sustained Magnesium Burning

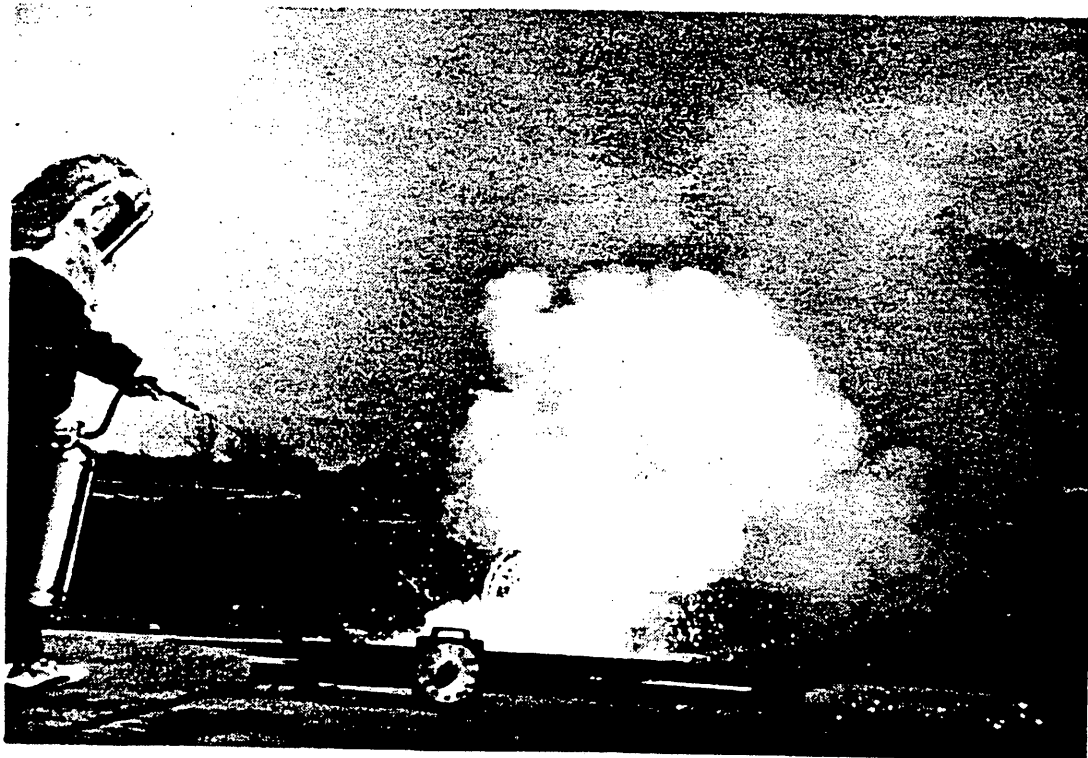

(b) Initial Spattering of Molted Magnesium

FIGURE D-1. FIRE EXTINGUISHING SEQUENCE (4 PHOTOGRAPHS) SHOWING THE DISCHARGE OF PYROCAP B-136 ON THE BURNING MAGNESIUM WHEEL (1 of 2)

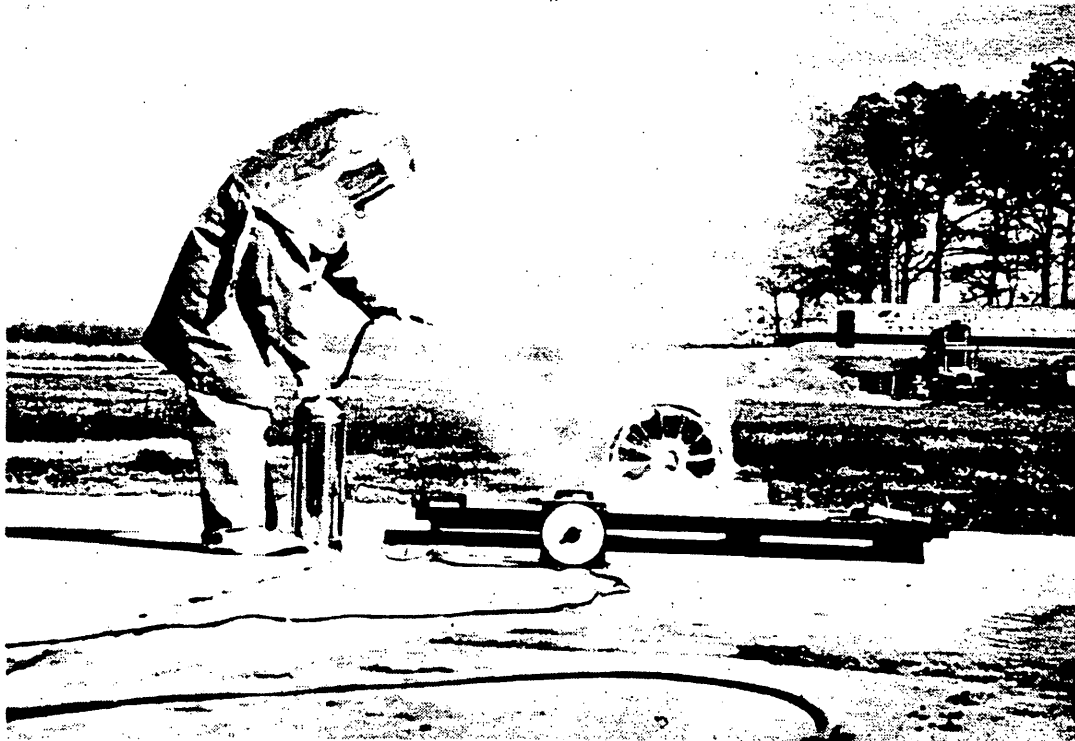

(c) Fire Brought Under Control With the Pyrocap B-136 Agent

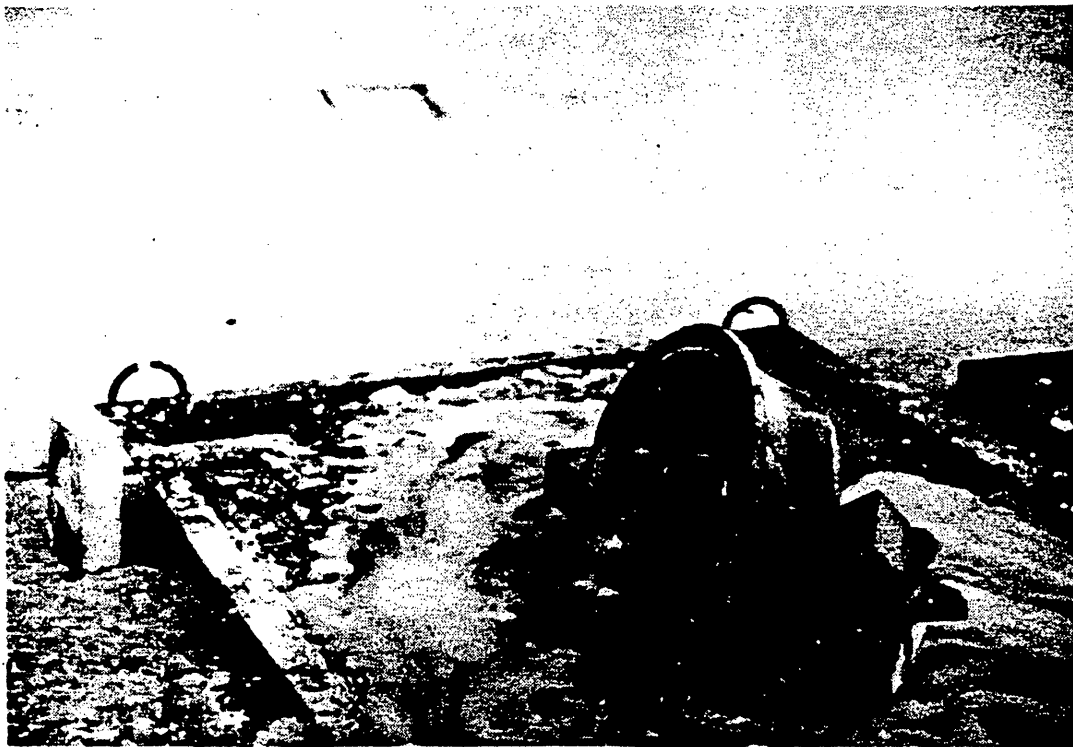

(d) Magnesium Fire Secured With Slag and the Pyrocap B-136 Agent

FIGURE D-1. FIRE EXTINGUISHING SEQUENCE (4 PHOTOGRAPHS) SHOWING THE DISCHARGE OF PYROCAP B-136 ON THE BURNING MAGNESIUM WHEEL (2 of 2)

**A COMPARISON OF THE EFFECTIVENESS OF PYROCAP AND  
WATER AS EXTINGUISHING AGENTS IN REDUCING  
EMISSIONS AND FIRE TEMPERATURES**

Prepared for:

**PYROCAP International Corporation  
Springfield, Virginia**

Prepared by:

**Versar, Inc.  
6850 Versar Center  
Springfield, Virginia 22151**

September 9, 1993



## INTRODUCTION

The objective of this study is to compare PYROCAP B-136™ (PYROCAP), a commercial water-based fire suppressant, to water in extinguishing controlled fires. The study will compare concentrations of selected gaseous emissions and temperature distributions from the fires and compare the efficiency of PYROCAP to water as a fire suppressant.

## PROCESS DESIGN

### Thermocouple Apparatus

Two separate apparatuses were designed for the experiment. The first apparatus was designed to determine the temperature distributions of the fire. This apparatus consisted of two inverted 'T' shaped structures made out of 3 inch angle iron connected horizontally by three 6.67 feet 2 inch angle iron cross bars. These cross bars held the thermocouples which were attached to 18 inch long stainless steel bars (the stainless steel bars were clamped to the cross bars). These stainless steel bars which are 1 inch wide and 1/8 inch thick allowed approximately 14 inch vertical adjustments in thermocouple height relative to a given cross bar. The thermocouple junctions protrude approximately 1 inch below the stainless steel bar to prevent bias of the temperature measurements due to heat absorbed by the stainless steel bars.

A total of eight type K thermocouples were used in each experiment. Three thermocouples were located in the bottom cross bar while two thermocouples were located in the middle cross bar and a single thermocouple was clamped to the top cross bar. The remaining 2 thermocouples were located in the fire material pile, one near the top of the material and the other near the bottom of the material.

The thermocouples were connected by high temperature thermocouple (type K) wire to a data acquisition system. The system consists of an IBM compatible PC based data acquisition system with temperature processing being performed and stored by the computer software. The data acquisition systems was set to a 0.1 second scan for all thermocouples. The data acquisition

systems was activated a few seconds after the fire was initiated and ran continuously for at least one minute after the flame was extinguished in order to capture any heat increases.

### Emission Capturing Apparatus

Emissions resulting from the fire were captured by 3.2 liter SUMMA passivated, stainless steel evacuated canisters and by colorimetric indicator tubes. The stainless steel canisters were forwarded to and analyzed by a laboratory after the experiment was concluded while the colorimetric indicator tubes were read visually immediately after the conclusion of each fire. The stainless steel canisters were used to measure six permanent gases, namely, oxygen, carbon dioxide, carbon monoxide, nitrogen, hydrogen, and methane. The colorimetric indicator tubes were used to measure the following emissions:

- Acetaldehyde
- Ammonia
- Carbon Monoxide
- Carbon Dioxide
- Formaldehyde
- Hydrogen Chloride (Hydrochloric Acid)
- Hydrogen Cyanide (Hydrocyanic Acid)
- Hydrogen Sulfide
- Methane (qualitative)
- Nitrogen Dioxide
- Nitrous Fumes
- Sulfur Dioxide

Since carbon monoxide is the leading cause of death through asphyxiation in most fires, it was captured and measured both by colorimetric indicator tube as well as by the stainless steel canisters. In addition, stainless steel in-line filters were used to capture smoke particulates to provide a relative measure of the smoke opacity.

All emission capturing equipment was mounted on a 3.5 feet by 8 feet flat bed which, in turn, was mounted on a forklift to provide vertical and horizontal mobility. There were five sets of colorimetric indicator tubes for each fire, and each set of tubes was mounted on a 14 tube manifold. The five set manifold system was immersed in a water bath inside a waterproof steel box to prevent the tubes from overheating due to the high temperature of the fire and captured gases. The canisters and the in-line filters were mounted on a wooden structure which was attached to the flat bed. Four, 12 volt custom made vacuum pumps were used to capture the emissions from the fire with a set of two pumps for the filter heads and two pumps for the colorimetric tubes. The pumps were remotely operated by a switch board located in the cab of the forklift. The switch board will also be used to operate the canisters remotely. Stainless steel sampling tubes were connected to the canisters, indicator tube sets and the in-line filters which were then exposed to the emissions through a wall perpendicular to the flat bed. This firewall prevented heat transfer from the fire to the equipment mounted on the flat bed.

## **THE EXPERIMENT**

All experiments were conducted at the University of Maryland Fire and Rescue Institute (UMFRI) under the supervision of UMFRI staff and PYROCAP officials. A total of three experiments were conducted. A great effort was made to keep the conditions the same for all experiments. A seven tire material pile was used for all three experiments and the tires were configured in three layers (three tires on the bottom two layers and one tire on the top layer). A half gallon of diesel fuel, ignited by a propane gas torch, was used to initiate each fire. The tires were enclosed in a three sided cubicle constructed of cinder blocks to reduce the hazards to personnel. The top of the cubicle was roofed with one half inch plywood with a centered 12 inch by 48 inch opening to allow the emissions to escape. The sampling probes (tubes) were centered above the roof opening. The tires were located seven inches above a concrete pad on top of a plywood pallet to protect the concrete surface. The following are the data from each run that was conducted.

Run # 1:

In this run the pumps were not operated and only the canisters and thermocouples were operational. Therefore, no indicator tube data or particulate data will be provided.

Fire suppressant : Water

Tire pile dimensions : 57" wide, 21.5" high and 51" deep

Thermocouple heights from top of plywood pallet, in inches (#3 through # 8) : 18, 26, 18.5, 37.75, 37.75, 51.25.

Heights in inches to the indicator tube probes, bottom cylinder probes, bottom filter probes and top cylinder probes and top filter probes respectively : 17, 16, 21, 26.

Wind direction : wind was hitting the cinder block wall throughout run # 1.

Run # 2:

Fire suppressant : PYROCAP

Tire pile dimensions : 48" wide, 20" high and 48" deep

Thermocouple heights from top of plywood pallet, in inches (#3 through # 8) : 19, 25, 18, 37, 37.75, 50.

Heights in inches to the indicator tube probes, bottom cylinder probes, bottom filter probes and top cylinder probes and top filter probes respectively : 17, 16, 21, 26.

Wind direction : wind was hitting in the direction of the open fire from the side of the open end, however, it somewhat changed directions in the end of the run.

Run # 3:

Fire suppressant : Water

Tire pile dimensions : 55" wide, 21" high and 48" deep

Thermocouple heights from top of plywood pallet, in inches (#3 through # 8) : 18, 26, no thermocouple, 37, 38, 49.

Heights in inches to the indicator tube probes, bottom cylinder probes, bottom filter probes and top cylinder probes and top filter probes respectively : 17, 16, 21, 26.

Wind direction : wind was hitting the cinder block wall across from the open end, however, it changed directions haphazardly after the fire began.

Each run consisted of five samples with the first sample taken 60 seconds after the fire was initiated. The sampling period for the colorimetric indicator tubes and the filter heads were 60 seconds in duration. The sampling period for the passivated stainless steel canisters were 10 seconds. During each run, extinguishing was initiated 10 seconds after the completion of the first sampling period or 130 seconds after the fire was initiated. The second sample was started 10 seconds after extinguishing was initiated with each subsequent sample started at 20 second intervals. Extinguishing continued throughout samples 2 through 5. Table 1 shows the sampling sequence for each run.

**TABLE 1**  
**Sampling Sequence**

<b>TIME (Seconds)</b>	<b>EVENT</b>
0	Fire Initiated
60	Start Sample 1
70	Close Sample 1 Canister
120	Stop Sample 1
130	Begin Extinguishing Fire
140	Start Sample 2
150	Close Sample 2 Canister
160	Start Sample 3
170	Close Sample 3 Canister
180	Start Sample 4
190	Close Sample 4 Canister
200	Stop Sample 2/ Start Sample 5
210	Close Sample 5 Canister
220	Stop Sample 3
240	Stop Sample 4
260	Stop Sample 5

## RESULTS AND DISCUSSION (Reference - Appendix A)

### Colorimetric Indicator Tubes

The only compound emitted during the tire fire that was significantly reduced by Pyrocap extinguishing versus water extinguishing was acetaldehyde (Tables A2, A3). The concentration of acetaldehyde for the water extinguishing varied from a high of 1100 ppm to a low of 80 ppm whereas for the Pyrocap extinguishing the concentration did not exceed 80 ppm. Carbon dioxide was also reduced during Pyrocap extinguishing by approximately 50% of that generated during water extinguishing.

The rate at which carbon monoxide (CO) was reduced was significantly greater during Pyrocap extinguishing as compared to water extinguishing (Figure 5, Tables A2 and A3). While the concentration of CO was not available from the colorimetric indicator tubes during the Pyrocap experiment for sample 1 (full burn) due to a failure of one of the silicone manifold connector tubes, it is evident from the canister concentration (0.42% by vol) that the initial CO concentration was considerably higher during the full burn phase than that developed during the full burn phase of the second water extinguishing experiment (<0.1% by vol). Comparing the initial CO concentration during sample 1 (full burn) to sample 2 (extinguishing) for run 3, water extinguishing (Table A3), the CO concentration as measured by the colorimetric indicator tubes was reduced from 180 ppm to 100 ppm, a 44.4% reduction, while the canister CO concentrations for both samples were less than 0.1% by volume. Even though the colorimetric indicator tube CO measurement failed during sample 1 for the Pyrocap experiment, the fact that the canister CO concentration during sample 1 (full burn) was 0.42% by volume and during sample 2 (extinguishing) was less than 0.1% by volume, strongly indicates that the initial reduction of carbon monoxide, after extinguishing was initiated with Pyrocap, was at least four times greater than the initial reduction of carbon monoxide when using water as the extinguishing agent. The rate of reduction of carbon monoxide concentration, while not as high, continued to be greater for Pyrocap extinguishing as compared to water extinguishing between samples 2 - 3 and 3 - 4 as shown in Table 2, below and Figure 5, Appendix A.

**TABLE 2**  
**Carbon Monoxide Reduction**

SAMPLE	WATER	PYROCAP
1 - 2	44.4%	> 178% *
2 - 3	25.0%	55.0%
3 - 4	33.3%	44.0%

\* estimated

The effectiveness of Pyrocap in reducing hydrogen cyanide, ammonia, formaldehyde, or sulphur dioxide can not be determined as the concentration of these compounds were too low (not generated or consumed in the fire) or an inadequate number of experiments were conducted to determine definitive trends.

Permanent Gases - Passivated Stainless Steel Canisters

The permanent gases did not deviate significantly from ambient conditions with the exception of the full burn phase (sample 1, Table A2) during the Pyrocap experiment. During this phase, over 50% of the oxygen was consumed and, in part, converted to carbon dioxide and carbon monoxide. When extinguishing with Pyrocap was initiated, the concentration of oxygen returned to ambient levels with a concomitant decrease in carbon monoxide and carbon dioxide. The concentration of carbon dioxide was slightly less throughout all extinguishing phases with Pyrocap as the extinguishing agent as compared to water as the extinguishing agent.

Particulates

The smoke particulates were captured on 1.0 micron, 47 mm, by 0.56 mm thick glass fiber filter pads housed in a stainless steel filter head. The weight of the particulates captured during the water extinguishing was significantly higher than that captured during the Pyrocap

extinguishing indicating that the fire was still smoldering and burning inspite of the applied water (Tables A2, A3). It is believed that the large increase in particulate weight during water extinguishing is due to partially combusted tire material resulting from the smoldering and partially burning tires. The low weight of particulates during Pyrocap extinguishing indicates that the fire was more completely extinguished in a much shorter time period than with water. The relatively low weight of particulates during the Pyrocap extinguishing is reinforced by visual observation. The smoke plume during the Pyrocap extinguishing was relatively white indicating a low concentration of particulates as compared to the dark gray to black smoke emitted during water extinguishing. The low weight of the particulates prior to extinguishing, while the fire was at a full burn, for both runs 2 and 3 is most likely due to the fact that the organic tire material was relatively completely combusted resulting in a low weight ash.

### Temperature

The temperature of the fire and the material pile was monitored using type K thermocouples connected to a PC based data acquisition system. Temperatures were read every 0.10 seconds. Temperature graphs for water extinguishing, Pyrocap extinguishing, and again, water extinguishing are shown in Appendix A, Figures 1, 2, and 3, respectively. To allow for a direct comparison of the temperature graphs, the axes were normalized and a 160 second period was plotted, inclusive of the extinguishing start, as Figures 1A, 2A, and 3A.

The location of each thermocouple is shown in Figure 4. Thermocouple A1:5 failed due to a loose terminal at the data acquisition terminal board and could not be field repaired. The thermocouple at position A1:4, centered directly above the tire pile, gave erroneous readings above approximately 1100 degrees Fahrenheit, consistently. The thermocouple at position A1:4 was switched with other thermocouples between experiments. Irrespective of the thermocouple used, the thermocouple at position A1:4 continued to give erroneous readings above 1100 degrees Fahrenheit, indicating that the cause of the erroneous readings was due to some type of interference resulting from a compound, gas, or tire material being emitted from the tire pile at a temperature of approximately 1100 degrees Fahrenheit.



The temperature readings for the lower material pile thermocouple (A1:1 Pile - lower, red graph) indicated that the temperatures were reduced much more rapidly when using Pyrocap as the extinguishing agent as compared to water. The temperature of the lower part of the tire pile was reduced to 200 degrees Fahrenheit in 8 seconds and 41 seconds, respectively for the two water extinguishing experiments plotted as Figure 1A, and 3A. When using Pyrocap as the extinguishing agent, the lower pile temperature reached 200 degrees Fahrenheit in 4 seconds (Figure 2A). The lower part of the tire pile reached ambient temperatures for the two water extinguishing and Pyrocap extinguishing experiments in 30 seconds, 52 seconds, and 33 seconds, respectively.

The upper pile temperature during the first water experiment (Figure 1A) took 112 seconds to drop to 200 degrees Fahrenheit and approximately 204 seconds to reach ambient temperature. When using Pyrocap as the extinguishing agent, it appears that a reaction occurred between Pyrocap, partially combusted tire material, and the thermocouple junction to create an interference in the temperature (Seebeck voltage) output as evidenced in the sharp temperature rises at approximately 600 degrees Fahrenheit at 153 seconds in Figure 2A. The apparent result of the thermocouple probe contamination was to impart a constant Seebeck voltage (result of dissimilar metals or materials) to the thermocouple junction such that the apparent temperature did not fall below 350 degrees Fahrenheit. If the constant voltage is ignored, and the temperature readings are extrapolated using line graph A1:2 Pile - upper in Figure 2A, it would appear that Pyrocap extinguishing would have reduced the upper pile temperature to 200 degrees Fahrenheit in approximately 9 seconds. The thermocouple probe was vigorously cleaned after the Pyrocap extinguishing experiment. During the cleaning process the apparent temperature was reduced to ambient temperatures. The probe was returned to service for the second water extinguishing experiment (Figure 3A). However, as evidenced by line graph A1:2 Pile - upper of Figure 3A, the probe was still contaminated making the results from that probe for the second water experiment suspect. The temperature results of the other six thermocouple probes were inconclusive as in some cases Pyrocap extinguishing resulted a more rapid cool-down and in other cases water appeared to be more effective. It is believed that the temperature results from the six thermocouples above the tire pile were more a function of direct cooling by liquid spray and the area to which the liquid spray was applied at any given time rather than a measure of the effectiveness of the fire suppressants in reducing the temperature of the fire/tire pile. It is

suggested that in any future experiments of this nature, that the thermocouple probes be placed in the material pile, or that the probes be located or the fire suppressant applied in such a manner that liquid spray cannot impinge on the thermocouple probes.

## CONCLUSION

Pyrocap, as an extinguishing agent, was very effective in reducing the concentration of acetaldehyde and carbon dioxide emitted for the tire material pile.

The rate at which carbon monoxide was reduced was significantly greater during Pyrocap extinguishing as compared to water extinguishing. The initial reduction of carbon monoxide after extinguishing was initiated with Pyrocap was at least four times greater than the initial reduction of carbon monoxide when using water as the extinguishing agent. During all extinguishing phases, for which comparative data was available, the rate of reduction of carbon monoxide concentration was greater during Pyrocap extinguishing as compared to water extinguishing.

The concentration of particulates in the smoke plume for the Pyrocap extinguished tire fire was significantly (an order of 5 times) less than that for the water extinguishing, indicating a more completely extinguished, less smoldering, tire material pile. The smoke plume during the Pyrocap extinguishing was observed to be relatively white which is indicative of a low concentration of particulates in comparison to the dark gray to black smoke emitted during water extinguishing.

The temperature of the tire material pile was reduced much more rapidly using Pyrocap as the extinguishing agent versus water. When using Pyrocap as the extinguishing agent, the temperature of the upper part of the tire material pile was reduced to 200 degrees Fahrenheit in one-twentieth (1/20) of the time as compared to using water as the extinguishing agent. Likewise, the temperature of the lower part of the tire material pile was reduced to 200 degrees Fahrenheit in one-half (1/2) to one-tenth (1/10) the time for Pyrocap as compared to water.

**APPENDIX A**  
**EXPERIMENTAL DATA**

**TABLE A1**

**RUN #1 - WATER EXTINGUISHING**

<b>COMPOUND</b>	<b>SAMPLE 1</b>	<b>SAMPLE 2</b>	<b>SAMPLE 3</b>	<b>SAMPLE 4</b>	<b>SAMPLE 5</b>
<b>COLORIMETRIC TUBE</b>	ppm	ppm	ppm	ppm	ppm
Acetaldehyde	N/A	N/A	N/A	N/A	N/A
Ammonia	N/A	N/A	N/A	N/A	N/A
Carbon Monoxide	N/A	N/A	N/A	N/A	N/A
Carbon Monoxide (% vol of 1 liter air)					
Carbon Dioxide (% vol of 1 liter air)	N/A	N/A	N/A	N/A	N/A
Formaldehyde	N/A	N/A	N/A	N/A	N/A
Hydrogen Chloride	N/A	N/A	N/A	N/A	N/A
Hydrogen Cyanide	N/A	N/A	N/A	N/A	N/A
Hydrogen Sulfide	N/A	N/A	N/A	N/A	N/A
Methane	N/A	N/A	N/A	N/A	N/A
Nitrogen Dioxide	N/A	N/A	N/A	N/A	N/A
Nitrous Fumes	N/A	N/A	N/A	N/A	N/A
Sulfur Dioxide	N/A	N/A	N/A	N/A	N/A
<b>CANISTER (2.9 liters air)</b>	<b>% Volume</b>	<b>% Volume</b>	<b>% Volume</b>	<b>% Volume</b>	<b>% Volume</b>
Carbon Dioxide	0.06	0.25	0.16	0.12	0.13
Carbon Monoxide	<0.10	<0.10	<0.10	<0.10	<0.10
Hydrogen	<0.20	<0.20	<0.20	<0.20	<0.20
Methane	<0.10	<0.10	<0.10	<0.10	<0.10
Nitrogen	78.8	78.85	78.77	78.78	78.83
Oxygen	21.14	20.90	21.07	21.09	21.04
<b>FILTER</b>	<b>mg/l</b>	<b>mg/l</b>	<b>mg/l</b>	<b>mg/l</b>	<b>mg/l</b>
Particulates	N/A	N/A	N/A	N/A	N/A

TABLE A2

## RUN #2 - PYROCAP EXTINGUISHING

COMPOUND	SAMPLE 1	SAMPLE 2	SAMPLE 3	SAMPLE 4	SAMPLE 5
<b>COLORIMETRIC TUBE</b>	ppm	ppm	ppm	ppm	ppm
Acetaldehyde	N/A	60	50	80	40
Ammonia	N/A	2	2	0	2
Carbon Monoxide	N/A	200	90	50	50
Carbon Monoxide (% vol of 1 liter air)	N/A	0.03%	0.015%	0.01%	0.01%
Carbon Dioxide (% vol of 1 liter air)	N/A	0.35%	0.2%	0.2%	0.2%
Formaldehyde	N/A	10	2.5	2.5	1
Hydrogen Chloride	N/A	0	0	0	0
Hydrogen Cyanide	N/A	5	2.5	1	0.5
Hydrogen Sulfide	N/A	0	0	0	200
Methane	N/A	Present	Present	Not Present	Not Present
Nitrogen Dioxide	N/A	0	0	0	N/A
Nitrous Fumes	N/A	0	0	2	1
Sulfur Dioxide	N/A	10	10	15	125
<b>CANISTER (2.9 liters air)</b>	% Volume	% Volume	% Volume	% Volume	% Volume
Carbon Dioxide	7.70	0.11	0.24	0.18	0.20
Carbon Monoxide	0.42	<0.10	<0.10	<0.10	<0.10
Hydrogen	<0.20	<0.20	<0.20	<0.20	<0.20
Methane	<0.1	<0.1	<0.1	<0.1	<0.1
Nitrogen	81.28	78.81	78.81	78.83	78.87
Oxygen	10.60	21.08	20.95	20.99	21.03
<b>FILTER</b>	mg/l	mg/l	mg/l	mg/l	mg/l
Particulates	6.57	6.18	9.00	6.16	5.36

TABLE A3

## RUN #3 - WATER EXTINGUISHING

COMPOUND	SAMPLE 1	SAMPLE 2	SAMPLE 3	SAMPLE 4	SAMPLE 5
<b>COLORIMETRIC TUBE</b>	ppm	ppm	ppm	ppm	ppm
Acetaldehyde	300	250	1100	80	N/A
Ammonia	11	0	0	0	N/A
Carbon Monoxide	180	100	75	50	N/A
Carbon Monoxide (% vol of 1 liter air)	0.25%	0.015%	0.015%	0.015%	N/A
Carbon Dioxide (% vol of 1 liter air)	0.6%	0.4%	0.45%	0.35%	N/A
Formaldehyde	10	4	9	3	N/A
Hydrogen Chloride	0	0	0	0	N/A
Hydrogen Cyanide	2.5	2.5	1	0	N/A
Hydrogen Sulfide	0	0	0	50	N/A
Methane	Present	Present	Present	Present	N/A
Nitrogen Dioxide	N/A	N/A	N/A	N/A	N/A
Nitrous Fumes	1	0	0	0	N/A
Sulfur Dioxide	200	10	18	0	N/A
<b>CANISTER (2.9 liters air)</b>	% Volume	% Volume	% Volume	% Volume	% Volume
Carbon Dioxide	0.73	0.57	0.28	0.21	0.23
Carbon Monoxide	<0.10	<0.10	<0.10	<0.10	<0.10
Hydrogen	<0.20	<0.20	<0.20	<0.20	<0.20
Methane	<0.10	<0.10	<0.10	<0.10	<0.10
Nitrogen	78.96	78.91	78.86	78.79	78.91
Oxygen	20.31	20.52	20.86	21.00	20.86
<b>FILTER</b>	mg/l	mg/l	mg/l	mg/l	mg/l
Particulates	4.29	5.09	31.75	41.71	28.43



Figure 1A: Water Extinguishing (1)

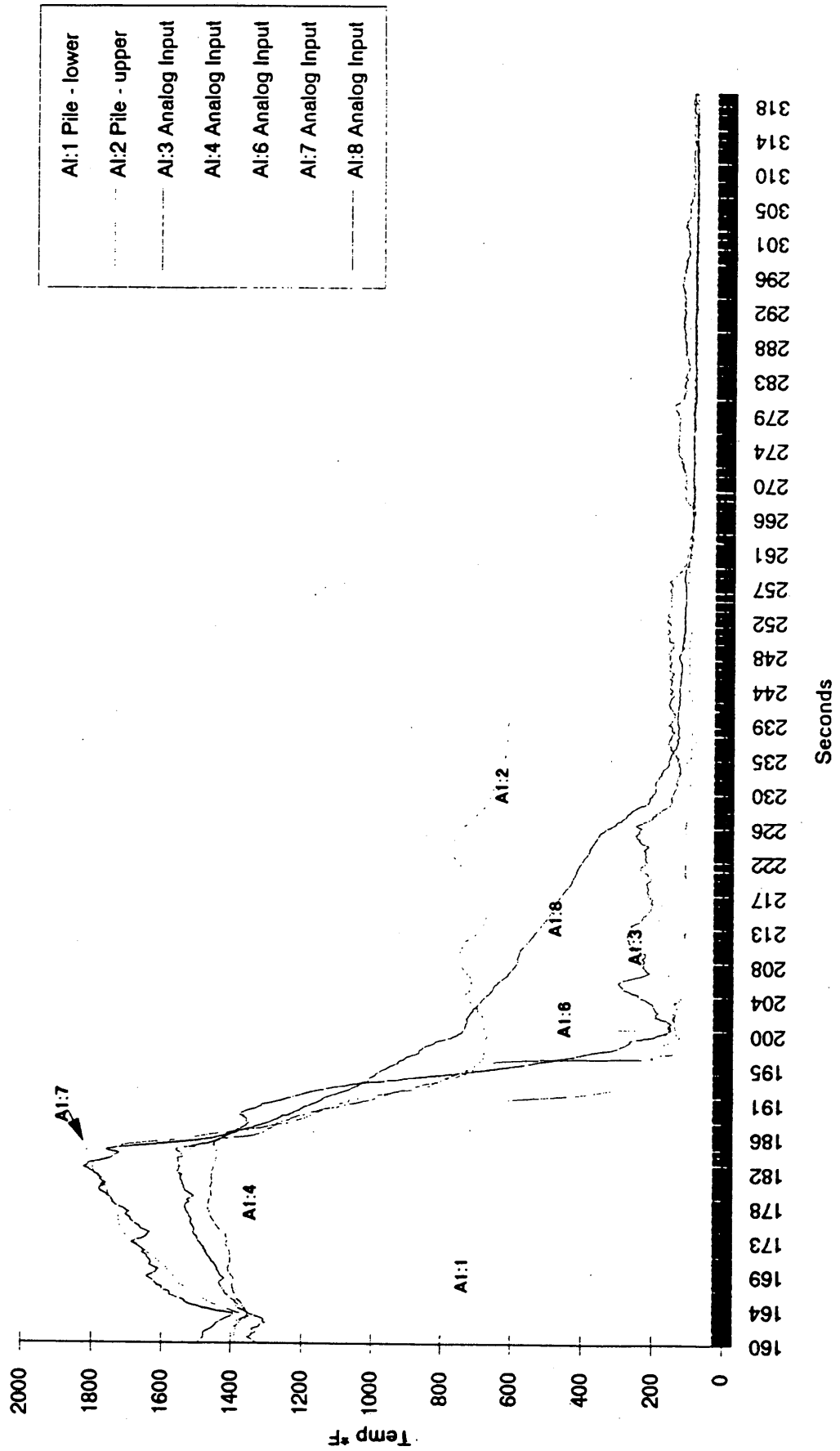



Figure 2: Pyrocap Extinguishing

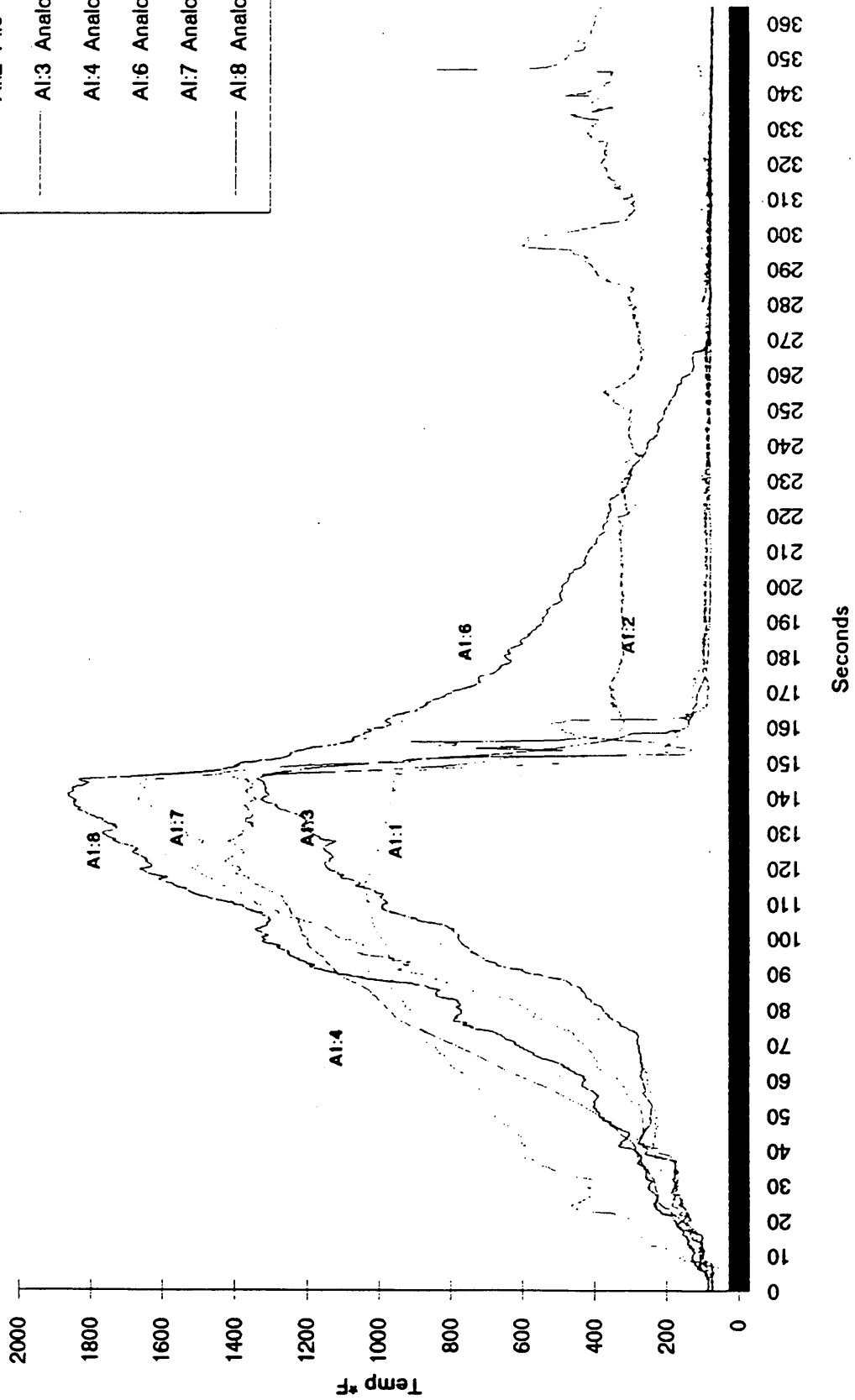

Figure 2A: Pyrocap Extinguishing

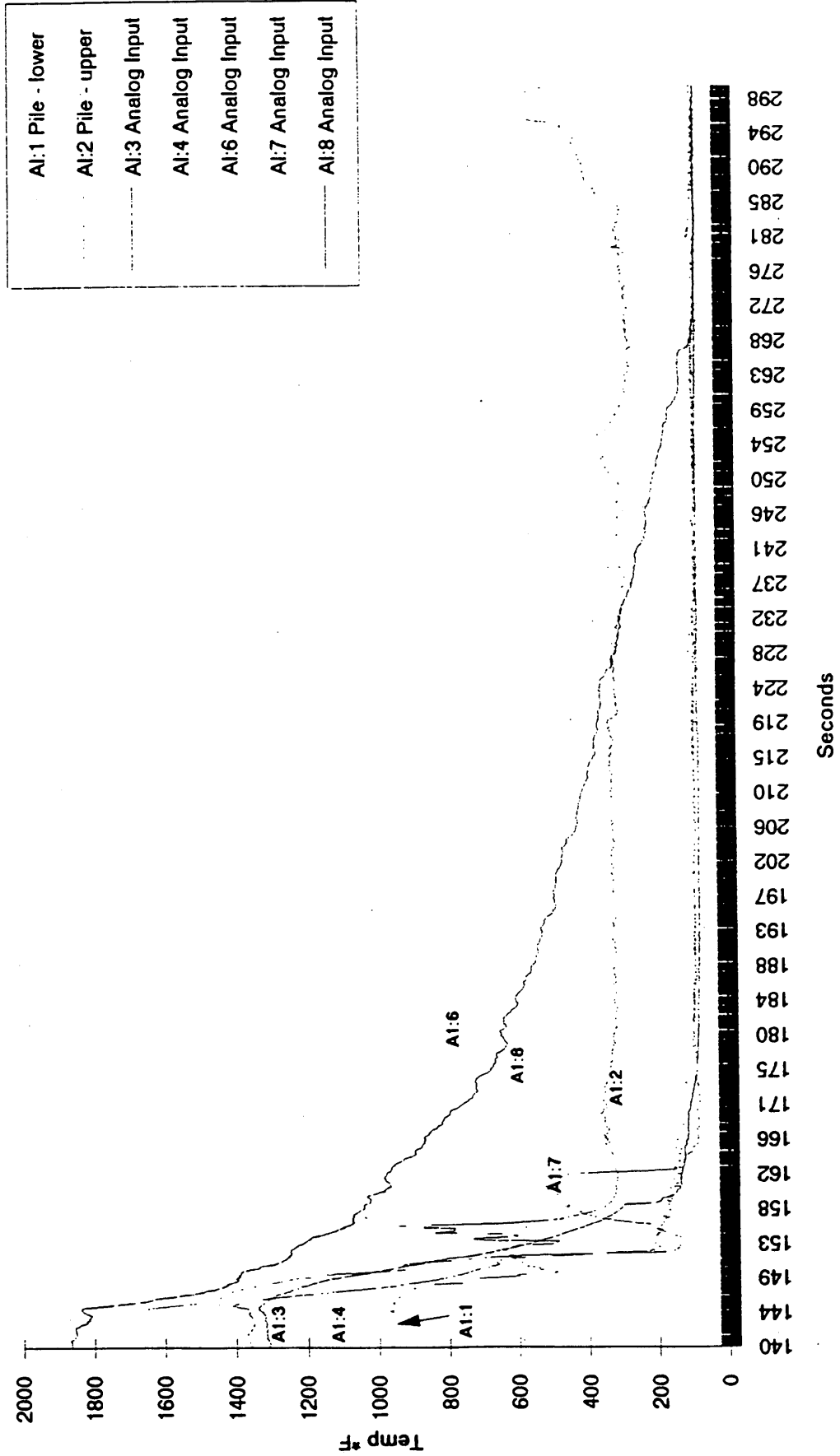
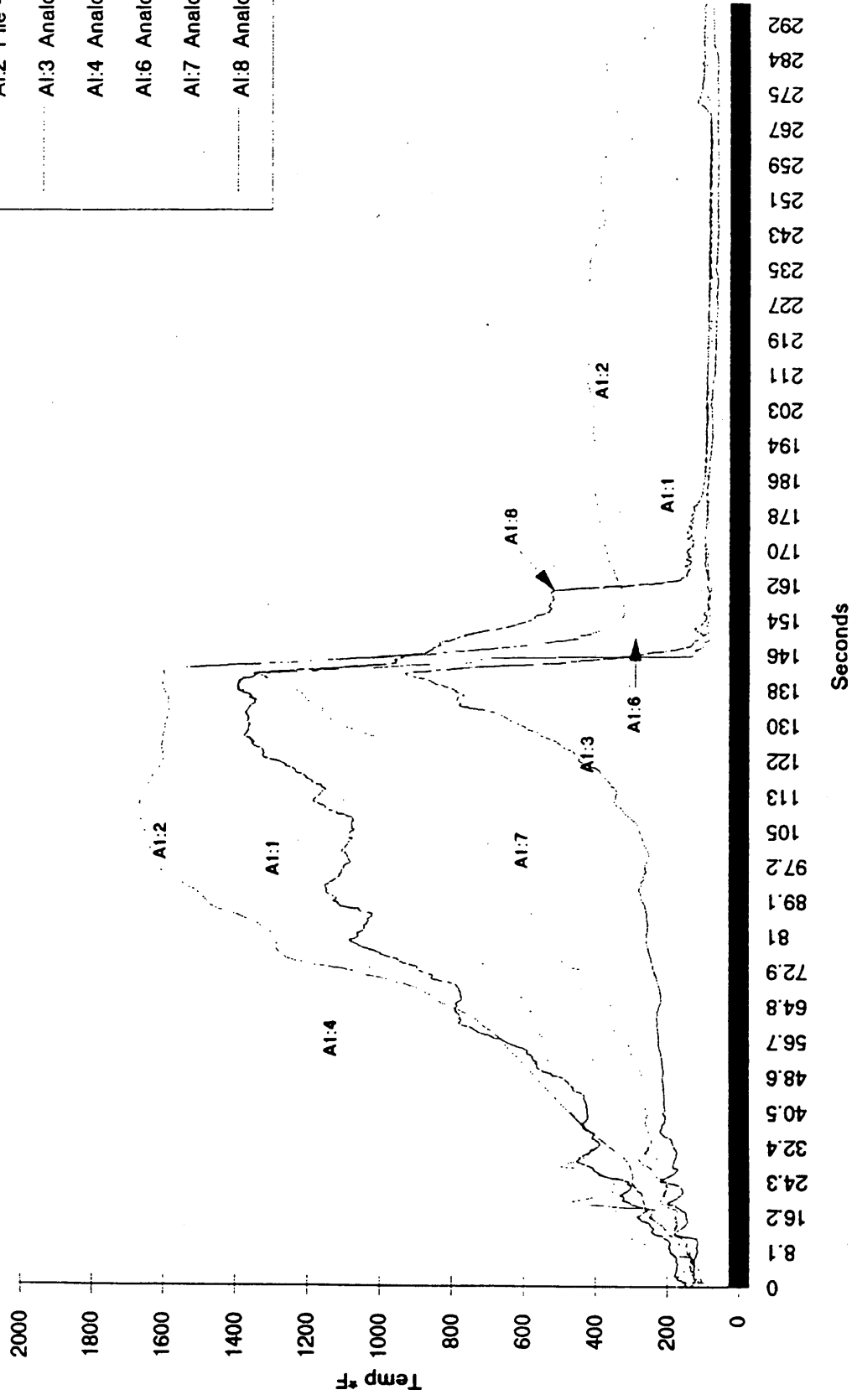

Figure 3: Water Extinguishing (2)



AI:1 Pile - lower  
 AI:2 Pile - upper  
 AI:3 Analog Input  
 AI:4 Analog Input  
 AI:6 Analog Input  
 AI:7 Analog Input  
 AI:8 Analog Input

Figure 3A: Water Extinguishing (2)

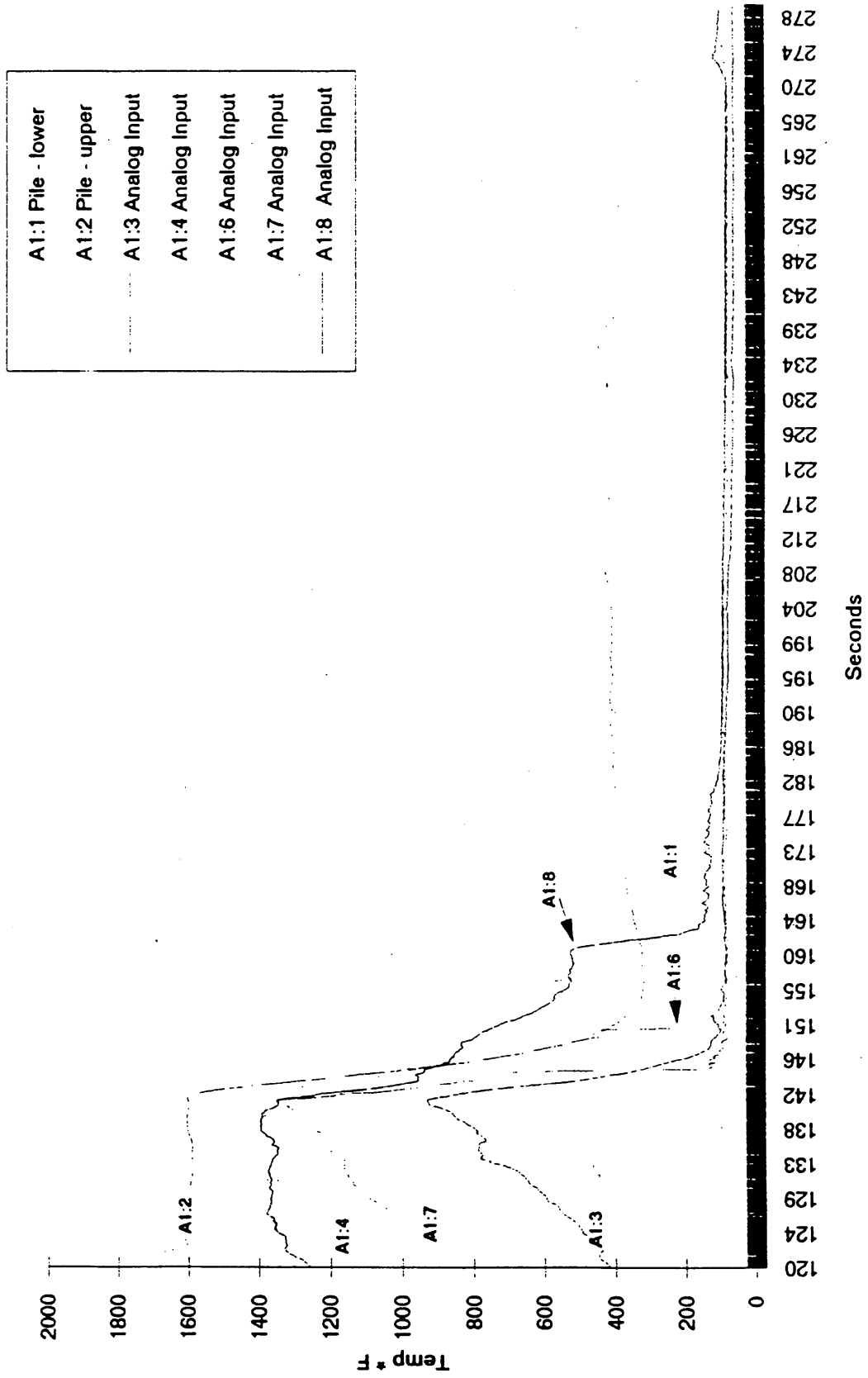

Figure 4: Thermocouple Locations

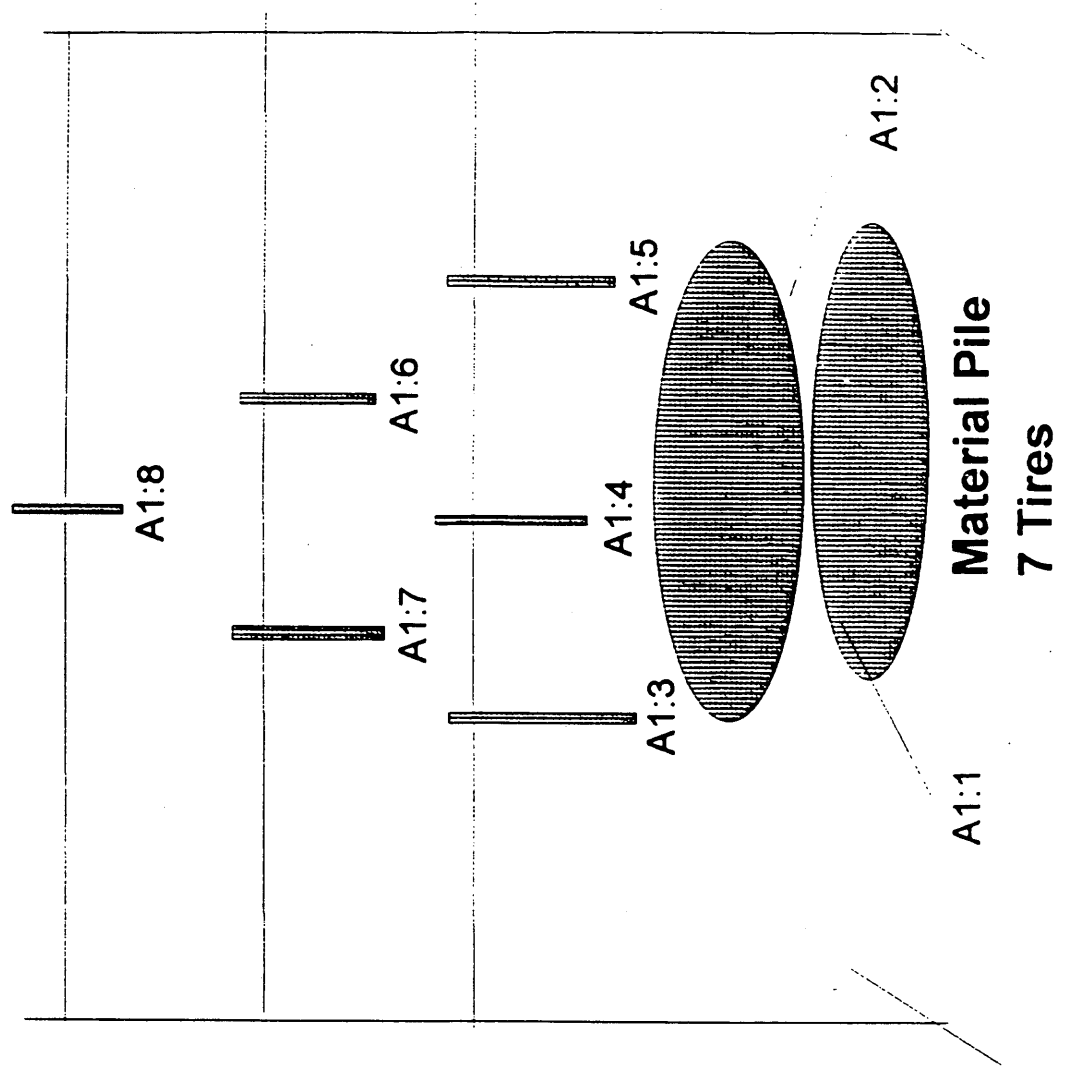
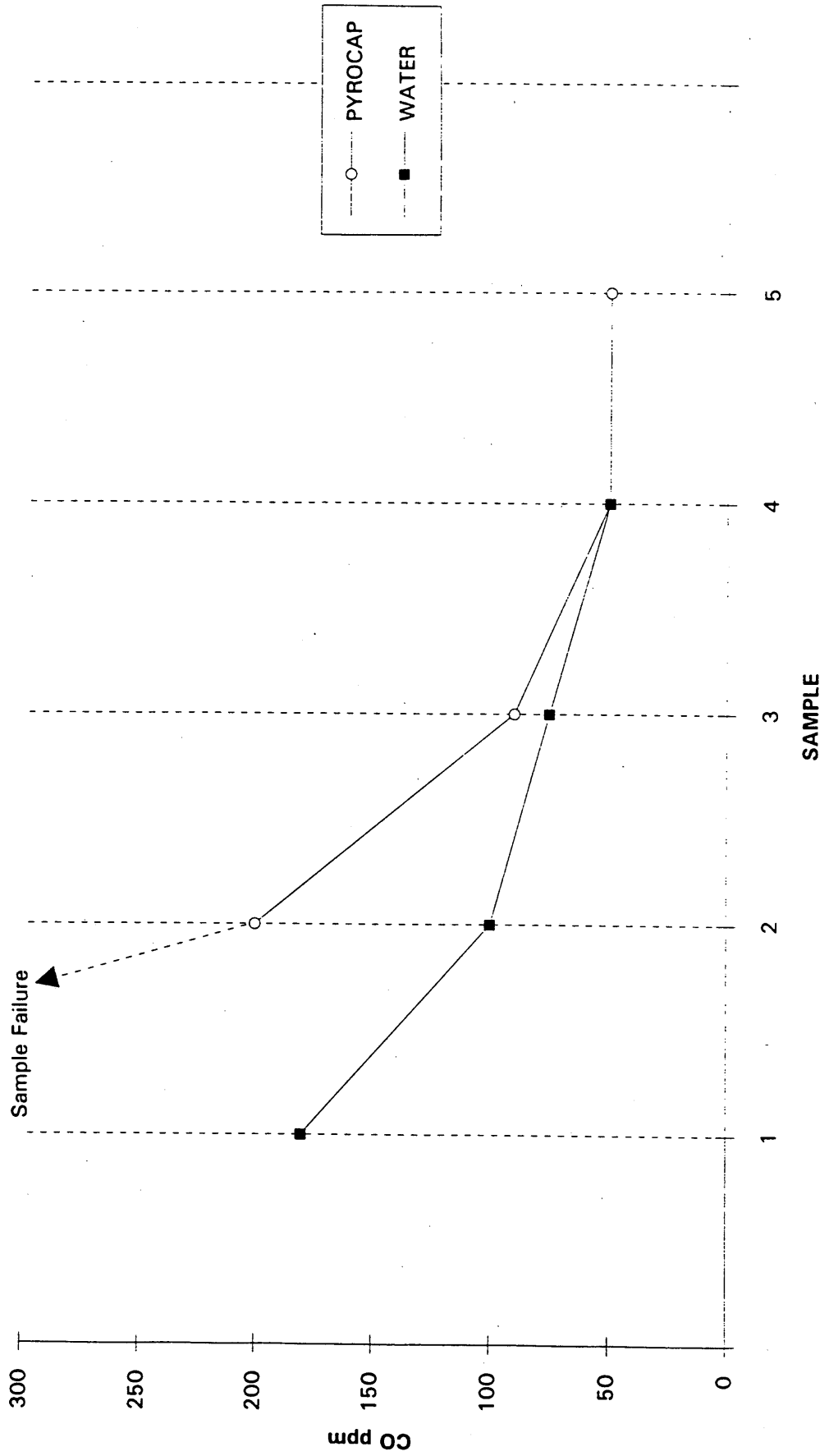

FIGURE 5: CARBON MONOXIDE CONCENTRATION



**VERSAR Inc.**

Versar Inc. is a leading multidisciplinary environmental engineering and consulting firm with a staff of over 650 professionals in 15 offices nationwide. The company has developed, for both industry and government, solutions to a wide range of environmental problems including: underground storage tank management, asbestos abatement, hazardous substance control, groundwater protection, solid waste management, wastewater treatment, and regulatory compliance.

Versar's laboratory services have been accredited and approved by numerous Federal, State, and industrial organizations, including:

- U.S. EPA Contract Laboratory Program
- National Institute of Science and Technology
- NIOSH Proficiency Analytical Program
- U.S. Army Corps of Engineers
- U.S. Fish and Wildlife Service
- California
- Illinois
- Maryland
- New Jersey
- New York
- North Carolina
- Utah
- Virginia
- American Industrial Hygiene Association
- Martin Marietta