

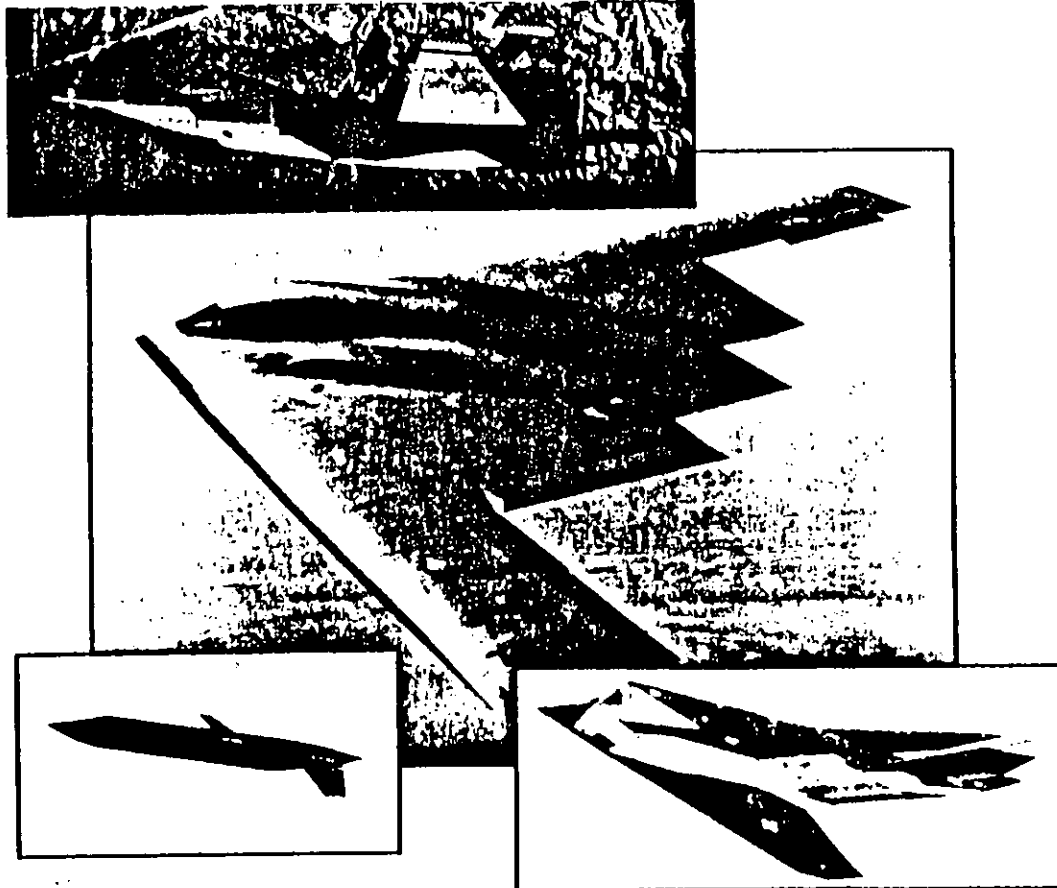

AIR FORCE STEALTH TECHNOLOGY REVIEW



10 - 14 JUNE 1991

#263
53 pp.

STEALTH WEEK BRIEF BOOK INDEX

VALUE OF STEALTH BRIEFING	TAB A
F-117 STEALTH FIGHTER	TAB B
B-2 STEALTH BOMBER	TAB C
F-22 STEALTH FIGHTER	TAB D
ADVANCED CRUISE MISSILE	TAB E

TAB A

**VALUE OF STEALTH
BRIEFING**



VALUE OF STEALTH

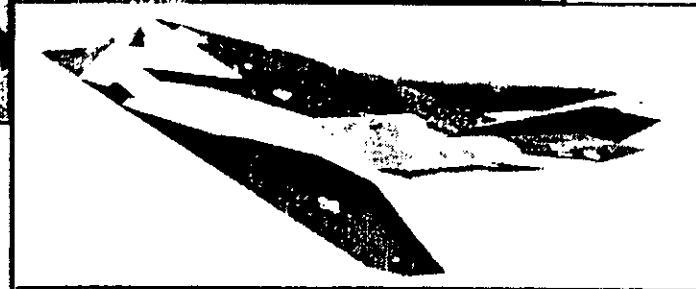
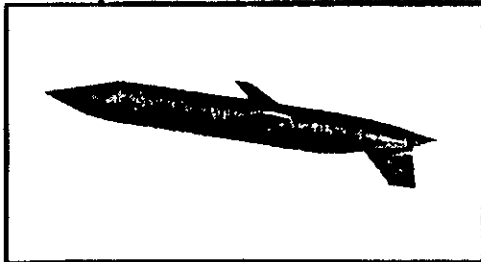
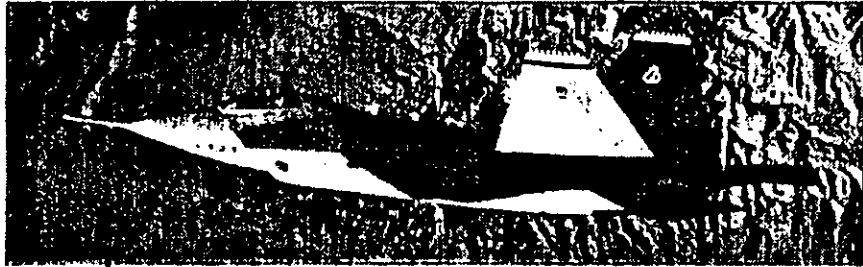



IMPACT OF TECHNOLOGY ON SURPRISE

WWI	WWII	KOREA	VIETNAM	IRAQ	?
-----	------	-------	---------	------	---

AIRCRAFT, SUBMARINES →

RADAR, SONAR →

JET ENGINE, NUCLEAR PROPULSION →

SMART BOMBS, SLCMs →

LOW OBSERVABLE PLATFORMS/SUBQUIETING →

- INITIALLY, AIRCRAFT AND SUBMARINES ENJOYED THE BENEFIT OF SURPRISE
- RADAR, SONAR, AND NEW PROPULSION TECHNIQUES CHANGED WARFARE
- LOW OBSERVABLES RESTORED THE ELEMENT OF SURPRISE FOR AIRPLANES
- SURPRISE IS PERISHABLE. OTHER COUNTRIES ARE WORKING HARD TO CATCH UP. THEREFORE, WE MUST CAPITALIZE ON OUR SIGNIFICANT INVESTMENT IN LOW OBSERVABILITY TO ENSURE A LASTING U.S. ADVANTAGE



PENETRATING BOMBER STEALTH EFFECTIVENESS

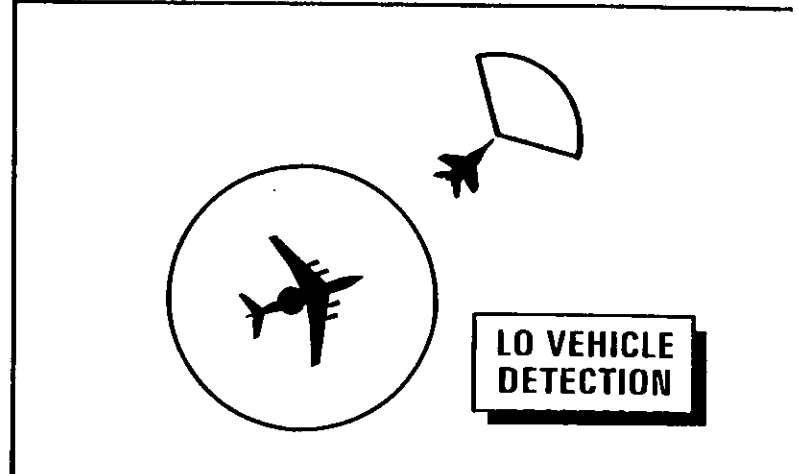
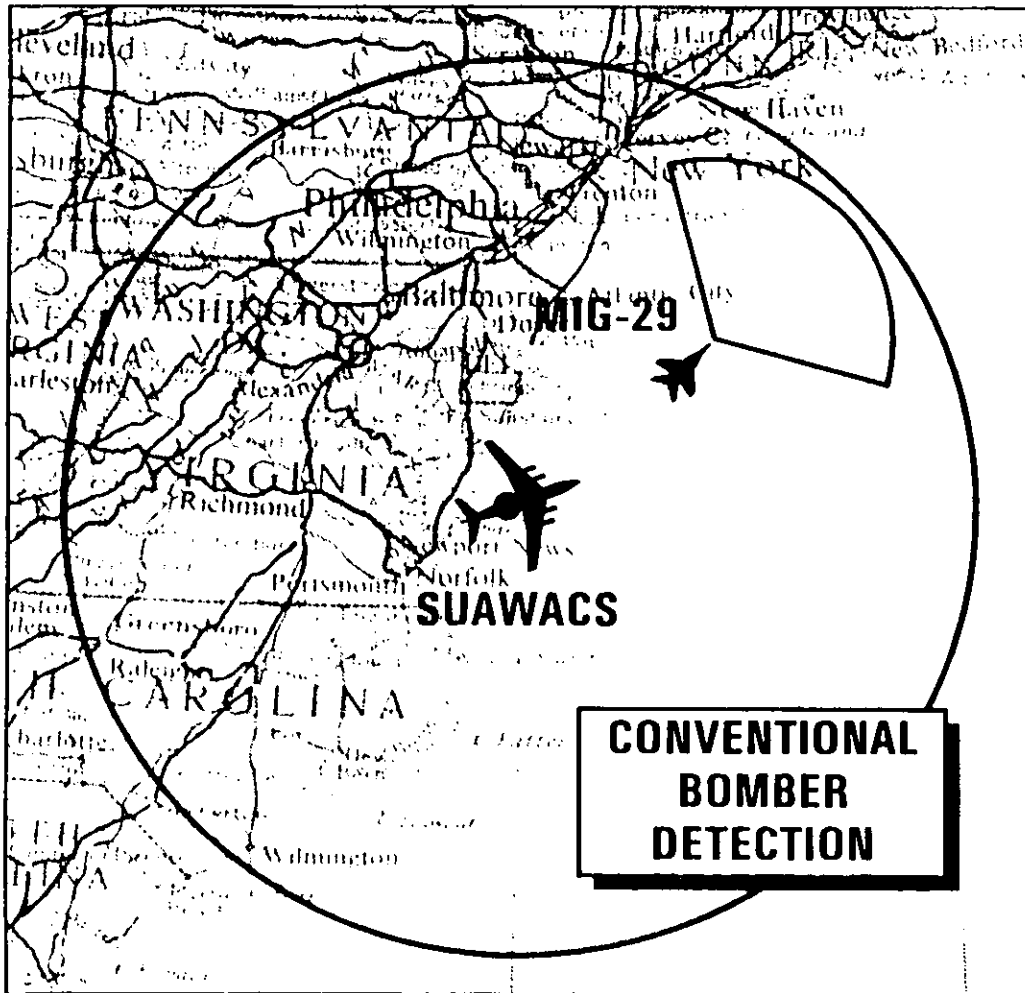

WHEN COMPARED TO CONVENTIONAL TARGETS, STEALTH GREATLY DECREASES THE EFFECTIVENESS OF OPERATIONAL RADAR SYSTEMS (e.g., SUAWACS, MIG-29)

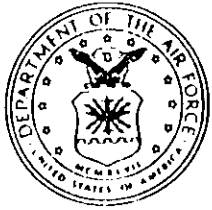

AIR-TO-AIR FIGHTER STEALTH EFFECTIVENESS

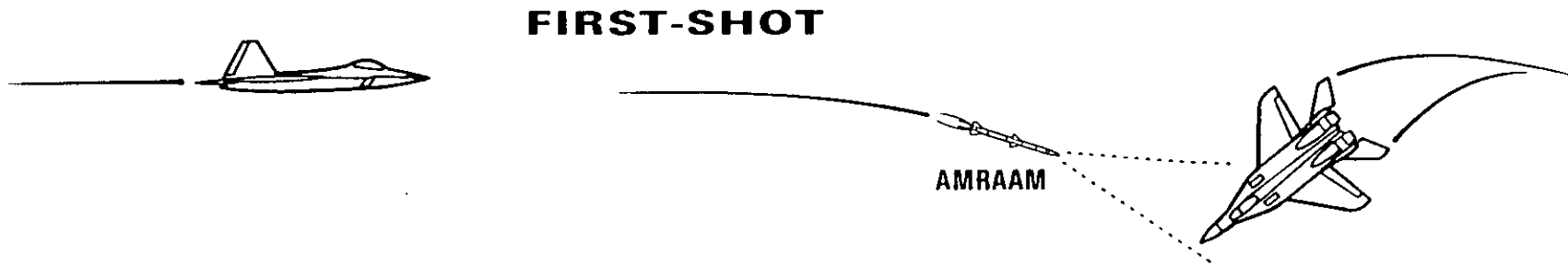
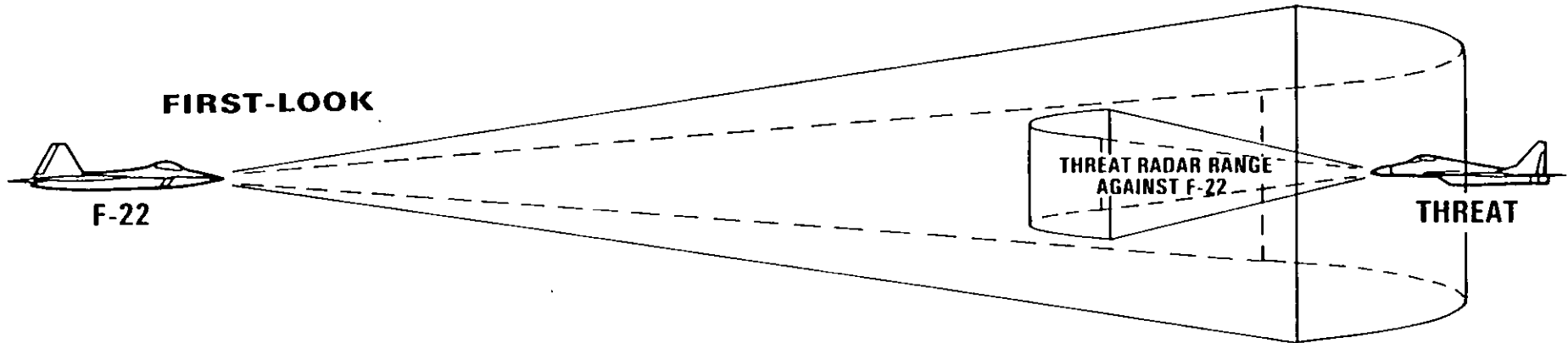



STEALTH AND SURVIVABILITY

- **LOW OBSERVABLE PLATFORMS, NOW COMBAT PROVEN, HAVE DRAMATICALLY CHANGED THE BATTLEFIELD—THEY CRIPPLE THE ENEMY'S EFFORTS TO DETECT, IDENTIFY, ENGAGE, AND DESTROY OUR FORCES**
 - ENEMY'S RETURN ON INVESTMENT IN AIR DEFENSES IS DENIED
- **RESTORE THE ELEMENT OF SURPRISE**
 - UNITED STATES CHOOSES THE TIME AND PLACE OF ATTACK
 - ENEMY CANNOT REACT EFFECTIVELY

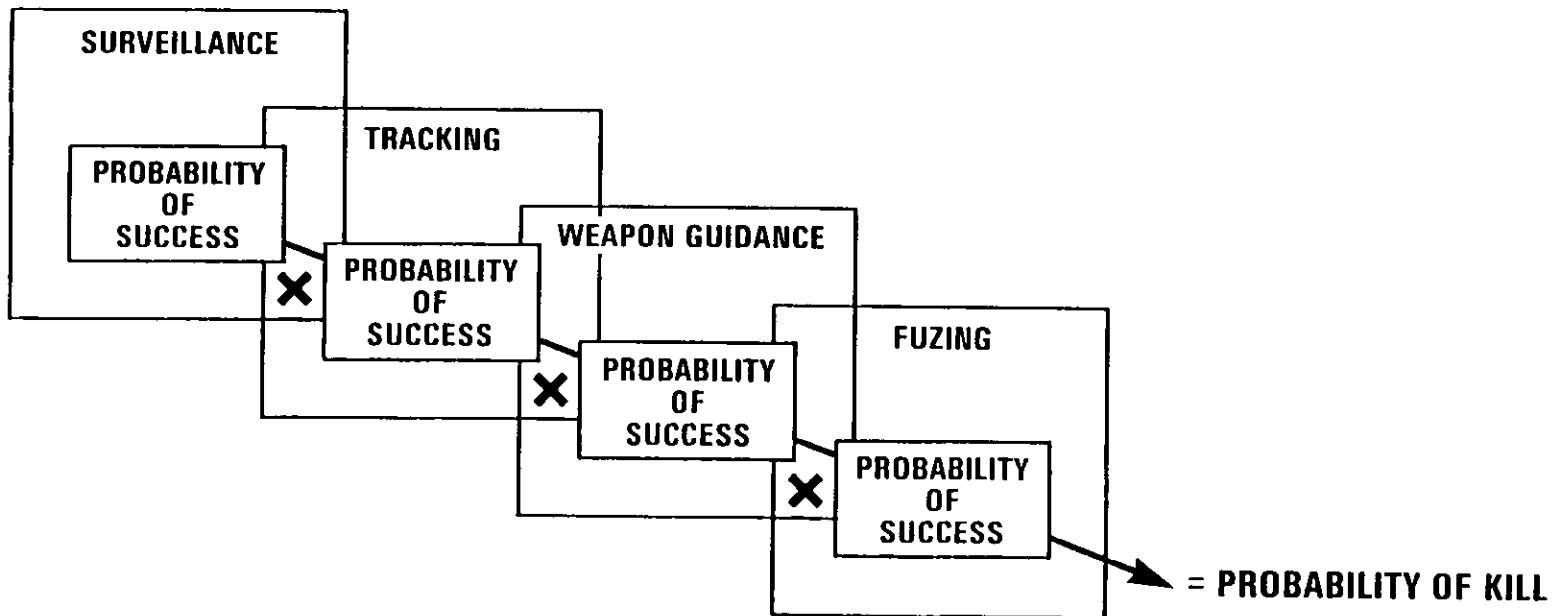

**SUCCESSFUL AIR DEFENSE IS A PROBLEM IN MULTIPLICATION:
STEALTH DRIVES THE PRODUCT TOWARDS ZERO**



The Value of Stealth

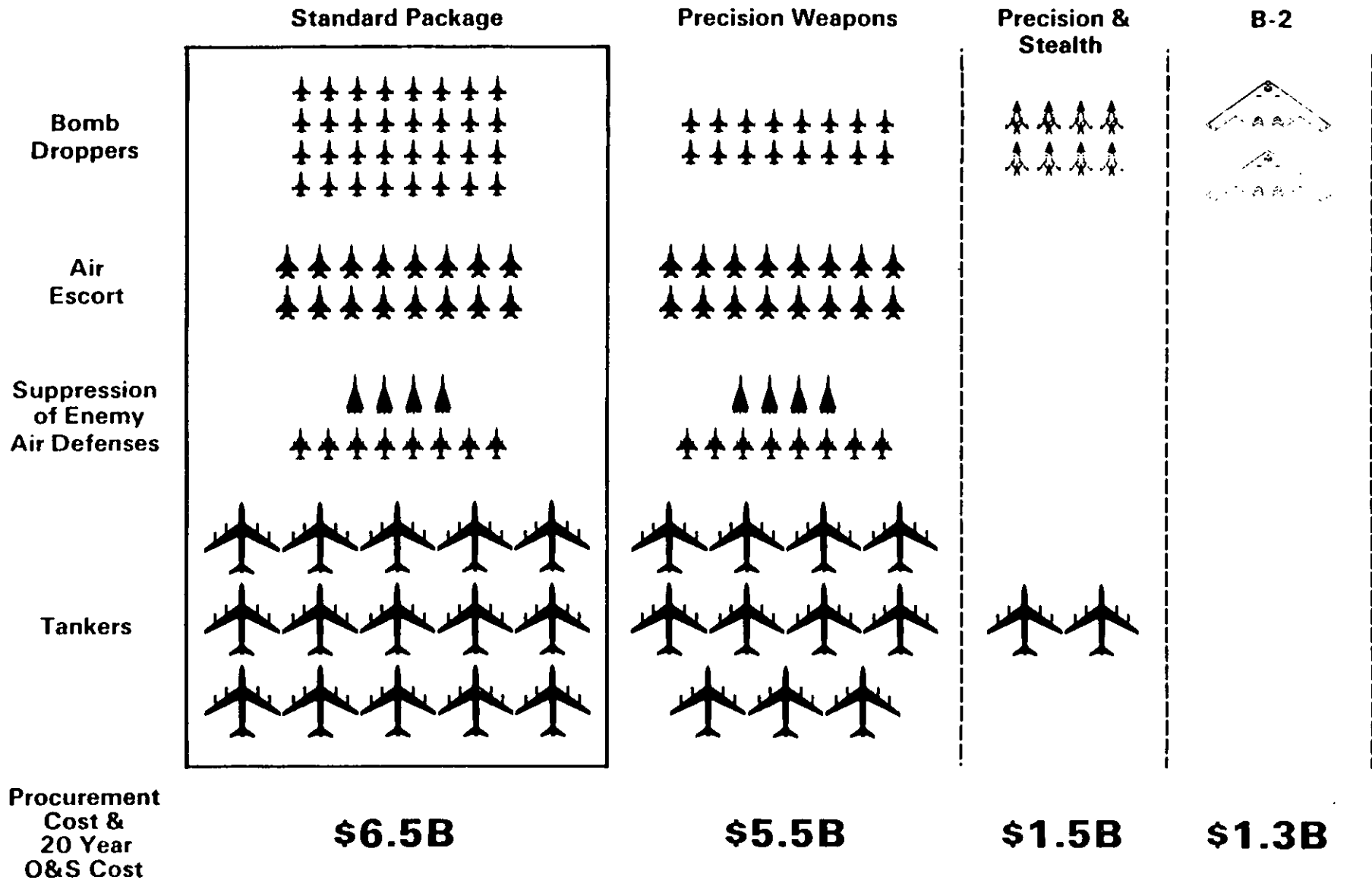



OPTIMIZATION OF STEALTH

- F-117**
 - **SECOND-GENERATION STEALTH**
 - **SIGNATURE OPTIMIZED FOR LIMITED ASPECTS**
 - **MEDIUM-ALTITUDE, NIGHT GROUND ATTACK**
 - **PENALTIES IN AERODYNAMIC AND ENGINE PERFORMANCE TO ACHIEVE A HIGH DEGREE OF STEALTH**

- ACM**
 - **THIRD-GENERATION STEALTH**
 - **FIRST SUCCESSFUL INTEGRATION OF AERODYNAMIC EFFICIENCY AND STEALTH IN A SMALL VEHICLE**

- B-2**
 - **FOURTH-GENERATION STEALTH**
 - **REVOLUTIONARY BLENDING OF STEALTH TECHNOLOGY IN LARGE AIRCRAFT WITH HIGH AERODYNAMIC EFFICIENCY AND LARGE PAYLOAD**
 - **BALANCED SIGNATURE FOR OPERATIONS AT BOTH HIGH AND LOW ALTITUDE**

- F-22**
 - **OPTIMIZED FOR AIR-TO-AIR OPERATIONS**
 - **SIGNATURE OPTIMIZED FOR A FIRST-LOOK/FIRST-KILL CAPABILITY**

COMMON DENOMINATOR ACROSS ALL STEALTH PLATFORMS IS EFFECTIVE MISSION PLANNING, WHICH GREATLY ENHANCES MISSION SURVIVABILITY.



STEALTH PAYOFF HIGH

- **STEALTHY AIRCRAFT CAN PENETRATE WITH FEWER SUPPORT ASSETS AND PRESERVE SURPRISE**
 - LESS RISK TO CREW MEMBERS
- **STEALTHY AIRCRAFT PERMIT MORE RAPID SUPPRESSION OF GROUND-BASED AIR DEFENSES**
 - ELIMINATES REQUIREMENT TO “ROLL BACK” DEFENSES
 - LESS RISK TO OUR GROUND FORCES PERSONNEL
- **STEALTH PERMITS MORE ACCURATE DELIVERY OF MUNITIONS**
 - ELIMINATES NEED FOR EVASIVE ACTIONS—PERMITS CONCENTRATION ON WEAPON DELIVERY
 - LESS RISK TO NONCOMBATANT PERSONNEL FROM COLLATERAL DAMAGE

STEALTH SAVES LIVES



VALUE OF STEALTH IN COMBAT ENVIRONMENT

- **STEALTH IS KEY ELEMENT**
 - SYNERGISTICALLY COMPLEMENTS OTHER SURVIVABILITY METHODS SUCH AS DEFENSE SUPPRESSION, STANDOFF, AND TACTICS
- **STEALTH APPLIED WHERE NEEDED**
 - PART OF OVERALL FORCE PACKAGE OPTIMIZED TO SUIT AIRCRAFT/MISSION

**STEALTH ALLOWS US TO MORE EFFECTIVELY
USE ALL COMBAT RESOURCES**

TAB B

F-117 STEALTH FIGHTER



F-117 STEALTH FIGHTER

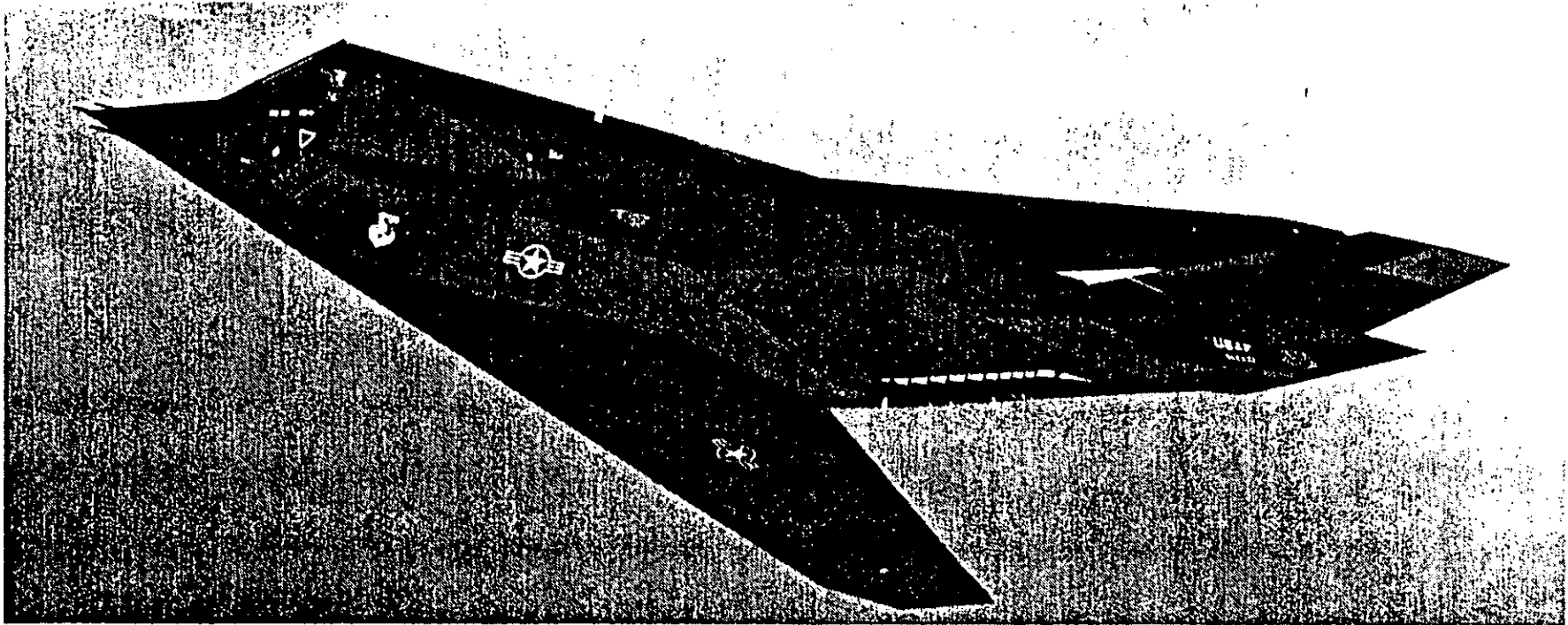

COMBAT-PROVEN STEALTH



F-117A CHARACTERISTICS

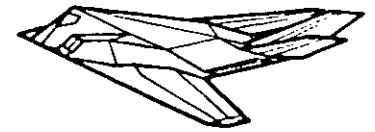

F-117A
Stealth Fighter

- **MAX GROSS WEIGHT: 52,500 LB**
- **SPEED: HIGH SUBSONIC**
- **CREW: ONE**
- **UNREFUELED RADIUS: 600 NM**
- **ARMAMENT: TWO 2,000-LB LASER GUIDED/CONVENTIONAL BOMBS; NUCLEAR CAPABLE**
- **ENGINES: TWO NONAFTERBURNING GE F-404 TURBOFAN ENGINES**

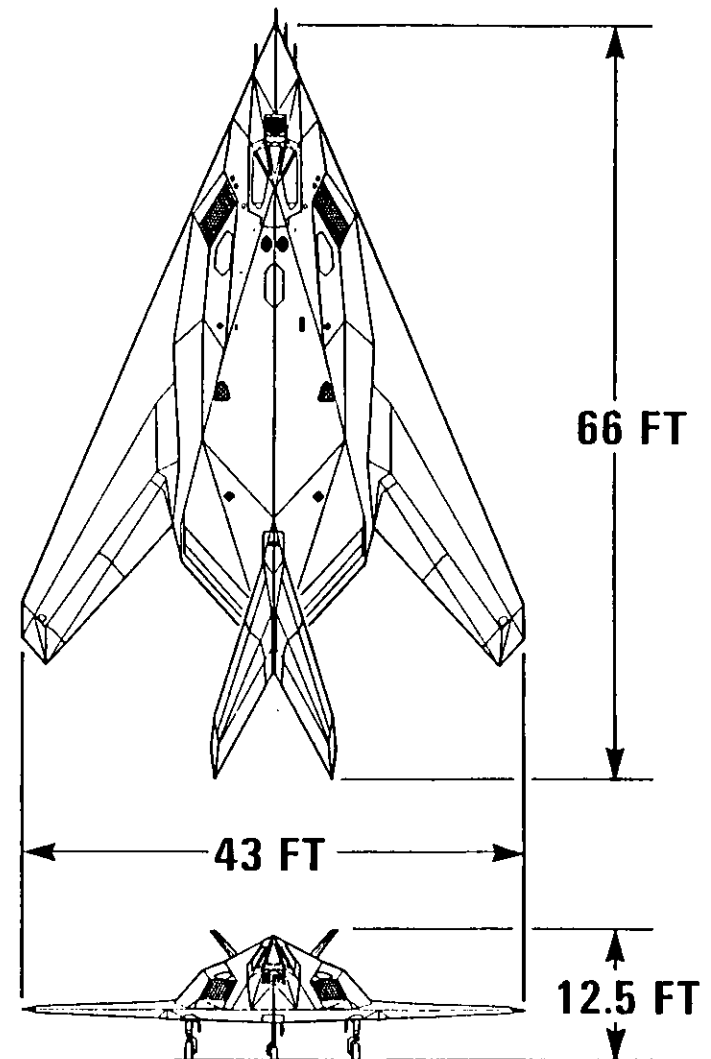



F-117 MISSION

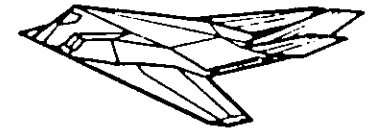

F-117A
Stealth Fighter

- **THE F-117A STEALTH FIGHTER IS THE FIRST OPERATIONAL AIRCRAFT CONCEIVED TO EXPLOIT LOW OBSERVABLE STEALTH TECHNOLOGY**
- **THIS SINGLE-SEAT FIGHTER IS DESIGNED TO PENETRATE DENSE THREAT ENVIRONMENTS AND ATTACK HIGH-VALUE TARGETS WITH PINPOINT ACCURACY**



F-117 PROGRAM

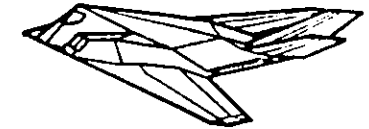

F-117A
Stealth Fighter

-
- **FIRST FLIGHT
(31 MONTHS AFTER FSD
CONTRACT AWARD)** JUN 1981
 - **FIRST AIRCRAFT DELIVERIES** 1982
 - **INITIAL OPERATIONAL CAPABILITY** OCT 1983
 - **LAST AIRCRAFT DELIVERY** JUN 1990
 - **TOTAL AIRCRAFT BUY** 59
 - **AIRCRAFT LOST TO PEACETIME
ACCIDENTS** 3
 - **FIRST COMBAT OPERATION** JUST CAUSE (DEC 1989)
 - **UNIT FLYAWAY COST** \$52.5 MILLION (FY 91\$)
 - **TOTAL PROGRAM COST** \$8.2 BILLION (FY 91\$)



F-117 FACT SHEET DESERT STORM

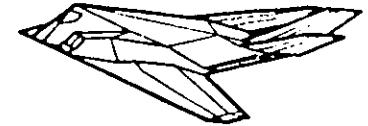

F-117A
Stealth Fighter

F-117s DEPLOYED:	42
TOTAL COMBAT SORTIES:	OVER 1,270
TONS OF BOMBS DROPPED:	OVER 2,000
NUMBER OF COMBAT HOURS:	OVER 6,900
MISSION CAPABLE RATE:	OVER 85%

**WHILE F-117s FLEW ONLY 2% OF TOTAL COMBAT SORTIES,
THEY COVERED APPROXIMATELY 40% OF THE STRATEGIC
TARGETS—ONLY SYSTEM TO FLY DOWNTOWN BAGHDAD IN
“TEETH” OF DEFENSES**

TAB C

B-2 STEALTH BOMBER



B-2 STEALTH BOMBER

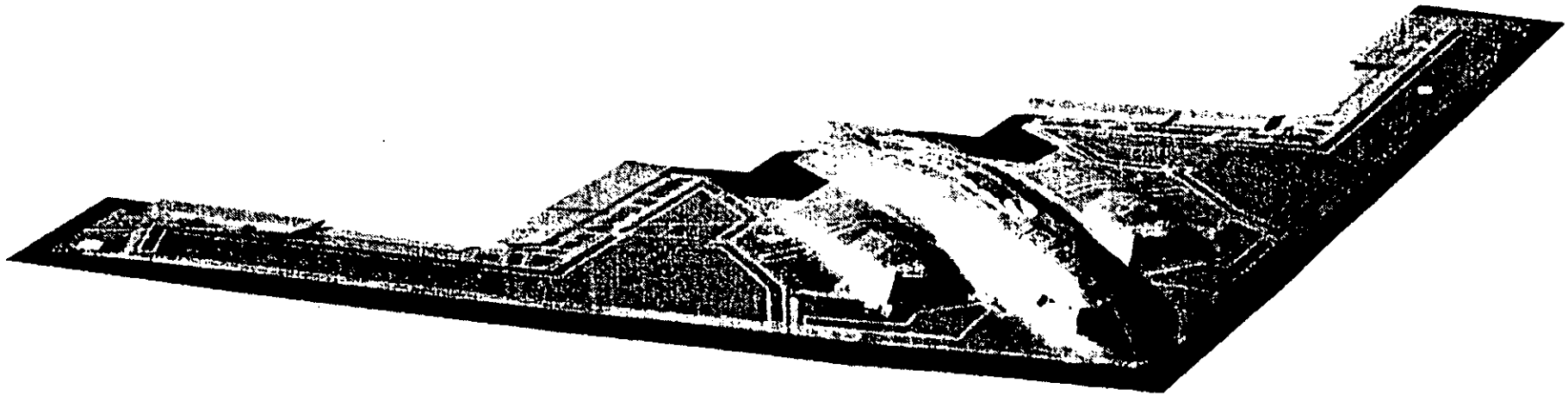

**GLOBAL REACH-GLOBAL POWER
FOR THE 21ST CENTURY**



B-2 CHARACTERISTICS



B-2
Stealth Bomber

- LARGE NUCLEAR OR CONVENTIONAL PAYLOAD
- PENETRATION SPEED: HIGH SUBSONIC
- ALTITUDE: UP TO 50,000 FEET
- UNREFUELED RANGE:
6,000 NM +
- HIGH RELIABILITY

ALL FEATURES DESIGNED TO MINIMIZE
OBSERVABLE, RADAR, INFRARED,
VISUAL, AND ACOUSTIC SIGNATURES

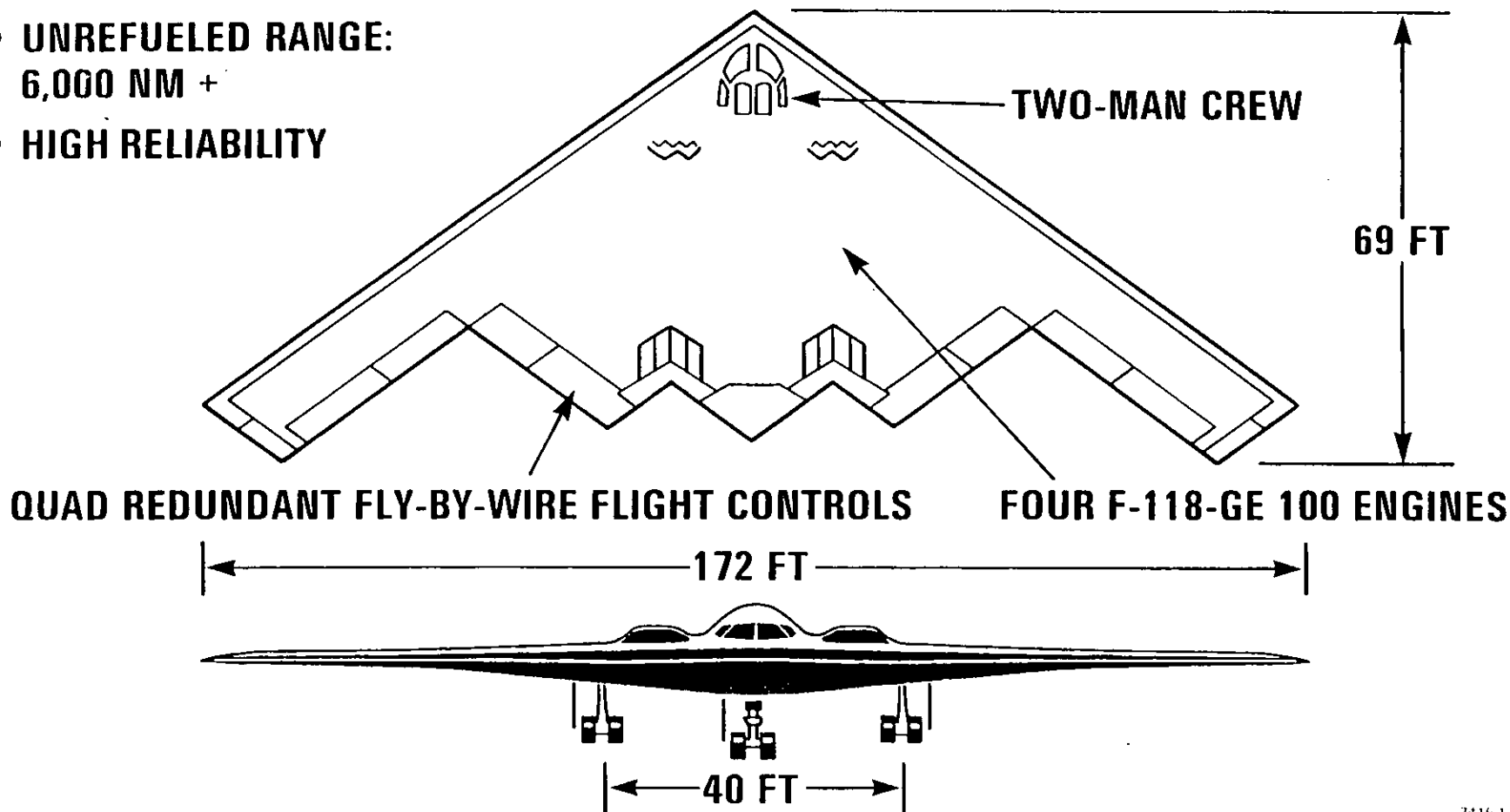



THE ORIGINAL B-2 MISSION STATEMENT



B-2
Stealth Bomber

“MISSION: THE ADVANCED STRATEGIC PENETRATING AIRCRAFT (ASPA) SHALL PROVIDE THE CAPABILITY TO CONDUCT MISSIONS ACROSS THE SPECTRUM OF CONFLICT, INCLUDING GENERAL NUCLEAR WAR, CONVENTIONAL CONFLICT, AND PEACETIME/CRISIS SITUATIONS.”

IN 1981 THE B-2 WAS KNOWN AS THE ASPA. THE NAME HAS CHANGED, BUT THE MISSION REMAINS THE SAME



Nuclear Deterrence

Our Number One Priority



B-2 Stealth Bomber

- **DETERRENCE HAS PROVIDED THE FOUNDATION FOR U.S. MILITARY STRATEGY FOR OVER 40 YEARS**

- **SOVIET UNION REMAINS THE ONLY NATION THAT CAN DESTROY THE U.S. – WITHIN 30 MINUTES**
 - **THE POTENTIAL FOR NUCLEAR EXCHANGE IS AT ITS LOWEST POINT IN 40 YEARS, HOWEVER...**
 - **THE CONSEQUENCES OF FAILURE TO DETER ARE UNACCEPTABLE**
 - **SOVIETS CONTINUE MODERNIZING THEIR OFFENSIVE AND DEFENSIVE FORCES**

- **THE TRIAD IS A TIME-PROVEN HEDGE AGAINST SOVIET TECHNOLOGICAL BREAKTHROUGHS AND U.S. SYSTEM FAILURES**

OUR REDUNDANT FORCES ARE A HIGH-VALUE INSURANCE POLICY



The Balanced Triad



B-2 Stealth Bomber

STRATEGIC TRIAD

ICBMs

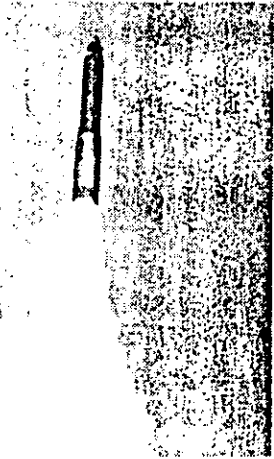

- Use when deterrence fails
- Low O&S cost
- High day-to-day alert
- Immediate response
- No recall
- No recycle
- No conventional use

BOMBERS

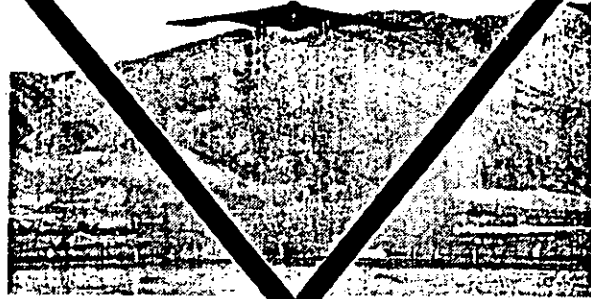

- Demonstrates resolve in crisis before deterrence fails
 - Most stabilizing
- Relieves decision time pressure
- Man-in-loop
- Most efficient weapon delivery
- Survivable
- Recallable
- Reuseable
- Rapid global conventional capability
- Proven in combat

SLBMs

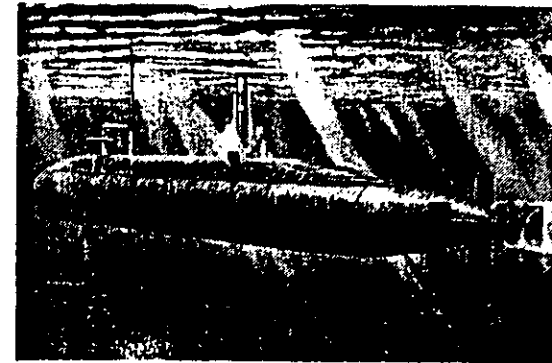

- Use when deterrence fails
- Survivable
- Low cost/warhead
- Prompt response
- No recall
- No recycle
- No conventional use

Each President Has Requested More Options



B-2: The Next Generation Stealth



B-2 Stealth Bomber

IF YOU LIKE THE F-117, WAIT TILL YOU SEE THE B-2

PRECISION & STEALTH

B-2

**BOMB
DROPPERS**



TANKERS



*** COST (FY91\$)**

\$1.5B

\$1.3B

- **BALANCED LOW OBSERVABLE DESIGN**
- **HIGH AND LOW ALTITUDE OPERATION**
- **LONGER RANGE WITH GREATER PAYLOAD**
- **TERRAIN FOLLOWING RADAR**
- **FAR LESS TANKER SUPPORT**

GREATER OPERATIONAL UTILITY

* Procurement and 20 year operations and support



B-2 Conventional Capability

Worldwide Force Projection Capability



B-2 Stealth Bomber

- 40,000 LB PAYLOAD + ONE REFUELING COVERS GLOBAL LANDMASS

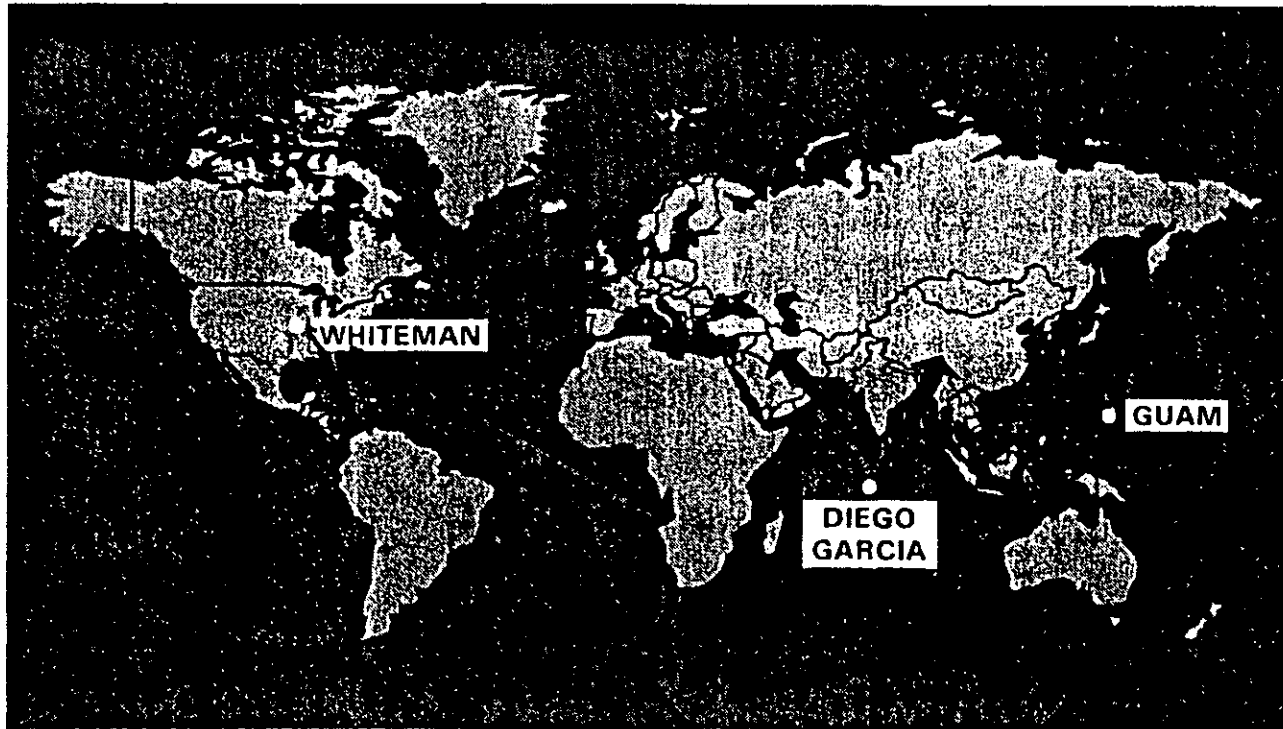

**B-2 CAN HOLD VIRTUALLY EVERY TARGET
IN THE WORLD AT RISK WITHIN 24 HOURS**



Cost Effective Force Multiplier



B-2 Stealth Bomber

- THE VALUE OF A B-2 WILL BE ITS ENDURING CONTRIBUTION TO NATIONAL SECURITY FOR MANY YEARS
- THE B-2 LEVERAGES OUR UP-FRONT INVESTMENT IN STEALTH TECHNOLOGY
- IN AN AUSTERE BUDGET ENVIRONMENT, THE B-2 WILL BE THE CENTERPIECE OF A SMALLER, MORE CAPABLE FORCE

Commitment to date

\$30.8B (TY\$)

With Termination Cost
(15 A/C - THEN STOP)

\$36.4B (TY\$)

Additional Cost to go

\$28.4B (TY\$)

"WE HAVE INVESTED A HUGE AMOUNT IN THE B-2 ALREADY. WE ARE AT THE STAGE NOW WHERE WE CAN BEGIN TO REAP THE BENEFITS OF THAT INVESTMENT AND WE WANT TO GO FORWARD WITH THE 75 PLANES."

SECRETARY OF DEFENSE



Test Reports



B-2 Stealth Bomber

Block I Testing: Initial Performance Testing

"...from the data available, nothing we have seen would conflict with the expectations that the B-2 should provide a significant capability in range and payload performance and will essentially negate the large investments the Soviets have made in air defense."

Defense Science Board, 20 Jan 1990

"...In general, the B-2 has performed equal to or better than predicted in the areas of performance and flying qualities."

OSD/DOT&E, 11 Jun 1990

Block II Testing: Initial Low Observable Testing

"Based on flight test results to date, there are no indications that basic B-2 aircraft survivability is in jeopardy."
OSD/DOT&E, 25 Feb 1991

"...we found no substantive signature surprises. Based on our review of the test results, we see nothing that would lead us to believe that the B-2 will not be the highly survivable aircraft intended at the start of this important program."

Defense Science Board, 20 Feb 1991

"The early Block 2 flight tests were responsive to the 1991 full performance matrix requirement of taking early measurements of the radar signature. The test objectives were to provide a preliminary assessment of the radar signature for the first B-2 at selected frequencies intended to be representative of threat radars."

General Accounting Office, 15 Apr 1991

"Flight tests for the second B-2 adequately demonstrated some basic flight characteristics beyond those accomplished in Block 1 testing. The tests also demonstrated that new flight control software corrected flight stability problems identified in Block 1 testing."

General Accounting Office, 15 Apr 1991



B-2 PROGRAM

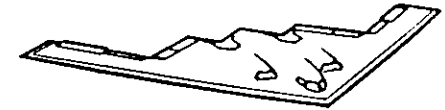

B-2
Stealth Bomber

● PROGRAM INITIATION	1981
● FULL SCALE DEVELOPMENT	1983
● LOW RATE PRODUCTION	1987
● FIRST FLIGHT	1989
● FIRST SAC DELIVERY	1993
● TOTAL AIRCRAFT BUY	75 AIRCRAFT; 2 WINGS
● UNIT FLYAWAY COST	\$437.4 MILLION (FY 91\$)
● TOTAL PROGRAM COST	\$60.8 BILLION (FY 91\$)
—COMMITMENT TO DATE	\$33.2 BILLION (FY 91\$)



B-2 Program Schedule



B-2 Stealth Bomber

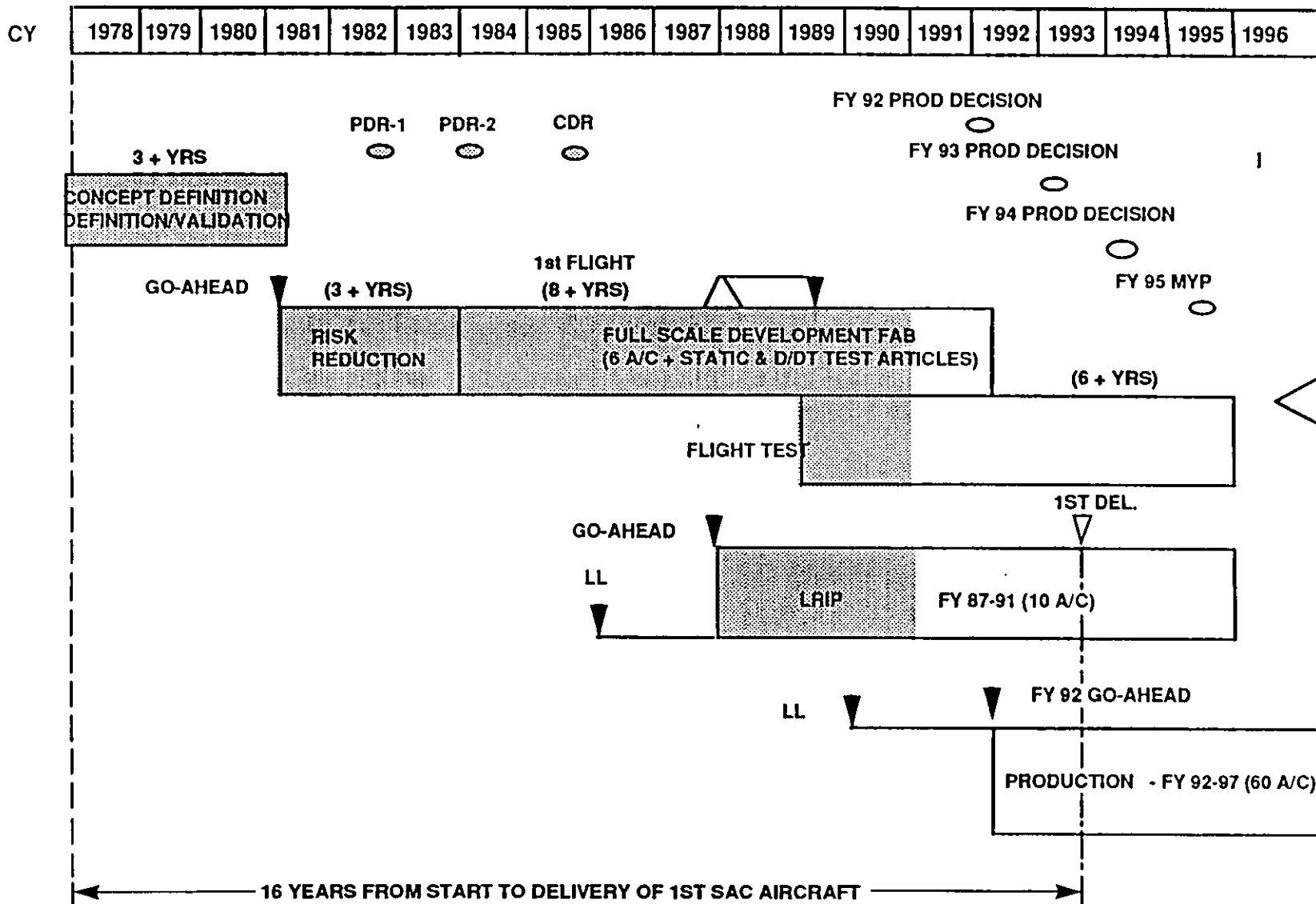



WHY B-2?



B-2
Stealth Bomber

- **MULTIROLE CAPABILITY**
 - NUCLEAR DETERRENCE—OUR NUMBER ONE PRIORITY
 - CONVENTIONAL WARFIGHTING—COMBINES F-117's SURVIVABILITY WITH RANGE/PAYLOAD OF THE B-52
- **STEALTH PAYOFF HIGH**
 - LESS RISK TO CREW MEMBERS; MORE ACCURATE DELIVERY OF MUNITIONS
- **SUCCESSFUL TEST PROGRAM DEMONSTRATES B-2 WORKS**
 - RESULTS CERTIFIED BY DEFENSE SCIENCE BOARD, INDEPENDENT TESTERS AND GAO
- **TIME IS RIGHT TO CAPITALIZE ON OUR INVESTMENT AND OUR SUCCESS**

TAB D

F-22 STEALTH FIGHTER



F-22 STEALTH FIGHTER

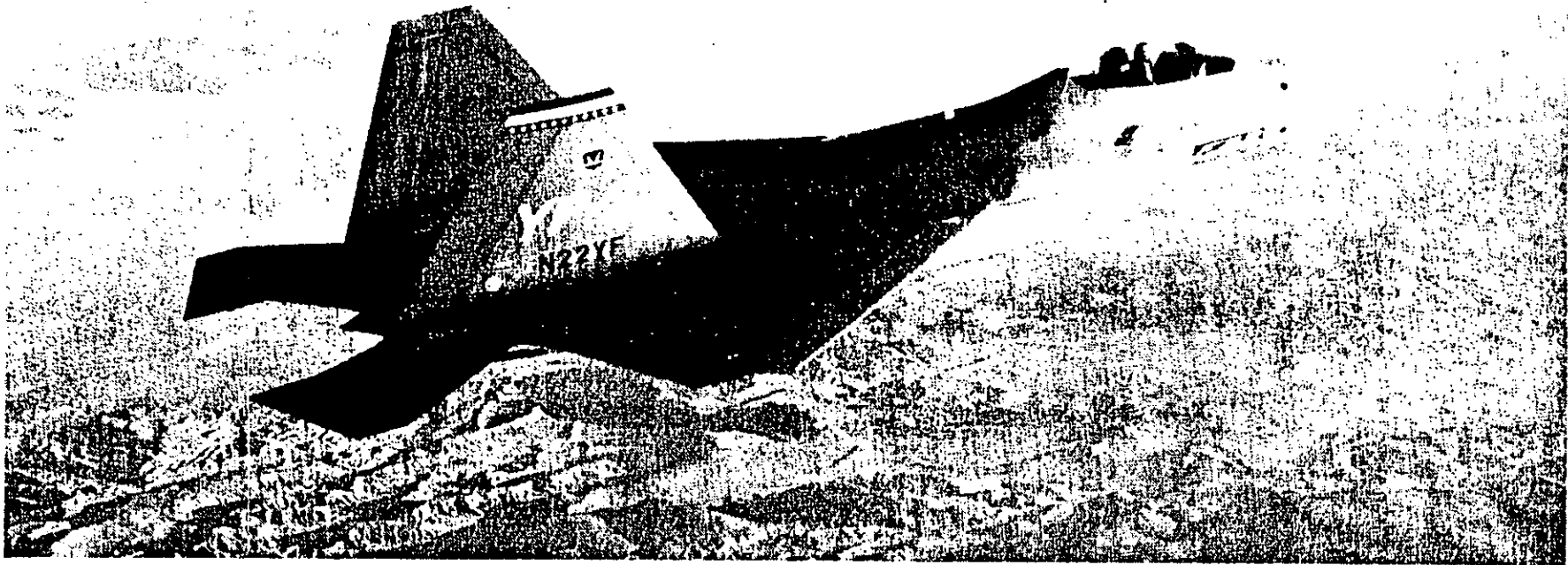

AIR SUPERIORITY FOR THE 21ST CENTURY



F-22 CHARACTERISTICS

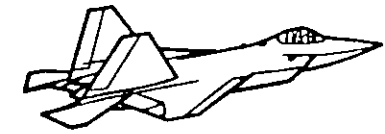

F-22
Stealth Fighter

- **LOW OBSERVABLE/HIGHLY MANEUVERABLE AIRFRAME**
- **LONG RADIUS OF ACTION WITH EXCELLENT PAYLOAD**
- **MACH NUMBER: 1.8 MACH+**
- **SUPERCruise IN MILITARY POWER: 1.4 MACH+**
- **ALTITUDE: 50,000 FEET**
- **HIGHLY RELIABLE INTEGRATED AVIONICS**
- **CREW: ONE**
- **ENGINES: TWO F119-PW-100**
- **ARMAMENT: AIM-9 SIDEWINDER
AIM-120 AMRAAM
20MM GATLING GUN**

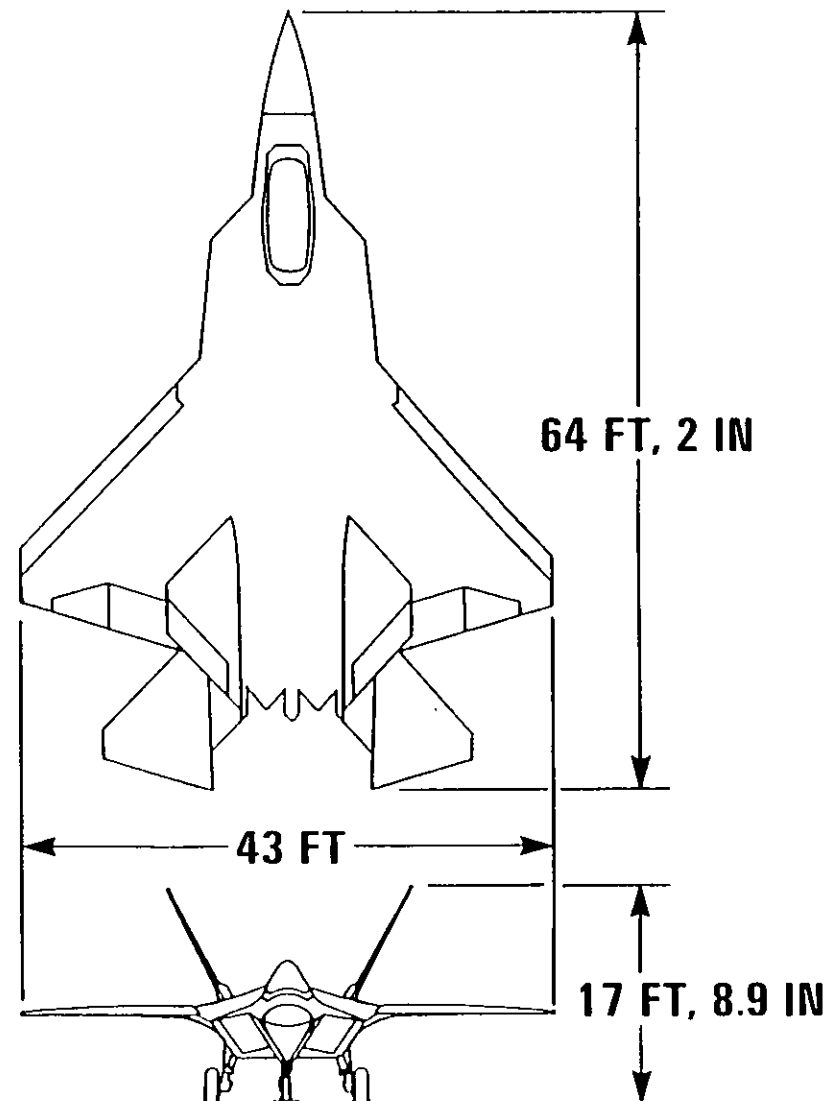



F-22 MISSION

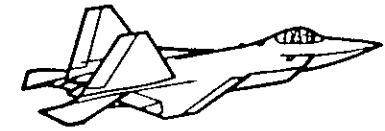

F-22
Stealth Fighter

FIRST-LOOK FIRST-SHOT FIRST-KILL

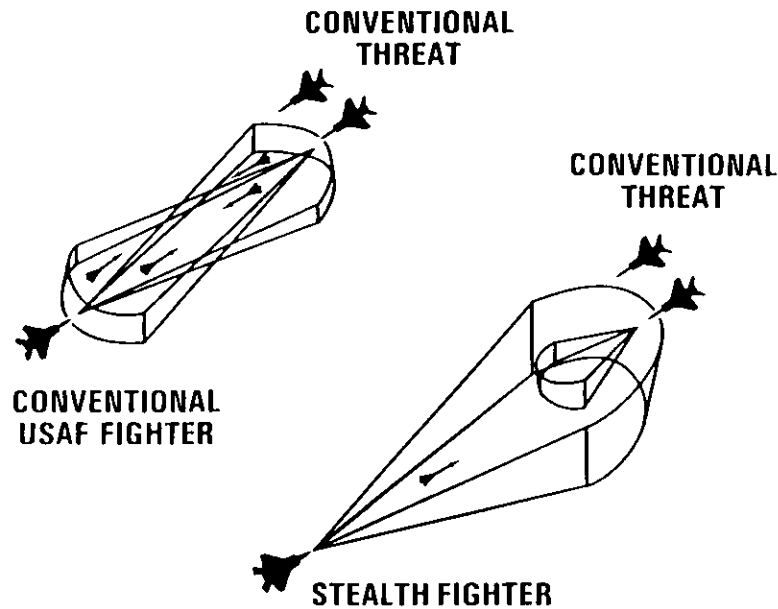

AIR SUPERIORITY FIGHTERS

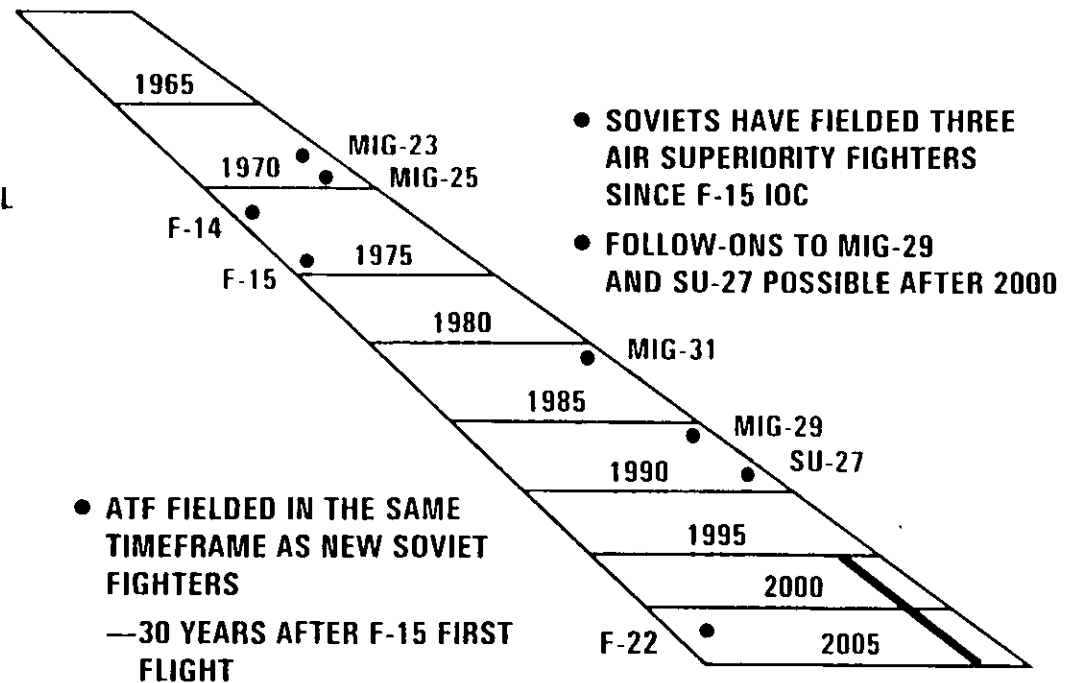



F-22 DEM/VAL ACHIEVED PERFORMANCE

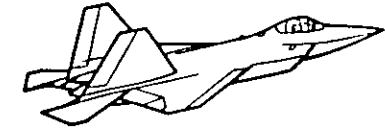

**F-22
Stealth Fighter**

- **PROTOTYPE AIRCRAFT TESTED IN FOLLOWING AREAS**
 - **THRUST VECTORING**
 - **MANEUVERING TO 60-DEGREE ANGLE OF ATTACK**
 - **AIM-9 AND AIM-120 LAUNCH**
 - **MANEUVERING AT MINIMUM AIRSPEED**
 - **HANDLING QUALITIES DURING TRACKING**
 - **WEAPONS BAY ENVIRONMENT**
 - **MACH 1.8+ (WITH F119 ENGINES)**
 - **AIR REFUELING**
 - **SUPERCUISE**
 - **LIMITED AIR STARTS**



F-22 DEM/VAL ACHIEVED PERFORMANCE—Continued

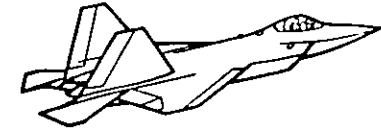

F-22
Stealth Fighter

● FLIGHT CONDITIONS

—AIR SPEED KCAS	83 TO 630
—MACH NUMBER	0.25 TO 1.8 MACH +
—SUPERCruise	1.4 MACH +
—ALTITUDE (FEET)	2,300 TO 50,000
—NORMAL LOAD FACTOR	-1.0 TO 7.7
—ANGLE OF ATTACK (DEGREE)	-5 TO 62
—ANGLE OF SIDESLIP (DEGREE)	1.25 LEFT/RIGHT
—ROLL RATE (DEGREE/SECOND)	200 LEFT/RIGHT



RM&S COMPARISONS

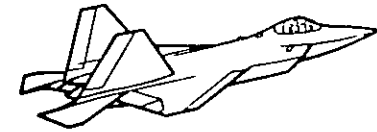

F-22
Stealth Fighter

SORTIE GENERATION RATE

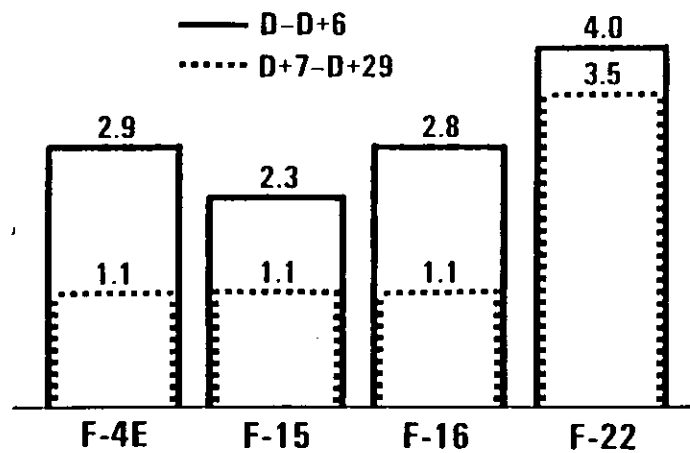

TOTAL MANPOWER SPACES PER AIRCRAFT

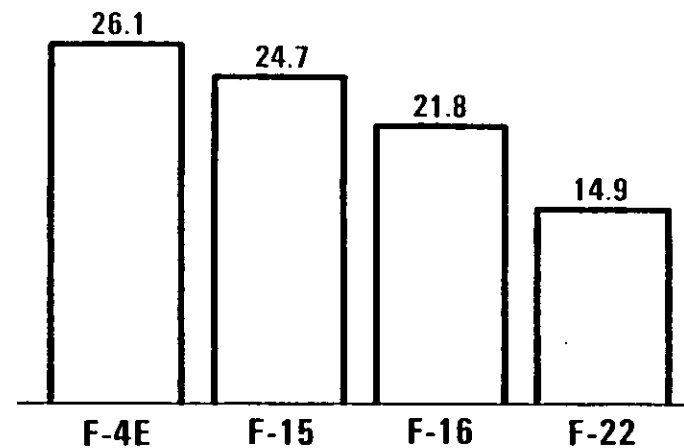

C-141s TO DEPLOY A 24 PAA SQDN

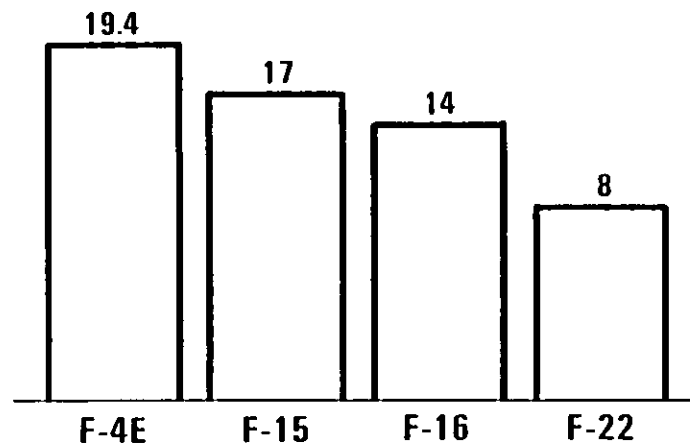

COMBAT RATE: SORTIES BETWEEN MAJOR MAINTENANCE

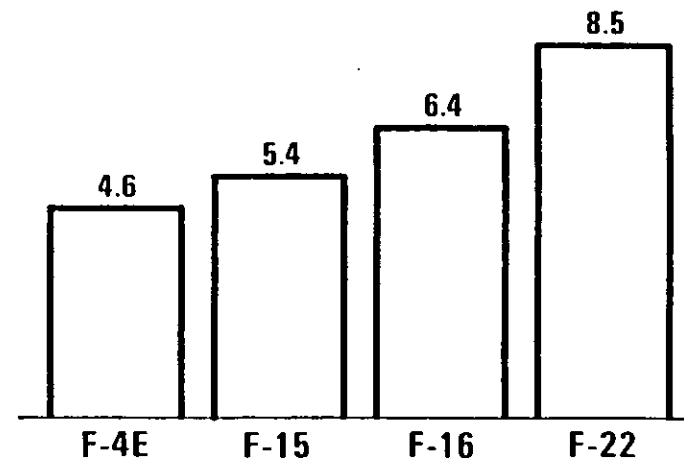



F-22 PRATT & WHITNEY YF119 ENGINE

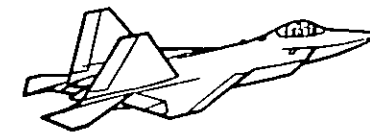

F-22
Stealth Fighter

TMS: YF119-PW-100

MFR: PRATT & WHITNEY

TYPE: TWIN-SPOOL AUGMENTED TURBOFAN

APPLICATION: ADVANCED TACTICAL FIGHTER

THRUST: 35,000 LB CLASS

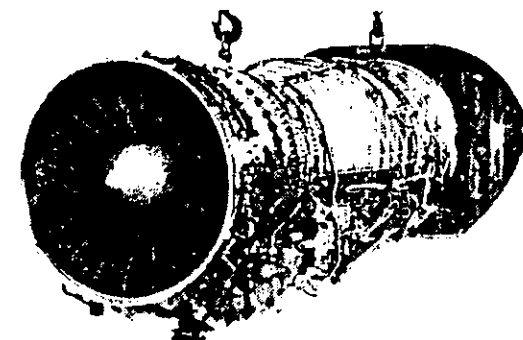

**ENGINE CONTROL: FULL AUTHORITY DIGITAL
ELECTRONIC CONTROL**

**COMPRESSION SYSTEM: TWIN-SPOOL/COUNTER-ROTATING/
AXIAL FLOW**

—3 STAGE FAN

—6 STAGE COMPRESSOR

COMBUSTOR: ANNULAR

TURBINE: AXIAL FLOW/COUNTER-ROTATING

—1 STAGE HIGH-PRESSURE TURBINE

—1 STAGE LOW-PRESSURE TURBINE

NOZZLE: VECTORING TWO-DIMENSIONAL CONVERGENT-DIVERGENT

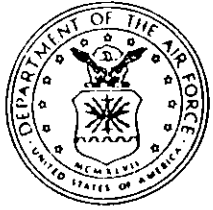

F-22 PROGRAM

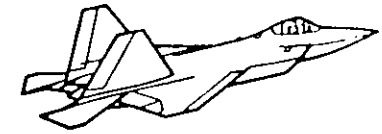

F-22
Stealth Fighter

-
- **DEMONSTRATION/VALIDATION PHASE** 1986 TO 1991
 - **REQUEST FOR PROPOSAL RELEASE** 1 NOV 1990
 - **DOWN SELECT** 23 APR 1991
 - **DEFENSE ACQUISITION BOARD** JUN 1991
 - **ENGINEER MANUFACTURING DEVELOPMENT** JUL 1991
 - **48 AIRCRAFT DELIVERED** 2002
 - **TOTAL AIRCRAFT PROCUREMENT** 648 AIRCRAFT TO SUPPORT 5.5 TACTICAL FIGHTER WINGS
 - **UNIT FLYAWAY** \$59.4 MILLION (FY 91\$)
 - **TOTAL PROGRAM** \$61.5 BILLION (FY 91\$)



F-22 FULL-SCALE DEVELOPMENT SCHEDULE

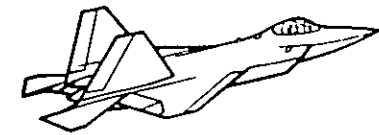

F-22
Stealth Fighter

CALENDAR YEAR	1991	1992	1993	1994	1995	1996	1997	1998	1999	2000	2001	2002	2003	2004
FISCAL YEAR	91	92	93	94	95	96	97	98	99	00	01	02	03	04
	O J A J	O J A J	O J A J	O J A J	O J A J	O J A J	O J A J	O J A J	O J A J	O J A J	O J A J	O J A J	O J A J	O J A J

MSII Δ [PDR] [COR] Δ MSIIIA Δ MSIIIB

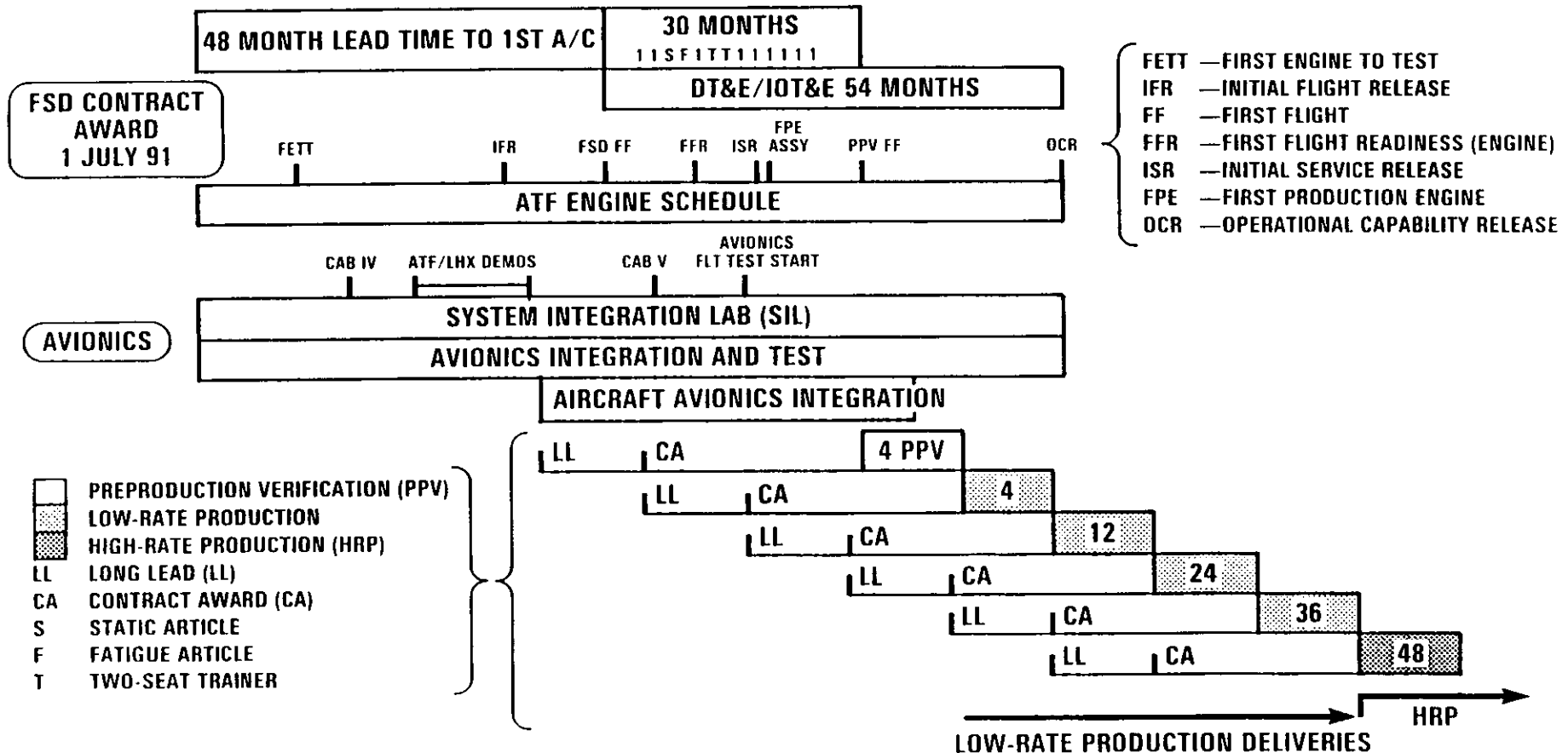



WHY F-22?

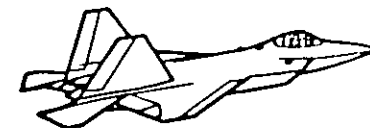

F-22
Stealth Fighter

- **FREEDOM OF MANEUVER FOR GROUND, AIR, AND NAVAL FORCES IS A NECESSITY FOR SUCCESSFUL ACCOMPLISHMENT OF MILITARY OBJECTIVES**
- **AIR SUPERIORITY IS REQUIRED TO PROVIDE THIS FREEDOM OF MANEUVER FOR ALL PHASES OF MILITARY OPERATIONS**
 - **PREVENTS ENEMY AIR ATTACK ON FRIENDLY SURFACE FORCES**
 - **ALLOWS INTERDICTION AND CLOSE AIR SUPPORT TO PROVIDE EFFECTIVE SUPPORT OF FRIENDLY FORCES**
 - **ALLOWS SEALIFT AND AIRLIFT AIRCRAFT FREEDOM TO DEPLOY AND RESUPPLY FRIENDLY FORCES**
- **THREATS THAT DENY AIR SUPERIORITY?**
 - **ENEMY FIGHTER AIRCRAFT**
 - **ENEMY SURFACE-TO-AIR MISSILES (SAMs)**

T A B L E

**ADVANCED CRUISE
MISSILE**



ADVANCED CRUISE MISSILE

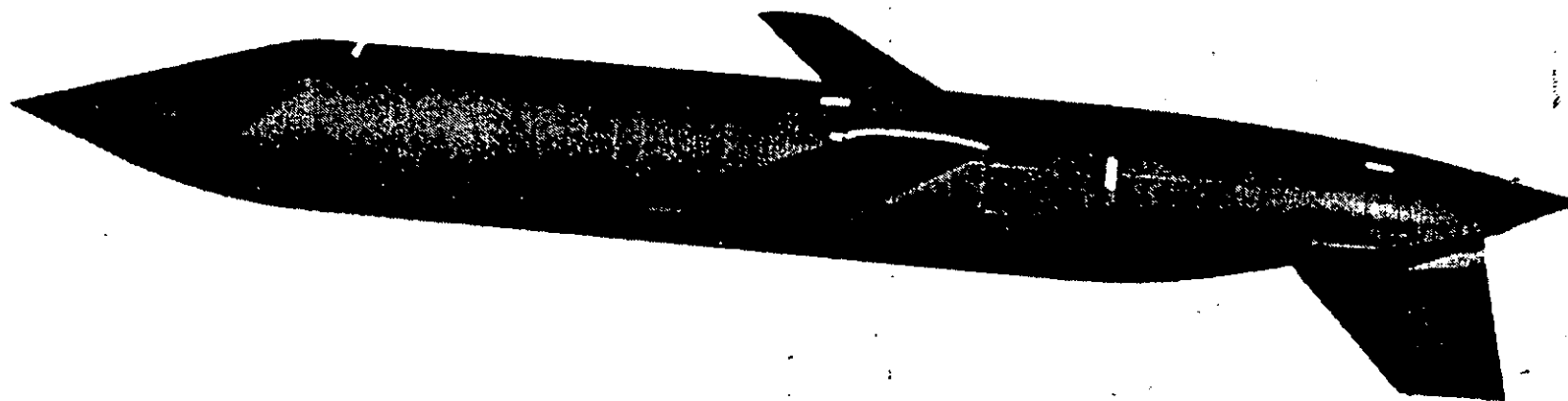

**DETERRENCE FOR THIS CENTURY
AND THE NEXT**



CRUISE MISSILE EVOLUTION



Advanced
Cruise Missile

- SLOWLY, AS TECHNOLOGY HAS IMPROVED, THE PERFORMANCE OF CRUISE MISSILES HAS IMPROVED ALSO
- THE FIRST MISSILES ONLY HAD TO FLY A FEW HUNDRED MILES AND BE ABLE TO STRIKE A CITY-SIZED TARGET—AND OFTEN FAILED EVEN IN THAT
- NOW THE MISSILES CAN FLY THOUSANDS OF MILES AND STRIKE WITH GREAT ACCURACY
- THE ADVENT OF NUCLEAR WEAPONS PROVIDES A WARHEAD THAT MAKES A CRUISE MISSILE A SERIOUS DETERRENT

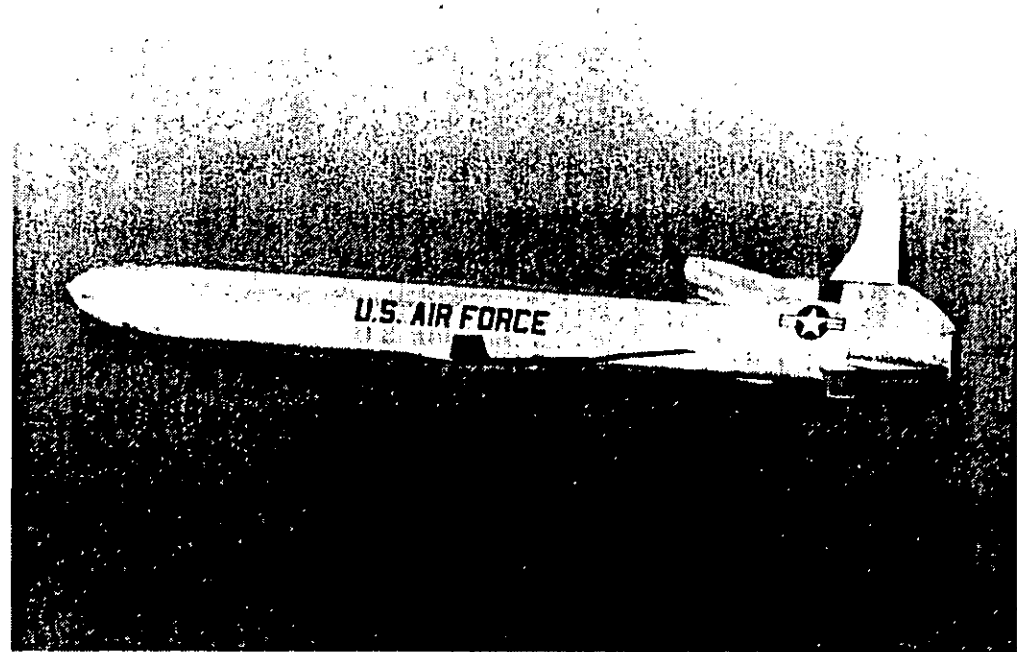

ALCM-B

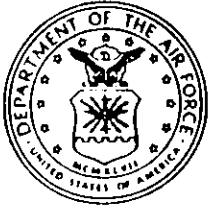

ADVANCED CRUISE MISSILE CHARACTERISTICS



Advanced
Cruise Missile

- BETTER ACCURACY, RANGE,
AND SURVIVABILITY
- HARD TARGET CAPABLE
- COMPLICATES ENEMY
AIR DEFENSES
- INCREASED STANDOFF
RANGE
- IMPROVES BOMBER
SURVIVABILITY

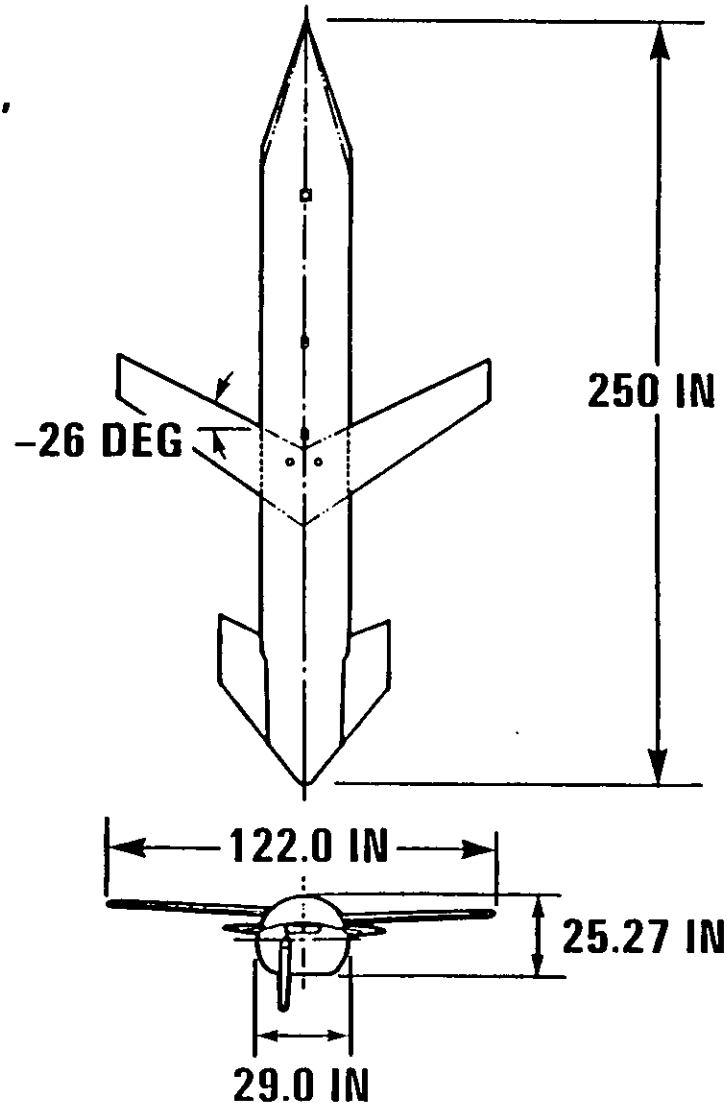



ADVANCED CRUISE MISSILE (AGM-129A)

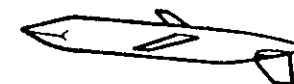

Advanced
Cruise Missile

SIGNATURE REDUCTION CHARACTERISTICS

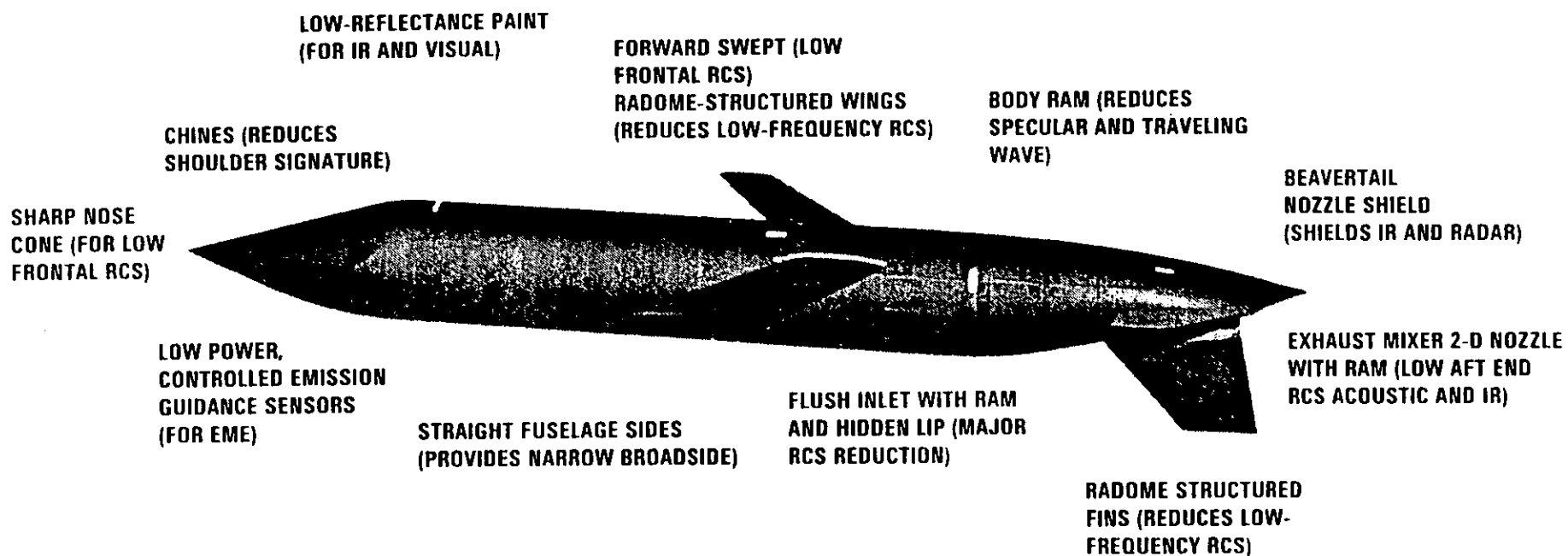



ADVANCED CRUISE MISSILE MISSION

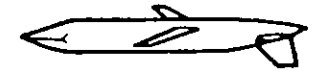

**Advanced
Cruise Missile**

-
- **ENHANCE THE LONG-TERM EFFECTIVENESS OF THE BOMBER LEG OF THE TRIAD WITH A CRUISE MISSILE CAPABLE OF DEFEATING PROJECTED SOVIET DEFENSES. ACM HAS**
 - **GREATER RANGE**
 - **IMPROVED SURVIVABILITY**
 - **INCREASED ACCURACY**
 - **ENHANCED OPERATIONAL FLEXIBILITY**
 - **MAXIMUM COMPATIBILITY WITH OTHER STRATEGIC SYSTEMS**



ACM UNIQUE CONTRIBUTIONS



Advanced
Cruise Missile

- **THE ACM SHARES AN ADVANTAGE WITH THE EARLIEST CRUISE MISSILES: IT GREATLY COMPLICATES ENEMY DEFENSE PLANNING**
- **CRUISE MISSILES ACT AS A FORCE MULTIPLIER: ONE BOMBER ORIGINATES A DOZEN INDEPENDENTLY FLYING THREATS**
- **AND THE ACM ADDS ITS OWN UNIQUE TWIST: IT IS NEARLY UNDETECTABLE EXCEPT AT THE VERY CLOSEST OF RANGES**





ACM F-112-WR-100 TURBOFAN ENGINE



Advanced
Cruise Missile

- **LOW BYPASS RATIO TURBOFAN WITH MIXED-FLOW EXHAUST, DEVELOPED ESPECIALLY FOR THE ACM**
- **MANUFACTURED BY WILLIAMS INTERNATIONAL COMPANY, WALLED LAKE, MICHIGAN**

FEATURES

THRUST CLASS:	500-750 POUNDS
WEIGHT:	161 POUNDS
FUEL TYPE:	JP-10
LENGTH:	31 INCHES
DIAMETER:	18.5 INCHES (WITH ACCESSORIES)



ACM GUIDANCE SYSTEM

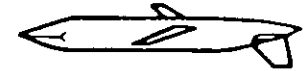

Advanced
Cruise Missile

- A HIGH-ACCURACY INERTIAL NAVIGATION SYSTEM THAT PROVIDES A SIGNIFICANT IMPROVEMENT OVER ALCM
- MANUFACTURED BY KEARFOTT GUIDANCE AND NAVIGATION CORPORATION, WAYNE, NEW JERSEY

FEATURES

- HIGH-SPEED DIRECT MEMORY ACCESS PROCESSOR WITH 128K OF RANDOM ACCESS MEMORY AND 64K OF ELECTRICAL ERASABLE PROGRAMMABLE READ-ONLY MEMORY
- LASER DOPPLER VELOCIMETER SENSOR THAT MEASURES MISSILE GROUND VELOCITY AFTER LAUNCH
- FOUR-GIMBAL TUNED ROTOR GYROSCOPE INERTIAL GUIDANCE PLATFORM THAT PROVIDES HIGHLY ACCURATE POSITION LOCATION



ADVANCED CRUISE MISSILE PROGRAM



Advanced
Cruise Missile

-
- | | |
|--|-------------------------|
| ● FULL-SCALE DEVELOPMENT BEGAN | APR 1983 |
| ● FIRST FLIGHT | JUL 1985 |
| ● PILOT PRODUCTION | JUL 1985 |
| ● TOTAL BUY (INCLUDING 120 SPECIAL VARIANTS) | 1,000 |
| ● PRODUCTION DECISION | SUMMER 1991 |
| ● UNIT FLYAWAY COST | \$3.8 MILLION (FY 91\$) |
| ● TOTAL PROGRAM COST | \$6.4 BILLION (FY 91\$) |

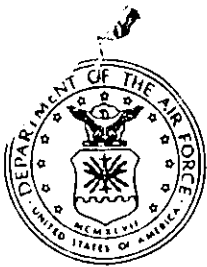

ACM TODAY AND TOMORROW

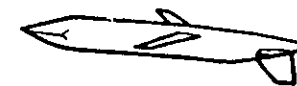

Advanced
Cruise Missile

- **THE ACM IS NOT JUST DESIGNED TO MEET CURRENT THREATS BUT WILL BE USEFUL WELL INTO THE NEXT CENTURY**
- **AS MISSILE CARRIER AIRCRAFT AGE AND ARE REMOVED FROM THE CRUISE MISSILE CARRIER OR PENETRATION ROLES, THE ACM CAN BE REDEPLOYED TO EXTEND THE USEFUL LIFE OF AIRCRAFT**
- **ACM FLEXIBILITY ADDRESSES AIR FORCE STRATEGIC AND BUDGETARY CHALLENGES**