

Headquarters  
 Departments of the Army and the Air Force  
 Washington, D.C. 20310-2500  
 1 October 1991

\*National Guard Regulation (AR) 500-1/  
 National Guard Regulation (AF) 55-5

**Employment of Army and Other Resources**

**MILITARY SUPPORT TO CIVIL AUTHORITIES**

**Summary.** This regulation prescribes policies, procedures, responsibilities and guidance for the employment of Army and Air National Guard units, personnel and equipment of the several states in support of civil authorities.

**Applicability.** This regulation applies to all Army National Guard (ARNG), and Air National Guard (ANG) units of the 50 States, Territories, and the District of Columbia.

**Impact on Unit Manning System.** This regulation does not contain policies that affect the Unit Manning System.

**Internal Control System.** This regulation incorporates guidance from AR II-2 and OMB Circular A-123. It includes internal control review provisions/checklists for ARNG and ANG Military Support.

**Supplementation.** Supplementation of this regulation is permitted at State level only after prior review and approval from National Guard Bureau, ATTN: NGB-MSO, The Pentagon, 2D374, Washington, DC 20310-2500.

**Interim changes.** Interim changes to this regulation are not official unless they are authenticated by the Chief, Administrative Services. Interim changes will be destroyed on their expiration dates unless sooner superseded or rescinded.

**Suggested improvements.** The proponent agency of this regulation is the National Guard Bureau, Directorate for Military Support. Users are invited to send comments and suggested improvements on DA Form 2028 (Recommended Changes to Publications and Blank Forms) directly to Chief, National Guard Bureau, ATTN: NGB-MSO, The Pentagon, 2D374, Washington, DC 20310-2500.

**CONTENTS**

	Para		Para
<b>Chapter 1</b>			
General	4	Use of equipment	3-3
Purpose	1-1	Use of Federal facilities	3-4
References	1-2	Use of National Guard Aircraft	3-5
Explanation of terms	1-3	Reimbursement	3-6
Authority	1-4	Equipment authorization	3-7
Responsibility	1-5		
Public Affairs	1-6		
<b>Chapter 2</b>		<b>Chapter 4</b>	
<b>Military Support Operations</b>		<b>Civil Disturbance Support Operations</b>	
General	2-1	Responsibility	4-1
Considerations for employment	2-2	Planning	4-2
Personnel	2-3	Resources	4-3
Planning	2-4	Employment guidance	4-4
		Training	4-5
		Use of Force	4-6
		Civil Disturbance evaluation	4-7
		Use of Unit Training assemblies	4-8
<b>Chapter 3</b>			
<b>Loan, Lease, and Use of Equipment</b>			
Loan and leases of equipment	3-1		
Loan Request Channels	3-2		

\*This regulation supersedes NGR 500-1/ANGR 55-04, 15 September 1988



<b>Chapter 5</b>	
<b>Terrorism Counter Action</b>	<b>Para</b>
General	5-1
Responsibility	5-2
Role of the National Guard	5-3
Training and operational guidance	5-4
National Guard missions	5-5
Other agency missions	5-6
Planning and coordination	5-7

<b>Chapter 6</b>	
<b>Reporting Requirements</b>	
Reports	6-1
Military support (civil disturbances, disaster, emergency)	6-2

**Appendices**

- A. References
- B. Reports

**CHAPTER 1  
GENERAL**

**1-1. Purpose**

This regulation prescribes the policies, procedures, responsibilities and guidance for employment of Army and Air National Guard units, personnel and equipment in support of civil authorities.

**1-2. References**

Required and related publications are listed in appendix A.

**1-3. Explanation of terms**

**a. Civil Authorities.** Elected and appointed public officials and employees of Federal, State and local Governments.

**b. Civil Disturbances.** Group acts of violence or disorder prejudicial to public law and order, terrorism, and disruption of vital public services. Includes all domestic conditions requiring the use of the Federal military forces pursuant to the provisions of Title 10 USC, Section 15.

**c. Civil Disturbance training.** Civil disturbance training is that individual and unit training which is directed toward providing assistance to civil authorities in maintaining law and order in any emergency situation.

**d. Emergencies.**

**(1) Civil.** Any man-caused emergency, or threat which causes or may cause substantial property damage or loss.

**(2) Natural.** Any hurricane, tornado, storm, flood, high water, wind driven water, tidal wave, earthquake, volcanic eruption, landslide, mudslide, snowstorm, drought, fire, or other catastrophe.

**(3) Other.** An emergency in any part of the United States which requires National Guard assistance to supplement local or state efforts to save lives and protect property, public health, and safety, or to avert or lessen the threat of a disaster.

**e. Federal property.** Equipment and supplies that are owned, leased, or possessed by the U.S. Government.

**f. States.** For the purpose of this regulation the term "states" includes the 50 States, Commonwealth of Puerto Rico, the U.S. Virgin Islands, Guam, and the District of Columbia.

**g. Terrorism.** The calculated use or threat of violence to attain goals which may be political, religious, or ideological in nature. Terrorism involves a criminal act that is often symbolic in nature, and is intended to influence an audience beyond the immediate victims through such means as intimidation, coercion, or instilling fear.

**h. Counter Terrorism.** Offensive measures taken to respond to a terrorist act, or the documented threat of such an act. Counter terrorism includes the gathering of information and threat analysis to support offensive measures.

**i. Anti-Terrorism.** Defensive measures used to reduce the vulnerability of personnel, family members, facilities, and equipment to acts of terrorism. This also includes the collection and analysis of information to accurately assess the magnitude of the threat.

**1-4. Authority**

The governor is the commander in chief of all Army and Air National Guard units within his/her jurisdiction, which are not in active federal service. This authority is derived from Article 1, Section 8, Clause 16, U.S. Constitution.

**a. Governors** may authorize the use of the National Guard to assist civil authorities in accordance with the State Code and/or State Constitution.

**b. Command of the National Guard** is normally exercised through the Adjutant General or his designated military representative.

**c. The President of the United States** is the Commander in Chief of the National Guard of the District of Columbia. The National Guard may be ordered



out in militia status to aid civil authorities under Title 39 of the District of Columbia Code and Executive Order No. 11485, 3 October 1969.

#### 1-5. Responsibility

The Chief, National Guard Bureau has overall responsibility for the National Guard military support program. State adjutants general are responsible for establishing military support programs in their states.

#### 1-6. Public Affairs

Public affairs is an important element of military support operations. National Guard public affairs guidelines are contained in NGB Pam 360-5/ANGP 190-9.

## CHAPTER 2 MILITARY SUPPORT OPERATIONS

### 2-1. General

a. This chapter prescribes guidance and procedures for ARNG/ANG personnel, units and activities conducting Military Support to Civil Authorities (MSCA) operations in a state active duty (SAD) status only. When a unit is on federal active duty, applicable Army or Air Force regulations will apply.

b. Primary responsibility for disaster relief shall be with the local and/or state government, and those federal agencies designated by statute.

### 2-2. Considerations for employment.

National Guard assistance normally is provided when:

a. The situation is so severe and so widespread that effective response and support is beyond the capacity of local and state government, and all civil resources have been exhausted.

b. Required resources are not available from commercial sources. National Guard Support will not be furnished if it is in competition with private enterprise or the civilian labor force.

c. National Guard resources will normally be committed as a supplement to civil resources that are required to cope with the humanitarian and property protection requirement caused by a civil emergency or mandated by law.

d. Assistance will be limited to tasks that, because of experience and the availability of organic resources, the National Guard can do more effectively or efficiently than another agency.

e. When an emergency or disaster occurs and waiting for instructions from higher authority would preclude an effective response, a National Guard commander may do what is required and justified to save human life, prevent immediate human suffering, or lessen major property damage or destruction. The commander will report the action taken to higher military authority, and to civil authority as soon as possible. Support will not be denied or delayed solely for lack of a commitment for reimbursement or certification of liability from the requestor.

f. The National Guard will be employed with adequate resources to accomplish the mission when conducting civil disaster/emergency relief operations. That determination will be made by the on-scene commander or the senior officer present. Military support to civil authorities will terminate as soon as possible after civil authorities are capable of handling the emergency.

g. When any public service is lost or withdrawn, and an immediate substantial threat to public health, safety, or welfare is evident, the National Guard may be called to restore and/or continue that public service. It is desirable that supervisors, managers, and key personnel of the public service be available to provide technical assistance to National Guard personnel. In the absence of key public service personnel, the state adjutant general will make plans and coordinate with appropriate civil authorities to perform the mission within the capabilities and limitations of the National Guard.

h. The capability of the National Guard to assist in the restoration/continuation of public services depends primarily on the degree of military or civilian skills possessed by National Guard personnel.

### 2-3 Personnel

a. States will prepare and maintain current information on the status and capabilities of units to respond to certain types of emergency situations. Particular emphasis will be placed to identify individuals in units who possess special or critical military and/or civilian skills which may be required to support specific operations.

b. Active Guard/Reserve (AGR) full time support may only be employed in accordance with the guidance contained in NGR (AR) 600-5 para 3-3 for the ARNG, and ANGR 35-03 Chapter 3 for the ANG. Military Technician (MT) personnel must be employed in accordance with the provisions of TPR 990-2. Technicians who provide support to state and local civil authorities must be placed in an appropriate leave status for all hours of their normal workday that fall within the period of military duty.

c. Because of their immediate availability, depending on the circumstances, and incidental to their full time positions, MT and/or AGR personnel may be used to provide an initial response to emergency situations involving the threat of loss of life, human suffering, or widespread property damage. In those cases, as soon as the immediate threat has diminished, it is imperative that:

(1) Full time support (FTS) personnel are replaced with traditional Guardsmen, or;

(2) The status of involved FTS personnel is changed consistent with the guidance contained in the appropriate ARNG/ANG AGR or technician personnel regulations.

#### 2-4 Planning

a. States will prepare and maintain emergency plans for the employment of the National Guard in a Military Support to Civil Authorities (MSCA) role. Plans will provide for response to civil disobedience/disturbance, natural, man-made or technological disasters, and other potential emergencies. Plans will be reviewed and updated, by the state, not later than 30 Sep each year. During annual reviews special emphasis should be given to ensuring that task organizations are consistent and compatible with force structure modifications.

b. Two copies of all emergency response plans (or changes) will be forwarded to NGB-MS as they are updated. If no changes are required, a memorandum indicating the title of the plan and the date of annual review shall be forwarded to NGB-MS not later than 15 Oct each year.

c. Plans will be coordinated with adjacent states and appropriate intrastate agencies, to include the state attorney general's office to ensure compatibility, non-redundancy, and effective lawful response.

d. Emergency plans will be comprehensive and responsive to all potential emergency requirements. They will be prepared based on worst case scenarios that can be expected locally. Plans will contain provisions for:

(1) Actions before, during and after disasters. Consider primary and alternate command and control facilities survivability, equipment evacuation, alert procedures, communications, and periodic exercises to test emergency plans.

(2) External assistance for support beyond state capabilities, and prepositioning of equipment and supplies.

e. Plans will provide for the possible transition to federal status; applicable Army and Air Force regulations and OPLANs are primary reference documents.

### CHAPTER 3 LOAN, LEASE AND USE OF EQUIPMENT

#### 3-1 Loans and leases of equipment.

a. Loans and leases of equipment are governed by AR 700-131 for the ARNG, and by AFM 67-1/ANGR 67-1 for the ANG. State adjutants general are given broad authority to loan equipment by these regulations; exceptions are noted in paragraph 3-1c below.

b. USPFOS are responsible for negotiating, preparing agreements and approving loans and leases of equipment in accordance with procedures established by AR 700-131 and AFM 67-1/ANGR 67-1. Formats for loan agreements are prescribed in cited references.

c. The loan of weapons, combat/tactical vehicles, vessels and aircraft require approval of the service secretary or their designee. Requests for loan/lease of National Guard equipment which require HQDA or HQAF approval will be reviewed by the National Guard Bureau as follows:

(1) The Deputy Director, NGB-MS is responsible for all military support loan requests for civil emergencies, law enforcement support, civil disturbances, disaster relief, terrorist situations, environmental protection, and hazardous or other dangerous material accidents/incidents.

(2) The Chief, Public Affairs (NGB-PA) is responsible for loan requests concerning community relations and domestic information programs.

(3) The Chief, Aviation Division (NGB-AVN-O) is responsible for requests for the loan or lease of ARNG aircraft; the Director of Operations, Plans & Programs (NGB/XOO) is responsible for the loan or lease of ANG aircraft.

(4) The Chief, Logistics Division (NGB-ARL) is responsible for all other requests for loan or lease of ARNG equipment; the Director of Logistics (NGB/LG) is responsible for loan or lease of ANG equipment.

d. All equipment loans or leases to support law enforcement agencies will be reported quarterly to NGB-MS IAW the schedule as outlined in RCS # DD-M(Q)1595.

#### 3-2 Loan request channels

a. Loan requests from state and local agencies will be routed directly to the respective state Adjutant General.

b. Loan requests from federal agencies will be routed through that agency's headquarters to the Department of Defense, and then to the appropriate service for resourcing.

**3-3 Use of equipment**

a. The State Adjutant General has authority to use federal property issued to the National Guard of his state during periods of civil disturbance and other emergency conditions declared by the Governor, in accordance with state law. Any reimbursement required under these conditions will be effected in accordance with paragraph 3-6 below.

b. Federal property used during state emergencies will remain under National Guard control, and operated only by qualified NG personnel.

c. If required, states may coordinate directly with other states for temporary loan of additional federal property required for a particular emergency. USP&FOs are responsible for coordinating all arrangements, including a report of all transactions to NGB-ARL IAW RCS # ARNG-194.

**3-4 Use of Federal facilities**

When situations arise that require use of federal facilities by the National Guard, permission must be obtained from the installation/ activity commander prior to use, including coordination for use of controlled or restricted access areas. NGB-MS will be notified of all use of federal facilities.

**3-5 Use of National Guard aircraft**

The operation of aircraft is expensive, and requires continuous special attention. The matter of cost effectiveness cannot be overlooked in the planning and execution of air movements to support MSCA operations. The use of National Guard aircraft is governed by the 95-series of regulations for the ARNG, and the 55-series for the ANG. These regulations shall be used as primary reference documents on all use of aircraft issues.

**a. Air transportation of civilians.**

(1) Eligibility requirements for all travelers on Department of Defense (DoD) owned or operated aircraft are contained in DoD Directive 4515.13R. The policy concerning use of DoD transportation resources and limitations on support to civilians is contained in DoD Directive 4500.9. General guidance on providing support to civilian law enforcement officials is contained in DoD Directive 5525.5.

(2) All non-DoD traffic must be supported by letter orders or Invitational travel orders, the supporting documents for which shall clearly articulate how the travel is in support of the DoD mission, or other statutory authority for the movement. The Economy Act requires reimbursement to the DoD when support is provided to another federal agency or activity. There are other laws (and policies emanating from those laws) which mandate reimbursement for DoD support.

(3) Requests for movement of non-DoD traffic must be forwarded thru NGB-MS to the Office of the Assistant Secretary of Defense (OASD) for Transportation Policy (P&L)/TP for review and appropriate action; reimbursement requirements will be determined in coordination with the OSD Comptroller.

**(4) Special circumstances.**

(a) Civilian law enforcement personnel may be transported on missions conducted incidental to training under the following conditions: the mission must be approved in advance by NGB-MS on a case-by-case basis; the operation must be consistent with the participating aviation unit(s)' military mission; and the mission must be conducted within available resources, including flying hours. Air transportation of media and other civilian (non-law enforcement) personnel on missions conducted incidental to training require NGB-PA approval on a case-by-case basis. No reimbursement is required in these cases. Care must be taken to ensure that the mission is in direct support of an operational requirement, and not just providing point-to-point transportation. That type of support would place the National Guard in competition with commercial enterprise, and in violation of the law.

(b) When National Guard aircraft are employed in response to a state-declared emergency, to include civil disorders, natural or man-made disasters, or any other type of emergency, civilian agency officials (federal, state, and local, including media personnel) may be transported consistent with mission requirements. The state shall reimburse the federal government at the direct flying hour cost (POL and Repair Parts) for the actual use of that aircraft. The liability issue in these cases is a function of state law. Aircrew personnel will normally be in a state active duty status, except for those initial operations required to prevent the immediate loss of life or limb, to mitigate human suffering, or to prevent widespread property damage.

(c) When National Guard aircraft are used in state active duty under non-emergency situations, as allowed by appropriate state laws, civilian personnel (government, law enforcement, media, etc.) may be transported under the following conditions: all passengers must have prior flight authorization. (See para 3-5a(2) above.) All passengers must execute a DD Form 1381 (Air Transportation Agreement), or other suitable liability release; the state must reimburse the federal government through the USP&FO at the non-US Government rate; and the state assumes all personal and property liability, including collateral damages, which may accrue from the mission.

**b. Training support to State emergency response personnel.**

(1) Requests to conduct this type of training will be forwarded to NGB-MS for approval, and coordination with NGB-AVN and other NGB staff. Such training may include: configuring of National Guard aircraft for aeromedical evacuation and conducting practice missions; high rise building rescue operations; rappelling into remote areas which are inaccessible by vehicle; and training in internal rescue hoist operations. The equipment and techniques used are technical, and proper team training is essential for safe operations.

(2) Approval of this training will be given on a case by case basis. If approved by the National Guard Bureau, the training may be conducted subject to the following conditions:

(a) All participating National Guard personnel will be in a state active duty status, and the state accepts total liability for National Guard personnel and property.

(b) The state will reimburse the federal government through the USP&FO for the direct flying hour cost of aircraft (POL and repair parts).

(c) Personal liability for state emergency response personnel is a state responsibility.

(d) National Guard aircraft and related equipment will be operated by qualified National Guard personnel only.

(3) Requests will include: identification of civil agency making request; description of training to be conducted; civil assets available/not available; full justification; duration; and starting and termination dates/times.

(4) An after action report will be forwarded to NGB-MS upon completion of the training.

**c. Training support of federal agency personnel.**

Requests for training support from federal agencies will be routed through that agency's headquarters, in Washington, to the Executive Secretariat of the Department of Defense, and then to the appropriate service for resourcing.

**3-6 Reimbursement**

**a. State Active Duty (SAD).** When federal property is used by National Guard personnel in a SAD status, as ordered by the Governor in response to an emergency relating to a civil disturbance, natural disaster, or other incident, the state will be liable for reimbursement (or replenishment in kind) to the federal government through the USP&FO for the following:

(1) Repair parts, other than fair wear and tear, expended in the objective area.

(2) POL (Petroleum, oils and lubricants) expended for direct mission accomplishment.

(3) Incremental costs (those costs above the expenses which normally accrue during scheduled training periods) which can be attributed to direct mission support.

**b. Use of aircraft.** Reimbursement policies and procedures for use of ARNG aircraft are outlined in NGB Pam 95-5, procedures for ANG aircraft are found in AFR 173-13.

**c. Loans of equipment.** Costs associated with the loan of equipment will be reimbursed in accordance with AR 700-131 and AFM 67-1/ANGR 67-1.

**d. Support to other Federal agencies.** When the National Guard is involved in military support operations in which another Federal agency has a requirement to reimburse the National Guard for assistance under the provisions of the Economy Act, or other statutory requirement, reimbursement for approved missions will be accomplished before the actual support IAW MOU/MOA between that agency and the National Guard. When another Federal agency requests support in an emergency that precludes prior reimbursement, the National Guard shall record the name of the requesting official, the date and time the request was made, the exact nature of the support requested, and the official's verbal commitment to reimburse the National Guard for the support costs.

**3-7. Equipment authorizations**

**a. Commercial equipment** must be authorized prior to procurement or leasing. If not already authorized, requests for authorization will be processed in accordance with AR 71-13 for TDA addition or addition to CTA 50-909.

**b. USP&FO's** have the authority to approve procurement of commercial nonstandard, nontype classified, noncontrolled, equipment consistent with limitations imposed by NGB-ARL.

**CHAPTER 4**

**CIVIL DISTURBANCE SUPPORT OPERATIONS**

**4-1. Responsibility**

The protection of life, property, and the maintenance of law and order within the territorial jurisdiction of any state, is the primary responsibility of civil authorities. The National Guard is employed only after all local and state resources have been fully utilized, or when the situation is beyond the capabilities of the local and state civil authorities. National Guard assistance is provided in support of civil authorities, not to replace civil authority command jurisdiction.

National Guard forces will remain under the command of National Guard officers, and missions are executed through the National Guard chain-of-command in coordination with civil authorities.

#### 4-2. Planning

Civil Disturbance plans will include provisions for communication and liaison with supported agencies. When a civil disturbance mission is imminent, liaison will immediately be established with appropriate civil authority to identify requirements and initiate planning. The DoD Civil Disturbance Plan "Garden Plot" will be used as a guide for developing civil disturbance plans and operations.

#### 4-3. Resources

The National Guard will be employed with sufficient resources to accomplish the mission when conducting civil disturbance operations. Support to civil authorities terminates as soon as possible after the situation is under control.

#### 4-4. Employment guidance

Only National Guard individuals who have received civil disturbance training, in accordance with current regulations, may be employed in "on-the-street" civil disturbance control operations.

a. The state civil disturbance mission is a joint Army and Air National Guard responsibility. The Air National Guard (ANG) is not authorized to conduct civil disturbance training (except the DCANG); it will not be used in a direct civil disturbance role and may only be used in administrative or support functions.

b. National Guard individuals not trained in civil disturbance operations may be used only in administrative or support functions. Selected ANG personnel/units should be considered for specific support missions, e.g. administrative duties, security of C3 elements, traffic control, etc.

#### 4-5. Training

a. *Individual training.* Army National Guard (ARNG) personnel in Army training centers no longer receive civil disturbance control training, while undergoing initial entry training. Unit commanders assigned a civil disturbance mission will ensure that all personnel receive, as a minimum, 16 hours of initial individual civil disturbance training, prior to participating in unit civil disturbance training.

(1) FM 19-15 will be used as a guide to develop individual and refresher training to ensure the unit is adequately trained for immediate deployment in civil disturbance control operations. In addition, commanders will ensure that personnel are adequately trained in assigned specialized equipment

such as shotguns, sniper rifles, and riot control agent dispersers, etc.

(2) All commanders, to include commanders of units classified as "other" units, will ensure that each individual has essential knowledge of policies pertaining to application of force in civil disturbance control.

b. *Unit training.* Units assigned an "on-the-street" civil disturbance mission will conduct annual refresher training and junior leadership training IAW NGR 350-1 and FORSCOM/NGB Regulation 350-2. Recommended subjects include: coordination of federal, state, and local agencies in the objective area; rules of engagement; force protection/security; logistical support; special riot control equipment; public information/community relations; actions prior to deployment, personnel accountability; discipline; law and order of troops; morale; unit tactics and application of force; use of deadly force; legal aspects; repositioning and redeployment of forces.

c. *Special team training.* Special reaction teams, such as sniper teams, etc, will be established for specific contingencies in accordance with FM 19-15 Chapter 5, section VII and Chapter 6, section II. Civil disturbance training time will be used to establish and maintain proficiency of these teams.

#### 4-6. Use of force

FM 19-15 Chapter 7, outlines degrees of force options, to include the use of deadly force, for consideration during civil disturbance control operations.

a. The use of force must be restricted to the minimum degree consistent with mission accomplishment.

b. The use of deadly force can be justified only by extreme necessity. It is authorized only where all three of the following circumstances are present:

(1) Lesser means have been exhausted or are unavailable.

(2) The risk of death or serious bodily harm to innocent persons is not significantly increased by its use.

(3) The purpose of its use is one or more of the following:

(a) Self-defense to avoid death or serious bodily harm, including the defense of other persons.

(b) Prevention of a crime that involves a substantial risk of death or serious bodily harm; for example, setting fire to an inhabited dwelling or sniping.

(c) Prevention of the destruction of property vital to public health and safety.

(d) Detention or prevention of the escape of a person who, during the detention or on the act of escaping, presents a clear threat of loss of life or serious bodily harm to another person.

**c. Force options**

(1) Consistent with the controlling principle that use of minimum force is of paramount importance, the force options outlined in FM 19-15 will be used as a guide when considering the use of face shields, vests, batons, and when arming personnel.

(2) When the M16/16A1/16A2 rifle is employed, a lock plate (NSN 1005-00-923-9031) must be installed IAW TM 9-1005-249-24P to prevent automatic firing.

(3) No automatic fire of any type will be employed during civil disturbance operations.

**d. Apprehension and arrest.** As much as possible, apprehension will be left to civilian authorities. However, if apprehension is necessary, guidelines for arrest and formal legal procedures will be provided by the state Attorney General in accordance with appropriate state law.

**e. Pre-commitment briefing.** Prior to commitment, personnel will be briefed by an officer on the following, as a minimum:

(1) The specific mission of the unit.

(2) Rules governing the application of force and state laws as they apply to the specific situation, to include the use of deadly force.

(3) Procedures regarding accountability and security of weapons, ammunition and other sensitive equipment.

(4) Use of weapons and control of ammunition. If weapons and ammunition are issued, the following must be thoroughly defined:

(a) Authority to insert clip/magazine in the weapon.

(b) Authority to chamber a round.

(c) Authority to fire.

(5) A psychological orientation on the local situation, specifically addressing types of abuse that individuals may be expected to receive and the proper response to these types of abuses.

(6) Briefing by local police or other state agencies.

(7) Special Orders for Civil Disturbance operations will be issued to all personnel prior to employment. These orders will include guidance specific to the current operation and, as a minimum, will address special instructions, acceptable standards of conduct, interface with the civilian populace, and contact with the media.

**4-7. Civil Disturbance evaluation**

Units assigned a civil disturbance mission will receive an annual evaluation of civil disturbance capabilities. Units that fail to meet criteria, as defined by AR 350-7 or state regulations, will be reported to National Guard Bureau; ATTN: NGB-MSO.

**4-8. Use of unit training assemblies**

a. When it is determined that a threat of civil disturbance is imminent, dates and times of unit training assemblies may be rescheduled for the purpose of alerting/assembling personnel for possible employment. A maximum of one MUTA-4 (ARNG) or four UTA's (ANG) may be used for this purpose; federal mission training will be conducted during these periods.

b. If it becomes necessary to employ or commit individuals or units, in support of civil authorities, the training status must terminate, and all personnel must be placed in State Active Duty status prior to commitment.

**CHAPTER 5  
TERRORISM COUNTERACTION**

**5-1. General**

Terrorism Counteraction (TC/A) consists of those actions taken to counter the terrorist threat. Antiterrorism and Counterterrorism are two major areas of the National Guard role in terrorism counteraction. Antiterrorism refers to defensive measures taken to reduce vulnerability to terrorist attack. Counterterrorism refers to the offensive measures taken in response to acts of terrorism.

**5-2. Responsibility**

Civil authorities have primary responsibility for counterterrorist operations within the state except on active military installations where the commander is responsible unless otherwise specified in jurisdictional agreements.

**5-3. Role of the National Guard**

The normal role of the National Guard in TC/A activities is to support the federal and state law enforcement agencies with equipment, facilities, and personnel.

**5-4. Training and operational guidance**

a. Direct confrontation and negotiation with terrorists should be accomplished by trained law enforcement personnel only.

b. Unit training in TC/A operations can be conducted during annual refresher civil disturbance training.

c. Commanders and selected staff members of units assigned a TC/A support mission should attend a formalized course of instruction. Some courses that are available are conducted by the U.S. Army Military Police School and the California Specialized Training Institute, San Luis Obispo, CA.

d. State civil disturbance plans will address provisions for support of civil counterterrorism operations.

#### 5-5. National Guard missions

The following are possible missions for National Guard support of counterterrorist operations conducted by civil authorities:

- a. Public safety measures.
  - (1) Traffic control and road block.
  - (2) Disaster search/relief and recovery team.
  - (3) Perimeter security and security of critical facility.
  - (4) Ground control.
  - (5) Area evacuation.
- b. Public health measures.
  - (1) Emergency medical treatment.
  - (2) Limited aeromedical evacuation.
- c. Public welfare measures.
  - (1) Emergency shelter.
  - (2) Mass feeding/water supply.
- d. Other essential public services.
- e. Limited engineering support.
- f. Transportation support.
- g. Communication support.
- h. Loan of resources.
- i. Aviation support.
- j. Logistic support.
- k. General support for emergency forces.

#### 5-6. Other agency missions

The following are types of support that require a high degree of training, and are normally performed by federal and state civil authorities:

- a. Civil authorities command and control team other than National Guard liaison elements.
- b. Hostage negotiation.

c. Intelligence collection and investigative teams.

d. Assault teams.

e. Arrest teams.

#### 5-7. Planning and coordination

The Adjutant General, in coordination with civil authorities, will develop plans to counterterrorist operations which may develop on National Guard installations and facilities. Plans developed must comply with AR 381-10, U.S. Army Intelligence Activities; and AR 381-20, U.S. Army Counterintelligence Activities. Plans shall include provisions for:

a. Immediate notification of the FBI and local law enforcement authorities. During the initial liaison and planning for the counter terrorism operation, a clarification of controlling law enforcement agency authority must be determined.

b. The notification of National Guard Bureau in accordance with instructions in chapter 6.

c. The use of National Guard resources and facilities to support law enforcement operations.

d. Protection, safeguarding, and disposition of intelligence information on terrorism, terrorist organizations and individuals, received during the planning, preparation, and execution of counterterrorism support missions.

## CHAPTER 6 REPORTING

### 6-1. Reports

Within the scope of military support there are specific information requirements to be transmitted via various reports. This chapter provides guidance regarding format and reporting procedures for all Military Support to Civil Authorities.

### 6-2. Military support (civil disturbance, disaster, emergency)

Upon an alert and/or call-up of the National Guard to duty in connection with a civil disturbance, natural disaster, or other emergency, an initial report will be made immediately to the NGB-MSO by telephone. Additionally, all contingencies involving ANG resources will require NGB/XOOC notification. ANG will comply with ANGR 55-03 and AFR 55-55 figure 3-1 and chapter 30 reporting requirements, as the situation dictates. Follow up reports will be made as the situation changes. Initial and follow up reports will be transmitted by telephone as follows.

a. During duty hours (0800-1630 EST/EDT Monday through Friday) to Directorate for Military Support, DSN 227-9044 or (703) 697-9044, FAX (703) 614-4104 or DSN 224-4104.

b. During nonduty hours to the NGB Staff Duty Officer, DSN 225-6987 or (703) 695-6987. If contact cannot be made, call NGB Andrews Operations Center at DSN 858-6001 or Commercial (301) 981-6001 for emergency notifications. Initial reports made to the Staff Duty Officer or NGB Andrews Operations Center shall be followed up by FAX or phone to NGB-MS the next duty day. Routine reports to NGB-MS can be left on an answering machine at DSN 224-7066 or (703) 614-7066.

c. If the contingency warrants, the CNGB will activate the Contingency Support Staff (CSS) at Andrews AFB, MD. Participating units will be advised of the CSS activation via an USMTF SYS.RRM Activation message. Units will be advised to initiate daily SITREP reporting to the NGB Contingency Support Center and specific reporting parameters will be identified in the message.

**d. Initial Mission Reports.**

(1) Format for content of this report is contained in appendix B. Information will be reported by reference to paragraph and subparagraph, omitting paragraphs for which no current information is available.

(2) Follow-up reports. As significant changes occur (i.e., changes in personnel, location of command post, or deployment of forces) or as additional information becomes available, follow-up reports will be made as prescribed above. Follow-up reports will be made NLT 1200 EST.

**e. After Action Reports.** An after action report (RCS ARNGB-98) will be prepared and forwarded to NGB-MS within 15 days after completion of each operation. The format for these reports are prescribed in appendix B.

(1) **After Action Report.** The format shown in appendix B will be used for most military support missions.

(2) **Abbreviated After Action Report.** The format shown in appendix B is intended to reduce administrative requirements in preparing lengthy after action reports for minor incidents, and may be used for missions in which less than 25 Guard personnel are used.



## INTERNAL CONTROL REVIEW CHECKLIST

1. The purpose of this checklist is to provide guidelines for personnel, property and other assets that normally are utilized in Military Support Operations. See AR 11-2 and OMB Circular A-123 for specific requirements of the Internal Control Program.

2. Internal Control is a command responsibility that receives up to congressional level attention. It emphasizes resource(s) accountability. This checklist must be used within 120 days of initial publication and every 2 years thereafter.

## 3. Internal Control Categories:

a. Categories of internal control are accounting and administrative.

(1). Accounting controls relate to safeguarding assets and effective financial management. Focus is on item accountability and performance measures.

(2). Administrative Controls apply to authorization actions for transactions and events. They focus on program performance and the economy as well as efficiency of operations.

b. The following Internal control checklist will be used as a guide when conducting internal military support reviews IAW AR 11-2 and OMB Circular A-123.

## Internal Control Review Checklist

Are commanders familiar with NGR (AR) 500-1 and ANGR 355-1?	Yes	No
Is the state terrorism counteraction plan up-to-date?	Yes	No
Does the state have an up-to-date personnel special skill list on hand IAW NGR (AR) 500-1?	Yes	No
Does the state review and update their emergency response plans annually IAW NGR (AR) 500-1?	Yes	No
Has NGB-MS been provided two copies of the emergency response plans IAW NGR (AR) 500-1 and ANGR 355-1?	Yes	No
Has the emergency response plan been coordinated with all appropriate federal and state agencies,(to include the state attorney general's office)?	Yes	No
Have procedures been established to record and report use of federal resources during State Active Duty?	Yes	No
Have procedures been established to effect reimbursement by the state to the USP&FO for federal resources used during State Active Duty?	Yes	No
Does the emergency response plan provide information to perform duty on federal status, using Garden Plot as a guide?	Yes	No
Has NGB-MS been provided with current state maps?	Yes	No
Do units assigned civil disturbance missions receive annual evaluation, IAW AR 350-77	Yes	No
Are units that do not meet criteria reported to NGB-MSO, IAW NGR (AR) 500-1?	Yes	No
Does the state have a current copy of: AR 500-60, AR 95-1, NGR (AR) 95-1, NGB Pam 95-5, NGR (AR) 600-5, ANGR 35-03, and AR 700-1?	Yes	No

**Internal Control Review Checklist--Continued**

Do units with "on-the-street" civil disturbance missions, conduct annual refresher and junior leadership training IAW NGR (AR) 350-1?	Yes	No
Are Secret service support missions coordinated with the state POMSO Office?	Yes	No
Are Air National Guard military support missions coordinated with the POMSO office?	Yes	No

**APPENDIX A  
REFERENCES**

**Section I  
Required Publications**

**AR II-2**  
Internal Control Systems. (Cited in the "Internal Control System" statement.)

**AR 350-7**  
Training/Evaluation of Civil Disturbance Forces (Cited in para 4-7.)

**AR 500-50**  
Civil Disturbances

**AR 500-60**  
Disaster Relief

**AR 500-70**  
Military Support to Civil Defense

**AR 700-131** Loan of Army Materiel. (Cited in para 3-1a.)

**AFR 208-1**  
Federal Tort Claims Act

**AFR 355-1**  
Disaster Preparedness Planning and Operation

**FORSCOM REG 525-54**  
Critical Facilities Protection Program

**DoD Civil Disturbance Plan "GARDEN PLOT"**

**FM 19-15**  
Civil Disturbance. (Cited in paras 4-5a(1), 4-5c, and 4-6.)

**NGB Pam 360-5/ANGP 190-9**  
National Guard Public Affairs Guidelines. (Cited in para 1-6.)

**ANGR 67-1**  
Loan/Use of Air National Guard Property. (Cited in para 3-1a.)

**Section II  
Related Publications**

**DOD Directive 3025.1**  
Use of Military Resources During Peacetime Civil Emergencies Within the US, Its Territories and Possessions

**DOD Directive 3025.12**  
Military Support to Civil Defense

**DOD Directive 5160.54**  
DoD Key Assets Protection Program (KAPP)

**DOD Directive 5525.5**  
DoD Cooperation with Civilian Law Enforcement Officials (Change 1)

**AR 71-13**  
Dept of Army Equipment Authorization and Usage Program

**AR 95-1/NGR (AR) 95-1**  
Aviation Flight Regulations

**AR 130-5/AFR 45-17**  
National Guard Bureau Organization/Functions

**AR 190-10**  
Threats to the President and Other Government Officials

**AR 310-49**  
The Army Authorization Documents System (TAADS)

**AR 525-13**  
The Army Terrorism Counteraction Program

**DA Pam 190-52**  
Personnel Security Precautions Against Terrorism

**AFR 55-3**  
Operations (Reporting, Meaconing, Intrusion, etc)

**CTA 50-909**  
Field and Garrison Furnishings and Equipment

**FORSCOM/NGB Regulation 350-2**  
Reserve Component (US Army) Training

**NGR 10-2**  
State Area Command, Army National Guard

**NGR (AR) 350-1**  
Army National Guard Training

**NGR (AR) 600-85**  
Drug Abuse Prevention and Control

**NGB Pam 95-5**  
Use of Army National Guard Aircraft

**ANGR 23-01**  
State Air National Guard Headquarters

**ANGR 35-03**  
Full-Time Military Duty Personnel Program - Air  
National Guard

**ANGR 55-03**  
Operations Event/Incident Report

**ANGR 355-1**  
Planning and Operations

**NGB study, "Military Support to Civil Authorities for  
Continuance of Vital Public Services, FY 79-1."**

**NGB study, "Terrorism and Hazardous Material In-  
cidents, August 1980."**

APPENDIX B  
NATIONAL GUARD MILITARY SUPPORT  
TELEPHONE REPORT OF STATE EMERGENCY DUTY

- 1. DATE \_\_\_\_\_ PERSON REPORTING \_\_\_\_\_ STATE \_\_\_\_\_
- 2. TYPE OF REPORT: INITIAL \_\_\_\_\_ FOLLOW-UP \_\_\_\_\_ CLOSING \_\_\_\_\_
- 3. SOURCE OF REQUEST: \_\_\_\_\_
- 4. TYPE INCIDENT: CIVIL DISTURBANCE \_\_\_ NATURAL DISASTER \_\_\_ OTHER \_\_\_\_\_
- 5. MISSION NUMBER: \_\_\_\_\_
- 6. LOCATION: CITY: \_\_\_\_\_ COUNTY \_\_\_\_\_
- 7. SITUATION: \_\_\_\_\_  
\_\_\_\_\_  
\_\_\_\_\_
- 8. MISSION: \_\_\_\_\_  
\_\_\_\_\_  
\_\_\_\_\_
- 9. DATES: EFFECTIVE \_\_\_\_\_ RELEASED \_\_\_\_\_
- 10. STATUS: SAD \_\_\_\_\_ IDT/AT \_\_\_\_\_ ST/FTTD \_\_\_\_\_ OTHER \_\_\_\_\_
- 11. PERSONNEL: ARNG \_\_\_\_\_ ANG \_\_\_\_\_ TOTAL \_\_\_\_\_
- 12. TASK FORCE COMMANDER: \_\_\_\_\_ EOC \_\_\_\_\_
- 13. UNIT'S ACTIVITIES: \_\_\_\_\_  
\_\_\_\_\_  
\_\_\_\_\_  
\_\_\_\_\_
- 14. EQUIPMENT: \_\_\_\_\_  
\_\_\_\_\_  
\_\_\_\_\_  
\_\_\_\_\_

**NATIONAL GUARD MILITARY SUPPORT  
AFTER-ACTION REPORT FORMAT**

**MEMORANDUM FOR:** Chief, National Guard Bureau ATTN: NGB-MSOPentagon,  
Washington, D.C. 20310-2500

**SUBJECT:** After Action Report (RCS: ARNGB-98) (Identify operation and Inclusive dates)

**1. General**

**a. Type emergency.** Include location by city, county, and state. (Identify type civil disturbance or emergency.)

**b. Inclusive dates by date time group:**

**c. Scope of emergency:**

(1) Use narrative explanation.

(2) Include percentage of State ARNG and/or ANG forces called to duty.

**2. Operations**

**a. Strength.** ARNG and/or ANG strength of called forces will be reported for each unit/organization for each day of duty. The report will be in column form as follows:

Date \_\_\_\_\_

Unit/Organization Designation	Service*	Number of Personnel**				Status***
		OFF	WO	EM	AGG	
		—	—	—	—	
	Total****					

- \* Service will be indicated by ARNG or ANG
- \*\* # Personnel present for duty with subtotals for ARNG & ANG
- \*\*\* Status will be indicated by UTA, MUTA, or SAD
- \*\*\*\*Total number of troops used during call-up

**b. Operations Summary.** Chronology of significant events in phases as follows:

(1) *Planning/alert.*

(2) *Execution.*

(3) *Post operations.*

**c. Communications.** Types or methods.

**d. Training.** Evaluation of the effectiveness of civil disturbance training conducted prior to the occurrence of this incident. Number of hours civil disturbance refresher training conducted by each unit during this operation.

**3. Administration**

**a. Public Affairs.**

**b. Special Services.**

1 October 1991

NGR (AR) 500-1/NGR (AF) 55-5

*c. Morale and discipline.*

*d. National Guard injuries or casualties.*

**4. Logistics**

Equipment. Special equipment and supplies used and source of issue (Note: If ARNG or ANG aircraft are used, the information provided shall include type of aircraft used and number of hours flown, by type.)

**5. Costs**

Total Cost of State Active Duty, including as a minimum the following:

*a. Pay.*

*b. Subsistence.*

*c. Housing.*

*d. Transportation.*

*e. Maintenance.*

*f. Supplies.*

*g. Equipment.*

*h. Fuel and petroleum.*

*i. Funds paid by other state agencies.*

*j. Reimbursable cost.*

**6. Problem areas**

*a. Personnel.*

*b. Intelligence.*

*c. Operations.*

*d. Organization.*

*e. Training.*

*f. Logistics.*

*g. Communications.*

*h. Material.*

*i. Other.*

**7. Lessons learned**

Include any special organization and new tactics or techniques developed to control the emergency.

**8. Recommendations**

**NATIONAL GUARD MILITARY SUPPORT  
MINOR INCIDENT AFTER ACTION REPORT FORMAT**

**MEMORANDUM FOR:** Chief, National Guard Bureau ATTN: NGB-MSO  
Washington, DC 20310-2500

**SUBJECT:** AFTER ACTION REPORT, (Title)

**STATE:**

**MISSION:**

**DATE(S):**

**EFFECTIVE:** COMPLETED

**LOCATION:** CITY COUNTY

**NUMBER OF TROOPS:** ARNG ANG

**MANDAYS USED:**

**EQUIPMENT USED:** (Note: If ARNG or ANG aircraft are used, the information provided should include type aircraft used and hours flown, by type.)

**APPROXIMATE COST:** (include all related costs)

**COMMENTS**



ber 1991

NGR (AR) 500-1/NGR (AF) 55-5

By Order of the Secretaries of the Army and the Air Force:

**JOHN B. CONAWAY**  
Lieutenant General, USAF  
Chief, National Guard Bureau

Official:

**E. DARDEN BAINES**  
Chief  
Administrative Services

Distribution: C/F

\*U.S. Government Printing Office: 1991 — 500-081/43025



Department of Defense  
**DIRECTIVE**

Reprint incorporating Chg

January 15, 1986  
NUMBER 5525.5

ASD (FM&P)

**SUBJECT:** DoD Cooperation with Civilian Law Enforcement Officials

**References:** (a) through (ll), see enclosure 1

**A. REISSUANCE AND PURPOSE**

This Directive reissues reference (a) to update uniform DoD policies and procedures to be followed with respect to support provided to Federal, State, and local civilian law enforcement efforts; and assigns responsibilities.

**B. APPLICABILITY AND SCOPE**

1. This Directive applies to the Office of the Secretary of Defense (OSD), the Military Departments, the Organization of the Joint Chiefs of Staff (OJCS), the Unified and Specified Commands, and the Defense Agencies (hereafter referred to collectively as DoD Components). The term "Military Service," as used herein, refers to the Army, Navy, Air Force, and Marine Corps.

2. DoD policy on assistance to law enforcement officials in foreign governments is not governed by this Directive except as specified by other DoD issuances.

**C. DEFINITIONS**

1. Civilian Agency. An agency of one of the following jurisdictions:

a. The United States (other than the Department of Defense, but including the U.S. Coast Guard). This includes U.S. agencies in international areas dealing with U.S. flag vessels or aircraft in violation of U.S. law.

b. A State (or political subdivision of it) of the United States.

c. Commonwealth, Territory, or Possession (or political subdivision of it) of the United States.

2. Civilian Law Enforcement Official. An officer or employee of a civilian agency with responsibility for enforcement of the laws within the jurisdiction of that agency.

3. DoD Intelligence Component. An organization listed in subsection C.4. of DoD Directive 5240.1 (reference (b)).

4. The Secretaries of the Military Departments and the Directors of the Defense Agencies, as appropriate, shall:

- a. Disseminate the guidance issued by the ASD(FM&P) under paragraph E.1.d., above.
- b. Review training and operational programs to determine how and where assistance can best be provided civilian law enforcement officials consistent with the policy in section D., above. This review should identify those programs under which reimbursement would not be required under enclosure 5.
- c. Issue implementing documents incorporating the guidelines and procedures of this Directive, including the following:
  - (1) Procedures for prompt transfer of relevant information to law enforcement agencies.
  - (2) Procedures for establishing local contact points in subordinate commands for purposes of coordination with Federal, State, and local civilian law enforcement officials.
  - (3) Guidelines for evaluating requests for assistance in terms of impact on national security and military preparedness.
- d. Inform the Joint Chiefs of Staff (JCS), through ASD(FM&P) of all requests for and taskings in support of civilian law enforcement that involve the resources of a Unified or Specified Command, which, if provided, could have significant impact on military preparedness or national security.

5. The Director, National Security Agency/Chief, Central Security Service (DIRNSA/CHCSS) shall establish appropriate guidance for the National Security Agency/Central Security Service (NSA/CSS).

6. The Joint Chiefs of Staff shall:

- a. Assist the ASD(FM&P) in the development of guidance for use by approving authorities in evaluating the impact of requests for assistance on national security and military preparedness.
- b. Provide advice on the impact on national security and military preparedness of any request for military assistance at the request of the Secretary of Defense, the ASD(FM&P), the Secretaries of the Military Departments, the Directors of Defense Agencies, or the Commanders of the Unified and Specified Commands.

F. INFORMATION REQUIREMENTS

A quarterly report of all requests for assistance (approved, denied, or pending) shall be submitted by the Secretaries of the Military Departments and the Directors of Defense Agencies to the ASD(FM&P), the General Counsel, the ASD(HA), and the ASD(RA), not later than 30 days after the end of each

**Enclosures - 7**

- 1. References**
- 2. Use of Information Collected During Military Operations**
- 3. Use of Military Equipment and Facilities**
- 4. Restrictions on Participation of DoD Personnel  
in Civilian Law Enforcement Activities**
- 5. Funding**
- 6. Sample Format for Preparing, "Report on Support to  
Civilian Law Enforcement (RCS DD-FM&P(Q)1595)"**
- 7. Aviation Assistance to Law Enforcement Agencies (Sample  
Format)**

REFERENCES

- (a) DoD Directive 5525.5, subject as above, March 22, 1982 (hereby canceled)
- (b) DoD Directive 5240.1, "Activities of DoD Intelligence Components that Affect U.S. Persons," December 3, 1982
- (c) DoD Directive 5106.1, "Inspector General of the Department of Defense," March 14, 1983
- (d) Title 10, United States Code (10 U.S.C.), §§331-334, 337, 371-378, 2576, and 2667; and Chapter 47 (Uniform Code of Military Justice)
- (e) DoD Directive 5200.27, "Acquisition of Information Concerning Persons and Organizations not Affiliated with the Department of Defense," January 7, 1980
- (f) DoD 5240.1-R, "Procedures Governing the Activities of DoD Intelligence Components that Affect United States Persons," December 1982, authorized by reference (b)
- (g) DoD Directive 5400.11, "Department of Defense Privacy Program," June 9, 1982
- (h) DoD 4515.13-R, "Air Transportation Eligibility," January 1980, authorized by DoD Directive 4515.13, June 26, 1979
- (i) Public Law, "The Economy Act," (31 U.S.C. §1535)
- (j) Public Law, "The Intergovernmental Cooperation Act of 1968," (40 U.S.C. §§531-535 and 42 U.S.C. §§4201, 4211-4214, 4221-4225, 4231-4233, 4241-4244)
- (k) Public Law, "Federal Property and Administrative Services Act of 1949," (40 U.S.C. §§471-476, 481, 483, 483c, 484-492, 512, 514, 531-535, 541-544, 751-759; 41 U.S.C. §§5, 251-255, 257-260; 44 U.S.C., Chapters 21, 25, 29, 31; and 50 U.S.C. Appendix 1622)
- (l) DoD Directive 3025.12, "Employment of Military Resources in the Event of Civil Disturbances," August 19, 1971
- (m) DoD Instruction 4160.23, "Sale of Surplus Military Equipment to State and Local Law Enforcement and Firefighting Agencies," January 27, 1981
- (n) DoD Instruction 4160.24, "Disposal of Foreign Excess Personal Property for Substantial Benefits or the Discharge of Claims," July 24, 1981
- (o) DoD Directive 4165.6, "Real Property Acquisition, Management and Disposal," December 22, 1976
- (p) DoD Directive 4165.20, "Utilization and Retention of Real Property," January 31, 1985
- (q) DoD Directive 5410.12, "Economic Adjustment Assistance to Defense-Impacted Communities," April 21, 1973
- (r) DoD Instruction 7230.7, "User Charges," January 29, 1985
- (s) DoD Instruction 7310.1, "Disposition of Proceeds from Sales of DoD Excess and Surplus Personal Property," November 15, 1984
- (t) DoD Instruction 7730.53, "Specialized or Technical Services Provided to State and Local Government," December 23, 1982
- (u) DoD Directive 5030.46, "Assistance to the District of Columbia Government in Combating Crime," March 26, 1971
- (v) Public Law, "Posse Comitatus Act," (18 U.S.C. §1385)
- (w) DoD Directive 5525.7, "Implementation of the Memorandum of Understanding Between the Department of Justice and the Department of Defense Relating to the Investigation and Prosecution of Certain Crimes," January 22, 1985
- (x) Title 5, United States Code, Appendix 3, Section 8(g)
- (y) Title 16, United States Code, §§23, 78, 593, and 1861(a)
- (z) Title 18, United States Code, §§112, 351, 831, 1116, 1751, and 3056; "Presidential Protection Assistance Act of 1976," Public Law 94-524, 90 Stat. 2475

USE OF INFORMATION COLLECTED DURING MILITARY OPERATIONS

A. ACQUISITION AND DISSEMINATION

Military Departments and Defense Agencies are encouraged to provide to Federal, State, or local civilian law enforcement officials any information collected during the normal course of military operations that may be relevant to a violation of any Federal or State law within the jurisdiction of such officials. The Secretaries of the Military Departments and Directors of the Defense Agencies shall prescribe procedures for releasing information upon reasonable belief that there has been such a violation.

1. The assistance provided under this enclosure shall be in accordance with 10 U.S.C. §371 (reference (d)) and other applicable laws.

2. The acquisition and dissemination of information under this enclosure shall be in accordance with DoD Directive 5200.27 (reference (e)), DoD Directive 5240.1 (reference (b)), and DoD 5240.1-R (reference (f)).

3. Military Departments and Defense Agencies shall establish procedures for "routine use" disclosures of such information in accordance with DoD Directive 5400.11 (reference (g)).

4. Under guidance established by the Secretaries of the Military Departments and the Directors of the Defense Agencies concerned, the planning and execution of compatible military training and operations may take into account the needs of civilian law enforcement officials for information when the collection of the information is an incidental aspect of training performed for a military purpose. In this regard, the needs of civilian law enforcement officials may be considered when scheduling routine training missions. This does not permit the planning or creation of missions or training for the primary purpose of aiding civilian law enforcement officials, and it does not permit conducting training or missions for the purpose of routinely collecting information about U.S. citizens. Local law enforcement agents may accompany routinely scheduled training flights as observers for the purpose of collecting law enforcement information. This provision does not authorize the use of DoD aircraft to provide point-to-point transportation and training flights for civilian law enforcement officials. Such assistance may be provided only in accordance with DoD 4515.13-R (reference (h)).

5. Under procedures established by the Secretaries of Military Departments and the Directors of the Defense Agencies concerned, information concerning illegal drugs that is provided to civilian law enforcement officials under this provision (reference (f)) may be provided to the El Paso Intelligence Center.

6. Nothing in this section modifies DoD policies or procedures concerning dissemination of information for foreign intelligence or counterintelligence purposes.

7. The Military Departments and Defense Agencies are encouraged to participate in Department of Justice Law Enforcement Coordinating Committees situated in each Federal Judicial District.

USE OF MILITARY EQUIPMENT AND FACILITIES

A. EQUIPMENT AND FACILITIES

Military Departments and Defense Agencies may make equipment, base facilities, or research facilities available to Federal, State, or local civilian law enforcement officials for law enforcement purposes in accordance with this enclosure.

1. The ASD(FM&P) shall issue guidance to ensure that the assistance provided under this enclosure is in accordance with applicable provisions of 10 U.S.C. §§372, 2576, and 2667 (reference (d)); the Economy Act (reference (i)); the Intergovernmental Cooperation Act of 1968 (reference (j)); the Federal Property and Administrative Services Act of 1949 (reference (k)); and other applicable laws.

2. The guidance in subsection A.1., above, shall ensure that the following Directives are complied with: DoD Directive 3025.12 (reference (l)); DoD Instruction 4160.23 (reference (m)); DoD Instruction 4160.24 (reference (n)); DoD Directive 4165.6 (reference (o)); DoD Directive 4165.20 (reference (p)); DoD Directive 5410.12 (reference (q)); DoD Instruction 7230.7 (reference (r)); DoD Instruction 7310.1 (reference (s)); DoD Instruction 7730.53 (reference (t)); and other guidance that may be issued by the ASD(FM&P) and the Assistant Secretary of Defense (Comptroller) (ASD(C)).

3. The assistance provided by DoD Intelligence Components is subject to DoD Directive 5240.1 (reference (b)) and DoD 5240.1-R (reference (f)).

B. LIMITATIONS ON THE USE OF PERSONNEL

1. A request for DoD personnel to operate or maintain or to assist in operating or maintaining equipment made available under section A., above, shall be considered under the guidance in subsection A.6. (enclosure 4).

2. Personnel in DoD intelligence components also are subject to the limitations in DoD Directive 5240.1 (reference (b)) and DoD 5240.1-R (reference (f)).

C. MILITARY PREPAREDNESS

Assistance may not be provided under this enclosure if such assistance could adversely affect national security or military preparedness. The implementing documents issued by the Secretaries of the Military Departments and the Directors of the Defense Agencies shall ensure that approval for the disposition of equipment is vested in officials who can assess the impact of such disposition on national security and military preparedness.

D. APPROVAL AUTHORITY

Requests by civilian law enforcement officials for DoD assistance in civilian law enforcement functions shall be forwarded to the appropriate approval authority under the guidance in this section.

Jan 15, 86  
5525.5 (Encl 3)

f. All requests, including those in which subordinate authorities recommend denial, shall be submitted promptly to the approving authority using the format and channels established by the ASD(FM&P). Requests will be forwarded and processed according to the urgency of the situation.

E. FUNDING

Funding requirements for assistance under this enclosure shall be established under the guidance in enclosure 5.



RESTRICTIONS ON PARTICIPATION OF DoD  
PERSONNEL IN CIVILIAN LAW ENFORCEMENT ACTIVITIES

A. STATUTORY REQUIREMENTS

1. Posse Comitatus Act. The primary restriction on military participation in civilian law enforcement activities is the Posse Comitatus Act (reference (v)), which provides:

"Whoever, except in cases and under circumstances expressly authorized by the Constitution or Act of Congress, willfully uses any part of the Army or the Air Force as a posse comitatus or otherwise to execute the laws shall be fined not more than \$10,000 or imprisoned not more than two years or both."

2. Permissible direct assistance. The following activities are not restricted by reference (v).

a. Actions that are taken for the primary purpose of furthering a military or foreign affairs function of the United States, regardless of incidental benefits to civilian authorities. This provision must be used with caution, and does not include actions taken for the primary purpose of aiding civilian law enforcement officials or otherwise serving as a subterfuge to avoid the restrictions of reference (v). Actions under this provision may include the following, depending on the nature of the DoD interest and the authority governing the specific action in question:

(1) Investigations and other actions related to enforcement of the Uniform Code of Military Justice (UCMJ) (reference (d)).

(2) Investigations and other actions that are likely to result in administrative proceedings by the Department of Defense, regardless of whether there is a related civil or criminal proceeding. See DoD Directive 5525.7 (reference (w)) with respect to matters in which the Departments of Defense and Justice both have an interest.

(3) Investigations and other actions related to the commander's inherent authority to maintain law and order on a military installation or facility.

(4) Protection of classified military information or equipment.

(5) Protection of DoD personnel, DoD equipment, and official guests of the Department of Defense.

(6) Such other actions that are undertaken primarily for a military or foreign affair's purpose.

b. Audits and investigations conducted by, under the direction of, or at the request of IG, DoD, 5 U.S.C., Appendix 3, §8(g) (reference (x)), subject to applicable limitations on direct participation in law enforcement activities.

(8) Removal of persons unlawfully present on Indian lands. See 25 U.S.C. §180 (reference (bb)).

(9) Execution of quarantine and certain health laws. See 42 U.S.C. §97 (reference (cc)).

(10) Execution of certain warrants relating to enforcement of specified civil rights laws. See 42 U.S.C. §1989 (reference (cc)).

(11) Removal of unlawful inclosures from public lands. See 43 U.S.C. §1065 (reference (dd)).

(12) Protection of the rights of a discoverer of a guano island. See 48 U.S.C. §1418 (reference (ee)).

(13) Support of territorial governors if a civil disorder occurs. See 48 U.S.C. §§1422 and 1591 (reference (ee)).

(14) Actions in support of certain customs laws. See 50 U.S.C. §220 (reference (ff)).

3. Restrictions on Direct Assistance. Except as otherwise provided in this enclosure, the prohibition on the use of military personnel "as a posse comitatus or otherwise to execute the laws" prohibits the following forms of direct assistance:

- a. Interdiction of a vehicle, vessel, aircraft, or other similar activity.
- b. A search or seizure.
- c. An arrest, apprehension, stop and frisk, or similar activity.
- d. Use of military personnel for surveillance or pursuit of individuals, or as undercover agents, informants, investigators, or interrogators.

4. Training

a. The Military Departments and Defense Agencies may provide training to Federal, State, and local civilian law enforcement officials. Such assistance may include training in the operation and maintenance of equipment made available under section A. of enclosure 3. This does not permit large scale or elaborate training, and does not permit regular or direct involvement of military personnel in activities that are fundamentally civilian law enforcement operations, except as otherwise authorized in this enclosure.

b. Training of Federal, State, and local civilian law enforcement officials shall be provided under the following guidance:

- (1) This assistance shall be limited to situations when the use of non-DoD personnel would be unfeasible or impractical from a cost or time perspective and would not otherwise compromise national security or military preparedness concerns.

(4) Any other law that establishes authority for DoD personnel to provide direct assistance to civilian law enforcement officials. In addition to the assistance authorized under this paragraph, the following assistance may be provided:

(a) DoD personnel may be assigned to operate or assist in operating equipment to the extent the equipment is used for monitoring and communicating to civilian law enforcement officials the movement of air and sea traffic with respect to any criminal violation of the laws specified in paragraph A.2.e., above. This includes communicating information concerning the relative position of civilian law enforcement officials and other air and sea traffic.

(b) In an emergency circumstance, equipment operated by or with the assistance of DoD personnel may be used outside the land area of the United States (or any Commonwealth, territory, or possession of the United States) as a base of operations by Federal law enforcement officials to facilitate the enforcement of a law in subparagraph A.2.c.(1), above, and to transport such law enforcement officials in connection with such operations, subject to the following limitations:

1 Equipment operated by or with the assistance of DoD personnel may not be used to interdict or interrupt the passage of vessels or aircraft, except when DoD personnel are otherwise authorized to take such action with respect to a civilian law enforcement operation.

2 There must be a joint determination by the Secretary of Defense and the Attorney General that an emergency circumstance exists under 10 U.S.C. §374(c)(2) (reference (d)). An emergency circumstance may be determined to exist for purposes of this subparagraph only when the size and scope of the suspected criminal activity in a given situation poses a serious threat to the interests of the United States; and enforcement of laws in paragraph A.2.e., above, would be impaired seriously if the assistance described in this subparagraph were not provided.

(c) The emergency authority in this subparagraph may be used only with respect to large scale criminal activity at a particular point in time or over a fixed period. It does not permit use of this authority on a routine or extended basis.

(d) Nothing in this subparagraph restricts the authority of military personnel to take immediate action to save life or property or to protect a Federal function as provided in paragraph A.2.b., above.

(3) When DoD personnel are otherwise assigned to provide assistance with respect to the laws specified in paragraph A.2.e., above, the participation of such personnel shall be consistent with the limitations in such laws, if any, and such restrictions as may be established by the Secretary of Defense, the ASD(FM&P), or the Secretaries of the Military Departments and the Directors of the Defense Agencies concerned.

7. Other Permissible Assistance. The following forms of indirect assistance are not restricted by the Posse Comitatus Act (reference (d)) (see enclosure 3):

**D. MILITARY PREPAREDNESS**

Assistance may not be provided under this enclosure if such assistance could adversely affect national security or military preparedness. The implementing documents issued by the Secretaries of the Military Departments and the Directors of the Defense Agencies shall ensure that approval for the disposition of equipment is vested in officials who can assess the impact of such disposition on national security and military preparedness.

**E. APPROVAL AUTHORITY**

Requests by civilian law enforcement officials for use of DoD personnel in civilian law enforcement functions shall be forwarded to the appropriate approval authority under the guidance in this section.

1. The use of DoD personnel in civil disturbances and related matters is governed by DoD Directive 3025.12 (reference (1)), which includes the approval authorities.

2. Approval authority for assistance to the government of the District of Columbia is governed by DoD Directive 5030.46 (reference (u)).

3. The following governs approval for assistance to civilian law enforcement officials in other circumstances.

a. The Secretary of Defense is the approval authority for requests that involve assignment of 50 or more DoD personnel or a period of assignment of more than 30 days.

b. The Secretaries of the Military Departments and Directors of Defense Agencies may approve the following types of assistance, except as provided in E.3.a., above:

(1) Use of DoD personnel to provide training or expert advice in accordance with subsections A.4. and A.5., above.

(2) Use of DoD personnel for equipment maintenance in accordance with subparagraph A.6.b.(1), above.

(3) Use of DoD personnel to monitor and communicate the movement of air and sea traffic in accordance with subparagraph A.6.b.(1), above.

c. The ASD(FM&P) is the approval authority for other requests for assignment of personnel. This authority may be delegated to the Secretaries of the Military Departments and the Directors of the Defense Agencies with respect to specific categories of assistance.

d. Requests that involve DoD intelligence components are subject to the limitations in DoD Directive 5240.1 (reference (b)) and DoD 5240.1-R (reference (f)), and are subject to approval by the Secretary of Defense.

e. The views of JCS shall be obtained on all requests that are considered by the Secretary of Defense or the ASD(FM&P) or that otherwise involve personnel assigned to a Unified or Specified Command.

## FUNDING

### A. ESTABLISHMENT OF GUIDANCE

Funding requirements and related reporting procedures shall be established by the ASD(FM&P), after consultation with the Assistant Secretary of Defense (Comptroller) (ASD(C)), subject to the guidance of this enclosure.

### B. PROCEDURAL REQUIREMENTS

1. As a general matter, reimbursement is required when equipment or services are provided to agencies outside the Department of Defense. The primary sources of law for reimbursement requirements are the Economy Act (reference (i)) for Federal agencies and the Leasing Statute, 10 U.S.C. §2667 (reference (d)). Other statutes may apply to particular types of assistance. (See section A. of enclosure 3.)

2. If reimbursement is not required by law for a particular form of assistance, the authority to waive reimbursement is delegated to the ASD(FM&P). The ASD(FM&P) may delegate to the Secretaries of the Military Departments and the Directors of the Defense Agencies (or designees) the authority to waive reimbursement on matters within their approval authority. See 10 U.S.C. §377 (reference (d)). The dollar value of a waiver shall be determined in accordance with Chapter 26 of DoD 7220.9-M (reference (11)). A request for waiver may be granted if reimbursement is not otherwise required by law and:

a. Is provided as an incidental aspect of the activity that is conducted for military purposes.

b. Involves the use of DoD personnel in an activity that provides DoD training operational benefits that are substantially equivalent to the benefit of DoD training or operations.

3. The Secretary of the Military Department or the Director of the Defense Agency (or his or her designees) may request the views of the Joint Chiefs of Staff when acting on a request for waiver of reimbursement when such waiver may adversely affect military preparedness.

4. In evaluating requests for waiver of reimbursement, consideration shall be given to the budgetary resources available to civilian law enforcement agencies.

### C. MILITARY PREPAREDNESS

Reimbursement may not be waived if deletion of such funds from a DoD account could adversely affect the national security or military preparedness of the United States.

Sample Format for Preparing, "Report on Support  
to Civilian Law Enforcement (RCS DD-FM&P(Q) 1595)"

The quarterly report shall contain the following information for each request considered:

1. Number and type of assistance requested.
  - a. Facilities.
  - b. Information.
  - c. Equipment.
    - (1) Aircraft
    - (2) Vehicles
    - (3) Vessels
    - (4) Special (night vision goggles, weapons, etc.)
    - (5) Miscellaneous
  - d. Aviation Mission Support.
    - (1) Surveillance
    - (2) Identification aircraft support
    - (3) Logistics
    - (4) Miscellaneous
  - e. Surface Mission Support.
    - (1) Surveillance
    - (2) Ship services (towing, tactical law enforcement teams TACLETs, etc.)
    - (3) Logistics
    - (4) Miscellaneous
  - f. Ground-based Mission Support.
    - (1) Radar/Sensor Surveillance
    - (2) Aerostats
    - (3) Transportation of law enforcement personnel

Jan 15, 86  
5525.5 (Encl 7)

AVIATION ASSISTANCE TO LAW ENFORCEMENT AGENCIES

(Sample Format)

Surveillance

Aircraft	Region State	Sorties	Flight Hours	Detections		Remarks
				Gained	Passed to LEA's	
E-2C	Pacific	18	76	10A	9	No CS support available
E-2C	Atlantic	23	88	13A	10	CHET successful intercept of one acft. Flown by Reserves.
P-3C	Atlantic	103	712	32S	28S	CG seized 3 vessels.

Identification

Aircraft	Region State	Sorties	Flight Hours	Visual/IRDS Attempts	Detections Successful	Remarks

Logistics/Miscellaneous Support

Aircraft	Region State	Sorties	Flights Hours	Remarks
UH-1N	Bahamas	332	299	Bahamas police seized 12,200# marijuana, 2000# cocaine.
RF-4C	Texas	4	7	Reconnaissance of remote airfields

Abbreviation Key:

A - Airborne	SS - Secret Service
Acft- Aircraft	Res - Reserve
S - Surface	ANG - Air Nat'l Guard
L - Land	ARNG - Army Nat'l Guard
CS - U.S. Customs Service	LEA - Law Enforcement Agency
CG - U.S. Coast Guard	CHET - Customs High Endurance Tracker (aircraft)
D - DEA	IRDS - Infrared Detection System

Attachment - 1

1. Aid for Completing Aviation Assistance Portion of Quarterly Report 7-1.

AID FOR COMPLETING AVIATION ASSISTANCE PORTION OF QUARTERLY REPORT

Aviation assistance is the largest area of DoD support to law enforcement agencies. This section is used to report to DoD the Services' aviation assistance. The following is an aid to complete this section.

- Acft - "Aircraft," if flown by other than active duty units, indicate in the "Remarks" column (e.g., Res, ANG, ARNG).
- Region State - Where sorties were flown. (e.g., Pacific, Caribbean, GA, TX, Bahamas, etc.).
- Sorties - Number of flights flown by the platform aircraft during the quarter.
- Flt Hrs. - Number of flight hours flown by the aircraft during the quarter.
- Detections Gained - Number of "raw data" detections against suspect air or surface vessels.
- Detections - The number of detections passed to law enforcement agency for possible investigation.
- Remarks - Used for comments to specify sorties flown by Reserve, ARG, ARNG units; amplify support contributing to known law enforcement success or failure, etc.
- Visual/IRDS - Applies to visual or infrared detection to identify suspect vessel.
- Identification - Aircraft (e.g., OV-10, OV-1) used to identify suspect aircraft prior to handover to the U.S. Customs Service tracker/interceptor aircraft.



FM 100-19  
FMFM 7-10

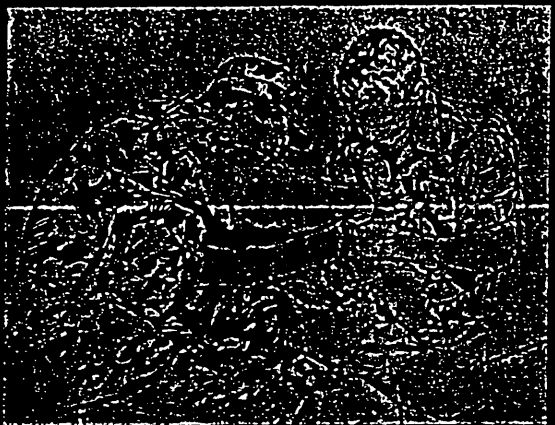

# DOMESTIC SUPPORT OPERATIONS

HEADQUARTERS, DEPARTMENT OF THE ARMY  
US MARINE CORPS

1 JULY 1985

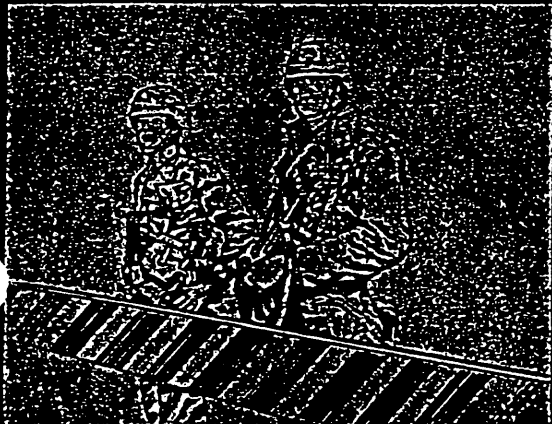

Field Manual  
FM 100-19  
Fleet Marine Force Manual  
FMFM 7-10

Headquarters  
Department of the Army  
The Marine Corps  
Washington, DC, 1 July 1993

# DOMESTIC SUPPORT OPERATIONS

## TABLE OF CONTENTS

	Page
PREFACE .....	vii
INTRODUCTION .....	viii
CHAPTER 1 CONCEPT AND PRINCIPLES .....	1-1
HISTORY AND CATEGORIES OF DOMESTIC SUPPORT .....	1-1
DISASTER ASSISTANCE .....	1-2
ENVIRONMENTAL ASSISTANCE .....	1-2
LAW ENFORCEMENT .....	1-3
COMMUNITY ASSISTANCE .....	1-3
CONCEPT .....	1-4
PRINCIPLES OF OPERATIONS OTHER THAN WAR .....	1-4
THE ARMY'S ROLE .....	1-5
SUMMARY .....	1-6
CHAPTER 2 ROLES AND RESPONSIBILITIES .....	2-1
THE PRESIDENT .....	2-1
FEDERAL AGENCIES OTHER THAN DOD .....	2-2
DEPARTMENT OF AGRICULTURE (USDA) .....	2-2
THE AMERICAN RED CROSS (ARC) .....	2-2
DEPARTMENT OF COMMERCE (DOC) .....	2-2
DEPARTMENT OF EDUCATION (DOEd) .....	2-2
DEPARTMENT OF ENERGY (DOE) .....	2-2
ENVIRONMENTAL PROTECTION AGENCY (EPA) .....	2-2
FEDERAL EMERGENCY MANAGEMENT AGENCY (FEMA) .....	2-3
GENERAL SERVICES ADMINISTRATION (GSA) .....	2-3
DEPARTMENT OF HEALTH AND HUMAN SERVICES (DHHS) ..	2-3
DEPARTMENT OF INTERIOR (DOI) .....	2-4
DEPARTMENT OF JUSTICE (DOJ) .....	2-4
DEPARTMENT OF LABOR (DOL) .....	2-4
NATIONAL COMMUNICATIONS SYSTEM (NCS) .....	2-4
NUCLEAR REGULATORY COMMISSION (NRC) .....	2-4
DEPARTMENT OF STATE (DOS) .....	2-4
DEPARTMENT OF TRANSPORTATION (DOT) .....	2-4
DEPARTMENT OF TREASURY .....	2-5
NATIONAL WEATHER SERVICE (NWS) .....	2-5
DEPARTMENT OF DEFENSE (DOD) .....	2-5
SECRETARY OF DEFENSE (SECDEF) .....	2-5

DISTRIBUTION RESTRICTION: Approved for public release; distribution is unlimited.  
Marine Corps: PCN 139000572 00

DOMESTIC SUPPORT OPERATIONS

	Page
SECRETARY OF ARMY .....	2-5
DIRECTOR OF MILITARY SUPPORT (DOMS) .....	2-5
UNIFIED COMMANDS .....	2-5
DEFENSE COORDINATING OFFICER (DCO) .....	2-8
NATIONAL GUARD .....	2-8
US ARMY RESERVE .....	2-9
MAJOR COMMANDS (MACOMs) .....	2-9
STATE AND LOCAL GOVERNMENT .....	2-9
STATE RESPONSIBILITIES .....	2-10
LOCAL RESPONSIBILITIES .....	2-13
SUMMARY .....	2-13
<b>CHAPTER 3</b>	
LEGAL CONSIDERATIONS AND CONSTRAINTS .....	3-0
CIVILIAN CONTROL OF THE MILITARY .....	3-0
THE ROLE OF THE ARMY .....	3-0
THE LAW .....	3-1
SUPPORT TO CIVILIAN LAW ENFORCEMENT: <i>The Posse</i>	
<i>Comitatus Act</i> .....	3-1
DOMESTIC DISASTER RELIEF: <i>The Robert T. Stafford</i>	
<i>Disaster Relief Act</i> .....	3-2
CIRCUMSTANCES CONCERNING ELECTIONS .....	3-3
COMBATTING TERRORISM, AIRCRAFT PIRACY,	
AND OTHER OPERATIONS .....	3-3
COMBATTING TERRORISM .....	3-3
AIRCRAFT PIRACY .....	3-4
OTHER OPERATIONS .....	3-4
USE OF PERSONNEL, MATERIEL, AND EQUIPMENT .....	3-5
USE OF MILITARY INTELLIGENCE (MI) PERSONNEL .....	3-5
USE OF RESERVE COMPONENT PERSONNEL .....	3-5
USE OF MATERIEL AND EQUIPMENT .....	3-5
REIMBURSEMENT .....	3-5
SUMMARY .....	3-6
<b>CHAPTER 4</b>	
LOGISTICS AND SUPPORT OPERATIONS .....	4-1
PLANNING .....	4-1
SOURCES OF SUPPORT .....	4-2
CONTRACTING .....	4-2
NEGOTIATED SUPPORT .....	4-2
MILITARY SUPPORT .....	4-2
SUPPORT FROM OTHER FEDERAL AGENCIES .....	4-2
LOGISTICS COMMAND AND CONTROL CELLS .....	4-3
RESOURCE MANAGEMENT .....	4-4
SUPPLIES AND FIELD SERVICES .....	4-4

	Page
DEFENSE LOGISTICS AGENCY .....	4-5
QUARTERMASTER (QM) UNITS .....	4-5
MORTUARY AFFAIRS UNITS .....	4-6
FORCE PROVIDER UNIT .....	4-6
OTHER SUPPORT .....	4-7
MAINTENANCE .....	4-8
TRANSPORTATION .....	4-8
DEPLOYMENT .....	4-9
CONVOYS .....	4-9
REDEPLOYMENT .....	4-9
AVIATION .....	4-9
ENGINEER .....	4-10
MAPS AND CHARTS .....	4-11
INTELLIGENCE .....	4-11
MILITARY POLICE .....	4-11
MILITARY HEALTH SERVICE SUPPORT .....	4-11
TASK-ORGANIZED MEDICAL TEAMS .....	4-12
KEY PLANNING GUIDANCE .....	4-12
NATIONAL DISASTER MEDICAL SYSTEM .....	4-12
SYSTEM ACTIVATION .....	4-12
PERSONNEL SERVICES .....	4-13
FINANCE .....	4-14
BAND .....	4-14
LEGAL .....	4-14
CHAPLAINCY .....	4-14
PUBLIC AFFAIRS (PA) .....	4-15
SPECIAL OPERATIONS FORCES (SOF) .....	4-15
CIVIL AFFAIRS .....	4-15
PSYCHOLOGICAL OPERATIONS .....	4-15
SPECIAL FORCES .....	4-16
SIGNAL .....	4-16
CHEMICAL CORPS .....	4-16
SAFETY .....	4-17
SUMMARY .....	4-18
<b>CHAPTER 5</b>	
DISASTERS AND DOMESTIC EMERGENCIES .....	5-1
THE ROLE OF THE ARMY .....	5-1
DISASTERS .....	5-1
RESPONSE FOLLOWING A PRESIDENTIAL DECLARATION ...	5-2
RESPONSE PRIOR TO A PRESIDENTIAL DECLARATION .....	5-3
PREPARING FOR DISASTER ASSISTANCE SUPPORT .....	5-4
THE FEDERAL RESPONSE PLAN .....	5-6
RESPONSIBILITIES .....	5-8
FEDERAL COORDINATING OFFICER .....	5-8

DOMESTIC SUPPORT OPERATIONS

	Page
DEFENSE COORDINATING OFFICER .....	5-8
STATE COORDINATING OFFICER (SCO) .....	5-8
JOINT TASK FORCE (JTF) .....	5-8
DOMESTIC EMERGENCIES .....	5-9
CIVIL DEFENSE EMERGENCIES .....	5-9
ENVIRONMENTAL DISASTERS .....	5-10
MASS IMMIGRATION EMERGENCY SUPPORT OPERATIONS ..	5-11
OTHER DIRECTED MISSIONS .....	5-11
SUMMARY .....	5-11
<b>CHAPTER 6</b> ENVIRONMENTAL MISSIONS .....	6-0
PLANNING AND EXECUTION .....	6-0
CHARACTERISTICS .....	6-1
CLASSIFICATIONS .....	6-2
COMPLIANCE .....	6-2
OIL AND HAZARDOUS MATERIAL SPILLS .....	6-2
PERMIT APPLICATIONS AND PLANS .....	6-3
ENVIRONMENTAL COMPLIANCE ASSESSMENTS (AUDITS) ..	6-3
RESEARCH AND DEVELOPMENT .....	6-3
WETLANDS .....	6-3
RESTORATION .....	6-4
FACILITY RESTORATION .....	6-4
REAL PROPERTY TRANSFERS .....	6-5
GENERAL SUPPORT .....	6-5
PREVENTION .....	6-5
CONSERVATION .....	6-6
NATURAL RESOURCES MANAGEMENT .....	6-6
WILDLAND FIREFIGHTING .....	6-7
ANIMAL DISEASE ERADICATION .....	6-7
CULTURAL RESOURCES MANAGEMENT .....	6-7
ARMY RESOURCES .....	6-8
DEPARTMENT OF THE ARMY .....	6-8
TECHNICAL SUPPORT ORGANIZATIONS .....	6-9
INSTALLATIONS AND STATE AREA COMMANDS .....	6-9
COMMANDERS .....	6-10
SUMMARY .....	6-11

	Page
<b>CHAPTER 7 MISSIONS IN SUPPORT OF LAW ENFORCEMENT</b> .....	7-0
COUNTERDRUG OPERATIONS .....	7-0
ROLES .....	7-0
CATEGORIES OF SUPPORT .....	7-2
REQUESTS FOR SUPPORT .....	7-7
PROVISION OF SUPPORT .....	7-8
CONSIDERATIONS FOR PLANNING .....	7-8
STAND-ALONE CAPABILITY .....	7-8
DECISION-MAKING PROCESS .....	7-8
LEGAL AND TACTICAL ASPECTS .....	7-8
LEGAL CONSTRAINTS .....	7-8
RULES OF ENGAGEMENT .....	7-9
OPERATIONS SECURITY .....	7-9
COMMAND AND CONTROL .....	7-9
COMMUNICATIONS .....	7-11
PUBLIC AFFAIRS .....	7-11
THREAT AWARENESS AND RISK ASSESSMENT .....	7-11
SUPPORT FOR CIVIL DISTURBANCE OPERATIONS .....	7-11
ROLES .....	7-11
REQUESTS FOR FEDERAL MILITARY ASSISTANCE .....	7-12
CONDUCT OF CIVIL DISTURBANCE OPERATIONS .....	7-12
SUPPORT FOR COMBATTING TERRORISM .....	7-14
ANTITERRORISM ASSISTANCE .....	7-14
COUNTERTERRORISM ASSISTANCE .....	7-14
TYPES OF SUPPORT .....	7-14
SUMMARY .....	7-15
<b>CHAPTER 8 COMMUNITY ASSISTANCE</b> .....	8-0
PRINCIPLES .....	8-0
COMMAND EMPHASIS .....	8-1
INDIVIDUAL AND UNIT ENHANCEMENT .....	8-1
READINESS ENHANCEMENT .....	8-1
COMMUNITY BENEFIT .....	8-1
COMMON INTEREST AND BENEFIT .....	8-1
NONCOMPETITIVE .....	8-1
NONPROFIT .....	8-1
TYPES OF COMMUNITY ASSISTANCE .....	8-2
NATIONAL EFFORTS .....	8-2
STATE AND LOCAL EFFORTS .....	8-3
SOCIAL IMPROVEMENTS .....	8-5
PUBLIC AFFAIRS CONSIDERATIONS .....	8-6
LEGAL IMPLICATIONS .....	8-6
SUMMARY .....	8-7

**DOMESTIC SUPPORT OPERATIONS**

---

	Page
<b>CHAPTER 9</b>	
<b>EDUCATION AND TRAINING</b> .....	9-0
<b>CONCEPT</b> .....	9-0
<b>TRAINING TECHNOLOGIES</b> .....	9-2
<b>READINESS</b> .....	9-3
<b>RISK MANAGEMENT</b> .....	9-3
<b>PUBLIC AFFAIRS</b> .....	9-3
<b>ENVIRONMENTAL ASSISTANCE</b> .....	9-4
<b>DISASTER ASSISTANCE OPERATIONS</b> .....	9-4
<b>LAW ENFORCEMENT SUPPORT OPERATIONS</b> .....	9-5
<b>SUMMARY</b> .....	9-6
<b>APPENDIX</b> .....	A-1
<b>GLOSSARY</b> .....	Glossary-0
<b>REFERENCES</b> .....	References-1
<b>INDEX</b> .....	Index - 1

---

## PREFACE

---

### PURPOSE

This manual provides the capstone doctrine for US Army and US Marine Corps domestic support operations. It also provides general information to civilian authorities at federal, state, and local levels involved in planning for and conducting such operations. It identifies linkages and defines relationships with federal, state, and local organizations and with other services that have roles and responsibilities in domestic support operations.

### SCOPE AND APPLICABILITY

This doctrine applies to all Army and Marine Corps commanders and staff tasked with planning, preparing for, and conducting domestic support operations. For overseas theaters, this doctrine applies to US unilateral operations only, subject to applicable host nation laws and agreements.

### USER INFORMATION

This publication was developed by the Army Doctrine Directorate at Headquarters, Training and Doctrine Command (HQ TRADOC) with the participation of the Doctrine Division (C42) at Marine Corps Combat Development Command (MCCDC). HQ TRADOC, with MCCDC, will review and update this publication as necessary. Send comments and recommendations directly to—

Commander  
HQ TRADOC  
ATTN: ATDO-A  
Fort Monroe, VA 23651-5000

or

Commanding General  
Doctrine Division (C42)  
MCCDC  
2042 Broadway Street, Suite 214  
Quantico, VA 22134-5021

Unless this publication states otherwise, masculine nouns and pronouns do not refer exclusively to men.



## INTRODUCTION

---

Domestic support operations are not new. They had their beginning with settlement of the new world and organization of the colonial militia. With the establishment of the United States and a federal military, the Army routinely provided support to state and territorial governors as the nation expanded westward. In some instances, it actually administered governmental affairs until the fledgling local government became a viable entity.

Congress has determined and the National Command Authorities have directed that the military should become more engaged in supporting domestic needs. In addition, the National Security Strategy "Domestic Imperative" affirmed that national security must be viewed in the context of the nation's well-being.

Acknowledging the inherent capabilities the Army possesses for supporting federal, state, and local governments, the Congress has passed numerous laws providing for domestic military support. These laws recognize that the National Guard, while in state status, has primary responsibility for providing initial support when military assistance is required. They also institutionalize interdepartmental and interagency coordination/planning, linking it to the national strategy.

Commanders should anticipate requirements to provide emergency assistance and use domestic support opportunities to enhance unit and individual wartime skills. The Army, particularly the National Guard and Army Reserve, with its extensive combat support and combat service support (CS/CSS) structure, is ideally equipped to assist civil authorities in a wide variety of missions that fall into four general categories: disaster assistance, environmental assistance, law enforcement support, and community assistance.

Although the frequency of domestic support operations may increase, they are not in lieu of wartime operational requirements. The Army's primary mission remains to defend the United States and its interests. It is the Army's combat readiness that enables it to accomplish domestic support operations.

This manual provides specific guidelines and operational principles in the conduct of domestic support operations. It emphasizes the utilization of the Army's core combat competencies and values to enhance combat readiness and the overall well-being of the nation.

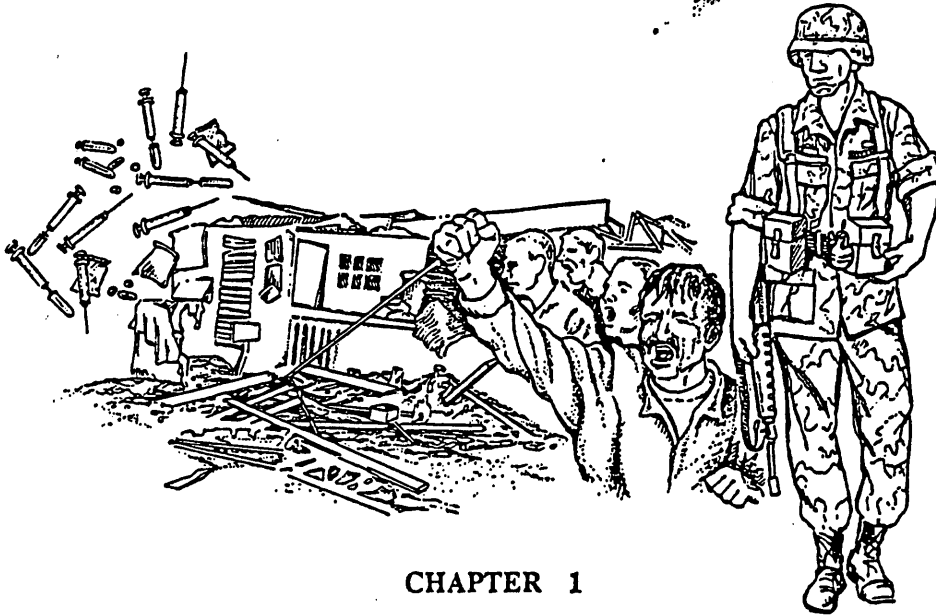

## CHAPTER 1

# CONCEPT AND PRINCIPLES

*This chapter presents a brief historical perspective and concept of Army domestic support operations, the principles of operations other than war that apply to these operations, and a description of the Army's role. The Army consists of the active component (AC), the Army National Guard (ARNG), the US Army Reserve (USAR), and Department of Army (DA) civilians. The National Guard (NG), in a state or territorial status, has primary responsibility for providing military assistance to state and local civil authorities.*

### HISTORY AND CATEGORIES OF DOMESTIC SUPPORT

**A domestic support operation is the authorized use of Army physical and human resources to support domestic requirements.**

Since the Army's inception, its mission has been to fight and win the nation's wars. At the same time, the Army has provided general military support to the nation, including participation in a wide variety of

activities to assist civilian authorities. The Army has enforced laws, quelled domestic violence and insurrection, combatted terrorism, participated in public works and environmental projects, and assisted in recovery operations following disasters.

The dramatic end of the Cold War caused significant changes in the nation's domestic and foreign priorities. During the Cold War, national attention was directed to the external threat and related issues. Today, along with a shift from a forward deployed to a force projection strategy is a new awareness of the benefits of military assistance to improve the nation's physical and social infrastructure. The Army's focus on and continuing involvement in all aspects of domestic support operations identified the need for published doctrine.

## DOMESTIC SUPPORT OPERATIONS

The Army's roles and responsibilities in domestic support operations divide into four primary categories: disaster assistance, environmental assistance, law enforcement support, and community assistance, as depicted in Figure 1-1.

### DISASTER ASSISTANCE.

From the earliest years of the republic, the Army has provided assistance to the country in times of disaster. During the final year of the Civil War, Army officers provided disaster relief through the Freedman's Bureau. The Army also played a direct role in many disaster relief operations in the late nineteenth century, including the great Chicago fire, the Johnstown flood, and the Charleston earthquake.

In recent years, Presidential and Congressionally mandated federal disaster assistance programs have evolved. The Army actively participates with federal

and state agencies in disaster assistance planning, exercises, and operations in response to both natural and man-made disasters.

Disaster assistance includes those humanitarian and civil defense activities, functions, and missions in which the Army has legal authority to act. The Army provides disaster assistance to states, the District of Columbia, territories, and possessions. Civil authorities must request assistance, usually as a result of disasters such as hurricanes, typhoons, earthquakes, or massive explosions.

### ENVIRONMENTAL ASSISTANCE

Environmental assistance has been evolving since the 1960s. The Army has provided a variety of resources to meet environmental challenges that have emerged as a result of increased public concern and demands for the restoration, conservation, and

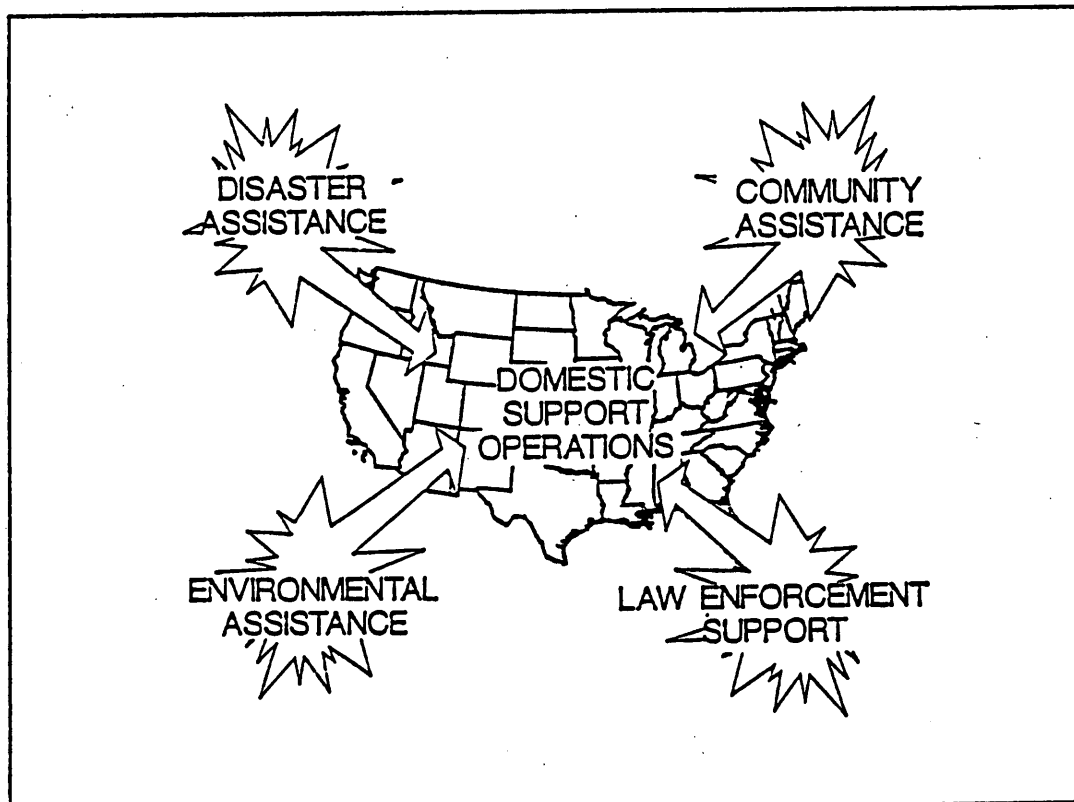

Figure 1-1. Domestic Support

protection of the environment. Typical missions are responding to hazardous material releases, restoring contaminated land and water, and conserving the nation's natural and cultural resources. With the passage of *The Comprehensive Environmental Response, Compensation, and Liability Act of 1980* and the later development of The National Oil and Hazardous Substances Contingency Plan, the Army became a member of the national and regional response teams that plan for and respond to hazardous substance spills.

The Army is inextricably linked to environmental stewardship. Its environmental assistance operations aid civil authorities in preserving, protecting, and enhancing the environment. Its strategy rests on the four pillars of compliance, restoration, prevention, and conservation.

- Compliance is responding to small-scale hazardous material spills and regulating support to other government agencies.
- Restoration is cleaning up contamination from past operations.
- Prevention is developing and sharing new technologies that reduce pollution generation.
- Conservation focuses on the preservation of natural and cultural resources such as wetlands and wildlands.

Army support in these areas may be initiated under disaster assistance or executed under separate authority.

#### LAW ENFORCEMENT

*The Posse Comitatus Act of 1878* severely restricts the use of federal forces to enforce public law. However, acting under Constitutional provisions, the Army has on many occasions been used to quell civil disturbances and restore order. Use of military force has ranged from the Whiskey Rebellion in 1794 to the urban riots of the 1960s and the Los Angeles riot of 1992.

In 1981, Congress passed *The Military Cooperation with Civilian Law Enforcement Agencies Act* to allow military collaboration with civilian law enforcement agencies. This act dramatically expanded the Army's participation in counterdrug efforts. Alliance and North Star are two examples of operations that use active and reserve component forces to halt the flow of contraband across United States borders.

Operations in support of law enforcement include assistance in counterdrug operations, assistance for civil disturbances, special security operations, combating terrorism, explosive ordnance disposal (EOD), and similar activities. Some, by their nature, may become international in scope due to a linkage between domestic and international operations. Constitutional and statutory restrictions and corresponding directives and regulations limit the type of support provided in this area.

#### COMMUNITY ASSISTANCE

Throughout its history, the Army has been involved in community projects and operations, applying its skills, capabilities, and resources to the needs and interests of American communities. Efforts at the national level focus on contributions to the nation and generate public support for the Army. State and local efforts foster an open, mutually satisfactory, cooperative relationship among installations, units, and the local community.

The most frequently conducted domestic support operations involve community assistance. Army resources may be used to support civilian organizations to promote the community's general welfare. These missions and operations include public works, education, and training. Other examples include participation in minor construction projects and providing color guards for local events. In compliance with existing regulations and directives, the Army and local communities may establish mutual support agreements concerning medical, police, and emergency services.

## CONCEPT

**The Secretary of the Army  
is the DOD's executive  
agent for most domestic  
support operations.**

The National Command Authorities (NCA) direct the Army to conduct domestic and international operations. The Secretary of Defense has designated the Secretary of the Army as the executive agent for most domestic support operations. During these operations, military support supplements, rather than replaces, civil agency responsibilities.

The Army provides domestic support through Army posts, camps, installations, armories, and stations as members of the communities in which they are located. Commanders should maintain close liaison with local elected and appointed officials.

Domestic support ranges from disaster assistance to more frequently conducted community assistance activities. All domestic support operations share the common characteristic of using Army human and physical resources to enhance national security, thus contributing to the nation's overall well-being. These operations, which usually draw extensive media attention, must consider public affairs implications.

Environmental missions and operations are directed at the physical infrastructure of the nation. National and local efforts may be supported by Army organizations, activities, and units.

Law enforcement support helps civil law enforcement authorities maintain law and order. Laws, directives, and regulations restrict the Army from assuming the civil law enforcement mission.

Community assistance operations help meet national, state, or local community objectives. Intended to fill needs not met, they should avoid duplication or competition with the civilian sector.

The Army offers assistance, such as providing equipment or personnel to accomplish a specific task, to other federal, state, or local agencies. The Army's goal is to use its assets prudently for domestic support

operations while providing a significant benefit to the nation.

Civilian emergency management is almost universally organized on the "unmet needs" philosophy. Local jurisdictions, responsible for the security and welfare of their citizens, request assistance only when their resources are insufficient to meet requirements. Most states conform to the general outlines of this emergency management concept, as do their constituent county and local jurisdictions. Normally the state directs large-scale efforts, and commanders should establish liaison at that level. Disaster or emergency declarations are associated with legal and funding requirements.

A final facet of this concept is that Army commanders should be aware that exercising Army core competencies and demonstrating Army values are vital aspects of providing domestic support. Basic soldier skills in logistical support, engineering, medical care, and communications are but a few examples of competencies that can be exercised in both wartime and peacetime operations. Commanders should, when possible, use domestic support requirements to exercise basic soldier competencies, thereby enhancing individual and unit wartime capabilities. Additionally, domestic support operations provide excellent opportunities for soldiers to interface with the civilian community and demonstrate traditional Army values such as teamwork, success-oriented attitude, and patriotism. These demonstrations provide positive examples of values that can benefit the community and also promote a favorable view of the Army to the civilian population.

## PRINCIPLES OF OPERATIONS OTHER THAN WAR

Domestic support operations occur under various scenarios and conditions. Regardless, the six principles for the conduct of operations other than war—*objective, unity of effort, legitimacy, perseverance, restraint, and security*—apply. A discussion of each follows.

- *Objective* - Direct every military operation toward a clearly defined, decisive, and attainable objective. All commanders and soldiers must understand the objective and integrate their efforts with those of the supported civil

authorities to achieve it. The concepts of mission, enemy, troops, terrain, and time available (METT-T) determine intermediate or subordinate objectives that must be accomplished to achieve the primary objective.

- *Unity of effort - Seek unity of effort toward every objective.* Commanders must seek, establish, and maintain unity of effort. In most crisis situations, they will be in support and under the general direction of civil authorities. They must coordinate closely with these authorities and clearly understand the lines of authority and control. Unity of effort also requires coordination and cooperation among the other federal agencies involved. Almost all domestic support operations will be conducted in a joint and interagency environment. Although unity of *command* may not be possible since command structures vary, the requirement for unity of *effort* remains.
- *Legitimacy - Sustain the people's willing acceptance of the right of the government to govern or of a group or agency to make and carry out decisions.* Legitimacy derives from the perception that using military force is a legal, effective, and appropriate means of exercising authority for reasonable purposes. However, the issue of legitimacy demands caution and critical judgment. The Army must be aware of the legitimate interests, prerogatives, and authority of the various levels of civil government involved and act accordingly. If the Army aids in the solution of a domestic problem but detracts from the legitimacy of the national or state governments by so doing, its actions will be detrimental to the federal government's long-term strategic objectives.
- *Perseverance - Prepare for the measured, protracted application of military capabilities in support of strategic aims.* Domestic support operations may require years to achieve desired effects. They may not have a clear beginning or end decisively. For example, the Army's involvement in counterdrug operations, which began in 1981, remains active.
- *Restraint - Apply appropriate military capability prudently.* Specific rules of engagement govern

the disciplined application of force. In operations other than war, these rules will be more restrictive, detailed, and sensitive to political concerns and may change frequently during operations. Restraints on weaponry, tactics, and levels of force characterize domestic support operations.

- *Security - Never permit hostile forces to acquire an unexpected advantage.* The Army must never be lulled into believing that the nonhostile intent of a mission involves little or no risk. Individuals or groups may wish to take advantage of a crisis situation for personal gain or to make a political statement. Commanders must be ready to counter activity that could bring harm to their units or jeopardize their mission. Disaster assistance operations focus on alleviating human suffering, but as Army forces involved in 1992 Hurricane Andrew relief discovered, prevention of looting and protection of supplies are also necessary.

## THE ARMY'S ROLE

The National Guard in a nonfederal status has the primary responsibility for providing military assistance to state and local governments.

In domestic support operations, the Army recognizes that National Guard forces, acting under the command of their respective governors in a state (nonfederal) status, have the primary responsibility for providing military assistance to state, territorial, and local governments. When state and National Guard resources need supplementation and the governor requests it, the Army will, at the direction of the NCA, assist civil authorities.

## DOMESTIC SUPPORT OPERATIONS

*During massive flooding of the Mississippi River and its tributaries in the summer of 1993, more than 7000 National Guardsmen from the states of Arkansas, Illinois, Iowa, Kansas, Missouri, and Wisconsin were called to state active duty to provide relief to flood victims. Their duties included providing fresh water, security, evacuation, reconnaissance and traffic control, plus sandbagging, hauling, and dike reinforcement support for the duration of the emergency.*

The Army provides this support at federal, state, and local levels. For example, it may help a state or local community by providing disaster relief or it may provide medical personnel and transportation for a state's firefighting effort. Another example is aiding governmental agencies in cleaning up the environment. The Army may also be designated a lead agent for a

specific operation, such as urban search and rescue (US&R) under the Federal Response Plan (FRP), the document that directs federal response to natural disasters such as earthquakes, hurricanes, typhoons, tornadoes, and volcanic eruptions; technological emergencies involving radiological or hazardous material releases; and other incidents requiring federal assistance as prescribed by law. The FRP provides standing mission assignments to selected governmental and nongovernmental organizations to carry out specific emergency support functions (ESFs). Each type of assistance may require an extensive commitment of resources, depending on the nature and scope of the operation, and close coordination with federal, state, or local officials.

Army commanders will frequently coordinate with civilian emergency managers, both professional and volunteer. They are often referred to as the "coordinators of emergency services" or similar titles and, in smaller jurisdictions, may be the fire chief, police chief, or other official. The Army will—

- Establish achievable objectives.
- Establish clear termination standards.
- Tailor forces to the mission.

## SUMMARY

The Army, composed of the AC, ARNG, USAR, and DA civilians, has a long and proud tradition of providing domestic support to the nation. It ranges from less demanding operations such as community activities to high-intensity crisis situations. Principles of operations other than war provide the Army a conceptual foundation on which to conduct domestic support operations. Although the National Guard has primary responsibility for developing plans and providing support to state and local governments, the national shift from a forward deployed to a force projection strategy has brought a new awareness of the benefits the Army can provide to America.

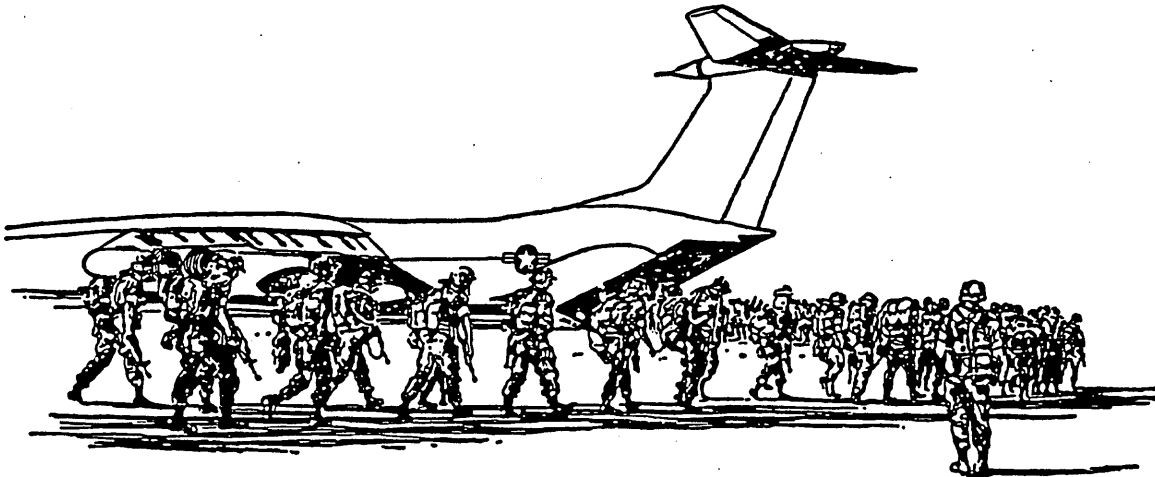

## CHAPTER 2

# ROLES AND RESPONSIBILITIES

*Army support to federal, state, and local agencies covers a broad range of activities, events, and occurrences. The type of domestic support may vary from a static display at a local fair to a large deployment of troops, material, and supplies in response to a natural disaster. The scope may vary from involvement at the local community to massive operations covering a multistate or international arena. Depending on the type and scope of required support, the civil authorities and organizations that Army commanders assist will also vary greatly. These organizations are addressed in this chapter in terms of their roles and responsibilities in disaster assistance, environmental assistance, law enforcement, and community assistance operations. Also addressed are the Department of Defense agencies and commands that have significant responsibilities for providing domestic support.*

### THE PRESIDENT

**The Army will conduct domestic support operations in a joint and interagency environment.**

The President, as the Chief Executive Officer of the US Government and Commander-in-Chief of all US

military forces, authorizes the use of federal resources for domestic support operations. During disasters or other periods of national emergency, the President provides guidance and direction to federal departments, agencies, activities, and other organizations. The President does this by declaring, usually at the request of a governor, a disaster or emergency and appointing a federal coordinating officer (FCO) to coordinate federal-level assistance.

The President also provides leadership and direction in other areas that may generate Army support, for example, drug abuse, the social and physical



## DOMESTIC SUPPORT OPERATIONS

infrastructure, and environmental pollution. The President may further assist in resolving these issues by committing federal resources or by proposing new programs.

### FEDERAL AGENCIES OTHER THAN DOD

Although not all-inclusive, the following list includes those organizations that have significant responsibilities in the categories of assistance addressed in this manual.

#### DEPARTMENT OF AGRICULTURE (USDA)

As the lead agency for food and firefighting under the FRP, the USDA has significant responsibilities in disaster assistance operations. The US Forest Service (USFS), an agency under the USDA, is responsible for leading firefighting efforts as well as protecting forest and watershed land from fire. Jointly with the Department of Interior (DOI), the USFS controls the National Interagency Fire Center (NIFC) in Boise, Idaho. The NIFC, in turn, provides national coordination and logistical support for federal fire control.

The USDA is scientifically and technically capable of measuring, evaluating, and monitoring situations where hazardous substances have impacted natural resources. In that regard, the USDA can also support environmental assistance operations involving cleanup of hazardous substances.

#### THE AMERICAN RED CROSS (ARC)

The ARC, under charter from Congress, is America's official volunteer disaster relief agency. In that capacity, it has a major role in disaster assistance operations, having been designated the lead agency for mass care under the FRP. Due to the general nature of its charter, it can provide support in environmental assistance, law enforcement, and selected community assistance operations.

#### DEPARTMENT OF COMMERCE (DOC)

The DOC provides fire and weather forecasting as needed from the NIFC or from a nearby weather forecasting facility. Through the National Oceanic and Atmospheric Administration, it provides scientific support for response and contingency planning in

coastal and marine areas. Support includes hazard assessments, trajectory modeling, and information on the preparedness and sensitivity of coastal environments to hazardous substances. Based on its responsibilities and capabilities, DOC can provide support in both disaster and environmental assistance operations.

#### DEPARTMENT OF EDUCATION (DOEd)

The DOEd establishes policy for, administers, and coordinates most federal assistance to education. It supports information and planning for disaster and environmental assistance operations. The DOEd may also become involved in selected Army community assistance programs that address education and training.

#### DEPARTMENT OF ENERGY (DOE)

As the FRP's lead agency for energy, the DOE provides the framework for a comprehensive and balanced national energy plan through the coordination and administration of the federal government's energy functions. The DOE—

- Provides nuclear technical assistance and executive national coordination with the oil, gas, electric power, and solid fuels industries.
- Coordinates international emergency responses with the International Energy Agency and with the International Atomic Energy Agency.
- Coordinates supporting resources for the energy industries involved with catastrophic disaster response and recovery.
- Plays a supporting role in disaster and environmental assistance operations.

#### ENVIRONMENTAL PROTECTION AGENCY (EPA)

As the lead agency for hazardous material response under the FRP, the EPA has a significant role and responsibilities in both disaster and environmental assistance operations. It provides for a coordinated response by federal departments and agencies, state and local agencies, and private parties to control oil and hazardous substance discharges or substantial threats of discharges. In selected operations, it coordinates closely with the US Coast Guard (USCG), which is responsible for conducting hazardous material operations over coastal and inland waterways.

**FEDERAL EMERGENCY MANAGEMENT AGENCY (FEMA)**

The FEMA is the federal government's executive agent for implementing federal assistance to a state and its local governments. In most cases, it implements assistance in accordance with the FRP. Organized into ten federal regions that provide support on a national basis, FEMA may be involved in either disaster or environmental assistance operations. Figure 2-1 depicts those regions.

**GENERAL SERVICES ADMINISTRATION (GSA)**

The GSA is the lead agency for resource support under the FRP. Having extensive expertise both in

contracting and providing services, GSA is an invaluable player in both disaster and environmental assistance operations.

**DEPARTMENT OF HEALTH AND HUMAN SERVICES (DHHS)**

The DHHS is the lead agency for health and medical services under the FRP. The Public Health Service (PHS), an agency under the DHHS, leads this effort by directing the activation of the National Disaster Medical System (NDMS). The DHHS is also responsible for assisting with the assessment of health hazards at a response site and the protection of both response workers and the general public. Agencies

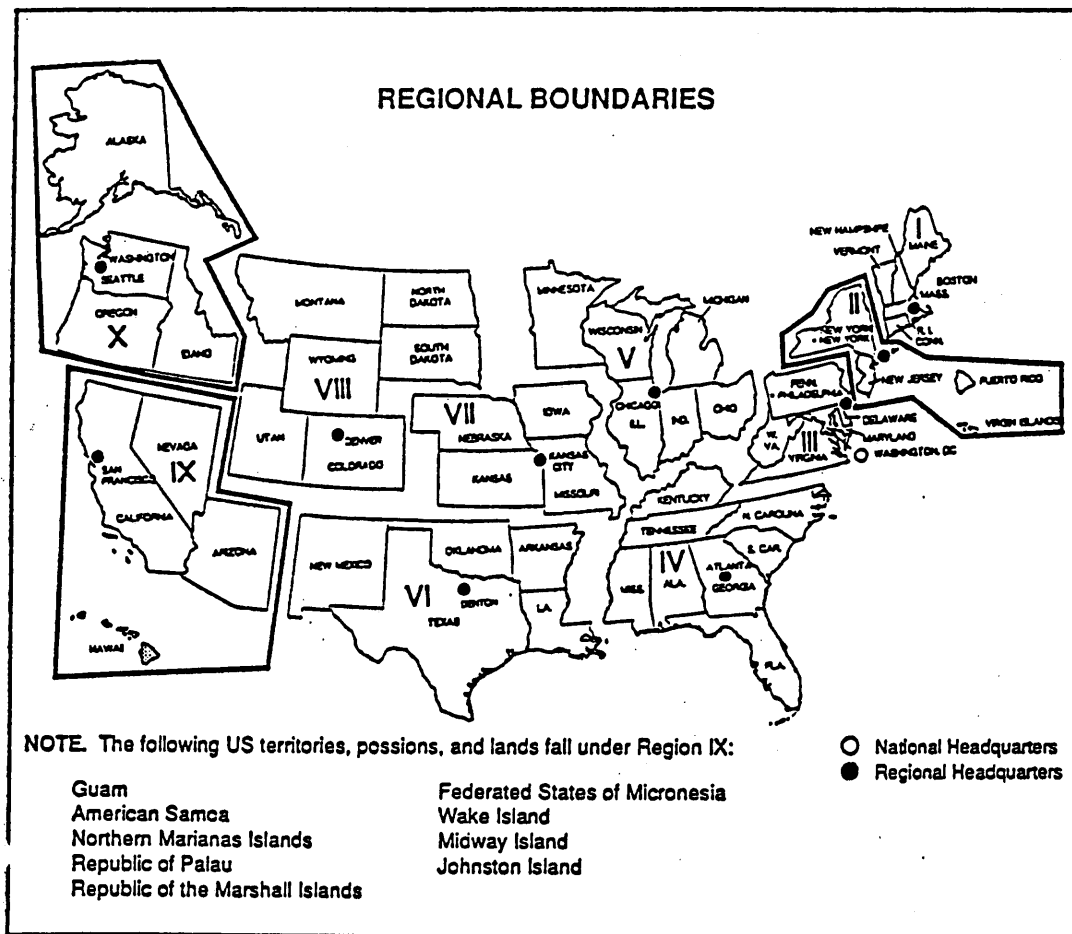

Figure 2-1. Federal Emergency Management Agency

## DOMESTIC SUPPORT OPERATIONS

within DHHS that have relevant responsibilities, capabilities, and expertise are the Agency for Toxic Substances and Disease Registry and the National Institute for Environmental Health Sciences. The DHHS provides support for both disaster and environmental assistance operations and may also become involved in selective Army community assistance operations that provide medical support to disadvantaged communities.

### DEPARTMENT OF INTERIOR

As a support agency under the FRP, the DOI provides support for disaster and environmental assistance operations. It also has major responsibility for American Indian reservations and for people who live in island territories under United States administration. Operating the NIFC jointly with the Department of Agriculture, the DOI has expertise on, and jurisdiction over, a wide variety of natural resources and federal lands and waters.

### DEPARTMENT OF JUSTICE (DOJ)

The DOJ plays a significant role in law enforcement and counterdrug operations. The Drug Enforcement Administration (DEA) is DOJ's lead agency for counterdrug operations. As the government's representative in legal matters, the DOJ may become involved in law enforcement operations, community assistance operations, and disaster and environmental assistance operations, providing legal advice on questions arising from oil and hazardous substance spills. The Attorney General supervises and directs US attorneys and US marshals in the various judicial districts. The DOJ has oversight authority for the Immigration and Naturalization Service (INS) and serves as the lead agency for operations involving illegal mass immigration. The Federal Bureau of Investigation (FBI) is an arm of DOJ.

### DEPARTMENT OF LABOR (DOL)

The DOL, through the Occupational Safety and Health Administration, conducts safety and health inspections of hazardous waste sites and responds to emergencies. It must assure that employees are being protected and determine if the site is in compliance with safety and health standards and regulations. The DOL can thus become a support agency for disaster and environmental assistance operations.

### NATIONAL COMMUNICATIONS SYSTEM (NCS)

As the lead agency for communications under the FRP, the NCS consists of representatives of 23 federal agencies and operates under the authority of the General Services Administration. The NCS provides communications support to federal, state, and local response efforts and is charged with carrying out the National Telecommunications Support Plan to ensure adequate communications following a disaster. It also provides technical communications support for federal fire control. Administratively structured, the NCS consists of an executive agent, a manager, a committee of principles, and the telecommunications assets.

### NUCLEAR REGULATORY COMMISSION (NRC)

Responsible for the Federal Radiological Emergency Response Plan (FRERP), the NRC responds to the release of radioactive materials by its licensees. It provides advice in identifying the source and character of other hazardous substance releases when the commission has licensing authority for activities using radioactive materials. The NRC may serve in a support role in disaster and environmental assistance operations.

### DEPARTMENT OF STATE (DOS)

The DOS advises the President in the formulation and execution of foreign policy. Its primary mission in the conduct of foreign relations is to promote the interests of the United States overseas. In this capacity, the DOS manages the US Agency for International Development and the US Information Agency. The DOS also has a support role in disaster or environmental assistance events or domestic counterdrug operations having international implications.

### DEPARTMENT OF TRANSPORTATION (DOT)

As the lead agency for transportation under the FRP, the DOT coordinates federal transportation in support of federal agencies, volunteer agencies, and state and local governmental entities. It has support roles in ten other ESFs of the FRP. A subordinate agency of the DOT during peacetime, the US Coast Guard conducts counterdrug operations and, in conjunction with the EPA, hazardous material operations. The DOT and the USCG have major roles in disaster and environmental assistance operations. The DOT provides expertise regarding transportation of oil or hazardous substances by all modes of transportation.

#### DEPARTMENT OF TREASURY

The Department of Treasury, through its agency, the US Customs Service (USCS), regulates goods, people, and vehicles entering or leaving the United States and its territories. The USCS assesses and collects duties on imports and controls merchandise to prevent smuggling of contraband, including narcotics. As one of the primary federal agencies involved in support of law enforcement, the USCS plays a support role in planning for disaster or environmental assistance operations. Through the US Secret Service (USSS), the Department of Treasury is responsible for providing security for the President, the Vice-President, and visiting heads of state. The USSS can request the aid of the military—in particular, military police, military working dogs, and explosive ordnance disposal and signal personnel—in the conduct of security and protection missions.

#### NATIONAL WEATHER SERVICE (NWS)

The NWS predicts, tracks, and warns of severe weather and floods. It plays a support role in disaster or environmental assistance operations.

#### DEPARTMENT OF DEFENSE

The DOD is the lead agency for public works and engineering, as well as urban search and rescue under the FRP. It has support roles in the 10 other ESFs, frequently becoming involved in disaster or environmental assistance operations. If directed by the President, DOD may provide support to law enforcement operations and selected community assistance initiatives. A diagram of DOD is at Figure 2-2.

#### SECRETARY OF DEFENSE (SECDEF)

The SECDEF has designated the Secretary of the Army (SA) as the DOD executive agent for providing DOD domestic support operations. These responsibilities are outlined in existing policies, procedures, and directives.

#### SECRETARY OF ARMY

As the DOD executive agent for domestic support operations, the SA develops necessary planning guidance, plans, and procedures. The SA has authority

to task DOD components to plan for and to commit DOD resources in response to requests for military support from civil authorities. Any commitment of military forces of the unified and specified commands must be coordinated in advance with the Chairman, Joint Chiefs of Staff (CJCS). The SA uses the inherent authority of his office to direct Army assistance to domestic support operations. A diagram of the Department of the Army is at Figure 2-3.

#### DIRECTOR OF MILITARY SUPPORT (DOMS)

The DOMS, a general officer appointed by the SA, is the DOD primary contact for all federal departments and agencies during periods of domestic civil emergencies or disaster response. On behalf of the DOD, the DOMS and his supporting staff, serving as a joint staff, ensure the planning, coordination, and execution of many domestic support operations.

#### UNIFIED COMMANDS

Selected commanders-in-chief (CINCs) have domestic support responsibilities, some of which are addressed below. More specific CINC responsibilities for civil assistance missions are identified in appropriate DOD directives, guidelines, and operational plans.

#### Commander-in-Chief, Forces Command (CINCFOR)

The CINCFOR serves as the DOD principal planning and operating agent for military support to civil authorities for all DOD components in the 48 contiguous states and the District of Columbia.

#### Commander-in-Chief, Atlantic Command (CINCLANT)

The CINCLANT serves as the DOD principal planning and operating agent for military support to civil authorities for all DOD components within the Atlantic command area of operations (AO).

#### Commander-in-Chief, Pacific Command (CINCPAC)

The CINCPAC serves as the DOD principal planning and operating agent for military support to civil authorities for all DOD components within the Pacific command AO.

DOMESTIC SUPPORT OPERATIONS

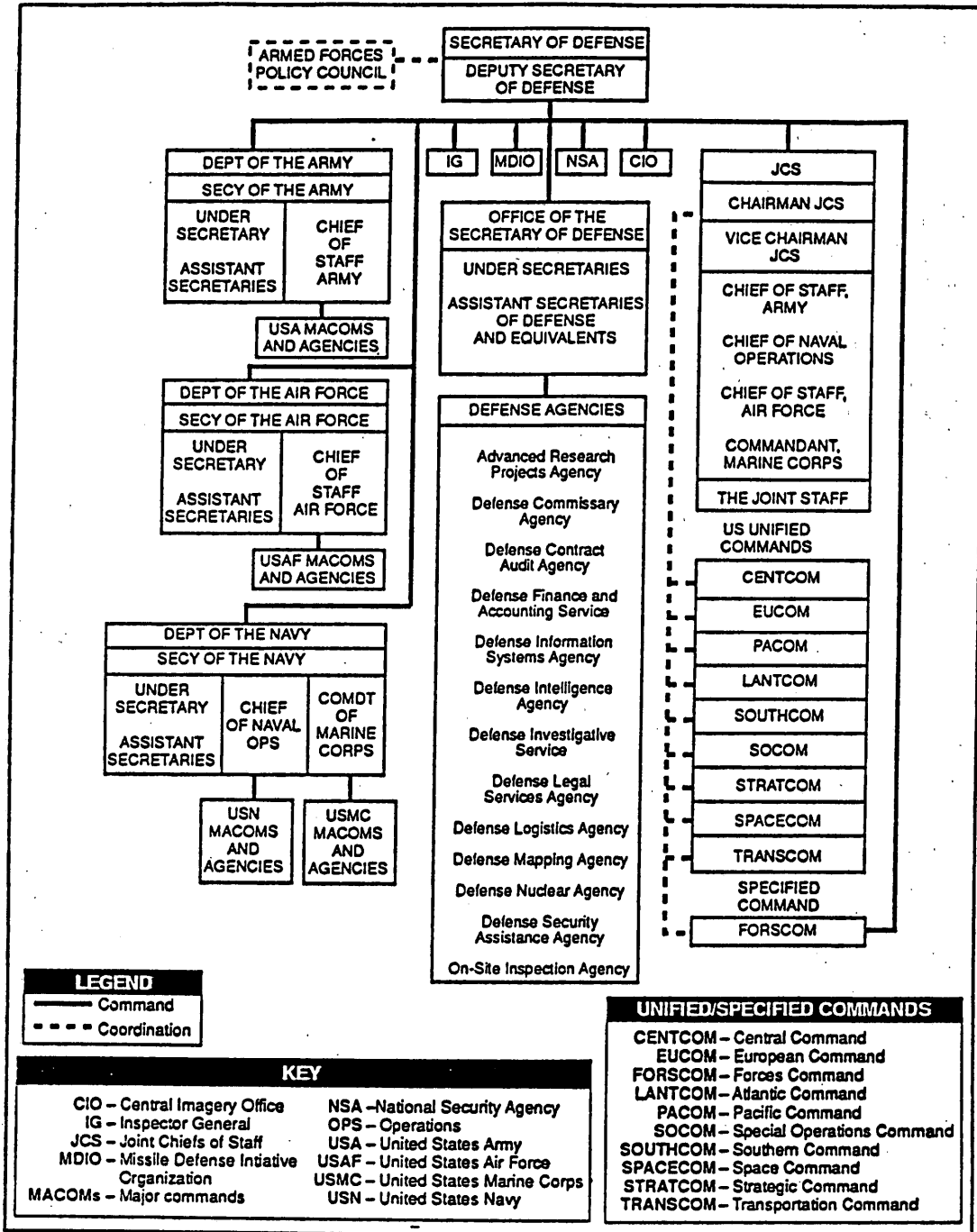

Figure 2-2. Department of Defense

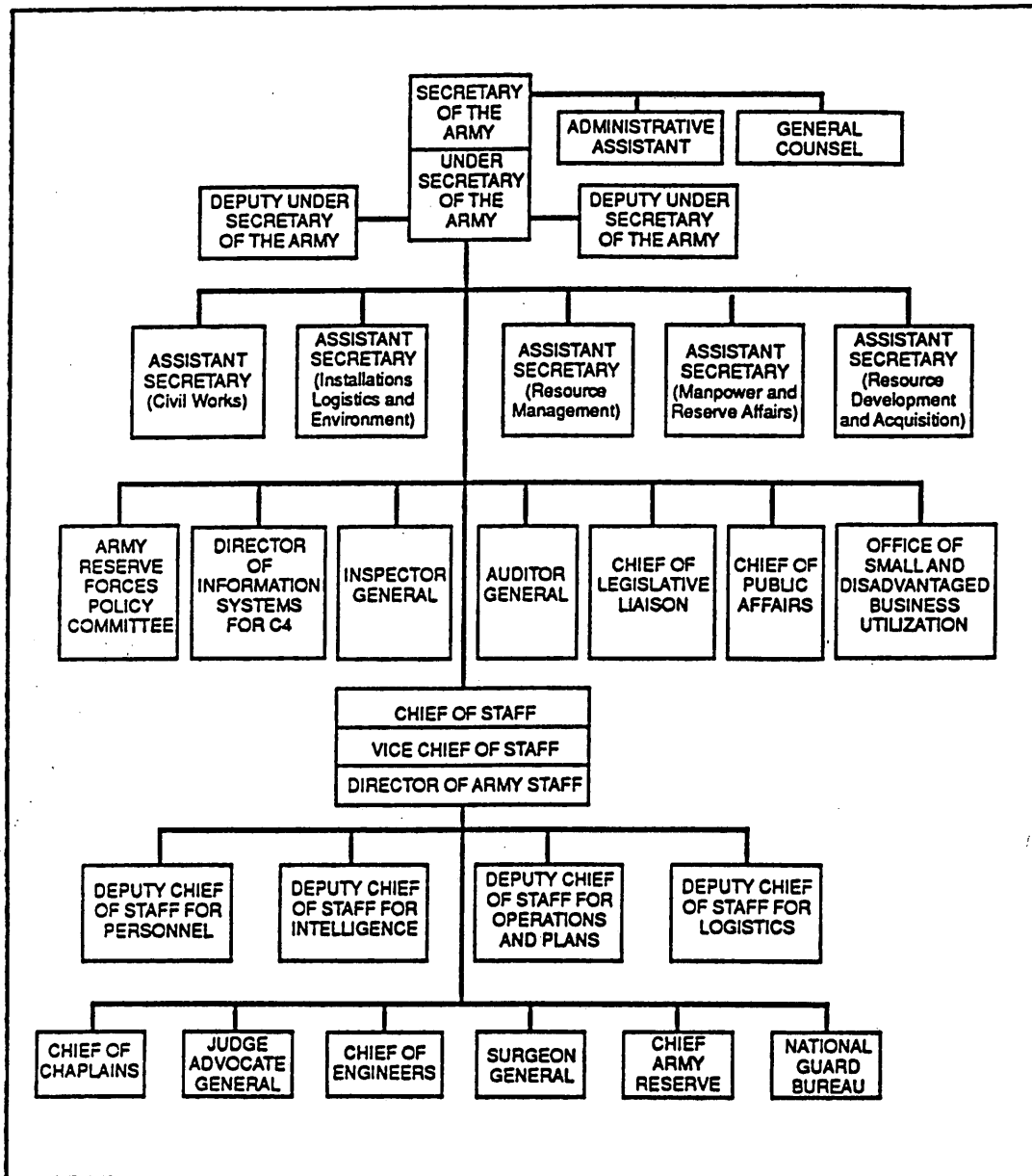

Figure 2-3. Department of the Army

## DOMESTIC SUPPORT OPERATIONS

### **Commander-in-Chief, Transportation Command (CINCTRANS)**

The CINCTRANS serves as the DOD single manager for transportation, providing air, land, and sea transportation to meet national security objectives. The CINCTRANS has combatant command (COCOM) of the Military Traffic Management Command, Air Mobility Command, and Military Sealift Command, collectively known as the transportation component commands.

### **Defense Logistics Agency (DLA)**

The DLA supports civil disturbance operations under the provisions of OPLAN GARDEN PLOT, the National Civil Disturbance Plan, with wholesale logistics support for military assistance in disasters.

### **DEFENSE COORDINATING OFFICER (DCO)**

A CINC appoints the DCO to serve as the DOD single point of contact to the federal coordinating officer for providing DOD resources during disaster assistance. The DCO should collocate with the FCO and coordinates all FEMA mission assignments for military support. The DCO usually has operational control of all DOD forces deployed to support the federal effort. A defense coordinating element (DCE) will be organized to provide support staff for the DCO in the disaster area. The size and composition of the DCE is situation-dependent.

### **NATIONAL GUARD**

#### **National Guard Bureau (NGB)**

The NGB is the federal coordination, administrative, policy, and logistical center for the Army and the Air National Guard (ANG). It serves as the legal channel of communication among the United States Army, the United States Air Force, and the National Guard in the 54 states and territories. The Chief, National Guard Bureau, has executive agent responsibility for planning and coordinating the execution of military support operations. The Director, Army National Guard (DARNG), in coordination with the Director, ANG, is responsible to the Chief, NGB. NG commanders are responsible for planning and training their forces for both their federal and state missions.

### **State Area Command (STARC)**

The STARC is a mobilization entity in each state and territory. It organizes, trains, plans, and coordinates the mobilization of NG units and elements for state and federal missions. The STARC is responsible for emergency planning and response using all NG resources within its jurisdiction. It directs the deployment and employment of ARNG units and elements for domestic support operations, including military support to civil authorities. As with active duty forces, emergency response may be automatic or deliberate. When the NG is in a nonfederal status, the governor serves as commander-in-chief of the NG in his state or territory and exercises command through the state adjutant general (TAG). While serving in state status, the NG provides military support to civil authorities, including law enforcement, in accordance with state law. Federal equipment assigned to the NG may be used for emergency support on an incremental cost-reimbursement basis.

### **US Property and Fiscal Officers (USPFOs)**

USPFOs are Title 10 officers assigned to the NGB and detailed for duty at each state or territory. They are accountable for all federal resources (equipment, dollars, and real estate) provided to the NG of each state. The USPFO staff provides supply, transportation, internal review, data processing, contracting, and financial support for the state's NG. When required, the USPFO can operate as a support installation for active component or USAR forces on a reimbursable basis.

### **Emergency Preparedness Liaison Officers (EPLOs)**

Representatives from the services are EPLOs to each state NG. As service planning agents' representatives to TAGs and STARCs, they plan and coordinate the execution of national security emergency preparedness (NSEP) plans, performing duty with the STARCs. EPLOs are Army, Navy, and Air Force Reservists who have been specifically trained in disaster preparedness and military support matters. Each reports to an active duty program manager or planning agent in his or her respective service who has responsibility and authority to provide (or seek further approval of) military support to the state. EPLOs must have a comprehensive knowledge of their respective service facilities. They must also monitor and update their portion of the DOD Resource Data

Base (DODRDB). Upon appointment of the DCO, EPLOs may be ordered to active duty to serve as liaison representatives to the STARCs and their respective services.

#### **US ARMY RESERVE**

The USAR is capable of extensive domestic support operations. This assistance and support may include the use of equipment and other resources, including units and individuals. USAR personnel may be activated in a volunteer status when ordered to active duty in lieu of annual training or after the President has declared a national emergency.

#### **MAJOR COMMANDS (MACOMs)**

MACOM commanders may provide domestic support operations in accordance with authorized agreements they have reached with civil authorities in their surrounding communities or as directed by higher headquarters. Specifically, they may provide resources for disaster relief upon request, generally placing these resources under the operational control of the military commander in charge of relief operations.

#### **US Army Health Services Command (HSC)**

The HSC, as requested by the supported CINC, provides health service support (HSS) resources, including clinical personnel under the Professional Officer Filler System (PROFIS), for all categories of domestic support operations. These resources are normally attached to, or placed under the operational control of, a supported CINC HSS unit for the duration of the operation.

#### **Continental US Army (CONUSA) Commanders**

CONUSA commanders provide regional military support to civil authorities by planning for and conducting disaster relief operations within their areas of responsibility. They also establish and maintain disaster relief liaison with appropriate federal, state, and local authorities, agencies, and organizations.

#### **US Army Corps of Engineers (USACE)**

The USACE is organized into geographically dispersed (CONUS and OCONUS) division and district subordinate commands. The USACE commander also serves as the chief of engineer soldier forces and in that

capacity guides the Army staff in their utilization. The USACE's mission is to provide quality, responsive engineering service to the nation. The command applies substantial expertise to the areas of operation and maintenance of the national waterway infrastructure, environmental restoration and remediation, project planning and management, coordination of complex interagency or regional technical issues, and disaster planning and response. The USACE serves as DOD's lead agent, in direct support of FEMA, for public works and engineering in the FRP. Figure 2-4 depicts USACE division and district regulatory boundaries.

#### **US Army Materiel Command (USAMC)**

The USAMC may organize and deploy a logistics support element for domestic support operations. It provides supply, maintenance, technical assistance, and other services to the units. In addition, the logistics support element may organize a humanitarian depot to receive, store, and distribute relief supplies. The USAMC is the Army's executive agent for chemical and nuclear accidents and incidents.

### **STATE AND LOCAL GOVERNMENT**

This section addresses general state and local government responsibilities for responding to disaster assistance operations. Responsibilities for environmental assistance, support of law enforcement, and community assistance are discussed in chapters specifically addressing those operations. State and local government officials, operating under authority granted by state constitutions and local charters, are responsible for most of the daily safety and security issues that impact on their citizens' quality of life. State and local officials have primary responsibility for emergency preparedness planning and responding to emergencies.

Historically, NG units, under control of state governors and TAGs, have been the primary military responders in emergencies. Using federal military forces to support state and local governments is the exception rather than the norm. Federal forces are normally used only after state resources have been exhausted.



## DOMESTIC SUPPORT OPERATIONS

### STATE RESPONSIBILITIES

#### Governor

A state governor is empowered by the US Constitution and each respective state constitution to execute the laws of the state and to command the state's NG when it is serving in state status. Governors are also responsible for issuing Executive Orders declaring "states of emergency" and ensuring that state agencies plan for actions in the event of a disaster.

Once a disaster occurs, the governor assesses its extent and determines if local government requests for assistance should be honored. If appropriate, the governor declares a state of emergency, activates the state response plan, and may call up the NG. The governor gives the NG its mission and determines when Guard forces can be withdrawn. In the event a disaster exhausts state resources, the governor may petition the President for federal assistance.

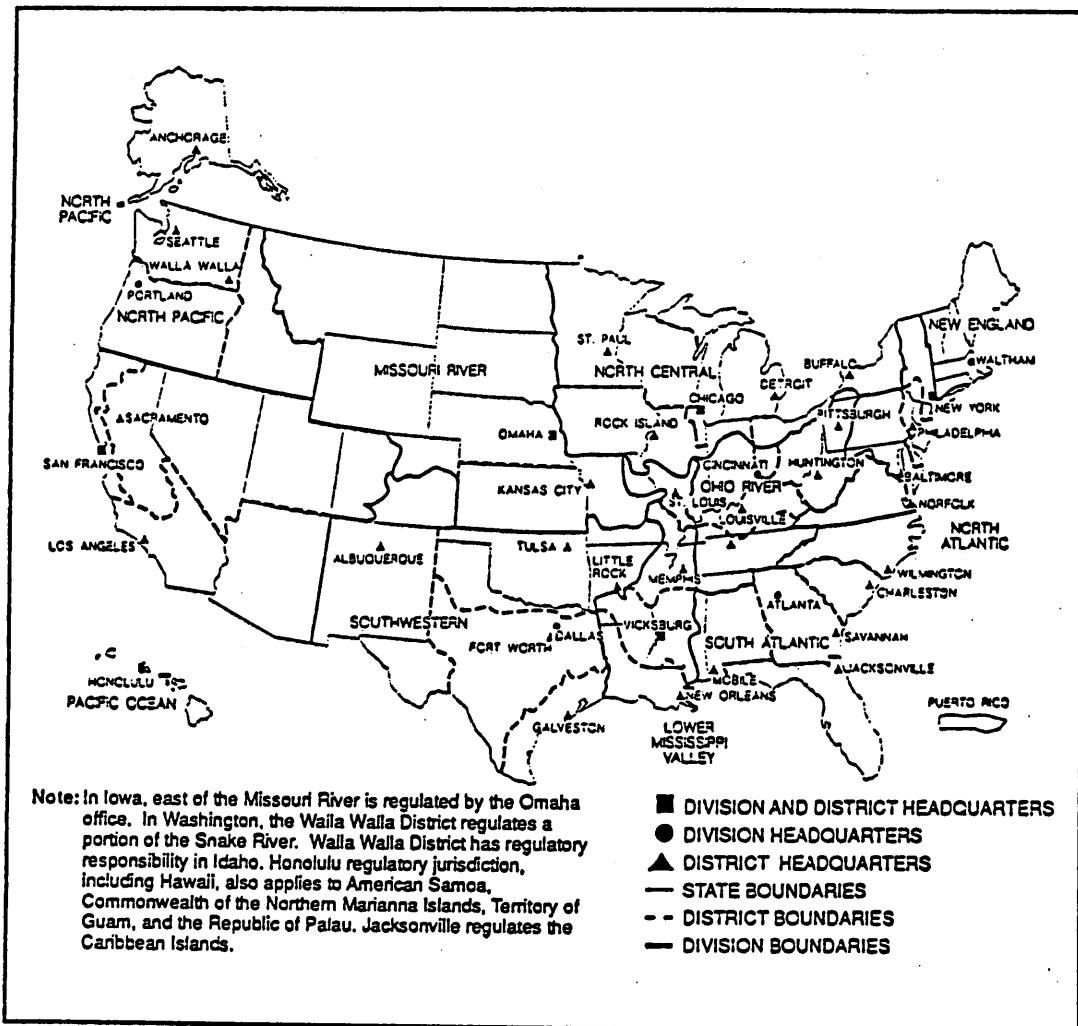

Figure 2-4. Corps of Engineers Division and District Regulatory Boundaries

**Office of Emergency Services (OES)**

All states have a specific agency that coordinates emergency preparedness planning, conducts emergency preparedness training and exercises, and serves as the governor's coordinating agency in an emergency. The titles of these offices vary from state to state, for example, *Division of Emergency Government, Emergency Management Agency, Department of Public Safety, or Office of Emergency Preparedness*. This manual refers to this office using the generic term *Office of Emergency Services*. A diagram depicting a typical structure for state and local operational emergency services organizations and their linkages with equivalent federal organizations is at Figure 2-5.

Generally, the OES is either organized as a stand-alone office under the governor or aligned under TAG or the state police. It operates the state emergency operations center during a disaster or emergency and coordinates with federal officials for support if required. A diagram depicting typical organizations involved in state and local emergency response is at Figure 2-6.

The Adjutant General. The state NG is the governor's primary response force in an emergency. The TAG, through the STARC (specifically the Plans, Operations and Military Support Officer (POMSO)) coordinates emergency response plans for

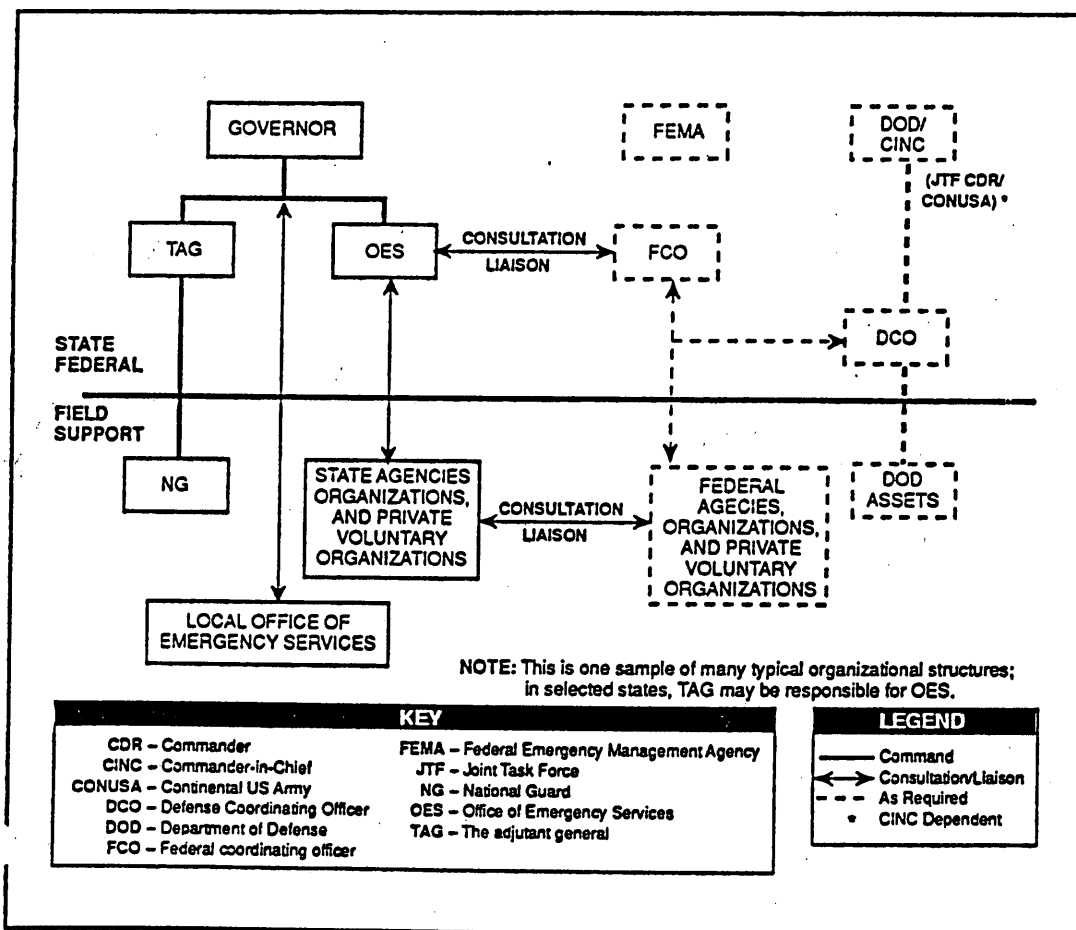

Figure 2-5. State/Local Operational Emergency Services Organization

DOMESTIC SUPPORT OPERATIONS

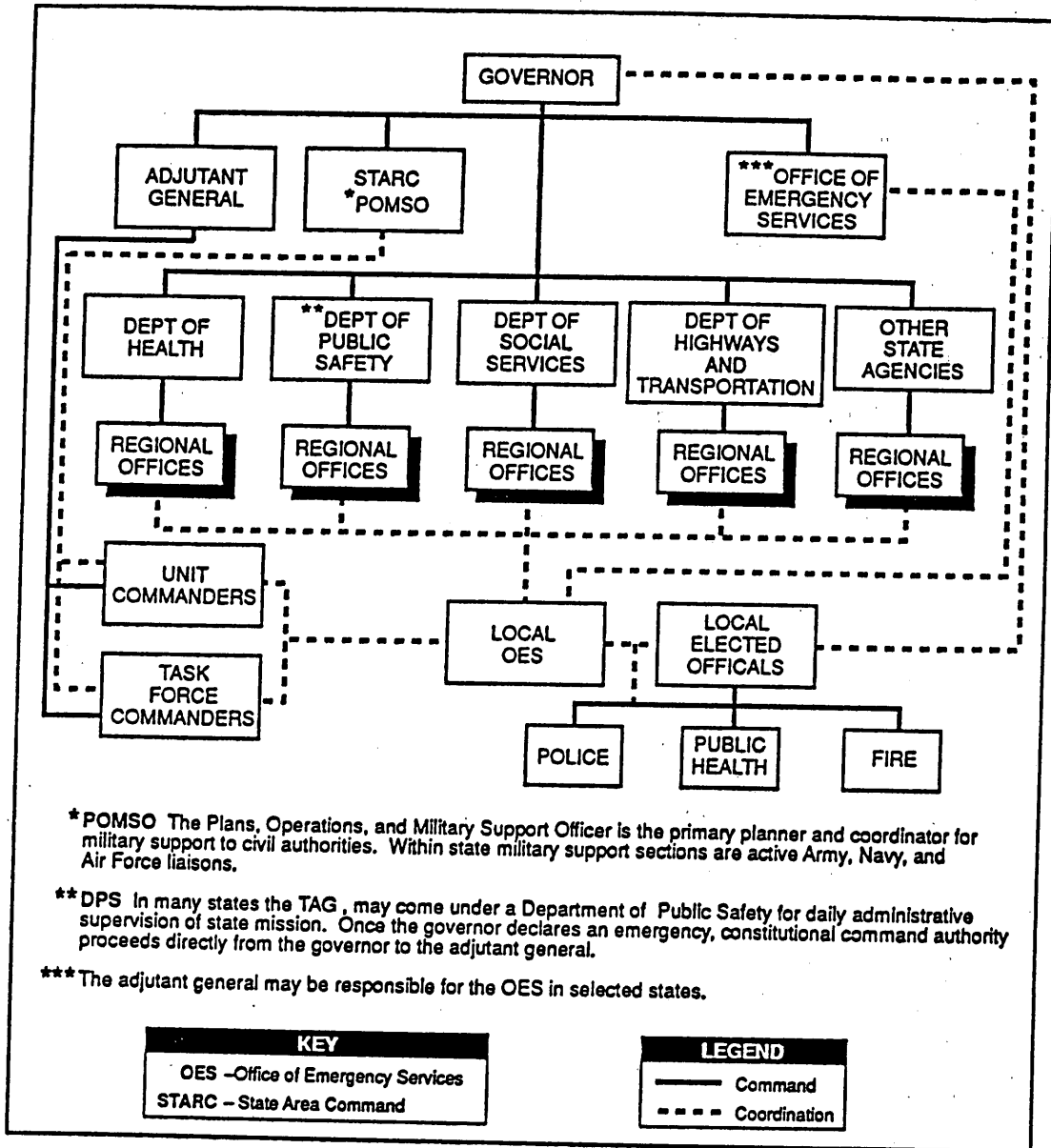

Figure 2-6. State and Local Emergency Response

disasters and emergencies. TAG is in command of state NG forces called to state active duty.

**Plans, Operations, and Military Support Officer**

The POMSO plans for disaster response and recovery operations within the full spectrum of military support missions. Within each state, the POMSO coordinates training plans and exercises between the state NG and federal, state, and local emergency management agencies. The POMSO will serve as the NG point of contact with DOD officials during a federal emergency or disaster.

**State Government Agencies**

State government departments and agencies prepare emergency response plans for their areas of specialization. They also participate in emergency preparedness exercises and respond according to plan.

**LOCAL RESPONSIBILITIES**

Within their respective communities, mayors, city managers, local police and fire protection officials, county executives, sheriffs, prosecuting attorneys, and public health officials are some of the people responsible for law enforcement, safety, health, and fire protection on a daily basis. They are responsible for developing appropriate emergency response plans and responding to emergencies within their jurisdictions. Most local jurisdictions have an OES to plan and coordinate actions in an emergency. In many cases, local jurisdictions have mutual aid agreements with other jurisdictions that allow for firefighter and police assistance. Once local officials determine that an emergency is beyond the scope of their resources or ability to respond, the senior local official is responsible for requesting additional assistance from the state governor.

**SUMMARY**

The Army may support or coordinate with many federal, state, and local governmental departments and agencies as it conducts domestic support operations. Although the Army is seldom the lead agency in disaster assistance operations, it is a support agency for all the FRP's emergency support functions. Almost all Army domestic support operations will be conducted in a joint or interagency environment. Throughout our history, the Army has provided community support at the national level and support to its surrounding communities. The Army also has a long history of providing domestic support and will continue to provide that assistance in the future.



## CHAPTER 3

# LEGAL CONSIDERATIONS AND CONSTRAINTS

*The Constitution, laws, regulations, policies, and other legal issues limit the use of federal military personnel in domestic support operations. This chapter presents an overview of those considerations and constraints.*

### CIVILIAN CONTROL OF THE MILITARY

**Commanders should discuss plans, policies, programs, exercises, funding, and operations with their legal advisors.**

Under the Constitution of the United States, Congress has the authority to raise and support an army, provide and maintain a navy, and make rules for governing and regulating the land and naval forces. The Constitution places the military under civilian control and designates the President as commander-in-chief. Statutes provide for civilian leadership in the form of a secretary of defense, service secretaries, and various other civilian authorities.

The unique capabilities of the military enable it to support federal, state, or local civilian agencies. In most circumstances, the DOD is one of many federal agencies reacting to a domestic emergency or crisis, playing a subordinate, supporting role to a lead, civilian agency.

### THE ROLE OF THE ARMY

Traditionally, nations have raised and maintained armies to provide for the national defense. Today, the United States calls upon its Army to perform various other functions as well, for example, controlling civil disturbances, assisting with disasters, and providing essential services.

- During the civil disturbances of the late 1960s and early 1970s, civilian authorities called upon the Army to help restore order.
- Soldiers provided assistance during times of natural disaster, such as the Hurricane Andrew cleanup in Florida in 1992. Civil authorities can call upon the Army to render assistance if a

major accident occurs at a nuclear power plant. The Army can also help prevent a major environmental disaster by assisting in the cleanup of petroleum or chemical spills.

- During the postal strike of 1970, the federal government called upon the Army to help operate post offices in several cities. Army air traffic controllers manned control towers during the 1981 air traffic controller walkout.

## THE LAW

Within the United States, civilian agencies, not the military, provide for the needs of citizens. Civilian, federal, state, and local government and law enforcement agencies execute US laws. Laws governing use of the military in domestic operations are complex, subtle, and ever-changing. For this reason, commanders should discuss plans, policies, programs, exercises, funding, and operations with their legal advisors. They should scrutinize each request for aid, whether it be for equipment or training, to ensure that it conforms with statutory requirements.

### SUPPORT TO CIVILIAN LAW

#### ENFORCEMENT: *The Posse Comitatus Act*

Generally, federal military forces may not give law enforcement assistance to civil authorities without running afoul of *The Posse Comitatus Act*. However, Constitutional and statutory exceptions to this prohibition do exist. The recent emphasis on drug interdiction has led to an increase in those exceptions.

*The Judiciary Act of 1789* allowed United States marshals to call upon the military as a *posse comitatus*. This continued until after the Civil War, when the federal government used the Army to execute Reconstruction Era policies. The southern states regarded the use of the military for this purpose as abusive and repressive, and in 1878 President Rutherford B. Hayes signed the original bill ending the practice. The current wording contained in 18 USC 1385 is:

*Whoever, except in cases and under circumstances expressly authorized by the Constitution or act of Congress, willfully uses any part of the Army or the Air Force as a posse comitatus or otherwise to execute the laws shall be fined not more than \$10,000 or imprisoned not more than two years, or both.*

*The Posse Comitatus Act* prescribes criminal penalties for use of the US Army or Air Force to execute the laws of or to perform civilian law enforcement functions within the US. DOD policy extends this prohibition to the US Navy and Marine Corps. Prohibiting the military from executing the laws means that military personnel may not participate directly—

- In arrest, search and seizure, stop and frisk, or interdiction of vessels, aircraft, or vehicles.
- In surveillance or pursuit.
- As informants, undercover agents, or investigators in civilian legal cases or in any other civilian law enforcement activity.

*The Posse Comitatus Act* does not apply to—

- Members of the National Guard when not in federal service.
- Members of a reserve component when not on active duty or active duty for training.
- DOD civilians, unless under the direct command and control of an active duty officer.
- A soldier when off duty and acting only in a private capacity.
- Soldiers taking action for the primary purpose of furthering a military or foreign affairs function of the US, for example, enforcing military justice, maintaining law and order on military installations, protecting classified materials.

**There are specific actions in which military personnel may not participate.**

#### Constitutional Exceptions

Under its inherent authority, the United States Government is responsible for preserving public order and carrying out governmental operations within its territorial limits, by force, if necessary. Under the Constitution, two exceptions allow the use of the military to execute or enforce the law: when necessary to protect civilian property and functions and when necessary to protect federal property and functions.

## DOMESTIC SUPPORT OPERATIONS

**When Necessary to Protect Civilian Property and Functions.** A sudden and unexpected civil disturbance, disaster, or calamity may seriously endanger life and property and disrupt normal governmental functions to such an extent that local authorities cannot control the situation. At such times, the federal government may use military force to prevent loss of life or wanton destruction of property and to restore government functions and public order. This exception has rarely been used.

**When Necessary to Protect Federal Property and Functions.** The federal government may use military force to protect federal property and federal government functions when local authorities cannot or decline to provide adequate protection.

The President may order the armed forces to aid state civil authorities who are suffering from an insurrection or civil disturbance—

- At the request of a state.
- To enforce federal authority.
- To protect federal property.
- To protect the Constitutional rights of citizens within any state.

The President must act personally by first issuing a proclamation calling upon insurgents to disperse and retire peaceably within a limited time (10 USC 331-333; 10 USC 3500; 10 USC 8500). Note: Not one of these authorities, in and of itself, provides sufficient legal basis to order the reserve components to active federal service.

### Statutory Exceptions

Other statutory exceptions (10 USC 371-380) allow military personnel to provide limited support to civilian law enforcement agencies (LEAs) indirectly. Under these laws, the military may share certain information and provide equipment, facilities, and other services to LEAs. The annual *DOD Authorization Act* also contains exceptions concerning military support to civilian authorities fighting illegal drugs. DOD policies for providing support to civilian LEAs, including personnel and equipment, are contained in DOD Directive 5525.5. AR 500-51 contains related US

Army policies. Examples of support that does not violate *The Posse Comitatus Act* follow:

- Loan of equipment and training to operate or repair the equipment. Certain customs and other laws—*The Controlled Substances Act*, *The Immigration and Nationality Act*—permit direct operation of this equipment.
- Civilian LEAs' use of installation research facilities.
- Transfer of information acquired during normal military operations.

### DOMESTIC DISASTER RELIEF:

#### *The Robert T. Stafford Disaster Relief Act*

*The Stafford Act*, 42 USC 5121, *et seq*, as amended, is the statutory authority for federal domestic disaster assistance. It empowers the President to establish a program for disaster preparedness and response, which the President has delegated to FEMA. *The Stafford Act* provides procedures for declaring an emergency or major disaster, as well as the type and amount of federal assistance available. The *Act* authorizes the President to provide DOD assets for relief once he formally declares an emergency or a major disaster. He may also provide DOD assets for emergency work on a limited basis prior to the declaration. DOD policy for providing domestic disaster assistance is contained in DOD Directive 3025.1, *Military Support to Civil Authorities*. Army policy is found in AR 500-60, *Disaster Relief*.

### Emergencies and Major Disasters

The difference between an emergency and a major disaster is one of duration, severity, and the extent of assistance required. Examples are hurricanes, floods, tornados, storms, tidal waves, earthquakes, volcanic eruptions, landslides, droughts, explosions, or other natural or man-made catastrophes. Emergencies are less severe than major disasters, requiring a shorter time to recover and to provide adequate relief. Both may require federal assistance to augment state and local resources and relief agencies. From a DOD perspective, an emergency and a major disaster may require the same type of work, that is, removal of debris, preservation of health and safety, and restoration of essential services.

**The difference between an emergency and a major disaster is one of duration, degree of damage, and extent of assistance needed.**

#### **The Federal Response Plan**

Once a state requests aid, the President may declare an emergency or a major disaster, enabling the FEMA to act under the FRP. The FRP is a memorandum of understanding (MOU) between the FEMA and other federal agencies, including the DOD, to provide domestic disaster assistance. Under the FRP, a single federal agency is assigned primary responsibility for each of twelve ESFs. The FEMA orchestrates disaster relief through these ESFs. Each primary agency orchestrates the federal effort within its sphere of responsibility and may, if authorized by the FEMA, task other agencies for support.

The DOD has primary responsibility for ESF 3, Public Works, and ESF 9, Urban Search and Rescue, and is a supporting agency for the remaining ten. The FEMA reimburses the DOD for the incremental costs of providing the tasked assistance. Without specific FEMA tasking, DOD units lack authority to provide domestic disaster assistance and, if provided, risk not being reimbursed for its cost. If in doubt, commanders should seek clarification from the FEMA through the defense coordinating officer.

#### **Emergency Work**

To save lives or to preserve property, the President may commit DOD resources to perform emergency work on public or private lands prior to his official declaration of an emergency or major disaster. Emergency work is defined as clearance and removal of debris and wreckage and temporary restoration of essential public facilities and services. Such work may not last more than 10 days.

#### **CIRCUMSTANCES CONCERNING ELECTIONS**

US law (18 USC 592) prescribes criminal penalties for US troops being at or near polling places.

Commanders should determine if elections are scheduled during disaster assistance operations. For example, during JTF Andrew operations, the FEMA asked the DOD, at the request of Florida election officials, to erect 66 tents, with generators and light sets, to serve as temporary polling sites during a general election. They further tasked DOD to maintain the equipment. Several other polling sites were located near DOD personnel performing disaster relief duties. The Department of Justice opined that so long as DOD personnel did all they could to respect the integrity of the sites, they would not violate 18 USC 592. This was true as they provided tasked support and as they continued relief operations in their vicinity.

*Hurricane Iniki left the Hawaiian island of Kauai devastated; one result was inoperative county polling places. Soldiers from the Hawaii Army National Guard (serving on state active duty) helped a state primary election take place as scheduled by providing tents and transportation assets to Kauai County polling officials.*

### **COMBATting TERRORISM, AIRCRAFT PIRACY, AND OTHER OPERATIONS**

#### **COMBATting TERRORISM**

Various DOD directives outline the policies for maintaining security and combatting terrorism. Because the DOD retains responsibility for protecting its resources, DOD domestic actions to combat terrorism do not always fall within the category of providing assistance to civilian authorities. OPLAN GARDEN PLOT contains DOD procedures for assisting the FBI in combatting terrorism on and off of US military installations.

#### **The FBI's Responsibility**

The FBI has overall jurisdiction at the scene of a terrorist incident wherever it occurs, including military



## DOMESTIC SUPPORT OPERATIONS

installations. The President has directed federal departments and agencies to cooperate to thwart terrorist incidents.

### The DOD's Responsibility

Commanders are responsible for the maintenance of law and order on their installations. They must take all actions to respond to and terminate any terrorist incident occurring on the installation and to protect the installation's personnel and equipment from attack. Installation commanders should coordinate protective measures with appropriate civilian LEAs.

**Commanders who perform disaster assistance missions not tasked by FEMA risk the Army's not being reimbursed for its cost.**

DOD components are authorized to respond to reasonable requests from the FBI for military resources for use in combatting acts of terrorism. Assistance may include material, facilities, and technical personnel in an advisory capacity. Without Presidential approval, military personnel may not be used in a law enforcement role outside of a military installation. With that approval, soldiers may perform missions designated by the FBI pursuant to its responsibilities during a terrorist incident. However, command and control of the soldiers always remain with their military chain of command.

DOD resources may be provided only upon request of the Director, FBI, or the senior FBI official at the scene of a terrorist incident. Commanders may accept the judgment of the requesting official if the official's determination is consistent with available facts. Commanders must forward requests for resources not based upon an actual or imminent terrorist incident—for example, requests for training or long-term equipment loans—to the DOD for processing in accordance with OPLAN GARDEN PLOT.

### AIRCRAFT PIRACY

The Federal Aviation Administration (FAA) has exclusive responsibility for directing law enforcement activity affecting the safety of persons on board in-flight aircraft involved in aircraft piracy. The DOD is required, upon request of the Administrator, FAA, to provide necessary assistance to carry out the the air piracy laws. The DOT and the DOD have a memorandum of understanding concerning aircraft piracy that covers DOD aircraft, regardless of location, and any non-DOD aircraft on DOD installations.

### OTHER OPERATIONS

DOD support to civilian agencies for other emergencies, such as hazardous substance cleanup, radiological threats, emergency evacuation, and flood control, may be under specific authority, for example, *The Flood Control Act*. Such support may also be executed in conjunction with other laws, policies, procedures, or regulations. It is not possible to discuss all situations within the constraints of this publication. For example, Army Corps of Engineers civil engineering projects exceed the scope of this discussion. Applicable references are listed at the back of this manual.

#### 10 USC 672(b), The 15-Day Rule.

The secretary concerned may order reserve component units—and personnel not assigned to units—to active duty for a period not to exceed 15 days per year. Activating NG units and personnel requires the governor's consent. USAR units and ARNG units performing annual training outside the US and its territories, however, use such orders as authority for their annual training period. If a reserve component unit ordered to active duty under this authority uses it to perform annual training, the authority is no longer available for that unit until the next fiscal year.

#### 10 USC 672(d), Volunteers

The secretary concerned may order to active duty reserve component personnel who volunteer. The governor must consent to activating NG personnel. Normally, as a matter of policy, USAR personnel are ordered to active duty for a period of more than 30 days to permit maximum benefits. However, they may or may not actually serve for more than 30 days.

Ordinarily, no USAR or NG personnel will be ordered to active duty as volunteers unless active duty and state ARNG personnel cannot perform the duty and the appropriate CINC validates the requirement.

## USE OF PERSONNEL, MATERIEL, AND EQUIPMENT

### USE OF MILITARY INTELLIGENCE (MI) PERSONNEL

Use of MI personnel during domestic support operations is restricted as a direct result of lessons learned from their improper use in the 1960s. Consequently, LEA requests for MI personnel or material for counterdrug support must be approved by the Secretary of the Army General Counsel and coordinated through the Department of the Army Office of the Deputy Chief of Staff for Intelligence.

During disaster assistance operations, MI personnel may be used for liaison as well as other MI support activities. However, a specific MI mission statement, coordinated through proper authorities, must authorize MI personnel to collect, analyze, and disseminate information. When so authorized, MI personnel may—

- Acquire information that may threaten the physical security of DOD employees, installations, operations, or official visitors, or that may be needed to protect the safety of any person, that is, force protection.
- Analyze and disseminate information to disaster relief personnel and emergency operations centers (EOCs).
- Support EOC operations using intelligence-preparation-of-the-battlefield (IPB) skills.

Information that MI personnel gather without using or retaining it is considered not to have been collected. Commanders and MI personnel will ensure that all such material is handed over to appropriate authorities before departing the disaster area.

When OPLAN GARDEN PLOT is executed in response to civil disturbance operations, MI activities

fall under the jurisdiction of law enforcement policies and regulations. Commanders must ensure that MI support missions, other than normal liaison with LEAs for force protection, have been coordinated with and approved by appropriate authorities.

### USE OF RESERVE COMPONENT PERSONNEL

Several statutes permit the President, the SECDEF, or the service secretaries to use portions of the reserve components. For domestic disaster assistance, generally only two apply: 10 USC 672(b) and 10 USC 672(d).

### USE OF MATERIEL AND EQUIPMENT

AR 700-131 provides HQDA guidance for the loan or lease of US Army materiel. The SA must approve the loan of arms, ammunition, combat vehicles, vessels, and aircraft. Ordinarily, when the DOD loans equipment, the borrowing agency must reimburse them for all DOD costs incident to its delivery, return, and repair. In addition, the borrower must reimburse the full purchase price for consumable or nondurable items, such as batteries, and for depreciation if it is significant.

DOD directives tightly regulate use of reserve component equipment. The MACOM commander approves temporary loans for 90 days or less. The Secretary or Deputy Secretary of Defense approves withdrawals of equipment for more than 90 days. Replacement plans must accompany requests for withdrawals.

## REIMBURSEMENT

In addition to the authorities mentioned above, *The Economy Act* (31 USC 1535) permits federal agencies to provide goods and services to other federal agencies on a reimbursable basis. *The Stafford Disaster Relief Act* requires reimbursement to the DOD for the incremental costs of providing support. Approval authority and reporting requirements vary depending upon the duration and type of support requested. OPLAN GARDEN PLOT contains procedures for reimbursing DOD for assistance during civil disturbances. Reimbursement for use of NG personnel and assets to assist state counterdrug operations and programs is authorized by 32 USC 112.

## DOMESTIC SUPPORT OPERATIONS

---

Other statutes permit federal agencies to seek waiver of reimbursement. For example, federal law enforcement agencies are not required to reimburse DOD if support—

- Is provided in the normal course of military training or operations.

- Results in a benefit to DOD that is substantially equivalent to that which would otherwise result from military training (10 USC 377). Ordinarily, the DOD makes this determination.

### SUMMARY

Domestic support operations raise many legal issues. The Constitution, statutes, and regulations strictly govern the relationship of the military to civilian authorities. The basic rule is that the military plays a subordinate and supporting role to civilian authority, which is different from the wartime role they would have in a foreign theater of operations. Questions of *posse comitatus*, use of force, disaster assistance, and federalization of troops raise issues that require timely legal advice. Commanders must be aware of the legal implications of domestic support operations, ensure that they are appropriately advised by competent legal counsel, and act accordingly.

---

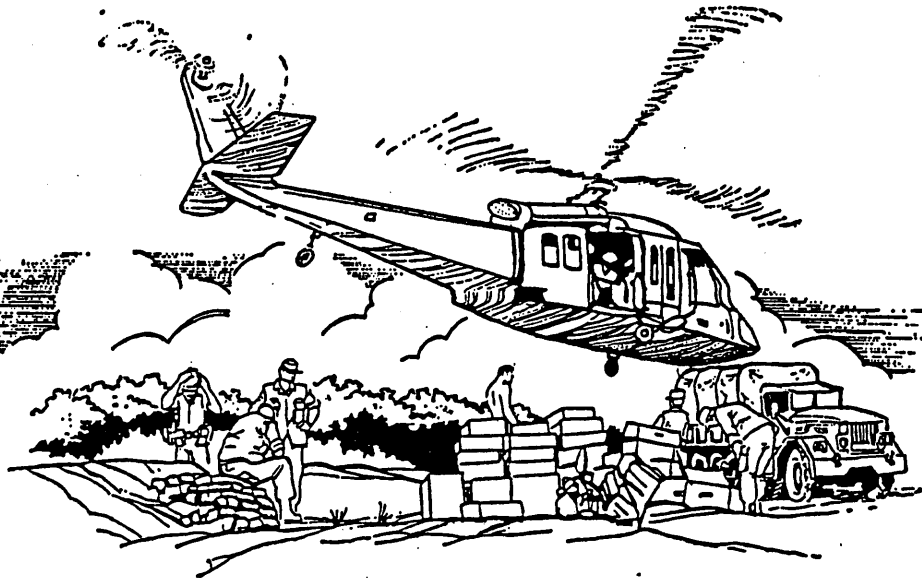

## CHAPTER 4

# LOGISTICS AND SUPPORT OPERATIONS

*Most domestic support operations are logistical in nature. Support is based on actual requests or requirements, rather than on standard support packages. In planning for support of national objectives amid growing complexities, military planners face ambiguities about how to prepare for and predict types of contingencies our forces will confront. However, certain support functions always apply, whether for combat forces or civil authorities. To avoid duplication, support planners must consider military and civil requirements and capabilities concurrently. This chapter addresses support common to all domestic operations, as well as specifics for tailoring a support force for particular purposes.*

### PLANNING

**Most domestic support operations are logistical in nature.**

In most crises, ARNG units under the control of the respective state governments will be the first military units to provide support. Although the military commander retains command and control of Army forces, a federal, state, or local official may control the overall operation. Detailed planning and familiarization

with the various levels of federal, state, and local government will help synchronize assistance efforts. Coordination and synchronization will avoid confusion and duplication of effort. A knowledge of other agencies' capabilities will help to avert adversarial situations.

Logistics assessment personnel should carefully identify requirements before US Army support assets are deployed. Before deployment, logistics commanders can form emergency response teams to react immediately to emergency situations. These teams would arrive on the scene early to assess the impact and severity of a crisis before commitment of operational forces.

## DOMESTIC SUPPORT OPERATIONS

Commanders must ensure that support to troops and to civil authorities is planned for and executed simultaneously. They must also ensure that—

- Logistics command and control cells arrive early.
- Deploying units have access to assured communications and to all Standard Automated Management Information Systems (STAMISs) directly at the support base (local installation).
- Support and supplies flow smoothly and continuously.
- Termination standards (end states) for all types of support are established early in the operation.
- Resource management is fully integrated into all phases of the operation.

### SOURCES OF SUPPORT

The four primary sources of logistical support are contracting, negotiated support, military support, and support from other federal agencies. See Figure 4-1.

#### CONTRACTING

Contracting—purchasing, renting, or leasing supplies or services from nonfederal sources—is a highly effective and efficient way to provide rapid support in a crisis. Included are all classes of supply, labor, mortuary affairs, laundry, showers, food service, sanitation, billeting, transportation, maintenance and repair, access to communications networks, temporary real property leasing, and limited minor construction.

Contracting can augment organic military unit support capabilities and provide new sources of critically required supplies, services, and real estate. It can also bridge gaps that may occur before the deployment of sufficient Army support. Contracting should always be the preferred method of support, beginning as soon as requirements are known.

Decentralized contracting provides a means to respond rapidly to immediate demands. As operations stabilize, centralized contracting becomes more important, allowing Army units to gradually diminish support, to transfer functions to civil agencies, and to disengage and redeploy.

**Warranted contracting officers will be needed early in domestic support operations.**

During the initial stages of a crisis operation, warranted contracting officers will be needed immediately to procure validated emergency supplies and services. Contracting officers may be brought in with federal forces or they may be provided by the ARNG from its property and fiscal offices, by the designated support installation, the USACE, or by a civil agency.

#### NEGOTIATED SUPPORT

In some cases, civil authorities may have enough logistical resources to support not only themselves but also the Army personnel providing assistance. For example, civil authorities may provide housing, food, and fuel to troops assisting in a counterdrug or firefighting operation. Such support is negotiated on a case-by-case basis with the appropriate civil authorities.

#### MILITARY SUPPORT

Whenever possible, installations will continue habitual support to units tasked to conduct domestic support operations. Installations may also have to support personnel with whom they have no established support relationship. These personnel may include civil authorities, elements from other services, and Army elements from other stations.

If an installation or one of the other sources discussed below cannot provide required support directly, planners will tailor a support force for that purpose. Most considerations for tailoring a support force are the same as they are for any operation: requirements, available resources, estimated length of the operation, and so on.

#### SUPPORT FROM OTHER FEDERAL AGENCIES

The GSA also provides support to civil authorities. GSA provides general supplies and services that are

common to more than one department of the federal government. GSA can provide an extensive amount of support to DOD for such commonly used items as office furniture and supplies, machine and hand tools, photo supplies and other items. Other federal agencies and organizations may be able to provide assistance depending on the nature, scope, and duration of the operation.

### LOGISTICS COMMAND AND CONTROL CELLS

Logistics command and control cells are critical to successful support operations. A materiel management center (MMC) can operate in a split-based mode. This concept provides for part of the MMC to remain in a secure location (out of harm's way), while a force projection MMC element deploys with the force it is supporting. The forward deployed MMC element

would provide a conduit for the electronic transmission of logistics data, messages, and voice communications traffic, resulting in inventory asset visibility. Such visibility is vital to logistics support operations.

**Logistics command and control cells must arrive early in domestic disaster operations.**

Combat service support units must continue to support units awaiting redeployment. Resource accountability remains critical during this phase to prevent waste, fraud, and abuse. At or near the

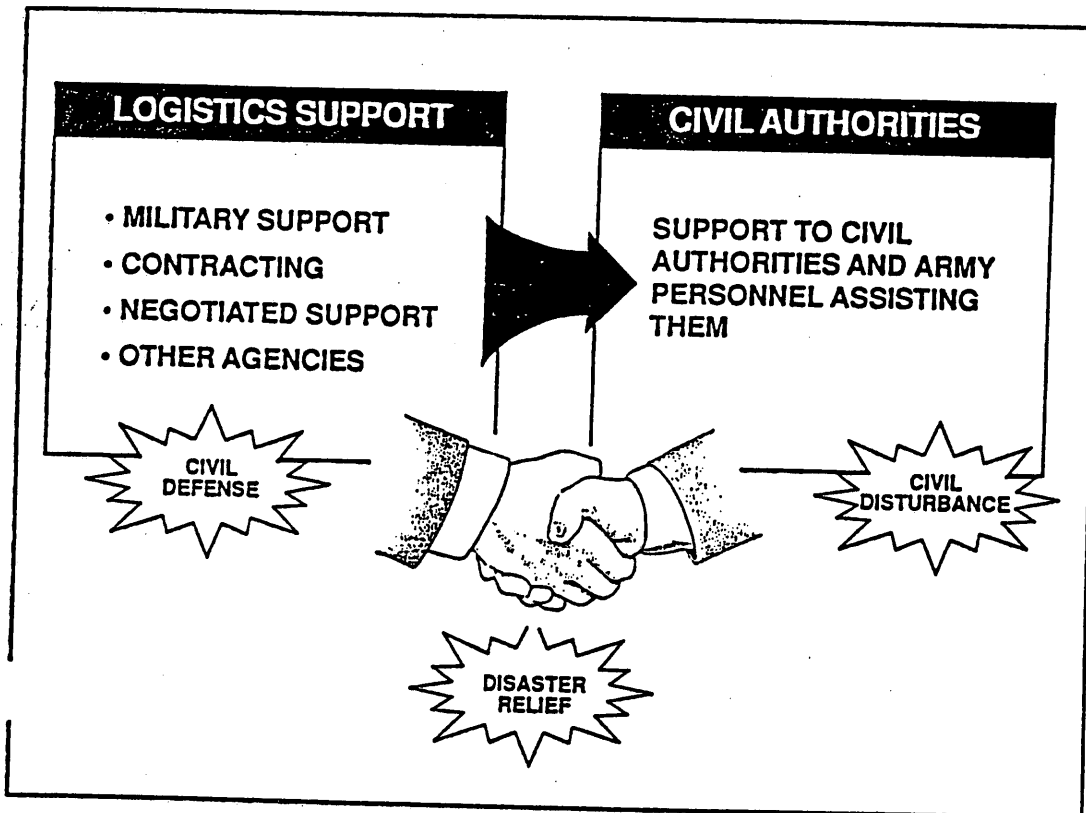

Figure 4-1. Sources of Support

## DOMESTIC SUPPORT OPERATIONS

completion of domestic operations, redeployment will be phased to allow for continued and uninterrupted support to civil authorities. Military support should not be curtailed before civil authorities assume the function. When state-activated ARNG units remain on site, special efforts should be undertaken to assist them. Transportation must be arranged through the appropriate movement control organization in accordance with established priorities.

*In the past three years (1989-92), US military forces have responded to three hurricanes and two typhoons that struck densely populated areas. After the most recent storms, Hurricane Andrew in Florida and Louisiana and Hurricane Iniki in Hawaii, Army soldiers provided relief services, prepared meals, cleared and hauled debris, produced and distributed water, restored power, and constructed life support centers. These missions provided important lessons in preparedness, leadership, organization, equipment, and safety.*

### RESOURCE MANAGEMENT

The commander is responsible for maintaining the readiness of the command to execute missions and operations. Any unprogrammed requirement may result in spending resources intended for other use. To request reimbursement for lost resources, the commander must be able to account for them. Equipment and supplies misused, improperly maintained, damaged, lost, or issued to others will adversely affect future readiness and timely deployment.

Judicious management and accountability should be an early and constant focus. When possible, resource management analysis should precede key operational and logistics decisions and actions. Army resource managers should seek early guidance as to reimbursement. For example, will the operation be reimbursable from civilian

sources, should specific Army accounting codes be used for the operation, and so forth. Project codes for use in accumulating costs should be requested at the onset of a disaster relief effort. Designating logistics organizations, for example, US Army Materiel Command corps support command (COSCOM), divisional support command (DISCOM), to receive, store, issue, and account for DOD material must also be considered.

**Judicious management and accountability should be an early and constant focus.**

State, local, or federal agencies; DOD; or other military services will normally reimburse the Army for assistance. The reimbursement process requires accurate billing for legitimate costs. Discrepancies must be resolved with the supported and/or reimbursing agency. Supported agencies should keep records of services and support received from the Army. To distinguish costs from those related to training or normal operating expenses, Army resource managers must maintain accountability throughout an operation for costs of equipment and supplies dedicated to operational support.

Commanders and managers should fully integrate resource management into all phases of the operation. Establishment of a resource management element to review procedures and advise the commander is also required. Positive resource management calls for planning to account for the expenditure of all resources supporting an operation with the expectation of being audited. By requesting early on-site involvement and advice from external functional experts, for example, Army Audit Agency (AAA) and General Accounting Office (GAO), resource managers can head off major accounting problems that could occur later in the support operations.

### SUPPLIES AND FIELD SERVICES

Supplies and services are critical to the life-threatening needs of some types of civil emergencies and to the sustainment of operations in others. Basic guidelines for support are to tailor the package for the

mission, to contract for services early on, and to utilize local resources when possible.

**DEFENSE LOGISTICS AGENCY**

The DLA may provide common supplies and services used by the military services when supporting domestic operations. The agency's mission is to provide effective logistics support to the operating forces of all military services and to federal civil agencies as assigned. DLA provides support at the lowest feasible cost to the taxpayer. It provides contract administration services in support of the military departments, other DOD components, and other government agencies upon request. The DLA

organization is shown in Figure 4-2. Its defense distribution depots are shown in Figure 4-3.

**QUARTERMASTER (QM) UNITS**

QM supply and field service units, which should be among the first logistics elements deployed, will satisfy immediate needs and establish receipt, storage, and distribution of incoming supplies. QM units can make food, water, clothing, and shelter available and coordinate required contractual services. The Army's field service companies provide personal hygiene services such as showers, laundry, and, if required, delousing.

The Army has various options for feeding people, even though no unit is specifically designed for mass

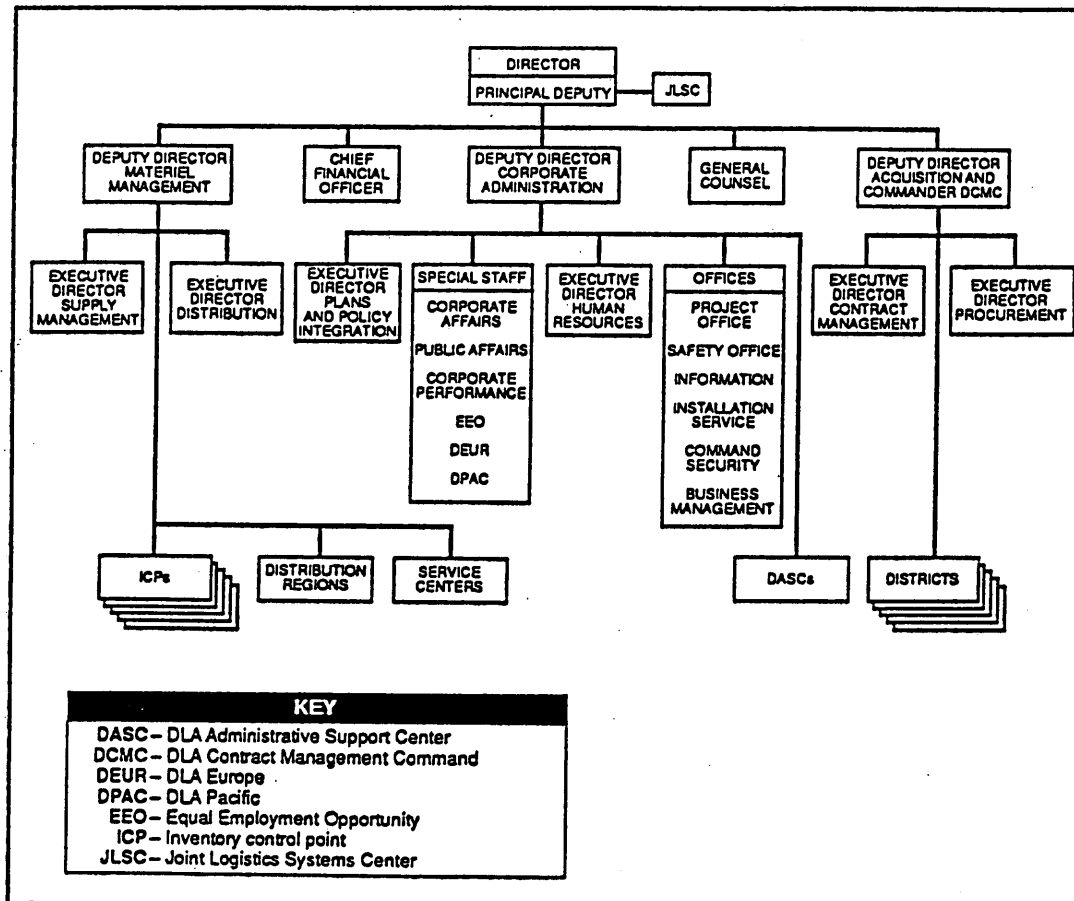

Figure 4-2. Defense Logistics Agency



## DOMESTIC SUPPORT OPERATIONS

feeding. Options range from distributing meals, ready-to-eat (MRE) to preparing and providing hot meals in a climate-controlled dining facility. Under certain conditions, contract feeding may be a viable means of support. However, local circumstances will dictate the method chosen to feed both supporting military personnel and the supported civilian population. To the extent available, QM units should use established structures suitable for feeding.

### MORTUARY AFFAIRS UNITS

Because disasters usually occur without warning, they create considerable confusion, as well as a shortage of personnel to handle the sensitive, unpleasant task of caring for the dead—a job that must be done quickly and efficiently. At such times, Army mortuary affairs forces can provide valuable assistance. When the requirement for such services exceeds a

community's capabilities, Army mortuary affairs units can provide search, recovery, evacuation, and identification services.

### FORCE PROVIDER UNIT

The Army's Force Provider Unit is specifically designed to provide logistical support in a consolidated location. It is also ideally suited for supporting disaster and humanitarian aid operations. This system, which can provide support for 3300 people, is designed in modules. Each module is capable of independent operations. The unit includes billeting facilities with heating/cooling, kitchens, latrines, showers, laundries, power generation, and water purification. It also includes facilities and equipment and material for religious support as well as morale, welfare, and recreation (MWR). Figure 4-4 shows a 550-person Force Provider module.

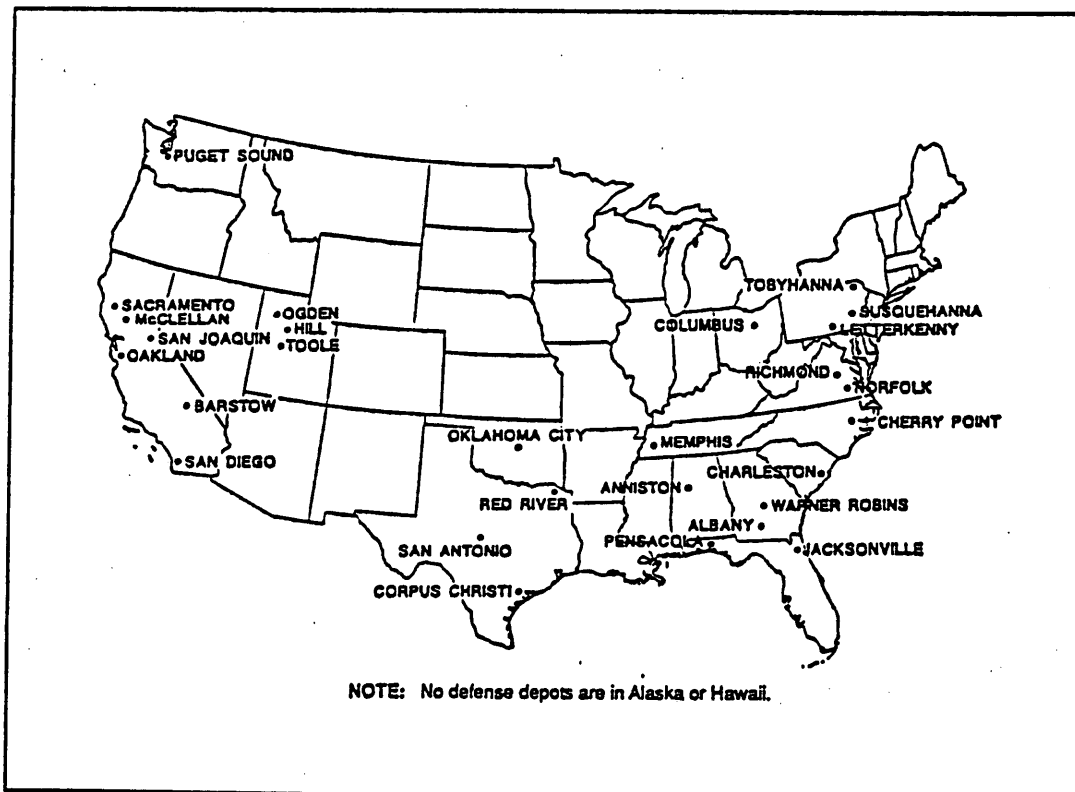

Figure 4-3. Defense Distribution Depots

**OTHER SUPPORT**

Depending on the magnitude of need and the flow of supplies, Army units may require an extensive storage complex.

In emergencies, large quantities of goods are routinely contributed to the affected populace. Normally, civil agencies handle these donated goods; however, they may request that Army forces do the job. Commanders must recognize the requirement for supply accountability and reimbursement for goods and services in accordance with applicable Army regulations. Likewise, they must honor their responsibility to provide designated common supplies to other services in accordance with regulatory guidance. Such efforts apply equally to US civil authorities and traditional military operations.

**Real Property**

Civil emergency service organizations and the NG should jointly coordinate the use of real property. Facilities should be selected based on their potential for support and the anticipated scale of assistance operations. Vacant warehouses, parking lots, potential staging areas, and other facilities that could be used for

supply activities should be acquired to enable receipt, storage, and distribution operations.

**Facilities must be identified to accommodate the receipt, storage, and transshipment of supplies to an impacted area.**

**Equipment**

The nature of the emergency and prevailing conditions will determine the proper mix of equipment needed. In many cases, military equipment is well-suited for domestic support operations. However, additional equipment may be required, either temporary loans from other units or civilian equipment. When civilian equipment is needed, the commander must convey the requirement to higher headquarters. The supporting contracting element (SCE) determines

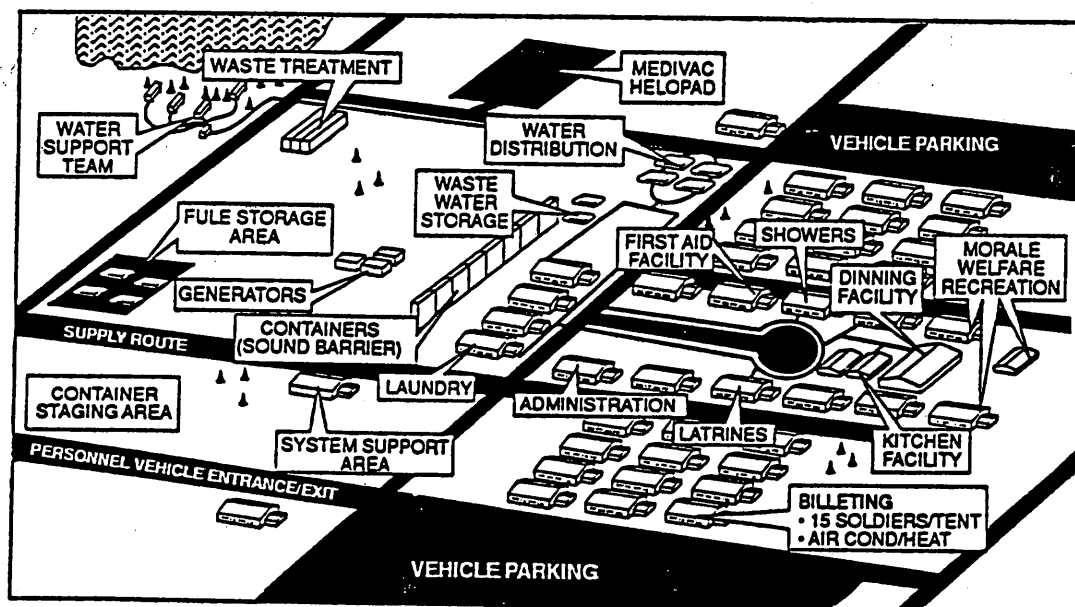

Figure 4-4. 550-Soldier Force Provider Module

## DOMESTIC SUPPORT OPERATIONS

market availability and processes local purchases or hires. In some cases, unit commanders will have the authority to commit funds.

Army equipment may be loaned between active and reserve units, to other services, or to federal government and law enforcement agencies to supplement their capabilities. With proper authorization, loans may be made to nonfederal agencies; state, county, local civil authorities; or private agencies. Normally, consumable supplies and repair parts are not loaned.

*As a result of Hurricane Andrew, the 16th Field Supply Co (FSC), 240th QM Battalion, was deployed to provide support. The 16th FSC mission provided laundry, bath, and light textile renovation support to disaster victims and deployed forces. Overall, the 16th FSC processed 5000 bundles of laundry and provided showers for more than 22,000 soldiers and civilians.*

The borrower must sign a statement assuming liability for equipment during the period of the loan, to include care, custody, security and safeguarding, proper use and maintenance, and responsibility for all incremental costs accrued to the Army. Prior to issue, the Army should clearly define condition standards for return.

Requests from nonfederal agencies must state that a commercial source for an item is not reasonably available. Loan of firearms, weapons, combat or tactical vehicles, water vessels, and aircraft must be approved by the Assistant Secretary of the Army.

### MAINTENANCE

The number and type of maintenance units deployed will depend on the operational requirements of the crisis. Military maintenance personnel will remain under military command and control throughout the assistance operation. Whenever possible, the normal planning and execution chain of command should remain in place.

Maintenance commanders should identify supporting vendors; organize maintenance elements; and organize assets from other agencies, contractors, and local maintenance resources. Commanders must consider not only support of their own equipment but support of diverse civilian equipment such as buses, trucks, ambulances, power generation equipment, and so forth.

Commanders must plan on maintenance being performed under field conditions. Disaster relief vehicles such as ambulances, firefighting equipment, buses, power generation and construction equipment will receive priority. As facilities are reactivated following a disaster, maintenance of local infrastructure equipment might be conducted in fixed facilities on an ever-increasing scale.

The types and quantities of Class III and Class IX supplies to be carried or constructed for support of local infrastructure equipment will depend largely on the type of disaster and the equipment being supported. Standard prescribed load lists (PLLs) and authorized stockage lists (ASLs) should be adequate for unit military type equipment committed to domestic support operations. However, this may need to be tailored to support equipment for units in attached or under operational control (OPCON) status.

A priority consideration is the early reestablishment of the local government's infrastructure. Maintenance units are particularly adept at providing this support, whether repairing the local television and radio stations or emergency vehicles. Emergency or quick-fix type repairs similar to the Army's Baule Damage Assessment and Repair (BDAR) System may be required in the early stages of disaster relief, allowing time for repair parts procurement and establishment of a maintenance program.

### TRANSPORTATION

Early assessment of transportation requirements is essential. Transportation support will be tailored to both the deployed military force and civil authorities under centralized control. The Army can provide numerous capabilities depending upon the mission. Transportation planners should be deployed early as part of the logistical assessment element.

Movement control units plan, schedule, and control Army movements into, within, and out of an area of

operations. They also support joint force movement control requirements and coordinate support with civil authorities. In this capacity, an Army movement control unit can provide the nucleus of a joint movement center (JMC) and effectively meet all requirements. The JMC is a proven concept and can be tailored to meet the operational transportation requirements. A notional JMC is depicted in Figure 4-5.

**The JMC is a proven concept and can be tailored to meet operational requirements.**

Transportation units may be organized under a multifunctional or pure transportation headquarters depending upon the tailored support package. Truck companies can distribute large quantities of essential cargoes over terrain normally impassable to most civilian trucking. Cargo transfer companies prepare cargo for transshipment at distribution centers. Terminal service companies operate water ports, load and offload ships, or assist civilian port operators. Watercraft companies move units, supplies, and equipment along intracoastal or inland waterways.

*Asked to provide a JMC during Hurricane Andrew, the US Army Transportation Center deployed a JMC nucleus to the JTF headquarters. With augmentation, the JMC succeeded in providing a combination of air, land, and sea transportation to DOD forces, disaster victims, and relief workers.*

#### EMPLOYMENT

Deployment to the area of operations will normally be under the centralized control of the US Transportation Command (USTRANSCOM) and will often be conducted under crisis action procedures. Units will deploy according to port-call instructions using

military and commercial transportation. Deploying units or teams follow existing policies, procedures, and regulations. When deployment control is not centralized under USTRANSCOM, the servicing installation arranges transportation to final destination.

#### CONVOYS

Military convoys are coordinated between the deploying unit's installation and the defense movement coordinators (DMCs) in states where the convoys originate. The DMC coordinates military movements with his state transportation, civil defense, and law enforcement officials. During domestic support operations, the DMC should provide liaison to the senior movement control organization in the joint force.

#### REDEPLOYMENT

Redeployment will be centrally controlled to provide for orderly movement out of the area in compliance with approved termination standards. The deployed force must be prepared to redeploy on commercial transportation since redeployment normally carries a lower priority for military lift than does deployment. The servicing installation transportation office (TTO) in the area of operations will procure the commercial transportation, prepare and issue shipping documentation, and monitor carrier performance. If an TTO is unavailable to service the area, a joint transportation office (JTO) must be organized to provide this support.

#### AVIATION

Army aviation support to domestic operations includes air movement support of logistics and transportation operations; command and control support to federal, state, and local authorities; and reconnaissance and surveillance support of law enforcement operations. Active duty and National Guard aviation units provide support to civil authorities for counterdrug programs, civil disturbances, and border surveillance operations.

Unmanned aerial vehicles (UAVs) have tremendous potential in surveillance and reconnaissance operations of US border areas. Army aviation's inherent flexibility and responsiveness are ideally suited to support military and civil authorities.

Aviation support during disaster assistance operations will concentrate on air movement,

## DOMESTIC SUPPORT OPERATIONS

aeromedical evacuation, and command and control. Disasters may temporarily close ground lines of communication due to debris or higher priority traffic. Large metropolitan areas will experience traffic gridlock. Aviation units should include medium lift assets in the initial response to enhance distribution of critical personnel, supplies, and equipment over these obstacles. Early aerial reconnaissance of the disaster area by federal, state, and local authorities will help to assess relief priorities.

Aviation operations in a particular area will include various DOD aviation assets and many civilian and public aircraft. Coordination with the FAA and DOD representatives is imperative to delineate disaster area airspace procedures, management, and safety. Recent aviation operations in support of civil authorities point out the critical need to form airspace management cells and an aviation liaison cell within the first 24 hours.

Relationships among military services and the FAA air traffic services (ATS) must be succinctly addressed. The development of an aviation procedure guide (APG) will assist airspace management. These guidelines must extend to all prospective airspace users. Planners should provide guidance on flying civilians (law enforcement and government officials, Red Cross, news media, and non-DOD relief workers) and allocating critical aviation assets at the very beginning of the operation.

### ENGINEER

Engineer assistance to civil authorities will vary with each type of operation. Engineers may become involved in these operations as individuals, teams, or complete units. Individuals may technically assist in assessing damage or estimating engineer work. They

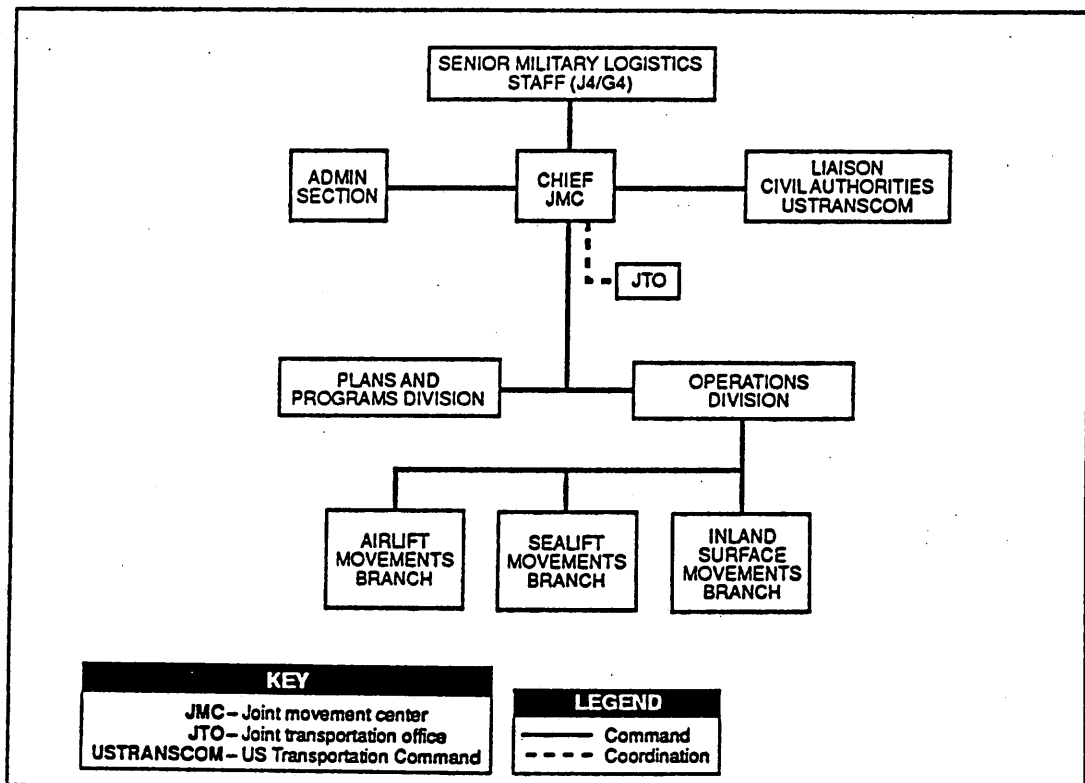

Figure 4-5. Typical Joint Movement Center Organization

may provide specialized support such as power supply and distribution or utilities repair and reconstruction.

The USACE provides expertise through its engineer districts and divisions. Support can include damage survey and assessment teams, contracting support, and technical advice. The US Army Engineering and Housing Support Center (USAEHSC), a field operating agency of USACE, provides prime power teams and equipment. These power teams restore temporary electrical power to key locations. Planners must resolve funding issues with USACE early in the assistance process.

Army engineer units provide a wide variety of skills and capabilities, including limited construction, structure repair, clearing and hauling debris, limited temporary electrical and plumbing facilities, and construction of life support centers. Engineer units possess heavy construction equipment, exterior lighting capability, and generators for temporary electrical power. Soldiers in engineer units are skilled in a variety of tasks useful during the response to and the recovery from natural disasters.

### MAPS AND CHARTS

In domestic support operations, map coverage is critical to provide a common frame of reference for all military and civil agencies. Paper maps, image-based substitute products, Geographic Information System (GIS) data bases, or a combination that provides total coverage is acceptable. Common maps and GIS data bases should be provided to all agencies and headquarters that are operationally involved. All controlling headquarters should operate from the same geographic frame of reference to coordinate support.

When locally produced products are available on a larger scale, they should be used. Maps or charts at a scale of 1:10,000 or 1:5,000 are extremely useful in assisting civil authorities. Products at these scales are better able to portray street names, local landmarks, and other commonly used reference points that are not usually portrayed on Defense Mapping Agency (DMA) - US Geological Survey (USGS) maps at smaller scales. Local planning agencies, realtor associations, travel agencies, or utility company records may be able

to provide such detailed map coverage. US Army topographic engineer units, federal mapping agencies, or local activities may be able to reproduce these products as required.

If map coverage does not exist over the area of operations, agencies can request image-based products, which can be produced in a relatively short time using unique imagery capabilities. US Army Engineer channels handle requests for such products.

### INTELLIGENCE

The importance of timely, focused information cannot be overstated. Military intelligence offers a disciplined and trained cadre of specialists who can quickly collect, integrate, analyze, and disseminate information that decision makers need to respond immediately to a situation. The first step is to sensitize military planners and operators to crucial needs of civilian authorities. Concurrently, they must keep in mind the distinction between the employment of military intelligence assets outside the US and the application of legal guidelines within the US. The best use of intelligence capabilities is through the skills and techniques employed in the IPB and liaison with law enforcement agencies.

### MILITARY POLICE

Military police have special expertise in counter-drug, terrorism, and civil disturbance operations. They are highly mobile and capable of providing search, rescue, and evacuation support; physical and area security; and traffic circulation control. Due to their decentralized operations and density of communications equipment, they are also valuable for notification and area damage control.

### MILITARY HEALTH SERVICE SUPPORT

Commanders may use medical forces and resources in domestic support operations when directed by the NCA. They may provide medical personnel and resources to support interregional military medical plan (IRMMP) missions before any NCA allocation

## DOMESTIC SUPPORT OPERATIONS

decisions. Commanders may withdraw this support, which is temporary, to meet higher priority military missions if they occur. The health services' goal in disaster operations is to assist the local and state health services organization return to normal. Figure 4-6 depicts levels of effort.

Medical support can range from local domestic support to a full-scale regional disaster. Guidance for DOD medical support for domestic operations will normally be based on priorities established by the DHHS at both regional and national levels.

### TASK-ORGANIZED MEDICAL TEAMS

When civilian authorities are unable to provide or are required to request medical support, the NCA can direct the deployment of medical teams. These task-organized teams will enter the affected area to assess the medical situation, determine treatment and evacuation requirements, establish treatment elements, and facilitate evacuation.

In situations where civil medical services are not available, for example in isolated areas, assistance includes, but is not limited to, personal hygiene, immunizations, chemical prophylaxis, pest management, nutritional programs, and epidemiological surveys. HSS encompasses several functional areas that call for immediate and sustained assessment of the public health status and local medical infrastructure.

### KEY PLANNING GUIDANCE

After the initial response, a mission analysis is conducted so that the HSS response can be tailored to meet the needs of the community in both the short and long term. Domestic emergency experience has shown that the senior US Army medical commander must locate his headquarters near the FCO's offices. Coordination between these two organizations is essential to unity of effort. Both should also centralize the location of HSS specific supply items from multiple sources (private and government). A medical logistics unit can provide assistance to non-DOD federal and civilian agencies in dispensing materiel.

### NATIONAL DISASTER MEDICAL SYSTEM

The NDMS was jointly developed by the DOD, the FEMA, the DHHS, and the VA to serve as a backup for the VA/DOD Contingency Hospital System for military casualties. NDMS is also the primary recipient of

casualties in the event of a catastrophic national disaster.

Depending upon the magnitude of the disaster, the local civilian hospitalization system and resources may become saturated, and NDMS may be activated. DHHS is responsible for ensuring sufficient available hospitalization capability. It considers a number of options to meet this requirement. First, the Army could deploy hospital resources such as a combat support hospital (CSH) or a mobile army surgical hospital (MASH) to the immediate disaster area. Second, the Army could coordinate the evacuation of patients to Army Medical Department Activities (MEDDACs) community hospitals or medical centers throughout the US. Third, Army medical units can use hospitalization resources from the other services.

During domestic national emergencies, the NDMS also depends on existing resources that will remain under the control of parent agencies. One of these is a nationwide network of more than 100,000 standby nonfederal acute care hospital beds. The NDMS depends on other in-place resources, including communication networks, transportation, and medical regulation systems to evacuate casualties to receiving hospitals. The national medical mutual aid response network provides patient clearing and staging services. It uses disaster medical assistance teams (DMATs), available military medical units, and supplementary medical supplies and equipment to carry out its functional support.

### SYSTEM ACTIVATION

The system may be activated in two ways. In the event of a domestic disaster, the governor of the affected state may request federal assistance under the authority of *The Disaster Relief Act of 1974*. This may result in the activation of NDMS. A state health officer may request that the the Secretary of Health and Human Services (HHS) activate the NDMS in situations where the President has not declared a disaster.

In a civil emergency, the principal interface will be through FEMA and HHS regional coordinators to the state disaster medical and health coordinator. If the system is activated, the lead agency will be the DHHS; in a national security emergency, the lead agency will be the DOD. Each agency will be responsible for managing its own resources in accordance with general policy.

### PERSONNEL SERVICES

Personnel units and soldiers will primarily be used to support soldiers conducting the domestic support operation. While this personnel support is provided during any operation, a domestic support operation may require additional planning and preparation. For example, maintaining accurate strength accountability may be more demanding due to unusual tailoring of units to fit the particular mission. In addition, personnel soldiers may support military and family members who are victims or are otherwise affected by the operation.

Personnel units and soldiers may be brought into an operation to assist civil authorities in accomplishing

their mission using civilian agency systems. Assistance in personnel identification, classification, and accounting may be needed. Personnel soldiers may also assist in receiving and interviewing civilians to collect information and identify unique skills. They may account for casualties. Military personnel services units also assist civil personnel in recognizing outstanding contributions from members of the supported population. Assistance is provided to the US Postal Service if it is not able to conduct essential mail operations. Morale, welfare, and recreation services are provided in limited scope or as part of a force provider package.

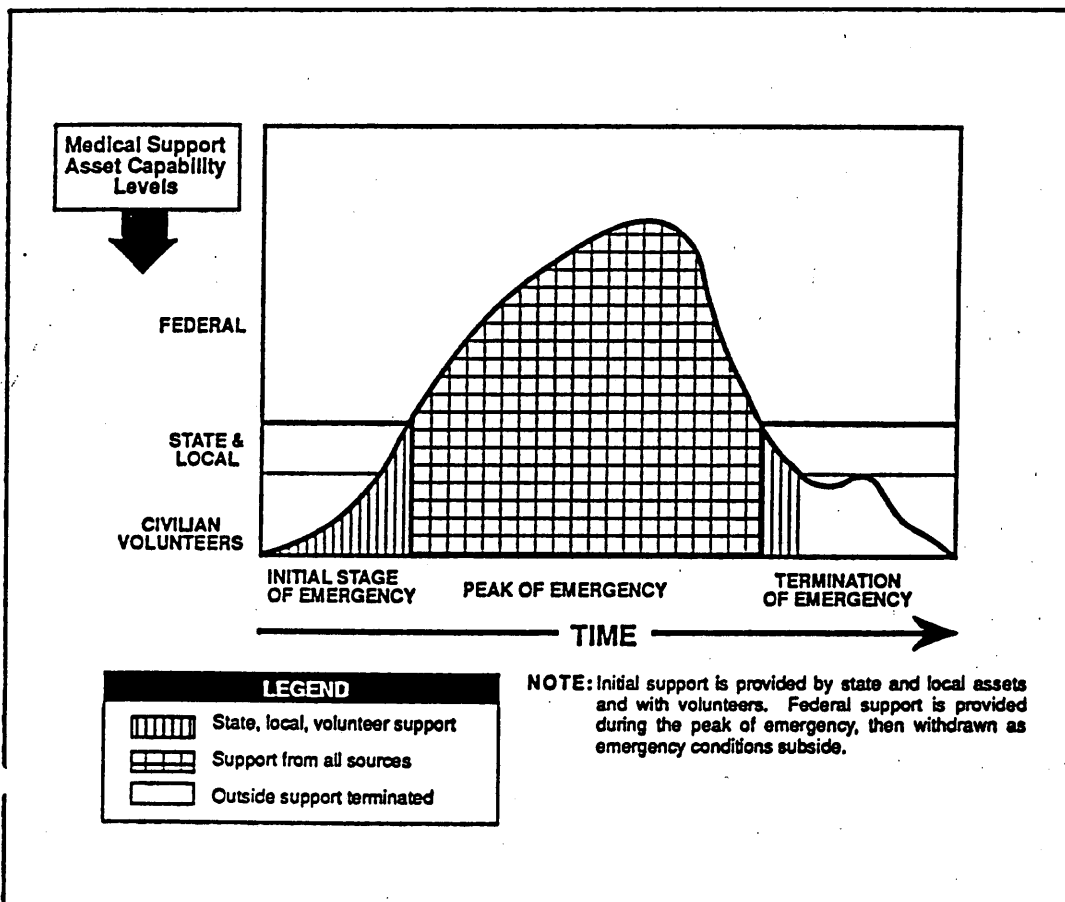

Figure 4-6. Military Medical Relief Support



## DOMESTIC SUPPORT OPERATIONS

### FINANCE

The finance mission is to sustain operations by providing timely commercial vendor and contractual payments, various pay and disbursing services, and all essential accounting. Organizational support is provided to organization units as required. It includes payment for local procurement of supplies and services, legal claims, and so forth. Finance units must provide accurate cost descriptions for initial input into the accounting system for all transactions.

Procurement support, the most critical finance mission, covers two areas. Contracting support involves the payment of commercial accounts for goods and services obtained through formal contracting procedures. Finance units can disburse currency and checks, which can alleviate shortages and delays in the procurement of various supplies and services. Commercial vendor services (CVS) meet immediate needs that cannot reasonably be met by normal logistics. Imprest fund cashiers, finance support teams (FST), and Class A agents may pay CVS in cash. Units must appoint Class A agent officers to make cash payments when they will be delayed.

*The 312th Army Reserve Band from Lawrence, Kansas, developed a counterdrug program for school kids. During their summer 1992 annual training (AT), band members designed a mixed program of music, dance, and testimonials that told the children, in terms they could understand, that drug use is wrong and leads nowhere. The band expanded its AT effort and now regularly visits local schools, playing for and talking to young students.*

### BAND

The Army also provides band support. Bands contribute effectively to commanders' community relations programs. Patriotic and popular music instill feelings of well-being and pride and provide respite from worries and problems. The band stationed nearest

the involved area should be the one tasked to support civil authorities with musical programs.

### LEGAL

Judge advocates provide advice and assistance in the functional areas of the law, including administrative, contract, international, and operational law, as well as claims, legal assistance, and military justice. Historically during military operations, the duties of the judge advocate have concentrated on the military justice system. During support operations to US civilian authorities, this military justice mission may take a secondary role to the mission of providing advice on the laws dealing with military and civilian relationships. Questions concerning the scope and source of the commander's authority, liability of soldiers, and contingency contracting may come to the forefront. For example, after-action reports from Hurricane Andrew identified a greater need for judge advocate support for claims and contingency contracting.

### CHAPLAINCY

When federal units are called in, a high probability exists that a significant amount of devastation and trauma will be associated with the emergency. Early deployment of unit ministry teams (UMTs), which consist of one chaplain and one chaplain's assistant, will put care givers on the scene to deal with trauma.

Particularly at risk are soldiers who are confronted with the emotional impact of the disaster as they arrive on the scene. The chaplain's key role is to provide spiritual care and perspective to enable the soldiers to deal with the situation as they find it.

Early deployment is particularly critical when civilian care givers, such as pastors and social workers, are themselves traumatized victims of the disaster. During the initial response phase, these people will be extremely limited in their ability to provide care. Although the UMTs may not provide direct care to affected people, they can identify those in need of care and refer them to those who can help. Through consultation with local civilian religious leaders, faith groups, and organizations, the senior chaplain of the response force will assess physical and spiritual needs and determine ways to meet both.

During the aftermath of Hurricane Andrew, UMTs provided religious support to military personnel who were providing food, water, shelter, and medical care

to civilian victims. They also talked with victims, distributed food, counseled children, picked up debris alongside other relief workers, and visited the elderly. As they met civilians in the affected area, UMTs provided religious support. They also coordinated with civilian clergy to provide religious services for civilians remaining in the life support centers. UMTs became key coordinators with local religious organizations.

### **PUBLIC AFFAIRS (PA)**

Public affairs is a critical consideration in Army domestic support operations, where commanders must operate in an environment of complex information demands. Domestic support operations impart a lasting impression relative to the commitment of the civil-military teams. Ultimately, the impression of the assistance effort depends to a great extent on the media. The public's perception will also be influenced by the cooperation and coordination between commanders and civilian leaders and the efforts of the public affairs personnel.

**Commanders must be prepared to operate in an environment of complex information demands.**

The news media will have unrestricted access to domestic support operations. Army public affairs officers (PAOs) must operate under any constraints imposed by the government agency that has jurisdiction. The lead agency will have release authority. The Army must coordinate all PA activities with the lead agency and comply with public affairs guidance. Public affairs officers must establish an Army information bureau to work with the Joint Information Center (JIC).

The PAO advises the commander on the information demands that he can anticipate, the information strategies available, and the effect of the communication effort. It is sometimes necessary to create an *ad hoc* PA organization to support the operation. Regardless of how Army units provide PA

support, it is critical that leaders involve their PA personnel in planning and decision making.

Commanders should be prepared to provide timely and pertinent information to the media on developing issues and changing perceptions. They must be prepared to appear on camera, answer questions, and provide explanations in order to tell the story as completely, accurately, honestly, and openly as possible.

Commanders must also fill the information needs of their soldiers. Providing effective command information is a critical element in maintaining soldier morale and unit esprit. Soldiers need information about the environment in which they are operating. They need to know that their work is valid, moral, and supported by the American people.

### **SPECIAL OPERATIONS FORCES (SOF)**

Army special operations forces are particularly suited to domestic support missions. They are trained and experienced in operating in austere environments. Many are cross-trained in various disciplines. Three types of SOF units are especially well-suited to domestic support missions: civil affairs (CA), psychological operations (PSYOP), and special forces (SF).

#### **CIVIL AFFAIRS**

CA units are specifically organized to use the civil sector functions and skills and to provide support to various levels of government in 20 specific functional areas. This working knowledge is especially useful in disasters. The units will tailor their capabilities to particular situations. CA units should be employed to advise the military commander on the impact of military activities on the civil sector. They assess damage to the civil infrastructure, assist in the operation of temporary shelters, and manage a civil-military operations center (CMOC). CA units may also serve as liaison between the military and the various civil organizations.

#### **PSYCHOLOGICAL OPERATIONS**

The rapid production and dissemination of accurate information to the population in crisis situations are important. This information may include safety and health messages, location of water or food distribution

## DOMESTIC SUPPORT OPERATIONS

points, and designation of restricted areas and temporary shelters. Since the normal civilian facilities may be disrupted, these units may have to employ alternative methods. Equipment assets of PSYOP units (portable printing presses, loudspeakers, and radio broadcasting stations) have often been needed in disaster operations. PSYOP personnel can provide a commander with real-time analysis of the perceptions and attitudes of the civilian population and the effectiveness of the information being disseminated.

### SPECIAL FORCES

The SF team's organization, training, capability, and adaptability allow them to operate effectively in remote and urban areas isolated by disaster events. They may be able to provide detailed reports and assessments on conditions in the area. The teams are rapidly deployable, have excellent radio communications capabilities, and are suited to working with culturally dissimilar ethnic groups.

### SIGNAL

Forces deployed in domestic support operations must carefully plan their communications packages. Communications objectives must be determined, responsibilities defined, and types of support identified. The level of information mission area (IMA) support required depends on the nature of the assigned mission. In all likelihood, a combination of military and commercial communications support will be required. A major concern for the signal planner will be the interface between military and commercial communications and information systems and networks.

If the commercial communication infrastructure is incapable of supporting civil and military communication requirements, the Army signal planner must coordinate with his civilian counterpart to determine what communication capabilities are required. This information is essential to tailoring the signal support package.

Most civil and military communications systems are incompatible for various reasons, for example, equipment, frequency allocation, and usage. Though possible, it is highly unlikely that either element will have sufficient assets on hand to equip both with compatible communications equipment. For these reasons, military and civil communication planners must exchange knowledgeable communication support personnel and compatible equipment to ensure connectivity is maintained between military and civilian operation centers. This exchange of personnel and equipment can occur at any level and should be implemented and modified as the situation dictates.

### CHEMICAL CORPS

Army chemical units are trained and equipped to provide support in many technological accident or incident situations. Although the current focus is on chemical or nuclear accidents or incidents, the present technologies and doctrine allow for greater flexibility in responding to any mission associated with the FRP. Chemical units can support domestic support operations as individuals, teams, or units.

**Chemical units can  
support domestic support  
operations as individuals,  
teams, or units.**

The Army Technical Escort Unit (TEU), as a DOD executive agent, has the primary mission of responding to incidents that include hazardous and toxic substances. TEU and associated explosive ordnance disposal, security, and command and control elements routinely deploy to support the movement and demilitarization of toxic chemical munitions and substances. Nuclear accident/incident (NAI) and chemical accident/incident (CAI) during domestic support operations require coordinated efforts through

DOD, and with the DOE, EPA, and LEAs. DOD and FEMA have established joint policy for a coordinated response to a nuclear material accident. Army policy and the Federal Radiological Emergency Response Plan describe duties of these agencies and organizations.

A chemical battalion headquarters can provide command, control, and communications resources, as well as training support, for any technological and consultative operation involving nuclear, biological, and chemical (NBC) defense and operations. Chemical reconnaissance units are equipped to conduct surveys and determine the type and extent of toxic contamination with mobile spectral analysis. Chemical decontamination units can deploy with high-mobility vehicles allowing off-road employment of a wide range of equipment and capabilities. Both reconnaissance and decontamination unit capabilities allow for chemical and nuclear hazard surveying, detection, identification, monitoring, and personnel and equipment decontamination. Additional capabilities provide local security, vector control, and limited water transfer, spray, and storage, allowing a limited personnel shower and a firefighting capacity. Chemical smoke units also possess high-mobility capabilities as well as equipment for the employment of smoke and obscurants.

Technical support available to other agencies includes surveying radiological and hazardous material, monitoring, determining downwind contamination hazards, and assessing vulnerability and area damage as may be required for environmental missions or for disaster assistance operations. Training and consultation in NBC defense and operations, including the use of defoliants, the employment of riot control agents, and the construction and employment of flame field expedient devices, are also available for civil preparedness. Chemical units are capable of providing NBC defense training in law enforcement and counterdrug operations.

If chemical units deploy as self-sustaining entities, they are capable of at least 72 hours of operations without additional support. Follow-on support requires coordination for resupply of chemical defense equipment and material and life support. Military, federal, or contracted logistics support can provide the required resources.

## SAFETY

Installation or unit safety professionals may be required to provide safety services to a community in support of assistance operations. Whereas military support is intended to provide aid and comfort, the potential for a catastrophic accident is greatly increased if equipment designed for combat is used for disaster assistance. If, due to expediency, soldiers are tasked to perform services in which they have little or no formal training, for example, civil disturbances, flood control, or firefighting, the result could be the loss of soldiers or military equipment and additional damage to the community the soldiers are trying to support. Army safety services must be focused toward both the Army unit providing the support and the civilian community receiving it.

The Army commander's primary responsibility is to accomplish the assigned mission and to provide for force protection. He accomplishes this through the systematic use of risk management techniques and the total integration of safety throughout all aspects of the operation. He must use the same philosophy and techniques to ensure that Army services provided to the civilian community are free of unnecessary risk. The safety (risk management) staff officer advises the commander and his staff on all applications of the risk management process and recommends how to integrate the safety function. He also maintains liaison with, and provides assistance to, other Army, joint, or combined elements as required or directed by the commander.

**SUMMARY**

Most domestic support operations are logistical in nature. Leaders and managers must understand the basic considerations and concerns necessary to accomplish those missions. Basic guidelines are to make a careful assessment of the mission, tailor the force for the mission, maintain accountability for resources expended, contract for support at the earliest opportunity, and transition support operations to local authorities as soon as possible. Force protection is a primary consideration and is implemented by identifying and eliminating unnecessary risks to the force and public.

---



## CHAPTER 5

# DISASTERS AND DOMESTIC EMERGENCIES

*The American people have come to expect Army support during times of critical need. Combat readiness, combined with organizational mobility, permits the Army to respond rapidly to crisis situations. This chapter describes how the Army provides support to federal, state, and local civil authorities during disasters and domestic emergencies.*

### THE ROLE OF THE ARMY

**The National Guard has primary responsibility for providing military assistance to its state.**

A fundamental principle for employing military resources is recognizing that civil authorities have the primary authority and responsibility for disaster assistance. The National Guard, in state active duty status, has primary responsibility for providing military disaster assistance in its state. The Army, as part of DOD, plays a supporting role to lead civil agencies during domestic emergencies.

As the DOD executive agent, the Secretary of the Army—through his Army Staff agent, the Director of Military Support—has both the responsibility and the authority to task the services, defense agencies, and the CINCs to support other federal, state, or local agencies. The SA will coordinate the commitment of unified and specified command forces with the CJCS. The chain of command is depicted at Figure 5-1.

### DISASTERS

A federal disaster is any event, either natural or man-made, whose severity or magnitude overwhelms the capabilities of local and state authorities to respond. Examples of natural disasters are hurricanes, earthquakes, floods, and fires. Hazardous chemical spills, radiological accidents, and massive electrical power disruptions are typical man-made disasters.

**DOMESTIC SUPPORT OPERATIONS**

Each state has a plan and an Office of Emergency Services, or similar agency, that is responsible to the governor for coordinating its disaster response efforts. Local emergency organizations will be the first to provide disaster relief assistance; next are state organizations, including the state NG.

Prior to or immediately following a disaster, the state will activate an Emergency Operations Center to gather information, assess damage, and advise the governor. The state OES, through its EOC, coordinates the local and state disaster response operations. The state's adjutant general and NG also play key roles in disaster assistance.

**RESPONSE FOLLOWING  
A PRESIDENTIAL DECLARATION**

When the severity of a situation exceeds local and state capabilities, the governor can request that the President declare a disaster, leading to the commitment of federal resources. At that time, the FEMA takes the lead in coordinating federal assistance. The FEMA coordinates the federal government's response to state

and local authorities for disasters and civil emergencies under the authority and provisions of *The Robert T. Stafford Disaster Relief and Emergency Assistance Act*. While the FEMA is the lead federal agency in most disasters, the DOE has the lead for civil radiological emergencies, and the EPA and the USCG share responsibility for chemical contaminations.

Regardless of the disaster scenario, DOD can expect to support the lead federal agency. The SA will issue an Execute Order, coordinated with the Chairman of the Joint Chiefs and the Joint Staff, through the DOMS to the appropriate CINCs, services, and agencies. The Execute Order will designate a supported CINC and specify the supporting CINCs, services, and agencies as well as the command relationships. The Army has designated CINCFOR as the DOD operating agent and the supported CINC for CONUS disaster assistance operations. CINCLANT and CINCPAC are operating agents and supported CINCs for US states, territories, and possessions within their respective areas of operations.

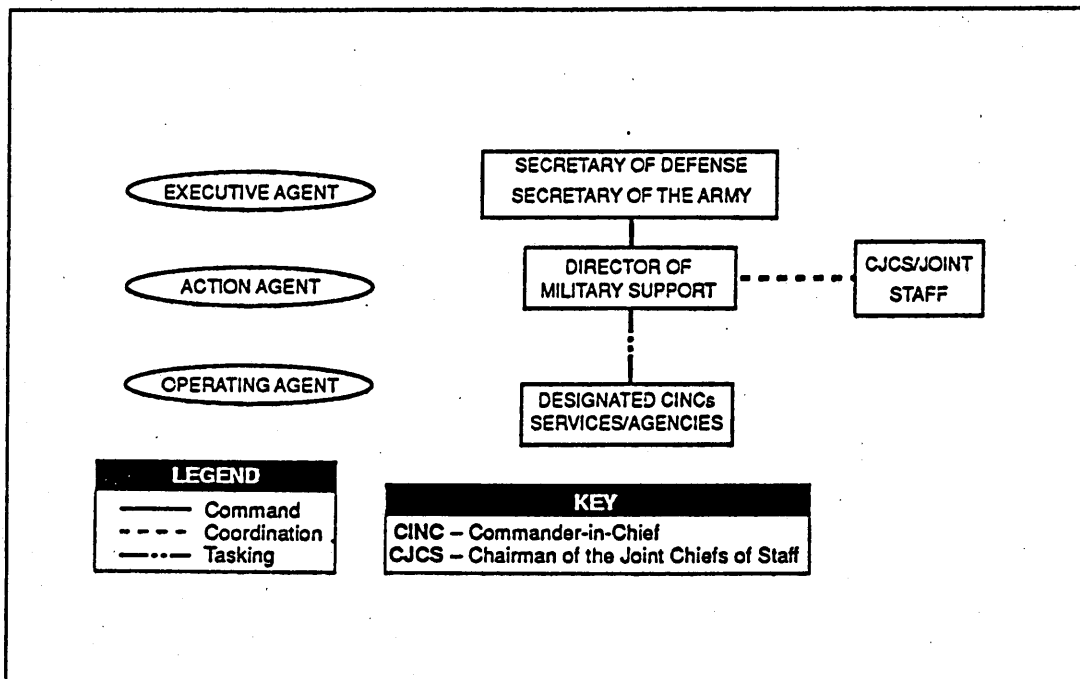

Figure 5-1. Chain of Command

**The CINC will  
appoint a defense  
coordinating officer to  
coordinate all requests for  
military assistance.**

mechanisms and structures by which the federal government mobilizes resources and conducts activities to augment state and local response efforts. The defense coordinating officer, appointed by the supported CINC, serves as the principal DOD point of contact for military support. The decision sequence for disaster support is illustrated at Figure 5-2.

**RESPONSE PRIOR TO  
A PRESIDENTIAL DECLARATION**

Military commanders may act before a Presidential declaration when an immediate life-threatening situation develops. When a disaster or emergency is imminent and awaiting instructions from higher authority—military or civil—would preclude responding effectively, military commanders may act. They

After declaring an emergency or disaster, the President will appoint an FCO to manage the federal assistance efforts under provisions of the FRP. The FRP addresses disaster or emergency situations in which federal response assistance is needed under the authority of *The Stafford Act*. The plan describes basic

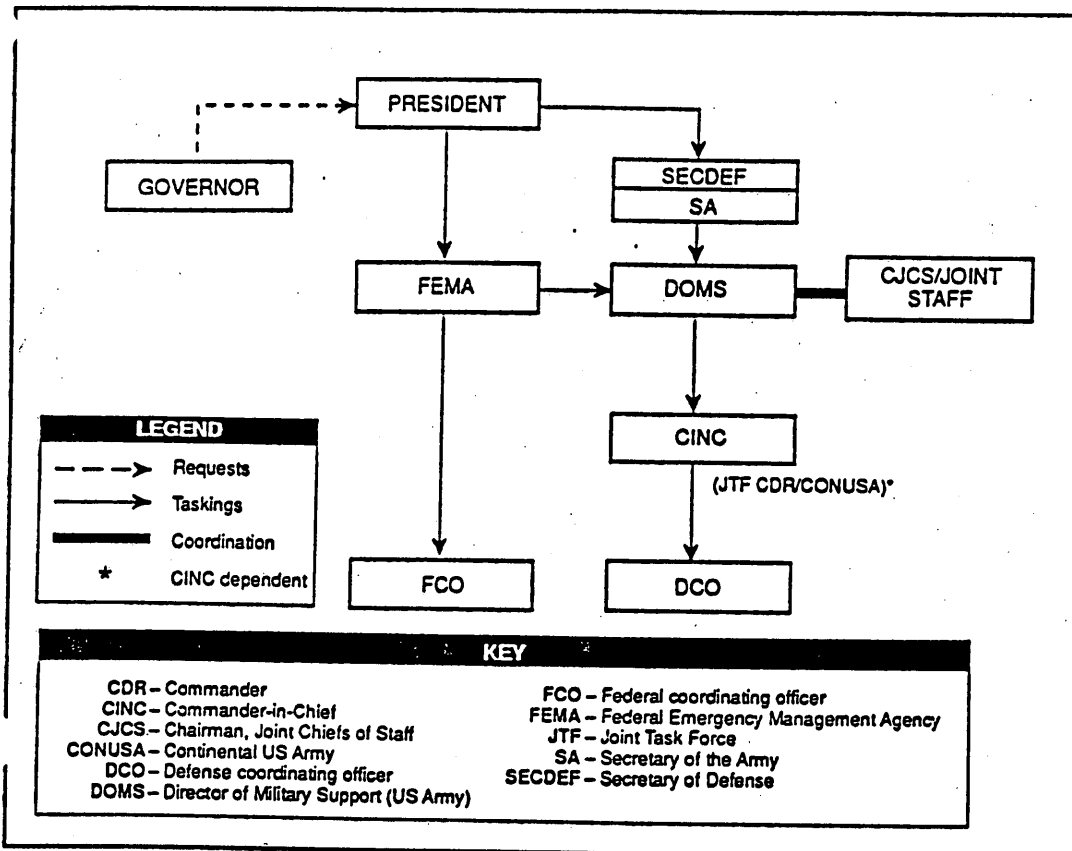

Figure 5-2. Decision Sequence for Disaster Support



may do what is required to save lives, alleviate human suffering, and mitigate major property damage within the proximity of their installations.

**Military commanders may act before a Presidential declaration when an immediate life-threatening situation develops.**

Commanders may use immediate response authority to assist in the rescue, evacuation, and emergency treatment of casualties; to restore emergency medical capabilities; and to safeguard public health. They may also provide essential public services and utilities. This list is not inclusive. Commanders use their assessment of mission requirements and the capabilities of their commands to judge the extent of immediate assistance they choose to provide.

Immediate response is a short-term emergency supplement to government authorities. It does not supplant established Army plans for supporting civil authorities, nor does it take precedence over a primary mission. Commanders notify their senior commanders and seek guidance for continuing assistance whenever Army resources are committed under immediate response circumstances. Immediate assistance is given with the understanding that its costs will be reimbursed; however, it should not be delayed or denied when the requestor is unable to make a commitment to reimburse.

When the President determines federal assistance will be provided in response to a natural or man-made disaster, the military commander will continue to provide immediate response assistance. He will adjust operations to conform with the tasks assigned by his higher headquarters, within the FRP.

#### **PREPARING FOR DISASTER ASSISTANCE SUPPORT**

Commanders can best prepare for disaster assistance operations by understanding the appropriate laws, policies, and directives that govern the military in these emergencies. The military's role is well-defined and by law is limited in scope and duration. Military resources

temporarily support and augment—they do not replace—the local, state, and federal civilian agencies that have primary authority and responsibility for domestic disaster assistance.

The military does not stockpile resources solely for domestic disaster assistance. Disaster planning and coordination must occur between the appropriate agencies at the appropriate levels, for example, between DOMS and FEMA, between CINCs and CONUSA, between the federal, state, and regional agencies.

The Army's structure and training in command and control, deployability, and sustainment operations offer ready and robust capabilities for disaster assistance support. Those same skills that soldiers and leaders use day to day often translate to the types of tasks required during disasters.

Domestic disaster operations are normally conducted in stages: response, recovery, and restoration. The role of the military is most intense in the response stage, decreasing steadily as the operation moves into the recovery and restoration stages.

Response operations focus on those life-sustaining functions required by the population in the disaster area. Recovery operations begin the process of returning the community infrastructure and services (both municipal and commercial) to a status that satisfies the needs of the population. Restoration is a long-term process that returns the community to predisaster normalcy. While the military has an important role in the relief and recovery stages, restoration is primarily a civilian responsibility. Military forces will redeploy as operations transition from the response and recovery stage to the restoration stage. The overlap of military support and effort during the three stages is depicted in Figure 5-3.

#### **Assessment**

Assessment is a fundamental task for providing effective disaster assistance. The assessment process requires the integration and analysis of information from many different sources. This process is not exclusively a DOD responsibility. It is first and foremost a local and state agency task. Federal agencies, including DOD, assist and cooperate in the information-gathering and assessment process.

Laws limit the types and ways military agencies can gather information in domestic situations. Commanders must ensure that all requests for information, both

before and during a domestic emergency, comply with the applicable laws and are handled in the appropriate military channels.

Responsibility for assessments is shared by federal, state, local, and military agencies. When a disaster occurs the damage and the anticipated military support requirements must be assessed before resources are committed. This ensures that the committed resources and forces will be appropriate for the mission and that they will be used efficiently.

The earliest information needed for the assessment process is the impact on the population, available critical infrastructure facilities, and any serious environmental hazards. Because saving lives is an immediate priority within the first 72 hours, especially in US&R operations, collapsed or badly damaged buildings that may contain trapped people must be identified. Mobile home communities, if not evacuated prior to the disaster, are especially vulnerable and likely to contain injured people. The status of the road

and rail systems, airports, and seaports must be determined. Identifying major fires, hazardous chemical spills, ruptured petroleum and natural gas pipelines, and downed electrical power lines—especially in populated areas—is a priority. Also essential is determining the status of local emergency services; police, firefighters, and health service providers.

As the federal relief effort escalates, including the deployment and employment of federal military resources in the disaster area, critical relief facilities must be made operational and accessible. These facilities include municipal offices, hospitals, water treatment plants, ice manufacturing and storage plants, electrical power stations or lines, and telecommunications nodes. Sites for the emergency shelter, feeding, and medical treatment of displaced civilians must be identified and prepared. These life support centers will be required within the first few days after a disaster. Sites for the reception, storage, and distribution of supplies in the affected area must be identified.

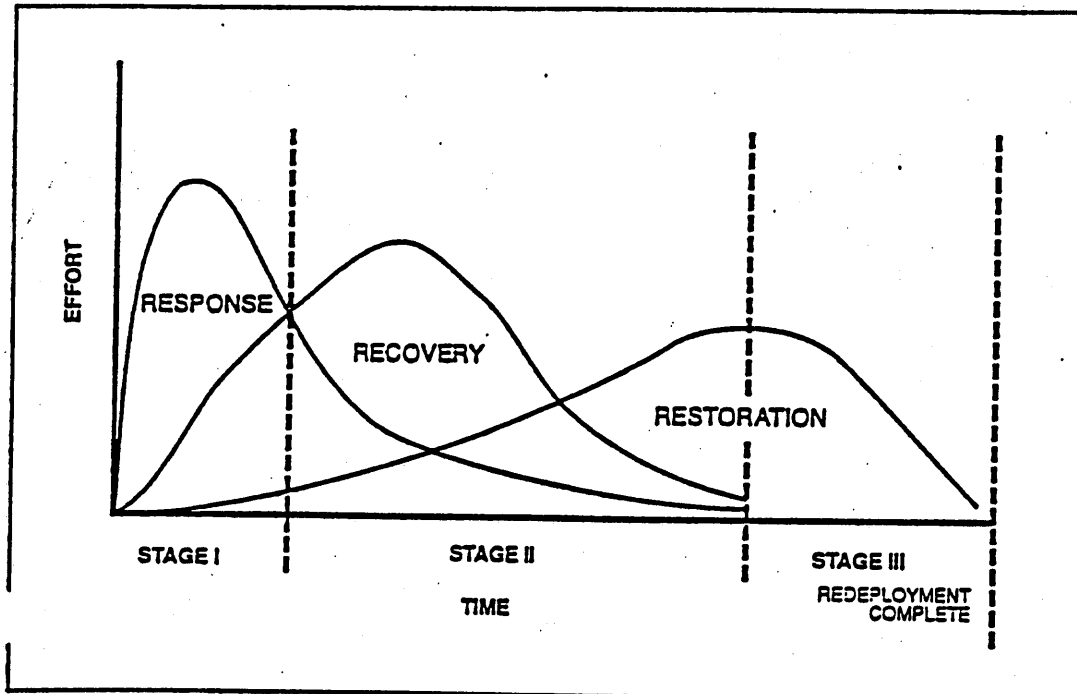

Figure 5-3. Military Stages and Levels of Effort

**Terminating Support**

The military's role in disaster assistance must end as soon as practical. The ultimate task of the federal disaster response effort is to assist the local community in returning to a normal, predisaster status. Consequently, the military should expect to be heavily committed during the response phase of the operation, and progressively less during the recovery phase. As a principle, the military does not compete with civilian commercial enterprises. As a commercial enterprise becomes more available in the community, the military's provision of support and services can diminish.

**The military's role in disaster assistance operations must be transferred to civilian organizations as soon as practical.**

Disaster assistance operations require that end states or conditions be established to mark the completion of disaster assistance missions. Conditions must be definable and attainable. End states must be developed from the highest (national) perspective to the lowest county and municipal levels. They must provide a road map that can be followed by all government and nongovernment agencies involved. The affected population must know when military operations will cease and local support organizations are to continue the mission. Mission success will be tied directly to the military's ability to accomplish specific end-state objectives.

In conjunction with federal, state, and local officials, commanders at all levels must understand the desired community objectives or goals. They will affect the termination standards for the military as well as other federal agencies. The return to normalcy requires a progressive downsizing of the military's role.

Termination standards, which are established in coordination with the FCO and state and local

authorities, must be clearly stated and understood by all. They can usually be expressed in terms of percentage of predisaster capability by specific function, for example, 70 percent of electrical power restored. In an operation such as disaster assistance, redeployment of forces becomes a sensitive issue since it can create misperceptions and anxiety in the population with respect to sustained support needed and the ability of local government and contractors to handle the support as federal forces are withdrawn.

The criteria for mission success and completion must be defined, articulated, and disseminated as soon as possible. Civil authorities and Army personnel should know when the operation has reached completion or when Army assets will be withdrawn. It is important to understand that the mission may not be fully complete from the civilian authorities' perspective. Army support may have to be replaced by civilian assets and local support organizations, which will continue the restoration mission. Mission success should be directly proportional to the military's ability to accomplish specific milestones. Planners need to identify these milestones in their functional areas and use them, when accomplished, to reduce further military support requirements. These norms should be coordinated and validated for each of the possible missions, operations, and activities.

**THE FEDERAL RESPONSE PLAN**

The Army and the DOD most often provide disaster assistance to other agencies in accordance with the FRP. This plan describes how the federal government responds to a declared disaster. When the plan is fully implemented, DOD and 26 other federal agencies provide support. The FRP groups disaster assistance into 12 functional areas called emergency support functions. During disaster response operations, some or all of these ESFs may be activated. The FRP assigns responsibility for each of the ESFs to a lead agency based on that agency's authority or capability. Each ESF will also have assigned supporting agencies. DOD has been designated the lead federal agency for ESF 3, Public Works and Engineering, and ESF 9, Urban Search and Rescue; a supporting agency in the remaining ten. Consequently, the Army may have resources committed in all 12 ESFs. The FRP emergency support assignment matrix is at Figure 5-4.

#	1	2	3	4	5	6	7	8	9	10	11	12
ESF	TRANSPORTATION	COMMUNICATIONS	PUBLIC WORKS AND ENGINEERING	FIREFIGHTING	INFORMATION AND PLANNING	MASS CARE	RESOURCE SUPPORT	HEALTH AND MEDICAL SERVICES	URBAN SEARCH AND RESCUE	HAZARDOUS MATERIALS	FOOD	ENERGY
ORG												
USDA	S	S	S	P	S	S	S	S	S	S	P	S
DOC		S	S	S	S	S	S	S	S	S		
DOD	S	S	P	S	S	S	S	S	P	S	S	S
DOEd					S							
DOE	S		S		S		S			S		P
DHHS			S		S		S	P	S	S	S	
DHUD						S						
DOI		S	S	S	S	S				S		
DOJ					S			S		S		
DOL			S				S		S	S		
DOS	S								S	S		
DOT	P	S	S		S	S	S	S	S	S	S	S
TREAS					S							
VA			S			S	S	S				
AID								S	S			
ARC					S	P		S			S	
EPA			S	S	S			S	S	P	S	
FCC		S						S	S			
FEMA		S		S	P	S	S	S	S	S	S	
GSA	S	S	S		S	S	P	S	S	S		S
ICC	S											
NASA					S							
NCS		P			S		S	S				S
NRC					S					S		S
OPM							S					
TVA	S		S									
USPS	S					S		S				S

**LEGEND**

P - Primary agency responsible for management of the ESF.  
S - Support agency responsible for supporting the primary agency.  
ESF - Emergency support function.  
ORG - Organization.

Figure 5-4. Emergency Support Assignment Matrix

## DOMESTIC SUPPORT OPERATIONS

### Public Works and Engineering

Public works and engineering support includes technical advice and evaluations, engineering services, potable water, construction management and inspection, emergency contracting, emergency repair of waste water and solid waste facilities, and real estate support. Activities within the scope of this ESF include emergency clearance of debris, temporary construction of emergency access routes, emergency restoration of critical public services and facilities, emergency demolition or stabilization of damaged structures and facilities, technical assistance and damage assessment, and support to other ESFs. The USACE is DOD's operating agent for planning, preparedness, and response operations for this ESF.

### Urban Search and Rescue

US&R activities include locating, extricating, and providing for the immediate medical treatment of victims trapped in collapsed structures. Designated operating agents for US&R in their respective areas of operation are the CINCFOR, the CINCLANT, and the CINCPAC. The DOMS will designate the appropriate operating agent as supported CINC.

The supported CINC will coordinate federal US&R operations and employ one or more task forces to conduct "light" (wood frame-type structures) US&R. The supported CINC will also manage military support for civilian US&R task forces. FEMA-sponsored teams provide the necessary expertise and equipment for "heavy" (masonry/concrete and steel, multistory structures) US&R. The USACE has structural specialists trained to assist in US&R. Transportation, medical, billeting, and maintenance are the types of support that civilian US&R teams may require.

### Support to Other ESFs

DOD support to other ESFs may come from one of two sources. First, when the primary agency for an ESF determines that it requires support or resources from outside its own agency, that agency may coordinate its requirements with the FEMA through its regional and national headquarters. The FEMA will then determine how to provide the required support or resources from any nationwide source. DOD, a designated supporting agency, may be tasked. Second, an FCO may task DOD to provide the required support or resources from military assets already within the disaster area or available through DOD channels. The FCO gets this

support through coordination with the defense coordinating officer.

## RESPONSIBILITIES

### FEDERAL COORDINATING OFFICER

An affected state or area will receive federal assistance through the management of FEMA and the overall coordination of an FCO, usually the FEMA regional director. The FCO is the on-scene commander for all federal resources supporting local and state authorities in the assistance effort.

### DEFENSE COORDINATING OFFICER

In the field, the DCO, appointed by the supported CINC, is the central point of contact to the FCO and ESF managers for all requests for military support. At the discretion of the CINC, the DCO may assume control of all federal military units involved in a disaster. The DCO's expertise and constant liaison with the FCO, local officials, and other ESF managers are critical to the effective coordination and integration of the federal and state disaster assistance efforts. Traditionally, CINCFOR has tasked the CONUSAs to plan for disasters and domestic emergencies and to appoint DCOs following a disaster declaration. The DCO supervises the DCE, a staff that can support both the administrative and the ESF functional areas for all coordination and decisions.

### STATE COORDINATING OFFICER (SCO)

As the governor's representative, the SCO is responsible for emergency management, disaster response, and recovery activities. The SCO is the primary point of contact for the FCO in facilitating disaster assistance. The STARC has developed disaster emergency plans in coordination with other state and local agencies. The STARC and the DCO will establish liaison so that local, state, and federal activities can be coordinated and managed effectively. The STARC can assist the federal forces with contracting support as well as logistical support from Guard resources not otherwise committed.

### JOINT TASK FORCE (JTF)

Military support to civil authorities in disasters and domestic emergencies is a DOD, not a service component responsibility. The supported CINC may decide

that the severity and scope of a disaster require a joint response. In disaster assistance, as in operational level warfighting, the CINC uses the different and complementary capabilities of each service to accomplish the mission. Such use requires knowledge of both the capability and the availability of all service component assets, to include their agencies and installations.

**The CINC may establish a joint task force to provide comprehensive military support.**

Establishing a JTF may provide the best DOD response in a disaster. The DOD's response to Hurricanes Andrew and Iniki in 1992 demonstrated that a JTF is effective in providing the comprehensive support needed in most catastrophic situations. A JTF is established to execute a specific mission limited in scope and duration. The JTF's objective in a disaster is to deploy forces to the disaster area rapidly, to assist immediately in saving lives and safeguarding property, and to continue providing assistance required by the FRP and the particular situation.

The CINC has the authority to determine the command relationship between the DCO and JTF commander. The DCO serves as the DOD's central point of contact for all requests from the FCO and ESF managers for military support. If the size of the JTF expands and the CINC decides to designate another, more senior officer as the JTF commander, the DCO becomes a special staff officer for the JTF commander.

The JTF is configured for each specific mission. In disasters, the JTF may require a greater proportion of combat service-support-type units and capabilities than in typical warfighting deployments. The JTF must be able to provide emergency assistance across all lines of support. All classes of supply and all types of services may be required. Because DOD has a supporting responsibility in all ESFs, close cooperation between the JTF and all other ESF agencies is required through the FCO, DCO, and state emergency structure. Command relationships between these authorities and organizations are illustrated at Figure 5-5.

*When Typhoon Omar struck the American territory of Guam in August 1992, the CINCPAC appointed the Commander, Naval Forces Marianas (COMNAVMAR), as the DCO and the JTF commander. In response to Hawaii's Hurricane Iniki less than one month later, the CINCPAC appointed the Commander, US Army, Pacific (USARPAC), as Commander, JTF Hawaii and the DCO.*

The military has been involved in such diverse disaster relief activities as the preparation and distribution of food, removal of debris and garbage, restoration of electrical power and water systems, management of donated goods and services, and establishment of life support centers that provide shelter, security, medical care, counseling, bath and laundry, and recreation activities. The JTF commander may establish joint cells to manage specific functional or technical areas, such as a joint movement center.

## DOMESTIC EMERGENCIES

### CIVIL DEFENSE EMERGENCIES

Civil defense emergencies result from the devastation following an enemy attack, although they may be proclaimed by appropriate authority in anticipation of an enemy attack. Specific plans and orders at the appropriate command levels provide general guidance for responding to an enemy attack. Local Army commanders are authorized to respond to civil defense emergencies under immediate response and to deal with immediate emergency conditions that would be created by such attacks or disasters.

In the event of an attack on the US, the scope of military support to the civil authorities in each affected area would depend on the requirements of military operations, the extent of damage sustained in the civilian community, and the status and reconstitution priorities of the active and reserve component forces. The Army National Guard STARC, when ordered to federal service, will become the DOD's focal point for providing military assistance at the state and local

## DOMESTIC SUPPORT OPERATIONS

levels. CONUSA commanders must coordinate the response to these civil emergencies with the STARCs.

### ENVIRONMENTAL DISASTERS

DOD may be called on to support other federal agencies during major environmental disasters. For example, the DOE has responsibility for civil radiological emergencies and the EPA and USCG

share responsibility for chemical contamination accidents, such as major oil spills. The FEMA may also be involved in a complementary role, managing federal relief operations associated with a disaster. Regardless of the disaster scenario, the Army and DOD should expect to provide military support appropriate to the nature of the disaster and the needs of the people affected.

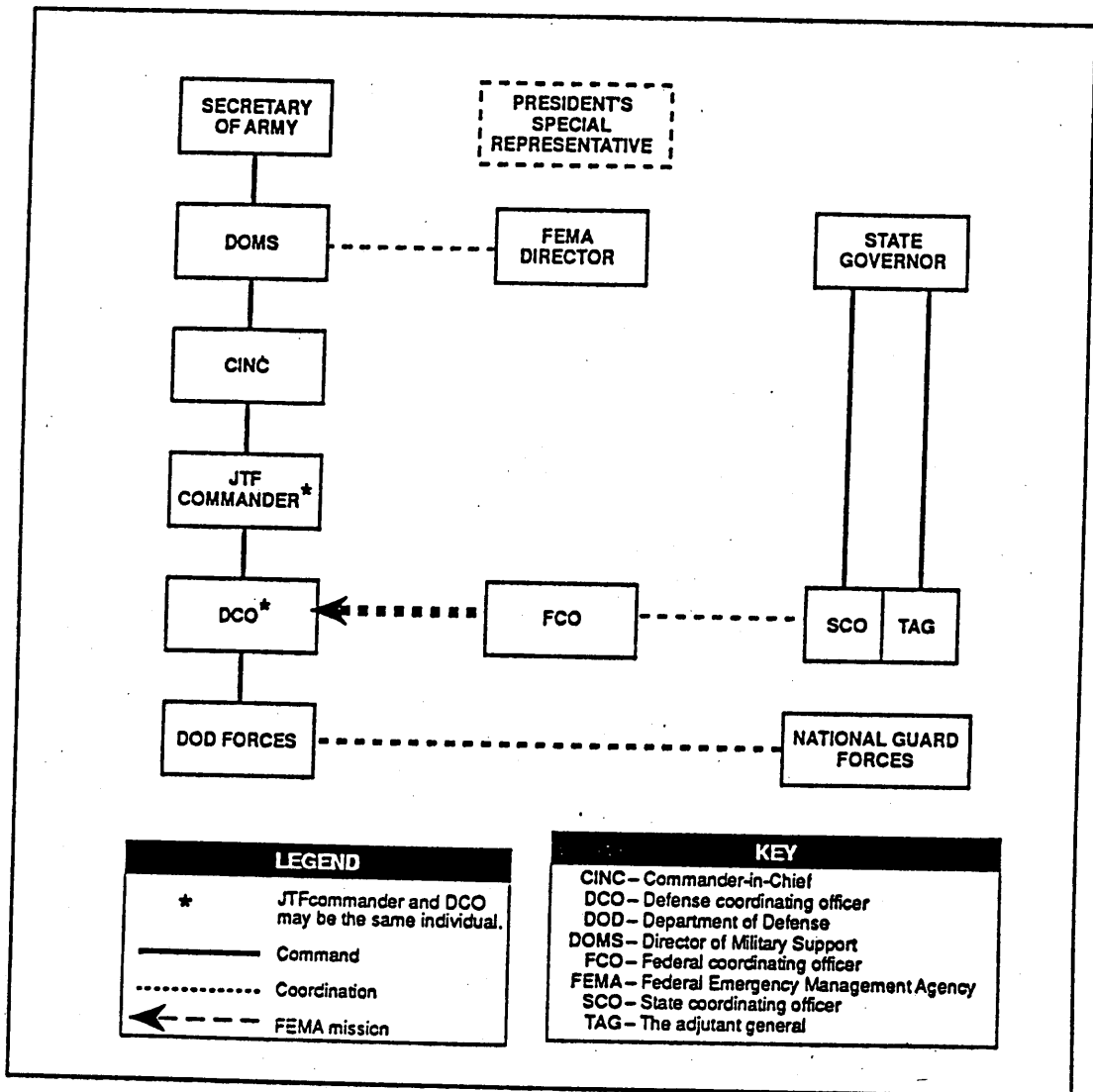

Figure 5-5. Command Relationships

### **MASS IMMIGRATION EMERGENCY SUPPORT OPERATIONS**

The DOD may be called on to provide support to the DOJ and its INS. The DOJ is the lead federal agency; INS is its action agency. In the event of an immigration emergency, the SA is the DOD executive agent, DOMS the action agent. The DOD may be tasked to assist in the reception, processing, transportation, and detention of the immigrants. DOD installations and facilities may be required to house immigrants for extended periods of time. These installations may have to provide a full range of services, either by DOD or by contracted agencies. Even on DOD installations and facilities, however, the DOJ and INS have the primary responsibility for the legal processing, custody, and eventual deportation or resettlement of the immigrants.

*During Operation Provide Refuge in February 1993, a task force from the 25th Infantry Division provided security and humanitarian assistance to 535 Chinese nationals who attempted to illegally enter the United States. The Chinese were fed, clothed, and housed in a US facility on Kwajalein Atoll, Republic of the Marshall Islands, until the People's Republic of China agreed to their repatriation.*

### **OTHER DIRECTED MISSIONS**

the DOD receives many diverse missions requiring military assistance to civil authorities. They include planning to use DOD personnel in the event of a large disruption to US mail service and air traffic control assistance in the event of a federal air traffic controller strike. The type and level of military support will be as diverse as the missions. The general concepts, principles, and guidelines for disasters, emergencies, and other assistance operations may be useful to Army commanders located OCONUS, but are subject to applicable CINC guidelines and host nation laws and agreements.

*Guardsman in Alabama, Georgia, Kansas, Kentucky, Maine, New York, North Carolina, Ohio, South Carolina, Virginia, and Wisconsin were called up in Operation Haylift to deliver relief to farmers throughout the southeast during the drought of 1987.*

### **SUMMARY**

The Army and the Department of Defense provide military support to civil authorities, especially in disaster assistance operations. DOD is a supporting agency, providing military support to other lead federal agencies. The SA is DOD's executive agent, and the DOMS is the SA's agent for disaster assistance support. In most cases, the Army will participate in disaster assistance operations as part of a DOD effort managed by the DOMS serving as a joint staff and commanded by a supported CINC. The Army is committed to providing timely and effective disaster assistance support to other federal agencies and the American people.





## CHAPTER 6

# ENVIRONMENTAL MISSIONS

*The Army has developed and fielded an integrated environmental program that employs a variety of resources to assist US civil authorities in environmental activities. The Army's environmental strategy rests on the pillars of compliance, restoration, prevention, and conservation. The pillars rest on a bedrock of shared national values that support the essential foundation of people, resources, communication, and organization. They also support the vision and ethic of environmental stewardship that underlies the Army program. Figure 6-1 depicts this strategy.*

### PLANNING AND EXECUTION

**The ethic of environmental stewardship underlies the Army's environmental strategy.**

If consistent with the unit's mission, commanders can allocate people and resources for the planning, technical assistance, oversight, and execution of environmental assistance missions.

- Planning focuses on environmental resource management and contingencies for incidents that adversely affect human health or the environment. It includes preassistance efforts such as developing local agreements and memorandums of understanding and integrating mutually supporting plans.
- Technical assistance covers a broad array of activities. The Army can help develop off-the-shelf plans and scopes of work, conduct on-site assessments, provide procurement advice, and augment local staffs with technical personnel.
- Oversight focuses on support roles such as administering contracts and providing staff support for operations.

- Execution employs US Army manpower and equipment to perform a mission.

A CH-54 "Skycrane" from Company D, 113th Aviation Battalion, Nevada National Guard, carried a slingload of construction materials from Mount Rushmore. The material had been on the mountain since 1941. The 113th removed the materials during Golden Coyote '92 in the Black Hills of South Dakota.

#### CHARACTERISTICS

Environmental support missions are characterized by the time required to accomplish them:

- Short-term or immediate-response missions require 30 days or less. They include oil and hazardous materials spills, removal of materials that contain military specific chemicals, and support in fighting wildland fires.
- Mid-term missions require 30 to 180 days. They include environmental compliance-related matters and responses requiring longer-term assistance.
- Long-term missions require more than 180 days. They include remediation or research and development support that requires contracted effort.

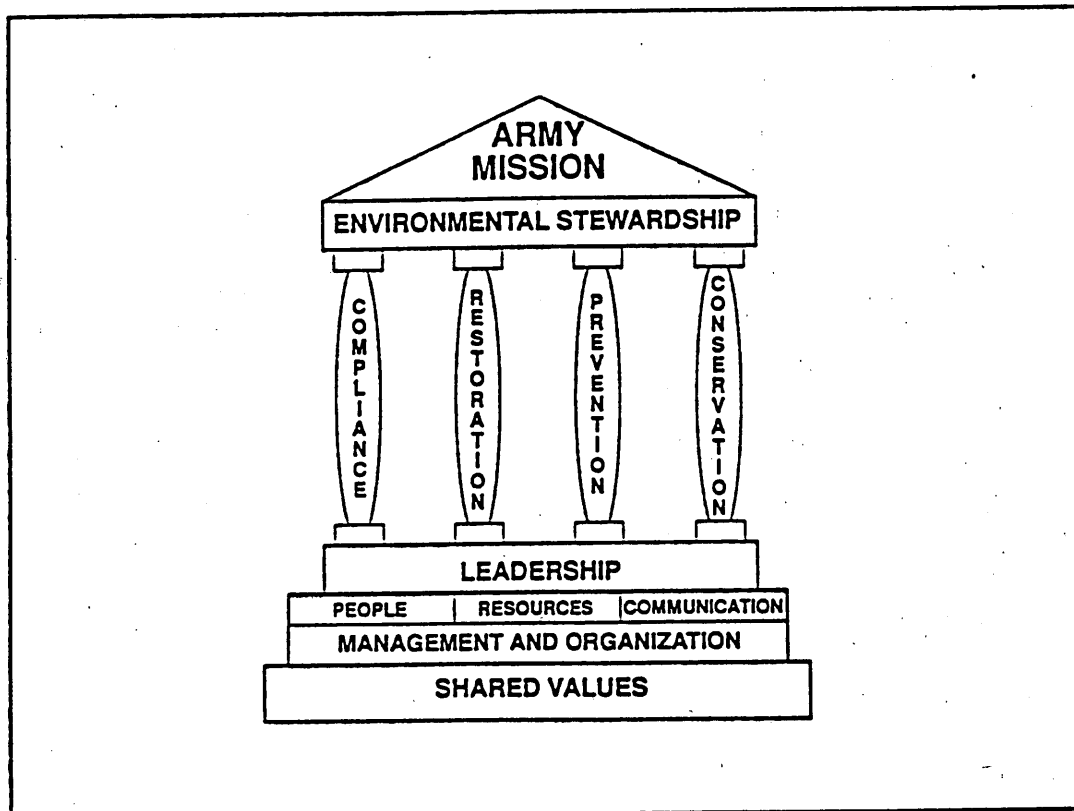

Figure 6-1. Pillars of Army Environmental Strategy

## DOMESTIC SUPPORT OPERATIONS

### CLASSIFICATIONS

The Army classifies environmental support as compliance, restoration, prevention, and conservation. These four classifications correspond to the pillars of the Army environmental strategy, which provide direction for attaining and sustaining environmental resources stewardship.

### COMPLIANCE

As an environmental leader, the Army works with regulators and citizens' groups, a cooperative approach that is necessary for successful relations with the local community and other government agencies. Army assistance responds to immediate needs or is provided as a general service.

Response includes support to correct oil and hazardous material spills under the National Contingency Plan (NCP) and control of chemical incidents. General services include support to improve compliance with environmental laws and regulations. The primary compliance missions are listed in Figure 6-2.

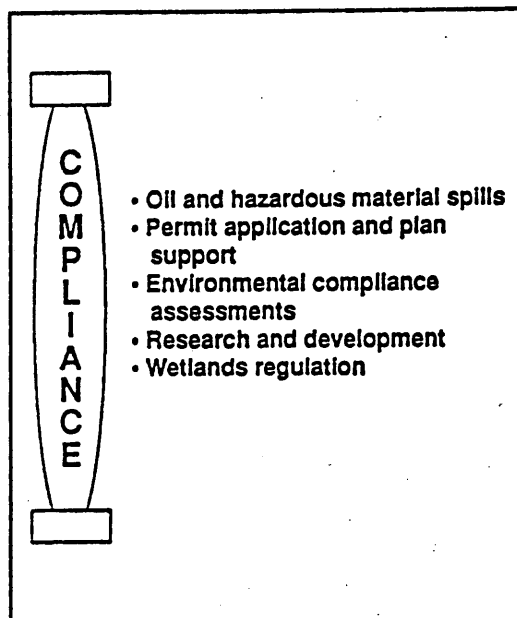

Figure 6-2. Compliance Missions

### OIL AND HAZARDOUS MATERIAL SPILLS

Oil and hazardous material spills are common occurrences. Any release of a reportable quantity of oil or hazardous material requires an immediate response. Larger-scale, catastrophic releases may occur as a result of man-made or natural disasters. Under the NCP for response to oil and hazardous material spills, the Army provides representatives to the national response team and the 10 regional response teams for both planning and response.

*On 5 January 1993, potentially volatile World War I-era liquid-filled munitions were unearthed in a residential area of Washington, DC. The location had been a chemical research site between 1917 and 1919. With support from the 101st Chemical Company, Fort Bragg, NC, the Army Environmental Hygiene Agency, the Army Armament, Munitions, and Chemical Command, the Corps of Engineers, and other local, state, and federal agencies, the cleanup began. By the last day of excavation, a total of 141 munitions had been safely unearthed.*

The director of military support coordinates Army response for large-scale spills based on requests from the EPA/USCG on-scene coordinator (OSC). Small-scale releases are more common. The Army can respond directly to small-scale releases when the spill is beyond the capability of civilian response assets or the Army has jurisdiction over the spill area.

**The Army can respond to oil and hazardous material spills under established procedures.**

An installation commander may assist in identifying, surveying, containing, and cleaning up small-scale releases of oil and hazardous materials. The commander's installation spill response group typically consists of trained personnel from the fire department or environmental staff. When the Army employs chemical units, it does so under the Nuclear and Chemical Accident and Incident Response and Assistance (NAIRA and CAIRA) Program.

Under the NAIRA and CAIRA Program, the Army can provide an immediate or planned response to a crisis or situation involving radiological or hazardous materials. Nuclear or chemical accident or incident control (NAIC/CAIC) emergency response elements organized as an initial response force (IRF) can respond immediately to the spill site to save lives, preserve health and safety, and prevent further damage to the environment.

If further action is needed, the service response force (SRF), a DA-level emergency response force, will deploy to the site. The SRF continues response operations, provides command and control of all military forces, and coordinates the activities of federal, state, and local response agencies. The Army SRF commander, executing the role of the federal OSC, executes coordinating duties per Army policy and the NCP.

#### PERMIT APPLICATIONS AND PLANS

Some government facilities may not be sufficiently staffed to address all applicable compliance requirements. Army personnel can assist these facilities in successfully completing and submitting applications and plans for permits. Depending on the size and mission of the environmental staff, a local commander can support short-term local missions. The USACE can best handle more extensive efforts on a cost-reimbursable basis. Typical compliance support projects include:

- Preparing *Resource Conservation and Recovery Act (RCRA) Part B* permit applications, closure plans, waste analysis plans, and underground storage tank site assessments.
- Preparing spill prevention, control, and countermeasures and spill contingency plans.
- Preparing National Pollutant Discharge Elimination System (NPDES) permit applications.
- Preparing air quality permit applications.

#### ENVIRONMENTAL COMPLIANCE ASSESSMENTS (AUDITS)

The Army can assist other government facilities in attaining and sustaining compliance with environmental laws and regulations. USACE districts provide comprehensive environmental compliance assessments that identify deficiencies and requirements for corrective action.

*The Army developed the Geographic Resource Analysis Support System (GRASS) that allows Army environmental and land managers to analyze, store, update, model, and display data quickly and easily. Analysis and display can be created for an entire geographic region. More than 100 Army installations, the National Park Service, and the Soil Conservation Service are currently using GRASS.*

#### RESEARCH AND DEVELOPMENT

The Army emphasizes joint technology development and use with the EPA, the DOI, and other government agencies. This transfer of information improves compliance throughout the nation. The Army conducts an extensive environmental research and development program that focuses on developing methods and equipment to meet the growing compliance requirements of new laws and regulations. The Army has developed technical products independently and transferred them to other government agencies. The Army has also developed them jointly with other federal agencies. Within the Army, most environmental research and development occurs through the USAEC and USACE laboratories.

#### WETLANDS

The USACE administers the National Wetlands Protection Program for the federal government. In this capacity, the Army serves as a regulator and oversees the restoration and mitigation of wetlands within the US.

*In Illinois, an Army National Guard engineer battalion detonated 5600 pounds of explosives as part of its training and built a home for ducks at the same time. The explosions were intentionally set off near a lake to create a series of duck ponds.*

### RESTORATION

Environmental restoration missions include correcting contamination problems resulting from past operations. Environmental investigations and remediation conducted by the Army mitigate adverse impacts to human health and the environment. Restoration efforts maximize the amount of property available for reuse and redevelopment.

Restoration missions fall into three categories: facility restoration, real property transfers, and general support. The USAEC and USACE can provide assistance in these areas. The USACE can provide longer-term assistance on a cost-reimbursable basis, while USAEC may provide short-term assistance. The primary restoration missions are depicted in Figure 6-3.

**The Army conducts environmental investigations and remediation to protect human health and the environment.**



- Facility restoration
- Real property transfers
- General environmental restoration support
- EPA support
- Defense and state memorandum of agreement/cooperative agreement
- Research and development

Figure 6-3. Restoration Missions

#### FACILITY RESTORATION

The Army has extensive expertise in investigating and restoring sites under their control. In the Installation Restoration Program (IRP), the Army investigates sources of contamination, extent of contamination, exposure pathways to potentially impacted people and ecosystems, and potential health and ecological risks. Activities routinely conducted at Army sites include:

- Assessing current site conditions, identifying past operations contributing to current site contamination, and determining whether further investigations are needed.
- Developing and implementing public involvement and public relations programs.
- Characterizing the nature and extent of contamination at suspected sites.
- Quantifying the risk to human health and the environment from contaminated sites and determining appropriate cleanup levels.

- Developing and evaluating alternatives for site remediation.
- Designing and implementing appropriate cleanup actions.

On request, USACE provides technical support to other federal agencies in the Work-for-Others Program. In this program, the other federal agency retains control and responsibility for the action but uses the technical capabilities of the Corps to accomplish the task.

#### REAL PROPERTY TRANSFERS

The storage, release, and disposal of hazardous materials and wastes directly affect the transfer of real property. The Army has gained considerable experience in mitigating these issues for unexploded ordnance (UXO), lead base paints, radon, asbestos, and polychlorinated biphenyls (PCBs). The Army assists local committees in developing reuse options that fully consider all appropriate environmental issues, identifying clean parcels, and remediating contaminated parcels. The Army can provide this support in any real estate transfer that other government agencies may consider.

#### GENERAL SUPPORT

The Army supports both state and federal agencies through specifically negotiated agreements. It provides direct support to the EPA in implementing *The Comprehensive Environmental Response, Compensation, and Liability Act (CERCLA) of 1980*. The Army supports state regulatory agencies through the Defense and State Memorandum of Agreement/Cooperative Agreement (DSMOA/CA) Program. It conducts cooperative efforts in developing innovative technologies with other government agencies.

#### EPA Support

The Army has entered into an interagency agreement with the EPA to provide assistance in executing CERCLA, also known as the *Superfund*. Under this agreement, USACE serves as the program manager for execution activities assigned by EPA. These assignments include—

- Providing technical assistance during the EPA's remedial investigations feasibility studies.
- Acting as the contracting officer for *federal lead* remedial design and remedial action activities.
- Providing technical assistance during the EPA's enforcement activities.

- Providing technical assistance and oversight of the EPA's alternative remedial contracting strategy (ARCS) contractors.
- Assisting in real estate and other support activities.

#### Defense and State Memorandum of Agreement/Cooperative Agreement Program

The DSMOA/CA Program was established to facilitate state and US territory involvement in cleanup activities conducted under the Defense Environmental Restoration Program. DSMOAs/CAs provide a mechanism to involve states in installation restoration activities by establishing the terms and conditions by which they are reimbursed for the cost of providing technical support.

#### Research and Development

As a part of its environmental research and development program, the Army pursues cost-effective restoration technologies that can be transferred to any user. The US Army Environmental Center can provide consultations in such areas as analytical chemistry and industrial hygiene. The USAEC and USACE laboratories can provide assistance in applying technology.

*The Army demonstrated an innovative idea for recovering heat lost at boiler plants at the Louisiana Army Ammunition Plant. The teflon-covered heat exchangers will pay back the investment in 5.2 years. This process saved the plant \$13,000 in FY 88 and has potential for widespread application in military and civilian boiler plants.*

#### PREVENTION

Prevention assistance missions focus primarily on participating in pollution prevention programs with other agencies. The Army also shares information and technologies that reduce the discharge of pollutants into the environment. Pollution prevention is an ethic that must be learned at all levels of an organization. As a result of implementing its own pollution prevention

## DOMESTIC SUPPORT OPERATIONS

program, the Army has gained considerable experience from recycling solid waste to manufacturing process changes.

**The Army has gained valuable experience in preventing pollution.**

Installation commanders can help local communities develop community recycling programs and support them. The local commander can work with local, county, or regional solid waste management organizations to integrate recycling efforts. Possible prevention missions are shown in Figure 6-4.

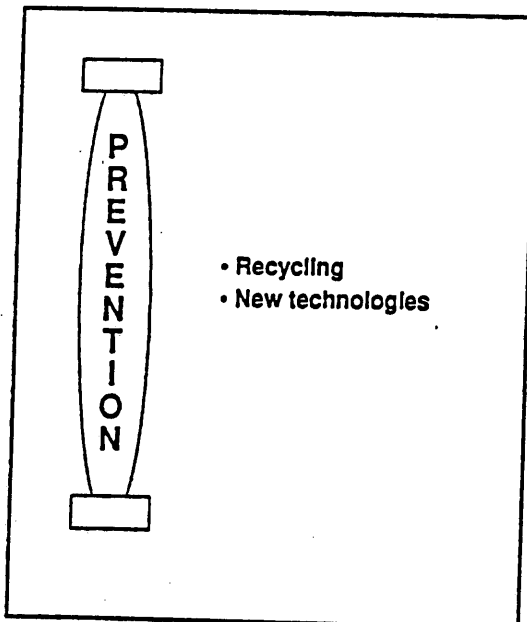

Figure 6-4. Prevention Missions

Pollution prevention is another driving force in the Army's environmental research and development program. Its efforts focus on changing or replacing existing processes to reduce and ultimately stop pollutant discharges. Examples of these technical innovations are the new generation of metal-plating procedures and advances in solid waste recycling.

Once again, the Army may develop these technologies in concert with other government agencies or alone, then share their findings with other agencies.

## CONSERVATION

Conservation assistance missions address the preservation and protection of America's natural and cultural resources for future generations. The Army works to conserve and protect natural and cultural resources on a daily basis. Typical Army conservation missions are listed at Figure 6-5.

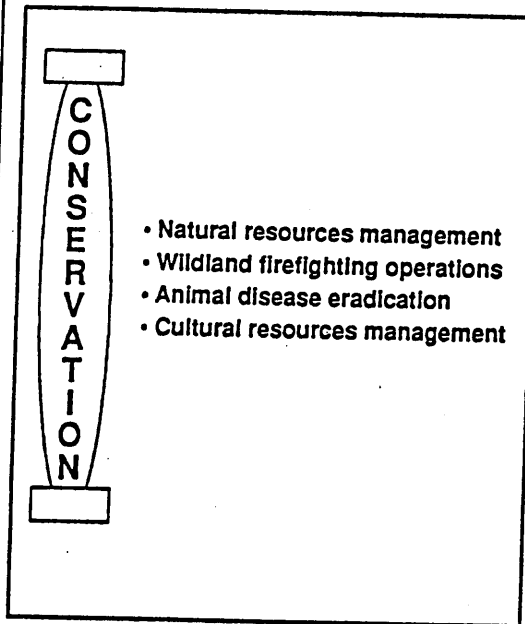

Figure 6-5. Conservation Missions

### NATURAL RESOURCES MANAGEMENT

With vast acreages, the Army conducts intensive military training while providing many sanctuaries for a wide variety of plants and animals. In so doing, the Army has gained experience in the proper care, repair, restoration, and management of these resources.

The Army often works with state and federal agencies in managing soils, vegetation, fish, wildlife, and water resources. The Army and the public both benefit from this cooperative effort because the

protection of natural resources enhances the mission and preserves the environment for all.

**The Army has vast experience in advanced land management techniques.**

*Approximately 300 breeding pairs of the Red Cockade woodpecker and other endangered bird species were on Fort Bragg, NC. To save them, the Army closed off areas to vehicles, marked bird colony nesting boundaries, taught soldiers to recognize and observe training restrictions, built beams to absorb rifle fire on ranges, and set up artificial nests to attract more birds.*

#### **WILDLAND FIREFIGHTING**

The Army may provide manpower and equipment to assist the NIFC in suppressing wildland fires. Initially, the NIFC contacts DOMS and requests military assistance. The DOMS tasks the appropriate CINC to appoint a DCO to confirm military support requirements. Once the DCO is appointed, the NIFC passes all resource requests to him. The Army may provide aviation, engineer, and communications support in addition to firefighters. The federal land manager trains soldiers before they are employed to fight fires. The NIFC provides the needed firefighting equipment and reimburses DOD from either the USDA or the USDOI. The wildland firefighting tasking and resourcing channels are depicted at Figure 6-6.

#### **ANIMAL DISEASE ERADICATION**

In the event of an emergency arising from an actual or imminent outbreak of a foreign plant or animal disease, the DOD provides assistance to the USDA's

Administrator for Animal and Plant Health Inspection Service (APHIS). The Secretary of the Army, as DOD's executive agent, designates the Commander-in-Chief, Forces Command, as the operating agent supported CINC for DOD support to the USDA.

CINCFOR, as directed by the director of military support, provides personnel, equipment, supplies, and services to support the Regional Emergency Animal Disease Eradication Organization (READEO) task force. The READEO is the USDA organization responsible for completing all containment and eradication missions.

Included in CINCFOR's support is designating the base support installations (BSIs); tasking supporting CINCs, services, and agencies; developing contingency plans; and participating in exercises. Upon direction of CINCFOR, the BSI commanders provide personnel and logistics to the task force. USDA reimburses DOD for actual costs, less pay and allowances.

The BSIs may be outside FORSCOM and the Army. Resources provided by the BSIs can include technically qualified personnel to assist the USDA; the LSO; minimum essential TOE, TDA, and individual equipment; and procurement support.

The two key liaison officers are the veterinary support officer (VSO) and the LSO. The VSO, who is designated by Health Services Command, serves as the military point of contact with the READEO task force for veterinary support requirements. The LSO coordinates with the READEO task force director and determines the personnel, administrative, and logistical support requirements in the area of operations. The LSO provides the support requirements to the BSI and oversees the employment of DOD personnel and equipment. Figure 6-7 depicts command relationships for animal disease eradication operations.

#### **CULTURAL RESOURCES MANAGEMENT**

The Army works to preserve cultural resources for present and future generations. The Army may provide experts in the field of historic preservation from the USAEC, USACE, and the local installations. Many communities are involved or are interested in preservation of historic buildings and similar properties but may lack expertise. This is especially true in many rural areas.

Installations or other Army activities may provide some assistance to local communities at no charge. Army experts may assist in developing local historic



**DOMESTIC SUPPORT OPERATIONS**

preservation committees and ordinances, identifying historic properties, and providing technical advice on the proper treatment of historic properties. For more involved projects, USACE districts and laboratories can provide assistance on a cost-reimbursable basis.

**ARMY RESOURCES**

Upon request, the Army can provide national-level resources for state and local environmental problems.

The Army offers a breadth of experience and the ability to provide solutions from regions throughout the United States to local environmental managers.

**DEPARTMENT OF THE ARMY**

At the DA level, the Director of Environmental Programs is responsible for policy guidance and program oversight. His primary source of technical expertise is the US Army Environmental Center, a field operating agency of the DA staff.

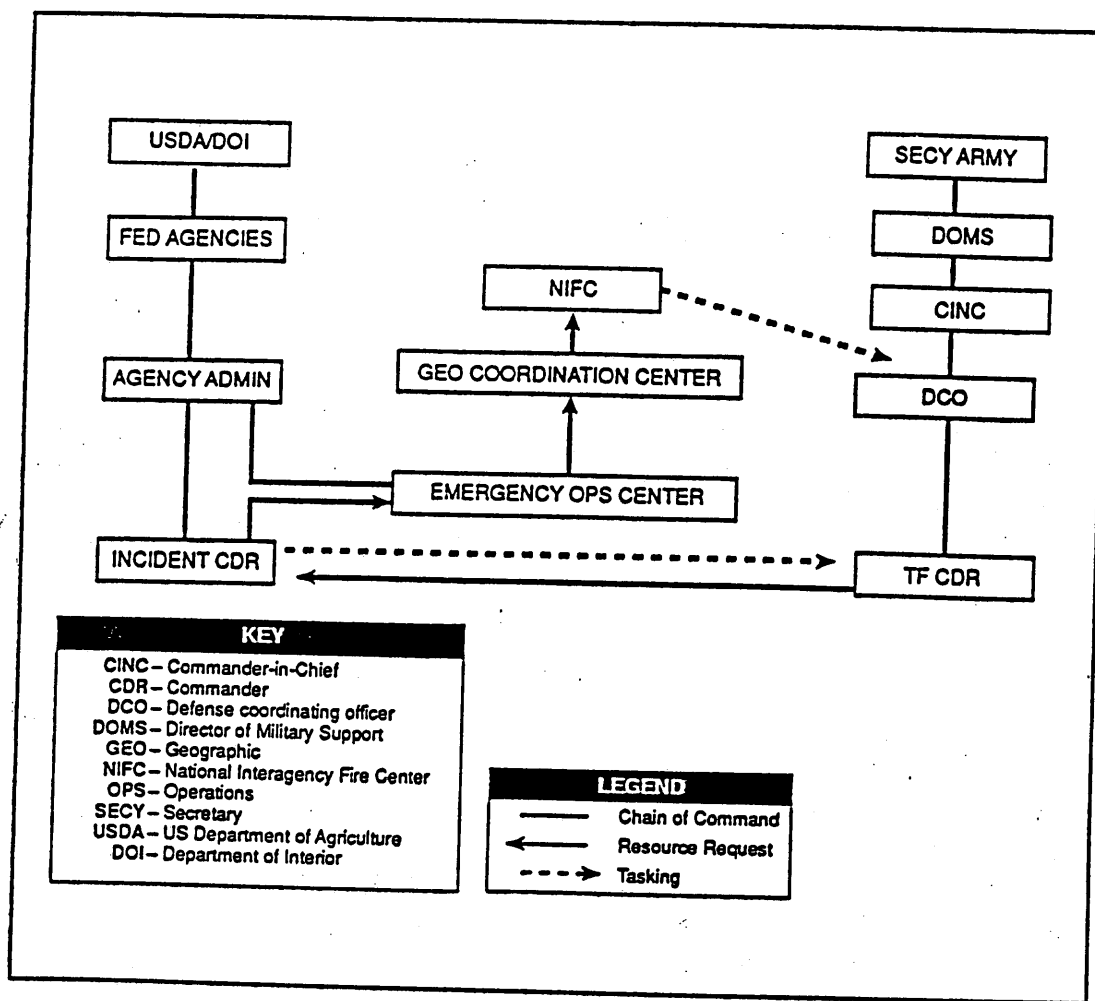

Figure 6-6. Wildland Firefighting and Resourcing Channels

**TECHNICAL SUPPORT ORGANIZATIONS**

A network of Army organizations provides a wide variety of technical support to installations. These organizations include the MACOM staffs; the USACE laboratories, districts, and divisions; and field operating agencies (FOAs) such as the US Army Environmental Hygiene Agency and the US Army Engineering and Housing Support Center.

MACOM staffs can execute many environment-related missions. The USACE organizations can provide specific technical services and contracting capabilities on a cost-reimbursable basis. Army FOAs

can provide technical experts in environmental engineering or science.

**INSTALLATIONS AND STATE AREA COMMANDS**

At this level, commanders can commit manpower and equipment to assist civil authorities in protecting, restoring, and preserving the environment. Environmental professionals at installations and STARCs focus on daily operations. These staffs are generally small. They concentrate on managing environmental resources and meeting regulatory requirements imposed

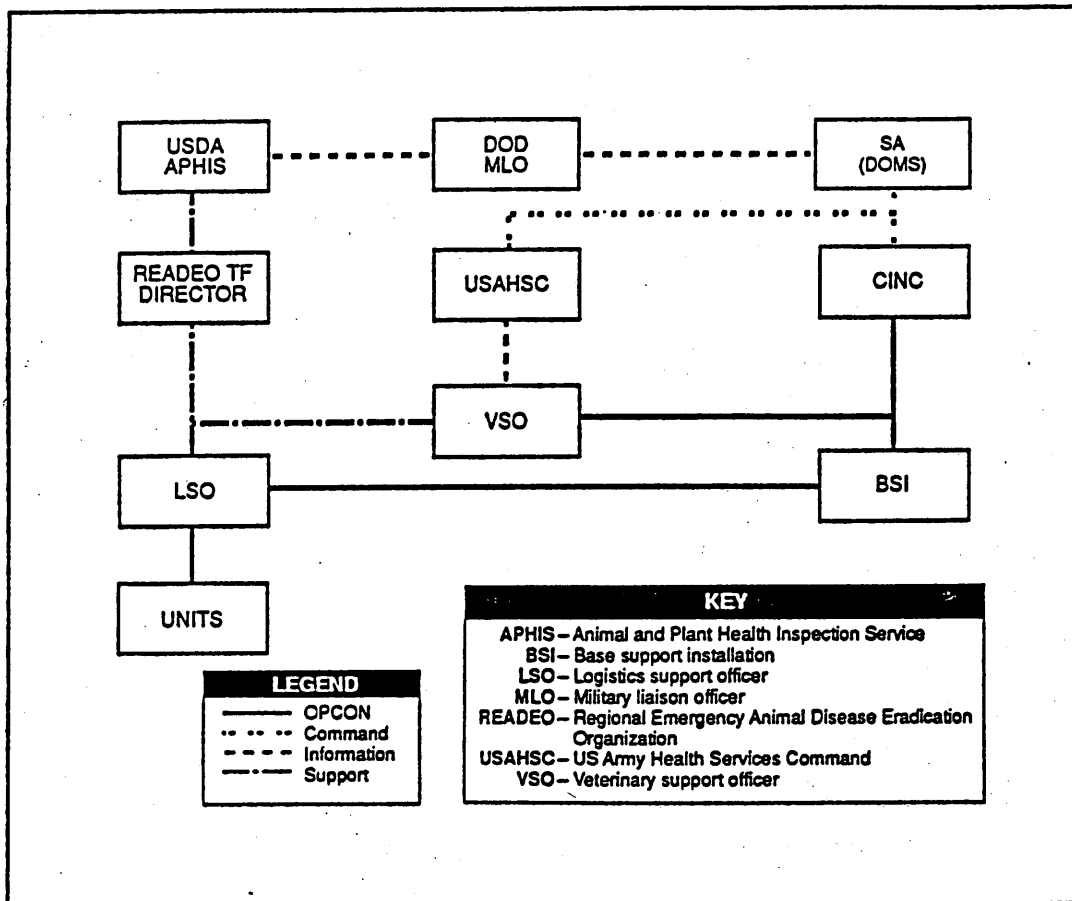

Figure 6-7. Animal Disease Eradication Command Relationships

**DOMESTIC SUPPORT OPERATIONS**

by federal, state, and local regulations. In addition to addressing daily requirements, they develop contingency plans for potential hazardous material spills or similar incidents or accidents. The various internal Army environmental agencies and their relationships are shown in Figure 6-8.

**COMMANDERS**

Commanders tailor forces to meet specific environmental support time requirements. Commanders may augment their forces with other related environmental professionals, including attorneys, public affairs specialists, safety specialists, and others who understand

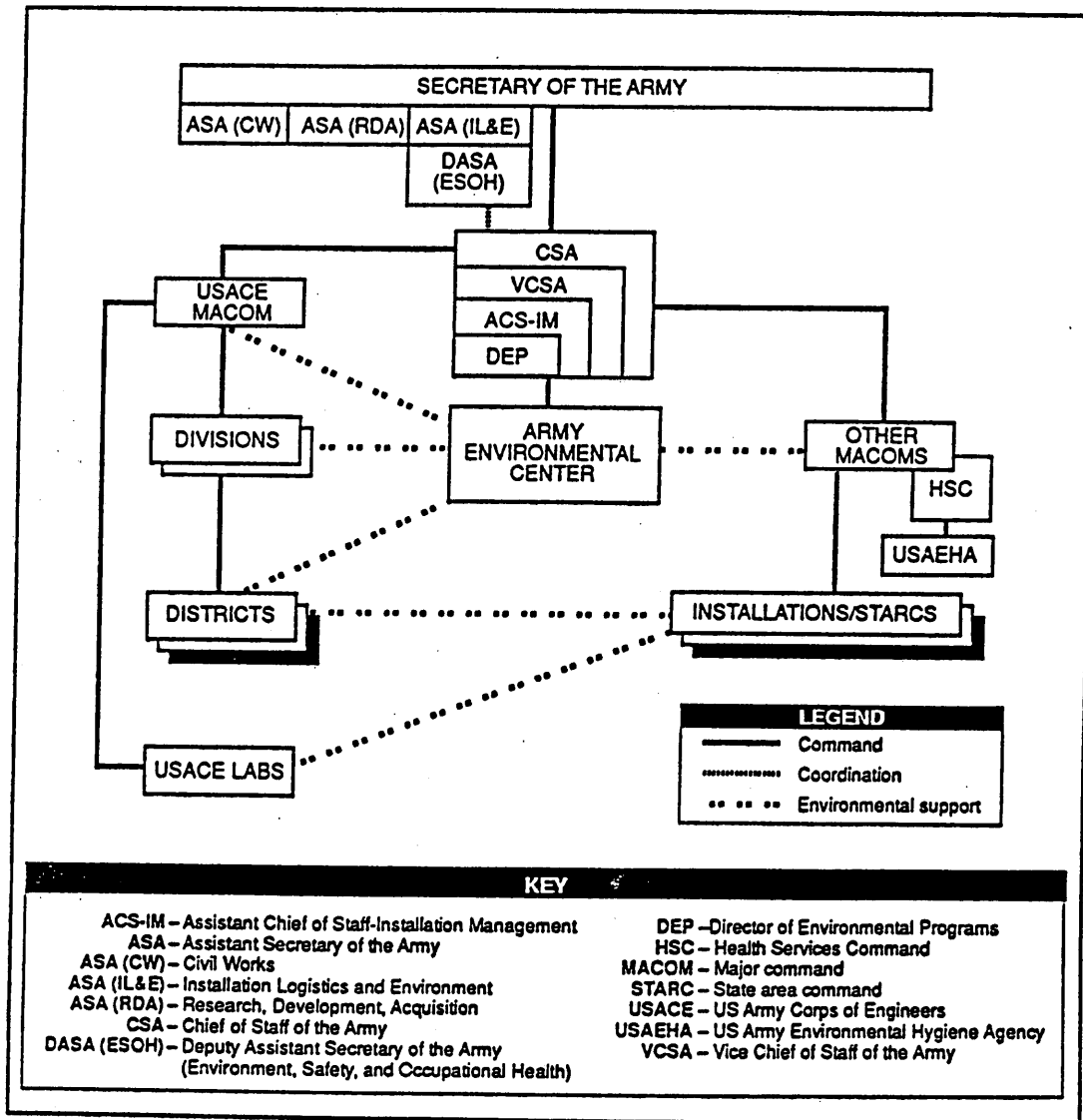

Figure 6-8. Internal Army Environmental Support Relationships

and work daily with environmental issues. Short-, mid-, and long-term missions on the local and regional levels

and the recommended organizations that may provide assistance are shown in Figure 6-9.

AREA	LOCAL			REGIONAL		
	SHORT-TERM	MID-TERM	LONG-TERM	SHORT-TERM	MID-TERM	LONG-TERM
Installation Level	P <sup>1</sup> AOE	E				
STARC Level	P <sup>1</sup> AOE	E				
MACOM Level		PAO				
USACE Districts		PAO	PAO		PAO	PAO
USACE Labs	AO	P		PAO	P	
USAEC	AO	PAO	PAO	PAO	PAO	PAO

LEGEND		KEY	
P - Planning	O - Oversight	MACOM - Major command	
A - Assistance	E - Execution	STARC - State area command	
		USACE - US Army Corps of Engineers	
		USAEC - US Army Environmental Center	

<sup>1</sup>Augmented by experts from USAEC and USACE laboratories.

Figure 6-9. Recommended Actions for Commanders Providing Environmental Assistance to US Civilian Authorities

### SUMMARY

The Army may support or coordinate with many federal, state, and local governmental departments and agencies as it conducts domestic support operations. Although the Army is seldom the lead agency in disaster assistance operations, it is a support agency for all the FRP's emergency support functions. Almost all Army domestic support operations will be conducted in a joint or interagency environment. Throughout our history, the Army has provided community support at the national level and support to its surrounding communities. The Army also has a long history of providing domestic support and will continue to provide that assistance in the future.

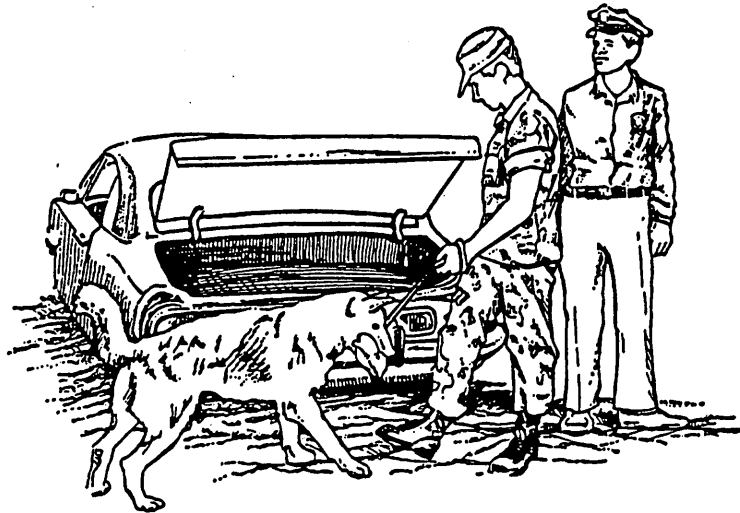

## CHAPTER 7

### MISSIONS IN SUPPORT OF LAW ENFORCEMENT

---

*Army forces may conduct missions in direct support of US federal, state, or local law enforcement agencies. Counterdrug, civil disturbance, and terrorism operations are missions that typically require such support. This chapter addresses the tasks necessary to plan for and provide this support.*

---

#### COUNTERDRUG OPERATIONS

**Army support to the counterdrug effort requires the sustained commitment of trained and equipped soldiers.**

Directives from the President, Congress, and the DOD have resulted in an expanded role for military forces in attacking illegal drugs in every phase of their flow: at the source, in transit, and in the US.

While this manual focuses on Army domestic counterdrug support and operations, a major portion of the DOD and Army counterdrug effort is conducted OCONUS, particularly in Central America and South

America under the supervision of the CINC US Southern Command (USSOUTHCOM). The Department of State has primary oversight responsibilities for all support provided OCONUS. The CONUS Drug Law Enforcement System is depicted at Figure 7-1.

#### ROLES

Military support to the national counterdrug effort requires sustained deployment of appropriately trained and equipped members of the armed forces. The effort also requires continuing cooperation and coordination among the military and federal, state, and local drug law enforcement agencies (DLEAs).

The DOD counterdrug support organization that receives and validates requests from LEAs and considers the actual resources to support those requests is illustrated at Figure 7-2.

The Army's counterdrug support program includes operational support provided by active and reserve component forces and nonoperational support such as

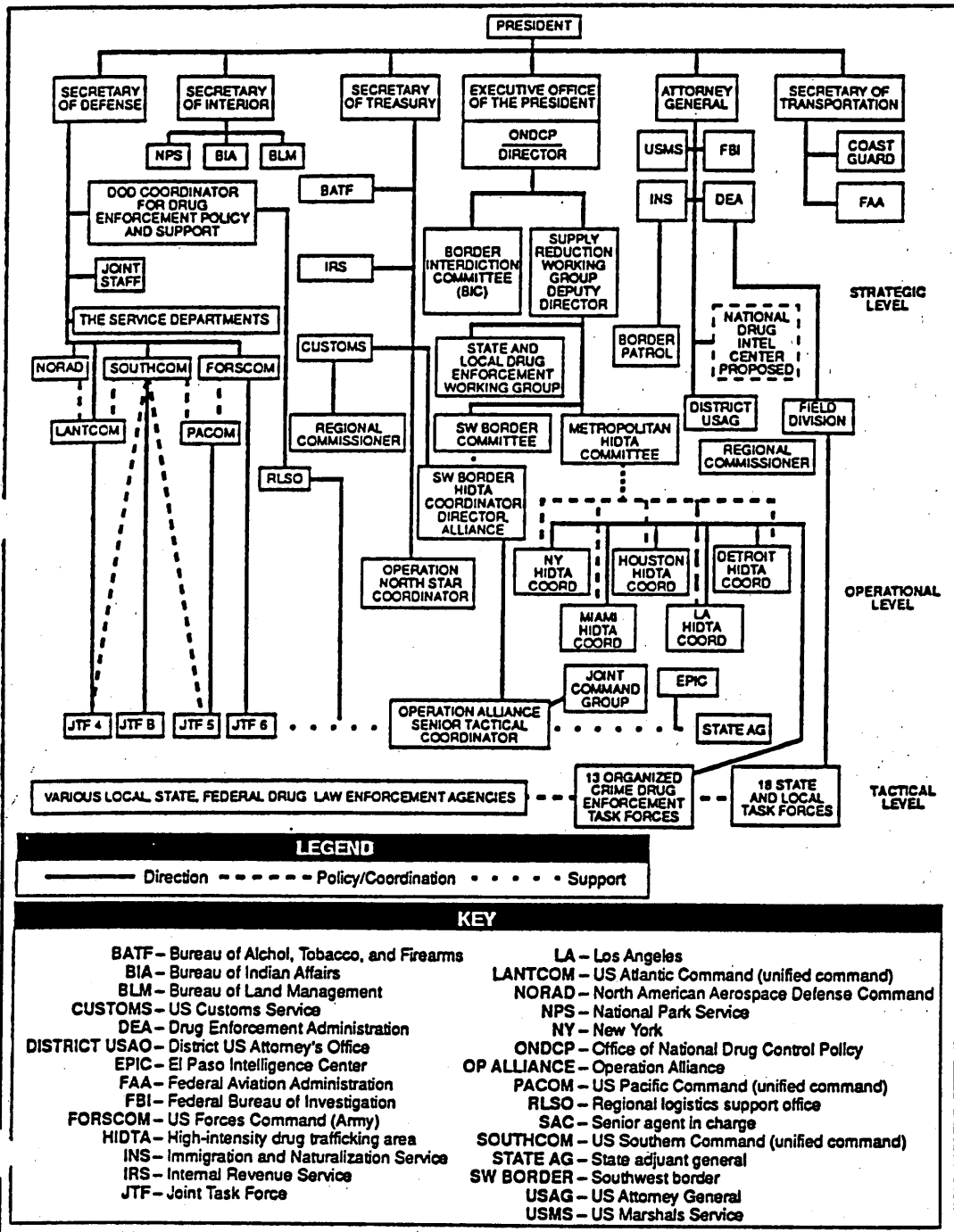

Figure 7-1. CONUS Drug Law Enforcement System

## DOMESTIC SUPPORT OPERATIONS

the provision (loan or transfer) of military equipment and facilities and training in formal schools.

The Army also plans and executes programs to reduce demand for illegal drugs. The Army executes its counterdrug missions with the same dedication, skill, and professionalism that it applies to all national security missions. The Army's organization for counterdrug support is illustrated in Figure 7-3.

## CATEGORIES OF SUPPORT

The Army conducts counterdrug support operations that generally fall within 11 DOD counterdrug mission categories. A critical factor in the program is that the Army provides support, rather than taking a lead role or directly participating in civil law enforcement activities such as performing searches or seizures or making arrests. The DOD counterdrug mission categories are illustrated in Figure 7-4.

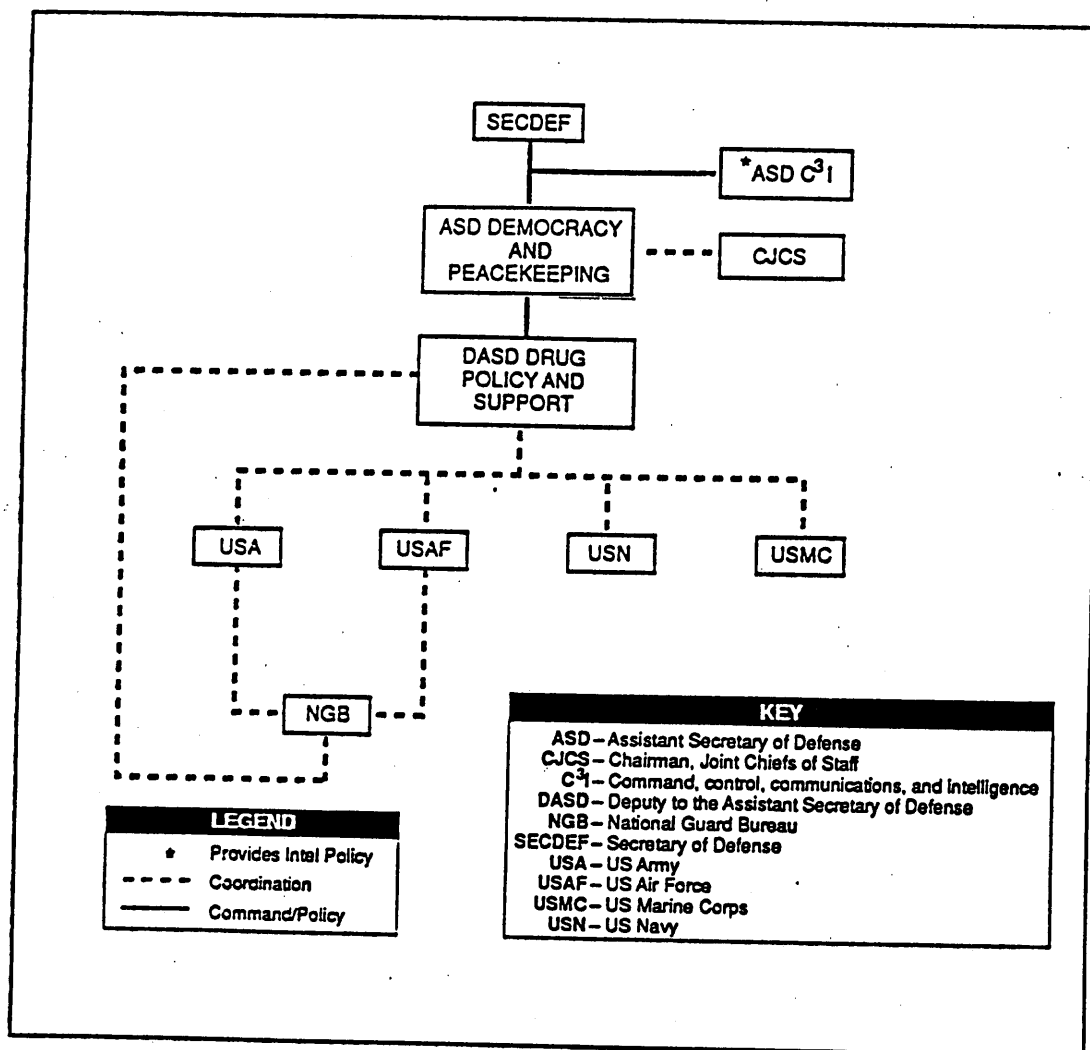

Figure 7-2. Present DOD Counterdrug Support Organization

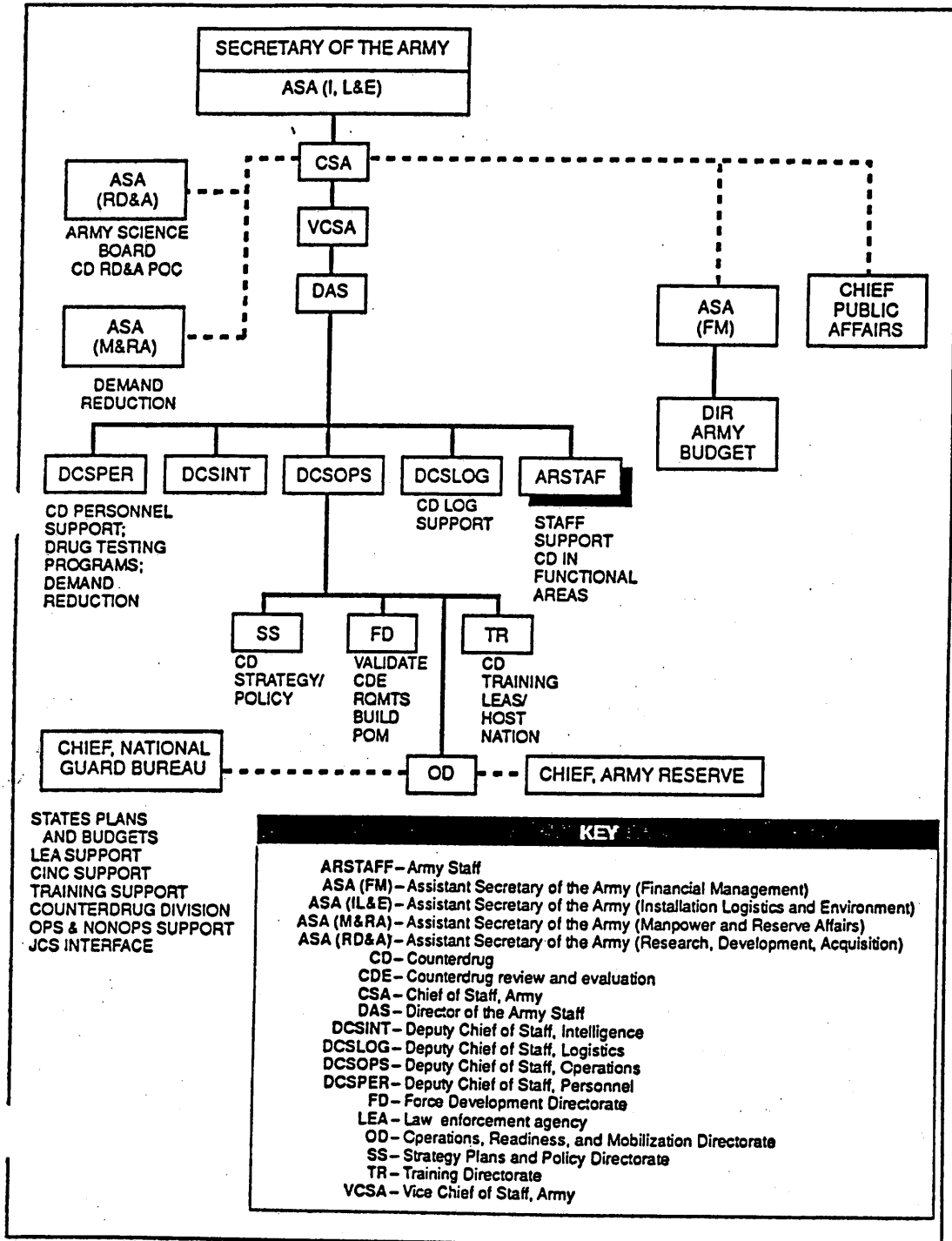

Figure 7-3. Army Organization For Counterdrug Support



## DOMESTIC SUPPORT OPERATIONS

### Detection and Monitoring

DOD is the lead agency for the detection and monitoring of the air, sea, and ground transit of illegal drugs bound for the US. The Army supports these missions with ocean-based aerostats, land-based aerostats, land-based radars (such as air defense radars), and OCONUS reconnaissance and surveillance activities. Responsibility for the subsequent interdiction (arrest and seizure) of suspects and contraband remains with LEAs.

*On 20 May 1991, a California National Guard counterdrug task force in Oakland, CA, was assisting the US Customs Service in inspecting warehouse cargo. While examining plastic produce bags from Taiwan, a task force member noticed inconsistencies in packaging and weight. A thorough examination of the complete shipment uncovered high-grade Southeast Asian heroin. The nearly 1100 pounds, the largest seizure in US history, reportedly had a wholesale value of more than \$2 billion.*

### Command, Control, Communication, and Computers

Army personnel and equipment may assist LEAs in designing, implementing, and integrating C<sup>4</sup> systems. Army personnel support national and departmental drug operations and LEA analytical centers. In addition, the Army provides liaison to LEAs to facilitate the smooth and successful integration of military support.

### Intelligence

The DA Deputy Chief of Staff for Intelligence (DCSINT), establishes policy for use of Army intelligence personnel or material. The DCSINT receives approval of policy statements and guidelines from the Secretary of the Army General Counsel. Commanders should ensure all use of Army intelligence personnel or material is in accordance with established policy and guidelines coordinated through the DCSINT and

approved by the Secretary of the Army General Counsel.

Army personnel can provide multidiscipline support to joint task force intelligence organizations or to individual drug enforcement agencies. Types of support normally provided are basic and advanced techniques used in the intelligence-preparation-of-the-battlefield process; linguists to translate counterdrug materials; and imagery collection, processing, and analysis. Also, the Army provides and participates in LEA intelligence training to facilitate an understanding of the military capabilities and support relationships.

Commanders must ensure that Army personnel are aware of and comply with legal and policy restrictions. Military personnel performing domestic counterdrug support duties are generally prohibited from collecting information on specific individuals. The supported LEA must retain data processed by intelligence augmenters. Army personnel will not maintain or store gathered counterdrug information files on specific individuals in military facilities or data bases. Additionally, Army intelligence personnel can provide assistance to LEAs by providing operations security (OPSEC) evaluations and training.

**Commanders and analysts must ensure that Army personnel comply with legal and policy restrictions.**

### Planning

Planning support consists of planning and coordinating counterdrug operations, determining resource requirements, and gathering information for operations financial support. Planning support can range from assisting a multiagency task force with developing long-range strategy, to facilitating campaign planning between LEA jurisdictions, to helping to write an operations order (OPORD) for a specific operation or mission.

Early planning is critical prior to missions using military operational support. Many LEAs are unfamiliar with military capabilities and limitations. Therefore, early coordination and liaison are vital to

ensure maximum effectiveness of joint military-LEA efforts. Because military and law enforcement communications systems are often incompatible, extensive communications planning is usually required prior to conducting joint military-civilian operations.

**Logistics**

Logistics support includes loaning equipment; providing engineering, air, and surface transportation; providing maintenance; and providing facilities. Loans and transfers of equipment are arranged through the four DOD regional logistics support offices (RLSOs). Army personnel may be tasked to provide MOS-related maintenance support on LEA equipment. Engineer operations can include construction of roads or structures, repairs, or terrain denial operations.

**Transportation**

Military vehicles and aircraft can be used, with some legal constraints, to transport personnel, cargo, or equipment. If evidence, seized property, or contraband is transported, a law enforcement officer must be present at all times to maintain the chain of custody. Precautions must be taken to ensure that Army aircraft and personnel are not placed in situations where they are likely to be fired upon.

**Training**

Army personnel may be tasked to train LEAs. This will often involve the use of mobile training teams (MTTs). As their title suggests, MTTs provide military trainers to instruct LEAs on-site. Subjects trained may include common soldier skills (especially field craft), planning, analysis, maintenance, languages, and physical security. For example, military police can provide training in counterdrug, civil disturbance, terrorism, and mass immigration operations.

*In fiscal year 1991, DOD trained 1471 military personnel and 253 police personnel, primarily in riverine operations, operational missions planning, intelligence management, communications planning and support, and civic action.*

*DOD continues to be the government leader in drug testing. The department certifies the operations of nine DOD and two civilian drug-testing labs.*

1. Detection and Monitoring (D&M)
2. Command, Control, Communications, and Computers (C <sup>4</sup> )
3. Intelligence
4. Planning
5. Logistics
6. Transportation
7. Training
8. Manpower
9. Research, Development, and Acquisition
10. Demand Reduction
11. Land Reconnaissance

Figure 7-4. DOD Counterdrug Mission Categories

## DOMESTIC SUPPORT OPERATIONS

### Manpower

Commanders may support LEAs by providing soldiers to conduct military-specific tasks that would otherwise require civilian law enforcement personnel. Law enforcement officers freed from this requirement can devote their efforts to arresting growers or collecting evidence.

Soldiers may also provide clerical and administrative support. National Guard personnel in state status may be used to assist the US Customs Service with inspections of cargo, vehicles, vessels, aircraft, baggage, and/or mail at ports of entry.

*On 28 October 1991, combat divers from the 3d Battalion, 20th Special Forces Group, conducting ship-bottom inspections in support of the US Customs in Florida, discovered an unusual package behind an intake grate of a 600-foot banana freighter from Turbo, Colombia. The divers ascertained that the package and grate were not booby-trapped and assisted customs agents in its recovery. Customs inspection revealed 75 pounds of cocaine packaged in an exceptionally waterproofed container.*

Army personnel may also provide military skills such as diver, EOD, linguist, dog team, and chemical support. Divers may visually inspect subsurface hulls of vessels but may not enter, search, or alter them. EOD teams can be called on to disarm explosive booby traps placed to protect contraband or equipment. Linguists may be used to translate documents or taped conversations. They may not conduct real-time translations of wire or oral intercepts.

Army forces may provide military dog teams to assist LEAs in detecting illegal drugs and contraband. Chemical liaison teams can advise on the use of

defoliants and identification of drug-producing hazardous chemicals.

### Research, Development, and Acquisition

The Army Counterdrug RDA Office provides technical liaison between the Army development community and the counterdrug community. The purpose of the office is to define technical requirements and facilitate technical transfer within the counterdrug community. The efforts of the Army counterdrug RDA office help to provide LEAs access to new and emerging technologies and equipment. This office may also assist LEAs with contracting and procurement.

### Demand Reduction

Prevention or reduction of drug abuse requires a combination of education, deterrence, and treatment or rehabilitation. Drug abuse awareness education includes programs for all the DOD schools and DOD civilian personnel. Also, to the maximum extent possible, the DOD provides drug education assistance programs to local community organizations. Drug deterrence for DOD personnel is provided through scheduled and random urinalysis testing. The DOD treatment and rehabilitation program is designed to diagnose, treat, and return to full productivity as many people as possible.

### Land Reconnaissance

While reconnaissance is an essential aspect of the DOD detection and monitoring mission, land reconnaissance refers specifically to support provided to US LEAs inside the US. This distinction is made due to legal and policy restrictions concerning the use of the military within our borders.

Army forces may execute a variety of aerial-based and land-based counterdrug reconnaissance missions. These can include the use of fixed wing aircraft, rotary wing aircraft, and unmanned aerial vehicles. Ground-based reconnaissance operations can be accomplished through establishing listening posts and observation posts, on foot or mounted patrols, operation of ground surveillance or air defense radars, and the emplacement and monitoring of remote sensors. Thermal images and other night vision devices may be used to conduct these missions.

*US Army, Pacific and Hawaii Army National Guard soldiers combined to provide support to Hawaii and federal DLEAs during Operation Wipeout in the early 1990s. Working together, these forces succeeded in eliminating more than 90 percent of Hawaii's visible marijuana crop, valued at more than \$6 billion.*

**REQUESTS FOR SUPPORT**

Law enforcement agencies may request support through either the state National Guard counterdrug coordinator, the appropriate CONUSA, the FORSCOM counterdrug support cell, the National Guard Bureau counterdrug task force, or the DOD coordinator for drug enforcement policy and support. The preferred method for requesting support is through the state NG counterdrug coordinator. If the NG is unable to provide support, the request will be passed to the appropriate CONUSA. Requests for CONUS military counterdrug operational support are illustrated in Figure 7-5.

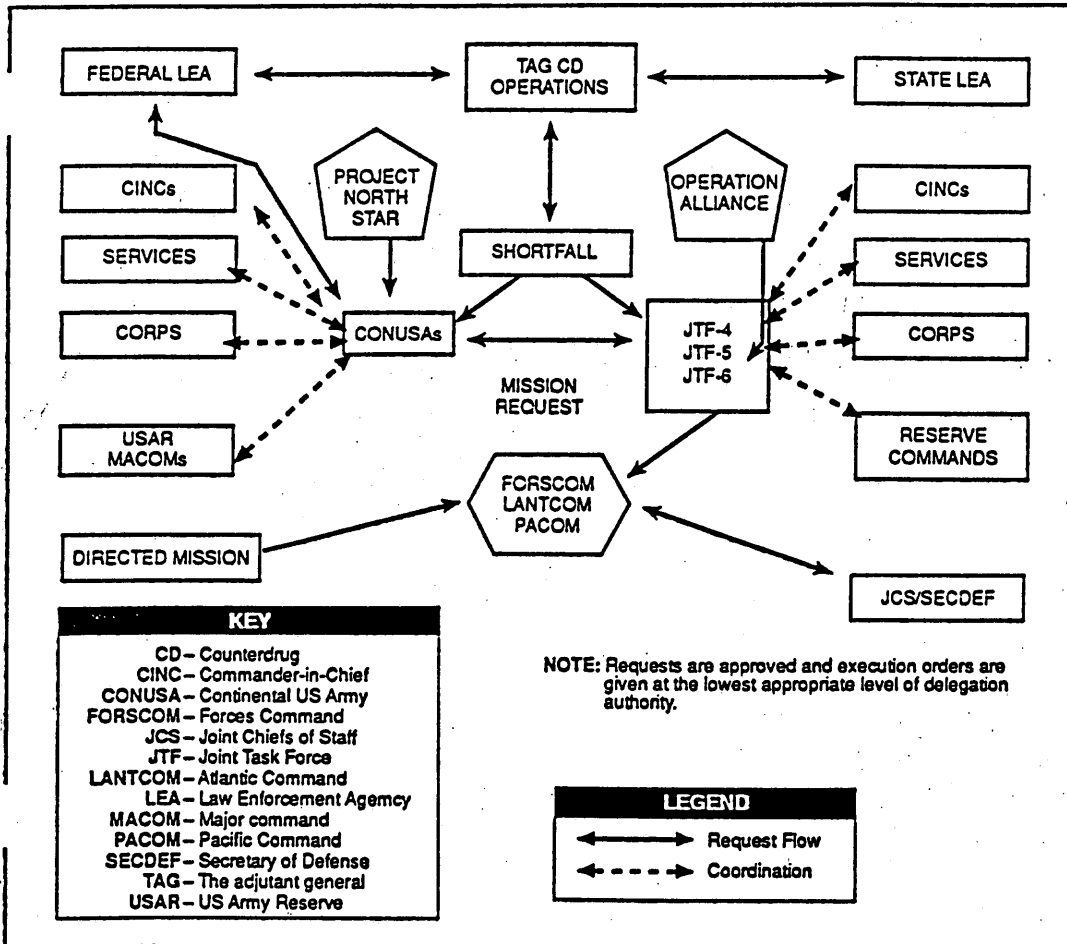

Figure 7-5. Requests for Military Domestic Counterdrug Operational Support

## DOMESTIC SUPPORT OPERATIONS

### PROVISION OF SUPPORT

Within the United States, the National Guard is the primary source of military support to federal, state, and local LEAs. Support is also provided to LEAs by both USAR and active duty units. This Army support to counterdrug operations is another aspect of the Army's traditional role of providing military support to civil authorities. Army National Guard forces execute these missions under control of the governor, while USAR and active duty units operate under the control of a regional joint task force, for example, JTF 6 in the US southwest, or in support of a CONUSA.

Each state or territory has a National Guard counterdrug coordinator to receive LEA requests for support and coordinate the execution of support as directed by the state adjutant general (or commanding general). Army National Guard counterdrug operations are conducted in accordance with state law and applicable National Guard regulations. Drug interdiction and eradication operations are conducted in all 54 states and territories. In fiscal year 1992, the National Guard helped confiscate drugs with a street value of \$69 billion.

The National Guard has categorized its support into 16 missions (approved by SECDEF) that are essentially subdivisions of the eleven DOD categories. These missions are depicted in Figure 7-6.

#### Coordination Requirements

The Joint Staff reviews all DOD operational support requests and the Secretary of Defense or delegate approves them. The CINCFOR coordinates counterdrug land operations in CONUS. Figure 7-7 illustrates the counterdrug operational support approval process.

#### Nonoperational Support Requests

In accordance with current DOD policy and service regulations, the appropriate regional logistics support office will process LEA requests for equipment, facilities, and formal school training. The Director of Operations, Readiness, and Mobilization, in coordination with the Assistant Secretary of the Army for Installations, Logistics, and Environment, administers such actions for the Department of the Army.

## CONSIDERATIONS FOR PLANNING

### STAND-ALONE CAPABILITY

Whenever possible, Army support will be packaged to provide a complete stand-alone capability. Units

tasked with providing counterdrug support should perform a mission analysis to ensure the requested forces or capabilities are sufficient to meet requirements.

### DECISION-MAKING PROCESS

Planning for a counterdrug support mission entails the same decision-making process as any other military operation. The conduct of counterdrug operations should be consistent with Army doctrine. Unlike combat operations where the massing of firepower is appropriate, however, the guiding principle for Army personnel during counterdrug operations is to avoid contact and use minimum necessary force.

Leaders at the lowest echelons will perform troop-leading procedures and analysis based on the factors of METT-T. Leaders at higher echelons will perform command and staff estimates. To the greatest extent possible, estimates should be coordinated with the supported LEA.

### LEGAL AND TACTICAL ASPECTS

In developing a threat estimate, the military counterdrug planner may have to rely heavily upon law enforcement sources for information. IPB should be performed before each mission but must be modified to account for less predictable drug traffickers, rather than for a doctrinally rigid threat. Also, planners must consider legal as well as tactical aspects when developing courses of action.

**Legal constraints are a major concern in planning counterdrug missions.**

### LEGAL CONSTRAINTS

Legal constraints constitute a major concern during counterdrug mission planning. Use of military support may require special procedures to ensure that legal proceedings resulting from joint military-LEA counterdrug operations can be effectively prosecuted in court. Counterdrug plans should be reviewed by a staff judge advocate. The supported LEA is responsible for obtaining any required warrants or determining instances in which warrants are not required.

#### **RULES OF ENGAGEMENT**

Rules of engagement (ROE) and use-of-force policies will usually be detailed and restricted by US law. Soldiers conducting counterdrug support missions must be familiar with and completely understand the ROE. Commanders routinely provide a precommitment briefing outlining the mission, legal considerations, and ROE to soldiers engaging in counterdrug operations.

#### **OPERATIONS SECURITY**

OPSEC during counterdrug support operations cannot be overemphasized. The mere appearance of military personnel or *strangers* in an area can cause drug traffickers to alter or delay their activities.

Planners must identify security vulnerabilities and implement measures to protect weaknesses. Commanders must take steps to preserve counterdrug force intentions and capabilities.

#### **COMMAND AND CONTROL**

Command and control relationships must be clearly established. The relationship between a military unit providing counterdrug support and the supported LEA is similar to a unit providing direct support (DS) and a supported unit. However, the military chain of command must always be maintained. US soldiers will not be placed under the command of law enforcement officers.

1. Surface Reconnaissance
2. Surface Transportation Support
3. Aerial Surveillance
4. Ground Radar Support
5. Training Programs
6. Engineer Support
7. Coordination, Liaison, and Management
8. Marijuana Greenhouse/Drug Lab Detection
9. Film Processing for Photo Reconnaissance
10. Administration, Information, Logistics, and Maintenance Support
11. Surface Surveillance
12. Aerial Reconnaissance
13. Aerial Transportation Support
14. Cargo Inspection
15. Aerial Photo Reconnaissance
16. Aerial Interdiction

Figure 7-6. National Guard Counterdrug Support Categories

DOMESTIC SUPPORT OPERATIONS

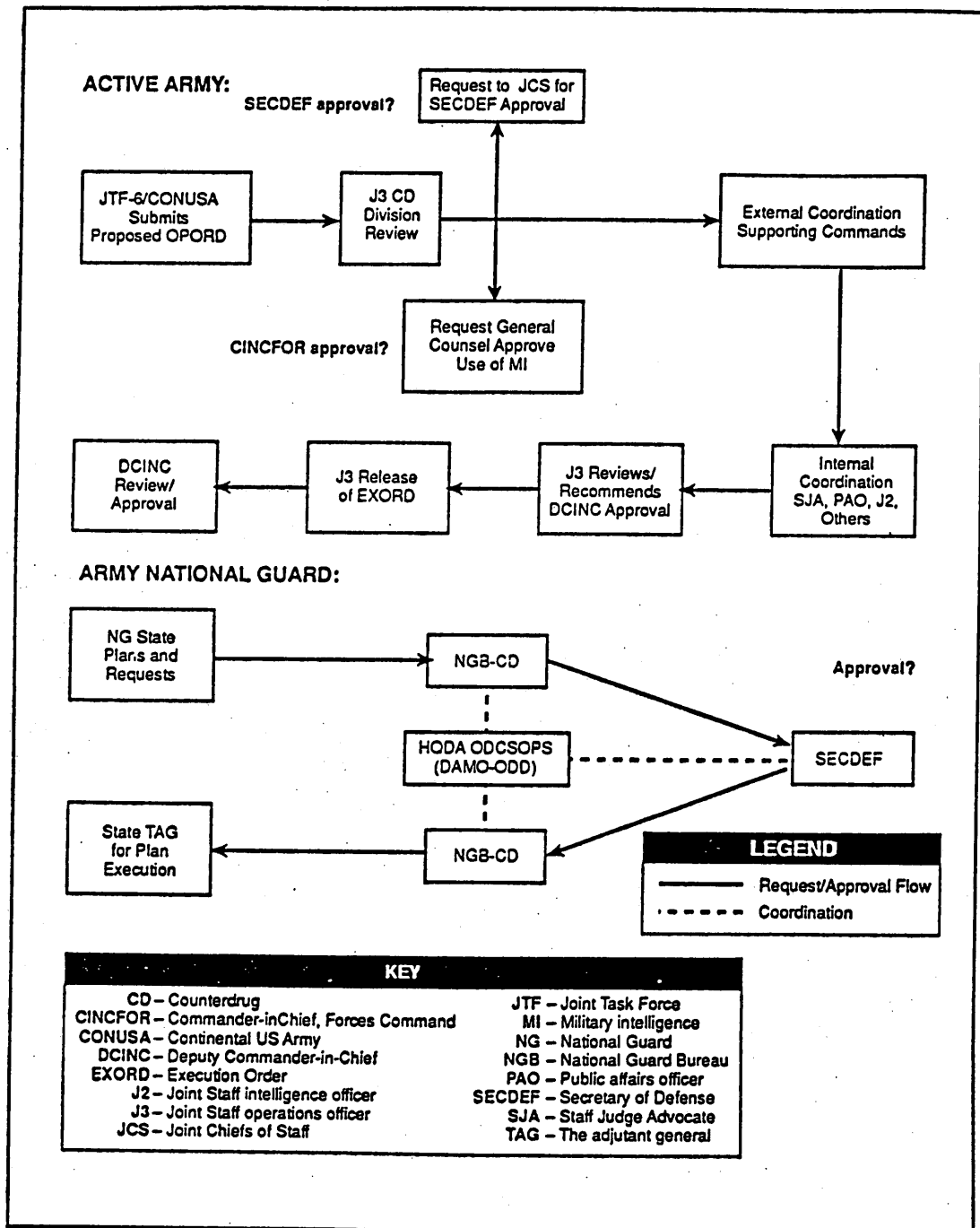

Figure 7-7. Counterdrug Operational Support Approval Process

*On 15 December 1992, members of the Oregon National Guard (ORNG) Counterdrug Support Program assisted the DEA, BATF, US marshals, and two IRS criminal investigation divisions in executing a search warrant in Hermiston, Oregon. With the support of the ORNG, the agencies seized a number of fully automatic weapons, 42 other weapons, and more than 3000 rounds of ammunition, including .50-caliber armor-piercing rounds.*

*LEA arrested four individuals and seized illegal drugs, \$115,000 cash, a 48-foot yacht, eight vehicles, military explosives, grenades, and booby traps.*

*From 1 to 19 June 1991, the New York National Guard counterdrug program was responsible for seizing \$24,589,110 in illegal drugs and \$3,192,106 worth of cash and travelers checks.*

#### **COMMUNICATIONS**

Communications plans must be detailed. Since military and civilian systems are often incompatible, military and supported LEA communications planners must coordinate as early as possible.

#### **PUBLIC AFFAIRS**

The lead for public affairs rests with the supported LEA. Army public affairs officers will coordinate any release of information with the supported LEA. Commanders should ensure their public affairs officers are included in the planning process for all counterdrug operations. Unwanted disclosure of operations by the media can render a plan ineffective. It can also negate favorable results of an operation such as arrests and seizures.

A good public affairs plan can minimize these risks by providing the media with only the information the

operational commander wishes to release. A good public affairs plan will serve the public's right to know while minimizing risk through effective security at the source and OPSEC awareness. The identity of soldiers providing counterdrug support will not be released to the media.

#### **THREAT AWARENESS AND RISK ASSESSMENT**

Commanders should perform a risk assessment prior to the deployment of troops. Threat awareness and risk assessments are a critical part of counterdrug planning. While soldiers should not be placed in situations where they will likely be fired upon or come into direct contact with suspected drug traffickers, such a possibility always exists. Units and soldiers may face an armed adversary. They should be prepared for actions related to combat, even when conducting training or other noncombat operations. Commanders should also be aware of the chemical hazards associated with drug production.

#### **SUPPORT FOR CIVIL DISTURBANCE OPERATIONS**

Civil disturbances may range from unruly demonstrations to widespread rioting with looting and arson. In extreme cases, civil disturbances may include criminal acts of terrorism and violence. Civil disturbances in any form are prejudicial to public law and order. The Army has a role in assisting civil authorities to restore law and order when local and state law enforcement agencies are unable to quell civil disturbances.

#### **ROLES**

The National Guard, as a state organization, responds to the governor in accordance with state law for civil disturbance operations. National Guard regulations direct planning and training for the civil disturbance mission. During most civil disturbance situations, the National Guard will be the first military responder and will usually remain in state active duty status throughout the operation. The National Guard can be brought on federal service for civil disturbance operations when so ordered under appropriate federal statute by the President. This will normally be done at the request of the state governor.



## DOMESTIC SUPPORT OPERATIONS

*The LA riots of 1992 were unquestionably the most costly civil disturbance in US history (\$800 million plus). At 2230 on 29 April 1992, as part of the response to this disorder, the 3d Battalion, 160th Infantry (Mechanized), 40th Infantry Division, California National Guard, was ordered to mobilize. Between 2100 and 2400 the following day, all 3d Battalion companies deployed to their assigned areas. It was the first tactical battalion to be mobilized, the first to deploy to the streets of LA, and the last to redeploy.*

The role of federal Army forces is to assist civil authorities in restoring law and order when the magnitude of the disturbance exceeds the capabilities of local and state law enforcement agencies, including the National Guard. Under the provisions of the Constitution and selected federal statutes, the President may order the employment of the federal armed forces to aid local and state civil authorities to protect the Constitutional rights of citizens. Federal military forces may also protect federal facilities and installations in any state, territory, or possession. The Department of the Army civil disturbance plan, nicknamed GARDEN PLOT, provides direction for Army forces directed to quell civil disturbances.

### REQUESTS FOR FEDERAL MILITARY ASSISTANCE

Requests for federal military assistance normally originate with the state and are forwarded to the President of the United States. The Attorney General is responsible for coordinating and managing all requests for federal military assistance for civil disturbance operations. The Attorney General advises the President whether and when to commit federal military forces. The President orders the employment of federal military forces in domestic civil disturbance operations.

The Attorney General, as the head of the lead federal agency responsible for law enforcement, will appoint a senior civilian representative of the Attorney General (SCRAG). The SCRAG is responsible for

coordinating federal civil disturbance operations and assisting the state civil authorities.

The SCRAG has the authority to assign missions to federal military forces. The SCRAG exercises this authority in coordination with the commander of the federal military forces committed to civil disturbance operations. Civilian officials remain in charge of civil disturbance operations.

The Secretary of the Army is the DOD executive agent for federal military operations in response to civil disturbances. Within the Department of the Army, the Director of Military Support coordinates the functions of all the military services when federal military assistance for civil disturbances is required. The executive agent, through DOMS, serving as a joint staff, publishes an execute order designating a supported CINC for civil disturbance operations. This execute order also designates the supporting CINCs, services, and agencies (see Figure 7-8).

The CINC will determine the organization and forces required to accomplish the civil disturbance mission. The CINC may establish a joint task force in order to make best use of the forces available for the mission.

### CONDUCT OF CIVIL DISTURBANCE OPERATIONS

The JTF commander exercises control of all federal military forces (including National Guard in federal status) committed to assist civil authorities. Federal military forces remain under the military chain of command during civil disturbance operations. Federal forces will not be placed under the command of either civil officials or National Guard commanders in nonfederal status. Civilian authorities retain control of their state and local law enforcement agencies. The JTF commander establishes liaison with the SCRAG and other appropriate federal, state, and local civil authorities.

Federal military forces must be tailored to the specific civil disturbance situation. Sufficient combat support and combat service support units will be required to sustain the force throughout the deployment. Coordination with civil officials may allow the force to draw on resources available from state and local agencies. Close and continuous coordination between the federal military forces and the LEAs will

provide the commander the detailed information required to employ and protect the force effectively.

In supporting OPLAN GARDEN PLOT, intelligence personnel may conduct close and continuous liaison with LEAs and the military police to ensure that their units receive the information needed to allow the commander to adequately protect the force. The JTF commander should staff intelligence support missions with his senior intelligence officer and legal counsel prior to approving the mission.

**Federal military forces remain under the military chain of command during civil disturbance operations.**

Federal military forces must be employed in tasks or missions appropriate to their organization and training; they must not be employed in ways that violate the legal restrictions in effect. Military forces may be used to disperse unlawful assemblies and to patrol disturbed areas to prevent unlawful acts. They may be used to assist in the distribution of essential goods and the maintenance of essential services. Forces may also establish traffic control points, cordon off areas, release smoke and obscurants, and serve as security or quick-reaction forces. Certain types of missions are always inappropriate for military forces during civil disturbance operations, for example, gathering intelligence on civilians.

Requests for the conduct of specific military missions are typically passed through a single state or federal law enforcement coordinating officer, as approved by the SCRAG. Validated requests are transmitted to the JTF commander and his headquarters

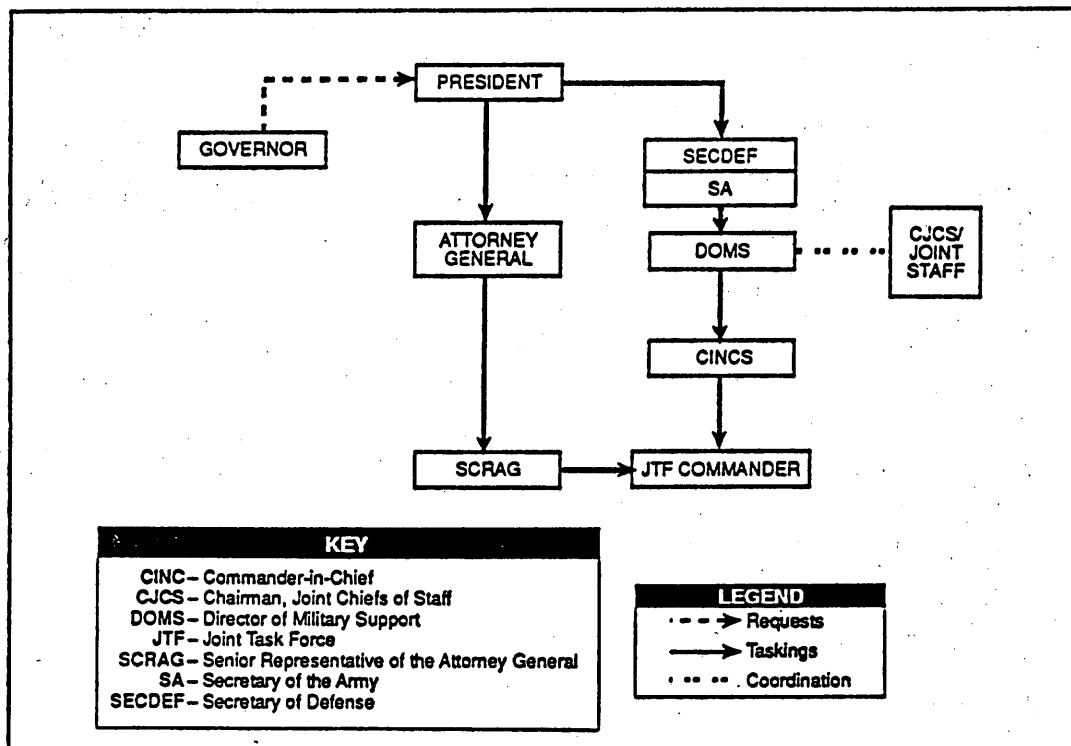

Figure 7-8. Decision Sequence for Law Enforcement Support

## DOMESTIC SUPPORT OPERATIONS

for staffing and coordination. Approved missions are assigned through the military chain of command to the appropriate element or unit for execution. Units and soldiers will not accept taskings or missions directly from law enforcement or civilian officials, except in a direct support relationship as approved and ordered through the military chain of command.

Military liaison should be provided to each LEA headquarters generating requests for support. This liaison can assist LEA officials in determining the types and quantities of military support to be requested. The JTF headquarters can facilitate this mission assignment process by providing LEAs with a detailed listing of the types of missions military forces may conduct.

A deployed unit's area of operation should coincide with the jurisdiction or subdivision boundaries of the law enforcement agency it supports. This arrangement facilitates liaison and coordination between law enforcement and military chains of command.

### SUPPORT FOR COMBATTING TERRORISM

#### ANTITERRORISM ASSISTANCE

Antiterrorism is the term encompassing defensive measures, to include limited response and containment of a terrorist incident involving DOD personnel and facilities. Since the FBI has the lead role in most matters concerning terrorism in the US, the Army's function in AT is essentially to reduce the vulnerability of Army personnel and property to terrorist attack.

Selected Army and civilian personnel may attend established AT training courses. Additionally, Army organizations may develop memorandums of understanding with civilian agencies for mutual support in the event of a terrorist incident. Such agreements may include arrangements for firefighting or EOD support, providing assistance in site isolation, security engineering and assisting in hostage negotiation.

#### COUNTERTERRORISM ASSISTANCE

Counterterrorism includes means taken to prevent, deter, and respond to terrorism. Assistance provided in counterterrorism is essentially a subset of civil disturbance operations. The Federal Bureau of Investigation is the lead law enforcement agency concerning incidents of terrorism in the US. The Secretary of the

Army remains the executive agent for the employment of military support.

#### TYPES OF SUPPORT

Support provided by Army forces may include material, facilities, and personnel acting in an advisory capacity. Presidential authorization is required before military personnel can perform law enforcement functions outside the military installation. At the request of the director of the FBI or the senior FBI official at the scene of a terrorist incident, the Secretary of the Army and OCONUS CINCs may provide the FBI military resources (barrier materials, smoke and obscurants, body armor, protective masks, clothing, communications equipment, firefighting equipment and operating personnel, and explosive detection dog teams for the purpose of combating terrorism). The Secretary of the Army has delegated this authority down to installation commanders. The approval of the Secretary of the Army or his designated representative is required to authorize the provision of arms, ammunition, combat tactical vehicles, vessels aircraft, and personnel (other than firefighting and EOD personnel).

#### Explosive Ordnance Disposal

The EOD mission is to assist public safety and law enforcement agencies in developing a capability to deal with the improvised explosive device (IED) threat and, when necessary, to provide EOD service in the interest of public safety. Army EOD personnel will not participate in bomb or IED search operations (except to support the US Secret Service) or assist in the enforcement of civil law. Army EOD personnel will respond to requests when a suspected or actual device has been located and when the responsible agency has no EOD capability or its capability is overextended.

**Army EOD personnel may  
support the US Secret  
Service or assist local law  
enforcement.**

EOD personnel do not normally respond to incidents involving commercial explosives or chemicals but may be authorized to provide technical assistance to preserve life or to prevent severe property

assistance to preserve life or to prevent severe property damage. Army EOD units may not transport, store, or dispose of commercial explosives or chemicals for agencies other than the DOD.

EOD personnel train military personnel, Defense Civil Preparedness Agency personnel, and civil authorities in—

- Explosive ordnance reconnaissance.
- Responding to bombings and sabotage.
- Combatting bombings and sabotage.
- Identification and dangers of ordnance.

**Department of  
Defense Key Asset Protection Program (KAPP)**

CINCFOR is designated the DOD executive agent for the DOD Key Asset Protection Program. CINCFOR develops and promotes the security of key assets within the US by providing to the owners or managers of such assets appropriate advice, guidance,

and planning assistance on the application of physical security and emergency preparedness measures. Such assistance is designed to protect key assets from sabotage, espionage, and other hostile or destructive acts and to minimize the effect of attack damage.

USACE provides security engineering advice for government installations. Examples of facilities selected for this program include, but are not limited to, munitions plants, production facilities producing critical national defense items, communication nodes, and power plants.

The DOD will not replace the primary responsibility of others for the physical security of any privately owned assets; federally owned assets under the control of any other federal department, agency, or contractor; or assets owned by any state or political subdivision of any state. The DOD will ensure that actions to protect key assets are included in military contingency plans for CONUS security.

## SUMMARY

The US Army can perform many tasks in support of civil law enforcement. Efforts to combat the flow and use of illegal drugs in the US have shown that the Army can provide effective assistance to LEAs. Army personnel and equipment can also help civilian law enforcement authorities quell civil disturbances and terrorist activities. By providing both operational and nonoperational support to law enforcement, the Army can be a formidable force multiplier for civil authorities.

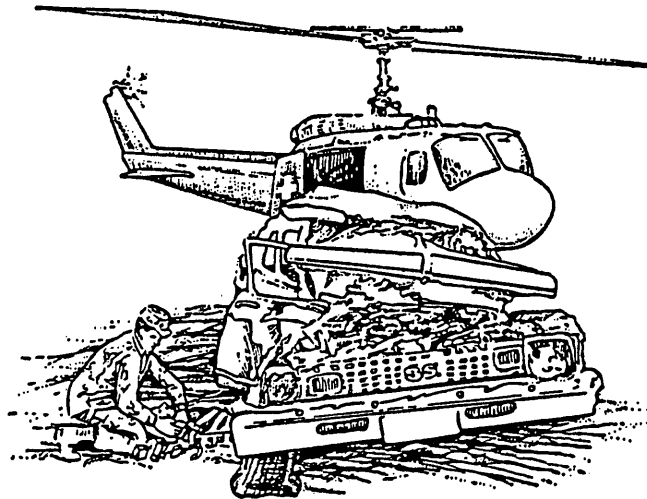

## CHAPTER 8

# COMMUNITY ASSISTANCE

---

*Community assistance applies the skills, capabilities, and resources of the Army to the needs and interests of America and local communities. Supporting and participating in events and activities that benefit the Army and the civilian community build on a long tradition of America's Army helping American communities. Community assistance can have a large-scale impact because active component, National Guard, and Army Reserve units are located in thousands of towns and cities across the nation. What a command does, or fails to do, for the community will affect the attitudes of the American people, upon whom the Army depends for its support and existence. Every commander should identify opportunities to conduct initiatives that meet specific needs, have specific start points and end states, enhance readiness, and advance the interests of the nation, the Army, and local communities.*

---

### PRINCIPLES

**America's Army has a long tradition of helping American communities.**

Community assistance projects and operations must enhance the Army's image, have a positive impact on

the unit or individual soldier, and contribute to the common good of the nation and local communities. Army commanders must be sure that their initiatives are not competitive with local resources or services, do not benefit any particular interest group, and will not result in monetary or service remuneration in any form. Army commanders located OCONUS may find these principles useful in fostering their established relationships with adjoining host nation commanders. However, they must consider applicable CINC guidelines and host nation laws and agreements before implementing community assistance programs.

#### **COMMAND EMPHASIS**

Commanders should take an active interest in their relationships with civilian officials, encouraging appropriate community assistance programs. Establishing long-term, harmonious, productive relationships with national, state, and community officials can significantly benefit both the Army and the nation's civilian communities.

#### **INDIVIDUAL AND UNIT ENHANCEMENT**

Community assistance activities increase public awareness and understanding of the Army, inspire patriotism, and enhance the Army's reputation as a good neighbor. They positively influence public opinion toward the Army while also enhancing the combat readiness of the organization. They help build unit morale and esprit de corps. Community assistance activities are an excellent opportunity for soldiers to serve as role models, which not only enhances recruiting but motivates other soldiers. These activities promote their self-esteem and further their sense of service to the nation.

#### **READINESS ENHANCEMENT**

Community assistance activities should enhance individual and unit combat readiness. They should make the best use of assets and foster a positive training environment where soldiers can become involved in realistic, hands-on training opportunities. Whenever possible, community assistance projects should exercise individual soldier skills, encourage teamwork, challenge leader planning and coordination skills, and result in measurable, positive accomplishments. Finally, they should enable a unit to use its equipment, providing training opportunities that increase operator proficiency.

#### **COMMUNITY BENEFIT**

Community assistance activities should contribute to the health and welfare of the nation and local communities, making the Army an integral partner in progress and development. These activities enhance the ability of the nation and communities to provide the best possible services to the citizenry. They promote a positive, healthy, safe environment, as well as an understanding of the basic principles, values, and ideals upon which America is built. This results in increased awareness of America's history and the Army's role in a continuously changing world.

*During the summer of 1992, units from the 89th US Army Reserve Command helped a nonprofit, community action organization in Kansas City, Kansas, lift, transport, and relocate 81 houses from Fort Leavenworth to the Kansas City area to provide housing for elderly, handicapped, and lower income families.*

#### **COMMON INTEREST AND BENEFIT**

Because the Army belongs to the American people, it should support only events and activities of common interest and benefit. Commanders should avoid providing assistance and support to one sponsor that it cannot also provide to other sponsors. Army assistance should not selectively benefit any person, group, or corporation, whether profit or nonprofit, religious or sectarian, ideological or quasireligious, fraternal, political, or commercial.

#### **NONCOMPETITIVE**

Army community assistance projects should not compete with resources and services commercially available in the community. Commanders must not authorize assistance activities when local businesses can provide the same or similar assistance and support.

**Assistance projects  
must be noncompetitive and  
nonprofit.**

#### **NONPROFIT**

Army support for or participation in community assistance activities cannot be provided on a for-profit basis. Commanders must ensure that no Army person or unit realizes a monetary profit, a gratuity, or a remuneration in any form not provided for by public law or regulation.

## TYPES OF COMMUNITY ASSISTANCE

Community assistance activities can be national efforts focused on developing public support for the Army and its contribution to the nation. They can also be state or local community efforts focused on improving the community, its infrastructure, and its ability to serve the local population. Both types improve the lives of American citizens, foster the values and purposes of democracy, and give the American people hope and confidence in a changing world.

### NATIONAL EFFORTS

The goal of national efforts is to develop an open, cooperative relationship between the Army and the American people. National efforts take advantage of the technical, vocational, and group skills of military professionals to enhance the lives of American people. They supplement programs available in the civilian sector and through other government agencies, not replace them. They provide opportunities for the Army to contribute to the growth and welfare of the nation, improving its perception of the Army, its capabilities, and its personnel. Army and DOD regulations provide detailed guidance on national effort programs. Examples of national efforts are described in the following paragraphs.

#### Public Works Maintenance and Management

The Army exercises its federal engineering executive oversight responsibilities through the US Army Corps of Engineers. The USACE manages myriad components of the nation's public works infrastructure. Executed principally, but not solely, through the civil works directorate, this unique Army national assistance program has developed an integrated understanding of complex federal, state, and local regulations and policies governing the national infrastructure, the national waterways, environmental remediation and recovery operations, real estate, disaster recovery operations, and general project management functions. The Army's efforts help maintain and improve the nation's infrastructure. Many federal, state, and local agencies engage the USACE on a reimbursable basis when they lack the expertise to manage the engineering dynamics of a particular project.

#### Assistance Programs

Army involvement in a wide variety of national assistance programs focuses on economic and social issues having national security implications. Large segments of our society face an unfulfilling lifetime of marginal existence, creating the potential for disorder in our nation. Army participation in programs designed to provide the nation's citizens opportunities to fulfill their potential is effective use of our resources and capabilities. Examples of national assistance programs in place or under consideration are described below.

**Civilian Community Corps.** This program provides managerial, organizational, and technical skills for disadvantaged Americans seeking the skills they need to succeed. Through this program, the Army helps participants become productive citizens. In exchange, participants perform a wide range of community service activities that improve the foundation of American society. This program encourages intra-governmental cooperation on the federal level. It also encourages partnerships with industry, education, state, federal, and local governments.

**Science and Technology Academies Reinforcing Basic Aviation and Space Exploration (STARBASE) Program.** This program is an innovative partnership of professional educators, military personnel, and corporate sponsors. It promotes science, mathematics, and technology basics for primary through secondary schools. Using NG resources to spark student interest, the program develops strong self-esteem, provides excellent role models, promotes positive attitudes, and develops goal-setting skills.

**Civilian Youth Opportunities Program (Challenge).** This is a youth program directed at attaining a high school diploma, providing job training and placement, improving personal and social skills, and providing health and hygiene education and physical training. Soldiers work with civilian leaders to provide a comprehensive support package, ranging from choosing appropriate clothing to attending residential training facilities.

**Drug Demand Reduction Programs.** These are activities in which soldiers work with community agencies and organizations to reach at-risk individuals. Program activities include presentations on drug

awareness and prevention, sponsorship of drug-free activities and events, leadership camps, fitness programs, and cultural exchange programs. One of the specific programs in this general category is the Drug Abuse Resistance Education (DARE) Program. Military police provide instructor support to law enforcement agencies teaching elementary students how to stay drug-free. This support is provided either on or off military installations based on the requests of local law enforcement agencies.

**Youth Physical Fitness Clinic Program.** The National Guard encourages fitness and combines academic and athletic achievement by helping schools conduct competitions in selected athletic events. This program also establishes a separate scholar-athlete category for those students with a 3.5 or higher grade point average.

*Crews from the 57th Medical Command (Air Ambulance), 1st Corps Support Command, Fort Bragg, provide emergency rescue support to the local community. In March 1993, they responded to a call to assist two 19-year-old canoeists who had been forced to climb a tree after losing their boat in the rampaging waters of the Eno River near Durham, North Carolina, which was swollen as a result of three inches of rain.*

**Medical Readiness Program.** The Medical Readiness Program is an activity in which Army medical unit personnel, together with state medical emergency officials, plan and provide support in the form of diagnosis, treatment, and preventive medical, dental, and veterinary care to citizens in remote areas of the US or its territories. The program is designed to enhance the unit's medical readiness, provide unit training opportunities, and serve the public in locations where medical care is not otherwise available. The

program may not compete with local private medical care that may be available.

**Air Ambulance Participation.** The Military Assistance to Safety and Traffic (MAST) Program is a proven example of Army support to civil authorities. This program permits the utilization of Army aviation assets to conduct emergency air evacuation and recovery efforts.

#### National Events

When directed, the Army provides support to national events and activities that promote the image of the country. Examples of such missions include support to national and international supporting events such as the Olympics and the Super Bowl, or political events such as the Presidential inauguration and other national celebrations and commemorations.

*Fort Eustis started a pilot program in 1992 called Operation Self-Enhancement to give high-risk middle school students the opportunity to visit the post and focus on careers, teamwork, and self-esteem. The program was so successful that it has become an annual event. Students receive light military training through an array of "testable" tasks and obstacles presented by members of a cadre team. This training helps students build their self-esteem and self-confidence and affords them the opportunity to interact with positive role models.*

#### STATE AND LOCAL EFFORTS

The guiding principle behind state and local efforts is that the installation and the community have a common interest in providing the best possible support for each other. A cooperative relationship exists, because soldiers stationed at the installation receive life support from the community while many of the civilians who make up the community receive life



## DOMESTIC SUPPORT OPERATIONS

support from the installation. The interdependence of the military installation and the civilian community can involve economics, education, health care, basic services, quality-of-life issues, and many others.

The goal of local commanders should be to develop an open, mutually satisfactory, cooperative relationship between the installation and the community. Good state and local efforts improve the community's perception of the Army, the installation and the soldiers, family members, and civilians who are part of the installation.

Commanders should consider appointing a committee or small agency to act as a clearing house for community assistance requests. This committee might be headed by the garrison commander or Director of Plans, Training, and Mobilization (DPTM). It should include the public affairs officer, the staff judge advocate, the chaplain, and representatives from the Directorate of Resource Management (DRM), the Directorate of Installation Support (DIS), and the Directorate of Personnel and Community Activities (DPCA). Units that play a major role in the activity should be represented. Key community leaders should also be invited to serve on this committee. A diagram depicting a typical flow of community assistance requests through command channels and the assistance committee is at Figure 8-1.

Many community activities and efforts can be established in a more formalized manner. These efforts permit both the installation and local community to expand and enhance their services to their respective residence. Examples of these efforts are explained in the following paragraphs.

### Memoranda Of Agreement (MOA) or Memoranda Of Understanding

An installation or organization can enter into an agreement with the local community to provide critical services not available in the community, to augment community services unable to meet demand, or to ensure that emergency services are available in the shortest possible time. Examples include arrangements to provide air ambulance support, search and rescue, firefighting capability, explosive ordnance disposal, emergency or broad-based medical care, wildlife and domestic animal management, assistance in safety and traffic control, emergency snow removal, and temporary supplemental housing for the displaced or disadvantaged.

### Speakers Bureaus

Speakers are an especially effective means of developing understanding of the Army and stimulating patriotic spirit. They inform the public about the activities of the installation, its units, and its soldiers. Commanders should establish an installation speakers bureau and encourage soldiers of all ranks to participate in the program.

### Community Liaison

Maintaining liaison through informal community relations councils can enhance open communications with community officials and organizations. Councils have a variety of responsibilities, such as developing and promoting new ways for members of the command to participate actively in local community activities and resolving potential and actual areas of conflict. Community liaison can also recognize, with public service awards, private citizens, local community leaders, citizen groups, and organizations for their support of the Army. Commands can further community liaison through membership in civic, business, and professional organizations when the goals and objectives of those organizations are beneficial to the Army and their programs and projects are consistent with Army interests.

### Band, Color Guard, and other Ceremonial Unit Participation

Participating in public events and memorials is an excellent way to accomplish community relations objectives. These representatives of the Army serve as ambassadors to the civilian community and promote patriotism, interest in the Army, and awareness of our forces' professionalism.

*Elements of the 489th Engineer Battalion, 420th Engineer Brigade (USAR), helped a rural community near Little Rock, Arkansas, plan, develop, and build a local recreational area for the general public.*

**Exhibits**

Exhibits and displays of Army equipment, historical materials, models, devices, and other information can enhance understanding of the Army and the installation. They can also promote patriotism and educate the public. They provide an excellent opportunity for interaction between our soldiers and members of the local community, communicating the professionalism, readiness, and standards of our forces.

**Physical Improvements**

Community service physical improvements focus on ensuring that the physical infrastructure is as safe as possible and provides the fullest possible range of support to the population. These activities encompass a wide range of programs that do not compete with the services provided by contractors and businesses in the local civilian community. Examples include—

- Construction projects that enhance the recreational, educational, environmental, or cultural facilities of the community, such as building community picnic areas and hiking and biking trails.

- Demolition projects that enhance the safety and appearance of the community, such as the removal of unstable playground equipment.
- Projects that create or enhance a safe, clean environment, such as the removal of debris from a community wildlife area or painting a community recreation center.

**SOCIAL IMPROVEMENTS**

Community service social improvements, which focus on making the social environment as healthy as possible, provide the widest range of support to the population. They encompass myriad projects, including—

- Support to youth programs, such as scouting, and programs that provide assistance to special need audiences, such as special olympics.
- Involvement in ventures and projects that enhance the educational or cultural climate of the community, such as adult literacy, school reading, or community theater programs.

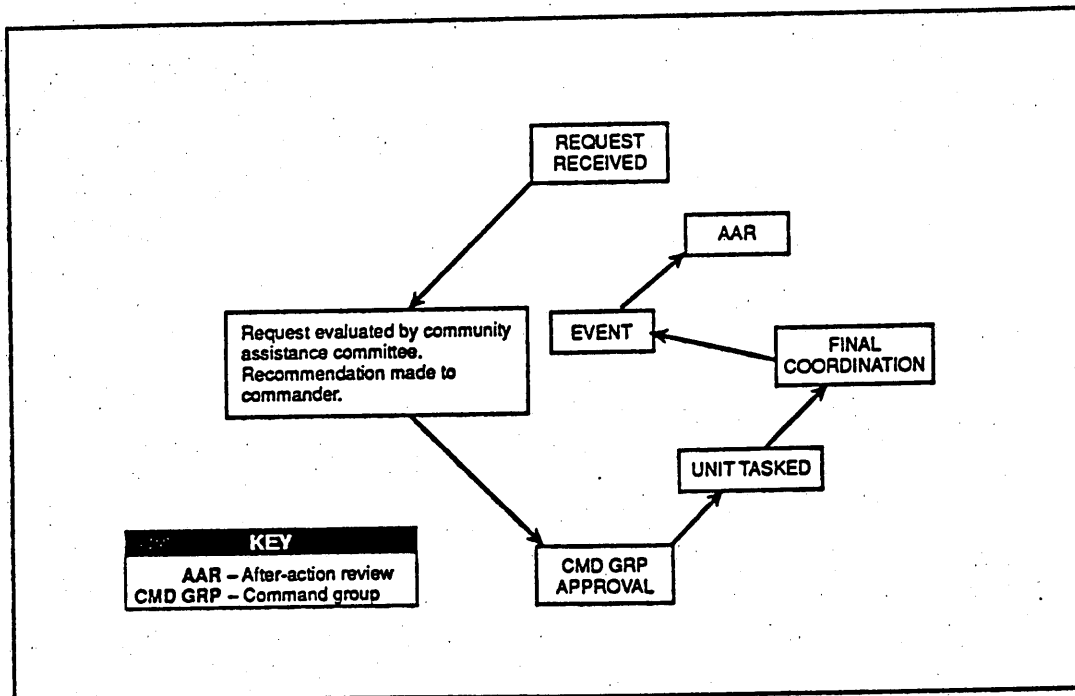

Figure 8-1. Community Assistance Request Flow

## DOMESTIC SUPPORT OPERATIONS

- Participation in special events, such as law enforcement or fire prevention awareness programs, which enhance the welfare of the community.

*The Fort Sill Public Affairs Office has worked with the local community college to establish an intern program for students in the communications and journalism programs. The students receive credit for work they do in the installation PAO office, providing the college with a valuable education asset and the students with an opportunity to get real-world experience in their academic fields.*

Commanders should consider the contributions that all organizations and personnel associated with their installation can make in community assistance activities. For example, Army Reserve Officers Training Corps (ROTC) cadets may be a valuable resource for participating in or supervising selected community assistance projects. ROTC cadets, particularly those in the final two years of training, can gain valuable leadership experience by participating in community activities. Communities will benefit from the dedication of intelligent, reliable, and energetic future Army leaders in their community efforts.

Another example of Army personnel that can contribute to community assistance activities is Army recruiters who are dispersed throughout the United States. These noncommissioned officers serve as positive role models and leaders who may be called on to assist in DOD-approved community activities as recruiting duties permit. Specific programs executed by Army recruiters include—

- The National Stay-in-School/Stay-Off-Drugs Program. Recruiters, supported by visual and print materials, serve as role models for youth at

risk of dropping out of school or using drugs. Recruiters assist school counselors and community leaders in fighting local drug problems through education and positive encouragement.

- The USAR Scholar-Athlete Program. With more than 13,000 high schools participating, the program honors the top male and female scholar and athlete selected by each school based on guidelines suggested by the Army.
- Planning for Life. This Army initiative, developed in concert with the Committee for Economic Development, recognizes excellent career planning at state and national levels. The Planning for Life award will be presented to the coalition of schools, business, labor, and communities that do an excellent job of preparing students for the work world.

## PUBLIC AFFAIRS CONSIDERATIONS

Almost all community assistance activities are conducted in public view. For this reason, PA officers are a valuable resource for commanders involved in community assistance activities. They can provide advice and assistance in determining the propriety, suitability, and appropriate level of support to be provided. They are experienced in working with civilian leaders and organizations and in planning and conducting programs involving the civilian community. They should be part of the commander's community assistance committee.

## LEGAL IMPLICATIONS

Army participation in community service activities is limited by law, regulation, and policy. Commanders must consider the objective and purpose of the proposed community assistance. They must consider the limitations under which Army participation in community assistance activities is authorized. They should ensure the SJA is an important element in the consideration and development of any community assistance programs.

### SUMMARY

Participation in community assistance activities is an effective method for projecting a positive Army image, making the best use of assets, providing alternative training opportunities, and enhancing the relationship between the Army and the American public. Activities vary widely, ranging from individual soldier involvement to full Army participation. They are characterized by detailed coordination between the military command and community authorities. They fulfill community needs that would not otherwise be met, enhance soldier and unit morale, skills, and readiness, and improve the mutual support between the military and civilian communities.

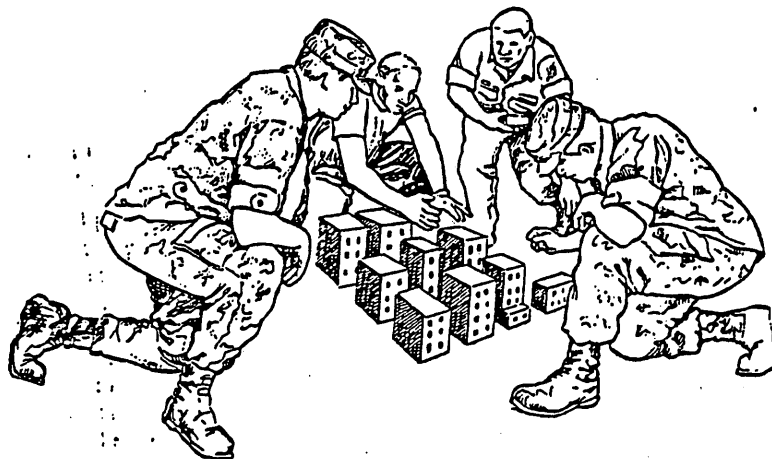

## CHAPTER 9

# EDUCATION AND TRAINING

*Training for war is the Army's top priority. With the exception of the training required in OPLAN GARDEN PLOT, the Army does not normally do specific training for domestic support missions until after a mission is assigned. Most domestic support missions can be accomplished by a disciplined force, proficient in its warfighting tasks, as described in its mission-essential task list (METL). However, in some cases unique training may be required to successfully complete an assigned domestic support mission. This chapter provides a guide to leaders on training for essentially non-METL-supported missions.*

### CONCEPT

**The basis of the Army's capability to provide domestic support is wartime mission training.**

Commanders should be familiar with the requirements and limitations peculiar to domestic support operations. They must ensure that leaders and

staffs are trained in the organization and processes of supporting civilian agencies. Units should be selected to perform specific domestic support missions consistent with known levels of training and military skills. The Army could be tasked to provide domestic support under a variety of missions and circumstances. The Army will seldom be tasked to provide such support independent of other services or civil agencies. All personnel require mission orientation and introduction to civil assistance techniques specific to the mission. Figure 9-1 provides insight into the factors that affect training for assigned domestic support missions.

Training required for domestic support is conducted within the tenets of current Army training doctrine.

Many tasks common to warfighting and domestic support exist at all levels. Senior commanders should make every effort to use domestic support missions as skill enhancers for subordinate units. They accomplish this by assigning domestic support missions to units whose combat skills and capabilities match the mission's requirements. Also, execution of domestic missions should mirror, as closely as possible, the execution of the same or similar tasks in combat. Such assignments will often favor selecting combat support and combat service support units. As an example, medical units may find little difference in the type of medical support required after a natural disaster from that required following a battlefield engagement. Commanders can exploit the relationship between METL and domestic missions to save time and training resources while maintaining combat readiness.

A unit's METL is the focus of the commander's training plan. While using unit METLs to focus training toward combat readiness, a number of factors, as seen in Figure 9-2, impact on readiness.

Commanders able to emphasize the positive aspects of these impacts when training for an assigned domestic support mission are able to improve readiness while supporting domestic needs. In many cases, specialized mission-oriented training will have to be accomplished prior to committing forces. The lead federal, state, or municipal agency may provide training information and requirements to Army forces. Training may be provided through cadre instructional programs or to entire units. The FEMA operates an Emergency Management Institute in Emmitsburg, Maryland. Courses that are of interest to Army planners include Integrated Emergency Management, Multihazard Planning, and Hazardous Material Spill

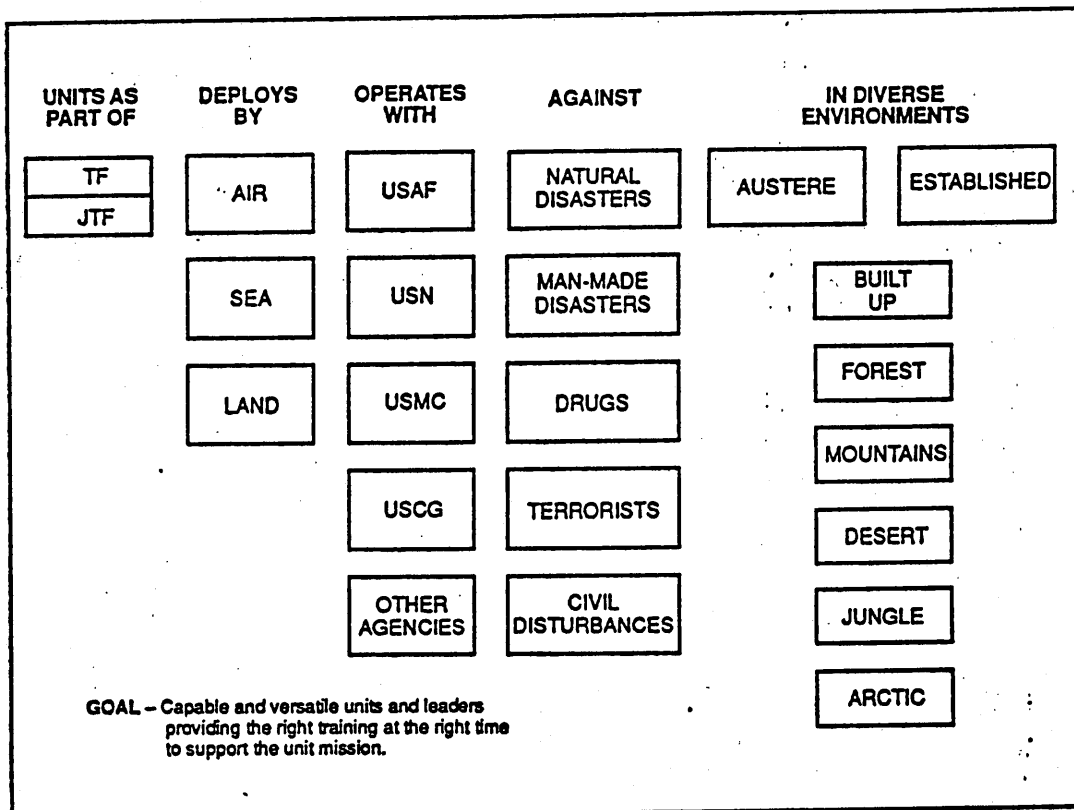

Figure 9-1. Dealing with a Variety of Missions in Domestic Support Operations

## DOMESTIC SUPPORT OPERATIONS

Response. The National Guard operates the National Interagency Counterdrug Institute in San Luis Obispo, California. It offers training to federal, state, and local agencies in counterdrug operations and techniques. An example of training provided to entire units is the three-day course in firefighting skills that the US Forest Service provides to units tasked to assist their efforts each summer. Interagency government training may be available in a variety of areas, such as counterdrug operations.

### TRAINING TECHNOLOGIES

Unit training is integrated into existing individual and collective events. Many conventional training exercises provide the opportunity to include interaction with federal, state, or municipal agencies. Exercises such as HURRICANE POLLY and RESPONSE 93

were developed and conducted to improve the coordination needed to respond to hurricanes and earthquakes. These exercises were developed by non-DOD agencies, but they can provide an opportunity to improve military capabilities for domestic support with minimal resources. These exercises emphasize interoperability requirements and stress staff coordination. A number of exercises are supported by Army organizations, such as the Louisiana Maneuvers Task Force.

The recent development of distributed simulation provides training technology that permits multiple organizations or agencies to participate in the same simulation exercise without having to be at the same location. It offers the potential for selected leaders to develop effective interagency communication and mutual understanding without having to be physically present at a specific exercise site.

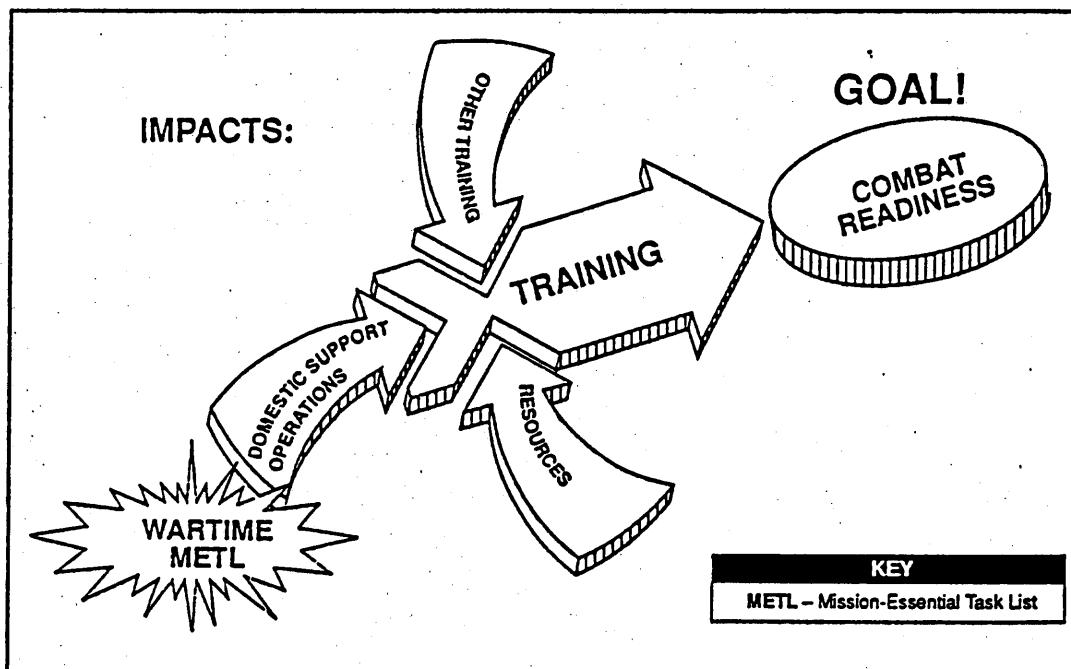

Figure 9-2. Impacts on Training Readiness

*The tiny Eskimo village on Diamede Island had not received any supplies for more than four months. Personnel from the 558th QM Company (Aerial Resupply), operating from the Alaskan General Depot, devised hasty rigging procedures. They rigged 25,000 pounds of food and fuel and air-dropped it to villagers in February 1956.*

### READINESS

Combat readiness is the primary focus of all military forces. Execution of domestic support missions should have minimal impact on unit readiness or mission essential task list proficiency, but it may adversely impact readiness of units given extended domestic support operations. Units committed to long-term domestic support may require significant resources, beyond that which the unit would normally be allocated, to regain warfighting standards after completion of their domestic support mission.

### RISK MANAGEMENT

Commanders realize that protecting soldiers and equipment is an implied aspect of any mission. Normal METL training will satisfy most protection requirements. Domestic support missions, however, could require the employment of personnel and equipment in roles other than those for which they were trained or designed. Consequently, leaders at all levels must make risk assessments. Commanders must ask four questions prior to and during any operation:

- Do my soldiers need specialized training for the mission?
- Will my soldiers be required to use their equipment in a manner other than that for which it was designed?
- Are my soldiers and their equipment operating under the conditions they had during training?

- Do my soldiers or their equipment endanger the civilians we are supporting?

Commanders and staffs must do everything possible to protect the force, regardless of the mission. In many cases it may be challenging to do so during some domestic support missions.

*Elements of the 391st Engineer Battalion, 120th US Army Reserve Command, assisted in the construction of a new training area for the County Sheriff's Department in Greenville, South Carolina.*

### PUBLIC AFFAIRS

Personnel in units conducting domestic support operations must become familiar with public affairs principles and procedures. Their activity will be of great interest to the news media. Commanders may capitalize on this interest by assisting the media in telling the Army story.

Commanders must be trained to accomplish their mission under the close scrutiny of the media. They will have to satisfy the media appetite for information. They will have to react rapidly to developing issues and changing perceptions while simultaneously fulfilling the information needs of their soldiers.

Public affairs training should be of a dual nature. PA staff elements must train themselves to identify the information expectations and requirements of internal and external audiences, evaluate the potential impact of information, develop information communication strategies, assess the effectiveness of information communication, and serve as the interface between the military and the media. They must also train commanders, staff, and soldiers to deal with the media. This includes providing information on First Amendment rights of the media to have access to and report news, soldier rights concerning media interviews, and OPSEC considerations.



**Assistance to local communities by Army units can provide training opportunities to soldiers of supporting units.**

### ENVIRONMENTAL ASSISTANCE

Environmental awareness instruction has been developed for inclusion in all leadership courses. The intent is to counter environmental apathy and integrate environmental awareness into operations and training. Training focuses on the four pillars of the Army Environmental Awareness Program, which are compliance, restoration, prevention, and conservation. This training will sensitize leaders to environmental considerations during domestic support operations. It will further enhance the image of the Army's stewardship of the environment.

Training soldiers and civilians to provide environmental assistance to domestic authorities generally requires no special efforts except the training needed to perform their Army jobs.

### DISASTER ASSISTANCE OPERATIONS

The Corps of Engineers has DOD-designated responsibilities for disaster assistance operations. It routinely conducts disaster response and recovery missions. Engineers, both military and Army civilian, must be educated and trained to accomplish unique responsibilities directed by the Federal Response Plan. All committed engineer units must be prepared to perform general engineering tasks necessary to establish temporary life-support facilities or to restore basic municipal services.

Commanders may encounter a variety of radiological and chemical hazardous materials (HAZMAT) during the conduct of domestic support operations.

Trained Chemical Corps HAZMAT specialists are available to advise commanders on the identification, avoidance, containment, and neutralization of these substances. Training can be provided by Chemical Corps personnel to emergency response personnel at the federal, state, or local level in several NBC areas. These areas include monitoring, surveying, detecting, identifying, and decontaminating chemical and nuclear hazards. Also, technical expertise is available to provide training to determine the type and extent of toxic contamination, to determine downwind contamination hazard, and to assess vulnerability.

Training for disaster assistance will primarily focus on light urban search and rescue. Selected units may achieve some degree of proficiency while conducting normal METL training. The urgency of response rarely affords commanders the ability to train after the alert notification is issued. Although CS and CSS units will routinely be expected to execute this mission, combat units could also be tasked. In all cases, unit METLs incorporate tasks which prepare personnel to perform this operation. For example, a supply company may have the METL task to receive, store, and distribute supplies. This same task could apply to disaster assistance operations, even though the supplies may be donated food and clothing and not military supplies. Figure 9-3 provides some additional examples of normal METL training that support disaster assistance.

The senior commanders involved must understand the DOD role in the Federal Response Plan. They then ensure subordinate leaders are familiarized with civil and municipal operations. For units to be quickly and smoothly deployed for domestic support they must know the specific rules for their employment. They must know the reporting channels, have a clear understanding of who is in charge, and know how the unit will receive necessary supplies. All leaders receive introductory contracting and ordering procedures training in professional development courses. However, they may require additional or refresher training in order to obtain supplies when operating outside the normal military logistics support arena. Some leaders may need to be trained as contracting and ordering officers.

Mass immigration emergency support is another form of humanitarian assistance. Again, routine

conduct of common skills training will prepare units to execute this operation. Any specialized training requirements will have to be identified by tasked commanders in conjunction with the Department of Justice and the Immigration and Naturalization Service.

### LAW ENFORCEMENT SUPPORT OPERATIONS

The three distinct missions grouped under law enforcement support are counterdrug, civil disturbance, and combatting terrorism. Many tasks on which units train to meet wartime mission requirements are directly applicable. In cases where requirements are unrelated to the wartime METL, commanders must employ mission focus to define new training needs. Civilian law enforcement agencies must understand that very specific laws govern the use of the military to support civilian law enforcement activities.

The National Guard conducts a great deal of training and maintains a viable force to support law enforcement in counterdrug, civil disturbance, combatting terrorism, and key asset protection. The National Guard Bureau provides funding to the states to develop key asset security plans and to train leaders in civil disturbance operations. Hurricane Andrew is an excellent example where the Florida National Guard was on the street within hours after passage, providing security support with trained personnel to law enforcement agencies.

Counterdrug missions present unique training opportunities. Units formulate plans to conduct training in high-intensity drug trafficking areas. If appropriate, units will be integrated into federal or state Drug Enforcement Agency operations.

*Elements of the 854th Engineer Battalion, 77th US Army Reserve Command, provided the manpower and equipment to clear and grade 20 acres for construction of a new softball and Little League fields in Hyde Park, New York.*

Commanders are responsible for civil disturbance operations training. As an exception to most domestic support operations, OPLAN GARDEN PLOT requires that Army units conduct civil disturbance training. Assigned missions and command guidance determine the frequency of training. Specific training for commanders and staffs should address legal and psychological considerations. Training for soldiers should address legal and psychological considerations, rules of engagement, search and seizure, use of special equipment, and crowd control techniques.

**Commanders are  
responsible for civil  
disturbance operations  
training.**

Combatting terrorism includes defensive measures against terrorist attack. All soldiers must train on the fundamentals necessary to defend installations, units, and individuals against terrorist attack. Combatting terrorism is a force protection measure and the responsibility of commanders at every level. Military police have the capability to conduct specialized training for combatting terrorism for both the Army and civil authorities. The use of explosives and booby traps is a common tool employed by terrorists. EOD personnel can provide training and planning assistance for combatting terrorism operations.

## DOMESTIC SUPPORT OPERATIONS

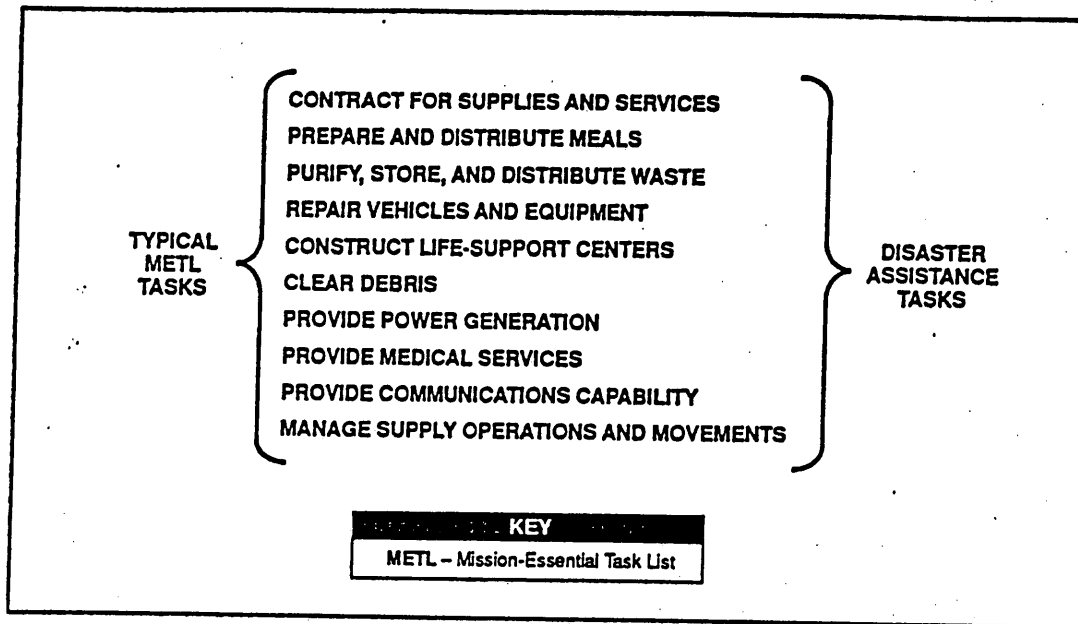

Figure 9-3. Disaster Assistance Supporting Tasks

### SUMMARY

Wartime mission training is the basis of the Army's capability to provide domestic support. Specialized training, when directed by the respective CINC or MACOM commander, will be conducted for selected operations. Leader training for domestic support operations is vital to provide unit responsiveness to the community without reducing proficiency in warfighting tasks.

## APPENDIX

# ANALYSIS OF THE AREA OF OPERATIONS FOR DISASTER ASSISTANCE

The analysis of the area of operations is a detailed study conducted within time constraints to serve as the basis for developing specific courses of action. It includes an analysis of weather, terrain, and other factors such as the political boundaries, governmental structures, economy, social groups, location, scope, and severity of damage throughout the commander's projected area of operations.

The civil-military operations (CMO) team is responsible for initiating, coordinating, completing and, disseminating the final analysis of the area of operations, which represents a coordinated staff effort with federal and state agencies. Considerations for area analysis may also apply to other types of operations. In any event, the assigned mission will dictate what essential elements of information (EEI) are needed.

### ESSENTIAL ELEMENTS OF INFORMATION

In most cases, the EEI about the area of operations can be readily determined by consulting several FORSCOM automated systems. One of these is the FORSCOM Automated Intelligence Support System (FAISS), a geographic information system that uses Defense Mapping Agency maps and a variety of data bases to locate and display many of the EEI. A second automated system available at FORSCOM is a DOD resource data base that contains information about military resources and points of contact that might be used or called upon to respond to domestic support operations. The FEMA also has automated systems, such as their Disaster Analysis System (an automated mapping program), which they make available to military commanders to facilitate analyses and mapping of the closest critical resources. Typical EEI are discussed briefly below.

In preparing the analysis of the area of operations, the information that the CMO team gathers to satisfy the commander's EEI normally includes:

- Location of victims needing rescue, evacuation, and emergency medical treatment and status of local emergency medical capabilities. Of particular importance are severe weather and terrain conditions that may significantly displace the population. Existing facilities or locations for temporary housing of displaced persons should be identified.
- Description and status of lines of communication (LOCs), including major roads, railroads, waterways, ports, and airports. Typically, the detailed status of airfields, ports and harbors, rail facilities, facilities for maintenance and storage, and electronic media and telephone towers is unknown during the first hours or day after the event. If possible, information on these infrastructure facilities within the impacted area should state the nature and extent of damage and projected repairs.
- Weather conditions. List or refer to other documents containing, for the period under study, meteorological conditions, including precipitation, fog, cloud conditions, temperature, relative humidity, light data (including moon phases, moonrise and moonset, beginning and end of nautical and civil twilights), magnetic phenomena, extended forecast, and other data as appropriate.
- Characteristics of physical damage in specific disaster areas, that is, housing, commercial, industrial, public utilities, and so forth. In

## DOMESTIC SUPPORT OPERATIONS

residential areas, damage assessment should start in high-density and low-income areas. Mobile homes are especially vulnerable and may contain a larger proportion of the elderly and children than other areas. High-rise apartment buildings and business offices are potential areas of risk in no-warning events (earthquakes and tornados), depending on the time of the occurrence.

- Numbers and locations of displaced persons. Economically distressed areas are characterized by higher residential density, lower maintenance, and older structures, which combine to increase the probability of victims. These areas are frequently adjacent to manufacturing or industrial areas containing potentially hazardous materials. Identifying fires, chemical spills, or ruptured pipelines near residential areas is a priority.
- Population of discrete areas such as trailer parks, apartments, and subdivisions. Residents of economically distressed areas are more likely to remain in the area and require a greater level of support after the event than those in more affluent areas. School buildings and warehouses in these areas are excellent candidates for shelter, feeding, and life-support sites. Generally, the more affluent population live in less densely populated areas with better construction. If not trapped, they have the economic resources to seek alternative living arrangements.
- General age distribution of population in above areas.
- General ethnic distribution of population in disaster areas; include types of linguists required.
- Areas without electricity.
- Areas without water, status of water purification systems, and availability of commercial purification equipment and products.
- Location and capabilities of medical facilities (hospitals, clinics, nursing homes, and so forth).
- Status of sanitation systems.
- Relief and drainage systems. Determine effects on trafficability for unit vehicles involved in rescue and relief efforts. Estimate time to improve drainage in flooded areas; include bridging requirements if applicable.

- Obstacles. Identify areas where debris impedes trafficability.
- Surface materials. Identify type and distribution of soils and subsoils in area and soil trafficability.
- Man-made features. Identify man-made changes in the topography, including roads, railroads, bridges, tunnels, mines, towns, industrial areas, and piers. Identify unsafe structures requiring demolition.
- Sources of all classes of supply needed for critical restoration activities.
- Local sources of media reproduction, especially high-speed, large-format printing.
- Availability of civilian engineer equipment and personnel.

The above EEI will be significantly modified after the first 72 hours and will be replaced by increasing demands for specific information on other aspects of the event. The management of information may become more difficult as the quantity and quality of information increase. As additional state and federal assets arrive in the area of operations, coordination and communication become more complicated.

New information requirements are generated by the need to deploy the resources efficiently and effectively. DOD planners and operators at this point should be integrated, if possible, with the FEMA's ESF-5, Information and Planning Operations, which focuses on establishing a centralized repository of data for executing relief operations.

### SOURCES OF INFORMATION

Sources of information that will satisfy many of the commander's EEI include:

- Information provided by federal, state, and local governments and commercial and private agencies.
- National and local media and their reports.
- Aerial reconnaissance.
- The engineer's terrain analysis.
- The staff weather officer's meteorological data.

- The provost marshal's analysis of route reconnaissance, state of law and order, and other information.
- Analysis prepared by other headquarters.
- Information on city, county, and state government; city, county, and state police; utility districts; fire, ambulance, and hospital districts; and federal/national agencies (USACE, Red Cross, and so forth). Intelligence personnel can be used for liaison as well as other intelligence support activities, but their use must be in accordance with governing directives.
- Maps. The US Geological Service and the Defense Mapping Agency are two sources for maps. DOD customers requiring USGS products may process requests through the DMA. Maritime and coastal maps may be obtained from the USCG as required. Local topography and maps can be provided by state land-use master plans, state pollution control, state water management, local public works departments, local water and sewer works, zoning boards, county recorder, local map printers, local tourism

departments, local geographic information systems, chambers of commerce, and university departments.

- Imagery Products. Imagery or imagery-derived products supporting domestic operations can be obtained from commercial or government sources. The USACE district offices can provide imagery products for floodplain areas. A request can also be forwarded through the chain of command to the Army Operations Center. Civilian aircraft imagery should be obtained wherever possible. If commercial capabilities are not available, aerial assets may be used.
- Demographics and business data for metropolitan areas. These are provided by the US Bureau of Census, the US HUD Community Block Grant Program, state agency or local housing authority, and commercial data base products.

The above list is not all-inclusive. As the operation progresses, changes in the mission or receipt of additional or more accurate information will require revision of the analysis and modification of the EEI.

## GLOSSARY

- AAA**  
Army Audit Agency
- AAR**  
after-action review
- AC**  
active component
- AC-IM**  
Assistant Chief of Staff-Installation Management
- AFR**  
Air Force regulation
- AD**  
Agency for International Development
- ANG**  
Air National Guard
- ANGR**  
Air National Guard regulation
- AO**  
area of operations
- AOC**  
Army operations center
- AOR**  
area of responsibility
- AP**  
assembly point
- APG**  
aviation procedure guide
- APHIS**  
Animal and Plant Health Inspection Service
- AR**  
Army regulation
- ARC**  
American Red Cross
- ARCS**  
alternative remedial contracting strategy
- Area of assistance**  
The geographical location for which a civil authority has requested some form of military assistance.
- Army**  
The term "Army" includes the active component, the Army National Guard, the US Army Reserves, and Department of Army civilians.
- Army support to civil law enforcement**  
The authorized use of Army assets to support civilian law enforcement officials and organizations.
- Army support for disaster assistance**  
The authorized use of Army physical and human resources to support civilian disaster relief.
- Army support for environmental assistance missions**  
The authorized use of Army assets to support civil authorities in the preservation and protection of human health and the environment.
- ARNG**  
Army National Guard
- ARSTAFF**  
Army Staff
- ASA**  
Assistant Secretary of the Army
- ASA (CW)**  
Assistant Secretary of the Army for Civil Works
- ASA (FM)**  
Assistant Secretary of the Army for Financial Management
- ASA (IL&E)**  
Assistant Secretary of the Army for Installation Logistics and Environment
- ASA (M&RA)**  
Assistant Secretary of the Army for Manpower and Reserve Affairs
- ASA (RD&A)**  
Assistant Secretary of the Army for Research, Development, and Acquisition
- ASD**  
Assistant Secretary of Defense
- ASL**  
authorized stockage list
- Assembly point**  
The designated location near a disaster-affected area where newly arriving personnel register, are oriented to the situation, and are assigned to a specific duty

station. Once established, the AP can be located at the POA or at the DFO.

**AT**  
annual training

**Attack**  
Sabotage or the use of bombs, shellfire, or nuclear, radiological, chemical, bacteriological, or biological means, or other weapons or processes by an enemy causing, or that may cause, substantial damage or injury to persons or property in the United States (or its territories) in any manner.

**B**

**Base camp**  
The designated location under local or state control within a disaster area that is equipped and staffed to provide sleeping facilities, food, water, and sanitary services for response personnel.

**BATF**  
Bureau of Alcohol, Tobacco, and Firearms

**BDAR**  
battle damage assessment and repair

**BIA**  
Bureau of Indian Affairs

**BLM**  
Bureau of Land Management

**BSI**  
base support installation

**C**

**C<sup>3</sup>I**  
command, control, communications and intelligence

**C<sup>4</sup>**  
command, control, communications, and computers

**CA**  
civil affairs

**CAI**  
chemical accident/incident

**CAIC**  
chemical accident or incident control

**CAIRA**  
chemical accident and incident response and assistance

**CARDA**  
Continental US airborne reconnaissance for damage assessment

**CCG**  
crisis coordination group

**CD**  
counterdrug

**CDE**  
counterdrug review and evaluation

**CDR**  
commander

**CENTCOM**  
Central Command

**CERCLA**  
*The Comprehensive Environmental Response, Compensation, and Liability Act*

**CFR**  
Code of Federal Regulation

**CINC**  
Commander-in-Chief

**CINCFOR**  
Commander-in-Chief, Forces Command

**CINCLANT**  
Commander-in-Chief, Atlantic Command

**CINCPAC**  
Commander-in-Chief, Pacific Command

**CINCSpace**  
Commander-in-Chief, Space Command

**CINTRANS**  
Commander-in-Chief, Transportation Command

**CIO**  
Central Imagery Office

**Civil authorities**  
Those elected and appointed officers and employees who constitute the government of the United States, of the 50 states, the District of Columbia, the Commonwealth of Puerto Rico, US possessions and territories, and political subdivisions thereof.

**Civil defense**  
All those activities and measures designed or undertaken to minimize the effects caused, or that would be caused, by an attack upon the United States or by a natural or technological disaster; to deal with the immediate emergency conditions that would be created; and to effect emergency repairs to, or the emergency restoration of, vital utilities and facilities destroyed or damaged by any such attack or disaster.

**Civil disturbances**  
Riots, acts of violence, insurrections, unlawful obstructions or assemblages, or other disorders prejudicial to public law and order. The term includes all domestic conditions requiring or likely to require the use of federal armed forces pursuant to the provisions of Chapter 15, Title 10, United States Code.



## DOMESTIC SUPPORT OPERATIONS

### **Civil emergency**

Any natural or man-made disaster or emergency that causes or could cause substantial harm to the population or infrastructure. This term can include a "major disaster" or "emergency" as those terms are defined in *The Stafford Act*, as amended, as well as consequences of an attack or a national security emergency. "Major disasters" and "emergencies" are defined substantially by action of the President in declaring that extent circumstances and risks justify his implementation of the legal powers provided by statute.

### **Civil emergency preparedness**

The nonmilitary actions taken by federal agencies, the private sector, and individual citizens to meet essential human needs, to support the military effort, to ensure continuity of federal authority at national and regional levels, and to ensure survival as a free and independent nation under all emergency conditions, including a national emergency caused by threatened or actual attack on the United States.

### **Civil government resources**

Civil resources owned by, controlled by, or under the jurisdiction of civilian agencies of the US Government, or of state and local government agencies.

### **Civilian law enforcement official**

An officer or employee of a civilian agency with responsibility for enforcing the laws within the jurisdiction of the agency. These may include the DEA, the FTA, the FBI, or state police.

### **Civil resources**

Resources that normally are not controlled by the government, including the work force, food and water, health resources, industrial production, housing and construction, telecommunications, energy, transportation, minerals, materials, supplies, and other essential resources and services. No one except authorized civil government authorities can order such resources to support the needs of the public.

### **CJCS**

Chairman of the Joint Chiefs of Staff

### **CMO**

civil-military operations

### **CMOC**

Civil-Military Operations Center

### **COCOM**

combatant command

### **Community assistance**

The authorized use of Army assets to provide support, enhance relations, and promote mutual understanding between the Army and the civilian community.

### **COMNAVMAR**

Commander, Naval Forces Marianas

### **Continental US airborne reconnaissance for damage assessment**

A system of aerial reconnaissance of the Continental United States for determining the effects of a nuclear attack. CARDA integrates the combined resources of all government agencies and military services for the National Command Authorities.

### **CONUS**

Continental United States

### **CONUSA**

Continental United States Army

### **COSCOM**

corps support command

### **CS**

combat support

### **CSA**

Chief of Staff, Army

### **CSH**

combat support hospital

### **CSS**

combat service support

### **CVS**

commercial vendor services

### **CW**

civil works

## D

### **DA**

Department of the Army

### **DACS-PAE**

Deputy Assistant Chief of Staff for Program Analysis and Evaluation

### **DARE**

drug abuse resistance education

### **DARNG**

Director, Army National Guard

### **DAS**

Director of the Army Staff

### **DASA**

Deputy Assistant Secretary of the Army

### **DASA (ESOH)**

Deputy Assistant Secretary of the Army for Environment, Safety, and Occupational Health

### **DASC**

Defense Logistics Agency Administration Support Center

**DASD**  
Deputy to the Assistant Secretary of Defense

**DCAS**  
Defense Contract Administration Service

**DCE**  
defense coordinating element

**DCINC**  
deputy commander-in-chief

**DCMC**  
Defense Contract Management Command

**DCO**  
defense coordinating officer

**DCS**  
Defense Communications System

**DCSINT**  
Deputy Chief of Staff for Intelligence

**DCSLOG**  
Deputy Chief of Staff for Logistics

**DCSOPS**  
Deputy Chief of Staff for Operations

**DCSPER**  
Deputy Chief of Staff for Personnel

**DEA**  
Drug Enforcement Administration

**Defense coordinating officer**  
A military or civilian official of any DOD component to whom the DOD executive agent has delegated authority to coordinate MSCA activities. Each DCO's authority will be defined in documentation issued or authorized by the DOD executive agent and will be limited either to the requirements of a specified interagency planning process or to a specified geographic area or emergency.

**Defense Emergency Response Fund**  
Established by Public Law No. 101-165 (1989), "The Fund shall be available for providing reimbursement to currently applicable appropriations of the Department of Defense for supplies and services provided in anticipation of requests from other federal departments and agencies and from state and local governments for assistance on a reimbursable basis to respond to natural or man-made disasters. The fund may be used upon determination by the Secretary of Defense that immediate action is necessary before a formal request for assistance on a reimbursement basis is received."

**DEP**  
Director of Environmental Programs

**DEUR**  
Defense Logistics Agency, Europe

**DFO**  
disaster field office

**DHHS**  
Department of Health and Human Services

**DHUD**  
Department of Housing and Urban Development

**DIS**  
Directorate of Installation Support

**Disaster Field Office**  
The primary field location in each affected state for the coordination of response and recovery operations. The DFO houses the FCO and staff comprising the ERT. It will operate 24 hours a day, as needed, or with a schedule sufficient to sustain federal response operations. Except where facilities do not permit, the FCO will be collocated at the DFO with the state coordinating officer.

**DISCOM**  
division support command

**DLA**  
Defense Logistics Agency

**DLEA**  
drug law enforcement agency

**DMA**  
Defense Mapping Agency

**DMAT**  
disaster medical assistance team

**DMC**  
defense movement coordinator

**DOC**  
Department of Commerce

**DOD**  
Department of Defense

**DODD**  
Department of Defense directive

**DOD executive agent**  
The individual designated by position to have and to exercise the assigned responsibility and delegated authority of the Secretary of Defense.

**DOD planning agent**  
An individual designated by position to facilitate and coordinate civil assistance contingency planning and operations when ordered for all DOD components within an assigned geographic area.

**DODRDB**  
Department of Defense resource data base

**DOD resources**  
Military and civilian personnel, including selected and ready reservists of the military services,

## DOMESTIC SUPPORT OPERATIONS

and facilities, equipment, supplies, and services owned by, controlled by, or under the jurisdiction of a DOD component.

### DOE

Department of Energy

### DOEd

Department of Education

### DOI

Department of Interior

### DOJ

Department of Justice

### DOL

Department of Labor

### Domestic support operations

The authorized use of Army physical and human resources to support domestic requirements.

### DOMS

Director of Military Support (US Army)

### DOS

Department of State

### DOT

Department of Transportation

### DPAC

Defense Logistics Agency, Pacific

### DPCA

Directorate of Personnel and Community Activities

### DPS

Department of Public Safety

### DPTM

Director of Plans, Training, and Mobilization

### DRM

Directorate of Resource Management

### DS

direct support

### DSMOA/CA

defense and state memorandum of agreement/cooperative agreement

### DWI

disaster welfare information

## E

### EEl

essential elements of information

### EEO

Equal Employment Opportunity

### Emergency Support Function (ESF)

A functional area-of-response activity established to facilitate the delivery of federal assistance during the immediate response phase of a disaster to save lives, to protect property and public health, and to maintain public safety.

### EOC

Emergency Operations Center

### EOD

explosive ordnance disposal

### EPA

Environmental Protection Agency

### EPIC

El Paso Intelligence Center

### EPLO

emergency preparedness liaison officer

### ERT

emergency support team

### ESF

emergency support function

### ESF 1 Transportation

This ESF coordinates federal transportation support to state and local government entities, voluntary organizations, and federal agencies requiring transportation to perform disaster assistance missions following a catastrophic earthquake, significant natural disaster, or other event requiring federal response.

### ESF 2 Communications

This ESF assures the provision of federal telecommunications support to federal, state, and local response efforts following a Presidentially declared emergency, major disaster, extraordinary situation, and other emergencies under the Federal Response Plan.

### ESF 3 Public Works and Engineering

Public works and engineering support includes technical advice and evaluations, engineering services, potable water, construction management and inspection, emergency contracting, emergency repair of wastewater and solid waste facilities, and real estate support as required.

### ESF 4 Firefighting

The purpose of this ESF is to detect and suppress wildland, rural, and urban fires resulting from, or occurring coincidentally with, a catastrophic earthquake, significant natural disaster, or other event requiring federal response assistance.

### ESF 5 Information and Planning

The purpose of this ESF is to collect, process, and disseminate information about a potential or actual disaster or emergency to facilitate the overall activities

of the federal government in providing response assistance to an affected state.

**ESF 6 Mass Care**

This ESF coordinates efforts to provide shelter, food, and emergency first aid following a catastrophic earthquake, significant natural disaster, or other event requiring federal assistance; to operate a DWI System to collect, receive, and report information about the status of victims and to assist with family reunification within the disaster area; and to coordinate bulk distribution of emergency relief supplies to disaster victims following a disaster.

**ESF 7 Resource Support**

This ESF provides logistical/resource support following a catastrophic earthquake, other significant natural disaster, or other event requiring federal response, including emergency relief supplies, space, office equipment, office supplies, telecommunications, contracting services, transportation services (in coordination with ESF 1), and personnel required to support immediate response activities.

**ESF 8 Health and Medical Services**

This ESF provides government-coordinated assistance to supplement state and local resources in response to public health and medical care needs following a significant natural disaster or man-made event.

**ESF 9 Urban Search and Rescue**

The US&R activities include locating, extricating, and providing for the immediate medical treatment of victims trapped in collapsed structures.

**ESF 10 Hazardous Materials**

This ESF provides federal support to state and local governments in response to an actual or potential discharge and/or release of hazardous materials following an earthquake or other disaster.

**ESF 11 Food**

This ESF identifies, secures, and arranges for the transportation of food to affected areas following a major disaster or emergency or other event requiring federal response.

**ESF 12 Energy**

This ESF facilitates restoration of the nation's energy systems following a catastrophic earthquake, natural disaster, or other significant event requiring federal assistance.

**EUCOM**

European Command

**EXORD**

Execution Order

**Explosive Ordnance Disposal**

Detecting, identifying, evaluating, rendering safe, recovering, and finally disposing of unexploded explosive ordnance.

**F**

**FAA**

Federal Aviation Administration

**FAISS**

FORSCOM Automated Intelligence Support System

**FBI**

Federal Bureau of Investigation

**FCC**

Federal Communications Commission

**FCO**

federal coordinating officer

**FED**

federal

**Federal coordinating officer**

The FCO is the senior federal official appointed to coordinate overall response and recovery activities. The FCO represents the President in coordinating the federal relief activities in a designated area.

**Federal function**

Any function, operation, or action carried out under the laws of the United States by a department, agency, officer, or employee of the United States.

**Federal property**

Property that is owned, leased, possessed, or occupied by the federal government.

**Federal region**

A grouping of states and territories by which FEMA coordinates responsibilities of the state governments with those of federal departments and agencies for disaster relief, civil defense, and planning for both civil and national security emergencies. These regions are sometimes referred to as "FEMA regions" to distinguish them from any one of the various alignments of other federal departments and agencies, all of which are circumscribed by FEMA's coordination authority.

**Federal Response Plan (FRP)**

The interdepartmental planning mechanism, developed under FEMA leadership, by which the federal government prepares for and responds to the consequences of catastrophic disasters. Federal planning and response are coordinated on a functional group basis, with designated lead and support agencies for each identified functional area.

**FEMA**

Federal Emergency Management Agency

## DOMESTIC SUPPORT OPERATIONS

### FESC

federal emergency support coordinator

### FM

field manual

### FOA

field operating agency

### Force protection

Security program developed to protect soldiers, civilian employees and family members, facilities and equipment, in all locations and situations. This is accomplished through the planned integration of terrorism, physical security, OPSEC, protective services, and law enforcement operations, supported by foreign intelligence, counterintelligence, and other security programs.

### Force provider

A transportable support system, operated by a company-size unit, equipped to provide services (food, hygiene, billeting, morale support) for up to 3300 soldiers.

### FORSCOM

Forces Command

### FRERP

Federal Radiological Emergency Response Plan

### FRP

Federal Response Plan

### FSC

field supply company

### FST

finance support teams

## G

### GAO

General Accounting Office

### GARDEN PLOT

DOD and subordinate headquarters OPLAN addressing civil disturbance operations.

### GEO

geographic

### GIS

Geographic Information System

### GRASS

Geographic Resource Analysis Support System

### GSA

General Services Administration

## H

### Hazard

A condition with the potential of injuring personnel, damaging equipment or structures, losing material, or reducing ability to perform a prescribed function.

### HAZMAT

hazardous materials

### HHS

health and human services

### HIDTA

high-intensity drug trafficking area

### High-tech improvised explosive device

An item with an explosive or special filler designed to cause extensive death or destruction. It may be complex or sophisticated in design, including many intricate arming or firing systems, including booby traps.

### HQ

headquarters

### HQDA

Headquarters, Department of the Army

### HRMSI

high-resolution multispectral stereo imager

### HSC

Health Services Command

### HSS

health services support

### HUD

Housing and Urban Development

## I

### ICC

Interstate Commerce Commission

### ICP

inventory control point

### ICS

Incident Command System

### IED

improvised explosive device

### IG

Inspector General

### IL&E

Installation logistics and environment

### IMA

information mission area

### Immediate response

Any form of immediate action taken by a DOD component or military commander under the authority

of the FRP and any supplemental guidance to assist in saving lives, preventing human suffering, or mitigating great property damage under imminently serious conditions where there has not been an attack or any declaration of major disaster or emergency by the President.

**Imminently serious conditions**

Emergency conditions in which, in the judgment of the military commander or responsible DOD official, immediate and possibly serious danger threatens the public and prompt action is needed to save lives, prevent human suffering, or mitigate great property damage. Under these conditions, timely prior approval from higher headquarters may not be possible before action is necessary for effective response.

**Improvised explosive device**

A nonstandard item, usually crude and simple in design, containing an arming or timing system, an initiator, and an explosive filler. A homemade bomb.

**INS**

Immigration and Naturalization Service

**Insurrection.**

The act of unlawfully rising in open resistance against established authority or government or against the execution of the laws of government.

**IPB**

intelligence preparation of the battlefield

**IRF**

initial response force

**IRMMP**

interregional military medical plans

**IRP**

installation restoration program

**IRR**

individual ready reserve

**IRS**

Internal Revenue Service

**ITO**

installation transportation office

**J**

**JCS**

Joint Chiefs of Staff

**JIC**

Joint Information Center

**JLSC**

Joint Logistics System Center

**JMC**

joint movement center

**Joint movement center**

A jointly staffed movement control organization attached to a joint force headquarters to plan, apportion, allocate, and coordinate transportation support for the joint force; deconflict priorities; and provide intransit visibility of movements.

**Joint transportation office**

An office established under a JMC to procure commercial transportation, issue documentation, manage commercial funding, and provide quality assurance.

**JP**

joint publication

**JRS**

joint reporting structure

**JTF**

joint task force

**JTO**

joint transportation office

**JTTP**

joint tactics, techniques, and procedures

**K**

**KAPP**

Key Asset Protection Program

**L**

**LA**

lead agency

**LANDSAT US System**

Formal designation for the Multispectral Imagery System. LANDSAT-7 will include the thematic mapping plus (TM+) and the HRMSI.

**LANTCOM**

United States Atlantic Command

**Law enforcement agency—drug related**

Those federal, state, or local agencies empowered to enforce civil laws and engage in official activities against the illegal production, transport, sale, or use of illegal drugs.

**LEA**

law enforcement agency

**LOC**

lines of communication

**Local government**

Any county, city, village, town, district, or other political subdivision of any state.

**LSO**

logistics support officer

## DOMESTIC SUPPORT OPERATIONS

### M

**MACOM**  
major command

**Major disaster**  
Any disaster caused by flood, drought, fire, earthquake, storm, hurricane, or environmental hazard of catastrophic magnitude that has major impact on life and property.

**Marshaling area**  
An area used for the mobilization and assemblage of personnel and resources prior to their being sent to the disaster-affected area.

**MASH**  
mobile army surgical hospital

**MAST**  
military assistance to safety and traffic

**MC**  
mobilization center

**MDIO**  
Missile Defense Initiative Organization

**MEDDAC**  
medical department activity

**METL**  
mission-essential task list

**METT-T**  
mission, enemy, troops, terrain, and time available

**MI**  
military intelligence

**Military resources**  
Military and civilian personnel, facilities, equipment, and supplies under the control of a DOD component.

**Military support to civil authorities**  
Those activities and measures taken by the DOD components to foster mutual assistance and support between the Department of Defense and any civil government agency in planning or preparing for, or in the application of resources in response to the consequences of civil emergencies or attacks, including national security emergencies.

**MLO**  
military liaison officer

**MMC**  
Materiel Management Center

**MOA**  
memorandum of agreement

**Mobilization center**  
The designated location at which response personnel and resources are received from the POA and pre-positioned for deployment to a local staging area or

an incident site. An MC also provides temporary support services, such as food and billeting, for response personnel prior to their deployment.

**MOU**  
memorandum of understanding

**M&RA**  
manpower and reserve affairs

**MRE**  
meals, ready-to-eat

**MSCA**  
military support to civil authorities

**MTT**  
mobile training team

**MWR**  
morale, welfare, and recreation

### N

**NAI**  
nuclear accident/incident

**NAIC**  
nuclear accident or incident control

**NAIRA**  
nuclear accident or incident response and assistance

**NASA**  
National Aeronautical and Space Administration

**National Disaster Medical System.**  
An interdepartmental mutual aid system developed by federal departments and agencies to provide for the medical needs of victims of major disasters and to provide backup support for DOD and VA medical systems in caring for casualties from military conflicts. The DHHS serves as the lead federal agency for administering NDMS and coordinates NDMS operations in response to civil emergencies. The DOD could activate and coordinate NDMS operations in support of military contingencies.

**National security emergency**  
Any occurrence, including natural disaster, military attack, technological emergency, or other emergency, that seriously degrades or threatens the national security of the United States.

**NBC**  
nuclear, biological, and chemical

**NCA**  
National Command Authorities

**NCP**  
National Contingency Plan

**NCS**  
National Communications System

**NDMS**  
National Disaster Medical System

**NG**  
National Guard

**NGB**  
National Guard Bureau

**NGR**  
National Guard regulation

**NIFC**  
National Interagency Fire Center

**NORAD**  
North American Aerospace Defense Command

**NPDES**  
National Pollutant Discharge Elimination System

**NPS**  
National Park Service

**NRC**  
Nuclear Regulatory Commission

**NSA**  
National Security Agency

**NSEP**  
national security emergency preparedness

**NWS**  
National Weather Service

O

**OCONUS**  
outside the Continental United States

**ODCSOPS**  
Office of the Deputy Chief of Staff for Operations

**OES**  
Office of Emergency Services

**ONDCP**  
Office of National Drug Control Policy

**OP ALLIANCE**  
Operation Alliance

**OPCON**  
operational control

**OPLAN**  
operation plan

**OPLAN GARDEN PLOT**  
DOD and subordinate headquarters' OPLANs  
addressing civil disturbance operations

**OPM**  
Office of Personnel Management

**OPORD**  
operation order

**OPS**  
operations

**OPSEC**  
operations security

**ORG**  
organization

**ORNG**  
Oregon National Guard

**OSC**  
on-scene coordinator

P

**PA**  
public affairs

**PACOM**  
United States Pacific Command

**PAO**  
public affairs officer

**PCB**  
polychlorinated biphenyl

**PHS**  
public health service

**PL**  
public law

**Planning agent**

A military or civilian official of any DOD component, who has been designated by the head of that component to exercise delegated authority for civil assistance planning for the entire component (i.e., "principal planning agent") or for certain subordinate elements or a specified geographic area (e.g., "regional planning agents"). Authority and responsibilities of each planning agent will be defined by the component and may include civil assistance response as well as planning at the election of any component. Planning agents' actual authority will be communicated to others as determined by the DOD component, or when requested by the DOD executive agent.

**PLL**  
prescribed load lists

**POA**  
point of arrival

**POC**  
point of contact

**Point of arrival**

The designated location (typically an airport) within or near the disaster-affected area where newly arriving



## DOMESTIC SUPPORT OPERATIONS

staff, supplies, and equipment are initially directed. Upon arrival, personnel and other resources are dispatched to either the DFO, a mobilization center, a staging area, or a disaster site.

### Point of departure

The designated location (typically an airport) outside of the disaster-affected area from which response personnel and resources will deploy to the disaster area.

### POMSO

Plans, Operations, and Military Support Officer

### POTO

plans, operations, and training officer

### Primary agency

The federal department or agency assigned primary responsibility for managing and coordinating a specific ESF.

### PROFIS

Professional Officer Filler System

### PSYOP

psychological operations

## Q

### QM

quartermaster

## R

### RC

reserve component

### RCRA

*The Resource Conservation And Recovery Act*

### RDA

research development and acquisition

### RADEO

Regional Emergency Animal Disease Eradication Organization

### RECA

residual capability assessment

### Regional military emergency coordinator

An individual designated on behalf of the Secretary of Defense and the DOD executive agent to coordinate, exchange, information, and perform liaison functions on behalf of the DOD with any federal emergency management structure established at the regional level.

### Regional Operations Center (ROC)

The facility established at a FEMA regional office (or a federal regional center) in response to (or in

anticipation of) an event that may require federal assistance under the FRP. The ROC is staffed by FEMA regional personnel and representatives from the ESF primary agencies as required. It serves as an initial point of contact in the region for the affected state(s), the national emergency support team, and federal agencies.

### Residual capability assessment

An assessment of the effects of a nuclear or conventional attack on US resources or of a major peacetime disaster that results in the declaration of a national security emergency. Such an assessment is made (through all appropriate means) to determine the remaining capabilities of the United States, with emphasis on military preparedness.

### Resource claimancy

The procedure, employed during any period of attack or national security emergency, whereby authorized federal agencies determine definitive requirements and justify the allocation of civil government and civil resources needed to support programs under their cognizance. It does not imply procurement activity, nor does it involve the government as an intermediary in the normal mechanisms of trade other than in expediting essential activities and ensuring equitable distribution of civil resources. Resource claimancy occurs at both the national and regional levels.

### Risk

An expression of possible loss over a specific period of time or number of operating cycles.

### Risk assessment

The process of detecting hazards and systematically assessing their overall risk. It is a part of the risk management process.

### Risk management

The process whereby decisions are made and actions implemented to eliminate or reduce the effects of identified hazards.

### RLSO

regional logistics support office

### RMEC

regional military emergency coordinator

### ROC

regional operations center

### ROE

rules of engagement

### ROTC

Reserve Officers Training Corps

**S**

**SA**  
Secretary of the Army

**SAC**  
senior agent in charge

**SCE**  
support contracting element

**SCO**  
state coordinating officer

**SCRAG**  
senior representative of the Attorney General

**SECDEF**  
Secretary of Defense

**SECY**  
secretary

**SF**  
special forces

**SJA**  
Staff Judge Advocate

**SOCOM**  
Special Operations Command

**SOF**  
special operations forces

**SOUTHCOM**  
United States Southern Command

**SPACECOM**  
Space Command

**SRF**  
service response force

**Staging area**  
The facility at the local jurisdictional level near the disaster site where personnel and equipment are assembled for immediate deployment to an operational site within the disaster area.

**STAMIS**  
Standard Automated Management Information System

**STARBASE**  
Science and technology academies reinforcing basic aviation and space exploration

**STARC**  
state area command

**State**  
Any state of the United States, the District of Columbia, Puerto Rico, the Virgin Islands, Guam, American Samoa, Northern Mariana Islands, and the Trust Territory of the Pacific Islands.

**State area commands**

Specific headquarters units of the Army National Guard for each state, the District of Columbia, Guam, Puerto Rico, and the Virgin Islands.

**STRATCOM**  
Strategic Command

**Support agency**  
A federal department or agency designated to assist a specific primary agency with available resources, capabilities, or expertise in support of ESF response operations under the coordination of the primary agency.

**T**

**TAG**  
The state adjutant general; the adjutant general

**TC**  
training circular

**Technological hazard**  
A range of hazards emanating from the manufacture, transportation, and use of such substances as radioactive materials, chemicals, explosives, flammables, agricultural pesticides, herbicides, and disease agents; oil spills on land, coastal waters, or inland water systems; and debris from space.

**Terrorism.**  
The calculated use of violence or the threat of violence to attain goals that are political, religious, or ideological in nature. This can be done through intimidation, coercion, or instilling fear. Terrorism includes a criminal act against persons or property that is intended to influence an audience beyond the immediate victims.

**TEU**  
technical escort unit

**TF**  
task force

**TM +**  
thematic mapping plus

**TREAS**  
Department of the Treasury

**TVA**  
Tennessee Valley Authority

**U**

**UAV**  
unmanned aerial vehicles

**UMT**  
unit ministry team

## DOMESTIC SUPPORT OPERATIONS

- Unit ministry team**  
A team consisting of a chaplain and a chaplain's assistant with the mission of providing religious support.
- USA**  
United States Army
- USACE**  
United States Army Corps of Engineers
- USAEC**  
United States Army Environmental Center
- USAEHA**  
United States Army Environmental Hygiene Agency
- USAEHSC**  
United States Army Engineering and Housing Support Center
- USAF**  
United States Air Force
- USAG**  
United States Attorney General
- USAHSC**  
United States Army Health Services Command
- USAMC**  
United States Army Materiel Command
- USAR**  
United States Army Reserve
- USARPAC**  
United States Army, Pacific
- USC**  
United States Code
- USCG**  
United States Coast Guard
- USCS**  
United States Customs Service
- USDA**  
United States Department of Agriculture
- USFS**  
United States Forest Service
- USGS**  
United States Geological Service
- USMC**  
United States Marine Corps
- USMS**  
United States Marshall Service
- USN**  
United States Navy
- USPFO**  
United States property and fiscal officers
- USPS**  
United States Postal Service
- US&R**  
urban search and rescue
- USSOUTHCOM**  
United States Southern Command
- USSS**  
United States Secret Service
- USTRANSCOM**  
United States Transportation Command
- UXO**  
unexploded ordnance
- V
- VA**  
Department of Veterans Affairs
- VCSA**  
Vice Chief of Staff, Army
- VSO**  
veterinary support officer

## REFERENCES

---

### STATUTES

- 10 USC, § 101, 102, 401, 672, 673, 2300 *et seq.* Mobilization/Contracting Statutes
- 10 USC, § 331-35. *Insurrection.*
- 10 USC, § 371-80. *Military Support for Civilian Law Enforcement Agencies.*
- 10 USC, § 410. *Civil Military Cooperative Action Program.*
- 14 USC, § 1-894. *US Coast Guard.*
- 18 USC, § 592. *Outlaws federal troops at polling places.*
- 18 USC, § 1385. *The Posse Comitatus Act.*
- 28 USC, § 2671, *et seq.* *The Federal Tort Claims Act.*
- 31 USC, § 1301. *Purpose Statute.*
- 31 USC, § 1535. *The Economy Act.*
- 32 USC, § 112. *Authority to Use Army and Air National Guard in Certain Counterdrug Operations.*
- 32 USC, § 502, 3500. *Mobilization Statutes (Army and Air National Guard).*
- 33 USC, § 701n, *et seq.* *The Flood Control Act of 1941.*
- 42 USC, § 5121, *et seq.*, as amended. *The Robert T. Stafford Disaster Relief Act.*
- 49 USC, § 1200, *et seq.*, as amended. *The Federal Aviation Act.*
- 50 USC, § 797. *The Internal Security Act.*
- 50 USC, § Appendix 2251, *et seq.*, as amended. *The Federal Civil Defense Act of 1950.*

### EXECUTIVE ORDERS

- Executive Order 12556. *Assignment of Emergency Preparedness Responsibilities.*
- Executive Order 12333. *US Intelligence Activities.*

### FEDERAL PUBLICATIONS

- 5 CFR, Part 2635. *Standards of Ethical Conduct for Employees of the Executive Branch.*
- 44 CFR, Part 206. *Federal Emergency Management Agency Regulations.*
- The Federal Acquisition Regulation.*
- The Federal Response Plan. April 1992.*

References-1

## DOMESTIC SUPPORT OPERATIONS

---

*National Military Strategy. 1992.*

*National Security Strategy of the United States. January 1993.*

### DOD PUBLICATIONS

DODD 1225.6. *Equipping the Reserve Forces. November 1992.*

DODD 2000.12. *DOD Combatting Terrorism Program. April 1983.*

DODD 3020.36. *Assignment of National Security Emergency Preparedness Responsibilities to DOD Components. November 1988.*

DODD 3025.1. *Military Support to Civil Authority. January 1993.*

DODD 3025.10. *Military Support of Civil Defense. July 1991.*

DODD 3025.12. *Employment of Military Resources in Event of Civil Disturbances. August 1971.*

DODD 3025.13. *Employment of DOD Resources in Support of the US Secret Service. September 1985.*

DODD 3150.5. *DOD Response to Improvised Nuclear Device (IND) Incidents. March 1987.*

DODD 5030.41. *Oil and Hazardous Substances Pollution Prevention and Contingency Program. June 1977.*

DODD 5100.1. *Functions of DOD and its Major Components. September 1977.*

DODD 5100.52. *DOD Response to an Accident or Significant Incident Involving Radioactive Materials. March 1981.*

DODD 5122.8. *Use of Military Carriers for PAO. December 1963.*

DODD 5160.54. *DOD Key Assets Protection Program. June 1989.*

DODD 5200.8. *Security of Military Installations and Resources. April 1991.*

DODD 5210.56. *Use of Deadly Force and the Carrying of Firearms by DOD Personnel Engaged in Law Enforcement and Security Duties. February 1992.*

DODD 5240.1. *DOD Intelligence Activities. April 1988.*

DODD 5240.1R. *Procedures Governing Activities of DOD Intelligence Components that Affect United States Persons. December 1982.*

DOD 5500.7-R. *DOD Ethics Program Regulation. May 1987.*

DODD 5525.5. *DOD Cooperation With Civilian Law Enforcement Officials. January 1986.*

DODD 6055.13. *Transportation Accident Prevention and Emergency Response Involving Conventional DOD Munitions and Explosives. May 1988.*

DODR 4500.43-R. *Operation Support Airlift Regulation. October 1985.*

DODR 4515.13-R. *Air Transportation Eligibility Regulation. January 1980.*

DOD Civil Disturbance Plan. *GARDEN PLOT.*

#### JOINT PUBLICATIONS

- JP 1-03. *Joint Reporting Structure*. November 1983.
- JP 1-03.6. *JRS, Event/Incident Reports*. April 1981.
- JP 1-03.8. *JRS, Situation Monitoring*. February 1988.
- JP 1-03.17. *JRS, Personnel*. (In development).
- JP 1-03.18. *JRS, Logistics*. March 1990.
- JP 1-03.25. *JRS, Aerial Ports and Air Operations Bases*. (In revision).
- JP 1-03.26. *JRS, Port Characteristics Report*. (In revision).
- JP 3-0. *Doctrine for Joint Operations*. (In development).
- JP 3-00.1. *Joint Doctrine for Contingency Operations*. (In development).
- JP 3-07. *Joint Operations Other Than War*. (In development).
- JP 3-07.2. *Joint Tactics, Techniques, and Procedures for Antiterrorism*. (In development).
- JP 3-07.3. *Joint Tactics, Techniques, and Procedures for Peacekeeping Operations*. (In development).
- JP 3-07.4. *Joint Doctrine and Joint Tactics, Techniques, and Procedures for Counter-Drug Operations*. (In development).
- JP 3-50.1. *National Search and Rescue Manual*. February 1991.
- JP 3-53. *Doctrine for Joint Psychological Operations*. (In revision).
- JP 3-57. *Doctrine for Joint Civil Affairs*. (In development).
- JP 4-01.3. *Joint Tactics, Techniques, and Procedures for Movement Control*. (In development).
- JP 4-02. *Doctrine for Health Service Support in Joint Operations*. (In development).
- JP 4-05. *Mobilization*. (In revision).
- JP 4-06. *Joint Tactics, Techniques, and Procedures for Mortuary Affairs in Joint Operations*. (In development).
- JP 5-00.2. *Joint Task Force Planning Guidance and Procedures*. September 1991.

#### ARMY PUBLICATIONS

##### Army Regulations

- AR 1-4. *Employment of DA Resources in Support of the US Secret Service*. October 1979.
- AR 11-2. *Internal Control Systems*. September 1990.
- AR 15-1. *Committee Management*. June 1978.
- AR 15-13. *Subsistence Review Committee*. December 1975.
- AR 30-1. *The Army Food Service Program*. January 1985.
- AR 30-5. *Food Cost and Feeding Strength Summary*. November 1985.
- AR 30-7. *Operational Rations, Health and Comfort Items*. March 1979.

## DOMESTIC SUPPORT OPERATIONS

---

- AR 30-16. *Food Service Data Feedback Program*. April 1988.
- AR 30-18. *Army Troop Issue Subsistence Activity Operating Procedures*. September 1984.
- AR 30-21. *The Army Field Feeding System*. September 1990.
- AR 37-1. *Army Accounting and Fund Control*. April 1991.
- AR 40-3. *Medical, Dental, and Veterinary Care*. February 1985.
- AR 40-5. *Preventive Medicine*. June 1985.
- AR 40-61. *Medical Logistics Policies and Procedures*. October 1988.
- AR 71-13. *DA Equipment Authorization and Usage Program*. January 1988.
- AR 75-15. *Responsibilities and Procedures for Explosive Ordnance Disposal*. November 1978.
- AR 95-1. *Army Aviation: Flight Regulations*. May 1990.
- AR 95-3. *Aviation: General Provisions, Training, Standardization, and Resource Management*. September 1990.
- AR 130-5. *National Guard Bureau Organization and Functions*. October 1983.
- AR 190-10. *Threats to the President and Other Government Officials*. June 1987.
- AR 190-14. *Carrying of Firearms and Use of Force by Law Enforcement and Security Duties*. September 1988.
- AR 190-40. *Serious Incident Report*. September 1981.
- AR 200-1. *Environmental Protection and Enhancement*. April 1990.
- AR 310-49. *The Army Authorization Documents System*. December 1980.
- AR 340-21. *The Army Privacy Program*. July 1985.
- AR 350-7. *Training and Evaluation of Forces for Civil Disturbances*. February 1973.
- AR 360-61. *Community Relations*. October 1980.
- AR 360-80. *Release of Information When More Than One Service is Involved in Accidents or Incidents*. August 1961.
- AR 360-81. *Command Information Program*. October 1989.
- AR 381-10. *US Army Intelligence Activities*. July 1984.
- AR 381-20. *US Army Counterintelligence Activities*. September 1986.
- AR 405-80. *Granting Use of Real Estate*. February 1979.
- AR 500-1. *Aircraft Piracy Emergencies*. October 1972.
- AR 500-2. *Search and Rescue (SAR) Operations*. January 1980.
- AR 500-4. *Military Assistance to Safety and Traffic*. January 1982.
- AR 500-5. *The Army Mobilization and Operations Training System (AMOPS)*. June 1986.
- AR 500-50. *Civil Disturbances*. April 1972.
- AR 500-51. *Emergency Employment of Army and Other Resources Support to Civilian Law Enforcement*. July 1973.

- AR 500-60. *Disaster Relief*. August 1981.
- AR 500-70. *Military Support of Civil Defense*. October 1982.
- AR 525-13. *Combatting Terrorism*. June 1993.
- AR 600-20. *Command Policy*. March 1988.
- AR 600-38. *The Meal Card Management System*. March 1988.
- AR 700-131. *Loan of Army Material*. September 1987.
- DA Pamphlet 27-21. *Administrative and Civil Law Handbook*. March 1992.
- DA Pamphlet 360-3. *Army Hometown News Program*. August 1984.
- FM 5-114. *Engineer Operations Short of War*. 13 July 1992.
- FM 8-10. *Health Service Support in Theater of Operations*. March 1991.
- FM 8-10-6. *Medical Evacuation in a Theater of Operations—Tactics, Techniques, and Procedures*. October 1991.
- FM 8-33. *Control of Communicable Diseases in Man*. May 1991.
- FM 8-55. *Planning for Health Service Support*. February 1985.
- FM 8-250. *Preventive Medicine Specialist*. January 1986.
- FM 8-285. *Treatment of Chemical Agent Casualties and Conventional Chemical Injuries*. February 1990.
- FM 9-15. *Explosive Ordnance Disposal Service and Unit Operations*. March 1987.
- FM 10-23. *Basic Doctrine for Army Field Feeding*. December 1991.
- FM 10-23-1. *Commander's Guide to Food Service Operations*. March 1992.
- FM 10-23-2. *Tactics, Techniques, and Procedures for Garrison Food Preparation and Class I Operations Management*. March 1992.
- FM 16-1. *Religious Support Doctrine*. November 1989.
- FM 19-15. *Civil Disturbances*. November 1985.
- FM 21-10. *Field Hygiene and Sanitation*. November 1988.
- FM 25-100. *Training the Force*. November 1988.
- FM 31-20. *Doctrine for Special Forces*. April 1990.
- FM 33-1. *Psychological Operations*. June 1989.
- FM 34-1. *Intelligence and Electronic Warfare Operations*. July 1987.
- FM 34-130. *Intelligence Preparation of the Battlefield*. May 1989.
- FM 41-10. *Civil Affairs Operations*. December 1985.
- FM 46-1. *Public Affairs Operations*. July 1992.
- FM 55-10. *Movement Control in a Theater of Operations*. July 1986.
- FM 100-5. *Operations*. June 1993.
- FM 100-25. *Doctrine for Army SOF*. December 1991.



## DOMESTIC SUPPORT OPERATIONS

---

NGB Regulation 350-2. *Reserve Component Training*. May 1989.  
NGB Pamphlet 95-5. *Use of Army National Guard Aircraft*. November 1984.  
NGB Pamphlet 360-5/ANGP 190-9. *National Guard Public Affairs Guidelines*. May 1978.  
NGB Study. *Military Support to Civil Authorities for Continuance of Vital Public Services*. FY 79-1.  
NGB Study. *Terrorism and Hazardous Material Incidents*. August 1980.  
NGR 10-2. *State Area Command, Army National Guard*. November 1992.  
NGR 350-1. *Army National Guard Training*. June 1991.  
NGR 500-1. *Military Support to Civil Authorities*. October 1991.  
NGR 600-85. *Drug Abuse Prevention and Control*. March 1990.  
TC 19-6. *Countering Terrorism*. October 1991.

## OTHER MILITARY PUBLICATIONS

AFR 55-3. *Operations*. December 1990.  
AFR 208-1. *Federal Tort Claims Act*. June 1987.  
AFR 355-1. *Disaster Preparedness Planning and Operation*. December 1989.  
ANGR 23-01. *State Air National Guard Headquarters*. August 1983.  
ANGR 35-03. *Full-Time Military Duty Personnel Program-Air National Guard*. June 1989.  
ANGR 55-03. *Operations Event/Incident Report*. December 1990.  
ANGR 67-1. *Loan/Use of Air National Guard Property*. July 1988.  
ANGR 355-1. *Planning and Operations*. December 1989.

## INDEX

AAA. *See* US Army Audit Agency.  
accountability 4-4, 4-7, 4-13, 4-14  
activating units 3-4

### Acts

*The Comprehensive Environmental Response, Compensation, and Liability Act of 1980* 1-34  
*The Controlled Substances Act* 3-2  
*The Department of Defense Authorization Act* 3-2  
*The Economy Act* 3-5  
*The Flood Control Act* 3-4  
*The Immigration and Nationality Act* 3-2  
*The Judiciary Act of 1789* 3-1  
*The Military Cooperation with Civilian Law Enforcement Agencies Act* 1-3  
*The Posse Comitatus Act* 1-3, 3-1  
*The Resource Conservation and Recovery Act* 6-3  
*The Robert T. Stafford Disaster Relief Act* 3-2, 3-5, 5-2, 5-3

Agency for Toxic Substances and Disease Registry 2-4  
Air

Mobility Command 2-8  
National Guard 2-8  
traffic control assistance 5-11  
traffic services 4-10

aircraft piracy 3-4  
alternative remedial contracting strategy 6-5  
American Indian reservations 2-4  
American Red Cross 2-2  
ANG. *See* Air National Guard.  
animal disease eradication 6-7  
Animal and Plant Health Inspection Service 6-7  
antiterrorism 7-14  
AO. *See* area of operations.  
APG. *See* aviation procedures guide.  
ARC. *See* American Red Cross.  
area of operations 2-5, 4-9, 4-10, 4-11, 6-7  
Army

Armament, Munitions, and Chemical Command 6-2  
Audit Agency 4-4  
and civil law enforcement 1-4  
Corps of Engineers 2-9, 2-10, 3-4, 5-8, 6-2 thru 6-5, 6-9, 7-15, 9-4  
Counterdrug RDA Office 7-6

and the Department of Defense 2-6  
Deputy Chief of Staff for Intelligence 7-4  
Engineering and Housing Support Center 4-11, 6-9  
Environmental Center 6-4, 6-8  
and environmental disasters 5-10  
Environmental Hygiene Agency 6-2, 6-9  
environmental research and development program 6-3  
environmental strategy 6-1  
Force Provider Unit 4-6  
Health Services Command 2-9  
and historic preservation 6-7, 6-8  
internal environmental support relationships 6-10  
Materiel Command 2-9, 4-4  
medical department activities 4-12  
mission of viii, 1-1, 1-3  
movement control unit 4-9  
and the National Guard Bureau 2-8  
organization for counterdrug support 7-2  
Reserve viii, 1-1, 2-9, 3-4, 3-5  
Reserve Officers Training Corps 8-6  
resources, 6-8  
role of 1-1, 1-2, 3-0, 5-1, 5-4, 7-0  
senior medical commander 4-12  
support assets 4-1  
support to counterdrug operations 7-8  
Technical Escort Unit 4-16  
values 1-4

ARNG. *See* National Guard, Army.  
ASL. *See* authorized stockage list.  
assessments 5-4, 5-5  
Atlantic Command 2-6  
Atomic Energy Agency 2-2  
Attorney General 2-4, 7-12  
audits 6-3  
authorized stockage list 4-8  
aviation procedure guide 4-10  
aviation support 4-9, 4-10

### B

bands 4-14  
base support installations 6-7  
battle damage assessment and repair 4-8

## DOMESTIC SUPPORT OPERATIONS

BDAR. *See* battle damage assessment and repair.  
BSI. *See* base support installations.

### C

CA. *See* civil affairs.  
CAI. *See* chemical accident/incident.  
CAIC. *See* chemical accident or incident control.  
CAIRA. *See* Chemical Accident and Incident Response and Assistance Program.  
CENTCOM. *See* Central Command.  
Central Command 2-6  
Central Imagery Office 2-6  
ceremonial unit participation 8-4  
chain of command 5-2  
Chairman, Joint Chiefs of Staff 2-5, 5-2  
chaplaincy 4-14  
charts 4-11  
chemical  
  accident/incident 2-9, 4-16  
  accident or incident control 6-3  
  Accident and Incident Response and Assistance Program 6-3  
  contaminations, responsibility for 5-2, 5-10  
  units 4-16, 4-17  
Chief, National Guard Bureau 2-8  
CINC. *See* commander-in-chief.  
CINCFOR. *See* Commander-in-Chief, Forces Command.  
CINCLANT. *See* Commander-in-Chief, Atlantic Command.  
CINCPAC. *See* Commander-in-Chief, Pacific Command.  
CINCTRANS. *See* Commander-in-Chief, Transportation Command.  
CIO. *See* Central Imagery Office.  
city managers 2-3  
civil  
  affairs 4-15  
  agencies, responsibilities of 1-4, 5-1  
  defense emergencies 5-9  
  disturbance operations training 9-5  
  disturbances 1-3, 3-0, 4-10, 4-17, 7-10, 7-12  
  -military operations center 4-15  
  radiological emergencies 5-2, 5-10  
civilian  
  community corps 8-2  
  emergency management 1-4  
  leadership 3-0  
  property and functions, protection of 3-2  
  Youth Opportunities Program (Challenge) 8-2  
civilians 1-1, 3-1  
CJCS. *See* Chairman, Joint Chiefs of Staff.  
CMOC. *See* civil-military operations center.  
COCOM. *See* combatant command.

Cold War 1-1  
combatant command 2-8  
combat service support viii, 4-3, 9-4  
combat support viii, 4-12, 7-12, 9-4  
combat support hospital 4-12  
command, control, communication, and computers 7-4  
command, control, and communications resources 4-17  
command and control of military personnel, 3-4  
commanders, 2-9, 4-17, 5-10, 6-10, 6-11  
Commander-in-Chief  
  Atlantic Command 2-5, 5-2, 5-8  
  Forces Command 2-5, 5-2, 5-8, 6-7  
  Pacific Command 2-5, 5-2, 5-8  
  Transportation Command 2-8  
  Southern Command 7-0  
commanders-in-chief 2-7, 5-2  
command relationships 5-9, 5-10, 7-9  
commercial  
  enterprise 5-8  
  vendor services 4-14  
communications 4-16, 7-11  
community assistance  
  and the American Red Cross 2-2  
  and the Department of Defense 2-5  
  and the Department of Health and Human Services 2-4  
  and the Department of Justice 2-4  
  liaison 8-4  
  principles of 8-0 thru 8-2  
  request flow 8-5  
  types of 8-2 thru 8-6  
*The Comprehensive Environmental Response, Compensation, and Liability Act* 1-34  
Constitutional exceptions 3-1  
containment and eradication missions 6-7  
contamination 1-3  
Continental United States Armies 5-8  
contracting 4-2, 4-14, 6-9  
contracting officers 4-2  
*The Controlled Substances Act* 3-2  
CONUS Drug Law Enforcement System 7-1  
CONUSA. *See* Continental United States Army.  
CONUSA commanders 2-9  
convoys 4-9  
coordination 4-1, 4-17, 5-1, 5-2, 5-4, 5-8, 7-0, 7-8  
coordinators of emergency services 1-6  
corps support command 4-4  
COSCOM. *See* corps support command.  
counterdrug  
  missions 7-2, 7-5  
  operations 1-3, 1-5, 2-4, 3-5, 7-0 thru 7-11  
  support approval process 7-10  
  support material 3-5  
counterterrorism 7-14

CS. *See* combat support.  
CSH. *See* combat support hospital.  
CSS. *See* combat service support.  
cultural resources management 6-7  
CVS. *See* commercial vendor services.

**D**

DARE. *See* Drug Abuse Resistance Education Program.  
DARNG. *See* National Guard.  
DCE. *See* defense coordinating element.  
DCO. *See* defense coordinating officer.  
DEA. *See* Drug Enforcement Administration.  
decision sequence for disaster support 5-3  
Defense  
  coordinating element 2-8, 5-8  
  coordinating officer 2-8, 2-9, 2-11, 5-8, 5-9, 6-7  
  distribution depots 4-6  
  Environmental Restoration Program 6-5  
  Logistics Agency 2-8, 4-5  
  Mapping Agency 4-11  
  movement coordinator 4-9  
  and State Memorandum of Agreement/Cooperative Agreement Program 6-5  
Department  
  of Agriculture 2-2, 2-4, 6-7  
  of the Army 2-7  
  of the Army civilians 1-1  
  of Commerce 2-2  
  of Education 2-2  
  of Energy 2-2, 4-17, 5-2, 5-10 5-13  
  of Health and Human Services 2-3, 2-4  
  of Interior 2-2, 2-4, 6-7  
  of Justice 5-11  
  of Labor 2-4  
  of Public Safety 2-12  
  of State 2-4, 7-0  
  of Transportation 2-4  
  of Treasury 2-5  
Department of Defense  
  counterdrug missions 7-2 thru 7-6  
  counterdrug support organization 7-2  
  executive agent 1-4  
  Key Asset Protection Program 7-15  
  regional logistics support offices 7-5  
  resources 3-4  
  Resource Data Base 2-8  
  responsibility 3-4  
*The Department of Defense Authorization Act* 3-2  
detection and monitoring 7-4  
DHHS. *See* Department of Health and Human Services.

Director  
  of Environmental Programs 6-8  
  of Military Support 2-5, 5-1, 5-2, 5-8, 5-11; 6-7  
  of Plans, Training, and Mobilization 8-6  
Directorate of Resource Management 8-6  
disaster  
  declaration 1-4, 2-1, 5-2  
  federal, definition of 5-1  
  man-made 5-1  
  medical assistance team 4-12  
  preparedness and response program 3-2  
  relief 1-2, 1-6, 2-2, 2-10, 3-2, 5-2  
  relief, stages of 5-4  
  response authority 5-4  
  response operations 5-2  
  response prior to Presidential declaration 5-3  
disaster assistance  
  and the Army 1-2  
  and the Department of Justice 2-4  
  and the Department of Labor 2-4  
  and the Department of Transportation 2-4  
  and the Department of Treasury 2-5  
  and the National Weather Service 2-5  
  and the Nuclear Regulatory Commission 2-4  
  requests for, 1-2, 1-4, 2-10, 2-13, 4-12  
  supporting tasks 9-6  
*The Disaster Relief Act* 4-12  
DISCOM. *See* divisional support command.  
divisional support command 4-4  
DLA. *See* Defense Logistics Agency.  
DMA. *See* Defense Mapping Agency.  
DMAT. *See* disaster medical assistance team.  
DMC. *See* defense movement coordinator.  
DOC. *See* Department of Commerce.  
doctrine 1-1  
DOD. *See* Department of Defense.  
DODRDB. *See* Department of Defense Resource Data Base.  
DOE. *See* Department of Energy.  
DOEd. *See* Department of Education.  
DOI. *See* Department of Interior.  
DOJ. *See* Department of Justice.  
DOL. *See* Department of Labor.  
domestic  
  emergencies 5-1, 5-10, 5-11, 5-12  
  priorities 1-1  
  violence 1-1  
domestic support  
  and commanders-in-chief 2-5  
  DOD executive agent for, 2-5  
  operations 1-1, 2-5  
  vital aspects of 1-4

## DOMESTIC SUPPORT OPERATIONS

DOMS. *See* Director of Military Support.  
DOS. *See* Department of State.  
DOT. *See* Department of Transportation.  
DPS. *See* Department of Public Safety.  
drug abuse 2-1, 7-5, 8-5  
drug abuse awareness education 7-6  
Drug Abuse Resistance Education (DARE)  
Program 8-5  
drug demand reduction programs 8-2, 8-3  
Drug Enforcement Administration 2-4  
drug law enforcement agencies 7-0

### E

854th Engineer Battalion, 77th US Army Reserve  
Command 9-5  
*The Economy Act* 3-5  
education 1-3, 2-2, 7-5, 8-3, 8-5  
elections 3-3  
electrical power disruptions 5-1  
emergency  
declarations 1-4, 2-1  
as distinguished from a major disaster 3-2, 3-3  
management concept 1-4  
Management Institute 9-1  
operations center 3-5, 5-2  
preparedness liaison officer 2-8, 2-9  
preparedness planning, responsibility for 2-9, 2-10  
response plans 2-9, 2-11, 2-13  
response teams 1-3, 4-1  
services 1-3, 1-6, 2-13, 5-2, 5-6, 8-6  
support assignment matrix 5-7  
support function managers 5-8  
support functions 1-6, 2-5, 3-2, 5-6  
end state 4-2, 5-6  
engineer  
assistance 4-10  
operations 7-4  
environmental  
compliance assessments 6-3  
compliance missions 6-2  
disasters 5-10  
pollution 2-2  
Protection Agency 2-2, 4-17, 5-2, 5-10, 6-5  
stewardship 1-3, 6-0  
strategy 1-3, 6-0  
support 6-0 thru 6-11  
environmental assistance  
and the American Red Cross 2-2  
and the Department of Labor 2-4  
and the Department of Transportation 2-4  
and the Department of Treasury 2-5  
and the National Weather Service 2-5  
and the Nuclear Regulatory Commission 2-4  
training 9-4

EOC. *See* emergency operations center.  
EOD. *See* explosive ordnance disposal.  
EPA. *See* Environmental Protection Agency.  
EPLO. *See* emergency preparedness liaison officer.  
ESF. *See* emergency support function.  
EUCOM. *See* European Command.  
execute order 5-2, 7-12  
exhibits 8-5  
explosive ordnance disposal 1-3, 4-16, 7-5, 7-14  
explosive ordnance disposal teams 7-6

### F

57th Medical Command (Air Ambulance), 1st Corps  
Support Command 8-3  
489th Engineer Battalion, 420th Engineer  
Brigade (USAR) 8-4  
558th QM Company (Aerial Resupply) 9-3  
FAA. *See* Federal Aviation Administration.  
facility restoration 6-4, 6-5  
FBI. *See* Federal Bureau of Investigation.  
FCO. *See* federal coordinating officer.  
Federal  
Aviation Administration 3-4  
Bureau of Investigation 2-4, 3-3, 3-4  
coordinating officer 2-1, 2-8, 2-11, 5-6, 5-8  
disaster 1-2, 5-1  
forces, use of 2-9  
property and functions, protection of 3-2  
Radiological Emergency Response Plan 2-4,  
4-16, 4-17  
resources, authorization of 2-1  
resources, commitment of 5-2  
Federal Emergency Management Agency  
and the Army Corps of Engineers 2-9  
and the coordination of federal response 5-2  
and the defense coordinating officer 2-8  
and the disaster preparedness and response  
program 3-2  
and environmental disasters 5-10  
and nuclear accidents, 4-17  
as part of an emergency services organization 2-11  
regional boundaries 2-3  
and reimbursement for tasked assistance 3-3  
Federal Response Plan  
and the American Red Cross 2-2  
and the Army 1-6  
and the Army Corps of Engineers 2-9  
and the Department of Agriculture 2-2  
and the Department of Defense 2-5  
and the Department of Energy 2-2  
and the Department of Health and Human  
Services 2-3  
and the Department of Interior 2-4  
and the Department of Transportation 2-4

*Federal Response Plan continued*  
and the Environmental Protection Agency 2-2  
and the Federal Emergency Management  
Agency 2-3, 3-3  
and the General Services Administration 2-3  
and the National Communications System 2-4  
and the 12 functional areas 5-6

feeding people 4-5, 4-6  
FEMA. *See* Federal Emergency Management Agency.  
field operating agency 4-11, 6-8  
field services 4-4  
field service units 4-5  
finance 4-14  
firefighting 1-6, 2-2, 2-13, 6-7  
fire forecasting 2-2  
*The Flood Control Act* 3-4  
force projection strategy 1-1, 1-6  
force protection 4-17  
Force Provider Unit 4-6, 4-7, 4-13  
Forces Command 2-6  
foreign  
policy 2-4  
priorities 1-1

FORSCOM. *See* Forces Command.  
Fort Sill Public Affairs Office 8-6  
Freedman's Bureau 1-2  
FRERP. *See* Federal Radiological Emergency  
Response Plan.  
FRP. *See* Federal Response Plan.

### G

GAO. *See* General Accounting Office.  
GARDEN PLOT. *See* OPLAN GARDEN PLOT.  
General Accounting Office 4-4  
General Services Administration  
and the National Communications System 2-4  
as a source of logistical support 4-2

Geographic Information System 4-11  
Geographic Resource Analysis Support System 6-3  
GIS. *See* Geographic Information System.  
governor, responsibilities of 2-10  
GRASS. *See* Geographic resource Analysis Support  
System.  
GSA. *See* General Services Administration.

### H

Hawaii Army National Guard 3-3  
hazard assessments 2-2  
hazardous  
chemicals 5-1  
material operations 2-4  
materials 1-3, 2-2, 2-7, 4-16, 6-1, 9-4  
substance spills 2-4, 6-2  
health service support 2-9, 4-12

host nation laws viii  
HSC. *See* United States Army Health Services  
Command.  
HSS. *See* health service support.  
humanitarian assistance 9-4

### I

IG. *See* Inspector General.  
illegal immigration 2-4  
IMA. *See* information mission area.  
immediate assistance 5-4  
immigration 5-11, 9-4  
*The Immigration and Nationality Act* 3-2  
Immigration and Naturalization Service 2-4, 5-11  
improvised explosive device 7-14  
information mission area support 4-16  
infrastructure 1-1, 1-4, 2-2, 2-10, 4-8, 4-12, 4-15,  
4-16, 5-4, 5-6, 8-3, 8-7  
INS. *See* Immigration and Naturalization Service.  
Inspector General 2-6  
Installation Restoration Program 6-4  
installation transportation office 4-9  
intelligence 3-5, 4-11, 7-4  
intelligence preparation of the battlefield 3-5, 7-8  
interagency environment 2-1  
International Atomic Energy Agency 2-2  
International Energy Agency 2-2  
interregional military medical plan 4-11  
IPB. *See* intelligence-preparation-of-the-battlefield.  
IRMMP. *See* interregional military medical plan.  
island territories 2-4  
ITO. *See* installation transportation office.

### J

JCS. *See* Joint Chiefs of Staff.  
JIC. *See* joint information center.  
JMC. *See* joint movement center.  
joint  
cells 5-9  
environment 2-1  
information center 4-15  
military-civilian operations 7-4  
movement center 4-9, 4-10, 5-9  
policy 4-17  
staff 2-7, 5-2, 7-8, 7-12  
task force 2-11, 5-8  
task force commander 7-12, 7-13  
technology development 6-3  
transportation office 4-9

Joint Chiefs of Staff 2-6  
JTF. *See* joint task force.  
JTO. *See* joint transportation office.  
judge advocates 4-14  
*The Judiciary Act of 1789* 3-1

## DOMESTIC SUPPORT OPERATIONS

### K

KAPP. *See* Key Asset Protection Program.  
Kauai County 3-3

### L

land management 6-7  
land reconnaissance 7-6  
LANTCOM. *See* Atlantic Command.  
law enforcement agencies 3-2, 3-4, 4-17, 7-4  
law enforcement support  
    and the American Red Cross 2-2  
    and the Department of Justice 2-4  
    and the Department of Treasury 2-5  
    and the Department of Defense 2-5  
    and the National Guard 2-8  
laws, execution of 3-1  
law and order, responsibility for 3-4  
LEA. *See* law enforcement agency.  
legal  
    advisors 3-1  
    assistance 4-14  
    considerations 7-9  
    constraints 7-4, 7-8  
*legitimacy. See* principles of operations other than war.  
liaison 1-4, 2-12, 3-5, 4-9, 4-17, 8-4  
lines of authority 1-5  
linguists 7-6  
local emergency organizations and disaster relief 5-2  
local governments 1-5, 1-6, 2-4, 2-10, 8-3  
local law enforcement agencies 7-12, 8-5  
logistical support, sources of 4-2  
logistics  
    assessment personnel 4-1  
    command and control cells 4-1, 4-3  
    command and control for 2-7, 4-1, 6-1, 7-2, 7-4  
    support 7-5  
    support officer 6-6  
Louisiana Army Ammunition Plant 6-5  
Louisiana Maneuvers Task Force 9-2  
LSO. *See* logistics support officer.

### M

MACOMs. *See* major commands.  
mail service, disruption to 5-11  
maintenance 4-8, 5-10, 7-4, 7-13, 8-3  
major commands 2-6  
manpower 7-6  
maps 4-11  
MASH. *See* mobile army surgical hospital.  
MAST. *See* Military Assistance to Safety and  
    Traffic Program.  
material and equipment, use of 3-5  
Material Management Center 4-3  
MDIO. *See* Missile Defense Initiative Organization.

MEDDAC. *See* Army Medical Department Activities.  
media 4-15  
Medical Readiness Program 8-3  
medical relief 4-13  
memorandum of agreement 8-4  
memorandum of understanding 3-3, 3-4, 8-4  
METL. *See* mission-essential task list.  
METT-T. *See* mission, enemy, troops, terrain, and time  
    available.  
MI. *See* military intelligence.  
military  
    assistance 1-1, 1-5, 1-6, 2-8, 5-12, 5-14, 6-7,  
        7-12, 8-5  
    Assistance to Safety and Traffic Program 8-3  
    health service support 4-11, 4-12  
    intelligence activities 3-5  
    intelligence personnel, use of 3-5  
    law enforcement, exceptions to 3-1, 3-2  
    personnel, use of 3-4  
    police 2-7, 4-11, 7-4, 7-13, 8-5  
    support 4-2  
*The Military Cooperation with Civilian Law Enforcement  
Agencies Act* 1-3  
Military Sealift Command 2-8  
Military Traffic Management Command 2-8  
Missile Defense Initiative Organization 2-6  
mission analysis 4-12  
mission, enemy, troops, terrain, and time available 1-5  
mission-essential task list 9-3, 9-4  
MMC. *See* Materiel Management Center.  
mobile army surgical hospital 4-12  
mobile training teams 7-5  
morale, welfare, and recreation 4-6, 4-14  
mortuary affairs 4-6  
MOU. *See* memorandum of understanding.  
MTT. *See* mobile training team.  
mutual air agreements 2-13  
MWR. *See* morale, welfare, and recreation.

### N

NAI. *See* nuclear accident/incident.  
NAIC. *See* nuclear accident or incident control.  
NAIRA. *See* Nuclear and Chemical Accident and  
    Incident Response Program.  
National  
    Civil Disturbance Plan 2-8  
    Command Authorities viii, 1-4, 4-11, 4-12  
    Communications System 2-4  
    contingency plan 6-3  
    Disaster Medical System 2-2, 2-3, 4-12  
    Interagency Counterdrug Institute 9-3  
    Interagency Fire Center 2-2, 2-4, 6-7  
    Institute for Environmental Health Sciences 2-4  
    Oceanic and Atmospheric Administration 2-2

*National continued*

Oil and Hazardous Substances Contingency Plan 1-3  
Park Service 6-3  
security 1-4  
Security Agency 2-6  
security emergency preparedness plans 2-8  
security strategy viii  
Telecommunications Support Plan 2-4  
Weather Service 2-5  
Wetlands Protection Program 6-3

National Guard  
Air 2-8  
Army 2-8, 3-4, 4-1, 5-9  
Bureau 2-8  
counterdrug coordinator 7-8  
counterdrug support missions 7-9  
and the drought of 1987 5-11  
forces called to state active duty 2-13  
and the National Guard Bureau 2-8  
in a nonfederal status 1-5, 2-8, 3-1  
as part of an emergency services organization 2-11  
as part of the US Army 1-1  
as primary source of support to LEAs 7-8  
resources 5-8  
responsibility of, 5-1  
state viii, 2-9, 2-11, 2-13, 2-14, 5-2, 7-6  
natural resources management 6-6  
Naval Forces Marianas 5-9  
NBC. *See* nuclear, biological, and chemical.  
NCA. *See* National Command Authorities.  
NCP. *See* national contingency plan.  
NCS. *See* National Communications System.  
NDMS. *See* National Disaster Medical System.  
negotiated agreements 6-5  
negotiated support 4-2  
NGB. *See* National Guard.  
NIFC. *See* National Interagency Fire Center.  
NRC. *See* Nuclear Regulatory Commission.  
NSA. *See* National Security Agency.  
NSEP. *See* national security emergency preparedness plans.  
nuclear  
accident/incident 2-9, 4-16  
accident or incident control 6-3  
biological, and chemical defense/operations 4-17  
and Chemical Accident and Incident Response Program 6-3  
hazard surveying 4-17  
Regulatory Commission 2-4  
technical assistance 2-2  
NWS. *See* National Weather Service.

O

101st Chemical Company 6-2  
113th Aviation Battalion, Nevada National Guard 6-1  
*objective. See* principles of operations other than war.  
Occupational Safety and Health Administration 2-4  
OES. *See* Office of Emergency Services.  
Office of the Deputy Chief of Staff for Intelligence 3-5  
Office of Emergency Services 2-11, 2-12, 2-13  
oil spills 2-4, 6-2  
on-scene commander 5-8  
on-scene coordinator 6-2  
Operation  
Alliance 1-3  
Haylift 5-15  
North Star 1-3  
Provide Refuge 5-11  
Self-Enhancement 8-3  
Wipeout 7-7  
operations other than war 1-1, 1-4, 1-5, 1-6  
operations security 7-4  
OPLAN GARDEN PLOT 2-8, 3-3, 3-4, 3-5, 7-13  
OPSEC. *See* operations security.  
Oregon National Guard 7-11  
OSC. *See* on-scene coordinator.

P

Pacific Command 2-6  
PACOM. *See* Pacific Command.  
permit applications 6-3  
*perseverance. See* principles of operations other than war.  
personnel services 4-13  
PHS. *See* Public Health Service.  
physical improvements  
piracy, aircraft 3-4  
planning 4-1, 4-12, 5-4, 7-4, 7-5, 7-8  
Plans, Operations, and Military Support Officer 2-11, 2-12, 2-13  
PLL. *See* prescribed load list.  
policy 7-4  
POMSO. *See* Plans, Operations, and Military Support Officer.  
*The Posse Comitatus Act* 1-3, 3-1  
prescribed load list 4-8  
prevention assistance missions 6-5, 6-6  
principles of operations other than war 1-4  
procurement support 4-14, 6-7  
Professional Officer Filler System 2-9  
PROFIS. *See* Professional Officer Filler System.  
psychological operations 4-15, 4-16  
PSYOP. *See* psychological operations.  
public affairs 1-4, 7-11, 8-6, 9-3  
Public Health Service 2-3



## DOMESTIC SUPPORT OPERATIONS

public works 1-1, 1-3, 8-2  
public works and engineering 2-5, 2-7, 2-9, 5-8

### R

radioactive materials 2-4  
radiological accidents/emergencies 5-1, 5-2  
READEO. *See* Regional Emergency Animal Disease Eradication Organization.  
readiness 9-3  
real estate 6-5  
real property 4-7, 6-4, 6-5  
recovery operations 1-1  
Regional Emergency Animal Disease Eradication Organization task force 6-7  
reimbursement 2-8, 3-3, 3-5, 4-4, 4-7, 6-7  
reimbursement waivers 3-6  
requests for counterdrug support 7-7  
research and development 6-3, 6-5, 6-6, 7-6  
reserve component  
    equipment, use of 3-5  
    personnel 2-8, 3-4, 3-5  
resource  
    accountability 4-3  
    commitment of 5-5  
    management 4-2, 4-4, 6-8  
*The Resource Conservation and Recovery Act* 6-3  
response teams 1-3  
responsibilities 5-8  
restoration 1-3, 6-1, 6-4, 6-5  
*restraint. See* principles of operations other than war.  
risk management 4-17, 9-3  
*The Robert T. Stafford Disaster Relief Act* 3-2, 3-5, 5-2, 5-3  
ROE. *See* rules of engagement.  
roles 1-2, 2-5, 2-6, 2-7, 5-2, 6-1, 7-0, 7-10  
rules of engagement 1-5, 7-9

### S

16th Field Supply Company 4-8  
SA. *See* Secretary of the Army.  
safety 4-17, 4-18, 6-3, 6-10, 7-14, 8-5, 8-6, 8-7  
SCE. *See* supporting contracting element.  
Science and Technology Academies Reinforcing Basic Aviation and Space Exploration Program 8-2  
SCO. *See* state coordinating officer.  
SCRAG. *See* senior civilian representative of the attorney general.  
SECDEF. *See* Secretary of Defense.  
Secretary of the Army 1-4, 5-1, 5-11  
Secretary of the Army General Counsel 3-5, 7-4  
Secretary of Defense 1-4, 2-5, 2-7, 3-0, 3-5, 7-7  
Secretary of Health and Human Services 4-12

*security. See* principles of operations other than war.  
security and protection missions 2-5  
senior civilian representative of the Attorney General 7-12  
service response force 6-3  
SF. *See* special forces.  
signal support package 4-16  
SOCOM. *See* Special Operations Command.  
SOF. *See* special operations forces.  
Soil Conservation Service 6-3  
SOUTHCOM. *See* Southern Command.  
Southern Command 2-6  
SPACECOM. *See* Space Command.  
Space Command 2-6  
speakers bureau 8-4  
special forces 4-15, 4-16  
Special Operations Command 2-6  
special operations forces 4-15  
SRF. *See* service response force.  
*The Stafford Act. See The Robert T. Stafford Disaster Relief Act.*  
stages of disaster relief, 5-4  
STAMIS. *See* Standard Automated Management Information System.  
Standard Automated Management Information System 4-2  
STARBASE. *See* Science and Technology Academies Reinforcing Basic Aviation and Space Exploration Program.  
STARC. *See* state area command.  
state  
    adjutant general 2-9, 2-11  
    area command 2-8, 2-11, 2-12, 5-8, 5-9  
    coordinating officer 5-8  
    emergency operations center 2-11  
    -local operational emergency services 2-11  
    office of emergency services 5-2  
    resources 1-5, 2-10  
    response plan 2-10  
    responsibilities 2-10  
STRATCOM. *See* Strategic Command.  
Strategic Command 2-6  
*Superfund. See The Comprehensive Environmental Response, Compensation, and Liability Act.*  
support  
    agreements 1-3  
    to civilian law enforcement 1-4, 3-1, 3-2  
    logistics 4-1, 4-2, 4-18, 7-4, 7-7  
    from other federal agencies 4-2  
supported CINC 2-10, 5-2, 5-8, 6-7  
supporting CINCs 5-2, 5-7  
supporting contracting element 4-7, 4-8

**T**

3d Battalion, 20th Special Forces Group 7-6  
3d Battalion, 160th Infantry (Mech), 40th Infantry  
Division, California National Guard 7-12  
312th Army Reserve Band 4-14  
391st Engineer Battalion, 120th US Army Reserve  
Command 9-3  
TAG. *See* state adjutant general.  
technical support organizations 6-9  
termination standards. *See* end states.  
terrorism 1-1, 1-3, 3-3, 3-4, 9-5  
TEU. *See* Army Technical Escort Unit.  
training  
    and community assistance 1-3  
    by EOC personnel 7-15  
    LEA intelligence 7-4  
    of LEAs 7-5  
    nuclear, biological, chemical defense 4-17  
trajectory modeling 2-2  
TRANSCOM. *See* Transportation Command.  
transportation 1-6, 2-5, 2-7, 2-8, 4-2, 4-4, 7-5  
Transportation Command 2-6

**U**

UAV. *See* unmanned aerial vehicles.  
UMT. *See* unit ministry teams.  
unexploded ordnance 6-5  
unified and specified commands 5-1  
unilateral operations viii  
United States  
    Agency for International Development 2-4  
    Air Force 2-6, 2-8  
    Army. *See* Army.  
    Coast Guard 2-2, 2-4, 5-2, 5-10  
    Customs Service 2-5, 7-6  
    Forest Service 2-2  
    Geological Survey 4-11  
    Information Agency 2-4  
    Marine Corps 2-6  
    Navy 2-6

property and fiscal officer 2-8  
Secret Service 2-5, 7-14  
Transportation Command 4-9  
unit ministry teams 4-14  
unity of command 1-5  
*unity of effort. See* principles of operations other  
than war.  
unmanned aerial vehicles 4-10, 7-5  
urban search and rescue 1-6, 2-5, 5-5, 5-8  
USACE. *See* Army Corps of Engineers.  
USAEC. *See* Army Environmental Center.  
USAHSC. *See* Army Engineering and Housing  
Support Center.  
USAMC. *See* Army Materiel Command.  
USAR. *See* Army Reserve.  
USCG. *See* United States Coast Guard.  
USCS. *See* United States Customs Service.  
USDA. *See* Department of Agriculture.  
USFS. *See* United States Forest Service.  
USGS. *See* United States Geological Survey.  
USPFO. *See* United States property and fiscal officer.  
US&R. *See* urban search and rescue.  
USSS. *See* United States Secret Service.  
USTRANSCOM. *See* United States Transportation  
Command.

**V**

veterinary support officer 6-7  
volunteers 3-4, 3-5

**W**

waiver of reimbursement 3-6  
weather forecasting 2-2  
wetlands 1-3, 6-3  
wildland firefighting and resourcing channels 6-8  
wildlands 1-3, 6-7  
Work-for-Others Program 6-5

**Y**

Youth Physical Fitness Clinic Program 8-3

FM 100-19  
FMFM 7-10  
1 JULY 1993

By order of the Secretary of the Army:

GORDON R. SULLIVAN  
General, United States Army  
Chief of Staff

Official:

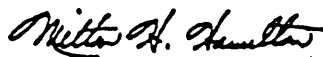
  
MILTON H. HAMILTON  
Administrative Assistant to the  
Secretary of the Army  
04489

By Direction of the Commandant of the Marine Corps:

  
C. C. KRULAK  
COMMANDING GENERAL  
Marine Corps Combat Development Command

**DISTRIBUTION:**

Active Army, USAR, and ARNG: To be distributed in accordance with DA Form 12-11E requirements for FM 100-19, *Domestic Support Operations* (Qty rqr block no. 5267).

Adjutant General's Department of Texas  
Austin, Texas  
13 July 1992

AGTX MILITARY SUPPORT TO CIVIL AUTHORITIES (MSCA) OPLAN  
References: See Annex K  
Time Zone Used Throughout The Plan: SIERRA  
Task Organization: See Annex A.

1. SITUATION

a. Intelligence. Annex B, Intelligence.

b. Friendly Forces,

(1) Division of Emergency Management, Texas Department of Public Safety.

(2) Division of Emergency Management Regional Liaison Officer of the six designated regions. (See Appendix 1 to Annex C).

(3) Texas Department of Public Safety.

(4) Disaster District Committee Members of the designated 19 Disaster Districts. (See Appendix 1 to Annex C).

(5) County judges and emergency directors/coordinators.

(6) City mayors and emergency directors/coordinators.

(7) City and county law enforcement agencies.

(8) City and county fire departments.

(9) All state agencies represented on the State Emergency Management Council.

(10) The Federal Emergency Management Agency (FEMA).

(11) American National Red Cross.

(12) Fifth United States Army.

(13) U. S. Army Engineer Division, Southwestern.

(14) Installation commanders of all Air Force, Navy, Marine Corps and Army installations in the state.

c. Attachments and Detachments: Personnel and units required to reinforce those units ordered to State Active Duty initially will be determined and notified as the situation dictates.

d. Assumptions:

(1) This plan will be implemented primarily during the time there is no national crises, and used as the basis for military support to civil authorities (MSCA) during national emergencies.

(2) Texas National Guard elements tasked in this plan are available to resource the plan during times other than national emergencies..

(3) State military forces will be called to State Active Duty only after it has been determined civil authorities cannot cope with the emergency.

(4) Disasters or civil disturbances may require the employment of State military forces in more than one area simultaneously.

(5) Martial law will not prevail initially and any declaration of martial law will be made by proclamation of the Governor.

(6) All or part of the National Guard may be ordered to federal status at anytime during the emergency.

(7) Civil authorities may request, and receive, military support for diverse missions, such as: manhunts, .. rescue operations, etc.

(8) All hurricanes originating in the Atlantic Ocean south of the 25th parallel will present a threat to the Gulf of Mexico coastal area.

(9) Hurricanes moving westerly after reaching 80 west longitude and below 25 north latitude are expected to enter the Gulf of Mexico and will strike the Texas-Louisiana Coasts.

(10) Tornadoes can occur as side effect of hurricanes; however, they may occur anywhere in the state, as part of a sever thunderstorm, with little or no warning.

(11) Range/brush fires occur in all parts of the state.

## 2. MISSION

On order, Texas military forces provide assistance to city, county and state civil authorities in recovery from the effects of natural or man-made disasters or to control civil disturbances.

## 3. EXECUTION

a. Concept of Operations. Annex A (Operations). State military forces are prepared and trained to react to a variety of natural or man-made disasters and civil disturbances that cause damage or circumstances beyond the capability of civil authorities. Forces to support local authorities in establishing or maintaining law and order, including the prevention of looting and plundering, restraint of curiosity seekers and directing traffic will be provided only at the direction of the Adjutant General's Department. Orders and coordination for emergency missions will be passed from the AGTX Emergency Operations Center, when activated, to major subordinate command, to the activated Task Force(s). Forces committed will be tailored to provide the support requested by civil authorities. Specific commitment of forces will be determined based on the type and severity of the situation. Task forces in Annex A have units designated capable of reacting to civil disturbances; however, these units may be redesignated to other task forces based upon requirements. In order to provide command and control for major command headquarters and subordinate task forces, the AGTX EOC will be activated and operated IAW AGTX EOC SOP Dated 1 Oct 91. Military support to civil authorities (MSCA) in state status will be accomplished in accordance with this plan. MSCA operations will be conducted in three phases.

(1) Phase I (PLANNING). 49AD; Det 1 (Trp Comd), STARC, TXARNG; HQ, TXANG; and Texas State Guard will prepare and maintain MSCA plans for employment of state military forces under their control. Task forces designated in Annex A, this plan, will prepare and maintain MSCA plans for their areas of responsibility. SOP for State Active Duty - AGTX and Annex C, this plan, provides additional guidance for execution of this phase of the operation.

(2) Phase II (TRAINING). TARNG Regulation 350-3 specifies the units of the TXARNG that have a civil disturbance control mission. Further, it provides training required for various units and staffs of units. Units not listed in TARNG Reg 350-3 may be committed to civil disturbance operations as the situation dictates.

(3) Phase III (EXECUTION). The order placing personnel and/or units on State Active Duty will be passed by the AGTX Emergency Operations Center (EOC) through the Major Subordinate Command (MSC) to the task force(s). The AGTX EOC will pass the order direct to the task force(s) only when a representative of the MSC cannot be contacted. The MSC will activate the task force(s) required to accomplish the mission. The MSC will be the control headquarters when more than one task force is activated. The MSC may establish a forward command post when required to better control operations. In the event of large operations, AGTX may co-locate a forward command post with the MSC forward command post.

b. Adjutant General of Texas (AGTX). The Plans, Operations and Military Support Officer (POMSO) (AGTX-OTM) represents the Adjutant General's Department on the State Emergency Preparedness (SEP) Council operated by the Division of Emergency Management. AGTX-OTM will notify Major Subordinate Commands of developing situations that may require state military force involvement. When the Governor orders TAG, TX to provide MSCA, AGTX-OTM will pass that order to major subordinate commands. AGTX-OTM in coordination with AGTX-CO will dispatch, as required, the Adjutant General's Department communications van. The van will move to a location where it can best be utilized to support operations.

c. HQ, STARC (-), TXARNG. Provide personnel and equipment required to command, control and support emergency operations.

d. HQ, 49AD. Serve as the major subordinate command for emergency operations conducted in Regions 1,3,4, and 5. Be prepared to serve as the major subordinate command in Regions 2 and 6 in the event Det 1 (Trp Comd) STARC is not available or when circumstances dictate.

e. Det 1 (Trp Comd), STARC. Serve as the major subordinate command for emergency operations conducted in Regions 2 and 6. Be prepared to serve as the major subordinate command in the other 4 regions in the event HQ, 49th AD is not available or when circumstances dictate.

f. HQ, Texas Air National Guard. Provide personnel and equipment support, as directed by TAG, TX, for emergency operations anywhere in Texas.

g. HQ, Texas State Guard. On order, provide Texas State Guard personnel to perform emergency operations.

h. Task Force GARLAND. On order, provide MSCA in District 1A, Subdistrict 1A and District 1B. Be prepared to receive OPCON units from other regions. Be prepared to conduct MSCA operations in Regions 2 and 5.

i. Task Force HOUSTON. On order, provide MSCA in District 2A, Subdistrict 2A, District 2B and Subdistrict 2B. Be prepared to receive OPCON units from other regions. Be prepared to conduct MSCA operation in Regions 1 and 6.

j. Task Force CORPUS CHRISTI. On order, provide MSCA in District 3A, Subdistrict 3A and District 3B. Be prepared to receive OPCON units from other regions. Be prepared to conduct MSCA operations in Regions 2 and 4.

k. Task Force MIDLAND. On order, provide MSCA in District 4A, Subdistrict 4A, District 4B and Subdistrict 4B. Be prepared to receive OPCON units from other regions. Be prepared to conduct MSCA operations in Region 5.

l. Task Force LUBBOCK. On order, provide MSCA in District 5A, Subdistrict 5A and District 5B. Be prepared to receive OPCON units from other regions. Be prepared to support MSCA operations in Regions 1 and 4.

m. Task Force WACO. On order, provide MSCA in Districts 6A and 6B. Be prepared to receive OPCON units from other regions. Be prepared to conduct MSCA operations in Regions 1, 2 and 4.



4. LOGISTICS/SERVICE SUPPORT

- a. Annex D (Logistics/Service Support).
- b. AGTX SOP for State Active Duty, 1 Jan 1991.

5. COMMAND AND SIGNAL

a. Command.

(1) Military forces will remain under military control at all times. Commanders will be responsible only to their superiors in the military chain of command.

(2) AGTX-EOC. AGTX-EOC in Bldg 1, Camp Mabry.

(3) State EOC., Division of Emergency Management EOC, Texas Department of Public Safety.

(4) All Command Post (CP) locations will be reported as they are established.

b. Signal. Annex E (Signal/Communications).

Acknowledge.

WILSON  
MG

OFFICIAL:

COTTLE

Annexes: A - Task Organization  
B - Intelligence  
C - Military Assistance/Operations  
D - Logistics/Service Support  
E - Signal/Communications  
F - Information/Public Affairs  
G - Finances  
H - Personnel/Legal  
I - Safety  
J - Reports  
K - References

Distribution:

Adjutant General's Department of Texas  
Austin, Texas  
13 July 1992

ANNEX A (TASK ORGANIZATION) TO AGTX MSCA OPLAN  
References. See Annex K  
Time Aone Used Throughout the order: SIERRA

The Adjutant General of Texas  
HQ Starc(-), TXARNG  
Det 1 (Troop Comd) STARC, TXARNG  
HQ 49th AD, TXARNG  
HQ, TXARNG  
HQ, State Guard

Task Force GARLAND  
HO, 3d Bde, 49th AD  
\*3d Bn (M) 144th INF  
3d Bn 149th AVN  
6th Bn 112th AR  
5th Bn 112th AR  
372d Spt Bn  
2d Bn 112th AR  
\*3d Bn 132d FA

Task Force HOUSTON  
HO, 36th Bde, 49th AD  
Co G 143 INF  
\*2d Bn (M) 141st INF  
386th ENGR Bn  
4th Bn 112th AR  
1st Bn 133d FA  
536th Spt Bn  
1st Bn 149th AVN  
\*136th Sig Bn

Task Force CORPUS CHRISTI  
HO, 49th DIVARTY, 49th AD  
\*2d Bn (M) 141st INF  
3d Bn (M) 141st INF  
1st Bn (M) 141st INF  
4th Bn 133d FA

Task Force MIDLAND  
2d Bde, 49th AD  
\*111th ENGR Bn  
3d Bn 112th AR  
3d Bn 133d FA  
\*3d Bn 132d FA  
\*249th Spt Bn  
\*2d Bn 142d INF

A-1

Z 0017099

Task Force LUBBOCK  
HO 2d Bde, 49th AD

Task Force WACO  
HO, 111th Spt Gp  
1st SQDN 124th CAV  
\*3d Bn (M) 144th INF  
\*249th Spt Bn  
\*136th Sig Bn

STARC(-), TXARNG Control

All elements of TXARNG and TSG are responsible for being capable of reacting to natural or man-made disasters and civil disturbances on order of TAG, TX anywhere in the state. Task force will be tailored by AGTX/STARC based upon the type emergency and troop and equipment requirements. Order to State Active Duty will be transmitted from AGTX/STARC through major subordinate commands to units. SOP for State Active Duty, AGTX provides emergency planning requirements for units.

\*NOTE: units are listed in two task forces because of the limited number of units authorized and equipped to perform civil disturbance missions.

249th Spt Bn will support either task force. Additional support will be provided from other support battalions as requested and required.

Adjutant General's Department of Texas  
Austin, Texas  
13 July 1992

ANNEX A (INTELLIGENCE) TO AGTX MSCA OPLAN  
References: See Annex K

- a. Map, Official State Highway Map, Texas Department of Highways and Transportation, Current Edition.
  - b. Current Intelligence summaries/Reports.
  - c. AR 381-20, U. S. Army Counterintelligence Activities.
  - d. Federal, state and local law enforcement agencies.
  - e. Current Weather Reports, National Weather Service.
- Time Zone Used Throughout the Order: SIERRA

1. SUMMARY OF ENEMY SITUATION

Information on the enemy forces/event will be obtained as the situation develops that requires MSCA. During MSCA operations, "enemy forces" may encompass a multitude of activities that may include personnel, weather, flooding, etc. Intelligence must be gathered and dispersed quickly to all elements involved.

2. ESSENTIAL ELEMENTS OF INFORMATION (EEI)

a. Natural Disaster.

(1) What effects will the hurricane have in your area of responsibility?

(2) What effects is flooding, tornadoes, storms or blizzard and snow having in your area of responsibility?

(3) What and where are the potential damage areas which will threaten life and create severe hardship and suffering:

(4) What are the projected requirements for support:

(5) Who and where is the civilian emergency operations point of contact:

b. Civil Disturbance.

(1) Who and what are the dissident elements, individuals, groups and organizations, including methods of operation and leadership?

- (2) What activities are being conducted that may require employment of state military forces:
- (3) What caused the dissident groups to react?
- (4) What capabilities do the dissident groups have?
- (5) What are the targets and objectives of military forces?
- (6) What participation is expected outside the local group or organization?
- (7) What are the geographic outlines of the actual civil disturbance area?
- (8) What methods, techniques, tactics and weapons are being used? What is the nature of the disturbance (arson looting, sniping)?
- (9) How many participants are involved? Is there leadership present? Identify agitator or motivating elements?
- (10) Identify issues or grievances causing the riot. What incident (factual or rumored) is stimulating the violence?

### 3. INTELLIGENCE ACQUISITION TASKS

#### a. Natural Disaster.

- (1) Report all construction and improvements (permanent and temporary) designed to provide protection and control of the effects of hurricane including high tides, flooding and high winds.
- (2) Report all measures taken by civil authorities to prepare for natural disaster, including plans and organization for emergency, evacuation, procurement and storage of material and equipment.
- (3) Report local information on the effects of the disaster on the civilian populace.
- (4) Report damage caused by natural disaster and their after effects on: (i) extent and duration of communication disruption, (ii) flooding or closing of roads and routes of access, (iii) status of operational airfields in the area, (iv) evacuation of civilians and the status of refugee problems.

(5) Report the occurrence of civil disobedience problems including looting.

b. Civil Disturbance.

(1) General. No command, unit, organization or individual will plan or engage in clandestine or covert intelligence collection operations. Information required to fulfill assigned mission will be obtained through such open sources as newspapers, radio and television broadcasts and officials as applicable and appropriate. Coordination of intelligence planning with civilian authorities is authorized and encouraged.

(2) Intelligence collection, reporting and dissemination activity prior to and during civil disturbances will fulfill the following criteria:

(a) Responsiveness to the EEI of the AGTX and the Task Force Commander.

(b) Conciseness and non-duplication of reported information.

4. MEASURES FOR HANDLING DISSIDENTS, DOCUMENTS AND MATERIAL - CIVIL DISTURBANCE.

a. Dissidents. Primary responsibility for handling dissidents rest with local and state law enforcements agencies. When National Guard forces are not accompanied by police and, are required to detain dissidents, local police will be notified by the most expeditious means available. A detainee turn-over record (Appendix 3 Annex J) will be safeguarded from destruction or removal until turned over to civil law enforcements agencies.

5. MAPS AND/OR EQUIPMENT REQUIRED>

a. Maps.

(1) City maps, full scale, four inches equals one mile, or half scale, two inches equals one mile, available from the Texas State Highway Department will be used as the operations map. Requirements will be submitted to AGTX-OTM.

(2) Oil company maps may be used by commanders to supplement the operational map.

(3) Task force commanders are responsible for supply of maps of target cities in their area to Task Force Units.

#### 6. COUNTERINTELLIGENCE

a. General: Successful implementation of this plan is dependent on coordination with civil officials throughout all phases:

b. Disaster: Planning and execution is generally not sensitive in nature.

c. Civil Disturbance:

(1) Planning Phase: Because potentially sensitive and/or controversial matters are involved, task force commanders are cautioned to exercise prudence in relations with civil officials while coordination reconnaissance, liaison, and other preparation for commitment of National Guard Forces to include training drills.

(2) Implementation Phase: Task force commanders will incorporate OPSEC measures as appropriate to the current situation.

7. REPORTS. See Annex J

Adjutant General's Department of Texas  
Austin, Texas  
13 July 1992

ANNEX C (MILITARY ASSISTANCE/OPERATIONS) TO AGTX MSCA OPLAN

References: Annex K (References).

1. SITUATION

- a. Enemy Forces. Annex B (Intelligence)
- b. Friendly Forces. No change from basic plan.

2. MISSION

No change from basic order.

3. EXECUTION

a. Concept of Operations. All military commanders are required to be prepared to furnish support to civil authorities for a limited period in civil disasters or emergencies using resources not required in the execution of their primary military missions. Under imminently serious conditions during an undeclared disaster or emergency, situations that require the immediate support of the military to save lives, prevent human suffering, or mitigate action, military commanders in closest proximity to the affected area(s) are responsible, upon civil request, for providing support to civil authorities within the unit's capability. Resources committed will be limited to those not immediately required for execution of the primary military mission and assistance will be terminated as soon as possible.

(1) Phase I (Planning). Appendix 1 (Operation Overlay) to Annex C:

(a) Regional Planning Responsibilities. Commanders designated with regional planning responsibility will effect and maintain coordination with the Division of Emergency Management Regional Liaison Officers. MSCA Plans for the individual regions will be prepared and maintained by the responsible units.

- 1 Region 1. Cdr, 3d Bde, 49th AD
- 2 Region 2. Cdr, 36th Bde, 49th AD



- 3 Region 3. Cdr, 36th Bde, 49th AD
- 4 Region 4. Cdr, 2d Bde, 49th AD
- 5 Region 5. Cdr, 2d Bde, 49th AD
- 6 Region 6. Cdr, AVN Bde, Trp Comd

(b) Disaster District Planning Responsibilities.

Commanders designated with disaster district planning responsibility will effect and maintain coordination with the Chairman, Disaster District Committee. MSCA plans for the districts/sub-districts will be prepared and maintained by the responsible units.

- 1 District 1A (Garland). Cdr, 372 Spt Bn
- 2 Subdistrict 1A (Hurst). Cdr, 949th Spt Bn
- 3 District 1B (Tyler). Cdr, 5th Bn 112th AR
- 4 District 2A (Houston). Cdr, 386th Engr Bn
- 5 Subdistrict 2A (Wharton). Cdr, 386th Engr Bn
- 6 District 2B (Beaumont). Cdr, 1st Bn 133d FA
- 7 Subdistrict 2B (Lufkin). Cdr, 1st Bn 133d FA
- 8 District 3A (Corpus Christi). Cdr, 2d Bn 141st INF
- 9 Subdistrict 3A (Harlingen). Cdr, 3d Bn 141st INF
- 10 District 3B (San Antonio). Cdr, 1st Bn 141st INF
- \*11 District 4A (Midland). Cdr, 2d Bn 142d INF
- 12 Subdistrict 4A (El Paso). Cdr, 3d Bn 133d FA
- \*13 District 4B (Abilene). Cdr, 111th Engr Bn
- 14 Subdistrict 4B (San Angelo). Cdr, 3d Bn 132d FA
- \*15 District 5A (Lubbock). Cdr, 2d Bn 142d Inf
- 16 Subdistrict 5A (Wichita Falls). Cdr, 2d Bn 142d INF
- \*17 District 5B (Amarillo). Cdr, 2d Bn 142d INF

18 District 6A (Waco). Cdr, 1st Sqdn 124th Cav

19 District 6B (Austin). Cdr, 249th Spt Bn (Main)

\* Unit has responsibility for more than on Disaster District.

(c) Task Force commanders will include plans for high priority objective areas assigned (Appendix 3, High Priority Objective Areas).

(d) AGTX-OTM will provide planning assistance on request.

(e) MSCA plans will be forwarded to the next higher headquarters for approval.

(2) Phase II (Training) Designated Regional Commanders will ensure that designated units and unit members are trained in accordance with TXARNG Regulation 350-3.

(3) Phase III (Execution). MSCA will normally be conducted in State Active Duty Status. However, all planning headquarters must take into consideration MSCA may be conducted in a "federal" status. Operations will be conducted in three stages.

(a) PREPARATORY STAGE. The preparatory stage is defined as the period from the date of receipt of the plan to receipt of the warning order for MSCA (Tab A, CIDCON 5, to Appendix 3, CIDCON, to this annex).

(b) ALERT STAGE. Extends from the time the warning order is received until the order to State Active Duty is received (Tab B, CIDCON 4 to Appendix 3, CIDCON, to this annex).

1 Designated task force commander will conduct a reconnaissance of the objective area to assess the situation, establish liaison with civil authorities and provide an estimate of the situation to AGTX-OTM within two hours after arrival in the objective area.

2 Establish land line and radio communication in accordance with Annex E, Signal/Communications, of this plan.

3 Alert key personnel in the unit(s).

4 Insure unit equipment is ready for employment.

(c) ASSEMBLY, MOVEMENT AND EMPLOYMENT STAGE. This period extends from the time the order to State Active Duty is received to time of release from State Active Duty AGTX (Tabs C, D and E, CIDCON 3,2, and 1, to Appendix 3, CIDCON, to this annex).

1 Personnel assemble at the designated assembly point and prepare for MSCA operations.

2 Designated units conduct movement to final assembly areas and prepare for employment in MSCA operations.

3 Units conduct MSCA operations.

a The task force commander is the sole military commander of State Military Forces in the objective area. AGTX provides administrative and logistical support of all Texas Army and Air National Guard Forces in the objective area. Under conditions where civilian control is no longer effective, commanders at appropriate echelons will take necessary measures for the protection of life and property and the restoration of order and civil control in accordance with the provisions of Appendix 4 (Application of Force/Rules of Engagement), Annex C.

b Reinforcement and/or replacement of units on state active duty will be ordered by AGTX.

4 Operational employment of military force in natural disaster or civil disturbance operations will be in accordance with the following concepts:

a Unless in federal service, forces remain under the control of the Governor of Texas and are state assets. Units may use federally owned National Guard equipment in conduct of disaster relief operations.

b Normally, Texas military forces are assigned missions through the state; however, with the concurrence of the Governor, we may accept missions from Fifth Army on a reimburseable basis.

5. COMMAND AND SIGNAL

No change from basic order.

APPENDICES:

- 1 - Operations Overlay  
Regional Planning Responsibilities  
Disaster District Planning Responsibilities
- 2 - Command Relationship
- 3 - High Priority Objective Areas
- 4 - Application of Force/Rules of Engagement  
Tab A CIDCON 5  
Tab B CIDCON 4  
Tab C CIDCON 3  
Tab D CIDCON 2  
Tab E CIDCON 1
- 5 - Mission Guidance
- 6 - Special Orders
- 7 - Searches
- 8 - Snipers, Arsonist, and looters

APPENDIX 1 (OPERATIONS OVERLAY) TO ANNEX C (Military Assistance/Operations) AGTX MSCA OPLAN

REGIONAL PLANNING RESPONSIBILITIES

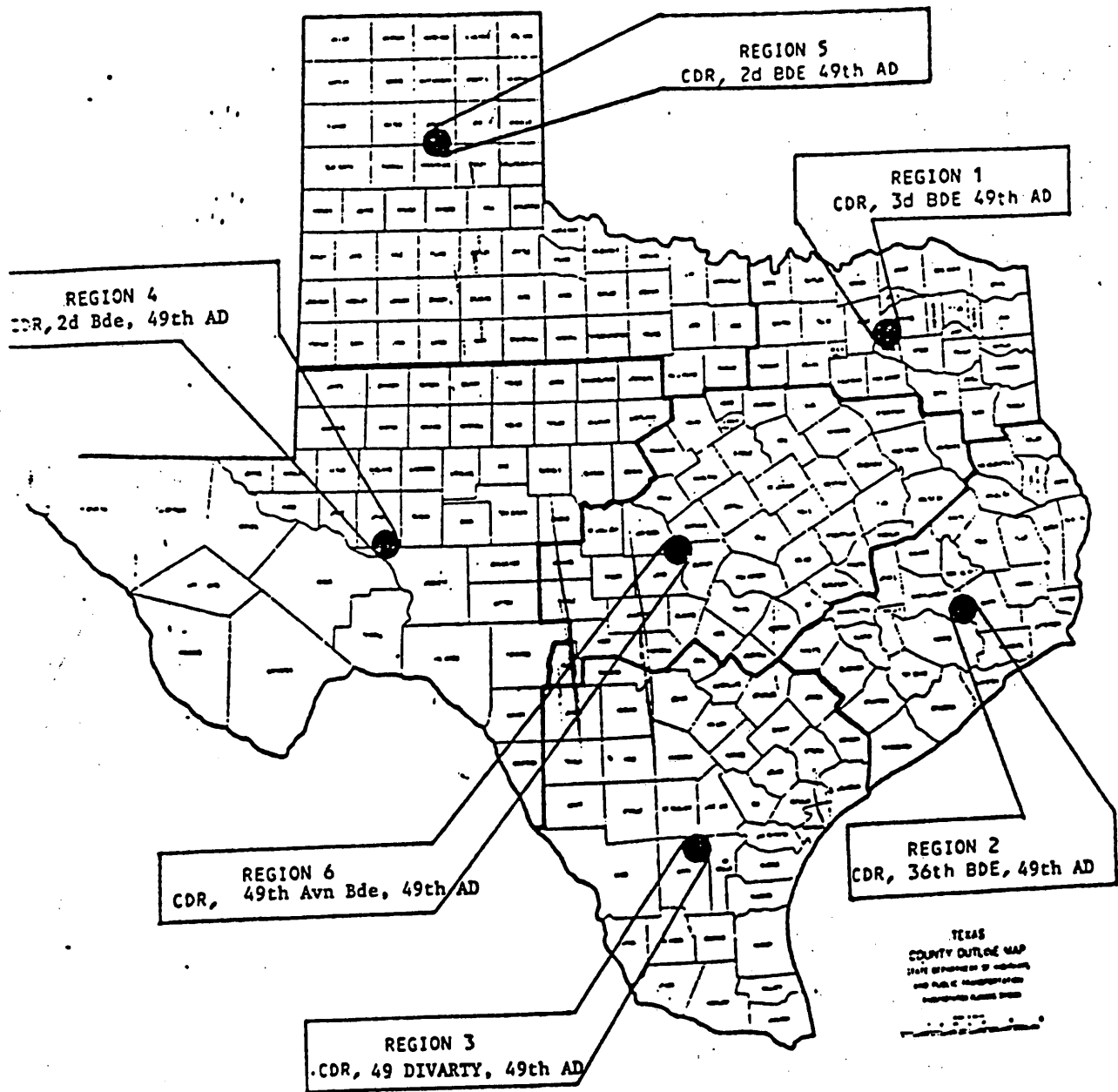

APPENDIX 1 (OPERATIONS OVERLAY) TO ANNEX C (Military Assistance/Operations) AGTX MSCA OPLAN

DISASTER DISTRICT PLANNING RESPONSIBILITIES

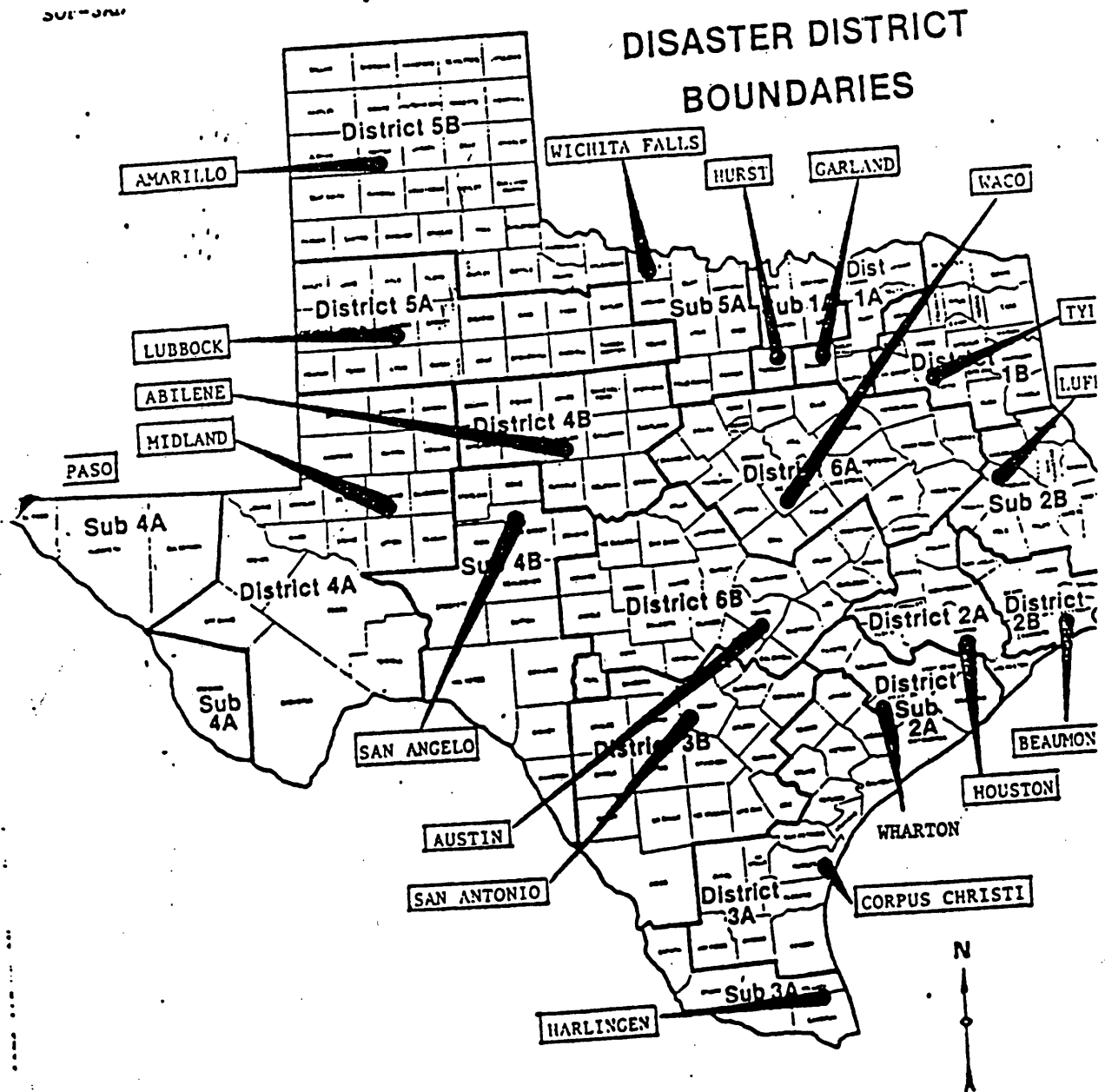

APPENDIX 2 (COMMAND RELATIONSHIP) TO ANNEX C (Military Assistance/Operation) AGTX MSCA OPLAN

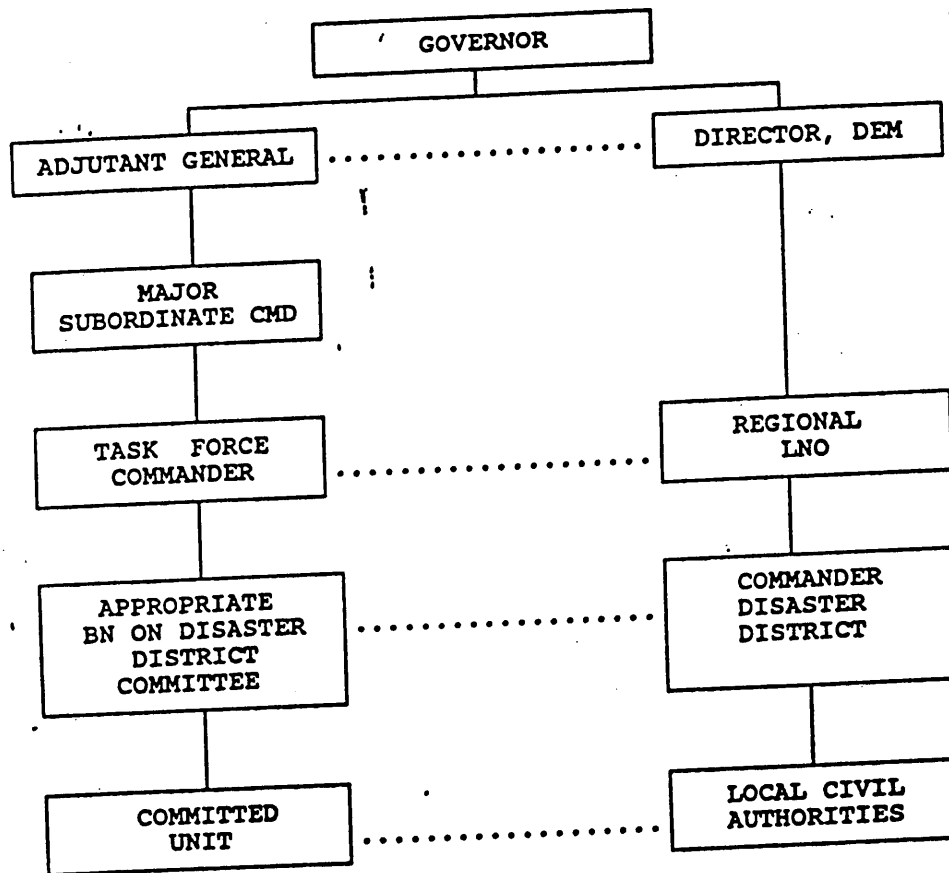

Lines of:  
 — Authority  
 ... Coordination

APPENDIX 3 (HIGH PRIORITY OBJECTIVE AREAS) TO ANNEX C (Military Assistance/Operations) AGTX MSCA OPLAN

1. GENERAL. Operational plans will be prepared by task force commanders for each of the following high priority objective areas assigned below. Task force commander should prepare additional plans for their area of responsibility as other high priority situations develop.

a. REGION 1. Develop operational plans for:

- (1) Dallas metropolitan area for natural/man-made disaster and civil disturbance.
- (2) Fort Worth metropolitan area for natural/man-made disaster and civil disturbance.
- (3) Civil disturbance in any part of region.
- (4) Natural/man-made disaster in any part of region.

b. REGION 2. Develop operational plans for:

- (1) Houston metropolitan area for natural/man-made disaster and civil disturbance.
- (2) Beaumont metropolitan area for natural/man-made disaster and civil disturbance.
- (3) Port Arthur metropolitan area for natural/man-made disaster and civil disturbance.
- (4) Baytown metropolitan area for natural/man-made disaster and civil disturbance.
- (5) Galveston metropolitan area for natural/man-made disaster and civil disturbance.
- (6) Hurricanes from Matagorda County to Jefferson County. Plans should include two counties deep along the coast.
- (7) Civil disturbance in any part of the region.
- (8) Natural/man-made disaster in any part of the region.

d. REGION 3. Develop operational plans for:

- (1) San Antonio metropolitan area for natural/man-made disaster and civil disturbance.
- (2) Corpus Christi metropolitan area for natural/man-made disaster and civil disturbance.



(3) Laredo metropolitan area for natural/man-made disaster and civil disturbance.

(4) Rio Grande metropolitan area for natural/man-made disaster and civil disturbance.

(5) Hurricanes from Cameron County to Calhoun County. Plans should include two counties deep along the coast.

(6) Civil disturbance in any part of the region.

(7) Natural/man-made disaster in any part of the region.

e. REGION 4. Develop operational plans for:

(1) El Paso metropolitan area for natural/man-made disaster and civil disturbance.

(2) Midland/Odessa metropolitan area for natural/man-made disaster and civil disturbance.

(3) Abilene metropolitan area for natural/man-made disaster and civil disturbance.

(4) Civil disturbance in any part of the region.

(5) Natural/man-made disaster in any part of the region.

f. REGION 5. Develop operational plans for:

(1) Lubbock metropolitan area for natural/man-made disaster and civil disturbance.

(2) Amarillo metropolitan area for natural/man-made disaster and civil disturbance.

(3) Wichita Falls metropolitan area for natural/man-made disaster and civil disturbance.

(4) Civil disturbance in any part of the region.

(5) Natural/man-made disaster in any part of the region.

g. REGION 6. Develop operational plans for:

(1) Austin metropolitan area for natural/man-made disaster and civil disturbance.

(2) Waco metropolitan area for natural/man-made disaster and civil disturbance.

(3) Temple metropolitan area for natural/man-made disaster and civil disturbance.

(4) Civil disturbance in any part of the region.

(5) Natural/man-made disaster in any part of the region.

2. DEFINITIONS. Civil Disturbance condition (CIDCON). CIDCONS are those required conditions of preparedness to be attained in preparation for or deployment to an objective area in response to an actual or threatened civil disturbance. (See Tabs A through E).

3. SCOPE. The CIDCON system is specifically tailored to the civil disturbance mission. This system will be implemented within all task force units.

4. GUIDANCE. This appendix provides policy guidance for use among all task force units on actions to be taken upon possible deployment of forces for civil disturbances operations. Changes in reaction posture (e.g. CIDCON 5 to CIDCON 4) will be directed by the Adjutant General.

TABS: Civil disturbance Conditions

- A - CIDCON 5
- B - CIDCON 4
- C - CIDCON 3
- D - CIDCON 2
- E - CIDCON 1

TAB A (CIDCON 5) TO APPENDIX 3 (High Priority Objective Areas)  
TO ANNEX C (Military Assistance/Operations) AGTX MSCA OPLAN.

1. Definition. The degree of preparedness required to sustain MSCA operations while maintaining the requirements of deployment preparedness, and equipping of forces for their CAPSTONE missions.

2. SITUATION. Normal.

3. ACTION LIST.

a. Continue normal operations and be prepare to assume a higher state of readiness if directed.

b. Maintain all MSCA plans in a current status.

c. Be prepared to attain CIDCON 4 as rapidly as possible.

d. Maintain liaison with civil authorities in area of responsibility.

e. Unit commanders will identify those personnel IAW FORMDEPS, Volume 3, RCUH who are trained and qualified for civil disturbance control operations. Those personnel not qualified will be used only in logistical/administrative support roles.

TAB B (CIDCON 4) TO APPENDIX 3 (High Priority Objective Areas)  
TO ANNEX C (Military Assistance/Operations) TO AGTEX MSCA OPLAN

1. DEFINITION. A condition whereby selected task force units have been designated for response to a civil disturbance and increased liaison with civil authorities in objective area has been directed.

2. SITUATION. A civil disturbance has develop which could result in a requirement for National Guard Troops.

3. ACTION LIST.

a. Task force commanders will be informed and will keep their superiors informed as to where and how they can be contacted without delay.

b. Task force commanders will notify all unit commanders within their task force. Troops will not be notified.

c. Subordinate commanders down to battalion level will maintain a duty officer/NCOIC at their headquarters on a 24 hour basis.

d. Maintain all MSCA plans in a current status.

e. Coordinate any special support required from subordinate, lateral, or higher commander necessary for the plan.

f. Emergency radio net is activated and monitored.

TAB C (CIDCON 3) TO APPENDIX 4 (High Priority Objective Areas)  
TO ANNEX C (Military Assistance/Operations) TO AGTEX MSCA OPLAN

1. DEFINITION. A condition whereby designated forces are alerted, assembles and prepared for movement to an objective area.

2. SITUATION. Situation in the objective area(s) continues to deteriorate.

3. ACTION LIST.

a. Upon notification personnel will move rapidly to local assembly area. Task force must be assembled, loaded and ready for movement within six hours of notification of CIDCON 3.

b. Advance parties will be prepared for movement to the objective area on order.

c. Loading plans will be implemented and vehicles prepared for movement.

d. A communications check will be made of all radios and radio nets.

e. Movement plans will be reviewed.

f. An orientation and safety briefing will be given to all personnel.

g. A check will be made to ensure all personnel have required items of individual clothing and equipment to include GTA 21-2-7 (Tab A reprint GTA 21-2-7) to Appendix 6 Special Orders to Annex C (Military Assistance/Operations)

h. Units furnishing vehicle support to another unit will dispatch the required number of vehicles to the supported unit.

i. Ammunition will be issued based on situation.

j. The Headquarters issuing CIDCON 3 order will be notified when the task force is ready for movement. The task force will be considered "ready" when 75% of assigned strength has been assembled and all required vehicles are on hand and loaded for movement.

k. Task force commanders effect liaison with local police authorities in their area of responsibility.

l. Submit reports as required.

TAB D (CIDCON 2) TO APPENDIX 3 (High Priority Objective Areas)  
TO ANNEX C (Military Assistance/Operations) TO AGTEX MSCA OPLAN

1. DEFINITION. This is a movement order. On attainment of CIDCON 2, sufficient elements of the designated forces have assembled and first vehicle has crossed the Start Point to the objective area.
2. SITUATION. Situation in the objective area(s) has deteriorated to the point that movement to the objective area(s) has been directed by the Adjutant General.
3. ACTION LIST.
  - a. Advance parties dispatched.
  - b. Main body elements cross SP.
  - c. Task force commander will report CIDCON 2 to AGTX when the head element of the main body crosses the SP.
  - d. Task force commander notifies AGTX when main body clears SP.
  - e. Task force commander notifies AGTX when his force has closed into the objective.
  - f. Submit reports as required to AGTX.

TAB E (CIDCON 1) TO APPENDIX 3 (High Priority Objective Areas)  
TO ANNEX C (Military Assistance/Operations) TO AGTEX MSCA OPLAN

1. DEFINITION. This is a "DEPLOYMENT ORDER".

2. SITUATION. Situation in the objective area(s) has deteriorated to the point where deployment of troops is required.

3. ACTION LIST.

a. Task force commander deploys forces in the objective area(s).

b. The major military unit within the area of responsibility will ordinarily be collocated with or as close as practical to the police precinct headquarters in the assigned area of responsibility.

c. Units will deploy the maximum number of motor and foot patrols in the objective area consistent with mission requirements.

d. Static guard positions will be kept to the minimum consistent with mission accomplishment. Security of command posts, base areas, and critical installation will normally require static guards. When necessary to restore law and order or to prevent a probable breakdown in law and order, it may be necessary to saturate a particular area with static guards in combination with patrols.

APPENDIX 4 (APPLICATION OF FORCE/RULES OF ENGAGEMENT) TO ANNEX C  
(Military Assistance/Operations) AGTX MSCA OPLAN

References: See Annex K

1. SITUATION.

a. General. This appendix provides the rules of engagement (ROE), specific guidance on use of force, and other pertinent responsibilities in providing for Military Support to Civil Authorities (MSCA).

b. Enemy. See basic plan and Annex B.

c. Friendly. See basic plan.

2. MISSION. See basic plan.

3. EXECUTION. Use of military forces will, unless directed by higher authority, be governed by the rules of engagement (ROE) in this appendix. Texas Military forces are authorized to implement these ROE based on mission specific operations. Implementing ROE will follow the guidance of this appendix.

a. Concept of Operations.

(1) General. Texas STARC/EOC will be utilized for specific plans and control of forces and resources provided to assist civil authorities.

(2) In the event of a loss of communications with the Major Command Headquarters and/or the AGTX EOC, all commanders are authorized to respond to requests from the civil sector to save lives or prevent human suffering.

b. U. S. National Policy. Upon plan execution, military forces may protect key civilian assets and conduct military operations in response to hostile acts within the state. Military operations may include:

(1) All lawful military measures required to defend citizens and property within the state.

(2) All lawful military measures required to defend key facilities against hostile treat.



c. APPLICATION OF FORCE. The following guidance is provided for the use of force in response to unauthorized action by the civilian populace.

(1) Minimum force consistent with mission accomplishment will be used by military personnel. (See Appendix 6 Special Orders, this Annex)

(2) The use of force to prevent looting and to detain persons caught in the act of looting may become necessary. The amount of force is that which is reasonably necessary under the circumstances.

(3) Riot control formations are used to disperse massed mobs which do not react to orders of the control force instructing them to disperse and retire peaceably to their homes. The employment of such formations is a show of force and has a strong psychological effect on any crowd. While the use of fixed bayonets can add considerably to this effect, there is a danger of intentional or accidental injury to nonviolent participants or fellow law enforcement personnel. Therefore, its risk must be considered and only an amount of force applied that is reasonably necessary under the circumstances.

(4) An officer will retain control over the loading of weapons until such time as the need for such action is clearly established. Command and control arrangements should be specifically designed to facilitate such careful control of deadly weapons.

(5) The presence of loaded weapons in these tense situations may invite the application of deadly force. In addition, it increases the hazard that the improper discharge of a weapon by one or more individuals will lead others to reflex response on the mistaken assumption that an order to fire has been given. Officers should be clearly instructed that they have a personal obligation to withhold permission for loading until circumstances indicate a high probability that deadly force will be immediately necessary and justified. Strong command supervision must be exercised to assure that the loading of weapons is not authorized in a premature or blanket manner.

(7) Ammunition for individual weapons will be retained at Task Force Headquarters. Ammunition will not be distributed, except on the approval of the controlling headquarters, in the objective area. The AGTX EOC may withhold the authority to use deadly force or load live ammunition, provided that such withholding is not inconsistent with these ROE. Once approval is provided through channels, Task Force commanders are authorized to have live ammunition issued to personnel under their command.

(8) Force options for determining how troops may be armed to accomplish the mission are enumerated below: \*

RIFLE	BAYONET		AMMUNITION	
	SCABBARD	BAYONET	MAGAZINE/CLIP	CHAMBER
At sling	On belt	In scabbard	In pouch on belt	Empty
At port	On belt	In scabbard	In pouch on belt	Empty
At port	On belt	Fixed**	In pouch on belt	Empty
At port	On belt	Fixed**	In weapon***	Empty
At port	On belt	Fixed	In weapon***	Round
			Chambered	

(a) \*While each of the above options represents an escalation in the level of force, they are not necessarily sequential. A commander may initially select the first option or proceed from one to another in any particular order. However, the option selected must be appropriate for the existing threat, and not violate the minimum necessary force principle.

(b) Rifles capable of automatic fire must be modified to prevent automatic operation. The M-16 lock plate is issued for modification of the M-16 Rifle and will be installed.

(c) Troops may be armed with riot batons in lieu of rifles.

(9) Texas military units are authorized to use force, including deadly force when necessary, to accomplish assigned military operations and protect the lives of the civilian population. Individual soldiers will be instructed that they may not load their weapons, except when authorized by an officer. However, if they are not under the direct control and supervision of an officer, the individual soldier must comply with all three of the following circumstances:

(a) Lesser means have been exhausted or unavailable.

(b) The risk of death or serious bodily harm to innocent persons is not significantly increased by its use.

(c) The purpose of its use is one or more of the following:

1 Self-defense to avoid death or serious bodily harm.

\* 2 Prevention of a crime which involves a substantial risk of death or serious bodily harm (for example, setting fire to an inhabited dwelling or sniping), including the defense of other persons.

3 Prevention of the destruction of public utilities or similar property vital to public health or safety.

4 Detention or prevention of the escape of persons against whom the use of deadly force has been authorized.

(10) In addition, the following policies in the use of deadly force will be observed:

(a) When deadly force is used, where possible, aim to wound, not to kill.

(b) When possible, a clear warning to the individual or group that use of deadly force is contemplated or imminent should be given.

(c) In order to avoid firing which creates a hazard to innocent persons and can create the mistaken impression on the part of citizens that sniping is widespread, warning shots will not be employed.

(d) Where other means have failed and firing is necessary to control sniping, well-aimed fire by expert marksmen will be used wherever possible and the number of rounds will be kept to a minimum to reduce the hazards to innocent persons.

d. All instances wherein DEADLY FORCE is employed by State Military Forces, whether or not injury or death results, will be reported immediately through operational channels to AGTX-OTM or the AGTX EOC, if activated, to include all known details. The task force commander will submit a follow-up written investigative report, within eight hours of the incident, to include the names of personnel involved and complete circumstances of the incidents. Any expenditure of conventional ammunition, accidental or intentional, whether or not injuries resulted, will be considered, for reporting purposes as an "Application of Deadly Force" and will be reported.

e. Authority to employ riot control agents is delegated to Task Force Commanders. Task Force Commanders are authorized to delegate the authority to use riot control agents and other non-deadly forces at their discretion.

f. Unit Commanders will assign by roster (attach roster to Civil Disturbance Plan) team members to operate and maintain special items of civil disturbance control equipment (i.e. shotguns, grenade launchers, chemical disperser). These individuals will not be assigned this duty until they are trained to operate and maintain the equipment.

STOP

g. Unit Commanders will prepare SOP's for the use/guidance of all chemical disperser operating personnel to include vehicle drivers and helicopter pilots. Included in the SOP should be specific individual duties and actions to be performed before, during and after operation of the disperser.

h. Custody and Detention of Civilians. Whenever possible, civilian police authorities should take personnel into custody. When assistance is necessary or in the absence of civilian police, military forces have the responsibility and legal authority to detain or take into custody personnel threatening or suspected of threatening key assets. However, the unit detaining any civilians must complete a record of the detention (See Appendix 3 to Annex J). Detained or apprehended nonmilitary personnel must be transferred to civilian law enforcement authorities as soon as possible. Military personnel will promptly furnish any information required by civilian police to secure an arrest, indictment, presentment, information and/or trial of suspects. In addition, military personnel, in cooperation with local Department of Justice law enforcement personnel, could provide, operate or maintain civilian detention facilities.

i. Troop Orientation. All personnel, prior to participation in MSCA operations, will be briefed as to:

- (1) The background, situation and unit's mission.
- (2) Rules governing the application of force as they apply to the specific situation.
- (3) The role of civil authorities who will assist military operations.
- (4) Identification markings used by officials assisting military operations.

j. Martial Law.

(1) Martial law is the law exercised in domestic (US) territory when civil authorities are no longer able to maintain law and order and there is no power left except for the military.

(2) Martial law depends on public necessity for its justification. The public necessity for imposing martial law depends upon the inability of the civil authorities to function and upon the extent of military force contemplated if martial law is imposed.

(3) Martial law is imposed by Presidential proclamation. This proclamation may, or may not, contain additional instructions concerning the exercise of martial law.

(4) Limitation on the Use of Military Forces. The posse Comitatus Act (18 U.S.C. 1385) states, "Whoever, except in cases and under circumstances expressly authorized by the Constitution or Act of Congress, willfully uses any part of the Army or the Air Force as a posse comitatus or otherwise to execute laws, shall be fined not more than \$10,000 or imprisoned not more than two years, or both. Military operations in consonance with this OPLAN and presidential executive orders and proclamations do not violate this act.

4. ADMINISTRATION AND LOGISTICS.

A. No change from basic order.

5. COMMAND AND CONTROL

A. No change from basic order.

APPENDIX 5 (MISSION GUIDANCE) TO ANNEX C (Military Assistance/Operations) TO AGTX MSCA OPLAN

1. ACCEPTABLE: Task force commanders must be extremely cautious in accepting or rejecting requests to perform certain missions. The following guidelines are provided; however, they do not preclude specific missions being assigned with the order to state active duty by the Adjutant General.

a. Missions of immediate necessity that require immediate action to prevent undue human suffering, loss of life and/or damage to property.

b. Law enforcement and security: Providing forces to work with local, county and/or state law enforcement agencies in law enforcement roles, to include traffic and crowd control, protection of public property and prevention of looting.

c. Evacuation: Limited to capabilities of unit in emergency situations. No authority exists for forced evacuation of civilian personnel.

d. Rescue: Limited to light rescue in emergency situations. A secondary mission only.

e. Emergency Communications: Assist in establishment of communications to support civil authorities within organic means and other support available at state level. We do not possess a large quantity of generators for emergency power. This type equipment should be obtained within the local jurisdictions.

f. Emergency Feeding Limited: Units have capability to feed organic personnel. Mass feeding missions will not be accepted.

g. Transportation of Equipment and/or Supplies: Limited to emergency use items such as medicines and small items of equipment of immediate necessity where there is no civilian transportation capability.

h. Assistance to Fire Fighters: The Guard can provide manpower to augment professional fire fighters. Lack of equipment and trained personnel preclude acceptance of fire fighting as a primary mission.

2. NON-ACCEPTANCE MISSION: These types of missions are normally not life threatening and are within the capability of the local community.

a. Debris Clearance/Removal: This is an emergency service that can be handled by civilian resources during the recovery phase and should not be accompanied by State Military Forces.

b. Restoration of utilities is the responsibility of public utility companies.

c. Return of Civilian Property: State Military Forces will not assume the responsibility of returning civilian property items lost during disaster of disturbance. This is a local authority function.

c. Burying of Dead Livestock and Animals: There is adequate civilian capability to perform this mission.

APPENDIX 6 (SPECIAL ORDERS) TO ANNEX C (Military Assistance/Operations) TO AGTX MSCA OPLAN

1. Purpose. To provide the individual soldier with rules of behavior when engaged in a civil disturbance operation.

2. SPECIAL ORDERS.

a. GTA 21-2-7 "Special Orders", dated December 1970, provides a list of rules of behavior for the individual soldier when engaged in civilian disturbance operations. A reprint of GTA 21-2-7 is furnished (See Tab A).

b. Distribution of the GTA's has been made to the major commands, with instructions for further distribution to units most likely to be involved in civil disturbance operations. Additional supply of the GTA may be ordered from AGTX-PEP.

c. Additional supply of the GTA is on hand in the AGTX-PEP office and distribution will be made to Task Force Commanders when it appears that they may become involved in a civil disturbance operation.

d. These GTA's will not be issued to individuals except when the unit is committed in an actual civil disturbance operation. The use of these GTA's for training purposes is authorized; however, strict accountability must be maintained.

TAB: A - REPRINT GTA 21-2-7



TAB A (REPRINT GTA 21-2-7) TO ANNEX 6 (SPECIAL ORDERS MILITARY ASSISTANCE/OPERATION) TO ANNEX C (Military Assistance/Operations) TO AGTX MSCA OPLAN

GTA 21-2-7  
DECEMBER 1970  
(SUPERSEDES  
GTA 21-2-7  
JANUARY 1969

SPECIAL ORDERS  
FOR ALL MILITARY PERSONNEL  
ENGAGED IN CIVIL DISTURBANCE OPERATIONS

1. CARRY OUT YOUR ASSIGNED DUTIES IN A MILITARY MANNER AND PRESENT A NEAT MILITARY APPEARANCE AT ALL TIMES. BE SURE THAT EVERYTHING YOU DO REFLECTS CREDIT UPON YOUR COUNTRY, THE MILITARY SERVICE, UNIT, AND YOURSELF.
2. HAVE REGARD FOR THE HUMAN RIGHTS OF ALL PERSONS. BE AS COURTEOUS TOWARD CIVILIANS AS POSSIBLE UNDER THE CIRCUMSTANCES. DO NOT MISTREAT ANYONE OR WITHHOLD MEDICAL ATTENTION FROM ANYONE NEEDING IT. DO NOT DAMAGE PROPERTY UNNECESSARILY.
3. USE ONLY THE MINIMUM AMOUNT OF FORCE REQUIRED TO ACCOMPLISH YOUR MISSION AND, IF NECESSARY, TO DEFEND YOURSELF. WHEN UNDER THE CONTROL OF AN OFFICER, YOU WILL LOAD OR FIRE YOUR WEAPON ONLY ON HIS ORDERS. WHEN NOT UNDER THE CONTROL OF AN OFFICER, YOU WILL LOAD OR FIRE YOUR WEAPON ONLY WHEN REQUIRED TO PROTECT PROPERTY DESIGNATED AS VITAL TO PUBLIC HEALTH OR SAFETY, OR TO PREVENT THE ESCAPE OF PERSONS ENDANGERING LIFE OR VITAL FACILITIES; YOU ARE NOT AUTHORIZED TO USE FIREARMS TO PREVENT OFFENSES WHICH ARE NOT LIKELY TO CAUSE DEATH OR SERIOUS BODILY HARM, NOR ENDANGER PUBLIC HEALTH OR SAFETY.
4. WHEN FIRING IS NECESSARY, SHOOT TO WOUND, NOT TO KILL.
5. WHEN POSSIBLE, LET CIVILIAN POLICE ARREST LAW BREAKERS. WHEN ASSISTANCE IS NECESSARY OR IN THE ABSENCE OF THE CIVIL POLICE, YOU HAVE THE DUTY AND THE AUTHORITY TO TAKE LAW BREAKERS INTO CUSTODY. TAKE SUCH PERSONS TO THE POLICE OR DESIGNATED MILITARY AUTHORITIES AS SOON AS POSSIBLE. COOPERATE FULLY WITH THE POLICE BY SAFEGUARDING EVIDENCE AND COMPLETING RECORDS AS INSTRUCTED.
6. ALLOW PROPERLY IDENTIFIED NEWS REPORTERS FREEDOM OF MOVEMENT, SO LONG AS THEY DO NOT INTERFERE WITH THE MISSION OF YOUR UNIT.

C-6-A-1

Z 0017130

7. DO NOT TALK ABOUT THIS OPERATION OR PASS ON INFORMATION OR RUMORS ABOUT IT TO UNAUTHORIZED PERSONS; REFER ALL CIVILIANS WHO ASK FOR INFORMATION ABOUT WHAT YOU ARE DOING TO YOUR COMMANDING OFFICER.

8. BECOME FAMILIAR WITH THESE SPECIAL ORDERS, AND CARRY THIS CARD ON YOUR PERSON AT ALL TIMES WHEN ENGAGED IN CIVIL DISTURBANCE OPERATIONS.

DISTRIBUTION:

ONE PER OFFICER, WARRANT OFFICER, AND ENLISTED PERSON ENGAGED IN CIVIL DISTURBANCE OPERATIONS.

C-6-A-2

Z 0017131

APPENDIX 7 (SEARCHES) TO ANNEX C (Military Assistance/Operations  
to AGTX MSCA OPLAN

1. PURPOSE. To Provide guidance on the responsibilities of personnel in the conduct of searches.

2. SEARCHES.

a. In carrying out the mission to help restore and maintain law and order, personnel may conduct searches of individuals and private property (including automobiles) in the following situations:

(1) If there is a reason to believe that an individual is armed or is carrying instruments of violence, a search of the individual for such weapons is authorized (females will be detained and released to the custody of police authorities).

(2) If there is reason to believe that an individual who has committed a crime of violence is hiding in a building or automobile, a search of the building or automobile, for the individual is authorized.

(3) If there is reason to believe that a vehicle contains weapons or instruments of violence, a search of the vehicle is authorized in order to prevent use of the weapons or instruments of violence.

b. As a general rule, such searches should be carried out by local and state law enforcement personnel because of their greater familiarity with standards of searches, including judicial warrants. However, personnel may be authorized to conduct such searches if it is determined that it is reasonably necessary to the accomplishment of the mission and that there is an immediate danger of violence unless the search is begun without delay. The task force commander may delegate the authority to authorize searches to subordinate military commanders not lower than the grade of Lieutenant Colonel. The commander authorizing such search will, as soon as is reasonably convenient, fully document the reasons for the search, including the events which lead to the decision to search. The commander authorizing such search will identify those things sought, and the source and content of the information leading to the conclusion that the items sought will probably be found in the place searched.

APPENDIX 8 (SNIPERS, ARSONISTS AND LOOTERS) TO ANNEX C (Military Assistance/Operations) to AGTX MSCA OPLAN

1. PURPOSE. To provide guidance for neutralizing the sniping and looting threat.

2. SNIPERS AND ARSONIST. The following procedures will facilitate the apprehension of snipers and arsonists:

a. Isolate the building or area where suspect is concealed, use of APCs or commercial armored truck is desirable.

b. Attempt to persuade the suspect to surrender by use of "Bull Horn" or other amplifying systems.

c. Conduct a room by room, floor by floor search. Evacuate building as the search progresses.

d. Attempt to flush the suspect into the open by discriminate use of riot control agents.

e. If all other methods fail, use selected fire (single shot) at specific individual targets by expert marksmen. Every effort will be made to minimize the danger to innocent individuals.

f. Artificial illumination should be used during the hours of darkness.

3. SECURITY OF FIREFIGHTING CREWS. Security guards will be provided for firefighting crews to protect them from snipers and arsonists while operating in disturbance area(s). Roof top and ground level surveillance and a maneuver capability are a necessity, helicopter surveillance desirable.

4. LOOTERS. The following measure will be employed in neutralizing the tactics of looters:

a. Isolate the affected area to prevent an increase in number and the spread of the looting.

b. Apprehend the looters quickly and promptly remove them from the area.

c. Automobiles or trucks suspected of containing goods looted from business establishment will not be searched but vehicle and occupants will be detained and turned over to police authority as soon as practicable.

d. Saturate the area with static guard and foot patrols and/or motor patrols.

5. ARREST. All arrests should be made if possible, by the civil police. Police and military forces should be jointly employed so that police will be readily available to arrest persons detained by military personnel. Detainee and property identification forms for use in prosecution will be issued at home armories. Completed detainee forms, evidence tags, and evidence will be transferred with detainee to civil authorities.

Adjutant General's Department of Texas  
Austin, Texas  
13 July 1992

ANNEX D (LOGISTICS/SERVICE SUPPORT) TO AGTX MSCA OPLAN

Time Zone Used Throughout The Plan: SIERRA  
References: Annex K (References)

1. SITUATION.

a. Military resources may be called for in a disaster relief/emergency domestic situations, when the capability of the private sector to provide relief has been exceeded.

b. Friendly Forces, Basic Plan.

2. MISSION. To provide logistics planning and guidance to military forces in preparation for and/or subsequent deployment for conducting military support operations.

3. CONCEPT OF LOGISTICS SUPPORT.

a. Current logistics policies and directives apply unless modified herein or by subsequent directives.

b. Forces will be equipped at home station with supplies needed to the fullest extent possible.

c. Resupply will be as indicated in paragraph 5, this annex.

d. Military forces participating in a disaster relief/domestic emergency operation will coordinate all logistics needs through channels to the Major Command Headquarters. In the event of unresolved logistics problems, Major Command Headquarters will contact AGTX-OTM, or if activated, the AGTX EOC.

e. Existing intraservice, interdepartmental/agency, and intraservice support agreement will be used as necessary. New support agreements will be arranged as required. All arrangements for exchange of support by intraservice, interdepartmental/agency, or intraservice support agreements will be documented IAW DODD 4000.19R, AR 1-35, and AR 37-49.

f. Procurement support will be provided IAW provisions of FORSCOM Reg 700-2.

g. Consideration will be given to contracting for services and/or resources in the disaster area if like military support would be more costly to provide, or would be neither timely nor responsive. Requests to contract for supplies/services will be submitted through channels to the Major Command Headquarters.

#### 4. RESPONSIBILITIES.

##### a. HQ, STARC.

(1) Provide military forces for possible military support operations.

(2) When required, dispatch a Logistic Liaison Team (LLT) to the appropriate disaster/domestic emergency area(s) to render maximum support to the TF commanders.

#### 5. MATERIEL AND SERVICES.

a. General. All military units tasked to support disaster relief/domestic emergency operations will deploy with only the minimum mission essential TOE, TDA, and individual equipment necessary to accomplish the mission. This annex provides service support guidance to units of the Texas National Guard ordered to State Active Duty by the Governor of the State of Texas. Attention is directed to SOP for State Active Duty, AGTX. The following paragraphs are for further information/direction.

##### b. Supply.

(1) Class I: Three days operational rations meal-ready to eat (MRE). Local procurement authorized as directed by the Task Force Commander. Cost of rations and procedures for payment will be in accordance with State Active Duty SOP.

(2) Class II, and as directed, VII, VIII, IX: Units will deploy with minimum/necessary quantities of these supplies to support military assistance operations.

(a) Task Force Commanders are authorized to utilize all TOE, TA and specialized items of equipment issued to units of their command.

(b) Request for resupply of authorized TOE and TA items will be through normal supply channels to USPFO. Each task force will report their Class I - IX status through channels IAW Appendix 5 to Annex J to the AGTX EOC SOP.

(c) Task Force Commanders will request authority through channels from AGTX-EOC for local procurement of specialized items including medical supplies that are not available from USPFO stocks. Procedures for payment will be in accordance with AGTX SOP for State Active Duty.

(3) Class III. Military sources will be used if readily available. Credit cards as required will be provided to committed forces by the appropriate support installation. Bulk purchases from commercial sources are authorized when military sources are not available. Local procurement from wholesale vendors is authorized as directed by the Task Force Commander. Procedures for payment will be in accordance with AGTX SOP for State Active Duty or TXARNG COMPTLOG.

(4) Class V. All Federal ammunition will be pre-located at Camp Mabry and requests will be made to AGTX-SL.

(a) In accordance with procedures established by the installation commander responsible for logistics support in the disaster area.

(b) Priority. An issue priority designator of "03" will be used on all requisitions submitted for short supply or equipment for mission accomplishment by a committed task force.

(c) The USPFO will be prepared to ship ammunition as directed by the AGTX EOC. A Warning Order and Point of Contact (POC) will be issued to USPFO by the EOC. Upon receipt of this Warning Order direct coordination between USPFO and Task Force Commander is authorized. The Task Force commander will request type and quantity of ammunition from USPFO, through AGTX EOC, and will coordinate time, location and method of delivery.

(d) The USPFO will prepare plans for shipment of ammunition on pallets by surface or air transportation to areas designated by the Task Force Commander.

c. Services.

(1) Billeting.

(a) Forces must be equipped to bivouac under field conditions in the event that suitable indoor facilities are not available.



(b) In obtaining billets, first consideration will be given to the use of buildings and/or areas under control of the military or other federal agencies. Arrangements for the use of other facilities will be coordinated with the TF headquarters.

(2) Food Services.

(a) The supporting installation commander will provide "A" rations to forces in the disaster/domestic emergency area as soon as possible after their arrival.

(b) Needs for refrigeration equipment will be submitted to the TF headquarters and furnished within capabilities by the installation tasked to support forces in the objective area.

(3) Laundry.

(a) As an exception to paragraph 1-15, AR 210-130, where task force are deployed from their home stations, authorization is granted to provide laundry services to military personnel at government expense. Whenever possible, laundry service will be provided through government fixed or mobile laundry facilities.

(b) Laundry service will be provided through commercial contractual arrangements only when the commander tasked to provide logistical support for the TF determines that suitable service is not otherwise available.

(c) Action will be initiated to provide laundry service to personnel at the earliest possible date. In planning for laundry service, a processing time not to exceed 48 hours, including weekends and holidays, is desirable. Task Force Commanders will request authority through channels from the AGTX EOC for utilization of commercial laundries for laundering individual uniforms. Procedures for payment will be in accordance with State Active Duty SOP.

(4) Bath.

(a) Provided by nearest military installation, if practical.

(b) Provided by mobile bath or decontamination units, if available. Environmental restrictions will be observed.

(c) If military or other government facilities are not available, high schools, armories, and recreational facilities may be used after necessary coordination with local officials. Use must be cleared with the TF headquarters.

(5) Mortuary Affairs. See AR 600-10 and AR 638-40.

d. Maintenance.

(1) TF elements will perform organizational maintenance on organic equipment moved to the disaster/domestic emergency area. Maintenance services for all technical service equipment will be provided by organic maintenance elements of assigned and/or attached units. Maintenance requirements beyond organic capability will be furnished by the nearest CSMS activity upon request by the Task Force Commander through channels to the AGTX EOC.

(2) Direct Support/General Support (DS/GS) maintenance needs will be coordinated with the TF headquarters and furnished by the installation tasked to support forces.

(3) Requests for mobile maintenance teams will be submitted to the TF headquarters.

(4) Organizational Maintenance Shop (OMS) will be used whenever possible after coordination with TF headquarters.

(5) Salvage. As directed by USPFO through the AGTX EOC.

6. ENGINEER.

a. Real Estate. Federal, state, or municipal buildings will be used whenever possible. Requests for commercial/private sector facilities will be coordinated by the TF headquarters.

b. Utilities.

(1) Electric power will be provided from existing real property facilities. Additional requirements will be satisfied through coordination with the TF headquarters.

(2) Water will be from approved sources only and coordinated through the TF headquarters.

(3) Sanitation will be through use of local sanitation facilities wherever possible. Coordination for additional facilities will be through TF headquarters. Fabrication or purchase of chemical latrines or negotiation of a service contract for commercial services may be feasible if local sanitation facilities are inadequate.

7. MEDICAL SUPPORT/EVACUATION AND HOSPITALIZATION. See Appendix 2, this Annex, and AGTX SOP for State Active Duty.

a. Army medical support may be provided in disaster relief upon request of appropriate civil authority. Support provided will be on a minimum essential basis and terminated at the earliest practical time.

b. Emergency movement of nonmilitary patients in Army aircraft may be authorized to the nearest medical facility where adequate care is available. Coordinate requests through channels to the AGTX EOC.

8. PERSONNEL. See Annex C, and AGTX SOP for State Active Duty.

9. TRANSPORTATION. Appendix 1, this Annex.

10. FINANCE. For guidance on fiscal matters related to units of Texas Military Forces ordered to State Active Duty by the Governor of the State of Texas, see SOP for State Active Duty, AGTX, Finance Annex. Procurement and expenditure of funds will be coordinated through AGTX-SA, IAW TXARNG COMPTLOG and Annex E, AGTX SOP for State Active Duty.

Appendices:

- 1 - Transportation
- 2 - Medical Support

Adjutant General's Department of Texas  
Austin, Texas  
13 July 1992

APPENDIX 1 (TRANSPORTATION) TO ANNEX D (Logistics/Service  
Support) TO AGTX MSCA OPLAN

1. GENERAL.

a. Upon order, Texas military units with accompanying equipment will deploy from home stations to areas affected by the natural disaster or domestic emergency.

b. Movement will be accomplished by military vehicles unless other means are directed.

c. Surface transportation support within the disaster/domestic emergency area is the responsibility of the task force commander.

d. Texas military forces will report movements IAW instructions furnished by their support installation or the installation responsible for deploying the force.

2. MOVEMENT OF MILITARY UNITS.

a. Concept for air movement. (TM 55-450 series).

(1) All units will submit requirements to HQ, STARC, to move their forces to and from home station to their support installation in the following format:

- (a) Unit, home station.
- (b) Desired onload air base.
- (c) Date/time available for loading.
- (d) Onload unit contact (names and telephone numbers).
- (e) Destination.
- (f) Required not later than due date (DTG) at destination.
- (g) Offload station unit contact (names and telephone numbers).

(h) Number of passengers and weight of accompanied handcarried baggage.

(i) Bulk cargo (not in vehicles by weight and cube. Give dimensions of largest item.

(j) Total weight, Short Ton (STON) and cubic feet of all cargo (do not include weight shown in (h) above).

(k) Vehicles include loaded cargo weights:

QUANTITY NOMENCLATURE WEIGHT(ea) CUBIC FEET(ea) DIMENSIONS  
(ea)

(1) Outsized/Overweight Items: (These items should be separate from (k) above).

QUANTITY NOMENCLATURE WEIGHT(ea) CUBIC FEET(ea)

(m) Special instructions/remarks - identify hazardous or dangerous cargo.

(2) Installation commanders responsible for deploying forces will provide:

(a) Necessary ground transportation for movement from home station to the departure airfield.

(b) Appropriate departure airfield control groups.

(3) The Base Support Installation (BSI) commander who will receive the deploying troops will provide:

(a) Necessary ground transportation from arrival airfield to final destination.

(b) Appropriate arrival airfield control groups.

b. Concept for surface movement.

(1) Military transportation will be used to the fullest extent in moving to and from disaster areas.

(2) Unit requirements in excess of organic capabilities will be reported to the support installation or the installation having responsibility for deploying the force.

(3) Convoy movement including movement of oversize/overweight vehicles will be executed IAW instructions contained in AR 55-29, AR 55-162, and FORSCOM Reg 55-1.

Adjutant General's Department of Texas  
Austin, Texas  
13 July 1992

APPENDIX 2 (MEDICAL SUPPORT) TO ANNEX D (Logistics/Service  
Support) TO AGTX MSCA OPLAN

REFERENCES. See Annex K

1. SITUATION. To identify procedures and requirements for medical support to military forces and civilian agencies involved in disaster response and to coordinate patient evacuation plans and procedures within the State of Texas.

a. General.

(1) Medical support to military forces employed in MSCA will be provided to the greatest extent possible by organic medical units. Medical care beyond the capability of these organic units will be provided by the nearest capable military medical unit. When neither of these type medical units can provide required care, the nearest capable civilian medical facility will be utilized.

(2) Victims rescued in the course of operations will, in many instances, require emergency medical care ranging from minor on-scene first aid to definitive treatment and hospitalization. Medical support will be provided by activated task forces medical personnel until civilian authorities are available to assume the mission.

b. Assumptions:

(1) See basic plan.

(2) Local and state medical resources will be overwhelmed and require augmentation from Texas Military Forces.

(3) National Guard medical units will be retained and employed by the Governor.

(4) Local and state OESSs and Emergency Medical Services (EMSSs) will be able to identify and establish or direct augmentation of TXARNG medical forces to casualty collection points and aeromedical evacuation points.

(5) Military medical personnel will not be available in sufficient numbers to meet all requests for support to health care facilities in a devastated area.

2. MISSION. To provide medical care to military forces employed in MSCA operations and, upon request, provide assistance and supplement state and local resources in response to public health and medical care needs following a major disaster.

3. EXECUTION.

a. Concept of Operations. Texas Military Forces must be prepared to provide medical support and services to military units and civilian agencies involved in disaster response operations. Medical units will accompany all task forces and provide medical support to their personnel and to all rescued victims who require it. They will stage and prepare for evacuation those patients who require additional definitive care. Ground and air ambulance units will transport these patients to hospitals at designated rear support bases.

(4) ASMRO will regulate reported casualties to an NDMS-FCC bed based upon bed availability reports and provide this information to the HQ MAC Patient Airlift Control Center for movement.

b. Coordinating Instructions.

(1) Refer to the Basic Plan for detailed information on coordinating instructions applicable to all military units engaged in MSCA operations.

(2) AGTX-EOC will establish and maintain liaison with the State Division of Emergency Management for medical activity.

4. LOGISTICS AND ADMINISTRATION.

a. Logistic issues (material, transport and fuels) are normally the responsibility of each Service, Department, Agency, or civil agency.

b. Medical units deploying in support of MSCA operations should deploy with at least three days worth of medical material.

c. Use of war readiness material including medical may be authorized and obtained from nearby military installations, contingent upon military needs and as guided by AGTX EOC directives.

5. COMMAND, CONTROL, AND COMMUNICATIONS.

a. Command of military forces employed in support of this plan remains with the military unit.

b. Control. Medical Support in the field is normally under the control of the senior medical representative to the city or the county or state emergency management system.

c. Communications.

(1) Communications between or among medical forces and other units/activities is normally by telephone and mobile radio systems.

(2) Additional communication support for medical operations is available through local and state ham radio operators.

(3) A courier or "runner" method of communication may need to be employed in the absence of electrical/HF radio capability.



3. EXECUTION:

a. Concept of Operation. The AGTX area communications system consisting of commercial telephone and teletype circuits, HF/SSB voice and FM radio nets will be implemented on a phased basis as required.

(1) Phase I - Planning and Periodic communication equipment operational checks.

(2) Phase II - The state owned emergency radio equipment package will be prepared for dispatch to supplement organic communication equipment.

(3) Phase III - All emergency operations net HF/SSB stations in the area of responsibility will man their stations on a twenty-four-hour basis for relay purposes. The Task Force Commander may approve and order installation of additional FM radio equipment packages and local telephone service as the situation requires.

(4) Phase IV - Upon completion of withdrawal operations, radio nets will be closed, logs will be closed out, and equipment secured on order by the Adjutant General.

b. Task to subordinate units.

(1) Task Force Commanders.

(a) Establish communications with the DPS and local law enforcement authorities by use of a hand held FM radio on 154.950 MHZ, if available, or by co-locating a radio team with a tactical radio with the local DPS/LAW enforcement dispatchers, if possible.

(b) Maintain communications with AGTX EOC at Camp Mabry, Austin, TX via the HF-SSB net using the current call signs and contact frequencies assigned.

(2) Aviation Bde, 49th AD. On order AGTX.

(a) Provide air messenger service on an on-call basis.

(b) Establish scheduled air messenger routes as the situation dictates.

(3) 249th Signal Battalion. On order AGTX.

(a) Provide Signal Support Team for AM and SSB radio communications between AGTX EOC and Task Force Headquarters.

(b) Additional communications support as available and as needed by committed task force.

(4) 254th Combat Communications Group. When directed by The Adjutant General, implement current TXARNG State OPLAN 2, (QUICK TALK), Emergency Communications.

(5) Texas State Guard. Coordinate with Army Guard Commanders to formulate plans to provide additional communications if directed by The Adjutant General.

c. Coordinating Instructions.

(1) Commercial telephone.

(a) Maximum use will be made of AUTOVON and State Telephone System services.

(b) Long distance telephone toll calls directly associated with natural disaster or civil disturbance operations will be made on Emergency Telephone Special Billing Number issued at the time unit is alerted for State Active Duty.

(c) Emergency hot line telephone and commercial teletype will be effected by this department with the approval of The Adjutant General only.

(2) Radio.

(a) Maximum use will be made of organic FM radio equipment to establish local command nets.

(b) All plans will include utilization of state owned FM and HF/SSB radio equipment as set out in the AGTX SOP for State Active Duty.

(c) Coordinate with local law enforcement agencies for the establishment of compatible communications.

4. SERVICE SUPPORT.

a. Maintain separate logs for each radio net and separate long distance toll call and STS call logs. Copies of all long distance toll call logs will be forwarded to AGTX-OTM.

b. AGTX SOP for State Active Duty.

5. COMMAND AND SIGNAL.

a. Signal.

(1) AGTX CEOI (AM) is in effect.

(2) TXARNG CEOI (Training) (FM) is in effect.  
(3) AGTX-CO has responsibility for ensuring these CEOIs are present in all units in the Texas Air & Army National Guard.

b. Command.

- (1) AGTX EOC - Command Post, Camp Mabry, Austin, Texas.
- (2) AGTX Forward - Command Post - To be announced.

(3) Subsequent to initial release, coordinate with AGTX-IO release of news of state or national interest in geographical area of responsibility.

(4) Provide news media assistance to correspondents in geographical area of responsibility.

4. PROCEDURES. See Annex G of the AGTX State Active Duty SOP.

5. ADMINISTRATION. See Annex G of the AGTX State Active Duty SOP. . . .

Adjutant General's Department of Texas  
Austin, Texas  
13 July 1992

ANNEX H (PERSONNEL/LEGAL) TO AGTX MSCA OPLAN

References. See Annex K

1. GENERAL. This annex provides instruction and guidance for planning and conducting the personnel mission in support of Texas Military Forces employed in providing assistance to civil authorities during domestic emergencies. Personnel policies, procedures, and responsibilities outlined in above references apply unless otherwise stated in or upon implementation of this plan.

2. REPORTS.

a. Annex M prescribes the reports required to support the personnel function for each type of operation. Additional reports will be requested as required.

b. Present casualty reporting system remains in effect IAW AR 600-10.

3. PERSONNEL MANAGEMENT.

a. Personnel and administrative support of deployed units/personnel normally will be the responsibility of parent installation/commands.

b. Direct coordination between the TF headquarters, parent installation/command, other Major Commands/AGTX installations, and AGTX-EOC is authorized.

c. Deployed strength of units will be defined by the AGTX-EOC in coordination with the Major Command Headquarters. Replacement policies and procedures remain in effect.

d. Individual records will not accompany units when deployed under this plan.

e. Use of civilian personnel will be in accordance with current regulations.

4. MILITARY LAW, DISCIPLINE, AND ORDER.

a. Commanders will ensure that personnel participating in disaster relief operations do not violate the provisions of The Posse Comitatus ACT (18 USC, Sec. 1385).

b. Maintenance of law and order, including the prevention of looting and plundering, is a civil responsibility. Military personnel designated to perform disaster relief or emergency assistance operations shall not be employed for such purposes except in the event of imminent serious conditions as described under Annex C.

c. National Guard Forces not in active federal service shall remain under the control of the Governor and shall be considered as part of the state resources available to assist civil law enforcement agencies in the performance of their duties. (See SOP for State Active Duty).

d. The administration of military justice shall remain a service responsibility.

e. Commanders authorized to convene courts-martial under Article 22, 23, or 24 of the Uniform Code of Military Justice shall retain such authority.

f. If military personnel are charged by civilian authorities of violating state or local laws, and such offenses arise from the performance of official duties, the AGTX-EOC shall be notified through command channels.

5. MORALE, RECREATION, AND WELFARE.

a. Unit Commanders will develop plans for the following :

(1) Support for family members of deployed personnel as required.

(2) Mail service to deployed units.

(3) Finance services, leave and passes, American Red Cross, religious services, and recreational activities for employed personnel/units.

b. Decorations and awards. Current policies and procedures apply.

6. USE OF MILITARY FORCES IN A LAW ENFORCEMENT ROLE. Every soldier has the right under law to use reasonable necessary force to defend himself or herself against violent and dangerous personal attack. (See Appendix 4 Application of force/Rules of Engagement of Annex C)

7. ADMINISTRATION OF MILITARY JUSTICE.

a. Commanders presently authorized to convene courts-martial shall retain that authority.

b. In the event it becomes necessary to attach units or individuals to a particular general court-martial jurisdiction for the administration of military justice, orders accomplishing such attachment shall be issued.

8. SERVICE SUPPORT. See basic plan Annex D and AGTX SOP for State Active Duty.

9. COMMAND AND CONTROL. See basic plan Annex E and AGTX SOP for State Active Duty.

3. RESPONSIBILITY. Commanders will ensure that leaders, both officer and NCO are aware of their responsibility to provide the requested support without exposing their troops to unnecessary risk. Further, they will be held accountable for accidents which occur.



Adjutant General's Department of Texas  
Austin, Texas  
13 July 1992

**ANNEX J (REPORTS) TO AGTX MSCA OPLAN**

Reference: See Annex K.

1. **GENERAL.** This appendix identifies the reporting procedures for MSCA Operations.
2. **PURPOSE.** To keep the AGTX Emergency Operations Center (EOC) and major subordinate commands informed of the status of all Texas Military Forces in support of State Emergencies.
3. **SUBMISSION RESPONSIBILITY.**
  - a. Commencing with the activation of State Military Forces all assigned forces at parent unit level (Company, separated platoon, detachment) will submit reports by the most expeditious means available through channels to AGTX EOC.
  - b. Subordinate headquarters will list and consolidate unit totals on each report.
  - c. Formats shown will be used by all reporting entities.
4. **FREQUENCY.** As noted in each report.

**APPENDICES:**

- 1- SPOT INTELLIGENCE REPORT
- 2- INTELLIGENCE SUMMARY
- 3- DETAINEE TURNOVER RECORD
- 4- PERSONAL STATUS (PERSTAT) - PERSONNEL STATUS REPORTS  
SAMPLE FORMAT
- 5- LOGISTIC REPORT  
TAB A - LOGISTICS STATUS REPORT FORMAT

APPENDIX 1 (SPOT INTELLIGENCE REPORT) TO ANNEX J (Reports) TO  
AGTX MSCA OPLAN

1. PURPOSE.

a. Spot intelligence reports (SPIREPS) are submitted as a continuing requirement when a situation of impending civil disorder is present and/or during a civil disturbance for the purpose of keeping all concerned headquarters informed of pertinent activities by dissident groups throughout Texas. Submitted by 1200 each day.

b. SPIREPS will be submitted to the task force commander and AGTX (ATTN: OTM) by the most expeditious means consistent with the urgency of the information. All intermediate headquarters are to be furnished a copy.

2. FORMAT OF SPIREPS:

- a. From.
- b. SPIREP number.
- c. Subject.
- d. Reference(s) to previous reports.
- e. Time, date and place.
- f. Individuals or organizations involved.
- g. Summary of activities.
- h. Impact statement.
- i. Time and date reported to task force commander.
- j. Source.
- k. Evaluation of source of information.
- l. Time and date information received by reporting headquarters.
- m. Comments of reporting headquarters.

APPENDIX 2 (INTELLIGENCE SUMMARY) TO ANNEX J (Reports) TO AGTX  
MSCA OPLAN

1. Intelligence summary (INTSUMS) will be submitted only during an actual civil disturbance for the purpose of keeping all concerned headquarters informed.
2. Committed task forces will transmit INTSUMS to AGTX-OTM not later than 1700 hours and 0500 hours commencing the initial day of force commitment and covering periods as of 1200 and 2400 respectively. Reports will be transmitted by telephone or radio by required times followed by message confirmation. Intermediate headquarters will be copy furnished.
3. Format of INTSUM.
  - a. Issuing headquarters.
  - b. Date and time..
  - c. Summary of dissident activity for period.
    - (1) Description of activity.
    - (2) Location of activity by street boundary.
    - (3) Use of unusual weapons or tactics.
    - (4) Indications of centralized control or organization.
    - (5) Other.
  - d. Personnel and equipment losses (dissident elements).
    - (1) Personnel (deaths - by cause).
    - (2) Personnel (injured - by cause).
    - (3) Personnel (arrests - by cause).
  - e. Obstacles and barriers used by dissidents.
  - f. Administrative activities.
  - g. Identification of dissident organizations and personalities involved.
  - h. Movement of dissident groups into or out of objective areas.
  - i. Brief discussion of capabilities and vulnerabilities of dissident groups.
  - j. Conclusions.

APPENDIX 3 (DETAINEE TURNOVER RECORD) TO ANNEX J (Reports) AGTX  
 MSCA OPLAN

DETAINEE TURN OVER RECORD		
1. DETAINEE		3. WHO MADE DETENTION
NAME		NAME
ADDRESS		GRADE OR TITLE
DESCRIPTION	2. WHAT DETAINEE DID DESCRIBE INCIDENT	UNIT
		4. WHO ESC DETAINEE TO DET CTR
		NAME
		GRADE OR TITLE
		UNIT
WHEN DID INCIDENT OCCUR (DATE AND TIME)	WHERE DID INCIDENT OCCUR	REMARKS:

(FRONT)

(REPRODUCE LOCALLY)

J-3-1

Z 0017157

APPENDIX 3 (DETAINEE TURNOVER RECORD) TO ANNEX J (Reports) TO  
AGTX MSCA OPLAN

<p>5. WITNESSES (GIVE NAME, GRADE OR TITLE IF APPL &amp; UNIT OR</p>	<p><b>DETAINEE TURNOVER RECORD</b></p> <p>This card will be filled out on each person detained and will be turned in at the Detention Center with the detainee. When possible, the person making the detention should do this. If this is not possible, the person designated to escort the detainee to the Detention Center will fill out the card (preferably before accepting the detainee), based on verbal information from the person making the detention.</p>
<p>a.</p>	
<p>b.</p>	
<p>c.</p>	
<p>6. WEAPONS AND ARTICLES REMOVED:</p>	

(BACK)

Adjutant General's Department of Texas  
Austin, Texas  
13 July 1992

APPENDIX 4 (PERSONAL STATUS REPORT) TO ANNEX J (Reports) TO AGTX  
MSCA OPLAN

1. Personnel reports will be submitted for the purpose of tracked activated personnel with each task force. Reports will be submitted through channels to the AGTX EOC by 1200 hours each day. . . .
2. Reports will be transmitmitted by telephone or radio by required times followed by message confirmation.
3. Personnel Status Reports - Sample format

PERSONNEL STATUS REPORT (PERSTAT)

1. From: Task Force Commander
2. THRU: HQ 49th Armored Division
3. TO: AGTX EOC
4. Subject: PERSTAT as of DD1200Z MMM YY
5. Strength Data

UNIT	OFF	WO	ENL	AGGR
3-144 Inf	27	2	510	539
3-149th Avn Bn	3		102	105
4-112th Ar	30		402	432
5-122th Ar	137	20	710	867
TOTAL	197	22	1724	1943

6. CASUALTY DATA-DEATHS

UNIT	OFF	WO	ENL	CIV	AGGR
------	-----	----	-----	-----	------

7. CASUALTY DATA-INJURED

UNIT	OFF	WO	ENL	CIV	AGGR
------	-----	----	-----	-----	------

Adjutant General's Department of Texas  
Austin, Texas  
13 July 1992

APPENDIX 5 (LOGISTIC REPORTS) TO ANNEX J (Reports) AGTX MSCA  
OPLAN

1. GENERAL.

a. Purpose: To provide the required logistic report to AGTX EOC and Major Subordinate Commands.

b. Users: Commanders in whose area forces are deployed in support of MSCA Operations.

2. SPECIFIC INSTRUCTIONS.

a. Logistic Representatives will provide the attached logistic report (s) IAW directions found at the bottom of the report.

b. Report (s) will be submitted through channels to the AGTX EOC by 1200 hours each day.

TAB A - LOGISTICS STATUS REPORT FORMAT

Adjutant General's Department of Texas  
Austin, Texas  
13 July 1992

TAB A (LOGISTIC STATUS REPORT) TO APPENDIX 5 (Logistics Reports)  
TO ANNEX J (Reports) TO AGTX MSCA OPLAN

FROM: Task Force \_\_\_\_\_

TO: AGTX EOC

C L A S S I F I C A T I O N

SUBJECT: Logstat/001/as of TIME DD MMM YY

1. ( ) PERSONNEL BY LOCATION

LOCATION	NUMBER
TOTAL	

2. ( ) CLASS I:

B-RATIONS	DAYS OF SUPPLY
-----------	----------------

MRE	DAYS OF SUPPLY
-----	----------------

3. ( ) CLASS II CRITICAL ITEMS:

NOMENCLATURE	NSN	REQ NO QTY DUE IN STATUS
--------------	-----	--------------------------

4. ( ) CLASS III (BULK):

LOCATION	THOUSAND GAL
----------	--------------

A. ( ) JETAL

B. ( ) MOGAS

C. ( ) DIESEL

D.. ( ) AVGAS

Report will be due as of 0400Z of the initial day forces are deployed, and as of 0400Z each day thereafter. Reports will be telephoned by the Major Subordinate Command Headquarters to the AGTX EOC.

J-5-A-1

Z 0017161



5. ( ) CLASS III (PKG) CRITICAL ITEMS (THREE D OF S OR LESS)  
 NOMENCLATURE NSN REQ NO QTY DUE IN STATUS
6. ( ) CLASS IV CRITICAL ITEMS (TEN D OF S OR LESS)  
 NOMENCLATURE NSN REQ NO QTY DUE IN STATUS
7. ( ) CLASS V:  
 NOMENCLATURE NSN REQ NO QTY DUE IN STATUS
8. ( ) CLASS VIII: REPORT ALL NON-OPERATIONAL EQUIPMENT.
9. ( ) CLASS VIII: CRITICAL ITEMS (THREE D OF S OR LESS):
10. ( ) CLASS IX: CRITICAL ITEMS (THREE D OF S OR LESS):
11. ( ) WATER  
 LOCATION ON HAND CONSUMPTION PRODUCTION CAPABILITY
12. ( ) MAJOR LOGISTICAL DEFICIENCIES/PROBLEMS (NARRATIVE):
13. ( ) REQUEST ASSISTANCE FROM (UNIT) IN RESOLVING THE  
 FOLLOWING LOGISTICAL PROBLEMS:

J-5-A-2

Z 0017163

Adjutant General's Department of Texas  
Austin, Texas  
13 July 1992

ANNEX K (REFERENCES) TO AGTX MSCA OPLAN

Reference:

- a. AR 95-3, Aviation General Provisions, Training, Standardization, and Resource Management.
- b. AR 358-10, The Army Safety Program.
- c. AR 385-40, Accident Reporting and Records.

Time Zone Used Throughout the Order: SIERRA

1. Map, Official State Highway, Texas Department of Highways and Transportation, Current Edition.
2. Standing Operation Procedures for State Active Duty, AGTX.
3. DA Civil Disturbance Plan GARDEN PLOT (U) (NOTAL).
4. HQ, FORSCOM Civil Disturbance Plan GARDEN PLOT (U) (NOTAL).
5. AR 140-488, License to Use Army Reserve Facilities.
6. AR 500-50, Civil Disturbances.
7. FM 19-15, Civil Disturbances.
8. NGR 10-2, State Area Command, Army National Guard.
9. NGR 350-1, Army National Guard Training.
10. NGR 500-1/ANGR 55-04, Military Support to Civil Authorities.
11. NGR 500-5, Civil Disturbance Control Operations.
12. TARNG Reg 350-3, Training for control of Civil Disturbances.

Headquarters  
 Departments of the Army and the Air Force  
 Washington, D.C. 20310-2500  
 1 October 1991

\*National Guard Regulation (AR) 500-1/  
 National Guard Regulation (AF) 55-5

**Employment of Army and Other Resources**  
**MILITARY SUPPORT TO CIVIL AUTHORITIES**

**Summary.** This regulation prescribes policies, procedures, responsibilities and guidance for the employment of Army and Air National Guard units, personnel and equipment of the several states in support of civil authorities.

**Applicability.** This regulation applies to all Army National Guard (ARNG), and Air National Guard (ANG) units of the 50 States, Territories, and the District of Columbia.

**Impact on Unit Manning System.** This regulation does not contain policies that affect the Unit Manning System.

**Internal Control System.** This regulation incorporates guidance from AR 11-2 and OMB Circular A-123. It includes internal control review provisions/checklists for ARNG and ANG Military Support.

**Supplementation.** Supplementation of this regulation is permitted at State level only after prior review and approval from National Guard Bureau, ATTN: NGB-MSO, The Pentagon, 2D374, Washington, DC 20310-2500.

**Interim changes.** Interim changes to this regulation are not official unless they are authenticated by the Chief, Administrative Services. Interim changes will be destroyed on their expiration dates unless sooner superseded or rescinded.

**Suggested Improvements.** The proponent agency of this regulation is the National Guard Bureau, Directorate for Military Support. Users are invited to send comments and suggested improvements on DA Form 2028 (Recommended Changes to Publications and Blank Forms) directly to Chief, National Guard Bureau, ATTN: NGB-MSO, The Pentagon, 2D374, Washington, DC 20310-2500.

**CONTENTS**

<b>Chapter 1</b>			
<b>General</b>	<b>Para</b>	<b>Use of equipment</b>	<b>3-3</b>
Purpose	1-1	Use of Federal facilities	3-4
References	1-2	Use of National Guard Aircraft	3-5
Explanation of terms	1-3	Reimbursement	3-6
Authority	1-4	Equipment authorization	3-7
Responsibility	1-5		
Public Affairs	1-6		
<b>Chapter 2</b>		<b>Chapter 4</b>	
<b>Military Support Operations</b>		<b>Civil Disturbance Support Operations</b>	
General	2-1	Responsibility	4-1
Considerations for employment	2-2	Planning	4-2
Personnel	2-3	Resources	4-3
Planning	2-4	Employment guidance	4-4
		Training	4-5
		Use of Force	4-6
		Civil Disturbance evaluation	4-7
		Use of Unit Training assemblies	4-8
<b>Chapter 3</b>			
<b>Loan, Lease, and Use of Equipment</b>			
Loan and leases of equipment	3-1		
Loan Request Channels	3-2		

\*This regulation supersedes NGR 500-1/ANGR 55-04, 15 September 1988



<b>Chapter 5</b>	
<b>Terrorism Counter Action</b>	<b>Para</b>
General	5-1
Responsibility	5-2
Role of the National Guard	5-3
Training and operational guidance	5-4
National Guard missions	5-5
Other agency missions	5-6
Planning and coordination	5-7

<b>Chapter 6</b>	
<b>Reporting Requirements</b>	
Reports	6-1
Military support (civil disturbances, disaster, emergency)	6-2

**Appendices**

- A. References
- B. Reports

**CHAPTER 1  
GENERAL**

**1-1. Purpose**

This regulation prescribes the policies, procedures, responsibilities and guidance for employment of Army and Air National Guard units, personnel and equipment in support of civil authorities.

**1-2. References**

Required and related publications are listed in appendix A.

**1-3. Explanation of terms**

**a. Civil Authorities.** Elected and appointed public officials and employees of Federal, State and local Governments.

**b. Civil Disturbances.** Group acts of violence or disorder prejudicial to public law and order, terrorism, and disruption of vital public services. Includes all domestic conditions requiring the use of the Federal military forces pursuant to the provisions of Title 10 USC, Section 15.

**c. Civil Disturbance training.** Civil disturbance training is that individual and unit training which is directed toward providing assistance to civil authorities in maintaining law and order in any emergency situation.

**d. Emergencies.**

**(1) Civil.** Any man-caused emergency, or threat which causes or may cause substantial property damage or loss.

**(2) Natural.** Any hurricane, tornado, storm, flood, high water, wind driven water, tidal wave, earthquake, volcanic eruption, landslide, mudslide, snowstorm, drought, fire, or other catastrophe.

**(3) Other.** An emergency in any part of the United States which requires National Guard assistance to supplement local or state efforts to save lives and protect property, public health, and safety, or to avert or lessen the threat of a disaster.

**e. Federal property.** Equipment and supplies that are owned, leased, or possessed by the U.S. Government.

**f. States.** For the purpose of this regulation the term "states" includes the 50 States, Commonwealth of Puerto Rico, the U.S. Virgin Islands, Guam, and the District of Columbia.

**g. Terrorism.** The calculated use or threat of violence to attain goals which may be political, religious, or ideological in nature. Terrorism involves a criminal act that is often symbolic in nature, and is intended to influence an audience beyond the immediate victims through such means as intimidation, coercion, or instilling fear.

**h. Counter Terrorism.** Offensive measures taken to respond to a terrorist act, or the documented threat of such an act. Counter terrorism includes the gathering of information and threat analysis to support offensive measures.

**i. Anti-Terrorism.** Defensive measures used to reduce the vulnerability of personnel, family members, facilities, and equipment to acts of terrorism. This also includes the collection and analysis of information to accurately assess the magnitude of the threat.

**1-4. Authority**

The governor is the commander in chief of all Army and Air National Guard units within his/her jurisdiction, which are not in active federal service. This authority is derived from Article 1, Section 8, Clause 16, U.S. Constitution.

**a.** Governors may authorize the use of the National Guard to assist civil authorities in accordance with the State Code and/or State Constitution.

**b.** Command of the National Guard is normally exercised through the Adjutant General or his designated military representative.

**c.** The President of the United States is the Commander in Chief of the National Guard of the District of Columbia. The National Guard may be ordered

1 October 1991

NGR (AR) 500-1/NGR (AF) 55-5

out in militia status to aid civil authorities under Title 39 of the District of Columbia Code and Executive Order No. 11485, 3 October 1969.

#### 1-5. Responsibility

The Chief, National Guard Bureau has overall responsibility for the National Guard military support program. State adjutants general are responsible for establishing military support programs in their states.

#### 1-6. Public Affairs

Public affairs is an important element of military support operations. National Guard public affairs guidelines are contained in NGB Pam 360-5/ANGP 190-9.

## CHAPTER 2 MILITARY SUPPORT OPERATIONS

### 2-1. General

a. This chapter prescribes guidance and procedures for ARNG/ANG personnel, units and activities conducting Military Support to Civil Authorities (MSCA) operations in a state active duty (SAD) status only. When a unit is on federal active duty, applicable Army or Air Force regulations will apply.

b. Primary responsibility for disaster relief shall be with the local and/or state government, and those federal agencies designated by statute.

### 2-2. Considerations for employment.

National Guard assistance normally is provided when:

a. The situation is so severe and so widespread that effective response and support is beyond the capacity of local and state government, and all civil resources have been exhausted.

b. Required resources are not available from commercial sources. National Guard Support will not be furnished if it is in competition with private enterprise or the civilian labor force.

c. National Guard resources will normally be committed as a supplement to civil resources that are required to cope with the humanitarian and property protection requirement caused by a civil emergency or mandated by law.

d. Assistance will be limited to tasks that, because of experience and the availability of organic resources, the National Guard can do more effectively or efficiently than another agency.

e. When an emergency or disaster occurs and waiting for instructions from higher authority would preclude an effective response, a National Guard commander may do what is required and justified to save human life, prevent immediate human suffering, or lessen major property damage or destruction. The commander will report the action taken to higher military authority, and to civil authority as soon as possible. Support will not be denied or delayed solely for lack of a commitment for reimbursement or certification of liability from the requestor.

f. The National Guard will be employed with adequate resources to accomplish the mission when conducting civil disaster/emergency relief operations. That determination will be made by the on-scene commander or the senior officer present. Military support to civil authorities will terminate as soon as possible after civil authorities are capable of handling the emergency.

g. When any public service is lost or withdrawn, and an immediate substantial threat to public health, safety, or welfare is evident, the National Guard may be called to restore and/or continue that public service. It is desirable that supervisors, managers, and key personnel of the public service be available to provide technical assistance to National Guard personnel. In the absence of key public service personnel, the state adjutant general will make plans and coordinate with appropriate civil authorities to perform the mission within the capabilities and limitations of the National Guard.

h. The capability of the National Guard to assist in the restoration/continuation of public services depends primarily on the degree of military or civilian skills possessed by National Guard personnel.

### 2-3 Personnel

a. States will prepare and maintain current information on the status and capabilities of units to respond to certain types of emergency situations. Particular emphasis will be placed to identify individuals in units who possess special or critical military and/or civilian skills which may be required to support specific operations.

b. Active Guard/Reserve (AGR) full time support may only be employed in accordance with the guidance contained in NGR (AR) 600-5 para 3-3 for the ARNG, and ANGR 35-03 Chapter 3 for the ANG. Military Technician (MT) personnel must be employed in accordance with the provisions of TPR 990-2. Technicians who provide support to state and local civil authorities must be placed in an appropriate leave status for all hours of their normal workday that fall within the period of military duty.

c. Because of their immediate availability, depending on the circumstances, and incidental to their full time positions, MT and/or AGR personnel may be used to provide an initial response to emergency situations involving the threat of lost of life, human suffering, or widespread property damage. In those cases, as soon as the immediate threat has diminished, it is imperative that:

(1) Full time support (FTS) personnel are replaced with traditional Guardsmen, or;

(2) The status of Involved FTS personnel is changed consistent with the guidance contained in the appropriate ARNG/ANG AGR or technician personnel regulations.

#### 2-4 Planning

a. States will prepare and maintain emergency plans for the employment of the National Guard in a Military Support to Civil Authorities (MSCA) role. Plans will provide for response to civil disobedience/disturbance, natural, man-made or technological disasters, and other potential emergencies. Plans will be reviewed and updated, by the state, not later than 30 Sep each year. During annual reviews special emphasis should be given to ensuring that task organizations are consistent and compatible with force structure modifications.

b. Two copies of all emergency response plans (or changes) will be forwarded to NGB-MS as they are updated. If no changes are required, a memorandum indicating the title of the plan and the date of annual review shall be forwarded to NGB-MS not later than 15 Oct each year.

c. Plans will be coordinated with adjacent states and appropriate intrastate agencies, to include the state attorney general's office to ensure compatibility, non-redundancy, and effective lawful response.

d. Emergency plans will be comprehensive and responsive to all potential emergency requirements. They will be prepared based on worst case scenarios that can be expected locally. Plans will contain provisions for:

(1) Actions before, during and after disasters. Consider primary and alternate command and control facilities survivability, equipment evacuation, alert procedures, communications, and periodic exercises to test emergency plans.

(2) External assistance for support beyond state capabilities, and prepositioning of equipment and supplies.

e. Plans will provide for the possible transition to federal status; applicable Army and Air Force regulations and OPLANs are primary reference documents.

### CHAPTER 3 LOAN, LEASE AND USE OF EQUIPMENT

#### 3-1 Loans and leases of equipment.

a. Loans and leases of equipment are governed by AR 700-131 for the ARNG, and by AFM 67-1/ANGR 67-1 for the ANG. State adjutants general are given broad authority to loan equipment by these regulations; exceptions are noted in paragraph 3-1c below.

b. USPFOs are responsible for negotiating, preparing agreements and approving loans and leases of equipment in accordance with procedures established by AR 700-131 and AFM 67-1/ANGR 67-1. Formats for loan agreements are prescribed in cited references.

c. The loan of weapons, combat/tactical vehicles, vessels and aircraft require approval of the service secretary or their designee. Requests for loan/lease of National Guard equipment which require HQDA or HQAF approval will be reviewed by the National Guard Bureau as follows:

(1) The Deputy Director, NGB-MS is responsible for all military support loan requests for civil emergencies, law enforcement support, civil disturbances, disaster relief, terrorist situations, environmental protection, and hazardous or other dangerous material accidents/incidents.

(2) The Chief, Public Affairs (NGB-PA) is responsible for loan requests concerning community relations and domestic information programs.

(3) The Chief, Aviation Division (NGB-AVN-O) is responsible for requests for the loan or lease of ARNG aircraft; the Director of Operations, Plans & Programs (NGB/XOO) is responsible for the loan or lease of ANG aircraft.

(4) The Chief, Logistics Division (NGB-ARL) is responsible for all other requests for loan or lease of ARNG equipment; the Director of Logistics (NGB/LG) is responsible for loan or lease of ANG equipment.

d. All equipment loans or leases to support law enforcement agencies will be reported quarterly to NGB-MS IAW the schedule as outlined in RCS # DD-M(Q)1595.

#### 3-2 Loan request channels

a. Loan requests from state and local agencies will be routed directly to the respective state Adjutant General.

b. Loan requests from federal agencies will be routed through that agency's headquarters to the Department of Defense, and then to the appropriate service for resourcing.

**3-3 Use of equipment**

a. The State Adjutant General has authority to use federal property issued to the National Guard of his state during periods of civil disturbance and other emergency conditions declared by the Governor, in accordance with state law. Any reimbursement required under these conditions will be effected in accordance with paragraph 3-6 below.

b. Federal property used during state emergencies will remain under National Guard control, and operated only by qualified NG personnel.

c. If required, states may coordinate directly with other states for temporary loan of additional federal property required for a particular emergency. USP&FOs are responsible for coordinating all arrangements, including a report of all transactions to NGB-ARL IAW RCS # ARNG-194.

**3-4 Use of Federal facilities**

When situations arise that require use of federal facilities by the National Guard, permission must be obtained from the installation/ activity commander prior to use, including coordination for use of controlled or restricted access areas. NGB-MS will be notified of all use of federal facilities.

**3-5 Use of National Guard aircraft**

The operation of aircraft is expensive, and requires continuous special attention. The matter of cost effectiveness cannot be overlooked in the planning and execution of air movements to support MSCA operations. The use of National Guard aircraft is governed by the 95-series of regulations for the ARNG, and the 55-series for the ANG. These regulations shall be used as primary reference documents on all use of aircraft issues.

**a. Air transportation of civilians.**

(1) Eligibility requirements for all travelers on Department of Defense (DoD) owned or operated aircraft are contained in DoD Directive 4515.13R. The policy concerning use of DoD transportation resources and limitations on support to civilians is contained in DoD Directive 4500.9. General guidance on providing support to civilian law enforcement officials is contained in DoD Directive 5525.5.

(2) All non-DoD traffic must be supported by letter orders or invitational travel orders, the supporting documents for which shall clearly articulate how the travel is in support of the DoD mission, or other statutory authority for the movement. The Economy Act requires reimbursement to the DoD when support is provided to another federal agency or activity. There are other laws (and policies emanating from those laws) which mandate reimbursement for DoD support.

(3) Requests for movement of non-DoD traffic must be forwarded thru NGB-MS to the Office of the Assistant Secretary of Defense (OASD) for Transportation Policy (P&L)/TP for review and appropriate action; reimbursement requirements will be determined in coordination with the OSD Comptroller.

**(4) Special circumstances.**

(a) Civilian law enforcement personnel may be transported on missions conducted incidental to training under the following conditions: the mission must be approved in advance by NGB-MS on a case-by-case basis; the operation must be consistent with the participating aviation unit(s)' military mission; and the mission must be conducted within available resources, including flying hours. Air transportation of media and other civilian (non-law enforcement) personnel on missions conducted incidental to training require NGB-PA approval on a case-by-case basis. No reimbursement is required in these cases. Care must be taken to ensure that the mission is in direct support of an operational requirement, and not just providing point-to-point transportation. That type of support would place the National Guard in competition with commercial enterprise, and in violation of the law.

(b) When National Guard aircraft are employed in response to a state-declared emergency, to include civil disorders, natural or man-made disasters, or any other type of emergency, civilian agency officials (federal, state, and local, including media personnel) may be transported consistent with mission requirements. The state shall reimburse the federal government at the direct flying hour cost (POL and Repair Parts) for the actual use of that aircraft. The liability issue in these cases is a function of state law. Aircrew personnel will normally be in a state active duty status, except for those initial operations required to prevent the immediate loss of life or limb, to mitigate human suffering, or to prevent widespread property damage.

(c) When National Guard aircraft are used in state active duty under non-emergency situations, as allowed by appropriate state laws, civilian personnel (government, law enforcement, media, etc.) may be transported under the following conditions: all passengers must have prior flight authorization. (See para 3-5a(2) above.) All passengers must execute a DD Form 1381 (Air Transportation Agreement), or other suitable liability release; the state must reimburse the federal government through the USP&FO at the non-US Government rate; and the state assumes all personal and property liability, including collateral damages, which may accrue from the mission.

**b. Training support to State emergency response personnel.**

(1) Requests to conduct this type of training will be forwarded to NGB-MS for approval, and coordination with NGB-AVN and other NGB staff. Such training may include: configuring of National Guard aircraft for aeromedical evacuation and conducting practice missions; high rise building rescue operations; rappelling into remote areas which are inaccessible by vehicle; and training in internal rescue hoist operations. The equipment and techniques used are technical, and proper team training is essential for safe operations.

(2) Approval of this training will be given on a case by case basis. If approved by the National Guard Bureau, the training may be conducted subject to the following conditions:

(a) All participating National Guard personnel will be in a state active duty status, and the state accepts total liability for National Guard personnel and property.

(b) The state will reimburse the federal government through the USP&FO for the direct flying hour cost of aircraft (POL and repair parts).

(c) Personal liability for state emergency response personnel is a state responsibility.

(d) National Guard aircraft and related equipment will be operated by qualified National Guard personnel only.

(3) Requests will include: identification of civil agency making request; description of training to be conducted; civil assets available/not available; full justification; duration; and starting and termination dates/times.

(4) An after action report will be forwarded to NGB-MS upon completion of the training.

**c. Training support of federal agency personnel.**

Requests for training support from federal agencies will be routed through that agency's headquarters, in Washington, to the Executive Secretariat of the Department of Defense, and then to the appropriate service for resourcing.

**3-6 Reimbursement**

**a. State Active Duty (SAD).** When federal property is used by National Guard personnel in a SAD status, as ordered by the Governor in response to an emergency relating to a civil disturbance, natural disaster, or other incident, the state will be liable for reimbursement (or replenishment in kind) to the federal government through the USP&FO for the following:

(1) Repair parts, other than fair wear and tear, expended in the objective area.

(2) POL (Petroleum, oils and lubricants) expended for direct mission accomplishment.

(3) Incremental costs (those costs above the expenses which normally accrue during scheduled training periods) which can be attributed to direct mission support.

**b. Use of aircraft.** Reimbursement policies and procedures for use of ARNG aircraft are outlined in NGB Pam 95-5, procedures for ANG aircraft are found in AFR 173-13.

**c. Loans of equipment.** Costs associated with the loan of equipment will be reimbursed in accordance with AR 700-131 and AFM 67-1/ANGR 67-1.

**d. Support to other Federal agencies.** When the National Guard is involved in military support operations in which another Federal agency has a requirement to reimburse the National Guard for assistance under the provisions of the Economy Act, or other statutory requirement, reimbursement for approved missions will be accomplished before the actual support IAW MOU/MOA between that agency and the National Guard. When another Federal agency requests support in an emergency that precludes prior reimbursement, the National Guard shall record the name of the requesting official, the date and time the request was made, the exact nature of the support requested, and the official's verbal commitment to reimburse the National Guard for the support costs.

**3-7. Equipment authorizations**

**a.** Commercial equipment must be authorized prior to procurement or leasing. If not already authorized, requests for authorization will be processed in accordance with AR 71-13 for TDA addition or addition to CTA 50-909.

**b.** USP&FO's have the authority to approve procurement of commercial nonstandard, nontype classified, noncontrolled, equipment consistent with limitations imposed by NGB-ARL.

**CHAPTER 4  
CIVIL DISTURBANCE SUPPORT OPERATIONS**

**4-1. Responsibility**

The protection of life, property, and the maintenance of law and order within the territorial jurisdiction of any state, is the primary responsibility of civil authorities. The National Guard is employed only after all local and state resources have been fully utilized, or when the situation is beyond the capabilities of the local and state civil authorities. National Guard assistance is provided in support of civil authorities, not to replace civil authority command jurisdiction.



National Guard forces will remain under the command of National Guard officers, and missions are executed through the National Guard chain-of-command in coordination with civil authorities.

#### 4-2. Planning

Civil Disturbance plans will include provisions for communication and liaison with supported agencies. When a civil disturbance mission is imminent, liaison will immediately be established with appropriate civil authority to identify requirements and initiate planning. The DoD Civil Disturbance Plan "Garden Plot" will be used as a guide for developing civil disturbance plans and operations.

#### 4-3. Resources

The National Guard will be employed with sufficient resources to accomplish the mission when conducting civil disturbance operations. Support to civil authorities terminates as soon as possible after the situation is under control.

#### 4-4. Employment guidance

Only National Guard individuals who have received civil disturbance training, in accordance with current regulations, may be employed in "on-the-street" civil disturbance control operations.

a. The state civil disturbance mission is a joint Army and Air National Guard responsibility. The Air National Guard (ANG) is not authorized to conduct civil disturbance training (except the DCANG); it will not be used in a direct civil disturbance role and may only be used in administrative or support functions.

b. National Guard individuals not trained in civil disturbance operations may be used only in administrative or support functions. Selected ANG personnel/units should be considered for specific support missions, e.g. administrative duties, security of C3 elements, traffic control, etc.

#### 4-5. Training

a. *Individual training.* Army National Guard (ARNG) personnel in Army training centers no longer receive civil disturbance control training, while undergoing initial entry training. Unit commanders assigned a civil disturbance mission will ensure that all personnel receive, as a minimum, 16 hours of initial individual civil disturbance training, prior to participating in unit civil disturbance training.

(1) FM 19-15 will be used as a guide to develop individual and refresher training to ensure the unit is adequately trained for immediate deployment in civil disturbance control operations. In addition, commanders will ensure that personnel are adequately trained in assigned specialized equipment

such as shotguns, sniper rifles, and riot control agent dispersers, etc.

(2) All commanders, to include commanders of units classified as "other" units, will ensure that each individual has essential knowledge of policies pertaining to application of force in civil disturbance control.

b. *Unit training.* Units assigned an "on-the-street" civil disturbance mission will conduct annual refresher training and junior leadership training IAW NGR 350-1 and FORSCOM/NGB Regulation 350-2. Recommended subjects include: coordination of federal, state, and local agencies in the objective area; rules of engagement; force protection/security; logistical support; special riot control equipment; public information/community relations; actions prior to deployment, personnel accountability; discipline; law and order of troops; morale; unit tactics and application of force; use of deadly force; legal aspects; prepositioning and redeployment of forces.

c. *Special team training.* Special reaction teams, such as sniper teams, etc, will be established for specific contingencies in accordance with FM 19-15 Chapter 5, section VII and Chapter 6, section II. Civil disturbance training time will be used to establish and maintain proficiency of these teams.

#### 4-6. Use of force

FM 19-15 Chapter 7, outlines degrees of force options, to include the use of deadly force, for consideration during civil disturbance control operations.

a. The use of force must be restricted to the minimum degree consistent with mission accomplishment.

b. The use of deadly force can be justified only by extreme necessity. It is authorized only where all three of the following circumstances are present:

(1) Lesser means have been exhausted or are unavailable.

(2) The risk of death or serious bodily harm to innocent persons is not significantly increased by its use.

(3) The purpose of its use is one or more of the following:

(a) Self-defense to avoid death or serious bodily harm, including the defense of other persons.

(b) Prevention of a crime that involves a substantial risk of death or serious bodily harm; for example, setting fire to an inhabited dwelling or sniping.

(c) Prevention of the destruction of property vital to public health and safety.

(d) Detention or prevention of the escape of a person who, during the detention or on the act of escaping, presents a clear threat of loss of life or serious bodily harm to another person.

**c. Force options**

(1) Consistent with the controlling principle that use of minimum force is of paramount importance, the force options outlined in FM 19-15 will be used as a guide when considering the use of face shields, vests, batons, and when arming personnel.

(2) When the M16/16A1/16A2 rifle is employed, a lock plate (NSN 1005-00-923-9031) must be installed IAW TM 9-1005-249-24P to prevent automatic firing.

(3) No automatic fire of any type will be employed during civil disturbance operations.

**d. Apprehension and arrest.** As much as possible, apprehension will be left to civilian authorities. However, if apprehension is necessary, guidelines for arrest and formal legal procedures will be provided by the state Attorney General in accordance with appropriate state law.

**e. Pre-commitment briefing.** Prior to commitment, personnel will be briefed by an officer on the following, as a minimum:

(1) The specific mission of the unit.

(2) Rules governing the application of force and state laws as they apply to the specific situation, to include the use of deadly force.

(3) Procedures regarding accountability and security of weapons, ammunition and other sensitive equipment.

(4) Use of weapons and control of ammunition. If weapons and ammunition are issued, the following must be thoroughly defined:

(a) Authority to insert clip/magazine in the weapon.

(b) Authority to chamber a round.

(c) Authority to fire.

(5) A psychological orientation on the local situation, specifically addressing types of abuse that individuals may be expected to receive and the proper response to these types of abuses.

(6) Briefing by local police or other state agencies.

(7) Special Orders for Civil Disturbance operations will be issued to all personnel prior to employment. These orders will include guidance specific to the current operation and, as a minimum, will address special instructions, acceptable standards of conduct, interface with the civilian populace, and contact with the media.

**4-7. Civil Disturbance evaluation**

Units assigned a civil disturbance mission will receive an annual evaluation of civil disturbance capabilities. Units that fail to meet criteria, as defined by AR 350-7 or state regulations, will be reported to National Guard Bureau; ATTN: NGB-MSO.

**4-8. Use of unit training assemblies**

a. When it is determined that a threat of civil disturbance is imminent, dates and times of unit training assemblies may be rescheduled for the purpose of alerting/assembling personnel for possible employment. A maximum of one MUTA-4 (ARNG) or four UTA's (ANG) may be used for this purpose; federal mission training will be conducted during these periods.

b. If it becomes necessary to employ or commit individuals or units, in support of civil authorities, the training status must terminate, and all personnel must be placed in State Active Duty status prior to commitment.

**CHAPTER 5  
TERRORISM COUNTERACTION**

**5-1. General**

Terrorism Counteraction (TC/A) consists of those actions taken to counter the terrorist threat. Antiterrorism and Counterterrorism are two major areas of the National Guard role in terrorism counteraction. Antiterrorism refers to defensive measures taken to reduce vulnerability to terrorist attack. Counterterrorism refers to the offensive measures taken in response to acts of terrorism.

**5-2. Responsibility**

Civil authorities have primary responsibility for counterterrorist operations within the state except on active military installations where the commander is responsible unless otherwise specified in jurisdictional agreements.

**5-3. Role of the National Guard**

The normal role of the National Guard in TC/A activities is to support the federal and state law enforcement agencies with equipment, facilities, and personnel.

**5-4. Training and operational guidance**

a. Direct confrontation and negotiation with terrorists should be accomplished by trained law enforcement personnel only.

b. Unit training in TC/A operations can be conducted during annual refresher civil disturbance training.

1 October 1991

NGR (AR) 500-1/NGR (AF) 55-5

c. Commanders and selected staff members of units assigned a TC/A support mission should attend a formalized course of instruction. Some courses that are available are conducted by the U.S. Army Military Police School and the California Specialized Training Institute, San Luis Obispo, CA.

d. State civil disturbance plans will address provisions for support of civil counterterrorism operations.

#### 5-5. National Guard missions

The following are possible missions for National Guard support of counterterrorism operations conducted by civil authorities:

- a. Public safety measures.
  - (1) Traffic control and road block.
  - (2) Disaster search/relief and recovery team.
  - (3) Perimeter security and security of critical facility.
  - (4) Ground control.
  - (5) Area evacuation.
- b. Public health measures.
  - (1) Emergency medical treatment.
  - (2) Limited aeromedical evacuation.
- c. Public welfare measures.
  - (1) Emergency shelter.
  - (2) Mass feeding/water supply.
- d. Other essential public services.
- e. Limited engineering support.
- f. Transportation support.
- g. Communication support.
- h. Loan of resources.
- i. Aviation support.
- j. Logistic support.
- k. General support for emergency forces.

#### 5-6. Other agency missions

The following are types of support that require a high degree of training, and are normally performed by federal and state civil authorities:

- a. Civil authorities command and control team other than National Guard liaison elements.
- b. Hostage negotiation.

c. Intelligence collection and investigative teams.

d. Assault teams.

e. Arrest teams.

#### 5-7. Planning and coordination

The Adjutant General, in coordination with civil authorities, will develop plans to counterterrorism operations which may develop on National Guard installations and facilities. Plans developed must comply with AR 381-10, U.S. Army Intelligence Activities; and AR 381-20, U.S. Army Counterintelligence Activities. Plans shall include provisions for:

a. Immediate notification of the FBI and local law enforcement authorities. During the initial liaison and planning for the counter terrorism operation, a clarification of controlling law enforcement agency authority must be determined.

b. The notification of National Guard Bureau in accordance with instructions in chapter 6.

c. The use of National Guard resources and facilities to support law enforcement operations.

d. Protection, safeguarding, and disposition of intelligence information on terrorism, terrorist organizations and individuals, received during the planning, preparation, and execution of counterterrorism support missions.

## CHAPTER 6 REPORTING

### 6-1. Reports

Within the scope of military support there are specific information requirements to be transmitted via various reports. This chapter provides guidance regarding format and reporting procedures for all Military Support to Civil Authorities.

### 6-2. Military support (civil disturbance, disaster, emergency)

Upon an alert and/or call-up of the National Guard to duty in connection with a civil disturbance, natural disaster, or other emergency, an initial report will be made immediately to the NGB-MSO by telephone. Additionally, all contingencies involving ANG resources will require NGB/XOOC notification. ANG will comply with ANGR 55-03 and AFR 55-55 figure 3-1 and chapter 30 reporting requirements, as the situation dictates. Follow up reports will be made as the situation changes. Initial and follow up reports will be transmitted by telephone as follows.

a. During duty hours (0800-1630 EST/EDT Monday through Friday) to Directorate for Military Support, DSN 227-9044 or (703) 697-9044, FAX (703) 614-4104 or DSN 224-4104.

b. During nonduty hours to the NGB Staff Duty Officer, DSN 225-6987 or (703) 695-6987. If contact cannot be made, call NGB Andrews Operations Center at DSN 858-6001 or Commercial (301) 981-6001 for emergency notifications. Initial reports made to the Staff Duty Officer or NGB Andrews Operations Center shall be followed up by FAX or phone to NGB-MS the next duty day. Routine reports to NGB-MS can be left on an answering machine at DSN 224-7066 or (703) 614-7066.

c. If the contingency warrants, the CNGB will activate the Contingency Support Staff (CSS) at Andrews AFB, MD. Participating units will be advised of the CSS activation via an USMTF SYS.RRM Activation message. Units will be advised to initiate daily SITREP reporting to the NGB Contingency Support Center and specific reporting parameters will be identified in the message.

**d. Initial Mission Reports.**

(1) Format for content of this report is contained in appendix B. Information will be reported by reference to paragraph and subparagraph, omitting paragraphs for which no current information is available.

(2) Follow-up reports. As significant changes occur (i.e., changes in personnel, location of command post, or deployment of forces) or as additional information becomes available, follow-up reports will be made as prescribed above. Follow-up reports will be made NLT 1200 EST.

**e. After Action Reports.** An after action report (RCS ARNGB-98) will be prepared and forwarded to NGB-MS within 15 days after completion of each operation. The format for these reports are prescribed in appendix B.

(1) **After Action Report.** The format shown in appendix B will be used for most military support missions.

(2) **Abbreviated After Action Report.** The format shown in appendix B is intended to reduce administrative requirements in preparing lengthy after action reports for minor incidents, and may be used for missions in which less than 25 Guard personnel are used.

**Internal Control Review Checklist—Continued**

Do units with "on-the-street" civil disturbance missions, conduct annual refresher and junior leadership training IAW NGR (AR) 350-1?	<b>Yes</b>	<b>No</b>
Are Secret service support missions coordinated with the state POMSO Office?	<b>Yes</b>	<b>No</b>
Are Air National Guard military support missions coordinated with the POMSO office?	<b>Yes</b>	<b>No</b>

1 October 1991

NGR (AR) 500-1/NGR (AF) 55-5

**APPENDIX A  
REFERENCES**

**Section I  
Required Publications**

**AR II-2**  
Internal Control Systems. (Cited in the "Internal Control System" statement.)

**AR 350-7**  
Training/Evaluation of Civil Disturbance Forces  
(Cited in para 4-7.)

**AR 500-50**  
Civil Disturbances

**AR 500-60**  
Disaster Relief

**AR 500-70**  
Military Support to Civil Defense

**AR 700-131** Loan of Army Materiel. (Cited in para 3-1a.)

**AFR 208-1**  
Federal Tort Claims Act

**AFR 355-1**  
Disaster Preparedness Planning and Operation

**FORSCOM REG 525-54**  
Critical Facilities Protection Program

**DoD Civil Disturbance Plan "GARDEN PLOT"**

**FM 19-15**  
Civil Disturbance. (Cited in paras 4-5a(1), 4-5c, and 4-6.)

**NGB Pam 360-5/ANGP 190-9**  
National Guard Public Affairs Guidelines. (Cited in para 1-6.)

**ANGR 67-1**  
Loan/Use of Air National Guard Property. (Cited in para 3-1a.)

**Section II  
Related Publications**

**DOD Directive 3025.1**  
Use of Military Resources During Peacetime Civil Emergencies Within the US, Its Territories and Possessions

**DOD Directive 3025.12**  
Military Support to Civil Defense

**DOD Directive 5160.54**  
DoD Key Assets Protection Program (KAPP)

**DOD Directive 5525.5**  
DoD Cooperation with Civilian Law Enforcement Officials (Change 1)

**AR 71-13**  
Dept of Army Equipment Authorization and Usage Program

**AR 95-1/NGR (AR) 95-1**  
Aviation Flight Regulations

**AR 130-5/AFR 45-17**  
National Guard Bureau Organization/Functions

**AR 190-10**  
Threats to the President and Other Government Officials

**AR 310-49**  
The Army Authorization Documents System (TAADS)

**AR 525-13**  
The Army Terrorism Counteraction Program

**DA Pam 190-52**  
Personnel Security Precautions Against Terrorism

**AFR 55-3**  
Operations (Reporting, Meaconing, Intrusion, etc)

**CTA 50-909**  
Field and Garrison Furnishings and Equipment

**FORSCOM/NGB Regulation 350-2**  
Reserve Component (US Army) Training

**NGR 10-2**  
State Area Command, Army National Guard

**NGR (AR) 350-1**  
Army National Guard Training

**NGR (AR) 600-85**  
Drug Abuse Prevention and Control

**NGB Pam 95-5**  
Use of Army National Guard Aircraft

**ANGR 23-01**  
State Air National Guard Headquarters

**NGR (AR) 500-1/NGR (AF) 55-5**

**1 October 1991**

**ANGR 35-03**  
Full-Time Military Duty Personnel Program - Air  
National Guard

**ANGR 55-03**  
Operations Event/Incident Report

**ANGR 355-1**  
Planning and Operations

**NGB study, "Military Support to Civil Authorities for  
Continuance of Vital Public Services, FY 79-1."**

**NGB study, "Terrorism and Hazardous Material In-  
cidents, August 1980."**

1 October 1991

NGR (AR) 500-1/NGR (AF) 55-5

APPENDIX B

NATIONAL GUARD MILITARY SUPPORT

TELEPHONE REPORT OF STATE EMERGENCY DUTY

1. DATE \_\_\_\_\_ PERSON REPORTING \_\_\_\_\_ STATE \_\_\_\_\_
2. TYPE OF REPORT: INITIAL \_\_\_\_\_ FOLLOW-UP \_\_\_\_\_ CLOSING \_\_\_\_\_
3. SOURCE OF REQUEST: \_\_\_\_\_
4. TYPE INCIDENT: CIVIL DISTURBANCE \_\_\_ NATURAL DISASTER \_\_\_ OTHER \_\_\_\_\_
5. MISSION NUMBER: \_\_\_\_\_
6. LOCATION: CITY: \_\_\_\_\_ COUNTY \_\_\_\_\_
7. SITUATION: \_\_\_\_\_  
\_\_\_\_\_  
\_\_\_\_\_
8. MISSION: \_\_\_\_\_  
\_\_\_\_\_  
\_\_\_\_\_
9. DATES: EFFECTIVE \_\_\_\_\_ RELEASED \_\_\_\_\_
10. STATUS: SAD \_\_\_\_\_ IDT/AT \_\_\_\_\_ ST/FTTD \_\_\_\_\_ OTHER \_\_\_\_\_
11. PERSONNEL: ARNG \_\_\_\_\_ ANG \_\_\_\_\_ TOTAL \_\_\_\_\_
12. TASK FORCE COMMANDER: \_\_\_\_\_ EOC \_\_\_\_\_
13. UNIT'S ACTIVITIES: \_\_\_\_\_  
\_\_\_\_\_  
\_\_\_\_\_  
\_\_\_\_\_  
\_\_\_\_\_
14. EQUIPMENT: \_\_\_\_\_  
\_\_\_\_\_  
\_\_\_\_\_  
\_\_\_\_\_  
\_\_\_\_\_



**NATIONAL GUARD MILITARY SUPPORT  
AFTER-ACTION REPORT FORMAT**

**MEMORANDUM FOR:** Chief, National Guard Bureau ATTN: NGB-MSOPentagon,  
Washington, D.C. 20310-2500

**SUBJECT:** After Action Report (RCS: ARNGB-98) (Identify operation and inclusive dates)

**1. General**

**a. Type emergency.** Include location by city, county, and state. (Identify type civil disturbance or emergency.)

**b. Inclusive dates by date time group:**

**c. Scope of emergency:**

(1) Use narrative explanation.

(2) Include percentage of State ARNG and/or ANG forces called to duty.

**2. Operations**

**a. Strength.** ARNG and/or ANG strength of called forces will be reported for each unit/organization for each day of duty. The report will be in column form as follows:

Date \_\_\_\_\_

Unit/Organization Designation	Service*	Number of Personnel**				Status***
		OFF	WO	EM	AGG	
		—	—	—	—	
	<b>Total****</b>					

\* Service will be indicated by ARNG or ANG

\*\* # Personnel present for duty with subtotals for ARNG & ANG

\*\*\* Status will be indicated by UTA, MUTA, or SAD

\*\*\*\* Total number of troops used during call-up

**b. Operations Summary.** Chronology of significant events in phases as follows:

(1) *Planning/alert.*

(2) *Execution.*

(3) *Post operations.*

**c. Communications.** Types or methods.

**d. Training.** Evaluation of the effectiveness of civil disturbance training conducted prior to the occurrence of this incident. Number of hours civil disturbance refresher training conducted by each unit during this operation.

**3. Administration**

**a. Public Affairs.**

**b. Special Services.**

1 October 1991

NGR (AR) 500-1/NGR (AF) 55-5

- c. Morale and discipline.*
- d. National Guard injuries or casualties.*

**4. Logistics**

Equipment. Special equipment and supplies used and source of issue (Note: If ARNG or ANG aircraft are used, the information provided shall include type of aircraft used and number of hours flown, by type.)

**5. Costs**

Total Cost of State Active Duty, including as a minimum the following:

- a. Pay.*
- b. Subsistence.*
- c. Housing.*
- d. Transportation.*
- e. Maintenance.*
- f. Supplies.*
- g. Equipment.*
- h. Fuel and petroleum.*
- i. Funds paid by other state agencies.*
- j. Reimbursable cost.*

**6. Problem areas**

- a. Personnel.*
- b. Intelligence.*
- c. Operations.*
- d. Organization.*
- e. Training.*
- f. Logistics.*
- g. Communications.*
- h. Material.*
- i. Other.*

**7. Lessons learned**

Include any special organization and new tactics or techniques developed to control the emergency.

**8. Recommendations**

1 October 1991

**NATIONAL GUARD MILITARY SUPPORT  
MINOR INCIDENT AFTER ACTION REPORT FORMAT**

**MEMORANDUM FOR:** Chief, National Guard Bureau ATTN: NGB-MSO  
Washington, DC 20310-2500

**SUBJECT:** AFTER ACTION REPORT, (Title)

**STATE:**

**MISSION:**

**DATE(S):**

**EFFECTIVE:** COMPLETED

**LOCATION:** CITY COUNTY

**NUMBER OF TROOPS:** ARNG ANG

**MANDAYS USED:**

**EQUIPMENT USED:** (Note: If ARNG or ANG aircraft are used, the information provided should include type aircraft used and hours flown, by type.)

**APPROXIMATE COST:** (include all related costs)

**COMMENTS**

ber 1991

NGR (AR) 500-1/NGR (AF) 55-5

By Order of the Secretaries of the Army and the Air Force:

**JOHN B. CONAWAY**  
Lieutenant General, USAF  
Chief, National Guard Bureau

Official:

**E. DARDEN BAINES**  
Chief  
Administrative Services

Distribution: C/F

U.S. Government Printing Office: 1991 — 500-081/43025

FM 19-15

# CIVIL DISTURBANCES



NOVEMBER 1985

## HEADQUARTERS, DEPARTMENT OF THE ARMY

**DISTRIBUTION RESTRICTION.** This publication contains technical or operational information that is for official government use only. Distribution is limited to US government use only. Distribution is limited to US government agencies. Requests from outside the US government for release of this publication under the Freedom of Information Act or the Foreign Military Sales Program must be made to Commander, TRADOC, Fort Monroe, VA 23651-5000.

Adjutant General's Department  
Austin, Texas 78763-5218  
1 August 1992

Texas Army National Guard  
Regulation 350-3

## TRAINING FOR CONTROL OF CIVIL DISTURBANCE

**Summary.** This regulation implements Training for Control of Civil Disturbances, and prescribed policies, procedures and standards for training of units and activities in the Texas Army National Guard IAW HQ DA CD Plan (GARDEN PLOT) (U); AR 500-50, Civil Disturbances; NGR 10-2, Organization and Functions, STARC; NGR 350-1, ARNG Training; NGR 500-50, Civil Disturbance Control Operations and TXARNG OPLAN MSCA.

**Applicability.** This regulation applies to the Texas Army National Guard while in a non-federalized status.

**Suggested improvements.** The proponent of this Regulation is the Plans, Operations and Military Support Branch, Adjutant General's Department, State of Texas. Users are invited to send comments and suggested improvements directed to the Adjutant General of Texas, Attention: AGTX-OTM, P.O. Box 5218, Austin, TX 78763-5218.

### Contents

	Paragraph	Page
Purpose.....	1-1	1
Scope.....	1-2	1
Objectives.....	1-3	2
Concept.....	1-4	2
Concept of Training.....	1-5	2
Training Emphasis.....	1-6	3
Unit Training Programs.....	1-7	4
References.....	1-8	4

### APPENDIXES

A Unit Assigned Civil Disturbance Control Missions.....	5
B Organizational Requirements.....	7
C Weapons Used in Formation.....	17
D Civil Disturbance Training.....	18
E Annual Evaluation Checklist.....	25

1-1. **PURPOSE.** This regulation directs training for TXARNG Units in Civil Disturbance Control Operations.

1-2. **SCOPE.** The training requirements contained in this regulation are applicable to all units and headquarters of the TXARNG. (See Appendix A).

This Regulation supersedes TXARNG REG 350-3, 11 January 1978

1 August 1992

1-3. OBJECTIVES.

a. To train Army National Guard (ARNG) personnel in the use of civil disturbance equipment and munitions.

b. To train ARNG personnel to function as team members in a civil disturbance control operation.

c. To produce units capable of functioning as teams and qualified to execute an operational mission in controlling a civil disturbance.

1-4. CONCEPT. Training in riot control operations will be conducted using the provisional riot control company organization described in Appendix B.

1-5. CONDUCT OF TRAINING. A maximum of two UTAs per training year is authorized for unit and staff refresher training. An additional two UTA's are authorized for annual evaluation as described in subparagraph d below. Neither Annual Training (AT) nor any of the remaining 44 UTAs will be used for civil disturbance control training without prior approval of AGTX-OT. Training will be conducted as follows:

a. Individual Training. All ARNG personnel who have not received initial entry civil disturbance training will receive the 16 hours of training shown in Appendix D of this regulation. No ARNG soldier will be committed to an "on-the-street" civil disturbance mission before receiving this individual training.

b. Unit Refresher Training. Unit refresher training for units assigned civil disturbance control missions will be conducted annually consisting of not more than two UTA's. The actual time and subjects to be devoted to unit refresher training is found in Appendix D, this regulation.

c. Staff Refresher Training. All TXARNG headquarters designated as having region or district planning responsibility in SOP for State Active Duty will conduct annual staff refresher training in civil disturbance control operations. Appendix D, this regulation provides guidance in this area. Where possible, Staff Refresher Training should be conducted in conjunction with paragraph 5b above.

d. Junior Leadership Training. Leadership training will be conducted only as authorized by AGTX-OT. (See Appendix D, para 3).

e. Training Immediately prior to Commitment. All soldiers who have had 16 hours of initial entry training or unit refresher training within the last year prior to commitment to a civil disturbance operation, will receive a minimum of two hours civil disturbance training shown in Appendix D, this regulation.

1 August 1992

TXARNG Reg 350-3

f. Shotgun Familiarization Firing. Individuals armed with a shotgun will undergo familiarization firing annually. Shotgun ammunition will be forecast and requisitioned the same as other training ammunition. Firing may be routinely conducted with unit's annual range firing. Firing table will consist of a minimum of three rounds per individual. Preliminary marksmanship training for the shotgun, will be conducted in accordance with TEC Lesson 470-091-1154A prior to firing being conducted.

g. Sniper Familiarization Firing. Individuals armed with the sniper rifle will undergo familiarization firing annually. The commander's estimate will determine ammunition and firing task requirements.

h. Annual Evaluation. Commanders listed in Appendix A, para 1, will conduct annual covo; dostirbance traomomg evaluations once each training year as follows:

(1) Inspections will cover command control elements at separate company and battalion level and at least one interior unit (on a revolving basis) of each battalion. Inspections will not be conducted during AT.

(2) Command and control elements are authorized two of the 48 UTA's for the conduct of a civil disturbance control CPX/FTX (see paragraph 5c above) during which the annual evaluation will take place. Joint participation with civil officials is encouraged. These two UTA's are in addition to the two UTA's authorized for annual staff refresher training.

(3) Annual Evaluation Checklists (Appendix E) will be used as the criteria in determining readiness of units.

(4) This Department, ATTN: AGTX-OTM, will be furnished two copies of the Annual Evaluation Reports within five working days of the evaluation completion. The report will include action taken to correct deficiencies and any assistance required of a higher headquarters. Commanders will retain a copy of the last annual evaluation at the inspecting unit and the inspected unit.

#### 1-6. TRAINING EMPHASIS.

a. The principle of minimum necessary force, consistent with mission accomplishment, will be emphasized in training. Command emphasis will be placed on the limited use of deadly force.

b. To give all personnel an opportunity to train under realistic conditions maximum use of CPX's/FTX's will be made.



1 August 1992

c. Training exercises, whenever possible, will include civil authorities and should stress communication procedures between military and civil operations.

d. Leadership training and troop leading procedures will be emphasized at all levels of command.

e. Training will be conducted in a manner to stress team effort, with emphasis on squad and platoon levels.

f. Personnel will be assigned and trained in the operation and maintenance of special riot control equipment authorized. (Dispersers; floodlight sets; search lights; truck mounted, accessory kit, vehicle body; camera equipment; generators and compressors; etc.).

1-7. UNIT TRAINING PROGRAMS. Specific training in control of civil disturbances will be reflected in the yearly training programs published by battalion and higher headquarters.

1-8. REFERENCES.

- a. US Constitution
- b. US Code
- c. HQ DA CD Plan (GARDEN PLOT)
- d. AR 500-50.
- e. NGR 10-2
- f. NGR 350-2
- g. NGR 500-50
- h. FM 19-15.
- i. TXARNG OPLAN MSCA

1 August 1992

TXARNG Reg 350-3

Appendix A  
UNITS ASSIGNED CIVIL DISTURBANCE CONTROL MISSIONS

1. Regional Command and Control units are designated below. These headquarters will conduct and document annual staff refresher training in addition to annual refresher civil disturbance. These headquarters also have responsibility for annual evaluations of the units listed in paragraph 2 below during their civil disturbance training.

<u>REGION</u>	<u>HEADQUARTERS</u>
I	HQ, 3d Bde 49th AD
II	HQ, 36th Bde 49th AD
III	HQ, DIVARTY 49th AD
IV	HQ, 142 RAOC
V	HQ, 2d Bde 49th AD
VI	HQ, Avn Bde, 49th AD

2. The units listed below have an "on-the-street" civil disturbance control mission. Evaluations of civil disturbance training is the responsibility of the headquarters listed under evaluation headquarters.

<u>UNIT</u>	<u>EVALUATION</u>
1st Bn (M) 141st Inf	HQ, DIVARTY 49th AD
2st Bn (M) 141st Inf	HQ, DIVARTY 49th AD
3d Bn (M) 141st Inf	HQ, DIVARTY 49th AD
2d Bn (M) 142d Inf	HQ, 2d Bde, 49th AD
3d Bn (M) 144th Inf	HQ, 3d Bde 49th AD
1st Bn 112th Armor	HQ, 3d Bde 49th AD
2d Bn 112th Armor	HQ, 2d Bde 49th AD
3d Bn 112th Armor	HQ, 2d Bde 49th AD
4th Bn 111th Armor	HQ, 36th Bde 49th AD
5th Bn 112th Armor	HQ, 3d Bde 49th AD
6th Bn 112th Armor	HQ, 3d Bde 49th AD
386th Engr Bn	HQ, 3d Bde 49th AD
111th Engr Bn	HQ, 142d9 RAOC
3d Bn 149th Avn	HQ, 3d Bde 49th AD
356th Spt Bn	HQ, 36th Bde 49th AD
1st Bn 133d FA	HQ, 36th Bde 49th AD
149th MP Co	HQ, DIVARTY 49th AD
949th Spt Bn	HQ, 2d Bde 49th AD
372d Spt Bn	HQ, 3d Bde 49th AD
249th Spt Bn	HQ, Avn Bde, 49th AD
1st Bn 149th Avn	HQ, 36th Bde 49th AD
1st Sqdn 124th Cav	HQ, Avn Bde, 49th AD

TXARNG REG 350-3

1 August 1992

UNIT

136th Sig Bn  
249th Sig Bn  
3d Bn 132d FA  
3d Bn 133d FA  
4th Bn 133d FA

EVALUATION HQ

HQ, Avn Bde 49th AD  
HQ, 3d Bde 49th AD  
HQ, 142d RAOC  
HQ, 142d RAOC  
HQ, DIVARTY 49th AD

1 August 1992

TXARNG REG 350-3

Appendix B  
ORGANIZATIONAL REQUIREMENTS

1. GENERAL.

a. Provisional Riot Control Company (PRCC). The PRCC is the basic organization for civil disturbance operations. Commander, 49th Armored Division and Commander, Troop Command are responsible for the formation of PRCCs. Scout and Mortar Platoons, Weapons Companies and other non-essential support personnel in HHC/HHB and Service Batteries may be used to fill positions in the PRCCs formed in the companies and batteries. Each PRCC will consist of a company headquarters and one to three PRC platoons. The number of PRC platoons organized will be dependent on the strength of the unit. Mechanized infantry battalions and field artillery battalions will form PRCC. Scout and Mortar Platoons of the mechanized infantry battalions and personnel of field artillery battalion headquarters and service batteries not involved in support operations may be used to fill out PRCCs.

b. Special Teams. Tank battalions are responsible for forming heavy teams and light teams. These teams may be used for independent operations or in support of PRCC.

c. Support Elements. Support battalions, aviation units, signal battalions and engineer battalions will conduct the 16 hours of initial civil disturbance, eight hours annual refresher training, staff refresher training and junior leader training as required. These units will be committed as a last resort. These units along with the headquarters and service units of battalions will give priority to support of the troops conducting "on-the-street" missions.

d. Riot Control Equipment. Stockage and distribution of riot control equipment is contained in Tab A to this appendix.

e. Each element responsible for manning a PRCC or special team will maintain a roster for the organization in the format at Tab B to this appendix. Personnel assigned to operate special items of civil disturbance control equipment will be annotated on the roster.

2. PROVISIONAL RIOT CONTROL COMPANY (PRCC).

a. Mission. On order, assist civil authorities suppress riots or civil disturbances by use of military force for containment, isolation and/or dispersal of rioters.

b. Definition. Civil disturbances are any group act of violence and disorder prejudicial to public law and order. Riots are the most extreme violent acts in civil disorders, and the tendency is to think of civil disturbances as riots. This has led to measures which sometimes made the situation worse. Some demonstrations authorized by permit are legitimate forms of protest. Each situation is unique requiring control measures geared to the type of civil disturbance that exists. Some of these types are:

(1) Civil disobedience involving women, children, and nonviolent men may put the control forces in an awkward position.

(2) Idealistic protest involving fanatical people, who are not deterred by force or threat of arrest.

(3) Dispersed crowds involving small irrational groups acting out frustration, and operating over a large urban area.

(4) Terrorism involving extremely violent tactics such as sniping and bombing attacks, which make conventional police operations hazardous and often not effective.

(5) A civil disturbance where any crowd represents a threat to law and order because of its vulnerability to manipulation by skillful agitators, and subsequent capacity for violence.

c. Assignment. The PRCC is assigned to a battalion headquarters.

d. Capabilities.

(1) This unit has the following capabilities:

(a) Sealing off a civil disturbance area.

(b) Containing and/or dispersing unlawful groups.

1 August 1992

TXARNG REG 350-3

- (c) Suppressing widespread arson.
- (d) Prevent looting and vandalism.
- (e) Conducting anti-sniper operations.
- (f) Two-way radio communication from organic equipment.

(2) This unit is dependent on the headquarters and headquarters company for logistical support.

(3) The commander has the authority to substitute higher or lower ranked enlisted men to the positions as shown in Tabs C and D of this appendix.

e. Mobility. This unit is dependent on transportation from battalion and supporting units for movement. Additional mobility requirements will be requested from higher headquarters.

1 August 1992

APPENDIX B  
TAB A  
SPECIAL RIOT CONTROL EQUIPMENT

1. GENERAL. Units order to state active duty for civil disturbance operations are authorized to utilize MTOE equipment assigned. Tactical tracked vehicles will NOT be used without prior approval of The Adjutant General.

2. SPECIAL EQUIPMENT:

<u>ITEM</u>			<u>AUSTIN</u>	<u>HOUSTON</u>	<u>DALLAS</u>	<u>EL PASO</u>	<u>MCALLEN</u>
Body Armor	O/H	2,720	640	640	640	400	400
	Auth	6,000	1,400	1,400	1,400	400	400
Compressor, Flame Thrower	O/H	22	6	7	7	1	1
	Auth	24	6	7	7	2	2
Dispenser, Helo Mtd	O/H	2	0	1	1	0	0
	Auth	4	2	1	1	0	0
Dispenser, Portable	O/H	33	9	9	9	3	3
	Auth	37	9	9	9	5	5
Floodlight Set	O/H	1	1	0	0	0	0
	Auth	1	1	0	0	0	0
Searchlight, Jeep Mtd	O/H	2	2	0	0	0	0
	Auth	2	2	0	0	0	0
5KW Generator	O/H	1	1	0	0	0	0
	Auth	1	1	0	0	0	0
1.5KW Gener- ator	O/H	130	30	30	30	20	20
	Auth	59	15	15	15	7	7
PA Set	O/H	165	39	39	39	24	24
	Auth	170	40	40	40	25	25
Svc Kit, Flame Thrower	O/H	12	3	3	3	1	2
	Auth	24	6	6	6	3	3
Riot Baton	O/H	2,776	658	659	659	400	400
	Auth	6,000	1,400	1,400	1,400	400	400

B-A-1

1 August 1992

TXARNG REG 350-3

Rifle, 7.62mm	O/H	20	6	5	5	2	2
w/scope	Auth	44	12	12	12	4	4
Rifle, Cal. 30	O/H	25	7	7	7	2	2
w/scope	Auth	0	0	0	0	0	0
Face Shield	O/H	2,720	640	640	640	400	400
	Auth	6,000	1,400	1,400	1,400	400	400

B-A-2

Z 0011873



1 August 1992

APPENDIX B  
TAB B  
ROSTER  
PROVISIONAL RIOT CONTROL COMPANY

Position	Auth Grade	Rank	Name	Training Level	Special Equipment Training
Co Cdr	O3	(1)	[REDACTED]	A	
XO	O2	(2)	[REDACTED]	A	
1SG	E8	(3)	[REDACTED]	A	
RTO/Rcdr	E3	(4)	[REDACTED]	B	Shotgun
Sqd Ldr	E6	(5)	[REDACTED]	A	
Sqd Mbr	E4	(6)	[REDACTED]	B	Disperser

\* TRAINING CODE: A - Received all required CD Tng. (Appendix D)

B - No CD Tng received. (Appendix D)

\*\* SPECIAL EQUIPMENT QUALIFICATIONS:

B-B-1

1 August 1992

TXARNG REG 350-3

APPENDIX B  
 TAB C  
 ORGANIZATIONAL CHART  
 PROVISIONAL RIOT CONTROL COMPANY

PARA	LINE	DESCRIPTION	GRADE	WPN	LINE AUTH STRENGTH	TOTAL AUTH STRENGTH
01	00	<u>Company Headquarters</u>				
	01	Company Commander	03	P	1	1
	02	Executive Officer	02	R	1	1
	03	First Sergeant	E8	R	1	1
	04	Supply Sergeant	E6	R	1	1
	05	Anti-Sniper Observer	E5	R	1	1
	06	Dispenser Operator	E5	P	1	1
	07	Asst Dispenser Opr	E4	R	1	1
	08	Anti-Sniper	E4	R*	1	1
	09	RTO/Recorder	E3	R	1	1
		SUBTOTAL			9	9
02	00	<u>3 Riot Control Platoons</u>				
	01	Platoon Leader	02	R	1	3
	02	Platoon Sergeant	E7	R	1	3
	03	RTO/Recorder	E3	R	1	3
		SUBTOTAL			3	9
03	00	<u>9 Riot Control Squads</u>				
	01	Squad Leader	E6	R	1	9
	02	Asst Squad Leader	E5	R or S	1	9
	03	Team Leader	E5	R or S	1	9

B-C-1

Z 0011876

04	Squad Members	E4/3	R	6	54
		SUBTOTAL		9	81
		TOTAL			99

(1) WEAPONS

R = Rifle, M-16                      \*Sniper Rifle  
 P = Pistol, 45 Cal  
 S = Shotgun, 12 Ga (as situation

dictates)

Wood Baton (82537N) Alternate for all.

NOTES: Each squad contains 9 people  
 Each platoon contains 30 people  
 Each company contains 99 people

(2) EQUIPMENT

Protective Vests (Body Armor A92145)  
 Helmets with Face Shields  
 Protective Masks  
 Dispenser M33  
 Compressor 3.5 cfm  
 Generator Set 5 kw

1 August 1992

TXARNG REG 350-3

APPENDIX B  
TAB D  
ORGANIZATIONAL CHART  
RIOT CONTROL SPECIAL TEAMS

1. TYPES OF TEAMS. Two types of teams will be formed: A platoon-sized heavy team and a squad-sized light team. These teams are to be formed in tank battalions and the cavalry squadron.

a. Heavy Team. This platoon-sized unit should be designated and held in reserve by each battalion-sized unit in the control force. This may be with a designated TOE platoon withdrawn from a subordinate company or a provisional unit of selected individuals as determined by the commander. The heavy team should consist of the same three elements as contained in the light team; however, the larger size will permit more specialization of individual duties. The heavy team should have the capability, if required, of splitting into several light teams to handle several different special threats.

PARA	LINE	DESCRIPTION	GRADE	LINE AUTH WPN	STRENGTH	TOTAL AUTH STRENGTH	
01	00	<u>Riot Control Support Platoon (Heavy Team)</u>					
	01	Platoon Leader	02	R	1	1	
	02	Platoon Sergeant	E7	R	1	1	
	03	RTO/Recorder (1)	E4	R	1	1	
		SUBTOTAL			3	3	
02	00	<u>3 Riot Control Support Sections (Light Team)</u>					
	01	Section Leader	02	R	1	3	
	02	Section Sergeant	E6	R	1	3	
	03	Anti-Sniper Observer	E5	R	1	3	
	04	Anti-Sniper	E4	R (2)	1	3	
	05	RTO/Recorder	E4	R	1	3	

B-D-1

Z 0011878

TXARNG REG 350-3

1 August 1992

06	Disperser Operator	E3/E4	P	2	6
07	Grenadier	E3/E4	M203	3	9
08	Photographer/ Recorder	E3/E4	P	<u>2</u>	<u>6</u>
			SUBTOTAL	12	36
02	00	<u>Riot Control Support Section (Heavy Team)</u>			
01	Supply Sergeant	E6	P	1	1
02	Motor Sergeant	E5	P	1	1
03	Armorer (1)	E3/E4	P	1	1
04	Wheel Veh/ Mechanic	(1)E3/E4	P	1	1
05	Generator/ Mechanic	(1)E3/E4	P	1	1
06	PA System Operator	E3/E4	R	<u>3</u>	<u>3</u>
			SUBTOTAL	9	9
			TOTAL		48

NOTES:

- (1) - Also Driver
- (2) - Sniper Rifle
- (3) - Each Heavy Team consists of 3 light teams plus command and support and support personnel for a total of 48.

b. Light Team. This squad-sized unit may be designated and held in reserve by each company unit in the control force. This unit may be either a designated by the commander. The light team should consist of three elements shown below and should include a member of the local law enforcement:

(a) A command element to include, as a minimum, a unit leader and a radioman/recorder.

(b) A security element to provide close-in-cover to the team and to apply the appropriate type of force the situation requires, such as marksman fire or riot control agents.

(c) An action element to search for and neutralize the special threat.

B-D-2

Z 0011879

1 August 1992

TXARNG REG 350-3

APPENDIX C  
WEAPONS USED IN FORMATION

1. Riot Baton. The riot baton may be utilized by troops in crowd control formations. The riot baton may also be used in combination with the rifle by having the element confronting the crowd armed with riot batons and the support or reserve element armed with rifles and bayonets.
2. Rifle. The rifle may also be used in crowd control formations.
3. Sniper Rifle. Each company should have one sniper rifle marksman to fire at specific targets as directed by a responsible individual and authorized under the criteria for use of deadly force.
4. Hand Weapons. Hand weapons may be carried by designated personnel when it is impractical to carry rifles. They are used as defensive weapons.
5. Disperser, Riot Control Agent, Portable M33. The disperser is used as directed by the company commander.
6. Disperser M36. To be used by personnel who have the responsibility to control or subdue small groups of rioters or attackers.
7. Shotgun. Two riot shotguns will be issued to each squad and carried by the assistant squad leader and team leader. They are used to engage selected targets when use of deadly force is justified and a short range weapon is advisable.
8. Launcher Projectile 64mm Riot Control M234. M234 Launcher will be issued to grenadiers of the Light and Heavy Teams.

NOTE: The basis for issue of special weapons named above is contained in AGTX OPLAN MSCA.

APPENDIX D  
CIVIL DISTURBANCE TRAINING

<u>SUBJECT</u>	<u>INDIVIDUAL TNG HOURS</u>
1. INDIVIDUAL TRAINING.	
Initial Individual	
Unit Refresher	
Refresher Prior to CPX/FTX	
Jr. Leader	
Employ Necessary Force	1
Contain Crowd	2
Disperse Crowd	2
Patrol Perimeter of Isolated Area	2
Use of Riot Baton (FM 19-15)	1
Employment of Individual Weapon & Bayonet	1
2. UNIT TRAINING.	
Patrol Disturbed Area	*(1) 2
Apprehend Law Violators	2
Control Traffic	1
Neutralize Special Threat	*(1) 2
Operate Temporary Detention Facility	1
Protect Fire Fighting Unit	1
Employ Special Equipment	*(1) 3
Use of Riot Baton (FM 19-15)	1
*( ) Required annually - other hours, up to maximum of eight (8), at the discretion of the commander.	

Appendix D  
CIVIL DISTURBANCE TRAINING

1. Civil Disturbance Training Requirements.

a. Initial individual civil disturbance training (16 hours) will be conducted for all members of the Texas Army National Guard at the earliest practical time after they are assigned to a unit. A record in the format at Tab A will be completed for each individual receiving the training. This record will become a permanent document in each individual's training file. Lesson plans for this training will be forwarded under separate cover. Subjects and required hours for this training are listed below:

<u>Subject</u>	<u>Hours</u>
Employ Necessary Force	2
Riot Control Agent	1
Riot Batons	3
Extreme Force Options	2
Contain Crowd	1
Crowd Control Formations	5
Apprehension and Detention Operations	<u>2</u>
TOTAL	<u>16</u>

b. Unit refresher civil disturbance training (8 hours) will be conducted annually for all members of the Texas Army National Guard. A record in the format at Tab A will be completed for each individual receiving the training. This record will be filed in each individual's training file. The form can be used to record training up to five years. If the initial individual civil disturbance training is recorded on this form, it must be retained. If not, the completed form may be destroyed when the sixth year annual unit refresher training is conducted. Lesson plans provided for the initial individual civil disturbances so as to fit into the time schedule for this training. Subjects and required hours for this training are listed below:

<u>Subject</u>	<u>Hours</u>
Employ Necessary Force	1
Riot Control Agents	1
Riot Batons	1
Extreme Force Options	1/2
Contain Crowd	1
Crowd Control Formations	3
Apprehension and Detention Operations	<u>1/2</u>
Total	8



1 August 1992

APPENDIX D  
CIVIL DISTURBANCE TRAINING

c. Staff Civil Disturbance Training. Each headquarters assigned regional command and control responsibility in Appendix A, this regulation, and each battalion headquarters listed in Appendix A, this regulation, will conduct a minimum of hour hours civil disturbance staff training annually. Suggested topics and explanation of concepts are provided below. A record in the format at Tab A will be completed for each individual receiving the training. This completed form will be filed in each individual's training and updated each time the training is conducted.

<u>Subject</u>	<u>Hours</u>
Command, Control and Support of Units Conducting Civil Disturbance Operations. "This period should include instruction/discussion on task organization of PRCC's and Heavy and Light Teams, establishment and operation of EOC/CP, employment of forces, administrative support requirements and logistical support requirements."	1/2
Coordination with local officials and Higher Headquarters. "This period should cover coordination/liaison with civil authorities, higher headquarters and other military organizations. SOP for State Active Duty and Military Support to Civil Authorities Plan should be reviewed. Special attention should be given to the procedures for civil authorities requesting military assistance."	1/2
Special Civil Disturbance Policies and Procedures. "Cover rules of engagement, procedures when state active duty and procedures when in federal status."	1/2
Practical Exercise. "The practical exercise should include exercising unit alert plans, provisions for training prior to operations, organizing	2 1/2

the force, equipping the force, deploying units, control of units during operations, after operation requirements and after action reports. The practical exercise should be conducted in conjunction with PRCC's training. Civil authorities, especially law enforcement officials, should be encouraged to participate with the staff. The practical exercise should be as realistic as possible which includes activities of the EOC/CP, liaison officers dispatched to civil EOC, issuance of OPORD, reporting and coordination with higher headquarters, etc. Mission Incident Lists should be used to drive the exercise."

d. Junior Leadership Training. Junior Leadership Training will be conducted on an as needed basis. Each individual assigned to a leadership position in the PRCC or Heavy Team will attend this training one time when they are initially assigned leadership duties in the PRCC or Heavy Team. Refresher training may be conducted only when fully justified by the units and approved by AGTX-OT and AGTX-OTM. Additional duty mandays to conduct this training may be requested from AGTX-OT annually.

<u>SUBJECT</u>	<u>HOURS</u>
Command and Control Unit in Civil Disturbance	1
Employ Civil Disturbance Control Measures	1
Tailor Civil Disturbance Control Measures to Specific Area of Operation.	2
Practical Exercise (Include hands-on type training for leaders in a civil disturbance environment. Exercises in dealing with civilian authorities, reporting, discipline of troops, administrative requirements, logistical requirements, command, control, communications, special situations, etc. should be included in the practical exercise.)	4

2. Record of Training. Tab A, this appendix, are the forms that will be used to record training in civil disturbance operations. They will be placed in each soldier's individual training file.

a. Initial Individual and Unit Refresher Training Form. Initial individual training is a one-time requirement. The unit refresher training will be updated annually. When this form is filled, keep it for the record of individual training and start another unit refresher record.

1 August 1992

b. Staff Training. The staff training portion will be updated annually. Junior Leader Training is normally a one-time period. Training prior to a civil disturbance will be completed as required.

1 August 1992

TXARNG 350-3

APPENDIX D  
TAB A  
CIVIL DISTURBANCE INDIVIDUAL  
TRAINING RECORD

NAME: \_\_\_\_\_ RANK: \_\_\_\_\_ SSN: \_\_\_\_\_

[ ] INITIAL INDIVIDUAL TRAINING

<u>SUBJECT</u>	<u>HOURS</u>
Employ Necessary Force	2
Riot Control Agencies	1
Riot Batons	3
Extreme Force Options	2
Contain Crowd	1
Crowd Control Formations	5
Apprehension and Detention Operations	2
TOTAL	<u>16</u>

Date Training Received: \_\_\_\_\_

[ ] UNIT REFRESHER TRAINING

<u>SUBJECT</u>	<u>HOURS</u>
Employ Necessary Force	1
Riot Control Agents	1
Riot Batons	1
Extreme Force Options	1/2
Contain Crowd	1
Crowd Control Formations	3
Apprehension and Retention Operations	1/2
TOTAL	<u>8</u>

Date Training Received: \_\_\_\_\_ Commander's Initials: \_\_\_\_\_

Date Training Received: \_\_\_\_\_ Commander's Initials: \_\_\_\_\_

Date Training Received: \_\_\_\_\_ Commander's Initials: \_\_\_\_\_

Date Training Received: \_\_\_\_\_ Commander's Initials: \_\_\_\_\_

Date Training Received: \_\_\_\_\_ Commander's Initials: \_\_\_\_\_

"I certify mandatory Civil Disturbance Control Training has been conducted as indicated for the individual listed above."

\_\_\_\_\_  
(Commanding)

D-A-1

1 August 1992

INDIVIDUAL RECORD  
CIVIL DISTURBANCE TRAINING

NAME: \_\_\_\_\_ RANK: \_\_\_\_\_ SSN: \_\_\_\_\_

[ ] STAFF TRAINING

NUMBER OF HOURS: \_\_\_\_\_

Date Training Received: \_\_\_\_\_ Commander's Initials: \_\_\_\_\_

Date Training Received: \_\_\_\_\_ Commander's Initials: \_\_\_\_\_

Date Training Received: \_\_\_\_\_ Commander's Initials: \_\_\_\_\_

Date Training Received: \_\_\_\_\_ Commander's Initials: \_\_\_\_\_

Date Training Received: \_\_\_\_\_ Commander's Initials: \_\_\_\_\_

[ ] JUNIOR LEADER CIVIL DISTURBANCE TRAINING

NUMBER OF HOURS: \_\_\_\_\_

Date Training Received: \_\_\_\_\_

[ ] TRAINING IMMEDIATELY PRIOR TO A CIVIL DISTURBANCE

<u>SUBJECT</u>	<u>MINUTES</u>
Employ Necessary Force	10
Riot Batons	20
Extreme Force Options	10
Contain Crowd	20
Crowd Control Formations	60
TOTAL	120

"I certify mandatory Civil Disturbance Control Training has been conducted as indicated for the individual listed above."

\_\_\_\_\_  
(Commanding)

1 August 1992

TXARNG REG 350-3

APPENDIX E  
ANNUAL EVALUATION  
CHECKLIST  
FOR  
CIVIL DISTURBANCE CONTROL TRAINING

UNIT: \_\_\_\_\_

LOCATION: \_\_\_\_\_

DATE: \_\_\_\_\_

RATING: OPERATIONALLY READY  
NOT OPERATIONALLY READY

\_\_\_\_\_  
Evaluator (Signature)

\_\_\_\_\_  
Unit Commander (Signature)

(Local Reproduction Authorized)

E-1

Z 0011890

1 August 1992

1. This checklist is intended only as a guide to aid commanders in developing criteria to assist in evaluating the civil disturbance control capability of their unit. This checklist is not all inclusive and must be supported by a thorough knowledge of material contained in civil disturbance plans and FM 19-15, which contains checklists for areas of staff responsibility.
2. This checklist consists of four sections: Personnel, Training and Operations, Logistics, and Commander's Estimate.
3. The unit will be graded as Operationally Ready (O-R) or Not Operationally Ready (N/O-R) with appropriate remarks as necessary.

SECTION A

PERSONNEL

A-1. Unit Strength.

	<u>AUTHORIZED STRENGTH</u>				<u>ASSIGNED STRENGTH</u>			
	OFF	WO	EM	AGG	OFF	WO	EM	AGG
Headquarters	---	---	---	---	---	---	---	---
Subordinate Units	---	---	---	---	---	---	---	---
_____	---	---	---	---	---	---	---	---
_____	---	---	---	---	---	---	---	---
_____	---	---	---	---	---	---	---	---
_____	---	---	---	---	---	---	---	---
_____	---	---	---	---	---	---	---	---
_____	---	---	---	---	---	---	---	---
_____	---	---	---	---	---	---	---	---
Total	---	---	---	---	---	---	---	---

A-2. Identify personnel shortages considered significant as they must be resolved before the unit is committed.

A-3. Personnel Turnover.

	<u>GAINS DURING PERIOD</u>	<u>LOSSES DURING PERIOD</u>
Jan-Mar	_____	_____
Apr-Jun	_____	_____
Jul-Sep	_____	_____
Oct-Dec	_____	_____

1 August 1992

TXARNG REG 350-3

A-4. Documentation: Does the unit have on file:

AR 350-1	Yes	_____	No	_____
NGR 500-2	Yes	_____	No	_____
TXARNG REG 350-3	Yes	_____	No	_____
SOP for State Active Duty	Yes	_____	No	_____
MSCA Plan (AGTX)	Yes	_____	No	_____
Training Record for Each Soldier	Yes	_____	No	_____

SECTION B

TRAINING AND OPERATIONS

	<u>O-R</u>	<u>N/O-R</u>	<u>REMARKS</u> <u>DATE</u>
B-1. When was the unit first classified as a civil disturbance mission unit?	_____	_____	_____
B-2. Has the unit conducted training in accordance with AR 350-7, Fm 19-15 and TARNG Reg 350-3?	_____	_____	_____
B-3. Do commander's and training officers correlate readiness with training requirements and personnel turnovers?	_____	_____	_____
B-4. Does each soldier have knowledge of civil disturbance control operation (IAW para 2-3c (3)(e), AR 350-1?	_____	_____	_____
B-5. Have individuals assigned to special equipment such as shot guns, sniper rifles, and riot control agent dispersers received qualifying training?	_____	_____	_____
B-6. Does a need exist to conduct additional civil disturbance training in the immediate future? (If so, state recommendation.)	_____	_____	_____

E-3

Z 0011892



TXARNG REG 350-3

1 August 1992  
REMARKS

O-R

N/O-R

B-7. Does the unit have an adequate alert plan?

\_\_\_\_\_

\_\_\_\_\_

\_\_\_\_\_

a. When was the last time it was tested?

Date: \_\_\_\_\_

b. Alert Test Results. %

\_\_\_\_\_ %

B-8. Have procedures been established to rapidly identify personnel who have not received training in civil disturbance control operations?

\_\_\_\_\_

\_\_\_\_\_

\_\_\_\_\_

B-9. Have procedures been established to insure that untrained personnel are not committed to riot control duty (They can be used in a support role)?

\_\_\_\_\_

\_\_\_\_\_

\_\_\_\_\_

B-10. Identify by assignment title personnel in the unit that have attended SEADOC.

\_\_\_\_\_

\_\_\_\_\_

\_\_\_\_\_

B-11. Are key personnel knowledgeable of appropriate civil disturbance plans?

\_\_\_\_\_

\_\_\_\_\_

\_\_\_\_\_

B-12. When was the last time the unit participated in a civil disturbance control CPX?

Date: \_\_\_\_\_

B-13. What percentage of key personnel currently assigned to the unit participated in the last civil disturbance control CPX?

\_\_\_\_\_ %

B-14. Has each individual been issued a card titled "Special Orders for Military Personnel Engaged in Civil Disturbance Operations" (Current GTA 21-2-7 or equivalent)?

YES

NO

NUMBER

OF

#CHECKED

1 August 1992

TXARNG REG 350-3

B-15. Do spot checks indicate that personnel understand what is meant by the term "application of minimum force"?

YES NO \_\_\_\_\_ OF \_\_\_\_\_  
NUMBER #CHECKED

B-16. Do personnel have essential personal knowledge of politics pertaining to civil disturbance control operations?

YES NO \_\_\_\_\_ OF \_\_\_\_\_  
NUMBER # CHECKED

B-17. Does a need exist to conduct a civil disturbance control CPX in the immediate future?

YES NO

B-18. What % of unit has received initial entry Civil Disturbance Training?

Assigned: \_\_\_\_\_  
Trained: \_\_\_\_\_  
Percent: \_\_\_\_\_

B-19. Has annual unit civil disturbance training been conducted?

Date: \_\_\_\_\_ or Date  
Scheduled: \_\_\_\_\_.

B-20. Is unit recording appropriate civil disturbance training and filing records in individual training files?

YES NO

B-21. Has civil disturbance staff training been conducted?

Date: \_\_\_\_\_ or Date  
Scheduled: \_\_\_\_\_.

B-22. Has Junior Leader Civil Disturbance Training been conducted?

Date: \_\_\_\_\_ or Date  
Scheduled: \_\_\_\_\_.

1 August 1992

SECTION C

LOGISTICS

	<u>O-R</u>	<u>N/O-R</u>	<u>REMARKS</u>
C-1. List major TOE and special civil service disturbance equipment shortages that would limit the ability of the unit to accomplish its civil disturbance control mission.	_____	_____	_____
C-2. Have procedures been established to provide for the continuing logistical support of committed units (rations, fuel, ammo, water, vehicle support, medical)?	_____	_____	_____
C-3. Are logistical personnel familiar with procedures governing the loan of DOD resources to civil authorities?	_____	_____	_____
C-4. Have appropriate movement plans been developed? When was the last time they were tested?	_____	_____	_____
C-5. Are commanders, staff, and personnel properly oriented on the need to accomplish civil disturbance control missions in the most economical way possible? (i.e.: minimize airlift and other requirements such as commercial latrines, hotel accommodations, rental vehicles, etc., to the maximum extent possible).	_____	_____	_____
C-6. Have procedures been established by the next higher command to review support requirements from a need versus cost effectiveness point of view?	_____	_____	_____

1 August 1992

TXARNG REG 350-3

	<u>O-R</u>	<u>N/O-R</u>	<u>REMARKS</u>
C-7. Have procedures been established to apprise the next higher level of command of resource requests over \$10,000?	_____	_____	_____
C-8. Are staff personnel aware of lessons learned from previous civil disturbance control operations?	_____	_____	_____
C-9. Do plans (where appropriate) provide for the comptroller function in the planning, coordination and execution of a civil disturbance control operation?	_____	_____	_____

SECTION D

COMMANDER'S ESTIMATE

Based on the information reported in section A through C and your personal knowledge of your unit:

a. Do you believe that your unit needs additional training prior to commitment to a civil disturbance control mission?

YES NO (Circle one)

b. If your unit needs or would significantly benefit from additional training, identify the shortcoming and the expected date of completion of the training.

\_\_\_\_\_  
\_\_\_\_\_  
\_\_\_\_\_  
\_\_\_\_\_

c. Are there logistical factors which must be resolved prior to commitment (if so, explain)?

\_\_\_\_\_  
\_\_\_\_\_

d. How long would it take to muster 85 percent of your unit on a weeknight? Weekend?

\_\_\_\_\_  
\_\_\_\_\_

e. Do you take exception to information contained in Section A through C (if so, identify and explain)?

\_\_\_\_\_  
\_\_\_\_\_  
\_\_\_\_\_

f. Identify and explain any other factors or considerations which should be considered by personnel making the evaluation and their supervisors who may review the report.

\_\_\_\_\_  
\_\_\_\_\_  
\_\_\_\_\_  
\_\_\_\_\_  
\_\_\_\_\_

1 August 1992

TXARNG 350-3

FOR THE ADJUTANT GENERAL:

DISTRIBUTION:  
E (+200 to 15)

JAMES H. MC KNIGHT Jr.  
Adjutant

Adjutant General's Department of Texas  
Austin, Texas  
13 July 1992

TAB A (LOGISTIC STATUS REPORT) TO APPENDIX 5 (Logistics Reports)  
TO ANNEX J (Reports) TO AGTX MSCA OPLAN

FROM: Task Force \_\_\_\_\_

TO: AGTX EOC

C L A S S I F I C A T I O N

SUBJECT: Logstat/001/as of TIME DD MMM YY

1. ( ) PERSONNEL BY LOCATION

LOCATION	NUMBER
----------	--------

TOTAL

2. ( ) CLASS I:

B-RATIONS	DAYS OF SUPPLY
-----------	----------------

MRE	DAYS OF SUPPLY
-----	----------------

3. ( ) CLASS II CRITICAL ITEMS:

NOMENCLATURE	NSN	REQ NO	QTY DUE	IN STATUS
--------------	-----	--------	---------	-----------

4. ( ) CLASS III (BULK):

LOCATION	THOUSAND	GAL
----------	----------	-----

A. ( ) JETAL

B. ( ) MOGAS

C. ( ) DIESEL

D. ( ) AVGAS

Report will be due as of 0400Z of the initial day forces are  
deployed, and as of 0400Z each day thereafter. Reports will be  
telephoned by the Major Subordinate Command Headquarters to the  
AGTX EOC.

J-5-A-1

5. ( ) CLASS III (PKG) CRITICAL ITEMS (THREE D OF S OR LESS)

NOMENCLATURE NSN REQ NO QTY DUE IN STATUS

6. ( ) CLASS IV CRITICAL ITEMS (TEN D OF S OR LESS)

NOMENCLATURE NSN REQ NO QTY DUE IN STATUS

7. ( ) CLASS V:

NOMENCLATURE NSN REQ NO QTY DUE IN STATUS

8. ( ) CLASS VIII: REPORT ALL NON-OPERATIONAL EQUIPMENT.

9. ( ) CLASS VIII: CRITICAL ITEMS (THREE D OF S OR LESS):

10. ( ) CLASS IX: CRITICAL ITEMS (THREE D OF S OR LESS):

11. ( ) WATER

LOCATION ON HAND CONSUMPTION PRODUCTION CAPABILITY

12. ( ) MAJOR LOGISTICAL DEFICIENCIES/PROBLEMS (NARRATIVE):

13. ( ) REQUEST ASSISTANCE FROM (UNIT) IN RESOLVING THE FOLLOWING LOGISTICAL PROBLEMS:



Adjutant General's Department of Texas  
Austin, Texas  
13 July 1992

ANNEX K (REFERENCES) TO AGTX MSCA OPLAN

Reference:

a. AR 95-3, Aviation General Provisions, Training, Standardization, and Resource Management.

b. AR 358-10, The Army Safety Program.

c. AR 385-40, Accident Reporting and Records.

Time Zone Used Throughout the Order: SIERRA

1. Map, Official State Highway, Texas Department of Highways and Transportation, Current Edition.
2. Standing Operation Procedures for State Active Duty, AGTX.
3. DA Civil Disturbance Plan GARDEN PLOT (U) (NOTAL).
4. HQ, FORSCOM Civil Disturbance Plan GARDEN PLOT (U) (NOTAL).
5. AR 140-488, License to Use Army Reserve Facilities.
6. AR 500-50, Civil Disturbances.
7. FM 19-15, Civil Disturbances.
8. NGR 10-2, State Area Command, Army National Guard.
9. NGR 350-1, Army National Guard Training.
10. NGR 500-1/ANGR 55-04, Military Support to Civil Authorities.
11. NGR 500-5, Civil Disturbance Control Operations.
12. TARNG Reg 350-3, Training for control of Civil Disturbances.

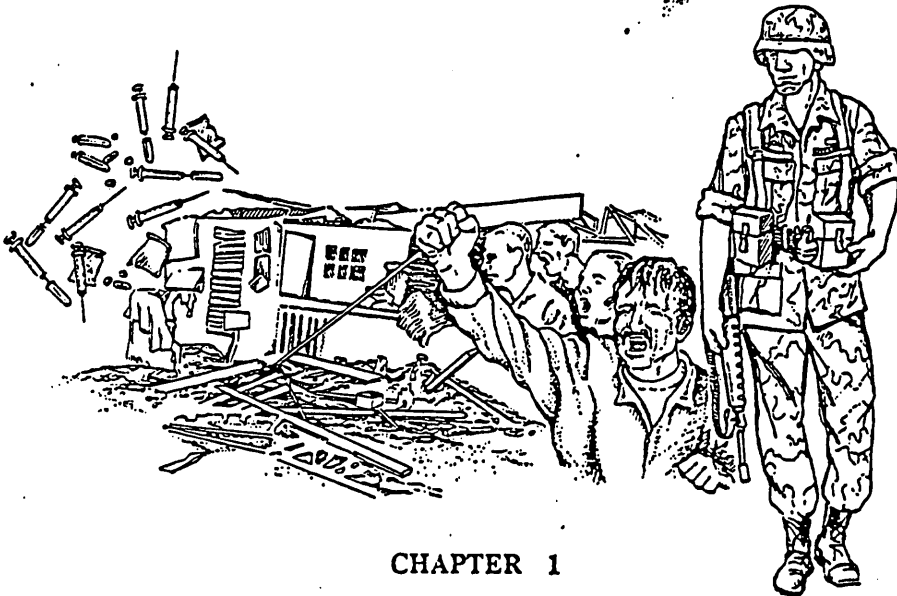

## CHAPTER 1

# CONCEPT AND PRINCIPLES

*This chapter presents a brief historical perspective and concept of Army domestic support operations, the principles of operations other than war that apply to these operations, and a description of the Army's role. The Army consists of the active component (AC), the Army National Guard (ARNG), the US Army Reserve (USAR), and Department of Army (DA) civilians. The National Guard (NG), in a state or territorial status, has primary responsibility for providing military assistance to state and local civil authorities.*

### HISTORY AND CATEGORIES OF DOMESTIC SUPPORT

**A domestic support operation is the authorized use of Army physical and human resources to support domestic requirements.**

Since the Army's inception, its mission has been to fight and win the nation's wars. At the same time, the Army has provided general military support to the nation, including participation in a wide variety of

activities to assist civilian authorities. The Army has enforced laws, quelled domestic violence and insurrection, combatted terrorism, participated in public works and environmental projects, and assisted in recovery operations following disasters.

The dramatic end of the Cold War caused significant changes in the nation's domestic and foreign priorities. During the Cold War, national attention was directed to the external threat and related issues. Today, along with a shift from a forward deployed to a force projection strategy is a new awareness of the benefits of military assistance to improve the nation's physical and social infrastructure. The Army's focus on and continuing involvement in all aspects of domestic support operations identified the need for published doctrine.

## DOMESTIC SUPPORT OPERATIONS

The Army's roles and responsibilities in domestic support operations divide into four primary categories: disaster assistance, environmental assistance, law enforcement support, and community assistance, as depicted in Figure 1-1.

### DISASTER ASSISTANCE.

From the earliest years of the republic, the Army has provided assistance to the country in times of disaster. During the final year of the Civil War, Army officers provided disaster relief through the Freedman's Bureau. The Army also played a direct role in many disaster relief operations in the late nineteenth century, including the great Chicago fire, the Johnstown flood, and the Charleston earthquake.

In recent years, Presidential and Congressionally mandated federal disaster assistance programs have evolved. The Army actively participates with federal

and state agencies in disaster assistance planning, exercises, and operations in response to both natural and man-made disasters.

Disaster assistance includes those humanitarian and civil defense activities, functions, and missions in which the Army has legal authority to act. The Army provides disaster assistance to states, the District of Columbia, territories, and possessions. Civil authorities must request assistance, usually as a result of disasters such as hurricanes, typhoons, earthquakes, or massive explosions.

### ENVIRONMENTAL ASSISTANCE

Environmental assistance has been evolving since the 1960s. The Army has provided a variety of resources to meet environmental challenges that have emerged as a result of increased public concern and demands for the restoration, conservation, and

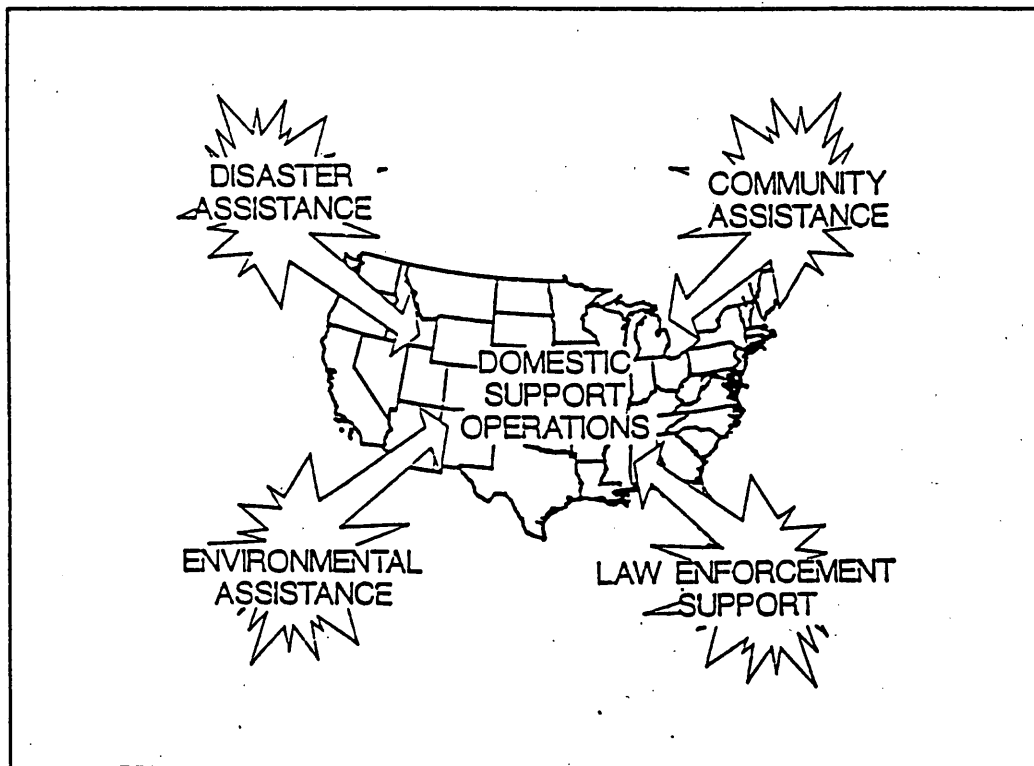

Figure 1-1. Domestic Support

protection of the environment. Typical missions are responding to hazardous material releases, restoring contaminated land and water, and conserving the nation's natural and cultural resources. With the passage of *The Comprehensive Environmental Response, Compensation, and Liability Act of 1980* and the later development of The National Oil and Hazardous Substances Contingency Plan, the Army became a member of the national and regional response teams that plan for and respond to hazardous substance spills.

The Army is inextricably linked to environmental stewardship. Its environmental assistance operations aid civil authorities in preserving, protecting, and enhancing the environment. Its strategy rests on the four pillars of compliance, restoration, prevention, and conservation.

- Compliance is responding to small-scale hazardous material spills and regulating support to other government agencies.
- Restoration is cleaning up contamination from past operations.
- Prevention is developing and sharing new technologies that reduce pollution generation.
- Conservation focuses on the preservation of natural and cultural resources such as wetlands and wildlands.

Army support in these areas may be initiated under disaster assistance or executed under separate authority.

#### LAW ENFORCEMENT

*The Posse Comitatus Act of 1878* severely restricts the use of federal forces to enforce public law. However, acting under Constitutional provisions, the Army has on many occasions been used to quell civil disturbances and restore order. Use of military force has ranged from the Whiskey Rebellion in 1794 to the urban riots of the 1960s and the Los Angeles riot of 1992.

In 1981, Congress passed *The Military Cooperation with Civilian Law Enforcement Agencies Act* to allow military collaboration with civilian law enforcement agencies. This act dramatically expanded the Army's participation in counterdrug efforts. Alliance and North Star are two examples of operations that use active and reserve component forces to halt the flow of contraband across United States borders.

Operations in support of law enforcement include assistance in counterdrug operations, assistance for civil disturbances, special security operations, combating terrorism, explosive ordnance disposal (EOD), and similar activities. Some, by their nature, may become international in scope due to a linkage between domestic and international operations. Constitutional and statutory restrictions and corresponding directives and regulations limit the type of support provided in this area.

#### COMMUNITY ASSISTANCE

Throughout its history, the Army has been involved in community projects and operations, applying its skills, capabilities, and resources to the needs and interests of American communities. Efforts at the national level focus on contributions to the nation and generate public support for the Army. State and local efforts foster an open, mutually satisfactory, cooperative relationship among installations, units, and the local community.

The most frequently conducted domestic support operations involve community assistance. Army resources may be used to support civilian organizations to promote the community's general welfare. These missions and operations include public works, education, and training. Other examples include participation in minor construction projects and providing color guards for local events. In compliance with existing regulations and directives, the Army and local communities may establish mutual support agreements concerning medical, police, and emergency services.

## DOMESTIC SUPPORT OPERATIONS

### CONCEPT

The Secretary of the Army  
is the DOD's executive  
agent for most domestic  
support operations.

The National Command Authorities (NCA) direct the Army to conduct domestic and international operations. The Secretary of Defense has designated the Secretary of the Army as the executive agent for most domestic support operations. During these operations, military support supplements, rather than replaces, civil agency responsibilities.

The Army provides domestic support through Army posts, camps, installations, armories, and stations as members of the communities in which they are located. Commanders should maintain close liaison with local elected and appointed officials.

Domestic support ranges from disaster assistance to more frequently conducted community assistance activities. All domestic support operations share the common characteristic of using Army human and physical resources to enhance national security, thus contributing to the nation's overall well-being. These operations, which usually draw extensive media attention, must consider public affairs implications.

Environmental missions and operations are directed at the physical infrastructure of the nation. National and local efforts may be supported by Army organizations, activities, and units.

Law enforcement support helps civil law enforcement authorities maintain law and order. Laws, directives, and regulations restrict the Army from assuming the civil law enforcement mission.

Community assistance operations help meet national, state, or local community objectives. Intended to fill needs not met, they should avoid duplication or competition with the civilian sector.

The Army offers assistance, such as providing equipment or personnel to accomplish a specific task, to other federal, state, or local agencies. The Army's goal is to use its assets prudently for domestic support

operations while providing a significant benefit to the nation.

Civilian emergency management is almost universally organized on the "unmet needs" philosophy. Local jurisdictions, responsible for the security and welfare of their citizens, request assistance only when their resources are insufficient to meet requirements. Most states conform to the general outlines of this emergency management concept, as do their constituent county and local jurisdictions. Normally the state directs large-scale efforts, and commanders should establish liaison at that level. Disaster or emergency declarations are associated with legal and funding requirements.

A final facet of this concept is that Army commanders should be aware that exercising Army core competencies and demonstrating Army values are vital aspects of providing domestic support. Basic soldier skills in logistical support, engineering, medical care, and communications are but a few examples of competencies that can be exercised in both wartime and peacetime operations. Commanders should, when possible, use domestic support requirements to exercise basic soldier competencies, thereby enhancing individual and unit wartime capabilities. Additionally, domestic support operations provide excellent opportunities for soldiers to interface with the civilian community and demonstrate traditional Army values such as teamwork, success-oriented attitude, and patriotism. These demonstrations provide positive examples of values that can benefit the community and also promote a favorable view of the Army to the civilian population.

### PRINCIPLES OF OPERATIONS OTHER THAN WAR

Domestic support operations occur under various scenarios and conditions. Regardless, the six principles for the conduct of operations other than war—*objective, unity of effort, legitimacy, perseverance, restraint, and security*—apply. A discussion of each follows.

- *Objective* - Direct every military operation toward a clearly defined, decisive, and attainable objective. All commanders and soldiers must understand the objective and integrate their efforts with those of the supported civil

authorities to achieve it. The concepts of mission, enemy, troops, terrain, and time available (METT-T) determine intermediate or subordinate objectives that must be accomplished to achieve the primary objective.

- *Unity of effort - Seek unity of effort toward every objective.* Commanders must seek, establish, and maintain unity of effort. In most crisis situations, they will be in support and under the general direction of civil authorities. They must coordinate closely with these authorities and clearly understand the lines of authority and control. Unity of effort also requires coordination and cooperation among the other federal agencies involved. Almost all domestic support operations will be conducted in a joint and interagency environment. Although unity of *command* may not be possible since command structures vary, the requirement for unity of *effort* remains.
- *Legitimacy - Sustain the people's willing acceptance of the right of the government to govern or of a group or agency to make and carry out decisions.* Legitimacy derives from the perception that using military force is a legal, effective, and appropriate means of exercising authority for reasonable purposes. However, the issue of legitimacy demands caution and critical judgment. The Army must be aware of the legitimate interests, prerogatives, and authority of the various levels of civil government involved and act accordingly. If the Army aids in the solution of a domestic problem but detracts from the legitimacy of the national or state governments by so doing, its actions will be detrimental to the federal government's long-term strategic objectives.
- *Perseverance - Prepare for the measured, protracted application of military capabilities in support of strategic aims.* Domestic support operations may require years to achieve desired effects. They may not have a clear beginning or end decisively. For example, the Army's involvement in counterdrug operations, which began in 1981, remains active.
- *Restraint - Apply appropriate military capability prudently.* Specific rules of engagement govern

the disciplined application of force. In operations other than war, these rules will be more restrictive, detailed, and sensitive to political concerns and may change frequently during operations. Restraints on weaponry, tactics, and levels of force characterize domestic support operations.

- *Security - Never permit hostile forces to acquire an unexpected advantage.* The Army must never be lulled into believing that the nonhostile intent of a mission involves little or no risk. Individuals or groups may wish to take advantage of a crisis situation for personal gain or to make a political statement. Commanders must be ready to counter activity that could bring harm to their units or jeopardize their mission. Disaster assistance operations focus on alleviating human suffering, but as Army forces involved in 1992 Hurricane Andrew relief discovered, prevention of looting and protection of supplies are also necessary.

## THE ARMY'S ROLE

The National Guard in a nonfederal status has the primary responsibility for providing military assistance to state and local governments.

In domestic support operations, the Army recognizes that National Guard forces, acting under the command of their respective governors in a state (nonfederal) status, have the primary responsibility for providing military assistance to state, territorial, and local governments. When state and National Guard resources need supplementation and the governor requests it, the Army will, at the direction of the NCA, assist civil authorities.

## DOMESTIC SUPPORT OPERATIONS

*During massive flooding of the Mississippi River and its tributaries in the summer of 1993, more than 7000 National Guardsmen from the states of Arkansas, Illinois, Iowa, Kansas, Missouri, and Wisconsin were called to state active duty to provide relief to flood victims. Their duties included providing fresh water, security, evacuation, reconnaissance and traffic control, plus sandbagging, hauling, and dike reinforcement support for the duration of the emergency.*

The Army provides this support at federal, state, and local levels. For example, it may help a state or local community by providing disaster relief or it may provide medical personnel and transportation for a state's firefighting effort. Another example is aiding governmental agencies in cleaning up the environment. The Army may also be designated a lead agent for a

specific operation, such as urban search and rescue (US&R) under the Federal Response Plan (FRP), the document that directs federal response to natural disasters such as earthquakes, hurricanes, typhoons, tornadoes, and volcanic eruptions; technological emergencies involving radiological or hazardous material releases; and other incidents requiring federal assistance as prescribed by law. The FRP provides standing mission assignments to selected governmental and nongovernmental organizations to carry out specific emergency support functions (ESFs). Each type of assistance may require an extensive commitment of resources, depending on the nature and scope of the operation, and close coordination with federal, state, or local officials.

Army commanders will frequently coordinate with civilian emergency managers, both professional and volunteer. They are often referred to as the "coordinators of emergency services" or similar titles and, in smaller jurisdictions, may be the fire chief, police chief, or other official. The Army will—

- Establish achievable objectives.
- Establish clear termination standards.
- Tailor forces to the mission.

## SUMMARY

The Army, composed of the AC, ARNG, USAR, and DA civilians, has a long and proud tradition of providing domestic support to the nation. It ranges from less demanding operations such as community activities to high-intensity crisis situations. Principles of operations other than war provide the Army a conceptual foundation on which to conduct domestic support operations. Although the National Guard has primary responsibility for developing plans and providing support to state and local governments, the national shift from a forward deployed to a force projection strategy has brought a new awareness of the benefits the Army can provide to America.

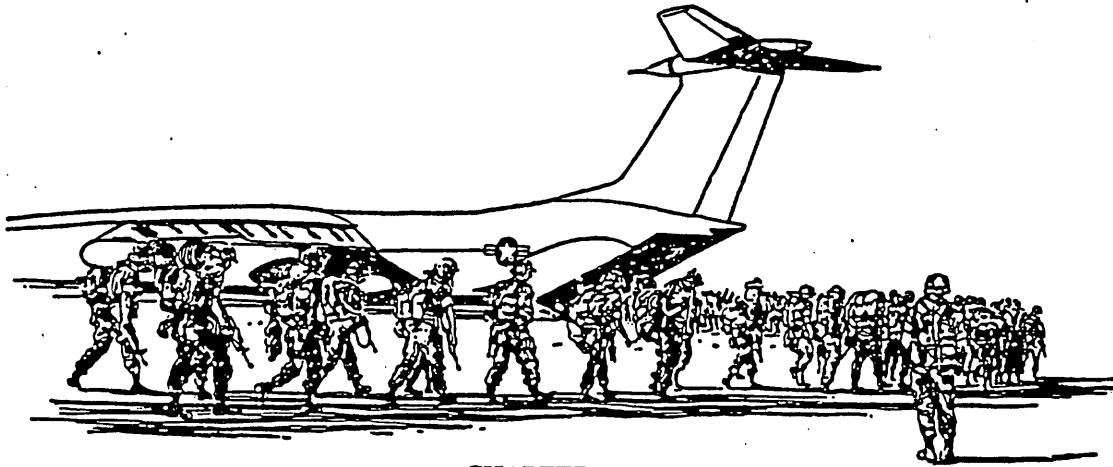

## CHAPTER 2

# ROLES AND RESPONSIBILITIES

---

*Army support to federal, state, and local agencies covers a broad range of activities, events, and occurrences. The type of domestic support may vary from a static display at a local fair to a large deployment of troops, material, and supplies in response to a natural disaster. The scope may vary from involvement at the local community to massive operations covering a multistate or international arena. Depending on the type and scope of required support, the civil authorities and organizations that Army commanders assist will also vary greatly. These organizations are addressed in this chapter in terms of their roles and responsibilities in disaster assistance, environmental assistance, law enforcement, and community assistance operations. Also addressed are the Department of Defense agencies and commands that have significant responsibilities for providing domestic support.*

---

### THE PRESIDENT

**The Army will conduct domestic support operations in a joint and interagency environment.**

The President, as the Chief Executive Officer of the US Government and Commander-in-Chief of all US

military forces, authorizes the use of federal resources for domestic support operations. During disasters or other periods of national emergency, the President provides guidance and direction to federal departments, agencies, activities, and other organizations. The President does this by declaring, usually at the request of a governor, a disaster or emergency and appointing a federal coordinating officer (FCO) to coordinate federal-level assistance.

The President also provides leadership and direction in other areas that may generate Army support, for example, drug abuse, the social and physical



## DOMESTIC SUPPORT OPERATIONS

infrastructure, and environmental pollution. The President may further assist in resolving these issues by committing federal resources or by proposing new programs.

### FEDERAL AGENCIES OTHER THAN DOD

Although not all-inclusive, the following list includes those organizations that have significant responsibilities in the categories of assistance addressed in this manual.

#### DEPARTMENT OF AGRICULTURE (USDA)

As the lead agency for food and firefighting under the FRP, the USDA has significant responsibilities in disaster assistance operations. The US Forest Service (USFS), an agency under the USDA, is responsible for leading firefighting efforts as well as protecting forest and watershed land from fire. Jointly with the Department of Interior (DOI), the USFS controls the National Interagency Fire Center (NIFC) in Boise, Idaho. The NIFC, in turn, provides national coordination and logistical support for federal fire control.

The USDA is scientifically and technically capable of measuring, evaluating, and monitoring situations where hazardous substances have impacted natural resources. In that regard, the USDA can also support environmental assistance operations involving cleanup of hazardous substances.

#### THE AMERICAN RED CROSS (ARC)

The ARC, under charter from Congress, is America's official volunteer disaster relief agency. In that capacity, it has a major role in disaster assistance operations, having been designated the lead agency for mass care under the FRP. Due to the general nature of its charter, it can provide support in environmental assistance, law enforcement, and selected community assistance operations.

#### DEPARTMENT OF COMMERCE (DOC)

The DOC provides fire and weather forecasting as needed from the NIFC or from a nearby weather forecasting facility. Through the National Oceanic and Atmospheric Administration, it provides scientific support for response and contingency planning in

coastal and marine areas. Support includes hazard assessments, trajectory modeling, and information on the preparedness and sensitivity of coastal environments to hazardous substances. Based on its responsibilities and capabilities, DOC can provide support in both disaster and environmental assistance operations.

#### DEPARTMENT OF EDUCATION (DOEd)

The DOEd establishes policy for, administers, and coordinates most federal assistance to education. It supports information and planning for disaster and environmental assistance operations. The DOEd may also become involved in selected Army community assistance programs that address education and training.

#### DEPARTMENT OF ENERGY (DOE)

As the FRP's lead agency for energy, the DOE provides the framework for a comprehensive and balanced national energy plan through the coordination and administration of the federal government's energy functions. The DOE—

- Provides nuclear technical assistance and executive national coordination with the oil, gas, electric power, and solid fuels industries.
- Coordinates international emergency responses with the International Energy Agency and with the International Atomic Energy Agency.
- Coordinates supporting resources for the energy industries involved with catastrophic disaster response and recovery.
- Plays a supporting role in disaster and environmental assistance operations.

#### ENVIRONMENTAL PROTECTION AGENCY (EPA)

As the lead agency for hazardous material response under the FRP, the EPA has a significant role and responsibilities in both disaster and environmental assistance operations. It provides for a coordinated response by federal departments and agencies, state and local agencies, and private parties to control oil and hazardous substance discharges or substantial threats of discharges. In selected operations, it coordinates closely with the US Coast Guard (USCG), which is responsible for conducting hazardous material operations over coastal and inland waterways.

**FEDERAL EMERGENCY MANAGEMENT AGENCY (FEMA)**

The FEMA is the federal government's executive agent for implementing federal assistance to a state and its local governments. In most cases, it implements assistance in accordance with the FRP. Organized into ten federal regions that provide support on a national basis, FEMA may be involved in either disaster or environmental assistance operations. Figure 2-1 depicts those regions.

**GENERAL SERVICES ADMINISTRATION (GSA)**

The GSA is the lead agency for resource support under the FRP. Having extensive expertise both in

contracting and providing services, GSA is an invaluable player in both disaster and environmental assistance operations.

**DEPARTMENT OF HEALTH AND HUMAN SERVICES (DHHS)**

The DHHS is the lead agency for health and medical services under the FRP. The Public Health Service (PHS), an agency under the DHHS, leads this effort by directing the activation of the National Disaster Medical System (NDMS). The DHHS is also responsible for assisting with the assessment of health hazards at a response site and the protection of both response workers and the general public. Agencies

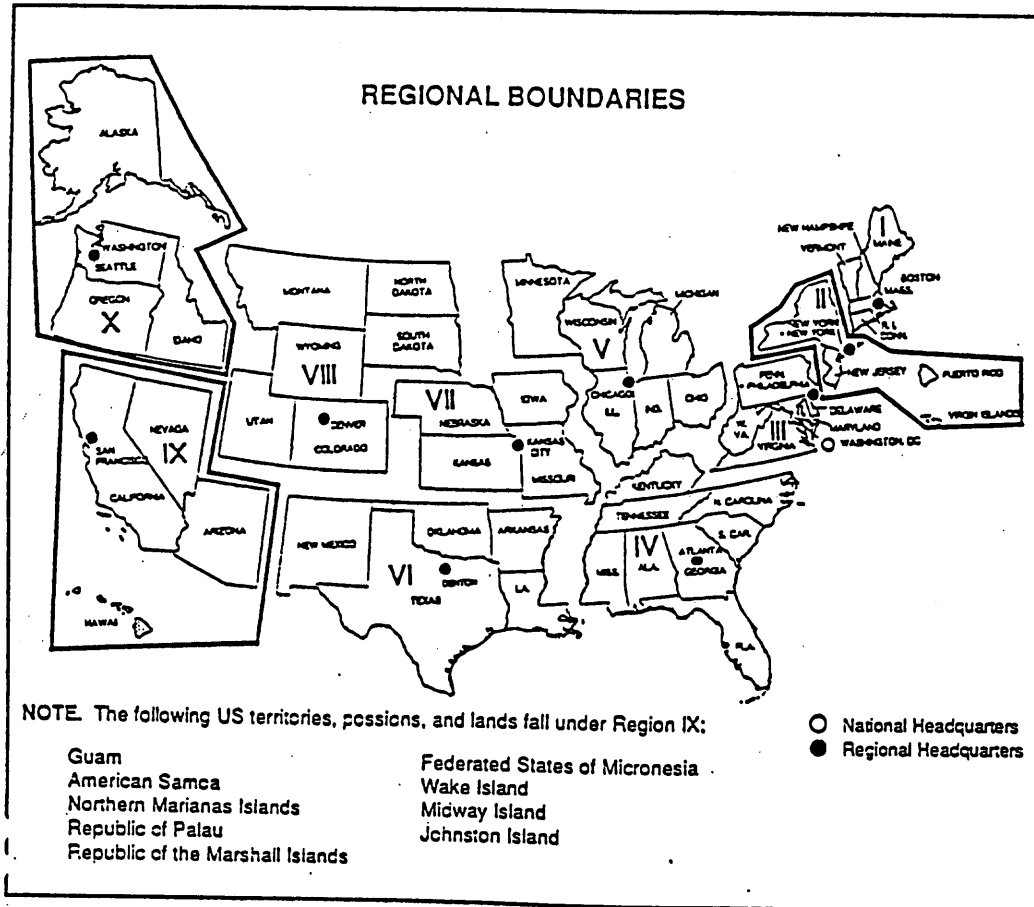

Figure 2-1. Federal Emergency Management Agency

## DOMESTIC SUPPORT OPERATIONS

within DHHS that have relevant responsibilities, capabilities, and expertise are the Agency for Toxic Substances and Disease Registry and the National Institute for Environmental Health Sciences. The DHHS provides support for both disaster and environmental assistance operations and may also become involved in selective Army community assistance operations that provide medical support to disadvantaged communities.

### DEPARTMENT OF INTERIOR

As a support agency under the FRP, the DOI provides support for disaster and environmental assistance operations. It also has major responsibility for American Indian reservations and for people who live in island territories under United States administration. Operating the NIFC jointly with the Department of Agriculture, the DOI has expertise on, and jurisdiction over, a wide variety of natural resources and federal lands and waters.

### DEPARTMENT OF JUSTICE (DOJ)

The DOJ plays a significant role in law enforcement and counterdrug operations. The Drug Enforcement Administration (DEA) is DOJ's lead agency for counterdrug operations. As the government's representative in legal matters, the DOJ may become involved in law enforcement operations, community assistance operations, and disaster and environmental assistance operations, providing legal advice on questions arising from oil and hazardous substance spills. The Attorney General supervises and directs US attorneys and US marshals in the various judicial districts. The DOJ has oversight authority for the Immigration and Naturalization Service (INS) and serves as the lead agency for operations involving illegal mass immigration. The Federal Bureau of Investigation (FBI) is an arm of DOJ.

### DEPARTMENT OF LABOR (DOL)

The DOL, through the Occupational Safety and Health Administration, conducts safety and health inspections of hazardous waste sites and responds to emergencies. It must assure that employees are being protected and determine if the site is in compliance with safety and health standards and regulations. The DOL can thus become a support agency for disaster and environmental assistance operations.

### NATIONAL COMMUNICATIONS SYSTEM (NCS)

As the lead agency for communications under the FRP, the NCS consists of representatives of 23 federal agencies and operates under the authority of the General Services Administration. The NCS provides communications support to federal, state, and local response efforts and is charged with carrying out the National Telecommunications Support Plan to ensure adequate communications following a disaster. It also provides technical communications support for federal fire control. Administratively structured, the NCS consists of an executive agent, a manager, a committee of principles, and the telecommunications assets.

### NUCLEAR REGULATORY COMMISSION (NRC)

Responsible for the Federal Radiological Emergency Response Plan (FRERP), the NRC responds to the release of radioactive materials by its licensees. It provides advice in identifying the source and character of other hazardous substance releases when the commission has licensing authority for activities using radioactive materials. The NRC may serve in a support role in disaster and environmental assistance operations.

### DEPARTMENT OF STATE (DOS)

The DOS advises the President in the formulation and execution of foreign policy. Its primary mission in the conduct of foreign relations is to promote the interests of the United States overseas. In this capacity, the DOS manages the US Agency for International Development and the US Information Agency. The DOS also has a support role in disaster or environmental assistance events or domestic counterdrug operations having international implications.

### DEPARTMENT OF TRANSPORTATION (DOT)

As the lead agency for transportation under the FRP, the DOT coordinates federal transportation in support of federal agencies, volunteer agencies, and state and local governmental entities. It has support roles in ten other ESFs of the FRP. A subordinate agency of the DOT during peacetime, the US Coast Guard conducts counterdrug operations and, in conjunction with the EPA, hazardous material operations. The DOT and the USCG have major roles in disaster and environmental assistance operations. The DOT provides expertise regarding transportation of oil or hazardous substances by all modes of transportation.

#### DEPARTMENT OF TREASURY

The Department of Treasury, through its agency, the US Customs Service (USCS), regulates goods, people, and vehicles entering or leaving the United States and its territories. The USCS assesses and collects duties on imports and controls merchandise to prevent smuggling of contraband, including narcotics. As one of the primary federal agencies involved in support of law enforcement, the USCS plays a support role in planning for disaster or environmental assistance operations. Through the US Secret Service (USSS), the Department of Treasury is responsible for providing security for the President, the Vice-President, and visiting heads of state. The USSS can request the aid of the military—in particular, military police, military working dogs, and explosive ordnance disposal and signal personnel—in the conduct of security and protection missions.

#### NATIONAL WEATHER SERVICE (NWS)

The NWS predicts, tracks, and warns of severe weather and floods. It plays a support role in disaster or environmental assistance operations.

#### DEPARTMENT OF DEFENSE

The DOD is the lead agency for public works and engineering, as well as urban search and rescue under the FRP. It has support roles in the 10 other ESFs, frequently becoming involved in disaster or environmental assistance operations. If directed by the President, DOD may provide support to law enforcement operations and selected community assistance initiatives. A diagram of DOD is at Figure 2-2.

#### SECRETARY OF DEFENSE (SECDEF)

The SECDEF has designated the Secretary of the Army (SA) as the DOD executive agent for providing DOD domestic support operations. These responsibilities are outlined in existing policies, procedures, and directives.

#### SECRETARY OF ARMY

As the DOD executive agent for domestic support operations, the SA develops necessary planning guidance, plans, and procedures. The SA has authority

to task DOD components to plan for and to commit DOD resources in response to requests for military support from civil authorities. Any commitment of military forces of the unified and specified commands must be coordinated in advance with the Chairman, Joint Chiefs of Staff (CJCS). The SA uses the inherent authority of his office to direct Army assistance to domestic support operations. A diagram of the Department of the Army is at Figure 2-3.

#### DIRECTOR OF MILITARY SUPPORT (DOMS)

The DOMS, a general officer appointed by the SA, is the DOD primary contact for all federal departments and agencies during periods of domestic civil emergencies or disaster response. On behalf of the DOD, the DOMS and his supporting staff, serving as a joint staff, ensure the planning, coordination, and execution of many domestic support operations.

#### UNIFIED COMMANDS

Selected commanders-in-chief (CINCs) have domestic support responsibilities, some of which are addressed below. More specific CINC responsibilities for civil assistance missions are identified in appropriate DOD directives, guidelines, and operational plans.

#### Commander-in-Chief, Forces Command (CINCFOR)

The CINCFOR serves as the DOD principal planning and operating agent for military support to civil authorities for all DOD components in the 48 contiguous states and the District of Columbia.

#### Commander-in-Chief, Atlantic Command (CINCLANT)

The CINCLANT serves as the DOD principal planning and operating agent for military support to civil authorities for all DOD components within the Atlantic command area of operations (AO).

#### Commander-in-Chief, Pacific Command (CINCPAC)

The CINCPAC serves as the DOD principal planning and operating agent for military support to civil authorities for all DOD components within the Pacific command AO.

DOMESTIC SUPPORT OPERATIONS

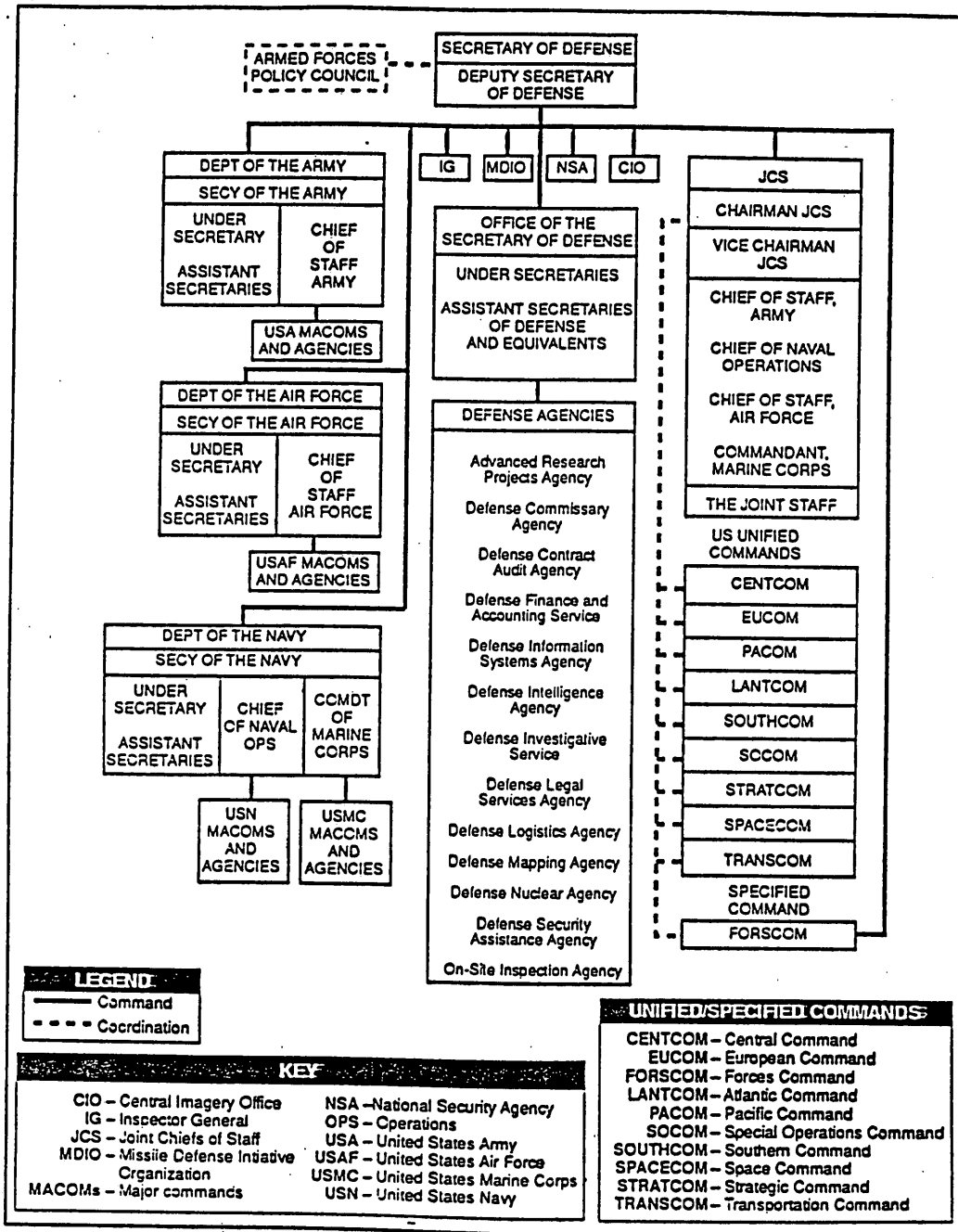

**LEGEND:**  
 — Command  
 - - - Coordination

**KEY:**  
 CIO - Central Imagery Office  
 IG - Inspector General  
 JCS - Joint Chiefs of Staff  
 MDIO - Missile Defense Initiative Organization  
 MACOMS - Major commands  
 NSA - National Security Agency  
 OPS - Operations  
 USA - United States Army  
 USAF - United States Air Force  
 USMC - United States Marine Corps  
 USN - United States Navy

**UNIFIED/SPECIFIED COMMANDS:**  
 CENTCOM - Central Command  
 EUCOM - European Command  
 FORSCOM - Forces Command  
 LANTCOM - Atlantic Command  
 PACOM - Pacific Command  
 SOCOM - Special Operations Command  
 SOUTHCOM - Southern Command  
 SPACECOM - Space Command  
 STRATCOM - Strategic Command  
 TRANSCOM - Transportation Command

Figure 2-2. Department of Defense

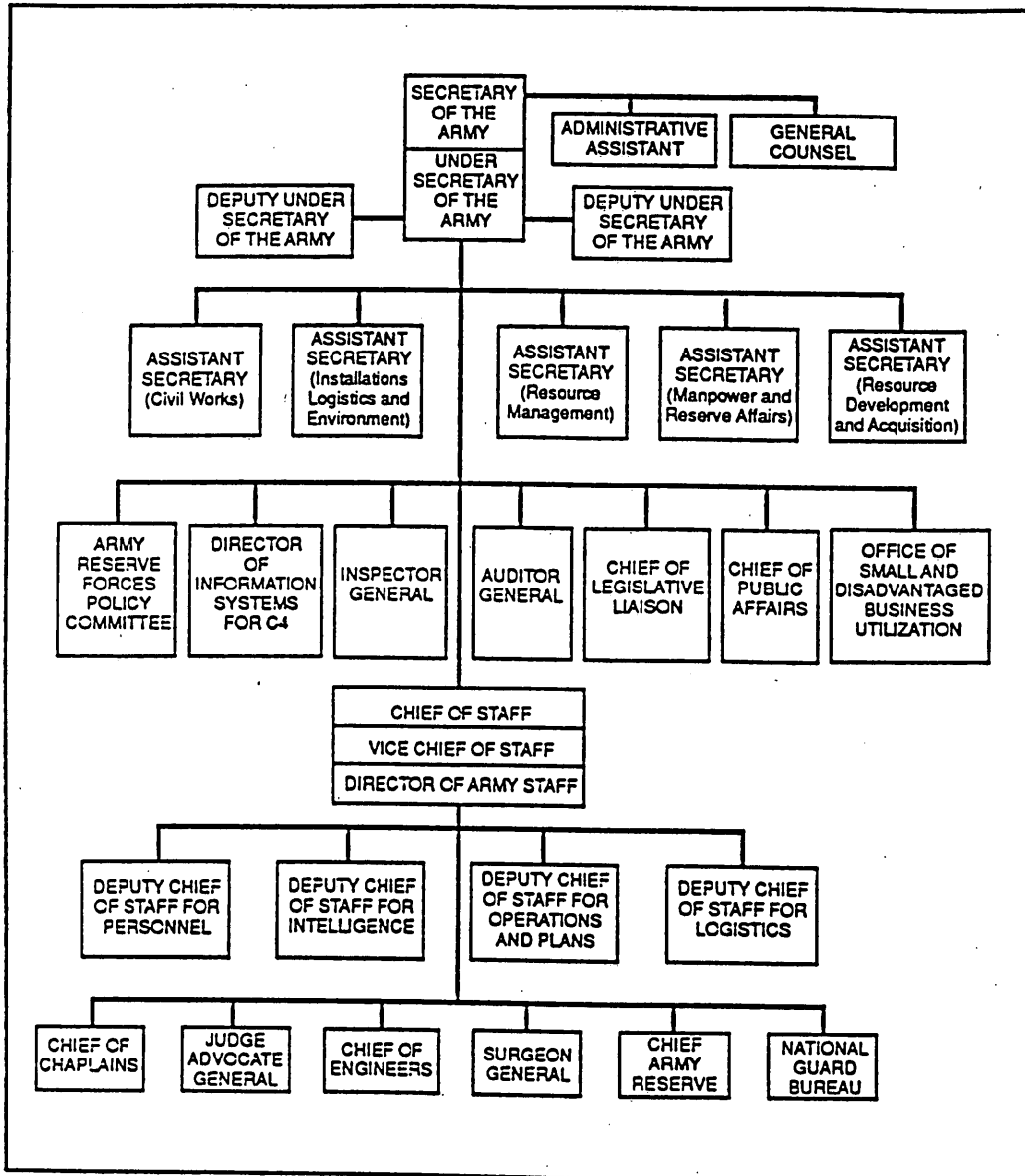

Figure 2-3. Department of the Army

## DOMESTIC SUPPORT OPERATIONS

### Commander-in-Chief, Transportation Command (CINTRANS)

The CINTRANS serves as the DOD single manager for transportation, providing air, land, and sea transportation to meet national security objectives. The CINTRANS has combatant command (COCOM) of the Military Traffic Management Command, Air Mobility Command, and Military Sealift Command, collectively known as the transportation component commands.

### Defense Logistics Agency (DLA)

The DLA supports civil disturbance operations under the provisions of OPLAN GARDEN PLOT, the National Civil Disturbance Plan, with wholesale logistics support for military assistance in disasters.

### DEFENSE COORDINATING OFFICER (DCO)

A CINC appoints the DCO to serve as the DOD single point of contact to the federal coordinating officer for providing DOD resources during disaster assistance. The DCO should collocate with the FCO and coordinates all FEMA mission assignments for military support. The DCO usually has operational control of all DOD forces deployed to support the federal effort. A defense coordinating element (DCE) will be organized to provide support staff for the DCO in the disaster area. The size and composition of the DCE is situation-dependent.

## NATIONAL GUARD

### National Guard Bureau (NGB)

The NGB is the federal coordination, administrative, policy, and logistical center for the Army and the Air National Guard (ANG). It serves as the legal channel of communication among the United States Army, the United States Air Force, and the National Guard in the 54 states and territories. The Chief, National Guard Bureau, has executive agent responsibility for planning and coordinating the execution of military support operations. The Director, Army National Guard (DARNG), in coordination with the Director, ANG, is responsible to the Chief, NGB. NG commanders are responsible for planning and training their forces for both their federal and state missions.

### State Area Command (STARC)

The STARC is a mobilization entity in each state and territory. It organizes, trains, plans, and coordinates the mobilization of NG units and elements for state and federal missions. The STARC is responsible for emergency planning and response using all NG resources within its jurisdiction. It directs the deployment and employment of ARNG units and elements for domestic support operations, including military support to civil authorities. As with active duty forces, emergency response may be automatic or deliberate. When the NG is in a nonfederal status, the governor serves as commander-in-chief of the NG in his state or territory and exercises command through the state adjutant general (TAG). While serving in state status, the NG provides military support to civil authorities, including law enforcement, in accordance with state law. Federal equipment assigned to the NG may be used for emergency support on an incremental cost-reimbursement basis.

### US Property and Fiscal Officers (USPFOs)

USPFOs are Title 10 officers assigned to the NGB and detailed for duty at each state or territory. They are accountable for all federal resources (equipment, dollars, and real estate) provided to the NG of each state. The USPFO staff provides supply, transportation, internal review, data processing, contracting, and financial support for the state's NG. When required, the USPFO can operate as a support installation for active component or USAR forces on a reimbursable basis.

### Emergency Preparedness Liaison Officers (EPLOs)

Representatives from the services are EPLOs to each state NG. As service planning agents' representatives to TAGs and STARCs, they plan and coordinate the execution of national security emergency preparedness (NSEP) plans, performing duty with the STARCs. EPLOs are Army, Navy, and Air Force Reservists who have been specifically trained in disaster preparedness and military support matters. Each reports to an active duty program manager or planning agent in his or her respective service who has responsibility and authority to provide (or seek further approval of) military support to the state. EPLOs must have a comprehensive knowledge of their respective service facilities. They must also monitor and update their portion of the DOD Resource Data

Base (DODRDB). Upon appointment of the DCO, EPLOs may be ordered to active duty to serve as liaison representatives to the STARCs and their respective services.

#### US ARMY RESERVE

The USAR is capable of extensive domestic support operations. This assistance and support may include the use of equipment and other resources, including units and individuals. USAR personnel may be activated in a volunteer status when ordered to active duty in lieu of annual training or after the President has declared a national emergency.

#### MAJOR COMMANDS (MACOMs)

MACOM commanders may provide domestic support operations in accordance with authorized agreements they have reached with civil authorities in their surrounding communities or as directed by higher headquarters. Specifically, they may provide resources for disaster relief upon request, generally placing these resources under the operational control of the military commander in charge of relief operations.

#### US Army Health Services Command (HSC)

The HSC, as requested by the supported CINC, provides health service support (HSS) resources, including clinical personnel under the Professional Officer Filler System (PROFIS), for all categories of domestic support operations. These resources are normally attached to, or placed under the operational control of, a supported CINC HSS unit for the duration of the operation.

#### Continental US Army (CONUSA) Commanders

CONUSA commanders provide regional military support to civil authorities by planning for and conducting disaster relief operations within their areas of responsibility. They also establish and maintain disaster relief liaison with appropriate federal, state, and local authorities, agencies, and organizations.

#### US Army Corps of Engineers (USACE)

The USACE is organized into geographically dispersed (CONUS and OCONUS) division and district subordinate commands. The USACE commander also serves as the chief of engineer soldier forces and in that

capacity guides the Army staff in their utilization. The USACE's mission is to provide quality, responsive engineering service to the nation. The command applies substantial expertise to the areas of operation and maintenance of the national waterway infrastructure, environmental restoration and remediation, project planning and management, coordination of complex interagency or regional technical issues, and disaster planning and response. The USACE serves as DOD's lead agent, in direct support of FEMA, for public works and engineering in the FRP. Figure 2-4 depicts USACE division and district regulatory boundaries.

#### US Army Materiel Command (USAMC)

The USAMC may organize and deploy a logistics support element for domestic support operations. It provides supply, maintenance, technical assistance, and other services to the units. In addition, the logistics support element may organize a humanitarian depot to receive, store, and distribute relief supplies. The USAMC is the Army's executive agent for chemical and nuclear accidents and incidents.

### STATE AND LOCAL GOVERNMENT

This section addresses general state and local government responsibilities for responding to disaster assistance operations. Responsibilities for environmental assistance, support of law enforcement, and community assistance are discussed in chapters specifically addressing those operations. State and local government officials, operating under authority granted by state constitutions and local charters, are responsible for most of the daily safety and security issues that impact on their citizens' quality of life. State and local officials have primary responsibility for emergency preparedness planning and responding to emergencies.

Historically, NG units, under control of state governors and TAGs, have been the primary military responders in emergencies. Using federal military forces to support state and local governments is the exception rather than the norm. Federal forces are normally used only after state resources have been exhausted.



**DOMESTIC SUPPORT OPERATIONS**

**STATE RESPONSIBILITIES**

**Governor**

A state governor is empowered by the US Constitution and each respective state constitution to execute the laws of the state and to command the state's NG when it is serving in state status. Governors are also responsible for issuing Executive Orders declaring "states of emergency" and ensuring that state agencies plan for actions in the event of a disaster.

Once a disaster occurs, the governor assesses its extent and determines if local government requests for assistance should be honored. If appropriate, the governor declares a state of emergency, activates the state response plan, and may call up the NG. The governor gives the NG its mission and determines when Guard forces can be withdrawn. In the event a disaster exhausts state resources, the governor may petition the President for federal assistance.

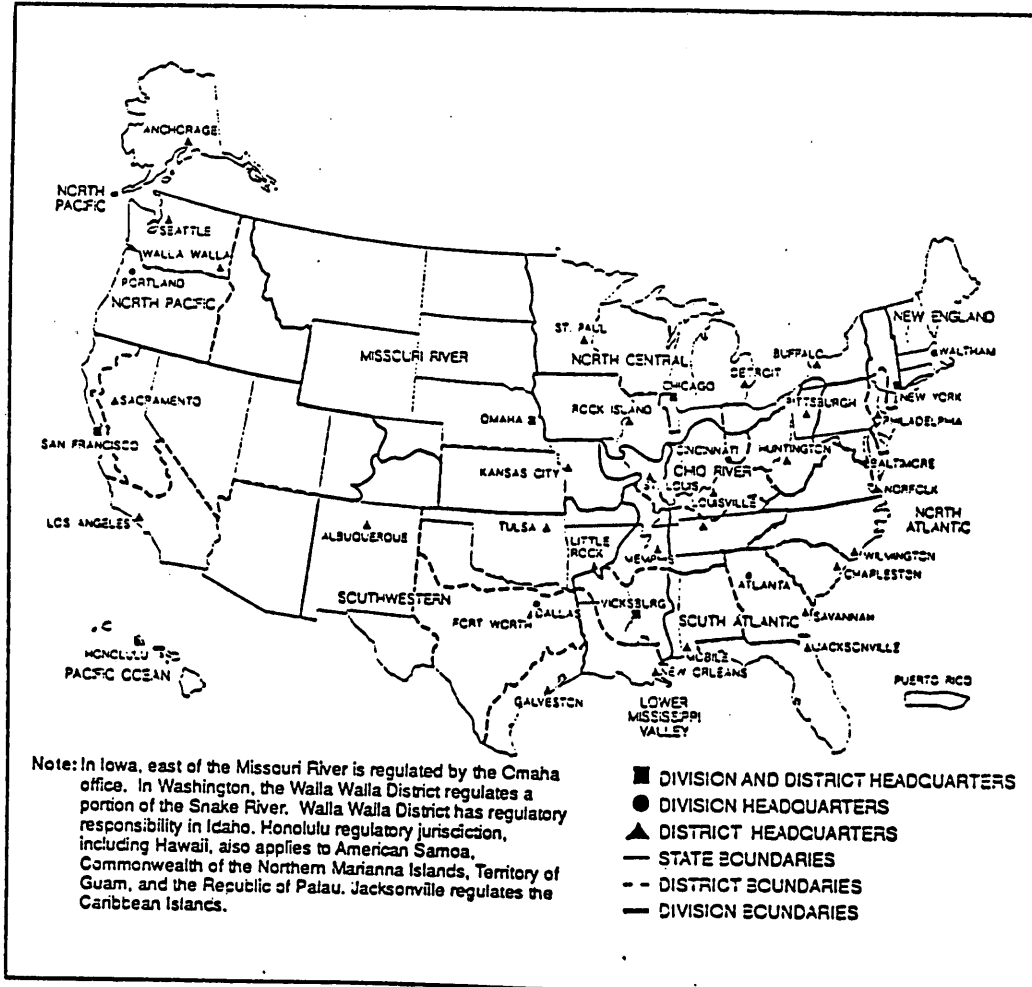

Figure 2-4. Corps of Engineers Division and District Regulatory Boundaries

**Office of Emergency Services (OES)**

All states have a specific agency that coordinates emergency preparedness planning, conducts emergency preparedness training and exercises, and serves as the governor's coordinating agency in an emergency. The titles of these offices vary from state to state, for example, *Division of Emergency Government, Emergency Management Agency, Department of Public Safety, or Office of Emergency Preparedness*. This manual refers to this office using the generic term *Office of Emergency Services*. A diagram depicting a typical structure for state and local operational emergency services organizations and their linkages with equivalent federal organizations is at Figure 2-5.

Generally, the OES is either organized as a stand-alone office under the governor or aligned under TAG or the state police. It operates the state emergency operations center during a disaster or emergency and coordinates with federal officials for support if required. A diagram depicting typical organizations involved in state and local emergency response is at Figure 2-6.

The Adjutant General. The state NG is the governor's primary response force in an emergency. The TAG, through the STARC (specifically the Plans, Operations and Military Support Officer (POMSO)) coordinates emergency response plans for

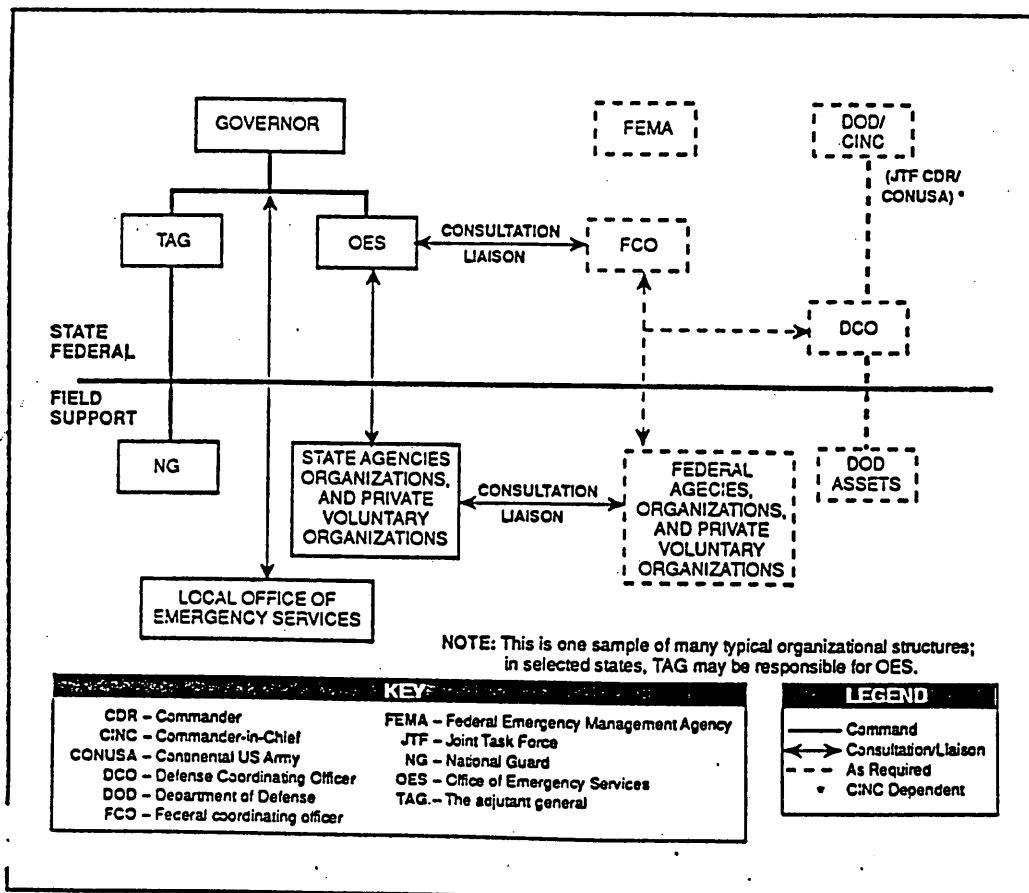

Figure 2-5. State/Local Operational Emergency Services Organization

DOMESTIC SUPPORT OPERATIONS

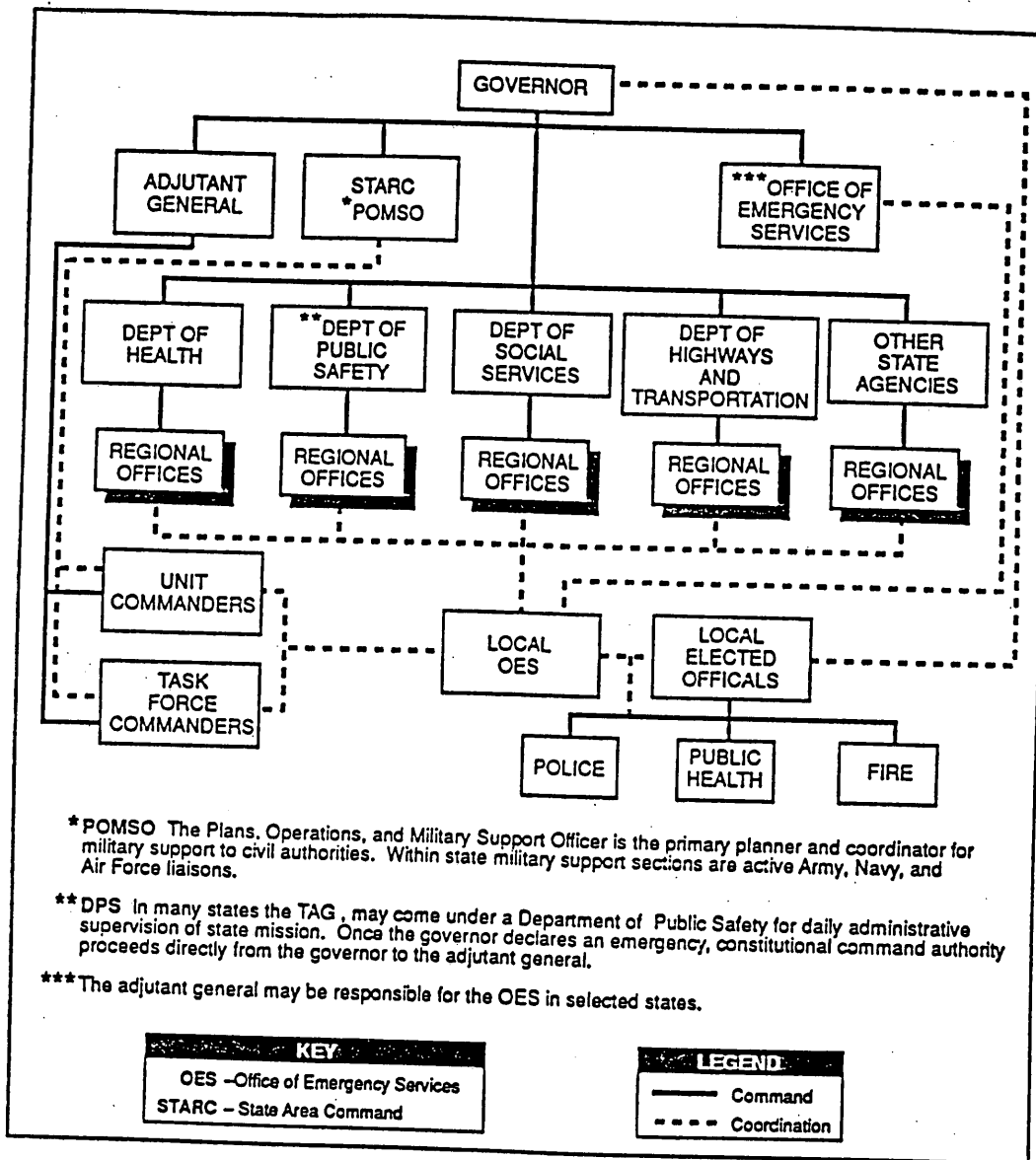

Figure 2-6. State and Local Emergency Response

disasters and emergencies. TAG is in command of state NG forces called to state active duty.

**Plans, Operations, and Military Support Officer**

The POMSO plans for disaster response and recovery operations within the full spectrum of military support missions. Within each state, the POMSO coordinates training plans and exercises between the state NG and federal, state, and local emergency management agencies. The POMSO will serve as the NG point of contact with DOD officials during a federal emergency or disaster.

**State Government Agencies**

State government departments and agencies prepare emergency response plans for their areas of specialization. They also participate in emergency preparedness exercises and respond according to plan.

**LOCAL RESPONSIBILITIES**

Within their respective communities, mayors, city managers, local police and fire protection officials, county executives, sheriffs, prosecuting attorneys, and public health officials are some of the people responsible for law enforcement, safety, health, and fire protection on a daily basis. They are responsible for developing appropriate emergency response plans and responding to emergencies within their jurisdictions. Most local jurisdictions have an OES to plan and coordinate actions in an emergency. In many cases, local jurisdictions have mutual aid agreements with other jurisdictions that allow for firefighter and police assistance. Once local officials determine that an emergency is beyond the scope of their resources or ability to respond, the senior local official is responsible for requesting additional assistance from the state governor.

**SUMMARY**

The Army may support or coordinate with many federal, state, and local governmental departments and agencies as it conducts domestic support operations. Although the Army is seldom the lead agency in disaster assistance operations, it is a support agency for all the FRP's emergency support functions. Almost all Army domestic support operations will be conducted in a joint or interagency environment. Throughout our history, the Army has provided community support at the national level and support to its surrounding communities. The Army also has a long history of providing domestic support and will continue to provide that assistance in the future.



## CHAPTER 3

# LEGAL CONSIDERATIONS AND CONSTRAINTS

*The Constitution, laws, regulations, policies, and other legal issues limit the use of federal military personnel in domestic support operations. This chapter presents an overview of those considerations and constraints.*

### CIVILIAN CONTROL OF THE MILITARY

**Commanders should discuss plans, policies, programs, exercises, funding, and operations with their legal advisors.**

Under the Constitution of the United States, Congress has the authority to raise and support an army, provide and maintain a navy, and make rules for governing and regulating the land and naval forces. The Constitution places the military under civilian control and designates the President as commander-in-chief. Statutes provide for civilian leadership in the form of a secretary of defense, service secretaries, and various other civilian authorities.

The unique capabilities of the military enable it to support federal, state, or local civilian agencies. In most circumstances, the DOD is one of many federal agencies reacting to a domestic emergency or crisis, playing a subordinate, supporting role to a lead, civilian agency.

### THE ROLE OF THE ARMY

Traditionally, nations have raised and maintained armies to provide for the national defense. Today, the United States calls upon its Army to perform various other functions as well, for example, controlling civil disturbances, assisting with disasters, and providing essential services.

- During the civil disturbances of the late 1960s and early 1970s, civilian authorities called upon the Army to help restore order.
- Soldiers provided assistance during times of natural disaster, such as the Hurricane Andrew cleanup in Florida in 1992. Civil authorities can call upon the Army to render assistance if a

major accident occurs at a nuclear power plant. The Army can also help prevent a major environmental disaster by assisting in the cleanup of petroleum or chemical spills.

- During the postal strike of 1970, the federal government called upon the Army to help operate post offices in several cities. Army air traffic controllers manned control towers during the 1981 air traffic controller walkout.

### THE LAW

Within the United States, civilian agencies, not the military, provide for the needs of citizens. Civilian, federal, state, and local government and law enforcement agencies execute US laws. Laws governing use of the military in domestic operations are complex, subtle, and ever-changing. For this reason, commanders should discuss plans, policies, programs, exercises, funding, and operations with their legal advisors. They should scrutinize each request for aid, whether it be for equipment or training, to ensure that it conforms with statutory requirements.

### SUPPORT TO CIVILIAN LAW

#### ENFORCEMENT: *The Posse Comitatus Act*

Generally, federal military forces may not give law enforcement assistance to civil authorities without running afoul of *The Posse Comitatus Act*. However, Constitutional and statutory exceptions to this prohibition do exist. The recent emphasis on drug interdiction has led to an increase in those exceptions.

*The Judiciary Act of 1789* allowed United States marshals to call upon the military as a *posse comitatus*. This continued until after the Civil War, when the federal government used the Army to execute Reconstruction Era policies. The southern states regarded the use of the military for this purpose as abusive and repressive, and in 1878 President Rutherford B. Hayes signed the original bill ending the practice. The current wording contained in 18 USC 1385 is:

*Whoever, except in cases and under circumstances expressly authorized by the Constitution or act of Congress, willfully uses any part of the Army or the Air Force as a posse comitatus or otherwise to execute the laws shall be fined not more than \$10,000 or imprisoned not more than two years, or both.*

*The Posse Comitatus Act* prescribes criminal penalties for use of the US Army or Air Force to execute the laws of or to perform civilian law enforcement functions within the US. DOD policy extends this prohibition to the US Navy and Marine Corps. Prohibiting the military from executing the laws means that military personnel may not participate directly—

- In arrest, search and seizure, stop and frisk, or interdiction of vessels, aircraft, or vehicles.
- In surveillance or pursuit.
- As informants, undercover agents, or investigators in civilian legal cases or in any other civilian law enforcement activity.

*The Posse Comitatus Act* does not apply to—

- Members of the National Guard when not in federal service.
- Members of a reserve component when not on active duty or active duty for training.
- DOD civilians, unless under the direct command and control of an active duty officer.
- A soldier when off duty and acting only in a private capacity.
- Soldiers taking action for the primary purpose of furthering a military or foreign affairs function of the US, for example, enforcing military justice, maintaining law and order on military installations, protecting classified materials.

There are specific actions in which military personnel may not participate.

### Constitutional Exceptions

Under its inherent authority, the United States Government is responsible for preserving public order and carrying out governmental operations within its territorial limits, by force, if necessary. Under the Constitution, two exceptions allow the use of the military to execute or enforce the law: when necessary to protect civilian property and functions and when necessary to protect federal property and functions.

## DOMESTIC SUPPORT OPERATIONS

**When Necessary to Protect Civilian Property and Functions.** A sudden and unexpected civil disturbance, disaster, or calamity may seriously endanger life and property and disrupt normal governmental functions to such an extent that local authorities cannot control the situation. At such times, the federal government may use military force to prevent loss of life or wanton destruction of property and to restore government functions and public order. This exception has rarely been used.

**When Necessary to Protect Federal Property and Functions.** The federal government may use military force to protect federal property and federal government functions when local authorities cannot or decline to provide adequate protection.

The President may order the armed forces to aid state civil authorities who are suffering from an insurrection or civil disturbance—

- At the request of a state.
- To enforce federal authority.
- To protect federal property.
- To protect the Constitutional rights of citizens within any state.

The President must act personally by first issuing a proclamation calling upon insurgents to disperse and retire peaceably within a limited time (10 USC 331-333; 10 USC 3500; 10 USC 8500). Note: Not one of these authorities, in and of itself, provides sufficient legal basis to order the reserve components to active federal service.

### Statutory Exceptions

Other statutory exceptions (10 USC 371-380) allow military personnel to provide limited support to civilian law enforcement agencies (LEAs) indirectly. Under these laws, the military may share certain information and provide equipment, facilities, and other services to LEAs. The annual *DOD Authorization Act* also contains exceptions concerning military support to civilian authorities fighting illegal drugs. DOD policies for providing support to civilian LEAs, including personnel and equipment, are contained in DOD Directive 5525.5. AR 500-51 contains related US

Army policies. Examples of support that does not violate *The Posse Comitatus Act* follow:

- Loan of equipment and training to operate or repair the equipment. Certain customs and other laws—*The Controlled Substances Act*, *The Immigration and Nationality Act*—permit direct operation of this equipment.
- Civilian LEAs' use of installation research facilities.
- Transfer of information acquired during normal military operations.

### DOMESTIC DISASTER RELIEF:

#### *The Robert T. Stafford Disaster Relief Act*

*The Stafford Act*, 42 USC 5121, *et seq*, as amended, is the statutory authority for federal domestic disaster assistance. It empowers the President to establish a program for disaster preparedness and response, which the President has delegated to FEMA. *The Stafford Act* provides procedures for declaring an emergency or major disaster, as well as the type and amount of federal assistance available. The *Act* authorizes the President to provide DOD assets for relief once he formally declares an emergency or a major disaster. He may also provide DOD assets for emergency work on a limited basis prior to the declaration. DOD policy for providing domestic disaster assistance is contained in DOD Directive 3025.1, *Military Support to Civil Authorities*. Army policy is found in AR 500-60, *Disaster Relief*.

### Emergencies and Major Disasters

The difference between an emergency and a major disaster is one of duration, severity, and the extent of assistance required. Examples are hurricanes, floods, tornados, storms, tidal waves, earthquakes, volcanic eruptions, landslides, droughts, explosions, or other natural or man-made catastrophes. Emergencies are less severe than major disasters, requiring a shorter time to recover and to provide adequate relief. Both may require federal assistance to augment state and local resources and relief agencies. From a DOD perspective, an emergency and a major disaster may require the same type of work, that is, removal of debris, preservation of health and safety, and restoration of essential services.

**The difference between an emergency and a major disaster is one of duration, degree of damage, and extent of assistance needed.**

#### The Federal Response Plan

Once a state requests aid, the President may declare an emergency or a major disaster, enabling the FEMA to act under the FRP. The FRP is a memorandum of understanding (MOU) between the FEMA and other federal agencies, including the DOD, to provide domestic disaster assistance. Under the FRP, a single federal agency is assigned primary responsibility for each of twelve ESFs. The FEMA orchestrates disaster relief through these ESFs. Each primary agency orchestrates the federal effort within its sphere of responsibility and may, if authorized by the FEMA, task other agencies for support.

The DOD has primary responsibility for ESF 3, Public Works, and ESF 9, Urban Search and Rescue, and is a supporting agency for the remaining ten. The FEMA reimburses the DOD for the incremental costs of providing the tasked assistance. Without specific FEMA tasking, DOD units lack authority to provide domestic disaster assistance and, if provided, risk not being reimbursed for its cost. If in doubt, commanders should seek clarification from the FEMA through the defense coordinating officer.

#### Emergency Work

To save lives or to preserve property, the President may commit DOD resources to perform emergency work on public or private lands prior to his official declaration of an emergency or major disaster. Emergency work is defined as clearance and removal of debris and wreckage and temporary restoration of essential public facilities and services. Such work may not last more than 10 days.

#### CIRCUMSTANCES CONCERNING ELECTIONS

US law (18 USC 592) prescribes criminal penalties for US troops being at or near polling places.

Commanders should determine if elections are scheduled during disaster assistance operations. For example, during JTF Andrew operations, the FEMA asked the DOD, at the request of Florida election officials, to erect 66 tents, with generators and light sets, to serve as temporary polling sites during a general election. They further tasked DOD to maintain the equipment. Several other polling sites were located near DOD personnel performing disaster relief duties. The Department of Justice opined that so long as DOD personnel did all they could to respect the integrity of the sites, they would not violate 18 USC 592. This was true as they provided tasked support and as they continued relief operations in their vicinity.

*Hurricane Iniki left the Hawaiian island of Kauai devastated; one result was inoperative county polling places. Soldiers from the Hawaii Army National Guard (serving on state active duty) helped a state primary election take place as scheduled by providing tents and transportation assets to Kauai County polling officials.*

### COMBATTING TERRORISM, AIRCRAFT PIRACY, AND OTHER OPERATIONS

#### COMBATTING TERRORISM

Various DOD directives outline the policies for maintaining security and combating terrorism. Because the DOD retains responsibility for protecting its resources, DOD domestic actions to combat terrorism do not always fall within the category of providing assistance to civilian authorities. OPLAN GARDEN PLOT contains DOD procedures for assisting the FBI in combating terrorism on and off of US military installations.

#### The FBI's Responsibility

The FBI has overall jurisdiction at the scene of a terrorist incident wherever it occurs, including military



## DOMESTIC SUPPORT OPERATIONS

installations. The President has directed federal departments and agencies to cooperate to thwart terrorist incidents.

### The DOD's Responsibility

Commanders are responsible for the maintenance of law and order on their installations. They must take all actions to respond to and terminate any terrorist incident occurring on the installation and to protect the installation's personnel and equipment from attack. Installation commanders should coordinate protective measures with appropriate civilian LEAs.

**Commanders who perform disaster assistance missions not tasked by FEMA risk the Army's not being reimbursed for its cost.**

DOD components are authorized to respond to reasonable requests from the FBI for military resources for use in combatting acts of terrorism. Assistance may include material, facilities, and technical personnel in an advisory capacity. Without Presidential approval, military personnel may not be used in a law enforcement role outside of a military installation. With that approval, soldiers may perform missions designated by the FBI pursuant to its responsibilities during a terrorist incident. However, command and control of the soldiers always remain with their military chain of command.

DOD resources may be provided only upon request of the Director, FBI, or the senior FBI official at the scene of a terrorist incident. Commanders may accept the judgment of the requesting official if the official's determination is consistent with available facts. Commanders must forward requests for resources not based upon an actual or imminent terrorist incident—for example, requests for training or long-term equipment loans—to the DOD for processing in accordance with OPLAN GARDEN PLOT.

### AIRCRAFT PIRACY

The Federal Aviation Administration (FAA) has exclusive responsibility for directing law enforcement activity affecting the safety of persons on board in-flight aircraft involved in aircraft piracy. The DOD is required, upon request of the Administrator, FAA, to provide necessary assistance to carry out the air piracy laws. The DOT and the DOD have a memorandum of understanding concerning aircraft piracy that covers DOD aircraft, regardless of location, and any non-DOD aircraft on DOD installations.

### OTHER OPERATIONS

DOD support to civilian agencies for other emergencies, such as hazardous substance cleanup, radiological threats, emergency evacuation, and flood control, may be under specific authority, for example, *The Flood Control Act*. Such support may also be executed in conjunction with other laws, policies, procedures, or regulations. It is not possible to discuss all situations within the constraints of this publication. For example, Army Corps of Engineers civil engineering projects exceed the scope of this discussion. Applicable references are listed at the back of this manual.

#### 10 USC 672(b), The 15-Day Rule.

The secretary concerned may order reserve component units—and personnel not assigned to units—to active duty for a period not to exceed 15 days per year. Activating NG units and personnel requires the governor's consent. USAR units and ARNG units performing annual training outside the US and its territories, however, use such orders as authority for their annual training period. If a reserve component unit ordered to active duty under this authority uses it to perform annual training, the authority is no longer available for that unit until the next fiscal year.

#### 10 USC 672(d), Volunteers

The secretary concerned may order to active duty reserve component personnel who volunteer. The governor must consent to activating NG personnel. Normally, as a matter of policy, USAR personnel are ordered to active duty for a period of more than 30 days to permit maximum benefits. However, they may or may not actually serve for more than 30 days.

Ordinarily, no USAR or NG personnel will be ordered to active duty as volunteers unless active duty and state ARNG personnel cannot perform the duty and the appropriate CINC validates the requirement.

## USE OF PERSONNEL, MATERIEL, AND EQUIPMENT

### USE OF MILITARY INTELLIGENCE (MI) PERSONNEL

Use of MI personnel during domestic support operations is restricted as a direct result of lessons learned from their improper use in the 1960s. Consequently, LEA requests for MI personnel or material for counterdrug support must be approved by the Secretary of the Army General Counsel and coordinated through the Department of the Army Office of the Deputy Chief of Staff for Intelligence.

During disaster assistance operations, MI personnel may be used for liaison as well as other MI support activities. However, a specific MI mission statement, coordinated through proper authorities, must authorize MI personnel to collect, analyze, and disseminate information. When so authorized, MI personnel may—

- Acquire information that may threaten the physical security of DOD employees, installations, operations, or official visitors, or that may be needed to protect the safety of any person, that is, force protection.
- Analyze and disseminate information to disaster relief personnel and emergency operations centers (EOCs).
- Support EOC operations using intelligence-preparation-of-the-battlefield (IPB) skills.

Information that MI personnel gather without using or retaining it is considered not to have been collected. Commanders and MI personnel will ensure that all such material is handed over to appropriate authorities before departing the disaster area.

When OPLAN GARDEN PLOT is executed in response to civil disturbance operations, MI activities

fall under the jurisdiction of law enforcement policies and regulations. Commanders must ensure that MI support missions, other than normal liaison with LEAs for force protection, have been coordinated with and approved by appropriate authorities.

### USE OF RESERVE COMPONENT PERSONNEL

Several statutes permit the President, the SECDEF, or the service secretaries to use portions of the reserve components. For domestic disaster assistance, generally only two apply: 10 USC 672(b) and 10 USC 672(d).

### USE OF MATERIEL AND EQUIPMENT

AR 700-131 provides HQDA guidance for the loan or lease of US Army materiel. The SA must approve the loan of arms, ammunition, combat vehicles, vessels, and aircraft. Ordinarily, when the DOD loans equipment, the borrowing agency must reimburse them for all DOD costs incident to its delivery, return, and repair. In addition, the borrower must reimburse the full purchase price for consumable or nondurable items, such as batteries, and for depreciation if it is significant.

DOD directives tightly regulate use of reserve component equipment. The MACOM commander approves temporary loans for 90 days or less. The Secretary or Deputy Secretary of Defense approves withdrawals of equipment for more than 90 days. Replacement plans must accompany requests for withdrawals.

## REIMBURSEMENT

In addition to the authorities mentioned above, *The Economy Act* (31 USC 1535) permits federal agencies to provide goods and services to other federal agencies on a reimbursable basis. *The Stafford Disaster Relief Act* requires reimbursement to the DOD for the incremental costs of providing support. Approval authority and reporting requirements vary depending upon the duration and type of support requested. OPLAN GARDEN PLOT contains procedures for reimbursing DOD for assistance during civil disturbances. Reimbursement for use of NG personnel and assets to assist state counterdrug operations and programs is authorized by 32 USC 112.

---

## DOMESTIC SUPPORT OPERATIONS

---

Other statutes permit federal agencies to seek waiver of reimbursement. For example, federal law enforcement agencies are not required to reimburse DOD if support—

- Is provided in the normal course of military training or operations.

- Results in a benefit to DOD that is substantially equivalent to that which would otherwise result from military training (10 USC 377). Ordinarily, the DOD makes this determination.

### SUMMARY

Domestic support operations raise many legal issues. The Constitution, statutes, and regulations strictly govern the relationship of the military to civilian authorities. The basic rule is that the military plays a subordinate and supporting role to civilian authority, which is different from the wartime role they would have in a foreign theater of operations. Questions of *posse comitanus*, use of force, disaster assistance, and federalization of troops raise issues that require timely legal advice. Commanders must be aware of the legal implications of domestic support operations, ensure that they are appropriately advised by competent legal counsel, and act accordingly.

---

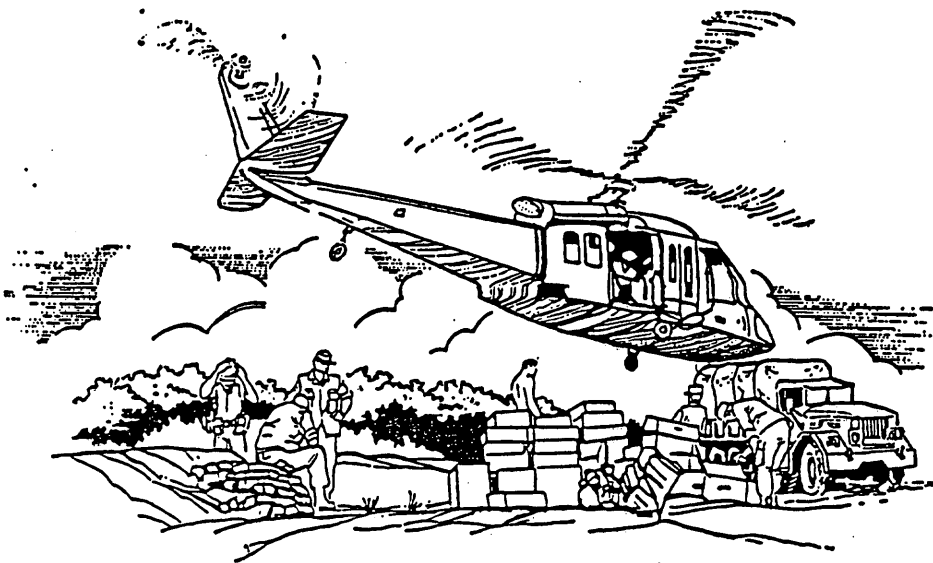

## CHAPTER 4

# LOGISTICS AND SUPPORT OPERATIONS

*Most domestic support operations are logistical in nature. Support is based on actual requests or requirements, rather than on standard support packages. In planning for support of national objectives amid growing complexities, military planners face ambiguities about how to prepare for and predict types of contingencies our forces will confront. However, certain support functions always apply, whether for combat forces or civil authorities. To avoid duplication, support planners must consider military and civil requirements and capabilities concurrently. This chapter addresses support common to all domestic operations, as well as specifics for tailoring a support force for particular purposes.*

### PLANNING

**Most domestic support operations are logistical in nature.**

In most crises, ARNG units under the control of the respective state governments will be the first military units to provide support. Although the military commander retains command and control of Army forces, a federal, state, or local official may control the overall operation. Detailed planning and familiarization

with the various levels of federal, state, and local government will help synchronize assistance efforts. Coordination and synchronization will avoid confusion and duplication of effort. A knowledge of other agencies' capabilities will help to avert adversarial situations.

Logistics assessment personnel should carefully identify requirements before US Army support assets are deployed. Before deployment, logistics commanders can form emergency response teams to react immediately to emergency situations. These teams would arrive on the scene early to assess the impact and severity of a crisis before commitment of operational forces.

## DOMESTIC SUPPORT OPERATIONS

Commanders must ensure that support to troops and to civil authorities is planned for and executed simultaneously. They must also ensure that—

- Logistics command and control cells arrive early.
- Deploying units have access to assured communications and to all Standard Automated Management Information Systems (STAMISs) directly at the support base (local installation).
- Support and supplies flow smoothly and continuously.
- Termination standards (end states) for all types of support are established early in the operation.
- Resource management is fully integrated into all phases of the operation.

### SOURCES OF SUPPORT

The four primary sources of logistical support are contracting, negotiated support, military support, and support from other federal agencies. See Figure 4-1.

#### CONTRACTING

Contracting—purchasing, renting, or leasing supplies or services from nonfederal sources—is a highly effective and efficient way to provide rapid support in a crisis. Included are all classes of supply, labor, mortuary affairs, laundry, showers, food service, sanitation, billeting, transportation, maintenance and repair, access to communications networks, temporary real property leasing, and limited minor construction.

Contracting can augment organic military unit support capabilities and provide new sources of critically required supplies, services, and real estate. It can also bridge gaps that may occur before the deployment of sufficient Army support. Contracting should always be the preferred method of support, beginning as soon as requirements are known.

Decentralized contracting provides a means to respond rapidly to immediate demands. As operations stabilize, centralized contracting becomes more important, allowing Army units to gradually diminish support, to transfer functions to civil agencies, and to disengage and redeploy.

**Warranted contracting officers will be needed early in domestic support operations.**

During the initial stages of a crisis operation, warranted contracting officers will be needed immediately to procure validated emergency supplies and services. Contracting officers may be brought in with federal forces or they may be provided by the ARNG from its property and fiscal offices, by the designated support installation, the USACE, or by a civil agency.

#### NEGOTIATED SUPPORT

In some cases, civil authorities may have enough logistical resources to support not only themselves but also the Army personnel providing assistance. For example, civil authorities may provide housing, food, and fuel to troops assisting in a counterdrug or firefighting operation. Such support is negotiated on a case-by-case basis with the appropriate civil authorities.

#### MILITARY SUPPORT

Whenever possible, installations will continue habitual support to units tasked to conduct domestic support operations. Installations may also have to support personnel with whom they have no established support relationship. These personnel may include civil authorities, elements from other services, and Army elements from other stations.

If an installation or one of the other sources discussed below cannot provide required support directly, planners will tailor a support force for that purpose. Most considerations for tailoring a support force are the same as they are for any operation: requirements, available resources, estimated length of the operation, and so on.

#### SUPPORT FROM OTHER FEDERAL AGENCIES

The GSA also provides support to civil authorities. GSA provides general supplies and services that are

common to more than one department of the federal government. GSA can provide an extensive amount of support to DOD for such commonly used items as office furniture and supplies, machine and hand tools, photo supplies and other items. Other federal agencies and organizations may be able to provide assistance depending on the nature, scope, and duration of the operation.

### LOGISTICS COMMAND AND CONTROL CELLS

Logistics command and control cells are critical to successful support operations. A materiel management center (MMC) can operate in a split-based mode. This concept provides for part of the MMC to remain in a secure location (out of harm's way), while a force projection MMC element deploys with the force it is supporting. The forward deployed MMC element

would provide a conduit for the electronic transmission of logistics data, messages, and voice communications traffic, resulting in inventory asset visibility. Such visibility is vital to logistics support operations.

**Logistics command and control cells must arrive early in domestic disaster operations.**

Combat service support units must continue to support units awaiting redeployment. Resource accountability remains critical during this phase to prevent waste, fraud, and abuse. At or near the

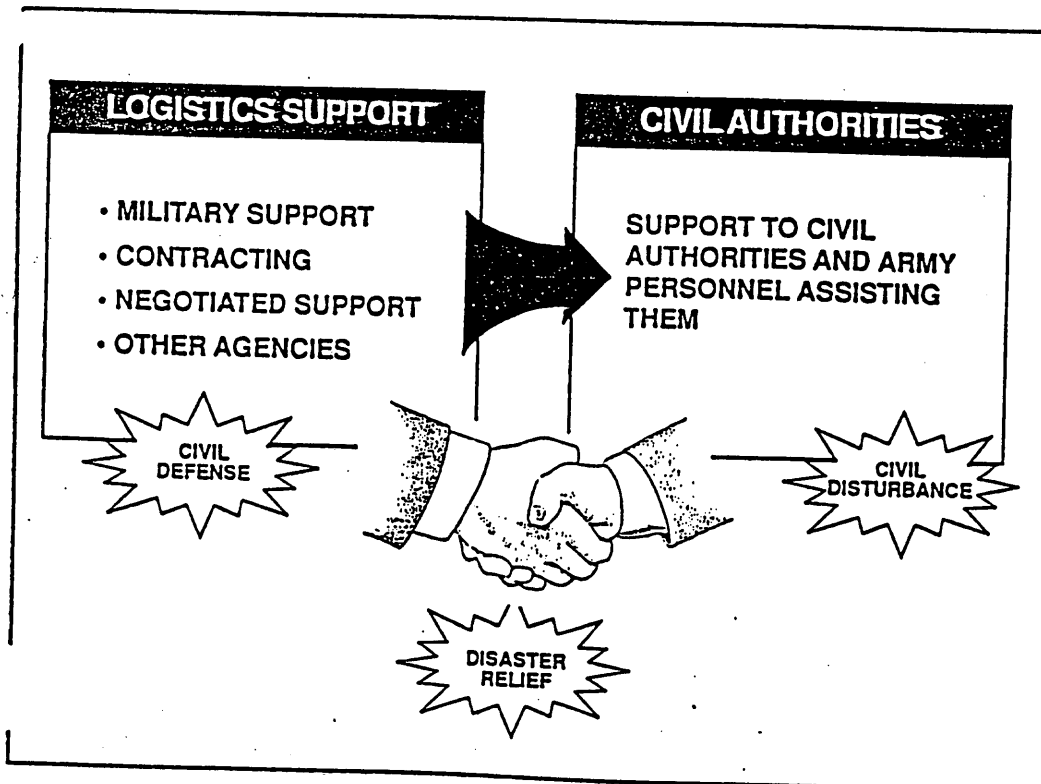

Figure 4-1. Sources of Support

## DOMESTIC SUPPORT OPERATIONS

completion of domestic operations, redeployment will be phased to allow for continued and uninterrupted support to civil authorities. Military support should not be curtailed before civil authorities assume the function. When state-activated ARNG units remain on site, special efforts should be undertaken to assist them. Transportation must be arranged through the appropriate movement control organization in accordance with established priorities.

*In the past three years (1989-92), US military forces have responded to three hurricanes and two typhoons that struck densely populated areas. After the most recent storms, Hurricane Andrew in Florida and Louisiana and Hurricane Iniki in Hawaii, Army soldiers provided relief services, prepared meals, cleared and hauled debris, produced and distributed water, restored power, and constructed life support centers. These missions provided important lessons in preparedness, leadership, organization, equipment, and safety.*

### RESOURCE MANAGEMENT

The commander is responsible for maintaining the readiness of the command to execute missions and operations. Any unprogrammed requirement may result in spending resources intended for other use. To request reimbursement for lost resources, the commander must be able to account for them. Equipment and supplies misused, improperly maintained, damaged, lost, or issued to others will adversely affect future readiness and timely deployment.

Judicious management and accountability should be an early and constant focus. When possible, resource management analysis should precede key operational and logistics decisions and actions. Army resource managers should seek early guidance as to reimbursement. For example, will the operation be reimbursable from civilian

sources, should specific Army accounting codes be used for the operation, and so forth. Project codes for use in accumulating costs should be requested at the onset of a disaster relief effort. Designating logistics organizations, for example, US Army Materiel Command corps support command (COSCOM), divisional support command (DISCOM), to receive, store, issue, and account for DOD material must also be considered.

**Judicious management and accountability should be an early and constant focus.**

State, local, or federal agencies; DOD; or other military services will normally reimburse the Army for assistance. The reimbursement process requires accurate billing for legitimate costs. Discrepancies must be resolved with the supported and/or reimbursing agency. Supported agencies should keep records of services and support received from the Army. To distinguish costs from those related to training or normal operating expenses, Army resource managers must maintain accountability throughout an operation for costs of equipment and supplies dedicated to operational support.

Commanders and managers should fully integrate resource management into all phases of the operation. Establishment of a resource management element to review procedures and advise the commander is also required. Positive resource management calls for planning to account for the expenditure of all resources supporting an operation with the expectation of being audited. By requesting early on-site involvement and advice from external functional experts, for example, Army Audit Agency (AAA) and General Accounting Office (GAO), resource managers can head off major accounting problems that could occur later in the support operations.

### SUPPLIES AND FIELD SERVICES

Supplies and services are critical to the life-threatening needs of some types of civil emergencies and to the sustainment of operations in others. Basic guidelines for support are to tailor the package for the

mission, to contract for services early on, and to utilize local resources when possible.

**DEFENSE LOGISTICS AGENCY**

The DLA may provide common supplies and services used by the military services when supporting domestic operations. The agency's mission is to provide effective logistics support to the operating forces of all military services and to federal civil agencies as assigned. DLA provides support at the lowest feasible cost to the taxpayer. It provides contract administration services in support of the military departments, other DOD components, and other government agencies upon request. The DLA

organization is shown in Figure 4-2. Its defense distribution depots are shown in Figure 4-3.

**QUARTERMASTER (QM) UNITS**

QM supply and field service units, which should be among the first logistics elements deployed, will satisfy immediate needs and establish receipt, storage, and distribution of incoming supplies. QM units can make food, water, clothing, and shelter available and coordinate required contractual services. The Army's field service companies provide personal hygiene services such as showers, laundry, and, if required, delousing.

The Army has various options for feeding people, even though no unit is specifically designed for mass

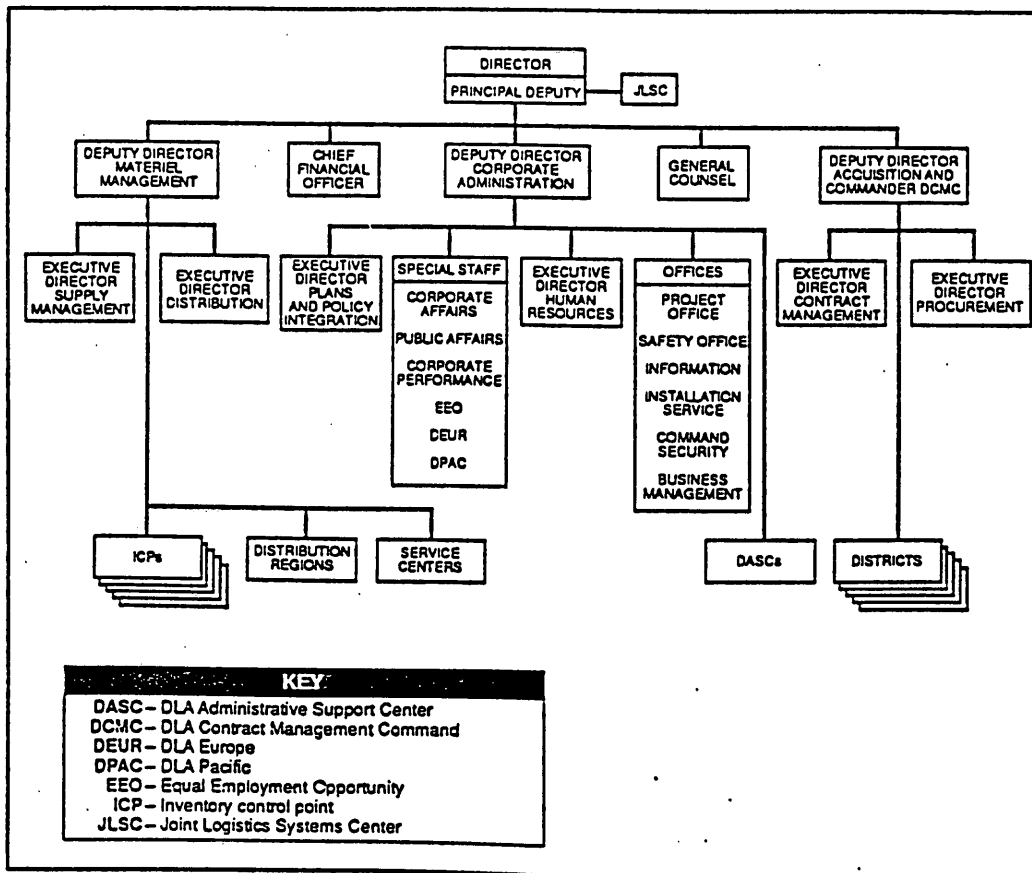

Figure 4-2. Defense Logistics Agency



## DOMESTIC SUPPORT OPERATIONS

feeding. Options range from distributing meals, ready-to-eat (MRE) to preparing and providing hot meals in a climate-controlled dining facility. Under certain conditions, contract feeding may be a viable means of support. However, local circumstances will dictate the method chosen to feed both supporting military personnel and the supported civilian population. To the extent available, QM units should use established structures suitable for feeding.

### MORTUARY AFFAIRS UNITS

Because disasters usually occur without warning, they create considerable confusion, as well as a shortage of personnel to handle the sensitive, unpleasant task of caring for the dead—a job that must be done quickly and efficiently. At such times, Army mortuary affairs forces can provide valuable assistance. When the requirement for such services exceeds a

community's capabilities, Army mortuary affairs units can provide search, recovery, evacuation, and identification services.

### FORCE PROVIDER UNIT

The Army's Force Provider Unit is specifically designed to provide logistical support in a consolidated location. It is also ideally suited for supporting disaster and humanitarian aid operations. This system, which can provide support for 3300 people, is designed in modules. Each module is capable of independent operations. The unit includes billeting facilities with heating/cooling, kitchens, latrines, showers, laundries, power generation, and water purification. It also includes facilities and equipment and material for religious support as well as morale, welfare, and recreation (MWR). Figure 4-4 shows a 550-person Force Provider module.

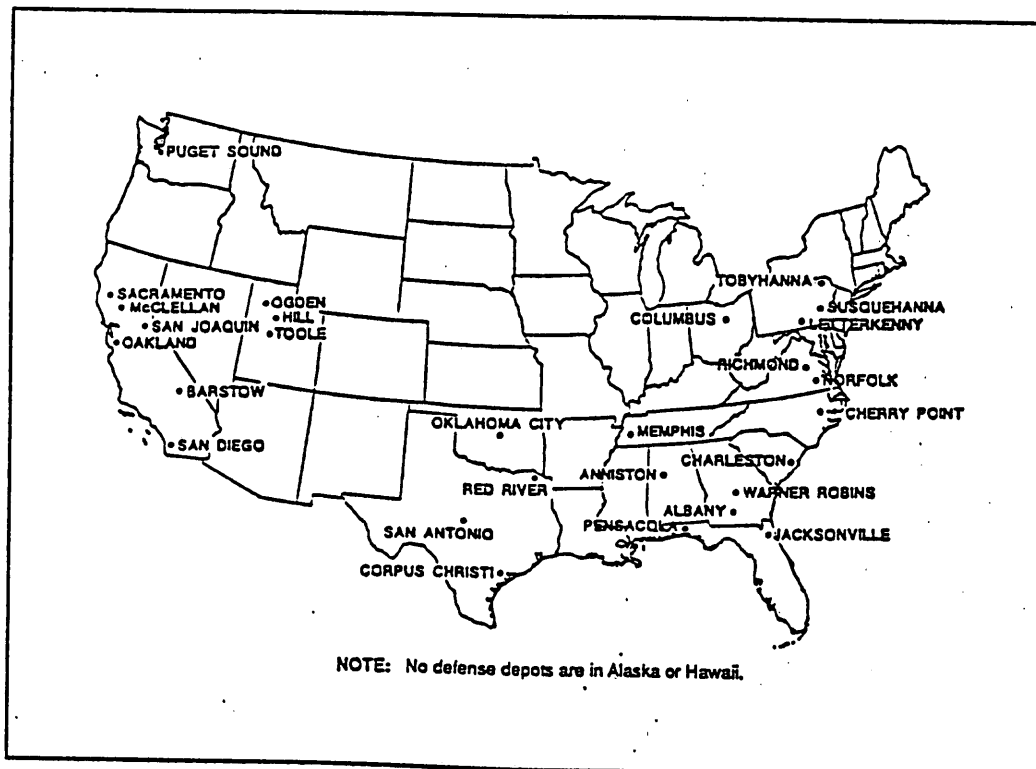

Figure 4-3. Defense Distribution Depots

### OTHER SUPPORT

Depending on the magnitude of need and the flow of supplies, Army units may require an extensive storage complex.

In emergencies, large quantities of goods are routinely contributed to the affected populace. Normally, civil agencies handle these donated goods; however, they may request that Army forces do the job. Commanders must recognize the requirement for supply accountability and reimbursement for goods and services in accordance with applicable Army regulations. Likewise, they must honor their responsibility to provide designated common supplies to other services in accordance with regulatory guidance. Such efforts apply equally to US civil authorities and traditional military operations.

### Real Property

Civil emergency service organizations and the NG should jointly coordinate the use of real property. Facilities should be selected based on their potential for support and the anticipated scale of assistance operations. Vacant warehouses, parking lots, potential staging areas, and other facilities that could be used for

supply activities should be acquired to enable receipt, storage, and distribution operations.

**Facilities must be identified to accommodate the receipt, storage, and transshipment of supplies to an impacted area.**

### Equipment

The nature of the emergency and prevailing conditions will determine the proper mix of equipment needed. In many cases, military equipment is well-suited for domestic support operations. However, additional equipment may be required, either temporary loans from other units or civilian equipment. When civilian equipment is needed, the commander must convey the requirement to higher headquarters. The supporting contracting element (SCE) determines

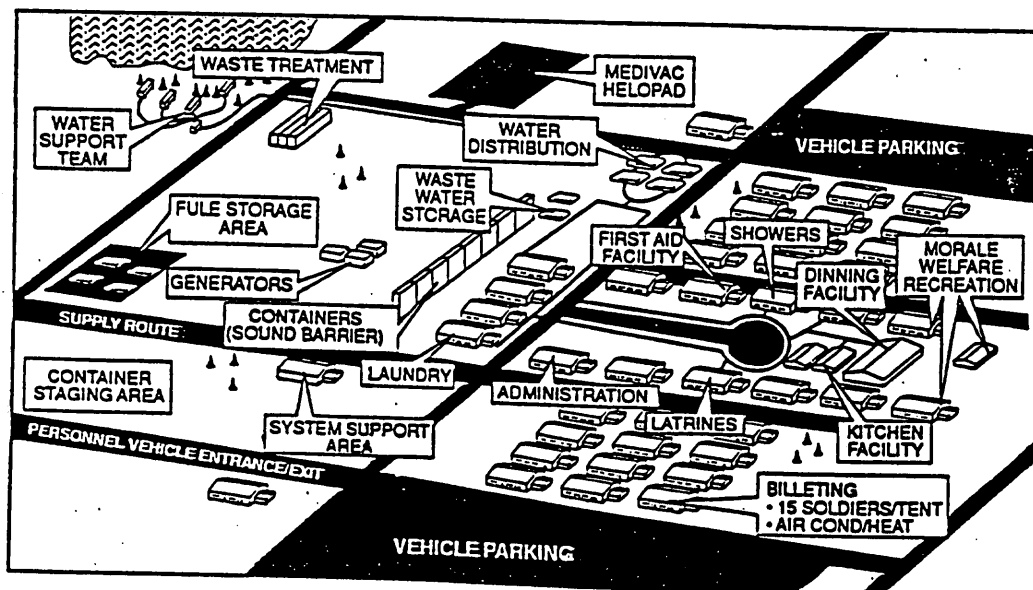

Figure 4-4. 550-Soldier Force Provider Module

## DOMESTIC SUPPORT OPERATIONS

market availability and processes local purchases or hires. In some cases, unit commanders will have the authority to commit funds.

Army equipment may be loaned between active and reserve units, to other services, or to federal government and law enforcement agencies to supplement their capabilities. With proper authorization, loans may be made to nonfederal agencies; state, county, local civil authorities; or private agencies. Normally, consumable supplies and repair parts are not loaned.

*As a result of Hurricane Andrew, the 16th Field Supply Co (FSC), 240th QM Battalion, was deployed to provide support. The 16th FSC mission provided laundry, bath, and light textile renovation support to disaster victims and deployed forces. Overall, the 16th FSC processed 5000 bundles of laundry and provided showers for more than 22,000 soldiers and civilians.*

The borrower must sign a statement assuming liability for equipment during the period of the loan, to include care, custody, security and safeguarding, proper use and maintenance, and responsibility for all incremental costs accrued to the Army. Prior to issue, the Army should clearly define condition standards for return.

Requests from nonfederal agencies must state that a commercial source for an item is not reasonably available. Loan of firearms, weapons, combat or tactical vehicles, water vessels, and aircraft must be approved by the Assistant Secretary of the Army.

### MAINTENANCE

The number and type of maintenance units deployed will depend on the operational requirements of the crisis. Military maintenance personnel will remain under military command and control throughout the assistance operation. Whenever possible, the normal planning and execution chain of command should remain in place.

Maintenance commanders should identify supporting vendors; organize maintenance elements; and organize assets from other agencies, contractors, and local maintenance resources. Commanders must consider not only support of their own equipment but support of diverse civilian equipment such as buses, trucks, ambulances, power generation equipment, and so forth.

Commanders must plan on maintenance being performed under field conditions. Disaster relief vehicles such as ambulances, firefighting equipment, buses, power generation and construction equipment will receive priority. As facilities are reactivated following a disaster, maintenance of local infrastructure equipment might be conducted in fixed facilities on an ever-increasing scale.

The types and quantities of Class III and Class IX supplies to be carried or constructed for support of local infrastructure equipment will depend largely on the type of disaster and the equipment being supported. Standard prescribed load lists (PLLs) and authorized stockage lists (ASLs) should be adequate for unit military type equipment committed to domestic support operations. However, this may need to be tailored to support equipment for units in attached or under operational control (OPCON) status.

A priority consideration is the early reestablishment of the local government's infrastructure. Maintenance units are particularly adept at providing this support, whether repairing the local television and radio stations or emergency vehicles. Emergency or quick-fix type repairs similar to the Army's Baule Damage Assessment and Repair (BDAR) System may be required in the early stages of disaster relief, allowing time for repair parts procurement and establishment of a maintenance program.

### TRANSPORTATION

Early assessment of transportation requirements is essential. Transportation support will be tailored to both the deployed military force and civil authorities under centralized control. The Army can provide numerous capabilities depending upon the mission. Transportation planners should be deployed early as part of the logistical assessment element.

Movement control units plan, schedule, and control Army movements into, within, and out of an area of

operations. They also support joint force movement control requirements and coordinate support with civil authorities. In this capacity, an Army movement control unit can provide the nucleus of a joint movement center (JMC) and effectively meet all requirements. The JMC is a proven concept and can be tailored to meet the operational transportation requirements. A notional JMC is depicted in Figure 4-5.

The JMC is a proven concept and can be tailored to meet operational requirements.

Transportation units may be organized under a multifunctional or pure transportation headquarters depending upon the tailored support package. Truck companies can distribute large quantities of essential cargoes over terrain normally impassable to most civilian trucking. Cargo transfer companies prepare cargo for transshipment at distribution centers. Terminal service companies operate water ports, load and offload ships, or assist civilian port operators. Watercraft companies move units, supplies, and equipment along intracoastal or inland waterways.

*Asked to provide a JMC during Hurricane Andrew, the US Army Transportation Center deployed a JMC nucleus to the JTF headquarters. With augmentation, the JMC succeeded in providing a combination of air, land, and sea transportation to DOD forces, disaster victims, and relief workers.*

#### EMPLOYMENT

Deployment to the area of operations will normally be under the centralized control of the US Transportation Command (USTRANSCOM) and will often be conducted under crisis action procedures. Units will deploy according to port-call instructions using

military and commercial transportation. Deploying units or teams follow existing policies, procedures, and regulations. When deployment control is not centralized under USTRANSCOM, the servicing installation arranges transportation to final destination.

#### CONVOYS

Military convoys are coordinated between the deploying unit's installation and the defense movement coordinators (DMCs) in states where the convoys originate. The DMC coordinates military movements with his state transportation, civil defense, and law enforcement officials. During domestic support operations, the DMC should provide liaison to the senior movement control organization in the joint force.

#### REDEPLOYMENT

Redeployment will be centrally controlled to provide for orderly movement out of the area in compliance with approved termination standards. The deployed force must be prepared to redeploy on commercial transportation since redeployment normally carries a lower priority for military lift than does deployment. The servicing installation transportation office (ITO) in the area of operations will procure the commercial transportation, prepare and issue shipping documentation, and monitor carrier performance. If an ITO is unavailable to service the area, a joint transportation office (JTO) must be organized to provide this support.

#### AVIATION

Army aviation support to domestic operations includes air movement support of logistics and transportation operations; command and control support to federal, state, and local authorities; and reconnaissance and surveillance support of law enforcement operations. Active duty and National Guard aviation units provide support to civil authorities for counterdrug programs, civil disturbances, and border surveillance operations.

Unmanned aerial vehicles (UAVs) have tremendous potential in surveillance and reconnaissance operations of US border areas. Army aviation's inherent flexibility and responsiveness are ideally suited to support military and civil authorities.

Aviation support during disaster assistance operations will concentrate on air movement,

**DOMESTIC SUPPORT OPERATIONS**

aeromedical evacuation, and command and control. Disasters may temporarily close ground lines of communication due to debris or higher priority traffic. Large metropolitan areas will experience traffic gridlock. Aviation units should include medium lift assets in the initial response to enhance distribution of critical personnel, supplies, and equipment over these obstacles. Early aerial reconnaissance of the disaster area by federal, state, and local authorities will help to assess relief priorities.

Aviation operations in a particular area will include various DOD aviation assets and many civilian and public aircraft. Coordination with the FAA and DOD representatives is imperative to delineate disaster area airspace procedures, management, and safety. Recent aviation operations in support of civil authorities point out the critical need to form airspace management cells and an aviation liaison cell within the first 24 hours.

Relationships among military services and the FAA air traffic services (ATS) must be succinctly addressed. The development of an aviation procedure guide (APG) will assist airspace management. These guidelines must extend to all prospective airspace users. Planners should provide guidance on flying civilians (law enforcement and government officials, Red Cross, news media, and non-DOD relief workers) and allocating critical aviation assets at the very beginning of the operation.

**ENGINEER**

Engineer assistance to civil authorities will vary with each type of operation. Engineers may become involved in these operations as individuals, teams, or complete units. Individuals may technically assist in assessing damage or estimating engineer work. They

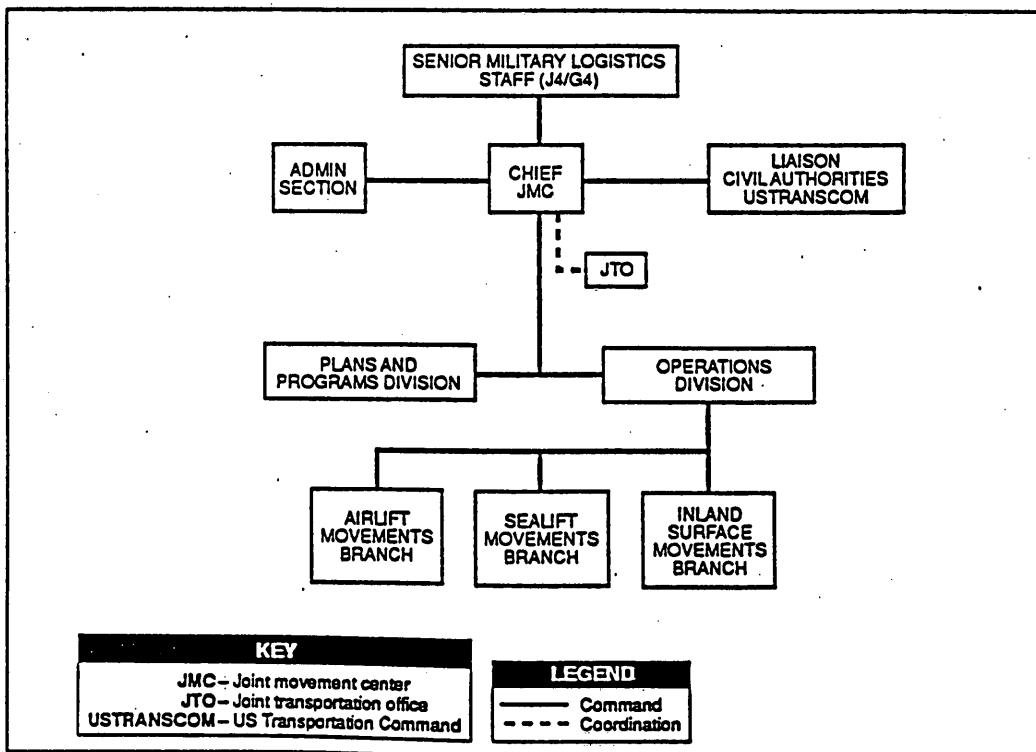

Figure 4-5. Typical Joint Movement Center Organization

may provide specialized support such as power supply and distribution or utilities repair and reconstruction.

The USACE provides expertise through its engineer districts and divisions. Support can include damage survey and assessment teams, contracting support, and technical advice. The US Army Engineering and Housing Support Center (USAEHSC), a field operating agency of USACE, provides prime power teams and equipment. These power teams restore temporary electrical power to key locations. Planners must resolve funding issues with USACE early in the assistance process.

Army engineer units provide a wide variety of skills and capabilities, including limited construction, structure repair, clearing and hauling debris, limited temporary electrical and plumbing facilities, and construction of life support centers. Engineer units possess heavy construction equipment, exterior lighting capability, and generators for temporary electrical power. Soldiers in engineer units are skilled in a variety of tasks useful during the response to and the recovery from natural disasters.

### MAPS AND CHARTS

In domestic support operations, map coverage is critical to provide a common frame of reference for all military and civil agencies. Paper maps, image-based substitute products, Geographic Information System (GIS) data bases, or a combination that provides total coverage is acceptable. Common maps and GIS data bases should be provided to all agencies and headquarters that are operationally involved. All controlling headquarters should operate from the same geographic frame of reference to coordinate support.

When locally produced products are available on a larger scale, they should be used. Maps or charts at a scale of 1:10,000 or 1:5,000 are extremely useful in assisting civil authorities. Products at these scales are better able to portray street names, local landmarks, and other commonly used reference points that are not usually portrayed on Defense Mapping Agency (DMA) or US Geological Survey (USGS) maps at smaller scales. Local planning agencies, realtor associations, travel agencies, or utility company records may be able

to provide such detailed map coverage. US Army topographic engineer units, federal mapping agencies, or local activities may be able to reproduce these products as required.

If map coverage does not exist over the area of operations, agencies can request image-based products, which can be produced in a relatively short time using unique imagery capabilities. US Army Engineer channels handle requests for such products.

### INTELLIGENCE

The importance of timely, focused information cannot be overstated. Military intelligence offers a disciplined and trained cadre of specialists who can quickly collect, integrate, analyze, and disseminate information that decision makers need to respond immediately to a situation. The first step is to sensitize military planners and operators to crucial needs of civilian authorities. Concurrently, they must keep in mind the distinction between the employment of military intelligence assets outside the US and the application of legal guidelines within the US. The best use of intelligence capabilities is through the skills and techniques employed in the IPB and liaison with law enforcement agencies.

### MILITARY POLICE

Military police have special expertise in counter-drug, terrorism, and civil disturbance operations. They are highly mobile and capable of providing search, rescue, and evacuation support; physical and area security; and traffic circulation control. Due to their decentralized operations and density of communications equipment, they are also valuable for notification and area damage control.

### MILITARY HEALTH SERVICE SUPPORT

Commanders may use medical forces and resources in domestic support operations when directed by the NCA. They may provide medical personnel and resources to support interregional military medical plan (IRMMP) missions before any NCA allocation

## DOMESTIC SUPPORT OPERATIONS

decisions. Commanders may withdraw this support, which is temporary, to meet higher priority military missions if they occur. The health services' goal in disaster operations is to assist the local and state health services organization return to normal. Figure 4-6 depicts levels of effort.

Medical support can range from local domestic support to a full-scale regional disaster. Guidance for DOD medical support for domestic operations will normally be based on priorities established by the DHHS at both regional and national levels.

### TASK-ORGANIZED MEDICAL TEAMS

When civilian authorities are unable to provide or are required to request medical support, the NCA can direct the deployment of medical teams. These task-organized teams will enter the affected area to assess the medical situation, determine treatment and evacuation requirements, establish treatment elements, and facilitate evacuation.

In situations where civil medical services are not available, for example in isolated areas, assistance includes, but is not limited to, personal hygiene, immunizations, chemical prophylaxis, pest management, nutritional programs, and epidemiological surveys. HSS encompasses several functional areas that call for immediate and sustained assessment of the public health status and local medical infrastructure.

### KEY PLANNING GUIDANCE

After the initial response, a mission analysis is conducted so that the HSS response can be tailored to meet the needs of the community in both the short and long term. Domestic emergency experience has shown that the senior US Army medical commander must locate his headquarters near the FCO's offices. Coordination between these two organizations is essential to unity of effort. Both should also centralize the location of HSS specific supply items from multiple sources (private and government). A medical logistics unit can provide assistance to non-DOD federal and civilian agencies in dispensing materiel.

### NATIONAL DISASTER MEDICAL SYSTEM

The NDMS was jointly developed by the DOD, the FEMA, the DHHS, and the VA to serve as a backup for the VA/DOD Contingency Hospital System for military casualties. NDMS is also the primary recipient of

casualties in the event of a catastrophic national disaster.

Depending upon the magnitude of the disaster, the local civilian hospitalization system and resources may become saturated, and NDMS may be activated. DHHS is responsible for ensuring sufficient available hospitalization capability. It considers a number of options to meet this requirement. First, the Army could deploy hospital resources such as a combat support hospital (CSH) or a mobile army surgical hospital (MASH) to the immediate disaster area. Second, the Army could coordinate the evacuation of patients to Army Medical Department Activities (MEDDACs) community hospitals or medical centers throughout the US. Third, Army medical units can use hospitalization resources from the other services.

During domestic national emergencies, the NDMS also depends on existing resources that will remain under the control of parent agencies. One of these is a nationwide network of more than 100,000 standby nonfederal acute care hospital beds. The NDMS depends on other in-place resources, including communication networks, transportation, and medical regulation systems to evacuate casualties to receiving hospitals. The national medical mutual aid response network provides patient clearing and staging services. It uses disaster medical assistance teams (DMATs), available military medical units, and supplementary medical supplies and equipment to carry out its functional support.

### SYSTEM ACTIVATION

The system may be activated in two ways. In the event of a domestic disaster, the governor of the affected state may request federal assistance under the authority of *The Disaster Relief Act of 1974*. This may result in the activation of NDMS. A state health officer may request that the the Secretary of Health and Human Services (HHS) activate the NDMS in situations where the President has not declared a disaster.

In a civil emergency, the principal interface will be through FEMA and HHS regional coordinators to the state disaster medical and health coordinator. If the system is activated, the lead agency will be the DHHS; in a national security emergency, the lead agency will be the DOD. Each agency will be responsible for managing its own resources in accordance with general policy.

### PERSONNEL SERVICES

Personnel units and soldiers will primarily be used to support soldiers conducting the domestic support operation. While this personnel support is provided during any operation, a domestic support operation may require additional planning and preparation. For example, maintaining accurate strength accountability may be more demanding due to unusual tailoring of units to fit the particular mission. In addition, personnel soldiers may support military and family members who are victims or are otherwise affected by the operation.

Personnel units and soldiers may be brought into an operation to assist civil authorities in accomplishing

their mission using civilian agency systems. Assistance in personnel identification, classification, and accounting may be needed. Personnel soldiers may also assist in receiving and interviewing civilians to collect information and identify unique skills. They may account for casualties. Military personnel services units also assist civil personnel in recognizing outstanding contributions from members of the supported population. Assistance is provided to the US Postal Service if it is not able to conduct essential mail operations. Morale, welfare, and recreation services are provided in limited scope or as part of a force provider package.

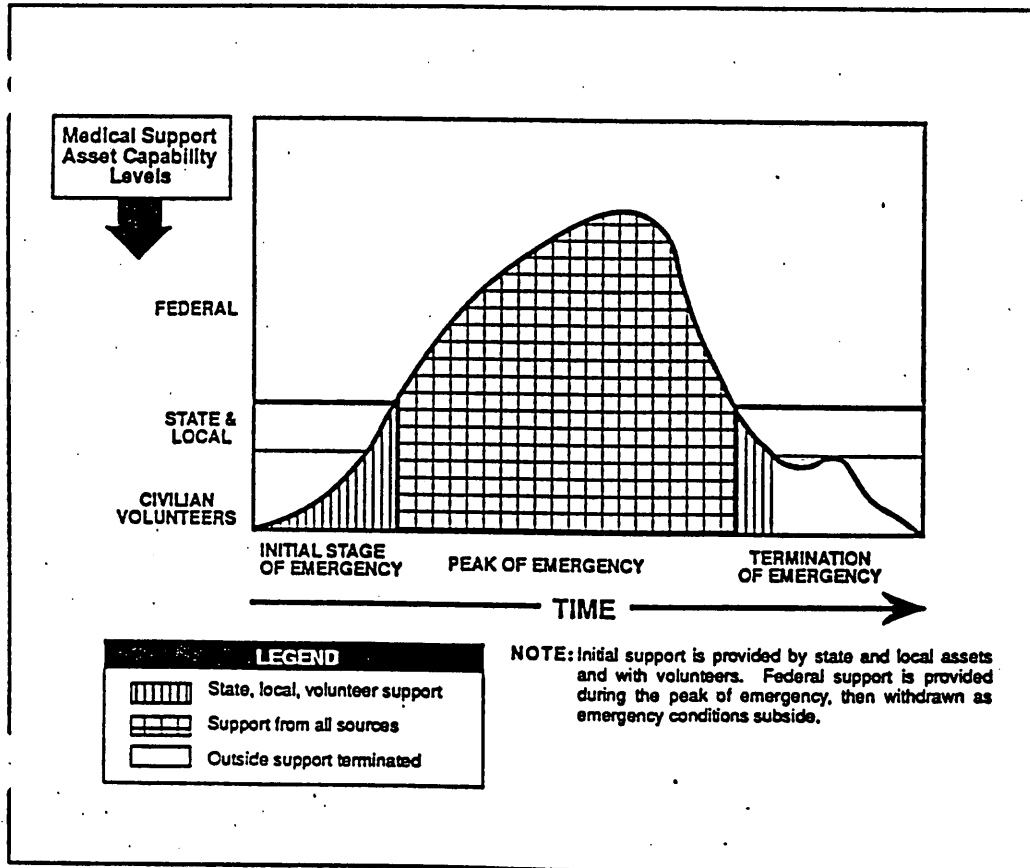

Figure 4-6. Military Medical Relief Support



## DOMESTIC SUPPORT OPERATIONS

### FINANCE

The finance mission is to sustain operations by providing timely commercial vendor and contractual payments, various pay and disbursing services, and all essential accounting. Organizational support is provided to organization units as required. It includes payment for local procurement of supplies and services, legal claims, and so forth. Finance units must provide accurate cost descriptions for initial input into the accounting system for all transactions.

Procurement support, the most critical finance mission, covers two areas. Contracting support involves the payment of commercial accounts for goods and services obtained through formal contracting procedures. Finance units can disburse currency and checks, which can alleviate shortages and delays in the procurement of various supplies and services. Commercial vendor services (CVS) meet immediate needs that cannot reasonably be met by normal logistics. Imprest fund cashiers, finance support teams (FST), and Class A agents may pay CVS in cash. Units must appoint Class A agent officers to make cash payments when they will be delayed.

*The 312th Army Reserve Band from Lawrence, Kansas, developed a counterdrug program for school kids. During their summer 1992 annual training (AT), band members designed a mixed program of music, dance, and testimonials that told the children, in terms they could understand, that drug use is wrong and leads nowhere. The band expanded its AT effort and now regularly visits local schools, playing for and talking to young students.*

### BAND

The Army also provides band support. Bands contribute effectively to commanders' community relations programs. Patriotic and popular music instill feelings of well-being and pride and provide respite from worries and problems. The band stationed nearest

the involved area should be the one tasked to support civil authorities with musical programs.

### LEGAL

Judge advocates provide advice and assistance in the functional areas of the law, including administrative, contract, international, and operational law, as well as claims, legal assistance, and military justice. Historically during military operations, the duties of the judge advocate have concentrated on the military justice system. During support operations to US civilian authorities, this military justice mission may take a secondary role to the mission of providing advice on the laws dealing with military and civilian relationships. Questions concerning the scope and source of the commander's authority, liability of soldiers, and contingency contracting may come to the forefront. For example, after-action reports from Hurricane Andrew identified a greater need for judge advocate support for claims and contingency contracting.

### CHAPLAINCY

When federal units are called in, a high probability exists that a significant amount of devastation and trauma will be associated with the emergency. Early deployment of unit ministry teams (UMTs), which consist of one chaplain and one chaplain's assistant, will put care givers on the scene to deal with trauma.

Particularly at risk are soldiers who are confronted with the emotional impact of the disaster as they arrive on the scene. The chaplain's key role is to provide spiritual care and perspective to enable the soldiers to deal with the situation as they find it.

Early deployment is particularly critical when civilian care givers, such as pastors and social workers, are themselves traumatized victims of the disaster. During the initial response phase, these people will be extremely limited in their ability to provide care. Although the UMTs may not provide direct care to affected people, they can identify those in need of care and refer them to those who can help. Through consultation with local civilian religious leaders, faith groups, and organizations, the senior chaplain of the response force will assess physical and spiritual needs and determine ways to meet both.

During the aftermath of Hurricane Andrew, UMTs provided religious support to military personnel who were providing food, water, shelter, and medical care

to civilian victims. They also talked with victims, distributed food, counseled children, picked up debris alongside other relief workers, and visited the elderly. As they met civilians in the affected area, UMTs provided religious support. They also coordinated with civilian clergy to provide religious services for civilians remaining in the life support centers. UMTs became key coordinators with local religious organizations.

### PUBLIC AFFAIRS (PA)

Public affairs is a critical consideration in Army domestic support operations, where commanders must operate in an environment of complex information demands. Domestic support operations impart a lasting impression relative to the commitment of the civil-military teams. Ultimately, the impression of the assistance effort depends to a great extent on the media. The public's perception will also be influenced by the cooperation and coordination between commanders and civilian leaders and the efforts of the public affairs personnel.

**Commanders must be prepared to operate in an environment of complex information demands.**

The news media will have unrestricted access to domestic support operations. Army public affairs officers (PAOs) must operate under any constraints imposed by the government agency that has jurisdiction. The lead agency will have release authority. The Army must coordinate all PA activities with the lead agency and comply with public affairs guidance. Public affairs officers must establish an Army information bureau to work with the Joint Information Center (JIC).

The PAO advises the commander on the information demands that he can anticipate, the information strategies available, and the effect of the communication effort. It is sometimes necessary to create an *ad hoc* PA organization to support the operation. Regardless of how Army units provide PA

support, it is critical that leaders involve their PA personnel in planning and decision making.

Commanders should be prepared to provide timely and pertinent information to the media on developing issues and changing perceptions. They must be prepared to appear on camera, answer questions, and provide explanations in order to tell the story as completely, accurately, honestly, and openly as possible.

Commanders must also fill the information needs of their soldiers. Providing effective command information is a critical element in maintaining soldier morale and unit esprit. Soldiers need information about the environment in which they are operating. They need to know that their work is valid, moral, and supported by the American people.

### SPECIAL OPERATIONS FORCES (SOF)

Army special operations forces are particularly suited to domestic support missions. They are trained and experienced in operating in austere environments. Many are cross-trained in various disciplines. Three types of SOF units are especially well-suited to domestic support missions: civil affairs (CA), psychological operations (PSYOP), and special forces (SF).

#### CIVIL AFFAIRS

CA units are specifically organized to use the civil sector functions and skills and to provide support to various levels of government in 20 specific functional areas. This working knowledge is especially useful in disasters. The units will tailor their capabilities to particular situations. CA units should be employed to advise the military commander on the impact of military activities on the civil sector. They assess damage to the civil infrastructure, assist in the operation of temporary shelters, and manage a civil-military operations center (CMOC). CA units may also serve as liaison between the military and the various civil organizations.

#### PSYCHOLOGICAL OPERATIONS

The rapid production and dissemination of accurate information to the population in crisis situations are important. This information may include safety and health messages, location of water or food distribution

## DOMESTIC SUPPORT OPERATIONS

points, and designation of restricted areas and temporary shelters. Since the normal civilian facilities may be disrupted, these units may have to employ alternative methods. Equipment assets of PSYOP units (portable printing presses, loudspeakers, and radio broadcasting stations) have often been needed in disaster operations. PSYOP personnel can provide a commander with real-time analysis of the perceptions and attitudes of the civilian population and the effectiveness of the information being disseminated.

### SPECIAL FORCES

The SF team's organization, training, capability, and adaptability allow them to operate effectively in remote and urban areas isolated by disaster events. They may be able to provide detailed reports and assessments on conditions in the area. The teams are rapidly deployable, have excellent radio communications capabilities, and are suited to working with culturally dissimilar ethnic groups.

### SIGNAL

Forces deployed in domestic support operations must carefully plan their communications packages. Communications objectives must be determined, responsibilities defined, and types of support identified. The level of information mission area (IMA) support required depends on the nature of the assigned mission. In all likelihood, a combination of military and commercial communications support will be required. A major concern for the signal planner will be the interface between military and commercial communications and information systems and networks.

If the commercial communication infrastructure is incapable of supporting civil and military communication requirements, the Army signal planner must coordinate with his civilian counterpart to determine what communication capabilities are required. This information is essential to tailoring the signal support package.

Most civil and military communications systems are incompatible for various reasons, for example, equipment, frequency allocation, and usage. Though possible, it is highly unlikely that either element will have sufficient assets on hand to equip both with compatible communications equipment. For these reasons, military and civil communication planners must exchange knowledgeable communication support personnel and compatible equipment to ensure connectivity is maintained between military and civilian operation centers. This exchange of personnel and equipment can occur at any level and should be implemented and modified as the situation dictates.

### CHEMICAL CORPS

Army chemical units are trained and equipped to provide support in many technological accident or incident situations. Although the current focus is on chemical or nuclear accidents or incidents, the present technologies and doctrine allow for greater flexibility in responding to any mission associated with the FRP. Chemical units can support domestic support operations as individuals, teams, or units.

**Chemical units can support domestic support operations as individuals, teams, or units.**

The Army Technical Escort Unit (TEU), as a DOD executive agent, has the primary mission of responding to incidents that include hazardous and toxic substances. TEU and associated explosive ordnance disposal, security, and command and control elements routinely deploy to support the movement and demilitarization of toxic chemical munitions and substances. Nuclear accident/incident (NAI) and chemical accident/incident (CAI) during domestic support operations require coordinated efforts through

DOD, and with the DOE, EPA, and LEAs. DOD and FEMA have established joint policy for a coordinated response to a nuclear material accident. Army policy and the Federal Radiological Emergency Response Plan describe duties of these agencies and organizations.

A chemical battalion headquarters can provide command, control, and communications resources, as well as training support, for any technological and consultative operation involving nuclear, biological, and chemical (NBC) defense and operations. Chemical reconnaissance units are equipped to conduct surveys and determine the type and extent of toxic contamination with mobile spectral analysis. Chemical decontamination units can deploy with high-mobility vehicles allowing off-road employment of a wide range of equipment and capabilities. Both reconnaissance and decontamination unit capabilities allow for chemical and nuclear hazard surveying, detection, identification, monitoring, and personnel and equipment decontamination. Additional capabilities provide local security, vector control, and limited water transfer, spray, and storage, allowing a limited personnel shower and a firefighting capacity. Chemical smoke units also possess high-mobility capabilities as well as equipment for the employment of smoke and obscurants.

Technical support available to other agencies includes surveying radiological and hazardous material, monitoring, determining downwind contamination hazards, and assessing vulnerability and area damage as may be required for environmental missions or for disaster assistance operations. Training and consultation in NBC defense and operations, including the use of defoliants, the employment of riot control agents, and the construction and employment of flame field expedient devices, are also available for civil preparedness. Chemical units are capable of providing NBC defense training in law enforcement and counterdrug operations.

If chemical units deploy as self-sustaining entities, they are capable of at least 72 hours of operations without additional support. Follow-on support requires coordination for resupply of chemical defense equipment and material and life support. Military, federal, or contracted logistics support can provide the required resources.

### SAFETY

Installation or unit safety professionals may be required to provide safety services to a community in support of assistance operations. Whereas military support is intended to provide aid and comfort, the potential for a catastrophic accident is greatly increased if equipment designed for combat is used for disaster assistance. If, due to expediency, soldiers are tasked to perform services in which they have little or no formal training, for example, civil disturbances, flood control, or firefighting, the result could be the loss of soldiers or military equipment and additional damage to the community the soldiers are trying to support. Army safety services must be focused toward both the Army unit providing the support and the civilian community receiving it.

The Army commander's primary responsibility is to accomplish the assigned mission and to provide for force protection. He accomplishes this through the systematic use of risk management techniques and the total integration of safety throughout all aspects of the operation. He must use the same philosophy and techniques to ensure that Army services provided to the civilian community are free of unnecessary risk. The safety (risk management) staff officer advises the commander and his staff on all applications of the risk management process and recommends how to integrate the safety function. He also maintains liaison with, and provides assistance to, other Army, joint, or combined elements as required or directed by the commander.

## DOMESTIC SUPPORT OPERATIONS

---

### SUMMARY

Most domestic support operations are logistical in nature. Leaders and managers must understand the basic considerations and concerns necessary to accomplish those missions. Basic guidelines are to make a careful assessment of the mission, tailor the force for the mission, maintain accountability for resources expended, contract for support at the earliest opportunity, and transition support operations to local authorities as soon as possible. Force protection is a primary consideration and is implemented by identifying and eliminating unnecessary risks to the force and public.

---

**DOMESTIC SUPPORT OPERATIONS**

Each state has a plan and an Office of Emergency Services, or similar agency, that is responsible to the governor for coordinating its disaster response efforts. Local emergency organizations will be the first to provide disaster relief assistance; next are state organizations, including the state NG.

Prior to or immediately following a disaster, the state will activate an Emergency Operations Center to gather information, assess damage, and advise the governor. The state OES, through its EOC, coordinates the local and state disaster response operations. The state's adjutant general and NG also play key roles in disaster assistance.

**RESPONSE FOLLOWING A PRESIDENTIAL DECLARATION**

When the severity of a situation exceeds local and state capabilities, the governor can request that the President declare a disaster, leading to the commitment of federal resources. At that time, the FEMA takes the lead in coordinating federal assistance. The FEMA coordinates the federal government's response to state

and local authorities for disasters and civil emergencies under the authority and provisions of *The Robert T. Stafford Disaster Relief and Emergency Assistance Act*. While the FEMA is the lead federal agency in most disasters, the DOE has the lead for civil radiological emergencies, and the EPA and the USCG share responsibility for chemical contaminations.

Regardless of the disaster scenario, DOD can expect to support the lead federal agency. The SA will issue an Execute Order, coordinated with the Chairman of the Joint Chiefs and the Joint Staff, through the DOMS to the appropriate CINCs, services, and agencies. The Execute Order will designate a supported CINC and specify the supporting CINCs, services, and agencies as well as the command relationships. The Army has designated CINCFOR as the DOD operating agent and the supported CINC for CONUS disaster assistance operations. CINCLANT and CINCPAC are operating agents and supported CINCs for US states, territories, and possessions within their respective areas of operations.

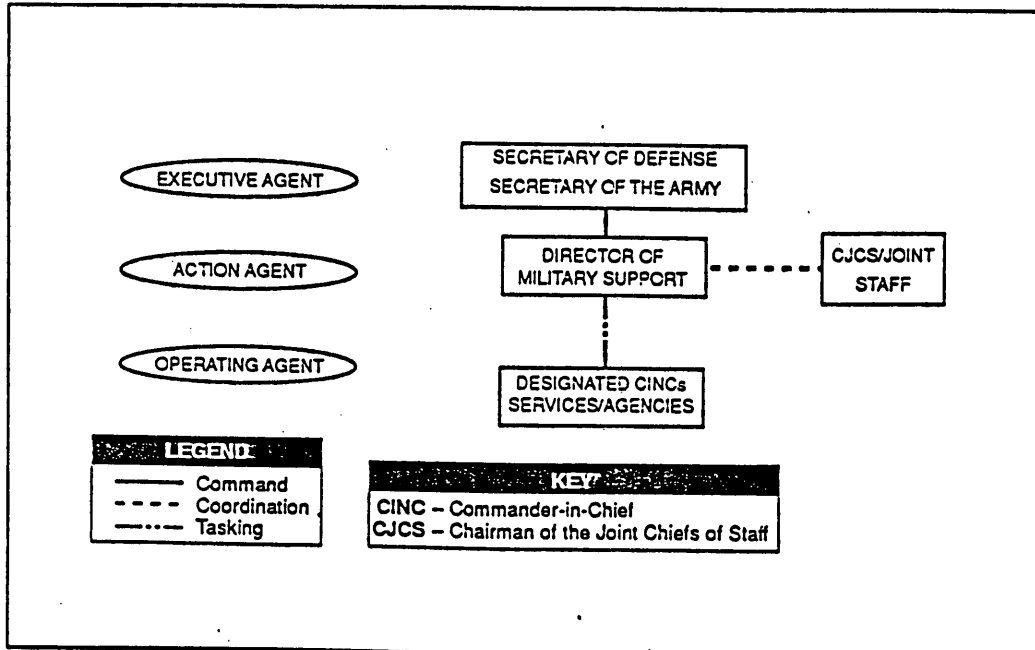

Figure 5-1. Chain of Command

**The CINC will appoint a defense coordinating officer to coordinate all requests for military assistance.**

After declaring an emergency or disaster, the President will appoint an FCO to manage the federal assistance efforts under provisions of the FRP. The FRP addresses disaster or emergency situations in which federal response assistance is needed under the authority of *The Stafford Act*. The plan describes basic

mechanisms and structures, by which the federal government mobilizes resources and conducts activities to augment state and local response efforts. The defense coordinating officer, appointed by the supported CINC, serves as the principal DOD point of contact for military support. The decision sequence for disaster support is illustrated at Figure 5-2.

**RESPONSE PRIOR TO A PRESIDENTIAL DECLARATION**

Military commanders may act before a Presidential declaration when an immediate life-threatening situation develops. When a disaster or emergency is imminent and awaiting instructions from higher authority—military or civil—would preclude responding effectively, military commanders may act. They

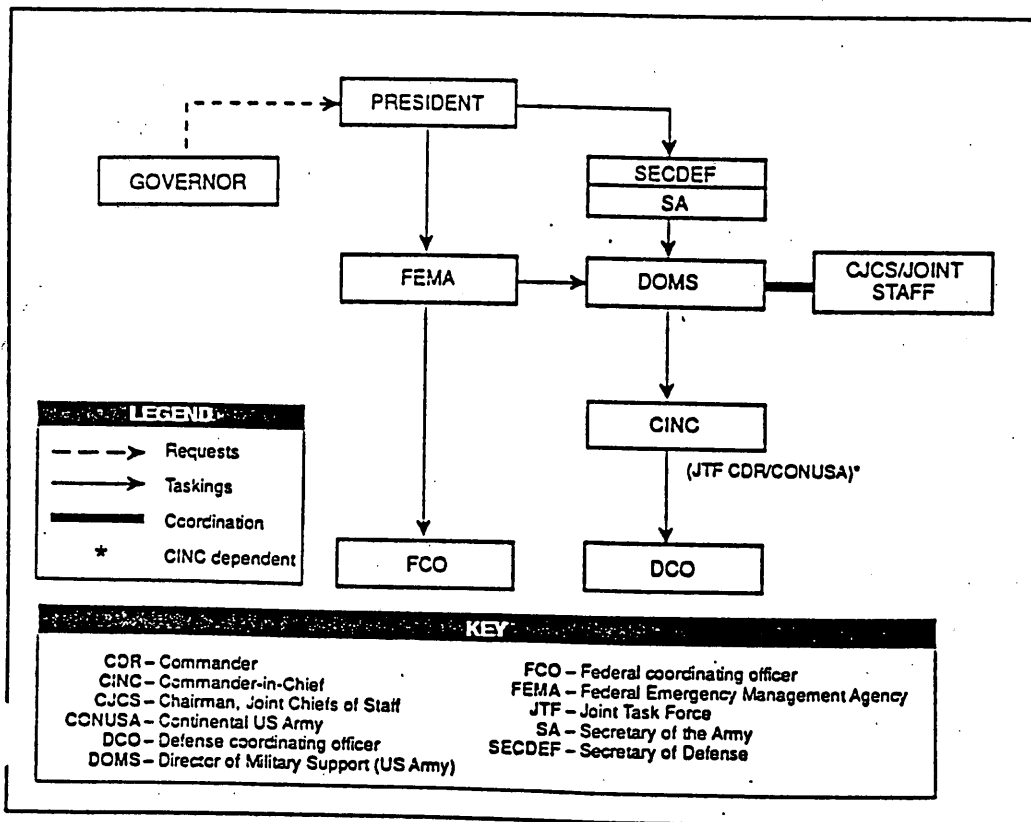

Figure 5-2. Decision Sequence for Disaster Support

may do what is required to save lives, alleviate human suffering, and mitigate major property damage within the proximity of their installations.

**Military commanders may act before a Presidential declaration when an immediate life-threatening situation develops.**

Commanders may use immediate response authority to assist in the rescue, evacuation, and emergency treatment of casualties; to restore emergency medical capabilities; and to safeguard public health. They may also provide essential public services and utilities. This list is not inclusive. Commanders use their assessment of mission requirements and the capabilities of their commands to judge the extent of immediate assistance they choose to provide.

Immediate response is a short-term emergency supplement to government authorities. It does not supplant established Army plans for supporting civil authorities, nor does it take precedence over a primary mission. Commanders notify their senior commanders and seek guidance for continuing assistance whenever Army resources are committed under immediate response circumstances. Immediate assistance is given with the understanding that its costs will be reimbursed; however, it should not be delayed or denied when the requestor is unable to make a commitment to reimburse.

When the President determines federal assistance will be provided in response to a natural or man-made disaster, the military commander will continue to provide immediate response assistance. He will adjust operations to conform with the tasks assigned by his higher headquarters, within the FRP.

#### **PREPARING FOR DISASTER ASSISTANCE SUPPORT**

Commanders can best prepare for disaster assistance operations by understanding the appropriate laws, policies, and directives that govern the military in these emergencies. The military's role is well-defined and by law is limited in scope and duration. Military resources

temporarily support and augment—they do not replace—the local, state, and federal civilian agencies that have primary authority and responsibility for domestic disaster assistance.

The military does not stockpile resources solely for domestic disaster assistance. Disaster planning and coordination must occur between the appropriate agencies at the appropriate levels, for example, between DOMS and FEMA, between CINCs and CONUSA, between the federal, state, and regional agencies.

The Army's structure and training in command and control, deployability, and sustainment operations offer ready and robust capabilities for disaster assistance support. Those same skills that soldiers and leaders use day to day often translate to the types of tasks required during disasters.

Domestic disaster operations are normally conducted in stages: response, recovery, and restoration. The role of the military is most intense in the response stage, decreasing steadily as the operation moves into the recovery and restoration stages.

Response operations focus on those life-sustaining functions required by the population in the disaster area. Recovery operations begin the process of returning the community infrastructure and services (both municipal and commercial) to a status that satisfies the needs of the population. Restoration is a long-term process that returns the community to predisaster normalcy. While the military has an important role in the relief and recovery stages, restoration is primarily a civilian responsibility. Military forces will redeploy as operations transition from the response and recovery stage to the restoration stage. The overlap of military support and effort during the three stages is depicted in Figure 5-3.

#### **Assessment**

Assessment is a fundamental task for providing effective disaster assistance. The assessment process requires the integration and analysis of information from many different sources. This process is not exclusively a DOD responsibility. It is first and foremost a local and state agency task. Federal agencies, including DOD, assist and cooperate in the information-gathering and assessment process.

Laws limit the types and ways military agencies can gather information in domestic situations. Commanders must ensure that all requests for information, both



before and during a domestic emergency, comply with the applicable laws and are handled in the appropriate military channels.

Responsibility for assessments is shared by federal, state, local, and military agencies. When a disaster occurs the damage and the anticipated military support requirements must be assessed before resources are committed. This ensures that the committed resources and forces will be appropriate for the mission and that they will be used efficiently.

The earliest information needed for the assessment process is the impact on the population, available critical infrastructure facilities, and any serious environmental hazards. Because saving lives is an immediate priority within the first 72 hours, especially in US&R operations, collapsed or badly damaged buildings that may contain trapped people must be identified. Mobile home communities, if not evacuated prior to the disaster, are especially vulnerable and likely to contain injured people. The status of the road

and rail systems, airports, and seaports must be determined. Identifying major fires, hazardous chemical spills, ruptured petroleum and natural gas pipelines, and downed electrical power lines—especially in populated areas—is a priority. Also essential is determining the status of local emergency services: police, firefighters, and health service providers.

As the federal relief effort escalates, including the deployment and employment of federal military resources in the disaster area, critical relief facilities must be made operational and accessible. These facilities include municipal offices, hospitals, water treatment plants, ice manufacturing and storage plants, electrical power stations or lines, and telecommunications nodes. Sites for the emergency shelter, feeding, and medical treatment of displaced civilians must be identified and prepared. These life support centers will be required within the first few days after a disaster. Sites for the reception, storage, and distribution of supplies in the affected area must be identified.

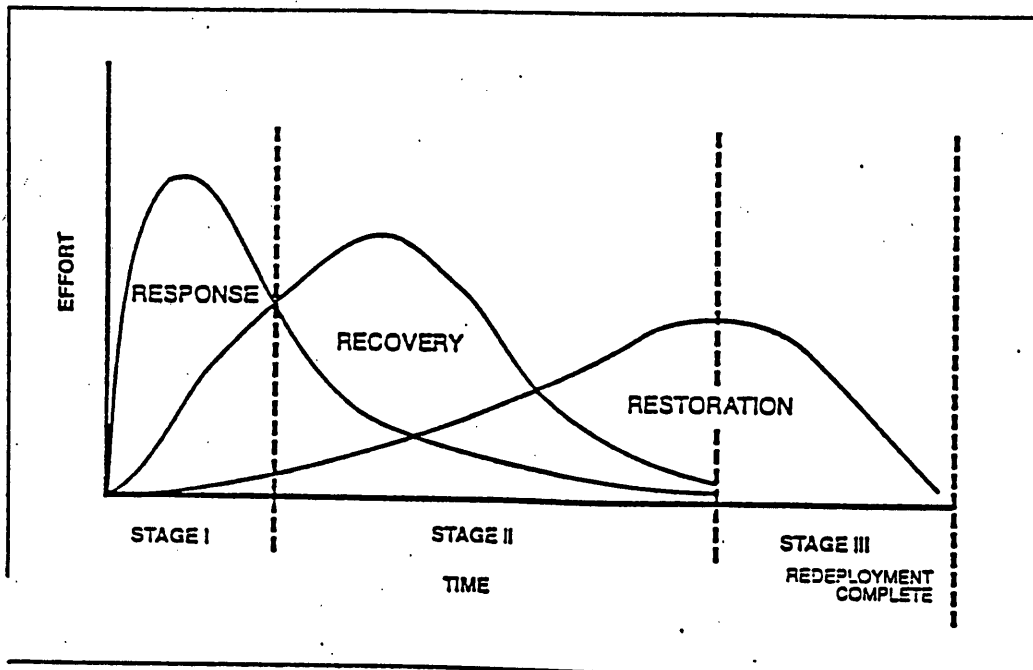

Figure 5-3. Military Stages and Levels of Effort

## DOMESTIC SUPPORT OPERATIONS

### Terminating Support

The military's role in disaster assistance must end as soon as practical. The ultimate task of the federal disaster response effort is to assist the local community in returning to a normal, predisaster status. Consequently, the military should expect to be heavily committed during the response phase of the operation, and progressively less during the recovery phase. As a principle, the military does not compete with civilian commercial enterprises. As a commercial enterprise becomes more available in the community, the military's provision of support and services can diminish.

**The military's role in  
disaster assistance  
operations must be  
transferred to civilian  
organizations  
as soon as practical.**

Disaster assistance operations require that end states or conditions be established to mark the completion of disaster assistance missions. Conditions must be definable and attainable. End states must be developed from the highest (national) perspective to the lowest county and municipal levels. They must provide a road map that can be followed by all government and nongovernment agencies involved. The affected population must know when military operations will cease and local support organizations are to continue the mission. Mission success will be tied directly to the military's ability to accomplish specific end-state objectives.

In conjunction with federal, state, and local officials, commanders at all levels must understand the desired community objectives or goals. They will affect the termination standards for the military as well as other federal agencies. The return to normalcy requires a progressive downsizing of the military's role.

Termination standards, which are established in coordination with the FCO and state and local

authorities, must be clearly stated and understood by all. They can usually be expressed in terms of percentage of predisaster capability by specific function, for example, 70 percent of electrical power restored. In an operation such as disaster assistance, redeployment of forces becomes a sensitive issue since it can create misperceptions and anxiety in the population with respect to sustained support needed and the ability of local government and contractors to handle the support as federal forces are withdrawn.

The criteria for mission success and completion must be defined, articulated, and disseminated as soon as possible. Civil authorities and Army personnel should know when the operation has reached completion or when Army assets will be withdrawn. It is important to understand that the mission may not be fully complete from the civilian authorities' perspective. Army support may have to be replaced by civilian assets and local support organizations, which will continue the restoration mission. Mission success should be directly proportional to the military's ability to accomplish specific milestones. Planners need to identify these milestones in their functional areas and use them, when accomplished, to reduce further military support requirements. These norms should be coordinated and validated for each of the possible missions, operations, and activities.

### THE FEDERAL RESPONSE PLAN

The Army and the DOD most often provide disaster assistance to other agencies in accordance with the FRP. This plan describes how the federal government responds to a declared disaster. When the plan is fully implemented, DOD and 26 other federal agencies provide support. The FRP groups disaster assistance into 12 functional areas called emergency support functions. During disaster response operations, some or all of these ESFs may be activated. The FRP assigns responsibility for each of the ESFs to a lead agency based on that agency's authority or capability. Each ESF will also have assigned supporting agencies. DOD has been designated the lead federal agency for ESF 3, Public Works and Engineering, and ESF 9, Urban Search and Rescue; a supporting agency in the remaining ten. Consequently, the Army may have resources committed in all 12 ESFs. The FRP emergency support assignment matrix is at Figure 5-4.

#	1	2	3	4	5	6	7	8	9	10	11	12
ESF	TRANSPORTATION	COMMUNICATIONS	PUBLIC WORKS AND ENGINEERING	FIREFIGHTING	INFORMATION AND PLANNING	MASS CARE	RESOURCE SUPPORT	HEALTH AND MEDICAL SERVICES	URBAN SEARCH AND RESCUE	HAZARDOUS MATERIALS	FOOD	ENERGY
ORG												
USDA	S	S	S	P	S	S	S	S	S	S	P	S
DOC		S	S	S	S	S	S			S		
DOD	S	S	P	S	S	S	S	S	P	S	S	S
DOEd					S							
DOE	S		S		S		S			S		P
DHHS			S		S		S	P	S	S	S	
DHUD						S						
DOI		S	S	S	S	S				S		
DOJ					S			S		S		
DOL			S						S	S		
DOS	S						S			S		
DOT	P	S	S		S	S	S	S	S	S	S	S
TREAS					S							
VA			S			S	S	S				
AID								S	S			
ARC					S	P		S	S			
EPA			S	S	S			S			S	
FCC		S						S	S	P	S	
FEMA		S		S	P	S	S	S	S	S	S	
GSA	S	S	S		S	S	P	S	S	S		S
ICC	S									S		S
NASA					S							
NCS		P			S		S	S				S
NRC					S					S		S
OPM							S					
TVA	S		S									S
USPS	S					S		S				

**LEGEND**

P - Primary agency responsible for management of the ESF.  
 S - Support agency responsible for supporting the primary agency.  
 ESF - Emergency support function.  
 ORG - Organization.

Figure 5-4. Emergency Support Assignment Matrix

## DOMESTIC SUPPORT OPERATIONS

### Public Works and Engineering

Public works and engineering support includes technical advice and evaluations, engineering services, potable water, construction management and inspection, emergency contracting, emergency repair of waste water and solid waste facilities, and real estate support. Activities within the scope of this ESF include emergency clearance of debris, temporary construction of emergency access routes, emergency restoration of critical public services and facilities, emergency demolition or stabilization of damaged structures and facilities, technical assistance and damage assessment, and support to other ESFs. The USACE is DOD's operating agent for planning, preparedness, and response operations for this ESF.

### Urban Search and Rescue

US&R activities include locating, extricating, and providing for the immediate medical treatment of victims trapped in collapsed structures. Designated operating agents for US&R in their respective areas of operation are the CINCFOR, the CINCLANT, and the CINCPAC. The DOMS will designate the appropriate operating agent as supported CINC.

The supported CINC will coordinate federal US&R operations and employ one or more task forces to conduct "light" (wood frame-type structures) US&R. The supported CINC will also manage military support for civilian US&R task forces. FEMA-sponsored teams provide the necessary expertise and equipment for "heavy" (masonry/concrete and steel, multistory structures) US&R. The USACE has structural specialists trained to assist in US&R. Transportation, medical, billeting, and maintenance are the types of support that civilian US&R teams may require.

### Support to Other ESFs

DOD support to other ESFs may come from one of two sources. First, when the primary agency for an ESF determines that it requires support or resources from outside its own agency, that agency may coordinate its requirements with the FEMA through its regional and national headquarters. The FEMA will then determine how to provide the required support or resources from any nationwide source. DOD, a designated supporting agency, may be tasked. Second, an FCO may task DOD to provide the required support or resources from military assets already within the disaster area or available through DOD channels. The FCO gets this

support through coordination with the defense coordinating officer.

## RESPONSIBILITIES

### FEDERAL COORDINATING OFFICER

An affected state or area will receive federal assistance through the management of FEMA and the overall coordination of an FCO, usually the FEMA regional director. The FCO is the on-scene commander for all federal resources supporting local and state authorities in the assistance effort.

### DEFENSE COORDINATING OFFICER

In the field, the DCO, appointed by the supported CINC, is the central point of contact to the FCO and ESF managers for all requests for military support. At the discretion of the CINC, the DCO may assume control of all federal military units involved in a disaster. The DCO's expertise and constant liaison with the FCO, local officials, and other ESF managers are critical to the effective coordination and integration of the federal and state disaster assistance efforts. Traditionally, CINCFOR has tasked the CONUSAs to plan for disasters and domestic emergencies and to appoint DCOs following a disaster declaration. The DCO supervises the DCE, a staff that can support both the administrative and the ESF functional areas for all coordination and decisions.

### STATE COORDINATING OFFICER (SCO)

As the governor's representative, the SCO is responsible for emergency management, disaster response, and recovery activities. The SCO is the primary point of contact for the FCO in facilitating disaster assistance. The STARC has developed disaster emergency plans in coordination with other state and local agencies. The STARC and the DCO will establish liaison so that local, state, and federal activities can be coordinated and managed effectively. The STARC can assist the federal forces with contracting support as well as logistical support from Guard resources not otherwise committed.

## JOINT TASK FORCE (JTF)

Military support to civil authorities in disasters and domestic emergencies is a DOD, not a service component responsibility. The supported CINC may decide

that the severity and scope of a disaster require a joint response. In disaster assistance, as in operational level warfighting, the CINC uses the different and complementary capabilities of each service to accomplish the mission. Such use requires knowledge of both the capability and the availability of all service component assets, to include their agencies and installations.

**The CINC may establish a joint task force to provide comprehensive military support.**

Establishing a JTF may provide the best DOD response in a disaster. The DOD's response to Hurricanes Andrew and Iniki in 1992 demonstrated that a JTF is effective in providing the comprehensive support needed in most catastrophic situations. A JTF is established to execute a specific mission limited in scope and duration. The JTF's objective in a disaster is to deploy forces to the disaster area rapidly, to assist immediately in saving lives and safeguarding property, and to continue providing assistance required by the FRP and the particular situation.

The CINC has the authority to determine the command relationship between the DCO and JTF commander. The DCO serves as the DOD's central point of contact for all requests from the FCO and ESF managers for military support. If the size of the JTF expands and the CINC decides to designate another, more senior officer as the JTF commander, the DCO becomes a special staff officer for the JTF commander.

The JTF is configured for each specific mission. In disasters, the JTF may require a greater proportion of combat service-support-type units and capabilities than in typical warfighting deployments. The JTF must be able to provide emergency assistance across all lines of support. All classes of supply and all types of services may be required. Because DOD has a supporting responsibility in all ESFs, close cooperation between the JTF and all other ESF agencies is required through the FCO, DCO, and state emergency structure. Command relationships between these authorities and organizations are illustrated at Figure S-5.

*When Typhoon Omar struck the American territory of Guam in August 1992, the CINCPAC appointed the Commander, Naval Forces Marianas (COMNAVMAR), as the DCO and the JTF commander. In response to Hawaii's Hurricane Iniki less than one month later, the CINCPAC appointed the Commander, US Army, Pacific (USARPAC), as Commander, JTF Hawaii and the DCO.*

The military has been involved in such diverse disaster relief activities as the preparation and distribution of food, removal of debris and garbage, restoration of electrical power and water systems, management of donated goods and services, and establishment of life support centers that provide shelter, security, medical care, counseling, bath and laundry, and recreation activities. The JTF commander may establish joint cells to manage specific functional or technical areas, such as a joint movement center.

## DOMESTIC EMERGENCIES

### CIVIL DEFENSE EMERGENCIES

Civil defense emergencies result from the devastation following an enemy attack, although they may be proclaimed by appropriate authority in anticipation of an enemy attack. Specific plans and orders at the appropriate command levels provide general guidance for responding to an enemy attack. Local Army commanders are authorized to respond to civil defense emergencies under immediate response and to deal with immediate emergency conditions that would be created by such attacks or disasters.

In the event of an attack on the US, the scope of military support to the civil authorities in each affected area would depend on the requirements of military operations, the extent of damage sustained in the civilian community, and the status and reconstitution priorities of the active and reserve component forces. The Army National Guard STARC, when ordered to federal service, will become the DOD's focal point for providing military assistance at the state and local

**DOMESTIC SUPPORT OPERATIONS**

levels. CONUSA commanders must coordinate the response to these civil emergencies with the STARCs.

**ENVIRONMENTAL DISASTERS**

DOD may be called on to support other federal agencies during major environmental disasters. For example, the DOE has responsibility for civil radiological emergencies and the EPA and USCG

share responsibility for chemical contamination accidents, such as major oil spills. The FEMA may also be involved in a complementary role, managing federal relief operations associated with a disaster. Regardless of the disaster scenario, the Army and DOD should expect to provide military support appropriate to the nature of the disaster and the needs of the people affected.

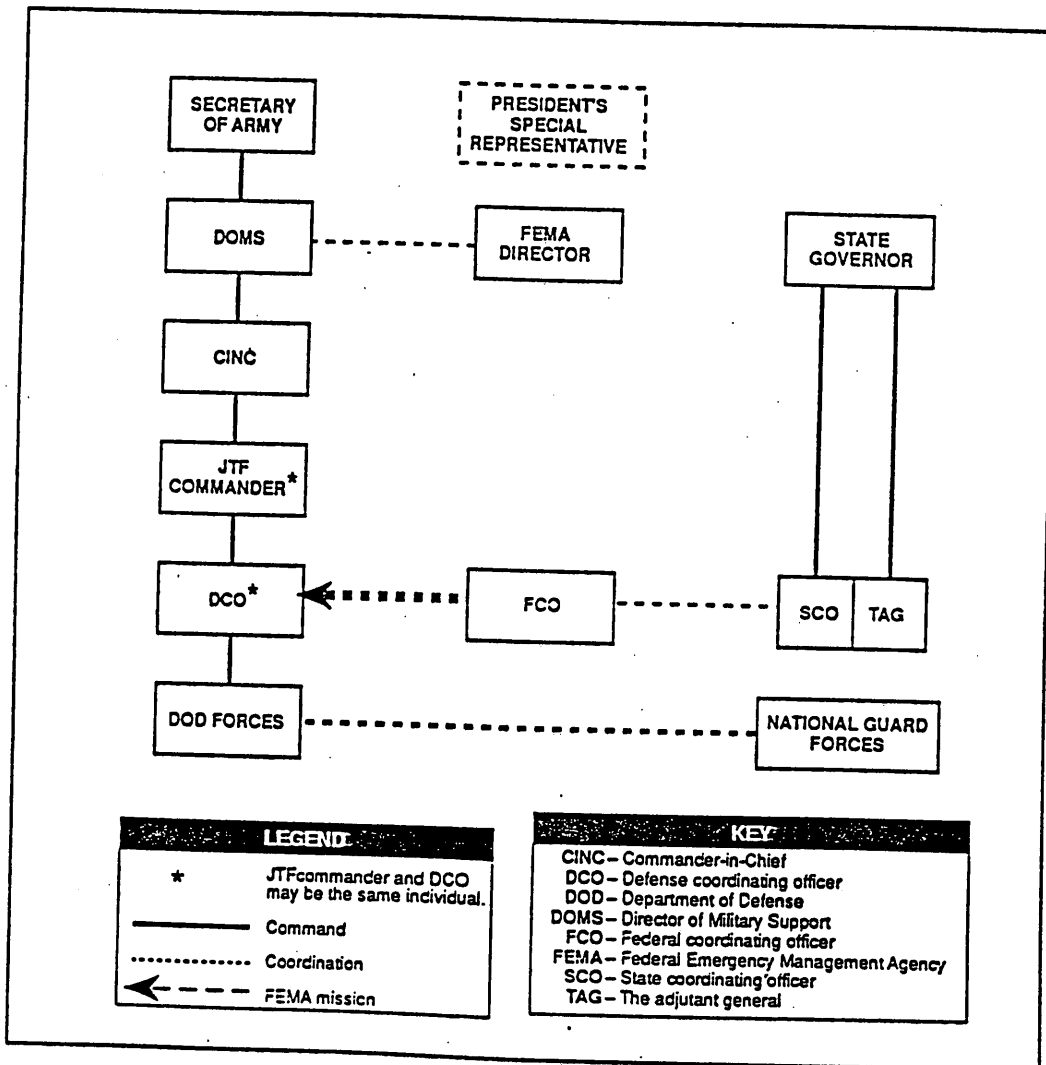

Figure 5-5. Command Relationships

### MASS IMMIGRATION EMERGENCY SUPPORT OPERATIONS

The DOD may be called on to provide support to the DOJ and its INS. The DOJ is the lead federal agency; INS is its action agency. In the event of an immigration emergency, the SA is the DOD executive agent, DOMS the action agent. The DOD may be tasked to assist in the reception, processing, transportation, and detention of the immigrants. DOD installations and facilities may be required to house immigrants for extended periods of time. These installations may have to provide a full range of services, either by DOD or by contracted agencies. Even on DOD installations and facilities, however, the DOJ and INS have the primary responsibility for the legal processing, custody, and eventual deportation or resettlement of the immigrants.

*During Operation Provide Refuge in February 1993, a task force from the 25th Infantry Division provided security and humanitarian assistance to 535 Chinese nationals who attempted to illegally enter the United States. The Chinese were fed, clothed, and housed in a US facility on Kwajalein Atoll, Republic of the Marshall Islands, until the People's Republic of China agreed to their repatriation.*

### OTHER DIRECTED MISSIONS

the DOD receives many diverse missions requiring military assistance to civil authorities. They include planning to use DOD personnel in the event of a large disruption to US mail service and air traffic control assistance in the event of a federal air traffic controller strike. The type and level of military support will be as diverse as the missions. The general concepts, principles, and guidelines for disasters, emergencies, and other assistance operations may be useful to Army commanders located OCONUS, but are subject to applicable CINC guidelines and host nation laws and agreements.

*Guardsman in Alabama, Georgia, Kansas, Kentucky, Maine, New York, North Carolina, Ohio, South Carolina, Virginia, and Wisconsin were called up in Operation Haylift to deliver relief to farmers throughout the southeast during the drought of 1987.*

### SUMMARY

The Army and the Department of Defense provide military support to civil authorities, especially in disaster assistance operations. DOD is a supporting agency, providing military support to other lead federal agencies. The SA is DOD's executive agent, and the DOMS is the SA's agent for disaster assistance support. In most cases, the Army will participate in disaster assistance operations as part of a DOD effort managed by the DOMS serving as a joint staff and commanded by a supported CINC. The Army is committed to providing timely and effective disaster assistance support to other federal agencies and the American people.



## CHAPTER 6

# ENVIRONMENTAL MISSIONS

*The Army has developed and fielded an integrated environmental program that employs a variety of resources to assist US civil authorities in environmental activities. The Army's environmental strategy rests on the pillars of compliance, restoration, prevention, and conservation. The pillars rest on a bedrock of shared national values that support the essential foundation of people, resources, communication, and organization. They also support the vision and ethic of environmental stewardship that underlies the Army program. Figure 6-1 depicts this strategy.*

### PLANNING AND EXECUTION

**The ethic of environmental stewardship underlies the Army's environmental strategy.**

If consistent with the unit's mission, commanders can allocate people and resources for the planning, technical assistance, oversight, and execution of environmental assistance missions.

- Planning focuses on environmental resource management and contingencies for incidents that adversely affect human health or the environment. It includes preassistance efforts such as developing local agreements and memorandums of understanding and integrating mutually supporting plans.
- Technical assistance covers a broad array of activities. The Army can help develop off-the-shelf plans and scopes of work, conduct on-site assessments, provide procurement advice, and augment local staffs with technical personnel.
- Oversight focuses on support roles such as administering contracts and providing staff support for operations.



- Execution employs US Army manpower and equipment to perform a mission.

*A CH-54 "Skycrane" from Company D, 113th Aviation Battalion, Nevada National Guard, carried a slingload of construction materials from Mount Rushmore. The material had been on the mountain since 1941. The 113th removed the materials during Golden Coyote '92 in the Black Hills of South Dakota.*

#### CHARACTERISTICS

Environmental support missions are characterized by the time required to accomplish them:

- Short-term or immediate-response missions require 30 days or less. They include oil and hazardous materials spills, removal of materials that contain military specific chemicals, and support in fighting wildland fires.
- Mid-term missions require 30 to 180 days. They include environmental compliance-related matters and responses requiring longer-term assistance.
- Long-term missions require more than 180 days. They include remediation or research and development support that requires contracted effort.

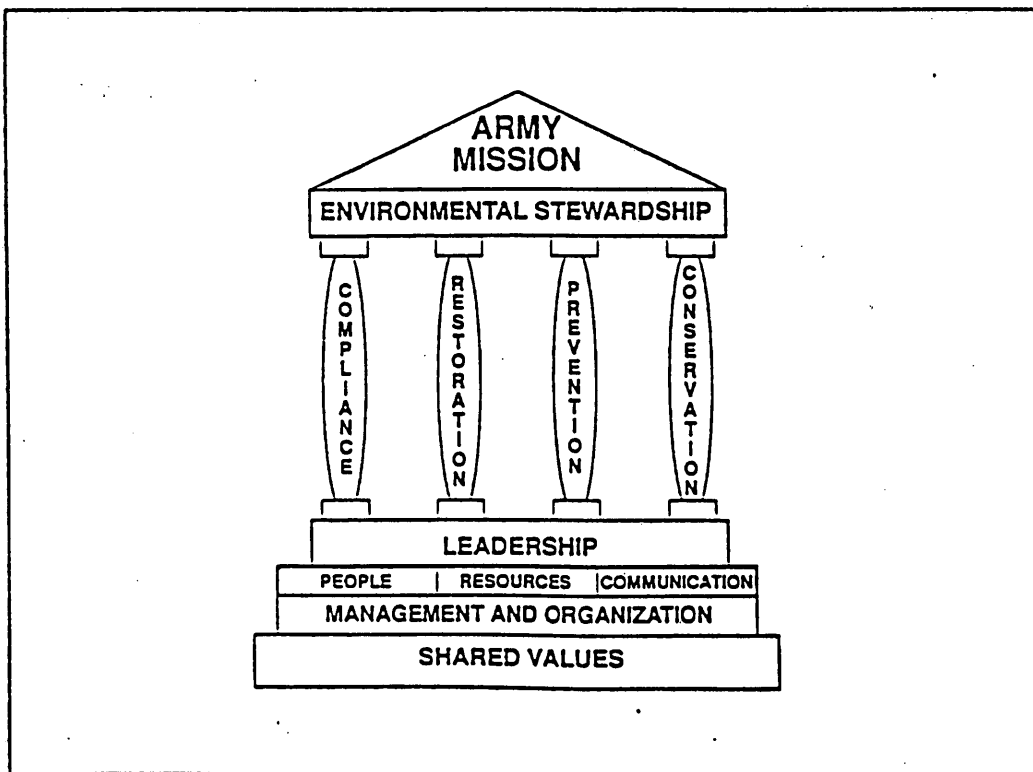

Figure 6-1. Pillars of Army Environmental Strategy

## DOMESTIC SUPPORT OPERATIONS

### CLASSIFICATIONS

The Army classifies environmental support as compliance, restoration, prevention, and conservation. These four classifications correspond to the pillars of the Army environmental strategy, which provide direction for attaining and sustaining environmental resources stewardship.

### COMPLIANCE

As an environmental leader, the Army works with regulators and citizens' groups, a cooperative approach that is necessary for successful relations with the local community and other government agencies. Army assistance responds to immediate needs or is provided as a general service.

Response includes support to correct oil and hazardous material spills under the National Contingency Plan (NCP) and control of chemical incidents. General services include support to improve compliance with environmental laws and regulations. The primary compliance missions are listed in Figure 6-2.

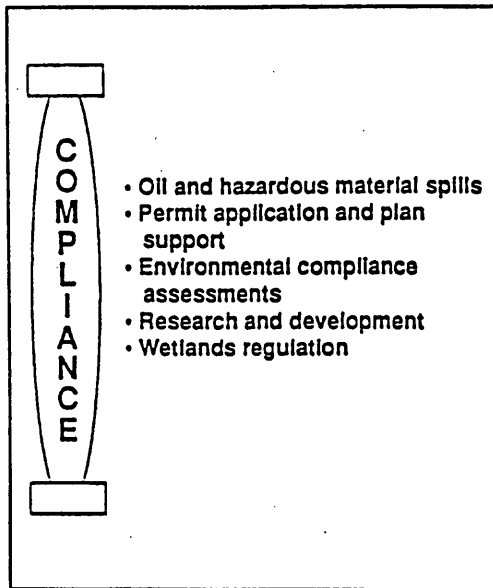

Figure 6-2. Compliance Missions

### OIL AND HAZARDOUS MATERIAL SPILLS

Oil and hazardous material spills are common occurrences. Any release of a reportable quantity of oil or hazardous material requires an immediate response. Larger-scale, catastrophic releases may occur as a result of man-made or natural disasters. Under the NCP for response to oil and hazardous material spills, the Army provides representatives to the national response team and the 10 regional response teams for both planning and response.

*On 5 January 1993, potentially volatile World War I-era liquid-filled munitions were unearthed in a residential area of Washington, DC. The location had been a chemical research site between 1917 and 1919. With support from the 101st Chemical Company, Fort Bragg, NC, the Army Environmental Hygiene Agency, the Army Armament, Munitions, and Chemical Command, the Corps of Engineers, and other local, state, and federal agencies, the cleanup began. By the last day of excavation, a total of 141 munitions had been safely unearthed.*

The director of military support coordinates Army response for large-scale spills based on requests from the EPA/USCG on-scene coordinator (OSC). Small-scale releases are more common. The Army can respond directly to small-scale releases when the spill is beyond the capability of civilian response assets or the Army has jurisdiction over the spill area.

**The Army can respond to oil and hazardous material spills under established procedures.**

An installation commander may assist in identifying, surveying, containing, and cleaning up small-scale releases of oil and hazardous materials. The commander's installation spill response group typically consists of trained personnel from the fire department or environmental staff. When the Army employs chemical units, it does so under the Nuclear and Chemical Accident and Incident Response and Assistance (NAIRA and CAIRA) Program.

Under the NAIRA and CAIRA Program, the Army can provide an immediate or planned response to a crisis or situation involving radiological or hazardous materials. Nuclear or chemical accident or incident control (NAIC/CAIC) emergency response elements organized as an initial response force (IRF) can respond immediately to the spill site to save lives, preserve health and safety, and prevent further damage to the environment.

If further action is needed, the service response force (SRF), a DA-level emergency response force, will deploy to the site. The SRF continues response operations, provides command and control of all military forces, and coordinates the activities of federal, state, and local response agencies. The Army SRF commander, executing the role of the federal OSC, executes coordinating duties per Army policy and the NCP.

#### PERMIT APPLICATIONS AND PLANS

Some government facilities may not be sufficiently staffed to address all applicable compliance requirements. Army personnel can assist these facilities in successfully completing and submitting applications and plans for permits. Depending on the size and mission of the environmental staff, a local commander can support short-term local missions. The USACE can best handle more extensive efforts on a cost-reimbursable basis. Typical compliance support projects include:

- Preparing *Resource Conservation and Recovery Act* (RCRA) Part B permit applications, closure plans, waste analysis plans, and underground storage tank site assessments.
- Preparing spill prevention, control, and countermeasures and spill contingency plans.
- Preparing National Pollutant Discharge Elimination System (NPDES) permit applications.
- Preparing air quality permit applications.

#### ENVIRONMENTAL COMPLIANCE ASSESSMENTS (AUDITS)

The Army can assist other government facilities in attaining and sustaining compliance with environmental laws and regulations. USACE districts provide comprehensive environmental compliance assessments that identify deficiencies and requirements for corrective action.

*The Army developed the Geographic Resource Analysis Support System (GRASS) that allows Army environmental and land managers to analyze, store, update, model, and display data quickly and easily. Analysis and display can be created for an entire geographic region. More than 100 Army installations, the National Park Service, and the Soil Conservation Service are currently using GRASS.*

#### RESEARCH AND DEVELOPMENT

The Army emphasizes joint technology development and use with the EPA, the DOI, and other government agencies. This transfer of information improves compliance throughout the nation. The Army conducts an extensive environmental research and development program that focuses on developing methods and equipment to meet the growing compliance requirements of new laws and regulations. The Army has developed technical products independently and transferred them to other government agencies. The Army has also developed them jointly with other federal agencies. Within the Army, most environmental research and development occurs through the USAEC and USACE laboratories.

#### WETLANDS

The USACE administers the National Wetlands Protection Program for the federal government. In this capacity, the Army serves as a regulator and oversees the restoration and mitigation of wetlands within the US.

*In Illinois, an Army National Guard engineer battalion detonated 5600 pounds of explosives as part of its training and built a home for ducks at the same time. The explosions were intentionally set off near a lake to create a series of duck ponds.*

### RESTORATION

Environmental restoration missions include correcting contamination problems resulting from past operations. Environmental investigations and remediation conducted by the Army mitigate adverse impacts to human health and the environment. Restoration efforts maximize the amount of property available for reuse and redevelopment.

Restoration missions fall into three categories: facility restoration, real property transfers, and general support. The USAEC and USACE can provide assistance in these areas. The USACE can provide longer-term assistance on a cost-reimbursable basis, while USAEC may provide short-term assistance. The primary restoration missions are depicted in Figure 6-3.

**The Army conducts environmental investigations and remediation to protect human health and the environment.**



- Facility restoration
- Real property transfers
- General environmental restoration support
- EPA support
- Defense and state memorandum of agreement/cooperative agreement
- Research and development

Figure 6-3. Restoration Missions

#### FACILITY RESTORATION

The Army has extensive expertise in investigating and restoring sites under their control. In the Installation Restoration Program (IRP), the Army investigates sources of contamination, extent of contamination, exposure pathways to potentially impacted people and ecosystems, and potential health and ecological risks. Activities routinely conducted at Army sites include:

- Assessing current site conditions, identifying past operations contributing to current site contamination, and determining whether further investigations are needed.
- Developing and implementing public involvement and public relations programs.
- Characterizing the nature and extent of contamination at suspected sites.
- Quantifying the risk to human health and the environment from contaminated sites and determining appropriate cleanup levels.

- Developing and evaluating alternatives for site remediation.
- Designing and implementing appropriate cleanup actions.

On request, USACE provides technical support to other federal agencies in the Work-for-Others Program. In this program, the other federal agency retains control and responsibility for the action but uses the technical capabilities of the Corps to accomplish the task.

#### REAL PROPERTY TRANSFERS

The storage, release, and disposal of hazardous materials and wastes directly affect the transfer of real property. The Army has gained considerable experience in mitigating these issues for unexploded ordnance (UXO), lead base paints, radon, asbestos, and polychlorinated biphenyls (PCBs). The Army assists local committees in developing reuse options that fully consider all appropriate environmental issues, identifying clean parcels, and remediating contaminated parcels. The Army can provide this support in any real estate transfer that other government agencies may consider.

#### GENERAL SUPPORT

The Army supports both state and federal agencies through specifically negotiated agreements. It provides direct support to the EPA in implementing *The Comprehensive Environmental Response, Compensation, and Liability Act (CERCLA) of 1980*. The Army supports state regulatory agencies through the Defense and State Memorandum of Agreement/Cooperative Agreement (DSMOA/CA) Program. It conducts cooperative efforts in developing innovative technologies with other government agencies.

#### EPA Support

The Army has entered into an interagency agreement with the EPA to provide assistance in executing CERCLA, also known as the *Superfund*. Under this agreement, USACE serves as the program manager for execution activities assigned by EPA. These assignments include—

- Providing technical assistance during the EPA's remedial investigations feasibility studies.
- Acting as the contracting officer for *federal lead* remedial design and remedial action activities.
- Providing technical assistance during the EPA's enforcement activities.

- Providing technical assistance and oversight of the EPA's alternative remedial contracting strategy (ARCS) contractors.
- Assisting in real estate and other support activities.

#### Defense and State Memorandum of Agreement/Cooperative Agreement Program

The DSMOA/CA Program was established to facilitate state and US territory involvement in cleanup activities conducted under the Defense Environmental Restoration Program. DSMOAs/CAs provide a mechanism to involve states in installation restoration activities by establishing the terms and conditions by which they are reimbursed for the cost of providing technical support.

#### Research and Development

As a part of its environmental research and development program, the Army pursues cost-effective restoration technologies that can be transferred to any user. The US Army Environmental Center can provide consultations in such areas as analytical chemistry and industrial hygiene. The USAEC and USACE laboratories can provide assistance in applying technology.

*The Army demonstrated an innovative idea for recovering heat lost at boiler plants at the Louisiana Army Ammunition Plant. The teflon-covered heat exchangers will pay back the investment in 5.2 years. This process saved the plant \$13,000 in FY 88 and has potential for widespread application in military and civilian boiler plants.*

#### PREVENTION

Prevention assistance missions focus primarily on participating in pollution prevention programs with other agencies. The Army also shares information and technologies that reduce the discharge of pollutants into the environment. Pollution prevention is an ethic that must be learned at all levels of an organization. As a result of implementing its own pollution prevention

## DOMESTIC SUPPORT OPERATIONS

program, the Army has gained considerable experience from recycling solid waste to manufacturing process changes.

**The Army has gained valuable experience in preventing pollution.**

Installation commanders can help local communities develop community recycling programs and support them. The local commander can work with local, county, or regional solid waste management organizations to integrate recycling efforts. Possible prevention missions are shown in Figure 6-4.

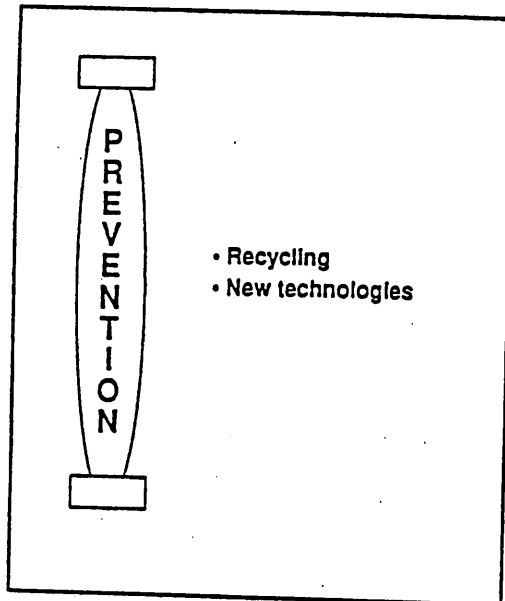

Figure 6-4. Prevention Missions

Pollution prevention is another driving force in the Army's environmental research and development program. Its efforts focus on changing or replacing existing processes to reduce and ultimately stop pollutant discharges. Examples of these technical innovations are the new generation of metal-plating procedures and advances in solid waste recycling.

Once again, the Army may develop these technologies in concert with other government agencies or alone, then share their findings with other agencies.

## CONSERVATION

Conservation assistance missions address the preservation and protection of America's natural and cultural resources for future generations. The Army works to conserve and protect natural and cultural resources on a daily basis. Typical Army conservation missions are listed at Figure 6-5.

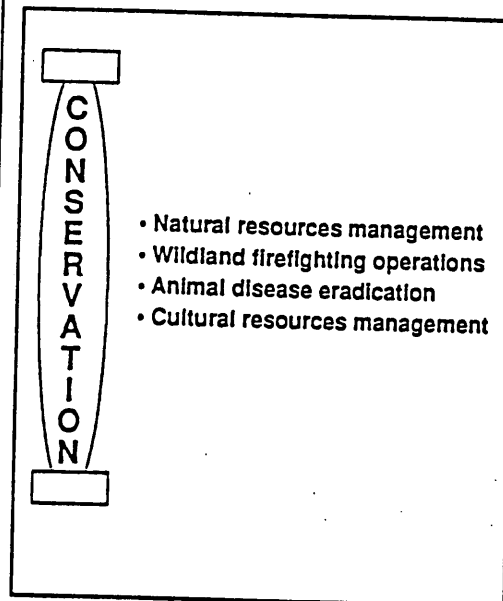

Figure 6-5. Conservation Missions

### NATURAL RESOURCES MANAGEMENT

With vast acreages, the Army conducts intensive military training while providing many sanctuaries for a wide variety of plants and animals. In so doing, the Army has gained experience in the proper care, repair, restoration, and management of these resources.

The Army often works with state and federal agencies in managing soils, vegetation, fish, wildlife, and water resources. The Army and the public both benefit from this cooperative effort because the

protection of natural resources enhances the mission and preserves the environment for all.

**The Army has vast experience in advanced land management techniques.**

*Approximately 300 breeding pairs of the Red Cockade woodpecker and other endangered bird species were on Fort Bragg, NC. To save them, the Army closed off areas to vehicles, marked bird colony nesting boundaries, taught soldiers to recognize and observe training restrictions, built beams to absorb rifle fire on ranges, and set up artificial nests to attract more birds.*

#### WILDLAND FIREFIGHTING

The Army may provide manpower and equipment to assist the NIFC in suppressing wildland fires. Initially, the NIFC contacts DOMS and requests military assistance. The DOMS tasks the appropriate CINC to appoint a DCO to confirm military support requirements. Once the DCO is appointed, the NIFC passes all resource requests to him. The Army may provide aviation, engineer, and communications support in addition to firefighters. The federal land manager trains soldiers before they are employed to fight fires. The NIFC provides the needed firefighting equipment and reimburses DOD from either the USDA or the USDOJ. The wildland firefighting tasking and resourcing channels are depicted at Figure 6-6.

#### ANIMAL DISEASE ERADICATION

In the event of an emergency arising from an actual or imminent outbreak of a foreign plant or animal disease, the DOD provides assistance to the USDA's

Administrator for Animal and Plant Health Inspection Service (APHIS). The Secretary of the Army, as DOD's executive agent, designates the Commander-in-Chief, Forces Command, as the operating agent supported CINC for DOD support to the USDA.

CINCFOR, as directed by the director of military support, provides personnel, equipment, supplies, and services to support the Regional Emergency Animal Disease Eradication Organization (READEO) task force. The READEO is the USDA organization responsible for completing all containment and eradication missions.

Included in CINCFOR's support is designating the base support installations (BSIs); tasking supporting CINCs, services, and agencies; developing contingency plans; and participating in exercises. Upon direction of CINCFOR, the BSI commanders provide personnel and logistics to the task force. USDA reimburses DOD for actual costs, less pay and allowances.

The BSIs may be outside FORSCOM and the Army. Resources provided by the BSIs can include technically qualified personnel to assist the USDA; the LSO; minimum essential TOE, TDA, and individual equipment; and procurement support.

The two key liaison officers are the veterinary support officer (VSO) and the LSO. The VSO, who is designated by Health Services Command, serves as the military point of contact with the READEO task force for veterinary support requirements. The LSO coordinates with the READEO task force director and determines the personnel, administrative, and logistical support requirements in the area of operations. The LSO provides the support requirements to the BSI and oversees the employment of DOD personnel and equipment. Figure 6-7 depicts command relationships for animal disease eradication operations.

#### CULTURAL RESOURCES MANAGEMENT

The Army works to preserve cultural resources for present and future generations. The Army may provide experts in the field of historic preservation from the USAEC, USACE, and the local installations. Many communities are involved or are interested in preservation of historic buildings and similar properties but may lack expertise. This is especially true in many rural areas.

Installations or other Army activities may provide some assistance to local communities at no charge. Army experts may assist in developing local historic

Adjutant General's Department of Texas  
Austin, Texas 78763-5218  
13 July 1992

AGTX MILITARY ASSISTANCE TO CIVIL AUTHORITIES OPLAN

Table of Contents

<u>SUBJECT</u>	<u>PAGE</u>
Basic Plan	1
Annex A - Task Organization	A-1
Annex B - Intelligence	B-1
Annex C - Military Assistance/Operations	C-1
Appendix 1 - Operations Overlay	C-1-1
Appendix 2 - Command Relationship	C-2-1
Appendix 3 - High Priority Objective Areas	C-3-1
TAB A - CIDCON 5	C-3-A-1
TAB B - CIDCON 4	C-3-B-1
TAB C - CIDCON 3	C-3-C-1
TAB D - CIDCON 2	C-3-D-1
TAB E - CIDCON 1	C-3-E-1
Appendix 4 - Application of Force/Rules of Engagement	C-4-1
Appendix 5 - Mission Guidance	C-5-1
Appendix 6 - Special Orders	C-6-1
Appendix 7 - Searches	C-7-1
Appendix 8 - Snipers, Arsonists, and Looters	C-8-1
Annex D - Logistic/Service Support	D-1
Appendix 1 - Transportation	D-1-1
Appendix 2 - Medical Support	D-2-1
Annex E - Signal/Communications	E-1
Appendix 1 - HF/SSB Radio Net	E-1-1
Annex F - Information/Public Affairs	F-1
Annex G - Finances	G-1
Annex H - Personnel/Legal	H-1
Annex I - Safety	I-1



Annex J - Reports	J-1
Appendix 1 - Spot Intelligence Report (SPIREP)	J-1-2
Appendix 2 - Intelligence Summary (INTSUM)	J-2-1
Appendix 3 - Detainee Turnover Record	J-3-1
Appendix 4 - Personnel Status Report (PERSTAT)	J-4-1
TAB A - Personnel Status Report	J-4-A-1
Appendix 5 - Logistic report	J-5-1
TAB A - Logistics Status Report Format	J-5-A-1
Annex K - References	K-1

HEADQUARTERS  
 Department of the Army and the Air Force  
 Washington, DC 20310-2500  
 1 October 1992 (Advance Copy)

National Guard Regulation (AR) 500-2/  
 National Guard Regulation (AF) 55-6

NATIONAL GUARD COUNTERDRUG SUPPORT TO LAW ENFORCEMENT AGENCIES

**Summary.** This regulation covers the utilization of National Guard resources and prescribes the policies, procedures, and responsibilities governing National Guard counterdrug support to Law Enforcement Agencies (LEAs). It must be used in conjunction with the procedures provided in the Counterdrug Coordinator's Handbook, 1 October 1992.

**Applicability.** This regulation applies only to the Army and Air National Guards of the 54 States, Territories, and the District of Columbia, hereafter referred to as states.

**Impact on Unit Manning System.** This regulation does not contain policies that affect the Unit Manning System.

**Internal Control System.** This regulation incorporates guidance from AR 11-2, AFR 51-1, and OMB Circular A-123. It includes internal control review provisions. Checklists for ARNG, ANG, and counterdrug support activities are included in the Counterdrug Coordinator's Handbook.

**Supplementation.** Supplementation of this regulation is prohibited without prior approval from National Guard Bureau, Counterdrug Task Force, Pentagon, Washington, DC 20310-2500.

**Interim Changes.** Interim changes to this regulation are not official unless they are authenticated by the Chief, Administrative Services. Interim changes will be destroyed on their expiration dates unless sooner superseded or rescinded.

**Suggested Improvements.** The proponent agency of this regulation is the National Guard Bureau, Counterdrug Task Force. Users are invited to send comments and suggested improvements on DA Form 2028 (Recommend Changes to Publications and Blank Forms) directly to Chief, National Guard Bureau, ATTN: Counterdrug Task Force, Pentagon, 2D374, Washington, DC 20310-2500.

CONTENTS (Listed by paragraph number)

	Para		Para
<b>CHAPTER 1</b>		<b>CHAPTER 3</b>	
General		Use, loan, and lease of equipment	
Purpose	1-1	General information	3-1
References	1-2	Loan and lease of equipment	3-2
Explanation of abbreviations and terms	1-3	Routing of requests	3-3
Responsibilities	1-4	Use of National Guard aircraft	3-4
Authority	1-5	Equipment authorization	3-5
<b>CHAPTER 2</b>		<b>CHAPTER 4</b>	
Administrative information		Reports and records	
Legal considerations and requirements	2-1	Information and archives	4-1
Use of force	2-2	Reports and reporting	4-2
Support of National Guard personnel	2-3	Special notification/coordination	4-3
Security guidelines	2-4		
Planning	2-5	<b>APPENDICES</b>	
Memoranda of understanding	2-6	A. References	
Funding	2-7	B. Rules of Engagement, Force Protection, and Safety	
Personnel	2-8		
Medical requirements	2-9		
Public affairs	2-10		
Training	2-11		
Office of Review and Evaluation	2-12	Glossary	



## CHAPTER 1

### GENERAL

#### 1-1. Purpose

This regulation prescribes policies and responsibilities relating to the use of Army and Air National Guard resources for counterdrug supply reduction activities in support of LEAs. Use this regulation in conjunction with the Counterdrug Coordinator's Handbook.

#### 1-2. References

Required and related publications are listed in Appendix A.

#### 1-3. Explanation of abbreviations and terms

Abbreviations and special terms used in this regulation are explained in the glossary.

#### 1-4. Responsibilities

a. The Secretary of Defense (SECDEF), in accordance with 32 USC 112, provides funds to states receiving approval of their plans for National Guard counterdrug support activities.

b. The Chief, National Guard Bureau, will provide federal resources to the National Guard for the Counterdrug Support Program.

c. The Counterdrug Task Force under the guidance of the National Program Manager, NGB has primary responsibility for the development and execution of all National Guard counterdrug support related program policies, procedures, and regulations. The Counterdrug Task Force gives guidance on the formulation of new program concepts, and reviews and approves such initiatives prior to submission to the states for implementation. Questions on counterdrug support policy should be directed to the Director, Counterdrug Task Force. Other Counterdrug Support Program questions shall be directed to the Counterdrug Support Division.

d. The State Plans, Operations, and Military Support Officer (POMSO) is the Counterdrug Support Manager and primary point of contact at the state level. The states also have a Counterdrug Coordinator who oversees the Counterdrug Support Program with specific guidance from the POMSO. All Army and Air National Guard counterdrug activities are directed by the POMSO.

#### 1-5. Authority

The Governor is the Commander-in-Chief of the Army and Air National Guard units of his/her state or territory when these units are not in federal (Title 10) status. Such authority is derived from Article 1, Section 8, Clause 16, U.S. Constitution. District of Columbia units serve under a Commanding General who is appointed by the President of the United States.

## CHAPTER 2

## ADMINISTRATIVE INFORMATION

## 2-1. Legal considerations and requirements

a. National Guard role. The National Guard provides counterdrug support to LEAs requesting assistance. National Guard personnel engaged in counterdrug support activities for which federal funding is provided by 32 USC 112 are considered to be in support of law enforcement agencies. Support requested that was not originally listed in state plans will be considered on a case by case basis. Generally, requests to provide federally funded mission support that were not included in the original execution memoranda require approval above state level. These will be processed through the Counterdrug Task Force for SECDEF consideration.

b. Requests for support. The National Guard will not initiate counterdrug support operations without a documented request for support from a LEA.

c. State law. The role of the National Guard with respect to counterdrug support operations is defined by each state's governor and must fall within the confines of that state's law.

(1) Proposed operations within state counterdrug plans must receive certification of legal review from the state Attorney General. Such certification ensures that the operations are consistent with and not prohibited by state law.

(2) The requirement for state certification of legal review is not waivable.

d. Arrests, searches, and seizures. National Guard personnel will not, except for exigent circumstances, directly participate in the arrest of suspects, conduct searches which include direct contact of Guard members with suspects or members of the public, or become involved in the chain of custody for any evidence. Commanders at all levels will ensure that personnel are thoroughly briefed on this subject before participating in counterdrug operations.

(1) Powers of arrest exercised by Guard members are normally the same as those authorized by private citizens as outlined by the laws of each state. The state JAG should provide detailed guidance in this area.

(2) Exigent circumstances are situations in which immediate action is necessary to protect police officers, Guard personnel, or other persons from injury; to prevent the loss or destruction of evidence; or to prevent the escape of a suspect already in custody.

(3) Supported LEAs are responsible for obtaining warrants required for searches or for determining the need for searches, inspections, and observations that do not require warrants. This responsibility includes the determination of any potential legal restrictions upon the use of thermal imaging systems.

e. Reconnaissance and surveillance. National Guard members engaged in counterdrug support activities may conduct area surveillance and/or

reconnaissance. This may include observation of persons incidental to such surveillance but Guard members will not conduct such activity when directed at specific individuals. Observation may include the tracking of vessels, aircraft, or ground vehicles suspected of involvement in drug activities.

f. Responsibility/liability. Responsibility/liability for the actions of National Guard personnel involved in counterdrug support activities are as follows:

(1) Supported LEAs are responsible for personal injury, death, property, or damage caused by their own personnel and equipment.

(2) Federal protections for personal injury, death, or property damage caused by National Guard personnel in Title 32 status is governed by the Federal Tort Claims Act.

(3) Responsibility and liability for actions by National Guard personnel on SAD is in accordance with state law. Personnel in a State Active duty status are not covered by the Federal Tort Claims Act.

(4) Responsibility and liability for loss and damage to National Guard equipment will be determined by a report of survey.

g. Environmental restrictions. All operations will be conducted in accordance with current environmental laws and regulations.

## 2-2. Use of force

a. This paragraph contains federal guidelines which cannot be broadened. However, states should review these rules and add further restrictions as appropriate to comply with state law.

b. The Adjutant General will determine whether or not troops will be armed. When Troops are armed it will be for the purpose of self protection only. Rounds will be chambered only on order of the senior ranking military member present and in conjunction with the supported LEA.

c. Guard members have the right to use force for the following purposes; only the minimum force necessary for the purpose may be used:

(1) Defend themselves, other members of their team, LEOs, or other persons.

(2) Protect property.

(3) Make arrests if they have arrest powers pursuant to paragraph 2-1d above.

d. Deadly force (any force capable of causing serious injury or death) may only be used under the following circumstances:

(1) All other means have failed.

(2) Risk of injury to other persons is not increased by the use of deadly force.

(3) When deadly force is the minimum force necessary to prevent death or serious injury to the member, other Guard members, LEOs, or other persons.

(4) The discharge of any firearm, even if the intent is only to wound and not to kill, is always to be considered deadly force.

e. Guard members will be thoroughly briefed about the Rules of Engagement and Use of Force prior to the commencement of any operation (see to Appendix B).

### 2-3. Subpoena of National Guard personnel

a. National Guard members may receive subpoenas to testify in judicial proceedings.

(1) Guard members will obey all subpoenas.

(2) Guard members should not testify unless specifically compelled to do so by subpoena.

(3) Guard members under subpoena will be placed on counterdrug support orders (if not already on orders) for the time period required to prepare and testify. Once on orders, any fees or expense reimbursements received by the summoned member for legal services will be turned in to the U.S. Treasury if the individual is in Title 32 status, or to the state if on State Active Duty orders.

b. A state legal officer will provide information to the subpoenaed Guard member regarding the legal proceedings before the member testifies.

c. The NGB Judge Advocate (NGB-JA) must be contacted immediately under the following circumstances:

(1) Possibility of civil liability on the part of the Guard member or the Guard itself.

(2) Occurrence of negative judicial rulings based wholly or in part upon the conduct of Guard members, including the suppression of evidence.

### 2-4. Security guidelines

a. Operations security (OPSEC).

(1) Counterdrug operations will follow OPSEC procedures IAW AR 530-1, OPSEC Program. Guard members will be briefed on the need to observe OPSEC measures.

(2) Mark state plans, operations plans/orders, memoranda of agreement/understanding, and other sensitive documents: "FOR OFFICIAL USE ONLY AND EXEMPT FROM MANDATORY DISCLOSURE."

b. Communications security (COMSEC). AR 380-19, Information System Security Program, will be used to determine the methods for transmission or reception of voice and hard copy information.

c. Physical security. Physical security personnel will conduct physical security risk assessments of all offices and operational areas.

d. Personnel Integrity Program. Due to the sensitive nature of the Counterdrug Support Program, all states will implement a Personnel Integrity Program. It will consist of two principle elements: an initial screening prior to selection for the program, and appropriate checks and supervision once an individual is placed on orders. Authority to perform such checks on individuals

volunteering for duty may be found in AR 380-67 and AFR 205-32.

(1) Each volunteer must be notified that integrity screening will be undertaken and that certain requirements must be met before a tour assignment can be made.

(2) Written consent will be obtained before background checks may be started.

(3) Personnel investigative reports and integrity determination information will be safeguarded and disposed IAW AR 380-67 or AFR 205-32.

(4) Integrity checks will collect the minimum amount of information necessary to determine suitability of the applicant for the Counterdrug Support Program. Sources which may be investigated include the military personnel records jacket, local criminal records, files of the National Crime Information Center, and other records (see the Counterdrug Coordinator's Handbook, Appendix D). An applicant must also have a favorable NAC/ENTAC within the last fifteen years.

(5) Interviews of the Guard member will be conducted by the appropriate supervisor in the Counterdrug Support Program IAW AR 380-67 appendix G or AFR 205-37 attachment 7.

(6) Additional criteria determining eligibility for assignment to a sensitive position within the counterdrug program includes but is not limited to security standards set forth in AR 380-67, paragraph 2-200 or AFR 205-32, paragraph 8-1.

(7) Only personnel who are recommended by their unit commander as being suitable for the Counterdrug Support Program will be considered for such duty.

(8) Review each individual's medical record to ensure there are no preexisting or disqualifying conditions prior to placing them on orders. (See paragraph 2-8, Medical Requirements.)

### 2-5. Planning

a. Each state will submit an annual Counterdrug Support Plan to the National Guard Bureau, ATTN: Counterdrug Task Force, for review and staffing prior to the plan's submission to SECDEF for approval. Plans will conform to Counterdrug Task Force guidelines and be approved and signed by the state Adjutant General.

b. Supplemental plans received after initial plan submission will be considered at the mid-year review. Upon approval at that time, funds will be authorized as available.

c. POMSOs/Counterdrug Coordinators will oversee preparation of plans for support as requested by a LEA.

d. The POMSO/Counterdrug Coordinator will establish and maintain a folder for each operation. The folder will contain all pertinent documentation to provide an audit trail, including all obligations and expenditures. A list of required documents and the definition of "an operation" are contained in the Counterdrug Coordinator's Handbook.

e. All air assets will be controlled by the State Army Aviation Officer (SAAO) for the Army Guard and the Executive Support Staff Officer (ESSO) for the Air Guard. Counterdrug flying hour support requests will be reconciled with these offices. (See paragraph 2-9, Flying hours/air support, of the Counterdrug Coordinator's Handbook.)

f. Request Channels. LEAs will request support from the POMSO/Counterdrug Coordinator. Requests which are beyond the capability of the National Guard will be forwarded to the appropriate Continental United States Army (CONUSA) and will be coordinated by the National Guard CONUSA Liaison Officer. In areas where LEA federations such as Operation Alliance or Project North Star exist, the aforementioned may be altered to accommodate regional procedures. Retain plans and supporting documents for two years. (Specific coordination requirements are contained in the Counterdrug Coordinator's Handbook.)

g. Missions are consolidated to minimize duplication. The following missions list has been coordinated with and approved by Office of the Secretary of Defense (OSD):

Mission #	Title
Msn # 1	Surface Reconnaissance
Msn # 2	Surface Surveillance
Msn # 3	Surface Transportation Support
Msn # 4	Aerial Reconnaissance
Msn # 5	Aerial Surveillance
Msn # 6	Aerial Transportation Support
Msn # 7	Ground Radar Support (includes Security)
Msn # 8	Cargo Inspection
Msn # 9	Training Program (NG & LEA)
Msn # 10	Aerial Photo Reconnaissance
Msn # 11	Coordination, Liaison, and Management
Msn # 12	Marijuana Greenhouse/Drug Laboratory Eradication/ Detection
Msn # 13	Film Processing for Photo Reconnaissance
Msn # 14	Administrative, Information, ADP, Logistics, and Maintenance Support
Msn # 15	Engineer Support
Msn # 16	Aerial Interdiction Support

Refer to The Counterdrug Coordinator's Handbook for mission descriptions and requirements.

2-6. Memoranda of Understanding (MOU)

a. For agencies receiving counterdrug support for a total of more than 30 days, states are required to develop MOUs with a LEA prior to providing the requested support. MOUs are also required for all

interstate support. These memoranda will cover the following:

- (1) Planned deployment of National Guard personnel and equipment.
- (2) Reporting procedures.
- (3) Command and control channels.
- (4) Scope of approved operations.
- (5) Force protection/

Rules of Engagement.

- (6) Public affairs.
- (7) Safety.
- (8) Areas of responsibility.
- (9) Acquisition of warrants, permits, hold harmless agreements. (Hold harmless requirements are not required for support provided to federal agencies.)

b. MOUs will be carefully reviewed by the state Judge Advocate General (JAG) and if applicable, the U.S. Property and Fiscal Officer (USPFO) and SAAO/ESSO.

2-7. Funding

a. 32 USC 112 provides funds for Pay and Allowances (P&A) and Operations and Maintenance (O&M) under the Counterdrug Support Program. Procurement of services and equipment (to include leases) is funded by the annual Authorization and Appropriations Acts.

b. Funding for operations is based on Congressional appropriations coupled with the Office of the Secretary of Defense plan for supporting the National Drug Control Strategy. Allocation of funds to support state plans is based on this strategy.

c. States may not transfer funds between appropriations nor transfer funds between the Army and Air Guards.

d. Counterdrug support mission costs associated with IDT/AD or AT training that include above normal expenditures (such as lodging) may be charged to counterdrug support accounts. Travel expenses incurred by personnel on ADSW with the Counterdrug Support Program when commuting to and from IDT/AD are chargeable to the program when the travel to IDT/AD is to a place other than the member's normal (i.e. ADSW) place of duty.

e. Counterdrug support funds are considered "fenced" and therefore cannot be transferred to disapproved missions, other state programs, or to other states.

f. Army National Guard funding

(1) Pay and Allowances (Appropriation 2060). Pay, allowances, travel, and per diem for ADSW personnel only, are chargeable to the National Guard Personnel Appropriation (NGPA) and are identified as program costs IAW AR 37-100-92.

(2) Operations and Maintenance (Appropriation 2065). Operations and maintenance expenses are chargeable to the Army National Guard

Operations and Maintenance Appropriation (OMNG) per AR 37-100-92. O&M includes the following types of expenditures.

(a) Pay of technicians employed by the state Adjutant General as staff to provide support explicitly for the Counterdrug program. Also covered are the employer's contribution to employee retirement funds, incentive awards, health and life insurance programs, FICA where applicable, and object class 12 Permanent Change of Station (PCS) benefits.

(b) Travel and per diem required for ARNG AGR (Titles 10 and 32), ARNG technicians, or National Guard Bureau employees directly employed with the Counterdrug Support Program.

(c) Medical expenditures for all personnel (other than AGR) directly employed in the Counterdrug Support Program such as line of duty civilian medical care, unique immunizations, and per diem with travel expenses for program applicants to obtain examinations needed to determine suitability for the counterdrug program. Approval for payment IAW NGR 40-3 is processed by NGB-ARS-MS.

(d) Procurement of material required for operating and maintaining facilities, aircraft, ground vehicles, and equipment.

(e) Procurement of medical supplies used in Counterdrug Support Program activities.

(f) Other expenses that cannot be linked directly to a specific mission. Additional guidance may be obtained from the Army Comptroller Division, Budget Branch (NGB-ARC-8).

#### g. Air National Guard funding

(1) Military Personnel (Appropriation 385C, Fund Code 56). Pay, allowances, and travel for personnel directly involved with the Counterdrug Support Program are chargeable under this appropriation.

(2) Operations and Maintenance (Appropriation 384D, Fund Code 58). Operations and maintenance funds cover a variety of costs that are the same as the ARNG, except that medical cost accounting differs.

(a) Medical expenses should be identified for CONUS plans and operations using the appropriately assigned Emergency Special Program (ESP) code.

(b) Line of duty civilian care expenditures which cannot be handled with local funds, should be submitted to Air National Guard, Medical Resource Management Office (ANGRC/SGAR) as an unfunded budget requirement.

h. Items identified for central procurement using Dedicated Procurement Program (DPP) funds, and/or USPFO procurement authority for O&M funds, will be identified and submitted in the annual Counterdrug Support Plan submitted by each state.

#### 2-8. Personnel administration

a. National Guard members may serve the Counterdrug Support Program under a variety of employment categories. Additional regulations within each category further govern the utilization of these

soldiers and airmen. Attention to detail is required so that members receive the benefits, pay and allowances due them. The support of the counterdrug program must be the primary mission of all federally funded counterdrug personnel.

b. State Active Duty (SAD). State funded SAD personnel may provide counterdrug support to LEAs. Such personnel will be employed IAW state regulations.

c. Active Guard Reserve (AGR) (Title 10/Title 32) and Full-time Technician Personnel.

(1) Do not place personnel on an AGR tour unless upon reaching eighteen years of active federal service they will have sufficient time remaining prior to their Mandatory Separation Date (MSD) to complete twenty years of active service.

(2) Employment of ARNG AGR personnel will be as stated in NGR (AR) 600-5 (Title 32) or NGR (AR) 600-10 (Title 10). Employment of ANG AGR personnel will be accordance with NGR (AF) 35-3.

(a) Counterdrug Orders will include a statement requiring the proper use of personnel. (See Counterdrug Coordinator's Handbook for Title 10 and Title 32 required statements.)

(b) Full-time ARNG AGR personnel serving tours other than those specifically in the Counterdrug Support Program will not spend more than thirty days total time per year involved with the counterdrug program. Requests for exception to policy will be submitted to the Army National Guard, Full-Time Support Division (NGB-ARM), who will in turn coordinate any approvals with the Counterdrug Task Force (NGB-CD).

(c) Air National Guard (ANG) AGR personnel. At the discretion of the commander, ANG AGR personnel other than Counterdrug Coordinators may participate in the Counterdrug Support Program without limit if participation is consistent with their Air Force Specialty Code (AFSC) duties or contributes to overall unit readiness. Tour length limitations and guidance found in ANGR 35-3 apply to full-time military personnel serving in support of counterdrug activities.

(3) Technician status is determined by TPR 990-2. Technicians who provide support to LEAs must be placed on appropriate leave for all normal workday hours during the time this support is rendered.

#### d. Active Duty Special Work (ADSW) (Title 32).

(1) The number of soldiers and airmen serving on ADSW tours for the Counterdrug Support Program will not impact allowable end strengths of personnel supporting reserve components. Neither shall they count against authorizations outlined in Title 10, sections 517 and 524. These same personnel are exempt from end strength reporting and limitations on the number of days members may perform in a fiscal year under AR 135-200, NGR 37-111, and ANGR 50-01. Guard members placed on extended ADSW orders are required to continue attending IDT/AD while remaining on the orders. They should be carried as "constructive" attendance for purposes of pay and accountability. Orders must be broken for any non-counterdrug training

lasting longer than three days. Additionally, soldiers and airmen on ADSW for twenty weeks or longer are entitled to PCS benefits.

(2) Officers on ADSW orders who enter the sanctuary zone (18-20 years of active federal service) must be retained on active duty until the completion of 20 years.

e. Duty Performed Incidental to Training. National Guard personnel may support LEAs and/or other parts of the Counterdrug Support Program in an IDTIAD or AT status if the performance of that duty is synonymous to the training originally planned.

f. Performance Evaluation. States will implement a system for the evaluation of a member's job performance while assigned to the Counterdrug Support Program for 90 or more consecutive days.

#### 2-9. Medical requirements

a. In addition to existing requirements outlined in AR 135-200, AR 40-501, and AFR 160-43, personnel on orders (Title 10 or Title 32) for federally funded (Section 112 funding) counterdrug support activities will adhere to the following physical examination requirements:

b. The requirement for physicals (medical fitness screening) depends on the length of a Guard member's ADSW orders and falls into two categories.

(1) Tours of thirty days or less do not require a medical examination. However, the individual will complete and sign a statement attesting to the status of current health IAW NGR 40-501, Appendix B or AF Form 895, AFR 160-43 prior to being placed on active orders.

(2) Tours thirty-one days or longer are required to meet entry level physical examination standards. IAW AR 40-501, Chapter 2 or AFR 160-43, Chapter 4. This examination must have been completed within one year of an individual's placement on orders for the counterdrug program. Personnel on flight status may substitute an annual aviation class II (long form) in lieu of the previously cited physical. This is not a recurring requirement. Once the entry level physical has been passed, retention (Chapter 3) physicals will be adequate unless the member is out of the program in excess of one year.

(3) Guard members whose physical examination results (or a waiver approved by NGB-ARS-MS or ANGRG/SGP) have not been received by the Counterdrug Support Program of their state by the end of thirty days will have their counterdrug ADSW orders terminated.

c. Personnel in the Counterdrug Support Program are also subject to drug analysis testing (DAT) and HIV testing. Females are required to sign a statement regarding pregnancy. Specific requirements are contained in the Counterdrug Coordinator's Handbook.

d. Guard members on ADSW orders who are injured while participating in counterdrug support

activities are entitled to benefits under Section 1074a of Title 10 USC.

#### 2-10. Public Affairs

a. The supported LEA should have the lead concerning public affairs and make the final determination as to what information is released to the public in coordination with the state PAO.

b. State PAOs will not divulge dates of specific operations, identification of units, or identification of personnel involved. (Photographs and video tapes will be carefully managed to ensure that faces and name tags are not visible). Operational questions regarding information on numbers and types of personnel or equipment involved in current or future activities will not be released until the mission is completed. Protection of the force and OPSEC will be the primary consideration.

c. News media representatives can accompany the National Guard on counterdrug support operations only with the approval of the LEA and notification of NGB-PA. Orientation flights with news media representatives must receive NGB-PA approval IAW NGB PAM 360-5

#### 2-11. Training

a. Training of National Guard personnel

(1) Middle and upper level managers (such as POMSOs and Counterdrug Coordinators), should at a minimum attend the Counterdrug Managers' Course provided by the National Interagency Counterdrug Institute (NICI). The program of instruction provides information regarding organizations, policies, and laws which they must be familiar with in order to execute a State Counterdrug Program.

(2) Tactical level planners and operators must be given training specific to the types of operations being planned or undertaken by their state counterdrug programs. Such training can take the form of everything from cargo inspection techniques to the operation of specialized equipment. Training plans should be created at the state or regional level and tailored to the specific requirements of the LEAs and approved missions.

b. Training of LEA personnel

(1) Congressional and DoD intent is that counterdrug support funding may not be used for other purposes such as train-ups for LEA personnel with deficiencies in areas such as marksmanship, weapons systems, etc. DoD guidance is that "other related topics" is not intended to act as a catch-all, but is designed to provide reasonable lee-way from listed examples of authorized training.

(2) NGB will approve training for LEAs when such training enhances the ability of LEA members working directly with the National Guard in the Guard's counterdrug support role. This training includes:

(a) Training for specific types of operations such as surveillance missions.

(b) Training for LEAs that enables them to interact with military forces in joint operations



such as eradication, border interdiction, and other similar events.

(3) Any LEA training not specially defined above must be approved in advance by the NGB Counterdrug Task Force.

**2-12. Office of Review and Evaluation**

a. The Office of Counterdrug Review and Evaluation implements internal controls and provides oversight functions for the program. It monitors and performs periodic inspections of operations ensuring that internal management controls will detect fraud, waste, or abuse of resources and assets.

b. The POMS/Counterdrug Coordinator will provide the Office of Counterdrug Review and Evaluation a copy of all reviews, inspections, and evaluations conducted in the state counterdrug program.

## CHAPTER 3

## USE, LOAN, AND LEASE OF EQUIPMENT

## 3-1. General information

a. The state Adjutant General has authority to use federal property issued to the National Guard in support of counterdrug support operations.

b. States are encouraged to make every effort to utilize military assets for counterdrug support activities.

c. States may coordinate directly with other states for the temporary loan of additional federal property needed to support a particular type of counterdrug activity. Formal arrangements should be made between USPFOS. The loan transactions will be reported to NGB-CDD and the Army National Guard, Logistics Division (NGB-ARL) or the Air National Guard, Directorate of Logistics, Supply and Equipment Division (ANGRC/LGS) as appropriate.

d. NGB-ARL and NGB/LGS will provide yearly guidance for counterdrug support equipment requirements, loans, leases, and procurement activities.

e. All equipment purchased, loaned, leased, or otherwise obtained using 32 USC 112 funds will not be used for anything other than counterdrug support.

f. All excess equipment will be reported to NGB-CD for redistribution.

## 3-2. Loan and lease of equipment

a. Loan and lease of equipment is governed by AR 700-131, and AFM 67-1/ANGR 67-1. USPFOS are responsible for preparing and negotiating agreements, and approving loans and leases of equipment. Loan formats may be found in the aforementioned references.

b. NGB will review requests for loans/leases of ARNG/ANG equipment that require HQDA and USAF approval. States will itemize/prioritize lists of requested/required equipment in their annual Counterdrug Support Program plans.

c. Areas of responsibility or request review are as listed:

(1) Director, NGB-CD will act on all counterdrug support to LEAs.

(2) The Public Affairs Division (NGB-PA) will be involved if requests will impact the community.

(3) The Aviation Division, Standardization and Training Branch (NGB-AVN-O) will control all areas related to ARNG aircraft.

(4) Air National Guard Counterdrug Support Division (ANGRC/DON) will act on requests for loan or lease of ANG equipment.

(5) The Logistics Division (NGB-ARL) will act on all other requests for loan/lease of ARNG equipment.

(6) ANG Logistics (ANGRC/LGS) will process all requests for ANG assets.

## 3-3. Routing of requests

a. Loan requests from state and/or local agencies should be routed directly to the state POMS/Counterdrug Coordinator.

b. Loan requests from federal agencies will be routed through that agencies' headquarters to the Department of Defense, and then to the appropriate service. Contact should be made with Regional Logistics Support Offices (RLSOs) to process requests for resources not available in standard channels.

3-4. Use of National Guard Aircraft. All support will be in compliance with applicable state and federal law and regulations.

a. The use of National Guard aircraft is prescribed by the 95-series regulations for the ARNG and the 55-series for the ANG. The Army safety program is covered in AR 385-10 and the Air Force safety program is covered in AFR 127-4. Additionally, the Air Force adheres to "Safety: Investigating the Reporting USAF Mishaps" IAW NGR (AF) 127-4 supplement, and Message Reporting of F-16 Flight Mishaps AFR 127-18. These regulations are the primary references on all use of aircraft issues. See NGR AR 500-1/NGR AF 55-5 for additional guidance.

b. ARNG and ANG aircraft may be used for counterdrug support activities in any of the listed categories.

(1) ADSW (Title 32) status and/or federally funded SAD status.

(2) Incidental-to-training.

(3) Training support to LEAs.

c. Reconnaissance and Interdiction Detachment (RAID) Aircraft.

(1) RAID aircraft are funded with counterdrug dollars, and intended for use in counterdrug operations. Acknowledging that some requests will likely be made wherein the use of the aircraft's thermal imaging and or communications capabilities are needed, the following allowances are made for use of RAID aircraft for other than counterdrug missions:

(a) The RAID aircraft may be used in a life/death emergency situation that meets the following criteria:

(1) The aircraft and thermal imaging/communication equipment is needed to search a wilderness area for a lost person(s), where the probability exists that the person(s) will most likely not survive inclement weather or other perilous circumstances/conditions.

(2) The aircraft and thermal imaging/communication equipment is needed to search for an escaped convict or suspected dangerous felon in a wilderness area, that if not quickly apprehended, will likely endanger the welfare of residents and innocent citizens.

NGH (AI) 500-2/NGH (AF) 55-6

(2) In each case of (1) and (7) above, the request must be made by a law enforcement agency to the National Guard. Flying hour time used for the mission must be reimbursed either by other National Guard Funding or by the state or local government making the request. Missions for other than counterdrug operations must not interfere with counterdrug missions unless LEA coordination is made and a life/death emergency exists.

### 3-5. Equipment authorizations

a. Commercial equipment must be authorized by NGB-CDD and NGB-ARL prior to procurement or leasing. ARNG requests, not previously approved will be processed as prescribed under AR 71-13 for a Table of Distribution and Allowance (TDA) addition or under CTA 50-909. ANG requests will be submitted on AF Form 601 so that the item will be included under the appropriate Allowance Source Code (ASC).

b. The USPFO retains the authority of approval to procure non-standard, non-type classified, commercial equipment that doesn't qualify for TDA addition. Annual ARNG procurement/lease guidance (to include dollar thresholds), is set forth by NGB-ARL. ANG units should submit AF Form 601 to NGB/LGSE/DON for approval.

c. States will not procure counterdrug support equipment already earmarked for central procurement by the Counterdrug Task Force (NGB-CD) and NGB-ARL unless authorized to do so by the same. ARNG and ANG Directorates will obtain and provide equipment to states through the Total Package Fielding Program. States will be updated annually on the status of the requisitions.

d. Modifications/equipment changes to ARNG aircraft must be coordinated through Aviation Division (NGB-AVN) and approved by the U.S. Army Aviation Systems Command and/or the U.S. Safety Center as appropriate.

## CHAPTER 4

## REPORTS AND RECORDS

## 4-1. Information and archives

The National Guard Bureau leadership has the recurring mission of providing expert testimony to the Congress of the United States. They must also continually interface with the DoD, along with many other federal agencies regarding the Counterdrug Support Program. Therefore it is vital that both current and historical records remain accurate, readily available, and up to date. This information flow from lower to higher provides the crucial link for obtaining this knowledge that will have great impact on current operations and future directions of the Counterdrug Support Program.

## 4-2. Reports and reporting

a. Counterdrug support operations records. Operation Plans (OPLANs) and Operation Orders (OPORDs) will be developed for each operation. These will be included in the operation folder or database that the POMS/Counterdrug Coordinator must maintain for each operation.

b. All reports must be made IAW the Counterdrug Coordinator's Handbook, Chapter 3. This includes, but is not limited to, missions performed incidental to training and after action reports.

## 4-3. Special notification/coordination

a. Reporting also includes unusual circumstances. The Director, Counterdrug Task Force will be notified by the POMS/Counterdrug Coordinator immediately in the event of an emergency or "immediate action" situation.

b. Immediate Action. An "immediate action" situation is defined as any situation which results in a gross deviation from the OPLAN to the extent that weapons are fired at or by Guard members, injuries from hostilities are sustained by Guard members, defensive or offensive actions (not planned for but reactive in nature) have been taken which escalate the original OPLAN or which may be classified as "serious incidents" as determined by the operation commander on the military side.

c. In addition to Counterdrug Support Program reporting requirements, Serious Incident Reports (SIRs) must be submitted through appropriate channels IAW applicable regulations.

Appendix A

References

Section I

REQUIRED PUBLICATIONS

Counterdrug Coordinator's Handbook, 1 October 1992

Title 32, United States Code

National Drug Control Strategy, beginning - September 1989

DoD Directive 4515.13R  
Air Transportation Eligibility

DoD Directive 4500.9  
Transportation and Traffic Management

AR 11-2  
Internal Control Systems

AR 25-55  
Department of the Army Freedom of Information Act

AR 37-100-85  
The Army Management Structure

AR 40-3  
Medical, Dental and Veterinary Care

AR 40-501  
Standards of Medical Fitness

AR 135-200  
Active Duty for Training, Annual Training and Active Duty  
Special Work of Individual Soldiers

AR 340-21  
The Army Privacy Program

AR 380-67  
Headquarters DA Personnel Security Program

AR 385-10  
Army Safety Program

AR 600-9  
Army Weight Control Program

AR 600-110  
Identification, Surveillance and Administration of  
Personnel Infected with Human Immunodeficiency Virus  
(HIV)

AR 700-131  
Loan of Army Material

AFR 12-30  
Air Force Freedom of Information Act Program

AFR 12-35  
Air Force Privacy Act Program

AFR 20-14  
Management of Government Property in the Possession  
of the Air Force  
AFR 67-23  
Standard Base Supply Customer's Guide

AFR 127-2  
The U.S. Air Force Mishap Prevention Program

AFR 160-43  
Medical Examinations and Medical Standards

AFR 208-1  
Federal Tort Claims Act

NGR 37-111  
Administration of Training and Special Work Workdays

NGR 40-3  
Medical Care for Army National Guard Members

NGR 40-501  
Medical Examination for Members of the Army National  
Guard

NGR (AR) 95-210  
Army National Guard: General Provisions and  
Regulations for Aviation Training

NGR (AR) 600-5  
The Active Guard/Reserve (AGR) Program, Title 32 Full-  
Time National Guard Duty (FTNGD)

NGR (AR) 600-10  
The Active Guard/Reserve (AGR) Program, Title 10 Full-  
Time National Guard Duty (FTNGD)

NGB Pam 360-5/ANGP 190-9  
National Guard Public Affairs Guidelines

ANGR 50-01  
Active and Inactive Duty For Training Management  
Within the Air National Guard

ANGR 67-1  
Loan and Use of Property Issued to the Air National  
Guard

TPR 890-2  
Hours of Duty, Pay and Leave

Section II  
RELATED PUBLICATIONS

(A related publication is merely a source of additional  
information. The user does not have to read it to  
understand this regulation).

4th Amendment to the U.S. Constitution

DoD Directives: 5525.5  
DoD Cooperation with Civilian Law Enforcement  
Officials: 5149.1; 5160.54

AR 25-1

The Army Information Resources Management Program

AR 71-13  
Department of the Army Equipment Authorization and Usage Program

AR 95-1  
Flight Regulations

AR 130-5/AFR 45-17  
Organization and Functions of National Guard Bureau

AR 190-40  
Serious Incident Reporting

AR 310-49  
The Army Authorization Documents System (TAADS)

AR 700-1  
Army Conversion to the Metric System of Measurement

DA Pam 190-52  
Personnel Security Precautions Against Terrorism

AFR 55-3  
Operations (Reporting, Meaoning, Intrusion, etc.)

AFM 67-1  
USAF Supply Manual

CTA 50-909  
Field and Garrison Furnishings and Equipment

FORSCOM/ARNG 350-2  
Reserve Component Training

NGR 10-2  
State Area Command, Army National Guard

NGR (AR) 95-1  
ARNG Aviation: Flight Regulations (Modifies AR 95-1)

NGR 190-11  
Physical Security of Arms, Ammunition, and Explosives

NGR (AR) 350-1  
Army National Guard Training

NGR (AR) 500-1/NGR (AF) 55-5  
Military Support to Civil Authorities

NGR (AR) 600-85  
Drug Abuse Prevention and Control

ANGR 23-01  
State Air National Guard Headquarters

ANGR 35-03  
Full-Time Military Duty Personnel Program - Air National Guard

Section III  
NATIONAL INTERAGENCY COUNTERDRUG  
INSTITUTE (NICI) PUBLICATIONS

Special Reports

Public Lands Drug Control Committee - 1990 After Action Assessment Seminar

\*Information and Intelligence Resources for the Law Enforcement Agencies on the Southwest Border

Counterdrug Managers' Course Resource Guide

National Guard Counterdrug Lessons Learned

NICI also publishes a variety of Information Papers, a monthly "NICI BULLETIN", on counterdrug related conferences and seminars, and "THE INFORMANT", a training and enforcement update.

Note: \*FOUO - Published for Operation Alliance. Available only to approved law enforcement and military agencies/organizations.

## Appendix B

## RULES OF ENGAGEMENT AND USE OF FORCE

## B-1. Purpose

The purpose of this guidance is to:

a. Emphasize the importance of safety in the conduct of counterdrug support operations.

b. Alert commanders to applicable areas of force protection, policy, and law.

## B-2. Force Protection

Commanders at all levels will ensure that pre-operation (liaison) coordination and planning with supported law enforcement agencies address the safety of personnel and equipment throughout the operation. Consideration will be given to potential threats to Guard members and property for force protection purposes. Commanders will also ensure that public affairs efforts, directed at complying with the public's right to know, do not jeopardize the safety of Guard members and equipment by disclosing personnel identification in photographs or video recordings by the media.

## B-3. Use of Force

All National Guard personnel will comply with the use of force guidelines contained in paragraph 2-2 of this regulation. Commanders at all levels must ensure that personnel are fully briefed upon, understand, and follow these restrictions.

## B-4. Aircraft Safety

The operation of aircraft constitutes a significant potential hazard. Pilots in Command (PIC) are responsible for the aircraft and the lives of passengers and crew. In addition to other guidance on aircraft safety, the PIC will not fly into or land in areas where the aircraft is likely to be fired upon. PICs will take appropriate measures to ensure the safety of passengers and the aircraft when inserting law enforcement personnel during counterdrug operations.

## B-5. Support Role.

The role of the National Guard in drug interdiction and law enforcement support operations is to support LEAs. Commanders will ensure that their personnel are not placed in situations that are likely to bring them in direct contact with suspects. They will also ensure that Guard members are not knowingly sent or directed to enter into a hostile environment where there is a probability of encountering small arms fire or life threatening situations. If life threatening situations occur, they must be handled according to use of force rules. Any final decision to go or not to go into a possible life threatening situation should be made using prudent judgment, keeping in mind that the safety of personnel is our greatest concern.

## B-6. Arming of Troops

The Adjutant General will determine whether or not troops will be armed. Since the National Guard is in a support role and not directly engaged in law enforcement, Guard members will not routinely be armed. Weapons and small arms ammunition, when issued, will only be used for personal protection. Arms and ammunition will be secured until issued. Rounds will be chambered only on order of the senior military member present and in conjunction with the supported LEA. Firearms will not be discharged from aircraft or motor vehicles.

## B-7. Rules of Evidence

Court system rules provide that exhibits cannot be offered into evidence in legal proceedings unless a chain-of-custody can be shown. This is especially true for items subject to adulteration. To ensure admissibility of evidence, only LEOs should seize or possess any items that are considered, or may become, evidence.

## B-8. Tort Liability

The Federal Tort Claims Act (FTCA) is applicable to Guard members engaged in drug interdiction and law enforcement support in a Title 32 status. Individuals whose property is lost, damaged, or destroyed, or who suffer personal injury or death as a result of a negligent act or omission of a Guard member acting within the scope of his employment may file a claim against the United States under the FTCA. Guard members acting within the scope of their authority and performing approved support (listed in State Counterdrug Support Plans and approved by Office of the Secretary of Defense (OSD)) requested by LEAs, are immune from suit except for Constitutional torts (i.e., when a negligent act or omission constitutes a violation of the Constitutional rights of the injured party, including persons suspected of criminal activity); and, certain intentional torts, such as assault and battery, and false arrest or imprisonment. Guard members engaged in counterdrug support activities in State Active duty status are entitled to whatever protections and immunities are afforded by state law.

## B-9. Pre-commitment Briefing

Prior to participating in an operation, Guard members will be provided with training as prescribed by this regulation and will be briefed on all aspects of the operation to include restrictions and limitations, use of force, safety, and force protection, and will be issued written guidance approved by the state JAG. Such written guidance will advise them of rules of engagement, their status (State Active Duty or Title 32), tort protection, and medical benefits. Guard members performing an operation of extended duration will receive an initial pre-commitment briefing and will be briefed semiannually thereafter. The briefing officer will certify that personnel have been briefed. Copies of written guidance provided as well as lists of individuals briefed will be maintained by the states.

## Glossary

## Section I

## Abbreviations

## ADSW

Active Duty Special Work

## AFSC

Air Force Specialty Code

## AGR

Active Guard Reserve

## ANG

Air National Guard

## ANGRC/DON

Air National Guard, Counterdrug Division

## ANGRC/LGS

Air National Guard, Directorate of Logistics

## ANGRC/SGP

Air National Guard, Physical Standards Branch

## ANGRC/SGAR

National Guard Bureau, Air National Guard, Resource Office

## ARNG

Army National Guard

## ASC

Allowance Source Code

## AT

Annual Training

## CNAC

Customs National Aviation Center

## CONUS

Continental United States

## CONUSA

Continental United States Army

## DAT

Drug Analysis Testing

## DLEA

Drug Law Enforcement Agency

## DoD

Department of Defense

## DPP

Dedicated Procurement Program

## EER

Enlisted Evaluation Report

## ENTNAC

Entrance National Agency Check

## EPIC

El Paso Intelligence Center

## ESP

Emergency Special Program

## ESSO

Executive Support Staff Officer

## FOIA

Freedom of Information Act

## FTCA

Federal Tort Claims Act

## FTNGD

Full-Time National Guard Duty

## HIV

Human Immunodeficiency Virus

## IAD

Inactive Duty Training

## IDT

Inactive Duty Training

## JAG

Judge Advocate General

## JTF

Joint Task Force

## LEA

Law Enforcement Agency/Agent

## LEO

Law Enforcement Officer

## MOA

Memoranda of Agreement

## MOS

Military Occupational Specialty

## MOU

Memoranda of Understanding

## MRD

Mandatory Retirement Date

## MSD

Mandatory Separation Date

## NAC

National Agency Check

## NCIC

National Crime Information Center

## NCO

Non commission Officer



**NCOER**  
Noncommissioned Officer Evaluation Report

**NGB**  
National Guard Bureau

**NGB-ARC-B**  
National Guard Bureau, Army Comptroller Division  
(Budget)

**NGB-ARL**  
National Guard Bureau, Army Guard, Logistics Division

**NGB-ARM**  
National Guard Bureau, Full-Time Support Division

**NGB-ARS-MS**  
Office of the Army Surgeon, Medical Standards

**NGB-AVN**  
National Guard Bureau, Aviation Division

**NGB-CD**  
National Guard Bureau, Counterdrug Task Force

**NGB-CDD**  
National Guard Bureau, Counterdrug Support Division

**NGB-JA**  
National Guard Bureau, Judge Advocate

**NGB-PA**  
National Guard Bureau, Public Affairs

**NGPA**  
National Guard Personnel Appropriation

**NICI**  
National Interagency Counterdrug Institute

**NORAD**  
North American Aerospace Defense Command

**OER**  
Officer Evaluation Report

**OMARNG**  
Army National Guard Operations and Maintenance  
Appropriation

**OMNG**  
National Guard Operations and Maintenance  
Appropriation

**OPLAN**  
Operation Plan

**OPORD**  
Operation Order

**OPSEC**  
Operations Security

**OPR**

**Officer Performance Report**

**OSD**  
Office of the Secretary of Defense

**PAO**  
Public Affairs Officer

**PCS**  
Permanent Change of Station

**PIC**  
Pilots in Command

**PIP**  
Personnel Integrity Program

**POC**  
Point of Contact

**POMSO**  
Plans, Operations, and Military Support Officer

**RLSO**  
Regional Logistical Support Office

**RON**  
Remain Overnight

**SAAO**  
State Army Aviation Officer

**SECDEF**  
Secretary of Defense

**SITREP**  
Situation Report

**SOP**  
Standard Operating Procedures

**SPMD/UMD**  
Office of the Air Surgeon, Aerospace Medicine

**ST**  
Special Training

**STARC**  
State Area Command

**TAADS**  
The Army Authorization Documents System

**TDA**  
Table of Distribution and Allowances

**TDC**  
Type Duty Code

**TPF**  
Total Package Fielding

**TPR**  
Technician Personnel Regulation

UMD  
Unit Manning Document

USCS  
U.S. Customs Service

USMEPCOM  
U.S. Military Entrance Processing Command

USPFO  
U. S. Property and Fiscal Officer

Section II  
Terms

Adjutant General  
Refers to the Commanding General in those states without an Adjutant General

Attorney General  
Refers to the equivalent official in states without an Attorney General

Civil Authorities  
Elected and appointed public officials and employees of federal, state, and local government.

Counterdrug Support Program  
Support provided to federal, state or local LEAs and other civil authorities to assist with drug interdiction and other counterdrug support authorized by Section 112 of Title 32, United States Code (32 USC 112) in support of the National Drug Control Strategy.

Exigent Circumstances  
Circumstances in which immediate action is necessary to protect police officers, Guard personnel, or other persons from injury; to prevent loss or destruction of evidence; or to prevent the escape of a suspect already in custody.

Incidental to Training  
Previously or otherwise scheduled training which would have been conducted regardless of counterdrug operations. Routes and schedules may be altered in order to maximize counterdrug benefits.

Law Enforcement Agency (LEA)  
An organization, or a coordinating council comprised of several LEAs, empowered by local, state or federal law to investigate, enforce or prosecute criminal laws regarding illegal drugs and controlled substances.

National Guard  
Except as stated otherwise, National Guard means a state National Guard when not in federal service, or all such organizations collectively.

States  
For the purpose of this regulation the term "states" includes all 50 states, the Commonwealth of Puerto

Rico, the U.S. Virgin Islands, Guam and the District of Columbia.

State Plans  
Plan submitted by the states for National Guard counterdrug support activities as authorized by 32 USC 112.

By Order of the Secretaries of the Army and the Air Force:

JOHN B. CONAWAY  
Lieutenant General, USAF  
Chief, National Guard Bureau

Official:

E. DARDEN BAINES  
Chief  
Administrative Services

Distribution:  
C. F

# CONTENTS

INTRODUCTION	1
CONCEPT OF MILITARY SUPPORT	3
MISSION PLANNING CONSIDERATIONS	5
OPERATIONAL RESTRICTIONS	9
SUPPORT REQUEST PROCEDURES	12
POINTS OF CONTACT	15
Annex A: Type Support Capabilities	17
Annex B: Sample Operational Support Missions	19
Annex C: Military Support Agencies	45

AS OF: 15 JANUARY 1993

## INTRODUCTION

The President's "*National Drug Control Strategy*" provides a clear objective and coherent structure which facilitates development of an operational level concept for military support to Southwest Border (SWB) law enforcement agencies (LEA). The FY89 DoD Authorization Act expanded the role of the National Guard (NG) in support of the LEAs. The 1990 DoD Authorization Act further directed that the U.S. Armed Forces, to the maximum extent possible, conduct military training in drug interdiction areas. The designation of the SWB as a High Intensity Drug Trafficking Area (HIDTA) further clarifies the priority for military support to SWB LEAs.

In September 1989, Defense Secretary Cheney issued guidance designating drug trafficking as a threat to U.S. national security. In support of the President's "*National Drug Control Strategy*," Secretary Cheney assigned NORAD the mission of air detection and monitoring of illegal drug traffickers. Commander-in-Chief, U.S. Forces Command (CINCFOR) was assigned the mission to coordinate all DoD (Title 10) operational support to counterdrug activities within the continental United States (CONUS), with priority to the Southwest Border.

In November 1989, Secretary Cheney announced the activation of Joint Task Force Six (JTF-6) at Fort Bliss, Texas, to serve as the planning and coordinating (operational) headquarters providing

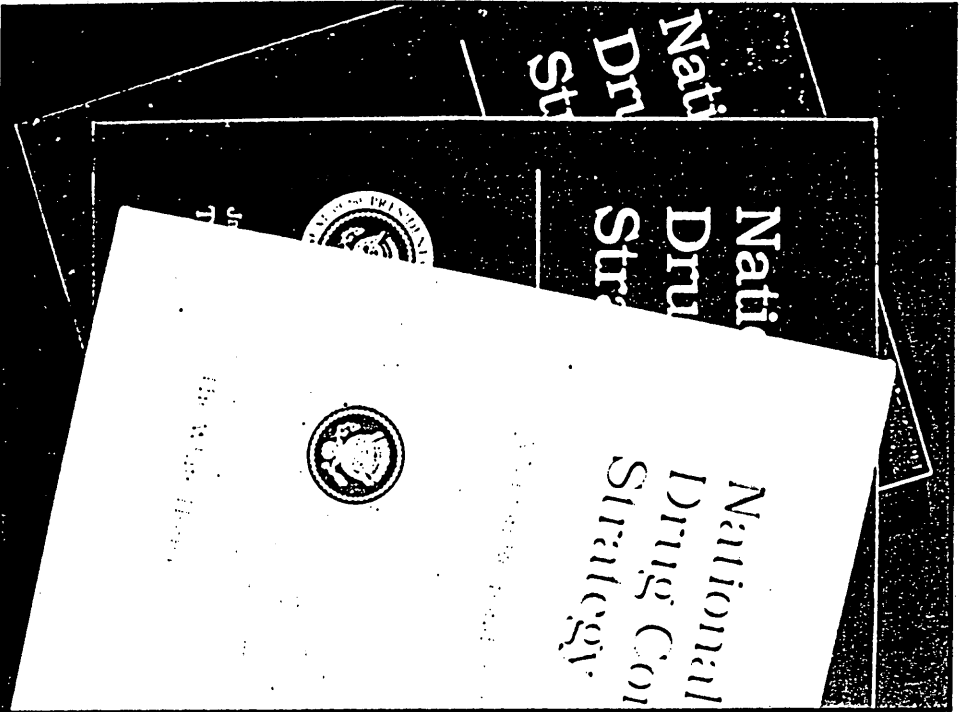

support to federal, state, and local LEAs within the SWB region. JTF-6's area of responsibility has since been expanded to match that of Operation Alliance and now encompasses the states of Texas, New Mexico, Arizona, and southern California. Secretary Cheney also directed the establishment of the Regional Logistics Support Office (RLSO) responding to LEA requests for non-operational military support (equipment loan, institutional training, facilities, etc.).

This guide is designed to give the law enforcement community an understanding of support available from the Department of Defense, the most effective methods of employing and integrating that support, and the means to request it.

The LEA/military environment along the SWB is dynamic. JTF-6 is committed to providing responsive, quality, professional support and continues to address legal issues which currently inhibit our ability to optimize the application of DoD capabilities. As changes occur, information will be disseminated by all means possible.

## CONCEPT OF MILITARY SUPPORT

Military support to SWB counterdrug operations is designed to assist LEAs in their mission to detect, deter, disrupt, and dismantle illegal drug trafficking organizations. JTF-6 support is intended to serve as a force multiplier to law enforcement agencies with the potential to enhance LEA effectiveness or release significant LEA resources to focus on interdiction/seizure actions. JTF-6 will provide support to LEAs using a Total Force approach -- support packages drawn from a variety of sources and guided by priorities established by Operation Alliance as the integrating operational law enforcement element for the SWB region. The Total Force approach will result in joint (LEA/Military) operations involving Title 10 (JTF-6, NORAD) and Title 32 (National Guard) personnel, and non-operational assets from the Regional Logistics Support Office to provide a variety of enhanced capabilities to support LEAs. A summary of the mission and capabilities of each of these agencies is contained in Annex C.

Operation Alliance, collocated with JTF-6 in El Paso, TX, reviews all requests for military support, coordinates the efforts of federal, state and local agencies, and determines the appropriate military agency to provide the support.

JTF-6 support to LEA supply reduction efforts is categorized as Operational (integral military units

providing tactical support through the execution of mission related training), General (augmentation of LEA with military specific skills, training, transportation, etc.), and Engineer (horizontal & vertical construction, road & range repair, etc.). A list of mission subcategories routinely available is provided at Annex A. Detailed descriptions of some typical mission types are contained in Annex B. No list of military support capabilities is ever all-inclusive. Innovative approaches to providing new and more effective support to LEAs are constantly sought, and legal and policy barriers to the application of military capabilities are gradually being eliminated.

JTF-6 military units providing support to law enforcement will be in direct support of the lead LEA. This means they provide assistance directly to the supported agency. During all phases of the support, these units will be under the tactical control (TACON) of JTF-6, and will establish and maintain contact with the JTF-6 Joint Operations Center.

JTF-6's primary measure of effectiveness is a twofold system which seeks to determine how well the LEA's objectives were met, and the value of the training derived by the unit providing the support. As Title 10 Federal forces under JTF-6 TACON are precluded by the Posse Comitatus Act from performing search, seizure, arrest, or other similar law enforcement activities, drug seizure data are not maintained or reported by JTF-6. Requests for such information will be referred to the supported LEAs.

## MISSION PLANNING CONSIDERATIONS

**\*\* RULES OF ENGAGEMENT:** Title 10 military support to LEAs is governed by The Joint Chiefs of Staff (JCS) peacetime rules of engagement (ROE). Military personnel deployed to border areas are authorized to be armed with their issued weapons for self-defense only. They may return fire when threatened with deadly force to defend either themselves, accompanying law enforcement personnel, or others present. These general rules provide adequate protection for military personnel engaged in counterdrug operations. Title 32 military support to LEAs is governed by similar rules as modified by each state governor.

**\*\* POLITICAL SENSITIVITIES:** During joint (LEA/military) operations conducted near the U.S./Mexican border, appropriate measures will be taken to respect Mexican sovereignty. Military units operating in close proximity (3km for ground ops, 3nm for avn ops) of the border will plan and implement extensive redundant control measures to eliminate the potential for border violations. Additionally, efforts will be made to minimize the perception of militarizing the border. These include restrictions against deployment of combat tracked vehicles, not visibly exhibiting crew-served weapons, and not arming aviation platforms on the border. Political sensitivities also extend to considerations of the employment of military forces in such a way as to avoid any potential confrontation with the civilian populace or American Indians on an established





optimum mission duration based on lessons learned. For other missions (e.g., analytical support) regulations limit operational support for a single request to no longer than 179 days. DoD considers periods beyond 179 days as non-temporary permanent change of station (PCS). This rule is predicated on the individual's need to maintain mastery of his military occupational skills and integrate with his team/unit in a collective training environment to achieve and sustain a high level of operational readiness. Absence of individuals from their units for periods beyond 179 days necessitates considerable training to reestablish proper cohesion. For manpower requirements greater than 179 days, in exigent circumstances, LEAs must accept the fact that military personnel will be rotated through the same duty position.

**\*\* OPERATIONAL SECURITY (ORSEC):** Operational security is the process by which the adversary is denied that information (critical indicators) which would provide him sufficient knowledge to determine LEA/military intentions and operations. Military units providing support within the SWB will conduct analyses to identify critical indicators, and determine and implement appropriate countermeasures to enhance force protection and mission effectiveness.

**\*\* SAFETY:** The safety of military personnel will never be compromised. Missions that have unacceptable risk to service personnel providing support will not be approved.

## OPERATIONAL RESTRICTIONS

**\*\* POSSE COMITATUS:** Title 10 (Federal) military forces are prohibited by law from searching, seizing, arresting, or conducting any related law enforcement activity involving civilians. Title 32 (State National Guard) military forces are not subject to the provisions of Posse Comitatus but are generally restricted, as a matter of policy, from direct participation in search, seizure, arrest, or related law enforcement activities. National Guard forces are actively involved in passenger vehicle and commercial cargo inspection operations at ports of entry and are normally accompanied by a law enforcement agent while performing these functions. Both Title 10 and Title 32 forces may conduct detection and monitoring missions in support of the LEAs. Suspected criminal activity observed by the supporting military forces is then reported to the supported LEA for appropriate LEA interdiction action.

**\*\* ECONOMY ACT:** Federal law normally requires interagency reimbursement when support is provided from one government agency to another. However, when military support is provided to LEAs and that support maintains or enhances individual or unit operational readiness, the support is exempt from the provisions of the Economy Act. During the military support planning phase, every effort will be made to ensure joint (LEA/military) training benefits are derived from the support mission. In some cases, particularly for non-operational support, interagency reimbursement is required. DoD will make every

effort to minimize the reimbursable costs associated with these support missions. Section 1212 of the DoD Authorization Act provides exemptions for specific types of military support.

**\*\* ACCESS TO PRIVATE LAND:** Title 10 (Federal) military forces are not authorized access to private lands without prior approval of the landowner. This applies even when accompanied by a duly empowered law enforcement agent with statutory authority for unrestricted access to private lands. Land use agreements facilitate the employment of Federal forces on private lands. In that regard, LEAs should consider obtaining long term, limited scope land use agreements in those areas where future military operations are envisioned. Title 32 (National Guard) military forces are not subject to this limitation.

**\*\* INTELLIGENCE COLLECTION AND DISPOSITION:** Executive Order 12333 and various other laws and regulations govern DoD Intelligence Collection activities. DoD agencies are prohibited from collection of intelligence on U.S. persons and organizations within the continental U.S. unless those persons or organizations are reasonably believed to be involved in international drug trafficking. Certain collection methods are also restricted by law. All information acquired by military units during LEA support operations will be provided to the support LEA for appropriate dissemination. Subject to the approval of the supported LEA, the supporting military unit will provide intelligence products to other military units, EPIC, and Operation Alliance.

Military units are not authorized to retain any data on U.S. persons or organizations after mission completion.

**\*\* CONTINUOUS OBSERVATION:** Until we receive policy and operational guidance from the Office of the Secretary of Defense and Joint Chiefs of Staff (JCS) concerning the proper application of the land detection and monitoring mission given to JTF-6 in the FY 93 DoD Authorization Act, military units providing support to LEAs are prohibited from pursuing suspect vehicles or persons for the purpose of providing their continuing coordinates to LEA or conducting systematic or deliberate observation on a continuing basis. This does not preclude continuous observation from a fixed point, such as an LP/OP, established for the purpose of detecting drug smuggling activity. Further, ground reconnaissance is limited to area coverage and excludes the specific targeting of buildings, vehicles, or persons. This restriction also impacts on the application of Forward Looking Infra-Red (FLIR). Though the use of FLIR is authorized for area coverage, use of FLIR to detect cross-border incursions is limited to a "one-time" report to LEAs because continued tracking would constitute continuous observation. Pending legislative actions may soon alleviate some of these restrictions and changes will be publicized as they occur. We expect these restrictions to be relaxed somewhat once the land detection and monitoring authority is applied to the Southwest Border.

## PROCEDURES FOR REQUESTING SUPPORT

**R**quest procedures remain flexible, and allow individual agencies to follow their own established formats or write directly to Operation Alliance on agency letterhead requesting the support required. The basic "who, what, when, where, and why" should be addressed in the request, and a Point of Contact (POC) must always be identified. LEAs requiring assistance in determining the availability of assets, the type of capability best suited for your requirement, or the current policy/legal restrictions of employing specific assets, may contact the JTF-6 Liaison Officers (LNO), assigned to each state. The LNOs and their telephone numbers are listed on pages 18 & 19.

### ESSENTIAL ELEMENTS OF A REQUEST

**WHO:** Requesting agency and specific POC.

**WHAT:** Specific need for which support is required. May include recommendation as to type support to accomplish mission.

**WHEN:** Date required and duration desired. If specific date is undetermined, provide month.

**WHERE:** Specific location for the proposed operation. Needs to specify whether location is *private or public* land.

**WHY:** Brief statement as to why military support is needed to assist in determining the type of

equipment required.

### REQUEST STAFFING PROCEDURES

**O**peration Alliance, in conjunction with the liaison officers from the National Guard, the Regional Logistics Support Office (RLSO), and JTF-6, reviews and validates all requests for support.

Requests for operational support forwarded to JTF-6 by Operation Alliance are received by the J3 Plans Branch. The Chief of the Plans Branch will assign staff responsibility for planning the support and the action officer immediately begins to work the request.

The action officer (AO) will contact the requestor to resolve any issues and begin the search for a unit to provide the support. JTF-6 has no tasking authority, but it has direct liaison authority with the Service's Major Commands, and sourcing a mission is never difficult given sufficient planning time. The AO then prepares a Concept Plan (CONPLAN) which is forwarded to Forces Command (FORSCOM) and, in the case of missions of large scope for long periods of time, JCS for approval. CONPLANS are standardized, and CINCFOR has been delegated much of the approval authority, thereby expediting this process. JCS Delegation of Authority (DOA) messages have delegated significant approval authority to CINCFOR, and this allows us to be more responsive to requests from the field. Further delegation will be requested in the future.

Members of the supporting unit are then brought to JTF-6 for a series of briefings to begin the planning process. This is followed by a site visit to coordinate directly with the requesting LEA. At the conclusion of its planning, and prior to mission execution, the supporting unit provides the supported LEA and JTF-6 an Operations Order (OPORD) briefing on their concept of operations or Program of Instruction for Mobile Training Teams. This serves as the agreement between the LEA and the military on the actual execution of the mission. It is customary for the LEA to brief the reaction/response plan at the conclusion of the OPORD.

When CINCFOR has approved the mission, an Execute Order is published and support is rendered. Units are required to conduct After Action Reviews (AAR) and submit a formal after action report at the conclusion of each operation to capture lessons learned.

## JOINT TASK FORCE SIX

### JTF-6 LNO TO NG

J3 PLANS	(915) 568-8415
J3 OPERATIONS	(915) 568-8843
J3 ENGINEER	(915) 568-8209
J2 INTEL	(915) 568-8133/9183
J2 IMAGERY	(915) 568-8788
JOINT OPERATIONS CENTER (TOLL FREE)	(800) 525-6864
JOINT OPERATIONS CENTER (NON-SECURE FAX)	(915) 568-8322
JOINT OPERATIONS CENTER (SECURE FAX)	(915) 568-8713
<b>JTF-6 LNO TO NG</b>	
LNO CALIFORNIA	(916) 854-3665
LNO ARIZONA	(602) 746-4401
LNO NEW MEXICO	(505) 846-4507/4473
LNO TEXAS	(512) 465-5592
REGIONAL LOGISTICS SUPPORT OFFICE	(915) 568-9088

## OPERATION ALLIANCE

OPERATION ALLIANCE	(915) 540-6130
OPERATION ALLIANCE FAX	(915) 540-7532
NG LNO to OPALL	(915) 568-9082
JTF-6 LNO to OPALL	(915) 568-9083

DEA LNO to JTF-6	(915) 568-8994
USCS AVN LNO to JTF-6	(915) 568-8159
USBP LNO to JTF-6	(915) 568-8663

## NORTH AMERICAN AEROSPACE DEFENSE COMMAND

NORAD J3 (OPERATIONS)	(719) 554-3423
NORAD J2 (INTELLIGENCE)	(719) 554-2329

### ANNEX A:

## JOINT TASK FORCE SIX SUPPORT CAPABILITIES

### *Aviation Operations*

Avn Recon by Military Units Only  
Avn Recon with LEAs on Board  
Avn Trans of Contraband/Vehicles  
Avn Trans of LEAs outside CONUS  
Avn Trans of LEAs to Bust Site

### *Engineer Operations*

Construction of Buildings  
Heliport Construction  
Range Construct/Repair (Rifle/Pistol)  
Build/Repair Border Roads/Fences  
Installation of Border Lights  
Erect Rappelling Towers

### *General Support*

Mobile Training Teams  
Canine Support  
Maintenance & Repair of Equipment  
Air/Ground Transportation

### *General Support INTEL*

Intel Analyst Support  
On-Site Transcription/Translation  
Data Base Construction

*Ground Reconnaissance*

*Ground Surveillance Radar*

*Imagery Operations*

*Forward Looking Infra-Red (FLIR)  
Photo Imagery*

*Listening Posts/Observation Posts (LP/OP)*

*Major Operations*

*Deterrent Operations  
Multi-Disciplined Intel Operations  
Large Scale Ground Recon*

*Rapid Support Unit (RSU) Operations*

*Special Reconnaissance  
Mobile Training Teams  
Dive Operations*

*Sensor Operations*

*Water Operations*

*Dive Operations  
Riverine Operations  
Watercraft Insert/Extract of LP/OPs*

Z  
0008517

**ANNEX B:**

**AVIATION OPERATIONS (RECONNAISSANCE)**

**DESCRIPTION:** The purpose of aviation reconnaissance operations is to provide real time information to the LEA or ground unit commander.



Reports include information on illegal border crossings (both ground and air), and the identification and/or observation of roads and trails which could be used by drug traffickers. An advantage of aviation reconnaissance is its ability to quickly cover large areas. Aviation reconnaissance missions can be conducted with or without LEA onboard the aircraft. Additionally, Forward Looking Infra-Red (FLIR) capable aircraft may be requested. The employment of FLIR allows for day/night operations with selected aircraft.

**MISSION PARAMETERS**

**DURATION:** Support normally ranges from 1 to 30 days. LEAs determine the number of days.

**COMBINED CAPABILITY:** Aviation is a significant force multiplier when combined with ground forces, either military or LEA.

**CONSIDERATIONS:**

- A. Lead time for request: 90 days is preferred planning time.
- B. Must conform to statutory limitations when employing FLIR or other technology to detect cross-border smuggling.
- C. Beware of political/public sensitivities associated with operating aircraft near the international border or populated areas.
- D. Unit must coordinate with Southwest Air Defense Sector (SWADS) and U.S. Customs Air (C3IWEST) prior to operating near the border.
- E. Must establish control measures when operating within 3 NM of the border.

**AVIATION TRANSPORTATION**

**DESCRIPTION:** Aviation Transportation is provided by Air Mobility Command (AMC) using military aircraft to transport law enforcement agents, vehicles, and illegal drugs in support of ongoing counterdrug operations. The military unit provides its own command, control and communications and takes care of logistic and administrative functions. Example missions include movement of tractor/trailer combinations containing seized illegal drugs LEAs wish to use to exploit the "Receiving End" in an ongoing investigation which is time sensitive. The size of the unit providing the support will vary from 5 to 20 personnel based on the number and type support aircraft and requirements.

**MISSION PARAMETERS**

**DURATION:** Missions are normally conducted in a one day period. Return flights after drug busts are not considered "critical, emergent requirements" and LEAs must coordinate for these.

**EQUIPMENT:** Can include the following: Air Force C130, C141, or C5 aircraft.

**COMBINED CAPABILITY:** Can be used in conjunction with intelligence operations to capitalize on intel received and provide rapid deployment of personnel and cargo, including oversized cargo.

**CONSIDERATIONS:**

**A. Lead time for request.**

\* Immediate Requirements - Minimum of 24 hours.

\* Routine Requests - Minimum of 14 days.

**B. LEA must provide the following information before a mission can be scheduled:**

\* Agent (passenger) name and social security number.

\* Detailed vehicle description, height, length, and weight.

\* Detailed itinerary.

**AERIAL IMAGERY/RECONNAISSANCE**

**DESCRIPTION:** Aerial imagery and reconnaissance is the process of obtaining photographs from an airborne platform for the purpose of identifying suspect activity such as: landing strips, possible cultivation sites, updating road and trail information, and other probable drug related activity. Black and white film is normally used but color film can be used for select missions which are small and well defined. The imagery is interpreted by trained photo analysts and the final product consists of annotated photographic prints.

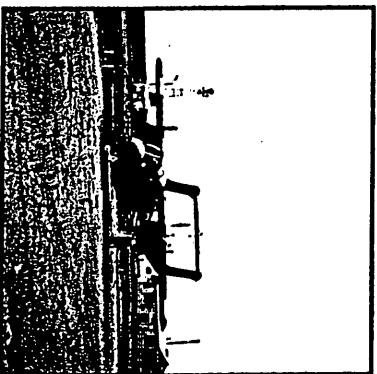

**MISSION PARAMETERS**

**DURATION:** Flights of the target area are usually completed within one day. Mission parameters are set to minimize possibility of detection. After flight completion, final product should be delivered within three weeks.



**COMBINED CAPABILITY:** Can be used to determine the need for a ground operation. When a ground operation is deemed necessary, aerial imagery will assist in the planning and execution phases of the operation.

**CONSIDERATIONS**

**A.** Lead time for request: 90 days is preferred, but a shorter lead time can be handled subject to aircraft availability.

**B.** Target area size: Size of target area determines what can be seen in the photos. Target size and photo scale go hand-in-hand; the larger the area, the smaller the scale - just like a map. Growing site detection requires a small target area; an area overview is an example of a large target area mission. Request for extremely large area coverage (i.e. counties, whole national parks, etc.) are extremely costly and have little tactical value.

**C.** Request process: Due to the number of variables involved in the aerial reconnaissance process, phone coordination with the JTF-6 imagery section should be conducted as soon as possible during the request process.

N  
00065 N0

**DETERRENT OPERATIONS**

**DESCRIPTION:** The purpose of ground deterrent missions is to deny a portion of the border to drug traffickers. The LEA's intent for having a military presence on the border may include delaying the movement of drugs across the border or disrupting the drug trafficker's normal movement schedule or routes. Ideally the trafficker will be forced to shift operations to a preplanned point for law enforcement interdiction. The effectiveness of this mission is enhanced by scheduling a stay-behind force to follow-up the deterrent mission. The supporting unit's composition and size depends of the size of the area of operation and LEA's intent. Ground, motorized, and aviation units can perform this mission. Supporting units have ranged from 100 to 750 personnel.

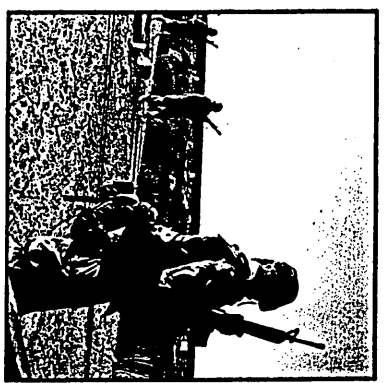

**MISSION PARAMETERS**

**DURATION:** Support ranges from 14 to 30 days.

Multiple sequential missions may be planned to enhance the effect of deterrent operations.

**COMBINED CAPABILITY:** Aviation is an excellent force multiplier in deterrent operations. Aviation can provide aerial observation, insert/extract of ground forces, emergency evacuation, and transportation of LEA response teams.

**CONSIDERATIONS:**

A. 90 days is the absolute minimum time allotted to plan for a request of this magnitude. 180 days or greater lead time facilitates planning even further.

B. Detailed unit planning, site reconnaissance, and IPB process to select LP/OP sites and patrol routes are part of mission preparation.

C. Land use agreements with private land-owners and permission from state and federal agencies to operate on their lands are required.

D. Dependent upon the size, scope, and location of the operation, an environmental assessment of the area of operation may be required. Assessments can take up to 120 days to complete.

E. Unit/LEA cross-training includes unit knowledge of rules of engagement, test of control measures to ensure unit does not violate the international border, and test the of LEA's response team procedures.

## MILITARY ENGINEERING/CONSTRUCTION

**DESCRIPTION:** Military engineering units may be used to clear vegetation, emplace or remove obstacles, construct or improve combat trails/roads and fences, perform light construction or demolish condemned facilities to block/deter drug smuggling corridors/activities along the international boundary of the United States.

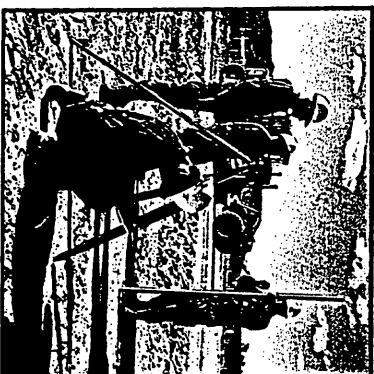

Military engineers can also construct or improve Law Enforcement Agency (LEA) firing ranges and training facilities. Requests for engineer support received through Operation Alliance are governed by a prioritization program that assesses factors such as the training value to engineer units, environmental and cultural impact of engineer operations, cost of construction and feasibility of completing each construction mission. Military engineering is focused on projects that have the greatest impact on the counterdrug effort of LEAs.

## GENERAL INTELLIGENCE

### CONSTRUCTION PARAMETERS

**MATERIALS:** Bills of materials are developed by engineer units for each project. The supported LEA must provide the funding for, as well as procure, the materials for each project through their own supply channels.

**PERSONNEL AND EQUIPMENT:** JTTF-6 sources the personnel and equipment for each project and funds all contracts related to transportation, equipment, billeting and meals of military personnel.

### CONSIDERATIONS

**A.** The average engineer construction mission consists of 50 personnel and lasts for a period of 40-60 days.

**B.** Allow 9-12 months for planning engineer missions due to environmental and cultural assessments, cost and contracting requirements incurred by construction projects, material and equipment availability, and coordination with land-owners and other affected parties.

**C.** Environmental assessments required for engineer missions are coordinated and funded by JTTF-6 incidental to project planning.

**D.** An average of 40 construction projects are completed each fiscal year.

N  
O  
O  
O  
S  
S  
N  
N

**DESCRIPTION:** Intel support generally entails on-site support to the requesting LEA and



usually involves one to eight personnel who will usually be deployed in civilian clothes. Missions include multiple intel-related functions, such as historical analysis, target selection, link and pattern analysis, intel data base construction/management, situation briefs, intel product dissemination, intel preparation of the battlefield (IPB), foreign language transcription and translation of court ordered Title III wire taps, and technical intel support.

### MISSION PARAMETERS

**DURATION:** Support normally ranges from 60 to a maximum of 179 days; however, actual mission duration will be determined by type of support requested, the intelligence resources involved, and the scope of work.



## LISTENING POST/OBSERVATION POST

### CONSIDERATIONS:

- A. Lead time for request: 90 days is the desired mission planning time.
- B. Mission normally entails detailed unit planning, site reconnaissance, and IPB process to select GSR sites.
- C. Obtain land use agreements with private landowners and permission from state and federal agencies to operate on their lands if systems are anticipated to operate on private land. Units can operate from public land and observe a target area located on private land.
- D. Employ the system within its capabilities. The GSR has a significant signature on the ground.

### DESCRIPTION: LP/OPs are hidden, manned

observation sites which are usually occupied by 3 to 6 people with a mission to watch for suspicious activity and report it to law enforcement.



Normally 2 to 10 LP/OPs are manned in an area at the same time; however, this is the decision of the supported LEA. The military unit provides its own command, control, and communications and takes care of logistics and administrative functions. The size of the unit providing the support will vary from 12-150 people (team/platoon to company sized) and can be manned 24 hours/day. Border LP/OPs watch for the illegal movement of drugs across the border via manpack, pack animals, or vehicles. Airfield LP/OPs are conducted to detect drug smuggling aircraft landing or airdropping on remote/clandestine airstrips. LP/OPs can also be positioned to observe illegal movement along routes leading to domestic marijuana production areas.

## MISSION PARAMETERS

**DURATION:** The mean is 21 days for missions conducted across the Southwest Border. LEAs will determine the length based upon their objectives, the threat, and the area being covered.

**EQUIPMENT:** Can include the following: secure communications, secure TACSAT communications, night observation devices, thermal imagery devices, tactical maps, medevac capability, and individual weapons for force protection.

**COMBINED CAPABILITY:** Other capabilities can be integrated with the LP/OP to increase effectiveness such as, helicopters, vehicles, ground sensors, and ground surveillance radars.

## CONSIDERATIONS

**A. Lead time for request:**

- \* Rapid Support Unit - 72 hours
- \* Routine LP/OP - 90 days
- \* Annual Requests - Submit annual program by 1 September for next calendar year.

**B. LEA response plan for reaction must be coordinated prior to mission operation order.**

**C. Sites positioned where the possibility of smuggler-military confrontation is high will require an accompanying LEA.**

## MOBILE TRAINING TEAM

**DESCRIPTION:** Military and/or civilian training

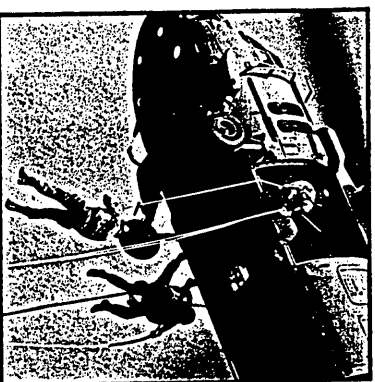

team consisting of one to five personnel, able to instruct on specific subjects selected by the requesting law enforcement agency.

**Advantages of Mobile Training Teams (MTT)** are that they can be tailored to meet specific LEA needs with regard to when, where, and how the instruction will be presented. The leader of the unit selected to perform the MTT will conduct an on-site visit with the requesting LEA for the purpose of ensuring the program of instruction (POI) fits law enforcement needs.

**Examples of MTTs:** Camouflage techniques, small unit tactics, land navigation, raid planning and execution, basic first aid, emergency medical training, marksmanship, vehicle maintenance, weapons training, interview/interrogation techniques, intel data base establishment, radio communications

2  
00855  
NS







operations and LEA-compatible radios.

B. Sensors fields are most effective when covered by direct observation with LEA reaction teams in the general vicinity.



## WATER OPERATIONS

**DESCRIPTION:** Includes open water (ocean), riverine, and dive operations. Military units have the capability to insert, extract and navigate in rivers or open water enabling observation of islands or rivers. Dive operations are normally conducted for hull searches of ocean-going vessels. SEALs, Special Forces, and Marine Reconnaissance are the military forces of choice for these missions, and these units range in size from 6 to 10 personnel for dive operations to approximately 50 personnel for riverine/open water operations.

### MISSION PARAMETERS

**DURATION:** Generally 14 to 21 days.

**EQUIPMENT:** Combat rubber raiding craft (CRRRC), rigid raider craft (RRC), SCUBA, secure communications, global positioning system (GPS), day/night observation devices, navigation charts, medevac capability, and individual weapons for force protection.

**COMBINED CAPABILITY:** Helicopters can be combined with water operations to enhance insert/extract and observation capabilities.

## CONSIDERATIONS

- A. Lead time for request:
- \* Rapid Support Unit (RSU) (Actionable Intelligence) - 72 hours or less.
  - \* Routine LP/OP - minimum of 90 days preferred.
  - \* Annual Requests - Submit annual requests, including water operations and all other type missions by 1 September for the following calendar year.
- B. LEA response plan for reaction must be coordinated prior to mission operation order.
- C. Sites positioned where the possibility of smuggler-military confrontation is high will require an accompanying LEA.
- D. National sovereignty issues preclude water operations in the Rio Grande (U.S./Mexican Border) River.

## RAPID SUPPORT UNIT (RSU)

**DESCRIPTION:** The Rapid Support Unit (RSU) is comprised of a Special Forces Company with attached aviation assets located at Fort Bliss, TX and under the Tactical Control (TACON) of JTF-6. In the RSU, JTF-6 has the capability to respond quickly to immediate LEA needs based on perishable intelligence. The RSU is capable of conducting special reconnaissance (LP/OP, ground recon), dive operations, mobile training teams, and aviation support operations. RSU missions are requested through Operation Alliance and approved by JTF-6 or FORSCOM. They are characterized by small, short duration, detection missions to support LEA interdiction, normally focused on border areas.

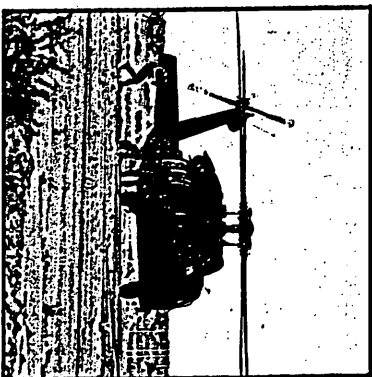

## MISSION PARAMETERS

**DURATION:** Support normally ranges from 1 to 14 days.

**COMBINED CAPABILITY:** RSU elements are configured with highly trained, experienced personnel. Equipment consists of night vision devices, scopes, satellite communications, and helicopters equipped for long range operations. The RSU can be used to augment or cover flanks of other ongoing operational missions. With the RSU's ability for clandestine insertion, these elements are ideal for filling the perceived void drug traffickers will try to take advantage of when major units redeploy.

### CONSIDERATIONS:

**A.** Lead time for request: only 48 hours are required unless aviation operations are anticipated within 3 nautical miles of the US/MX border or ground positions are planned within 3 km of the border. In those cases 72 hours advance notice is preferred.

**B.** Missions should be planned for short duration, as these are reusable assets for other areas of the border.

**C.** Operation Alliance will determine priorities when conflicts occur.

N  
O  
O  
O  
O  
O  
O  
O

## ANNEX C:

### MILITARY SUPPORT AGENCIES

The following military organizations are the focus of military support (operational manpower and non-operational equipment/schools only) provided to LEAs in the Operation Alliance area of responsibility:

*Joint Task Force Six* - JTF-6 coordinates all DoD Title 10 (Active and Reserve federal military) support for LEAs within the Southwest Border region (AZ, Southern CA, NM, TX,) to assist them in their mission to detect, deter, disrupt, and dismantle illegal drug trafficking organizations. To facilitate coordination of that support, JTF-6 has liaison officers located in each of the Southwest Border states (see list on page 18). The JTF-6 liaison officers are available to answer questions, assist with support requests, provide information on availability and capability of military support, and assist with the coordination and de-confliction of military support operations. The entire array of Total Force (Active and Reserve components) DoD resources are available to support LEAs subject to certain legal and policy constraints mentioned previously.

*National Guard (NG)* - The Adjutant General (TAG) of each of the border states (CA, AZ, NM, TX) provides NG (Title 32) military support to federal, state, and local LEAs as directed by the Governor and as resourced by the National Guard Bureau. The National Guard offers considerable capability to perform military missions in support of law enforcement and is not subject to some of the

constraints affecting Title 10 forces.

**Regional Logistic Support Office (RLSO) (El Paso AND Long Beach)** - The RLISO is the focal point for local, state, and regional offices of LEAs seeking *non-operational* logistic and training support. A major element of the RLISO mission is to develop points of contact within the various services and local military installations who will provide timely replies to requests for appropriate military equipment/training from LEAs in order to accomplish their CD mission. The Southwest Border is basically covered by the El Paso office, which is collocated with JTF-6 and Operation Alliance. California is also covered by the Long Beach office, although this office concentrates primarily on assistance requests from agencies north of Fresno, California.

**North American Aerospace Defense Command (NORAD)** - NORAD is assigned the role of air surveillance operations into and over North America. This mission includes responsibility for detection and monitoring of suspected aerial transit of illegal drugs into the U.S. and Canada, integrating NORAD operations into the counterdrug command, control, communications, and intelligence network, and coordinating with other federal agencies engaged in detecting and monitoring suspected drug trafficking. The Commander in Chief (CINCPAC), NORAD conducts this mission in coordination with other supported and supporting CINCs (including the JTFs) and agencies as part of their normal peacetime air sovereignty mission.

**THIS GUIDE IS DESIGNED TO GIVE THE LAW ENFORCEMENT COMMUNITY AN UNDERSTANDING OF SUPPORT AVAILABLE FROM THE DEPARTMENT OF DEFENSE, THE MOST EFFECTIVE METHODS OF EMPLOYING AND INTEGRATING THAT SUPPORT, AND THE MEANS TO REQUEST IT.**

**THE LEA/MILITARY COUNTERDRUG ENVIRONMENT IS DYNAMIC. AS CHANGES OCCUR, INFORMATION WILL BE DISSEMINATED BY ALL MEANS POSSIBLE. JTF-6 IS COMMITTED TO PROVIDING RESPONSIVE, QUALITY AND PROFESSIONAL SUPPORT TO LAW ENFORCEMENT AGENCIES.**

## **CONTENTS**

<b>INTRODUCTION</b>	<b>1</b>
<b>CONCEPT OF MILITARY SUPPORT</b>	<b>3</b>
<b>MISSION PLANNING CONSIDERATIONS</b>	<b>5</b>
<b>OPERATIONAL RESTRICTIONS</b>	<b>9</b>
<b>SUPPORT REQUEST PROCEDURES</b>	<b>12</b>
<b>POINTS OF CONTACT</b>	<b>16</b>
Appendix A: Military Support Agencies	A-1
Appendix B: JTF-6 Support Capabilities	B-1
Appendix C: Sample Operational Support Missions	C-1
Appendix D: Mobile Training Team Missions	D-1
Appendix E: Agency Telephone Numbers	E-1
Appendix F: Acronyms and Abbreviations	F-1

AS OF: 1 JULY 1995

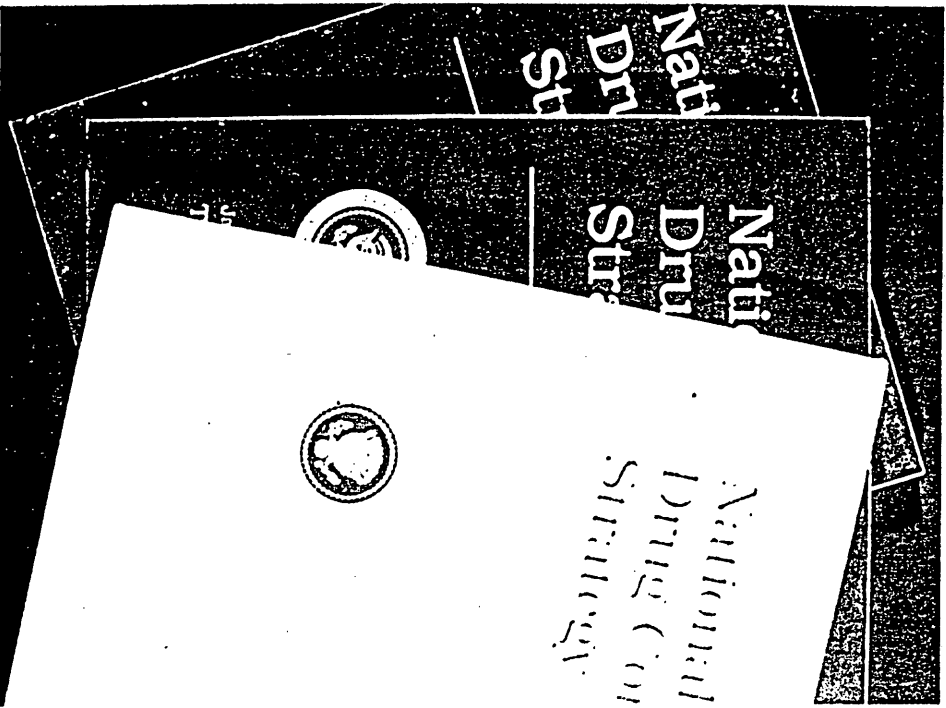

## INTRODUCTION

The President's *National Drug Control Strategy* provides clear goals and coherent structure which facilitates development of an operational level concept for military support to law enforcement agencies (LEA). The FY89 DoD Authorization Act expanded the role of the National Guard (NG) in support of law enforcement agencies (LEAs). The 1990 DoD Authorization Act further directed that the U.S. Armed Forces, to the maximum extent possible, conduct military training in drug interdiction areas. The designation of high intensity drug trafficking areas (HIDTAs) further clarified the priority for military support to LEAs.

In September 1989, Defense Secretary Cheney issued guidance designating drug trafficking as a threat to U.S. national security. In support of the President's *National Drug Control Strategy*, Secretary Cheney assigned North American Aerospace Defense Command (NORAD) the mission of air detection and monitoring (D&M) of illegal drug traffickers. The Commanding General, Forces Command (CG, FORSCOM) was assigned the mission to coordinate all DoD (Title 10) operational support to counterdrug (CD) activities within the Continental United States (CONUS).

In November 1989, Joint Task Force Six (JTF-6) activated at Fort Bliss, Texas. JTF-6's mission is to plan and coordinate all DoD (Title 10, Active and Reserve) military CD support that is requested by Federal, state and local LEAs within CONUS, Puerto Rico and the American Virgin

Islands. FORSSCOM is the higher operational headquarters of JTF-6. The CG, FORSSCOM can approve most CD missions; however, he has delegated to CG, JTF-6 the authority to approve mobile training teams (MTTs), transportation requests, intelligence analyst support within CONUS, linguist support and missions with the Rapid Support Unit (RSU).

The Regional Logistics Support Office (RLSO) works with LEAs to provide non-operational support such as the transfer of excess military property. There are four RLSOs located at Atlanta, Georgia; Buffalo, New York; Fort Bliss, Texas; and Long Beach, California. The RLSO at Fort Bliss, Texas, is collocated with Operation Alliance and JTF-6.

## CONCEPT OF MILITARY SUPPORT

Military support to CD operations is designed to assist LEAs in their mission to detect, deter, disrupt and dismantle illegal drug trafficking organizations. JTF-6 support serves as a force multiplier to law enforcement agencies with the potential to enhance LEA effectiveness or to release LEA resources to focus on interdiction/seizure actions. JTF-6 provides support to LEAs using a Total Force approach -- support packages drawn from a variety of sources and guided by priorities established by DoD. The Total Force approach results in joint (LEA/military) operations involving Title 10 and Title 32 (National Guard) personnel and non-operational assets from the RLSO to provide a variety of enhanced capabilities to supported LEAs. A summary of the missions and capabilities of each of these agencies is contained in Appendix A.

Operation Alliance, collocated with JTF-6 in El Paso, Texas, reviews all requests for military support from Federal, state and local agencies along the Southwest border. Project North Star, located at Buffalo, New York, performs a similar function for LEAs located in the CONUS northern tier of states. State National Guard counterdrug coordinators receive and review requests from their state for military support, and coordinate and approve these requests within their capabilities.

JTF-6 support to LEAs is categorized as operational (military units providing tactical support through the execution of mission related training); general support (augmentation of LEAs with military specific skills, training, transportation, etc.); engineer (horizontal and vertical construction, road and range repair, etc.); intelligence (linguists, analysts, imagery, etc.) and Rapid Support Unit (rapid response to actionable intelligence). A list of mission subcategories is provided in Appendix B. Detailed descriptions of some typical mission types are contained in Appendix C.

JTF-6 military units that provide support to law enforcement are in direct support (DS) of the lead LEA. This means that they provide assistance directly to the supported agency. During all phases of the support, these units will be under the tactical control (TACCON) of JTF-6 and will establish and maintain contact with the JTF-6 Joint Operations Center (JOC).

JTF-6's primary measure of effectiveness is a twofold system which seeks to determine how well LEA objectives were met and the value of the military training derived by the unit providing the support. However, in order to attempt to measure the value added to LEAs by DoD support, we do ask for measurable results such as: pounds of drugs seized, number of people apprehended, weapons seized, or people trained.

## MISSION PLANNING CONSIDERATIONS

**\*\* RULES OF ENGAGEMENT:** Title 10 military support to LEAs is governed by the Joint Chiefs of Staff (JCS) standing rules of engagement (ROE). Military personnel deployed to border areas are authorized to be armed with their issued weapons for self-defense only. They may return fire when threatened with deadly force to defend either themselves, accompanying law enforcement personnel or others present. Title 32 military support to LEAs is governed by similar rules as modified by each state governor.

**\*\* POLITICAL SENSITIVITIES:** During joint (LEA/military) operations conducted near the U.S./Mexican or U.S./Canadian border, appropriate measures are taken to respect Mexican and Canadian sovereignties. Military units operating in the vicinity (3KM for ground operations, 3NM for aviation operations) of the border plan and implement redundant control measures to reduce the potential for border violations. Additionally, efforts are made to minimize the perception of militarizing the border. These include restrictions against deploying tracked combat vehicles, visibly exhibiting crew-served weapons and arming aviation platforms on the border. Political sensitivities also extend to considerations of the employment of military forces in such a way as to avoid any potential confrontation with non-mission personnel. Large operations or operations in environmentally sensitive areas may require an environmental assessment. These assessments typically require 120-180 days to prepare and staff.



**\*\* PUBLIC AFFAIRS GUIDANCE:** Many aspects of CD operations are inherently sensitive and involve various risks which may be heightened by the release of information to the public. Announcements regarding a drug-related investigation, seizure or arrest will be made by the agency that actually makes the seizure or arrest. Military public affairs officers will be available to provide specific information and assist the LEA as required. Military spokespersons will emphasize that military elements serve in support of the LEA, and that DoD is not the lead agency. Finally, "speaking with one voice" is critical; therefore, release of information must be consistent, accurate, timely and thoroughly coordinated with all appropriate agencies.

**\*\* CLOSE PROXIMITY:** During joint operations which involve a substantial likelihood that military units will encounter criminal elements, a law enforcement agent will normally be an integral member of each deployed team. The specific requirements for these close proximity situations are addressed and determined during joint (LEA/Military) planning for each support operation.

**\*\* LEA RESPONSE PLAN:** During tactical operations designed to detect and report illegal drug activity, LEAs must plan to respond for interdiction purposes or emergencies. Although response time may vary from mission to mission, a good rule of thumb is that the LEA should be able to respond to the mission location within 30 minutes of notification.

**\*\* REQUEST LEAD TIME:** All major military commands follow a quarterly/annual training schedule which must be adjusted to accommodate unforecasted military support to law enforcement. LEAs should allow 90 days for planning (lead-time) for platoon (50 personnel or less) operations, 120 days for company (200 personnel or less) and 180 days for battalion (400 personnel or more) operations to ensure proper unit planning and coordination and appropriate operations security (OPSEC) measures. These lead times contribute to a safer, smoother and more effective mission. Annual requests for mission support submitted no later than 15 July each year for the following calendar year greatly facilitate planning by permitting military units to include this support in their training plans, allocate appropriate resources and reduce the cost of missions. Annual LEA requests need not specify exact dates at the time of submission. Adjustments can be made as necessary. As an exception to requested lead-time, JTF-6 can provide the RSU for detection in support of interdiction based on real-time intelligence. Engineer projects require a minimum of 365 days planning time. There is an annual request for forecasting the next year's engineer missions compiled every June.

**\*\* DURATION OF SUPPORT:** The duration of missions varies based upon the military capability being employed. JTF-6 planners can assist LEAs in determining the optimum mission duration based on prior similar missions. For other missions (e.g., analyst support), regulations limit operational support for a single request to

no longer than 179 days for active duty personnel and 139 days for reservists. On a case-by-case basis, reservists may be extended to a duration that does not exceed 179 days.

**\*\* OPERATIONS SECURITY (OPSEC):** Operations security is the process by which the adversary is denied information which would provide him sufficient knowledge to determine LEA/military intentions and operations. Military units providing support will conduct analysis to identify key friendly information and implement appropriate countermeasures to enhance force protection and mission effectiveness.

**\*\* SAFETY:** The safety of military personnel will never be compromised. Missions that have unacceptable risk to military personnel providing support will not be approved. Medical evacuation from notification of injury to a hospital will not exceed one hour.

**\*\* LOGISTICS:** The JTF-6 J4 provides or coordinates logistics support for DoD organizations under the JACON of the CG, JTF-6. In addition to facilitating logistics support for military organizations, the J4 can provide controlled delivery transportation assistance and meal surcharge exemption for LEAs conducting joint (military/LEA) tactical operations, where civilian dining facilities are unavailable.

## OPERATIONAL RESTRICTIONS

**\*\* POSSE COMITATUS:** Federal military forces are prohibited by law from searching, seizing, arresting, interrogating or conducting any related law enforcement activity involving civilians. NG forces are not subject to the provisions of Posse Comitatus but are generally restricted as a matter of policy from direct participation in search, seizure, arrest or related law enforcement activities. NG forces are actively involved in passenger vehicle and commercial cargo inspection operations at ports of entry and are normally accompanied by a law enforcement agent while performing these functions. Suspected criminal activity observed by the supporting military forces is then reported to the supported LEA for appropriate LEA interdiction action.

**\*\* ECONOMY ACT:** The Economy Act normally requires interagency reimbursement when support is provided from one government agency to another. However, when military support is provided to LEAs and that support maintains or enhances individual or unit operational readiness, the support is exempt from the provisions of the Economy Act. During the planning phase, every effort will be made to ensure joint (LEA/military) training benefits are derived from the support mission. In some cases, particularly for non-operational support, interagency reimbursement is required. DoD will make every effort to minimize the reimbursable costs associated with these support missions. Section 1212 of the DoD

Authorization Act provides exemptions for specific types of military support.

**\*\* ACCESS TO PRIVATE LAND:** Federal military forces are not authorized access to private lands without prior written approval of the landowner. This applies even when accompanied by a law enforcement agent with statutory authority for unrestricted access to private lands. Land use agreements facilitate the employment of Federal forces on private lands. In that regard, LEAs should consider obtaining long term, limited scope land use agreements in those areas where future military operations are envisioned. NG forces are not subject to this limitation.

**\*\* INTELLIGENCE COLLECTION AND**

**DISPOSITION:** Executive Order 12333 and various other laws and regulations govern DoD intelligence collection activities. DoD agencies are prohibited from collection of intelligence on U.S. persons and organizations within the continental U.S. unless these persons or organizations are reasonably believed to be involved in international drug trafficking. Certain collection methods are also restricted by law. All information acquired by military units during LEA support operations will be provided to the supported LEA for appropriate dissemination. Subject to the approval of the supported LEA, the supporting military unit will provide intelligence products to other military units, the El Paso Intelligence Center and Operation Alliance. Military units are not authorized to retain any data on U.S. persons or organizations after mission completion.

**\*\* DETECTION & MONITORING:** The detection, monitoring and communication (D&M) of movement of surface traffick detected crossing the border into the U.S. requires SECDEF approval. Monitoring is limited to an area within 25 miles of the border.

**\*\* CONTINUOUS OBSERVATION:** For missions not authorized D&M authority, military units providing support to LEAs are prohibited from pursuing suspect vehicles or persons for the purpose of providing their continuous coordinates to an LEA or conducting systematic or deliberate observation on a continuing basis. This does not preclude continuous observation from a fixed point such as an LP/OP, that has been established for the purpose of detecting illegal drug related activity. Further, ground reconnaissance is limited to area coverage and excludes the specific targeting of buildings, vehicles or persons. This restriction also applies to the employment of Forward Looking Infrared Radar (FLIR). Though the use of FLIR is authorized for area coverage, its use to detect cross-border incursions is limited to a "one-time" report to LEAs unless D&M is specifically authorized.

## SUPPORT REQUEST PROCEDURES

Individual law enforcement agencies may write directly to an affiliated HIDTA, state NG counterpart coordinator (CDC), Project North Star, Operation Alliance or JTF-6 to request support. We strongly encourage all state and local LEAs to solicit support first from their state NG CDC, then if the NG is unable to fulfill the request, the NG may then submit to JTF-6. The basic "who, what, when, where, and why" should be addressed in the request along with a point of contact (POC). LEAs requiring assistance in determining the availability of assets, the type of capability best suited for their requirements, or the current policy/legal restrictions of employing specific assets may contact the JTF-6 action officer assigned to each region. Telephone numbers are listed at Appendix E.

### ESSENTIAL ELEMENTS OF A REQUEST

**WHO:** Requesting agency and specific POC. Specify if other agencies are involved and if the agency is affiliated with a HIDTA.

**WHAT:** Specify need for the kind and type of support that is required to accomplish the mission.

**WHEN:** Date required and duration desired. If specific date is undetermined, provide month or calendar quarter desired.

### JTF-6 INTERNAL SUPPORT REQUEST FLOW

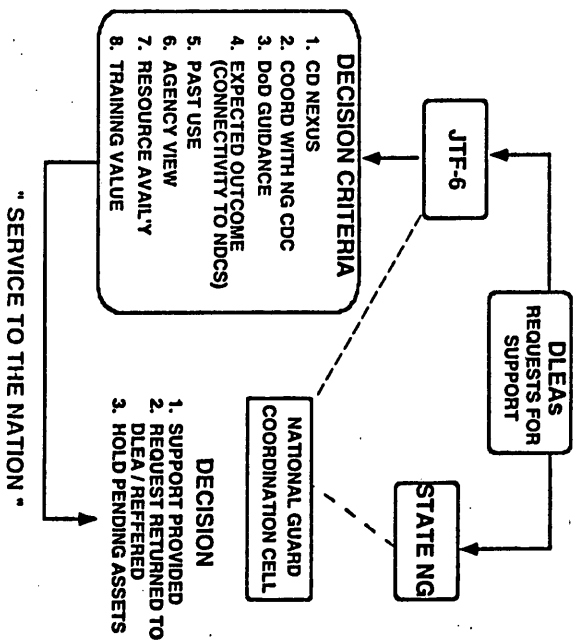

Figure 1

**WHERE:** Specific location for the proposed operation. Specify whether location is on private or public land.

**WHY:** Brief statement as to why military support is needed. This will assist JTF-6 in determining the type of equipment required. Include the counterdrug nexus in this discussion.

### **REQUEST STAFFING PROCEDURES**

Figure 1 shows the internal support request flow once it reaches JTF-6.

JTF-6 reviews and validates all requests received directly or from another agency for DoD support.

These requests are received by the J5 Plans Division. The Chief of the Plans Division assigns staff responsibility for planning the support and a mission sourcing action officer who attempts to source the request with a DoD unit or individual.

J5 Plans will contact the requestor to determine the scope of mission support, then will search for a unit or individual to provide the support. JTF-6 can not task units, but it has direct liaison authority with the services' major commands; thus, given sufficient planning time, sourcing a mission is usually not difficult. The J5 Plans then prepares a Concept of Mission message which is sent to FORSSCOM for approval.

Members of the supporting military unit are brought to JTF-6 for an initial planning conference (IPC). The IPC is followed by a site visit to coordinate directly with the requesting LEA. At the conclusion of its planning, and before mission execution, the supporting unit provides the supported LEA and JTF-6 an operations order (OPORD) briefing on its concept of operation. This serves as the agreement between the LEA and the military on the concept for execution of the mission. It is customary for the LEA to brief the reaction/response plan at the conclusion of the OPORD.

When the mission is approved, an execute order (EXORD) is published and support is rendered. In order to capture lessons learned, units conduct an after action review (AAR) and submit a formal after action report at the conclusion of each operation.

## JOINT TASK FORCE SIX

J3 PLANS	(915) 568-8415
J3 OPERATIONS	(915) 568-8888
J3 ENGINEER	(915) 568-8209
J2 INTEL	(915) 568-8133/9183
J2 IMAGERY	(915) 568-8788
J4 OPERATIONS	(915) 568-8757/8162
J4 TRANSPORTATION	(915) 568-8942
TECHNOLOGY OFFICER	(915) 568-8873
JOINT OPERATIONS CENTER <small>COLL FREE</small>	(800) 525-6864
JOINT OPERATIONS CENTER <small>NON-SECURE</small>	(915) 568-8322
JOINT OPERATIONS CENTER <small>SECURE/FAN</small>	(915) 568 8713

## JTF-6 REGIONAL TEAMS

SOUTHWEST REGION	(915) 568-8110/8185
SOUTHEAST REGION	(915) 568-8649/8146
NORTH CENTRAL REGION	(301) 677-4906/4898

## APPENDIX A:

### MILITARY SUPPORT AGENCIES

The following military organizations are the focus of military support (operational manpower and non-operational equipment) provided to LEAs:

*Joint Task Force Six* - JTF-6 coordinates all DoD Title 10 (active and reserve Federal military) support for LEAs within CONUS to assist them in their mission to detect, deter, disrupt and dismantle illegal drug trafficking organizations. To facilitate coordination of this support, JTF-6 has regional team officers ( see list at Appendix D). These officers can assist with support requests, provide information on availability and capability of military support, and assist with the coordination and deconfliction of military support operations. Most DoD resources (Active and Reserve components) are available to support LEAs.

*National Guard (NG)* - The adjutant general (TAG) of each state provides NG (Title 32) military support to Federal, state and local LEAs as directed by the governor and as resourced by the NG Bureau. The NG offers considerable capabilities to perform military missions in support of law enforcement and is not subject to some of the restrictions affecting Title 10 forces.

**Regional Logistic Support Office (RLSO) I/EI Paso, TX; Buffalo, NY; Long Beach, CA; and Atlanta, GA / - The RLISO mission is to provide a focal point for Drug LEAs seeking DoD non-operational logistical support. The transfer of free, excess DoD equipment to support drug enforcement agencies comprises the majority of all RLISO requests.**

**North American Aerospace Defense Command (NORAD) - NORAD is assigned the role of air surveillance operations into and over North America. This mission includes responsibility for detection and monitoring of suspected aerial transit of illegal drugs into the U.S. and Canada, integrating NORAD operations into the counterdrug command, control, communications and intelligence network; and coordinating with other Federal agencies engaged in detecting and monitoring suspected drug trafficking. NORAD conducts this mission in coordination with other agencies as part of its normal peacetime air sovereignty mission.**

**APPENDIX B:**

**JOINT TASK FORCE SIX  
SUPPORT CAPABILITIES**

**Operational Missions**

- Aviation MEDEVAC
- Aviation Operations
- Aviation Reconnaissance
- Controlled Delivery
- Dive Operations
- Ground Reconnaissance
- Ground Transportation
- Ground Surveillance Radar
- Imagery FLIR
- Listening Post/Observation Post
- Radar
- Sensors
- Unmanned Aerial Vehicle

**Intelligence Missions**

- General Support Intelligence
- Imagery Photo
- Intelligence Analysts
- Linguists/Translators

*General Support Missions*

- Canine
- Communications
- General Support Miscellaneous
- Maintenance
- Mobile Training Team
- Technology

*Engineer Missions*

- Engineer Assessments
- Engineer Base Ops Facility
- Engineer Demo of Ops Facility
- Engineer Training Facilities
- Engineer Border Fences
- Engineer Lighting
- Engineer Border Roads

*Rapid Support Missions*

- RSU Aviation Operations
- RSU Deployment
- RSU Dive Operations
- RSU Ground Reconnaissance
- RSU Listening Post/Observation Post
- RSU Mobile Training Team
- RSU Sensors

B-2

Z 0008544

APPENDIX C:

**AVIATION OPERATIONS**

**DESCRIPTION:** Aviation operations consist of transportation of Military/LEA personnel, insertion/extraction and medical evacuation (MEDEVAC). Movement of contraband, equipment or prisoners can be made available by either rotary or fixed wing aircraft. Helicopter transport to a "bust site" can be requested, provided that the military aircraft will not be used to block the ingress or egress of suspect personnel or land in imminent danger.

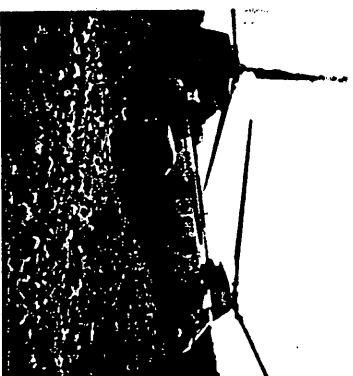

**MISSION PARAMETERS**

**DURATION:** The average length for this type of mission is 21 days. LEAs will determine the length based upon their objectives, the threat and the area to be covered.

C-1



**COMBINED CAPABILITY:** Aviation is a significant force multiplier when combined with ground forces, either military or LEA.

**CONSIDERATIONS:**

**A. Lead time for request:**

- \* Routine Aviation - 150 days
- \* Annual Requests - Submit annual program by 15 July for the next calendar year.

**B. Beware of political/public sensitivities associated with operating aircraft near the international border or populated areas.**

**C. Unit must coordinate with the appropriate air defense sector and the Domestic Air Interdiction Coordination Center (DAICC) before operating near (within 25 NM) the U.S./Mexican or U.S./Canadian border.**

**D. Unit must establish control measures when operating within three NM of the border to prevent inadvertent border crossing.**

**E. A person severely injured during any aviation operation must be at an emergency treatment facility within one hour of injury. This may necessitate the need for a dedicated military MEDEVAC if adequate commercial air/ground assets are not available.**

**AVIATION RECONNAISSANCE/  
FORWARD LOOKING INFRARED RADAR  
(FLIR)**

**DESCRIPTION:** The purpose of aviation reconnaissance/FLIR operations is to provide real time information to the LEA. Reports include information on illegal border crossings (both ground and air), and the observation of roads and trails which can be used by drug traffickers. An advantage of aviation reconnaissance is its ability to cover large areas quickly. Aviation reconnaissance missions can be conducted with or without an LEA on board the aircraft. The employment of night vision goggles (NVGs)/FLIR allows for night operations with selected aircraft.

**MISSION PARAMETERS**

**DURATION:** The average length for this type of mission is 2-3 days; however, it may run up to a month. LEAs will determine the length based upon their objectives, the threat and the area to be covered.

**COMBINED CAPABILITY:** Aviation is a significant force multiplier when combined with ground forces, either military or LEA.

## CONSIDERATIONS:

A. Lead time for request:

- \* Routine Aviation - 150 days
- \* Annual Requests - Submit annual program by 15 July for the next calendar year.

B. Beware of political/public sensitivities associated with operating aircraft near the international border or populated areas.

C. Unit must coordinate with the appropriate air defense sector and Domestic Air Interdiction Coordination Center (DAICC) before operating near (within 25 NM) the U.S./Mexican or U.S./Canadian border.

D. Unit must establish control measures when operating within three NM of the border to prevent inadvertent border over flight or crossing.

E. A person severely injured during aviation operation must be at an emergency treatment facility within one hour of injury. This may necessitate the need for a dedicated military MEDEVAC if adequate commercial air/ground assets are not available.

F. Unit must conform to legal limitations when employing high technology systems such as FLIR to detect cross-border smuggling.

## DIVE OPERATIONS

**DESCRIPTION:** Includes open water (ocean), riverine and inland dive operations. Military units have the capability to insert, extract and

navigate in rivers or open water, thus enabling observation of islands, coast lines or rivers. Dive operations are normally conducted for hull searches of ocean-going vessels. Navy SEAL, Army Special Forces and Marine Reconnaissance units are the best military forces for these missions. These units range in size from 6 to 10 personnel for dive operations to approximately 50 personnel for riverine/open water operations.



## MISSION PARAMETERS

**DURATION:** The average length for this type of mission is 21 days. LEAs will determine the length based upon their objectives, the threat and the area to be covered.

**EQUIPMENT:** Combat rubber raiding craft (CRRC), rigid raider craft (RRC), SCUBA, secure communications, Global Positioning System (GPS), day/night observation devices, navigation charts, MEDEVAC and individual weapons for force protection.

**COMBINED CAPABILITY:** Dive operations can be combined with helicopter operations to enhance insert/extract and observation capabilities.

## **CONSIDERATIONS**

**A.** Lead time for request:

- \* Rapid Support Unit (RSU) - 72 hours.
- \* Routine requests - 150 days.
- \* Annual Requests - Submit annual program by 15 July for the next calendar year.

**B.** LEA response plan for reaction must be coordinated before the mission and incorporated into the unit's operations order. LEA may need to provide vehicles and radios to support the operation.

**C.** Sites positioned where the possibility of smuggler-military encounter is high will require an accompanying LEA.

**D.** National sovereignty issues preclude water operations in the Rio Grande River because it is the international boundary between the U.S. and Mexico.

**E.** A person severely injured during water operation must be at an emergency treatment facility within one hour of injury. This may necessitate the need for a dedicated military MEDEVAC if adequate commercial air/ground assets are not available.

## GROUND RECONNAISSANCE

**DESCRIPTION:** Operations of this nature have the capability to cover large areas of terrain, both desert and forest. The intent is to help LEAs locate marijuana growing sites or identify potential smuggling routes and clandestine airfields. These missions can consist of 12-400 people (75 is average) who can perform detailed reconnaissance patrols. Ground recons usually insert by contract vehicles, but may also use aviation assets. Most operations are conducted in low visibility and avoid contact with non-mission personnel. These missions also have night vision devices and daylight long-range vision capability.

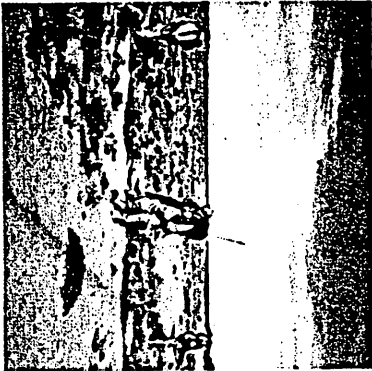

### MISSION PARAMETERS

**DURATION:** The average length for this type of mission is 21 days. LEAs will determine the length based upon their objectives, the threat and the area to be covered.

**EQUIPMENT:** Can include the following equipment: secure communications, secure tactical satellite (TACSAT) communications, night vision devices, thermal imagery devices and individual weapons for force protection.

**COMBINED CAPABILITY:** Other capabilities can be integrated with ground reconnaissance to increase its effectiveness such as helicopters, vehicles, ground sensors and ground surveillance radars.

### CONSIDERATIONS

- A. Lead time for request:
- \* Rapid Support Unit - 72 hours
  - \* Routine Ground Reconnaissance - 150 days
  - \* Annual Requests - Submit annual program by 15 July for next calendar year.
- B. LEA response plan for reaction must be coordinated before the mission and incorporated into the unit's operations order. LEA may need to provide vehicles and radios to support the operation.
- C. Sites or routes that are positioned where the possibility of drug smuggler and military encounter is high must have an accompanying LEA.

D. A person seriously injured during ground reconnaissance operation must be at an emergency treatment facility within one hour of injury. This may necessitate the need for a dedicated military MEDEVAC if adequate commercial air/ground assets are not available.

## GROUND TRANSPORTATION

**DESCRIPTION:** Ground transportation is provided on a case by case basis by active and reserve medium and light-medium truck companies from throughout CONUS.

Transportation support to LEAs is provided for long haul and heavy lift of material in direct support of CD operations. Use of military transportation assets will not be provided when the LEA has the capability to perform the mission with organic assets (e.g., driving a vehicle between points when the LEA has drivers). A typical mission would be the transportation of large quantities of steel airfield landing mats in direct support of an approved engineer border fence construction project.



## CONTROLLED DELIVERY

**DESCRIPTION:** Controlled deliveries are requested through JTF-6 J4 and are provided by U.S. Transportation Command (TRANSCOM) using military aircraft to transport law enforcement agents, vehicles and illegal drugs in support of ongoing CD operations. The military unit provides its own command, control and communications and is responsible for logistics and administrative functions. Typical missions include movement of vehicles containing confiscated illegal drugs in support of an ongoing investigation that is time sensitive. The size of the unit providing the support will vary from 5 to 20 personnel based on the number and type of support aircraft.

### MISSION PARAMETERS

**DURATION:** Duration of missions varies depending on the location of the transportation unit and the pick up/drop off point of the material. Ground transportation missions can last between 30 and 60 days. Controlled deliveries can usually be done in 1-2 days.

**EQUIPMENT:** Ground transportation will normally consist of tractor trailers, chase vehicles and maintenance contact teams. The LEA is responsible for coordinating material handling equipment (MHE) at both the point of origin and the final destination.

**COMBINED CAPABILITY:** Ground transportation can be used in support of engineer operations to position materials necessary for the mission.

### CONSIDERATIONS:

#### A. Lead time for request:

- \* Ground Transportation - 150 days
- \* Controlled Deliveries - 24 to 72 hours

#### B. LEA must provide the following information;

- \* LEA point of contact/telephone number for the mission.
- \* LEA point of contact at the point of origin and all destinations.
- \* LEA point of contact for support equipment (MHE).
- \* Type of cargo to include dimensions, weight and cube.
- \* Required delivery date (RDD).

C-12

C-13

## GROUND SURVEILLANCE RADAR

**DESCRIPTION:** The purpose of ground surveillance radar (GSR) mission is to provide detection of movement along the border or around LEA checkpoints. The system can be used for intelligence collection on activity in an area or to assist in interdiction operations. GSRs can detect vehicular and personnel traffic. In support of intelligence collections missions, the GSR can provide the LEA with the amount and type of traffic moving through a sector. In support of interdiction missions, the GSR can provide cuing for LEA response teams regarding the type of traffic and general direction of movement. GSR is best employed with redundant means of observation to confirm GSR reports.

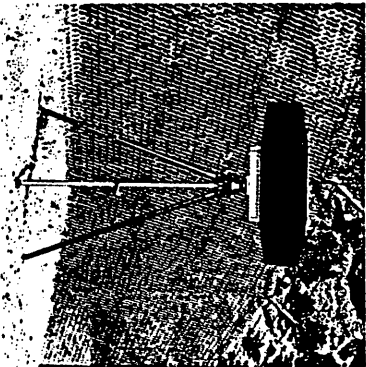

### MISSION PARAMETERS

**DURATION:** Support normally ranges from 7 to 30 days. LEAs will determine the length based upon their objectives, the threat and the area to be covered.

C-14

**COMBINED CAPABILITY:** GSRs are most effective when combined with other ground elements, such as sensors or LP/OPs to confirm GSR reports.

### CONSIDERATIONS:

- A. Lead time for request:
  - \* Routine GSR - 150 days
  - \* Annual Requests - Submit annual program by 15 July for next calendar year.
- B. Mission normally entails detailed unit planning, site reconnaissance and Intelligence Preparation of the Battlefield (IPB) process to select GSR sites.
- C. LEA response plan for reaction must be coordinated before the mission and incorporated into the unit's operations order. LEA may need to provide vehicles and radios to support the operation.
- D. Obtain land use agreements with private landowners to operate on their lands if systems are anticipated to operate on private land. GSR can operate from public land and observe a target area located on private land.

C-15

**E. A person seriously injured during any GSR operation must be at an emergency treatment facility within one hour of injury. This may necessitate the need for a dedicated military MEDEVAC if adequate commercial air/ground assets are not available.**

### **LISTENING POST/OBSERVATION POST (LP/OP)**

**DESCRIPTION:** LP/OPs are concealed, manned observation sites that are usually occupied by three to six people to watch for suspicious activity and report it to an LEA. Normally, two to ten LP/OP positions are manned in an area simultaneously. The military unit provides its own command, control, communications, logistics and administrative support. The size of the unit providing the support will vary from 12-150 people (team/platoon to company size). LP/OPs can be manned 24 hours a day. Border LP/OPs watch for the illegal movement of drugs across the border via manpack, pack animals or vehicles. Airfield LP/OPs detect drug smuggling aircraft landing or airdropping contraband on remote/ clandestine airstrips. LP/OPs can also be positioned to observe movement along routes leading to domestic marijuana production areas.

### **MISSION PARAMETERS**

**DURATION:** The average length for this type of mission is 21 days. LEAs will determine the length based upon their objectives, the threat and the area to be covered.

**EQUIPMENT:** Can include the following equipment: secure communications, night vision devices, thermal imagery devices and individual weapons for force protection.



**COMBINED CAPABILITY:** Other capabilities can be integrated with LP/OPs to increase their effectiveness such as helicopters, vehicles, ground sensors and GSRs.



## CONSIDERATIONS

- A. Lead time for request:
- \* Rapid Support Unit - 72 hours
  - \* Routine LP/OP - 150 days
  - \* Annual Requests - Submit annual program by 15 July for next calendar year.

B. LEA response plan for reaction must be coordinated before the mission and incorporated into the unit's operations order. LEA may need to provide vehicles and radios to support the operation.

C. Sites positioned where the possibility of drug smuggler and military encounter is high must have an accompanying LEA.

D. A person seriously injured during an LP/OP operation must be at a treatment facility within one hour of the injury. This may necessitate the need for a dedicated military MEDEVAC if adequate commercial air/ground assets are not available.

E. Without D&M authority unit is limited to area coverage and excludes specific targeting of buildings, vehicles, or persons. Does not preclude continuous observation from a fixed point.

## AIR SURVEILLANCE RADAR

**DESCRIPTION:** Ground-based air surveillance radar is available to an LEA who desires to gather intelligence or conduct interdiction operations in air corridors entering his sector. Most military radars do not have a data link into the Domestic Air Interdiction Coordination Center (DAICC), March AFB, California which is responsible for monitoring intrusions into domestic air space. Integration with existing FAA radars is possible by augmenting them with military radar in facilities routinely closed at night. Request must be coordinated with NORAD, appropriate air defense sector and U.S. Customs Air.

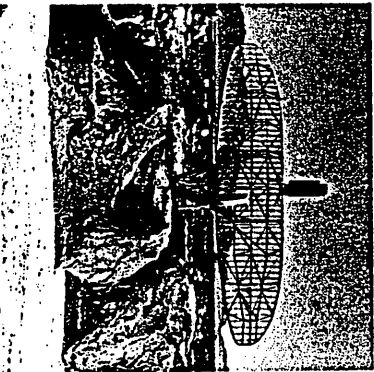

### MISSION PARAMETERS

**DURATION:** The average length for this type of mission is 21 days. LEAs will determine the length based upon their objectives, the threat and the area to be covered.

C-20

**EQUIPMENT:** Can include secure communications, night vision devices, and individual weapons for force protection.

**COMBINED CAPABILITY:** Helicopters and LP/OPs can be integrated with radar operations to add depth and increase their effectiveness.

### CONSIDERATIONS:

- A. Lead time for request:
  - \* Routine Radar Operations - 180 days
  - \* Annual Requests - Submit annual program by 15 July for next calendar year.
- B. LEA response plan for reaction must be coordinated before the mission and incorporated into the unit's operations order. LEA may have to provide vehicles to aid radar emplacement operations.
- C. Radar is most effective when supplemented by direct observation from LP/OPs with LEA reaction teams in the general vicinity.
- D. A request for radar operations must be coordinated with the DAICC.

C-21

## SENSOR OPERATIONS

**DESCRIPTION:** Sensor operations are information collection activities that

can significantly enhance LEA efforts. The types of sensors used in counterdrug operations normally include seismic, infrared (thermal), magnetic and acoustic devices. Detection ranges will vary. Military units provide the sensors, their emplacement and monitoring. They can also emplace and/or monitor LEA sensors. Units providing support usually consist of 8-10 personnel with 24 hour capability. Sensors are used to expand the capability of LEAs to monitor border crossing sites, suspected air strips, sections of remote roads, fence gates, etc. Properly emplaced, a sensor field can detect/determine the type of traffic (person/vehicle) and the direction/speed of travel.

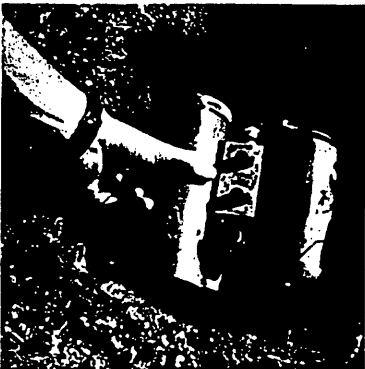

## MISSION PARAMETERS

**DURATION:** The average length for this type of mission is 21-90 days. LEAs will determine the length based upon their objectives, the threat and the area to be covered.

**EQUIPMENT:** Can include secure communications, night vision devices and individual weapons for force protection.

**COMBINED CAPABILITY:** Helicopters, GSR and LP/OPS can be integrated with sensor operations to add depth and increase their effectiveness.

### CONSIDERATIONS:

A. Lead time for request:

- \* Rapid Support Unit - 72 hours
- \* Routine Sensor - 150 days
- \* Annual Requests - Submit annual program by 15 July for next calendar year.

B. LEA response plan for reaction must be coordinated before the mission and incorporated into the unit's operations order. LEA may need to provide vehicles and radios to support the operation.

**C. Sensor fields are most effective when covered by direct observation and backed with LEA reaction teams which can be in the general vicinity.**

**D. A person seriously injured during any sensor operation must be at an emergency treatment facility within one hour of injury. This may necessitate the need for a dedicated military MEDEVAC if adequate commercial air/ground assets are not available.**

## **UNMANNED AERIAL VEHICLE (UAV)**

**DESCRIPTION:**The purpose of unmanned aerial vehicle operations is to provide real time imagery to the LEA. Reports include information on illegal border crossings (both ground and air), and the identification and/or observation of roads and trails that can be used by drug traffickers. An advantage of UAV operations is its ability to cover large areas quickly. The employment of various equipment packages will vary the capability of the UAV.

### **MISSION PARAMETERS**

**DURATION:** The average length for this type of mission is 21 days. LEAs will determine the length based upon their objectives, the threat and the area to be covered.

**COMBINED CAPABILITY:** UAVs are a significant force multiplier when combined with ground forces, either military or LEA, sensors or GSRs.

## CONSIDERATIONS:

- A. Lead time for request:
- \* Routine UAV - 150 days
  - \* Annual Requests - Submit annual program by 15 July for the next calendar year.
- B. Beware of political/public sensitivities associated with operating aircraft near the international border or populated areas.
- C. Unit must coordinate with appropriate air defense sector and Domestic Air Interdiction Coordination Center (DAICC) before operating near (within 25 NM) the U.S./Mexican or U.S./Canadian border.
- D. Unit must establish control measures when operating within three NM of the border to prevent inadvertent border over flight or crossing.

## GENERAL INTELLIGENCE

**DESCRIPTION:** Military Intelligence assets may be used to provide dedicated, on-site support to an LEA. Specific intelligence support can include:

### INTELLIGENCE

**ANALYSTS:** Trained military intelligence analysts generally provide face-to-face contact with law enforcement investigators for case specific analysis. Analysts may also conduct intel preparation before ground/air operations to greatly enhance the effectiveness of the mission.

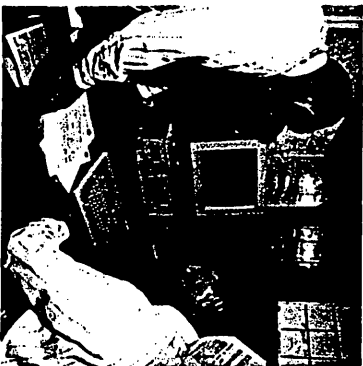

**LINGUISTS/TRANSLATORS:** Transcription/translation support is normally provided from a centralized center for court-approved Title III intercepts. Translated media (documents, recorded voice or video cassettes) are mailed to the center. On-site support is usually provided for non-spanish translations and high priority active Title III wiretaps with court imposed reporting requirements. DOD personnel may not perform real-time translation of oral or wire intercepts.



## IMAGERY PHOTO

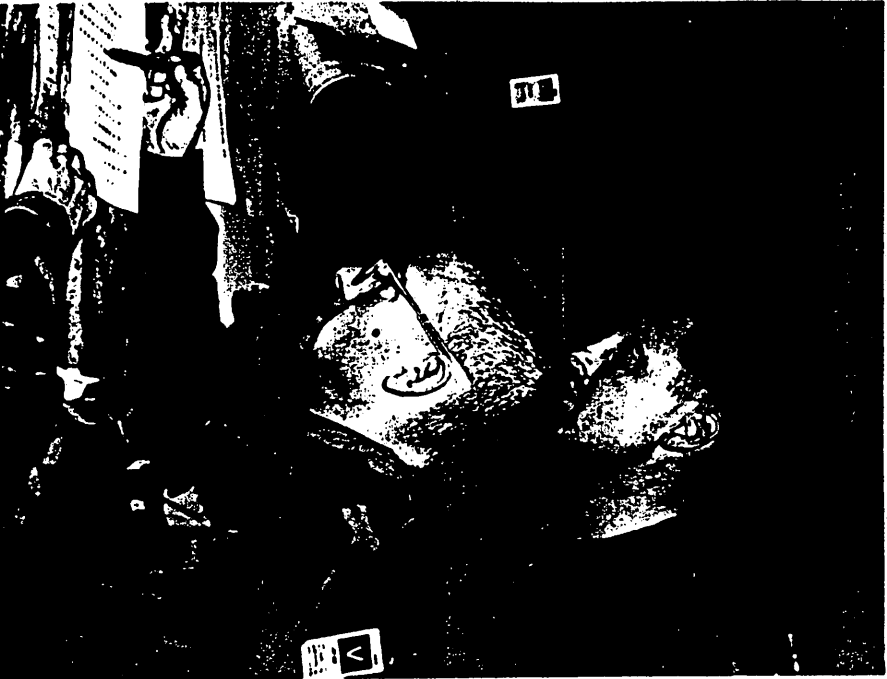

**DESCRIPTION:** Imagery Photo is the process of obtaining photographs or video for the purpose of identifying suspected activity such as landing strips, possible drug cultivation sites, road and trail information and other probable drug related activity. Black and white film is normally used but color film can be used for selected missions that are small and well defined. Imagery products are provided as photo mosaic, grid-reference graphics, annotated photo imagery, or multi-imagery and central paper parts. Imagery is interpreted by trained photo analysts and the final product consists of annotated photographic prints.



## MISSION PARAMETERS

**DURATION:** Flights over the target area are usually completed within one day. Mission parameters are set to minimize possibility of detection. After flight completion, the final product should be delivered within three weeks.

**COMBINED CAPABILITY:** Can be used to determine the need for a ground operation. When a ground operation is deemed necessary, aerial imagery will assist in the planning and execution phases of the operation.

#### **CONSIDERATIONS**

**A. Lead time for request:**

- \* Routine Requests - 150 days
- \* Annual Requests - Submit annual program by 15 July for next year.

**B. Target area size:** Size of target area determines what can be seen in the photos. Target size and photo scale go hand-in-hand; the larger the area, the smaller the scale. Drug site detection requires a small target area; an area overview is an example of a large target area mission. Requests for extremely large area coverage (i.e., counties, whole national parks, etc.) are costly and usually have little tactical value.

**C. Request process:** Due to the number of variables involved in the aerial reconnaissance process, phone coordination with the JTF-6 imagery section should be conducted as soon as possible during the request process. The phone number for the Imagery Section is 915-568-8788

#### **CANINE TEAMS**

**DESCRIPTION:** Unit will provide a dog handler and a dog employed as a team for working dog support.

#### **MISSION PARAMETERS**

**DURATION:** Up to 179 days for military working dog support.

**EQUIPMENT:** Housing facilities, dog food and all related K-9 equipment.

#### **CONSIDERATIONS:**

**A. Lead time for request:**

- \* Routine Requests - 150 days
- \* Annual Request - Submit annual program by 15 July for next calendar year.

**B. Dogs can only actively search for several hours and need frequent rest/recovery time.**

**C. Dogs require a kennel.**



## CANINE TRAINING/FIRST AID

**DESCRIPTION:** To support training, a unit will provide a team of instructors who can teach handler and canine drug/attack dog techniques, as well as canine emergency first aid and care. Each team consists of canine trainers, handler trainers and veterinary personnel.

### MISSION PARAMETERS

**DURATION:** 2 to 60 days for military working dog support.

**EQUIPMENT:** Training facilities, open areas, K9 drug training devices/equipment and all other related K-9 equipment.

### CONSIDERATIONS:

- A. Lead time for request:**
- \* Routine Requests - 150 days
  - \* Annual Request - Submit annual program by 15 July for next calendar year.
- B. Must have access to a variety of training locations, both indoor and outdoor, day and night, as well as any substances that the dog will be required to detect.**
- C. Teams will be able to instruct beginning and advanced courses.**



C-34

C-35

## COMMUNICATIONS

**DESCRIPTION:** Communications support is used to enhance law enforcement use of the electromagnetic spectrum. Supporting units may assist by installing, erecting and removing antennas, towers, or providing communications-electronics equipment. Acceptance of communications support requests is governed by factors such as military unit availability, training value to the communications unit, environmental/cultural/electromagnetic impact, mission cost and feasibility.

### MISSION PARAMETERS

**MATERIALS:** Communications units develop the material requirements for each specific mission. The supported LEA must fund and procure the materials for each project through its own supply channels.

**PERSONNEL:** JTF-6 sources the personnel for each project and funds all contracts related to transportation, billeting and meals of military personnel.

**CONSIDERATIONS:** Allow 6 to 12 months for planning communications missions due to unit scheduling, environmental and engineering issues, and coordination with land-owners and other affected parties.



C-37

## MOBILE TRAINING TEAM

### MISSION PARAMETERS

**DESCRIPTION:** Military and/or civilian training teams consisting of one to five personnel are able to instruct on specific subjects selected

by the requesting law enforcement agency.

The mission commander of the unit selected to perform the Mobile Training Teams (MTT) will conduct an on-site visit with the requesting LEA for the purpose of ensuring the program of instruction (POI) fits law enforcement needs.



**EXAMPLES OF MTTS:** Language training, basic first aid, combat lifesaver training, tactical fieldcraft and defensive skills (patrolling, mission planning and organization, basic survival training, booby trap detection and avoidance, land navigation, night vision devices, and rappelling), interview/interrogation techniques, intelligence and link analysis, basic and advanced marksmanship, and K9 training and first aid. Specific courses of instruction are listed in Appendix D.

**DURATION:** MTTs can normally be accomplished within three to five days. Actual duration will depend on the amount of training requested and the number of students.

**EQUIPMENT:** MTTs usually provide the necessary training aids. However for weapons training, LEAs are required to provide their own weapons and ammunition.

### CONSIDERATIONS:

A. Lead time for request:

- \* Routine - 150 days. Actual time is dependant on type of training requested and availability of a training team.

- \* Submission of annual requests by 15 July each year for the next calendar year greatly facilitates planning, preparation, and tasking of appropriate instructors. Annual requests do not require specific class dates, month or quarter is sufficient.

B. LEA must have a suitable training area or facility.

C. To receive training on certain "high risk" techniques such as rappelling, fast roping or simunitions, LEAs must sign a "release from liability" form before the start of training.

## TECHNOLOGY

**DESCRIPTION:** The purpose of technology support is to provide LEAs with a source of expert advice, equipment, technology demonstrations, vendor screening and on-site technology solutions for the purpose of enhancing LEA CD capabilities. JTF-6 can provide assistance with commercial or DoD technology.

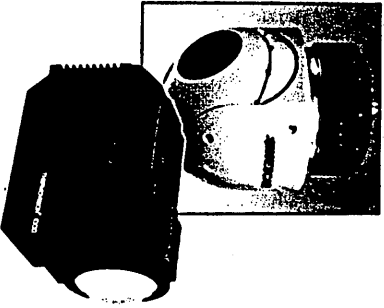

## MISSION PARAMETERS

**DURATION:** Duration varies depending on the nature of the request, but is normally from 1 to 60 days.

**COMBINED CAPABILITY:** Technology support can enhance CD capabilities at or between ports of entry (POE) and for intelligence, mapping, eradication and communication-electronics. Technology can support land, air and water operations.

### CONSIDERATIONS:

- A. Longer lead times are necessary when the LEA requests in-depth support.
- B. The variety of technology in DoD and commercial sources, combined with differing support methods of various agencies, makes it difficult to specify support request lead time. Early informal coordination before submitting a support request can help ensure adequate response.
- C. Priority is given to requests which provide a direct or residual benefit to DoD counterdrug efforts.

## MILITARY ENGINEERING/CONSTRUCTION

## CONSIDERATIONS

**DESCRIPTION:** Military engineer units may be used to perform engineer assessments, emplace or remove obstacles, construct or improve CD trails/roads and fences, perform light construction of bases of operations or demolish condemned facilities to help block/deter drug smuggling corridors/activities along the international border of the United States. Military engineers can also construct or improve LEA training facilities. Military engineering is focused on projects that have the greatest impact on the CD effort of LEAs. Requests for engineer support are prioritized using factors such as training value to engineer units, environmental and cultural impact of engineer operations, cost of construction and feasibility of completing each construction mission.

## CONSTRUCTION PARAMETERS

**MATERIALS:** Engineer units develop the material requirements for the specific mission. The supported LEA must fund and procure the materials for each project through its own supply channels.

**PERSONNEL AND EQUIPMENT:** JTF-6 sources the personnel and equipment for each project and funds all contracts related to transportation, equipment, billeting and meals for military personnel.

A. The average engineer construction mission consists of 50-100 personnel and lasts for a period of 40-60 days.

B. Allow 12 months for planning engineer missions due to environmental and cultural assessments, cost and contracting requirements incurred by construction projects, material and equipment availability, and coordination with land owners and other affected parties.

C. Environmental assessments required for engineer missions are coordinated by JTF-6 as part of project planning. JTF-6 can fund environmental assessments required for military training if the supported LEA has no in-house environmental study capabilities.

## **RAPID SUPPORT UNIT (RSU)**

**DESCRIPTION:** The RSU is composed of a U.S. Army Special Forces Company which operates from facilities at Fort Bliss, Texas. It can conduct operations throughout the JTF-6 area of operation. The RSU is under the TACON of the Commanding General, JTF-6. It has the capability to respond quickly to immediate LEA needs based on perishable or predicted intelligence. The RSU is specifically trained, organized and equipped to conduct special reconnaissance (LP/OP, ground recon) and mobile training team missions. Additionally, it is usually capable of conducting limited dive operations and sensor missions. Special reconnaissance missions are characterized by small teams (9-12 soldiers), conducting detection-oriented operations that are designed to enhance LEA interdiction efforts.

### **MISSION PARAMETERS**

**DURATION:** Support normally ranges from 1 to 14 days.

**COMBINED CAPABILITIES:** RSU elements are configured with highly trained, experienced personnel. Unit equipment consists of long-range day and night optics, satellite communications, sensors and advanced medical kits. In addition to conducting separate missions, the RSU can be used to augment or cover the flanks of other ongoing JTF-6 operational missions. With the RSU's ability for low-

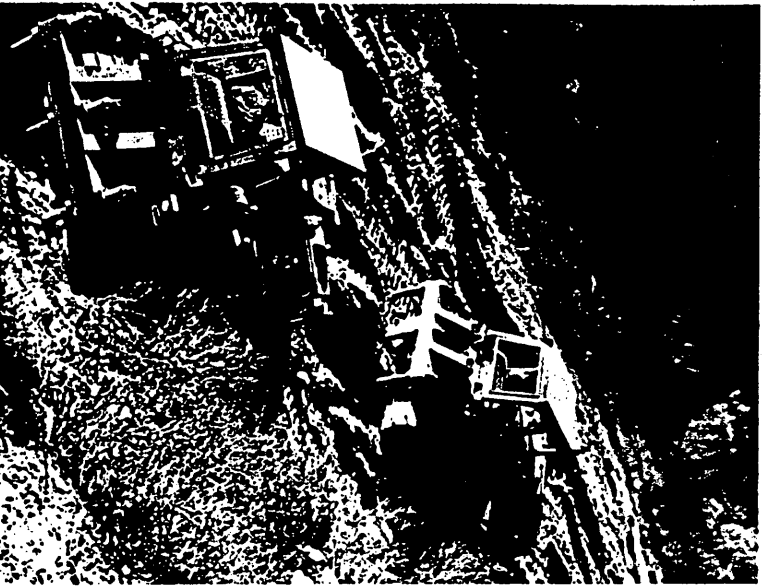

C-44

C-45

visibility insertion, it is ideal for filling perceived voids that drug traffickers will try to exploit when major unit operations terminate.

**CONSIDERATIONS:**

- A. Lead time for request: 72 hours are required.
- B. Missions should be planned for short duration as these are reusable assets for other areas.



C-46

**APPENDIX D:**

**JOINT TASK FORCE SIX  
MOBILE TRAINING TEAM MISSIONS  
COURSES OF INSTRUCTION**

- 1. Language Training.
  - a. Duration. 5 days.
  - b. Description. A basic language course in field survival and law enforcement phrases. Spanish is predominate language. Russian, Vietnamese, Chinese and European languages available on request.
  - c. LEA Requirements. Using Headstart material provided 30 days before mission start, LEAs will do preparatory training. LEA will purchase this Headstart Material, if the LEA desires to retain this material at the conclusion of the training. Maximum student load is 10 students per class. LEA must provide a classroom with audiovisual equipment to support the instruction.
  - d. Instructors. Defense Language Institute (DLI) and School of the Americas (SOA), both from U.S. Army TRADOC, and AFRES.

D-1

## 2. Combat Lifesaver Training.

### a. Duration. 5 days.

b. Description. Course includes a variety of medical and "buddy" aid tasks to include mouth-to-mouth resuscitation, applying field or pressure dressings, applying a tourniquet, applying dressings to abdominal and head wounds, preventing shock, splinting a fracture, first aid for burns, transporting an injured person and identify /reat heat or cold injuries.

c. LEA Requirements. LEA must provide a classroom, TV with VCR, audiovisual equipment that includes an overhead projector and an outdoor training area.

d. Instructors. U.S. Army MEDCOM, SOCOM and USAF Medical Group (49th and 355th MDG)

## 3. First Aid or CPR.

### a. Duration. 2-5 days.

b. Description. Instruction covers basic or advanced first aid or trauma treatment. Can be tailored to cover a variety of tasks that range from basic first aid (treatment of bleeding, infection control, heat/cold injuries) to CPR certification.

c. LEA Requirements. LEA must provide a classroom, TV with VCR, audiovisual equipment to include an overhead projector.

d. Instructors. U.S. Army MEDCOM, SOCOM, USAF Medical Group (49th and 355th MDG) and AFRES.

## 4. Multi-Subject Tactical Instruction (MSTI).

### a. Duration. 5 Days.

b. Description. MSTI is a broad category to cover a wide variety of fieldcraft and defensive skills and techniques. LEAs requesting a MSTI must specify those tasks for which they wish to receive instruction. Individual subjects available to LEAs include patrolling (camouflage techniques, individual/team movement, reconnaissance techniques), mission planning (task organization, operation planning), booby traps (detection and avoidance), survival skills (tactical first aid, fire craft and water procurement), land navigation (basic map and compass techniques, day and night land navigation), night vision devices (introduction, uses and basic maintenance) and rappelling techniques.

c. LEA Requirements. LEA must select the tasks he wishes to have taught during the instruction. LEA must provide appropriate classroom or outdoor training facilities in which to conduct training or practical exercises. LEA participants must sign waiver of liability statements before participating in training.

d. Instructors. SOCOM, Marine Corps Security Force Battalion and AFRES GCRC.



**5. Interview and Interrogation.**

a. Duration. 3-5 days.

b. Description. Instruction includes undercover drug operations, source recruitment, drug criminal intelligence system, interview and interrogation techniques, risk management, raid/arrest planning and tactics.

c. LEA Requirements. LEA must provide classroom, TV with VCR, audiovisual equipment to include overhead projector.

d. Instructors. USAMPS, USAICFH, SOCOM and AFRES.

**6. Intelligence and Link Analysis.**

a. Duration. 2-3 days.

b. Description. Instruction covers collection, evaluation and analyzing information, developing hypothesis using information, drawing conclusions from information, and developing links among people, organizations and events.

c. LEA Requirements. LEA must provide classroom, TV with VCR, and classroom support items such as easel, butcher paper and chalkboard.

d. Instructors. USAICFH and AFRES.

**7. Basic Marksmanship.**

a. Duration. 5 days.

b. Description. Training concentrates on marksmanship fundamentals such as body position, breathing techniques, trigger control and target acquisition. It also includes instruction on handgun and rifle maintenance and day/night firing.

c. LEA Requirements. LEAs must provide ammunition, targets, classroom, range, weapons and scopes. All students must sign a waiver of liability statement before instruction.

d. Instructors. SOCOM, Marine Corps Security Force Battalion, USAF CATAMS and AFRES.

**8. Advanced Marksmanship.**

a. Duration. 5 days.

b. Description. Training includes refresher instruction on basic marksmanship. Tasks will include instruction on deflection shooting, range estimation, low light firing techniques, weapons maintenance, external ballistics, shot calculation and shot placement. It will also include day and night firing. This course is not a sniper course of instruction.

c. LEA Requirements. LEAs must provide ammunition, targets, classroom, range, weapons and scopes. All students must sign a waiver of liability statement before instruction.

d. Instructors. SOCOM and Marine Corps Security Force Battalion.

**9. Counterdrug Investigation Course.**

a. Duration. 5 days.

b. Description. Provides training in covert drug investigation techniques, procedures and methodology. Emphasis is on risk management, officer safety and practical application. Officers should be newly assigned to drug law enforcement.

c. LEA Requirements. LEA must provide a classroom, TV with VCR, easel with butcher paper or chalk board.

d. Instructors. USAMPS and AFRRES.

**10. K9 Training and First Aid.**

a. Duration. 3 days to 3 weeks.

b. Description. Training includes basic dog handling, basic and advanced narcotics detection dog training, drug detection search patterns, canine change of behavior, canine final response, methods of clearing various areas e.g., open,

buildings, vehicles, aircraft and other facilities. A separate basic first aid for dogs training course has been developed.

c. LEA Requirements. LEAs must provide all canine equipment, drug training aids, access to training areas for day and night search, classrooms and radios for communications during training.

d. Instructors. U.S. Army Veterinary personnel and USAF or USA certified dog handlers.

**11. Counterdrug Narco-Terrorism Personal Protection.**

a. Duration. 5 days.

b. Description. Training includes Executive and Witness protective services applicable to counter drugs. Emphasis will be placed upon protection of public officials, witnesses against drug offenders and others threatened in a Narco-terrorism environment.

c. LEA Requirements. LEAs must provide a classroom, TV with VCR, easel with butcher paper or chalk board. Motorcade operations and driving requires a vehicle driving range and vehicles.

d. Instructors. USAMPS.

**12. Counterdrug Field Tactical Police Operations.**

a. Duration. 5 days.

b. Description. Training includes practical and technical aspects of planning and conduction a marijuana eradication program. Emphasis is placed on investigative methods to identify and gather evidence to convict marijuana cultivators. Students should be involved in marijuana eradication missions.

c. LEA Requirements. LEAs must provide a classroom, TV with VCR, easel with butcher paper or chalk board. Course requires a woodland or high desert environment suitable for a land navigation course. The training area must be large enough to conduct two simultaneous marijuana patch raids.

d. Instructors. USAMPS

**13. Counterdrug Special Reaction Team Training.**

a. Duration. 5 days.

b. Description. To train police officers in conducting drug raids on houses, apartments and other dwellings. Officers should have a basic knowledge of drug investigations and be in good physical condition.

c. LEA Requirements. LEAs must provide a classroom, TV with VCR, easel with butcher paper or chalk board. Course requires firing ranges and a building suitable for the paint ball exercises. All students must sign a waiver of liability statement before instruction.

d. USAMPS.

**14. Counterdrug Marksman/Observer Training Course.**

a. Duration. 5 days.

b. Description. Training provides police marksman/observer teams techniques needed to effectively neutralize hostile targets in special threat situations using select long rifle fire.

c. LEA Requirements. LEAs must be a graduate of the Counterdrug Special Reaction Team Training course or another approved police tactical course. LEAs must provide ammunition, targets, classroom, range, weapons and scopes. All students must sign a waiver of liability statement before instruction.

d. Instructors. USAMPS

APPENDIX E:

**OPERATION ALLIANCE/PROJECT NORTHSTAR**

OPERATION ALLIANCE	(915) 540-6130
OPERATION ALLIANCE FAX	(915) 540-7532
MG INO to OPALL	(915) 568-9082
JTF-6 INO to OPALL	(915) 568-9083
PROJECT NORTHSTAR INO	(716) 551-3053

**NORTH AMERICAN AEROSPACE**

**DEFENSE COMMAND**

NORAD J3 (OPERATIONS)	(719) 554-6919
NORAD J2 (INTELLIGENCE)	(719) 554-8588

**REGIONAL LOGISTICS**

**SUPPORT OFFICES**

ATLANTA, GEORGIA	(404) 362-3135, FAX 362-3276
BUFFALO, NEW YORK	(716) 846-3053, FAX 846-3067
EL PASO, TEXAS	(915) 568-9088, FAX 568-9091
LONG BEACH, CALIFORNIA	(310) 980-4490, FAX 980-4385

**APPENDIX F:**

**ACRONYMS AND ABBREVIATIONS**

AAR	after action review
AFRES	Air Force Reserve
CATMS	Combat Arms Training Management System
CINC	Commander-in-Chief
CINCUSACOM	Commander-in Chief, U.S. Atlantic Command
CG	Commanding General
CONUS	Continental United States
CRRC	combat rubber raiding craft
DAICC	Domestic Air Interdiction Coordination Center
D&M	detection and monitoring
DoA	delegation of authority
DoD	Department of Defense
DLI	Defense Language Institute
EPIC	El Paso Intelligence Center
EXORD	execute order
FAA	Federal Aviation Agency
FAX	facsimile
FLIR	forward looking infrared radar
FORSCOM	U.S. Army Forces Command
FY	fiscal year
GCRC	Ground Combat Readiness Command
GPS	global positioning system
GSR	ground surveillance radar
HELO	helicopter
HIDTA	High Intensity Drug Trafficking Area
INTEL	intelligence
IPB	intelligence preparation of the battlefield
J2	Director of Intelligence
J3	Director of Operations
J4	Director of Logistics

J5	Director of Plans and Policy	TACON	tactical control
JCS	The Joint Chiefs of Staff	TACSAT	tactical satellite
JTF-6	Joint Task Force Six	TAG	The Adjutant General
KM	kilometers	Title 10	Federal military forces (active and reserve)
LEA	law enforcement agency	Title 32	National Guard forces
LNO	liaison officer	TRADOC	Training and Doctrine Command
LP/OP	listening post/observation post	TRANSCOM	U.S. Transportation Command
MDDG	Medical Group	U.S.	United States
MEDCOM	U.S. Army Medical Command	USAF	United States Air Force
MEDEVAC	medical evacuation	USAICFH	United States Army Intelligence Center and Fort Huachuca
MHE	material handling equipment	USAMPS	United States Army Military Police School
MTT	mobile training team	WADS	Western Air Defense Sector
NG	National Guard		
NM	nautical miles		
NORAD	North American Air Defense Command		
NVG	Night Vision goggles		
OPALL	Operation Alliance		
OPCON	operational control		
OPORD	operations order		
OPSEC	operations security		
POC	point of contact		
POI	program of instruction		
RDD	required delivery dates		
recon	reconnaissance		
RLSO	Regional Logistics Support Office		
ROE	rules of engagement		
RRC	rigid raider craft		
RSU	Rapid Support Unit		
SCUBA	self contained underwater breathing apparatus		
SEALS	SEA, Air, Land Navy Special Operations Teams		
SFOD-A	Special Forces Operational Detachment - Alpha		
SOA	School of Americas		
SOCOM	Special Operations Command		
SWB	Southwest Border		

National Guard Bureau  
Counterdrug Coordinator's Handbook

DEPARTMENTS OF THE ARMY AND AIR FORCE  
National Guard Bureau  
Washington, D.C. 20310-2500  
1 October 1992 (ADVANCE COPY)

NATIONAL GUARD COUNTERDRUG COORDINATOR'S HANDBOOK

---

**SUGGESTED IMPROVEMENTS.** The proponent of this handbook is the Counterdrug Task Force, National Guard Bureau. Users are invited to send comments and suggested improvements to Chief, National Guard Bureau, ATTN: NGB-CD, Washington, D.C. 20310-2500

**APPLICABILITY.** This handbook provides counterdrug support guidance for the employment of Army and Air National Guard resources of the 50 states, the Commonwealth of Puerto Rico, the U.S. Virgin Islands, Guam, and the District of Columbia, hereafter referred to as states. It complements NGR (AR) 500-2/NGR (AF) 55-6 and is intended primarily for Counterdrug Support Program managers and support personnel.

---

TABLE OF CONTENTS

	<u>Para.</u>	<u>/</u>	<u>Page</u>
<b>CHAPTER 1 INTRODUCTION</b>			
Purpose	1-1		3
References	1-2		3
Explanations of abbreviations and terms	1-3		3
<b>CHAPTER 2 COUNTERDRUG SUPPORT PROGRAM (SUPPLY REDUCTION)</b>			
General	2-1		4
State annual Counterdrug Support Program plans (state plans)	2-2		4
Effective use of personnel	2-3		6
AGR of personnel	2-4		9

**Counterdrug Coordinator's Handbook 1 October 1992 (ADVANCE COPY)**

Extended orders	2-5	9
Permanent change of station (PCS) considerations	2-6	10
Counterdrug support operations	2-7	10
Duty uniforms	2-8	13
Flying hours/air support	2-9	13
Counterdrug missions	2-10	14
<b>CHAPTER 3 COUNTERDRUG REPORTING</b>		
Reporting procedures	3-1	19
Operation numbering system	3-2	20
NGB Counterdrug Support Program reports	3-3	20
<b>CHAPTER 4 REVIEW AND EVALUATION</b>		
Review and evaluation	4-1	23
<b>APPENDICES</b>		
Appendix A--References		
Appendix B--Glossary		
Appendix C--Pregnancy Certification Form		
Appendix D--Integrity Check Forms		
Tab 1--Informed Consent Form		
Tab 2--Consent to Release Information		
Appendix E--Report Forms		
Tab 1--Air National Guard Monthly Financial Report (NGB Form 525-1-R)		
Tab 2--Army National Guard Monthly Financial Report (NGB Form 525-2-R)		
Tab 3--Law Enforcement Survey (NGB Form 525-3-R)		
Tab 4--National Guard Survey (NGB Form 525-4-R)		
Tab 5--Law Enforcement Request Report (NGB Form 525-5-R)		
Tab 6--Counterdrug Support Operations Report (NGB Form 525-R)		
Appendix F--After Action Report Format		
Appendix G--Counterdrug Operations Risk Assessment Instrument		
Appendix H--Sample LEA Request for Support		
Appendix I--Personnel File Checklist		
Appendix J--Operations Folder Checklist		
Appendix K--Counterdrug Review and Evaluation Checklist		



## CHAPTER 1

### INTRODUCTION

#### 1-1. Purpose.

a. This handbook provides guidance to National Guard counterdrug support managers and planners on the conduct of federally funded supply reduction activities. Intended primarily for Counterdrug Support Program managers and personnel, it complements and expands upon NGR (AR) 500-2/NGR (AF) 55-6, NATIONAL GUARD COUNTERDRUG SUPPORT TO LAW ENFORCEMENT AGENCIES.

b. Counterdrug Support Program activities are financed with federal funds under 32 USC 112 or may also be conducted incidental to training. This handbook does not apply to or restrict the authority of a state to make use of the National Guard for any purpose authorized by state law in state active duty status when federal counterdrug funds are not involved except where explicitly made applicable to state active duty with respect to use of federal supplies of equipment.

1-2. References. Appendix A lists required and related publications.

1-3. Explanation of abbreviations and terms. The glossary provides an explanation of abbreviations and terms.

CHAPTER 2

COUNTERDRUG SUPPORT PROGRAM (SUPPLY REDUCTION)

2-1. General.

a. The National Guard role in counterdrug supply reduction activities is to provide support to local, state, and federal LEAs that request assistance. All National Guard counterdrug support (supply reduction) activities will be in response to a documented request for support from a LEA. Appendix H contains a sample format for such requests.

b. The majority of National Guard counterdrug support activities are currently conducted by the states using federal funds authorized under 32 USC 112. The SECDEF provides funds, through the National Guard Bureau, to execute approved counterdrug plans. States requesting funds authorized by 32 USC 112 must prepare and submit an annual counterdrug plan as described below (see para. 2-2).

c. While 32 USC 112 approves funding, it does not provide independent legal authority for the National Guard to conduct counterdrug operations. Therefore, the respective governors define the role of each state's National Guard. This role must be consistent with state law.

d. POMSOs/Counterdrug Coordinators are responsible for planning, supervision, and execution of their state Counterdrug Support Program.

2-2. State annual Counterdrug Support Program plans (state plans).

a. Annual plans submitted by the states is one aspect of the National Guard Bureau's management of the Counterdrug Support Program. The states submit their plans to National Guard Bureau, ATTN: Counterdrug Task Force, for review and staffing. The Counterdrug Task Force then forwards the plans to the SECDEF for approval. Plans received after the suspense for the initial yearly submission will be considered as part of the mid-year review.

b. Each state plan is the Adjutant General's strategy for providing the National Guard support requested by various federal, state, and local drug law enforcement agencies within the state. These plans must be approved and signed by the Adjutant General (or equivalent).

c. The state plan must specify how National Guard personnel will be used (see NGB Approved Missions List, paragraph 2-10 below), certify that operations will occur only when personnel are not in federal (Title 10) service, and ensure that service is in addition to training required by 32 USC 502.

(1) Coordinate the state plan with the governor or his/her designated representative.

(2) Include state JAG, USPFO, SAAO, and ESSO representation in the planning process.

(3) If your state plan requires the purchase of equipment, include an acquisition plan identifying procurement requirements for the following fiscal year. The acquisition plan will be for items that are not in the inventory, but are required for the Counterdrug Support Program. This plan will be a joint effort of the POMSO and the USPFO contracting officer to identify the necessary equipment and propose the means for obtaining it (loan, purchase, lease, etc.). In addition to the copy sent to NGB-CD as part of the annual state plan, provide a copy of the acquisition plan to NGB-CP. NGB-CDD will provide additional guidance on acquisition plan development during the annual state plans process.

d. Base state plans on the counterdrug support requirements for the next fiscal year as forecasted by LEAs.

(1) Forecasting LEA requests for support for the following year can be one of the most difficult aspects of developing a state plan. Since individual LEA operations are often in response to a specific drug production or smuggling activity, LEAs may be hesitant to request missions several months in advance. Historical data (how many missions did they want last year?) and the experience of law enforcement officers and military personnel must be used to forecast the need for counterdrug support. During the process of forecasting LEA requests for support it may be useful to emphasize that the LEA is not necessarily committing itself to use counterdrug support a certain number of times, but helping the National Guard to plan its counterdrug budget.

(2) Coordinate with LEAs requesting support to ensure that projected missions meet the approval criteria listed in sub-paragraph 2-7(c) below. Counterdrug coordinators may need to educate LEAs on the legal restrictions concerning the employment of counterdrug support. Some states may hold annual support planning conferences while others prefer to meet individually with key LEAs.

e. Each state plan must have a certification by the State Attorney General that the activities proposed or approved under the state plan are consistent with state law. This requirement cannot be waived. The following is the recommended format for the Attorney General's certification:

I certify that I have reviewed the National Guard Drug Interdiction and Counterdrug Activities Plan (short title: Counterdrug Support Plan) for the State of \_\_\_\_\_ for the fiscal year ending September 30, 199\_\_, and that all operations and activities proposed for federal funding under the plan are consistent with and not prohibited by State law.

(signed)

\_\_\_\_\_  
(typed name)

State Attorney General

State of \_\_\_\_\_

Date \_\_\_\_\_

f. NGB-CD will establish suspense dates and provide a sample format each year to aid in the preparation of state plans.

2-3. Effective use of personnel.

a. Counterdrug coordinators should identify special or critical military and/or civilian skills that may be required to support specific operations. They must ensure that personnel are qualified to conduct assigned missions.

b. The counterdrug program is subject to audit. Supervisors at all levels will ensure that personnel are used effectively and efficiently.

c. If such assignment is practical, use personnel at their proper level according to their skill and rank. An example of misuse is tasking senior non-commissioned officers to physically perform cargo inspection when qualified lower ranking personnel are available to perform the duty.

d. Place on duty only the minimum number of personnel required to accomplish the mission. Do not duplicate the responsibilities of existing full-time resources unless the support requirement exceeds regular full-time responsibilities.

e. Physical examination requirements. All personnel in the Counterdrug Support Program must comply with medical administration requirements per NGR (AR) 500-2/NGR (AF) 55-6, paragraph 2-9.

Counterdrug Coordinator's Handbook 1 October 1992 (ADVANCE COPY)

(1) Physical Examinations and ADSW. Physical exams taken as a prerequisite for employment will remain valid IAW AR 40-501.

(a) Guard members whose physical examination results have not been received by the Counterdrug Support Program of that state by the end of thirty days will have that set of ADSW orders terminated.

(b) Guard members who have a break in Counterdrug Support Program orders of ninety days or more and who possess a current physical may sign a Statement in Lieu of Current Medical Examination as found in NGR 40-501, Appendix B or AFR 160-43, Form 895.

(2) Individuals requiring a medical waiver will not be placed on an ADSW tour or tour extension for more than thirty consecutive days until such waiver has been processed and approved.

(3) Specifics for "Over 40" Physicals.

(a) Phase 1 physicals must provide enough information for the Health System Specialist at a State Area Command (STARC) to determine a pass or failure. Requirements for "Over 40 Physicals" are IAW current service directives, AR 40-501 and AFR 160-43.

(b) Refer to current regulations and directives for procedures if an individual fails the Phase 1 physical.

(4) Examination Providers. Military Entrance Processing Stations (MEPS) will be the primary provider of physical exams required for ADSW orders. Coordination of appointments should be made through the MEPS National Guard Liaison Noncommissioned Officer (NCO). If a MEPS is unavailable, Active Duty Medical Testing Facilities (AMTF) may also be utilized. Sources other than these may be used only with the prior approval of the Office of the Army Surgeon, Medical Standards Branch (NGB-ARS-MS) or the Air National Guard, Physical Standards Branch (ANGRC/SGP).

(5) Restricted Testing. MEPS will not include DAT, HIV testing, or pregnancy testing as part of the provided physical exams. DAT and HIV tests will be performed under the NGB national contract or at an active duty military facility. The requirement for pregnancy testing is waived; however, additional requirements are listed below.

(6) Pregnancy. The following are guidelines regarding pregnancy and Counterdrug Support Program ADSW orders:

(a) Guard members already pregnant at the time of employment application to the Counterdrug Support Program will not be placed on ADSW orders unless a waiver is obtained. Approval authority for such waivers is NGB-ARS-MS or ANGR/SGP accordingly.

(b) Members who become pregnant while on a Counterdrug Support Program ADSW tour will be retained on orders for the duration of those orders. At the conclusion of this tour, the Guard member's orders may not be renewed until after completion of the pregnancy, unless a waiver is obtained IAW sub-paragraph 2-3e(6)(a) above.

(c) Unit commanders will brief female Guard members on the restrictions presented above prior to requesting ADSW orders. A record of counseling/pregnancy certification form will be completed at this briefing and a copy maintained in the individual's personnel file. A recommended format to certify that females have been briefed on pregnancy guidelines is at Appendix C.

(7) Human Immunodeficiency Virus (HIV). Members serving tours of thirty days or longer, will have a current HIV test with date of test on file. HIV testing will be performed IAW current service component requirements.

(8) Drug Analysis Testing (DAT). Guard personnel involved with counterdrug support operations will pass DAT prior to being placed on initial program ADSW orders or, if the individual has been separated from the program previously for ninety consecutive days, prior to orders renewal. Counterdrug personnel in continuous service will be tested at least once per year. State POMSOs will include projected DAT costs attributable solely to the Counterdrug Support Program under O&M expenses within their annual budget plan. Should the DAT requirement negatively impact a current counterdrug support operation, the state Adjutant General may postpone testing, on a case by case basis, for up to thirty days. Refer to AR 40-501 or AFR 160-43 for additional guidance.

f. Personnel Integrity Program requirements.

(1) NGR (AR) 500-2/NGR (AF) 55-6, sub-paragraph 2-3(d) provides guidance on background checks for individuals applying to the Counterdrug Support Program. Suggested formats for written consent to conduct a background check are at Appendix D.

(2) Use the following objective criteria to determine acceptability for the Counterdrug Support Program on the basis of an integrity check:

Suitability for the Counterdrug Support Program is made by determining whether the investigation of the applicant's background would reasonably call into question their reliability, trustworthiness, and ability to withstand the pressures and influences that may arise to compromise the integrity of the program. Areas of concern leading to disqualification are those which create an unacceptable risk or susceptibility to bribery, conflicts of interest, extortion, and blackmail. Additional areas of concern include other situations that create a reasonable possibility of compromising sensitive criminal justice or law enforcement operations and information, especially those dealing with the usage, possession for sale, distribution, or trafficking in illegal drugs.

**Counterdrug Coordinator's Handbook 1 October 1992 (ADVANCE CR**

**c. Personnel files.** A personnel file will be maintained for each individual in Counterdrug Support Program. At a minimum, each file will contain the following:

- (1) Orders to duty.
- (2) Consent to Release Information
- (3) Informed Consent Form
- (4) Pregnancy Certification (females)
- (5) Briefing Form(s)
  - (a) Safety/Rules of Engagement
  - (b) Standards of Conduct
  - (c) Pre-commitment
  - (d) OPSEC
  - (e) Physical Security
  - (f) World Threat
- (6) Evaluation Reports
- (7) Counterdrug Training Records
- (8) Personnel File Checklist (Example at Appendix I)

**2-4. AGR personnel.** The following statements must be included in the orders of AGR personnel assigned to the Counterdrug Support Program.

a. Title 10. "Member's primary duties will be performed in direct staff support of the counterdrug mission. Member will not directly participate in drug interdiction activities of the National Guard or in any activities in violation of 10 USC 375 or 18 USC 1385 (interdiction, search and seizure, arrest, etc.).

b. Title 32. "Gaining agency/command must ensure that individual does not participate in drug interdiction activities of the National Guard which violate 32 USC 112, or in any activities which violate 10 USC 375. This individual will not be used for any purpose other than the Counterdrug Support Program as provided for IAW 32 USC 112.

**2-5. Extended orders.**

a. When a state plan calls for the extended use of M-Day/traditional members on ADSW status, place individuals on orders for the duration of the mission to ensure they receive the appropriate benefits and entitlements.

b. Individuals on counterdrug support orders must participate in inactive duty training (IDT/IAD) assemblies and may do so while remaining on counterdrug support orders.

(1) Personnel will be carried as "constructive" attendance when attending IDT/IAD while on ADSW orders.

(2) Regardless of the unit of assignment's location or member's residence, eligibility for travel reimbursement is based upon travel away from the member's normal duty station. Therefore, when traveling to IDT/IAD at a location other than the normal (i.e., ADSW) place of duty or duty station while on ADSW orders, personnel are entitled to travel reimbursement as prescribed by the Joint Travel Regulation.

(3) Orders will be broken for AT or schools lasting more less than three days.

c. The Counterdrug Support Program is not intended to be a career program.

2-6. Permanent change of station (PCS) considerations.

a. Consistent with OPSEC requirements, use personnel within commuting distance if possible. When the use of local personnel is not practical, states will identify and plan for PCS requirements. PCS requirements and associated costs will be forecasted by operation in the state's annual counterdrug support plan submitted to the NGB Counterdrug Task Force.

b. PCS for the purpose of counterdrug support should be given careful consideration to ensure it does not invoke a hardship upon the individual in matters of drill attendance

2-7. Counterdrug support operations.

a. The state plan is a budgeting and forecasting tool to broadly plan for numbers and types of operations. Once a state plan has been approved and funded, the POMSO and/or counterdrug coordinator executes the plan by approving specific requests for support to LEAs and assigning personnel to provide the requested support.

b. The SECDEF approves the type of counterdrug support activities the National Guard will perform. A list of missions coordinated with and approved by the Office of the Secretary of Defense is at paragraph 2-10.

c. Approval criteria. Besides ensuring that the type of mission requested is approved by the SECDEF under the state plan, counterdrug coordinators will confirm that missions meet the following criteria before counterdrug support is provided:

(1) A LEA must submit a formal request for support. Maintain this request on file for at least two years. Appendix H contains a sample format for such requests.

(2) Support will not interfere with scheduled training. Whenever practical, support provided will be compatible with the military occupational specialty or Air Force specialty code of support personnel.

(3) Maximize the use of support performed incidental to training.



**Counterdrug Coordinator's Handbook 1 October 1992 (ADVANCE COPY)**

(4) Establish rules of engagement in accordance with NGR (AR) 500-2/ NGR (AF) 55-6.

(5) National Guard commanders will retain final authority over flight and/or ground operation of National Guard aircraft, vehicles, and personnel.

(6) Take appropriate safety precautions when carrying weapons on board aircraft. Do not discharge weapons or pyrotechnics from aircraft or vehicles.

(7) Conduct risk assessments and appropriate accident prevention measures in accordance with AR 385-10, AFR 127-2, and applicable NGRs. Appendix G contains a sample risk assessment instrument.

**d. Request channels.**

(1) Where practical, have LEAs coordinate their requests through the state's lead LEA. This procedure will facilitate the request process and reduce duplication of effort.

(2) The POMSO or counterdrug coordinator will forward requests that are beyond the National Guard's capabilities to the appropriate Continental United States Army (CONUSA).

(3) CONUSA support operations conducted within a state will be coordinated by the National Guard CONUSA liaison officer.

(4) For support requested within the area of operation of a regional LEA federation (e.g., Operation Alliance, Project North Star, etc.), use regional LEA federation procedures to coordinate and consolidate military support operations.

(5) LEA requests received directly by NGB or OSD will be staffed back to the appropriate state.

**e. Establish an operation folder or data file system for each operation/mission performed. At a minimum, the folder or file system must include the following:**

- (1) LEA request for support.
- (2) OPORD/OPLAN
- (3) Initial Report (NGB Form 525-R)
- (4) Resource List
- (5) Obligations/Expenditures (Use NGB Form 525-1-R or 525-2-R to record obligations/expenditures for each operation.)
- (6) Seizure Report (NGB Form 525-R, as necessary)
- (7) Incident Report (as necessary)
- (8) After Action Report
- (9) Situation/In-Process Report (NGB Form 525-R, as necessary)

- (10) Termination Report (NGB Form 525-R)
- (11) LEA Survey Report (NGB Form 525-3-R)
- (12) NG Survey Report (NGB Form 525-4-R)
- (13) Media Reports (as necessary)
- (14) Operation Folder Checklist (see Appendix J)

f. Develop standard operating procedures to complement orders and plans.

g. Coordination requirements. Ensure operations are fully coordinated with the supported LEA and appropriate military organizations. The supported LEA is responsible for operational coordination with other LEAs.

(1) Every operation must be coordinated with each LEA and military organization that could be affected, to include the appropriate CONUSA and JTF. Such coordination should be conducted as a joint effort of the supported agency and the state National Guard providing support.

(2) All mobile ground radar and aerial interdiction operations, and those aerial reconnaissance or aerial photo reconnaissance operations over coastal waters or along international borders, must be coordinated with NORAD and either C3I East or West.

(3) NORAD is the lead DoD agency for the detection and monitoring of suspected aerial trafficking of illegal drugs into the U.S. and Canada. As such, NORAD will coordinate and integrate multi-agency surveillance efforts directed against aerial drug trafficking.

(4) Ground mobile radar and aerial operations near international borders or coastal waters require coordination with the INS and the USCS Customs National Aviation Center.

(5) Aerial operations over or near the Pacific require coordination with USCINCPAC (JTF-5). Coordinate operations over or near the Atlantic or Caribbean Basin with USCINCLANT (JTF-4). These requirements apply to all National Guard aircraft, both Army and Air.

(6) Ground operations near international borders or coastal waters require coordination with the INS and the USCS. Operations on or near the Southwest border require coordination with Operation Alliance and JTF-6. Coordinate operations on or near the Northern Border with Project Northstar.

(7) Coordinate all mobile ground radar operations with ANGRD/DON.

(8) Information that may affect ongoing or future counterdrug operations should be reported by the supported LEA to EPIC and potentially affected LEAs and military agencies.

- (9) Coordinate interstate operations with NGB-CDD.

2-8. Duty uniforms.

a. Personnel will wear the appropriate duty uniform during counterdrug operations. Adjutants General may authorize the wear of civilian clothing or coveralls on a case-by-case basis.

b. Individuals performing flight crew duties will wear flight uniforms and other aviation life support equipment essential for the mission and the environment.

c. Situations when wearing civilian clothing or coveralls would be appropriate include:

(1) When Guard members accompany plain clothes law enforcement officers or detectives during observation or surveillance operations.

(2) When the supported LEA requests Guard personnel to wear civilian clothes for OPSEC or other security reasons.

(3) When performing cargo inspections in support of the U.S. Customs Service, coveralls (LIN G31439) may be authorized.

2-9. Flying hours/air support.

a. Coordinate with the State Army Aviation Officer (SAAO) to ensure counterdrug flying hours can be supported from the perspectives of safety, training, personnel, and logistics.

(1) The SAAO manages the flying hour program; the POMSO or counterdrug coordinator manages counterdrug support.

(2) Do not use counterdrug support flying hours for purposes other than counterdrug support operations.

b. Coordinate Air National Guard flying hour requests with the ANG Executive Support Staff Officer (ESSO).

c. Aviation support will adhere to all applicable military and civilian safety rules and regulations.

(1) Aircraft will not fly into or land in an area if likely to receive hostile fire. Take appropriate measures to ensure the safety of personnel and the aircraft when inserting law enforcement personnel.

(2) Law enforcement personnel are responsible for initial security of landing zones.

(3) Pilots in command will ensure that all passengers are briefed on aircraft safety prior to take off.

2-10. Counterdrug missions. The SECDEF has approved conduct of the following missions by the National Guard.

a. Mission descriptions.

(1) Mission #1--Surface Reconnaissance. Guard members reconnoiter an area (private lands, abandoned property, and public lands) for cultivated marijuana or other drug operations. Marijuana may be eradicated under this mission if requested by the supported LEA following its discovery. Areas may be land or water.

(2) Mission #2--Surface Surveillance. Guard members maintain area surveillance on isolated air strips, drop zones, border crossing points, shore landing points, waterways, or other locations suspected as sites for drug trafficking or production activity. Areas may be land or water. Surveillance may be conducted from land or water.

(3) Mission #3--Surface Transportation Support. National Guard members provide surface transportation (ground or maritime) of LEA personnel, persons in LEA custody, seized property or contraband, to and from counterdrug operations sites. LEA officers are responsible for the security of any evidence or persons in their custody. This transportation assistance must be concurrent with on-going counterdrug operations and is limited to:

(a) Transportation of LEA personnel and person in their custody to and from an area of counterdrug operations, and to an initial detention facility within CONUS. (Puerto Rico, Virgin Islands, Hawaii, and Guam may provide transportation within their state.)

(b) Transportation of seized property or contraband to a facility designated by the supported LEA.

(c) Transportation of seized property or contraband for the purpose of either disposal/destruction or use in active counterdrug operations. (Transportation for use in an active counterdrug operation may be provided regardless of National Guard involvement in the operation.) The supported LEA shall be responsible for security of the transported items at all times. Requests for this type of support must include written certification from the requesting LEA that the mission is for the purpose of disposal/destruction or use in an active counterdrug operation.

(d) Transportation missions which do not meet the above criteria may be performed on a reimbursable basis under the provisions of the Economy Act (31 USC 1534) or as incidental to training.

1. For transportation provided under the provisions of the Economy Act, the requester must provide certification to OSD that commercial transportation is neither available, readily obtainable, nor satisfactory for the mission. The requester must also provide a fund cite and billing address.

2. Transportation may be provided incidental to training.

(4) Mission #4--Aerial Reconnaissance. Guard members reconnoiter an area by air for cultivated marijuana, suspicious water craft, aircraft, or motor vehicles.

(5) Mission #5--Aerial Surveillance. Guard members maintain area surveillance from the air for cultivated marijuana, suspicious water craft, aircraft, or motor vehicles.

(6) Mission #6--Aerial Transportation Support. National Guard members provide aerial transportation of LEA personnel, persons in LEA custody, seized property or contraband, to and from counterdrug operations sites. LEA officers are responsible for the security of any evidence or persons in their custody. This transportation assistance must be concurrent with on-going counterdrug operations and is limited to:

(a) Transportation of LEA personnel and person in their custody to and from an area of counterdrug operations, and to an initial detention facility within CONUS. (Puerto Rico, Virgin Islands, Hawaii, and Guam may provide transportation within their state.)

(b) Transportation of seized property or contraband to a facility designated by the supported LEA.

(c) Transportation of seized property or contraband for the purpose of either disposal/destruction or use in active counterdrug operations. (Transportation for use in an active counterdrug operation may be provided regardless of National Guard involvement in the operation.) The supported LEA shall be responsible for security of the transported items at all times. Requests for this type of support must include written certification from the requesting LEA that the mission is for the purpose of disposal/destruction or use in an active counterdrug operation.

(d) Transportation missions which do not meet the above criteria may be performed on a reimbursable basis under the provisions of the Economy Act (31 USC 1534) or as incidental to training.

1. For transportation provided under the provisions of the Economy Act, the requester must provide certification to OSD that commercial transportation is neither

**Counterdrug Coordinator's Handbook 1 October 1992 (ADVANCE COPY)**

available, readily obtainable, nor satisfactory for the mission. The requester must also provide a fund cite and billing address.

2. Transportation may be provided incidental to training.

(7) Mission #7--Ground Radar Support. On the basis of a LEA request for support, Guard members establish and operate ground radar sites capable of providing air intercept control. Mission includes site security.

(8) Mission #8--Cargo Inspection. Guard members assist LEAs by inspecting cargo. Cargo includes: unoccupied vehicles, containers, aircraft, water craft, baggage, suspect mail, etc. Guard members will not make arrests, conduct searches of individuals, or seize evidence. LEAs must be present at inspection sites, make seizures, and maintain custody of evidence and control of vehicle occupants.

(9) Mission #9--Training Program (NG and LEA). Guard members and LEA personnel provide training such as aerial identification of cultivated marijuana, legal aspects of drug enforcement support, aircraft safety, aircraft operations, specialized equipment, and other related topics. LEAs must pay for meals, lodging, and transportation for LEA attendees/participants.

(10) Mission #10--Aerial Photo Reconnaissance. National Guard aircraft is used to generate information about specific areas or sites. Supporting unit provides photo analysis and interpretation as required.

(11) Mission #11--Coordination, Liaison and Management. The state establishes liaison with supported LEAs, plans and coordinates operations, resources, personnel, and equipment requirements for those operations, and gathers information for operation/financial reports.

(12) Mission #12--Marijuana Greenhouse/Drug Laboratory Detection. Mission may involve surveillance or monitoring, eradication, and destruction or dismantling of marijuana greenhouses/drug labs. This mission is designed for drug activities in enclosed areas or facilities. LEAs must accompany the operation, and will have obtained necessary authorizations (warrants, permits, etc.) to make necessary arrest/seizures and maintain custody of evidence after neutralization of chemical hazards. National Guard personnel will not handle chemicals or other hazardous materials.

(13) Mission #13--Film Processing for Photo Reconnaissance. The supporting unit provides film processing, photo analysis and interpretation.

(14) Mission #14--Administrative, Information, Logistics, and Maintenance Support. Guard members conduct various support operations when approved. Operation may include mandays to provide administrative, maintenance and logistics support (in MOS/AFSC related areas) to release commissioned law enforcement personnel for

**Counterdrug Coordinator's Handbook 1 October 1992 (ADVANCE COPY)**

counterdrug duty. Support must not be used for non-counterdrug duty. National Guard Bureau policy is that Guard members may translate taped conversations as a means to maintain interpreter or translator proficiency and improve unit readiness. However, Guard personnel will not participate in active/real time conversation monitoring. LEAs must obtain appropriate legal authorization.

(15) Mission #15--Engineer Support. States may request authority to use National Guard engineer support for activities such as maintaining existing border roads, removal of abandoned vehicles suspected as drug drop-off or pick-up locations, or to destroy or deny access to (seal or raze) known "crack houses" or similar facilities such as drug labs, in support of local LEA counterdrug support operations. Local LEA and government must take possession and obtain clearances, court orders, warrants and/or permits for destruction, removal disposal, or other environmental (EPA) hazards/concerns.

(16) Mission #16--Aerial Interdiction. Resources from various units/states may be brought into action in a joint ARNG and ANG "Hub" effort to detect, track, monitor, and transport LEA personnel to effect arrest of drug smugglers/traffickers. Mission includes site security for counterdrug aircraft and for ground mobile radar. Appropriate Memoranda of Agreement must exist between participating states. "Hub" operations will be based on LEA requests and multi-source intelligence; Guard personnel will provide support but not perform arrests/searches/seizures.

**b. Special requirements.**

(1) Eradication, interdiction, and information gathering missions (Missions 1, 2, 4, 5, 7, 8, 10, 12, 14, and 16) have a special requirement for the presence of a law enforcement officer. If LEOs are not collocated with each National Guard support element during an operation, they must be in continuous tactical communication with each element and able to physically respond immediately to each element's location (including each LP/OP).

(2) Missions 1, 2, 4, 5, 7, 8, 10, 12, 14, and 16 are information gathering in nature. Leaders will ensure that there is sufficient chain of command involvement during these missions. National Guard support to the National Drug Control strategy must not be jeopardized by illegal activities and unwarranted intrusion into the privacy of U.S. citizens. National Guard personnel will not maintain or store gathered information files in National Guard facilities or data bases; information will be reported as designated by the supported LEA.

(3) Interstate transport support (Mission numbers 3, 4, 5, 6, and 16) will be coordinated with NGB-CDD on a case-by-case basis. Transportation support is intended for operational counterdrug activity support as opposed to administrative travel support.

(4) Methods of surveillance or reconnaissance may include, but are not limited to, photographic and optical devices, infrared devices, thermal imaging systems, and other sensors.



## CHAPTER 3

### COUNTERDRUG REPORTING

#### 3-1. Reporting Procedures.

a. NGB-CDD has numerous responsibilities in managing the National Guard Counterdrug Support Program, including both operations and budget management. To successfully perform its required functions, NGB-CDD must receive timely and accurate reports from the states.

b. NGB-CDD receives over 6,000 reports each year from the 54 states. To manage this information, several different types of reports are required. Some missions may require several reports--when the mission begins, when the mission results in a seizure, and when the mission ends. Other reports, such as the monthly operational/financial report are submitted periodically.

c. Telephonic reports: Immediately phone Incident Reports to NGB-CDD at DCTN 286-7744 or commercial (703) 746-7744. After duty hours, phone the ANG Readiness Center, Operations Center, at DCTN 858-6001 or commercial (301) 981-6001. (Follow up telephonic Incident Reports by facsimile and hard copy as described in sub-paragraph 3-2(g) below.)

#### d. Facsimile reports.

(1) Submit the Initial Operations Report, Situation/In-Process Report, Seizure Report, and Termination Report (Form 525-R) via facsimile NLT 1600 ZULU (1100 NGB time) each day such reports are required. Submit the Monthly Operational/Financial Report (NGB Form 525-1-R for ARNG, NGB Form 525-2-R for ANG) NLT 5 working days after the end of each month.

(2) The NGB-CDD fax number is DCTN 286-7752 or commercial (703) 746-7752. Do not use a fax cover sheet when sending a properly completed NGB Form 525-R. Send Incident Reports via facsimile as soon as possible, then follow up with a hard copy.

#### e. Hard copy reports.

Counterdrug Coordinator's Handbook 1 October 1992 (ADVANCE COPY)

(1) Mail After Action Reports, LEA Surveys, and National Guard Surveys to NGB-CDD, NLT 15 calendar days following the termination of each operation. Submit the Monthly LEA Request Report within 30 calendar days after the end of each month.

(2) Mail hard copy reports to:

CNGB, ATTN: NGB-CDD  
Pentagon, Room 2D374  
Washington, DC 20310-2500

f. Serious Incident Reports (SIRs). Any SIRs required must be sent through appropriate channels IAW applicable regulations in addition to Counterdrug Support Program reporting requirements.

3-2. Operation numbering system.

a. An eighteen character operation number will identify each operation on all NGB Series 525 Forms. Use the following format:

- (1) Positions 1 and 2: State postal code.
- (2) Positions 3 thru 6: Serial number.
- (3) Position 7 and 8: Fiscal Year.
- (4) Positions 9 thru 16: Supported agency abbreviation (may be any number of characters less than 9).
- (5) Positions 17 and 18: NGB Mission number (from paragraph 2-10).

b. An example operation number would be: TX-0508-92-DEA-14.

c. Definition of "an operation." For purposes of counterdrug reporting, an operation is defined as each identifiable iteration, occurrence, or location of one of the 16 NGB Approved Missions, based on a LEA request to conduct that mission. Therefore, it is possible for a single operation (with an individual number) to last for any period of time from hours to months. An ongoing operation should not be repeatedly reported with new operation numbers on a daily, weekly, monthly, or quarterly basis. Accordingly, at the very minimum there should be an Initial Operations Report, a Termination Report, an After Action Report, a LEA Survey, and National Guard Survey submitted for each operation.

3-3. NGB Counterdrug Support Program reports. Submit the following required reports as indicated. Appendix E contains sample report forms and formats.

a. Initial Operations Report (NGB Form 525-R). This is a facsimile report submitted NLT the day before any operation begins. The report must be received by NGB-CDD NLT 1600 hours ZULU (1100 NGB time) in the format identified in Appendix E, Tab 6.

b. Situation/In-Process Report (SITREP) (NGB Form 525-R). This is a facsimile report submitted NLT 1600 ZULU (1100 NGB time) daily for operations currently underway. Submit this report only if there is a change since the previous report. (Enter only state, POC, and operation identification information in addition to new or changed data. Include seizure, flying hours, and cargo inspection information). Do not enter information that is unchanged since previous reports. Submit this report in the format identified at Appendix E, Tab 6.

c. Seizure Report (NGB Form 525-R). This is a facsimile report submitted to NGB-CDD for any operation in which the National Guard was providing support, which resulted in a seizure. Information submitted must be cumulative Fiscal year-to-date, by a state operation number. Submit reports in the format identified in Appendix E, Tab 6. (Complete only those portions of the form necessary to report state, POC, operation identification, seizure and new or changed information.) Submit these reports regardless of whether the LEAs are reporting the same data. This information is vital for reporting up the chain of command and must be as timely as possible to avoid misrepresenting seizures for a particular period of time.

d. Termination Report (NGB Form 525-R). This is a facsimile report submitted immediately upon termination of any operation. Submit this report NLT 1600 ZULU (1100 NGB time) in the format identified at Appendix E, Tab 6. (Complete only those portions of the form necessary to report state, POC, operation identification, and new or changed information including seizure, flying hours, and cargo inspection data.)

e. Monthly Operational/Financial Report. This is a facsimile report submitted NLT 5 workdays after the end of each month. Submit these reports in the format identified at Appendix E, Tab 2 (NGB Form 525-2-R) for ARNG and Appendix E, Tab 1 (NGB Form 525-1-R) for ANG. This form will also be used to track the expenditures for each operation and kept in the appropriate operation folder.

f. After Action Report, LEA Survey, National Guard Survey. Mail these written reports to NGB-CDD NLT 15 calendar days after completing an operation. Do not send after action and survey reports via facsimile. Submit After Action Reports using the format identified in Appendix F. The LEA Survey (NGB Form 525-3-R, Appendix E, Tab 3), and the National Guard Survey (NGB Form 525-4-R, Appendix E, Tab 4) must be included as part of the After Action Report.

g. Monthly LEA Request Report (NGB Form 525-5-R). Submit this report within 30 calendar days after the end of the month. The format is at Appendix E, Tab 5.

h. Incident Report.

(1) This is an initial telephonic report, followed by facsimile transmission, and then a hard copy in memorandum format. Make this report to NGB-CD immediately after an incident involving:

- (a) Death or personal injury to any person involved in an operation.
- (b) Any loss, theft, damage or destruction of property in connection with the operation.
- (c) Any attempt by unauthorized individuals/suspected traffickers to gather any information pertaining to counterdrug support operations.

(2) The incident report will contain as much detail as is available and will answer the questions who, what, why, and how, as applicable, i.e., what occurred and how (type of incident), when (date/time of incident), where and who was involved. Provide the name of a POC and their telephone number. During non-duty hours, make initial telephonic reports involving incidents (Army and Air) to the NGB Duty Officer at the ANG Readiness Center, Operations Center, Andrews Air Force Base DCTN 858-6001 or commercial (301) 981-6001.

i. Use of forms. Locally reproduce NGB Form 525-R (State Counterdrug Support Operations Report), NGB Form 525-2-R (Army National Guard Monthly Financial Report), NGB Form 525-1-R (Air National Guard Monthly Financial Report), NGB Form 525-4-R (National Guard Counterdrug Support Operations National Guard Survey), and NGB Form 525-5-R (National Guard Counterdrug Support Operations Law Enforcement Request Report) on 8 1/2 x 11 inch paper. Appendix E at the back of this handbook contains a copy of each of these forms for reproduction.

CHAPTER 4

REVIEW AND EVALUATION

4-1. Review and evaluation.

a. The Office of Counterdrug Review and Evaluation (NGB-CDR) is responsible to monitor, implement internal controls, perform periodic inspections, and conduct reviews to evaluate the effectiveness of management and execution of the National Guard Counterdrug Support Program for all 54 states. NGB-CDR ensures that internal controls detect any loss, fraud, waste, or abuse of resources and assets. This office also provides assistance to all organizations involved in National Guard support to counterdrug law enforcement agencies.

b. The state Counterdrug Coordinator or POMSO will provide NGB-CDR copies of all reviews, inspections, and evaluations conducted in the state counterdrug program.

c. The NGB-CDR Counterdrug Review and Evaluation Checklist is at Annex K. This checklist is the internal control guide for all National Guard organizations in the Counterdrug Support Program. NGB-CDR will use this checklist to review and evaluate state counterdrug programs.

APPENDIX A--REFERENCES

Section I  
REQUIRED PUBLICATIONS

Title 32, United States Code  
National Drug Control Strategy - Sep 89, 90,  
Feb 91, and Jan 92

DoD Directive 4515.13R  
Air Transportation Eligibility

DoD Directive 4500.9  
Transportation and Traffic Management

AR 11-2  
Internal Control Systems

AR 25-55  
Department of the Army Freedom of Information  
Act

AR 37-100-85  
The Army Management Structure

AR 40-3  
Medical, Dental and Veterinary Care

AR 40-501  
Standards of Medical Fitness

AR 135-200  
Active Duty for Training, Annual Training and  
Active Duty Special Work of Individual Soldiers

AR 340-21  
The Army Privacy Program

AR 380-67  
Headquarters DA Personnel Security Program

AR 385-10  
Army Safety Program

AR 600-9  
Army Weight Control Program

AR 600-110  
Identification, Surveillance and Administration of  
Personnel infected with Human  
Immunodeficiency Virus (HIV)

AR 700-131  
Loan of Army Material

AFR 12-30  
Air Force Freedom of Information Act Program

AFR 12-35  
Air Force Privacy Act Program

AFR 20-14  
Management of Government Property in the  
Possession of the Air Force

AFR 67-23  
Standard Base Supply Customer's Guide

AFR 127-2  
The U.S. Air Force Mishap Prevention Program

AFR 160-43  
Medical Examinations and Medical Standards

AFR 208-1  
Federal Tort Claims Act

NGR 37-111  
Administration of Training and Special Work  
Workdays

NGR 40-3  
Medical Care for Army National Guard Members

NGR 40-501  
Medical Examination for Members of the Army  
National Guard

NGR (AR) 95-210  
Army National Guard: General Provisions and  
Regulations for Aviation Training

NGR (AR) 600-5  
The Active Guard/Reserve (AGR) Program, Title  
32 Full-Time National Guard Duty (FTNGD)

NGB Pam 360-5/ANGP 190-9  
National Guard Public Affairs Guidelines

ANGR 50-01  
Active and Inactive Duty For Training  
Management Within the Air National Guard

ANGR 67-1  
Loan and Use of Property Issued to the Air  
National Guard

TPR 990-2  
Hours of Duty, Pay and Leave

Section II  
RELATED PUBLICATIONS  
(A related publication is merely a source of  
additional information. The user does not have  
to read it to understand this regulation).

**Counterdrug Coordinator's Handbook**

**1 October 1992 (Advance Copy)**

4th Amendment to the U.S. Constitution

DoD Directives: 5525.5  
DoD Cooperations with Civilian Law  
Enforcement Officials; 5149.1; 5160.54

AR 25-1  
The Army Information Resources Management  
Program

AR 71-13  
Department of the Army Equipment  
Authorization and Usage Program

AR 95-1  
Flight Regulations

AR 130-5/AFR 45-17  
Organization and Functions of National Guard  
Bureau

AR 190-40  
Serious Incident Reporting

AR 190-51  
Security of Army Property at Unit /Installation  
Level

AR 310-49  
The Army Authorization Documents System  
(TAADS)

AR 700-1  
Army Conversion to the Metric System of  
Measurement

DA Pam 190-52  
Personnel Security Precautions Against  
Terrorism

AFR 55-3  
Operations (Reporting, Meaconing, Intrusion,  
etc.)

AFM 67-1  
USAF Supply Manual

CTA 50-909  
Field and Garrison Furnishings and Equipment

FORSCOM/ARNG 350-2  
Reserve Component Training

NGR 10-2  
State Area Command, Army National Guard

NGR (AR) 95-1

ARNG Aviation: Flight Regulations (Modifies  
AR 95-1)

NGR 190-11  
Physical Security of Arms, Ammunition, and  
Explosives

NGR (AR) 350-1  
Army National Guard Training

NGR (AR) 500-1/NGR (AF) 55-5  
Military Support to Civil Authorities

NGR (AR) 600-85  
Drug Abuse Prevention and Control

ANGR 23-01  
State Air National Guard Headquarters

ANGR 35-03  
Full-Time Military Duty Personnel Program - Air  
National Guard

Section III  
NATIONAL INTERAGENCY COUNTERDRUG  
INSTITUTE (NICI) PUBLICATIONS

Special Reports

Public Lands Drug Control Committee - 1990  
After Action Assessment Seminar

\*Information and Intelligence Resources for the  
Law Enforcement Agencies on the Southwest  
Border

Counterdrug Managers' Course Resource Guide

National Guard Counterdrug Lessons Learned

NICI also publishes a variety of Information  
Papers, a monthly "NICI BULLETIN", on  
counterdrug related conferences and seminars,  
and "THE INFORMANT", a training and  
enforcement update.

Note: \*FOUO - Published for Operation Alliance.  
Available only to approved law enforcement and  
military agencies/organizations.

Appendix B--Glossary

Section I  
Abbreviations

ADSW  
Active Duty Special Work

AFSC  
Air Force Specialty Code

AGR  
Active Guard Reserve

ANG  
Air National Guard

ANGRC/DON  
Air National Guard, Counterdrug  
Division

ANGRC/LGS  
Air National Guard, Directorate of  
Logistics

ANGRC/SGP  
Air National Guard, Physical Standards  
Branch

ARNG  
Army National Guard

ASC  
Allowance Source Code

AT  
Annual Training

CNAC  
Customs National Aviation Center

CONUS  
Continental United States

CONUSA  
Continental United States Army

DAT  
Drug Analysis Testing

DLEA  
Drug Law Enforcement Agency

DoD  
Department of Defense

DPP  
Dedicated Procurement Program

EER  
Enlisted Evaluation Report

ENTNAC  
Entrance National Agency Check

EPIC  
El Paso Intelligence Center

ESP  
Emergency Special Program

ESSO  
Executive Support Staff Officer

FOIA  
Freedom of Information Act

FTCA  
Federal Tort Claims Act

FTNCD  
Full-Time National Guard Duty

HIV  
Human Immunodeficiency Virus



IAD Inactive Duty Training	NCOER Noncommissioned Officer Evaluation Report
IDT Inactive Duty Training	NGB National Guard Bureau
JAC Judge Advocate General	NGB-ARC-B National Guard Bureau, Army Comptroller Division (Budget)
JTF Joint Task Force	NGB-ARL National Guard Bureau, Army Guard, Logistics Division
LEA Law Enforcement Agency/Agent	NGB-ARM National Guard Bureau, Full-Time Support Division
LEO Law Enforcement Officer	NGB-ARS-MS Office of the Army Surgeon, Medical Standards
MOA Memoranda of Agreement	NGB-AVN National Guard Bureau, Aviation Division
MOS Military Occupational Specialty	NGB-CD National Guard Bureau, Counterdrug Task Force
MOU Memoranda of Understanding	NGB-CDD National Guard Bureau, Counterdrug Support Division
MRD Mandatory Retirement Date	NGB-JA National Guard Bureau, Judge Advocate
MSD Mandatory Separation Date	NGB-PA National Guard Bureau, Public Affairs
NAC National Agency Check	ANGRC/SCAR National Guard Bureau, Air National Guard, Resource Office
NCIC National Crime Information Center	
NCO Non commission Officer	

<b>NCPA</b> National Guard Personnel Appropriation	<b>PIP</b> Personnel Integrity Program
<b>NICI</b> National Interagency Counterdrug Institute	<b>POC</b> Point of Contact
<b>NORAD</b> North American Aerospace Defense Command	<b>POMSO</b> Plans, Operations, and Military Support Officer
<b>OER</b> Officer Evaluation Report	<b>RLSO</b> Regional Logistical Support Office
<b>OMARNG</b> Army National Guard Operations and Maintenance Appropriation	<b>RON</b> Remain Overnight
<b>OMNG</b> National Guard Operations and Maintenance Appropriation	<b>SAAO</b> State Army Aviation Officer
<b>OPLAN</b> Operation Plan	<b>SECDEF</b> Secretary of Defense
<b>OPORD</b> Operation Order	<b>SITREP</b> Situation Report
<b>OPSEC</b> Operations Security	<b>SOP</b> Standard Operating Procedures
<b>OPR</b> Officer Performance Report	<b>SPMD/UMD</b> Office of the Air Surgeon, Aerospace Medicine
<b>OSD</b> Office of the Secretary of Defense	<b>ST</b> Special Training
<b>PAO</b> Public Affairs Officer	<b>STARC</b> State Area Command
<b>PCS</b> Permanent Change of Station	<b>TAADS</b> The Army Authorization Documents System
<b>PIC</b> Pilots in Command	<b>TDA</b> Table of Distribution and Allowances

TDC  
Type Duty Code

TPF  
Total Package Fielding

TPR  
Technician Personnel Regulation

UMD  
Unit Manning Document

USCS  
U.S. Customs Service

USMEPCOM  
U.S. Military Entrance Processing  
Command

USPFO  
U. S. Property and Fiscal Officer

## **Counterdrug Coordinator's Handbook**

1 Oct

### **Section II Terms**

#### **Adjutant General**

Refers to the Commanding General in those states without an Adjutant General

#### **Attorney General**

Refers to the equivalent official in states without an Attorney General

#### **Civil Authorities**

Elected and appointed public officials and employees of federal, state, and local government.

#### **Counterdrug Support Program**

Support provided to federal, state or local LEAs and other civil authorities to assist with drug interdiction and other counterdrug support authorized by Section 112 of Title 32, United States Code (32 USC 112) in support of the National Drug Control Strategy.

#### **Exigent Circumstances**

Circumstances in which immediate action is necessary to protect police officers, Guard personnel, or other persons from injury; to prevent loss or destruction of evidence; or to prevent the escape of a suspect already in custody.

#### **Incidental to Training**

Previously or otherwise scheduled training which would have been performed regardless of counterdrug operations. Routes and schedules may be altered in order to maximize counterdrug benefits.

#### **Law Enforcement Agency (LEA)**

An organization, or a coordinating council comprised of several LEAs, empowered by local, state or federal law to investigate, enforce or prosecute criminal laws regarding illegal drugs and controlled substances.

#### **National Guard**

Except as stated otherwise, National Guard means a state National Guard when not in federal service, or all such organizations collectively.

#### **States**

For the purpose of this regulation, "states" includes all 50 states, the Commonwealth of Puerto Rico, the U.S. Virgin Islands, Guam and the District of Columbia.

#### **State Plans**

Plans submitted by the states for National Guard counterdrug support activities as authorized by 32 USC 112.

\_\_\_\_\_  
(Last Name)

Pregnancy Certification Form

To: Commander, \_\_\_\_\_ Date \_\_\_\_\_

I certify that I have been briefed on the provisions of NGR (AR) 500-2/NGR (AF) 55-6, paragraph 2-9 and The Counterdrug Coordinator's Handbook, subparagraph 2-3e(6). I further certify that, to the best of my knowledge, I am not pregnant at this time. I understand that if I am pregnant when my tour ends, I may not be eligible for a follow-on tour until the conclusion of my pregnancy.

\_\_\_\_\_  
(Witness)

\_\_\_\_\_  
(Signature)

\_\_\_\_\_  
(Print Name)

\_\_\_\_\_  
(Name)

\_\_\_\_\_  
(Last Name)

Informed Consent Form

My signature affirms that \_\_\_\_\_ has disclosed to me in simple, non-technical language, the nature of the Personnel Integrity Program as specified in NGR (AR) 500-2/NGR (AF) 55-6. I understand that a personal background/integrity check will be made and that satisfactory results are a condition of my employment in the National Guard Counterdrug Support Program. I understand that I may revoke this consent at any time; however, without the aforementioned checks, I am ineligible for tour assignment with the Counterdrug Support Program.

\_\_\_\_\_  
(Witness)

\_\_\_\_\_  
(Signature)

\_\_\_\_\_  
(Print Name)

\_\_\_\_\_  
(Name)



COMPLETE ALL PERTINENT INFORMATION

State Counterdrug Support Operations Report

Proponent: Agency NGB-CDD

TO: Counterdrug Task Force					1. FROM (STATE):	
2. DATE:						
3. Operation Number:		State	Serial #	FY	Agency	NGB #
					4. Operation Code Name:	
5. POC:			6. Telephone:		7. Fax Line:	
8. Initial <input type="checkbox"/>		Situation/ In-Process <input type="checkbox"/>		Seizure <input type="checkbox"/>		Termination <input type="checkbox"/>
9. Agency Supported:						
10. Location of Operations:						
11. Start Date:				12. Scheduled Ending Date:		
13. Counterdrug Funded		Incidental to Training				
Title 32 <input type="checkbox"/>	Title 10 <input type="checkbox"/>	AFTP <input type="checkbox"/>		IDT <input type="checkbox"/>	Annual Training <input type="checkbox"/>	
14. ARNG Commissioned/Warrant: Units:				ARNG Enlisted:		
15. ANG Commissioned: Units:				ANG Enlisted:		
16. Equipment (Including uniforms, weapons, vehicles, radios, etc.):						
Aircraft by type:						

FYTD NATIONAL GUARD ASSISTED SEIZURE INFORMATION

17. (Cumulative- Expressed in pounds and decimals thereof)

A. # MJ Plants:	B. Cocaine Lbs:	C. Heroin Lbs:
D. MJ Lbs:	E. Opium Lbs:	F. Hashish Lbs:
G. Vehicles:	H. Weapons:	I. Ammo Rounds:
J. Arrest:	K. Currency (\$\$):	L. Other Drugs Lbs:
M. Property \$\$ Value:	N. Property by Type:	

FLYING HOURS

18.

Aircraft Hrs Flown:	UH-1:	OH-58:	OH-6:	C-130:	C-12:
F-16:	RF-4C:	T-42:	UH-60:	C-26:	OV-1D:
Other:					

FYTD CARGO INSPECTION (IN-PROCESS) INFORMATION

This information is required (Cumulative FYTD)

19.

A. Containers:	B. Aircraft:	C. Vehicles:
D. Buses:	E. Vessels:	F. 55 Gal. Drums:
G. Pallets Full: Pallets Empty:	H. Crates Full: Crates Empty:	I. Trailers Full: Trailers Empty:
J. Warehouses:	K. Boxes, etc.:	L. Buildings:



## AAR INSTRUCTIONS

### Part I

This should be a one page objective summary of the mission.

1-3. Self explanatory

4. Use the operations number from the following list:

Ops # Description

- (1) Ground Recon or Mobile Patrols
  - (2) Ground Surveillance (Drug Interdiction)
  - (3) Surface Transportation Support
  - (4) Aerial Recon (Marijuana Eradication)
  - (5) Aerial Surveillance (Drug Interdiction)
  - (6) Aerial Transportation Support
  - (7) Ground Radar Support (Includes Security)
  - (8) Cargo Inspection (Includes vehicles)
  - (9) Training Program (Military and DLEA)
  - (10) Aerial Photo Recon
  - (11) Coordination, Liaison, and Management
  - (12) Marijuana/Drug Lab Eradication/Detection
  - (13) Film Processing for Photo Recon
  - (14) Administration, Information, Automated Data Processing, Logistics, and/or Maintenance Support
  - (15) Engineer Support
  - (16) Aerial Interdiction Support
  - (17) Other (Describe)
- 5-9. Self explanatory
10. e.g. Active Army: #; Army National Guard: #, Active Air Force: #; etc.
- 11-14. Self explanatory
- 15-16. Obtain from supported DLEA
- 17-18. Self explanatory

### Part II

a. Mission Description. This is a brief description of what was supposed to happen and what did happen. Line and block charts may be used to show chains of command and communications arrangements.

b. Lessons learned. These should address what went right, what went wrong, and how things could be done better next time from the perspectives of: the supported DLEA, supporting military unit, and controlling headquarters (CONUSA, Joint Task Force, etc.).

### Part III

Attach these documents to the AAR, if applicable.

Appendix I--Counterdrug Support Personnel File Checklist

Name and Rank

\_\_\_\_\_

SSN \_\_\_\_\_

Form

Date Filed

Orders \_\_\_\_\_

Medical Requirements

Physical Exam (SF 88 & 93 or Statement in Lieu of Exam) \_\_\_\_\_

HIV Test Result \_\_\_\_\_

Urinalysis \_\_\_\_\_

Pregnancy Certification (females) \_\_\_\_\_

Background Checks

Personnel Record \_\_\_\_\_

Local Agency Check \_\_\_\_\_

National Crime Information Center Check \_\_\_\_\_

State LEA Check \_\_\_\_\_

Unit Commander's Recommendation \_\_\_\_\_

Personal Interview \_\_\_\_\_

Informed Consent \_\_\_\_\_

Consent to Release Information \_\_\_\_\_

Briefings Received

Safety \_\_\_\_\_

Rules of Engagement \_\_\_\_\_

Standards of Conduct \_\_\_\_\_

Pre-Commitment \_\_\_\_\_

OPSEC \_\_\_\_\_

Physical Security \_\_\_\_\_

World Threat \_\_\_\_\_

Guidelines for Vehicle Use \_\_\_\_\_

Federal Tort Liability Claims Act \_\_\_\_\_

Line of Duty Counseling \_\_\_\_\_

Duty Performance Evaluation \_\_\_\_\_

Copy of Civilian & Military Driver's License \_\_\_\_\_

Appendix J--Counterdrug Support Operation File Checklist

Operation Number \_\_\_\_\_

Date File Opened \_\_\_\_\_ Date  
 Closed \_\_\_\_\_

<u>Item</u>	<u>Date Entered</u>	<u>Initials</u>
LEA Request	_____	_____
Threat Analysis	_____	_____
Risk Assessment	_____	_____
OPORD/OPLAN	_____	_____
Initial Operations Report	_____	_____
Situation/In-Process Report	_____	_____
Seizure Report*	_____	_____
Termination Report	_____	_____
Obligations/Expenditures	_____	_____
Incident Report*	_____	_____
After Action Report	_____	_____
LEA Survey Report	_____	_____
NG Survey Report	_____	_____
Media Report*	_____	_____

\*As required

1 OCTOBER 1992

NATIONAL GUARD BUREAU  
DIRECTOR, COUNTERDRUG TASK FORCE  
OFFICE OF COUNTERDRUG REVIEW AND EVALUATION  
PENTAGON, WASHINGTON, DC 20310-2500

(REVIEW AND EVALUATION CHECKLIST)

REFERENCES:

- AR 11-2, INTERNAL MANAGEMENT CONTROL
- AFR 15-1, AIR FORCE INTERNAL CONTROLS
- AR 20-1, INSPECTOR GENERAL ACTIVITIES AND PROCEDURES
- AR 25-1, THE ARMY INFORMATION RESOURCES MANAGEMENT PROGRAM
- AR 37-100-XX, 92, 93 THE ARMY MANAGEMENT STRUCTURE (AMS)
- AFR 123-1, THE INSPECTION SYSTEM
- NGR (AR) 500-2/NGR (AF) 55-6, NATIONAL GUARD COUNTERDRUG SUPPORT TO LAW ENFORCEMENT AGENCIES

STATE: \_\_\_\_\_  
DATE: \_\_\_\_\_  
LOCATION: \_\_\_\_\_  
POMSO:  
NAME: \_\_\_\_\_ RANK: \_\_\_\_\_  
STATE DRUG COORDINATOR:  
NAME: \_\_\_\_\_ RANK: \_\_\_\_\_



1 OCTOBER 1992

NATIONAL GUARD BUREAU OFFICE OF COUNTERDRUG REVIEW AND EVALUATION (NGB-CDR). IT SERVES AS AN INTERNAL CONTROL GUIDE FOR ALL NATIONAL GUARD ORGANIZATIONS RESPONSIBLE FOR OR INVOLVED IN PROVIDING COUNTERDRUG SUPPORT TO LAW ENFORCEMENT AGENCIES (LEAs).

EVALUATION OBJECTIVE:

1. To evaluate the management of the state's Counterdrug Support Program as specified by policies, regulations, and guidance provided by the National Guard Bureau.
2. To evaluate the receipt, distribution, and obligation practices of Counterdrug Support Funds.
3. To evaluate the effectiveness of management and use of resources.
4. To evaluate the management of aviation resources to include flying hours.
5. To evaluate the procurement and management controls of equipment.
6. To evaluate lease of equipment and facilities.
7. To evaluate the adequacy, effectiveness, and management of the State Counterdrug Support Program, to ensure that all operations are conducted in accordance with DoD, DA, DAF, NGB regulations, policies and procedures and state laws.
8. To determine if the state has consulted and coordinated with appropriate Law Enforcement Agencies (LEAs) before developing plans and initiating support.
9. To determine if the State Attorney General has certified that Counterdrug activities comply with and are authorized by state laws.
10. To determine if the State NG Public Affairs offices are working in direct coordination with LEA's Public Information Offices for interface with news media representatives.

COUNTERDRUG COORDINATOR'S HANDBOOK  
APPENDIX K

1 OCTOBER 1992

11. To determine if the POMSO/Counterdrug Coordinator is maintaining historical records (files) on all operations supported by the National Guard.
12. To determine if each mission folder (file) contains the required counterdrug reports.
13. To determine if the state has developed a feedback mechanism with the LEAs to evaluate and improve support.
14. To determine if the state is: a) measuring the effectiveness of the support to LEAs in the following areas: satisfactory responses to valid requests, timeliness of support provided, and execution of counterdrug plans, and b) evaluating local policies and taking action on identified deficiencies.
15. To determine if the state assesses the degree of completion of priority elements within its plan and to review the method of assessment for adequacy and completeness.
16. To evaluate all Memorandum of Understanding/Agreement (MOU/MOA) between the state and supported LEAs.
17. To evaluate all Internal Controls in the Counterdrug Support Program.
18. To review the training of CD personnel and use of Active Duty/Special Work (ADSW) in the Counterdrug Support Program.
19. To evaluate the propriety of Guard equipment usage including the adequacy of reimbursements to the National Guard.

**ASSESSABLE UNIT**            NGB, AND ALL ARMY AND AIR NATIONAL GUARD UNITS OF THE SEVERAL STATES, THE COMMONWEALTH OF PUERTO RICO, GUAM, THE VIRGIN ISLANDS AND THE DISTRICT OF COLUMBIA.

**STEP 1:**                    Develop goals and objectives with law enforcement agencies.

**RISK:**                      Counterdrug support operations or program will be severely impaired without a reasonable working plan.

1 OCTOBER 1992

- CONTROL OBJECTIVE:** Develop/implement policies, procedures, and controls to ensure the most management effective and efficient use of resources to accomplish the mission and meet objectives.
- CONTROL TECHNIQUE:** Implement policies, procedures, and controls to standardize the Counterdrug Support Program and ensure that policies are implemented and enforced.
- TESTING:** Testing is required to verify that control techniques are operational and functioning as intended.

COUNTERDRUG REVIEW AND EVALUATION CHECKLIST

- STATE PLANS:**  
Are the state plans certified by State Attorney General verifying that support is authorized? Yes No  
**REMARKS:**
- Are the state plans reviewed by the USPFO and JAG? Yes No  
**REMARKS:**
- Are state plans marked FOR OFFICIAL USE ONLY AND EXEMPT FROM MANDATORY DISCLOSURE? Yes No  
**REMARKS:**
- Are the counterdrug support plans coordinated with appropriate federal, state, and local agencies and approved (signed) by the Adjutant General IAW NGR (AR) 500-2/NGR (AF) 55-6? Yes No  
**REMARKS:**
- Does the POMSO keep records of counterdrug support planning meetings? Yes No  
**REMARKS:**
- Is the State Aviation Officer part of the counterdrug planning staff? Yes No  
**REMARKS:**
- Is the Executive Support Staff Officer (ESSO) part of the counterdrug planning staff? Yes No  
**REMARKS:**



1 OCTOBER 1992

COUNTERDRUG REVIEW AND EVALUATION CHECKLIST

MEMORANDUM OF UNDERSTANDING/AGREEMENT:

Are MOUs/MOAs reviewed by the USPFO and JAG? Yes No  
REMARKS:

Is a "Hold Harmless" clause included in Non-Federal agency MOUs/MOAs? Yes No  
REMARKS:

Are MOUs/MOAs marked FOUO and EXEMPT FROM MANDATORY DISCLOSURE? Yes No  
REMARKS:

Are parameters for employment of National Guard personnel and equipment included in all MOUs/MOAs? Yes No

- (1) Reporting procedures
- (2) Command and Control Procedures
- (3) OPSEC
- (4) Communication channels
- (5) Scope of approved operations
- (6) Property accountability
- (7) Force protection
- (8) Public Affairs
- (9) Safety
- (10) Time frame

REMARKS:

Are MOUs/MOAs reviewed by the SAO/ESSO when aviation support is requested? Yes No  
REMARKS:

MISSION FILES/OPERATIONS:

Are documented LEA requests being retained for two years? Yes No  
REMARKS:

Is a LEA historical record (requests) of unsupported missions maintained on file? Yes No  
REMARKS:

1 OCTOBER 1992

COUNTERDRUG REVIEW AND EVALUATION CHECKLIST

Are all missions conducted/supported approved in the state plan? REMARKS:	Yes	No
Are safety risk assessments and accident prevention measures conducted? REMARKS:	Yes	No
Are operations plans/orders utilized for each operation? REMARKS:	Yes	No
Are Standard Operating Procedures (SOP) utilized? REMARKS:	Yes	No
Is an index utilized in each operation file? REMARKS:	Yes	No
Is a LEA representative present during the conduct of all operations? REMARKS:	Yes	No
Are all obligations/expenditures tracked by operation? REMARKS:	Yes	No
Is the Adjutant General authorizing wear of civilian clothing on a case-by-case basis? REMARKS:	Yes	No
Are all counterdrug support operations, regardless of status in which conducted reported to NGB-CD? REMARKS:	Yes	No
Did the state experience any emergency or immediate action situations during CD operations? REMARKS:	Yes	No
Did the state notify NGB-CD immediately? REMARKS:	Yes	No
Is this action documented? REMARKS:	Yes	No
Are all National Guard Counterdrug missions/operations coordinated with the POMSO? REMARKS:	Yes	No

1 OCTOBER 1992

COUNTERDRUG REVIEW AND EVALUATION CHECKLIST

Is the state developing/utilizing operation files IAW NGR (AR) 500-2/NGR (AF) 55-6? REMARKS:	Yes	No
Are state counterdrug operations controlled and managed from one local central point? REMARKS:	Yes	No
Are counterdrug operations historical and current supporting records in one central point, IAW NGR (AR) 500-2/NGR (AF) 55-6? REMARKS:	Yes	No
SECURITY/PERSONNEL INTEGRITY PROGRAM (PIP):		
Are National Guard personnel being briefed on Operations Security (OPSEC) by an appropriate security manager? REMARKS:	Yes	No
Are National Guard personnel being briefed on Physical Security to include facilities and equipment IAW AR 190-51? REMARKS:	Yes	No
Are National Guard personnel being briefed on security of weapons and ammunition IAW NGR 190-11? REMARKS:	Yes	No
Are individuals who volunteer for counterdrug support being screened IAW NGR (AR) 500-2/NGR (AF) 55-6 and NGB-CD policies and procedures? REMARKS:	Yes	No
Are personal interviews conducted IAW AR 380-67, Appendix G/AFR 205-32, Attachment 7? REMARKS:	Yes	No
Are local criminal records checks conducted? REMARKS:	Yes	No
Are National Crime Information (NCIC) checks conducted? REMARKS:	Yes	No
PERSONNEL:		
Are orders coded U.S.C. Title 32 section 502? REMARKS:	Yes	No

1 OCTOBER 1992

COUNTERDRUG REVIEW AND EVALUATION CHECKLIST

Are MOSS/AFSCs commensurate with support to LEAs? REMARKS:	Yes	No
Are PCS/VHA costs identified/forecast? REMARKS:	Yes	No
Are any entitlements being denied? REMARKS:	Yes	No
Is rank commensurate with the mission/operational duty? REMARKS:	Yes	No
Are personnel being used within commuting distance? REMARKS:	Yes	No
Are Technician Personnel employed IAW TPR 990-2? REMARKS:	Yes	No
Are AGR Personnel employed IAW Regulations? REMARKS:	Yes	No
Are operations/counterdrug staff overmanned? REMARKS:	Yes	No
Are personnel placed on ADSW/ST for more than 90 consecutive days receiving a performance evaluation in compliance with NGR (AR) 500-2/ NGR (AF) 55-6? REMARKS:	Yes	No
Are members placed on extended orders for the duration of the operation? REMARKS:	Yes	No
Are counterdrug personnel attending IDT/IAD training assemblies? REMARKS:	Yes	No
Are counterdrug personnel receiving military training in excess of three consecutive days taken off counterdrug support orders in compliance with NGR (AR) 500-2/ NGR (AF) 55-6? REMARKS:	Yes	No
Is an index utilized in each personnel file? REMARKS:	Yes	No

1 OCTOBER 1992

COUNTERDRUG REVIEW AND EVALUATION CHECKLIST

- Are personnel ordered to ADSW 30 days or less completing AF Form 895, or Appendix B, NGR 40-501, accomplishing urinalysis drug testing, and meeting worldwide service requirements to include pregnancy restrictions, prior to issuance of orders? Yes No  
REMARKS:
- Are personnel tested for drug usage prior to being placed on initial orders? Yes No  
REMARKS:
- Are personnel separated from the counterdrug program for more than 90 consecutive days re-tested for drugs prior to returning to ADSW orders? Yes No  
REMARKS:
- Are personnel on orders for greater than 30 consecutive days receiving Chapter 2/4 physicals? Yes No  
REMARKS:
- Are personnel being terminated who have not received physical results within 30 days? Yes No  
REMARKS:
- Are personnel with breaks of greater than 90 days and who possess a current counterdrug physical signing a statement in lieu of current medical examination? Yes No  
REMARKS:
- Are personnel participating in the counterdrug program prior to medical waivers being approved? Yes No  
REMARKS:
- Are HIV tests being conducted? Yes No  
REMARKS:
- Is annual urinalysis testing of counterdrug personnel being conducted? Yes No  
REMARKS:
- Does the state counterdrug program conduct random drug testing? Yes No  
REMARKS:
- Is a pregnancy certification statement being signed? Yes No  
REMARKS:

COUNTERDRUG COORDINATOR'S HANDBOOK  
APPENDIX K

1 OCTOBER 1992

COUNTERDRUG REVIEW AND EVALUATION CHECKLIST

Is the state developing/utilizing personnel files IAW National Guard Coordinator's Handbook? REMARKS:	Yes	No
Does the state screen all members' (to include officers) qualifications prior to assignment to the counterdrug program? REMARKS:	Yes	No
Is a review of military personnel records being conducted? REMARKS:	Yes	No
Are CD personnel receiving a Unit Commander recommendation prior to entering the CD Support Program? REMARKS:	Yes	No
Is a "Statement of Release of Personal Information" signed by NG personnel in the Counterdrug Support Program? REMARKS:	Yes	No
Does the state have supporting documents verifying that NG personnel have attended periodic refresher training, IAW NGR (AR) 500-2/NGR (AF) 55-6? REMARKS:	Yes	No
Does the state maintain supporting documentation (daily rosters, etc.) to verify the presence of all NG personnel on duty IAW NGR (AR) 500-2/NGR (AF) 5-6? REMARKS:	Yes	No
Is the counterdrug personnel daily roster verified by the POMSO or drug coordinator IAW NGR (AR) 500-2/NGR (AF) 55-6? REMARKS:	Yes	No
Does a local system exist to adequately manage and control personnel and equipment resources? REMARKS:	Yes	No
Are physicals reviewed for preexisting and possibly disqualifying medical conditions? REMARKS:	Yes	No

COUNTERDRUG REVIEW AND EVALUATION CHECKLIST

FINANCE/FUNDING:

- Is there supporting documentation for all funding transactions? Yes No  
REMARKS:
- Are all local funding documents properly coordinated and reviewed prior to signature to preclude over-distribution of program funding? Yes No  
REMARKS:
- Are procedures in place to prevent an over-distribution or over-obligation of funds? Yes No  
REMARKS:
- Does a local system exist to adequately account for and control funds to prevent fraud, waste, and abuse of resources? Yes No  
REMARKS:
- Is a counterdrug Fund Control Ledger maintained and coordinated with the USPFO? Yes No  
REMARKS:
- Does the state have a local internal management control program that would detect any loss, waste, or abuse of assets? Yes No  
REMARKS:
- Does the state retain historical records for audit trail? Yes No  
REMARKS:
- Is the POMSO or CD Coordinator receiving a CD financial (local) summary from the USPFO? Yes No  
REMARKS:
- What is the time cycle for current (up-to-date) funds data from the USPFO managers to the POMSO/CD Coordinator? Is it current? -----  
Yes No  
REMARKS:
- Is the CD financial (local) summary being reconciled by the CD Coordinator/CD staff? Yes No  
REMARKS:
- Does the CD Coordinator or a member of their staff verify travel expenses (hotel/motel etc.)? Yes No  
REMARKS:

COUNTERDRUG REVIEW AND EVALUATION CHECKLIST

Is the CD Coordinator reviewing/verifying that the Joint Military Pay System (JUMPS) is not duplicating payment for NG personnel in the CD program while attending drill? Yes No  
REMARKS:

EQUIPMENT:

Have any Reports of Survey been conducted? Yes No  
REMARKS:

Is counterdrug equipment purchased, loaned, leased, and utilized for the counterdrug program? Yes No  
REMARKS:

Are leasing and procurement requirements submitted with the state counterdrug support plans? Yes No  
REMARKS:

Does a local system exist to adequately manage and control equipment resources? Yes No  
REMARKS:

Is the ANG Counterdrug section submitting AF Form 601 to NGB/LGSE/DON for approval for procurement or lease of equipment? Yes No  
REMARKS:

Is the ANG Counterdrug section submitting AF Form 601 to have an item included in the appropriate allowance source code? Yes No  
REMARKS:

Is the state reporting all excess CD equipment to NGB-CD for redistribution in compliance with NGR (AR) 500-2/NGR (AF) 55-6? Yes No  
REMARKS:

Did the state purchase any equipment during the end of the fiscal year, just to exhaust CD funds? Yes No  
REMARKS:

PUBLIC AFFAIRS:

Is the Public Affairs Officer working in direct coordination with the LEA Public Affairs Officer? Yes No  
REMARKS:



1 OCTOBER 1992

COUNTERDRUG REVIEW AND EVALUATION CHECKLIST

Is the Public Affairs Officer aware of OPSEC issues? REMARKS:	Yes	No
Is the LEA Public Affairs Officer making the final determination concerning public information? REMARKS:	Yes	No
Does a qualified Public Affairs Officer escort news media on operations? REMARKS:	Yes	No
REPORTING:		
Are variations from approved funding identified in the Monthly Report? REMARKS:	Yes	No
Is NGB-CD provided with a copy of the Initial Operations Report IAW NGR (AR) 500-2/ NGR (AF) 55-6? REMARKS:	Yes	No
Is NGB-CD provided with a copy of the Daily Operational Situation Report (SITREP), IAW NGR (AR) 500-2/NGR (AF) 55-6? REMARKS:	Yes	No
Are National Guard Assisted Seizure Reports submitted to NGB-CD, IAW NGR (AR) 500-2/ NGR (AF) 55-6? REMARKS:	Yes	No
Are (Monthly) In-Progress Report submitted to NGB-CD, IAW NGR (AR) 500-2/NGR (AF) 55-6? REMARKS:	Yes	No
Are After Action Reports submitted to NGB-CD, IAW NGR (AR) 500-2/NGR (AF) 55-6? REMARKS:	Yes	No
Is NGB-CD provided a copy of the Operation Termination Report IAW NGR (AR) 500-2/ NGR (AF) 55-6? REMARKS:	Yes	No

1 OCTOBER 1992

COUNTERDRUG REVIEW AND EVALUATION CHECKLIST

- Is the State requesting feedback surveys from agencies being supported in order to measure the effectiveness of support provided in accordance with NGR (AR) 500-2/NGR (AF) 55-6?  
REMARKS: Yes No
- Is the State forwarding NG/LEA surveys to NGB-CD as enclosure to AAR IAW NGR (AR) 500-2/NGR (AF) 55-6?  
REMARKS: Yes No
- Are all CD Incident Reports reported and submitted to NGB-CD, IAW (AR) 500-2/NGR (AF) 5-6?  
REMARKS: Yes No
- Are Monthly Operational/Financial Report submitted to NGB-CD IAW NGR (AR) 500-2/NGR (AF) 55-6?  
REMARKS: Yes No
- SECURITY:**
- Are personnel investigative reports safeguarded in accordance with AR 380-67, chapter 10, para 10-103 and AFR 205-32, chapter 9, para 9-5?  
REMARKS: Yes No
- Are investigative reports disposed of in accordance with AR 380-67, chapter 10, para 10-104 and AFR 205-32, chapter 9, para 9-6?  
REMARKS: Yes No
- Is a document signed by the applicant constituting express permission to obtain applicable records covered by the Privacy Act?  
REMARKS: Yes No
- Do any CD personnel have an National Agency Check/ENTNAC older than 15 years old?  
REMARKS: Yes No
- Are appropriate risk assessments being conducted for the CD program by the State Security Office?  
REMARKS: Yes No
- ARMY AVIATION:**
- Is the flying hour program managed by the State Aviation Officer?  
REMARKS: Yes No

1 OCTOBER 1992

COUNTERDRUG REVIEW AND EVALUATION CHECKLIST

Are LEAs briefed on weapon carriage and safety? REMARKS:	Yes	No
Is a copy of DA form 2408-12 submitted with after action reports to the CD office as supporting documentation and audit trail? REMARKS:	Yes	No
Is the SAO insuring that all safety, environmental, and flight regulations, policies, procedures, and state laws are followed? REMARKS:	Yes	No
<b>AIR NATIONAL GUARD</b>		
Is the ESSO included in all CD planning? REMARKS:	Yes	No
Are records for Air National Guard officers checked for years of active service? REMARKS:	Yes	No
Are Air National Guard flying hours request coordinated with the Executive Support Staff Officer (ESSO)? REMARKS:	Yes	No
Is the CD office notified of operations that are conducted by ANG personnel in all cases? REMARKS:	Yes	No
Is a copy of AFTO Form 781 submitted to the CD office as supporting documentation and audit trail with an after action report? REMARKS:	Yes	No
<b>BRIEFINGS:</b>		
Does a record exist of the briefings of all commanders on counterdrug planning and support processes? REMARKS:	Yes	No
Have individuals signed a statement verifying that they have been briefed on rules of engagement, use of deadly force and operational requirements? REMARKS:	Yes	No

1 OCTOBER 1992

COUNTERDRUG REVIEW AND EVALUATION CHECKLIST

Are National Guard personnel being briefed before counterdrug operations on real world threat from drug trafficking and dealers, legal consideration and local/state restrictions, OPSEC, Physical, Personnel Security and Safeguards? REMARKS:	Yes	No
Are National Guard personnel receiving the nature and scope of the standard pre-commitment briefing required by NGR (AR) 500-2/NGR (AF) 55-6 prior to deployment on a counterdrug support operation? REMARKS:	Yes	No
Are National Guard personnel being briefed and trained on Standards of Conduct? REMARKS:	Yes	No
Are National Guard personnel being briefed on ethics standards and conflicts of interest by a JA officer? REMARKS:	Yes	No
Are National Guard personnel being briefed on pay and allowances and legal rights? REMARKS:	Yes	No
<b>GENERAL:</b>		
Have any operations been conducted incidental to (IDT/IAD or AT) training? REMARKS:	Yes	No
Is the POMSO in Chain of Command as the manager in compliance with NGR (AR) 500-2/NGR (AF) 55-6? REMARKS:	Yes	No
Is the state conducting intelligence gathering operations? REMARKS:	Yes	No
Are counterdrug support records maintained for two (2) years in compliance with appropriate regulations? REMARKS:	Yes	No
Does the state have a lead LEA agency? REMARKS:	Yes	No

1 OCTOBER 1992

COUNTERDRUG REVIEW AND EVALUATION CHECKLIST

- Are unsupported request forwarded to the appropriate CONUSA? Yes No  
REMARKS:
- Are "Exempt from Mandatory Disclosure" utilized on counterdrug sensitive papers? Yes No  
REMARKS:
- Is NGB-JA contacted where there is possibility of liability on the part of a Guard member or the Guard itself? Yes No  
REMARKS:
- Is the AG authorizing training of LEAs? Yes No  
REMARKS:
- DEMAND REDUCTION:
- INTERNAL CONTROLS:
- Is the state submitting a copy of the USPFO audit report to NGB-CD IAW NGR (AR) 500-2/NGR (AF) 55-6? Yes No  
REMARKS:
- Have local state internal controls been developed and implemented in compliance with AR 11-2 and AFR 15-1? Yes No  
REMARKS:
- Does the CD Coordinator maintain daily personnel internal controls (daily rosters, etc.) to verify presence of NG personnel? Yes No  
REMARKS:
- Does a local system exist to adequately manage all CD funds at the POMSO and CD Coordinator level? Yes No  
REMARKS:
- Are local finance internal controls/procedures in the CD system to detect and prevent fraud, waste, and abuse? Yes No  
REMARKS:
- Does the Adjutant General authorize the carriage of weapons by National Guard personnel on a case by case basis? Yes No  
REMARKS:

COUNTERDRUG COORDINATOR'S HANDBOOK  
APPENDIX K

1 OCTOBER 1992

COUNTERDRUG REVIEW AND EVALUATION CHECKLIST

Does the CD Coordinator require an LEA request for  
carriage of weapons by National Guard personnel?      Yes      No  
REMARKS:

HEADQUARTERS \*NATIONAL GUARD REGULATION 500-2/  
DEPARTMENTS OF THE ARMY AIR NATIONAL GUARD INSTRUCTION 10-801  
AND THE AIR FORCE  
Washington, DC  
(DRAFT) (21 June 1996)

NATIONAL GUARD COUNTERDRUG SUPPORT

Emergency Employment of Army and Other Resources

**Summary.** This regulation/instruction covers the utilization of National Guard and DoD resources and prescribes the policies, procedures, and responsibilities governing National Guard Counterdrug Support and Internal Prevention and Control procedures. National Guard Counterdrug Support includes: Supply Reduction Operations, Drug Demand Reduction (DDR) activities, and Internal Prevention and Control (IPC). This regulation/instruction must be used in conjunction with the procedures provided in the Counterdrug Coordinator's Handbook which supersedes NG Pam (AR) 500-2/ANGPAM 10-801, dated 30 September 1993, and Commanders' Drug Urinalysis Collection Guide.

**Applicability.** This regulation/instruction applies to the Army and Air National Guards of the 50 States, The Commonwealth of Puerto Rico, Guam, U.S. Virgin Islands, and the District of Columbia, hereafter referred to as states, while performing counterdrug missions when not in Federal Service.

**Impact on Unit Manning System.** This regulation/instruction does not contain policies that affect the Unit Manning System.

**Internal Control System.** This regulation/instruction is subject to the requirements of AR 11-2/AFI 65-201. The Counterdrug Coordinator's Handbook includes a Counterdrug Review and Evaluation Checklist.

**Supplementation.** Supplementation of this regulation/instruction is prohibited without prior approval from the Chief, National Guard Bureau, ATTN: Director, Counterdrug Directorate, 2500 Army Pentagon, Washington, DC 20310-2500.

**Interim Changes.** Interim changes to this regulation/instruction are not official unless they are authenticated by the Chief, Administrative Services, NGB. Interim changes will be destroyed on their expiration dates unless sooner superseded or rescinded.

**Suggested Improvements.** The proponent agency of this regulation/instruction is the National Guard Bureau, Counterdrug Directorate. Users are encouraged to send comments and suggested improvements on DA Form 2028 (Recommended Changes to Publications and Blank Forms) directly to Chief, National Guard Bureau ATTN: Counterdrug Directorate, NGB-CD, Washington, DC 20310-2500.

Contents (Listed by paragraph number)

Chapter 1	Para
<b>General</b>	
Purpose	1-1
References	1-2
Explanation of abbreviations and terms	1-3
Responsibilities	1-4
Authority	1-5
<b>Chapter 2</b>	
<b>Administrative Information</b>	
Legal considerations and requirements	2-1
Subpoenas and requests for information	2-2
Tort Liability	2-3
Security guidelines	2-4
Planning and Operations	2-5
Missions	2-6
Agreement Between the States and LEAs	2-7
Funding	2-8
Screening of Personnel	2-9
Personnel Administration	2-10
Standards of Conduct	2-11
Medical Requirements	2-12
Training of National Guard personnel	2-13
Technical Assistance	2-14
<b>Chapter 3</b>	
<b>Use, Loan and Lease of Equipment</b>	
Loan, Lease and Procurement of Equipment	3-1
Non-Counterdrug Use of Counterdrug Equipped Aircraft	3-2
<b>Chapter 4</b>	
<b>Counterdrug Operations</b>	
Reports and Records	4-1
Safety and Accident Prevention Program	4-2
Operational Briefings	4-3
Public Affairs	4-4
Support Role	4-5
Force Protection, Rules of Engagement, and Use of Force	4-6
Training and Operational Load Counterdrug Ammunition Requirements	4-7



Rules of Evidence	4-8
Supply Reduction Missions Operations	
Security	4-9
Intelligence Oversight	4-10

\*This regulation supersedes NGR (AR) 500-2/ANGI 10-801, 30  
September 1993

Appendix References

Glossary

## Chapter 1

### General

#### 1-1 Purpose

a. This regulation/instruction prescribes policies and responsibilities relating to the use of Federal funds for National Guard counterdrug support.

b. Use this regulation/instruction in conjunction with the Counterdrug Coordinator's Handbook.

#### 1-2 References

Required and related publications are listed in the appendix.

#### 1-3 Explanation of abbreviations and terms

Abbreviations and special terms used in this regulation/instruction are explained in the glossary.

#### 1-4 Responsibilities

a. The Secretary of Defense (SECDEF), in accordance with Title 32 USC 112, may provide resources through the Chief, National Guard Bureau to states receiving SECDEF approval of the Governor's State Plan for National Guard counterdrug support.

b. The Counterdrug Directorate has primary responsibility for the development and execution of all National Guard counterdrug support related program policies, procedures, and regulations/instructions. Submit questions on counterdrug support policy to the Director, Counterdrug Directorate.

c. The National Guard Bureau funds a full-time Active Guard/Reserve (AGR) Counterdrug Coordinator (CDC) position in each state who is responsible for the administration and management of the Counterdrug Support Program in that state. The CDC is the single point of contact at the state level for all National Guard counterdrug support issues. All counterdrug communications between the National Guard Bureau and the states should be through the CDC.

d. The National Guard Bureau is the official channel of communication between the states and the Departments of the Army and Air Force as well as other Federal agencies.

e. The National Guard Bureau Counterdrug Directorate (NGB-CD) is the single point of contact for all Army and Air counterdrug issues within the National Guard. The organizational structure of NGB-CD has been approved by the Chief, National Guard Bureau. Recommended changes to this organizational structure will be brought to the NGB Counterdrug Advisory Board for review and coordinated with the Army and Air Directors, prior

to being presented to the Vice Chief and Chief, National Guard Bureau.

f. The counterdrug support program, both supply and demand reduction and Internal Prevention and Control (IPC) are operated within the existing National Guard structure. Unless otherwise provided for by this regulation/instruction, all existing rules, regulations, instructions and procedures applicable in general to the National Guard apply to the Counterdrug Support Program. It is highly recommended that management of all counterdrug functions be placed under the control of the Counterdrug Coordinator. However, the Adjutant General/Commanding General will provide the final guidance for the management of the supply reduction, demand reduction and Internal Prevention and Control Programs within each state.

#### 1-5 Authority

Statutory authority for National Guard counterdrug missions is found in Title 32 USC 112. The Governor is the Commander-in-Chief of the National Guard of the states when units are not in Federal (Title 10) service. District of Columbia units serve under the Commanding General.

## Chapter 2

### Administrative Information

#### 2-1 Legal considerations and requirements

a. National Guard role. The National Guard provides counterdrug support to Federal, state and local law enforcement agencies (LEAs) and to Community Based Organizations (CBOs) that request Drug Demand Reduction assistance. National Guard personnel engaged in counterdrug support activities for which Federal funding is provided by 32 USC 112 must be acting in support of LEAs and/or CBOs. When using funds under Title 32 USC 112, states may only execute missions that have been approved by the SECDEF within their Governor's State Plan IAW paragraph 2-6 of this regulation/instruction.

(1) Requests to perform missions that are on the SECDEF approved mission list (paragraph 2-6) but were not included in the original annual state plan execution memorandum must be submitted to NGB-CD for approval. Written state attorney general (or equivalent) certification must be included with the submission. (See paragraph 2-1d(1).)

(2) Requests to perform missions that are not on the approved mission list must be submitted by the TAG through NGB-CD to the SECDEF for approval. Requests must include the respective state's attorney general (or equivalent) written certification.

b. Requests for support. The National Guard will not initiate counterdrug support operations without a request for support. Verbal requests must be followed by a written LEA or CBO request.

c. National Guard counterdrug support using Federal funds must be for a counterdrug law enforcement purpose. The "counterdrug law enforcement purpose" standard requires that the activity has a direct connection to the enforcement of the criminal drug laws or, in the case of Drug Demand Reduction, has the principal purpose of encouraging members of the public not to violate criminal drug laws. "Direct connection" means that the offense in question involves the sale, use, possession, importation, manufacture, cultivation, transportation, or transfer for value or not for value of a controlled substance.

d. State law. The authority for the National Guard to conduct counterdrug support operations is defined by state law. Title 32 USC 112 authorizes the SECDEF to provide funding support for counterdrug support operations.

(1) The plan submitted by the governor must include a certification by the attorney general (or equivalent) of the state that the activities in the plan are consistent with, and not prohibited by, state law.

(2) The requirement for state attorney general certification may not be waived.

e. Arrests, searches, and seizures. The Posse Comitatus Act (Title 18 USC 1385) does not apply to National Guard personnel in a Title 32 USC status. As a matter of policy, however, National Guard personnel will not, except for exigent circumstances or as otherwise authorized in this regulation, directly participate in the arrest of suspects, conduct searches which include direct contact of National Guard members with suspects or members of the public, or become involved in the chain of custody for any evidence. State law may impose additional restrictions. The CDC will ensure that personnel are thoroughly briefed on this subject before participating in counterdrug operations.

(1) Exigent circumstances are situations, in which: immediate action is necessary to protect police officers, National Guard personnel, or other persons from death or injury; to prevent the loss or destruction of evidence; or to prevent the escape of a suspect already in custody.

(2) Supported LEAs are responsible for obtaining warrants required for searches or for determining the need for searches, inspections, and observations that do not require warrants. This responsibility includes the determination of any potential legal restrictions upon the use of thermal imaging or sense enhancing systems.

f. Responsibility/liability. Responsibility/liability for the actions of National Guard personnel involved in counterdrug support activities (including volunteer personnel in a non-paid status) are as follows:

(1) Federal protection for personal injury, death, or property damage caused by National Guard personnel in Title 32 status is governed by the Federal Tort Claims Act (28 USC 2671-2680).

(2) Responsibility and liability for actions by National Guard personnel on State Active Duty (SAD) are in accordance with state law. Personnel in a SAD status are not covered by the Federal Tort Claims Act.

(3) Responsibility and liability for loss and damage to National Guard equipment will be determined by a report of survey IAW AR 735-5 and AFR 68-1.

(4) Personnel in a Title 32 duty (on orders) without pay status pursuant to written orders are considered employees of the U.S. government for purposes of the Federal Tort Claims Act.

g. Environmental and/or Historical Landmark restrictions. All operations will be conducted in accordance with Federal and state environmental and/or historical landmark laws and regulations.

## 2-2 Subpoenas and requests for information

a. The National Guard, and its current and former members and employees, may receive subpoenas, orders or other requests for the appearance or testimony of individuals or to produce, disclose or release "official information" regarding the Counterdrug Support Program. The state judge advocate will be immediately notified in such cases.

(1) Comply with the provisions of AR 27-40 or AFI 51-301, as appropriate, when the above situations are related to "judicial proceedings" and "litigation" (as defined by these regulations).

(2) The payment of travel expenses, per diem and fees is covered by AR 27-40 and AFI 51-301. National Guard members under subpoena who are not already on counterdrug support orders will be put on orders for the period required for preparation and testimony. The CDC will maintain a copy of the subpoena or other documents. If the member is placed on orders by the National Guard, any payments received from the court must be turned over to the USPFO (ARNG) or unit comptroller (ANG).

(3) Comply with the provisions of AR 25-55 or AFI 37-132, as appropriate, when the above situations are related to producing, disclosing or releasing official information (as defined by these regulations/instructions; AR 25-55 and AFI 37-132 apply when Federal records are released to the public).

b. The NGB Chief Counsel (NGB-JA), through NGB-CD must be contacted immediately under the following circumstances (for personnel operating within the scope of the CD program):

(1) Possibility of civil liability on the part of a National Guard member, the National Guard, or volunteers.

(2) Occurrence of negative judicial rulings based wholly or in part upon the conduct of National Guard members, or volunteers, including the suppression of evidence.

## 2-3 Tort Liability

The Federal Tort Claims Act (FTCA) (28 USC 2671-2680) is applicable to National Guard members engaged in counterdrug support under Title 32. Individuals whose property is lost, damaged or destroyed, or who suffer personal injury or death as a result of the negligent acts or omissions of National Guard members acting within the scope of their duties, may file a claim against the United States under the FTCA. National Guard members acting within the scope of their authority and performing

approved support (listed in the Governor's State Plan and approved by OSD) are immune from suit except for certain Constitutional torts; i.e., when a negligent act or omission constitutes a violation of the Constitutional rights of the injured party, including persons suspected of criminal activity, and certain intentional torts, such as assault and battery, false arrest and imprisonment. National Guard members engaged in counterdrug support activities in a State Active Duty status are entitled to the protections and immunities afforded by state law. Because there is, at the present time, no protection from FTCA liability or Federal Employees Compensation Act coverage for volunteers, including National Guard members not on orders or in any recognized status, such persons should not be used in any program without being advised of the foregoing lack of coverage.

#### 2-4 Security guidelines

a. Operations security (OPSEC). Supply reduction support operations will follow OPSEC procedures IAW AR 530-1 and AFI 37-131, Freedom of Information Act Program. National Guard members will be briefed on the need to observe OPSEC measures.

b. Physical security. National Guard physical security personnel will conduct physical security risk assessments of all National Guard counterdrug controlled offices or work areas IAW AR 190-51 and AFI 31-401.

#### 2-5 Planning and Operations

a. Each state will submit, for review and staffing, an annual Governor's State Plan to the National Guard Bureau, ATTN: Counterdrug Directorate. Plans will conform to annual Counterdrug Directorate guidance and will be approved and signed by the governor and the state attorney general (or equivalent).

b. The CDC is responsible for the submission of the Governor's State Plan for counterdrug support.

c. The Internal Prevention and Control (IPC) state plan is not part of the Governor's State Plan and does not require approval from the Governor, Attorney General, or SECDEF. A separate state IPC plan will be submitted, through the CDC, under separate cover IAW NGR 600-85.

d. The CDC will establish and maintain a folder for each operation/activity. The folder will contain all pertinent documentation to provide an audit trail. A list of required documents is contained in the Counterdrug Coordinator's Handbook.

e. All aviation assets will be controlled by the State Army Aviation Officer (SAAO) for the Army National Guard and the appropriate flying unit commander for the Air National Guard. Counterdrug flying hours will be reconciled with these offices. CDC and NGB-AVN and/or NGB-CDO will coordinate to determine the

number of flying hours needed to support the program. The CDC will coordinate with the SAAO/ANG flying unit to confirm the capability to fly those hours.

f. Request Channels. LEAs and CBOs will request counterdrug support through The Adjutant General, ATTN: Counterdrug Coordinator. Support requests which are beyond the capability of the state National Guard will be forwarded to NGB-CD, ATTN: Regional Coordination Team.

#### 2-6 Missions

The following counterdrug mission descriptions are activities which the SECDEF will fund under the authority of Title 32 USC 112. However, counterdrug activities must be consistent with, and not prohibited by, state law. Some states may not authorize their National Guard to perform every SECDEF approved mission.

#### Mission Category #1 - Program Management

##### Mission 1. Counterdrug Coordination, Liaison, and Management.

Plan and coordinate state counterdrug supply and demand reduction support, establish liaison with supported LEAs and other community organizations, resource and manage personnel and equipment requirements for counterdrug support operations, and prepare operational/financial reports and briefings as required.

#### Mission Category #2 - Technical Support

##### Mission 2a. Linguist Support (Translator Support).

Provide transcription/translation of audio/video tapes, seized documents and other information media. National Guard personnel will not participate in active/real-time Title III conversation monitoring or directly participate in interrogation activities. The National Guard will not maintain or store final products in National Guard facilities or databases.

##### Mission 2b. Intelligence Analyst Support.

Assist LEAs in the establishment of counterdrug intelligence systems/data bases and provide intelligence analysis support. All intelligence activities must be conducted IAW appropriate DoD regulations. The National Guard will not maintain or store final products in National Guard facilities or databases.

##### Mission 2c. Operational/Investigative Case Support.

Provide assistance to LEAs in developing investigations and cases for prosecution. Activities include, but are not limited to, inputting, reviewing, and analyzing collected LEA information, and providing assistance such as legal, paralegal, and auditing. Operational support to LEAs is designed to enhance the effectiveness of the supported agency and release law enforcement officers for drug enforcement duties. This category of support excludes such tasks as secretarial, janitorial, or receptionist assistance.



**Mission 2d. Communications Support.**  
Provide personnel to establish, operate and maintain communications stations, bases, and equipment in support of LEA counterdrug operations.

**Mission 2e. Engineer Support.**  
Provide engineer support to LEAs and community organizations where the project has a counterdrug nexus. This will exclude drug laboratories or hazardous materials. Local LEAs and governments must secure the area prior to arrival of National Guard personnel, take possession of any evidence or materials to be confiscated/destroyed and obtain clearances, court orders, warrants and/or permits for destruction, removal or disposal of materials or other environmental hazards/concerns.

**Mission 2f. Subsurface/Diver Support.**  
Conduct subsurface inspections of commercial vessel hulls within U.S. territorial waters or U.S. maritime ports of entry (POE) through the use of sidescan sonar buoys or divers to detect alien devices or containers attached to the vessel hulls or other underwater activities. Prior to the use of National Guard personnel for inspection activities, the vessels must be secured by the responsible law enforcement officials. Divers may visually inspect and report to LEAs any unusual physical hull configurations but, may not attempt entry, search, or alteration of features detected.

**Mission Category #3 - General Support**

**Mission 3a. Domestic Cannabis Suppression/Eradication Operations Support.**  
Support of LEA domestic cannabis suppression and eradication operations. This includes, but is not limited to, aerial support, logistic support, communications support, intelligence, planning support, operational staff coordination, medical, physical security, ground transportation, eradication and destruction of contraband, and spraying of herbicides.

**Mission 3b. Transportation Support.**  
Provide transportation (aerial, ground, or maritime) of LEA personnel/equipment, persons in LEA custody, seized property or contraband to, from, or as part of counterdrug operations, or when security or other special circumstances reasonably necessitate National Guard support and there is a counterdrug nexus. LEA officers are responsible for the security of any evidence or persons in their custody. Provide ground transportation of youth, adults, and associated equipment and supplies for community/state demand reduction program activities.

**Mission 3c. Maintenance/Logistical Support.**  
Provide maintenance/logistical support of LEA vehicles and equipment to enhance the counterdrug effectiveness of the supported agency and release Law Enforcement Officers (LEOs) for

drug enforcement duties. General maintenance/logistics of non-counterdrug vehicles and equipment is prohibited.

**Mission 3d. Cargo/Mail Inspection.**

Assist LEAs by inspecting cargo and mail. Primary emphasis will be placed on POEs and functional equivalents. Cargo/Mail includes, but is not limited, to vehicles, containers, commercial cargo, aircraft, watercraft, baggage, and mail. National Guard personnel will not make arrests, conduct searches of individuals, seize property, or enter into the chain of evidence. Law enforcement officers must be present at inspection sites, make seizures, maintain custody of evidence, and maintain control of vehicle occupants.

**Mission Category #4 - Counterdrug-related Training**

**Mission 4. Train LEA/Military Personnel.**

Train LEA/military personnel in military subjects and skills useful in the conduct of counterdrug operations or in the operation of military equipment used in counterdrug operations. LEA participants are responsible for associated travel and per diem expenses.

**Mission Category #5 - Reconnaissance/Observation**

**Mission 5a. Surface.**

Reconnoiter or perform area observation by land or water to detect and report illegal drug activities which include, but are not limited to, cultivated marijuana, suspected isolated drug trafficking airstrips, drug drop zones, drug trafficking corridors, illegal drug labs, suspicious aircraft, watercraft, or motor vehicles. Pursuit or targeting specific persons for surveillance is prohibited. National Guard personnel will not maintain or store gathered information in National Guard facilities or databases. Information will be reported as designated by the supported LEA. Approved categories of counterdrug activities include, but are not limited to:

**1. Unattended Sensor Support.**

Personnel will support LEAs in the emplacement, monitoring, and maintenance of unattended sensors in areas where suspected drug activity is occurring.

**2. Visual reconnaissance/observation by mobile patrols and listening posts/observation posts (LP/OP) using binoculars, cameras, night vision devices, and infrared/thermal imagery, including FLIR or low-light devices. An LEA officer must be present or in direct contact with the National Guard team.**

### 3. Ground Surveillance Radar (GSR)

Establish and operate ground radar sites using either Army or Air GSR systems. Mission includes site security and may require transportation support.

#### Mission 5b. Aerial

Conduct reconnaissance/observation of airspace, maritime, or surface areas (land and internal waters and waterways of the US and its territories) for illegal drug activities which include, but are not limited to, cultivated marijuana, suspected isolated drug trafficking airstrips, drug drop zones, drug trafficking corridors, suspicious aircraft, watercraft, or motor vehicles. For RAID/C-26/MH-60G FLIR missions, an LEA officer must be present or in direct contact. Mission may require site security for aircraft and ground mobile radar. Approved equipment and techniques include, but are not limited to:

1. Radars
2. Unmanned Aerial Vehicles (UAVs)
3. Aerial visual, including infrared/thermal imagery, and photographic reconnaissance
4. Photo reconnaissance/film processing

#### Mission Category #6 Demand Reduction Support.

Demand reduction support organizes National Guard resources, members, and their families in support of drug abuse prevention programs in the community. Support missions in this category should complement, but must not duplicate, other organizations' programs.

#### Mission 6a. Community Based.

Provide support to community activities primarily designed to educate, train, or otherwise prevent drug abuse among youth. This includes, but is not limited to, support of youth centers, drug-free events, community recreational programs, safe havens and community mobilization events.

#### Mission 6b. Educational Institutions.

Support community based activities that focus on educational institutions, or otherwise have an educational institution as the primary sponsor, and are primarily designed to educate, train, or otherwise prevent youth from drug abuse. This includes, but is not limited to, tutoring, mentoring, D.A.R.E. support, after-school programs, drug-free activities, role modeling programs, and sports-drug awareness programs.

#### Mission 6c. Informational.

Provide information about drug abuse or drug abuse programs. This includes, but is not limited to, static displays, the Red Ribbon

Campaign, educational material distribution, and expenses for speakers.

Mission 6d. Leadership Development.

Support camps, retreats, seminars and programs, not primarily associated with educational institutions, that focus on developing drug abuse prevention leadership skills in youth and adults. This includes, but is not limited to, Cadet programs, QUEST, PULSAR, Freedom Academy, Parent Training programs, and Young Leaders.

Mission 6e. Coalition Development.

Assist in the development of functioning community coalitions organized to reduce the illegal use of legitimate drugs and the use of illegal drugs.

2-7 Agreement Between the State and LEAs

a. Agreements between the states and with LEAs should be drawn in accordance with the procedures established by the state and by the LEAs. When counterdrug personnel conduct interstate operations, there should be an MOU/MOA in place prior to providing the support. For interstate operations, an MOU/MOA is defined as an agreement between the requesting state and the supporting state sufficient to establish, under the law of both states, that the supporting Guardsmen are operating in the requesting state lawfully, with the consent and authority of the governors of both states. This agreement should be initiated and established by the respective CDC's with legal review provided by the state judge advocate or equivalent. An agreement is also required for support provided to LEAs. The agreement will comply with applicable state laws, Federal laws, and regulations/instructions. The agreements should include the following:

- (1) Purpose.
- (2) Authorities (i.e., regulations, statutes).
- (3) Planned deployment of National Guard personnel and/or equipment.
- (4) Reporting procedures.
- (5) Command and control.
- (6) Scope of operations.
- (7) Force protection/Rules of Engagement.
- (8) Public affairs.
- (9) Safety.
- (10) Responsibilities, including acquisition of warrants and permits.
- (11) Relative liabilities of parties including any hold harmless agreements. (NOTE: Federal Government may not hold harmless a State or other jurisdiction and no hold harmless agreements are needed between Federal agencies.)
- (12) Period of Agreement.

(13) Asset forfeiture/sharing. (If appropriate, provisions for asset forfeiture/sharing will be included in the agreement IAW paragraph 2-81.)

b. The agreements will be reviewed by a state judge advocate or the attorney general (or equivalent) to ensure compliance with state law.

c. Agreements must be signed and in place prior to any support being provided.

## 2-8 Funding

a. Title 32 USC 112 provides the funding authority for the National Guard Counterdrug Support Program. It authorizes funding for pay and allowances, clothing, subsistence, gratuities, travel, and related expenses of personnel of the National Guard used for the purpose of counterdrug activities; and the operations and maintenance of the equipment and facilities of the National Guard used for the purpose of counterdrug support activities. It also authorizes funding for the procurement of services and the procurement/leasing of equipment for National Guard use for the purpose of counterdrug support activities.

b. National Guard counterdrug support funds are part of the DoD counterdrug appropriation and may not be used for purposes other than the National Guard counterdrug support program. These funds are fenced by Modified Army Management Structure Codes (MAMSCO) and DoD Project Element Codes (PEC). Request for transfer of funds between appropriations or between ARNG and ANG must be submitted through NGB-CD.

c. Incremental costs associated with missions performed incidental to training that include above normal expenditures (such as lodging) may be charged to counterdrug support accounts.

d. Soldiers and airmen are entitled to travel and transportation allowances while performing travel away from their permanent duty station (counterdrug duty location) IAW the Joint Federal Travel Regulation (JFTR). Local area travel reimbursement is authorized for expenses incurred by members conducting official business in the local commuting area as defined by local commanders. Travel expenses incurred by personnel on ADSW with the counterdrug support program when commuting to and from unit home station for monthly Inactive Duty Training (IDT) and/or Annual Training (AT) are chargeable to the counterdrug support program when the unit home station is a place other than the member's primary (ADSW) place of duty.

### e. Army National Guard funding.

(1) Pay and Allowances (Appropriation 2060). Pay, allowances, travel, and per diem for ADSW and AGR (Title 10 USC and Title 32 USC) personnel are chargeable to the National Guard Personnel, Army Appropriation (NGPA) and are identified as program costs IAW AR 37-100-XX. Travel and per diem for non-CD personnel (AGR/ADSW/IDT) supporting counterdrug activities are chargeable to this appropriation.

(2) Operations and Maintenance (Appropriation 2065). Operations and maintenance expenses are chargeable to the Operations and Maintenance, National Guard Appropriation (OMNG),

IAW AR 37-100-XX. O&M includes the following types of expenditures:

(a) Travel and per diem for ARNG technicians and NGB civilian employees directly employed with the counterdrug support program are chargeable to this appropriation.

(b) Pay of technicians employed by the state Adjutant General as staff to provide support explicitly for the Counterdrug Support Program. Also covered are the employer's contribution to employee retirement funds, incentive awards, health and life insurance programs, FICA where applicable, and object class 12 Permanent Change of Station (PCS) benefits.

(c) Medical expenditures for all personnel directly employed in the counterdrug support programs such as line of duty civilian medical care, unique immunizations, and per diem with travel expenses for program applicants to obtain examinations needed to determine suitability for the Counterdrug Support Program. Approval for payment, IAW NGR 40-3, is processed by NGB-ARP-HS.

(d) Procurement of material required for operating and maintaining counterdrug facilities, aircraft, ground vehicles, and equipment.

(e) Procurement of medical supplies used in the Counterdrug Support Program.

(f) Other expenses that cannot be linked directly to a specific mission. Additional guidance may be obtained from the Army Comptroller Directorate, Program and Budget Division (NGB-ARC-PB).

f. Air National Guard funding.

(1) Military Personnel (ANG Appropriation 3850, ANG Fund Code 5 (6). Pay, allowances, travel and per diem for ADSW personnel and pay and allowances for AGR are chargeable under this appropriation IAW ANGI 36-101.

(2) Operations and Maintenance (Appropriation 3840, Fund Code 58). Operations and maintenance funds cover costs that are the same as the ARNG but include funding for Air National Guard AGR travel and per diem.

(3) Line of duty civilian care expenditures which cannot be handled with local funds should be submitted to Air National Guard, Medical Resource Management Office (ANGRC/SGMM) as an unfunded budget requirement.

g. Items identified for central procurement by NGB using Dedicated Procurement Program (DPP) funds, and/or USPFO procurement authority for O&M funds, will be identified and submitted in the Governor's State Plan.

h. The 32 USC 112 counterdrug funds will not be used for the procurement of items of minimal value (i.e., give-aways such as caps, T-shirts, pens, pencils etc.) for distribution outside of the military.

i. Contracted training, trainers, training materials, and training development are authorized as follows:

(1) Training in support of missions approved in the State Counterdrug Support Plan.

(2) When internal training resources are not available.

j. Contracting for external evaluations of National Guard DDR Programs must be approved by NGB-CD.

k. Accounting for nonappropriated funds, i.e., asset forfeiture-sharing funds, grants, and foundation donations, is a state responsibility. Accounting for military nonappropriated funds instrumentalities, e.g., PX, BX, will be done in coordination with the USPFO and the comptroller as required IAW applicable regulations.

l. Asset forfeiture sharing. Both the Department of Justice and the Department of Treasury have asset sharing programs for state National Guards. The criteria for qualification to participate in the programs are set by the agencies which run the programs and generally require that the state National Guard qualify as a law enforcement agency and use the percentage of participation in a particular case to determine the extent of the sharing. Participation is voluntary by the states and is at the



discretion of the TAG and only permitted if allowed by state law. The funds received, IAW Justice or Treasury guidelines, can only be used to enhance National Guard law enforcement support efforts to include investigations, training and purchase of equipment or facilities, but not real property. There are also accounting procedures, reporting requirements and internal controls that must be implemented depending on the amount of funds received. In addition, shared funds may be used by LEA's to conduct drug awareness and education programs. Additional information about participation may be obtained from the legal policy coordinator at NGB-CD.

m. Internal Prevention and Control (IPC) Funding.

(1) ARNG counterdrug Operations and Maintenance (O&M) funds are used to purchase supplies to support the collection and shipment of urine specimens to the toxicology laboratory. The ANG uses non-counterdrug medical funds to purchase supplies to support collection and shipment of specimens.

(2) ARNG litigation support packages (LSP) are budgeted and paid by NGB. Each state/territory will submit a request for the LSP to the appropriate toxicology laboratory and will provide a copy of the request to NGB-CDI. The LSP must be ordered by the state JAG or ADCO. These same procedures will be utilized for payment of expert witness and telephone consultation fees for drug boards after coordination and approval from NGB-CDI.

(3) ARNG and ANG IPC O&M funds are authorized to purchase education, prevention, and training materials and equipment that convey a drug abuse prevention and/or educational message for National Guard members and their families. IPC O&M funds may not be used to purchase promotional items for individual members of the National Guard and their families.

(4) Budgeting and payment of all drug urinalysis testing is done at NGB.

(5) Counterdrug funds will not be used to rehabilitate National Guard members from substance abuse.

(6) ARNG IPC Pay and Allowance (P&A) funds are used for training personnel to conduct drug urinalysis collection, and administrative support of the ADAPCP.

n. Cooperative Agreements. A Cooperative Agreement between the USPFO, acting on behalf of the Chief, NGB, and the Adjutant General, acting on behalf of the state, shall be prepared prior to the issuance of any funding for counterdrug activities. The agreement shall comply with the provisions of NGR 5-1/ANGI 65-101.

2-9 Screening of Personnel

a. National Guard members who volunteer for ADSW/AGR/Technician duty in the Counterdrug Support Program will be screened (Table 1-1) as follows:

(1) The applicant must be recommended in writing by the unit commander.

(2) The applicant will be personally interviewed by the CDC or designated representative.

(3) The custodian of the applicant's Military Personnel Record will review the records to determine the individual's eligibility for duty.

(4) The CDC must review the applicants total Active Federal Service and Mandatory Removal Date to determine the individuals retainability.

(5) Although a security clearance is not required, counterdrug personnel are required to have had a favorable Entrance National Agency Check or National Agency Check (ENTNAC/NAC) within the past 15 years. The State Security Manager will review existing records to determine eligibility. However, any additional background/security checks or investigations will be conducted by the gaining organization (LEA).

(6) Counterdrug Support personnel will undergo biochemical testing when:

(a) Performing duty for more than 30 consecutive days, or

(b) At the discretion of the CDC, biochemical testing is deemed appropriate/necessary, regardless of the length of time on counterdrug support orders.

(7) Biochemical testing of National Guard members must be conducted while the individual is on military status and within 30 days of entry on counterdrug duty.

(8) The applicant must meet medical qualifications in accordance with paragraph 2-12 of this regulation/instruction.

(9) National Guard personnel in direct support of an LEA may be subject to any security requirements pertinent to that organization.

b. Screening of National Guard Volunteers for DDR. National Guard members participating in DDR activities, regardless of their duty status, must be screened prior to participating in the DDR activity.

(1) The CDC will establish screening procedures for National Guard members when they are utilized in other than ADSW status to support DDR activities. All security issues must be handled by the State Security Manager.

(2) Screening must ensure, within reason, that the volunteer is an appropriate representative of the National Guard and is suitable for the level of volunteer participation.

(3) Every effort must be made to ensure that all volunteers are of the highest moral character, are highly

motivated, and members in good standing. National Guard members pending disciplinary action, under civilian court orders or awaiting adjudication, awaiting discharge, or involved in other potentially negative situations will be carefully screened to ensure that they are not put into a sensitive situation which might negatively reflect on the DDR Program, the National Guard, and the state.

## 2-10 Personnel Administration

a. National Guard members may serve the Counterdrug Support Program in a variety of categories. The support of the Counterdrug Support Program must be the primary mission of all Federally funded counterdrug personnel. ADSW orders will reflect the entire duration of the mission and will not be broken or exclude weekends for the sole purpose of avoiding cost of pay and allowances and associated entitlements or benefits.

b. State Active Duty (SAD). State funded SAD personnel may provide counterdrug support. Such personnel will be employed IAW state regulations.

c. Active National Guard/Reserve (AGR). Employment of ARNG AGR personnel will be as stated in NGR (AR) 600-5 (Title 32 USC) or NGR (AR) 600-10 (Title 10 USC). Employment of ANG AGR personnel will be IAW ANGI 36-101. Counterdrug orders will include the following statement requiring the proper use of personnel:

(1) Title 10 USC. "Member's primary duties will be performed in direct staff support of the counterdrug mission. Member will not directly participate in drug interdiction activities of the National Guard or in any activities in violation of Title 10 USC 375 or Title 18 USC 1385 (interdiction, search and seizure, arrest, etc.)".

(2) Title 32 USC. "Gaining agency/command must ensure that individual does not participate in drug interdiction activities of the National Guard which violate Title 32 USC 112, or in any activities which violate Title 10 USC 375. This individual will not be used for any purpose other than the Counterdrug Support Program as provided for IAW Title 32 USC 112".

NOTE: NG personnel in a Title 32 status will not perform or participate in any OCONUS counterdrug missions. All OCONUS activities must be performed while in a Title 10 status. Requests for approval and funding codes for OCONUS (Title 10) activities will be directed through NGB-CD or NGB-CDO for all support to Air Force OCONUS counterdrug missions or NGB-ARO for Army OCONUS support.

d. Active Duty Special Work (ADSW) (Title 32 USC).

(1) The number of soldiers and airmen serving on ADSW tours for the Counterdrug Support Program will not impact allowable end strengths of personnel supporting reserve components. Neither will they count against authorizations outlined in Title 10, section 517 and 524. These same personnel are exempt from end strength reporting and limitations on the number of days members may perform in a fiscal year under AR 135-200, NGR 37-111, and ANGR 50-01. National Guard members placed on ADSW orders are required by 32 USC 112 to continue attending monthly IDT while on counterdrug orders. Personnel should be carried as "constructive" attendance for purposes of pay and accountability. Non-counterdrug training (excluding monthly IDT) lasting longer than three days, excluding travel time, cannot be performed with counterdrug support program funds. Consistent with the 3-day limit, CDCs must approve non-counterdrug training other than the normal monthly IDT.

(2) Annual training must be paid with training funds (orders break, dual-fund sites, etc. as allowed and appropriate).

(3) Soldiers and airman on ADSW for twenty weeks or longer are entitled to PCS benefits.

(4) Sanctuary provisions are addressed in AR 135-200, paragraph 6-6c and NGR (AF) 50-1.

(5) CD personnel performing self-terminating full-time duty pursuant to section 112 of Title 32 are, with certain limited exceptions outlined in the DoD Pay Manual, entitled to separation pay if they meet the requirements of section 1174 of Title 10.

(6) CDCs must ensure that personnel understand that the duration and size of the program is subject to annual appropriated funding levels.

e. Duty Performed Incidental to Training or As Training. Ordinarily, National Guard personnel perform their counterdrug missions in a Title 32 ADSW status in addition to their IDT/AT. As an exception to this, National Guard personnel may support LEAs and/or other parts of the Counterdrug Support Program in an IDT/AT status if the performance of that duty is incidental to the training already scheduled. Under the authority of Section 1004, P.L. 101-510, and only if coordinated and approved by NGB-ARO or ANG/XO, National Guard units may perform their period of AT in support of counterdrug missions which meet the METL or readiness requirements of the unit.

f. All Title 32 USC ADSW and AGR Counterdrug orders will cite 32 USC 502(f) as authority, unless otherwise directed or authorized by NGB-ARO.

g. Evaluation. Counterdrug supervisory personnel may be required to provide letter reports for Army and Air National

Guard members when dual supervision rules apply. (See AR 623-205, para 2-4c and table 2-3 or AFR 36-10, paragraph 7-7.) The CDC will coordinate with the state Executive Staff Support Officer (ESSO) and Military Personnel Officer (MILPO) to ensure requirements are met.

h. Leave. In accordance with AR 630-5 and AFI 36-3003, CDCs will manage leave procedures and should encourage counterdrug support personnel to use all accrued leave prior to the end of each fiscal year.

i. Personnel who perform more than ninety days of active duty may be entitled to a DD Form 214 IAW AR 635-5/ AFR 35-9 upon a break in active service.

#### 2-11 Standards of Conduct

National Guard members participating in the Counterdrug Support Program will comply with state laws while involved in these programs and are required to uphold the highest standards of conduct and personal appearance. Outside employment, associates, associations and off-duty conduct/activities should be consistent with DoD Joint Ethics Regulation and conflict of interest policies.

#### 2-12 Medical Requirements

a. In addition to existing requirements outlined in AR 135-200, AR 40-501, and AFI 48-123, personnel on orders (Title 10 USC or Title 32 USC) for federally funded (IAW 32 USC 112) counterdrug support activities will meet the following physical examination requirements:

b. The requirement for medical fitness screening depends on the length of ADSW orders and falls into two categories.

(1) Tours of thirty days or less do not require an additional screening. However, the individual will complete and sign a statement of current health IAW NGR 40-501, Appendix B or AF Form 895, AFI 48-123, prior to being placed on active duty orders.

(2) Individuals being placed on a tour of more than thirty days are required to meet the standards of medical fitness in Chapter 2 of AR 40-501 or AFI 48-123 Chapter 7, attachment 3. This will be determined by the State Surgeon/Medical Officer reviewing a medical screening form (AF Form 895 or Appendix B, NGR 40-501) completed by the applicant within the preceding 30 days, and the applicant's most recent valid periodic physical (to include flight physicals), applying Chapter 2/7 standards. The period of validity for a periodic physical is five years, except (ARNG only) two years if age 40 or over. In addition, all ARNG applicants, age 40 and over, must have successfully passed the Cardiovascular Screening Phase I or II within the preceding two years.

If the individual fails to meet these standards, the Surgeon/Medical Officer may elect to deny duty without appeal, or with reasonable cause, may submit the records with an appropriate current clinical evaluation to NGB-ARP-HS or ANGRC/SGXE as appropriate, for waiver consideration. The NGB-ARP-HS or ANGRC/SGXE decision on the waiver request is final. Once duty has been authorized by Chapter 2/7 standards, retention standards govern. However, if a break in excess of one year occurs, reentry will require Chapter 2/7 standards again.

c. National Guard members on counterdrug ADSW/AGR orders who are injured while participating in counterdrug support activities are entitled to benefits under 10 USC 1074(a) during the period of their active duty. Members on tours for over 30 days may be extended on active duty, with their consent, for medical treatment of a disability. Members on tours of 30 days or less will be released from active duty but are entitled to medical care and incapacitation pay provided their disability was incurred in line of duty.

#### 2-13 Training of National Guard personnel

a. Middle and upper level managers (such as Drug Demand Reduction Administrators and Counterdrug Coordinators) should attend the appropriate course provided by the National Interagency Counterdrug Institute (NICI). The program of instruction provides information regarding organizations, policies, and laws with which they need to be familiar in order to execute a state Counterdrug Support Program.

b. Counterdrug Support personnel may receive training specific to the types of activities being planned or to familiarize them with LEA or CBO office procedures or methods of operation. If special training is identified, the "train the trainer" concept will be utilized as appropriate. The use of Counterdrug Support Program funds for MOS/AFSC producing or MOS/AFSC enhancing skills (i.e., airborne, air-assault, Ranger, etc.) must be approved by the Director, NGB Counterdrug Directorate in addition to appropriate regulations/instructions.

c. The Western Army Aviation Training Site (WAATS) has the responsibility for qualification and standardization of Reconnaissance And Interdiction Detachment (RAID) qualified aviators. Candidates for RAID qualification must meet course prerequisites as defined in the aviation training site flight training guide. The WAATS RAID section has the authority to designate Regional Standardization Pilots (using existing resources) that will ensure proficiency and currency requirements are maintained.

d. C-26 counterdrug aircraft crew and mission training will be conducted as coordinated by NGB-CDO.

e. Counterdrug personnel supporting operations which employ sensory enhancing equipment will be trained in the use of the devices. Scheduling and selection of personnel for training will be the responsibility of the CDC. Any training requirements involving aviation personnel will be coordinated by the CDC through the SAO for ARNG or flying unit commander for ANG.

f. Drug Urinalysis Collection. National Guard personnel, performing drug urinalysis collection procedures, will receive training as directed by the Office of Internal Prevention and Control, Counterdrug Directorate, IAW applicable regulations and directives of the active component. State level responsibilities are as follows:

(1) Army National Guard personnel are trained by their State Alcohol and Drug Abuse Coordinator or NCOIC, Alcohol and Drug Abuse Section.

(2) Air National Guard personnel are trained by the medical sections at the unit level.

2-14 Technical Assistance. The CDC will provide NGB-CD copies of all scheduled reviews, inspections, and evaluations conducted in the state counterdrug program (e.g., DoD IG, GAO, AAA, USPFO IR, etc.) When NGB-CD schedules a technical assistance visit, the CDC will notify NGB-CD of any and all Inspector General and/or USPFO Internal Review audits in progress.

### Chapter 3

#### Use, Loan or Lease of Equipment

##### 3-1 Loan, Lease and Procurement of Equipment

###### a. General information.

(1) The state Adjutant General has authority to conduct CD operations with Federal property issued to the National Guard.

(2) States may coordinate directly with other states for the temporary loan of additional Federal property needed to support a particular type of counterdrug activity. Formal arrangements should be made with USPFO. The loan transactions will be reported to NGB-CD and the Army National Guard, Logistics Directorate (NGB-ARL) or the Air National Guard, Director of Logistics (ANGRC/LG).

(3) Unless authorized, all equipment/services purchased, loaned, leased, or otherwise obtained using 32 USC 112 funds will be used only for counterdrug support.

(4) Excess equipment. CDCs will notify NGB-CD of all excess equipment. NGB-CD will, in turn, offer the excess



equipment to other CDCs. If needed, NGB-CD will notify the appropriate USPFO to laterally transfer the equipment to the HQ STARC property book of the gaining CD support program. If not needed by another state, the CDC will be instructed by NGB-CD to report the equipment as excess to the USPFO.

b. Loan and lease of equipment (lend/borrow).

(1) Loan and lease of equipment is governed by AR 700-131, AFM 67-1, and AFM 67-1/ANG Supplement 1. USPFOs are responsible for preparing and negotiating agreements and approving loans and leases of equipment. Loan formats may be found in referenced publications.

(2) Loan or lease of items of equipment covered by AR 700-131, AFM 67-1, and AFM 67-1/ANG Supplement 1 require HQDA or HQ USAF approval. NGB-CD will coordinate all such requests.

c. Routing of requests to borrow equipment.

(1) Loan requests from state and/or local agencies should be routed through the CDC.

(2) Loan requests from Federal agencies will be routed through that agency's headquarters to DoD, Coordinator for Drug Enforcement Policy and Support. Contact should be made with Regional Logistical Support Offices (RLSOs) to process requests for resources not available in standard channels.

d. Equipment authorizations.

(1) Commercial equipment must be authorized by NGB-CD prior to procurement or leasing. ARNG requests not previously approved will be processed as prescribed under AR 71-13 for a Table of Distribution and Allowance (TDA) addition or under CTA 50-909. ANG requests will be submitted on AF Form 601 so that the item will be included under the appropriate Allowance Source Code (ASC).

(2) The USPFO retains the authority to procure non-standard, non-type classified, commercial equipment that doesn't qualify for TDA addition. Expenditures of OMNG funds for equipment purchases and leases IAW AR 71-13, AR 710-2 and all other applicable regulations/instructions, policy letters and local unit standing operating procedures will be approved at the state level by the USPFO.

(3) States will not procure counterdrug support equipment already earmarked for central procurement unless authorized to do so. ARNG and ANG Directorates will obtain and provide equipment to states through the Total Package Fielding Program. States will be updated annually on the status of the requisitions.

### 3-2 Non-Counterdrug Use of Counterdrug Equipped Aircraft

a. The use of National Guard aircraft is prescribed by the 95-series regulations for the ARNG and the 55-series for the ANG. The Army safety program is covered in AR 385-10 and the Air Force safety program is covered in AFI 91-202. Additionally, the Air Force adheres to "Safety: Investigating and Reporting USAF Mishaps" IAW NGR (AF) 127-04 supplement. These regulations are the primary references on all use of aircraft issues. See NGR (AR) 500-1/NGR (AF) 55-5 for additional guidance.

b. Counterdrug equipped aircraft are funded with counterdrug dollars and intended for use in counterdrug operations. Acknowledging that some requests will likely be made wherein the use of the aircraft's thermal imaging and or communications capabilities are needed, allowances are made for use of counterdrug aircraft for other than counterdrug missions. Counterdrug equipped aircraft may be used in a life/death emergency situation that meets the following criteria:

(1) The aircraft and thermal imaging/communication equipment are needed to search for a lost person(s), where without this support a high probability exists that the person(s) will not survive inclement weather or other perilous circumstances/conditions.

(2) The aircraft and thermal imaging/communication equipment are needed to search for escapees or suspected dangerous felons, that if not quickly apprehended, will likely endanger the welfare of innocent persons.

(3) The aircraft and thermal imaging or communications equipment are needed for support during civil disturbances or disasters.

c. In each case of (1.), (2.) and (3.) above, the request must be made by a law enforcement agency, the Office of Emergency Services, or equivalent agency to the National Guard. Flying hours used for the mission must be reimbursed/paid either by other National Guard funding or by the federal, state or local agency making the request. Missions for other than counterdrug operations must not interfere with counterdrug missions unless LEA coordination is made and a life/death emergency exists. Any situation not meeting the above criteria will be considered on a case-by-case basis by NGB-CD.

d. Standard tactical egress operations (HELOCAST, rappel, paradrop, and STABO) are specifically addressed by NGR (AR) 95-210. A training program approved by NGB-AVN-0 must be completed prior to conducting such operations.

## Chapter 4

### Counterdrug Operations

#### 4-1 Reports and Records

a. Information and archives. Current and historical records should be maintained in one central location and be established IAW AR 25-400-2 or AFI 37-122.

b. Reports and reporting.

(1) Counterdrug support operations records. Operation Plans (OPLANS) and Operation Orders (OPORDs) will be developed for each operation. These will be included in the operation folder or database that the CDC must maintain for each operation.

(2) All reports must be made IAW the Counterdrug Coordinator's Handbook. Reports (including After Action) are required for all counterdrug operations including those performed incidental to training.

(3) The CDC will prepare and maintain the original reports and transmit the required data electronically to NGB-CD via the wide area network (WAN).

c. Special notification/coordination.

(1) Reporting requirements include unusual circumstances. The Director, Counterdrug Directorate will be immediately notified by the CDC in the event of an emergency or "immediate action" situation.

(2) Immediate Action. An "immediate action" situation is defined as any situation which: results in a gross deviation from the OPLAN to the extent that weapons are fired at or by National Guard members; National Guard members inflict injury; injuries from hostilities are sustained by National Guard members; defensive or offensive actions (not planned for but reactive in nature) have been taken which escalate the original OPLAN; or which may be classified as "serious incidents" as determined by the senior National Guard member present.

(3) In addition to Counterdrug Support Program reporting requirements, Serious Incident Reports (SIRs) must be submitted through appropriate channels IAW AR 190-40 or applicable Air Force Instructions with copy furnished to NGB-CD.

#### 4-2 Safety and Accident Prevention Program

a. General. Accident prevention in counterdrug activities is based upon the philosophy that accidents can be prevented. Accident prevention is everyone's responsibility and an inherent function of leadership. This Counterdrug Safety Program establishes responsibilities, implementation instructions, goals, and methods to ensure the safety of all counterdrug personnel. It will enhance the accomplishment of Counterdrug Support Program activities by preventing accidental injury and/or loss of personnel or equipment. Everyone must comply with safety requirements set by Army/Air Force regulations/instructions, higher headquarters, this safety program, and the State Counterdrug Safety SOP.

(1) The safe accomplishment of all counterdrug support missions and activities is the main thrust of the program. The safety goals of the Counterdrug Support Program are:

(a) Enhance the total counterdrug mission effectiveness by eliminating/minimizing accidental manpower and material loss.

(b) Always provide a safe and healthy environment for all counterdrug personnel and others exposed to counterdrug activities.

(2) The safety goals are achieved through the following safety program objectives:

(a) Preventing injuries on or off duty.

(b) Detecting and eliminating the causes of preventable accidents.

(c) Identifying and controlling risks.

(d) Complying with all Federal, state, and local safety/environmental requirements.

NOTE: Since the current ANG Mishap Prevention Program complies with the intent of this program, ANG units will continue to abide by established ANG directives and procedures when conducting CD operations, with the exception that reporting procedures will be amended to include the CDC as an info addressee on all CD related matters. The CD Safety Officer will coordinate with each ANG unit Chief of Safety to ensure the CD Safety SOP and related directives do not conflict with the ANG Mishap Prevention Program. Published ANG directives and procedures take precedence for ANG units.

b. Responsibilities. Counterdrug accident prevention and reporting is everyone's responsibility. Policies, objectives and

standards must be established and understood by everyone to ensure effective accident prevention.

(1) The CDC has the overall responsibility for the state counterdrug accident prevention program and will develop and implement a State Counterdrug Safety SOP. Special attention will be given to aircraft and vehicle safety (i.e., designating an assistant driver for travel to unfamiliar areas or trips of longer duration) and the unique requirements of each state (i.e., weather, geography, legal). The CDC will staff the SOP with the appropriate safety/environmental officers/agencies.

(2) The CDC will ensure that:

(a) A Counterdrug Safety Officer/NCO is appointed.

(b) Operation plans are reviewed to ensure that mission assignments are within personnel and equipment capabilities and that the most appropriate assets, consistent with operational success and safety goals, are utilized.

(c) Sound safety principles and standardized procedures are followed for all operations regardless of mission urgency.

(d) Mission briefings and risk assessments are completed for all missions.

(e) Execution of duties and performance of accident prevention surveys are IAW AR 385-95, AR 385-10, NGR (AR) 385-10 and ANG Safety Instructions.

(f) Safety files, statistics and literature are maintained IAW AR 385-10, NGR (AR) 385-10, and ANG Instructions.

(g) Counterdrug Safety SOP complies with the Counterdrug Safety and Accident Prevention Program.

(h) Mishap reports are submitted, reviewed and corrective actions are implemented.

(3) Counterdrug personnel will:

(a) Correct all known deficiencies. Everyone, regardless of rank, will make immediate on-the-spot corrections when unsafe activities are observed.

(b) Report all unsafe conditions to the CDC/Counterdrug Safety Officer/NCO when on-the-spot corrections cannot be made.

(c) Immediately report all safety incidents/accidents through the chain of command to the Counterdrug Safety Officer/NCO.

SOP. (d) Read and comply with the Counterdrug Safety

(4) SOP requirements, as a minimum, will include the following in the state Counterdrug Safety SOP:

- (a) Safety considerations by mission category.
- (b) Risk Management Program.
- Briefings. (c) Pre-Mission Briefings and Post-Mission
- (d) Training and Operation Rehearsals.
- (e) Safety Council/Lessons Learned/Air and/or Ground Pre-accident Prevention Plan.
- (f) Medical/Response Planning.
- (g) General considerations for ground safety.
- (h) General considerations for Army/Air Aviation.
- (i) Environmental Review.

#### 4-3 Operational Briefings

a. Upon acceptance into the counterdrug support program, National Guard members will be provided with training as prescribed by this regulation/instruction and will be briefed on all aspects of the program to include legal restrictions and limitations, use of force, safety, force protection, and standards of conduct, and will be issued written guidance approved by the state JAG. Such written guidance will advise them of the rules of engagement, their status (State Active Duty or Title 32), tort protection, and medical benefits.

b. Prior to every operation, National Guard members will be given a briefing which reviews, at a minimum, use of force, safety, force protection, standards of conduct, and medical evacuation considerations. The briefing officer will certify that personnel have been briefed and that they have signed an acknowledgment of such. Copies of written guidance will be provided and a roster of individuals briefed will be maintained by the CDC.

c. Aircraft safety. The LEA will be responsible for establishing and securing landing zones prior to aviation operations. The operation of aircraft constitutes a significant hazard to LEA personnel, NG personnel and civilians. Pilots in Command (PIC) are responsible for the aircraft and the lives of passengers and crew. In addition to other guidance on aircraft

safety, PICs will not fly into or land in known hostile areas and will ensure that passengers are instructed in the principles of aircraft safety. Aircraft will maintain a safe distance from any known hostile elements when initially inserting LEA personnel into the operational area.

#### 4-4 Public Affairs

a. The State Public Affairs Officer (PAO) and the CDC, in coordination with the supported LEA or CBO, will have the lead in release of NG information to the public.

b. State PAOs will not divulge dates of specific supply reduction operations, identification of units, or identification of personnel involved in supply reduction operations. Photographs and video tapes will be carefully managed to ensure that faces and nametags are not visible. Operational questions regarding information on numbers and types of personnel and equipment involved in current or future activities will not be released until the mission is completed. Protection of the force will be the primary consideration.

c. News media may accompany the National Guard on supply reduction operations only with the approval of the LEA. IAW NGB Pam 360-5, National Guard counterdrug flights with news media representatives require prior approval by NGB-PA.

d. DDR activities should be coordinated with State PAO for media support.



#### 4-5 Support Role

The role of the National Guard in counterdrug supply reduction operations is to support LEAs. The CDC will ensure that personnel are not placed in situations that are likely to bring them in direct contact with suspects. The CDC will also ensure that National Guard members are not knowingly sent or directed to enter into a hostile environment where information indicates there is a high probability of encountering hostile fire or other life threatening situations.

#### 4-6 Force Protection, Rules of Engagement, and Use of Force

a. Purpose. The purpose of this guidance is to:

(1) Emphasize the importance of safety in the conduct of counterdrug supply reduction operations.

(2) Alert commanders to policy concerning force protection.

b. Force Protection. National Guard personnel at all levels will ensure that pre-operation (liaison) coordination and planning with supported law enforcement agencies address the safety of personnel and equipment throughout the operation. Consideration will be given to potential threats to National Guard members and property for force protection purposes. National Guard personnel will ensure that public affairs efforts, directed at complying with the public's right to know, do not jeopardize the safety of National Guard members and equipment by disclosing personnel identification in photographs or video recordings by the media.

c. Use of Force and Arming of Troops.

(1) This paragraph contains Federal guidelines which cannot be broadened. However, states should review these rules and add further restrictions as appropriate to comply with state law or policy.

(2) The Adjutant General will determine whether or not troops will be armed. Since the National Guard is in a support role and not directly engaged in law enforcement, National Guard members will not routinely be armed. Arms and ammunition will be secured until issued. Rounds will be chambered only on order of the senior National Guard member present and in coordination and conjunction with the supported LEA. The senior military member must be able to clearly describe what imminent danger exists to warrant the chambering of rounds. Firearms will not be discharged from aircraft or moving vehicles. Possession or use of non-issued or personally owned firearms and/or ammunition is prohibited during counterdrug support operations.

(3) When arming of troops is necessary and authorized by the TAG, the CDC will ensure National Guard members are fully qualified and remain current on their issued weapon through verification of appropriate documentation.

(4) NG members may use minimum force (restrain, detain, subdue) for the following purposes:

(a) Defend themselves or other persons.

(b) Protect property, or prevent loss/destruction of evidence.

(c) Make arrests if they have arrest powers pursuant to state law and exigent circumstances require such action.

(5) Deadly force (any force capable of causing serious injury or death) may only be used under the following circumstances:

(a) Lesser/other means have failed or their use would reasonably appear to be futile.

(b) Risk of injury to other persons is not increased by the use of deadly force.

(c) When deadly force is the minimum force necessary to prevent death or serious injury to the individual member, other National Guard members, LEOs, or other persons.

(6) The discharge of any firearm is always to be considered deadly force.

(7) National Guard members will be thoroughly briefed on the Rules of Engagement and Use of Force prior to the commencement of any operation.

(8) The PIC has the authority to override the order to chamber rounds onboard aircraft.

4-7. Training and Operational Load Ammunition Requirements. There is no "special ammunition account." A STAR Derivative (DUIC) for counterdrug (CD) organizations is required for the management of ammunition. A DUIC gives the State Training Ammunition Planner (STAP) and your Supply Support Activity (SSA) the ability to authorize, account for expenditures and track your operational load munitions. Ammunition is authorized for issue to support CD training and operational use as follows:

a. Training Ammunition.

(1) Ammunition required for qualification with the individual weapons are listed below.

(a) For ARNG qualification on the rifle use Table 5-31, TRC "C" and Table 5-37, TRC "C" (MP Standards, not CID) for pistol qualification, tables are located in DA Pam 350-38/39, (STRAC).

(b) Air National Guard personnel must qualify IAW AFI 36-2227, Vol 1, follow chapter 2 for 9mm pistol qualification and chapter 3 for M-16 rifle qualification.

NOTE: Ammunition for weapons qualification will be requested through local supply points to NGB-ARO-TS (Ammunition Team).

(2) Ammunition to support additional operational or CD training missions may be authorized provided:

(a) Quantities requested are based on a valid Law Enforcement Agency Program of Instruction.

(b) Such requests are forwarded to and approved by NGB-CDS.

(c) Approved requests are forwarded by the state through the STAP via the TAMIS system. The STAP then forwards the approved request to VIP015, NGB-ARO-TS.

(d) Ammunition authorized as prescribed above will be used for training purposes only. The STAP is responsible for making sure the training ammunition is closely monitored to ensure compliance with AR 5-13, Training Ammunition Management System. The STAP must forecast quantities for the appropriate SSA, monitor ammunition issuance, turn-ins, consumption and ensure the appropriate UIC is credited to TAMIS.

b. Operational Ammunition.

(1) Per CTA 50-909, para 26(18) an ammunitions account may be established to support missions within the counterdrug program. Operational munitions are used when performing guard duty, police patrols, or investigative type duties, with the following provisions:

(a) TAG approval has been obtained.

(b) The operational load of ammunition is secured and accounted for IAW AR 710-2, paragraph 2-40c(1)(a), DA Pam 710-2-1, paragraph 11-5, DA Pam 710-2-2, chapter 25.

(c) NGB-CD has determined the following line item numbers and quantities extracted from CTA 50-909, Table 62 (MP Operational Loads) will be considered the basis of issue for the CD operational load.

D22628	.38 Spl Ball (A400)	12 rds/wpn
D23313	.45 Ball (A475)	21 rds/wpn

C39136	9mm Ball (A363)	45 rds/wpn
D34821	00 Buckshot (A011)	10 rds/wpn
D34973	5.56 Ball M193 (A071)	120 rds/wpn
J77626	Grenade, Green Smk (G940)	24 ea/DUIC
J79133	Grenade, Red Smk (G950)	24 ea/DUIC

(d) The number and type of weapons used for computing the operational load will be limited to those necessary to conduct CD support missions.

(2) The local purchase of commercial ammunition is not authorized.

#### 4-8 Rules of Evidence

Rules of evidence in civilian and military courts provide that evidence cannot be offered or accepted unless a chain of custody, setting forth in writing the names of all persons who have handled the evidence in question, can be shown. This is especially true for items subject to adulteration such as drugs. To ensure admissibility of such evidence, only LEO's should seize, handle and/or maintain custody of items that may be considered as evidence.

#### 4-9 Supply Reduction Missions Operations Security

a. Protective markings. Mark counterdrug plans, operations plans/orders, memorandum of understanding, and other sensitive documents, "FOR OFFICIAL USE ONLY," IAW AR 25-55, Chapter IV and AFI 37-132, paragraph 26. Refer to regulation/instruction for the proper marking of "FOR OFFICIAL USE ONLY" documents. Mark FOUO material sent to authorized persons outside the DoD with the following explanation typed or stamped on the document: "This document contains information EXEMPT FROM MANDATORY DISCLOSURE UNDER THE FOIA. Exemptions (b) (5); (b) (7) (F). Further distribution is prohibited without the approval of the Office of Primary Responsibility (OPR)." The OPR is the office within the state holding ownership of the documents being shipped.

b. Communications security (COMSEC). Use AR 380-19, Information System Security Program/AFI 14-201 Intelligence Production and Applications, to determine the methods for transmission or reception of voice and hard copy information.

c. LEA sensitive material will be treated as classified material protected to the confidential level.

#### 4-10 Intelligence Oversight

The CDC will establish an intelligence oversight program IAW NGR (AR) 380-13/(AF) 200-19.

Appendix  
References

Section 1  
Required Publications

Title 32, United States Code  
National Drug Control Strategy - Sep 89, 90, Feb 91 and Jan 92

National Drug Control Strategy  
Beginning - September 1989

DoD Directive 4515.13R  
Air Transportation Eligibility

DoD Directive 4500.9  
Transportation and Traffic Management

AFI 37-131  
Air Force Freedom of Information Act (FOIA) System

AR 11-2  
Internal Control Systems

AFI 14-201  
Intelligence Production and Applications Requirements

AR 25-55  
Department of the Army Freedom of Information Act

ANGR 30-2  
Social Actions Regulation

AFI 31-501  
Personnel Security Management Program

ANGI 36-101  
The Active Guard/Reserve (AGR) Program

AR 37-100-85  
The Army Management Structure

NGR 37-111  
Administration of Training and Special Work Workdays

AFI 37-132  
Air Force Privacy Act Program

AR 40-3  
Medical, Dental and Veterinary Care

NGR 40-3  
Medical Care for Army National Guard Members

AR 40-501  
Standard of Medical Fitness

NGR 40-501  
Medical Examination for Members of the Army National Guard

AFI 44-120  
Drug Abuse Testing Program

NGR (AF) 50-1  
Management of Active and Inactive Duty for Training and  
Operational Support Within the Air National Guard

AFM 67-1 Vol 2 Pt 2 Ch 2/ANG Sup 1  
Loan and Use of Property Issued to the Air National Guard

AFR 67-23  
Standard Base Supply Customer's Guide

AFR 68-1  
Reports of Survey for Air Force Property

AFI 91-202  
The U.S. Air Force Mishap Prevention Program

NGR (AR) 95-210  
Army National Guard: General Provisions and Regulations for  
Aviation Training

AR 135-200  
Active Duty for Training, Annual Training and Active Duty Special  
Work of Individual Soldiers

AFI 48-123  
Medical Examinations and Standards

AFI 31-401  
The Air Force Physical Security Program

AFI 31-210  
Coping with Violence Abroad Personal Protection Pamphlet

AR 340-21  
The Army Privacy Program

AR 360-5  
Army Public Affairs

NGB Pam 360-5/ANGP 190-9  
National Guard Public Affairs Guidelines

AR 380-67  
Headquarters DA Personnel Security Program

AR 385-10  
Army Safety Program

NGR (AR) 600-5  
The Active Guard/Reserve (AGR) Program, Title 32, Full-Time  
National Guard Duty (FTNGD)

AR 600-9  
Army Weight Control Program

NGR (AR) 600-10  
The Active Guard/Reserve (AGR) Program, Title 10 Full-Time  
National Guard Duty (FTNGD)

AR 600-85  
Alcohol and Drug Abuse Prevention and Control Program

AR 600-110  
Identification, Surveillance and Administration of Personnel  
Infected with Human Immunodeficiency Virus (HIV)

AR 700-131  
Loan of Army Material  
TPR 990-2  
Hours of Duty, Pay and Leave

Armstrong Laboratory, Brooks AFB, TX, Drug Urinalysis Collection  
Handbook

## Section 2

Related Publications  
(A related publication is merely a source of additional  
information. The user does not have to read it to understand  
this regulation)

NGR 10-2  
State Area Command, Army National Guard

AFR 55-3  
Reporting Meaconing, Intrusion, Jamming and Interference of  
Electromagnetic Systems

ANGR 23-01  
State Air National Guard Headquarters

AFM 67-1  
USAF Supply Manual

AR 25-1  
The Army Information Resources Management Program

AFI 36-101  
Federal Executive Boards and Associations

CTA 50-909  
Field and Garrison Furnishings and Equipment

AR 71-13  
Department of the Army Equipment Authorization and Usage Program

AR 95-1  
Flight Regulations

NGR (AR) 95-1  
ARNG Aviation: Flight Regulations (Modifies AR 95-1)

AR 130-5/AFMD 12  
Organization and Functions to National Guard Bureau

NGR 190-11  
Physical Security of Arms, Ammunition, and Explosives

AR 190-40  
Serious Incident Reporting

DA Pam 190-52  
Personnel Security Precautions Against Terrorism

AR 190-51  
Security of Army Property at Unit/Installation Level

AR 310-49  
The Army Authorization Documents System (TAADS)  
NGR (AR) 350-1  
Army National Guard Training

FORSCOM/ARNG 350-2  
Reserve Component Training

AR 350-9  
Overseas Deployment

AR 700-1  
Army Conversion to the Metric System of Measurement

NGR (AR) 500-1/NGR (AF) 55-5  
Military Support to Civil Authorities

NGR (AR) 600-85  
Drug Abuse Prevention and Control

DoD Directives 5525.5  
DoD Cooperation with Civilian Law Enforcement Officials; 5149.1;  
5160.54



**Glossary**

**Section I  
Abbreviations**

**A/C**  
Aircraft Commander (ANG)

**ADCO**  
Alcohol Drug Abuse Control Officer

**ADSW**  
Active Duty Special Work

**AFSC**  
Air Force Specialty Code

**AGR**  
Active Guard Reserve

**ANG**  
Air National Guard

**ANGRC/LG**  
Air National Guard, Directorate of Logistics

**ANGRC/SGPS**  
Air National Guard, Physical Standards Branch

**ANGRC/SGMM**  
National Guard Bureau, Air National Guard, Resource  
Office

**RNG**  
Army National Guard

**ASC**  
Allowance Source Code

**AT**  
Annual Training

**CBO**  
Community-based organization

**CDC**  
Counterdrug Coordinator

**COMSEC**

Communication Security

CNAC  
Customs National Aviation Center

CONUS  
Continental United States

CONUSA  
Continental United States Army

COSA  
Chief, Office of Substance Abuse

DAACC  
Drug and Alcohol Abuse Control Committee (ANG)

DAT  
Drug Analysis Testing

DBMS  
Director of Base Medical Services (ANG)

DDR  
Drug Demand Reduction

DDRA  
Drug Demand Reduction Administrator

DLEA  
Drug Law Enforcement Agency

DoD  
Department of Defense

DPP  
Dedicated Procurement Program

EER  
Enlisted Evaluation Report

ENTNAC  
Entrance National Agency Check

EPIC  
El Paso Intelligence Center

ESP  
Emergency Special Program

ESSO  
Executive Support Staff Officer

FOIA  
Freedom of Information Act

FTCA  
Federal Tort Claims Act

FTDTL  
Forensic Toxicology Testing Laboratory

FTNGD  
Full-Time National Guard Duty

GSU  
Geographically Separated Unit (ANG)

HIV  
Human Immunodeficiency Virus

IAD  
Inactive Duty Training

IDT  
Inactive Duty Training

JAG  
Judge Advocate General

JTF  
Joint Task Force

LAN  
Local Area Network

LEA  
Law Enforcement Agency/Agent

LEO  
Law Enforcement Officer

LSP  
Litigation Support Package

MOA  
Memorandum of Agreement

MOS  
Military Occupational Specialty

MOU  
Memorandum of Understanding

MRD

Mandatory Retirement Date

MRO  
Medical Review Officer (ANG)

MSD  
Mandatory Separation Date

MUTPM  
Medical Urinalysis Testing Program Monitor (ANG)

NAC  
National Agency Check

NCIC  
National Crime Information Center

NCO  
Noncommissioned Officer

NCOER  
Noncommissioned Officer Evaluation Report

NGB  
National Guard Bureau

NGB-ARC-P  
National Guard Bureau, Army Comptroller Program and Budget  
Division (Budget)

NGB-ARL  
National Guard bureau, Army Guard, Logistics Directorate

NGB-ARP-F  
National Guard Bureau, Full-Time Support Division

NGB-ARP-HS  
Office of the Army Surgeon, Medical Standards

NGB-AVN  
National Guard Bureau, Aviation Directorate

NGB-CD  
National Guard Bureau, Counterdrug Directorate

NGB-JA  
National Guard Bureau, Judge Advocate

NGB-PA  
National Guard Bureau, Public Affairs

NGPA

National Guard Personnel Appropriation

NICI  
National Interagency Counterdrug Institute

NORAD  
North American Aerospace Defense Command

OER  
Officer Evaluation Report

OMARNG  
Army National Guard Operations and Maintenance Appropriation

ONMG  
National Guard Operations and Maintenance Appropriation

OPLAN  
Operation Plan

OPORD  
Operation Order

OPSEC  
Operations Security

OPR  
Officer Performance Report

OPR  
Office of Primary Responsibility (ANG) - another definition

OSD  
Office of the Secretary of Defense

PAO  
Public Affairs Officer

PCS  
Permanent Change of Station

PC  
Pilot in Command (ARNG)

POC  
Point of Contact

POM  
Program Objective Memorandum

POMSO  
Plans, Operations, and Military Support Officer

RLSO

Regional Logistical Support Office

RON  
Remain Overnight

SAAO  
State Army Aviation Officer

SAO  
Social Actions Officer

SAPCP  
ANG Substance Abuse Prevention and Control Program

SAPRP  
Substance Abuse Prevention and Control Program

SECDEF  
Secretary of Defense

SIC  
Senior Installations Commander (ANG)

SITREP  
Situation Report

SOP  
Standard Operating Procedures

SPMD/UMD  
Office of the Air Surgeon, Aerospace Medicine

ST  
Special Training

STARC  
State Area Command

TAADS  
The Army Authorization Documents System

TDA  
Table of Distribution and Allowances

TDC  
Type Duty Code

TPF  
Total Package Fielding

TPR  
Technician Personnel Regulation

UADC

Unit Alcohol and Drug Coordinator

UMD  
Unit Manning Document

USCS  
U.S. Customs Service

32 USC 112 Section  
112 of Title 32, United States Code

USMEPCOM U.S.  
Military Entrance Processing Command

USPFO  
U.S. Property and Fiscal Officer

WAN  
Wide Area Network

Section II  
Terms

Adjutant General  
Refers to the Commanding General in those states without an  
Adjutant General

Attorney General  
Refers to the equivalent official in states without an Attorney  
General

Civil Authorities  
Elected and appointed public officials and employees of Federal,  
state, and local government.

Coalition  
A combination into one body, different factions, parties, or  
organizations for a specific purpose.

Community  
People with common interests living in a particular area. The  
area itself. A group linked by a common history, social,  
economic, or political interests.

Counterdrug Support Program  
Support provided to Federal, state or local LEAs, civil  
authorities or Community Based Organizations to assist with drug  
interdiction and demand reduction activities authorized by 32 USC  
112 in support of the National Drug Control Strategy.

Exigent Circumstances

Circumstances in which immediate action is necessary to protect police officers, Guard personnel, or other persons from injury; to prevent loss or destruction of evidence; or to prevent the escape of a suspect already in custody.

#### Incidental to Training

Previously or otherwise scheduled training which would have been conducted regardless of counterdrug operations. Routes and schedules may be altered in order to maximize counterdrug benefits.

#### Law Enforcement Agency (LEA)

An organization, or a coordinating council comprised of several LEAs, empowered by Federal, state or local law to investigate, enforce or prosecute criminal laws regarding illegal drugs and controlled substances.

#### Mishap Sequence

All events that lead up to and all action or inactions that involve an accident or incident that result in death, bodily injury, and/or loss or damage to property and/or equipment which may create liability on an individual or the United States.

#### National Guard

Except as stated otherwise, National Guard means a state National Guard when not in Federal service, or all such organizations collectively.

#### Organizations

Agencies, coalitions, committees, councils, task forces, and similar groups who support drug abuse educations, awareness, and prevention.

#### States

For the purpose of this regulation the term states includes all 50 states, the Commonwealth of Puerto Rico, the U.S. Virgin Islands, Guam, and the District of Columbia.

#### State Plans

Plan submitted by the states for National Guard counterdrug support activities as authorized by 32 USC 112.



By Order of the Secretaries of the Army and the Air Force:

EDWARD D. BACA  
Lieutenant General, USA  
Chief, National Guard Bureau

Official:

DEBORAH GILMORE  
Chief  
Administrative Services

Distribution: B

DRAFT  
NGR 500-2/ANGI 10-801 20 May 1996  
NGR 500-2/ANGI 10-801 10 April 1996  
NGR 500-2/ANGI 10-801 20 March 1996  
NGR 500-2/ANGI 10-801 17 March 1996  
NGR 500-2/ANGI 10-801 11 March 1996  
NGR 500-2/ANGI 10-801 27 January 1996  
NGR 500-2/ANGI 10-801 30 January 1995  
30 January 1995 NGR 500-2/ANGI 10-801  
NGR 500-2/ANGI 10-801 30 January 1995  
30 January 1995 NGR 500-2/ANGI 10-801  
NGR 500-2/ANGI 10-801 30 January 1995  
30 January 1995 NGR 500-2/ANGI 10-801

NGR 500-2/ANGI 10-801 30 January 1995  
30 January 1995 NGR 500-2/ANGI 10-801  
NGR 500-2/ANGI 10-801 30 January 1995  
30 January 1995 NGR 500-2/ANGI 10-801  
NGR 500-2/ANGI 10-801 3 October 1994  
3 October 1994 NGR 500-2/ANGI 10-801

# TEXAS COUNTERDRUG INFORMATION HANDBOOK



## GENERAL INFORMATION

Additional information or assistance with this section is available through your counterdrug (CD) chain of command from the Command Group in Austin, commercial (512) 485-5516.

**A. PURPOSE.** This handbook will provide a quick-reference guide for all Texas National Guard Counterdrug (AGTX-CD) personnel. Exceptions to the policies referenced here must be approved in writing, through the AGTX-CD commander, by the Adjutant General of Texas. Suggested changes/improvements to this handbook may be submitted in writing to:

AGTX-CD  
ATTN: J-3 OPERATIONS OFFICER  
P.O. BOX 5218  
AUSTIN, TEXAS 78763-5218

**B. MISSION.** The Texas National Guard provides personnel, equipment, training, and materiel in support of local, state, and federal law enforcement agencies (LEAs) to detect, deter, and disrupt cultivation, production, and trafficking of illegal narcotics in Texas.

**C. AUTHORITY.** The United States Congress has provided authority to the counterdrug support program under Title 32, U.S. Code. Congress also allocates specific funding to the Texas National Guard to support drug law enforcement agencies in Texas. Personnel ordered to Federal Active Duty Special Work (ADSW) status remain under the control of the Adjutant General of Texas and the Governor of Texas. National Guard Regulation (NGB) 500-2 dated 30 September 1993 provides additional guidance.

**D. DISTRIBUTION.** This handbook is distributed to all National Guard soldiers and airmen performing counterdrug duty in Texas. Specific supporting commands and units also receive this handbook for general recruiting and coordinating information.



# TEXAS COUNTERDRUG INFORMATION HANDBOOK

## TABLE OF CONTENTS

GENERAL INFORMATION.....	1
TABLE OF CONTENTS.....	ii
EMERGENCY CONTACT PROCEDURES.....	iii
RECRUITING PROCEDURES.....	1
PERSONNEL INFORMATION.....	4
OPERATIONAL INFORMATION.....	8
LOGISTICAL INFORMATION.....	12



## TEXAS COUNTERDRUG INFORMATION HANDBOOK



### EMERGENCY CONTACT PROCEDURES

Additional information or assistance with this section is available through your counterdrug (CD) chain of command and from AGTX-CD, Austin, commercial (512) 465-5516.

#### A. EMERGENCY CONTACT PROCEDURES.

##### 1. Contact Regional OIC immediately:

a. The phone numbers are provided to task force members upon assignment to their region.

b. These phone numbers are confidential.

##### 2. Contact Counterdrug Headquarters in Austin:

###### a. During duty hours (0730-1630 M-F):

Commercial: (512) 465-5516 - Main Number  
(512) 406-6915 - Executive Officer  
(512) 465-5633 - Operations Officer  
(512) 465-5603 - Administrative Officer  
(512) 465-5654 - Logistics Officer

TEXAN: Dial: 1-(800) 448-3926  
at tone enter: (512) 465-5516  
at tone enter: Authorized TEXAN Code \*

###### b. During Non-duty hours (after 1630, weekends, holidays):

Camp Mabry Staff Duty Officer:

Commercial: (512) 465-5001

TEXAN: Dial: 1-(800) 448-3926  
at tone enter: (512) 465-5001  
at tone enter: Authorized TEXAN Code \*

\* TEXAN Code provided upon assignment to region.

## TEXAS COUNTERDRUG INFORMATION HANDBOOK

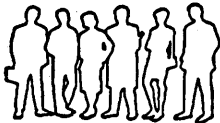

### I. RECRUITING PROCEDURES

Additional information or assistance with this section is available through your chain of command from the Assistant Interagency Coordinator of the Texas National Guard Counterdrug Program (AGTX-CD) in Austin, commercial (512) 465-5531, DSN: 954-5531.

**A. GENERAL.** National Guardsmen performing counterdrug duty usually do so on long term ADSW orders and in support of sensitive law enforcement operations. Because of these unique mission requirements AGTX-CD has personnel selection requirements which in most cases are more stringent than most other programs found in the National Guard.

**B. PREREQUISITES.** Individuals interested in applying for ADSW in AGTX-CD must meet the following MINIMUM qualifications:

1. Member of Texas National Guard, Army or Air.
2. No unfavorable (flagging) actions pending.
3. No temporary physical profiles.
4. Meet entry physical standards, Chapter 2 for Army or Chapter 4 for Air.
5. Meet height/weight standards IAW AR 600-9/AF Reg 35-11.
6. Be able to pass physical fitness test (Army/Air).
7. Be recommended, in writing, by their unit commander.

**C. APPLICATION PACKET FOR TXANG PERSONNEL.** Air National Guard personnel must contact the Counterdrug Air Guard Unit Administrator at their Base of Assignment (i.e. Kelly AFB, Ellington Field, Hensley Field, or Fort Bliss).

**D. APPLICATION PACKET FOR TXARMG PERSONNEL.** Individuals must submit the following completed documents for consideration.

1. Request for Orders (AGTX Form 73R) must be signed by the unit requesting ADSW orders and forwarded through the chain of command for a major command authorization. Adhere to the following directions when completing this form:

a. Complete the top four lines of the form except for the Type Duty Code (TDC). TDCs for the applicants being considered will be determined by the J-1 section at Counterdrug Headquarters.

b. Insure that the Station Unit Code (SUC) and the Service member's (SMs) home of record (HOR) are correct.

## TEXAS COUNTERDRUG INFORMATION HANDBOOK

- c. The "PURPOSE" block should read "Support Counterdrug Operations".
  - d. Do not enter any information from "INCLUSIVE DATES" through the Cost Estimation line (EST P&A, TVL, ect.).
  - e. Enter the Applicant's home, work or other daytime contact telephone numbers in the "REMARKS" block. Make SURE this is a current, usable phone number, to ensure questions about your packet can be answered immediately.
2. Letter of Recommendation. This document must be signed by the commander of your drill unit, and must specifically state that the recommendation is for counterdrug duty.
  3. Resume of skills and experience, to include Military Occupational Skill (MOS) designators and special identifier codes, as well as civilian skills and education.
  4. Copies of most recent SF 88 and SF 93, administered within the last four years.
  5. Copies of any and all Profiles incurred since last SF 88/SF 93 was administered.
  6. NGR 40-501 Appendices B and C (supplied upon request). These forms are not an option but in addition to the SF 88 and SF 93.
  7. AGTX-CD Informed Consent Form (supplied upon request). Before completing this form, SM must receive a briefing by J-1 on the subject of the Counterdrug Personnel Integrity Program.
    - a. In the first line of the statement a "write-in" line is provided. The name of the counterdrug representative who presented the briefing will be entered there.
    - b. This document must be signed before a witness.
  8. AGTX-CD Background Integrity Check Request Form (supplied upon request). This document is used to conduct the required background investigation on the applicant.
    - a. Complete the vital information listed on the front, to include signature and date. Do not fill out the "Security Clearance" or the "Urinalysis" blocks.
    - b. Read the Privacy Act Information on the reverse side of the form before signing the statement.
    - c. This document must also be signed before a witness.

## TEXAS COUNTERDRUG INFORMATION HANDBOOK

9. DA 705 (copy) showing SM passed a recent APFT for record. Please include any bodyfat content worksheets (DA 5500-R) with their corresponding test results.

**E. SELECTION CRITERIA.** The selection process begins only after satisfactory completion of items outlined in paragraphs B, C, and D of this section. The application will then be screened against the following criteria:

1. Available Vacancies. Vacancies in AGTX-CD are created through attrition and/or program expansion. Once vacancies are identified; application packets on file are evaluated and compared against vacancy needs.

2. Skill Requirements. Applicants who have the training (skills) to meet the duty description are identified first.

3. Residents in Duty Area. Applicants are then screened a second time to identify who already lives within "reasonable commuting distance" from the duty location. Applicants who live in the duty area may be given priority over applicants who live outside the duty area.

4. Applicant Availability. Applicants meeting the above requirements are then contacted by phone to determine their interest and availability. At this point, applicants are usually invited to travel on orders to Austin for the qualification phase.

**F. QUALIFICATION PHASE.** This phase is the final step for acceptance for counterdrug ADSW orders. During this phase, applicants are given a physical fitness test (ARNG/ANG) which they must pass. Applicants are also screened medically. A police background (integrity) check is also conducted. Applicants successfully completing the qualification phase will then receive training before deployment to their duty location.

### G. POINTS OF CONTACT.

1. Send packets to:

The Adjutant General's Dept.  
ATTN: AGTX-CD/Assistant Interagency Coordinator  
P.O. Box 5218  
Austin, TX 78763-5218

2. Questions : DSN 954-5531; Commercial (512) 465-5531.  
FAX : DSN 954-5144; Commercial (512) 465-5144.



# TEXAS COUNTERDRUG INFORMATION HANDBOOK



## II. PERSONNEL INFORMATION

Additional information or assistance with this section is available through your CD chain of command from the J1 personnel section in Austin, commercial (512) 465-5603.

**A. GENERAL.** The following topics are personnel issues that affect soldiers/airmen once on the counterdrug program. Some differences between branch procedures exist. In those cases where a policy affects only one branch, the applicable service branch will be shown in parentheses.

### B. SPECIFIC.

1. Texas Code of Military Justice (TCMJ). The AGTX-CD task force commander is authorized to administer non-judicial punishment IAW the TCMJ. TCMJ was granted to AGTX-CD by the Judge Advocate General (AGTX) on 28 March 1991. AGTX-CD's authority to use TCMJ does not remove TCMJ authority from any unit commander during drill or annual training.

2. Urinalysis. Testing of AGTX-CD personnel will be scheduled (unannounced) a minimum of two (2) times per year. These test events are in addition to any urinalysis conducted by your unit. Positive results, testing "Hot", will result in immediate termination from counterdrug orders. The task force commander will properly notify the unit commander as prescribed by personnel policies.

3. Leave/Pass. ADSW personnel on orders for 30 days or more will accrue 2.5 days of leave per month (30 days/year). Aggressive use of leave is encouraged; leave will not be denied unless it interferes with a mission. Advanced leave must be approved by the task force commander, (submit through your OIC). Because AGTX-CD is funded one year at a time, leave may not be carried over into the next fiscal year. Leave will be charged for non-duty days and holidays which are bracketed by the leave. Leave cannot be used in conjunction with pass. All leave must be taken by 31 August; exceptions are approved by the task force commander on a case-by-case basis. Leave is accrued, specifically, on the first day of each window shown below.

Days 01-06 in the calendar month = 0.5 days of leave  
Days 07-12 in the calendar month = 1.0 days of leave  
Days 13-18 in the calendar month = 1.5 days of leave  
Days 19-24 in the calendar month = 2.0 days of leave  
Days 25-31 in the calendar month = 2.5 days of leave

## TEXAS COUNTERDRUG INFORMATION HANDBOOK

4. Sexual Harassment. The Adjutant General of Texas has taken an aggressive stand against sexual harassment in the Texas military forces. Problems of this kind should be resolved at the lowest level possible. Unresolved complaints will be forwarded through your AGTX-CD chain of command.
5. Travel Orders. Official military travel must be performed only after appropriate Temporary Duty (TDY) orders have been published. SMs authorized TDY to drill by AGTX-CD will request orders through their AGTX-CD chain of command (not their M-Day unit). These orders are published by AGTX-CD (ARNG) or the base administrator (ANG). SMs required, by their unit, to travel TDY will do so on TDY orders published by their M-Day unit. TDY orders are necessary to claim travel expenses and to protect the SM while travelling to/from duty station.
6. Reimbursement for Travel Expenses. Authorized expenses incurred during official military travel are claimed on DD Form 1351-2 and forwarded through your AGTX-CD chain of command. Reimbursements are processed through the J-1 (ARNG) or your base administrator (ANG).
7. VHA. Variable Housing Allowance (VHA) is authorized IF you have a current mortgage or lease contract naming you as the mortgagee or lessee, and your tour orders put you on duty for 140 days or more. To start, change or stop VHA, submit through your AGTX-CD chain of command a DA Form 5960 or AF Form 3502.
8. BAQ. AGTX-CD personnel are authorized Basic Allowance for Quarters (BAQ). To start, change, or stop BAQ, submit through your unit a DA Form 5960 or AF Form 594.
9. Pay Problems. J-1 needs to be aware of all pay problems. The only pay documents that are submitted through J-1, are VHA forms with supporting documents and travel reimbursements. All other payroll problems are handled by SM's M-Day unit.
10. American Express Government Issue Credit Cards. These cards are issued on a case-by-case basis according to mission requirements for travel. USE OF THE CARDS IS FOR AUTHORIZED TRAVEL EXPENSES ONLY WHILE IN AN OFFICIAL TDY STATUS. Cash advances and purchases of alcoholic beverages are specifically prohibited. All credit card debts are due and payable upon receipt; satisfaction of the debt is the responsibility of the individual. Copies of your monthly statement or a statement of non-use will be submitted through your AGTX-CD chain of command. Abuse of credit card privileges may result in termination from counterdrug orders.
11. Payment for Meals. Each AGTX-CD member receives Basic Allowance for Subsistence (BAS) above base pay.

## TEXAS COUNTERDRUG INFORMATION HANDBOOK

a. Officers. All officers are required to pay the surcharge (i.e. B: 2.45, L: 5.00, D: 5.00) plus the base rate (i.e. B: .95, L: 1.85, D: 1.85) for all government meals, regardless of TDY status.

b. Enlisted. When members attend drill and meals are provided by the government, they are required to pay the base rate (i.e. B: .95, L: 1.85, D: 1.85). Members authorized to attend drill in a TDY status are paid per diem and therefore will pay the surcharge (i.e. B: 2.45, L: 5.00, D: 5.00) plus the base rate.

c. For members on TDY status, when completing DD Form 1351-2, notate under GOVT column the total number of meals. Then notate under itinerary, the type of meal (i.e. 2B, 2L, 1D).

d. If government meals are available the cost of meals will be deducted from the daily per diem amount, whether you eat it or not. Units will be contacted for number of meals available.

e. This policy does not apply when members are off AGTX-CD orders such as for annual training or military schools.

### 12. Medical.

a. AGTX-CD Personnel: All AGTX-CD members must use military medical treatment facilities (MTF) for routine sick call. Where military MTFs are not within 30 miles or 60 minutes driving time one way, members are authorized to use a previously approved civilian MTF. See your AGTX-CD chain of command for the approved civilian MTF in your area. Any need for on-going or extensive medical care requires that the member go to a military MTF regardless of distance. Civilian MTFs may be used for emergency situations. A medical emergency is defined as life threatening or when there is a threat of permanent injury or loss of limb.

### b. Dependents.

1. MTF: Authorized dependents (i.e. spouse, children) may use a military MTF or a CHAMPUS approved civilian MTF. The civilian MTF should be a CHAMPUS provider and take assignment of medical costs. If the civilian MTF does not take CHAMPUS assignment, then you will be responsible for submitting the claim and paying any costs above the normal CHAMPUS rates.

2. CHAMPUS: All dependents must be enrolled in Defense Enrollment Eligibility Reporting System (DEERS) to be eligible for CHAMPUS benefits. CHAMPUS does not cover dental care. Call AGTX-CD, J-1 at (512) 465-5603 or CHAMPUS at 1-(800) 982-2883 for different options and additional information.

## TEXAS COUNTERDRUG INFORMATION HANDBOOK

13. **Benefits.** Active duty benefits include pay and allowances, medical and dental care for the sponsor, and CHAMPUS benefits for dependents. Points of contact for all ADSW benefits is the J-1 section. There are other benefits available to all guardsmen, both active and M-Day. Points of contact for some of these benefits are listed below.

a. Family Assistance - DSN 954-5000 or (512) 465-5000. Assistance on family benefits, family support groups, etc.

b. Legal Assistance - DSN 954-5057 or (512) 465-5057. Advice and assistance on legal matters concerning wills for the soldier/airman, powers of attorney, child support, etc.

c. State Education Officer - DSN 954-6024 or commercial (512) 465-6024. Assistance in earning credit for college courses through tests, applying for college correspondence courses, acquiring financial assistance, etc.

d. Veterans Administration - 1-(800) 827-1000. Provides loans for home purchases to active component veterans and National Guard members with six (6) or more years.

e. Texas Veterans Land Board - 1-(800) 252-8387. Provides low interest loans for purchases of land, homes, and home improvements for Texas veterans to include reserve duty.

14. **Termination.** Task Force personnel are members of AGTX-CD on a voluntary basis and may voluntarily resign from ADSW service with the program. Requests to terminate should be submitted through their AGTX-CD chain of command. Two weeks notice is preferred. More advanced notice is required if your accrued leave exceeds the normal two week notice requirement. Your outprocessing packet, turned into your chain of command or the J-1 section, must include the following actions:

a. final payroll/travel documents prepared.

b. military sponsor and dependent ID cards turned in.

c. government issued credit cards turned in.

d. terminal leave documents filled out and signed by appropriate personnel (If no leave is accrued, a statement to that effect must be included in the packet).

e. all AGTX-CD and LEA badges, special passes, tools, computer disks, etc., inventoried and turned in.

f. a final, updated Personnel Data Card (PDC) turned in

## TEXAS COUNTERDRUG INFORMATION HANDBOOK

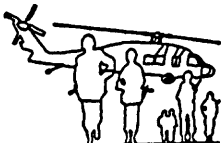

### III. OPERATIONAL INFORMATION

Additional information or assistance with this section is available through your CD chain of command from the J3 operations section in Austin, commercial (512) 465-5622.

**A. GENERAL.** The J-3 Operations section plans, coordinates, and reports on AGTX-CD operations and training events. The following topics are operational and training concerns:

**B. SPECIFIC.**

**1. Operations Security (OPSEC).** OPSEC involves the safeguarding of sensitive information in all aspects of the AGTX-CD mission. AGTX-CD has very specific and restrictive requirements for access to, and storage of, military classified material or information. Due to the nature of the AGTX-CD mission however, all material/information is considered LEA sensitive. For this reason, all members are required to sign an OPSEC statement upon entry into the program. The OPSEC statement is updated annually and signed by every AGTX-CD member. Improper use or discussion of AGTX-CD material/information, even unintentionally, may compromise the mission and, possibly, the safety of AGTX-CD or LEA personnel.

**2. Counterdrug Intelligence Oversight (CDIO).** CDIO is intended and mandated to protect the constitutional rights of U.S. persons. "U.S. persons" is defined as (1) U.S. citizens, (2) aliens known by the DoD to be permanent U.S. residents, and (3) certain associations and corporations. References on CDIO include (1) Executive Order 12333, (2) DoD 5240.1-R, (3) NGR(AR) 381-10, and (4) NGR(AF) 200-19. AGTX-CD members are held responsible to avoid any possible violations of the above references. AGTX-CD members receive entry and annual briefings on this topic. If you have any questions, need assistance, or need to report any violations that occur, call (512) 465-5633.

**3. Standards of Conduct.** AGTX-CD members are required to behave within a professional set of ethics and standards normally expected of an active duty soldier/airman. AGTX-CD members will maintain proper military bearing and appearance even when assigned to a civilian duty location. They are not to participate in "office politics". A good rule to remember is that the AGTX-CD member is a "guest" in the LEA's office.

## TEXAS COUNTERDRUG INFORMATION HANDBOOK

4. Serious Incident Reports (SIRs). This is an initial telephonic report through regional OIC's to AGTX-CD. OIC's will follow the initial call to AGTX-CD with a facsimile transmission, report format, with as much detail as is available and will answer the questions who, what, when, where, why, and how. OIC's will make this report to AGTX-CD, task force commander, at (512) 465-5516 immediately after an incident involving:

- a. Death or personal injury to any person involved in a counterdrug operation.
- b. Any loss, theft, damage or destruction of property in connection with the operation.
- c. Any attempt by unauthorized individuals/suspected traffickers to gather information pertaining to counterdrug support operations.

5. Contact/Encounters with Law Enforcement Agencies. All members must report to their OIC any contact with police or any law enforcement agency, military or civilian. This contact includes (but is not limited to):

- a. moving traffic violations, subpoenas, or court orders.
- b. unfavorable investigations of immediate family or domestic abuse or disturbances.
- c. arrests for any reason (public intoxication, driving under the influence of drugs or alcohol, possession of weapons/controlled substances, etc.).
- d. any meeting, discussion or exchange of counterdrug information with outside LEAs (military or civilian).
- e. A specific reporting format will be provided by regional OICs.

6. Physical Training. AGTX-CD personnel are required to pass the physical fitness test twice a year. ARNG and ANG members will take the test prescribed by their branch of service. Both tests will be conducted with their assigned unit. As a result, all AGTX-CD personnel are required to participate in a physical fitness program. Region personnel must attend a PT formation once a week, during duty hours, conducted by the regional OIC or senior member on site. Staff personnel will participate in a similar program.

## TEXAS COUNTERDRUG INFORMATION HANDBOOK

7. Drill Attendance. Service on the counterdrug program is voluntary and cannot detract from the mission readiness of your assigned unit. Attendance of regularly scheduled drills and annual training takes priority over AGTX-CD missions. Any soldier/airman who needs to drill at a time different from the unit training schedule must request written authorization from the unit commander. (This includes requests from the unit commander for counterdrug personnel to perform additional unscheduled training). That authorization must be forwarded to the task force commander for coordination and approval prior to the event.

8. NG/LEA Relationships. Good relations between AGTX-CD and the supported LEAs are vital to effective mission accomplishment. Every soldier/airman on the counterdrug program has a direct impact on that relationship. It is essential that each member maintain a professional attitude and appearance. Proper adherence to the standards of conduct mentioned earlier in this handbook is the best insurance.

### 9. Rules of Engagement.

a. Support Role. AGTX-CD personnel support LEAs. National Guard members are not authorized to act as law enforcement officers.

b. Force Protection. In accordance with memorandums of understanding (MOU) with the supported LEAs, all precautions are taken to keep the soldier/airman out of hostile environments. There is no direct contact with suspects. Additionally, no pictures, videos, or interviews of AGTX-CD Guard personnel can be made without prior approval through the task force commander and from the public affairs office.

c. Use of Force. AGTX-CD personnel have the primary right to use the minimum force necessary to defend themselves, team members, Law Enforcement officers or innocent bystanders.

d. Deadly Force. Defined as that force likely to cause serious injury or death. Deadly force can be used only when lesser means (minimum force) have been exhausted or are unavailable, while the risk of injury to innocent persons is not increased by use of deadly force.

e. Rules of Evidence. AGTX-CD personnel will not become a link in the chain of custody for LEA evidence. To ensure admissibility of evidence, only law enforcement officers can seize, safeguard, or possess any items having the potential of becoming evidence.

## TEXAS COUNTERDRUG INFORMATION HANDBOOK

f. Arming of Troops. AGTX-CD personnel will not routinely be armed. Weapons, (if authorized), will be secured until issued. Only approved military or LEA weapons will be issued. Personal weapons are not authorized. When weapons are issued, AGTX-CD personnel will follow the use of force and use of deadly force rules of engagement.

### 10. Weapons.

a. Authority. Only the task force commander may authorize the request for a AGTX-CD member to carry a weapon. The request must be submitted by the supported LEA in writing, (no personal requests). AGTX-CD personnel must have written approval from the task force commander with the written approval on their person prior to accepting a weapon.

b. Qualification. All AGTX-CD members authorized to carry a weapon must be qualified on that weapon on a scheduled, recurring basis. Qualification documentation must be submitted to the J-3 for review and is maintained on file.

c. Weapons. Only issued (military/LEA) weapons are authorized during operations. Personally owned weapons are NOT allowed on person, in auto, at work or duty location. Recreational weapons (for hunting, target shooting, etc.), taken to TDY locations or transported by TDY personnel, require prior written approval by the task force commander.

11. Tort Laws. The Federal Tort Claims Act protects all AGTX-CD personnel from third party (non-government) liability claims due to any third party personal or property damage incurred as a result of your actions. The Act protects counterdrug personnel if they are acting within "the course and scope of their duties". Soldiers/airman are NOT relieved of responsibility under the Report of Survey System for intentional misconduct or negligence which results in damage to U.S. government property.

12. Mexico/Travel to Foreign Countries. AGTX-CD personnel must request and receive written approval from the task force commander before any travel into Mexico or any other foreign country. Vacations into the interior of Mexico (resorts) or travel to family reunions, family funerals, etc., in Mexico are normally approved. ANY travel into Mexico must be done while in an approved leave status.



## TEXAS COUNTERDRUG INFORMATION HANDBOOK



### IV. LOGISTICAL INFORMATION

Additional information or assistance with this section is available through your CD chain of command from the J4 logistics section in Austin, commercial (512) 465-5654.

**A. GENERAL.** The J-4 section is responsible for logistics, supply, and physical security within the counterdrug program in Texas. The following issues are J-4 concerns. Due to the stringent requirements for the care and safeguarding of government property, this reference must NOT be considered as a complete reference. Always consult with the J-4 for detailed guidance.

#### **B. PROPERTY ACCOUNTABILITY/RESPONSIBILITY.**

**1. Accountability.** All persons entrusted with government property are responsible for its proper use, care, custody, and safeguarding. "Property" includes all military and law enforcement equipment. Property will not be used for any private purpose. No government property will be sold, given as a gift, loaned, exchanged, or otherwise disposed of unless specifically authorized by law.

**2. Responsibility.** Any individual entrusted with the possession, command, or supervision of government property must ensure the proper care, custody, and safeguarding of that property. There are four types of responsibility.

**a. Command.** Responsibility as evidenced by assignment to a command (i.e. regional OIC) which includes ensuring the security of all property of the command whether in storage or in use.

**b. Supervisory.** The obligation inherent to all supervisory positions and is not contingent upon signed receipt or responsibility statements.

**c. Direct.** Direct responsibility results from assignment as an accountable officer, receipt of formal written delegation, or acceptance of property on hand receipt from an accountable officer.

**d. Personal.** Personal responsibility always accompanies the physical possession of property, with or without a hand receipt.

## TEXAS COUNTERDRUG INFORMATION HANDBOOK

### C. SECURITY.

1. Buildings/Offices. Buildings, rooms, and offices containing government property should always be secured whenever an individual permanently assigned to the location is not present. Security will consist of locking all doors and windows as a minimum.

2. Office Machines. Allowing for size and weight, all office equipment should be secured in desks or cabinets when not in use. Computers, printers, etc., should be disconnected from electrical sources or on a surge protector when not in use.

3. Office Supplies. Government office supplies will be centrally secured in locked storage and issued as needed.

4. Keys, Cards, and Miscellaneous. Keys to government vehicles and U.S. National Credit cards will be stored in a locked cabinet, metal container, or safe when not dispatched or issued. Audio-visual equipment will be afforded single barrier protection as a minimum.

5. Task Force/Military Vehicles. Commercial Task Force vehicles will be locked with the normal factory installed locks and "The Club" anti-theft device when the vehicle is not in use. Assigned military vehicles will be secured and locked when not in use.

### D. DRIVER REQUIREMENTS.

1. Selection Criteria. Command emphasis will be exercised in the selection of drivers. Drivers must have an inherent ability to safeguard military equipment which includes the leased vehicles. Drivers are hereby advised that they should obtain an Extended Non-owned Coverage rider to their existing automobile insurance coverage. Drivers must meet the following criteria:

- a. be 21 years of age
- b. hold the minimum pay grade of E-5
- c. possess a valid Texas driver's license
- d. possess a valid DA Form 5984-E, U.S. Army Vehicle Operator's Identification Card, (ARNG) or a valid AF Form 2293, U.S. Air Force Motor Vehicle Operator Identification Card, (ANG).
- e. Exceptions to policy are submitted through OIC's to AGTX-CD, task force commander.

## TEXAS COUNTERDRUG INFORMATION HANDBOOK

2. Qualification. All assigned personnel will attend a command supervised viewing of Army Driver Improvement Program (ADIP) film. This requirement is mandatory prior to an individual being selected as a driver.

3. Loss of Authority to Operate Task Force Vehicles. Any individual responsible for a vehicle accident, military or civilian, may not be permitted to operate a AGTX-CD or LEA vehicle, at the discretion of the task force commander.

4. Additional Driver Requirements. Vehicles used in support of the Texas National Guard Counterdrug Program will have an assistant driver, when the mission allows or when risk factor is high. The assistant driver must act as ground guide each and every time the vehicle is operated in reverse gear. When parking a vehicle overnight, drivers will use a pre-selected area. If no area has been pre-designated, the driver will select a parking area using lighting, traffic, and security considerations.

5. Accident/Damage Reporting. The driver will report to their AGTX-CD chain of command any accidents and/or damage which occurs to a AGTX-CD vehicle while it was under their operational control.

E. U.S. GOVERNMENT NATIONAL CREDIT CARDS. Use of these cards will be in accordance with established AGTX-CD Standing Operating Procedures (SOP). Use of the card must also be IAW the Government Vehicles Operators Guide.

### F. LOSS OR THEFT OF GOVERNMENT PROPERTY.

1. Reporting. Upon discovery that arms, ammunition, explosives, or sensitive items of government property are missing, all personnel will, by the most expeditious means available, notify the following:

- a. Your immediate supervisor (worksite).
- b. Your OIC.
- c. The command group and logistics officer.

2. Investigations. Reports of any losses of weapons, ammunition, explosives, sensitive items, expensive items, and certain items designated by the Adjutant General of Texas, will be investigated.

ARMY REGULATION  
No. 500-50

\*AR 500-50  
HEADQUARTERS  
DEPARTMENT OF THE ARMY  
WASHINGTON, DC, 21 April 1972

EMERGENCY EMPLOYMENT OF ARMY AND OTHER RESOURCES  
CIVIL DISTURBANCES

Effective 1 June 1972

*This is a complete revision of AR 500-50 and changes are made throughout. Local limited supplementation of this regulation is permitted but is not required. If supplements are issued, Army Staff agencies and major Army commands will furnish one copy of each to the Deputy Chief of Staff for Operations and Plans (HQDA(DAMD-ODS) WASH, DC 20310).*

CHAPTER 1. GENERAL	Para- graph	Page
Scope.....	1-1	1-1
Explanation of terms.....	1-2	1-1
Basic policies.....	1-3	1-1
Training.....	1-4	1-2
<b>2. EMPLOYMENT OF FEDERAL ARMED FORCES</b>		
Common types.....	2-1	2-1
Other statutory provisions.....	2-2	2-1
Prerequisites of employment.....	2-3	2-2
Emergency.....	2-4	2-2
Restrictions.....	2-5	2-2
Command authority.....	2-6	2-3
Martial law.....	2-7	2-3
Protection of Federal property.....	2-8	2-3
End of commitment.....	2-9	2-4
<b>3. RESPONSIBILITIES</b>		
Department of the Army.....	3-1	3-1
Contingency planning.....	3-2	3-1
Military commander.....	3-3	3-2
Training requests.....	3-4	3-2
<b>4. FUNDING AND REQUESTS FOR MILITARY RESOURCES</b>		
Funding and reporting.....	4-1	4-1
Military resources.....	4-2	4-1
Loans to State and local governments and law enforcement agencies.....	4-3	4-3
Loans to the National Guard.....	4-4	4-4
Loans to Federal agencies.....	4-5	4-4

\*This regulation supersedes AR 500-50, 14 July 1971, including all changes.

TAGO 625A—April 450-474\*—72

## CHAPTER 1

### GENERAL

**1-1. Scope.** This regulation prescribes responsibilities, policy, and guidance for the Department of the Army in planning and operations involving the use of Army resources in the control of actual or anticipated civil disturbances. Basic authority is contained in DOD Directive 3025.12, *Employment of Military Resources in the Event of Civil Disturbances*.

**1-2. Explanation of terms.** *a. Civil authorities* are those elected and appointed public officials and employees who constitute the governments of the 50 States, District of Columbia, Commonwealth of Puerto Rico, US possessions and territories, and political subdivisions thereof.

*b. Civil disturbances* are group acts of violence and disorders prejudicial to public law and order within the 50 States, District of Columbia, Commonwealth of Puerto Rico, US possessions and territories, or any political subdivision thereof. The term civil disturbance includes all domestic conditions requiring or likely to require the use of Federal Armed Forces pursuant to the provisions of 10 USC chapter 15.

*c. Federal property* is property owned, leased, possessed, or occupied by the Federal Government.

*d. Federal function* is any function, operation, or action, carried out under the laws of the United States, by any department, agency, or instrumentality of the United States or by an officer or employee thereof.

*e. The Posse Comitatus Act (18 USC 1385)* prohibits the use of the Army and Air Force to execute local, State or Federal laws, unless authorized by the Constitution or act of Congress.

*f. An objective area* is the city or other geographical location where a civil disturbance is occurring or is anticipated, and where Federal Armed Forces are, or may be, employed.

**1-3. Basic policies.** *a.* The protection of life and property and the maintenance of law and order within the territorial jurisdiction of any State are the primary responsibilities of State and local civil authorities. Generally, Federal Armed Forces are employed after State and local civil authorities have utilized all of their own forces which are reasonably available for use, and are unable to

control the situation, or when the situation is beyond the capabilities of State or local civil authorities, or when State and local civil authorities will not take appropriate action. Employment of Federal Armed Forces will take place only—

(1) under the provisions of this regulation; and

(2) when the Secretary of the Army, pursuant to the orders and policies of the Secretary of Defense and the President, has generally or specifically so ordered, except in cases of emergency (para 2-4). See paragraph 2-3.

*b.* The Secretary of the Army has been designated as the Executive Agent for the Department of Defense in all matters pertaining to the planning for, and deployment and employment of military resources in the event of civil disturbances. The Department of the Army is responsible for coordinating the functions of all the Military Services in this activity for the Executive Agent. The Secretaries of the other Military Services are responsible for providing such assistance as may be requested by the Executive Agent.

*c.* Requests from civil authorities, the National Guard, and non-DOD Federal agencies for US Army resources may be honored in accordance with chapter 4. However, requesters should be encouraged to provide sufficient resources of their own to minimize the need for reliance on Army assistance. Availability of such assistance is contingent upon military requirements for the requested resources.

*d.* Persons not normally subject to military law taken into custody by the military forces incident to the use of armed forces, as contemplated by this regulation, will be transferred, as soon as possible, to the civil authorities. Prior to the establishment and operation of Army detention facilities, the designated task force commander will verify the fact that available Federal, State, and local confinement facilities and personnel can no longer effectively accommodate the number of persons apprehended who are awaiting arraignment and trial by civil jurisdiction. Further, this authority may be exercised only in the event Federal Armed Forces have been employed under the provisions

AR 500-50

21 April 1972

of this regulation and only with the prior approval of the Chief of Staff, US Army. When the requirement exists for the establishment and operation of Army detention facilities during civil disturbances, the provisions of AR 190-20 will be complied with.

e. Whenever military aid is requested by civil authorities in the event of civil disturbances within the States of Alaska or Hawaii, the Commonwealth of Puerto Rico, or US possessions and territories, the commander of the unified command concerned coordinates the provision of such aid as directed by the DOD Executive Agent and consistent with defense priorities.

f. Units and members of the Army Reserve in active Federal service may be employed in civil disturbance operations in the same manner as other active forces. Units and members of the Army Reserve may be ordered to active duty for this purpose

by the President as provided by law. Members of the Army Reserve, with their consent, may be ordered to active duty for civil disturbance operations under the provisions of 10 USC 672.

g. Civil disturbance information on civilian individuals or organizations will not be collected unless these activities can, in a reasonably direct manner, be related to a distinct threat of civil disturbance exceeding the law enforcement capabilities of local and State authorities. Collection of such information will be accomplished only on order of the Department of the Army following authorization by the Secretary or Under Secretary of the Army. (See para 3-1b(6) and 3-1c.)

1-4. Training. Training of Active Army USAR, and NG forces for civil disturbance operations will be conducted in accordance with current training directives. See paragraph 3-4.

## CHAPTER 2

### EMPLOYMENT OF FEDERAL ARMED FORCES

**2-1. Common types.** In addition to the provisions of the Constitution and other basic legal principles, there are numerous statutes authorizing the employment of Federal Armed Forces in cases of violence, or for other specific purposes, within any State and within the territories of the United States. The possibility of employment under many of these provisions is considered remote, and only those instances where employment is most likely are treated in this paragraph. Additional constitutional and statutory provisions are cited in paragraph 2-2.

*a. To aid State civil authorities at the request of the State.* Article IV, section 4, of the Constitution makes it the duty of the Federal Government at the request of the legislature of any State (or of the Governor if the legislature cannot be convened), to protect the State against domestic violence. Congress has enacted legislation authorizing the President to utilize Federal Armed Forces for this purpose. See 10 USC 331, 3500.

*b. To enforce Federal authority.* Article II, Section 3, of the Constitution makes it the duty of the President to see that the laws of the United States are faithfully executed. Congress has implemented this provision by providing that whenever the President considers that unlawful obstructions, combinations, or assemblages, or rebellion against the authority of the United States, make it impracticable to enforce the laws of the United States in any State or territory by the ordinary course of judicial proceedings, he may utilize such Federal Armed Forces as he deems necessary to enforce those laws or to suppress the rebellion. See 10 USC 332, 3500.

*c. To protect the civil rights of citizens within any State.* The 14th Amendment of the Constitution forbids any State to deny equal protection of the laws to any person within its jurisdiction. In implementation of this provision and of Article II, Section 3, mentioned above, Congress has provided that whenever insurrection, civil violence, unlawful combinations, or conspiracies in any State so oppose, obstruct, or hinder the execution of the laws of the State, and of the United States,

as to deprive any of the population of that State of rights, privileges, and immunities named in the Constitution and secured by laws, and the authorities of that State are unable, fail, or refuse to provide such protection, it will be deemed a denial by that State of the equal protection of the laws. Thereupon, it becomes the duty of the President to take such measures, by intervention with Federal Armed Forces, or by other means, as he deems necessary, to suppress such disturbances. See 10 USC 333, 3500.

**2-2. Other statutory provisions.** *a. Insurrection after intervention* (see also para 2-1a, b, and c): See 12 Stat. 257, 284 50 USC 205.

*b. Military areas and zones.* See 18 USC 1383.

*c. Miscellaneous.* The President is authorized by statutes to employ, at his discretion, the military forces for the following purposes. (See statutes cited for full text of laws, only the general purposes of which are herein stated):

(1) *Civil rights.* To authorize persons appointed to execute warrants issued to enforce certain laws enacted for the safeguarding of civil rights to summon the land and naval forces for assistance. See 36 Stat. 1167, 42 USC 1989.

(2) *Indians.* To remove unauthorized persons from lands belonging by treaty to Indian tribes. See 4 Stat. 730, 25 USC 180.

(3) *Public lands.* For the preservation and protection of certain public lands and public lands generally. See 3 Stat. 651, 16 USC 593; Sec. 1, act 3 March 1807, 2 Stat. 445; Sec. 5, act 25 February 1885, 23 Stat. 322, 43 USC 1065; Sec. 1, act 6 June 1900, 31 Stat. 618, 16 USC 78; act 3 March 1883, 22 Stat. 627, 16 USC 23.

(4) *Offenses against neutrality.* To enforce neutrality by preventing belligerents in foreign wars from using territory of the United States and to prevent the illegal exportation of war material. See Sec. 14, act 4 March 1909, 35 Stat. 1901, as amended, 22 USC 462; Sec. 4, title II, act 15 June 1917, 40 Stat. 225, 22 USC 408.

(5) *Customs and public health.* To enforce customs laws of the United States. See 12 Stat. 256, 50 USC 220.

(6) *Quarantine and health laws.* To aid in the execution of quarantine and health laws. See 1 Stat. 619, 42 USC 97.

(7) *Guano islands.* To protect the rights of the discoverer of a guano island. See 11 Stat. 120, 48 USC 1418.

**2-3. Prerequisites of employment.** *a. At the request of a State* (para 2-1a). Formal requests by a State for the assistance of Federal Armed Forces must originate with the legislature of the State concerned, or with the Governor if the legislature cannot be convened, and should be made to the President. The Attorney General of the United States has been designated by the President to receive and coordinate preliminary requests from States for Federal military assistance under the authority cited in paragraph 2-1a. Should such an application, either formal or preliminary, be presented to a local commander, that commander will request the person making the application to transmit his request to the Attorney General. The commander will also inform the Army Chief of Staff of the fact of the request by the most expeditious means and will include a statement of all material facts known to him (exempt report, para 7-2o, AR 335-15).

*b. Presidential proclamation.* No employment orders will be issued by the Department of the Army for the purposes indicated in paragraph 2-1a, b, and c until the President directs the Secretary of Defense to take the necessary action. In practice this direction to the Secretary of Defense follows issuance of the proclamation required by law demanding that the insurgents cease and desist from acts of violence and disperse and retire peaceably forthwith. See 10 USC 334. This requirement does not preclude the alerting of forces and, if necessary, the repositioning of forces by the Executive Agent. However, repositioning of more than a battalion-sized unit will be undertaken only with the informal approval of the President.

*c. Department of the Army approval.* Due to the serious political and legal implications of employment of Federal Armed Forces, prior Department of the Army approval of any intended employment is required in every case except for purposes indicated in paragraph 2-8 or action in an emergency as justified under paragraph 2-4.

**2-4. Emergency.** *a.* In cases of sudden and un-

expected invasion or civil disturbance, including civil disturbances incident to earthquake, fire, flood, or other public calamity endangering life or Federal property or disrupting Federal functions or the normal processes of government, or other equivalent emergency so imminent as to make it dangerous to await instructions from the Department of the Army requested through the most expeditious means of communications available, an officer of the Active Army in command of troops may take such action, before the receipt of instructions, as the circumstances of the case reasonably justify. However, in view of the availability of rapid communications capabilities, it is unlikely that action under this authority would be justified without prior Department of the Army approval while communications facilities are operating. Such action, without prior authorization, of necessity may be prompt and vigorous but should be designed for the preservation of law and order and the protection of life and property until such time as instructions from higher authority have been received, rather than as an assumption of functions normally performed by the civil authorities. In the event of civil disturbances requiring action before the receipt of instructions, the officer taking such action will report immediately his action, and the circumstances requiring it, to the Director of Military Support (DOMS), Department of the Army (DACS-MSO-W), by the most expeditious means of communication available, in order that appropriate instructions can be issued at the earliest possible time (exempt report, para 7-2o, AR 335-15).

*b.* Emergency explosive ordnance disposal service and emergency firefighting assistance may be provided in accordance with paragraphs 4-2b (1)(c) 1 and 2. Instances of such assistance which relate to civil disturbances will be reported in the format shown in figure 4-2.

**2-5. Restrictions.** *a.* Willful violation of the provisions of the Posse Comitatus Act (para 1-2e) is an offense punishable by fine or imprisonment, or both.

*b.* Federal law prohibits a person in the civil, military, or naval service of the United States from ordering, bringing, keeping, or having under his authority or control any troops or armed men at any place where a general or special election is being held, unless such force is necessary to repel



21 April 1972

AR 500-50

armed enemies of the United States. Violations are punishable by fine or imprisonment, or both, and by disqualification from holding any office of honor, profit, or trust under the United States. See 18 USC 592 and 593.

2-6. Command authority. *a.* In the enforcement of the laws, Federal Armed Forces are employed as a part of the military power of the United States and act under the orders of the President as Commander in Chief. When employment of Federal Armed Forces has taken place, the duly designated military commander at the objective area will act to the extent necessary to accomplish his mission. In the accomplishment of his mission, reasonable necessity is the measure of his authority, subject, of course, to instructions he may receive from his superiors.

*b.* Federal Armed Forces employed in aid of the civil authorities will be under the command of, and directly responsible to, their military and civilian superiors through the Department of the Army chain of command. They will not be placed under the command of an officer of the State defense forces or of the National Guard not in the Federal service, or of any local or State civil official. As directed by the Army Chief of Staff, military commanders will be responsive to authorized Federal civil officials.

2-7. Martial law. It is unlikely that situations requiring the employment of Federal Armed Forces during civil disturbance operations will necessitate the declaration of martial law. When Federal Armed Forces are employed in the event of civil disturbances, their proper role is to support, not supplant, civil authority. Martial law depends for its justification upon public necessity. Necessity gives rise to its imposition; necessity justifies its exercise; and necessity limits its duration. The extent of the military force used and the legal propriety of the measures taken, consequently, will depend upon the actual threat to order and public safety which exists at the time. In most instances, the decision to impose martial law is made by the President, who normally announces his decision by a proclamation which usually contains his instructions concerning the exercise of martial law and any limitations thereon. However, the decision to impose martial law may be made by the local commander on the spot, if the circumstances demand immediate action,

and time and available communications facilities do not permit obtaining prior approval from higher authority (para 2-4). Whether or not a proclamation of martial law exists, it is incumbent upon commanders concerned to weigh every proposed action against the threat to public order and safety so that the necessity therefor may be ascertained. Except in the limited circumstances mentioned in paragraph 2-4, when conditions requiring the imposition of martial law arise, the military commander at the scene will so inform the Army Chief of Staff, and await instructions (exempt report, para 7-20, AR 335-15). When Federal Armed Forces have been employed in an objective area in a martial law situation, the population of the affected area will be informed of the rules of conduct and other restrictive measures the military is authorized to enforce. These normally will be announced by proclamation or order and will be given the widest possible publicity by all available media. Federal Armed Forces ordinarily will exercise police powers previously inoperative in the affected area, restore and maintain order, insure the essential mechanics of distribution, transportation, and communications, and initiate necessary relief measures.

2-8. Protection of Federal property. *a.* The right of the United States to protect Federal property or functions by intervention with Federal Armed Forces is an accepted principle of our Government. This form of intervention is warranted only where the need for protection exists and the local civil authorities cannot or will not give adequate protection. This right is exercised by executive authority and extends to all Federal property and functions.

*b.* AR 210-10 recognizes the commander's authority to maintain law and order on a military installation. To maintain law and order and protect his installation and the activities thereon, the commander may take such actions as are reasonably necessary and lawful, including ejection from, or denial of access to, the installation of individuals who threaten a civil disturbance upon or directed against the installation or its activities (see 18 USC 1382). If appropriate, such individuals may also be apprehended or restrained in accordance with AR 600-40.

*c.* When the commander of a class II installation/activity under the jurisdiction of a major

Army command is reasonably certain that a civil disturbance presents a threat to persons, property, or functions on his installation/activity which is beyond the combined protection capability of his own and civil law enforcement resources and those of the appropriate major command, the major commander concerned will request support directly from CG CONARC.

*d.* When the commander of a class II installation/activity under the direct supervision of Headquarters, Department of the Army, is reasonably certain that a civil disturbance presents a threat to persons, property, or function/activity which is beyond the combined protection capability of his own and civil law enforcement resources, he will request support through appropriate CONUS Army to CG CONARC or MDW to DA, (DACS-MSO-W) and advise the appropriate headquarters, Department of the Army, staff agency of such request.

*e.* Upon receiving requests for assistance from commanders as indicated in *c* and *d* above, the CG CONARC, has authority to employ augmentation forces as required to reinforce the internal security forces of class II installations/activities. When such action is taken, the CG CONARC, will notify Department of the Army (DACS-MSO-

W) through established command channels. If, however, because of its location within an area predominantly under civil rather than military jurisdiction, in the judgment of the major commander(s) involved there may be jurisdictional implications connected with the use of Federal troops to protect a class II installation/activity, no action will be taken until the appropriate major commander requests and receives specific instructions through established command channels from HQDA (DACS-MSO-W).

*f.* When an installation commander learns that a need for the protection of other Federal property or functions (except class I and class II installations/activities) exists, he will notify HQDA (DACS-MSO-W) through established command channels.

**2-9. End of commitment.** The use of Federal Armed Forces for civil disturbance operations should end as soon as the necessity therefor ceases and the normal civil processes can be restored. Determination of the end of the necessity will be made by the Department of the Army after coordination with the Department of Justice. The military commander will submit his recommendations direct to HQDA (DACS-MSO-W) (exempt report, para 7-2y, AR 335-15).

## CHAPTER 3 RESPONSIBILITIES

**3-1. Department of the Army. Responsibilities assigned to the Secretary of the Army as DOD Executive Agent are contained in section VII, DOD Directive 8025.12. The following civil disturbance responsibilities are assigned within the Department of the Army:**

*a. Chief of Staff, US Army.*

- (1) Exercises, through designated task force commanders, direction of Federal forces employed for the purpose of civil disturbance operations.
- (2) Informs the Secretary of the Army of unusual military resource requirements (actual or potential) and other significant developments in connection with civil disturbance planning and operations.

*b. The Director of Military Support.*

- (1) Coordinates the functions of all the Military Services when Federal military aid to civil authority in civil disturbances is required.
- (2) Develops policies and procedures for—
  - (a) Calling or ordering to active Federal service—

1. The Army National Guard units or members required to carry out the provisions of the Presidential Executive Order or other appropriate authority.

2. The specific Air National Guard units or members required to carry out the provisions of the Presidential Executive Order or other appropriate authority.

- (b) Providing military resources of the United States Army, consistent with defense priorities, including—

1. The military resources of the Army National Guard called or ordered to active Federal service under the provisions of (a)1 above.

2. The military resources of the Army Reserve ordered to active duty to carry out the purposes of this regulation.

- (c) The employment of forces that may be required to carry out the purposes of DOD Directive 3025.12.

- (3) Develops Department of the Army civil disturbance plans as required.

- (4) Develops and establishes command and control facilities for alerting, moving, preposition-

ing, and employing Federal Armed Forces for civil disturbance operations.

- (5) Provides for communications-electronics support for Department of the Army, Federal agencies, and Army task forces employed in civil disturbance operations.

- (6) Receives determination by the Secretary or Under Secretary of the Army that there is a distinct threat of a civil disturbance beyond the capability of local and State authorities to control, and communicates authorization for employment of Army intelligence collection resources to ACISI.

- (7) In coordination with appropriate Department of the Army and other Federal agencies, provides essential planning, operational, logistics, and intelligence data to the National Military Command Center (NMCC) and the Military Service command centers on a timely basis to insure that the National Command Authorities and appropriate Military Service command authorities are adequately informed.

- (8) Develops procedures for review and coordination of all DOD components' directives, instructions, and plans affecting civil disturbance planning and operations to assure conformity with DOD policies and DOD Executive Agent policies.

*c. Assistant Chief of Staff for Intelligence.*  
Initiates Department of the Army orders for activation of Army intelligence resources in civil disturbance situations when informed by the Director of Military Support of authorization by the Secretary or Under Secretary of the Army.

**3-2. Contingency planning.** *a.* Commanders of major US Army commands and activities within the 50 States, District of Columbia, Commonwealth of Puerto Rico, and US possessions and territories, and National Guard State Adjutants General will develop and maintain appropriate civil disturbance plans.

*b.* The Department of the Army and subordinate commanders will, upon request of the State Adjutant General, advise and assist the National Guard of the several States, Commonwealth of Puerto Rico, and the District of Columbia in planning for civil disturbance operations. In connection with contingency planning, CONUS Army com-

manders will advise State Adjutants General of Department of the Army operations plans and supporting CONUS Army and task force plans. Direct coordination of planning between CONUS Army commanders and State Adjutants General is authorized.

**3-3. Military commander.** *a.* In case of employment of Federal Armed Forces, the task force commander will cooperate with and assist, to the fullest extent possible, the Governor and other State and local authorities and forces, unless or until such cooperation interferes with the accomplishment of his mission.

*b.* The task force commander will accept and, if reasonably possible within the framework of his orders, comply with requests for assistance received from duly constituted civil authorities. Even though the task force commander may direct subordinate elements of his command to assist designated civil authorities or police officials, military personnel will not be placed under the command of civilians, but will be commanded and

controlled by their military superiors through the chain of command. This requirement does not preclude the establishment of joint patrols and jointly manned fixed posts.

*c.* In carrying out his duties, the military commander will insure that only the minimum necessary force is used to restore order. He will observe the policies outlined in his instructions and the provisions of Field Manual 19-15, Civil Disturbances. The commander will insure positive control over loading and firing of weapons.

**3-4. Training requests.** The Department of Justice is responsible for Federal efforts directed toward improving and evaluating the capabilities of local civil law enforcement authorities to deal with civil disturbances. The Department of the Army will assist this effort by providing limited training assistance through the Department of Justice when requested by civil law enforcement authorities. Such requests will not be approved at the local level, but will be referred to the nearest United States Attorney, Department of Justice.

## CHAPTER 4

### FUNDING AND REQUESTS FOR MILITARY RESOURCES

**4-1. Funding and reporting. a. Funding.** Participation of Federal Armed Forces in civil disturbance operations is an unprogramed emergency requirement. Therefore, costs incurred by the Army as a result of operations under the Department of the Army Civil Disturbance Plan will be financed as prescribed below—

(1) *Resources employed under Army direction.*

(a) *Employment of Active Army forces.* Unless specified as reimbursable in the Army directive, expenses incurred in connection with a civil disturbance will be financed as follows:

1. Cost for travel and transportation (except commercial or Military Airlift Command airlift), communications, supplies, and other operating costs will be financed from funds which are normally used for such purposes of the command sponsoring the movement of troops, and/or providing the Government-owned transportation.

2. Cost for commercial or MAC airlift incurred in the movement of troops (including troops of other Services) will be funded by CON ARC under the Secretary of the Army's responsibility as DOD Executive Agent.

3. Cost of military pay, allowances, subsistence and other costs to military personnel appropriations of military personnel on active duty will be financed in the normal manner.

(b) *Employment of Army Reserve units ordered to active duty.* The policies prescribed in (a) 1 and 2 above also apply to Army Reserve units. When the President determines that it is necessary to increase the number of Army personnel on active duty beyond the number for which funds are provided in current Army appropriations, the cost of such increased Army military personnel is authorized as an excepted expense in accordance with the provisions of 34 Stat. 255, 41 USC 11 (section III, AR 37-20).

(2) *Resources employed without Department of the Army direction.* When Army expenditures are required for the immediate employment of Army resources required in cases of sudden and unexpected civil disturbances or other emergencies endangering life or Federal property or disrupting

the normal processes of Government, or in protecting life or Federal property or preventing the disruption of Federal activities, such expenses will be chargeable to funds available to the installation or command. The policies prescribed in (1) above apply, except that the use of commercial or MAC airlift will be financed from funds available to the Military Service which directed the movement of troops.

(3) *Resources provided to civil authorities.* Loan or sale of Army equipment to civil authorities will be handled as follows:

(a) Loan or disposition of equipment other than sales of surplus Army equipment will be made in accordance with policies established in paragraphs 4-3 through 4-5.

(b) Sales of surplus Army equipment will be made in accordance with, AR 37-108, AR 37-151, and AR 755-1.

b. *Reporting.* A Report of Civil Disturbance Operations Costs (RCS DD-A (AR) 1112) will be prepared in accordance with figure 4-1.

4-2. *Military resources.* Paragraphs 4-2 through 4-5 provide general guidance in providing US Army resources to State and local governments and law enforcement agencies, National Guard units not in Federal service, and Federal agencies.

a. *Classification of resources.*

(1) US Army resources are classified in three groups as follows:

(a) *Group One.* Personnel, arms, ammunition, tank-automotive equipment and aircraft.

(b) *Group Two.* Riot control agents, concertina wire, and other like military equipment to be employed in control of civil disturbances which is not included in group one.

(c) *Group Three.* Firefighting resources (including operating personnel); equipment of a protective nature (such as masks, helmets, body armor vests), and other equipment not included in groups one or two (such as clothing, communications equipment, searchlights); and the use of Army facilities.

(2) Requests for personnel to be used in a direct law enforcement role are not within the purview of this section and must be made by the legis-

21 April 1972

lature or Governor of a State in accordance with 10 USC 331. Pursuant to the Posse Comitatus Act, US Army operating personnel employed in connection with loaned equipment may not be used in a direct law enforcement role.

(3) Repair parts and POL items are classified according to the group of the equipment for which the parts of POL are intended.

*b. Approval of requests.*

(1) Requests for US Army resources will be considered for approval as follows:

(a) Requests for group one resources may be granted only with the personal approval of the DOD Executive Agent or, when designated by him for that purpose, the Under Secretary of the Army.

(b) Requests for group two resources may be granted only with the personal approval of the DOD Executive Agent or, when designated by him for that purpose, the Under Secretary of the Army or a task force commander employed at an objective area during a civil disturbance.

(c) Requests for group three resources may be granted by the Secretary or Under Secretary of the Army, commanding generals of CONUS Armies and the MDW, and CINC of unified commands outside CONUS.

1. Installation commanders are authorized to provide emergency explosive ordnance disposal service in accordance with AR 75-14 and AR 75-15.

2. Where installation fire departments have mutual aid agreements with nearby civil communities, the installation commander is authorized to provide emergency civilian or mixed civilian/military firefighting assistance. In the absence of a mutual aid agreement and when in the best interest of the United States, a commander with group three approval authority is authorized to provide emergency civilian or mixed civilian/military assistance in extinguishing fires and in preserving life or property from fire, within the vicinity of an installation. In either case, civilian firefighters may be used provided:

(a) In civil disturbance situations where there is significant danger of physical harm to firefighters, the civilian employees volunteer for the assignment. (Department of the Army civilian employees acting in this volunteer capacity are acting as Federal employees.)

(b) Firefighting equipment is not to be used for riot control.

(c) Civil authorities recognize that prior to the employment of Federal forces to assist in restoring law and order, the protection of firefighting crews and equipment is the responsibility, in ascending order, of municipal, county, and State officials. Failure on the part of such authorities to recognize this responsibility and/or to provide adequate protection will be grounds for refusal to employ installation resources or for withdrawal of resources already employed. This requirement in no way infringes upon the right of the individual to use necessary force to protect himself from violent attack.

(2) Requests for groups one, two, or three resources, and for renewal of outstanding loans, may be denied at any level in the chain of command down to and including commanders delegated group three approval authority.

(3) Commanders having initial approval authority may grant, for good cause shown, a single extension of an outstanding loan. Extensions of type I loans (c(1) below) will be for a maximum of 15 days. Extensions of type II loans (c(2) below) will be for a maximum term of 90 days. Further extensions will be approved only at military departmental level.

*c. Categories of loans.* Loans are categorized by type, contingent upon the duration of the loan period.

(1) *Type I.* To meet an urgent need during an actual disorder. Loans of this type will be for the duration of the disorder, up to a maximum term of 15 days, renewable only as provided in b(3) above.

(2) *Type II.* To meet a need in anticipation of an imminent threatened civil disorder. Such loans may be granted to a civil authority when a binding purchase contract has been executed to procure resources substantially similar to the military property requested and there is substantial lead time before delivery. Loans of this type will be for the duration of the procurement period up to a maximum term of 90 days, renewable only as provided in b(3) above. The fact that a civil authority has submitted a purchase request for DOD surplus military equipment is not considered a binding purchase contract without assurance from the Defense Logistics Services Center that

21 April 1972

the items for which the purchase request is made can be delivered to the civil authority within a 90-day period. See DOD Instruction 4160.23.

*d. Reports.* Civil Disturbances Report—Providing Resources to Civil Authorities, RCS DD-A (AR) 1112 (fig. 4-2).

(1) Reports of all requests for Army resources (approved, denied, or pending) will be prepared by the appropriate approving authorities, using the format shown in figure 4-2, and forwarded through channels as follows:

(a) To Department of the Army (DACS-MSO-W) in the case of requests received in CONUS.

(b) To Department of the Army (DACS-MSO-W) with information copies to Joint Chiefs of Staff in the case of requests received by organizations or installations outside CONUS over which the commanders of unified commands exercise command authority.

(2) The DOMS Watch Team will transmit information copies of all approved requests for groups one and two resources to the DOD General Counsel and the Deputy Attorney General of the United States.

(3) A weekly summary will be compiled by DOMS from reports submitted by the Services and other DOD agencies, showing action taken (approved, denied, or pending) and submitted to the Deputy Attorney General; General Counsel, Department of Defense, Assistant Secretary of Defense (Installations and Logistics); Under Secretary of the Army; and the General Counsel, Department of the Army. Negative summary reports are required.

4-3. Loans to State and local governments and law enforcement agencies. *a. Policy.* As a temporary emergency measure, US Army resources under the control of the Department of the Army may be loaned to State and local governmental bodies and law enforcement agencies for use during civil disturbance operations.

*b. Processing of requests.* Requests from officials of the 50 States,\* the Commonwealth of Puerto Rico, and US possessions and territories, or any political subdivision thereof, for military resources for use in connection with civil disturbances will be promptly forwarded through channels to the

\*For loan purposes, the District of Columbia will be governed by paragraph 4-5.

appropriate approving authority (commanders of unified commands will coordinate such requests originating from areas outside CONUS) using the format shown in figure 4-2, except as noted below—

(1) Requests for resources that require DOD Executive Agent approval will be forwarded through channels to Department of the Army (DACS-MSO-W).

(2) Requests for group three resources not available to commanders having approval authority will be forwarded through channels to Department of the Army (DACS-MSO-W). Intermediate commands will, as appropriate, approve and make available the requested resources.

(3) Requests received by personnel of Defense agencies will be referred to local military commanders for processing.

(4) Requests will be forwarded and processed in keeping with the degree of urgency dictated by the situation.

(5) Requests from civil law enforcement agencies for training assistance related to the control of civil disturbances will not be approved at the local level. Such requests should be referred to the nearest United States Attorney, Department of Justice.

*c. Loan agreements.* Written agreements will be executed concurrently with all loans of US Army property to civil authorities.

(1) Loan agreements will include provisions for a fidelity bond in the amount of the total current item price of the loaned property.

(a) The fidelity bond will be generally governed by the provisions of Part 2 of Sec. X, ASPR, and will consist of properly executed Standard Form 25 (Performance Bond) or certified bank check, or cash or negotiable US bonds deposited with the Treasurer of the United States. The fidelity bond need not be posted by the borrowing agency itself; so long as the bond is valid, the source or originating agency is immaterial. For example, in order to secure a loan, a State may post bond on behalf of a city, county, or other governmental body or authority within the State.

(b) In an extreme emergency, when the requirement of posting bond would unduly delay approval of a valid request for loan of military property involving a total current item price of \$1,000 or less, a commander having approval au-

21 April 1972

thority under paragraph 4-2b may approve the request on the condition that bond be posted within a reasonable time not to exceed five days. Absolute waiver of the requirement to post bond will be granted only by the Secretary of the Army or his designee.

(c) Bond will be forfeited on account of failure to return loaned property only with the concurrence of the DOD Executive Agent. Requests for authority to forfeit bond will be transmitted to Department of the Army (DACS-MSO-W) who will refer them to the proper authorities for action.

(2) A sample loan agreement is provided at figure 4-3.

(a) This format is for type I loans. For type II loans, the format is modified by substituting paragraph 2, figure 4-4 and adding exhibit IA, figure 4-5.

(b) When a cash deposit is used in lieu of a properly executed Standard Form 25, Performance Bond, this format is modified by substituting paragraph 7, figure 4-6.

(c) Modifications of the loan agreement format, except as authorized in this regulation, will be made only with the approval of the Under Secretary of the Army or his designee.

#### 4-4. Loans to the National Guard. a. Policy.

(1) Commanders having group three approval authority under paragraph 4-2b are authorized to approve requests for the loan of Army resources, less personnel, regardless of classification under paragraph 4-2a, of Active and Reserve forces to the National Guard of a State or the District of Columbia for use of its units in an active duty status in anticipation of or during civil disturbances. Firefighting and explosive ordnance disposal support may be provided, as a complete resource, to include personnel.

(2) Loans of Army resources will be approved, if possible, when the National Guard is authorized such resources and the Department of the Army is unable to provide them on a permanent basis. The National Guard of the several States, the Commonwealth of Puerto Rico, and the District of Columbia will be responsible for reimbursement of costs over and above normal Department of the Army operating expenses incurred in connection with loaned Department of the Army equipment. Guidance contained in paragraph 6, figure 4-3 pertaining to loans to civil au-

thorities is also applicable to reimbursement by the National Guard.

(3) Military property issued or loaned to the National Guard may not be further loaned in connection with civil disturbances without approval of the National Guard Bureau and the DOD Executive Agent. Requests to do so will be forwarded to Department of the Army (DACS-MSO-W).

b. *Processing of requests.* Requests for US Army resources received from the National Guard will be promptly submitted through channels to the appropriate approving authority using the format shown in figure 4-2, except as noted below:

(1) Requests for resources that require DOD Executive Agent approval will be forwarded through channels to Department of the Army (DACS-MSO-W).

(2) Requests for resources not available to commanders having group three approval authority will be forwarded through channels to Department of the Army (DACS-MSO-W). Intermediate commands will, as appropriate, approve and make available the requested resources.

(3) Requests for equipment which involve operating personnel, excluding firefighting and explosive ordnance disposal, will be processed as a group one Army resource.

c. *Loan receipt.* The receiving State will receipt for loaned Army property by completing the format shown at figure 4-7.

#### 4-5. Loans to Federal agencies. a. Policy.

(1) Commanders having group three approval authority under paragraph 4-2b are authorized to approve requests for the loan of group three military resources, less personnel, of Active and Reserve forces to non-DOD Federal agencies\* in anticipation of or during civil disturbances. Firefighting and explosive ordnance disposal support may be provided as a complete resource, including personnel.

(2) As required by 31 USC 686, Federal agencies will be responsible for reimbursement of costs in addition to normal Department of the Army operating expenses which are incurred in connection with loaned property. Reimbursement will be in accordance with AR 700-49 and DSAR 4140.27, except that Federal agencies shall not be required to make any payment on account of fair

\*Loans to the government of the District of Columbia will be governed by this paragraph.

TAGO 625A



21 April 1972

wear or tear or normal depreciation of any of the property.

(3) Army property loaned to Federal agencies may not be further loaned without the approval of the director of the requesting agency and the DOD Executive Agent. Requests to do so will be forwarded to Department of the Army (DACS-MSO-W).

(4) Loans to the US Secret Service will be in accordance with AR 1-4.

*b. Processing of requests.* Requests for US Army resources received from Federal agencies will be promptly submitted through channels to the appropriate approving authority using the format shown in figure 4-2, except as noted below:

(1) Requests for resources that require DOD Executive Agent approval will be forwarded through channels to Department of the Army (DACS-MSO-W).

(2) Requests for resources not available to

commanders having group three approval authority will be forwarded through channels to Department of the Army (DACS-MSO-W). Intermediate commands will, as appropriate, approve and make available the requested resources.

(3) Requests for equipment which involve operating personnel excluding firefighting and explosive ordnance disposal, will be processed as for a Group One Army resource.

*c. Loan agreements.* Written agreements will be executed concurrently with all loans of Army property to Federal agencies in connection with civil disturbances.

(1) Neither fidelity bonds nor binding purchase contracts are required.

(2) A sample loan agreement is provided at figure 4-3. The words "Federal agency" will be substituted for "civil authority." Other modifications to suit the sample format for use by Federal agencies may be made as necessary.

21 April 1972

**REPORT OF CIVIL DISTURBANCE OPERATIONS COST  
(US ARMY) (RCS DD-A (AR) 1112)****1. REQUIREMENTS**

Costs\* reports will be submitted to Headquarters, Department of the Army, (DACA-FI), for the purpose of meeting requirements for staff information, reprogramming, or requesting additional funds to meet increased Army expenses resulting from costs associated with civil disturbance operations.

**2. SUBMITTING AGENCIES**

All Army commands, agencies, and the Army General Staff will submit the required reports when expenses have been incurred that are attributable to civil disturbances.

**3. REQUIRED COST REPORTS**

Initial report (estimated costs) will be submitted within 24 hours of a time to be designated by DOMS. The final report (actual costs) will be submitted within 12 working days after the termination of the redeployment phase of the civil disturbance operation. Reporting instructions ("as of" and due dates) will be disseminated by DOMS message.

**4. REIMBURSABLE COSTS**

Operations costs for civil disturbances are payable from funds of agencies providing resources. To enable prompt reimbursement for resources, billing for reimbursable incremental costs will be accomplished within 30 days of submission of the final report of actual costs.

**5. INTERIM REPORTS**

Interim reports may be required of a civil disturbance operation requires lengthy deployment of military forces. These interim reports, if required, will be requested by message or telephone. Interim reports will be based on the best cost information available at the time.

**6. PREPARATION INSTRUCTIONS**

*a. General.* Costs will be identified and reported as normal operating costs, incremental costs, and total costs. Normal operating costs are those costs which would have been incurred in the absence of a civil disturbance. Incremental costs are those costs which would not have been incurred in the absence of a civil disturbance.

(1) Cost reports will include data reported separated for each city or location in which Federal forces are employed in civil disturbance operations. Costs shown will be net costs for each component, i.e., they will include and identify costs reimbursable to other DOD components or agencies and costs reimbursable to the reporting component or agency by other DOD components or agencies.

\*Costs are synonymous with obligations.

Figure 4-1.

21 April 1972

AR 500-50

(2) Report separately plus and minus reimbursable adjustments, between reporting component or agency and non-DOD Government agencies or civil authorities.

(3) Report the number of active duty military personnel, National Guard personnel, called to active Federal service and Reserve personnel ordered to active duty, employed as of the end of the month, unless the reporting period is less than a month (30 days). If less than a month, report the beginning and ending strengths for the reporting period. Data will reflect officer and enlisted strengths separately.

b. Negative reports will not be submitted.

7. FORMAT

a. Dollar costs:

	(Thousands of \$)				Net
	Total	Normal	Reim- burse- ment to others	Incre- mental Reim- burse- ment from others	
(1) Military personnel, Army.					
(a) Active duty.	_____	_____			
(b) National Guard called to Federal service and mobilized Reserve.					
(c) NGPA (Savings)	( )				
(d) RPA (Savings)	( )				
TOTAL MPA	_____	_____	_____	_____	_____
(2) Procurement of equipment and missiles, Army.					
(a) Issues to military forces.	_____				
(b) Assistance to other Federal agencies (Identify separately by agency).	_____				
TOTAL PEMA	_____				
(3) Operation and maintenance, Army.					
(a) Temporary duty costs.					
1. Military.	_____				
2. Civilian.	_____				
(b) Civilian overtime.	_____				
(c) Transportation.	_____				
1. USAF transportation.	_____				

Figure 4-1—Continued.

	<u>(Thousands of \$)</u>				<u>Net</u>			
	<u>Total</u>	<u>Normal</u>	<u>Reim- burse- ment to others</u>	<u>Incre- mental Reim- burse- ment from others</u>				
2. Military motor transportation.	_____	_____	_____	_____	_____			
3. Army Air transportation.	_____	_____	_____	_____	_____			
(d) Assistance to other Federal agencies (identify separately by agency).	_____	_____	_____	_____	_____			
(e) Support to other DOD components and agencies (identify separately).	_____	_____	_____	_____	_____			
(f) Support to National Guard on State status.	_____	_____	_____	_____	_____			
(g) Support to civilian law enforcement agencies (identify separately by agency).	_____	_____	_____	_____	_____			
(h) Construction costs (identify individual line items whose cost exceeds \$500 per line).	_____	_____	_____	_____	_____			
(i) Material and supplies.	_____	_____	_____	_____	_____			
(j) Other OMA costs (identify individual line items whose cost exceeds \$500 per line).	_____	_____	_____	_____	_____			
TOTAL OMA	_____	_____	_____	_____	_____			
b. Number of forces employed.								
	<u>Active</u>		<u>Reserve</u>		<u>Federalized National Guard</u>		<u>Total</u>	
	<u>Off</u>	<u>Enl</u>	<u>Off</u>	<u>Enl</u>	<u>Off</u>	<u>Enl</u>	<u>Off</u>	<u>Enl</u>

Figure 4-1--Continued.

21 April 1972

AR 500-50

**CIVIL DISTURBANCES REPORT—PROVIDING RESOURCES TO  
CIVIL AUTHORITIES, RCS DD-A(AR)1112**

1. All requests for assistance received, whether denied, approved or forwarded for approval, will be reported promptly (Reports Control Symbol DD-A(AR) 1112) in the following format:
  - a. DOD organization receiving request.
  - b. Place (city, town, village, county) of actual or anticipated civil disturbance.
  - c. Name and title of requesting official.
  - d. Date-time group (ZULU), request for assistance was received.
  - e. Scope of the disturbance or the threat of such a disturbance existing at the time of the request.
  - f. Type, group, and quantities of assistance requested.
  - g. Purpose for which the assistance was requested.
  - h. Anticipated duration the assistance will be required.
  - i. Anticipated impact on local community relations resulting from approval/disapproval of the request.
  - j. Statement as to whether the request was granted or denied (including date-time group (ZULU) of notification to requester) and the level at which the decision was made.
  - k. Reasons for denying or referring the request to higher headquarters.
    - l. If request referred to higher headquarters, provide a recommendation and comments, as appropriate, for approval or denial based upon knowledge of facts at hand.
    - m. If appropriate, provide additional information on emergency fire-fighting assistance provided in a civil disturbance situation.
    - n. Other pertinent information, e.g., effect on ability to perform assigned missions and if so, the extent and duration; category and duration of loan; and ability to provide items requested.
2. Appropriate security classification will be placed on this document when completed.

*Figure 4-2*

TAGO 636A

4-9

Z 0011816

### LOAN AGREEMENT

This loan agreement is entered into by and between the United States of America, hereinafter called the Government, represented by (Name and title of military representative) for the purpose of entering into this agreement, and (City, county, State or other government body or authority) a (Definition) organized and existing under the authority of (Governing law), hereinafter called the civil authority, represented by (Name and title of civil authority's representative) for the purpose of entering into this agreement.

#### 1. PURPOSE

Under the authority of Department of Defense Directive 3025.12, and in consideration of the premises, the Government hereby lends to the civil authority and the civil authority hereby borrows from the Government the Government property, hereinafter called the property, listed and described in exhibit I hereto attached and incorporated by reference into the terms of this agreement, which property is required by the civil authority to assist in maintaining public civil order in the area over which it has jurisdiction.

#### 2. TERM

This loan of property is intended to meet an urgent need during actual civil disorder. The civil authority shall keep the property only for the actual duration of the disorder and in no case longer than 15 days after the date of this loan agreement, unless this agreement shall be renewed. Nevertheless, the Government may revoke and terminate this agreement and demand return of the property in whole or in part at any time.

#### 3. LIABILITY FOR USE OF PROPERTY

The Government shall make every effort to see that each item of the property is furnished in serviceable and usable condition according to its originally intended purpose. Nevertheless, the Government makes no warranty or guarantee of fitness of any of the property for a particular purpose or use, or warranty of any other type whatsoever. The civil authority assumes all responsibility for any liability or claims arising from the transportation, use, or possession of the property during the term of this loan, and agrees to hold the Government harmless from any such liability or claims.

#### 4. CARE OF PROPERTY

The civil authority is responsible for the care of the property during the term of this loan. The civil authority shall transport, use and store the property with due care and diligence. The civil authority shall safeguard and secure any high value items, any sensitive serial numbered items, and any arms and ammunition loaned by the Government in substantially the same manner as would the Government under its applicable regulations. The civil authority shall not mortgage, pledge, assign, transfer, sublet, or part with possession of any of the property in any manner to any third party either directly or indirectly, except that this provision shall not preclude the civil authority from permitting the use of the property by a third party with the prior written approval of the Government. The civil authority shall neither make nor permit any modification

*Figure 4-3.*

to any of the nonexpendable property. At all times the Government shall have free access to all of the property for the purpose of inspecting or inventorying it.

#### 5. RETURN OF PROPERTY

The nonexpendable property, and all of the expendable property which has not been expended, shall be returned by the civil authority to the Government at the expiration or termination of this loan.

#### 6. PAYMENT

The civil authority shall reimburse the Government for expenses incurred in connection with this loan, as provided below:

a. Transportation expenses. The civil authority shall reimburse the Government for any expenses for movement of the property incurred by the Government incident to this loan, including those for necessary packing and crating, movement of the property from (Location) to (Location where the property will be used), and return of the property to (Location).

b. Repair expenses. The civil authority shall reimburse the Government for any expenses necessary to repair, rehabilitate, or replace parts of any of the property following its return to the Government, except that the civil authority shall not be required to make any payment on account of fair wear and tear or normal depreciation of any of the property.

c. Replacement expenses. The civil authority shall reimburse the Government (as indicated and at the price shown on Exhibit I) for the cost of all of the expendable property (including but not limited to petroleum, oil, and other lubricants) used or consumed during this loan, and for any of the property lost, destroyed, damaged beyond repair, or otherwise not available for return or not returned to the Government.

d. Personnel expenses. The civil authority shall reimburse the Government for costs incident to the pay of additional civilian personnel who may be temporarily required in connection with the loaned property, overtime pay of civilian personnel, and travel and per diem expenses of civilian and military personnel.

#### 7. BOND

The civil authority has provided a performance bond in the amount of the total value of the property as shown on Exhibit I, which performance bond is marked Exhibit II hereto attached and incorporated by reference into the terms of this agreement.

a. Should the civil authority fail to return any of the property as provided in paragraph 5 above, or fail to reimburse the Government within 30 days after receiving a request for payment of expenses, the bond shall be forfeited as liquidated damages in the amount equal to the expense to the Government computed in accordance with paragraph 6 above.

b. Payment of liquidated damages by forfeiture of any portion of the bond to the Government shall not operate as a sale to the civil authority of any of the property available to be returned but not returned to the Government, nor to extinguish the Government's right to have the available missing property returned.

Figure 4-3—Continued.

21 April 1972

c. Should the civil authority later return to the Government any of the missing property on account of which a portion of the bond was forfeited as liquidated damages, the civil authority shall be entitled to recoup from the Government a sum equal to 80% of the price of the late returned property as shown on Exhibit I, less an amount in payment for expenses, if any, computed in accordance with paragraph 6 above, and less an amount for depreciation. If the normal life expectancy of an item can be determined by reference to applicable military publications, the amount for depreciation shall be computed by the straight line method, using the price shown on Exhibit I and the date of expiration or termination of this loan as initial points. When normal life expectancy is not established by applicable military publications, the amount for depreciation shall be computed by the same method, applying a uniform depreciation rate of 50% per annum.

#### 8. OFFICIALS NOT TO BENEFIT

No member of or delegate to Congress shall be admitted to any share or part of this loan, or to any benefit arising in connection with it.

#### 9. CONTINGENCY FEES

No persons or agency acting for or on behalf of the civil authority to solicit or obtain this loan shall be paid any commission, percentage, brokerage, or contingent fee in any way connected with this loan.

#### 10. DISPUTES

Any disputes concerning a question or fact arising under this loan agreement which are not disposed of by mutual agreement shall be decided by the Secretary of the Army as the Government's Executive Agent for civil disturbance matters, or by his designee.

Done at (Place) this (Date) day of (Month) 19 (Year).

FOR THE GOVERNMENT:

FOR THE CIVIL AUTHORITY:

\_\_\_\_\_  
(Name and Title)

\_\_\_\_\_  
(Name and Title)

Figure 4-3—Continued.



21 April 1972

AR 500-50

**CERTIFICATE**

I, the (Title) of the (City, county, State or other governmental body or authority), named as civil authority in this loan agreement, certify that (Name), who signed this agreement on behalf of the civil authority, was then (Title) of (City, county, State, or other governmental body or authority) and that this loan agreement was duly signed for and on behalf of (City, county, State, or other governmental body or authority) by authority of its governing body and is within the scope of its lawful powers. In witness whereof I have hereunto affixed my hand and seal of (City, county, State, or other governmental body or authority) this (Day) day of (Month) 19 (Year)

(OFFICIAL SEAL)

\_\_\_\_\_  
(Name and title of certifying officer)

**EXHIBIT I**

**MILITARY PROPERTY OF THE UNITED STATES**

<u>FEDERAL</u> <u>STK NO</u>	<u>NOMEN-</u> <u>CLATURE</u>	<u>QUAN-</u> <u>TITY</u>	<u>CURRENT ITEM</u> <u>PRICE. EACH</u>	<u>TOTAL</u> <u>PRICE</u>
---------------------------------	---------------------------------	-----------------------------	---	------------------------------

GRAND TOTAL

**EXHIBIT II**

Properly executed Standard Form 25, Performance Bond (June, 1967, ed.), or evidence of deposit acceptable in accordance with part 2 of sec X, ASPR, in the amount of the grand total shown on Exhibit I.

Figure 4-3—Continued.

## SUBSTITUTE PARAGRAPH 2

(For use when the civil authority has initiated procurement action and the term of the loan is to be longer than 15 days.)

## 2. TERM

This loan of property is intended to meet an urgent need connected with threatened civil disorder. The civil authority hereby covenants and certifies that it has made a binding purchase contract to procure for itself certain public property as listed and described on Exhibit IA hereto attached and incorporated by reference into the terms of this agreement, and that the Government property which is the subject of this loan agreement, is required as a substitute only until delivery of the civil authority's own property listed and described in Exhibit IA. The civil authority shall keep the Government property only until delivery of its own property, and in no case longer than 90 days after the date of this loan agreement, unless this agreement shall be renewed. Nevertheless, the Government may revoke and terminate this agreement and demand return of the property in whole or in part at any time.

*Figure 4-1.*

21 April 1972

AR 500-50

EXHIBIT 1A  
PROPERTY BEING PROCURED BY CIVIL AUTHORITY

<u>NOMENCLATURE</u>	<u>QUANTITY</u>	<u>SOURCE</u>	<u>DATE ORDERED</u>
---------------------	-----------------	---------------	-------------------------

Figure 4-5.

TAGO 625A

4-15

Z 0011822

## SUBSTITUTE PARAGRAPH 7

(To be used when the civil authority posts bond in the form of a cash deposit as an alternative to a properly executed Standard Form 25, Performance Bond.)

## 7. CASH DEPOSIT

The civil authority has deposited with the Government an amount of money which is equal to the total price of the property as shown on Exhibit I, which deposit is evidenced by Exhibit II hereto attached and incorporated by reference into the terms of this agreement.

a. Not later than 60 days after the expiration or termination of this agreement this deposit shall be returned to the civil authority, less an amount to compensate the Government for its expenses computed in accordance with paragraph 6 above.

b. Retention of a portion of the deposit by the Government shall not operate as a sale to the civil authority of any of the property available to be returned but not returned to the Government, nor to extinguish the Government's right to have the available missing property returned.

c. Should the civil authority later return to the Government any of the missing property on account of which a portion of the deposit was withheld by the Government, the civil authority shall be entitled to recoup from the Government a sum equal to 90% of the price of the late returned property as shown on Exhibit I, less an amount in payment for expenses, if any, computed in accordance with paragraph 6 above, and less an amount for depreciation. If the normal life expectancy of an item can be determined by reference to applicable military publications, the amount for depreciation shall be computed by the straight line method, using the price shown on Exhibit I and the date of expiration or termination of this loan as initial points. When normal life expectancy is not established by applicable military publication, the amount for depreciation shall be computed by the same method, applying a uniform depreciation rate of 50% per annum.

*Figure 4-6.*

21 April 1972

AR 500-50

(Date)

**LOAN RECEIPT**

As the authorized representative of the Adjutant General, State of (State), I acknowledge receipt from (Lending unit) this date, of the property described below, temporarily loaned to the National Guard of (State), under the provisions of the Department of the Army Civil Disturbance Plan dated \_\_\_\_\_.

<u>FEDERAL STOCK NO.</u>	<u>NOMENCLATURE</u>	<u>QUANTITY</u>
--------------------------	---------------------	-----------------

It is understood that the National Guard of the State of (State) is responsible for the cost of transportation, repair, rehabilitation or replacement of the above property utilizing State funds. It is also understood that the use of this property is subject to the following limitations:

\_\_\_\_\_  
Signature of AG Representative

*Figure 4-7.*

HEADQUARTERS  
DEPARTMENTS OF THE ARMY AND THE AIR FORCE  
Washington, DC 20310-2500  
1 March 1993

National Guard Regulation (AR) 500-2/  
National Guard Regulation (AF) 55-6

Emergency Employment of Army and Other Resources

NATIONAL GUARD COUNTERDRUG SUPPORT TO LAW ENFORCEMENT AGENCIES

**Summary.** This regulation covers the utilization of National Guard resources and prescribes the policies, procedures, and responsibilities governing National Guard counterdrug support to Law Enforcement Agencies (LEAs). It must be used in conjunction with the procedures provided in the Counterdrug Coordinator's Handbook, 1 March 1993.

**Applicability.** This regulation applies only to the Army and Air National Guards of the 54 States, Territories, and the District of Columbia, hereafter referred to as states.

**Impact on Unit Manning System.** This regulation does not contain policies that affect the Unit Manning System.

**Internal Control System.** This regulation is subject to the requirements of AR 11-2. A Counterdrug Review and Evaluation Checklist will be published at a later date.

**Supplementation.** Supplementation of this regulation is prohibited without prior approval from National Guard Bureau, Counterdrug Task Force, Pentagon, Washington, DC 20310-2500.

**Interim Changes.** Interim changes to this regulation are not official unless they are authenticated by the Director, Administrative Services. Interim changes will be destroyed on their expiration dates unless sooner superseded or rescinded.

**Suggested Improvements.** The proponent agency of this regulation is the National Guard Bureau, Counterdrug Task Force. Users are invited to send comments and suggested improvements on DA Form 2028 (Recommended Changes to Publications and Blank Forms) directly to Chief, National Guard Bureau (NGB-CD), ATTN: Counterdrug Task Force, Washington, DC 20310-2500.

Contents (Listed by paragraph number)

	Para		Para
<b>Chapter 1</b>			
<b>General</b>		Equipment authorization	3-5
Purpose	1-1		
References	1-2	<b>Chapter 4</b>	
Explanation of abbreviations and terms	1-3	<b>Reports and Records</b>	
Responsibilities	1-4	Information and archives	4-1
Authority	1-5	Reports and reporting	4-2
		Special notification/coordination	4-3
<b>Chapter 2</b>			
<b>Administrative Information</b>		<b>Appendices</b>	
Legal considerations and requirements	2-1	A. References	
Use of force	2-2	B. Rules of Engagement, Force Protection, and Safety	
Subpoena of National Guard personnel	2-3		
Security guidelines	2-4	<b>Glossary</b>	
Planning	2-5		
Memoranda of understanding	2-6		
Funding	2-7		
Personnel	2-8		
Medical requirements	2-9		
Public affairs	2-10		
Training	2-11		
Office of Review and Evaluation	2-12		
<b>Chapter 3</b>			
<b>Use, Loan, and Lease of Equipment</b>			
General information	3-1		
Loan and lease of equipment	3-2		
Routing of requests	3-3		
Use of National Guard aircraft	3-4		

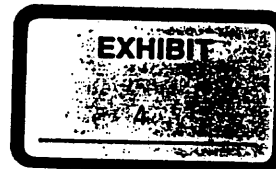

1 March 1993

## Chapter 1 General

### 1-1. Purpose

a. This regulation prescribes policies and responsibilities relating to the use of Army and Air National Guard resources for counterdrug supply reduction activities in support of LEAs.

b. Use this regulation in conjunction with the Counterdrug Coordinator's Handbook. To obtain a copy of this Handbook, submit your request to—

National Guard Bureau  
NGB-CD  
ATTN: Counterdrug Task Force  
Washington, DC 20310-2500

### 1-2. References

Required and related publications are listed in appendix A.

### 1-3. Explanation of abbreviations and terms

Abbreviations and special terms used in this regulation are explained in the glossary.

### 1-4. Responsibilities

a. The Secretary of Defense (SECDEF), in accordance with 32 USC 112, provides funds to states receiving approval of their plans for National Guard counterdrug support activities.

b. The Chief, National Guard Bureau, will provide federal resources to the National Guard for the Counterdrug Support Program.

c. The Counterdrug Task Force under the guidance of the National Program Manager, NGB has primary responsibility for the development and execution of all National Guard counterdrug support related program policies, procedures, and regulations. The Counterdrug Task Force gives guidance on the formulation of new program concepts, and reviews and approves such initiatives prior to submission to the states for implementation. Questions on counterdrug support policy should be directed to the Director, Counterdrug Task Force. Other Counterdrug Support Program questions will be directed to the Counterdrug Support Division.

d. The State Plans, Operations, and Military Support Officer (POMSO) is the Counterdrug Support Manager and primary point of contact at the state level. The states also have a Counterdrug Coordinator who oversees the Counterdrug Support Program with specific guidance from the POMSO. All Army and Air National Guard counterdrug activities are directed by the POMSO.

### 1-5. Authority

The Governor is the Commander-in-Chief of the Army and Air National Guard units of his/her state or territory when these units are not in federal (Title 10) status. Such authority is derived from Article 1, Section

8, Clause 16, U.S. Constitution. District of Columbia units serve under a Commanding General who is appointed by the President of the United States.

## Chapter 2 Administrative Information

### 2-1. Legal considerations and requirements

a. **National Guard role.** The National Guard provides counterdrug support to LEAs requesting assistance. National Guard personnel engaged in counterdrug support activities for which federal funding is provided by 32 USC 112 are considered to be in support of law enforcement agencies. Support requested that was not originally listed in state plans will be considered on a case-by-case basis. Generally, requests to provide federally funded mission support that were not included in the original execution memoranda require approval above state level. These will be processed through the Counterdrug Task Force for SECDEF consideration.

b. **Requests for support.** The National Guard will not initiate counterdrug support operations without a documented request for support from a LEA.

c. **State law.** The role of the National Guard with respect to counterdrug support operations is defined by each state's governor and must fall within the confines of that state's law.

(1) Proposed operations within state counterdrug plans must receive certification of legal review from the state Attorney General. Such certification ensures that the operations are consistent with and not prohibited by state law.

(2) The requirement for state certification of legal review is not waivable.

d. **Arrests, searches, and seizures.** National Guard personnel will not, except for exigent circumstances, directly participate in the arrest of suspects, conduct searches which include direct contact of Guard members with suspects or members of the public, or become involved in the chain of custody for any evidence. Commanders at all levels will ensure that personnel are thoroughly briefed on this subject before participating in counterdrug operations.

(1) Powers of arrest exercised by Guard members are normally the same as those authorized by private citizens as outlined by the laws of each state. The state JAG should provide detailed guidance in this area.

(2) Exigent circumstances are situations in which immediate action is necessary to protect police officers, Guard personnel, or other persons from injury; to prevent the loss or destruction of evidence; or to prevent the escape of a suspect already in custody.

(3) Supported LEAs are responsible for obtaining warrants required for searches or for determining the need for searches, inspections, and observations that do not require warrants. This responsibility in-

cludes the determination of any potential legal restrictions upon the use of thermal imaging systems.

**e. Reconnaissance and surveillance.** National Guard members engaged in counterdrug support activities may conduct area surveillance and/or reconnaissance. This may include observation of persons incidental to such surveillance but Guard members will not conduct such activity when directed at specific individuals. Observation may include the tracking of vessels, aircraft, or ground vehicles suspected of involvement in drug activities.

**f. Responsibility/liability.** Responsibility/liability for the actions of National Guard personnel involved in counterdrug support activities are as follows:

(1) Supported LEAs are responsible for personal injury, death, property, or damage caused by their own personnel and equipment.

(2) Federal protections for personal injury, death, or property damage caused by National Guard personnel in Title 32 status are governed by the Federal Tort Claims Act.

(3) Responsibility and liability for actions by National Guard personnel on State Active Duty (SAD) is in accordance with state law. Personnel in a SAD status are not covered by the Federal Tort Claims Act.

(4) Responsibility and liability for loss and damage to National Guard equipment will be determined by a report of survey.

**g. Environmental restrictions.** All operations will be conducted in accordance with current environmental laws and regulations.

## 2-2. Use of force

**a.** This paragraph contains federal guidelines which cannot be broadened. However, states should review these rules and add further restrictions as appropriate to comply with state law.

**b.** The Adjutant General will determine whether or not troops will be armed. When Troops are armed it will be for the purpose of self protection only. Rounds will be chambered only on order of the senior ranking military member present and in conjunction with the supported LEA.

**c.** Guard members have the right to use force for the following purposes; only the minimum force necessary for the purpose may be used:

(1) Defend themselves, other members of their team, LEOs, or other persons.

(2) Protect property.

(3) Make arrests if they have arrest powers pursuant to paragraph 2-1d above.

**d.** Deadly force (any force capable of causing serious injury or death) may only be used under the following circumstances:

(1) All other means have failed.

(2) Risk of injury to other persons is not increased by the use of deadly force.

(3) When deadly force is the minimum force necessary to prevent death or serious injury to the member, other Guard members, LEOs, or other persons.

(4) The discharge of any firearm, even if the intent is only to wound and not to kill, is always to be considered deadly force.

**e.** Guard members will be thoroughly briefed about the Rules of Engagement and Use of Force prior to the commencement of any operation. (See app B.)

## 2-3. Subpoena of National Guard personnel

**a.** National Guard members may receive subpoenas to testify in judicial proceedings.

(1) Guard members will obey all subpoenas.

(2) Guard members should not testify unless specifically compelled to do so by subpoena.

(3) Guard members under subpoena will be placed on counterdrug support orders (if not already on orders) for the time period required to prepare and testify. Once on orders, any fees or expense reimbursements received by the summoned member for legal service will be turned in to the U.S. Treasury if the individual is in Title 32 status, or to the state if on State Active Duty orders.

**b.** A state legal officer will provide information to the subpoenaed Guard member regarding the legal proceedings before the member testifies.

**c.** The NGB Judge Advocate (NGB-JA) must be contacted immediately under the following circumstances:

(1) Possibility of civil liability on the part of the Guard member or the Guard itself.

(2) Occurrence of negative judicial rulings based wholly or in part upon the conduct of Guard members, including the suppression of evidence.

## 2-4. Security guidelines

### **a. Operations security (OPSEC).**

(1) Counterdrug operations will follow OPSEC procedures IAW AR 530-1, OPSEC Program. Guard members will be briefed on the need to observe OPSEC measures.

(2) Mark state plans, operations plans/orders, memoranda of agreement/understanding, and other sensitive documents: "FOR OFFICIAL USE ONLY AND EXEMPT FROM MANDATORY DISCLOSURE."

**b. Communications security (COMSEC).** AR 380-19, Information System Security Program, will be used to determine the methods for transmission or reception of voice and hard copy information.

**c. Physical security.** Physical security personnel will conduct physical security risk assessments of all offices and operational areas.

**d. Personnel Integrity Program.** Due to the sensitive nature of the Counterdrug Support Program, all states will implement a Personnel Integrity



Program. It will consist of two principle elements: an initial screening prior to selection for the program, and appropriate checks and supervision once an individual is placed on orders. Authority to perform such checks on individuals volunteering for duty may be found in AR 380-67 and AFR 205-32.

(1) Each volunteer must be notified that integrity screening will be undertaken and that certain requirements must be met before a tour assignment can be made.

(2) Written consent will be obtained before background checks may be started.

(3) Personnel investigative reports and integrity determination information will be safeguarded and disposed IAW AR 380-67 or AFR 205-32.

(4) Integrity checks will collect the minimum amount of information necessary to determine suitability of the applicant for the Counterdrug Support Program. Sources which may be investigated include the military personnel records jacket, local criminal records, files of the National Crime Information Center, and other records. (See the Counterdrug Coordinator's Handbook, App D.) An applicant must also have a favorable NAC/ENTAC within the last fifteen years.

(5) Interviews of the Guard member will be conducted by the appropriate supervisor in the Counterdrug Support Program IAW AR 380-67, appendix G or AFR 205-37, attachment 7.

(6) Additional criteria determining eligibility for assignment to a sensitive position within the counterdrug program includes, but is not limited to, security standards set forth in AR 380-67, paragraph 2-200 or AFR 205-32, paragraph 8-1.

(7) Only personnel who are recommended by their unit commander as being suitable for the Counterdrug Support Program will be considered for such duty.

(8) Review each individual's medical record to ensure there are no preexisting or disqualifying conditions prior to placing them on orders. (See para 2-9, Medical requirements.)

**2-5. Planning**

a. Each state will submit an annual Counterdrug Support Plan to the National Guard Bureau, ATTN: Counterdrug Task Force, for review and staffing prior to the plan's submission to SECDEF for approval. Plans will conform to Counterdrug Task Force guidelines and be approved and signed by the state Adjutant General.

b. Supplemental plans received after initial plan submission will be considered at the mid-year review. Upon approval at that time, funds will be authorized as available.

c. POMSOs/Counterdrug Coordinators will oversee preparation of plans for support as requested by a LEA.

d. The POMSO/Counterdrug Coordinator will establish and maintain a folder for each operation. The folder will contain all pertinent documentation to

provide an audit trail, including all obligations and expenditures. A list of required documents and the definition of "an operation" are contained in the Counterdrug Coordinator's Handbook.

e. All air assets will be controlled by the State Army Aviation Officer (SAAO) for the Army Guard and the Executive Support Staff Officer (ESSO) for the Air Guard. Counterdrug flying hour support requests will be reconciled with these offices. (See paragraph 2-9, Flying hours/air support, of the Counterdrug Coordinator's Handbook.)

f. Request Channels. LEAs will request support from the POMSO/Counterdrug Coordinator. Requests which are beyond the capability of the National Guard will be forwarded to the appropriate Continental United States Army (CONUSA) and will be coordinated by the National Guard CONUSA Liaison Officer. In areas where LEA federations such as Operation Alliance or Project North Star exist, the aforementioned may be altered to accommodate regional procedures. Retain plans and supporting documents for two years. (Specific coordination requirements are contained in the Counterdrug Coordinator's Handbook.)

g. Missions are consolidated to minimize duplication. The following missions list has been coordinated with and approved by the Office of the Secretary of Defense (OSD):

Mission #	Title
Msn # 1	Surface Reconnaissance
Msn # 2	Surface Surveillance
Msn # 3	Surface Transportation Support
Msn # 4	Aerial Reconnaissance
Msn # 5	Aerial Surveillance
Msn # 6	Aerial Transportation Support
Msn # 7	Ground Radar Support (includes Security)
Msn # 8	Cargo Inspection
Msn # 9	Training Program (NG & LEA)
Msn # 10	Aerial Photo Reconnaissance
Msn # 11	Coordination, Liaison, and Management
Msn # 12	Marijuana Greenhouse/Drug Laboratory Eradication/Detection
Msn # 13	Film Processing for Photo Reconnaissance
Msn # 14	Administrative, Information, ADP, Logistics, and Maintenance Support
Msn # 15	Engineer Support
Msn # 16	Aerial Interdiction Support

Refer to The Counterdrug Coordinator's Handbook for mission descriptions and requirements.

**2-6. Memoranda of Understanding (MOU)**

a. For agencies receiving counterdrug support for a total of more than 30 days, states are required to develop MOUs with a LEA prior to providing the re-

requested support. MOUs are also required for all interstate support. These memoranda will cover the following:

- (1) Planned deployment of National Guard personnel and equipment.
- (2) Reporting procedures.
- (3) Command and control channels.
- (4) Scope of approved operations.
- (5) Force protection/Rules of Engagement.
- (6) Public affairs.
- (7) Safety.
- (8) Areas of responsibility.
- (9) Acquisition of warrants, permits, hold harmless agreements. (Hold harmless requirements are not required for support provided to federal agencies.)

b. MOUs will be carefully reviewed by the state Judge Advocate General (JAG) and if applicable, the U.S. Property and Fiscal Officer (USPFO) and SAAO/ESSO.

#### 2-7. Funding

a. 32 USC 112 provides funds for Pay and Allowances (P&A) and Operations and Maintenance (O&M) under the Counterdrug Support Program. Procurement of services and equipment (to include leases) is funded by the annual Authorization and Appropriations Acts.

b. Funding for operations is based on Congressional appropriations coupled with the Office of the Secretary of Defense plan for supporting the National Drug Control Strategy. Allocation of funds to support state plans is based on this strategy.

c. States may not transfer funds between appropriations nor transfer funds between the Army and Air Guards.

d. Counterdrug support mission costs associated with IDT/IAD or AT training that include above normal expenditures (such as lodging) may be charged to counterdrug support accounts. Travel expenses incurred by personnel on ADSW with the Counterdrug Support Program when commuting to and from IDT/IAD are chargeable to the program when the travel to IDT/IAD is to a place other than the member's normal (i.e. ADSW) place of duty.

e. Counterdrug support funds are considered "fenced" and therefore cannot be transferred to disapproved missions, other state programs, or to other states.

#### f. Army National Guard funding.

(1) **Pay and Allowances (Appropriation 2060).** Pay, allowances, travel, and per diem for ADSW personnel only, are chargeable to the National Guard Personnel Appropriation (NGPA) and are identified as program costs IAW AR 37-100-93.

(2) **Operations and Maintenance (Appropriation 2065).** Operations and maintenance expenses are chargeable to the Army National Guard Opera-

tions and Maintenance Appropriation (OMNG) per AR 37-100-93. O&M includes the following types of expenditures.

(a) Pay of technicians employed by the state Adjutant General as staff to provide support explicitly for the Counterdrug program. Also covered are the employer's contribution to employee retirement funds, incentive awards, health and life insurance programs, FICA where applicable, and object class 12 Permanent Change of Station (PCS) benefits.

(b) Travel and per diem required for ARNG AGR (Titles 10 and 32), ARNG technicians, or National Guard Bureau employees directly employed with the Counterdrug Support Program.

(c) Medical expenditures for all personnel (other than AGR) directly employed in the Counterdrug Support Program such as line of duty civilian medical care, unique immunizations, and per diem with travel expenses for program applicants to obtain examinations needed to determine suitability for the counterdrug program. Approval for payment IAW NGR 40-3 is processed by NGB-ARP-HS.

(d) Procurement of material required for operating and maintaining facilities, aircraft, ground vehicles, and equipment.

(e) Procurement of medical supplies used in Counterdrug Support Program activities.

(f) Other expenses that cannot be linked directly to a specific mission. Additional guidance may be obtained from the Army Comptroller Directorate, Program and Budget Division (NGB-ARC-P).

#### g. Air National Guard funding.

(1) **Military Personnel (Appropriation 3850, Fund Code 56).** Pay, allowances, and travel for personnel directly involved with the Counterdrug Support Program are chargeable under this appropriation.

(2) **Operations and Maintenance (Appropriation 3840, Fund Code 58).** Operations and maintenance funds cover a variety of costs that are the same as the ARNG, except that medical cost accounting differs.

(a) Medical expenses should be identified for CONUS plans and operations using the appropriately assigned Emergency Special Program (ESP) code.

(b) Line of duty civilian care expenditures which cannot be handled with local funds, should be submitted to Air National Guard, Medical Resource Management Office (ANGRC/SGAR) as an unfunded budget requirement.

h. Items identified for central procurement using Dedicated Procurement Program (DPP) funds, and/or USPFO procurement authority for O&M funds, will be identified and submitted in the annual Counterdrug Support Plan submitted by each state.

#### 2-8 Personnel administration

a. National Guard members may serve the Counterdrug Support Program under a variety of employment categories. Additional regulations within each category further govern the utilization of these soldiers and airmen. Attention to detail is required so that members receive the benefits, pay and al-

allowances due them. The support of the counterdrug program must be the primary mission of all federally funded counterdrug personnel.

**b. State Active Duty (SAD).** State funded SAD personnel may provide counterdrug support to LEAs. Such personnel will be employed IAW state regulations.

**c. Active Guard Reserve (AGR) (Title 10/Title 32) and Full-time Technician Personnel.**

(1) Do not place personnel on an AGR tour unless upon reaching eighteen years of active federal service they will have sufficient time remaining prior to their Mandatory Separation Date (MSD) to complete twenty years of active service.

(2) Employment of ARNG AGR personnel will be as stated in NGR (AR) 600-5 (Title 32) or NGR (AR) 600-10 (Title 10). Employment of ANG AGR personnel will be accordance with NGR (AF) 35-3.

(a) Counterdrug Orders will include a statement requiring the proper use of personnel. (See Counterdrug Coordinator's Handbook for Title 10 and Title 32 required statements.)

(b) Full-time ARNG AGR personnel serving tours other than those specifically in the Counterdrug Support Program will not spend more than thirty days total time per year involved with the counterdrug program. Requests for exception to policy will be submitted to the Army National Guard, Full-Time Support Division (NGB-ARM), who will in turn coordinate any approvals with the Counterdrug Task Force (NGB-CD).

(c) Air National Guard (ANG) AGR personnel. At the discretion of the commander, ANG AGR personnel other than Counterdrug Coordinators may participate in the Counterdrug Support Program without limit if participation is consistent with their Air Force Specialty Code (AFSC) duties or contributes to overall unit readiness. Tour length limitations and guidance found in ANGR 35-3 apply to full-time military personnel serving in support of counterdrug activities.

(3) Technician status is determined by TPR 990-2. Technicians who provide support to LEAs must be placed on appropriate leave for all normal workday hours during the time this support is rendered.

**d. Active Duty Special Work (ADSW) (Title 32).**

(1) The number of soldiers and airmen serving on ADSW tours for the Counterdrug Support Program will not impact allowable end strengths of personnel supporting reserve components. Neither will they count against authorizations outlined in Title 10, sections 517 and 524. These same personnel are exempt from end strength reporting and limitations on the number of days members may perform in a fiscal year under AR 135-200, NGR 37-111, and ANGR 50-01. Guard members placed on extended ADSW orders are required to continue attending IDT/IAD while remaining on the orders. They should be carried as "constructive" attendance for purposes of pay and accountability. Orders must be broken for any non-counterdrug training lasting longer than three days.

Additionally, soldiers and airmen on ADSW for twenty weeks or longer are entitled to PCS benefits.

(2) Officers on ADSW orders who enter the sanctuary zone (18-20 years of active federal service) must be retained on active duty until the completion of 20 years.

**e. Duty Performed Incidental to Training.** National Guard personnel may support LEAs and/or other parts of the Counterdrug Support Program in an IDT/IAD or AT status if the performance of that duty is synonymous to the training originally planned.

**f. Performance Evaluation.** States will implement a system for the evaluation of a member's job performance while assigned to the Counterdrug Support Program for 90 or more consecutive days.

**2-9. Medical requirements**

a. In addition to existing requirements outlined in AR 135-200, AR 40-501, and AFR 160-43, personnel on orders (Title 10 or Title 32) for federally funded (Section 112 funding) counterdrug support activities will adhere to the following physical examination requirements:

b. The requirement for physicals (medical fitness screening) depends on the length of a Guard member's ADSW orders and falls into two categories.

(1) Tours of thirty days or less do not require a medical examination. However, the Individual will complete and sign a statement attesting to the status of current health IAW NGR 40-501, Appendix B or AF Form 895, AFR 160-43 prior to being placed on active orders.

(2) Individuals being placed on a tour of more than thirty days are required to meet the standards of medical fitness as set forth in Chapter 2 of AR 40-501 or Chapter 4 of AFR 160-43. This will be determined by the State Surgeon (or his/her designee) reviewing a medical screening form (AF Form 895 or Appendix B, NGR 40-501) completed by the applicant within the preceding 30 days, and the applicant's most recent valid periodic physical, applying Chapter 2/4 standards. The period of validity for periodic physicals is four years, except (ARNG only) two years if age 40 or over. In addition, all ARNG applicants, age 40 and over, must have successfully passed the Cardiovascular Screening Phase I or II within the preceding two years. If the individual meets these standards, he/she may be placed on duty. If the individual fails to meet these standards, the Surgeon may elect to deny duty without appeal, or with reasonable cause, may submit the records with an appropriate current clinical evaluation to NGB-ARP-HS or ANGRC/SGP, as appropriate, for waiver consideration. The decision of the waiver by NGB-ARP-HS or ANGRC/SGP is final. Once duty has been authorized by Chapter 2/4 standards, retention standards govern. However, if a break in excess of one year occurs, reentry will require Chapter 2/4 standards again.

(3) Guard members whose physical examination results (or a waiver approved by NGB-ARP-HS or ANGRC/SGP) have not been received by the Counterdrug Support Program of their state by the end of thirty days will have their counterdrug ADSW orders terminated.

c. Personnel in the Counterdrug Support Program are also subject to drug analysis testing (DAT) and HIV testing. Females are required to sign a statement regarding pregnancy. Specific requirements are contained in the Counterdrug Coordinator's Handbook.

d. Guard members on ADSW orders who are injured while participating in counterdrug support activities are entitled to benefits under Section 1074a of Title 10 USC.

#### 2-10. Public Affairs

a. The supported LEA should have the lead concerning public affairs and make the final determination as to what information is released to the public in coordination with the state PAO.

b. State PAOs will not divulge dates of specific operations, identification of units, or identification of personnel involved. (Photographs and video tapes will be carefully managed to ensure that faces and name tags are not visible). Operational questions regarding information on numbers and types of personnel or equipment involved in current or future activities will not be released until the mission is completed. Protection of the force and OPSEC will be the primary consideration.

c. News media representatives can accompany the National Guard on counterdrug support operations only with the approval of the LEA and notification of NGB-PA. Orientation flights with news media representatives must receive NGB-PA approval IAW NGB Pam 360-5

#### 2-11. Training

##### a. Training of National Guard personnel.

(1) Middle and upper level managers (such as POMSOs and Counterdrug Coordinators), should at a minimum attend the Counterdrug Managers' Course provided by the National Interagency Counterdrug Institute (NICI). The program of instruction provides information regarding organizations, policies, and laws which they must be familiar with in order to execute a State Counterdrug Program.

(2) Tactical level planners and operators must be given training specific to the types of operations being planned or undertaken by their state counterdrug programs. Such training can take the form of everything from cargo inspection techniques to the operation of specialized equipment. Training plans should be created at the state or regional level and tailored to the specific requirements of the LEAs and approved missions.

##### b. Training of LEA personnel.

(1) Congressional and DoD intent is that counterdrug support funding may not be used for other purposes such as train-ups for LEA personnel with deficiencies in areas such as marksmanship, weapons systems, etc. DoD guidance is that "other related topics" is not intended to act as a catch-all, but is designed to provide reasonable lee-way from listed examples of authorized training.

(2) NGB will approve training for LEAs when such training enhances the ability of LEA members working directly with the National Guard in the Guard's counterdrug support role. This training includes:

(a) Training for specific types of operations such as surveillance missions.

(b) Training for LEAs that enables them to interact with military forces in joint operations such as eradication, border interdiction, and other similar events.

(3) Any LEA training not specially defined above must be approved in advance by the NGB Counterdrug Task Force.

#### 2-12. Office of Review and Evaluation

a. The Office of Counterdrug Review and Evaluation implements internal controls and provides oversight functions for the program. It monitors and performs periodic inspections of operations ensuring that internal management controls will detect fraud, waste, or abuse of resources and assets.

b. The POMSO/Counterdrug Coordinator will provide the Office of Counterdrug Review and Evaluation a copy of all reviews, inspections, and evaluations conducted in the state counterdrug program.

### Chapter 3

#### Use, Loan, and Lease of Equipment

##### 3-1. General Information

a. The state Adjutant General has authority to use federal property issued to the National Guard in support of counterdrug support operations.

b. States are encouraged to make every effort to utilize military assets for counterdrug support activities.

c. States may coordinate directly with other states for the temporary loan of additional federal property needed to support a particular type of counterdrug activity. Formal arrangements should be made between USPFOs. The loan transactions will be reported to NGB-CD and the Army National Guard, Logistics Directorate (NGB-ARL) or the Air National Guard, Directorate of Logistics, Supply and Equipment Division (ANGRC/LGS) as appropriate.

d. NGB-ARL and NGB/LGS will provide yearly guidance for counterdrug support equipment requirements, loans, leases, and procurement activities.

e. All equipment purchased, loaned, leased, or otherwise obtained using 32 USC 112 funds will not be used for anything other than counterdrug support.

f. All excess equipment will be reported to NGB-CD for redistribution.

### 3-2. Loan and lease of equipment

a. Loan and lease of equipment is governed by AR 700-131, and AFM 67-1/ANGR 67-1. USPFOs are responsible for preparing and negotiating agreements, and approving loans and leases of equipment. Loan formats may be found in the aforementioned references.

b. NGB will review requests for loans/leases of ARNG/ANG equipment that require HQDA and USAF approval. States will itemize/prioritize lists of requested/required equipment in their annual Counterdrug Support Program plans.

c. Areas of responsibility or request review are as listed:

(1) Director, NGB-CD will act on all counterdrug support to LEAs.

(2) The Public Affairs Division (NGB-PA) will be involved if requests will impact the community.

(3) The Aviation Division, Standardization and Training Branch (NGB-AVN-OT) will control all areas related to ARNG aircraft.

(4) Air National Guard Counterdrug Support Division (ANGRC/CD) will act on requests for loan or lease of ANG equipment.

(5) The Logistics Directorate (NGB-ARL) will act on all other requests for loan/lease of ARNG equipment.

(6) ANG Logistics (ANGRC/LGS) will process all requests for ANG assets.

### 3-3. Routing of requests

a. Loan requests from state and/or local agencies should be routed directly to the state POMSO/Counterdrug Coordinator.

b. Loan requests from federal agencies will be routed through that agencies' headquarters to the Department of Defense, and then to the appropriate service. Contact should be made with Regional Logistics Support Offices (RLSOs) to process requests for resources not available in standard channels.

### 3-4. Use of National Guard Aircraft

All support will be in compliance with applicable state and federal law and regulations.

a. The use of National Guard aircraft is prescribed by the 95-series regulations for the ARNG and the 55-series for the ANG. The Army safety program is covered in AR 385-10 and the Air Force safety program is covered in AFR 127-4. Additionally, the Air Force adheres to "Safety: Investigating the Reporting USAF Mishaps" IAW NGR (AF) 127-4 supplement, and Message Reporting of F-16 Flight Mishaps AFR 127-18. These regulations are the primary references

on all use of aircraft issues. See NGR (AR) 500-1/NGR (AF) 55-5 for additional guidance.

b. ARNG and ANG aircraft may be used for counterdrug support activities in any of the listed categories.

(1) ADSW (Title 32) status and/or federally funded SAD status.

(2) Incidental-to-training.

(3) Training support to LEAs.

c. Reconnaissance and Interdiction Detachment (RAID) Aircraft

(1) RAID aircraft are funded with counterdrug dollars, and intended for use in counterdrug operations. Acknowledging that some requests will likely be made wherein the use of the aircraft's thermal imaging and or communications capabilities are needed, the following allowances are made for use of RAID aircraft for other than counterdrug missions:

(a) The RAID aircraft may be used in a life/death emergency situation that meets the following criteria:

1. The aircraft and thermal imaging/communication equipment is needed to search a wilderness area for a lost person(s), where the probability exists that the person(s) will most likely not survive inclement weather or other perilous circumstances/conditions.

2. The aircraft and thermal imaging/communication equipment is needed to search for an escaped convict or suspected dangerous felon in a wilderness area, that if not quickly apprehended, will likely endanger the welfare of residents and innocent citizens.

(2) In each case of 1. and 2. above, the request must be made by a law enforcement agency to the National Guard. Flying hour time used for the mission must be reimbursed either by other National Guard Funding or by the state or local government making the request. Missions for other than counterdrug operations must not interfere with counterdrug missions unless LEA coordination is made and a life/death emergency exists.

### 3-5. Equipment authorizations

a. Commercial equipment must be authorized by NGB-CD and NGB-ARL prior to procurement or leasing. ARNG requests, not previously approved will be processed as prescribed under AR 71-13 for a Table of Distribution and Allowance (TDA) addition or under CTA 50-909. ANG requests will be submitted on AF Form 601 so that the item will be included under the appropriate Allowance Source Code (ASC).

b. The USPFO retains the authority of approval to procure non-standard, non-type classified, commercial equipment that doesn't qualify for TDA addition. Annual ARNG procurement/lease guidance (to include dollar thresholds), is set forth by NGB-ARL. ANG units should submit AF Form 601 to NGB/LGSE/DON for approval.

c. States will not procure counterdrug support equipment already earmarked for central procurement by the Counterdrug Task Force (NGB-CD) and NGB-ARL unless authorized to do so by the same. ARNG and ANG Directorates will obtain and provide equipment to states through the Total Package Fielding Program. States will be updated annually on the status of the requisitions.

d. Modifications/equipment changes to ARNG aircraft must be coordinated through Aviation Division (NGB-AVN) and approved by the U.S. Army Aviation Systems Command and/or the U.S. Safety Center as appropriate.

#### Chapter 4 Reports and Records

##### 4-1. Information and archives

The National Guard Bureau leadership has the recurring mission of providing expert testimony to the Congress of the United States. They must also continually interface with the DoD, along with many other federal agencies regarding the Counterdrug Support Program. Therefore it is vital that both current and historical records remain accurate, readily available, and up to date. This information flow from lower to higher provides the crucial link for obtaining this knowledge that will have great impact on current operations and future directions of the Counterdrug Support Program.

##### 4-2. Reports and reporting

a. Counterdrug support operations records. Operation Plans (OPLANs) and Operation Orders (OPORDs) will be developed for each operation. These will be included in the operation folder or database that the POMSO/Counterdrug Coordinator must maintain for each operation.

b. All reports must be made IAW the Counterdrug Coordinator's Handbook, Chapter 3. This includes, but is not limited to, missions performed incidental to training and after action reports.

c. The following forms will be used for some of the reports mentioned in *b* above:

- (1) NGB Form 525-R (State Counterdrug Support Operations Report).
- (2) NGB Form 525-1-R (Air National Guard Monthly Financial Report).
- (3) NGB Form 525-2-R (Army National Guard Monthly Financial Report).
- (4) NGB Form 525-3-R (National Guard Counterdrug Support Operations Law Enforcement Agency Survey).
- (5) NGB Form 525-4-R (National Guard Counterdrug Support Operations National Guard Survey).
- (6) NGB Form 525-5-R (National Guard Counterdrug Support Operations Law Enforcement Request Report).

A copy of each form is located at the back of this regulation. Locally reproduce these forms on 8 1/2 by 11-inch paper. For preparation of these forms, see the Counterdrug Coordinator's Handbook, chapter 3.

##### 4-3. Special notification/coordination

a. Reporting also includes unusual circumstances. The Director, Counterdrug Task Force will be notified by the POMSO/Counterdrug Coordinator immediately in the event of an emergency or "immediate action" situation.

b. Immediate Action. An "immediate action" situation is defined as any situation which results in a gross deviation from the OPLAN to the extent that weapons are fired at or by Guard members, injuries from hostilities are sustained by Guard members, defensive or offensive actions (not planned for but reactive in nature) have been taken which escalate the original OPLAN or which may be classified as "serious incidents" as determined by the operation commander on the military side.

c. In addition to Counterdrug Support Program reporting requirements, Serious Incident Reports (SIRs) must be submitted through appropriate channels IAW applicable regulations.

**Appendix A  
References**

**Section I**

**Required Publications**

**Counterdrug Coordinator's Handbook**  
1 March 1993

**Title 32, United States Code**

**National Drug Control Strategy**  
Beginning - September 1989

**DoD Directive 4515.13R**  
Air Transportation Eligibility

**DoD Directive 4500.9**  
Transportation and Traffic Management

**AR 11-2**  
Internal Control Systems

**AR 25-55**  
Department of the Army Freedom of Information Act

**AR 37-100-85**  
The Army Management Structure

**AR 40-3**  
Medical, Dental and Veterinary Care

**AR 40-501**  
Standards of Medical Fitness

**AR 135-200**  
Active Duty for Training, Annual Training and Active  
Duty Special Work of Individual Soldiers

**AR 340-21**  
The Army Privacy Program

**AR 380-67**  
Headquarters DA Personnel Security Program

**AR 385-10**  
Army Safety Program

**AR 600-9**  
Army Weight Control Program

**AR 600-110**  
Identification, Surveillance and Administration of Per-  
sonnel Infected with Human Immunodeficiency Virus  
(HIV)

**AR 700-131**  
Loan of Army Material  
**AFR 12-30**  
Air Force Freedom of Information Act Program

**AFR 12-35**  
Air Force Privacy Act Program

**AFR 20-14**  
Management of Government Property in the Posses-  
sion of the Air Force

**AFR 67-23**  
Standard Base Supply Customer's Guide

**AFR 127-2**  
The U.S. Air Force Mishap Prevention Program

**AFR 160-43**  
Medical Examinations and Medical Standards

**AFR 205-32**  
USAF Personnel Security Program [Modified by NGR  
(AF) 205-032]

**AFR 208-1**  
Federal Tort Claims Act

**NGR 37-111**  
Administration of Training and Special Work Work-  
days

**NGR 40-3**  
Medical Care for Army National Guard Members

**NGR 40-501**  
Medical Examination for Members of the Army  
National Guard

**NGR (AR) 95-210**  
Army National Guard: General Provisions and Regu-  
lations for Aviation Training

**NGR (AR) 600-5**  
The Active Guard/Reserve (AGR) Program, Title 32  
Full-Time National Guard Duty (FTNGD)

**NGR (AR) 600-10**  
The Active Guard/Reserve (AGR) Program, Title 10  
Full-Time National Guard Duty (FTNGD)

**NGB Pam 360-5/ANGP 190-9** National Guard Pub-  
lic Affairs Guidelines

**ANGR 50-01**  
Active and Inactive Duty For Training Management  
Within the Air National Guard

**ANGR 67-1**  
Loan and Use of Property Issued to the Air National  
Guard

**TPR 990-2**  
Hours of Duty, Pay and Leave

**Section II  
RELATED PUBLICATIONS**

(A related publication is merely a source of additional  
information. The user does not have to read it to un-  
derstand this regulation).

1 March 1993

NGR (AR) 500-2/NGR (AF) 55-6

**4th Amendment to the U.S. Constitution**

**DoD Directives: 5525.5 DoD Cooperation with Civilian Law Enforcement Officials; 5149.1; 5160.54**

**AR 25-1**  
The Army Information Resources Management Program

**AR 71-13**  
Department of the Army Equipment Authorization and Usage Program

**AR 95-1**  
Flight Regulations

**AR 130-5/AFR 45-17**  
Organization and Functions of National Guard Bureau

**AR 190-40**  
Serious Incident Reporting

**AR 190-51**  
Security of Army Property at Unit/Installation Level

**AR 310-49**  
The Army Authorization Documents System (TAADS)

**AR 700-1**  
Army Conversion to the Metric System of Measurement

**DA Pam 190-52**  
Personnel Security Precautions Against Terrorism

**AFR 55-3**  
Operations (Reporting, Meaconing, Intrusion, etc.)

**AFM 67-1**  
USAF Supply Manual

**CTA 50-909**  
Field and Garrison Furnishings and Equipment

**FORSCOM/ARNG 350-2**  
Reserve Component Training

**NGR 10-2**  
State Area Command, Army National Guard

**NGR (AR) 95-1**  
ARNG Aviation: Flight Regulations (Modifies AR 95-1)

**NGR 190-11**  
Physical Security of Arms, Ammunition, and Explosives

**NGR (AR) 350-1**  
Army National Guard Training

**NGR (AR) 500-1/NGR (AF) 55-5**  
Military Support to Civil Authorities

**NGR (AR) 600-85**  
Drug Abuse Prevention and Control

**ANGR 23-01**  
State Air National Guard Headquarters

**ANGR 35-03**  
Full-Time Military Duty Personnel Program - Air National Guard

**Section III**  
**National Interagency Counterdrug Institute (NICI) Publications**

**Special Reports**

Public Lands Drug Control Committee - 1990 After Action Assessment Seminar

\*Information and Intelligence Resources for the Law Enforcement Agencies on the Southwest Border

Counterdrug Managers' Course Resource Guide

National Guard Counterdrug Lessons Learned

NICI also publishes a variety of Information Papers, a monthly "NICI BULLETIN", on counterdrug related conferences and seminars, and "THE INFORMANT", a training and enforcement update.

**Note:**

\*FOUO - Published for Operation Alliance. Available only to approved law enforcement and military agencies/organizations.

**Appendix B**

**Rules of Engagement and Use of Force**

**B-1. Purpose**

The purpose of this guidance is to:

a. Emphasize the importance of safety in the conduct of counterdrug support operations.

b. Alert commanders to applicable areas of force protection, policy, and law.

**B-2. Force Protection**

Commanders at all levels will ensure that pre-operation (liaison) coordination and planning with supported law enforcement agencies address the safety of personnel and equipment throughout the operation. Consideration will be given to potential threats to Guard members and property for force protection purposes. Commanders will also ensure that public affairs efforts, directed at complying with the public's right to know, do not jeopardize the safety of Guard members and equipment by disclosing personnel identification in photographs or video recordings by the media.



**B-3. Use of Force**

All National Guard personnel will comply with the use of force guidelines contained in paragraph 2-2 of this regulations. Commanders at all levels must ensure that personnel are fully briefed upon, understand, and follow these restrictions.

**B-4. Aircraft Safety**

The operation of aircraft constitutes a significant potential hazard. Pilots in Command (PIC) are responsible for the aircraft and the lives of passengers and crew. In addition to other guidance on aircraft safety, the PIC will not fly into or land in areas where the aircraft is likely to be fired upon. PICs will take appropriate measures to ensure the safety of passengers and the aircraft when inserting law enforcement personnel during counterdrug operations.

**B-5. Support Role**

The role of the National Guard in drug interdiction and law enforcement support operations is to support LEAs. Commanders will ensure that their personnel are not placed in situations that are likely to bring them in direct contact with suspects. They will also ensure that Guard members are not knowingly sent or directed to enter into a hostile environment where there is a probability of encountering small arms fire or life threatening situations. If life threatening situations occur, they must be handled according to use of force rules. Any final decision to go or not to go into a possible life threatening situation should be made using prudent judgment, keeping in mind that the safety of personnel is our greatest concern.

**B-6. Arming of Troops**

The Adjutant General will determine whether or not troops will be armed. Since the National Guard is in a support role and not directly engaged in law enforcement, Guard members will not routinely be armed. Weapons and small arms ammunition, when issued, will only be used for personal protection. Arms and ammunition will be secured until issued. Rounds will be chambered only on order of the senior military member present and in conjunction with the supported LEA. Firearms will not be discharged from aircraft or motor vehicles.

**B-7. Rules of Evidence**

Court system rules provide that exhibits cannot be offered into evidence in legal proceedings unless a chain-of-custody can be shown. This is especially true for items subject to adulteration. To ensure admissibility of evidence, only LEOs should seize or possess any items that are considered, or may become, evidence.

**B-8. Tort Liability**

The Federal Tort Claims Act (FTCA) is applicable to Guard members engaged in drug interdiction and law enforcement support in a Title 32 status. Individuals whose property is lost, damaged, or destroyed, or who suffer personal injury or death as a result of a negligent act or omission of a Guard member acting

within the scope of his employment may file a claim against the United States under the FTCA. Guard members acting within the scope of their authority and performing approved support (listed in State Counterdrug Support Plans and approved by Office of the Secretary of Defense (OSD)) requested by LEAs, are immune from suit except for Constitutional torts (i.e., when a negligent act or omission constitutes a violation of the Constitutional rights of the injured party, including persons suspected of criminal activity); and, certain intentional torts, such as assault and battery, and false arrest or imprisonment. Guard members engaged in counterdrug support activities in State Active duty status are entitled to whatever protections and immunities are afforded by state law.

**B-9. Pre-commitment Briefing**

Prior to participating in an operation, Guard members will be provided with training as prescribed by this regulation and will be briefed on all aspects of the operation to include restrictions and limitations, use of force, safety, and force protection, and will be issued written guidance approved by the state JAG. Such written guidance will advise them of rules of engagement, their status (State Active Duty or Title 32), tort protection, and medical benefits. Guard members performing an operation of extended duration will receive an initial pre-commitment briefing and will be briefed semi-annually thereafter. The briefing officer will certify that personnel have been briefed. Copies of written guidance provided as well as lists of individuals briefed will be maintained by the states.

**Glossary****Section I  
Abbreviations**

**ADSW**  
Active Duty Special Work

**AFSC**  
Air Force Specialty Code

**AGR**  
Active Guard Reserve

**ANG**  
Air National Guard

**ANGRC/CD**  
Air National Guard, Counterdrug Division

**ANGRC/LGS**  
Air National Guard, Directorate of Logistics

**ANGRC/SGP**  
Air National Guard, Physical Standards Branch

1 March 1993

NGR (AR) 500-2/NGR (AF) 65-6

<b>ANGRC/SQAR</b> National Guard Bureau, Air National Guard, Resource Office	<b>IDT</b> Inactive Duty Training
<b>ARNG</b> Army National Guard	<b>JAG</b> Judge Advocate General
<b>ASC</b> Allowance Source Code	<b>JTF</b> Joint Task Force
<b>AT</b> Annual Training	<b>LEA</b> Law Enforcement Agency/Agent
<b>CNAC</b> Customs National Aviation Center	<b>LEO</b> Law Enforcement Officer
<b>CONUS</b> Continental United States	<b>MOA</b> Memorandum of Agreement
<b>CONUSA</b> Continental United States Army	<b>MOS</b> Military Occupational Specialty
<b>DAT</b> Drug Analysis Testing	<b>MOU</b> Memorandum of Understanding
<b>DLEA</b> Drug Law Enforcement Agency	<b>MRD</b> Mandatory Retirement Date
<b>DoD</b> Department of Defense	<b>MSD</b> Mandatory Separation Date
<b>DPP</b> Dedicated Procurement Program	<b>NAC</b> National Agency Check
<b>EER</b> Enlisted Evaluation Report	<b>NCIC</b> National Crime Information Center
<b>ENTNAC</b> Entrance National Agency Check	<b>NCO</b> Noncommission Officer
<b>EPIC</b> El Paso Intelligence Center	<b>NCOER</b> Noncommissioned Officer Evaluation Report
<b>ESP</b> Emergency Special Program	<b>NGB</b> National Guard Bureau
<b>ESSO</b> Executive Support Staff Officer	<b>NGB-ARC-P</b> National Guard Bureau, Army Comptroller Program and Budget Division (Budget)
<b>FOIA</b> Freedom of Information Act	<b>NGB-ARL</b> National Guard Bureau, Army Guard, Logistics Directorate
<b>FTCA</b> Federal Tort Claims Act	<b>NGB-ARP-F</b> National Guard Bureau, Full-Time Support Division
<b>FTNGD</b> Full-Time National Guard Duty	<b>NGB-ARP-HS</b> Office of the Army Surgeon, Medical Standards
<b>HIV</b> Human Immunodeficiency Virus	<b>NGB-AVN</b> National Guard Bureau, Aviation Directorate
<b>IAD</b> Inactive Duty Training	<b>NGB-CD</b> National Guard Bureau, Counterdrug Task Force

**NGB-CDS**  
National Guard Bureau, Counterdrug Support Division

**NGB-JA**  
National Guard Bureau, Judge Advocate

**NGB-PA**  
National Guard Bureau, Public Affairs

**NGPA**  
National Guard Personnel Appropriation

**NICI**  
National Interagency Counterdrug Institute

**NORAD**  
North American Aerospace Defense Command

**OER**  
Officer Evaluation Report

**OMARNG**  
Army National Guard Operations and Maintenance Appropriation

**OMNG**  
National Guard Operations and Maintenance Appropriation

**OPLAN**  
Operation Plan

**OPORD**  
Operation Order

**OPSEC**  
Operations Security

**OPR**  
Officer Performance Report

**OSD**  
Office of the Secretary of Defense

**PAO**  
Public Affairs Officer

**PCS**  
Permanent Change of Station

**PIC**  
Pilots in Command

**PIP**  
Personnel Integrity Program

**POC**  
Point of Contact

**POMSO**  
Plans, Operations, and Military Support Officer

**RLSO**  
Regional Logistical Support Office

**RON**  
Remain Overnight

**SAAO**  
State Army Aviation Officer

**SECDEF**  
Secretary of Defense

**SITREP**  
Situation Report

**SOP**  
Standard Operating Procedures

**SPMD/UMD**  
Office of the Air Surgeon, Aerospace Medicine

**ST**  
Special Training

**STARC**  
State Area Command

**TAADS**  
The Army Authorization Documents System

**TDA**  
Table of Distribution and Allowances

**TDC**  
Type Duty Code

**TPF**  
Total Package Fielding

**TPR**  
Technician Personnel Regulation

**UMD**  
Unit Manning Document

**USCS**  
U.S. Customs Service

**32 USC 112**  
Section 112 of Title 32, United States Code

**USMEPCOM**  
U.S. Military Entrance Processing Command

**USPFO**  
U. S. Property and Fiscal Officer

**Section II**  
**Terms**

**Adjutant General**  
Refers to the Commanding General in those states without an Adjutant General

1 March 1993

NGR (AR) 500-2/NGR (AF) 55-6

**Attorney General**

Refers to the equivalent official in states without an Attorney General

**Civil Authorities**

Elected and appointed public officials and employees of federal, state, and local government.

**Counterdrug Support Program**

Support provided to federal, state or local LEAs and other civil authorities to assist with drug interdiction and other counterdrug support authorized by Section 112 of Title 32, United States Code (32 USC 112) in support of the National Drug Control Strategy.

**Exigent Circumstances** Circumstances in which immediate action is necessary to protect police officers, Guard personnel, or other persons from injury; to prevent loss or destruction of evidence; or to prevent the escape of a suspect already in custody.

**Incidental to Training**

Previously or otherwise scheduled training which would have been conducted regardless of counter-

drug operations. Routes and schedules may be altered in order to maximize counterdrug benefits.

**Law Enforcement Agency (LEA)**

An organization, or a coordinating council comprised of several LEAs, empowered by local, state or federal law to investigate, enforce or prosecute criminal laws regarding illegal drugs and controlled substances.

**National Guard**

Except as stated otherwise, National Guard means a state National Guard when not in federal service, or all such organizations collectively.

**States**

For the purpose of this regulation the term "states" includes all 50 states, the Commonwealth of Puerto Rico, the U.S. Virgin Islands, Guam and the District of Columbia.

**State Plans**

Plan submitted by the states for National Guard counterdrug support activities as authorized by 32 USC 112.

By Order of the Secretaries of the Army and the Air Force:

**JOHN B. CONAWAY**  
Lieutenant General, USAF  
Chief, National Guard Bureau

Official:

**E. DARDEN BAINES**  
Director  
Administrative Services

Distribution: C/F

## APPENDIX G--Sample Risk Assessment Instrument

**Instructions:**

The following matrices provide one method for estimating the relative risk of a counterdrug operation. To use this risk assessment instrument, circle the appropriate value in each of the individual matrices. If the mission is marijuana eradication under hasty conditions, for example, the value would be 12. If the troops will be armed, add 5 points. The total for the Mission matrix in such a case would be 17. Repeat this procedure to obtain a score for the Threat Level, Planning, Complexity, Soldier Endurance, Terrain, Soldier Proficiency, and Environmental Conditions matrices. Add up the scores from the eight matrices to obtain a risk value for the proposed mission. As the risk gauge at the bottom indicates, the higher the value, the greater the relative risk of the mission.

A risk assessment does not determine whether or not a mission should be performed--it provides a method for the decision maker to estimate the relative level of risk involved in an operation. The decision as to what level of risk is acceptable remains with the commander.

The assessment process also indicates factors that may increase or decrease the level of risk in a particular mission. For example, based upon a high risk score a commander may decide to postpone a mission to provide greater planning time, give the soldiers optimum rest, and/or wait for better weather conditions. This decision could reduce the relative risk value of a mission by more than 15 points.

The following example of a risk assessment instrument is provided as a suggested technique. The weighting of each element of risk provides a generic example for the risk assessment process. Local commanders may wish to create their own criteria or adopt different relative values based upon their own situation and the recommendation of supported LEAs.



State Counterdrug Support Operations  
 Proponent Agency: NGB-CDD

NATIONAL GUARD COUNTERDRUG SUPPORT OPERATIONS LAW ENFORCEMENT AGENCY SURVEY						
TO: Counterdrug Task Force					1. FROM (STATE):	
					2. DATE:	
3. Operation Number:		State	Serial #	FY	Agency	4. Operation Code Name:
5. NG POC:			6. Telephone:		7. Fax Line:	
8. Start Date:			9. Scheduled Ending Date:			
PURPOSE: To provide Senior DoD Staff and Congress with timely feedback concerning National Guard Support to Law Enforcement Agencies.						
Rating Scheme: 1 (Poor) 2 (Good) 3 (Excellent)						
10. It is requested that this survey be completed by the senior law enforcement official (LEO) participating in this operation. Score each question with a numerical score (1-2-3) as follows:						
1. WAS THE SUPPORT PROVIDED IN A TIMELY MANNER?						_____
2. WAS THE SUPPORT PROVIDED FOR THE FULL PERIOD REQUESTED?						_____
3. WAS THE NATIONAL GUARD FULLY EQUIPED TO SUPPORT MISSION REQUIREMENTS?						_____
4. DID THE LEO FEEL THAT THE OPERATION WAS A SUCCESS?						_____
5. WAS THERE A COOPERATIVE ATTITUDE AMONG ALL PARTIES?						_____
6. DID THE NATIONAL GUARD PERSONNEL FULLY UNDERSTAND THEIR ASSIGNED MISSION?						_____
7. WAS THERE AMPLE FLEXIBILITY IN THE NATIONAL GUARD CHAIN OF COMMAND?						_____
8. DID NATIONAL GUARD SUPPORT ENHANCE THE OVERALL DEGREE OF MISSION ACCOMPLISHMENTS?						_____
Total Point Value						_____
11. Law Enforcement Officer (Name/Title):					12. Signature:	
NOTE:						
1. This survey if completed must be submitted as an attachment to the National guard After Action Report (AAR: NGB 525-6-R).						
2. Success Equals (0 - 10 Poor) (11 - 19 Good) (20 - 30 Excellent)						

State Counterdrug Support Operations  
 Proponent Agency: NGB-CDD

NATIONAL GUARD COUNTERDRUG SUPPORT OPERATIONS NATIONAL GUARD SURVEY						
TO: Counterdrug Task Force					1. FROM (STATE):	
					2. DATE:	
3. Operation Number:		State	Serial #	FY	Agency	4. Operation Code Name:
5. NG POC:		6. Telephone:			7. Fax Line:	
8. Start Date:				9. Scheduled Ending Date:		
PURPOSE: To provide Senior DoD Staff and Congress with timely feedback concerning National Guard Support to Law Enforcement Agencies.						
Rating Scheme: 1 (Poor) 2 (Good) 3 (Excellent)						
10. It is requested that this survey be completed by the senior National Guard Member participating in this operation. Score each question with a numerical score (1 - 2 - 3) as follows:						
1. WAS THE SUPPORT PROVIDED AS PER LEA REQUEST?						_____
2. DID SUPPORT START ACCORDING TO LEA REQUEST?						_____
3. WAS THE NATIONAL GUARD PROPERLY EQUIPPED TO SUPPORT THIS OPERATION?						_____
4. DID THE NATIONAL GUARD FEEL THAT THE OPERATION WAS SUCCESSFUL?						_____
5. WAS THERE A COOPERATIVE ATTITUDE AMONG ALL PARTIES?						_____
6. WAS THE SUPPORT OF TRAINING VALUABLE TO THE NATIONAL GUARD? (SQT, COMMON TASK, ARTEP, MOS/AFSC TASKS)						_____
7. WAS THERE A PRE-COMMITMENT BRIEFING CONDUCTED WHICH OUTLINED THE RULES OF ENGAGEMENT AND USE OF DEADLY FORCE?						_____
8. DID NATIONAL GUARD PERSONNEL FULLY UNDERSTAND THE MISSION?						_____
9. WAS THERE AMPLE FLEXIBILITY IN THE NATIONAL GUARD CHAIN OF COMMAND?						_____
10. WAS THERE ADEQUATE TIME FOR NATIONAL GUARD PERSONNEL TO PREPARE FOR THE MISSION?						_____
Total Point Value						_____
11. Officer/NCO In-Charge. (Name/Title):					12. Signature:	
NOTE:						
1. This survey if completed must be submitted as an attachment to the National guard After Action Report (AAR: NGB 525-6-R).						
2. Success Equals (0 - 10 Poor) (11 - 19 Good) (20 - 30 Excellent)						



State Counterdrug Support Operations  
 Proponent Agency: NGB-CDD

<b>NATIONAL GUARD COUNTERDRUG SUPPORT OPERATIONS                      LAW ENFORCEMENT REQUEST REPORT</b>		
<b>TO: Counterdrug Task Force</b>	<b>1. FROM (STATE):</b> _____	
		<b>2. DATE:</b> _____
<b>3. POC:</b> _____	<b>4. Telephone:</b> _____	<b>5. Fax Line:</b> _____
<b>6. Month of Report:</b> _____		
<b>7. A. Response to Law Enforcement Agency Requests (A single "request" may consist of several items all related to a single mission, operation, units, etc.):</b>		
1. Number of valid requests. (legally supportable)		_____
2. Number of valid requests filled. (legally supportable)		_____
3. Number of valid requests filled at the level requested.		_____
4. Number of requests filled within time frame requested.		_____
5. Number of requests referred to CONUSA, RLSO, etc.		_____
<b>B. Analysis of requests not supported:</b>		
1. Number of requests not supported. (Provide brief explanation)		_____
2. Number of requests not operationally supportable. (Provide brief explanation)		_____
3. Number of missions which were not executed due to lack of DoD support.		_____
<b>C. Description of training benefits to forces employed:</b>		
<b>D. Description of other benefits to DoD:</b>		

JOINT COUNTERNARCOTICS OPERATIONS  
AFTER ACTION REPORT FORMAT

**Part I: Mission Summary Data**

1. Date AAR prepared
2. Unit providing CN support
3. Mission or OPORD number
4. Type of mission (see operations list)
5. Dates of operation
6. Location
7. Other military units providing support
8. Drug Law Enforcement Agency (DLEA) requesting support
9. Other participating DLEAs
10. Number of military personnel participating and branch of service/status
11. Uniform
12. Communications equipment used
13. Other equipment
14. Flight hours by aircraft type
15. Arrests
16. Seizures (type, amount, estimated value)
17. Other results (number and type of containers/vehicles searched, miles of road built, etc.)
18. AAR point of contact and phone number

**Part II: Mission Narrative**

a. Mission Description

1. Military support requested
2. Military support provided
3. Military Chain of Command
4. DLEA Chain of Command
5. Communications network

b. Lessons Learned (Address strengths and weaknesses relating to: Doctrine, Training, Material, Organization, and Leadership)

1. Observation
2. Discussion
3. Lessons learned
4. Recommended action
5. Comments

**Part III: Mission Planning, Execution, and Recovery**

1. Chronology
2. OPLAN/OPORD
3. SOP(s)

**COUNTERDRUG RISK ASSESSMENT INSTRUMENT**

**MISSION**

Task	Deliberate	Hasty
Ground Recon	08	14
Ground Surveillance	05	10
Marijuana Eradication	08	12
Meth Lab Eradication	10	15
Other	01	05

Add 5 for night operations. Add 5 if troops are armed.

**THREAT LEVEL**

Number of Suspects	Suspect History			
	Unknown	No Priors	Non-Violent	Known Violent
Single	08	04	05	14
Multiple	10	09	11	15

Unknown: Suspect(s) are unknown  
 No Priors: Suspect(s) are known, have no prior arrests or convictions  
 Non-Violent: Suspect(s) are known, have prior non-violent arrests/convictions  
 Known Violent: Suspect(s) are known, have prior violent arrests/convictions

**PLANNING**

Guidance	Preparation		
	In Depth	Adequate	Minimal
FRAGO	06	09	13
OPORD	03	06	09
OPLAN/LOI	01	03	06

**COMPLEXITY**

Length of Operations	Urban	Tactical	Unknown
8 Hour	01	02	03
24 Hours	02	03	04
48 Hours	03	04	05
> 2 Days	04	05	06

Urban: Operations in built-up area  
 Tactical: Operations in previously reconned rural/field environment  
 Unknown: Operations with no prior reconnaissance

**SOLDIER ENDURANCE**

Quality of Rest	Length	of	Rest
	Optimum	Adequate	Minimal
Tactical	05	07	09
Urban	02	04	06
Training	01	03	05

**TERRAIN**

Type	Mode of Operation		
	Stationary	Mobile-Vehicles	Mobile-On Foot
Forrest	06	08	11
Open	01	03	06
Urban	03	06	09

**SOLDIER PROFICIENCY**

Difficulty of Task	Highly Qualified	Adequate Training	Minimal Training
Complex	04	05	07
Routine	03	04	05
Simple	01	03	04

**ENVIRONMENTAL CONDITIONS**

Temperature (Degrees F)	Precipitation	and/or	Visibility
	Clear	Drizzle/ Light Snow	Fog/Rain/Ice/ Heavy Snow
90+	05	07	09
60	01	02	03
32	03	05	07
0	07	09	11

TOTAL SCORE: \_\_\_\_\_

**RISK GAUGE**

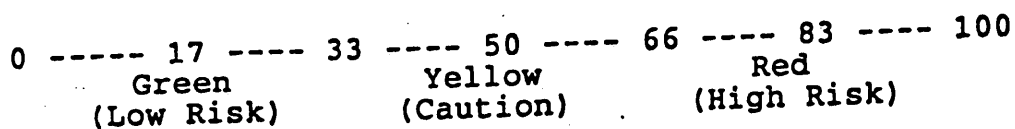

Appendix H--Sample LEA Request For Support

**(LEA Letterhead)**

Date

Office of the Adjutant General  
ATTN: LTC John Doe, Counterdrug Coordinator  
1111 Military Avenue  
City, State 99999

LTC Doe:

This is an official notification that (Requesting Agency) requests military support in conducting counterdrug operations. The operation will occur in \_\_\_\_\_ County, and is scheduled to begin (date) and end (date).

Please provide the following military support activities:

(use SECDEF-approved mission descriptions)

(Requesting agency) will obtain any specific legal authorization (i.e., warrants, etc.) that may be required, maintain communications with military support elements during the operation, and respond to any emergency situation. A memorandum of understanding between our organizations will control all activities.

The point of contact for this request and the proposed operation is (name and title) at (telephone number).

(Requesting Official's Signature)

Official's Typed Name

Title

**CHAPTER 6**  
**SAFEGUARDING**  
**SECTION I -- CONTROL MEASURES**

**6-100. General.**

a. Components shall have a system of control measures that ensure that access to classified information is limited to authorized persons. The control measures shall be appropriate to the environment in which the access occurs and the nature and volume of the information. The system shall include technical, physical, and personnel control measures. Administrative control measures which may include records of internal distribution, access, generation, inventory, reproduction, and disposition shall be required when technical, physical and personnel control measures are insufficient to deter and detect access by unauthorized persons.

b. **Top Secret Control Procedures.** Top Secret information will be controlled and accounted for within USSOCOM. Each activity with a Top Secret Control Account (See Appendix I for authorized accounts) shall appoint, in writing, a primary and alternate Top Secret Control Officer (TSCO). Copies of those appointments will be distributed to SOIO-C4I-S and SOCS-SI. Primary TSCOs will be in the rank of E-7 or higher /GS-9 or higher. Alternate TSCOs will be E-5 or higher/GS-5 or higher. SOIO-C4I-S will be the Command Top Secret Control Office. The following procedures apply to the authorized control and accountability of Top Secret information in USSOCOM:

- (1) Individuals appointed will have prior experience with classified information accountability procedures.
- (2) SOIO-C4I-S shall process all Top Secret material entering and leaving USSOCOM, except for SCI and various SAPs (CORB/SOOR maintains accountability for SAP material), and shall interact directly with the activity TSCOs.
- (3) The Emergency Action Officer (EAO) is authorized to receipt for TS material and release TS messages during non-duty hours. The EAO will reconcile TS accounts with SOIO-C4I-S no later than (NLT) 24 hours after the action elapsed.

**c. Top Secret Accountability.**

(1) **Top Secret Registers.** Top Secret accountability registers shall be maintained by each office originating or receiving Top Secret information, to include Top Secret magnetic media. The accountability documentation shall be initiated NLT 1 duty day after Top Secret material is created or received. Persons who record Top Secret information on magnetic media should attempt to have accountability of the media established before the information is recorded thereon. Such registers shall be retained for 5 years and shall, as a minimum, reflect the following:

- (a) Sufficient information to identify adequately the Top Secret document or material to include the title or appropriate short title, date of the document, and identification of the originator;
- (b) The date the document or material was received;
- (c) The number of copies received or later reproduced; and
- (d) The disposition of the Top Secret document or material and all copies of such documents or material. The Primary TSCO shall prepare AF Form 143 (Top Secret Register Page) for each Top Secret item received or originated. SOIO-C4I-S will use AF Form 143 to control all Top Secret messages received or dispatched.

Control action shall be completed within 1 duty day of receipt or origination. Top Secret material shall be brought under control of the TSCO of the activity to which the originator is assigned, or of the Primary TSCO, if the originator is assigned to an activity which does not have a TSCO.

(e) A Top Secret register is a complete file of all AF Forms 143 which shall be kept on a calendar year basis. It shall have an active and inactive section. AF Forms 143 in each section shall be filed numerically, based on the assigned register page number. The register shall be supported by receipts and Certificates of Destruction. The TSCO may establish separate registers for messages, other documents, and equipment. The last page of each register shall be marked THIS IS THE LAST PAGE OF THE TOP SECRET REGISTER FOR CALENDAR YEAR 19??/200?.

(f) Each document shall be assigned a number, which shall be entered on the document, on the disclosure record and on the register page. The format is the two-digit year, the two- or three-character code, and the sequential number of the document: if the TSCO has established more than one register, document number formats shall be expanded to indicate the type of register: "-M" for messages, "D" for other documents, and "E" for equipment. The alphabetical letters A, B, C, and so on shall be used when preparing continuation pages to the basic form, for example: 87-J5-OOIA-D. Previously assigned control numbers shall not be obliterated.

(g) Top Secret material on hand at the end of a calendar year shall be reconrolled during January of each year to a new register as follows. Waivers for annual account reconrol will be processed through SOCS-SI and SOIO-C4I-S, for Chief of Staff approval.

1. A register page that contains active and inactive entries shall be closed by transferring active entries to a new page in the new year register. Reconrolling remarks shall be entered in item 12f of the previous register page, and item 15 of the new register page.

2. A register page that contains only active entries shall be closed by reproducing the register page and placing the duplicate copy in the register being closed. The original page shall be renumbered and placed in the new year register. Reconrolling remarks shall be placed in item 16 of the previous year page, and item 15 of the new year page.

(h) The following guidance is provided for accountability and control of Top Secret material received through any medium during other than normal duty hours. These procedures will be used to release Top Secret material prior to SOIO-C4I-S control:

1. Complete AF Form 310 (Document Receipt and Destruction Certificate).
2. Retain and file the original AF Form 310 in files for 5 years.
3. Give one copy of the AF Form 310 to the person receiving the document. Instruct this individual to provide this copy to the Center Top Secret Control Officer on the next duty day.
4. Give the second copy of the AF Form 310 to SOIO-C4I-S on the next duty day.
5. If the document is not released to anyone during non-duty hours, secure the document IAW this Chapter and contact SOIO-C4I-S on the next duty day.

d. **Serialization and Copy Numbering.** Top Secret documents and material shall be numbered serially. In addition, each Top Secret document shall be marked to indicate its copy number, for example: copy -1- of -2- copies. Originators shall enter copy numbers on documents. Recipients of electronically transmitted messages shall enter copy numbers based on the number of copies received. Numbering of reproduced copies shall be based on the copy number used as a source: for example, if three copies are reproduced from copy number 8, they would be numbers 8-1, 8-2, and 8-3.

e. **Disclosure Records.** Each Top Secret document or item of material shall have appended to it a Top Secret disclosure record.

The name and title (printed), not signature, of all individuals, including stenographic and clerical personnel to whom information in such documents and materials has been disclosed, and the date of each such disclosure, shall be recorded thereon. Disclosures to individuals who may have had access to containers in which Top Secret information is stored, or who regularly handle a large volume of such information need not be so recorded. Such individuals, when identified on a roster, are deemed to have had access to such information. Disclosure records shall be maintained for 5 years after the documents or materials are transferred, downgraded, or destroyed. When AF Form 144 is not used, rosters are required, and shall be retained by the TSCO for 5 years following the publication of new rosters.

f. Inventories. All Top Secret documents and material shall be inventoried at least once annually. The inventory shall reconcile the Top Secret accountability register with the documents or material on hand. At such time, each document or material shall be examined for completeness. Center Directors may authorize the annual inventory of Top Secret documents and material in repositories, libraries, or activities that store large volumes of Top Secret documents or material to be limited to documents and material to which access has been granted within the past year, and 10 percent of the remaining inventory. If a storage system contains large volumes of information and security measures are adequate to prevent access by unauthorized persons, a request for waiver of the annual inventory requirement accompanied by full justification may be submitted to the Chief of Staff through SOIO-C4I-S and SOCS-SM. An inventory shall be conducted on change of a TSCO. Change of custody inventories shall be conducted as of the appointment date of the new TSCO. Annual inventories shall be conducted as of the anniversary date of the last inventory.

(1) Inventory Officials. The head of an activity authorized a TSCA shall appoint a disinterested person(s) who have knowledge of Top Secret control procedures. The number of persons appointed depends on the volume of material to be inventoried. During inventories, the inventory officials shall evaluate the management of the TSCA. The TSCO, the alternate(s), or persons who are evaluated by the TSCO or the alternate(s) may not participate in the inventory, but may assist the inventory officials. During a change of custody inventory, the new TSCO may evaluate the management of the TSCA by serving as an inventory official prior to assuming his duties. For other than a change of custody inventory, the senior inventory official shall be senior in grade to the TSCO. The current TSCO may not be a signatory to the inventory report.

(2) Inventory Procedures. The inventory is conducted to audit inactive register page entries for proper disposition, to physically sight active material, and to ensure compliance with Top Secret control procedures.

(a) The appointing authority, in coordination with operating officials, shall review the volume and need for retaining the Top Secret material, and shall certify this review when endorsing the inventory report.

(b) When accomplishing the audit, the inventory official shall determine that all pages of the register are available or accounted for. The inventory official shall date item 11g, and sign item 13g, AF Form 143, when review of the register page reflects a final disposition:

1. A receipt covering transfer of the document (item 13a or a separate receipt).
2. A recontrolled document (item 12f or item 16 and the presence of a new register page).
3. Downgrading or declassification (item 13f and supporting documentation).
4. Destruction (items 13d and 13e).
5. Incorporation into another document (item 13f and supporting documentation).
6. Other relief from accountability (item 13f and supporting documentation).



(c) An entry marked as being audited shall not be reaudited. Register page entries showing action, review, or coordination transfers, as well as entries for which suspense receipts are being held for transmitted documents, shall not be audited.

(d) The sighting portion of the inventory is physically locating each document which register page entries reflect the TSCO accountable, and ensuring that all Top Secret documents on hand have been entered into the register. Documents received for action, review, or coordination requirements shall be sighted.

(3) Inventory Reports. The senior inventory official shall prepare an inventory report and submit it to the appointing authority.

(a) The report shall contain the specimen signatures and initials of all inventory officials, and shall be of sufficient scope to explain compliance with all Top Secret control procedures. The report will list any material reflected in the register for which accountability could not be established; any material on hand but not entered in the register, and any condition that could have resulted in the compromise or probable compromise of Top Secret material.

(b) The head of the activity shall endorse the report to specify corrective action to be taken, including action to certify that Top Secret material in custody is needed for mission accomplishment. A copy of the report shall be filed in the account for reference purposes during the next inventory and for internal TSCOs, a copy shall be forwarded to the Primary TSCO, SOIO-C4I-S, and SOCS-SM.

g. Retention. Top Secret information shall be retained only to the extent necessary to satisfy current requirements. Custodians shall destroy non-record copies of Top Secret documents when no longer needed. Record copies of documents that cannot be destroyed shall be reevaluated and when appropriate, downgraded, declassified, or retired to designated record centers.

h. Receipts. Top Secret documents and material will be accounted for by a continuous chain of receipts. Within USSOCOM, the receipt used shall be AF Form 143.

i. Foreign government information shall be controlled and safeguarded as described in Section VI of this Chapter.

**6-101. Working Papers.** Working papers are documents and material accumulated or created in the preparation of finished documents and material. Working papers containing classified information shall be:

a. Dated when created;

b. Marked with the highest classification of any information contained therein;

c. Protected in accordance with the assigned classification;

d. Conspicuously marked "Working Paper" on the first page of the document in letters larger than the text.

e. Destroyed when no longer needed; and

f. Accounted for, controlled, and marked in the manner prescribed for a finished document of the same classification when retained more than 180 days from date of origin or released by the originator outside the activity.

g. In USSOCOM, if working papers require more than 90 days for final disposition, annotate the working paper with current date (pen/ink) and follow procedures in paragraph 6-101. Only one extension is authorized.

h. Any person who includes Top Secret information in a working paper shall ensure an AF Form 143 is initiated. The AF Form 143 may be typewritten or handwritten; however, it shall be initiated no later than 1 duty day after the Top Secret working paper is created. The working paper and the AF Form 143 will be turned into the Center's Top Secret Control Officer NLT the first duty day after the working paper was created.

The TSCO or alternate shall acknowledge receipt for the working papers on line C, Section 1, Part III of the AF Form 143. Accountability records shall be maintained as required for finished documents from that point. Coordination with SOIO-C4I-S will be affected and the working paper will be brought under control and accountability in the Command TS Accountability and Control Log. As work continues on the document, additions shall be described in Part I of the AF Form 143 and recorded as changes in Part II of the form. When work is completed and the working paper is no longer required, it shall be properly destroyed and relieved of accountability. A separate AF Form 143 for the finished document shall be initiated.

## SECTION II -- ACCESS

**6-200. Policy.** Except as otherwise provided in subsection 6-201, no person may have access to classified information unless that person has been determined to be trustworthy and access is essential to the accomplishment of a lawful and authorized Government purpose. DoD Regulation 5200.2-R contains detailed guidance concerning personnel security investigation, adjudication and clearance. **Neither rank nor grade automatically qualifies an individual(s) for access to classified information, regardless of the level of classification.** The final responsibility for determining whether an individual's official duties require possession of or access to any element or item of classified information, and whether the individual has been granted the appropriate security clearance by proper authority, rests with the individual who has authorized possession, knowledge, or control of the information and not on the prospective recipient. **Any employee may contact SOCS-SC for verification of personnel clearance and access authorizations.**

**6-201. Access by Persons Outside the Executive Branch.** Classified information may be made available to individuals or agencies outside the Executive Branch provided that such information is necessary for performance of a function from which the Government will derive a benefit or advantage, and that such release is not prohibited by the originating department or agency. Heads of DoD Components shall designate appropriate officials to determine, before the release of classified information, the propriety of such action in the interest of national security and assurance of the recipient's trustworthiness and need-to-know. **All foreign release and release to agencies outside the Executive Branch will be coordinated through SOCS-SM.**

a. **Congress.** Access to classified information or material by Congress, its committees, members, and staff representatives shall be IAW DoD Directive 5400.4. Any DoD employee testifying before a Congressional committee in executive session in relation to a classified matter shall obtain the assurance of the committee that individuals present have a security clearance commensurate with the highest classification of information that may be discussed. Members of Congress by virtue of their elected positions, are not investigated or cleared by the Department of Defense.

b. **Government Printing Office (GPO).** Documents and material of all classification may be processed by the GPO, which protects the information IAW the DoD/GPO Security Agreement of February 20, 1981.

c. **Representatives of the General Accounting Office (GAO).** Representatives of the GAO may be granted access to classified information originated by and in the possession of DoD when such information is relevant to the performance of the statutory responsibilities of that office, as set forth in DoD Directive 7650.1. Certifications of security clearances, and the basis therefor, shall be accomplished pursuant to arrangements between GAO and the DoD Component concerned. Personal recognition or presentation of official GAO credential cards are acceptable for identification purposes.

d. **Historical Researchers.** Persons outside the Executive Branch who are engaged in historical research projects may be authorized access to classified information provided that an authorized official within the DoD Component with classification jurisdiction over the information:

(1) Makes a written determination that such access is clearly consistent with the interests of national security in view of the intended use of the material to which access is granted by certifying that the requester has been found to be trustworthy pursuant to paragraph 6-200, and DoD 5200.2-R;

(2) Limits such access to specific categories of information over which the DoD Component has classification jurisdiction and to any other category of information for which the researcher obtains the written consent of a DoD Component or non-DoD department or agency that has classification jurisdiction over information contained in or revealed by documents within the scope of the proposed historical research;

(3) Maintains custody of the classified material at a DoD installation or activity or authorizes access to documents in the custody of the National Archives and Records Administration;

(4) Obtains the researcher's agreement to safeguard the information and to submit any notes and manuscript for review by all DoD Components or non-DoD departments or agencies with classification jurisdiction for a determination that no classified information is contained therein by execution of a statement entitled, "Conditions Governing Access to Official Records for Historical Research Purposes"; and

(5) Issues an authorization for access valid for not more than 2 years from the date of issuance that may be renewed under regulations of the issuing DoD Component.

e. **Former Presidential Appointees.** Persons who previously occupied policy making positions to which they were appointed by the President may not remove classified information upon departure from office as all such material must remain under the security control of the U.S. Government. Such persons may be authorized access to classified information they originated, received, reviewed, signed, or that was addressed to them while serving as such an appointee, provided that an authorized official within the DoD Component with classification jurisdiction for such information:

(1) Makes a written determination that such access is clearly consistent with the interests of national security in view of the intended use of the material to which access is granted and by certifying that the requester has been found to be trustworthy pursuant to subsection 7-100;

(2) Limits such access to specific categories of information over which that DoD Component has classification jurisdiction and to any other category of information for which the former appointee obtains the written consent of a DoD Component or non-DoD department or agency that has classification jurisdiction over information contained in or revealed by documents within the scope of the proposed access;

(3) Retains custody of the classified material at a DoD installation or activity or authorizes access to documents in the custody of the National Archives and Records Administration; and

(4) Obtains the former presidential appointee's agreement to safeguard the information and to submit any notes and manuscript for review by all DoD Component or non-DoD departments or agencies with classification jurisdiction for a determination that no classified information is contained therein.

f. **Judicial Proceedings.** DoD Directive 5405.2 governs the release of classified information in litigation. **All classified release determinations pertaining to judicial proceedings will have SOCS-SM and SOJA coordination affected.**

g. **Other Situations.** When necessary in the interests of national security, heads of DoD Components, or their senior agency official, may authorize access by persons outside the Federal Government, other than those enumerated above, to classified information upon determining that the recipient is trustworthy for the purpose of accomplishing a national security objective; and that the recipient can and will safeguard the information from unauthorized disclosure.

**6-202. Visits.** Heads of DoD Components shall establish procedures to accommodate visits to their Component facilities involving access to, or disclosure of, classified information. As a minimum, these procedures will include verification of the identity, personnel security clearance, access (if appropriate), and need-to-know for all visitors. **Visitors to USSOCOM will be processed through Visitor Control, SOCS-SC, including visits requiring SCI and/or SAP access. Foreign visits will also affect SOCS-SM coordination and authorization, IAW DoD Directive 5230.20, Visits and Assignments of Foreign Representatives.**

## SECTION III -- SAFEGUARDING

**6-300. General Policy.**

a. Everyone who has been granted access to classified information is responsible for providing protection to information and material in their possession or control that contains such information. Classified information must be protected at all times either by storage in an approved device or facility or having it under the personal observation and control of an authorized individual. Everyone who works with classified information is personally responsible for taking proper precautions to ensure that unauthorized persons do not gain access to it.

b. It is also the responsibility of cleared personnel to refuse custody of classified material that exceeds the level of their security clearance or access authorization. Rank and/or grade does not automatically qualify someone for access to classified information.

c. Release of classified information to contractors must be authorized by a bona-fide contractual relationship, as described in DoD 5220.22-R, DoD Industrial Security Regulation.

**6-301. Care During Working Hours.**

a. Classified material removed from storage shall be kept under constant surveillance of authorized persons. Classified document cover sheets (Standard Forms 703, 704 and 705) will be placed on classified documents not in secure storage. Cover sheets may be permanently affixed to materials *frequently* removed from storage.

b. Preliminary drafts, carbon sheets, plates, stencils, stenographic notes, worksheets, typewriter and printer ribbons, floppy disks, and other items containing classified information shall be either destroyed immediately after they have served their purpose or protected as required for the level of classified information they contain. Classified waste shall be shredded or be placed into containers which have been clearly marked as intended for classified waste.

c. All paper waste, except those items listed in paragraph 6-301b, will be treated as classified and/or sensitive material and destroyed accordingly. Paper waste such as newspapers, Early Bird, commercial magazines and publications, candy wrappers, paper cups, etc. , are not considered sensitive and will continue to be collected and disposed of by custodial personnel. Recycling standards apply.

**6-302. End-of-Day Security Checks.**

a. Heads of activities that process or store classified information shall establish a system of security checks at the close of each working day to ensure that the area is secure. Standard Form 701, Activity Security Checklist, shall be used to record such checks. An integral part of the security check system shall be the securing of all vaults, secure rooms, and containers used for the storage of classified material. Standard Form 702, Security Container Check Sheet, shall be used to record such actions. In addition, Standard Forms 701 and 702 shall be annotated to reflect after-hours, weekend, and holiday activity. Further, mechanical or electrically activated locks are not authorized locks for protection of classified information after duty hours.

b. Discovery of unsecured classified material including classified waste, magnetic media, and unmarked typewriter/printer ribbons/computer media, shall be processed as a suspected security violation.

c. Work areas in all USSOCOM activities shall be secured by personnel who work in those buildings. USSOCOM Security Force, *when available*, shall respond to requests for assistance in double checking security container(s), doors of vaults, and vault type rooms. USSOCOM Security Force shall conduct random checks of offices in all buildings housing USSOCOM activities to verify the integrity of the end-of-day checks.

**d. Procedures.**

(1) At the close of each duty day, and when a person works during non-duty hours or holidays, each person whose work space is outside an authorized open storage area, or vault type room shall:

(a) Clear all extraneous papers from desk tops (Clean desk policy applies).

(b) Clear typewriters or word processors, remove classified typewriter or printer ribbons, whether fabric or carbon; remove all program and data disks. Ribbons clearly marked as Unclassified need not be removed at the end of the day.

(c) Secure all of the above material including classified waste in an authorized security container or open storage area.

(d) Lock all security containers ; ensure that another person checks those containers; and make appropriate entries on SF 702, attached to the container.

(e) Ensure unclassified waste as specified in paragraph 6-301(c) has not been inadvertently deposited in trash containers.

(2) The Area Security Inspector (ASI) shall conduct end-of-day security checks:

(a) If the area is unoccupied and all containers secured:

1. Verify the security of each container and office space and then mark the appropriate block for each item and date the SF 701.

2. Enter the time and initial the appropriate blocks on the last two lines of the form.

(b) If an area is occupied, advise the senior occupant in the area to ensure that an end-of-day check is conducted prior to the departure of the last person who works late.

(c) If the area is unoccupied and all actions required by paragraph (2)(a.) have not been completed, notify the USSOCOM Security Force of a suspected security violation.

(3) The senior person remaining after normal duty hours shall conduct an end-of-day check of the area in accordance with the procedures in (2) above, and if necessary, notify the USSOCOM Security Force, and remain in the work area until the security personnel arrive to complete the double check of the security container(s), and door of vault(s) and vault type room(s).

(4) Personnel who work after normal duty hours must conduct end-of-day security checks IAW paragraph 6-102(d)(2).

e. This policy applies to all security containers in areas not designated as open storage areas. Containers within open storage areas are encouraged to perform this task, but not required.

**6-303. Emergency Planning.**

a. Plans shall be developed for the protection, removal, or destruction of classified material in case of fire, natural disaster, civil disturbance, terrorist activities, or enemy action, to minimize the risk of its compromise. The level of detail and amount of testing and rehearsal of these plans should be determined by an assessment of the risk of hostile action, natural disaster, or terrorist activity that might place the information in jeopardy. SOCS-SM shall prepare the USSOCOM Emergency Plan for protection of classified material (See Appendix J).

Center Directors shall assist in the preparation of the overall plan and, as required, prepare supporting plans, and coordinate those plans with SOCS-SM. These plans will be prominently displayed in the vicinity of the container.

b. Planning for the emergency protection (including emergency destruction under no-notice conditions) of classified COMSEC material shall be developed IAW requirements of National Telecommunications Information Systems Security Instruction (NTISSI) 4004. Consult SOIO-C4I-OC for additional guidance.

c. When preparing emergency plans, consideration should be given to:

- (1) Reduction of the amount of classified material on hand;
- (2) Storage of less frequently used classified material at more secure locations; and
- (3) Transfer of as much retained classified information to microforms or to removable automated information systems media as possible, thereby reducing its bulk.

d. The Emergency Plan shall require that classified material holdings be assigned a priority for emergency evacuation or destruction. In some instances, simply placing the material in the safe and securing it will suffice (fire alarms, civil disturbances, etc.) An example is at Appendix J. SCI holdings will follow the priority system established in DOD S-5105.21-M-1. Priorities should be based upon the potential effect on national security should such holdings fall into hostile hands, IAW the following guidelines:

(1) *Priority One:* Exceptionally grave damage (Top Secret, COSMIC Top Secret ATOMAL CCTSA, COSMIC Top Secret (CTS), Special Category (FP), and Special Access Program (SAP) material);

(2) *Priority Two:* Serious damage (Secret, NATO Secret ATOMAL (NSA), and NATO Secret (NS) material);  
and

(3) *Priority Three:* Identifiable damage (Confidential, NATO Confidential ATOMAL (NCA) and NATO Confidential (NC) material).

**6-304. Telephone Conversations.** Classified information shall be discussed in telephone conversations only over secure communications circuits approved for transmission of information at the specific level of classification (STU-III, Red Phones, etc.). When discussing classified information on the telephone, the ability of others in the area to overhear what is being said must be considered. See USSOCOM Regulation 25-13, *Use of STU IIIs*, 25 April 1995, for further guidance on safeguarding of STU-III and Red phones.

**6-305. Removal of Classified Storage Equipment.** Storage containers that may have been used to store classified information shall be inspected by properly cleared personnel before removal from protected areas or unauthorized persons are allowed access to them. The inspection should ensure that no classified information remains within the equipment. Written approval by the Center Director is required. Security manager is responsible for ensuring equipment leaving their activities are free of any classified contents.

**6-306. Residential Storage Arrangements.**

a. Only the Secretary of Defense, the Secretaries of the Military Departments, the Combatant Commanders and the Senior Agency Official of the DoD Component may authorize removal of Top Secret information from designated working areas in off-duty hours for work at home.

b. Heads of DoD Components or their designees may authorize removal of Secret and Confidential information from designated working areas in off-duty hours for work at home. Authority to approve such removal shall not be delegated below the major command or equivalent level.

c. A GSA-approved security container shall be furnished for residential storage. Written procedures shall be developed to provide for appropriate protection of the information, to include a record of the information that is authorized for removal. In USSOCOM, requests for removal of any classified material for residential storage must have written authorization of the Center Director and Chief of Staff. Request will be coordinated through SOCS-SM.

**6-307. Classified Meetings and Conferences.**

a. Meetings and conferences that involve classified information present special vulnerabilities to unauthorized disclosure. Heads of the DoD Components shall establish specific requirements for protection of classified information at Component conferences, seminars, exhibits, symposia, conventions, training courses, or other such gatherings during which classified information is disseminated. This does not apply to in-house gatherings, routine gatherings of U.S. Government officials, classes conducted by DoD schools, or gatherings of personnel of a DoD Component and foreign government representatives or U.S. and/or foreign contractor representatives on a matter related to a specific government contract, program, or project. The number of meetings involving dissemination of classified information must be limited and those conducted shall be authorized only when the Head of the appropriate DoD component, or a designee (In USSOCOM, the Chief of Staff or higher) determines the following in writing. Requirements developed shall, as a minimum, include a determination that:

- (1) The meeting will serve a specific U.S. Government purpose;
- (2) The use of other appropriate channels for dissemination of classified information or material are insufficient;

(3) The meeting location will be under the security control of a U.S. Government agency or a U.S. contractor with an appropriate facility security clearance. The location selected for the classified sessions of the meeting must provide for proper control of access and dissemination of the classified information to be presented, and must have a secure storage capability, if necessary. Post or base theaters and other facilities normally open to uncontrolled access may be used for classified meetings only if no secure facility is available and unauthorized physical and aural access is prevented during the course of the meetings. A technical surveillance countermeasures (TSCM) survey may be conducted if deemed necessary by the TSCM program manager of one of the DoD Components listed in DoD Instruction 5240.5, paragraph E.1.f., after consideration of relevant factors, such as sensitivity of the information to be presented, proximity to foreign embassies or consulates, and the degree of day-to-day public access to the post, base, or facility. The TSCM program manager should base his/her decision on the probability of installation of technical monitoring equipment by a hostile intelligence service at the facility to be used for the meeting. Contact SOCS-SM to determine adequacy of a TSCM.

(4) Adequate security procedures have been developed and will be implemented to minimize risk to the classified information involved;

(a) *Procedures.*

1. The initial steps in the process of organizing a classified meeting are to certify the Government's purpose for conducting the meeting, establish conditions under which the meeting shall be organized, and obtain the required authorization.

a. The subject of the meeting and scope of classified topics, to include the maximum classification level.

b. The expected dates and location of the meeting.

c. The degree to which foreign participation shall be permitted, if appropriate, either by nationality, personal identity, organization affiliation, or a combination thereof.

d. The general content of the proposed announcement and/or invitation to be sent to prospective attendees or participants.

e. The identity of any non-government organization involved, and a full description of the type of support it shall provide.

f. The security arrangements necessary to comply with DoD 5200.1-R, DoD 5220.22-R, and DoD 5220.22-M. A written Security Plan will be required and will be approved by the DCINC or higher. The Security Plan will address the following:

- (1) Full name, title, dates and location of the conference.
  - (2) The sponsoring activity/agency.
  - (3) Classification level of the conference (highest level of information to be disclosed).
  - (4) The name, title, rank, mailing symbol and phone number of the assigned security manager.
  - (5) List of personnel who will assist the security manager during the conference (registration, access control, guards).
  - (6) Certification that all of the classified information to be disclosed has been authorized by the agency who has proponentry over the information.
  - (7) Identification of physical points of entry into the conference area. Each entry point must be controlled.
  - (8) Identification of storage facilities at the location for the classified information involved (safes, courier authorization, transportation plans).
  - (9) Establishment of a single checkpoint for access into the conference. Means of personnel identification include picture I.D., military I.D., etc.
  - (10) Visit requests receipt procedures (verified prior to authorized entrance.) Hand-carried visit requests are not authorized.
  - (11) Badging procedures.
  - (12) Photographs and audio recordings are not authorized. Notes will be collected and mailed to each attendee after the conference adjourns. Individuals who wish to hand-carry notes must have approved courier authorization and must return directly to their respective place of duty. Overnight stops at hotel accommodations are strictly forbidden, unless the information can be stored overnight at a DoD installation or cleared contractor activity.
  - (13) The conference host will provide guards. Any cleared employee can act as a guard for the conference Security clearance and Need-to-Know certification will be accepted via one of two means: by message or authorized agency visit request format. Each must be received prior to the conference. Hand-carried forms are not acceptable.
- (5) Classified sessions shall be segregated from unclassified sessions whenever possible; and
- (6) Access to the meeting or conference, or specific sessions thereof, at which classified information will be discussed or disseminated, will be limited to persons who possess an appropriate security clearance and need-to-know. Access to classified meetings shall be authorized to those persons whose security clearance and requirement for attendance have been certified by the security officer of the organization represented. The names of all properly authorized attendees or participants must appear on access list with entry permitted to the classified meeting only after verification of the DoD security manager, or their designee, based on presentation of official photographic identification (e.g., passport, contractor identification card, etc.).



(7) Any participation by foreign nationals or foreign representatives complies with the requirements of DoD Instruction 5230.20 and DoD Directive 5230.11; e.g., assurance is obtained, in writing, from the responsible U.S. Government foreign disclosure office(s) that the information to be presented has been cleared for foreign disclosure. **Contact SOCS-SM for further guidance.**

(8) Announcement of the classified meeting shall be unclassified and limited to a general description of topics expected to be presented, names of speakers, logistical information, and administrative and security instructions. **The content of announcements and invitations concerning classified meetings shall be approved by the DoD security manager before dissemination. See 6-307a.(10) for further guidance.**

(9) Non-government organizations may assist in organizing and provide administrative support for a classified meeting, but all security requirements remain the specific responsibility of the DoD Component sponsoring the meeting.

(10) Procedures must ensure that classified documents, recordings, audiovisual material, notes, and other materials created, distributed, or used during the meeting are controlled, safeguarded, and transported as required by other provisions of this manual. Note taking or electronic recording during classified sessions shall be permitted only when it is determined that such action is necessary to fulfill the U.S. Government purpose for the meeting. **Classified presentations shall be delivered orally and/or visually. Classified documents shall not be distributed and classified note taking and electronic recordings shall not be permitted by attendees during classified presentations. However, a DoD Component that conducts a classified meeting may compile and distribute classified presentations to authorized representatives of Government Agencies and cleared U.S. contractors having storage capability subject to compliance with this manual and the NISPOM. A DoD Component similarly may authorize compilation and distribution of classified presentations on its behalf. The release of classified presentations to foreign governments and their representatives shall be in compliance with DoD Instruction 5230.20 and DoD Directive 5230.11.**

b. Special requirements apply to meetings, conferences, seminars, and activities other than those described in subparagraph 6-307a., at which classified information is to be presented and discussed as follows:

(1) Meetings must be approved by the head of the DoD Component **(In USSOCOM, the CS through SOCS-SM) a person serving at the level of Deputy Assistant Secretary or above within OSD, the Director of the Joint Staff, the Directors of the Defense Agencies, or the Senior Agency Officials appointed within the Military Departments IAW Section 5.6(c) of E.O. 12958.**

(2) A DoD official is appointed by the DoD Component sponsoring the meeting, to serve as security manager for the meeting and physical security of the actual site of the classified meeting is established and maintained by U.S. Government personnel. **The security manager shall be a DoD official of sufficient rank and experience to ensure that the requirements of this manual and DoD Instruction 5230.20 are met. Other U.S. Government organizations or cleared DoD contractors with appropriate facility security clearances may assist with implementation of security requirements under the direction of the appointed security manager.**

(3) **The ASD,C3I shall be provided a copy of all authorizations for classified meetings that are conducted in collaboration with a non-government organization or association; the information specified in paragraph 6-307(a)(4), shall be included. The Director, National Security Agency (NSA)/Chief, Central Security Service (CSS), shall be notified in the case of participation by foreign representatives in meetings involving special intelligence IAW DoD Directive C-5230.23.**

**6-308. U.S. Classified Information Located in Foreign Countries.** Except for classified information that has been authorized for release to a foreign government or international organization pursuant to DoD Directive 5230.11, and is under the security control of that government or organization, U.S. classified material may be retained in foreign countries only when necessary to satisfy specific U.S. Government requirements. Heads of the DoD Components will prescribe requirements for protection of this information, with particular attention to ensuring proper enforcement of controls on release of U.S. classified information to foreign entities. U.S. classified material in foreign countries shall be stored as described in paragraphs a. through d. The provisions of Section IV, also apply.

- a. At a U.S. military installation, or a location where the United States enjoys extraterritorial status, such as an embassy or consulate.
- b. At a U.S. Government activity located in a building used exclusively by U.S. Government tenants, provided the building is under 24-hour control by U.S. Government personnel.
- c. At a U.S. Government activity located in a building not used exclusively by U.S. Government tenants nor under host government control, provided the classified material is stored in security containers approved by the GSA and is placed under 24-hour control by U.S. Government personnel.
- d. At a U.S. Government activity located in a building not used exclusively by U.S. Government tenants but which is under host government control, provided the classified material is stored in GSA-approved security containers which are further secured in a locked room or area to which only U.S. personnel have access.
- e. On the CINCSOC's command and control aircraft, the information will be afforded 24 hour control by U.S. Government personnel, or follow 6-308a. - 6-308d.

**6-309. Information Processing Equipment.** DoD has a variety of non-COMSEC-approved equipment that is used to process classified information. This includes copiers, facsimile machines, AIS equipment and peripherals, electronic typewriters, word processing systems, and others. Activities must identify those features, parts, or functions of equipment used to process classified information that may retain all or part of the information. Activity security procedures must prescribe the appropriate safeguards to:

- a. Prevent unauthorized access to that information.
- b. Replace and destroy equipment parts as classified material when the information cannot be removed from them. Alternatively, the equipment may be designated as classified and appropriately protected at the retained information's classification level.
- c. Ensure that equipment is inspected by appropriately cleared and technically knowledgeable personnel before the equipment is removed from protected areas.
- d. In USSOCOM, a Designated Approval Authority (DAA) must authorize *All* classified information processing systems. Collateral, SCI, and SAP information processing systems all require DAA approval. This does *not* include copiers or facsimile machines. See USSOCOM Manual 380-3, *Automated Information Systems Manual*, 4 May 1994, further guidance.

## SECTION VI - STORAGE

**6-400. General Policy.** Classified information shall be secured under conditions adequate to prevent access by unauthorized persons. The requirements specified in this manual represent acceptable security standards. DoD policy concerning the use of force for the protection of classified information is specified in DoD Directive 5210.56. Weapons or sensitive items such as funds, jewels, precious metals or drugs, **keys or combinations to containers used to store such items** shall not be stored in the same container used to safeguard classified information. Security requirements for Sensitive Compartmented Information Facilities (SCIF) are established by the Director of Central Intelligence. Current holdings of classified material shall be reduced to the minimum required for mission accomplishment. See section 7, Chapter 6, for annual clean out day designation.

**6-401. Standards for Storage Equipment.** GSA establishes and publishes minimum standards, specifications, and supply schedules for containers, vault doors, modular vaults, alarm systems, and associated security devices suitable for the storage and protection of classified information. DoD Directive 3224.3 describes acquisition requirements for physical security equipment used within DoD. **Questions concerning approved storage equipment can be addressed to SOCS-SP.**

**6-402. Storage of Classified Information.** Classified information that is not under the personal control and observation of an authorized person is to be guarded or stored in a locked security container, vault, room, or area, as follows:

a. Top Secret information shall be stored by one of the following methods:

(1) In a GSA-approved security container with one of the following supplementary controls:

(a) The location that houses the security container shall be subject to continuous protection by cleared guard or duty personnel;

(b) Cleared guard or duty personnel shall inspect the security container once every 2 hours;

(c) An Intrusion Detection System (IDS) meeting the requirements of Appendix E with personnel responding within 15 minutes from onset of the alarm annunciation; or

(d) Security-In-Depth when the GSA-approved container is equipped with a lock meeting Federal Specification FF-L-2740.

(2) Modular vault, vault, or a secure room constructed IAW Appendix E and equipped with an IDS with the personnel responding to the alarm within 15 minutes of the alarm annunciation if the area is covered by Security-In-Depth, or a 5 minute alarm response time if it is not. **Within USSOCOM vault/secure rooms shall be approved in writing by SOCS-SP prior to use for open storage of classified material. Requests for approval shall be submitted to SOCS-SM. Approved requests shall be maintained by the requester and SOCS-SP. Vault/secure rooms will be recertified by SOCS-SM during the annual security program reviews or after any structural modifications.** (Other rooms that were approved for the storage of Top Secret in the U.S. may continue to be used.) **Vault specifications are listed in Appendix E of this manual. If an IDS is used, the Center Security Manager will provide SOCS-SM with an alphabetical roster of individuals, complete with Social Security Numbers, authorized to open/close the area.**

(3) New purchases of combination locks for GSA-approved security containers, vault doors and secure rooms shall conform to Federal Specification FF-L-2740. Existing non-FF-L-2740 mechanical combination locks will not be repaired. If they should fail, they will be replaced with locks meeting FF-L-2740.

(4) Under field conditions during military operations, the commander may prescribe the measures deemed adequate to meet the storage standard contained in subparagraphs 6-402a.1. and 2.

b. Secret information shall be stored by one of the following methods:

- (1) In the same manner as prescribed for Top Secret information,
- (2) In a GSA-approved security container or vault without supplemental controls;
- (3) In secure rooms that were approved for the storage of Secret information by the DoD Components prior to October 1, 1995; or

(4) Until October 1, 2002, in a non-GSA -approved container having a built-in combination lock or in a non-GSA approved container secured with a rigid metal lockbar (Cabinets with lockbars shall not be used unless the building in which they are located is protected by a security force 24 hours a day. Within USSOCOM vault/secure rooms shall be approved in writing by SOCS-SM prior to use for open storage of Secret and Confidential material. Requests for approval shall be submitted to SOCS-SM. Approved requests shall be maintained by the requester and SOCS-SM. Vault/secure rooms will be recertified by SOCS-SM during the annual security inspection or after structural modifications) and a GSA-approved padlock with one of the following supplemental controls:

- (a) The location that houses the container is subject to continuous protection by cleared guard or duty personnel;
  - (b) Cleared guard or duty personnel shall inspect the security container once every 4 hours; or
  - (c) An IDS with the personnel responding to the alarm arriving within 30 minutes of the alarm.
- c. Confidential information shall be stored in the same manner as prescribed for Top Secret or Secret information except that supplemental controls are not required.

d. Specialized Security Equipment.

(1) The Heads of the DoD Components shall, consistent with this manual, delineate the appropriate security measures required to protect classified information stored in containers on military platforms or for classified munitions items.

(2) GSA-approved field safes and special purpose one and two drawer light-weight security containers approved by the GSA are used primarily for storage of classified information in the field and in military platforms. Such containers shall be securely fastened to the structure or under sufficient surveillance to prevent their theft.

(3) GSA-approved map and plan files are available for storage of odd-sized items such as computer media, maps, charts, and classified equipment.

(4) GSA-approved modular vaults meeting Federal Specification AA-V-2737 may be used to store classified information as an alternative to vault requirements described in Appendix E.

e. **Replacement of Combination Locks.** The mission and location of the activity, the classification level and sensitivity of the information, and the overall security posture of the activity determines the priority for replacement of existing combination locks. All system components and supplemental security measures including electronic security systems (e.g., intrusion detection systems, automated entry control subsystems, and video assessment subsystems), and level of operations must be evaluated by the commander when determining the priority for replacement of security equipment. Appendix E, provides a matrix illustrating a prioritization scheme for the replacement of existing combination locks on GSA-approved security containers and vault doors. Priority 1 requires immediate replacement. **Contact SOCS-SP for further guidance.**

f. Storage areas for bulky material containing Secret or Confidential information may have access openings secured by GSA-approved changeable combination padlocks (Federal Specification FF-P-110 series) or high security key-operated padlocks (Military Specification MIL-P-43607). Other security measures are required, in accordance with subsection 6-308.

**M 380-1**

(1) When special circumstances exist, Heads of DoD Components may authorize the use of key operated locks for the storage of Secret and Confidential information. **Use of key operated padlocks for storage of classified material must be approved in advance and in writing by SOCS-SM.** Whenever such locks are used, administrative procedures for the control and accounting of keys and locks shall be established. The level of protection provided such keys shall be equivalent to that afforded the classified information being protected by the padlock.

(2) Section 1386 of title 18, United States Code, makes unauthorized possession of keys, key-blanks, keyways or locks adopted by any part of DoD for use in the protection of conventional arms, ammunition, or explosives, special weapons, and classified equipment, a criminal offense punishable by fine or imprisonment for up to 10 years, or both.

**g. Classified information shall not be left unattended in offices locked with key-operated or non-GSA-approved combination locks. Further, mechanical, electrical, or card access devices shall not be used to protect classified information during non duty hours.**

**h. Any deviations from the above established storage requirement must be approved in writing by SOCS-SM. Requests for construction or modification to classified storage vaults/secure rooms must be approved by SOCS-SM in advance.**

**6-403. Procurement of New Storage Equipment.**

a. New security storage equipment shall be procured from those items listed on the GSA Federal Supply Schedule. Exceptions may be made by the heads of the DoD Components, with notification through SOCS-SP and Chief of Staff to ASD (C<sup>2</sup>I).

b. Nothing in this chapter shall be construed to modify existing Federal supply class management assignments made under DoD Directive 5030.47.

**6-404. Equipment Designations and Combinations.**

a. There shall be no external mark revealing the level of classified information authorized to be or actually stored in a given container or vault/vault type room or to the priority assigned to the container for emergency evacuation and destruction. This does not preclude placing a mark or symbol, (e.g. a bar code) on the container for other purposes (e.g. identification and/or inventory purposes) consisting of the activity identification (such as SOIO-01, SOIO-02, etc.). Center Security Managers shall maintain a record of all containers in service in the Center; the record shall reflect the container number and the building and room number in which the container is located, the individual responsible for the container, and the date of last container change. This record/listing will be maintained in the Security Manager's Handbook. Since emergency evacuation/destruction priorities are based on the classification of information, no security container will be externally marked with any emergency evacuation/destruction priority marking (Such markings shall be affixed to the inside of each drawer in the top front portion) nor from applying decals or stickers required by the Director of Central Intelligence for containers and equipment used to store or process intelligence information.

b. Combinations to Containers and Vaults.

(1) Combinations to security containers, vaults and secure rooms shall be changed only by individuals having that responsibility and an appropriate security clearance. Combinations shall be changed:

(a) When placed in use;

(b) Whenever an individual knowing the combination no longer requires access to it unless other sufficient controls exists to prevent access to the lock; or

(c) When the combination has been subject to possible compromise or when container is found open and unsecured after duty hours;

(d) When taken out of service. Built-in combination locks shall then be reset to the standard combination 50-25-50; combination padlocks shall be reset to the standard combination 10-20-30.

**(2) In addition to the above listed instructions the following will be adhered to:**

**(a) Combinations of containers shall be selected randomly. Birth, anniversary, rotation, or other dates and telephone numbers shall not be used.**

**(b) Combinations shall be changed by the Center Security Manager or the base contracted locksmith. SOCS-SM can provide training on proper procedures.**

**(3) The combination of a container, vault or secure room used for the storage of classified information shall be treated as information having a classification equal to the highest category of the classified information stored therein. Any written record of the combination shall be marked with the appropriate classification level.**

**(4) A record shall be maintained for each vault or secure room door, or container used for storage of classified information, showing location of the door or container, and the names, home addresses, and home telephone numbers of the individuals having knowledge of the combination who are to be contacted in the event that the vault, secure room, or container is found open and unattended. Standard Form 700, Security Container Information, shall be used for this purpose.**

**(5) Access to the combination of a vault, secure room or container used for the storage of classified information shall be granted only to those individuals who are authorized access to the classified information to be stored therein or for the purpose of changing combinations or the repair of vaults or security containers. Records of combinations shall be stored as follows:**

**(a) The Center shall designate one container as a central repository, in which the records of the combinations of all other containers in the Center, except those used to secure Sensitive Compartmented Information, Special Access Program or Focal Point materials, shall be stored.**

**(b) The combination of the Center's central repository, #1 safe, shall be forwarded to and maintained by the USSOCOM Command Center (SOIO-CC).**

**(c) The combinations of Center's containers used to store CJCS Focal Point Material shall be forwarded to the Command OPR for JCS Focal Point Communications Systems Information (SOOP-A).**

**(d) Accountability records are required for Top Secret combinations. TS combinations will be maintained by USSOCOM Command Center separately from Secret Element central repository (#1 safe) combinations. The activity security managers, along with Top Secret Control Officers, are required to reconcile TS accounts with both the Command Center (SOIO-CC) and Command Top Secret Control Officer (SOIO-C4I-S) when combinations are changed.**

**(e) The combinations of safes located in SCIFs will be forwarded to the SSO.**

c. Entrances to secure rooms or areas should be under visual control at all times during duty hours to prevent entry by unauthorized personnel or equipped with electric, mechanical or electromechanical access control devices to limit access during duty hours (See 6-402 for requirements during non-duty hours). Appendix E provides standards for these access control devices; the use of automated systems described therein is encouraged. Electrically actuated locks (e.g., cypher and magnetic strip card locks) do not afford by themselves the required degree of protection for classified information and must not be used as a substitute for the locks prescribed in subsection 6-402.

**6-405. Repair of Damaged Security Containers.** Neutralization of lock-outs or repair of any damage that affects the integrity of a security container approved for storage of classified information shall be accomplished only by authorized persons who have been the subject of a trustworthiness determination IAW DoD 5200.2-R or are continuously escorted while so engaged.

The MacDill AFB contract locksmiths may perform such tasks and are also authorized to change combinations. Use of contract locksmith to simply change combinations is discouraged. Each security manager should be trained and certified to change combinations of storage containers in their AOR. SOCS-SI will provide assistance on a pre-scheduled, time available basis.

a. With the exception of frames bent through application of extraordinary stress, a GSA-approved security container manufactured prior to October 1991 (identified by a silver GSA label with black lettering affixed to the exterior of the container) is considered to have been restored to its original state of security integrity if repaired in accordance with Appendix E.

(1) All damaged or altered parts, for example, the locking drawer, drawer head, or lock, are replaced; or

(2) Has been drilled immediately adjacent to or through the dial ring to neutralize a lock-out, a replacement lock meeting FF-L-2740 is used, and the drilled hole is repaired with a tapered, hardened tool-steel pin, or a steel dowel, drill bit, or bearing with a diameter slightly larger than the hole and of such length that when driven into the hole there shall remain at each end of the rod a shallow recess not less than 1/8 inch nor more than 3/16-inch deep to permit the acceptance of substantial welds, and the rod is welded both on the inside and outside surfaces. The outside of the drawer head must then be puttied, sanded, and repainted in such a way that no visible evidence of the hole or its repair remains on the outer surface.

(3) SOCS-SP will make final recertification determinations that container repairs are adequate and in compliance with this section. All certifications will be in writing and forwarded to SOCS-SP for coordination and approval.

b. In the interests of cost efficiency, the procedures identified in paragraph 6-405.a.(2), should not be used for GSA-approved security containers purchased after October 1991 (distinguished by a silver GSA label with red lettering affixed to the outside of the container control drawer) until it is first determined whether warranty protection still applies. To make this determination, it will be necessary to contact the manufacturer and provide the serial number and date of manufacture of the container. If the container is under warranty, a lock-out will be neutralized using the procedures described in the Naval Facilities Engineering Service Center (NFESC) Technical Data Sheet (TDS) 2000-SHR.

c. Unapproved modification or repair of security containers and vault doors is considered a violation of the container's or door's integrity and the GSA label shall be removed. Thereafter, they may not be used to protect classified information except as otherwise authorized in this manual.

**6-406. Maintenance and Operating Inspections.** Heads of DoD Components shall establish procedures concerning repair and maintenance of classified material security containers and vaults. The MacDill AFB locksmith will perform all repairs and maintenance of classified material security containers and vaults. Written verification of work performed by locksmith must be maintained by the Center Security Manager as long as the container remains in operation.

**SECTION V -- REPRODUCTION OF CLASSIFIED MATERIAL**

**6-500. Policy.** Documents and other material containing classified information shall be reproduced only when necessary for accomplishment of the organization's mission or for compliance with applicable statutes or directives. Since reproduction equipment and the reproduction process involve substantial risk, Heads of the DoD Components shall establish and enforce procedures for reproduction of classified material that limit reproduction to that which is mission-essential and ensure that appropriate countermeasures are taken to negate or minimize risk. The use of technology that prevents, discourages, or detects unauthorized reproduction of classified information is encouraged.

**6-501. Approval for Reproduction.** Unless restricted by the originating agency, Top Secret, Secret, and Confidential information may be reproduced to the extent required by operational needs. The DoD Components shall establish procedures that, as a minimum:

- a. Ensure compliance with reproduction limitations placed on documents by originators and special controls applicable to Special Access Programs and other special categories of information;
- b. Facilitate oversight and control of reproduction of classified material; and,
- c. Ensure the expeditious processing of documents in connection with review for declassification.
- d. **Each activity will specifically designate copiers authorized for classified reproduction and place a conspicuous notice on or near the machine. This equipment will be included on all activity checklists used for End of Day inspections.**

**6-502. Control Procedures.** The DoD Components shall establish controls to ensure that:

- a. Reproduction is kept to a minimum consistent with mission requirements;
- b. Classified material is not reproduced on equipment that poses unacceptable risks (**contact SOCS-SP for equipment approved for classified reproduction**);
- c. Personnel doing the reproduction are aware of the risks involved with the specific reproduction equipment and the appropriate countermeasures they are required to take (**In USSOCOM, run two blank sheets of paper through the Reproduction Machine prior to any replacements or repairs**);
- d. Reproduced material is clearly identified as classified at the applicable level;
- e. Reproduced material is placed under the same accountability and control requirements as apply to the original material; and
- f. Waste products generated during reproduction are properly protected and disposed of (**placed in burn bags, protected appropriately, and destroyed accordingly**).



## SECTION VI -- FOREIGN GOVERNMENT INFORMATION

**6-600. General.** NATO classified information shall be controlled and safeguarded in compliance with USSAN Instruction 1-69. Other foreign government information shall be controlled and safeguarded in the manner described in this Chapter for U.S. classified information, except as described below. The control and safeguarding requirements for foreign government information may be modified as required or permitted by a treaty or international agreement, or, for other obligations that do not have the legal status of a treaty or international agreement (e.g., a contract), by the responsible national security authority of the originating government. **SOIO-C4I-S is the command proponent for NATO information. SOIO-C4I-S will provide NATO read-on for USSOCOM personnel with final clearance. Activity security managers are required to maintain listings for all personnel with NATO read-on.**

### **6-601. Foreign Government Top Secret, Secret and Confidential Information.**

a. **Top Secret.** Records shall be maintained of the receipt, internal distribution, destruction, annual inventory, access, reproduction, and transmittal of foreign government Top Secret information. Reproduction requires the consent of the originating government. Destruction shall be witnessed. Records shall be maintained for 5 years.

b. **Secret.** Records shall be maintained of the receipt, distribution, external dispatch and destruction of material containing foreign government Secret information. Other records may be necessary if required by the originator. Secret foreign government information may be reproduced to meet mission requirements. Reproduction shall be recorded. Records shall be maintained for 3 years.

c. **Confidential.** Records shall be maintained for the receipt and external dispatch of Confidential foreign government information. Other records need not be maintained for foreign government Confidential information unless required by the originating government. Records shall be maintained for 2 years.

**6-602. Foreign Government Restricted Information and Information Provided in Confidence.** In order to ensure the protection of other foreign government information provided in confidence (e.g., foreign government "Restricted," or foreign government unclassified information provided in confidence), such information must be classified under E.O. 12958. The receiving DoD Component shall provide a degree of protection to the foreign government information at least equivalent to that required by the foreign government or international organization that provided the information. If the foreign protection requirement is lower than the protection required for U.S. CONFIDENTIAL information, the information shall be marked as described in Section 7 of Chapter 5 of this Regulation and the following requirements shall be met:

a. The information shall be provided only to those individuals who have an established need-to-know, and where access is required by official duties.

b. Individuals given access shall be notified of applicable handling instructions. This may be accomplished by a briefing, written instructions, or by applying specific handling requirements to an approved cover sheet.

c. Documents shall be stored so as to prevent unauthorized access (e.g., a locked desk or cabinet or a locked room to which access is controlled).

**6-603. Third-Country Transfers.** The release or disclosure of foreign government information to any third-country requires the prior written consent of the originating government. **Contact SOCS-SI for further guidance.**

**6-604. Storage.** To the extent practical, foreign government information should be stored separately from other information to facilitate its control. To avoid additional costs, separate storage may be accomplished by methods such as using separate drawers in the same container as other information or, for small amounts, the use of separate file folders in the same drawer.

## SECTION VII -- DISPOSITION AND DESTRUCTION OF CLASSIFIED MATERIAL

### 6-700. Policy.

a. Classified documents and other material shall be retained within DoD organizations only if they are required for effective and efficient operation of the organization or if their retention is required by law or regulation. Documents that are no longer required for operational purposes shall be disposed of IAW the provisions of the Federal Records Act (44 U.S.C. Chapters 21, 31 and 33) and appropriate implementing directives and records schedules (**Contact SOIO-C4I-S for further guidance**). Material that has been identified for destruction shall continue to be protected, as appropriate, for its classification until it is actually destroyed. Destruction of classified documents and material shall be accomplished by means that eliminate risk of reconstruction of the classified information they contain.

b. Heads of the DoD Components shall ensure that management of retention of classified material is included in oversight and evaluation of program effectiveness. Each activity with classified holdings should establish at least 1 day each year when specific attention and effort is focused on disposition of unneeded classified material ("clean-out day"). **In USSOCOM, the second week of January of each year will be designated as the annual "clean out" day. Security managers will record the amount destroyed in cubic feet. One drawer is equivalent to two cubic feet.**

### 6-701. Methods and Standards.

a. Classified information identified for destruction shall be destroyed completely to preclude recognition or reconstruction of the classified information in accordance with procedures and methods prescribed by the Head of the DoD Component or their designee. Methods and equipment used to routinely destroy classified information include burning, cross-cut shredding, wet-pulping, mutilation, chemical decomposition or pulverizing **in the central destruction facility located in Building 502 and operated by the Headquarters Commandant, cross-cut shredding (GSA approved office shredders will be certified by the Center Security Manager and will produce a residue of 1/32" by 1/2" or less). Burn bags will be safeguarded in security containers or authorized open storage areas and will contain ONLY material designated for destruction.**

b. Technical guidance concerning appropriate methods, equipment, and standards for the destruction of classified electronic media, processing equipment components, and the like may be obtained by contacting the Directorate for Information Systems Security, National Security Agency, Ft. Meade, MD 20755. Specifications concerning appropriate equipment and standards for destruction of other storage media may be obtained from the General Services Administration.

c. Classified microfilm and microfiche shall be destroyed in a pyrolytic furnace, or as approved by SOCS-SM.

d. Classified magnetic information storage media, that is, tapes (computer, audio, and video), discs, drums, cores, card strips, and rods on which any classified information has been recorded may be handled as Unclassified when degaussed by equipment and procedures authorized by the Director, National Security Agency. Approved degaussing equipment and instructions for use of the equipment are available from the SOIO or SOCS-SM. If approved degaussing equipment is not available, magnetic media shall be safeguarded in the manner prescribed for the highest classification ever recorded thereon as long as the media are usable.

e. Microcomputer diskettes shall be removed from their jackets or casings and shall be destroyed in the central destruction facility listed above; the jackets or casings may be placed in unclassified waste. Other magnetic media which are no longer usable, and other classified material shall be destroyed using an approved method in this chapter.

f. Center personnel will ensure that paper trash is properly prepared prior to destruction or disposal. All newspapers, food, cups, etc., large staples, paper clips, fasteners, and other metal objects will be removed prior to shredding. Envelopes, unclassified transmittal documents accompanying classified material, paper disk jackets, or any other medium bearing classification markings will be shredded.

If paper copy will be retained, and if removal or obliteration is not feasible, simply mark through classification markings with a pen, pencil or marker sufficiently enough to alert any person that the classified contents have been removed and safeguarded accordingly. The preferred method of destruction is to shred the paper material.

g. Security managers will establish procedures that require Area Security Inspectors to ensure paper waste is secured as classified/sensitive information at the end of each duty day, and that trash containers to be emptied by custodial personnel do not contain paper that is considered sensitive.

## SECTION VIII -- ALTERNATIVE OR COMPENSATORY CONTROL MEASURES

### 6-800. General.

a. This Chapter prescribes the minimum requirements that will normally be applied for the safeguarding of classified information. Senior Agency Officials may, through issuance of appropriate Component guidelines and, consistent with other provisions of this paragraph and subsection 6-801, approve the use of alternative or compensatory security controls to ensure that the protection afforded classified information is sufficient to reasonably deter and detect actual or possible compromise. Approval to use alternative or compensatory control measures shall be documented, to include identification of the actual controls employed, and furnished upon request to other agencies with whom classified information or secure facilities are shared. A copy of this documentation must also be provided to the ASD(C3I) or USD(P), as appropriate, for reporting to the Director, Information Security Oversight Office, consistent with paragraph 1-401.a. of Chapter 1 of this manual.

b. Alternative or compensatory security control measures shall be employed only after consideration of risk management factors such as criticality, sensitivity, and value of the information; analysis of the threats both known and anticipated; vulnerability to exploitation; and countermeasures benefits versus cost.

c. Authority to use any of the following security controls that would extend program-wide and that are program-specific shall require the approval of a Component official with original classification authority. The following security controls may be applied to another DoD Component or another Executive Branch agency, only with the written agreement of that Component or agency. Moreover, the Component instituting use of any of the following controls shall maintain a centralized record that, as a minimum, reflects the control(s) used and the rationale for use. (The provisions of this subparagraph do not apply to the Single Integrated Operational Plan (SIOP).)

(1) Maintenance of lists or rosters of personnel to whom the classified information has been or may be provided.

(2) Using an unclassified nickname to identify classified information requiring the alternative or compensatory protection. (NOTE: Codewords shall not be used for this purpose. Other special terminology or special markings shall not be used except as prescribed for the handling of message traffic, or as authorized by this manual)

(3) Requiring that classified information be placed in sealed envelopes marked only with the nickname and stored in a manner to avoid commingling with other classified files.

(4) Requiring unique DoD Component oversight or inspection procedures.

d. Alternative or compensatory security controls may be applied to contractors only when specifically identified in the DD Form 254, Department of Defense Contract Security Classification Specification.

e. Alternative or compensatory security controls shall not be applied to Restricted Data.

f. Requests to use alternative or compensatory security controls for the safeguarding of NATO or foreign government information shall be submitted through channels to the Deputy to the Under Secretary of Defense (Policy) for Policy Support.

g. Alternative or compensatory security controls shall not preclude, nor unnecessarily impede, Congressional, Office of the Secretary of Defense, or other appropriate oversight of program or activity functions or operations

**6-801. Special Access Controls.** The following security control measures shall be used only in those instances where a program has been approved IAW Chapter 8 of this manual as a Special Access Program:

- a. Personnel security investigative or adjudicative requirements more stringent than those normally required for a comparable level of classified information;
- b. Specialized non-disclosure agreements or briefing statements;
- c. Use of any special terminology; other than a nickname issued IAW established JCS procedures, or as prescribed for the handling of message traffic; or special markings, other than those authorized by this manual; to identify or control the dissemination of the information that has been determined to require enhanced security.
- d. Exclusion of a classified contract from inspection by the Defense Investigative Service (use of a carve-out); or
- e. A centralized billet system to control the number of personnel authorized access.
- f. **Contact CORB/SOOR for specific control measures regarding SAPs.**

HEADQUARTERS  
DEPARTMENTS OF THE ARMY AND THE AIR FORCE  
Washington, DC 20310-2500  
30 September 1993

\*NATIONAL GUARD REGULATION (AR) 500-2/  
AIR NATIONAL GUARD INSTRUCTION 10-801

Emergency Employment of Army and Other Resources

NATIONAL GUARD COUNTERDRUG SUPPORT TO LAW ENFORCEMENT AGENCIES

**Summary.** This regulation covers the utilization of National Guard resources and prescribes the policies, procedures, and responsibilities governing National Guard counterdrug support to Law Enforcement Agencies (LEAs). It must be used in conjunction with the procedures provided in the Counterdrug Coordinator's Handbook NG Pam (AR) 500-2/ANGPAM 10-801).

**Applicability.** This regulation applies only to the Army and Air National Guards of the 50 States, the Commonwealth of Puerto Rico, Guam, U.S. Virgin Islands, and the District of Columbia, hereafter referred to as states.

**Impact on Unit Manning System.** This regulation does not contain policies that affect the Unit Manning System.

**Internal Control System.** This regulation is subject to the requirements of AR 11-2. This regulation in-

cludes a Counterdrug Review and Evaluation Checklist.

**Supplementation.** Supplementation of this regulation is prohibited without prior approval from National Guard Bureau, Counterdrug Task Force, Pentagon, Washington, DC 20310-2500.

**Interim Changes.** Interim changes to this regulation are not official unless they are authenticated by the Director, Administrative Services. Interim changes will be destroyed on their expiration dates unless sooner superseded or rescinded.

**Suggested Improvements.** The proponent agency of this regulation is the National Guard Bureau, Counterdrug Task Force. Users are invited to send comments and suggested improvements on DA Form 2028 (Recommended Changes to Publications and Blank Forms) directly to Chief, National Guard Bureau (NGB-CD), ATTN: Counterdrug Task Force, Washington, DC 20310-2500.

Contents (Listed by paragraph number)

	Para		Para
<b>Chapter 1</b>		<b>Chapter 3</b>	
<b>General</b>		<b>Use, Loan, and Lease of Equipment</b>	
Purpose	1-1	General information	3-1
References	1-2	Loan and lease of equipment	3-2
Explanation of abbreviations and terms	1-3	Routing of requests	3-3
Responsibilities	1-4	Use of National Guard aircraft	3-4
Authority	1-5	Equipment authorization	3-5
<b>Chapter 2</b>		<b>Chapter 4</b>	
<b>Administrative Information</b>		<b>Reports and Records</b>	
Legal considerations and requirements	2-1	Information and archives	4-1
Use of force	2-2	Reports and reporting	4-2
Subpoenas and request for information	2-3	Special notification/coordination	4-3
Security guidelines	2-4		
Planning	2-5	<b>Review and Evaluation Checklist</b>	
Memoranda of understanding	2-6		
Funding	2-7	<b>Appendices</b>	
Personnel	2-8	<b>A. References</b>	
Medical requirements	2-9	<b>B. Rules of Engagement, Force Protection, and Safety</b>	
Public affairs	2-10		
Training	2-11	<b>Glossary</b>	
Office of Review and Evaluation	2-12		

\*This regulation supersedes NGR (AR) 500-2/NGR (AF) 55-6, 1 March 1993

## Chapter 1 General

### 1-1. Purpose

*a.* This regulation prescribes policies and responsibilities relating to the use of Army and Air National Guard resources for counterdrug supply reduction activities in support of LEAs.

*b.* Use this regulation in conjunction with the Counterdrug Coordinator's Handbook (NG Pam (AR) 500-2/ANGPAM 10-801).

### 1-2. References

Required and related publications are listed in appendix A.

### 1-3. Explanation of abbreviations and terms

Abbreviations and special terms used in this regulation are explained in the glossary.

### 1-4. Responsibilities

*a.* The Secretary of Defense (SECDEF), in accordance with 32 USC 112, provides funds to states receiving approval of their plans for National Guard counterdrug support activities.

*b.* The Chief, National Guard Bureau, will provide federal resources to the National Guard for the Counterdrug Support Program.

*c.* The Counterdrug Task Force under the guidance of the National Program Manager, NGB has primary responsibility for the development and execution of all National Guard counterdrug support related program policies, procedures, and regulations. The Counterdrug Task Force gives guidance on the formulation of new program concepts, and reviews and approves such initiatives prior to submission to the states for implementation. Questions on counterdrug support policy should be directed to the Director, Counterdrug Task Force. Other Counterdrug Support Program questions will be directed to the Counterdrug Support Division.

*d.* The State Plans, Operations, and Military Support Officer (POMSO) is the Counterdrug Support Manager and primary point of contact at the state level. The states also have a Counterdrug Coordinator who oversees the Counterdrug Support Program with specific guidance from the POMSO. All Army and Air National Guard counterdrug activities are directed by the POMSO.

### 1-5. Authority

The Governor is the Commander-in-Chief of the Army and Air National Guard units of his/her state or territory when these units are not in federal (Title 10) status. Such authority is derived from Article 1, Section 8, Clause 16, U.S. Constitution. District of Columbia units serve under a Commanding General who is appointed by the President of the United States.

## Chapter 2 Administrative Information

### 2-1. Legal considerations and requirements

*a. National Guard role.* The National Guard provides counterdrug support to LEAs requesting assistance. National Guard personnel engaged in counterdrug support activities for which federal funding is provided by 32 USC 112 are considered to be in support of law enforcement agencies. Support requested that was not originally listed in state plans will be considered on a case-by-case basis. Generally, requests to provide federally funded mission support that were not included in the original execution memoranda require approval above state level. These will be processed through the Counterdrug Task Force for SECDEF consideration.

*b. Requests for support.* The National Guard will not initiate counterdrug support operations without a documented request for support from a LEA.

*c. State law.* The role of the National Guard with respect to counterdrug support operations is defined by each state's governor and must fall within the confines of that state's law.

(1) Proposed operations within state counterdrug plans must receive certification of legal review from the state Attorney General. Such certification ensures that the operations are consistent with and not prohibited by state law.

(2) The requirement for state certification of legal review is not waivable.

*d. Arrests, searches, and seizures.* National Guard personnel will not, except for exigent circumstances, directly participate in the arrest of suspects, conduct searches which include direct contact of Guard members with suspects or members of the public, or become involved in the chain of custody for any evidence. Commanders at all levels will ensure that personnel are thoroughly briefed on this subject before participating in counterdrug operations.

(1) Powers of arrest exercised by Guard members are normally the same as those authorized by private citizens as outlined by the laws of each state. The state JAG should provide detailed guidance in this area.

(2) Exigent circumstances are situations in which immediate action is necessary to protect police officers, Guard personnel, or other persons from injury; to prevent the loss or destruction of evidence; or to prevent the escape of a suspect already in custody.

(3) Supported LEAs are responsible for obtaining warrants required for searches or for determining the need for searches, inspections, and observations that do not require warrants. This responsibility includes the determination of any potential legal restrictions upon the use of thermal imaging systems.

**e. Reconnaissance and surveillance.** National Guard members engaged in counterdrug support activities may conduct area surveillance and/or reconnaissance. This may include observation of persons incidental to such surveillance but Guard members will not conduct such activity when directed at specific individuals. Observation may include the tracking of vessels, aircraft, or ground vehicles suspected of involvement in drug activities.

**f. Responsibility/liability.** Responsibility/liability for the actions of National Guard personnel involved in counterdrug support activities are as follows:

(1) Supported LEAs are responsible for personal injury, death, property, or damage caused by their own personnel and equipment.

(2) Federal protections for personal injury, death, or property damage caused by National Guard personnel in Title 32 status are governed by the Federal Tort Claims Act.

(3) Responsibility and liability for actions by National Guard personnel on State Active Duty (SAD) is in accordance with state law. Personnel in a SAD status are not covered by the Federal Tort Claims Act.

(4) Responsibility and liability for loss and damage to National Guard equipment will be determined by a report of survey.

**g. Environmental restrictions.** All operations will be conducted in accordance with current environmental laws and regulations.

## 2-2. Use of force

**a.** This paragraph contains federal guidelines which cannot be broadened. However, states should review these rules and add further restrictions as appropriate to comply with state law.

**b.** The Adjutant General will determine whether or not troops will be armed. When Troops are armed it will be for the purpose of self protection only. Rounds will be chambered only on order of the senior ranking military member present and in conjunction with the supported LEA.

**c.** Guard members have the right to use force for the following purposes; only the minimum force necessary for the purpose may be used:

(1) Defend themselves, other members of their team, LEOs, or other persons.

(2) Protect property.

(3) Make arrests if they have arrest powers pursuant to paragraph 2-1d above.

**d.** Deadly force (any force capable of causing serious injury or death) may only be used under the following circumstances:

(1) All other means have failed.

(2) Risk of injury to other persons is not increased by the use of deadly force.

(3) When deadly force is the minimum force necessary to prevent death or serious injury to the

member, other Guard members, LEOs, or other persons.

(4) The discharge of any firearm, even if the intent is only to wound and not to kill, is always to be considered deadly force.

**e.** Guard members will be thoroughly briefed about the Rules of Engagement and Use of Force prior to the commencement of any operation. (See app B.)

## 2-3. Subpoenas and request for information

**a.** The National Guard and its current and former members and employees may receive subpoenas, orders or other requests for the appearance or testimony of individuals or to produce, disclose or release "official information" regarding the counterdrug program.

(1) The provisions of AR 27-40, or AFR 110-5, as appropriate, must be complied with when these situations are related to "judicial proceedings" and "litigation" (as defined by these regulations). If the information is covered by these regulations, legal approval is required prior to release of information or testimony. All such requests will be immediately referred to the appropriate Staff Judge Advocate for determination.

(2) The payment of travel expenses, per diem and fees is covered by AR 27-40 and AFR 110-5. Guard members under subpoena who are not already on counterdrug support orders may be put on orders for the period required for preparation and testimony.

**b.** A state legal officer should be made available to provide information to the prospective witness regarding the proceedings for which the subpoena was issued.

**c.** The NGB Judge Advocate (NGB-JA) must be contacted immediately under the following circumstances:

(1) Possibility of civil liability on the part of the Guard member or the Guard itself.

(2) Occurrence of negative judicial rulings based wholly or in part upon the conduct of Guard members, including the suppression of evidence.

## 2-4. Security guidelines

### **a. Operations security (OPSEC).**

(1) Counterdrug operations will follow OPSEC procedures IAW AR 530-1, OPSEC Program. Guard members will be briefed on the need to observe OPSEC measures.

(2) Mark state plans, operations plans/orders, memoranda of agreement/understanding, and other sensitive documents: "FOR OFFICIAL USE ONLY", IAW AR 25-55, Chapter IV and AFR 4-33, Section G. When FOU material is sent outside the Department of Defense to authorized recipients, place an expanded marking to explain its meaning. Do this by typing or stamping the following statement on the document before transfer IAW AR 25-55/AFR 4-33:

"This document contains information EXEMPT FROM MANDATORY DISCLOSURE under the Freedom of Information Act. Exemptions (b) (5), (b) (7) (C), (b) (7) (E), and (b) (7) (F) apply. (Further distribution is prohibited without the approval of (enter Office of Primary Responsibility).)" (The OPR is the office in the State responsible for this material).

**b. Communications security (COMSEC).** AR 380-19, Information System Security Program, will be used to determine the methods for transmission or reception of voice and hard copy information.

**c. Physical security.** Physical security personnel will conduct physical security risk assessments of all offices and operational areas.

**d. Screening of personnel.** National Guard members who volunteer for duty in the Counterdrug Support Program will be screened as follows: (Table of Screening Actions/Responsibilities (Table 2-1 below) and the Screening Checklist shown in appendix B of the Counterdrug Coordinator's Handbook (NG Pam (AR) 500-2/ANGPAM 10-801) will be retained as a guide and audit trail for screening actions.)

(1) The applicant must be recommended by the unit commander.

(2) The applicant will be personally interviewed by the CDC or his designated representative.

(3) The custodian of the applicant's Military Personnel Records will review the records for information bearing on the individual's eligibility for Counterdrug duty.

(4) Although a security clearance is not required, counterdrug personnel are required to have had a favorable Entrance National Agency Check or National Agency Check (ENTNAC/NAC) within the past 15 years. The State Security Manager will determine the applicant's (ENTNAC/NAC) status.

(5) Applicants must pass biochemical testing for acceptance in the counterdrug program. Testing must have been conducted while on military status and within 90 days prior to entry on counterdrug duty. The Counterdrug Coordinator will ask the State Alcohol and Drug Coordinator (ADC) to review records and conduct testing as appropriate.

(6) A determination of medical qualifications in accordance with NGR (AR) 500-2/ANGI 10-801, paragraph 2-9.

(7) Applicant volunteering for support of LEAs will meet all the above requirements before being referred to LEAs. LEAs will initiate and conduct any checks pertinent to their organization/requirements.

ACTION	ACTION REQUESTED BY	ACTION PERFORMED BY	RECORDS DISPOSITION
Recommendation by Unit Commander	Counterdrug Coordinator (CDC)	Unit Commander (IAW CD Program Requirements)	Checklist Remark Only
Personal Interview	CDC	CDC or Representative	Checklist Remark Only
Military Personnel Records Review	CDC	Custodian of Records (IAW CD Program Requirements)	Checklist Remark Only
ENTNAC/NAC Verification	CDC	Security Manager (IAW CD Program Requirements)	Checklist Remark Only
Biochemical Test Verification	CDC	ADC Coordinator	Checklist Remark Only
Medical Qualification (30 days or less)	CDC	Health Records Custodian	Checklist Remark Only
Medical Qualification (30 or more consecutive days)	CDC	State Surgeon (IAW CD Program Requirements)	Checklist Remark Only
Criminal Records Check (at option of LEA)	LEA	LEA	LEA Checklist Remark Only



30 September 1993

NGR (AR) 500-2/ANGI 10-801

## 2-5. Planning

a. Each state will submit an annual Counterdrug Support Plan to the National Guard Bureau, ATTN: Counterdrug Task Force, for review and staffing prior to the plan's submission to SECDEF for approval. Plans will conform to Counterdrug Task Force guidelines and be approved and signed by the state Adjutant General.

b. Supplemental plans received after initial plan submission will be considered at the mid-year review. Upon approval at that time, funds will be authorized as available.

c. POMSOs/Counterdrug Coordinators will oversee preparation of plans for support as requested by a LEA.

d. The POMSO/Counterdrug Coordinator will establish and maintain a folder for each operation. The folder will contain all pertinent documentation to provide an audit trail, including all obligations and expenditures. A list of required documents and the definition of "an operation" are contained in the Counterdrug Coordinator's Handbook (NG Pam (AR) 500-2/ANGPAM 10-801).

e. All air assets will be controlled by the State Army Aviation Officer (SAAO) for the Army Guard and the Executive Support Staff Officer (ESSO) for the Air Guard. Counterdrug flying hour support requests will be reconciled with these offices. (See paragraph 2-9, Flying hours/air support, of the Counterdrug Coordinator's Handbook (NG Pam (AR) 500-2/ANGPAM 10-801).)

f. Request Channels. LEAs will request support from the POMSO/Counterdrug Coordinator. Requests which are beyond the capability of the National Guard will be forwarded to the appropriate Continental United States Army (CONUSA) and will be coordinated by the National Guard CONUSA Liaison Officer. In areas where LEA federations such as Operation Alliance or Project North Star exist, the aforementioned may be altered to accommodate regional procedures. Retain plans and supporting documents for two years. (Specific coordination requirements are contained in the Counterdrug Coordinator's Handbook (NG Pam (AR) 500-2/ANGPAM 10-801).)

g. Missions are consolidated to minimize duplication. The following missions list has been coordinated with and approved by the Office of the Secretary of Defense (OSD):

Mission #	Title
Msn # 1	Surface Reconnaissance
Msn # 2	Surface Surveillance
Msn # 3	Surface Transportation Support
Msn # 4	Aerial Reconnaissance
Msn # 5	Aerial Surveillance
Msn # 5R	Reconnaissance and Interdiction Detachment (RAID)

Mission #	Title
Msn # 6	Aerial Transportation Support
Msn # 7	Ground Radar Support (includes Security)
Msn # 8	Cargo Inspection
Msn # 9	Training Program (NG & LEA)
Msn # 10	Aerial Photo Reconnaissance
Msn # 11	Coordination, Liaison, and Management
Msn # 12	Marijuana Greenhouse/Drug Laboratory Eradication/Detection
Msn # 13	Film Processing for Photo Reconnaissance
Msn # 14	Administrative, Information, ADP, Logistics, and Maintenance Support
Msn # 15	Engineer Support
Msn # 16	Aerial Interdiction Support

Refer to The Counterdrug Coordinator's Handbook (NG Pam (AR) 500-2/ANGPAM 10-801) for mission descriptions and requirements.

## 2-6. Memoranda of Understanding (MOU)

a. For agencies receiving counterdrug support for a total of more than 30 days, states are required to develop MOUs with a LEA prior to providing the requested support. MOUs are also required for all interstate support. These memoranda will cover the following:

- (1) Planned deployment of National Guard personnel and equipment.
- (2) Reporting procedures.
- (3) Command and control channels.
- (4) Scope of approved operations.
- (5) Force protection/Rules of Engagement.
- (6) Public affairs.
- (7) Safety.
- (8) Areas of responsibility.
- (9) Acquisition of warrants, permits, hold harmless agreements. (Hold harmless requirements are not required for support provided to federal agencies.)

b. MOUs will be carefully reviewed by the state Judge Advocate General (JAG) and if applicable, the U.S. Property and Fiscal Officer (USPFO) and SAAO/ESSO.

## 2-7. Funding

a. 32 USC 112 provides funds for Pay and Allowances (P&A) and Operations and Maintenance (O&M) under the Counterdrug Support Program. Procurement of services and equipment (to include leases) is funded by the annual Authorization and Appropriations Acts.

b. Funding for operations is based on Congressional appropriations coupled with the Office of the Secretary of Defense plan for supporting the National Drug Control Strategy. Allocation of funds to support state plans is based on this strategy.

c. States may not transfer funds between appropriations nor transfer funds between the Army and Air Guards.

d. Counterdrug support mission costs associated with IDT/IAD or AT training that include above normal expenditures (such as lodging) may be charged to counterdrug support accounts. Travel expenses incurred by personnel on ADSW with the Counterdrug Support Program when commuting to and from IDT/IAD are chargeable to the program when the travel to IDT/IAD is to a place other than the member's normal (i.e., ADSW) place of duty.

e. Counterdrug support funds are considered "fenced" and therefore cannot be transferred to disapproved missions, other state programs, or to other states.

f. Army National Guard funding.

(1) *Pay and Allowances (Appropriation 2060)*. Pay, allowances, travel, and per diem for ADSW and AGR, are chargeable to the National Guard Personnel Appropriation (NGPA) and are identified as program costs IAW AR 37-100-XX.

(2) *Operations and Maintenance (Appropriation 2065)*. Operations and maintenance expenses are chargeable to the Army National Guard Operations and Maintenance Appropriation (OMNG) per AR 37-100-93. O&M includes the following types of expenditures.

(a) Pay of technicians employed by the state Adjutant General as staff to provide support explicitly for the Counterdrug program. Also covered are the employer's contribution to employee retirement funds, incentive awards, health and life insurance programs, FICA where applicable, and object class 12 Permanent Change of Station (PCS) benefits.

(b) Travel and per diem required for ARNG technicians or National Guard Bureau employees directly employed with the Counterdrug Support Program.

(c) Medical expenditures for all personnel (other than AGR) directly employed in the Counterdrug Support Program such as line of duty civilian medical care, unique immunizations, and per diem with travel expenses for program applicants to obtain examinations needed to determine suitability for the counterdrug program. Approval for payment IAW NGR 40-3 is processed by NGB-ARP-HS.

(d) Procurement of material required for operating and maintaining facilities, aircraft, ground vehicles, and equipment.

(e) Procurement of medical supplies used in Counterdrug Support Program activities.

(f) Other expenses that cannot be linked directly to a specific mission. Additional guidance may be obtained from the Army Comptroller Directorate, Program and Budget Division (NGB-ARC-P).

g. Air National Guard funding.

(1) *Military Personnel (Appropriation 3850, Fund Code 56)*. Pay, allowances, and travel for personnel directly involved with the Counterdrug Sup-

port Program are chargeable under this appropriation.

(2) *Operations and Maintenance (Appropriation 3840, Fund Code 58)*. Operations and maintenance funds cover a variety of costs that are the same as the ARNG, except that medical cost accounting differs.

(a) Medical expenses should be identified for CONUS plans and operations using the appropriately assigned Emergency Special Program (ESP) code.

(b) Line of duty civilian care expenditures which cannot be handled with local funds, should be submitted to Air National Guard, Medical Resource Management Office (ANGRC/SGAR) as an unfunded budget requirement.

h. Items identified for central procurement using Dedicated Procurement Program (DPP) funds, and/or USPFO procurement authority for O&M funds, will be identified and submitted in the annual Counterdrug Support Plan submitted by each state.

2-8 Personnel administration

a. National Guard members may serve the Counterdrug Support Program under a variety of employment categories. Additional regulations within each category further govern the utilization of these soldiers and airmen. Attention to detail is required so that members receive the benefits, pay and allowances due them. The support of the counterdrug program must be the primary mission of all federally funded counterdrug personnel.

b. *State Active Duty (SAD)*. State funded SAD personnel may provide counterdrug support to LEAs. Such personnel will be employed IAW state regulations.

c. *Active Guard Reserve (AGR) (Title 10/Title 32) and Full-time Technician Personnel*.

(1) Do not place personnel on an AGR tour unless upon reaching eighteen years of active federal service they will have sufficient time remaining prior to their Mandatory Separation Date (MSD) to complete twenty years of active service.

(2) Employment of ARNG AGR personnel will be as stated in NGR (AR) 600-5 (Title 32) or NGR (AR) 600-10 (Title 10). Employment of ANG AGR personnel will be accordance with NGR (AF) 35-3.

(a) Counterdrug orders will include a statement requiring the proper use of personnel. (See Counterdrug Coordinator's Handbook (NG Pam (AR) 500-2/ANGPAM 10-801, para 2-4) for Title 10 and Title 32 required statements.)

(b) Full-time ARNG AGR personnel serving tours other than those specifically in the Counterdrug Support Program will not spend more than thirty days total time per year involved with the counterdrug program. Requests for exception to policy will be submitted to the Army National Guard, Full-Time Support Division (NGB-ARM), who will in turn coordinate any approvals with the Counterdrug Task Force (NGB-CD).

(c) Air National Guard (ANG) AGR personnel. At the discretion of the commander, ANG AGR personnel other than Counterdrug Coordinators may participate in the Counterdrug Support Program without limit if participation is consistent with their Air Force Specialty Code (AFSC) duties or contributes to overall unit readiness. Tour length limitations and guidance found in ANGR 35-03 apply to full-time military personnel serving in support of counterdrug activities.

(3) Technician status is determined by TPR 990-2. Technicians who provide support to LEAs must be placed on appropriate leave for all normal workday hours during the time this support is rendered.

**d. Active Duty Special Work (ADSW) (Title 32).**

(1) The number of soldiers and airmen serving on ADSW tours for the Counterdrug Support Program will not impact allowable end strengths of personnel supporting reserve components. Neither will they count against authorizations outlined in Title 10, sections 517 and 524. These same personnel are exempt from end strength reporting and limitations on the number of days members may perform in a fiscal year under AR 135-200, NGR 37-111, and ANGR 50-01. Guard members placed on extended ADSW orders are required to continue attending IDT/IAD while remaining on the orders. They should be carried as "constructive" attendance for purposes of pay and accountability. Orders must be broken for any non-counterdrug training lasting longer than three days. Additionally, soldiers and airmen on ADSW for twenty weeks or longer are entitled to PCS benefits.

(2) Soldiers applying for ADSW who are or will be within 2 years of qualifying for an active Federal Service retirement will enter the statement (found in para 6-6c, AR 135-200) in the remarks section of DA Form 1058-R.

**e. Duty Performed Incidental to Training.** National Guard personnel may support LEAs and/or other parts of the Counterdrug Support Program in an IDT/IAD or AT status if the performance of that duty is synonymous to the training originally planned.

**f. Evaluation.** Counterdrug supervisory personnel may be required to make letter reports for National Guard members when the dual supervision provisions of AR 623-105, paragraph 3-18, are applicable. The CDC will coordinate with the State Military Personnel Officer to ensure compliance with officer and enlisted evaluation procedures.

**2-9. Medical requirements**

**a.** In addition to existing requirements outlined in AR 135-200, AR 40-501, and AFR 160-43, personnel on orders (Title 10 or Title 32) for federally funded (Section 112 funding) counterdrug support activities will adhere to the following physical examination requirements:

**b.** The requirement for physicals (medical fitness screening) depends on the length of a Guard member's ADSW orders and falls into two categories.

(1) Tours of thirty days or less do not require a medical examination. However, the individual will complete and sign a statement attesting to the status of current health IAW NGR 40-501, Appendix B or AF Form 895, AFR 160-43 prior to being placed on active orders.

(2) Individuals being placed on a tour of more than thirty days are required to meet the standards of medical fitness as set forth in Chapter 2 of AR 40-501 or Chapter 4 of AFR 160-43. This will be determined by the State Surgeon (or his/her designee) reviewing a medical screening form (AF Form 895 or Appendix B, NGR 40-501) completed by the applicant within the preceding 30 days, and the applicant's most recent valid periodic physical, applying Chapter 2/4 standards. The period of validity for periodic physicals is four years, except (ARNG only) two years if age 40 or over. In addition, all ARNG applicants, age 40 and over, must have successfully passed the Cardiovascular Screening Phase I or II within the preceding two years. If the individual meets these standards, he/she may be placed on duty. If the individual fails to meet these standards, the Surgeon may elect to deny duty without appeal, or with reasonable cause, may submit the records with an appropriate current clinical evaluation to NGB-ARP-HS or ANGRC/SGP, as appropriate, for waiver consideration. The decision of the waiver by NGB-ARP-HS or ANGRC/SGP is final. Once duty has been authorized by Chapter 2/4 standards, retention standards govern. However, if a break in excess of one year occurs, reentry will require Chapter 2/4 standards again.

(3) Guard members whose physical examination results (or a waiver approved by NGB-ARP-HS or ANGRC/SGP) have not been received by the Counterdrug Support Program of their state by the end of thirty days will have their counterdrug ADSW orders terminated.

**c.** Personnel in the Counterdrug Support Program are also subject to drug analysis testing (DAT).

**d.** Guard members on ADSW orders who are injured while participating in counterdrug support activities are entitled to benefits under Section 1074a of Title 10 USC.

**2-10. Public Affairs**

**a.** The supported LEA should have the lead concerning public affairs and make the final determination as to what information is released to the public in coordination with the state PAO.

**b.** State PAOs will not divulge dates of specific operations, identification of units, or identification of personnel involved. (Photographs and video tapes will be carefully managed to ensure that faces and name tags are not visible). Operational questions regarding information on numbers and types of personnel or equipment involved in current or future activities will not be released until the operation is completed. Protection of the force and OPSEC will be the primary consideration.

c. News media representatives can accompany the National Guard on counterdrug support operations only with the approval of the LEA and notification of NGB-PA. Orientation flights with news media representatives must receive NGB-PA approval IAW NGB Pam 360-5

## 2-11. Training

### a. Training of National Guard personnel.

(1) Middle and upper level managers (such as POMSOs and Counterdrug Coordinators), should at a minimum attend the Counterdrug Managers' Course provided by the National Interagency Counterdrug Institute (NICI). The program of instruction provides information regarding organizations, policies, and laws which they must be familiar with in order to execute a State Counterdrug Program.

(2) Tactical level planners and operators must be given training specific to the types of operations being planned or undertaken by their state counterdrug programs. Such training can take the form of everything from cargo inspection techniques to the operation of specialized equipment. Training plans should be created at the state or regional level and tailored to the specific requirements of the LEAs and approved missions.

### b. Training of LEA personnel.

(1) Congressional and DoD intent is that counterdrug support funding may not be used for other purposes such as train-ups for LEA personnel with deficiencies in areas such as marksmanship, weapons systems, etc. DoD guidance is that "other related topics" is not intended to act as a catch-all, but is designed to provide reasonable lee-way from listed examples of authorized training.

(2) NGB will approve training for LEAs when such training enhances the ability of LEA members working directly with the National Guard in the Guard's counterdrug support role. This training includes:

(a) Training for specific types of operations such as surveillance missions.

(b) Training for LEAs that enables them to interact with military forces in joint operations such as eradication, border interdiction, and other similar events.

(3) Any LEA training not specially defined above must be approved in advance by the NGB Counterdrug Task Force.

## 2-12. Office of Review and Evaluation

a. The Office of Counterdrug Review and Evaluation implements internal controls and provides oversight functions for the program. It monitors and performs periodic inspections of operations ensuring that internal management controls will detect fraud, waste, or abuse of resources and assets.

b. The POMSO/Counterdrug Coordinator will provide the Office of Counterdrug Review and Evaluation a copy of all reviews, inspections, and evaluations conducted in the state counterdrug program.

## Chapter 3

### Use, Loan, and Lease of Equipment

#### 3-1. General Information

a. The state Adjutant General has authority to use federal property issued to the National Guard in support of counterdrug support operations.

b. States are encouraged to make every effort to utilize military assets for counterdrug support activities.

c. States may coordinate directly with other states for the temporary loan of additional federal property needed to support a particular type of counterdrug activity. Formal arrangements should be made between USPFOs. The loan transactions will be reported to NGB-CD and the Army National Guard, Logistics Directorate (NGB-ARL) or the Air National Guard, Directorate of Logistics, Supply and Equipment Division (ANGRC/LGS) as appropriate.

d. NGB-ARL and NGB/LGS will provide yearly guidance for counterdrug support equipment requirements, loans, leases, and procurement activities.

e. All equipment purchased, loaned, leased, or otherwise obtained using 32 USC 112 funds will not be used for anything other than counterdrug support.

f. The following procedures address reporting excess counterdrug equipment:

(1) Counterdrug Program Manager identifies excess counterdrug equipment purchased with counterdrug funds and reports it via memorandum to NGB-CDS-S. The memorandum will address the disposition (type, quantity, readiness status, etc.) of the equipment.

(2) NGB-CDS-S will conduct a survey to determine if the equipment is required in another state in the Counterdrug Program. NGB-CDS-S will put the respective program managers in communication with each other.

(3) NGB-CDS-S will then send a memorandum through the USPFO to the Counterdrug Program Manager instructing them to laterally transfer the excess equipment to the HQ STARC property book of the gaining Counterdrug Program.

(4) Upon advertisement, if no other counterdrug program expresses an interest in the reported excess equipment the Counterdrug Program Manager will be instructed to report the excess equipment to the USPFO IAW AR 710-2.

#### 3-2. Loan and lease of equipment

a. Loan and lease of equipment is governed by AR 700-131, and AFM 67-1/ANGR 67-1. USPFOs are responsible for preparing and negotiating agreements, and approving loans and leases of equipment. Loan formats may be found in the aforementioned references.

b. NGB will review requests for loans/leases of ARNG/ANG equipment that require HQDA and USAF approval. States will itemize/prioritize lists of requested/required equipment in their annual Counterdrug Support Program plans.

c. Areas of responsibility or request review are as listed:

(1) Director, NGB-CD will act on all counterdrug support to LEAs.

(2) The Public Affairs Division (NGB-PA) will be involved if requests will impact the community.

(3) The Aviation Division, Standardization and Training Branch (NGB-AVN-OT) will control all areas related to ARNG aircraft.

(4) Air National Guard Counterdrug Support Directorate (ANGRC/CD) will act on requests for loan or lease of ANG equipment.

(5) The Logistics Directorate (NGB-ARL) will act on all other requests for loan/lease of ARNG equipment.

(6) ANG Logistics (ANGRC/LGS) will process all requests for ANG assets.

### 3-3. Routing of requests

a. Loan requests from state and/or local agencies should be routed directly to the state POMSO/Counterdrug Coordinator.

b. Loan requests from federal agencies will be routed through that agencies' headquarters to the Department of Defense, and then to the appropriate service. Contact should be made with Regional Logistics Support Offices (RLSOs) to process requests for resources not available in standard channels.

### 3-4. Use of National Guard Aircraft

All support will be in compliance with applicable state and federal law and regulations.

a. The use of National Guard aircraft is prescribed by the 95-series regulations for the ARNG and the 55-series for the ANG. The Army safety program is covered in AR 385-10 and the Air Force safety program is covered in AFR 127-4. Additionally, the Air Force adheres to "Safety: Investigating and Reporting USAF Mishaps" IAW NGR (AF) 127-4 supplement, and Message Reporting of F-16 Flight Mishaps AFR 127-18. These regulations are the primary references on all use of aircraft issues. See NGR (AR) 500-1/NGR (AF) 55-5 for additional guidance.

b. ARNG and ANG aircraft may be used for counterdrug support activities in any of the listed categories.

(1) ADSW (Title 32) status and/or federally funded SAD status.

(2) Incidental-to-training.

(3) Training support to LEAs.

c. Reconnaissance and Interdiction Detachment (RAID) Aircraft.

(1) RAID aircraft are funded with counterdrug dollars, and intended for use in counterdrug opera-

tions. Acknowledging that some requests will likely be made wherein the use of the aircraft's thermal imaging and or communications capabilities are needed, the following allowances are made for use of RAID aircraft for other than counterdrug missions:

(a) The RAID aircraft may be used in a life/death emergency situation that meets the following criteria:

1. The aircraft and thermal imaging/communication equipment is needed to search a wilderness area for a lost person(s), where the probability exists that the person(s) will most likely not survive inclement weather or other perilous circumstances/conditions.

2. The aircraft and thermal imaging/communication equipment is needed to search for an escaped convict or suspected dangerous felon in a wilderness area, that if not quickly apprehended, will likely endanger the welfare of residents and innocent citizens.

(2) In each case of 1. and 2. above, the request must be made by a law enforcement agency to the National Guard. Flying hour time used for the mission must be reimbursed either by other National Guard Funding or by the state or local government making the request. Missions for other than counterdrug operations must not interfere with counterdrug missions unless LEA coordination is made and a life/death emergency exists.

### 3-5. Equipment authorizations

a. Commercial equipment must be authorized by NGB-CD and NGB-ARL prior to procurement or leasing. ARNG requests, not previously approved will be processed as prescribed under AR 71-13 for a Table of Distribution and Allowance (TDA) addition or under CTA 50-909. ANG requests will be submitted on AF Form 601 so that the item will be included under the appropriate Allowance Source Code (ASC).

b. The USPFO retains the authority of approval to procure non-standard, non-type classified, commercial equipment that doesn't qualify for TDA addition. Annual ARNG procurement/lease guidance (to include dollar thresholds), is set forth by NGB-ARL. ANG units should submit AF Form 601 to ANGRC/LGSE for coordination with ANGRC/CD.

c. States will not procure counterdrug support equipment already earmarked for central procurement by the Counterdrug Task Force (NGB-CD) and NGB-ARL unless authorized to do so by the same. ARNG and ANG Directorates will obtain and provide equipment to states through the Total Package Fielding Program. States will be updated annually on the status of the requisitions.

d. Modifications/equipment changes to ARNG aircraft must be coordinated through Aviation Division (NGB-AVN) and approved by the U.S. Army Aviation Systems Command and/or the U.S. Safety Center as appropriate.

## Chapter 4 Reports and Records

### 4-1. Information and archives

The National Guard Bureau leadership has the recurring mission of providing expert testimony to the Congress of the United States. They must also continually interface with the DoD, along with many other federal agencies regarding the Counterdrug Support Program. Therefore it is vital that both current and historical records remain accurate, readily available, and up to date. They should be maintained in one central location and be established IAW AR 25-400-2 or AFR 4-20, Volume 2 and the guidance of NGB-CD found in the Counterdrug Coordinator's Handbook (NG Pam (AR) 500-2/ANGPAM 10-801). This information flow from lower to higher provides the crucial link for obtaining this knowledge that will have great impact on current operations and future directions of the Counterdrug Support Program.

### 4-2. Reports and reporting

a. Counterdrug support operations records. Operation Plans (OPLANs) and Operation Orders (OPORDs) will be developed for each operation. These will be included in the operation folder or database that the POMSO/Counterdrug Coordinator must maintain for each operation.

b. All reports must be made IAW the Counterdrug Coordinator's Handbook, Chapter 3 (NG Pam (AR) 500-2/ANGPAM 10-801). This includes, but is not limited to, operations performed incidental to training and after action reports.

c. The following forms will be used for some of the reports mentioned in b above:

(1) NGB Form 525-R (State Counterdrug Support Operations Report).

(2) NGB Form 525-1-R (Air National Guard Monthly Financial Report).

(3) NGB Form 525-2-R (Army National Guard Monthly Financial Report).

(4) NGB Form 525-3-R (National Guard Counterdrug Support Operations Law Enforcement Agency Survey).

(5) NGB Form 525-4-R (National Guard Counterdrug Support Operations National Guard Survey).

(6) NGB Form 525-5-R (National Guard Counterdrug Support Operations Law Enforcement Request Report).

A copy of each form is located at the back of this regulation. Locally reproduce these forms on 8 1/2 by 11-inch paper. For preparation of these forms, see the Counterdrug Coordinator's Handbook, chapter 3 (NG Pam (AR) 500-2/ANGPAM 10-801).

### 4-3. Special notification/coordination

a. Reporting also includes unusual circumstances. The Director, Counterdrug Task Force will be notified by the POMSO/Counterdrug Coordinator immediately in the event of an emergency or "immediate action" situation.

b. Immediate Action. An "immediate action" situation is defined as any situation which results in a gross deviation from the OPLAN to the extent that weapons are fired at or by Guard members, injuries from hostilities are sustained by Guard members, defensive or offensive actions (not planned for but reactive in nature) have been taken which escalate the original OPLAN or which may be classified as "serious incidents" as determined by the operation commander on the military side.

c. In addition to Counterdrug Support Program reporting requirements, Serious Incident Reports (SIRs) must be submitted through appropriate channels IAW AR 190-40 or AFR 127-4.

**NATIONAL GUARD BUREAU  
DIRECTOR, COUNTERDRUG TASK FORCE  
OFFICE OF COUNTERDRUG REVIEW AND EVALUATION  
PENTAGON, WASHINGTON, DC 20310-2500**

**(REVIEW AND EVALUATION CHECKLIST)**

**REFERENCES:**

- AR 11-2, INTERNAL MANAGEMENT CONTROL
- AFR 15-1, AIR FORCE INTERNAL CONTROLS
- AR 20-1, INSPECTOR GENERAL ACTIVITIES AND PROCEDURES
- AR 25-1, THE ARMY INFORMATION RESOURCES MANAGEMENT PROGRAM
- AR 37-100-93, THE ARMY MANAGEMENT STRUCTURE (AMS)
- AFR 123-1, THE INSPECTION SYSTEM
- NGR (AR) 500-2/ANGI 10-801, NATIONAL GUARD COUNTERDRUG SUPPORT TO LAW ENFORCEMENT AGENCIES

**STATE:** \_\_\_\_\_

**DATE:** \_\_\_\_\_

**LOCATION:** \_\_\_\_\_

**POMSO:**

**NAME:** \_\_\_\_\_ **RANK:** \_\_\_\_\_

**STATE DRUG COORDINATOR:**

**NAME:** \_\_\_\_\_ **RANK:** \_\_\_\_\_

**EVALUATOR:** \_\_\_\_\_

**RANK/GRADE:** \_\_\_\_\_

**REPRESENTATIVE(S) PRESENT DURING INSPECTION:**

<b>GRADE</b>	<b>NAME</b>

- 12. To determine if each mission folder (file) contains the required counterdrug reports.
- 13. To determine if the state has developed a feedback mechanism with the LEAs to evaluate and improve support.
- 14. To determine if the state is: a) measuring the effectiveness of the support to LEAs in the following areas: satisfactory responses to valid requests, timeliness of support provided, and execution of counterdrug plans, and b) evaluating local policies and taking action on identified deficiencies.
- 15. To determine if the state assesses the degree of completion of priority elements within its plan and to review the method of assessment for adequacy and completeness.
- 16. To evaluate all Memoranda of Understanding (MOU) between the state and supported LEAs.
- 17. To evaluate all Internal Controls in the Counterdrug Support Program.
- 18. To review the training of CD personnel and use of Active Duty/Special Work (ADSW) in the Counterdrug Support Program.
- 19. To evaluate the propriety of Guard equipment usage including the adequacy of reimbursements to the National Guard.

**ASSESSABLE UNIT** ALL ARMY AND AIR NATIONAL GUARD UNITS OF THE 54 STATES AND TERRITORIES.

**STEP 1:** Develop goals and objectives with law enforcement agencies.

**RISK:** Counterdrug support operations or program will be severely impaired without a reasonable working plan.

**CONTROL OBJECTIVE:** Develop/implement policies, procedures, and controls to ensure the most management effective and efficient use of resources to accomplish the mission and meet objectives.

**CONTROL TECHNIQUE:** Implement policies, procedures, and controls to standardize the Counterdrug Support Program and ensure that policies are implemented and enforced.

**TESTING:** Testing is required to verify that control techniques are operational and functioning as intended.

**COUNTERDRUG REVIEW AND EVALUATION CHECKLIST**

STATE PLANS:	Yes	No
1. Are the state plans certified by State Attorney General verifying that support is authorized? REMARKS:	Yes	No
2. Are the state plans reviewed by the USPFO and JAG? REMARKS:	Yes	No
3. Are state plans marked "FOR OFFICIAL USE ONLY"? REMARKS:	Yes	No
4. Are the counterdrug support plans coordinated with appropriate federal, state, and local agencies and approved (signed) by the Adjutant General IAW NGR (AR) 500-2/ANGI 10-801? REMARKS:	Yes	No
5. Does the POMSO keep minutes of counterdrug support planning meetings? REMARKS:	Yes	No



## COUNTERDRUG REVIEW AND EVALUATION CHECKLIST

17. Are operations plans/orders utilized for each operation? REMARKS:	Yes	No
18. Are Standard Operating Procedures (SOP) utilized? REMARKS:	Yes	No
19. Is an index utilized in each operation file? REMARKS:	Yes	No
20. Is a LEA representative present during the conduct of all operations? REMARKS:	Yes	No
21. Are all obligations/expenditures tracked by operation? REMARKS:	Yes	No
22. Is the Adjutant General authorizing wear of civilian clothing? REMARKS:	Yes	No
23. Did the state experience any emergency or immediate action situations during CD operations? REMARKS:	Yes	No
24. Did the state notify NGB-CD immediately? REMARKS:	Yes	No
25. Is this action documented? REMARKS:	Yes	No
26. Are all National Guard Counterdrug missions/operations coordinated with the POMSO? REMARKS:	Yes	No
27. Is the state developing/utilizing operation files? REMARKS:	Yes	No
28. Are state counterdrug operations controlled and managed from one central location? REMARKS:	Yes	No
29. Are counterdrug operations historical and current supporting records at one central location, IAW AR 25-400-2 or AFR 4-20, Vol 2? REMARKS:	Yes	No
<b>PERSONNEL:</b>		
30. Are individuals who volunteer for counterdrug support being screened IAW NGR (AR) 500-2/ANGI 10-801? REMARKS:	Yes	No
31. Are National Guard personnel being briefed on Operations Security (OPSEC) by the security manager? REMARKS:	Yes	No
32. Are National Guard personnel being briefed on Physical Security to include facilities and equipment IAW AR 190-51? REMARKS:	Yes	No
33. Do orders show U.S.C. Title 32, section 502 has authority? REMARKS:	Yes	No

## COUNTERDRUG REVIEW AND EVALUATION CHECKLIST

<b>PERSONNEL:</b>		
50. Are personnel with breaks of greater than 90 days and who possess a current physical examination signing a statement in lieu of medical examination? REMARKS:	Yes	No
51. Are personnel participating in the counterdrug program for more than thirty consecutive days prior to medical waivers being approved? REMARKS:	Yes	No
52. Is annual urinalysis testing of counterdrug personnel being conducted? REMARKS:	Yes	No
53. Does the state screen all members' qualifications (both officer and enlisted) prior to accession to the counterdrug program? REMARKS:	Yes	No
54. Is a review of military personnel records being conducted prior to entry on CD duty? REMARKS:	Yes	No
55. Are CD personnel receiving a Unit Commander recommendation prior to entering the CD Support Program? REMARKS:	Yes	No
56. Does the state have supporting documents verifying that NG personnel have attended periodic refresher training, IAW NGR (AR) 500-2/ANGI 10-801? REMARKS:	Yes	No
57. Does the state have internal controls to verify the presence of all NG personnel on duty IAW AR 11-2/AFR 15-1? REMARKS:	Yes	No
58. Does a local system exist to adequately manage and control personnel and equipment resources? REMARKS:	Yes	No
59. Are physicals reviewed for preexisting and possibly disqualifying medical conditions? REMARKS:	Yes	No
60. Are records checked prior to entry to the CD program for years of active service (18 years sanctuary). REMARKS:	Yes	No
<b>FINANCE/FUNDING:</b>		
61. Is there supporting documentation for all funding transactions? REMARKS:	Yes	No
62. Are all local funding documents properly coordinated and reviewed prior to signature to preclude over-distribution of program funding? REMARKS:	Yes	No
63. Are procedures in place to prevent an over-distribution or over-obligation of funds? REMARKS:	Yes	No
64. Does a local system exist to adequately account for and control funds to prevent fraud, waste, and abuse of resources? REMARKS:	Yes	No

**COUNTERDRUG REVIEW AND EVALUATION CHECKLIST**

<b>EQUIPMENT:</b>			
80. Is the ANG Counterdrug section submitting AF Form 601 to have an item included in the appropriate allowance source code? REMARKS:	Yes	No	
81. Is the state reporting all excess CD equipment to NGB for redistribution in compliance with NGR (AR) 500-2/ANGI 10-801? REMARKS:	Yes	No	
82. Did the state purchase any equipment during the end of the fiscal year just to exhaust CD funds? REMARKS:	Yes	No	
<b>PUBLIC AFFAIRS:</b>			
83. Is the Public Affairs Officer (PAO) working in coordination with the LEA counterpart? REMARKS:	Yes	No	
84. Is the State PAO aware of OPSEC issues? REMARKS:	Yes	No	
85. Is the LEA making the final determination concerning public information? REMARKS:	Yes	No	
86. Does a qualified Public Affairs Officer escort news media on visits to operations? REMARKS:	Yes	No	
<b>REPORTING:</b>			
87. Is NGB-CD provided with the Initial Operations Report (NGB Form 525-R) IAW NGR (AR) 500-2/ANGI 10-801? REMARKS:	Yes	No	
88. Is NGB-CD provided with the Situation (SITREP) (NGB Form 525-R), IAW NGR (AR) 500-2/ANGI 10-801? REMARKS:	Yes	No	
89. Are National Guard Assisted Seizure/In Process Reports (NGB Form 525-R) submitted to NGB-CD, IAW NGR (AR) 500-2/ANGI 10-801? REMARKS:	Yes	No	
90. Are After Action Reports submitted to NGB-CD, IAW NGR (AR) 500-2/ANGI 10-801? REMARKS:	Yes	No	
91. Is the State forwarding LEA/NG surveys (NGB Form 525-3-R/525-4-R) to NGB-CD, IAW NGR (AR) 500-2/ANGI 10-801? REMARKS:	Yes	No	
92. Are all CD Incident Reports reported and submitted to NGB-CD, IAW NGR (AR) 500-2/ANGI 10-801? REMARKS:	Yes	No	
93. Are Obligations/Expenditures Reports (NGB Form 525-1R or NGB Form 525-2-R) submitted to NGB-CD IAW NGR (AR) 500-2/ANGI 10-801? REMARKS:	Yes	No	

## COUNTERDRUG REVIEW AND EVALUATION CHECKLIST

<b>ARMY AVIATION:</b>		
109. Is the RAID Detachment in compliance with the TDA? REMARKS:	Yes	No
<b>AIR NATIONAL GUARD</b>		
110. Is the Executive Support Staff Office (ESSO) included in all CD planning? REMARKS:	Yes	No
111. Are Air National Guard flying hour requests coordinated with the ESSO? REMARKS:	Yes	No
112. Is the ESSO/CD office notified of operations that are conducted by ANG personnel in all cases? REMARKS:	Yes	No
113. Is a copy of AFTO Form 781 submitted to the CD office as supporting documentation and audit trail with an after action report? REMARKS:	Yes	No
<b>BRIEFINGS:</b>		
114. Are Unit Commanders briefed on the CD program? REMARKS:	Yes	No
115. Have individuals signed a statement verifying that they have been briefed on rules of engagement, use of deadly force, and operational requirements? REMARKS:	Yes	No
116. Are National Guard personnel being briefed before counterdrug operations on real world threat from drug trafficking and dealers, legal considerations, local/state restrictions, OPSEC, and Physical Personnel Security and Safeguards? REMARKS:	Yes	No
117. Are National Guard personnel receiving the nature and scope of the standard pre-commitment briefing required by NGR (AR) 500-2/ANGI 10-801 prior to deployment on a counterdrug support operation? REMARKS:	Yes	No
118. Are National Guard personnel being briefed on pay and allowances, entitlements, and special requirements? REMARKS:	Yes	No
119. Are National Guard personnel being briefed on Physical Security to include facilities and equipment IAW AR 190-51? REMARKS:	Yes	No
120. Are National Guard personnel being briefed on security of weapons and ammunition IAW NGR 190-11? REMARKS:	Yes	No
121. Are National Guard personnel being briefed on Operational Security (OPSEC) by an appropriate security manager? REMARKS:	Yes	No

**COUNTERDRUG REVIEW AND EVALUATION CHECKLIST**

<b>INTERNAL CONTROLS:</b>		
<p><b>137. Does a local system exist to adequately manage all CD funds at the POMSO/CD Coordinator level?</b>  <b>REMARKS:</b></p>	Yes	No
<p><b>138. Are local finance internal controls/procedures in the CD system to detect and prevent fraud, waste, and abuse?</b>  <b>REMARKS:</b></p>	Yes	No
<p><b>139. Does the CD staff retain leasing contracts for ground vehicles, equipment, etc.?</b>  <b>REMARKS:</b></p>	Yes	No
<p><b>140. Does the Adjutant General authorize the carriage of weapons by National Guard personnel on a case-by-case basis IAW NGR (AR) 500-2/ANGI 10-801?</b>  <b>REMARKS:</b></p>	Yes	No
<p><b>141. Does the CD Coordinator require an LEA request for carriage of weapons by National Guard personnel?</b>  <b>REMARKS:</b></p>	Yes	No
<p><b>142. Does the CD staff ensure all vehicle operators have a valid OF 46/AF Form 2293 (U.S. Government Vehicle Operator's Identification Card)?</b>  <b>REMARKS:</b></p>	Yes	No
<p><b>143. Does the CD staff ensure government vehicles are managed IAW DA Pam 738-750 and AFM 77-310, Vol I?</b>  <b>REMARKS:</b></p>	Yes	No

30 September 1993

NGR (AR) 500-2/ANGI 10-801

**NGB Pam 360-5/ANGP 190-9** National Guard Public Affairs Guidelines

**NGR (AF) 50-1**  
Active and Inactive Duty For Training Management Within the Air National Guard

**ANGR 67-1**  
Loan and Use of Property Issued to the Air National Guard

**TPR 990-2**  
Hours of Duty, Pay and Leave

**Section II**

**RELATED PUBLICATIONS**

(A related publication is merely a source of additional information. The user does not have to read it to understand this regulation).

**4th Amendment to the U.S. Constitution**

**DoD Directives: 5525.5** DoD Cooperation with Civilian Law Enforcement Officials; 5149.1; 5160.54

**AR 25-1**  
The Army Information Resources Management Program

**AR 71-13**  
Department of the Army Equipment Authorization and Usage Program

**AR 95-1**  
Flight Regulations

**AR 130-5/AFR 45-17**  
Organization and Functions of National Guard Bureau

**AR 190-40**  
Serious Incident Reporting

**AR 190-51**  
Security of Army Property at Unit/Installation Level

**AR 310-49**  
The Army Authorization Documents System (TAADS)

**AR 700-1**  
Army Conversion to the Metric System of Measurement

**DA Pam 190-52**  
Personnel Security Precautions Against Terrorism

**AFR 55-3**  
Operations (Reporting, Meaoning, Intrusion, etc.)

**AFM 67-1**  
USAF Supply Manual

**CTA 50-909**  
Field and Garrison Furnishings and Equipment

**FORSCOM/ARNG 350-2**  
Reserve Component Training

**NGR 10-2**  
State Area Command, Army National Guard

**NGR (AR) 95-1**  
ARNG Aviation: Flight Regulations (Modifies AR 95-1)

**NGR 190-11**  
Physical Security of Arms, Ammunition, and Explosives

**NGR (AR) 350-1**  
Army National Guard Training

**NGR (AR) 500-1/NGR (AF) 55-5**  
Military Support to Civil Authorities

**NGR (AR) 600-85**  
Drug Abuse Prevention and Control

**ANGR 23-01**  
State Air National Guard Headquarters

**ANGR 35-03**  
Full-Time Military Duty Personnel Program - Air National Guard

**Section III**

**National Interagency Counterdrug Institute (NICI) Publications**

**Special Reports**

Public Lands Drug Control Committee - 1990 After Action Assessment Seminar

\*Information and Intelligence Resources for the Law Enforcement Agencies on the Southwest Border

Counterdrug Managers' Course Resource Guide

National Guard Counterdrug Lessons Learned

NICI also publishes a variety of Information Papers, a monthly "NICI BULLETIN", on counterdrug related conferences and seminars, and "THE INFORMANT", a training and enforcement update.

**Note:**

\*FOUO - Published for Operation Alliance. Available only to approved law enforcement and military agencies/organizations.

**Glossary**

**Section I  
Abbreviations**

**ADSW**  
Active Duty Special Work

**AFSC**  
Air Force Specialty Code

**AGR**  
Active Guard Reserve

**ANG**  
Air National Guard

**ANGRC**  
Air National Guard Readiness Center

**ANGRC/CD**  
Air National Guard, Counterdrug Directorate

**ANGRC/LGS**  
Air National Guard, Directorate of Logistics

**ANGRC/SGP**  
Air National Guard, Physical Standards Branch

**ANGRC/SGAR**  
National Guard Bureau, Air National Guard, Resource Office

**ARNG**  
Army National Guard

**ARNGRC**  
Army National Guard Readiness Center

**ASC**  
Allowance Source Code

**AT**  
Annual Training

**CNAC**  
Customs National Aviation Center

**CONUS**  
Continental United States

**CONUSA**  
Continental United States Army

**DAT**  
Drug Analysis Testing

**DLEA**  
Drug Law Enforcement Agency

**DoD**  
Department of Defense

**DPP**  
Dedicated Procurement Program

**EER**  
Enlisted Evaluation Report

**ENTNAC**  
Entrance National Agency Check

**EPIC**  
El Paso Intelligence Center

**ESP**  
Emergency Special Program

**ESSO**  
Executive Support Staff Officer

**FOIA**  
Freedom of Information Act

**FTCA**  
Federal Tort Claims Act

**FTNGD**  
Full-Time National Guard Duty

**HIV**  
Human Immunodeficiency Virus

**IAD**  
Inactive Duty Training

**IDT**  
Inactive Duty Training

**JAG**  
Judge Advocate General

**JTF**  
Joint Task Force

**LEA**  
Law Enforcement Agency/Agent

**LEO**  
Law Enforcement Officer

**MOA**  
Memorandum of Agreement

**MOS**  
Military Occupational Specialty

**MOU**  
Memorandum of Understanding

**MRD**  
Mandatory Retirement Date

**MSD**  
Mandatory Separation Date

30 September 1993

NGR (AF) 500-2/ANGI 10-801

**TDA**  
Table of Distribution and Allowances

**TDC**  
Type Duty Code

**TPF**  
Total Package Fielding

**TPR**  
Technician Personnel Regulation

**UMD**  
Unit Manning Document

**USCS**  
U.S. Customs Service

**32 USC 112**  
Section 112 of Title 32, United States Code

**USMEPCOM**  
U.S. Military Entrance Processing Command

**USPFO**  
U. S. Property and Fiscal Officer

**Section II**  
**Terms**

**Adjutant General**  
Refers to the Commanding General in those states without an Adjutant General

**Attorney General**  
Refers to the equivalent official in states without an Attorney General

**Civil Authorities**  
Elected and appointed public officials and employees of federal, state, and local government.

**Counterdrug Support Program**  
Support provided to federal, state or local LEAs and other civil authorities to assist with drug interdiction and other counterdrug support authorized by Section 112 of Title 32, United States Code (32 USC 112) in support of the National Drug Control Strategy.

**Exigent Circumstances** Circumstances in which immediate action is necessary to protect police officers, Guard personnel, or other persons from injury; to prevent loss or destruction of evidence; or to prevent the escape of a suspect already in custody.

**Incidental to Training**  
Previously or otherwise scheduled training which would have been conducted regardless of counterdrug operations. Routes and schedules may be altered in order to maximize counterdrug benefits.

**Law Enforcement Agency (LEA)**  
An organization, or a coordinating council comprised of several LEAs, empowered by local, state or federal law to investigate, enforce or prosecute criminal laws regarding illegal drugs and controlled substances.

**National Guard**  
Except as stated otherwise, National Guard means a state National Guard when not in federal service, or all such organizations collectively.

**States**  
For the purpose of this regulation the term "states" includes all 50 states, the Commonwealth of Puerto Rico, the U.S. Virgin Islands, Guam and the District of Columbia.

**State Plans**  
Plan submitted by the states for National Guard counterdrug support activities as authorized by 32 USC 112.

**By Order of the Secretaries of the Army and the Air Force:**

**JOHN B. CONAWAY**  
Lieutenant General, USAF  
Chief, National Guard Bureau

**Official:**

**E. DARDEN BAINES**  
Director  
Administrative Services

**Distribution: B/F**



**COMPLETE ALL PERTINENT INFORMATION**  
**State Counterdrug Support Operations Report**  
 (For use of this form see NGR (AR) 500-2 / ANGI 10-801, Proponent Agency NGB-CD)

TO: <b>Counterdrug Task Force</b>					1. FROM (STATE):					
					2. DATE:					
3. Operation Number:			State	Serial #	FY	Agency	NGB #	4. Operation Code Name:		
5. POC:					6. Telephone: DSN <input type="checkbox"/> COMM <input type="checkbox"/>			7. Fax Line: DSN <input type="checkbox"/> COMM <input type="checkbox"/>		
8. Initial <input type="checkbox"/>		Situation <input type="checkbox"/>			Seizure/ In-Process <input type="checkbox"/>					
9. Agency Supported:										
10. Location of Operations:										
11. Start Date:					12. Scheduled Ending Date:					
13. Counterdrug Funded					Incidental to Training					
Title 32	<input type="checkbox"/>	Title 10	<input type="checkbox"/>	AFTP	<input type="checkbox"/>	IDT	<input type="checkbox"/>	Annual Training	<input type="checkbox"/>	
14. ARNG Commissioned/Warrant: Units:					ARNG Enlisted:					
15. ANG Commissioned : Units:					ANG Enlisted:					
16. Equipment (Include Uniforms, Weapons, Vehicles, Radios, Etc.):										
Aircraft by type:										

**FYTD NATIONAL GUARD ASSISTED SEIZURE INFORMATION**  
 (Cumulative - Expressed in pounds and decimals thereof)

17.										
A. # MJ Plants:			B. Cocaine Lbs:			C. Heroin Lbs:				
D. MJ Lbs:			E. Opium Lbs:			F. Hashish Lbs:				
G. Vehicles:			H. Weapons:			I. Ammo Rounds:				
J. Arrests:			K. Currency (In \$\$):			L. Other Drugs Lbs:				
M. Property \$\$ value:					N. Property by type:					

18. <b>FLYING HOURS</b>										
Aircraft Hrs Flown:		UH-1:	OH-58:	OH-6:	C-130:	C-12:				
F-16:	RF-4C:	T-42:	UH-60:	C-26:	OV-1D:	Other_____:				

**FYTD CARGO INSPECTION (IN-PROCESS) INFORMATION**  
 This information is required (Cumulative FYTD)

19. A. Containers:			B. Aircraft:			C. Vehicles:				
D. Buses:			E. Vessels:			F. 55 Gal Drums:				
G. Pallets Full: Pallets Empty:			H. Crates Full: Crates Empty:			I. Trailers Full: Trailers Empty:				
J. Warehouses:			K. Boxes, etc.:			L. Buildings:				

**State Counterdrug Support Operations**  
 (For use of this form see NGR (AR) 500-2 / ANGI 10-801, Proponent Agency NGB-CD)

**AIR NATIONAL GUARD MONTHLY FINANCIAL REPORT**

TO: <b>Counterdrug Task Force</b>		1. FROM (STATE):	
		2. DATE:	
3. POC:	4. Telephone:	DSN <input type="checkbox"/> COMM <input type="checkbox"/>	5. Fax Line: DSN <input type="checkbox"/> COMM <input type="checkbox"/>
6. Month of Report:			

**7. YEAR-TO-DATE TOTAL OBLIGATIONS**

A. ASN	Workdays		D. Fund Code 56 Travel	Fund Code 58		
	B. OFF	C. ENL		E. Supplies	F. Travel	G. Miscellaneous Obligations

**8. FLYING HOURS FOR THIS MONTH (YTD CUMULATIVE)**

A. ASN	B. Operation Number					C. Aircraft Type	D. Total Hours Flown
	State	Serial #	FY	Agency	NGB #		

(Use reverse side of this form if additional space is required)



**State Counterdrug Support Operations**  
 (For use of this form see NGR (AR) 500-2 / ANGI 10-801, Proponent Agency NGB-CD)

<b>NATIONAL GUARD COUNTERDRUG SUPPORT OPERATIONS LAW ENFORCEMENT AGENCY SURVEY</b>						
<b>TO:</b> Counterdrug Task Force				1. FROM (STATE):		
				2. DATE:		
3. Operation Number:		State	Serial #	FY	Agency	NGB #
				4. Operation Code Name:		
5. NG POC:			6. Telephone:		DSN <input type="checkbox"/>	COMM <input type="checkbox"/>
			7. Fax Line:		DSN <input type="checkbox"/>	COMM <input type="checkbox"/>
8. Start Date:			9. Scheduled Ending Date:			
PURPOSE: To provide Senior DOD Staff and Congress with timely feedback concerning National Guard Support to Law Enforcement Agencies.						
Rating Scheme:    1 (Poor)    2 (Good)    3 (Excellent)						
10. It is requested that this survey be completed by the Senior Law Enforcement Official (LEO) participating in this operation. Score each question with a numerical score (1 - 2 - 3) as follows:						
1. WAS THE SUPPORT PROVIDED IN A TIMELY MANNER?						_____
2. WAS THE SUPPORT PROVIDED FOR THE FULL PERIOD REQUESTED?						_____
3. WAS THE NATIONAL GUARD FULLY EQUIPPED TO SUPPORT MISSION REQUIREMENTS?						_____
4. DID THE LEO FEEL THAT THE OPERATION WAS A SUCCESS?						_____
5. WAS THERE A COOPERATIVE ATTITUDE AMONG ALL PARTIES?						_____
6. DID THE NATIONAL GUARD PERSONNEL FULLY UNDERSTAND THEIR ASSIGNED MISSION?						_____
7. WAS THERE AMPLE FLEXIBILITY IN THE NATIONAL GUARD CHAIN OF COMMAND?						_____
8. DID NATIONAL GUARD SUPPORT ENHANCE THE OVERALL DEGREE OF MISSION ACCOMPLISHMENTS?						_____
Total Point Value						_____
11. Law Enforcement Officer (Name/Title):				12. Signature:		
NOTE:						
1. This survey if completed must be submitted as an attachment to the National Guard After Action Report.						
2. Success Equals    (0 - 10 Poor)    (11 - 19 Good)    (20 - 24 Excellent)						

## State Counterdrug Support Operations

(For use of this form see NGR (AR) 500-2 / ANGI 10-801, Proponent Agency NGB-CD)

<b>NATIONAL GUARD COUNTERDRUG SUPPORT OPERATIONS NATIONAL GUARD SURVEY</b>						
TO: Counterdrug Task Force				1. FROM (STATE):		
				2. DATE:		
3. Operation Number:		State	Serial #	FY	Agency	NGB #
				4. Operation Code Name:		
5. NG POC:			6. Telephone:		7. Fax Line:	
			DSN <input type="checkbox"/> COMM <input type="checkbox"/>		DSN <input type="checkbox"/> COMM <input type="checkbox"/>	
8. Start Date:			9. Scheduled Ending Date:			
<b>PURPOSE:</b> To provide Senior DOD Staff and Congress with timely feedback concerning National Guard Support to Law Enforcement Agencies.						
Rating Scheme:    1 (Poor)    2 (Good)    3 (Excellent)						
10. It is requested that this survey be completed by the Senior National Guard Member participating in this operation. Score each question with a numerical score (1 - 2 - 3) as follows:						
1. WAS THE SUPPORT PROVIDED AS PER LEA REQUEST?						___
2. DID SUPPORT START ACCORDING TO LEA REQUEST?						___
3. WAS THE NATIONAL GUARD PROPERLY EQUIPPED TO SUPPORT THIS OPERATION?						___
4. DID THE NATIONAL GUARD FEEL THAT THE OPERATION WAS SUCCESSFUL?						___
5. WAS THERE A COOPERATIVE ATTITUDE AMONG ALL PARTIES?						___
6. WAS THE SUPPORT OF TRAINING VALUABLE TO THE NATIONAL GUARD? (SQT, COMMON TASK, ARTEP, MOS / AFSC TASKS)						___
7. WAS THERE A PRE-COMMITMENT BRIEFING CONDUCTED WHICH OUTLINED THE RULES OF ENGAGEMENT AND USE OF DEADLY FORCE?						___
8. DID NATIONAL GUARD PERSONNEL FULLY UNDERSTAND THE MISSION?						___
9. WAS THERE AMPLE FLEXIBILITY IN THE NATIONAL GUARD CHAIN OF COMMAND?						___
10. WAS THERE ADEQUATE TIME FOR NATIONAL GUARD PERSONNEL TO PREPARE FOR THE MISSION?						___
						Total Point Value
11. Officer/NCO In-Charge (Name/Title):				12. Signature:		
<b>NOTE:</b> 1. This survey if completed must be submitted as an attachment to the National Guard After Action Report. 2. Success Equals    (0 - 10 Poor)    (11 - 19 Good)    (20 - 30 Excellent)						

## State Counterdrug Support Operations

(For use of this form see NGR (AR) 500-2 / ANGI 10-801, Proponent Agency NGB-CD)

<b>NATIONAL GUARD COUNTERDRUG SUPPORT OPERATIONS LAW ENFORCEMENT REQUEST REPORT</b>		
<b>TO:</b> <div style="text-align: center; font-size: 1.2em;">Counterdrug Task Force</div>	<b>1. FROM (STATE):</b> <hr/>	
<b>2. DATE:</b> <hr/>		
<b>3. NG POC:</b>	<b>4. Telephone:</b>	<b>5. Fax Line:</b>
		DSN <input type="checkbox"/> COMM <input type="checkbox"/>
<b>6. Month of Report:</b> <hr/>		
<b>7. A. Response to Law Enforcement Agency Requests (A single "request" may consist of several items all related to a single mission, operation, units, etc.) :</b>		
1. Number of valid requests. (legally supportable)	<hr/>	
2. Number of valid requests filled. (legally supportable)	<hr/>	
3. Number of valid requests filled at the level requested.	<hr/>	
4. Number of requests filled within timeframe requested.	<hr/>	
5. Number of requests referred to CONUSA, RLSO, etc.	<hr/>	
<b>B. Analysis of requests not supported:</b>		
1. Number of requests not supported. (Provide brief explanation)	<hr/>	
2. Number of requests not operationally supportable. (Provide brief explanation)	<hr/>	
3. Number of missions which were not executed due to lack of DOD support.	<hr/>	
<b>C. Description of training benefits to forces employed:</b>  <hr/>		
<b>D. Description of other benefits to DOD:</b>  <hr/>		

**\* FM 19-15**

**Field Manual  
No. 19-15**

**Headquarters  
Department of The Army  
Washington, DC, 25 November 1985**

## **CIVIL DISTURBANCES**

### **PREFACE**

---

The purpose of this field manual is to provide guidance for the commander and his staff in preparing for and providing assistance to civil authorities in civil disturbance control operations. It discusses the principles, policies, and legal considerations that govern the commitment of federal forces to civil disturbance control operations, the principles of civil disturbance control operations, planning and training for such operations, and the operational tasks and techniques employed to control civil disturbances and neutralize special threats.

This guidance is intended for use of both active and reserve component US Armed Forces. Commanders of federal installations that use nonmilitary personnel, such as DOD police or contract security guards, for security must consult current DOD policy on the use of such personnel in civil disturbance control operations.

The proponent of this publication is HQ TRADOC. Submit changes for improving this publication on DA Form 2028 (Recommended Changes to Publications and Blank Forms) and forward it to Commandant, United States Army Military Police School, ATTN: ATZN-MP-DML, Fort McClellan, AL 36205-5030.

Unless otherwise stated, whenever the masculine gender is used, both men and women are included.

\*This publication supersedes FM 19-15, 30 October 1975, and TC 19-1, 1 August 1975.

# CIVIL DISTURBANCES

## TABLE OF CONTENTS

---

	Page
<b>Chapter 1 Civil Disturbances .....</b>	<b>1-1</b>
Federal Intervention and Aid .....	1-1
Causes .....	1-2
Locations .....	1-3
Mission of Military Forces in a Civil Disturbance .....	1-3
<b>2 The Participants .....</b>	<b>2-1</b>
Crowd Behavior .....	2-2
Crowd Tactics .....	2-3
<b>3 Federal Intervention .....</b>	<b>3-0</b>
Civil Disturbances in Civilian Communities .....	3-0
Civil Disturbances on DOD Installations .....	3-3
Command and Control .....	3-3
Task Force Organization .....	3-5
<b>4 Information Planning and Threat Analysis .....</b>	<b>4-0</b>
Information Needs and Sources .....	4-0
Information Restrictions .....	4-1
Threat Analysis .....	4-2
<b>5 Operations Planning .....</b>	<b>5-1</b>
Coordination of Civilian and Military Efforts .....	5-1
Funding and Military Resources .....	5-2
Logistics .....	5-3
Communications .....	5-6
Relief .....	5-6
Administration .....	5-8
Media Relations .....	5-8
Plans and Reports .....	5-10
<b>6 Control Force Operations .....</b>	<b>6-0</b>
Isolate the Area .....	6-0
Protect Likely Targets .....	6-4
Exert Control .....	6-5
Establish Area Control .....	6-9
Neutralize Special Threats .....	6-13
<b>7 Force Options .....</b>	<b>7-1</b>



<b>8</b>	<b>Crowd Control Formations</b> .....	<b>8-0</b>
	Types of Formations .....	8-1
	Weapon Positions .....	8-3
	Commands .....	8-4
	Cadence .....	8-4
	Interval and Distance .....	8-4
	Commander and Leader Positions .....	8-5
	Squad Formations .....	8-5
	Four-Squad Platoon Formations .....	8-7
	Three-Squad Platoon Formations .....	8-19
	Company Formations .....	8-21
<b>9</b>	<b>Riot Control Agents</b> .....	<b>9-1</b>
	Grenades .....	9-5
	Dispersers .....	9-5
	Water .....	9-13
<b>10</b>	<b>Riot Batons</b> .....	<b>10-0</b>
	Employment .....	10-0
	Baton Grip and Positions .....	10-2
	Offensive Techniques .....	10-4
	Defensive Techniques .....	10-6
<b>11</b>	<b>Extreme Force Options</b> .....	<b>11-1</b>
	Ring Airfoil System .....	11-1
	Shotguns .....	11-5
	Rifles .....	11-5
	Machine Guns .....	11-6
<b>12</b>	<b>Apprehension and Detention Operations</b> .....	<b>12-1</b>
	Apprehensions .....	12-2
	Searches .....	12-3
	Come-Along Techniques .....	12-5
	Detention Facility Operations .....	12-13
<b>13</b>	<b>Training for Civil Disturbances</b> .....	<b>13-1</b>
	Unit Training .....	13-2
	Leadership .....	13-4
	Special Reaction Team Training .....	13-5
	Appendix .....	A-1
	Glossary .....	Glossary-0
	References .....	Reference-1
	Index .....	Index-0

## CHAPTER 1

### Civil Disturbances

**Civil disturbances arise from acts of civil disobedience.** They occur most often when participants in mass acts of civil disobedience become antagonistic toward authority, and authorities must struggle to wrest the initiative from an unruly crowd. In the extreme, civil disturbances include criminal acts of terrorism. Civil disturbances, in any form, are prejudicial to public law and order.

### FEDERAL INTERVENTION AND AID

Under the US Constitution and the US Code, the President is empowered to direct federal intervention in civil disturbances to:

- Respond to state requests for aid in restoring order.
- Enforce the laws of the United States.
- Protect the civil rights of citizens.
- Protect federal property and functions.

Under the Constitution, each state is responsible for protecting life and property within its boundaries. State and local governments use their civil forces to maintain law and order and to quell civil disturbances. However, if a civil disturbance exceeds the resources of a state, federal troops may be called upon to help restore and maintain law and order.

The Constitution and federal statutes authorize the President to direct the use of federal armed troops within the 50 states, the District of Columbia, Puerto Rico, and US possessions and territories and their political subdivisions. The President is also empowered to federalize the National Guard of any state to suppress rebellion and enforce laws.

Federal aid is given to a state when the state has used all of its resources, including its National Guard, to quell a disorder

and finds the resources not sufficient. Usually, active-duty federal forces are used to augment the requesting state's National Guard. But the President may choose to federalize another state's National Guard and use them, alone or with other forces, to restore order.

The President also can employ federal troops to ensure the execution of US law when a state opposes or obstructs US law or impedes the course of justice under those laws. And the President can employ armed federal troops to suppress insurrection, domestic violence, unlawful assemblies, and conspiracy if such acts deprive the people of their constitutional rights and privileges and a state's civil authorities cannot or will not provide adequate protection.

The President is also authorized to use armed federal troops to protect federal property and functions when the need for protection exists and the local civil authorities cannot or will not give adequate protection. The right of the United States to protect all federal property and functions regardless of their locations is an accepted principle of our government.

As a temporary measure, federal military equipment and facilities may be loaned to

state and local governmental bodies and law enforcement agencies for use during civil disturbances. These resources may also be loaned to a state's National Guard and to nonDOD federal agencies. *The*

*requesting agencies are expected to provide enough resources of their own to minimize the need for US military resources. And the loan of the resources must not conflict with US military needs.*

## CAUSES

Civil disturbances may arise from a number of causes. Most often they arise from political grievances, urban economic conflicts and community unrest, terrorist acts, or foreign influences. The event may be triggered by a single cause. Or it may arise from a combination of causes.

Demonstrations of political grievances range from simple protests of specific issues to full-scale civil disobedience. Many forms of political protest, while disruptive, are not unlawful. These protests may be spontaneous, but they generally are planned events. They may even be coordinated with local authorities. Most protestors are law-abiding citizens. They intend their protests to be nonviolent. Violence occurs mainly when control forces must try to contain a protest or arrest protestors involved in civil disobedience. The presence of agitators increases the chance of violence. Agitators want to provoke the control force into overreacting. This embarrasses authorities. It can also gain media and public sympathy for the protestors.

Urban conflicts and community unrest arise from highly emotional social and economic issues. Economically deprived inner-city residents may perceive themselves treated unjustly or ignored by the people in power. Tension can build in a community over a variety of issues. Community services and housing and labor issues are often disputed. Tension creates the potential for violence. When tension is high, it takes only a minor incident or a rumor of an injustice to ignite a civil disturbance. This is particularly true if the

community's relations with local police are part of the problem.

Significant cultural differences in a community can create an atmosphere of distrust. Unrest among ethnic groups competing for jobs can erupt into civil disturbance. Sometimes a large group of refugees resettles in one community, creating unrest in the community. If jobs are in short supply and refugees are taking what jobs there are, feelings of animosity can arise. As emotions run high, violence becomes likely.

Civil disturbances may be organized by disaffected groups. These groups like to embarrass the government. Or they may demonstrate as a cover for terrorism. Their goal is to cause an overreaction by authorities. They think this will generate sympathy for their cause among the general population. Foreign nations may promote civil disturbances through surrogate organizations. The surrogates involve themselves in activities that promote a particular nation's interests. Their actions may be quite overt. Sometimes they even conduct fund-raising and membership drives. The surrogate's sponsors provide support in many ways. The sponsors give money, organizational help, and moral support. They may also help by training members of the surrogate group in civil disobedience, vandalism, and agitation and manipulation of crowds and media. Agents of foreign nations may influence civil disturbances. Agents infiltrate disaffected groups to increase their potential for violence. If they are successful and government forces overreact, the targeted government may be seen as repressive.

## LOCATIONS

Civil disturbances usually occur at places symbolic of a grievance, near the cause of a grievance, or close at hand to an aggrieved crowd. Examples of such places are nuclear weapons facilities or power plants, in urban areas, at refugee camps, or at government facilities. Nuclear weapons facilities and power plants are subject to demonstrations by anti-nuclear activists. These activists demonstrate at places they know or think are used to develop, build, transport, or store nuclear weapons or their parts. The facilities can belong to federal agencies or to businesses with DOD contracts. Active involvement with nuclear weapons is not necessary. Past involvement or the activists' belief of past involvement can make the facilities targets for demonstrations. Nuclear power plants are also targets of environmentalists and other activist groups. The plants are seen as dangers to society and the environment. Demonstrations at plants or plant construction sites may be held to try to interfere with plant operations.

US government facilities like recruiting offices, federally-leased buildings, ROTC buildings, and federal courthouses also can be the targets of demonstrations. A government facility may be targeted simply because a protesting group attaches a symbolic value to, or perceives a connection with, a protested policy. This is especially true of anti-war and anti-nuclear protest groups. They may choose a facility because they see it as the source of their grievance. Or they may target a facility because the people working there are seen as having the power to address the group's grievance.

Urban areas can be the scene of inner-city conflicts, labor disputes, and political struggles. Disturbances in urban areas are usually fueled by aggrieved members of the community. However, an urban area having symbolic value to a particular group may be the stage used by outside demonstrators to draw attention to their cause.

Refugee and resettlement camps can become the focus of a civil disturbance. Large numbers of refugees entering the US in mass are often placed temporarily in refugee camps until they can be resettled. Resettlement can be a slow and difficult process. The boredom, frustration, and other stresses refugees experience in these camps can create tensions that may erupt into violence. And agitators may infiltrate refugee camps to exploit these tensions in ways that will embarrass the US.

Demonstrations at US government facilities are not limited to those in the US. US facilities in foreign nations can be locations of civil disturbances. DOD installations, US embassies, and US consulates in foreign nations are favorite targets of demonstrators. DOD installations in foreign nations are often scenes of protests against US foreign policies. The actual installation and its mission may or may not be the true target. Often the installation is just used as a highly visible symbol of US government. American embassies and consulates also are subject to disturbances. They too are highly visible, concrete representations of the US government.

## MISSION OF MILITARY FORCES IN A CIVIL DISTURBANCE

The mission of the military forces in a civil disturbance is to help local authorities restore law and order. The preservation of law and order in the civilian community

is the responsibility of state and local governments and law enforcement authorities. The preservation of law and order on the federal property of a military

installation is the responsibility of the installation commander and military law enforcement authorities. The military performs civil disturbance operations in support of these local authorities. Most often the military is used to disperse unauthorized assemblages and to patrol disturbed areas to prevent unlawful acts. Military forces may be used to maintain the mechanics of essential distribution, transportation, and communications systems. Military forces are also used to make a show of force, set up roadblocks, cordon off areas, disperse crowds, release riot control agents, and serve as security forces or reserves. And the military may be tasked to initiate needed relief measures.

The commitment of military forces to civil disturbance control operations does not automatically give these forces police power. The police power of military forces is bound by legal constraints as well as humanitarian consideration. Only the degree of force reasonably needed in a circumstance is permitted. All military leaders and planners must be familiar with the laws, regulations, and policies that govern military involvement in civil disturbances. They must know the laws and policies that have a direct impact on military civil disturbance control plans and actions. Those laws and policies dictate how the military can and should act when controlling a civil disturbance.

Military control force commanders must know what options are available to them. Commanders must be able to be highly

flexible and selective in their responses. A commander must select the option that is the best response to a given civil disturbance in that specific physical and psychological environment. He must be able to both reduce the intensity of the confrontation and restore order.

In all contacts with the civilian population and the participants of the disturbance, military forces must display fair and impartial treatment. And they must adhere to *the principle of minimum force*. Whenever possible, civil police apprehend, process, and detain civil-law violators. Military forces perform these functions only when necessity dictates and only to the minimum extent required. These functions are returned to civil authorities as soon as possible. When military forces have achieved enough order to allow the local authorities to resume control, the military's mission is accomplished and their active role in controlling the disturbance ends.

As the disturbance subsides, the commander takes steps to restore control to the civil authorities. The control force gradually reduces the number and scope of its operations and begins removing its equipment from the area. But the control force takes care not to give the impression that all controls have been removed. Withdrawal is not immediate. That would create the impression of abandonment and could lead to a resurgence of the disturbance. The control force gradually withdraws in a phased return of control to civil authorities.

## CHAPTER 2

### The Participants

A civil disturbance occurs only in a particular environment. That environment is a fusing of cause, place, and willingly confrontive participants. Civil disturbance participants come from all walks of life. Participants cover the political spectrum from the far right to the far left. They range from members of special interest groups to the ranks of the unemployed. They may be environmentalists, anti-nuclear activists, or foreign and domestic opponents of US policy. They come from all age groups and from all classes.

They may be curious onlookers who have become swept away by the excitement of an event. They may be demonstrators or counterdemonstrators who have become emotional about their cause. Whoever they are, they have become subject to the social and psychological factors that can turn a large gathering of people into a disruptive, disorderly mass. Understanding these factors can help reduce confrontation and permit order to be restored with a minimum of force.

*The basic human element sparking a disturbance is the presence of a crowd. There are almost as many types of crowds as there are reasons for people to assemble. There are casual crowds like the crowd that assembles for a football game or gathers at an accident. Persons in such a crowd probably have no common bonds other than enjoyment of the game or curiosity about the accident. And there are "planned" crowds like the crowd that assembles at the call of a leader to accomplish a goal. Members of a planned crowd have common bonds of interest and purpose.*

Simply being a part of a crowd affects a person. Each person in a crowd is, to some degree, open to actions different from his usual behavior. Crowds provide a sense of anonymity because they are large and often temporary congregations. Crowd members often feel that their moral responsibility has shifted from themselves to the crowd as a whole. Large numbers

of people discourage individual behavior; the urge to imitate is strong in humans. People look to others for cues and disregard their own background and training. Only well-disciplined persons or persons with strong convictions can resist conforming to a crowd's behavior. Crowd behavior influences the actions of *both* the disorderly participants and the authorities tasked to control them.

Under normal circumstances, a crowd is orderly. It does not violate any laws. It does not threaten life or property. It does not present a problem to authorities. But when a crowd's collective behavior becomes unacceptable to the common good, cause for concern arises. When a crowd's law-abiding collective behavior breaks down and takes a dramatic form, a civil disturbance ensues.

Civil disturbances arise when a crowd—

- Gathers to air grievances on issues and transfers its anger from the issues to the people dealing with the issues.
- Swells uncontrollably as curious bystanders and sympathetic onlookers join forces with the activists or protestors.
- Is incited to irrational action by skillful agitators.
- Adopts irrational behavior and becomes a mob.
- Consists of two or more groups with opposing views, and they become engaged in a violent confrontation.

## CROWD BEHAVIOR

Crowd behavior is influenced by the presence or absence of social factors like leadership, moral attitudes, and social uniformity. Crowd behavior is also influenced by the psychological factors of suggestion, imitation, anonymity, impersonality, emotional release, emotional contagion, and panic.

Crowd behavior expresses the emotional needs, resentments, and prejudices of the crowd members. However, a crowd only does those things that most of its members want to do. The crowd is influenced by the concerns of its members as to what is right, based on local custom, convention, and morality. But the emotional stimulus and protection of being in a crowd encourages its members to unleash impulses, aggressions, and rages that they usually restrain. When blocked from expressing its emotions in one direction, a crowd's hostility often is or can be redirected elsewhere. In a civil disturbance environment, any crowd can be a threat to law and order because it is open to manipulation.

Leadership has a profound effect on the intensity and direction of crowd behavior. In many crowd situations, the members become frustrated by confusion and uncertainty. They want to be directed. The first person to give clear orders in an authoritative manner is likely to be followed. When crowd members become frustrated, radicals can take charge. They can exploit a crowd's mood and turn them against a convenient target. A skillful agitator can increase a crowd's capacity for violence. He or she can convert a group of frustrated, resentful people into a vengeful mob. An agitator can direct a crowd's aggression toward any target included in their resentment. In fact, skillful agitators using television, radio, and other communications media can reach large portions of the population and incite them to unlawful acts without having direct personal contact. On the other hand, one person can sometimes calm or divert a crowd by a

strategic suggestion or command. An experienced leader may be able to calm a crowd, appeal to the reasoning powers of its members, and avoid a serious situation.

Crowd behavior is influenced by emotional contagion. Excitement, transmitted from one person to another, creates a high state of collective emotion. Ideas conceived by crowd leaders and dominant crowd members pass rapidly from person to person. These ideas and the general mood of the crowd sweep to bystanders and curiosity seekers, who can become caught in the wave of excitement and crowd action. Emotional contagion exceeds the bounds of personal contact. It can be passed by mass media.

Emotional contagion is especially significant in a civil disturbance environment. It provides the crowd psychological "unity." The unity is usually temporary. But this unity may be the only momentum a crowd needs to turn it to mob action. When emotional contagion prevails, self-discipline is low. Normal controls give way to raw emotions. Personal prejudices and unsatisfied desires, which usually are restrained, are readily released. This is a strong incentive for individuals to follow the crowd, to do things they have wanted to do but dared not try alone. This contagion can cause a crowd to lose its concern for law and authority. A crowd that follows its leaders into unlawful and disruptive acts becomes a mob. Mob behavior is highly emotional. It is often unreasonable. It is always potentially violent.

Panic also affects crowds. It prompts unreasoning and frantic efforts to seek safety. Panic is extremely contagious and spreads rapidly. In a state of panic, people become so irrational they endanger themselves and others. Panic can occur during a civil disturbance when crowds—

- Think or feel danger is so close at hand that the only course of action is to flee.

- Think escape routes are limited or that only one escape route exists.
- Think the limited routes are blocked or congested and passage is slowed or stopped.
- Believe an escape route is open after it is blocked and in trying to force a way to the exit, cause those in front to be crushed, smothered, or trampled.
- Are not able to disperse quickly after being exposed to riot control agents and begin to believe their lives are at risk.

*Like participants, control force members are also susceptible to crowd behavior.* They, too, are likely to become emotionally stimulated during a tense confrontation. The highly emotional atmosphere of a disturbance can infect control force members despite their disciplined training. When emotional tension is high, members may lose their feeling of restraint. Then they may commit acts they normally would suppress. Emotional contagion can also make a control force easily affected by rumor and fear. Commanders must watch for this and counteract it quickly.

In a large control force dealing with masses of demonstrators, control force members can lose their sense of individuality. Control force members must not be allowed to develop a feeling of

anonymity. Leaders must know their subordinates' names and address them by name at every opportunity. Commanders must ensure that soldiers of questionable emotional stability or with strong prejudices against the group being controlled do not participate directly in civil disturbance control operations.

Control force members, like crowd members, tend to imitate the actions of others. One improper act copied by others can result in a chain of wrong behavior. But rigorous training, effective supervision, and immediate correction of improper acts can prevent this. During confrontations a control force also must guard against coming to see the participants impersonally rather than as people. The control force should have a racial and ethnic balance to reduce the chance of seeing the disturbance as a confrontation between "them" and "us." Some control force members may harbor ill feelings toward people who look, think, or behave unlike themselves. If they take advantage of the confrontation and show their ill will, their behavior will inflame rather than reduce a confrontation. A control force must be thoroughly briefed on fair and impartial performance of their duties. *All members of the control force must be aware that they are accountable for all their actions.*

## CROWD TACTICS

In civil disturbances, crowds employ any number of tactics to resist control or to achieve their goals. Tactics may be unplanned or planned, nonviolent or violent. The more purposeful the disturbance, the more likely is the possibility of well-planned tactics.

Nonviolent tactics may range from name-calling to building barricades. Demonstrators may converse with control force members to distract them or to gain their sympathy. Demonstrators may try to convince control force members to leave their posts and join the demonstrators.

They may use verbal abuse. Obscene remarks, taunts, ridicule, and jeers can be expected. Crowd members want to anger and demoralize the opposition. They want authorities to take actions that later may be exploited as acts of brutality.

Sometimes women, children, and elderly people are placed in the front ranks. This plays on a control force's sympathy to try to discourage countermeasures. When countermeasures are taken, agitators take photographs to stir public displeasure and to embarrass the control force. Demonstrators may form human blockades to



impede traffic by sitting down in roads or at the entrances to buildings. This can disrupt normal activity, forcing control personnel to physically remove the demonstrators. Demonstrators may lock arms, making it hard for the control force to separate and remove them. It also makes the control force seem to be using excessive force.

Groups of demonstrators may trespass on private or government property. They want to force mass arrests, overwhelm detainment facilities, and clog the legal system. Or demonstrators may resist by going limp, forcing control force members to carry them. They may chain or handcuff themselves to objects or to each other. This prolongs the demonstration. Agitators may spread rumors to incite the crowd and to try to force the control force to use stronger measures to control or disperse the crowd. The agitators want to make the control force appear to be using excessive force. Terrorist groups may try to agitate crowds as a diversion for terrorist acts. They also try to provoke an overreaction by the control force.

Mass demonstrations tend to consist of people on foot. But sometimes groups organize mobile demonstrations using cars, vans, and trucks. Mobile groups often coordinate their actions by CB radios and walkie-talkies. Demonstrators also may monitor police frequencies by using scanners. They may even try to use transmitters to jam police communications or to confuse control forces through misinformation.

Violent crowd tactics, which may be extremely destructive, can include physical attacks on people and property, setting fires, and bombings. Crowd use of violent tactics is limited only by the attitudes and ingenuity of crowd members, the training of their leaders, and the materials available to them. Crowd or mob members may commit violence with crude, homemade weapons. Or they may employ sophisticated small arms and explosives. If un-

planned violence occurs, a crowd will use rocks, bricks, bottles, or whatever else is at hand. If violence is planned, a crowd can easily conceal makeshift weapons or tools for vandalism. They may carry—

- Balloons filled with paint to use as "bombs."
- Bolt cutters to cut through fences.
- Picket signs to be used as clubs.
- Pipes wrapped in newspapers to throw as deadly missiles.
- Firecrackers dipped in glue and covered with BBs or small nails to use as deadly grenades.
- Plywood shields and motorcycle helmets to protect against riot batons.
- Safety goggles to protect against tear gas.

A crowd may erect barricades to impede troop movement or to prevent a control force from entering certain areas or buildings. They may use vehicles, trees, furniture, fences, or any other material that may be handy. In an effort to breach barriers, rioters may throw grapples into wire barricades and drag them. They may use grapples, chains, wire, or rope to pull down gates or fences. They may use long poles or spears to keep control forces back while removing barricades or to prevent the use of bayonets. They also may crash vehicles into gates or fences to breach them.

Rioters can be expected to vent their emotions on individuals, troop formations, and control force equipment. Rioters may throw rotten fruits and vegetables, rocks, bricks, bottles, improvised bombs, or any other objects at hand from overpasses, windows, and roofs. In the past, troops, firefighters, and utility workers on duty during a civil disorder have been beaten, injured, or killed. Vehicles have been overturned, set on fire, or otherwise damaged.

Rioters may direct dangerous objects like vehicles, carts, barrels, and liquids at troops located on or at the bottom of a

slope. On level ground, they may drive wheeled vehicles at the troops, jumping out before the vehicles reach the target. This tactic is also used to breach roadblocks and barricades.

Rioters may set fire to buildings and vehicles to block the advance of troops. Fires are also set to create confusion or diversion, to destroy property, and to mask looting and sniping. Rioters may flood an area with gasoline or oil and ignite it. Or they may pour gasoline or oil down a slope or drop it from buildings and ignite it.

Weapons fire against troops may take the form of selective sniping or massed fire. The fire may come from within the ranks of the rioters or from buildings or other adjacent cover. The weapons used can vary from homemade one-shot weapons to high-powered rifles. Snipers may try to panic

control force members into firing a volley into the crowd. Innocent casualties make a control force appear both undisciplined and oppressive.

Explosives may be used to breach a dike, levee, or dam. Bombs can be exploded ahead of troops or vehicles so rubble blocks a street. They can be used to block an underpass by demolishing the overhead bridge. In extremely violent confrontations, bombs placed in buildings may be timed to explode when troops or vehicles are near. Demolition charges can be buried in streets and exploded as troops or vehicles pass over them. Explosive-laden vehicles can be rolled or driven at troops. Animals with explosives attached to their bodies can be forced toward troops to be set off by remote control. Even harmless looking objects like cigarette lighters and toys have been loaded with explosives and used.

## CHAPTER 3

### Federal Intervention

Federal intervention in civil disturbances begins with the issuance of a presidential proclamation to the citizens engaged in the disturbance. The proclamation directs all persons engaged in acts of domestic violence and disorder to cease and desist and to disperse and retire peaceably. If the proclamation is not obeyed, the President issues an executive order directing the use of federal forces to suppress the violence and authorizing the Secretary of Defense to use whatever forces are needed to accomplish the mission. Federal intervention in a civil disturbance ends when order is restored and the Secretary of Defense directs the withdrawal of federal forces.

### CIVIL DISTURBANCES IN CIVILIAN COMMUNITIES

A state requesting federal help to restore and maintain law and order addresses its request to the Attorney General of the United States, the chief civilian officer in charge of coordinating all federal activities relating to civil disturbances. The Attorney General has been designated by the President to receive and coordinate preliminary requests from states for federal military assistance. (Applicants presenting a request to a local commander are informed of the need to address the request to the Attorney General. The commander then immediately informs the Director of Military Support of the request and any facts pertaining to it.) When a request for federal assistance is received by the Attorney General, he sends a representative to assess the situation and make recommendations.

When the representative's assessment shows that a need for federal assistance exists, the Attorney General advises the President, who issues the proclamation directing that order be restored. If the

disorder continues, the President issues the executive order directing the Secretary of Defense to employ such National Guard and federal troops as are needed to restore law and order. The Secretary of the Army alerts and, if necessary, pre-positions control forces through the CSA, but such forces do not become involved in the disturbance until the executive order is issued.

When directed by the Secretary of the Army the CSA directs the FORSCOM commander in CONUS or appropriate commanders in US territories outside CONUS to position ground forces near disturbance areas or to move such forces into disturbance areas. The CSA alerts the Air Force to provide required air transport. He tasks other military services and DOD components to provide military resources as planned and required. He also informs the JCS, and commanders of unified commands if the operations are outside CONUS, of the actual or potential use of military resources.

Civil disturbance deployment occurs as follows:

1. Following coordination with the JCS (and OCONUS commanders, if applicable), the CSA issues a warning order or CIDCON message. This is done as far in advance as possible to allow airlift and ground force preparedness measures to begin. (For more information on CIDCONs, see Appendix.)
2. The FORSCOM commander (in CONUS) or commanders of unified or designated commands (OCONUS) nominate the task force commander and units to make up the task force.
3. CSA (COMAAC in Alaska) directs the designated task force commander and his staff to reconnoiter the disturbance area to assess the situation. The reconnaissance is made in civilian clothing using commercial transportation and communications equipment.
4. The National Guard Bureau chief notifies the state or territorial adjutant general of the task force commander's arrival.
5. The task force commander submits recommendations concerning the commitment of federal forces directly to the CSA within two hours of his arrival in the disturbance area.
6. Meanwhile, the FORSCOM commander or appropriate commander OCONUS ensures that the military forces are prepared to move. In CONUS the FORSCOM commander submits airlift and surface transportation requirements for all designated ground forces to Director of Military Support. Outside CONUS the commanders of unified or designated commands provide transportation within their capabilities. When additional transport is needed, they submit their request to the Secretary of the Army. If additional units are needed from CONUS forces to augment the forces assigned to the command concerned, REDCOM nominates the required units, provides surface transportation, and submits airlift requirements to the Secretary of the Army.
7. At the appropriate time, the CSA (COMAAC in Alaska) issues a letter of instruction to the task force commander. The content of the letter of instruction—
  - ▣ Provides for planning and preparatory actions when received. It is effective for execution on order of the CSA.
  - ▣ Specifies the task force commander's mission and designates the task force units. It also instructs the commander to be prepared to assume operational control of additional federal troops and others when so ordered.
  - ▣ Designates a command post location and authorizes direct communication with other armed forces commanders in the vicinity.
  - ▣ States that the task force commander will consult with the Attorney General's senior civilian representative, who will coordinate the federal civilian effort and assist the task force commander's liaison activities with civil authorities.
  - ▣ Directs the task force commander to cooperate with, but not take orders from, civilian law enforcement officials.
  - ▣ Advises that an on-site DOD public affairs chief will be designated to furnish public affairs advice and guidance.
  - ▣ Designates a personal liaison officer to provide assistance and advice.

- Designates the Director of Military Support as responsible for setting up and maintaining communications between the task force and the Director of Military Support watch team.
  - Provides specific instructions on the applications of force, the use and control of firearms, the detention of civilians, searches of individuals and private property, and cooperation with civil police in these matters.
  - Directs the submission of situation reports to DA at stated times and of interim reports on major changes or significant events.
  - Provides a code name for the task force for communications purposes.
8. When the task force commander receives an execution message directing him to proceed with his mission, military forces move into the disturbance area, and the task force commander assumes command of all military forces placed under his OPCON. At the discretion of the CSA, the liaison officer is withdrawn or remains in the area to assist the task force commander.

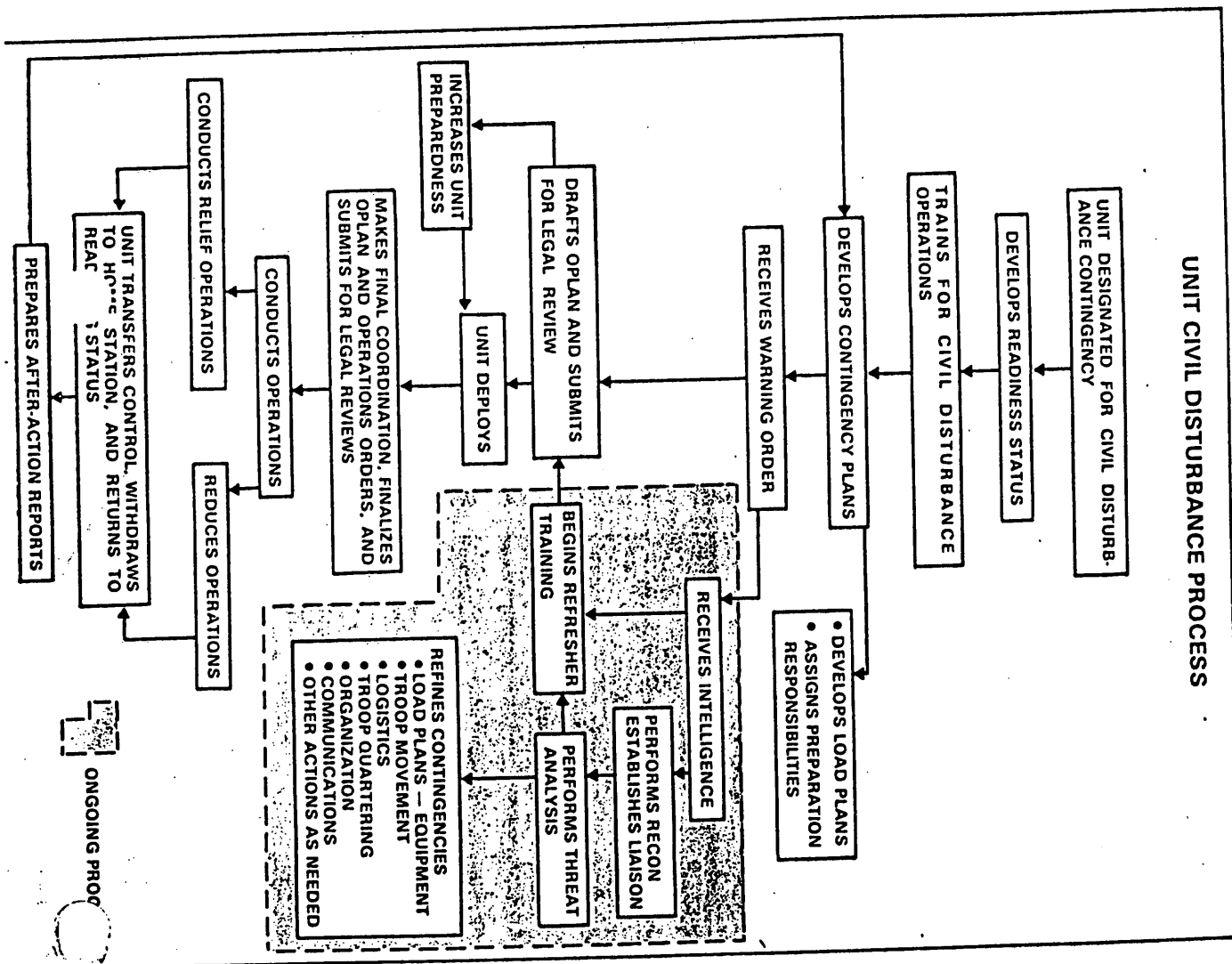

## CIVIL DISTURBANCES ON DOD INSTALLATIONS

When a civil disturbance occurs on a US DOD installation, commanders immediately take action to control the disturbance. Commanders have the authority and responsibility to control the personnel under their military jurisdiction. And commanders have the authority to apprehend and restrain or remove from the installation those persons who do not come under military jurisdiction. A commander may exercise this authority by taking such actions as are reasonably necessary and lawful based on applicable regulations.

In general, a commander's employment of the installation's military, law enforcement and security forces is sufficient to fragment, and carry out civil disturbance operations on the military reservation. (Before using nonmilitary installation security forces during civil disturbance operations, commanders obtain advice from the SJA. The SJA advises on DOD policy limiting or prohibiting the use of DOD civilian police and guards or contract security guards for civil disturbance.) But additional Federal aid may be requested if a civil disturbance presents a threat to persons, property, or functions on an installation or activity and the threat is beyond the combined capabilities of local resources.

The installation or activity commander requests support through appropriate channels to the Director of Military Support. He also advises the appropriate HQDA staff agency of the request. If an installation commander learns of a need to protect other federal property or functions,

he notifies the Director of Military Support through command channels. At the direction of HQDA, FORSCOM and MDW commanders employ augmentation forces to reinforce the internal security forces of installations and activities.

If the civil disturbance erupts so suddenly that notifying DA and awaiting instructions through normal channels presents a danger to life and property, an active Army troop commander may take such actions as the circumstances justify. Actions taken without prior authority must be for the protection of life, the preservation of law and order, and the protection of property. The overall situation may cause the commander at the site to limit his mission to the protection of life and federal property. The officer taking such action immediately reports his action and the circumstances requiring it to the Director of Military Support.

On DOD installations overseas and at US embassies and consulates, because of the possible international political ramifications of foreign civil disturbances, host-nation forces generally control disturbances targeted at US facilities. Status of forces agreements define the legal considerations that guide and constrain actions by US military commanders. Commanders must have an effective liaison with host-nation authorities. Through close coordination with host-nation authorities, US commanders can determine the level of visibility and the involvement, if any, of US forces.

## COMMAND AND CONTROL

Unlike conventional military operations under a unified command, civil disturbance operations may not have a single commander with the required authority to direct all control forces. When federal

forces are deployed to enforce US laws because civil authorities have not or will not, the federal forces serve as a part of the military power of the United States and act under the orders of the President. The



But, just as the task force commander does not turn his command over to civilian authorities, civilian authorities are not required to turn their local and state police over to the task force commander. And civilian police cannot be federalized. Thus operational unity sometimes must be sought through such means as collocating operational centers, integrating communications systems, and establishing organizational responsibilities.

Even on federal installations, the control force may consist of more than military forces. US marshals, DOD police or guards, and contract security guards may have a role in protecting an installation and preserving order. Responsibilities of non-military security and law enforcement agencies must be consistent with legal restrictions and prohibitions on their use. Job descriptions, contracts, and local laws determine how these agencies can be used to protect the installation and what duties they can perform.

Military authorities cooperate with civilian law enforcement officials to the maximum extent possible consistent with—

- The tradition of limiting direct military involvement in civilian law enforcement activities.
- National security needs and military preparedness.
- The requirements of applicable law.

The task force commander cooperates to the fullest extent possible with the governor and other civil authorities and forces unless, or until, such cooperation interferes with the mission. The task force commander, when he reasonably can, honors requests for help from civil authorities. He may direct elements of his command to assist civil authorities, but he does not place military personnel under the command of civilians. This does not preclude such measures as having joint patrols and jointly-manned fixed posts.

## TASK FORCE ORGANIZATION

An effective civil disturbance task force depends on an organizational structure that allows for inclusion of a variety of military units and personnel, including National Guard and reserve units. It also must allow for the possible integration of military units and civilian agencies within an overall force structure. The organization must take into account the responsibilities of the civil authorities and agencies that will be a part of the control force. This includes not only law enforcement agencies but community support agencies as well. Units organized for a civil disturbance mission must be in accord with the organizational principles of:

- Essentiality.
- Balance.
- Coordination.
- Flexibility.
- Efficiency.

Each part of the organization must be needed to accomplish the mission. Each element of the organization must be designed to do its part of the mission effectively without duplicating the missions of the other organizational elements. The organization must provide effective channels of communications to ensure complete coordination of all plans and operations and to prevent gaps and overlaps. The organization must be designed to perform its mission without disruption as the operation changes in scope or as the environment changes. A unit's ability to task-organize to meet mission needs, and to do so quickly, is imperative for civil disturbance operations. The total organization must provide for the efficient use of men, money, material, and facilities.

The DA Civil Disturbance Plan, known as Garden Plot, provides guidance to



all DOD components in planning civil disturbance missions. It addresses the use of military resources for civil disturbances. It sets the requirements for DOD representation at a task force's headquarters. It is published under the authority of the Secretary of the Army, DOD's executive agent for military involvement in civil disturbances. The FORSCOM commander publishes guidance on model Garden Plot organizations for FORSCOM and TRADOC units. The Director of Military Support maintains the DA Civil Disturbance Plan.

#### TASK FORCE CONTROL ELEMENT

Responsibility for controlling the civil disturbance resides with the task force. Its control element consists of the command group and the crisis management team. The command group of city, county, state, and military command personnel sets policy and issues directives. They coordinate the activities of civil and military support agencies, supervise the crisis management team, and coordinate with outside agencies. The CMT, made up of representatives of civilian and military staff sections, advises the command group and coordinates operations and support for the action element of the task force. The control elements locate in an EOC to facilitate information processing, resource management, and operational control. If community leaders have established an EOC, the task force commander may use the EOC for his command post. If an EOC has not been set up, the commander establishes one and makes provisions for including civil authorities to ensure a unity of effort.

Not all CMT members are located at the EOC. Some key people may use liaisons to represent them at the EOC. The key people can then research and discuss ideas freely, away from the confusion associated with crisis management. The liaison can transmit guidance and answers to the EOC. Some agencies may not be needed in the

EOC. Still, they may need to be notified to be prepared for inclusion. Inclusion in the EOC is based on the likelihood of an agency having to take an action or a support role and on the agency's importance to the mission.

#### TASK FORCE ACTION ELEMENT

The threat management force is the action element of the task force. The TMF carries out the orders of the command group to accomplish the overall mission of restoring order. The command group employs the TMF consistent with the rules of force and the force options. The TMF consists of three subelements: the control force, the negotiation team, and the special reaction team. The control force performs most of the operational tasks. The negotiation team establishes and maintains communications with demonstration leaders, if possible, and reduces the threat to life in special circumstances like hostage situations or bomb threats. The special reaction team serves as the final force option for handling special threats like snipers or hostage takers. When federal forces are supporting civil authorities, the TMF, like the command group and CMT, is likely to be a mix of civil and military components. Civilian and military control force assets often perform control force tasks jointly. However, civilian negotiations teams should be used rather than USACIDC negotiations teams whenever possible. And military SRT assets are used only when civilian SRT assets are not available in civilian communities.

#### Control Force

The diversity of missions in civil disturbance operations creates the need for simultaneous commitment of forces in a variety of operations. The control force must be task-organized to accomplish the mission. The control force must be composed of small units able to function separately, as well as part of the total force. The small units and teams must be able to be

committed independently of each other. The small units must be responsive to changes in the situation. And they must be able to react immediately to their leaders' orders.

Small-unit leaders must receive clear, specific, and complete guidance so they know what actions to take to deal with rapidly changing situations. Clearly defined responsibilities must be assigned and exercised at the lowest practicable level. Small-unit leaders must have adequate authority to allow them to do their jobs effectively. At the same time, organizational development must be based on unit integrity. For example, in an infantry unit the squad may be considered the basic patrol unit. If smaller units are needed, fire teams can be used. Other types of units may have to organize in a similar fashion.

Military police units are particularly well suited for employment in civil disturbance operations. MP are trained and experienced in orderly confrontation management. With very little augmentation, an MP company possesses the basic capabilities needed for successful civil disturbance operations. MP capabilities include mobility, communications, and a structure that readily adapts to task organization. MP units also have special equipment, such as hand irons, recognizable symbols of authority, and vehicle emergency equipment. MP units are routinely task-organized to accomplish MP missions. This makes the transition from one configuration to another relatively easy for MP.

**Negotiation Team**

The negotiation team's primary purpose is to assist in hostage situations that may accompany a disturbance. The team's mission is to peacefully resolve the event. It is preferable that civilian teams be employed for hostage negotiations. The task force commander coordinates with civil authorities to obtain this support. If civilian negotiators are unavailable, he

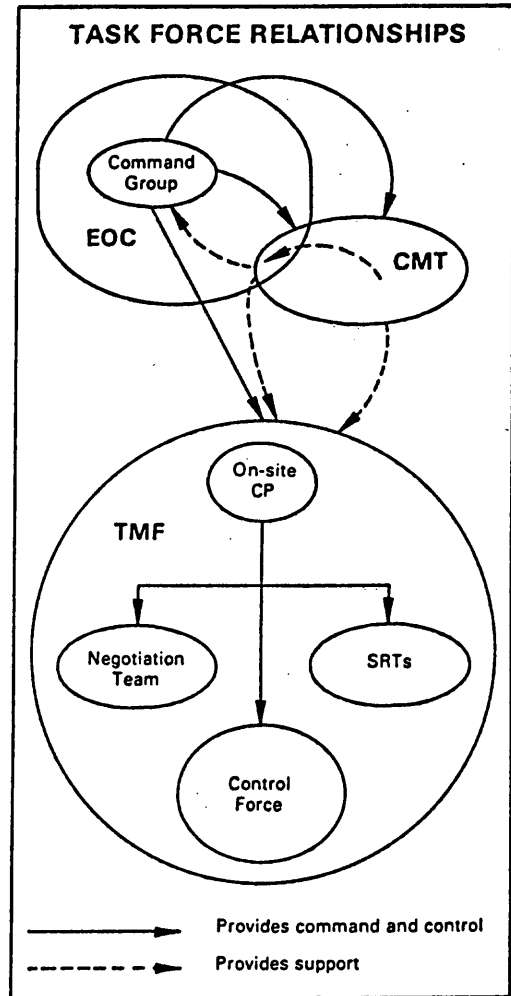

coordinates with USACIDC for a team of trained hostage negotiators.

A USACIDC negotiation team usually consists of a team leader, a coordinator, a record keeper, and trained negotiators. A linguist may be added if a language other than English is spoken by many residents in the disturbance area, especially OCONUS. The team leader coordinates the team's efforts. He commands the team and ensures that the negotiator is located away from the mainstream of CP operations, free

from distractions and interference. He also keeps the negotiator apprised of needed intelligence. The coordinator collects reported intelligence. His work is extensive when collecting intelligence on hostages, hostage takers, weapons and explosives, and the seige area. He gets intelligence from many sources, including the control force, witnesses, released hostages, and family members. The record keeper maintains a chronological record of all conversation between the negotiator and subjects, especially when dealing with hostages and hostage takers. He keeps a separate list of any and all demands and deadlines set by hostage takers. He also keeps a separate list of any and all promises and deceptions made by the negotiator.

Hostage negotiators establish a rapport with hostage takers to prolong contact and promote concessions while allowing demands to be delayed or refused. Prolonging the situation by constructively stalling for time produces advantages for the control force. These advantages are:

- The longer a situation is prolonged, the more intelligence can be gathered on the location, motivation, identity, and *modus operandi* of the hostage taker.
- The passage of time generally reduces anxiety, allowing the hostage taker to assess the situation rationally.
- Given enough time, one, some, or all of the hostages may find a way to escape on their own.
- In time, hostage takers may tire or fall asleep. This would allow peaceful resolution of the situation.
- The necessary resolve to kill or to hold out lessens with time.
- Time gives the hostage taker a chance to make the mistakes on which an alert control force can capitalize.
- Transference, also known as the Stockholm Syndrome, may take effect (see TC 19-16).

The negotiation team also can be very helpful when control force representatives meet with demonstrators to communicate concerns of the control force, to resolve issues allowing withdrawal from occupied buildings, or even to plan ways permitting peaceful demonstrators in a disturbed area. In these circumstances, the negotiator serves as a "neutral" who attempts to align the interests of the subjects with the responsibilities of the control force. The negotiator strives to—

- Be a mediator, not an arbitrator.
- Allow the subjects to set the pace, mood, and topic of conversation.
- Accept the subject's views neutrally, expressing neither approval nor disapproval.
- Keep the subjects talking.

**SUGGESTED  
NEGOTIATION TEAM  
EQUIPMENT**

- STANDARD AUDIO CASSETTE TAPE RECORDERS AND 10 HOURS OF TAPES.
- MICROCASSETTE AUDIO TAPE RECORDERS AND 10 HOURS OF TAPES.
- VIDEO RECORDING EQUIPMENT.
- ELECTRONIC MONITORING EQUIPMENT.
- EAR MICROPHONES FOR TELEPHONES FOR RECORDING AND LISTENING.
- PORTABLE TYPEWRITERS AND OTHER WRITING SUPPLIES.
- FIELD TABLES AND CHAIRS.
- PUBLIC ADDRESS SYSTEMS OR BULLHORNS.
- RELIABLE COMMUNICATIONS FOR USE BETWEEN THEMSELVES AND THE SUBJECTS.
- HAND-HELD RADIOS.
- PROTECTIVE MASKS.
- INDIVIDUAL CONCEALABLE BODY ARMOR.

The negotiation process is physically and mentally exhausting. Hostage situations especially are often lengthy. It is recommended that each team have two negotiators. If more than one negotiator is used, a gradual shift from one negotiator to another helps to maintain the desired level of rapport. Successful negotiators are mature, mentally and emotionally stable, and neither overbearing nor antagonistic in their attitudes. They are experienced in communication techniques, including being good listeners. They also are sincere, flexible in their dealings, and physically fit.

#### Special Reaction Team

If high-risk incidents posing a grave danger occur during civil disturbance operations, the control force must have access to specially-trained teams to neutralize the special threat effectively and safely. Special threat incidents include—

- Hostage rescues.
- Barricaded criminals.
- Barricaded criminals with hostages.
- Sniper incidents.
- Terrorist incidents.
- Apprehensions of dangerous suspects.
- VIP protection and escort.
- Threatened suicides.
- Search and evacuation operations.
- Barricaded, mentally disturbed people.

The control force commander can quickly and successfully resolve a special threat by requesting the support of an SRT. A highly-motivated, well-conditioned team specially equipped and trained to function as a tactical unit can be effectively and safely employed in such special threat

situations. The commander uses civilian SRTs, if possible. If civil authorities do not have SRT assets, then a military SRT may be employed. A low-level threat only requires a general SRT manpower and equipment response capability. A sophisticated threat, posed by groups having unique abilities and seeking specific targets, requires responding SRTs to possess specialized training and equipment.

SRT actions are based on a thorough knowledge of the situation, a tactical plan, and a minimum use of deadly force. The priority of actions by SRTs during an operation is—

1. Protecting lives, including hostages, law enforcement personnel, bystanders, suspects, and offenders.
2. Securing the safe release of hostages.
3. Apprehending the offenders.
4. Isolating and containing the incident.
5. Gathering information and intelligence. This is a continuous responsibility from the start of an incident until its resolution.
6. Protecting property and equipment.
7. Conducting an assault if all other available options have been exhausted or the situation has deteriorated to the point where loss of life is considered imminent. An SRT assault is a last resort.

These priorities apply to nearly all special threat situations. The one exception to these priorities is a special threat situation involving a nuclear weapon. The recovery of the weapon is the overriding consideration. See AR 50-5.

E
MEMBER
TEAM LEADER
SCOUT
MARKS- MAN
OBSERVER
DEFENSE- MAN

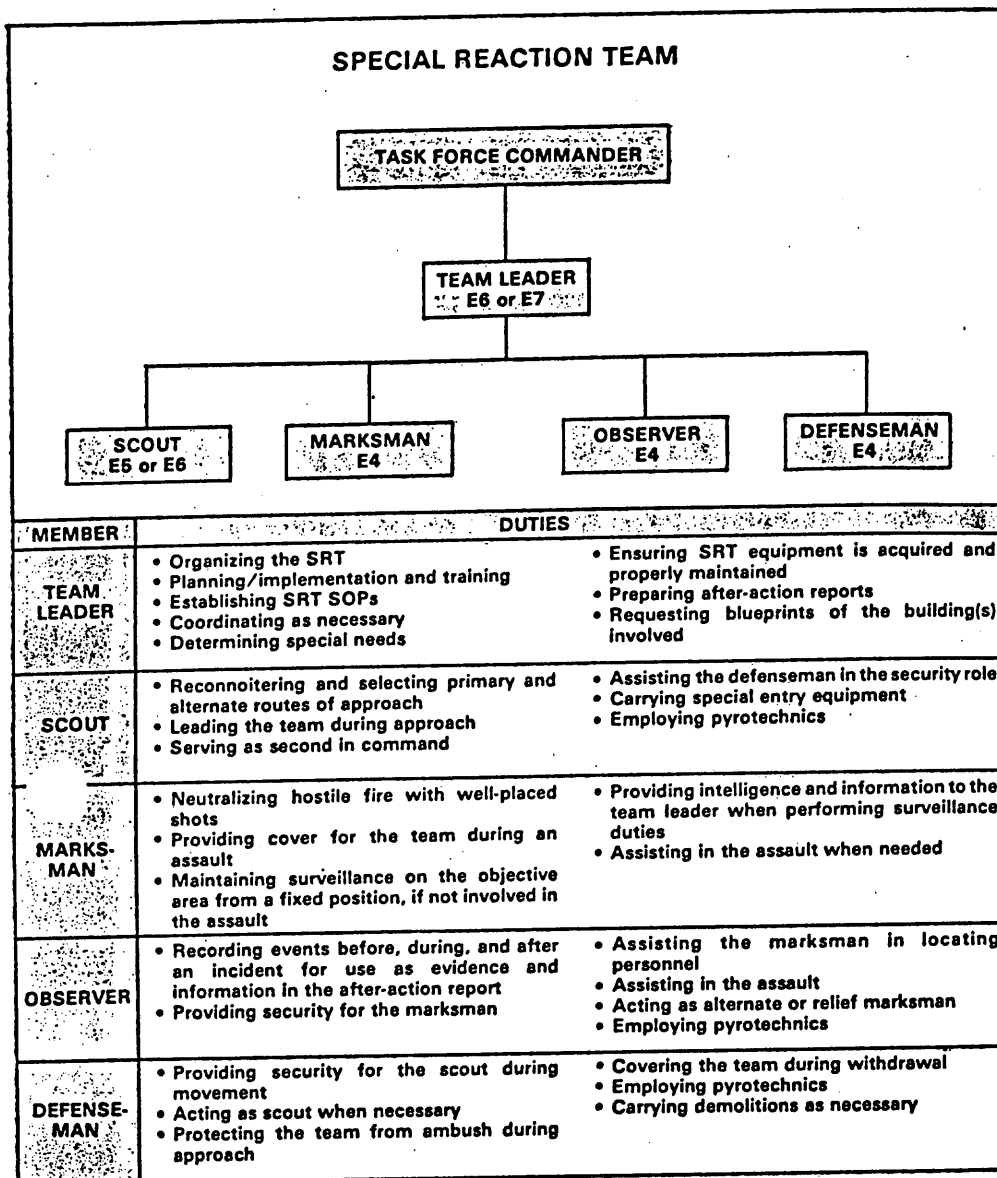

fold in

## CHAPTER 4

### Information Planning and Threat Analysis

Information is the key to developing civil disturbance plans. Who are the demonstrators? When and where will they demonstrate? What are their capabilities and possible courses of action? A civil disturbance task force commander's need for current, valid information cannot be overemphasized. He must learn as much as he can about the participants, their motivations, their strategies and tactics, their targets, and their dedication. The more knowledge he has about the participants, the better equipped he is to counter their actions. He needs sound information to decide how best to use his available resources.

To be useful, collected data must be processed into "intelligence." It must be seen in relation to the social, economic, and political climate of the area, and the likelihood of active participation or support from the local populace. Obtaining and developing intelligence in a timely manner is a top priority in order to use the information to assess the threat. Threat analysis begins with a broad examination of all

information bearing on the security of an installation or a community. It focuses on potential threats. It identifies likely targets and vulnerabilities. Completed, it enables a commander to assess the threat of a civil disturbance to an installation, a mission, or a community. It forms the basis for his operational plans to counteract a civil disturbance.

### INFORMATION NEEDS AND SOURCES

Planners must decide what data is needed to develop a threat assessment. They must also develop a list of information sources. Planners must be able to obtain information quickly during a disturbance. And they must have ways to obtain information from many sources at once.

Useful information can come from open sources, law enforcement sources, and military sources. Having a diversity of sources is the best approach. Information from many sources prevents biased behavior.

Open sources of information are perhaps the most overlooked valuable sources of

information. The installation library is usually a good source of information. It may have a wealth of open-source material on past and current political events relating to a disturbance. Newspapers and news periodicals are also good sources of information. They run articles or special sections on events that may lead to or have led to a disturbance. Often, they publish interviews with organizers. These interviews may provide insights into the thoughts, perceptions, and intentions of a crowd's leaders. Radio and television interviews are very informational. And they provide more real-time information than newspapers, which have less flexible deadlines. In some cases, radio and TV

provide live coverage of a disturbance. For this reason access to a TV and a radio is a must.

Law enforcement sources can provide useful information on criminal activists. Provost marshals, military police, and criminal investigators routinely work with criminal information. Information also can be obtained from local, state, and federal law enforcement agencies. Criminal information provided by law enforcement agencies may reveal potential agitators. It also may provide information on criminals or terrorists who may try to exploit a disturbance.

The intelligence community is the most restricted source of information. Liaison

with agencies that routinely collect information or intelligence is needed to know if they can support civil disturbance control operations. The DOD intelligence organizations operate under limitations imposed by regulations and executive orders. Attempts to skirt these restrictions may violate regulations or federal statutes. But intelligence organizations often can provide important, reliable data for operational planning within these limitations. Local MI field offices must be an integral part of all plans. They know the rules for collecting and storing intelligence. And they can provide valuable advice in this area. If any doubts arise about the legality of collecting and storing intelligence, the SJA must be consulted.

## INFORMATION RESTRICTIONS

Collecting information related to a civil disturbance is strictly limited to protect the civil rights of people and organizations not affiliated with DOD. Civil disturbance plans and materials must not include lists of groups or people not affiliated with DOD. But lists of local, state, and federal officials who have direct responsibility for the control of civil disturbances are exempt. Data on vital public, commercial, and private facilities that are believed to be civil disturbance targets also are exempt from this prohibition. Information on civilians and civilian organizations can be collected only with specific authorization from the Secretary or the Under Secretary of the Army. Conditions for collecting information include the existence of threats against Army personnel, functions, or property. (See AR 380-13 and AR 381-10.) Civil disturbance information available in public documents, or open source information, may be collected. But specific rules regarding its storage must be followed. Commanders must coordinate with SJA, MI, and USACIDC personnel before collecting any such information.

The Army cannot gather, process, store, or report information on civilians unless civilian activities can be linked directly to a distinct threat of a civil disturbance that may involve federal military forces. Even when information can be collected, certain restrictions apply. The key restrictions include the following:

- Computerized data banks for storage of civil disturbance information are established or retained only with the approval of the Secretary of the Army.
- Civil disturbance information relating to persons or organizations is stored only when DA so orders.
- Spot reports generated by information collection efforts must be destroyed within 60 days after the disturbance ends.
- After-action reports may, for clarity's sake, contain names of people and organizations who were directly involved in the civil disturbance being reported. But the inclusion of names must be kept to an absolute minimum.

- When a civil disturbance ends, the nature and extent of all accumulated files other than spot reports and after-action reports must be reported to DA. The report also must recommend that the Department of Justice either release the files or destroy them.

Classification of information also limits storage, access, and handling. In general, classified information cannot be shared with local and state law enforcement agencies. This restriction can hinder working relationships with these agencies. The law enforcement agency may see the military only as a receiver of intelligence, providing nothing in return. If this problem arises, and time is available, planners can ask the source to release an unclassified version. Secure transmission capabilities *must be used* to discuss any portions of classified information being requested.

If the Department of Justice determines federal intervention in a civil disturbance is likely, information relating to the disturbance is provided to the Army Assistant Chief of Staff for Intelligence. The information is analyzed and then provided to the Director of Military Support

and the task force commander for planning purposes.

Military intelligence collection efforts, except liaison, may begin only when DA so orders. During a civil disturbance, the orders must come through the CSA's personal liaison officer and the task force commander. Covert operations to gather information on nonDOD individuals and groups must be approved by the Under Secretary of the Army. Such approval is on an operation-by-operation basis, and it must come through the personal liaison officer and the task force commander.

When DA approves collection efforts, MI elements establish and maintain liaison with the appropriate local, state, and federal authorities. Using these liaisons, the MI elements collect information on incidents and the general situation. They estimate the civil authorities' ability to control the situation. Based on current plans, they report the results of their collection efforts to DA. They keep the appropriate commander informed. They provide intelligence support to the personal liaison officer and the task force commander. They also recommend other overt collection methods to DA for DA approval.

## THREAT ANALYSIS

Threat analysis is a fluid and continuous process. As data for the analysis change, so do the results. Planners must adjust their plans to incorporate changes that occur during the threat analysis.

Three kinds of information are analyzed to produce a valid threat analysis: intelligence and criminal information, threat information, and installation/community vulnerabilities. Intelligence and criminal information provide information on the goals, methods of operation, techniques, strategies, tactics, and targets of individuals and groups. Threat information identifies individuals and groups. Vulnerability information identifies security weaknesses and high-risk targets.

Both subjective and objective information are analyzed. Public perceptions are compared with more objective, measurable information. This can show how much public opinion differs from the objective measurement. Key factors to be analyzed include:

- State of the economy.
- Standard of living.
- Effectiveness of law enforcement.
- Stability of the government and of the population's social and economic situation.
- Morale of the population, their support of the government, and the government's support of them.



Some factors change slowly or infrequently. These factors include the terrain of the area being analyzed and the political and ethnic traits of the population. Dynamic factors like weather, economic conditions, and security and law enforcement resources change often. Some dynamic factors can be controlled. Movements of money and weapons, security of local sites, and allocations of military personnel can all be controlled. But many dynamic factors cannot be controlled. These include the weather and the actions of local law enforcement agencies.

Planners can use the Installation Vulnerability Determining System as an analytic tool. It will help them identify vulnerabilities, set up training priorities, and allocate resources. IVDS was developed to help counter terrorist threats. But by exchanging terms, like demonstrators for terrorists and community for installation, IVDS can be tailored for civil disturbances. IVDS is a guide only. A low score does not necessarily mean that there is not a problem. For detailed information on the IVDS, see TC 19-16.

IVDS assesses:

- The installation's or community's characteristics and its attractiveness as a target for terrorist acts or civil disturbances.
- Status of training.
- Availability of communications.
- Nonmilitary law enforcement resources.
- Time and distance from US military installations that can lend assistance.
- Time and distance from urban areas.
- Geographic region.
- Proximity to foreign borders.
- Access to the installation or the community.
- Population density of the installation or the community.
- Terrain.

There are other techniques for making a threat analysis. Planners can apply a think-like-the-opposition technique and develop plans that the opposition might use. This technique can help identify vulnerabilities and how they could be exploited. Games can be used to develop scenarios to identify the threat and to plan countermeasures. Scenarios can be developed for situations involving passive resistance, blockades, violent confrontations, bombings, arson, hostages, and occupations of buildings. Although scenarios are unlikely to occur exactly as conceived, they are beneficial. They help identify potential problems that can be corrected before a disturbance becomes a reality. Command post exercises and field training exercises are useful methods for training personnel to respond to civil disturbances. CPXs can help identify high-risk targets. They also are useful in training the people who will operate the EOC. An FTX allows planners to assess response capabilities. FTXs also provide opportunities for evaluating vulnerabilities from the demonstrators' viewpoint. If an FTX cannot be held in the community where a disturbance may be expected, a community or an area with similar characteristics can be used. And committees or councils are another means of evaluating threats and vulnerabilities. Such groups should include people who would play a major role in a civil disturbance operation, particularly logistics personnel and key community officials. Groups such as these ease the exchange of information and make for more effective civil disturbance planning.

When available information has been collected and the vulnerability study is complete, an assessment of the threat can be made. Although some weaknesses cannot be corrected, others may only require the careful use of resources. Plans must be made to obtain resources that are not readily available. Using the identified vulnerabilities, planners categorize these

weaknesses based on the specific countermeasures needed to offset them. An overview of the countermeasures can reveal additional weaknesses.

To be of value, threat analysis must be a continuous function. As vulnerabilities are reduced in some areas, other areas

may become more vulnerable. Changes in mission, tasks, and personnel also may have an impact on the status of the current threat analysis. Failure to update a threat analysis on a regular basis or to correct or compensate for vulnerabilities can adversely affect response capabilities for civil disturbances.

#### INFORMATION NEEDS FOR PLANNING CIVIL DISTURBANCE OPERATIONS

- Goals of the groups that are likely to cause or are causing civil disturbances.
- Times and locations of disturbances.
- Causes of disturbances.
- Identity of persons, groups, or organizations that have distinctly threatened to cause or are causing disturbances.
- Estimated number of people who will be or are involved in the disturbance.
- Likely places where crowds could assemble.
- Presence and location of leaders and individuals who have threatened to cause a civil disturbance.
- Group structure and types of activities group can carry out.
- Sources, types, and locations of arms, equipment, and supplies available to the group.
- Possible use of sewers, storm drains, and other underground systems by participants.
- Attitude of general populace toward groups causing civil disturbances, toward civil law enforcement authorities, and toward federal intervention.
- Presence of threats to utilities that serve the public.
- Kinds of communications and control methods used by participants and organizers.

## CHAPTER 5

### Operations Planning

Successful civil disturbance operations depend on adequate plans and well-trained control forces. Planning for civil disturbance operations is a continuous process. Such planning involves coordination of personnel, logistics, and operational considerations. It provides for the actions to be taken before, during, and after civil disturbances. It is based on the assumption that federal military resources may be committed at any time, with or without warning, to assist local and state authorities or to enforce federal law. Such commitment may involve either limited or massive employment of forces.

#### COORDINATION OF CIVILIAN AND MILITARY EFFORTS

When federal forces are requested to help civil authorities attempting to control a disturbance, coordination with local civil authorities is a must to prevent duplication

of effort. The task force commander must know what civilian resources have been and will be committed to disturbance operations.

#### SUGGESTED COORDINATION CONTACTS

- CITY/COUNTY/STATE GOVERNMENTS
- CITY/COUNTY/STATE LAW ENFORCEMENT AND SECURITY AGENCIES
- IMMIGRATION AND NATURALIZATION SERVICE AND ITS BORDER PATROL
- CAMPUS SECURITY POLICE
- PRIVATE POLICE AND SECURITY ORGANIZATIONS
- FIRE DEPARTMENTS
- EMERGENCY RESCUE AND MEDICAL SERVICES
- PUBLIC WORKS DEPARTMENTS
- PUBLIC UTILITIES
- PARKS AND RECREATION DEPARTMENTS
- CITY SOCIAL SERVICES DEPARTMENTS
- CITY ENGINEERS
- CITY ATTORNEYS
- CITY PUBLIC RELATIONS OFFICIALS
- CIVIL AIR PATROL
- CIVIL DEFENSE ORGANIZATIONS
- INDEPENDENT SOCIAL RELIEF AGENCIES, SUCH AS THE RED CROSS AND THE SALVATION ARMY

Civil agencies and their responsibilities, organization, and authority vary considerably from community to community. The task force commander must have an index of the various agencies, their responsibilities, lines of communication, and points of contact. Based on this index, he can plan for liaison needs and for joint civilian and military efforts. Local authorities and National Guard troops can supply valuable information. They know the area, the local agencies, and the population. Among the major areas requiring coordination are the following:

- Preservation of law and order.
- Custody of offenders.
- Documentation of evidence.
- News releases.
- Traffic and circulation control.
- Exchanges of situation information.
- Care of the injured.
- Evacuation, housing, and feeding.
- Protection of key areas, facilities, and personnel.
- Delineation of areas of responsibility and establishment of joint patrols.
- Removal of debris that interferes with operations.
- Explosive ordnance support.
- Equipment.
- Use of facilities.

Sometimes commanders must undertake joint civilian and military efforts with agencies that provide resources under "mutual aid" agreements. Mutual aid agreements and their legal considerations vary from community to community. Some states have more detailed agreements than others. Lines of responsibility and authority between state, county, and local

authorities can be confusing. Civilian command is not clear cut. State laws and local ordinances vary widely on this point. The legal aspects of mutual aid agreements may affect the types of activities in which the agencies may become involved. Joint operational plans must be drawn up with due consideration to legal authority. Legal and jurisdictional boundaries also affect the process of controlling the disturbance, especially if the disturbance crosses these boundaries. Because control of a disturbance within a given jurisdiction is the responsibility of that jurisdiction, command and control of the disturbance may suddenly shift when the disturbance crosses boundaries. In some states, especially where mutual aid is not clearly defined, law enforcement personnel operating outside of their normal jurisdiction only have the power of citizens arrest. And the laws concerning citizens arrest also vary considerably from community to community. Early discussion of jurisdictions with the agencies involved can reduce possible confusion and provide for a smooth transfer of control.

Whenever practical, assigned unit boundaries should coincide with local police subdivisions. This simplifies coordination of activities in the area. Boundaries usually are located along streets or alleys, with coordinating points at intersections. When a street is designated as a boundary, responsibility for both sides of the street is given to one unit to ensure proper coverage. Arrangements should be made to have troops and civil police operate together. In addition to the joint patrols and posts, arrangements should be made to exchange liaison officers at each headquarters, from company through division, on a 24-hour basis.

## FUNDING AND MILITARY RESOURCES

Federal forces participate in civil disturbance operations as an unprogrammed

emergency requirement, and Army resources under DA control are loaned to

state and local governments and law enforcement agencies as a temporary emergency measure. Therefore the costs incurred by the Army as a result of such operations are financed in accordance with AR 500-50. And the policies and procedures for equipment loans, including property issued to the National Guard are delineated by AR 500-50.

Army resources are classified in three groups. Requests are considered for approval in the following order:

- **Group One**—Personnel, arms, ammunition, tank-automotive equipment, and aircraft. Requests for personnel to be used for direct law enforcement must be made by the state's legislature or governor. Requests for other Group One resources can only be granted by the Secretary of the Army or, when so designated, the Under Secretary of the Army.
- **Group Two**—Riot control agents, concertina wire, and similar military equipment that is not included in Group One. Requests for these can only be granted by the Secretary of the Army, the Under Secretary of the Army, or the Director or Deputy Director of Military Support in coordination with the

General Counsel of the Army. When authorized by the Secretary of the Army, the task force commander also may approve Group Two requests.

- **Group Three**—Firefighting resources, including personnel; protective equipment and other equipment not included in Group One or Two; and the use of Army facilities. Requests for these resources may be granted by the Secretary or Under Secretary of the Army, major Army commanders, commanding generals of CONUS armies, the MDW commander, and commanders-in-chief of unified commands outside CONUS.

Commanders who have Group Three approval authority can approve requests for Group Three military resources, less active duty and reserve forces, to nonDOD federal agencies before or during civil disturbances. Commanders who have Group Three approval authority also can approve requests for Army resources less personnel, regardless of classification, to National Guard units in an active duty status. Loans of Army resources will be approved, if possible, when the National Guard is authorized such resources, but DA cannot provide them on a permanent basis.

## LOGISTICS

Civil disturbance operations involve special consideration of logistical needs. Logistics planning must provide for obtaining supplies, services, and facilities through local procurement. This includes food and beverages, laundry services, and sanitation facilities. When planners set up lines of supply, they should consider using nearby installations or National Guard and Reserve facilities. Logistics planners should visit the disturbance area to identify sources and to coordinate support. Authorities must identify all civil and military equipment and material

assets, regardless of ownership, that are available within a disturbance area to supplement military resources.

### TASK FORCE SUPPLIES AND EQUIPMENT

Supplies and equipment that will accompany a unit must be ready so the unit can respond rapidly in emergencies. Supply lists must be developed with unit integrity in mind. Units must be able to operate with self-sufficiency. Among the items that must be provided for are

ammunition, food, water, gasoline, lubricants, spare parts, riot control agents, maps, and administrative supplies. A running inventory must be kept and complete inspections made as necessary. Procedures must be in place for the periodic replacement of certain items. Bulk riot control agents, ammunition, food, and gasoline deteriorate in prolonged storage. Retention of unserviceable materials can have grave consequences in an emergency. Ammunition must be segregated by type. That way, if there is a late notification of weapons restrictions, nonessential ammunition can be separated before shipment.

Some equipment or supply items that the task force may need are not organic to the unit or may not be transportable by the available means of transportation. If this situation should arise, commanders must advise the chain of command so that these items can be made available to the task force through special transportation arrangements, by drawing from pre-positioned stocks, or by borrowing them from units close to the objective area. For example, STANO equipment, which not all units may have, can be used to—

- Locate and neutralize snipers.
- Secure roadblocks and checkpoints.
- Prevent ambushes or frontal attacks by crowds.
- Augment security patrols of isolated areas.
- Identify friendly and hostile elements.

Individual and organizational equipment prescribed in CTA and TOE for troops and units are often not sufficient for civil disturbance operations. Ways to obtain additional equipment must be considered when planning logistical support. For example, vehicle augmentation may be needed to meet mission requirements. Other additional equipment that may be needed includes:

- Locally purchased or manufactured body shields.
- Armored vehicles.
- Riot batons.
- Flexcuffs.
- Riot control agent dispersers.
- Floodlights, spotlights, and searchlights.
- Night observation devices.
- Communications equipment, particularly hand-held equipment.
- Videotape and instant-developing film cameras.
- Public address systems.
- Heavy construction equipment.
- Concertina wire.
- Aircraft, especially helicopters.
- Ambulances, first aid kits, and firefighting equipment.
- Grappling hooks, ladders, and rope.
- Special weapons.
- Generators.
- Personal protective equipment, such as faceshields and protective vests.

Planners should consider the need for extra tents, cots, and, perhaps, tent stoves. Plans also should provide for barricade and roadblock materials and equipment needed to build, set up, and remove barricades.

Procedures must be established for resupply in the disturbance area. Logistical contact teams can be set up in the disturbance area. Contact teams must have direct communications with support units so they can get critical supplies as soon as needed. Requisition priorities must be set to ensure a fast response to resupply requests.

Suggested supplies and equipment to accompany the task force are listed in Appendix 1 to Annex D of Garden Plot. The list of supplies contained in Garden Plot is the *minimum* needed to support a civil disturbance operation. Commanders and other planners should not rule out other items of equipment just because they are not on this list.

### ASSEMBLY AND TROOP QUARTERING AREAS

When possible, assembly and troop quartering areas should be on federal, state, or public property to reduce claims for property damages, contract costs, and the dissatisfaction over perceived inequities among the populace. Reserve centers and National Guard armories are ideal locations. As a general rule, assembly areas should be located away from the direct observation of disturbance crowds. This improves operations security and avoids direct harassment of the troops. Quartering areas are selected only after careful consideration of the physical security measures needed to protect the area and the troops. But assembly and quartering areas must be close enough to a disturbance area to ensure that troops can be committed quickly. And there must be adequate main and alternate routes between the areas. Other factors to be considered when selecting quartering areas are:

- Weather that is likely to be encountered.
- Number of troops that are likely to be using the area.
- Length of time that the troops will be using the area.
- Availability of sanitation facilities and recreation areas.

### TASK FORCE MOVEMENT

Movement to and within disturbance areas must be considered when developing operational plans. The means of movement is critical to the success of the operation because of the time factor involved. Usually, troops are committed to civil disturbance missions on extremely short notice. They must arrive promptly if the disturbance is to be contained with minimal injuries and property damage. Troops must be moved to the objective area in a mission-ready status, while minimizing the cost to DOD and to the military departments concerned.

Because rioters can use tactics that will delay the arrival of troops, the commander selects the most direct routes that are least vulnerable. Close coordination with the movements officer is vital. The commander plans reconnaissance patrols for security en route and at arrival points. The main body must be preceded by a party of sufficient strength to prevent interference with the main body's arrival. The commander also plans alternate routes and arrival points.

Coordination with transportation units must be a part of task force development. Each mode of transportation must be carefully developed during logistics planning. The final plans must be able to be executed quickly. Foot, rail, water, air, and motor movements all offer certain advantages and disadvantages. Some modes require more coordination and earlier preparation than others. Rail movements usually involve the use of special trains, the selection of entraining and detraining points, and the calculation of departure and arrival schedules. Coordination with railroad officials, therefore, is an important planning step. When selecting air travel, task force planners must determine the characteristics of available aircraft to facilitate proper loading. In motor moves, provisions must be made for supplies of gasoline and repair parts. When forces are to be airlifted into a disturbance area, planning must include provisions for sufficient ground transportation and communications equipment in the disturbance area.

Planners must also consider transportation for use within the disturbance area. They consider the use of commercial buses and rental cars. The buses could be used for mass transportation in the disturbance area. Unit vehicles can be augmented with additional vehicles to provide sufficient flexibility and mobility for operational and support elements and mobile cordons. Helicopters and fixed wing aircraft also should be included in transport planning

for use within a disturbance area. Whenever possible, helicopters are employed to provide command and control, surveillance, medical evacuation, troop lift, and supply lift capabilities. Planning also must address the selection of landing zones and the use of air traffic control measures in the disturbance area.

All units with civil disturbance missions must maintain qualified personnel for preparing load plans and certifying special

handling data forms. Load plans must be developed for each mode of transportation. Personnel and equipment load plans must be based on unit integrity to ensure that the control force arrives in the disturbance area prepared for immediate employment. Except for limitations in handling hazardous equipment, each element of the force should take its required equipment and a small reserve of ammunition, riot control agents, and basic supplies. Load plans must be rehearsed and made a part of unit SOPs.

## COMMUNICATIONS

Civil disturbance operations require adequate and versatile communications equipment. Communications must be maintained at the disturbance scene and between the scene and the operations headquarters. Planners must consider using every means of communication available, including:

- Telephones.
- Hand-carried and vehicle-mounted public address systems.
- Commercial radio and television stations.
- Teletype machines.
- Taxicab radio nets.
- Military and civilian police radios.

Civilian communications systems should be used as much as possible, but they must be supported by an independent military system. And the military system must be able to sustain all essential communications. If military equipment is not compatible with the civilian equipment, plans must be made to collocate stations, exchange equipment, allocate frequencies, or

set up net radio interface/phone patches. (Net radio interface stations connect mobile radios to switching systems. From there, the routing goes to telephone subscribers.) Signal security measures, including authentication systems, are used during disturbance operations. Radio operators working close to rioters use headsets to receive messages and a low voice to send messages to keep rioters from hearing the messages. And troops must know emergency procedures for clearing the radio nets.

Public address systems are useful in issuing proclamations and psychological pronouncements or persuasions. They can drown out vocal demonstrations. They help prevent vocal communications between crowd leaders and crowd members. And they can be used by commanders to direct and control troops. Control force leaders wearing protective masks can use megaphones with battery-operated loudspeakers to convey instructions to troops.

Visual signals also can be useful. Flares can signal the beginning and ending of operational phases. Hand and arm signals and messengers also can be used.

## RELIEF

Civil disturbance operations are demanding, both mentally and physically. Troops

need relief if efficiency and discipline are to be maintained. During civil disturbance



## ADMINISTRATION

Plans and administrative procedures must be developed to handle personnel actions resulting from the commitment of forces to civil disturbance duty. Personnel plans must provide for care of dependents and personal property left at home station, indebtedness, emergency leave, sickness, and injury. To ensure personnel matters are properly handled in the disturbance area, members of unit personnel sections must accompany the task force.

### DISCIPLINE, LAW, AND ORDER

Directives must be published that clearly set the standards of conduct and appearance expected of the troops in the performance of their missions. Troop relationships with, and attitudes toward, civilians must be stressed. The provost marshal can provide helpful advice on matters of discipline, law, and order. Troops must refrain from acts that could be damaging to the high standards of personal conduct and discipline of the Army.

Appearance and discipline of federal forces have a psychological impact on the populace and facilitate mission accomplishment. Leaders must ensure that subordinates are clean, well-groomed, neat, and conduct themselves in the highest standards of military courtesy and discipline. *The importance of strict adherence to prescribed standards of conduct and fair treatment of civilians must be stressed continuously.*

### MORALE AND WELFARE

Morale and welfare are areas of particular concern in civil disturbance planning because of the restrictions and demands imposed on the troops. Because control forces must perform very sensitive duties under great physical and mental stress, the

following services are extremely important:

- Rest and recreational facilities, such as free movies, special service activities, TVs in barracks, and athletic equipment and facilities.
- Assistance to dependents and access to American Red Cross and Army Emergency Relief services.
- Post exchange facilities, including barber shop and laundry facilities.
- Financial services and access to a bank.
- Medical and dental services.
- Postal services.
- Leave and passes.
- Religious services.
- Legal assistance.
- Decorations and awards.

These services are necessary to maintain high morale and to allow soldiers to concentrate on the complex, sensitive, and stressful tasks that they must perform during civil disturbance operations.

### MEDICAL SERVICES

Emergency medical attention must be available for military and civilians. Medical support for civilians, however, should be provided by civilian medical facilities. Military facilities should be used by civilians only to prevent undue suffering or loss of life or limb. Plans must provide for qualified medical personnel, air and ground ambulance service, medical facilities, medical supplies, medical evacuations, and casualty reporting. Casualty notification procedures are prescribed in AR 600-10. Factors to consider for medical facilities include location, sources of power and water, and sanitation facilities. Existing medical facilities, military and civilian, can be used whenever practical.

### MEDIA RELATIONS

Whenever federal forces are committed to a disorder, media interest is generated. In a

disturbance area the public is directly affected by actions taken individually and

collectively by military personnel. Similarly, the public outside the area has an intense interest in events taking place within the area. Press interest in most cases will be high. Unless timely, accurate information is furnished, the press will be forced to rely on speculation and rumor.

Soldier responsibilities with regard to media contact must be made clear. Soldiers must be informed that they must treat media members with courtesy and respect. They also must be cautioned not to make any comments concerning upcoming or active civil disturbances and unit missions, even if told their remarks will be "off the record." Soldiers, when approached, refer media members to superiors or the PAO.

The task force commander must anticipate media contact. Plans must include the clearance of all news releases with the Assistant Secretary of Defense for Public Affairs, the on-site public affairs chief, or a higher authority, whichever is appropriate. Procedures must be established for confiscating film and videotape of prohibited areas. Both the PAO and the SJA must review the procedures to ensure that the ability of the media to gather and report news is not unduly restricted. To help maintain media relations, plans also must include:

- Procedures for furnishing accredited media members with press passes to facilitate their passage through police lines and military checkpoints. News media members must be allowed freedom of movement as long as they do not interfere with control force operations.
- SOPs for coordinating press requests to cover operations in the disturbance area, including furnishing military escorts.
- Establishment of a newsroom by the task force PAO. The newsroom can be used for periodic press briefings and for furnishing the media with fact sheets

and other background data concerning the operation.

- Regular news conferences and periodic briefings. They should be held by senior civilian and military officials who can provide timely, accurate information and the opportunity for the media to question senior commanders. When it is practical, the task force commander should consider allowing the media to accompany senior officials on tours of the affected area.
- Making news releases concerning civil disturbance operations and instructions for public cooperation. These releases must comply with AR 360-5.
- Liaison and coordination with local civilian public affairs officials and information agencies. This simplifies the exchange of information, ensures the information's accuracy, and generally aids the news-gathering effort.
- Setting up a rumor control center. A rumor control center helps reduce the adverse effects of misinformation.

DA public affairs policy is to provide the public, through cooperation with the news media, prompt, responsive, and accurate information. Emphasis must be placed on the fact that the Secretary of the Army has been assigned a mission, assisted by DOD components, to help civil authorities in restoring and/or maintaining law and order. It also must be pointed out that the mission will be accomplished using the minimum force needed. Maximum disclosure of accurate information on the situation in the disturbance area with minimum delay is the governing principle, subject only to security and operational needs. Annex F of Garden Plot provides the commander with guidance on the responsibilities for disseminating public information. Annex F also provides guidance that can aid in planning for personnel and equipment to conduct information activities in the disturbance area.

Appropriate operating procedures and command guidance must be issued *in writing* to prevent the release of information potentially harmful to the military mission. Members of the news media must be clearly informed of the location of prohibited areas that may not be photographed or videotaped and restricted areas where they must have a proper escort. If soldiers must detain or apprehend members of the media for entering restricted areas without proper authorization or for trying to film or videotape prohibited areas, the soldiers notify their leaders immediately. Operating procedures should include the locations of

newsrooms and the access control procedures for restricted areas. In most instances, the media will not be furnished communications or transportation, nor will a press center be set up in the disturbance area. But a newsroom should be set up. The media should be afforded the use of tables, chairs, typewriters, and other equipment associated with a newsroom operation when this use does not interfere with control force operations. If the military is the only source capable of providing communications and transportation support, such support will be provided, if possible. However, prior arrangements must be made for reimbursement.

## PLANS AND REPORTS

Detailed plans for civil disturbance operations at each level of command implement the plans of the next higher echelon. Contingency plans are prepared based on a reconnaissance of the disturbance area and a comprehensive review of after-action reports of similar operations. Each plan shows an assembly area, routes and alternate routes to the assembly area, tentative locations of roadblocks and OPs, and temporary facilities for billeting, feeding, and detention. Maps, overlays, aerial photographs, and sketches of the area should be obtained. Plans for distribution and reserve stockpiling are developed. Usually, contingency plans are not implemented exactly as written. Their value is not in rigid application, but as a firm base from which to mount flexible tactics in response to developing situations.

Operational plans provide for the main tasks to be accomplished in controlling a civil disturbance. The plans include:

- A plan to isolate the affected area.
- A patrol plan.
- Plans for crowd control.
- Plans for the neutralization of special threats and for rescue operations.

- Plans for deployment.
- Plans for withdrawing after order is restored.
- Plans for medical care and for evacuation operations.
- A security plan for priority facilities that are vulnerable to dissident activity, that are critical to the community's well-being, and that have value to the dissidents.

Operations plans must also provide for establishing and maintaining command posts. Locations for the EOC and tactical command posts should be selected in advance. Collocation of command posts and establishment of joint operations centers facilitate liaison and coordination between military and civil authorities. Plans must be made for staffing and equipping the CPs with a minimum of delay.

The EOC must have security. Key personnel can become targets for terrorists. An alternate EOC, and people to staff it, also must be considered. The primary EOC could be overrun by the disturbance. The need for an alternate EOC can be determined by threat analysis. If an alternate

EOC is needed, procedures for evacuating the primary EOC or for passing command and control must be in place.

The EOC must have extensive radio and wire communications. Sufficient phone lines must be installed to facilitate coordination and information dissemination with outside agencies and operational forces. If a particular agency must be able to communicate without delays, some lines may have to be dedicated. And the EOC must have sufficient radio equipment to monitor all civilian and military operational frequencies. The EOC also must have space for individual work areas and for conference rooms for meetings and briefings. An overcrowded EOC is noisy and raises the stress level of EOC members. Distractors have an adverse impact on the decision-making process.

Planning considerations must cover both the main CP and the tactical CPs in the various areas where rioting is most likely to occur. Security measures must be taken to ensure that CPs are not penetrated or overrun by riotous elements. Each CP must have an evacuation/relocation plan.

Plans must include the collecting of data for reports and lessons learned. Task force personnel must keep detailed records and journals during and after operations. An important part of the termination process is preparing and submitting an after-action report. The after-action report is as detailed as the commander feels is necessary. Or it is based on higher headquarters requirements. National Guard Regulation 500-50 sets the format for submitting National Guard after-action reports. The report's contents are not limited to just the findings of the commander and his staff. The report may include materials or lessons learned contributed by subordinates or other sources that the commander feels are valuable.

In the aftermath of civil disturbance operations, many claims and investigations are likely to occur. There must be accurate and timely information for processing claims and conducting investigations. Legal matters are a service responsibility and all third party tort claims must be processed according to AR 27-20. Plans also must include provisions for resolving legal problems of task force personnel.

operations, units assigned an area control mission may be totally committed, preventing relief operations within the unit. Relief must be provided by a higher echelon retaining uncommitted units. Ready reserve forces should not be used for relief because they may become actively involved in operations. Relief must be accomplished in place to ensure that the relieving unit physically occupies assigned facilities and the area of operation. Relief during civil disturbance operations must be conducted during the least critical times. Relief priorities must be set to ensure that forces employed at the most vulnerable facilities and in the most riot-prone areas are relieved first. The relief units may have more or fewer troops than the units being relieved, depending on the situation.

Relief operations must be coordinated with civil police, fire departments, and other agencies operating in the disturbance area. Civilian relief operations must be conducted in such a way that they do not conflict with military relief operations. Any time that unit capabilities or the task force commander change, the incoming commander reviews the joint control and support agreements. If it is necessary, he coordinates new agreements. This action helps ensure available resources are used in the most effective manner possible.

Commanders at each echelon should be present at the field CP of the outgoing unit to facilitate command and control. The commander of the outgoing unit directs the relief procedures. He usually remains responsible for the area of operations until most of the relieving unit is in position and communications and control have been established by the incoming commander. The exchange of responsibility is agreed upon by the commanders concerned and is verified by the concurrence of the next higher commander. If riotous activity occurs before the incoming commander assumes responsibility, he assists the outgoing commander with all means available.

Commanders at each level must conduct a thorough reconnaissance of their operational areas. All unit leaders must receive a complete briefing from the outgoing unit. Routes into the areas must be reconnoitered. Critical facilities, barricades and roadblocks, patrol routes, and other items of operational importance must be identified. And unit leaders must familiarize themselves with their assigned area and establish a rapport with the law-abiding citizens in the area.

Commanders of the incoming and outgoing units must arrange for the exchange of special equipment items essential to the mission that may be in short supply. Vehicles and radios may be exchanged because the need for them in civil disturbance operations usually exceeds the TOE issue authority. Other items, such as barricade and roadblock material, wirelines, switchboards, extra ammunition, and riot control agent munitions, can be left with the relief unit. Equipment exchanges are based on the authority included in the relief order of the next higher commander. Equipment exchange must be made using proper accountability procedures.

#### KEY ELEMENTS OF A RELIEF ORDER

- Time for the relief to begin and end.
- The time or the condition for exchanging responsibility for the operational area.
- Routes to be used by the incoming and outgoing units.
- Civil authorities who are operating in the area.
- Locations of critical facilities and barricades and roadblocks.
- Patrol routes, guard posts, and other security measures that are in place.
- Any requirements for periodic reports by subordinate leaders during the relief effort.

## CHAPTER 6

### Control Force Operations

To restore order in a civil disturbance, a control force must isolate the disturbance area to prevent the disturbance from spreading. It must protect the people, facilities, and services likely to become targets of attacks in a continuing disturbance. It must exert control over the disobedient crowds. It must establish control of the disturbance area. And it must neutralize any special threats that arise.

Federal forces can expect to do one, some, all, or any part of these operational tasks. Which operational tasks they perform and to what extent depends on the kind of disturbance and the reason for federal intervention.

#### ISOLATE THE AREA

The initial task in controlling a disturbance is to isolate the people creating the disturbance from those who have not yet become actively involved. Once a crowd is isolated, time is on the side of the commander. The first action is to identify the area and the people to be isolated. The second is to seal off the disturbance area. The objectives of the task are to—

- Prevent disorder from spreading to unaffected areas.
- Move uninvolved people from the area quickly.
- Prevent unauthorized people from entering the affected area.
- Prevent the escape of people who are bent on expanding the disturbance.

Every effort must be made to allow a crowd to leave an area peacefully. This reduces the number of people who may have to be apprehended or dispersed.

Useful measures for isolating an area include barriers, patrols, pass and ID systems, and control of public utilities. Some measures may be in place before the disturbance. Civil authorities usually have

a means to control public utilities. Street lights, gas, electric, water, and telephone service must be able to be turned on or off to support control force tactics. Passage into and out of the isolated area must be controlled. Persons connected with the disturbance should not be able to move into or out of the area. But emergency medical personnel, public work crews, media members, and others may need to enter or leave the disturbance area. And persons residing within a disturbance area may need to travel to and from work. Installation and/or municipal contingency plans usually include a pass and ID system to allow authorized personnel into and out of restricted areas. To be effective, a pass and ID system must be carefully planned in detail before it is needed.

Barriers like barricades and roadblocks can be used to stop the passage of people and vehicles to and from an area. Or they may be constructed to permit specific people and vehicles to pass. Often it is impractical to seal off an area due to physical and geographical limitations. College campuses and suburban areas, for example, often have woods and open fields that make them difficult to seal off.

Temporary barriers of troops can be set up until more permanent barriers can be made. When a troop perimeter is used to isolate an area, the control force sets up an inner and an outer perimeter. The inner perimeter contains the area of the disturbance and keeps the disorder from spreading. Troops on the inner perimeter face the disturbance. The outer perimeter prevents outsiders from entering the disturbance area. Outer perimeter troops

face away from the disturbance. The use of two perimeters protects the backs of the troops in each line. The use of two perimeters also creates a clear zone in which to stop people who breach one of the lines. In large crowds control forces stand shoulder-to-shoulder. In small crowds they stand double arm's length apart. If a closed perimeter is needed, they can link themselves together with riot batons.

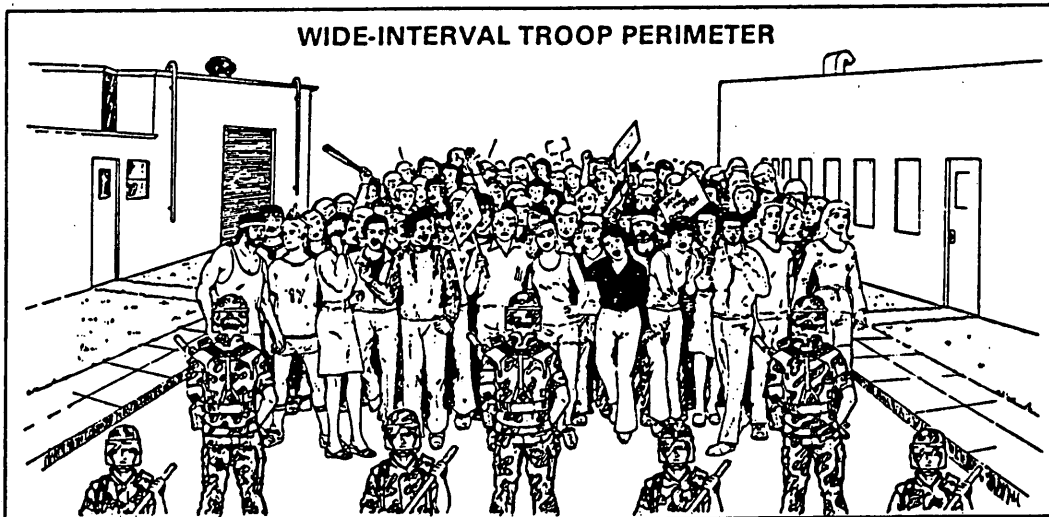
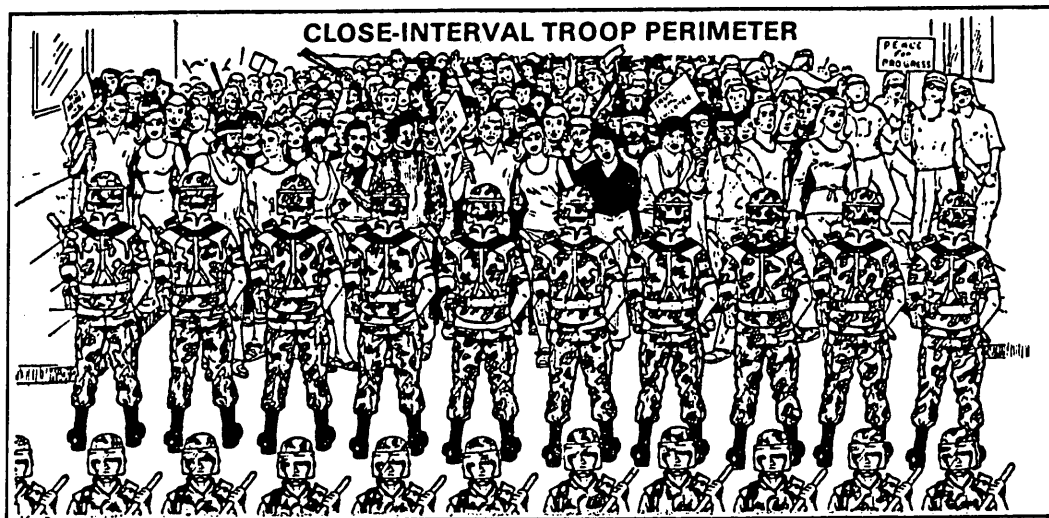

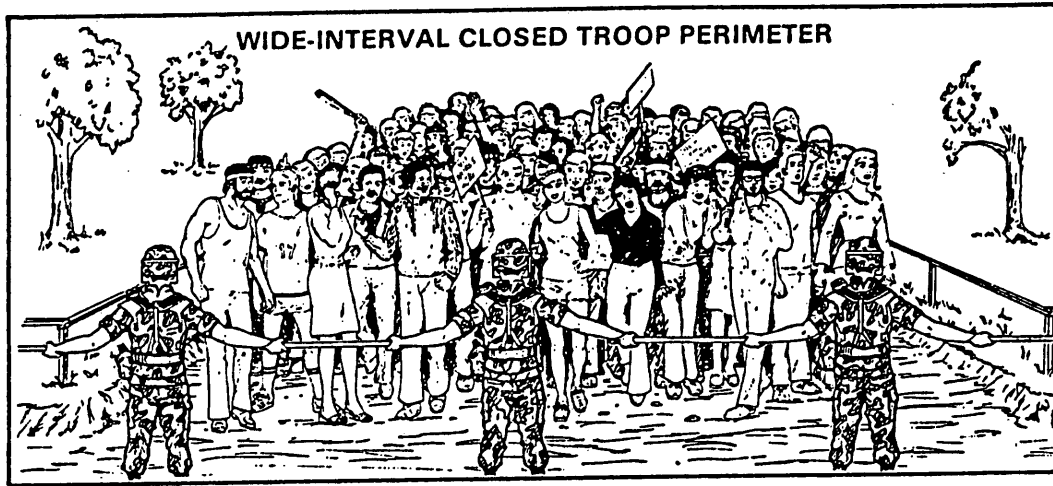

Portable barricades of sawhorses, ropes, and other field-expedient devices can be used to impede pedestrian traffic. Concertina wire is a suitable material for rapidly constructed, effective barricades.

But concertina wire is used only under the most serious circumstances. And then it is used sparingly, because it is indicative of violent disorders.

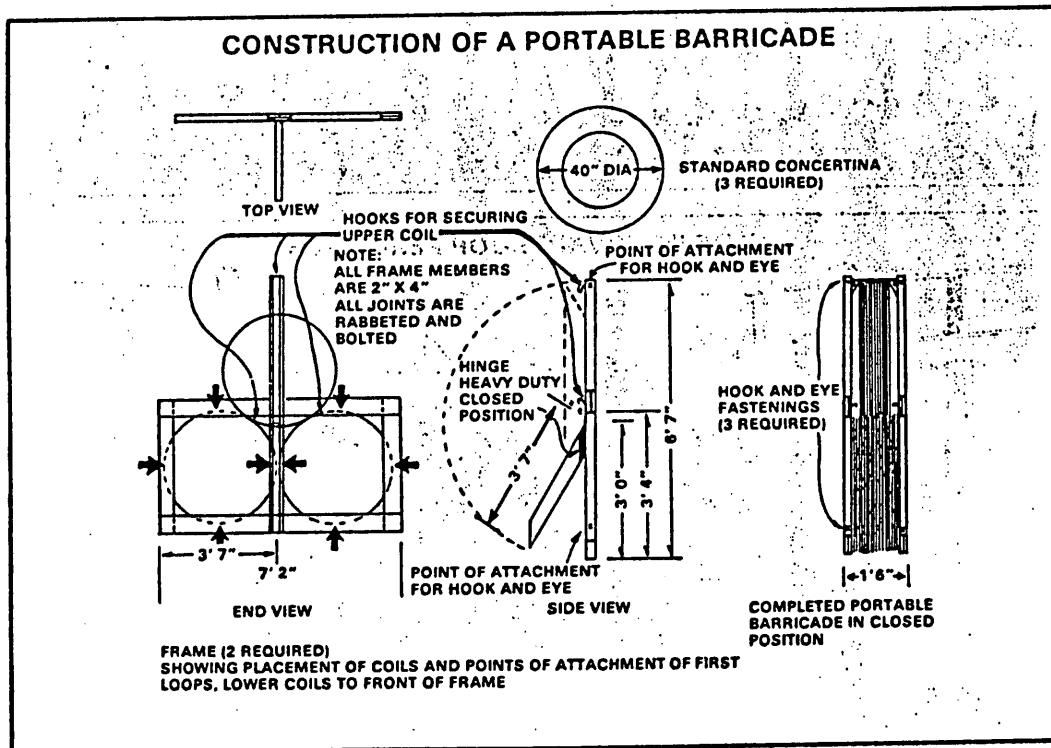



In most civil disturbances, civil police enforce the laws in the disturbance area, and military forces protect likely targets. Key buildings, utilities, and services critical to the functioning of a community must be protected. Also, key people and VIPs can be targets for crowds angered by official policy.

VIPs may be at risk in public, at work, or at home. Off-duty control force members may be targets if they are recognized by demonstrators with whom they have been in conflict. Control force members on patrols too small to defend themselves against a violent crowd also may be in danger.

Armories, arsenals, hardware and sporting goods stores, pawnshops, gunsmiths, construction sites, outlets for chemical products, and other places where weapons or ammunition are stored must be protected. To conserve manpower, the control force may move dangerous items to a central facility. Facilities that could be symbolic targets for radicals must also be identified and protected when possible. Likely targets for such attacks are control force CPs, billeting areas, and motor parks.

Priorities for providing physical security must be established. Effort and manpower must be placed where they will do the most good. When setting priorities for the protection of facilities, for example, consideration is given to the facility's importance to the well-being of the community or the installation. The loss of water and electric utilities endangers the health of the community. The loss of government buildings disrupts government functions. Radio and TV stations, if seized by demonstrators, can be a powerful tool for spreading disorder. A facility's susceptibility to damage or loss must be considered. The degree of risk to a facility is based on its physical layout, its type of construction, and its existing protective measures. When developing priorities for protection, the intent and ability of the crowd is always a

factor to be considered. Planners must analyze the destructive intent and the capabilities of the participants. This analysis will help identify both likely targets and the degree of violence likely to occur.

The military must anticipate the need for the rapid implementation of physical security measures. (Detailed information on physical security measures and procedures is found in FM 19-30.) Perimeter barriers, protective lighting, alarm systems, and intrusion detection devices help deter and detect intruders. These preventive measures impede unauthorized access to a facility.

Measures of this type may or may not be in effect at the time of the disturbance. Troops also can be used to implement security measures. Troops used as sentinels or walking guards and at checkpoints must be committed jointly with guards from the facility being protected. Existing guard forces can be augmented with additional equipment. Fixed security posts must be manned by enough guards to be effective and to protect themselves until relieved. And troops can be used as a highly mobile response force, centrally located near likely targets. A mobile response force reduces the need for fixed security, freeing troops for other operational tasks.

MEASURES TO PROTECT LIKELY TARGETS	
VIP	<ul style="list-style-type: none"> <li>• Restrict release of personal data.</li> <li>• Do not identify parking areas; identify parking spaces by number.</li> <li>• Urge key personnel and VIPs to keep a low profile.</li> <li>• Brief personnel on their environment and report any suspected surveillance by strangers.</li> <li>• Use duress codes to alert others of possible threat.</li> <li>• Limit access to data on itineraries and travel arrangements to as few people as possible.</li> </ul>
CONTROL FORCE	<ul style="list-style-type: none"> <li>• Use at least squad-size patrols when extensive looting or group violence is occurring.</li> <li>• Prohibit off-duty control force members from the disturbance area.</li> <li>• Prevent direct access by public to EOC, CPs, and staging and billeting areas.</li> <li>• Equip visitor entrances with duress alarms.</li> <li>• Escort visitors; control access to sensitive and command areas.</li> <li>• Control entrances to sensitive areas; control locked entrances periodically.</li> </ul>
BUILDINGS	<ul style="list-style-type: none"> <li>• Select an interior safe room for sensitive facilities in case they are attacked.</li> <li>• Store supplies for extended operations and emergencies, including first aid equipment, bomb blankets, food, candles, and lanterns.</li> </ul>

# EMPLOYMENT OF A PORTABLE BARRICADE

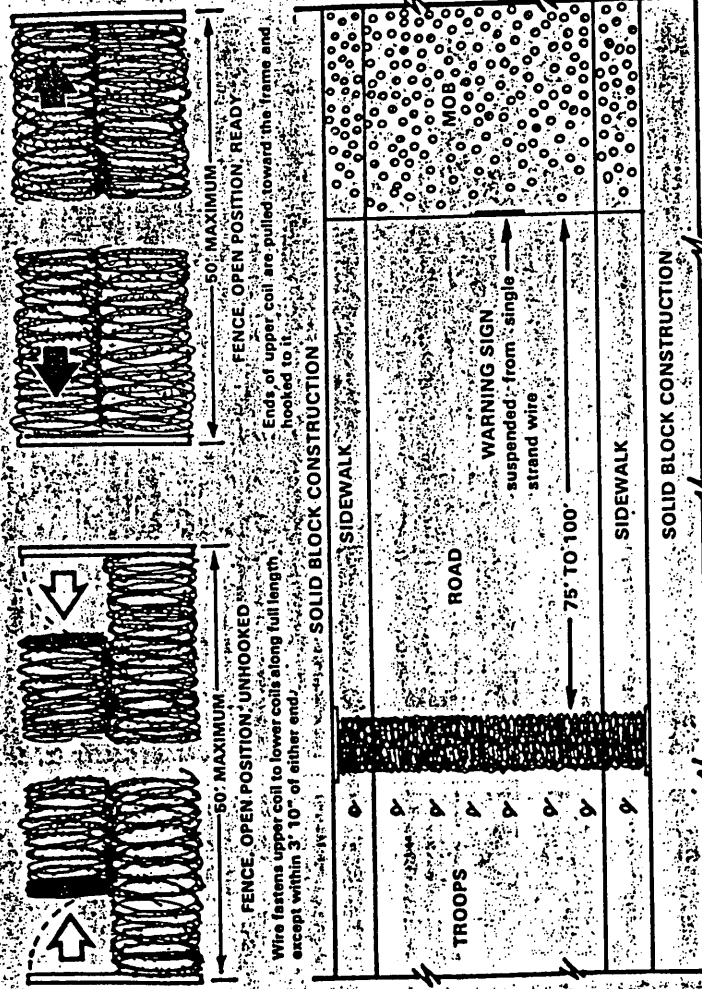

Roadblocks that cannot be easily breached by vehicles require large and heavy construction materials. Barrier materials are loaded on staged trucks for rapid emplacement. A quickly-erected barrier can be made by parking vehicles bumper-to-bumper. However, the vehicles may be damaged by a hostile crowd. A vehicle-mounted barricade is useful both as a barricade and as part of a formation. It can be made locally by fitting a wire-covered wood or metal frame on the bumper of a vehicle. More permanent roadblocks can be made from 55-gallon drums filled with water or earth. Sandbags, earthworks, and trees can also be used to block roads. Several roadblocks placed at intervals of 25 to 50 feet will usually prevent advances by heavy or high-speed vehicles. If small arms fire is likely, barriers must be placed at intervals of 100 to 150 feet.

Approaches to the position must be illuminated without silhouetting the people manning it. Auxiliary lighting may include hand-carried lights, vehicle-mounted searchlights, spotlights, floodlights, flashlights, and vehicle headlights. Canvas or sandbags should cover materials that could chip or shatter when hit by thrown objects. And signs must be placed in front of the position to warn unauthorized personnel not to approach.

Perimeter patrols are useful to prevent entry to and exit from the disturbance area of people or groups trying to bypass barricades and roadblocks. These patrols operate in the outer operational boundary of the disturbance area. Their routes can be integrated with patrol routes within the disturbance area.

## EXERT CONTROL

The measures used to exert control in a disturbance affects the crowd's behavior. Each crowd is unique. The makeup of a crowd can vary during the disturbance. Control force measures must be geared to each crowd's size, temperament, cooperativeness, and degree of organization and uniformity. Measures should change as the crowd's characteristics change. Even a change of one characteristic can drastically alter a crowd's response to control force measures. Large crowds may be easy to control if they are organized, cooperative, and nonviolent. Nonviolent crowds are often easy to control with a very limited show of force. Small crowds can be hard to control if they are organized, uncooperative, and violent.

To control a cooperative crowd, a control force may only have to direct traffic, provide information, and control isolated criminal acts like theft and vandalism. A cooperative crowd may even have its own security force, which can provide liaison and assist the control force. But uncooperative crowds do not have to be violent to evade control. They can passively resist attempts to disperse them. They can form human blockades, occupy buildings, or chain themselves to objects to force arrests and bodily removal.

Crowd size has a direct impact on the selection and use of crowd control measures. Small crowds can be very mobile. They are easily dispersed, but they can quickly re-form elsewhere. Because of this, crowd control formations are seldom effective against small crowds. Large crowds are less mobile. Because they are easier to contact, most crowd control formations are effective against them.

A control force can disperse a disorganized crowd more easily than an organized crowd. A disorganized crowd lacks the leadership that gives a crowd direction. If violence has not broken out, a proclamation and an organized show of

force may be enough to disperse a disorganized crowd. But organized crowds have leaders to give the crowd direction. Leaders can plan actions to frustrate or counteract control force plans and tactics. They may use small groups, operating independently of the main crowd, to divert or fragment the control force.

A generally uniform crowd having a common cause and belief in their actions may respond to control attempts in a predictable manner. The response of a varied crowd is harder to predict. A varied crowd often has conflicts between factions within the crowd. These conflicts can lead to heated arguments and, eventually, to violence. A control force is open to charges of favoritism if it appears that they do not treat all factions evenhandedly. The control force must balance its responses to the actions of the various factions. They must be careful not to show favoritism toward any one faction.

The military control force uses carefully selected tactics and wisely committed resources to exert control over disobedient crowds. The task force commander chooses the control measures most useful for controlling a particular crowd. The variables that influence his choice include:

- Intensity level of the disturbance.
- Public opinion.
- Current policies.
- Crowd mood, intent, composition, and activity.
- Capabilities and readiness of control forces.
- Immediate and long-range benefits of control force action.
- Weather, terrain, and time of day.

In general, the commander has four options available to him. He can monitor, disperse, contain, or block the crowd. These crowd control options are often used in combination. He chooses his options based on his evaluation of the particular crowd.

He selects any combination of control techniques and force options he thinks will influence the particular situation. He must always try to choose the response that can be expected to reduce the intensity of the situation. (Control techniques and force options not fully discussed below are detailed in separate chapters later in the manual.)

### MONITORING

The commander may task control force teams to monitor crowd activity and note developments. The monitoring done by these observation teams enables the commander to gage the crowd's activity and intent in relation to the overall disturbance. It also may allow him to influence the crowd by persuasion. Monitoring is employed throughout crowd control operations. Monitoring is appropriate when more decisive action is not feasible due to crowd size or when the intensity of a situation might escalate. It is particularly useful in large, nonviolent demonstrations. Monitoring can serve as an interim measure until more control forces arrive. Monitoring includes establishing communications with crowd leaders to convey official interest and intent to the crowd. It also includes efforts to gain the cooperation of crowd leaders.

Observation teams monitor a crowd's activities to gather information. They observe and report on crowd size, location, mood, and on the developing situation. An observation team may consist of a marksman, a radio operator, and an observer equipped with binoculars. They may be posted on strategic rooftops and other high terrain that overlooks the crowd. Sometimes observers use helicopter-mounted observation devices. This also affords security for the control force. The control force must know where observation teams are located so they do not mistake the teams for snipers.

Communications with crowd leaders and participants can help a commander to

control a situation without need for more severe measures. If communications exist with crowd leaders, the authorities may be able to divert either the leaders or the crowd from their stated or apparent goal. Pressure can be put on the leaders to channel the crowd into an area that minimizes disruption to the community and aids control force operations. March routes and demonstration areas can be limited to those that will help contain the crowd and reduce their potential for disrupting the community. Pressure can be positive, like offering concessions, or negative, through the use of deterrents.

If the control force can gain the cooperation of crowd leaders, it can decrease the crowd's potential for disorder. If crowd leaders seek cooperation from authorities, officials should try to be accommodating. Crowd leaders can be placed in liaison positions between the crowd and the control force. Leaders can be made responsible for managing the crowd by policing their own activities.

When planned demonstrations, marches, or rallies within a disturbance area are announced, the task force commander and local authorities meet with the organizers. Authorities convey the control force's interests and learn the organizer's plans. Crowd leaders can be encouraged to help plan ways for the protestors to peacefully demonstrate. Joint guidelines can lessen a demonstration's impact on the community. The following matters, if they apply, are discussed:

- Parade or demonstration permits.
- Locations of the demonstration and the march routes.
- Time limits for the activity.
- Provision of marshals by activity organizers.
- Prevention of violence.
- Safety of all involved.

The task force commander and local authorities can also inform the organizers how authorities plan to deal with violence, unlawful actions, and violations of limits imposed on the activity. But they do not express their plans as an ultimatum. If they do, the organizers may hold the demonstration in defiance of authority. Instead, they solicit the cooperation of all concerned so the demonstration, rally, or parade can occur without incident.

Taking pictures of the faces of crowd members can prevent or reduce unlawful and violent acts. Knowing they can be recognized lessens crowd members' sense of anonymity. And, if needed, photographs or videotapes can be used as evidence for prosecutions. To be effective, crowd members must see their presence being recorded. The photographer or cameraman should be in uniform to let the crowd know he or she is a member of the control force. The photographer must be close enough to the crowd to be easily seen, but not close enough to be endangered.

### DISPERSING

The commander may task the control force to disperse the crowd. The intent of dispersal is to fragment a crowd. This option is most useful for small crowd situations in congested urban sites. But dispersal may increase and spread lawlessness rather than reduce it. Thus the control force must control the dispersal routes and the areas in which dispersal will occur. The force must protect the facilities that are likely targets for dispersing groups. And dispersal operations may need to be followed by apprehensions of small groups still active in the area. The use of proclamations, a show of force, crowd control formations (see Chapter 8), and riot control agents (see Chapter 9) can disperse crowds.

Issuing a proclamation can help disperse a crowd. A proclamation officially

establishes the illegal nature of a crowd's actions. A proclamation puts the populace on notice that the situation demands special measures. It prepares the people for the presence of military authority. It tends to inspire respect. It supports law-abiding elements. It psychologically bolsters military forces trying to restore order. It also demonstrates to all concerned the gravity of the situation. It is an excellent way to make a commander's intentions known to a crowd. And it is a good way to reduce a crowd's size before direct action is taken. The control force commander can make a verbal proclamation similar to the following: "In the name of the President of the United States, I command that you disperse and retire peaceably to your homes." Such a proclamation may even make direct action unnecessary.

In making a proclamation, a commander may consider imposing a time limit. But the situation may change, and the lack of a time limit would leave the commander free to choose other actions when he wants. A proclamation must be specific in its instruction. If a time limit is stated, it must allow a reasonable length of time for the crowd to comply with the instructions. When drafting a proclamation, the commander must consult closely with his SJA. He must use the simplest language possible to maximize the proclamation's effect. If proclamations must be translated to a local language, the translation must be made with great care. The commander at the scene may direct that a proclamation be issued over public address systems. The force of the words used in the proclamation must be gaged to the composition of the crowd. If the crowd consists of usually law-abiding citizens who are presently assembled to show disagreement with an existing situation, the proclamation requires less force. On the other hand, if the crowd consists of militant rioters, the proclamation requires more force. The text may take a number of forms, depending on the situation.

<b>SAMPLE ANNOUNCEMENTS</b>	
<b>I. DISPERSAL</b>	<b>II. EMPLOYMENT OF TROOPS</b>
<p style="text-align: center;"><b>UNLAWFUL GATHERING</b></p> <p>"ATTENTION! ATTENTION! THIS AREA MUST BE CLEARED AT ONCE! NO FURTHER UNLAWFUL BEHAVIOR CAN BE TOLERATED. CLEAR THIS AREA AT ONCE OR THE NECESSARY FORCE TO DO SO WILL BE USED." *</p> <p style="text-align: center;"><b>DEMONSTRATION</b></p> <p>"DISPERSE AND RETIRE PEACEABLY! DISPERSE AND RETIRE PEACEABLY! ATTENTION ALL DEMONSTRATORS!</p> <p>THE DEMONSTRATION IN WHICH YOU ARE PARTICIPATING ENDS AT _____ THE PERMIT THAT WAS AGREED TO BY THE LEADERS OF THE DEMONSTRATION EXPIRES AT THAT TIME. ALL DEMONSTRATORS MUST DEPART FROM THE _____ BY _____ ALL PERSONS WHO WISH TO LEAVE VOLUNTARILY CAN BOARD POSITIONED BUSES. THESE BUSES WILL GO TO THE _____ THOSE WHO WISH TO TAKE THE BUSES SHOULD MOVE TO THE _____ THOSE DEMONSTRATORS WHO DO NOT LEAVE VOLUNTARILY BY _____ WILL BE ARRESTED AND TAKEN TO A FEDERAL DETENTION CENTER. ALL DEMONSTRATORS ARE URGED TO ABIDE BY THE PERMIT." *</p> <p style="text-align: center;"><b>WARNING OF LOOTING</b></p> <p>"RETURN TO YOUR HOMES! SOMEONE MAY BE LOOTING THEM AT THIS MOMENT! DURING A DISTURBANCE, CRIMINAL ACTIVITY IS AT ITS PEAK. YOUR FAMILY OR YOUR PROPERTY MAY BE IN DANGER!" *</p>	<p style="text-align: center;"><b>EMPLOYMENT</b></p> <p>"ATTENTION! ATTENTION! TROOPS ARE PRESENT IN THIS AREA. THEY ARE PREPARING TO ADVANCE. ORDER MUST AND WILL BE MAINTAINED. DISPERSE PEACEABLY AND LEAVE THIS AREA. TO AVOID POSSIBLE INJURY, LEAVE AT ONCE.</p> <p>DISPERSE NOW AND AVOID POSSIBLE INJURY! DISPERSE NOW AND AVOID POSSIBLE INJURY!" *</p> <p>(Repeat until troops are committed.)</p> <p style="text-align: center;"><b>WHEN TROOPS ARE COMMITTED</b></p> <p>"TROOPS ARE ADVANCING NOW. THEY WILL NOT STOP UNTIL THE CROWD IS DISPERSED AND ORDER IS RESTORED. TO AVOID INJURIES, LEAVE THE AREA AT ONCE. RETURN TO YOUR HOMES AS PEACEFUL CITIZENS. TROOPS HAVE THEIR ORDERS, AND THEY WILL NOT STOP UNTIL THE CROWD IS DISPERSED. DO NOT GET HURT. LEAVE THIS AREA." *</p>
	<p style="text-align: center;"><b>III. PRESENCE OF CHILDREN</b></p> <p>(Used in conjunction with other announcements)</p> <p>"ATTENTION! ATTENTION! DO NOT ATTEMPT TO CAUSE FURTHER DISORDER. DISPERSE NOW IN AN ORDERLY MANNER AND AVOID POSSIBLE INJURY TO CHILDREN. RETURN AT ONCE TO YOUR OWN AREA." *</p>
<p>* INDICATE THE METHOD, THE STREETS, AND THE DIRECTION THAT THE CROWD SHOULD USE WHEN DISPERSING.</p>	

Marching troops in a show of force is often a useful measure for dispersing a crowd. Troops arriving by truck dismount and assemble out of sight of the crowd. This point is as close as possible to save time and conserve troop energy, but far enough away to ensure security. When

troops arrive by helicopter, the psychological impact of the helicopters can be used. Troops dismount from the helicopters in sight of the crowd, but far enough away to prevent damage to the aircraft by thrown objects. (The first echelon to dismount from the aircraft secures the

landing area.) When small groups are scattered throughout a large disturbance area, a show of force can be made by marching troops, by motor marches through an area, by saturation patrolling, and by setting up static posts. Sometimes marching a well-equipped, highly-disciplined control force into view of a crowd may be all that is needed to convince them to disperse and retire peaceably. However, a show of force may attract people to an event. And it may provoke a nonviolent crowd into a violent confrontation.

### CONTAINING

The commander may task the control force to contain the crowd. Containment limits a crowd to the area they are presently occupying. It prevents the disorder from spreading. Containment is a suitable option for a campus disorder. It keeps demonstrators from spreading out to surrounding communities. It keeps outsiders from entering the campus. Containment also is useful when crowd members must be apprehended. Crowds can be contained by crowd control formations, perimeter patrols, and barriers.

Armored vehicles are adaptable to roadblock operations, serving as barriers. They also can provide added protection for the troops. They provide an easily accessible barrier for troops to crouch behind and protection for those troops inside. Military vehicles traveling at close intervals in a column formation next to a crowd is a largely psychological barrier. They can be used to contain a large, fast-moving crowd. The moving cordon creates

a temporary obstacle between a crowd and a line beyond which they will not be allowed to cross. A well-trained mobile cordon can effectively do the job of as many as 10 times the number of dismounted soldiers. But troops must train intensely to be able to execute safe, quick reversals of direction for mobile cordons on narrow roads. By-the-numbers commands issued over vehicle radios is a good method for coordinating cordon movements. The cordon's speed is usually about 5 miles per hour with an interval of at least 20 feet. Troops must be silent and alert. Blue and red lights, sirens, blinkers, and horns may or may not be used. Armored vehicles also can serve as mobile CPs. They provide security, communications, and mobility.

Vehicles equipped with a public address system are useful. The address system can be used to issue commands and directives during control operations. And the vehicle itself may be used as a command post or a rally point. It can also serve as a weapons carrier and a barricade for channeling crowd movement.

### BLOCKING

The commander may task the control force to block a crowd. Blocking physically denies a crowd's advance. It may be used to protect a facility or area that is a potential or actual target. Crowd control formations, mainly the line formation, and barricades are used to block. Barricades of vehicles, concertina wire, and water-filled barrels are used to block or to channel the movement of the crowd.

### ESTABLISH AREA CONTROL

Unimpeded government operations are essential. Public transportation, communications, and other public services and utilities also must continue operations during periods of unrest and tension. Disruption of such services works hardships

and increases unrest and the possibility of group violence. The control force must prevent acts of interference with public functions and help maintain those functions.

Control of a civil disturbance area usually does not require the imposition of martial rule. The role of the military is to support, not supplant, civil authority. Thus military forces never take over. They issue orders and regulations only to support and enforce civil law and to restore civil authority.

The concept of martial rule is unusual in that *it is not written*, neither in the form of law nor as a military regulation. Martial rule is based on public necessity. Public necessity in this sense means public safety. Martial rule usually is exercised at the direction of the President. But state authorities may take such action within their own jurisdictions. And local military commanders do have emergency authority if time factors would thwart effective action. For example, after the 1906 earthquake General Funston ordered buildings in San Francisco dynamited to halt the spread of fire. At the same time, he announced and enforced measures against looting.

Whether or not martial rule has been proclaimed, commanders must weigh each proposed action against the threat to public order and safety. If the need for martial rule arises, the military commander at the scene must so inform the Army Chief of Staff and await instructions. If martial rule is imposed, the civilian population must be informed of the restrictions and rules of conduct that the military can enforce. The information, whether announced by proclamation or order, is given the widest possible distribution by all media.

#### LOOTING AND ARSON

Control in the disturbance area must prevent looting and arson. Liquor, drugs, weapons, ammunition, and explosives must not fall into the hands of rioters. Liquor stores, drug stores, sporting goods stores, pawn shops, and hardware stores are highly sensitive targets in a disturbance area. Simply ordering that they be closed is not sufficient. Quick action must be taken

to prevent these businesses from being looted.

Looting may start at any time or any place. It may start as an isolated incident and quickly spread throughout an affected area. Looting often involves women, children, and the aged. Troops dealing with looters must exercise extreme caution, being careful to apply the principle of minimum force. Most children found looting have no idea of the seriousness of their actions.

Commanders must be familiar with the antilooting measures that can be taken by civil authorities. These measures include boarding up windows, covering windows with two sheets of plastic containing CS agents or luminescent particles between the sheets, and promptly posting looting penalty warnings. Antilooting measures that can be taken by the control force include:

- Foot and motor patrols.
- Fixed guard posts.
- Roadblocks and barricades.
- Illumination of likely looting targets.

Troops can be posted in likely businesses, and patrols can be increased in and around these businesses. Weapons can be temporarily confiscated and stored in a central, secure facility. Troops at fixed posts must be briefed not to leave their posts to pursue individual looters on foot. They must remain on post and prevent looters from approaching their areas of responsibility.

Troops must be briefed that deadly force will not be used to apprehend looters. *Deadly force is not authorized to control looting.* Even the looting of weapons and ammunition does not justify the use of deadly force. But the potential danger that such looting represents dictates that every available measure, short of deadly force, be employed immediately to prevent looting.



Acts of arson frequently accompany outbreaks of lawlessness. Lives and property must be protected from lawless firestarters. Once a fire breaks out, the firefighting task force must be able to respond rapidly. The control force is also responsible for providing security for the firefighters.

Fires may be started without apparent purpose. They may be planned to destroy public and commercial records. Or they may be reprisals for past grudges. Fires can be set by an ordinary person with little sophisticated knowledge. The equipment consists of easy-to-obtain common items, such as a candle, a jar lid, some rags, and lighter fluid. But their destructive potential is considerable. Because of the innocuous appearance of makeshift arson materials and the ease with which an arsonist can move through the chaos of a disturbance, detection and prevention are extremely difficult.

Arsonists can present a grave threat to life. The immediate saturation of a disturbance area by a control force may impede an arsonist's mobility and reduce his ability to strike. Lighting the disturbance area at night reduces an arsonist's chances to operate undetected. Portable lights can augment the existing lighting system for this purpose. The threat of arson must be reduced with a minimum of force. But when deadly force is the only way to prevent the arson and all of the conditions for using deadly force are met, deadly force may be used.

#### **CIVIL LAWS, ORDINANCES, AND RESTRICTIONS**

Civil laws and ordinances that can be helpful to control forces may already exist in the disturbance area. Some of these laws, because they limit civil liberty, are enforceable only during times of civil violence. The Civil Disorders Act of 1968 makes it a federal offense to obstruct, impede, or interfere with any fireman or law enforcement officer who is lawfully

performing his official duties. The act includes members of the National Guard and of a federal control force in its definition of law enforcement officers. Close coordination with local governmental bodies can help the commander make use of civil laws, ordinances, and restrictions. And the advice of the SJA will ensure that no improper actions are taken by a control force in regard to civil law. News media provide a means by which laws, ordinances, and similar restrictions can be publicized and explained to the populace.

Except in the unlikely event of martial rule, federal forces cannot impose restrictions on a civilian population. But restrictions may be imposed by civilian authorities to aid the control of lawlessness. Military leaders can recommend which restrictions have the most value in comparison to the amount of effort needed to enforce them. The most commonly recommended restrictions are curfews and sales restrictions.

Imposing a curfew is a highly effective control measure in many civil disturbances. It restricts the movement of people on streets and in public places, especially at night. Before curfews are imposed, joint civilian-military planning must address:

- Coordination of the initiation, enforcement, and termination of a curfew.
- Public proclamations to initiate and terminate curfews.
- Curfew exemptions and guidance on who should receive the exemptions, including written authorizations and passes.
- Provisions for the apprehension and disposition of curfew violators.

Local civil authorities set up a curfew and pass system based on local laws and ordinances. Control forces help enforce the system. Some persons must be granted passes so essential businesses and public

utilities can operate during the curfew period. Sometimes all travel must be restricted. As tensions ease, limited travel can be allowed if permission is granted by civil authorities.

Restrictions on the sale, transfer, and possession of certain materials can help reduce the chance and likelihood of violence. Access to alcohol, drugs, gasoline, firearms, ammunition, and explosives needs to be controlled to prevent violence. Civil authorities can also prohibit the carrying of firearms, ammunition, and explosives. This can apply to automatic weapons, grenades, shotguns and sporting rifles, pistols, revolvers, firing devices, and some chemical agents. This prohibition would allow seizure of privately-owned weapons being carried in vehicles or in the open in public.

Receipts must be provided for all confiscated items to maintain accountability. Receipts ensure that any items that can be returned will get to the right people. Civil law enforcement agents may have authority to confiscate not only weapons but items that could be used as weapons. If so, vehicles and people entering or leaving a disturbance area can be inspected, and objects like clubs, bottles, and chains can be confiscated.

Other restrictions that may be imposed include restrictions on:

- Assembly.
- Interference with public functions.
- Communications.

During a civil disturbance, it may be advisable to prevent people from assembling. Civil law can make it unlawful for people to meet to plan an act of violence, rioting, or civil disturbance. Prohibitions on assembly may forbid gatherings at any place and time. Or gatherings may be restricted to certain places at certain times. Civil law may also specify the number of people that may lawfully gather in an area at one time. Inciting or participating

in rioting and public disorder may be made unlawful. Making hostile or inflammatory speeches advocating the overthrow of the lawful government and threats against public officials, if it endangered public safety, could violate such law. Such laws, if imposed at an early stage, reduce the danger of disorder and riot by large groups of people.

As tensions ease, assemblies can be allowed if permission has been granted by the proper civil authority. A group can apply for a permit to meet at a certain place and time for a specific reason. Use of permits lets civil authorities prepare for and be alert to potential trouble areas. Permits are appropriate for large events like parades, rallies, athletic events, political and labor meetings, and similar gatherings.

Laws and ordinances may already be in place to reduce communications interference with official messages to the public. These laws also place an effective limit on the ability of agitators and mob leaders to reach a large number of people. It helps if all communications equipment able to transmit or interfere with official messages are required to be registered. Sound trucks and electronic megaphones would also come under these restrictions.

### CONTROL FORCE PATROLS

Alert, aggressive patrolling of the disturbance area deters the gathering of crowds. The use of saturation patrolling is most effective for this purpose. It allows information to be collected. And it creates the psychological impression of the control force being everywhere at once.

Standard military transport vehicles provide mobility and communications for area coverage. Troops must be deployed with enough vehicles to provide the flexibility to handle all situations in the disturbance area. The vehicles can be modified with sandbags, armor plate, wire

screen, or similar materials to protect against sniper fire and thrown objects.

Armored vehicles patrolling an area of violence provide an added psychological effect. And they allow troops to maneuver close to snipers to make an apprehension. They also may be used as rescue vehicles to extract hostages or people surrounded by a hostile crowd.

Varying patrol routes and times for mounted and dismounted patrols keeps lawbreakers from being able to pick a safe place or time to act. Patrols are particularly useful in preventing overt arson and violence. Patrol members can also spot and promptly report fires. Whenever possible, military patrols are integrated with civil police patrols. Joint patrols conserve military forces and aid civilian-military communications. They also help troops become familiar with an area quickly. And the civil police are available to make apprehensions if they are needed. Patrol members must practice proper standards of conduct and fair treatment of civilians at all times. They are performing an important community relations function as well as a control function.

Several types of patrols can be employed effectively for area control. Foot patrols are most effectively used in small areas or in areas where many people are moving about. Foot patrols must be able to control the disorderly. They must also be able to

protect themselves. The size of the patrols may vary with the degree of violence and the extent of activity in the patrol area. But most often foot patrols are squad-size. A squad has enough patrol members to keep the use of force minimal. It also keeps the patrol from being easily isolated or placed in jeopardy.

Land or water motor patrols, because of their speed and mobility, provide timely reconnaissance and broad area coverage. Motor patrols are in radio contact with task force headquarters. They can make periodic contacts with foot patrols and stationary posts that lack communications. And motor patrols can respond quickly to calls for help from other patrols and from guard posts. Land patrols should have at least two vehicles with four men in each. The patrol must have strength in numbers. And it must not be easily isolated or placed in jeopardy. All motor patrols are equipped with fire extinguishers to put out small fires, thus reducing the burden on the fire department.

Air patrols are helpful in directing the overall control effort in the disturbance area. They can perform reconnaissance and surveillance over the disturbance area. They are an excellent means of providing timely information. They can monitor rioters' actions, the extent of damage, the status of access routes, the locations and conditions of road barriers, and other important conditions.

## NEUTRALIZE SPECIAL THREATS

Control forces can be exposed to special threats that pose grave danger to both the control force and the general community. These threats include, hostage/barricade situations, sniping, bomb threats, and fires. Quick, organized action by the control force can reduce or possibly prevent the tragedy that these events can cause.

### SNIPER FIRE

Troops who take part in civil disturbance operations may be fired upon by snipers. And when crowd control formations are being used, the threat of sniper fire increases. Troops must be prepared to react immediately. Measures to counteract sniper

fire must be executed with speed and precision.

The troops must be aware, however, that persons in the crowd may try to disrupt a formation with loud noises, such as fireworks or bursting paper bags. The troops must be alert to such tactics. Automobile backfires, firecrackers, light flashes, accidental weapon discharges, indiscriminate firing by control forces, or distant sounds of firing can all be misconstrued as sniper fire.

The normal reaction of a well-trained combat soldier is to respond to sniper fire with an overwhelming mass of firepower. In a civil disturbance, this tactic endangers innocent people more than snipers. The preferred tactic is to use an SRT to enter the building from which the sniper fire originates. Troops must *not* return a sniper's fire unless the prerequisites for using deadly force exist and they have a *positively* identified target. The control force leader must not permit a mass return of fire that may endanger innocent people. If firing is necessary, it must be done by a selected marksman acting on orders from the senior military person present. And the marksman must consider the possibility of ricochets before engaging a target.

When troops encounter possible sniper fire they:

1. Take cover immediately.
2. Notify bystanders to clear the area or seek cover.
3. Verify that it is sniper fire that has, in fact, been encountered.
4. Report verified sniper fire and request assistance.
5. Locate the sniper's position.

When sniper fire is verified, the troops inform the appropriate people of the situation so help can be sent to the scene.

Usually this will be an SRT and a negotiation team. The troops should try to fix the exact position of the suspected sniper so they can inform the SRT leader.

Measures must be taken to secure the area. If the control force unit on the scene is large enough, they can secure the area. In most situations, however, it will be necessary to commit reserves or other control force elements. Regardless of what units are used, they must take steps to isolate, evacuate, observe, and support.

A security unit sets up an inner and an outer perimeter to isolate the area and to block the sniper's escape routes. The perimeters are set up far enough from the danger area to prevent exposure to sniper fire. The unit notifies all other control force units that are not involved in neutralizing the sniper to stay clear of the area.

If the sniper is encountered in a lightly populated area or building, the unit advises residents to leave using a specific route or exit. As the residents exit, the security unit screens and identifies them to make sure that the sniper is not among them. Witnesses and people suspected of being involved with the sniper are detained. Some residents may be unwilling, unable, or afraid to leave. The unit then makes a second announcement advising the remaining residents to seek cover, stay where they are, and stay away from exposed areas and windows.

Control force units set up observation posts on rooftops and in windows of nearby buildings. The observers must have communications equipment. Control force units must be ready to support the SRT. That support may include:

- Setting up a staging area for the SRT and for emergency and support equipment.
- Setting up a field CP.
- Controlling crowds.

When the SRT takes action, team members will:

- Surround the building in which the sniper is concealed and gain access. They may use armored vehicles if necessary and if they are available.
- Illuminate the area during darkness. Darkening a street to gain protection from sniper fire is counterproductive. They may use night observation devices if they are available.
- Employ riot control agents initially, if feasible, rather than small arms fire. If the agents are not successful, then the team may use well-aimed fire by a specifically designated expert marksman. The number of rounds fired is kept to a minimum to reduce the hazard to innocent people.

#### HOSTAGE/BARRICADE SITUATIONS

In a hostage situation, the control force's main concerns are to contain the event and to remove bystanders from the area to reduce the chances of more hostages being taken. The control force contains the hostage site by setting up two perimeters. The inner perimeter of troops must be located so they can restrict the hostage taker's mobility without endangering the hostages. The outer perimeter of troops must be located where they can prevent innocent bystanders from getting injured or killed or from interfering with the activities at the hostage site. It also helps prevent observation by bystanders. The presence of onlookers may only inflame the situation.

As security is being established and innocent people are being evacuated from the area, the commander requests the negotiation team and alerts the SRT. The SRT may prepare for an assault, but they must be very careful not to interfere with the negotiation effort. For the SRT to

be ready when needed, they may have to stand by as part or all of the inner perimeter. If the hostage taker tries to communicate demands to the control force before the negotiators arrive, the demands are recorded and communications are maintained, but no commitments are made. They tell the hostage taker that a negotiator will be there shortly. Any demands made and any additional information about the event are provided to the hostage-site CP. The demands and information must be provided to the negotiation team and the responding SRT.

The negotiation team must have information to support negotiations. They get their information from interviews with initial response personnel, witnesses, escaped and released hostages, and captured suspects. It is critical that the team quickly learns the identities, personalities, motives, habits, and abilities of the offenders. This information helps the negotiator relate to the offenders persuasively and on a personal level. The negotiator must know to whom he is talking. The intelligence must be organized to answer the following questions:

- Do the offenders have criminal records? If so, a wealth of personal information may be derived from their records.
- Do the offenders possess special skills and knowledge? Could they possibly be trained in explosives and sniper tactics? This information must be considered before deciding to make a straight-on assault.
- Do the offenders have any special affiliation? Are they members of any group or religious sect that may dictate or influence their behavior?
- What habits or addictions do they have that could predictably influence their behavior?

## FM 19-15

- What immediate needs do they have, such as transportation, medical care, food, water, or other basic concerns, that could be negotiable?
- If they are recognized terrorists, what are their previous methods of operation? Do they shoot hostages?

The physical descriptions of the offenders and other people inside the barricade are important. They must be distributed immediately to all persons involved in the operation. Any photographs help to identify offenders quickly if they come out pretending to be hostages. Hostage takers have forced hostages to trade clothes with them in an effort to fool control force personnel. And hostage takers have been known to give hostages empty rifles and force them to a window to see if control force personnel will fire.

Intelligence about the hostages is equally important. First, it helps ensure hostage safety. Second, it helps evaluate what might happen inside a barricade before a seige is ended. As well as knowing the number of hostages, their identities, and their descriptions, every effort must be made to learn the following information:

- Sexes and ages.
- Relationships with each other.
- Special training or skills.
- Special food and medical needs.
- Degree to which they are being threatened.
- Susceptibility to hysteria or other adverse reactions to extreme excitement or stress.

These factors can help determine the order in which a negotiator may try to have hostages released. If possible, all information about hostages should come from outside the barricade.

The control force commander must maintain strict control of firepower at all

times. All the efforts and progress of a negotiation team can be destroyed with one accidental or unauthorized shot. The goal is for the negotiation team to resolve the situation without resorting to violence. The decision to commit the SRT must not be based on trying to obtain a quick resolution to the problem. Negotiations must be given time to succeed. If negotiations fail, the SRT is employed as a last resort.

## FIRES

Fire, and its potential for destruction, requires detailed plans to provide immediate and effective responses to limit its effects. The actions of the firefighting task force must be closely coordinated with those of the control force. Local authorities are responsible for the task force. The firefighting task force consists of firefighting and lifesaving equipment and operational and security personnel. Additional equipment and people may be requested through mutual aid if additional resources are needed. The firefighting task force must be able to move rapidly with enough equipment to quickly put out or contain large fires and then move on. More than one firefighting task force may be needed. Each firefighting task force has its own area of operation. When large-scale fires occur in a limited area, several task forces operate together.

The firefighting task force is totally committed to containing fires. It depends on other agencies for its security. Firefighters and their equipment are extremely vulnerable to harassment and attacks. Security for firefighters usually is provided by military units. The military leaders work closely with the senior fireman or with a designated liaison to ensure that adequate and timely assistance is provided. The size of the security force varies with the size of the firefighting task force. It also varies with the level of hostility in the area and the number of people and equipment that can be allocated to the security mission.

**SAMPLE TELEPHONE CHECKLIST (FRONT)**

6-116 (Rev. 8-27-77)



**FBI BOMB DATA CENTER**

PLACE THIS CARD UNDER YOUR TELEPHONE

**QUESTIONS TO ASK:**

1. When is bomb going to explode?
2. Where is it right now?
3. What does it look like?
4. What kind of bomb is it?
5. What will cause it to explode?
6. Did you place the bomb?
7. Why?
8. What is your address?
9. What is your name?

**EXACT WORDING OF THE THREAT:**

\_\_\_\_\_  
 \_\_\_\_\_  
 \_\_\_\_\_  
 \_\_\_\_\_  
 \_\_\_\_\_  
 \_\_\_\_\_  
 \_\_\_\_\_  
 \_\_\_\_\_

Sex of caller: \_\_\_\_\_ Race: \_\_\_\_\_  
 Age: \_\_\_\_\_ Length of call: \_\_\_\_\_  
 Number at which call is received: \_\_\_\_\_

Time: \_\_\_\_\_ Date: \_\_\_\_/\_\_\_\_/\_\_\_\_ FBI/DOJ

**BOMB THREAT**

and joint operational facilities during civil disturbances. If possible, each facility should have a telephone tracing capability.

Switchboard operators and others likely to receive bomb threats can be provided with a checklist so they will know to—

- Activate the telephone tracer system if one is available.
- Learn and record the bomb's location; the time of detonation; the type of device, including physical description; the sex, approximate age, and attitude of the caller; speech peculiarities or accent; distinguishing sounds or background noises coming from the caller's location; and the reason for placing the bomb.
- Inform the appropriate people of the threat.

The checklist needs to be placed near as many telephones as possible.

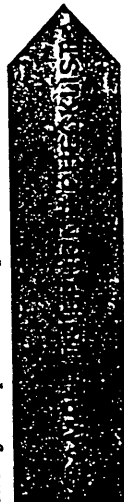

When a bomb threat is received, the responsible commander notifies appropriate control force elements, fire and medical services, utilities, and EOD units. He has them report to a staging area near the threatened facility. He orders roadblocks or checkpoints set up as needed to keep unauthorized people out of the area. Perimeters to isolate the area must be far enough away to prevent danger from an explosion.

If the occupants must evacuate the building, the evacuation must be orderly. This is best accomplished by using a bomb evacuation plan, a fire plan, or announcements and directions to building occupants. The plan must designate withdrawal building or an area that offers shelter from the elements. Care must be taken not to create panic. Occupants

Mobility is a must. Control force elements tasked with security must have enough vehicles and communications equipment to move rapidly. Vehicles must be equipped with flashing emergency lights to enable them to move safely through traffic and intersections. Military police vehicles, if they are available, can escort the security force.

The following actions are taken at the fire scene:

- A protective cordon is set up around the firefighters' area of operation. The cordon includes security of hoses and hydrants. The cordon concentrates on activities outside the cordon. Small units are assigned areas of responsibility like they would be for any defensive posture.
- Observation posts are positioned in and on nearby tall buildings to prevent sniping or other attacks.
- Hostile crowds are controlled with crowd control techniques. If necessary, reinforcements are called up.
- Traffic trying to enter the area is blocked and diverted.

**BOMB THREATS**

Bomb threats often occur during civil disturbances. Frequently, warnings are given to avoid the loss of innocent lives when a bomb has been planted. However, after an explosion, cranks or disturbed persons occasionally may make threats or give false notice to interrupt activities or business by forcing evacuations. If a fake threat successfully causes an evacuation, then more threats usually follow. But any doubts concerning safety must always be resolved in favor of evacuation.

at bomb threats are received by telephone operators of businesses and schools. Bomb threats also may be received at





**COMPANY ECHELON IN MASS, ONE PLATOON IN LATERAL SUPPORT**

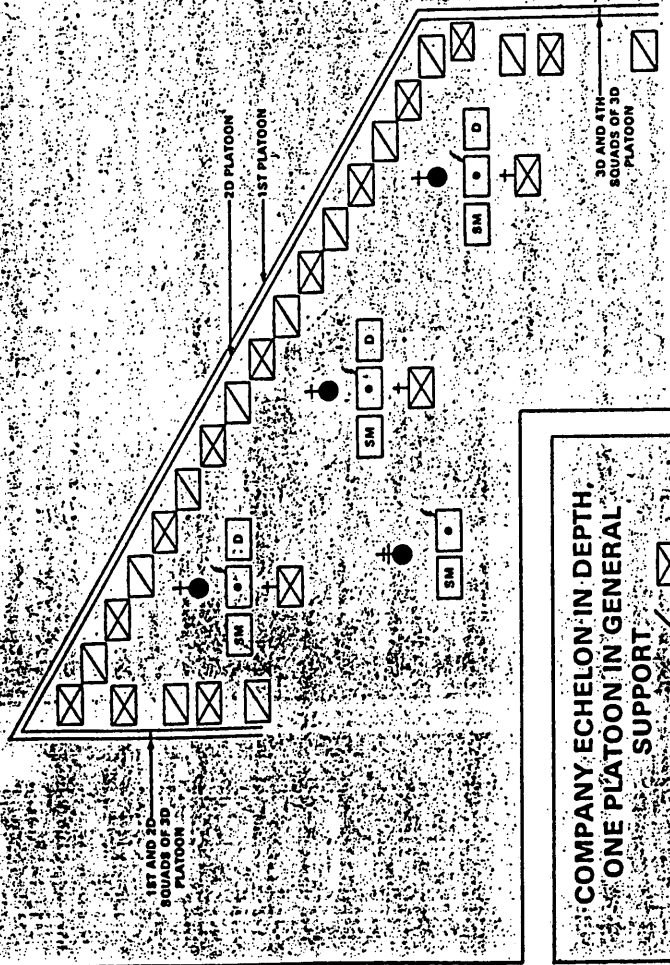

**COMPANY ECHELON IN DEPTH, ONE PLATOON IN GENERAL SUPPORT**

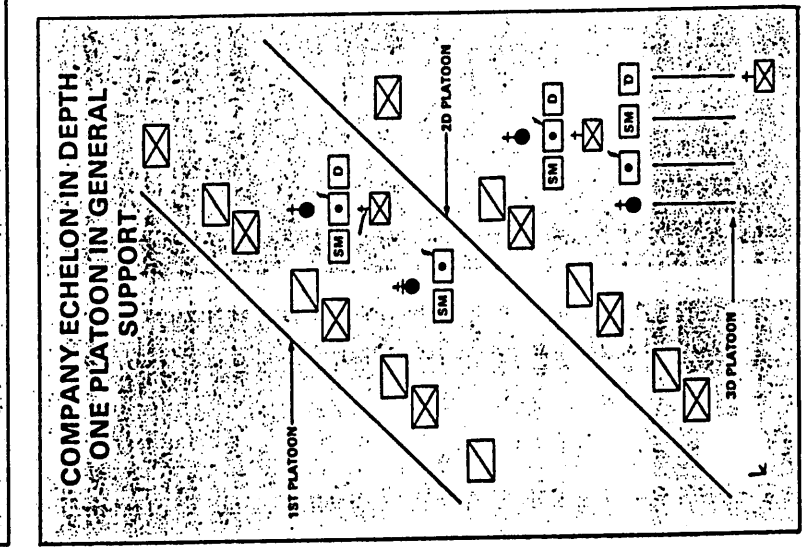

**COMPANY ECHELON IN MASS, ONE PLATOON IN GENERAL SUPPORT**

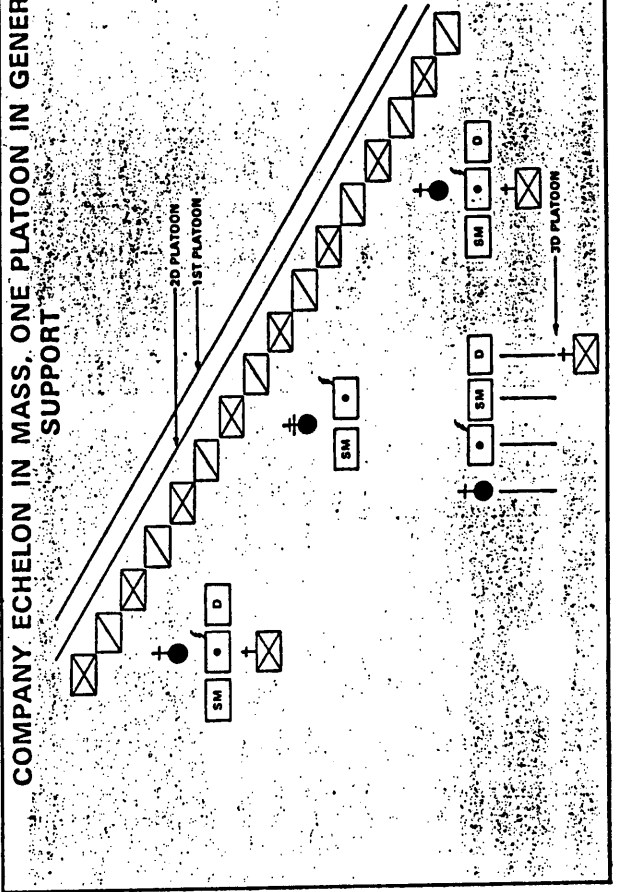

## CHAPTER 7

### Force Options

The task force commander's mission is to help restore law and order. In carrying out this mission, the task force commander ensures that only minimum force is used. In selecting an operational approach to a civil disturbance situation, the commander and his staff must adhere scrupulously to the "minimum necessary force" principle. For example, crowd control formations or riot control agents must not be used if saturation of an area with troops will suffice. The presence of large numbers of troops can prevent the development of situations in which the use of deadly force is necessary. A large reserve of troops should be maintained during civil disturbance operations. Knowing that a large reserve force is available builds morale within the control force and helps prevent them from overreacting to provocative acts by disorderly persons. Any doubts about the number of troops required usually should be resolved in favor of large numbers.

Every effort is made to avoid appearing as an invading force. The commander has many troops at his disposal. But he commits them only when and in the numbers necessary. When he does commit troops, he ensures that they function in a highly organized and disciplined manner. The control force must present the image of a restrained and well-disciplined force whose sole purpose is to assist in restoring law and order with a minimum loss of life and property and with due respect for those citizens whose involvement may be purely accidental. While control force personnel must be visible, their tactics or force concentrations should be those that will calm rather than those that may excite.

All troops, before taking part in civil disturbance operations, must be briefed on—

- The background of the situation and the specific mission of the unit.

- Rules governing the application of force as they apply to the specific situation.
- The psychological aspects of the local situation, specifically addressing types of abuse that the troops can expect to receive and the proper responses to that abuse.
- Identification to be used by news media representatives and civil officials, if known.
- The special orders contained on GTA 21-2-7.

When the troops arrive at the disturbance area, they must know and understand operational restrictions and the permissible degrees of force. They must have a written copy of the special orders. All troops must understand and comply with the special orders.

The intent of the special orders is to achieve a balance in the use of force and thereby avoid indiscriminate firing in civil disturbance situations while protecting the soldier's right of self-defense. These special orders can be supplemented by additional written orders for special posts, positions, or operations. Such orders must be as simple and brief as possible.

Each unit commander must ensure that his troops have all the personal protective equipment needed for civil disturbance operations. Civil disturbance equipment is not stockpiled or issued in quantity. It is requested or acquired when it is needed. Generally, each soldier's equipment consists of the battle dress uniform, a helmet, a faceshield, a flak or protective vest, a pistol belt, a first-aid kit, a canteen, a protective mask, leather gloves, and a body shield (2 1/2 feet x 4 1/2 feet). Protective vests are required when violence is expected. The vest protects the vital organs in the torso. On the other hand, protective vests are heavy and cumbersome. In very hot weather, they may increase the risk of heat injuries. There is a trade-off between protection and a loss of effectiveness, mobility, and visibility caused by the equipment.

The helmet and the faceshield protect the head and face. Protective masks are vital items when CS agents and/or smoke are present during a civil disturbance. The soldiers must know how to use the mask in

stressful situations. The masks, especially when worn with the hood, can increase the risk of heat casualties. They limit the amount of strenuous activity that soldiers can perform. Proper training is the best way to reduce the disadvantages of wearing the protective mask. The protective mask carrier is worn in the front to give added protection to the groin area.

The black leather gloves with inserts protect the hands. However, soldiers using equipment or weapons may not need the protection of the gloves. They may need flexibility more than protection.

Body shields provide protection that complements the protective vest. They may replace the flak vest altogether. Body shields are very effective protection against thrown objects. When pushing back a crowd, body shields deny demonstrators something to grab. When body shields are used in groups or formations, they provide a protective wall for rescue forces and have strong psychological effects on the crowd. The Army does not stock body shields. However, they may be purchased locally from police equipment manufacturers or distributors. Body shields also may be constructed locally using aluminum sheets. In any case, they must be sturdy and lightweight. They must cover the body's width from the chin to the knees. If the resources are available, viewing slits can be cut in the shields approximately 6 inches from the top.

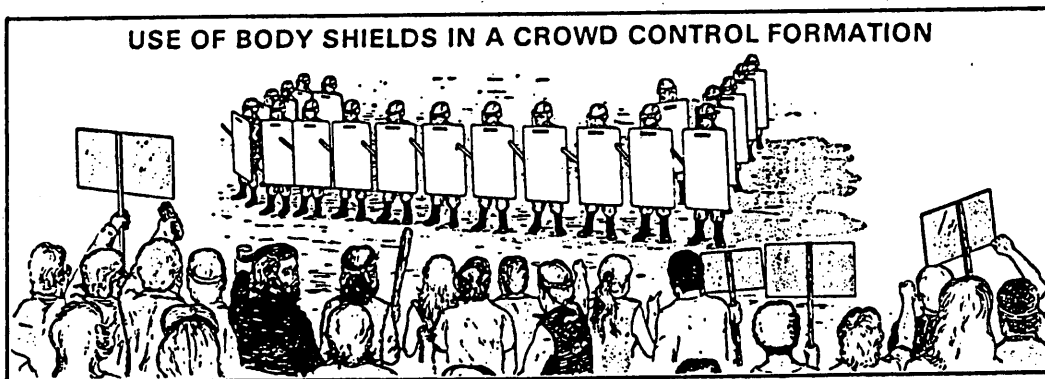

Hand irons are needed for apprehensions. The use of hand irons requires special training to avoid damaging the detainee's wrists and to ensure their efficient use. Hand irons require a key to double-lock and to open them. A good alternative to hand irons are flexcuffs. Flexcuffs require minimum training. One soldier can carry several without hindering his mobility. Flexcuffs require no equipment for applying them. But they require wire cutters to take them off and to clip off the tail end after application.

Riot control agents have many advantages over other measures. They have an immediate effect on large groups of people without causing permanent harm. Riot control agents, when properly used, disperse large crowds without troops having to come into contact with the crowds. The troops must understand the capabilities and limitations of riot control agents in order to use them in the safest and most efficient manner. Only the task force commander has the authority to order the use of riot control agents. Based on the situation, he may delegate this authority to qualified personnel.

People do not easily develop a tolerance to riot control agents. But experience and knowledge tend to reduce the fear that gives the control force an added psychological advantage. Riot control agents lose some of their advantages in crowd control as they are more widely used and understood.

Short of masking, there are no effective defensive measures against a well-planned and executed riot control agent deployment. Surplus masks and other types of masks are available to the public. Troops can expect masks to be used by highly motivated members of the crowd. Therefore, riot control agents are not a cure-all. They are a tool that must be used in conjunction with well-trained and well-equipped troops.

The commander may elect to arm his troops with riot batons, shotguns, or rifles.

But his choice will always be consistent with the principle of using only the minimum force needed to accomplish the mission.

The task force commander is authorized to issue live ammunition to troops under his command. But he must ensure positive control over the loading and the firing of weapons. Guidance concerning placing magazines in weapons must be specified when the ammunition is issued. Individual soldiers must be instructed, however, that they may not place a round in the chamber unless authorized by an officer or, if they are not under the direct control and supervision of an officer, unless circumstances justify the use of deadly force. Retention of control over the loading of weapons by an officer until the need for such action is clearly established is of critical importance in preventing the unjustified use of deadly force. Whenever possible, command and control arrangements must be specifically designed to facilitate careful control of deadly weapons. Planners must realize that if a participant in the disturbance seizes a loaded weapon from a control force member, the potential for escalated violence will increase greatly.

The presence of loaded weapons in tense situations may invite the use of deadly force in response to provocations that, while subject to censure, are not sufficient to justify its use. It also increases the hazard that an improper discharge of a weapon by one or more soldiers will lead others to fire reflexively on the mistaken assumption that an order to fire has been given. Officers must be clearly instructed that they have a personal obligation to withhold permission for loading until circumstances indicate that deadly force will very likely be necessary and justified. Strong command supervision ensures that the loading of weapons is not authorized in a routine, premature, or blanket manner.

Task force commanders must exercise positive control over the use of weapons at all times. Each soldier must be instructed

that he may not fire his weapon except when authorized by an officer or when he is not under the direct control and supervision of an officer and circumstances justify the use of deadly force. He must be thoroughly acquainted with not only the prerequisites for the use of deadly force, but also that whenever he is operating as a part of a unit or element under the immediate command and control of an officer, the officer decides whether the firing of live ammunition is necessary. For this reason, control force members should have ready access to an officer.

The use of deadly force can be justified only by extreme necessity. Accordingly, its use is not authorized for the purpose of preventing activities like curfew violations or looting that do not pose a significant risk of death or serious bodily harm. If a mission cannot be accomplished without the use of deadly force, but deadly force is not permitted under the guidelines authorizing its use, the mission must be delayed until sufficient nondeadly force can be brought to bear. The commander reports the situation and seeks instructions from higher authority. The use of deadly force is authorized only when *all* of the following conditions exist:

- Lesser means have been exhausted or are unavailable.
- The risk of death or serious bodily harm to innocent people is not significantly increased by its use.
- The purpose of its use is one or more of the following:
  - Self-defense to avoid death or serious bodily harm.
  - Prevention of a crime that involves a substantial risk of death or serious bodily harm, such as setting fire to an inhabited dwelling or sniping, including the defense of other people.

- Detention or prevention of the escape of a person who, during detention or while escaping, presents a clear threat of loss of life or serious bodily harm to another person.

Every soldier has the legal right to use reasonably necessary force to defend himself against violent and dangerous personal attack. The limitations described above are not meant to infringe on this right. However, it must be emphasized that a control force member is part of a unit and is subject to a chain of command. As such, he must act in accord with his orders and as a member of a unit. Therefore, unless an attack is directed at him personally and unless his response can be directed specifically at the attacker, his response must be governed by the guidance of his immediate supervisor.

In the United States and its territories, the acts of individual soldiers are subject to civil laws as well as the provisions of the UCMJ. Reckless or malicious use of force may subject soldiers to civil or criminal liability under local law or to administrative or criminal liability under military law. The US Code guarantees any member of the Armed Forces the right to trial before a federal court, rather than a state court, for any charge or claim against him for any act committed while performing his official duties. Acts found to be outside the scope of military authority can result in the loss of this right. In a criminal prosecution, civil courts ordinarily do not convict a subordinate for acts done in good faith while obeying orders from superiors. However, if an act is so obviously illegal that it would be immediately apparent to a reasonable person, obeying the order probably would not be a valid defense.

In each situation where federal forces are committed, the task force commander must determine which facilities within his area of operation constitute vital facilities and, as such, justify the use of deadly force in protecting them. Those troops assigned to

security missions must know if a particular facility or activity is so vital to the health and safety of the public that the use of deadly force would be justified to protect it.

The degree of force authorized for securing a facility must be consistent with the rules of force. The task force commander must ensure that a community's or an installation's vital facilities are designated as such. Vital facilities can be protected by the use of deadly force if the prerequisites for using deadly force exist.

In addition, the following policies regarding the use of deadly force must be observed:

- Task force commanders, at their discretion, may delegate the authority to authorize the use of deadly force if such delegation is consistent with the policies that follow and if the person to whom such delegation is made understands the constraints on the use of deadly force.
- Even when the use of deadly force is authorized pursuant to established constraints, it must be employed with great selectivity and precision against the particular threat that justifies its use. For example, receiving sniper fire—no matter how deadly—from an

unknown location can never justify returning fire against any or all persons who may be visible on the street or in nearby buildings. Such an indiscriminate response is far too likely to result in casualties among innocent bystanders or fellow law enforcement personnel. The appropriate response is to take cover and to try to locate the source of fire so the threat can be neutralized, either through negotiation or by force.

- When possible, the use of deadly force should be preceded by a clear warning to the person or group that the use of deadly force is contemplated or imminent.
- Warning shots must *not* be used. They constitute a hazard to innocent people and can lead citizens and fellow law enforcement personnel to mistakenly believe that sniping is widespread.
- When firing, the marksman should aim to wound rather than to kill if it is at all possible.

Task force commanders may use force to control a disturbance, to prevent crimes, and to apprehend or detain people who have committed crimes. But the degree of force used must be no greater than that reasonably necessary under the circumstances.

## CHAPTER 8

### Crowd Control Formations

Crowd control formations, when properly employed and executed against a crowd of limited size, are one of the most practical methods of crowd control. In selecting force options, the riot baton generally is the main weapon of the control force. If the situation is serious, the commander may consider employing a mix of batons and rifles. For example, the first line of the formation is armed with batons and the second or supporting ranks are armed with rifles or rifles with fixed bayonets.

Crowd control formations may be employed to disperse, contain, or block a crowd. When employed to disperse a crowd, they are particularly effective in urban areas because they enable the control force to split a crowd into smaller segments. When a crowd has been dispersed, the control force must not assume that they have capitulated and returned to peaceful activities. Small groups can initiate dispersed riotous acts. Therefore, the use of formations is only a part of the total dispersal effort. If the crowd refuses to move, the control force may have to employ other techniques, such as riot control agents or apprehensions.

Commanders must realize the limitations of formations. Formations are not the answer to all civil disturbance situations. The commander must not subject his troops to unnecessary sniper fire and violence simply to impress the crowd with a show of force. When small, dispersed mobs are rampant in an area, formations are of little value. Even when a large mob has been split up, the problem is not necessarily solved. The small elements that break away from the large mob may engage in small-mob tactics, such as sniping, looting, and burning. Commanders then, of necessity, must revert to area control measures,

such as building searches, saturation patrolling, and other tactics.

Rooftops must be secured to help prevent sniper fire from these vantage points. Helicopter observation is one method of visually securing rooftops. Occupation of the rooftops is another. When troops are stationed in high buildings or on rooftops, all other troops must be informed of this to avoid the possibility of control force members being mistaken for snipers.

Crowd control formations also may be used for more than just dispersal operations. If the decision is made to apprehend crowd members, the crowd control formation may be used as a blocking formation. Apprehension teams then escort apprehended crowd members back through the formation. (See Chapter 12.) A crowd control formation also may be used to aid containment operations by using blocking, flanking, and confrontation elements of the formation.

Commanders analyze the threat, the control force's missions, and how crowd control formations can be used to aid mission accomplishment. Experience has shown that the formations, to be effective, must be tailored to meet the situation.

Whatever the modification, troops must be proficient in the basic formation movements to be able to react or adjust to a changing situation.

Civil disturbance training must ensure that the soldiers understand the need to

stay in formation. Troops are much more vulnerable to attack when individual soldiers break ranks and chase after crowd members. The individual soldiers place themselves in danger, and the entire formation may be threatened if it begins to break down.

## TYPES OF FORMATIONS

Past civil disturbances indicate that the most frequently used formations are the line, the wedge, and the echelon. The line formation is used more often because of its offensive and defensive applications. As an offensive formation, the line is used to push or drive crowds straight back, across an open area, or up a city street. As a defensive formation, the line is used to hold the crowd or to deny access to restricted streets or areas. The echelon is an offensive formation used to turn or divert groups in either open or built-up areas and to move crowds away from buildings, fences, and walls. The wedge is an offensive formation that is used to penetrate and split crowds. The diamond, as an offensive formation, is used to enter a crowd and is suitable for apprehending ring leaders. As a defensive formation, the diamond is used when all-around security is required. The circular formation may be used for the same purposes as the diamond. The decision to use either the diamond or the circle is based on the conformation of the crowd.

When a control force encounters large riotous groups, it may be best to employ vehicles with troops on foot in crowd control formations. Although vehicles add strength to formations, certain precautions must be taken. Precautions include:

- Ensuring windshields of vehicles are upright, removed, or completely depressed. If the windshields are safety glass, they offer some protection in the upright position, minimizing the danger of injury from glass fragments.

- Building shields for mobile barriers by mounting a wooden or metal frame strung with barbed wire across the front of a vehicle.
- Having foot troops in formation walk as near the front corners of each vehicle as possible to keep rioters from attacking the sides and rear of the vehicles.

Armored vehicles are employed when practical. They have a strong psychological effect, and they offer protection for the occupants. Wheeled armored vehicles are best because they do not deface the pavement.

Vehicles are used only in conjunction with troops on foot. Whenever vehicles and foot troops are employed, the commander of the foot troops commands the unit. He joins the leader of the motor section in the command vehicle, where he has a vantage point. In every instance, his commands are executed through the subordinate leaders.

Many suitable variations of the crowd control formations can be employed. But appropriate commands and signals must be devised to execute the formations. Because of their somewhat complicated nature and the coordination required for these formations, new variations must be practiced extensively before they are used in an actual civil disturbance.





### HAND SIGNALS FOR FORMATIONS



**LINE**

Raise both arms from the sides until they are horizontal. The arms and hands should be extended with the palms down.

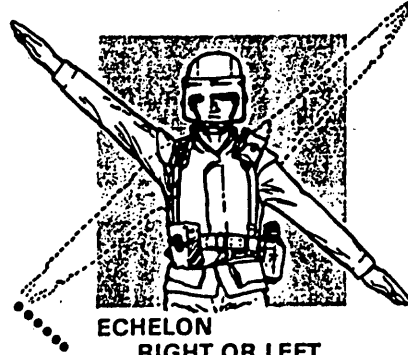

**ECHELON**

**RIGHT OR LEFT**

Extend one arm 45 degrees above the horizontal and the other 45 degrees below the horizontal. The arms and hands should be extended. The upper arm shows the direction of the echelon when the commander faces the troops.

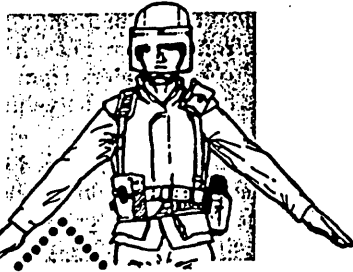

**WEDGE**

Extend both arms downward and to the sides at a 45-degree angle. The arms and hands should be extended with the palms down and in.

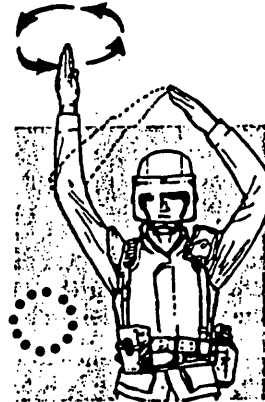

**CIRCULAR**

Give the diamond signal. Then give a circular motion with the right hand.

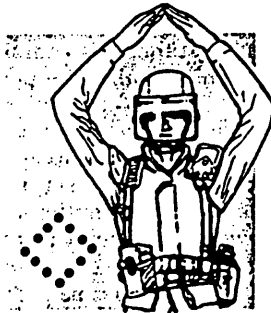

**DIAMOND**

Extend both arms above the head. Bend the elbows slightly, and touch the fingertips together.

## WEAPON POSITIONS

At the commander's discretion, the members of the crowd control formation may carry their weapons in any of the positions prescribed in FM 22-5. Port arms is especially useful for resting support troops who are not in direct contact with the crowd. The positions for safe port, safeguard, and on guard shown below are for the M16 rifle. These positions are equally suited for the M14 rifle and the M1 rifle. The hand grasps need only be altered where necessary.

The safe-port position is quite effective when making a show of force. In this elevated position, bayonets can be seen by participants in the rear of the crowd. The sight of bayonets can create an impression of strength and numerical superiority.

Troops move into and assemble from all crowd control formations with weapons in the safe-port position. Troops automatically assume the safe-port position on the preparatory command for a crowd control

formation and when commanded to assemble.

Commanders use the safe-port position to impress rioters. However, troops should not be kept in the position very long as it is very tiring.

The safeguard position is a position of semireadiness. It is less tiring than the on-guard position. It is used to rest troops when circumstances permit. For example, as troops advance, they maintain the safeguard position until just before contact is made or resistance is expected. The safeguard position can also be used when troops are pursuing a crowd that is withdrawing without resistance.

On guard is a position of complete readiness. It is used whenever troops are in contact with a group that is showing any kind of resistance or hesitation to withdraw. It also is a tiring position to maintain for extended periods of time. Commanders must rest their troops at every opportunity by using less tiring positions.

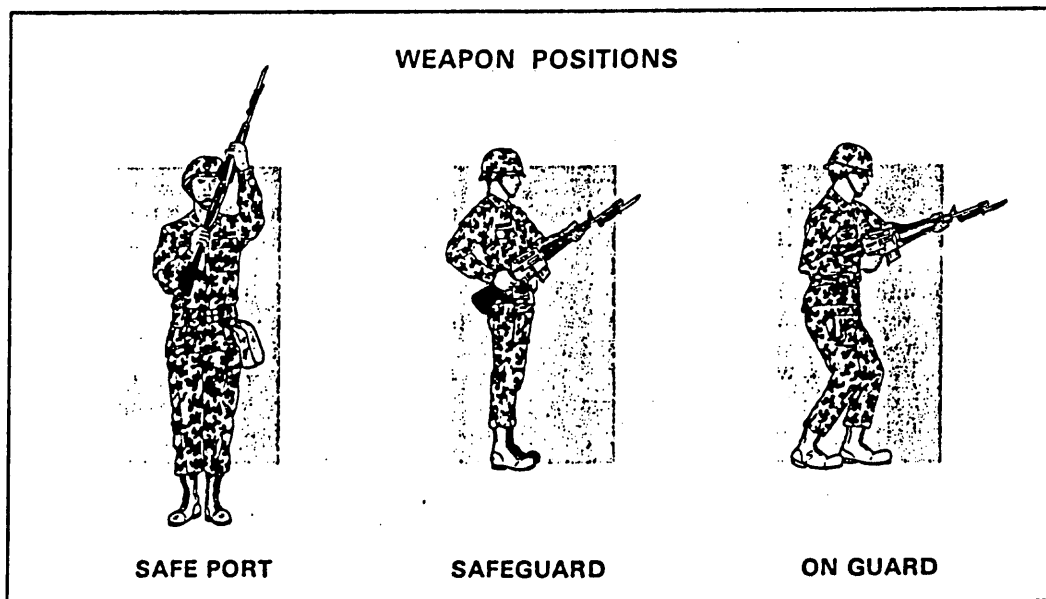

## COMMANDS

Commands can be given to crowd control units in formation either orally or with hand signals. The oral commands for safe port, safeguard, and on guard are given in one count. All other commands are given in two counts, a preparatory command followed by an execution command. Oral commands cannot be relied on completely. Commanders must plan to use alternate methods for relaying commands. When it is necessary, commanders use hand and arm signals with oral commands.

The unit marches in column formation a reasonably safe distance from the crowd and within plain view of it. The unit halts and remains in formation. The commander decides on what crowd formation he desires for the situation. The unit is ordered into or assembled from crowd control formations while halted. As each soldier reaches his proper position, he automatically faces in the direction of the unit's intended advance and comes to a halt. He remains halted in the safe-port position and awaits further orders. On the preparatory command, the troops automatically assume the safe-port position. On the execution command, they form the formation. Once the troops

are in the crowd control formation, the commander commands, "Safeguard," and issues the proclamation. Following the proclamation, the commander informs the participants that they have a specific time in which to comply with the order to disperse. If the participants fail to disperse within the given time, the commander employs the measures needed to disperse the crowd.

When the commander gives the safe-guard and on-guard commands, the commands are for the lead element only. When using squads in support and the commands for safeguard and on guard are given, the support squads automatically move to the port-arms position when the command of safeguard is given to the lead element. If the squads are in general or lateral support and must move to another support position, they assume the safe-port position. They move to the new support position and are then commanded to port arms. The support elements give a re-sounding stomp with the left foot when the lead element goes to the on-guard position. On the command, "Forward march," the support elements maintain the same half-step cadence as the lead element.

## CADENCE

The usual cadence for moving troops into and out of crowd control formations is double time. The troops are at safe port when performing these maneuvers. When troops in a crowd control formation are moving in the safeguard position, the usual cadence is quick time. When they are moving in the on-guard position, the usual cadence is 60 steps per minute. For psy-

chological effect, troops using the on-guard cadence may accentuate each left-foot step with a stomp.

The commander may increase or decrease the cadence, depending on the situation. For example, the commander may call a quick-time cadence to keep pressure on a crowd that is withdrawing.

## INTERVAL AND DISTANCE

Interval is the lateral space between elements. Distance is the space between elements in a column. The usual interval

and distance between soldiers in crowd control formations are one pace or 30 inches.

Interval and distance can be adjusted for particular situations. The 30-inch interval may not be sufficient in some situations. It may have to be lengthened. Some police

forces have found that a greater interval makes formation members less vulnerable to thrown objects.

### COMMANDER AND LEADER POSITIONS

When a unit is in a column formation, each echelon commander usually takes a position at the head of the column. In crowd control formations, squad leaders and their assistants, platoon leaders and their assistants, and company commanders take positions where they can best direct and control their units. For diamond and circle formations, they place themselves in the center of the formation. For all other formations, they place themselves at the rear of the unit. However, these are only guidelines. The leaders can adjust their position with respect to their unit as they see fit.

In column formations, messengers, radio operators, marksmen, disperser operators,

and other platoon HQ members usually take positions at the front of the column. In a crowd control formation, HQ personnel, at the commander's discretion, may be positioned near the commander. If the situation does not allow this kind of positioning, HQ personnel may be positioned behind the control element.

Control force formations can be based on 12-man squads, 4-squad platoons, 3-squad platoons, and 3-platoon companies with 4-squad platoons. However, a 9-man or a 10-man squad can be adapted easily to the example for a 12-man squad. Any size squad, platoon, or larger unit can be employed, and a crowd control formation can be adapted to fit the unit's organization.

### SQUAD FORMATIONS

When moving a squad into a crowd control formation from a column formation, the squad leader takes one or more steps to the right of the squad and faces the squad. He gives the hand and arm signal for the formation that he wants. He then gives the

preparatory command. As he gives the execution command, he points to where he wants the unit to form. The squad's number two man, or base man, moves to that position. The squad forms on the base man's position.

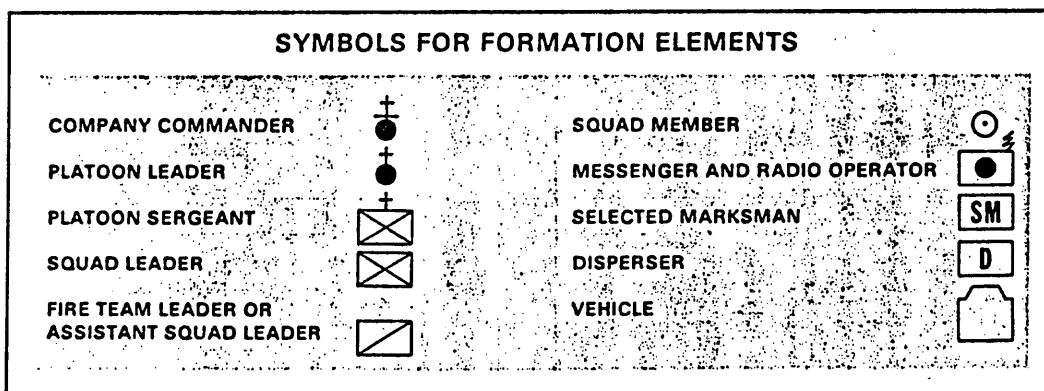

**SQUAD LINE**

The command for having a squad form in a line formation is "Squad as skirmishers, move." On the execution command, the base man moves to the place indicated by the squad leader. The squad members align themselves in sequence on the base man, one pace apart.

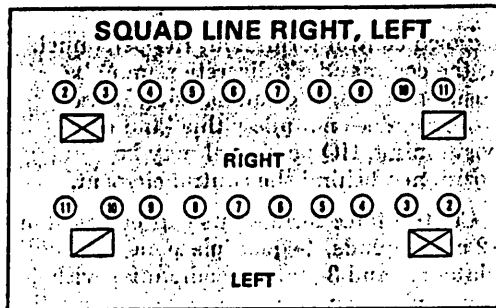

indicated by the squad leader. The squad members align themselves in sequence on the base man, one pace to the side and one pace to the rear.

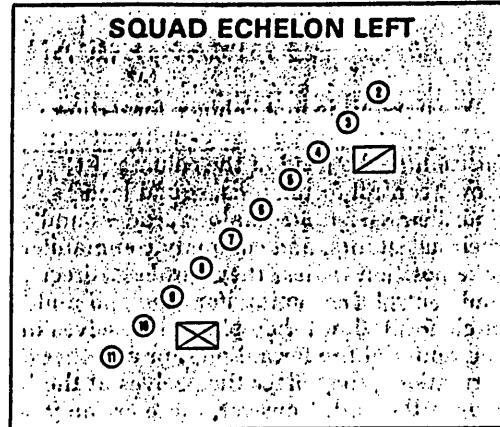

Based on the situation, the squad leader may designate a specific interval. He does this when he gives the preparatory command. If no interval is specified, the squad automatically forms using a one-pace interval.

**SQUAD ECHELON**

The command for having a squad form in an echelon formation is "Squad echelon right (left), move." On the execution command, the base man moves to the place

**SQUAD WEDGE**

The command for having a squad form in a wedge formation is "Squad wedge, move." On the execution command, the base man moves to the place indicated by the squad leader. Even-numbered squad members align themselves in sequence on the base man, one pace to the right and one pace to the rear of each preceding man. Odd-numbered members align themselves in the same way to the left of the base man.

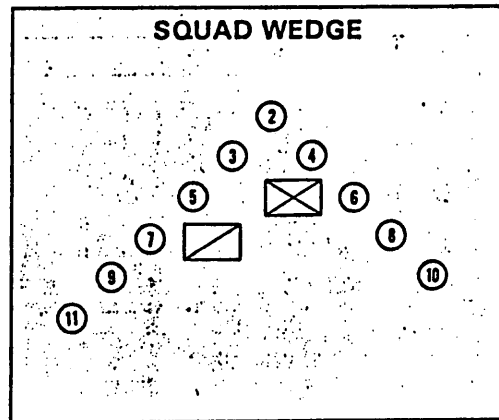
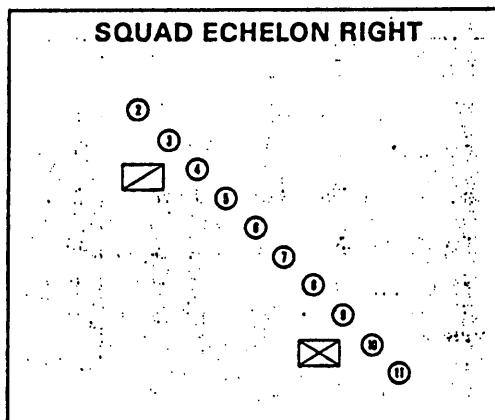

### SQUAD ASSEMBLY

When assembling a squad from the line formation, the squad leader takes a position a sufficient distance to the rear of the squad and commands, "Squad assemble." At the same time, he raises his right hand in the air and makes a circular motion. Squad members who hear the command automatically come to the safe-port position. The base man does an about-face. The other squad members face toward the base man. On the execution command, "Move," the squad leader points to the place where he wants the base man to assemble. The base man double-times to the designated spot, and the other members of the squad follow the base man. When the

squad is in a column formation again, they are ordered to port arms.

To assemble from a squad echelon formation, the squad leader takes the same steps as for the line formation. The base man does an about-face. The squad members do either a half left face for an echelon right or a half right face for an echelon left and follow the base man.

To assemble from a squad wedge formation, the squad leader takes the same steps as for the line and echelon formations. The base man does an about-face. All even-numbered men do a half left face, and all odd-numbered men do a half right face. They then follow the base man in sequence.

### FOUR-SQUAD PLATOON FORMATIONS

Platoon headquarters consists of the following four people:

- Platoon leader.
- Platoon sergeant.
- Selected marksman.
- Messenger or radio operator.

When directed by the platoon leader, other people, such as disperser operators and firefighters, may augment the platoon headquarters.

In forming all crowd control formations from the column, the platoon leader moves to the right of the platoon and faces them when giving his commands. He gives the arm and hand signal and the preparatory command. On the execution command, "Move," he points to the approximate location where he wants the platoon to form. The platoon leader pauses between the preparatory command and the execution command to allow each squad leader to issue a preparatory command to his squad.

### PLATOON LINE

The command for forming a platoon line is "Platoon as skirmishers, move." Immediately following the platoon leader's preparatory command, the squad leaders of the first and fourth squads command, "Follow me." The squad leaders of the second and third squads command, "Stand fast." On the platoon leader's execution command, the first and fourth squads move forward to the point designated by the platoon leader. The number two man of the fourth squad is the base man for the platoon formation. The fourth squad forms a squad line to the right of the base man, and the first squad forms a squad line to the left of the base man, dressed on the fourth squad. After the first and fourth squads have cleared the platoon, the second and third squad leaders command, "Follow me." The second squad forms a squad line to the left of the first squad. The third squad forms a squad line to the right on the fourth squad, all squads dressing on the fourth squad.

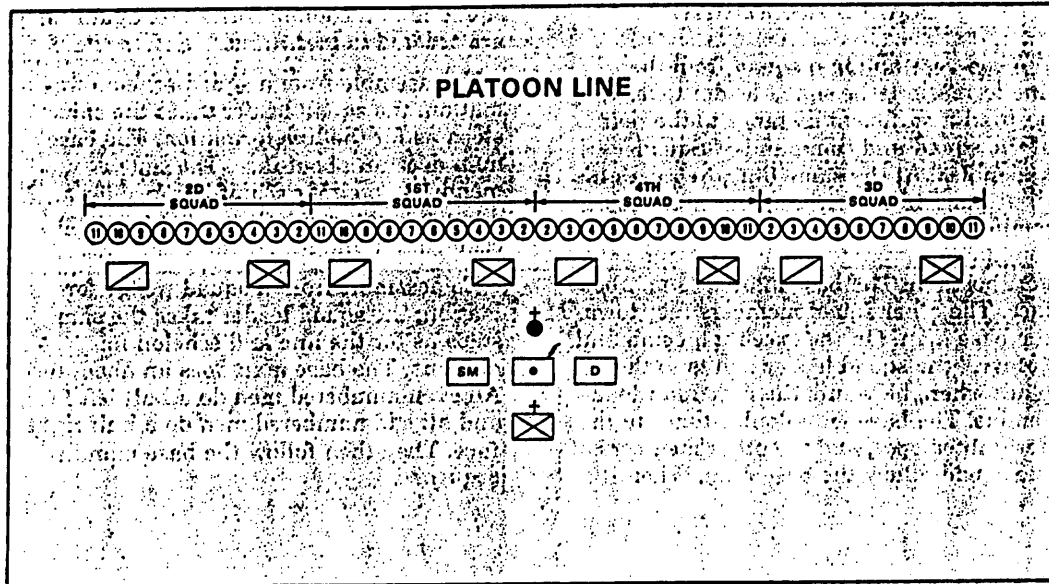

When assembling the platoon from the platoon line formation, the platoon leader and his HQ personnel take a position to the rear of the platoon. He then gives the command, "Platoon assemble," raising his right arm and making a circular motion above his head. The members of the platoon automatically assume the safe-port position. All squad leaders go to their number two men and face the platoon leader. All number two men do an about-face. All other squad members do a facing movement toward their respective number two men. On the platoon leader's execution command, he points to where he wants the platoon to assemble. The squad leaders of the fourth and third squads command, "Follow me," and together they move toward the platoon leader. As the fourth and third squads clear the line formation, the first and second squad leaders command, "Follow me," and together they move toward the platoon leader, dressing to the left of the fourth and third squads. All squads halt automatically behind the platoon HQ and dress. After the squads are in column, the platoon leader commands, "Port arms." If the platoon leader wants

the platoon facing back in the direction of the crowd control formation, he commands, "Counter-column, march."

#### PLATOON LINE WITH GENERAL SUPPORT

Whenever the command for establishing a crowd control formation contains the phrase, in support, without modification, it means that the support element is to remain in general support.

The command for forming a platoon line with two squads in general support is "Platoon as skirmishers, second and third squads in support, move." The first and fourth squads execute the line, while the second and third squads remain in the column. The number two man of the fourth squad is the base man for the formation.

To assemble a platoon with two squads in general support, the procedure is the same as for the platoon line, except the second and third squads do a counter-column. The fourth squad then dresses to the right of the third squad, and the first squad dresses to the left of the second squad.

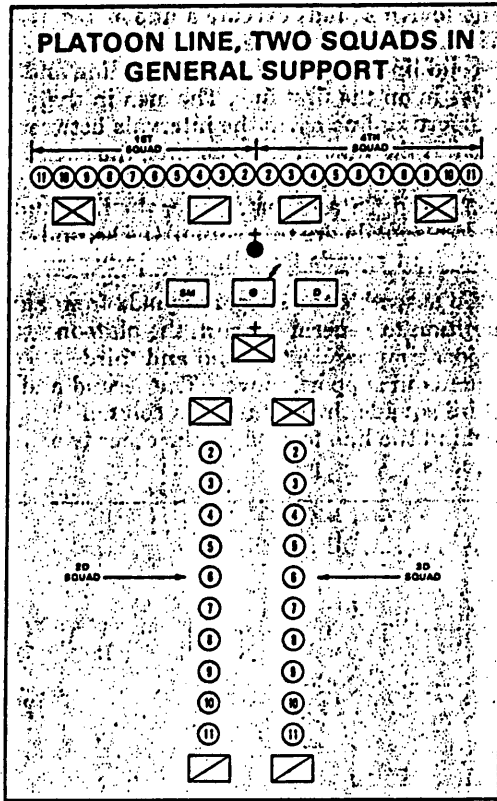

**PLATOON LINE WITH LATERAL SUPPORT**

The command for forming a platoon line with two squads in lateral support is "Platoon as skirmishers, second and third squads in lateral support, move." The fourth and first squads execute the line as before, and the second and third squads stand fast. After the line has been formed, the squad leaders of the second and third squads command, "Follow me." The second and third squads move out to their respective flanks. The second squad forms a column behind the last man on the line to the left. The third squad forms a column behind the last man on the line to the right.

The second and third squads may be moved from general support to lateral

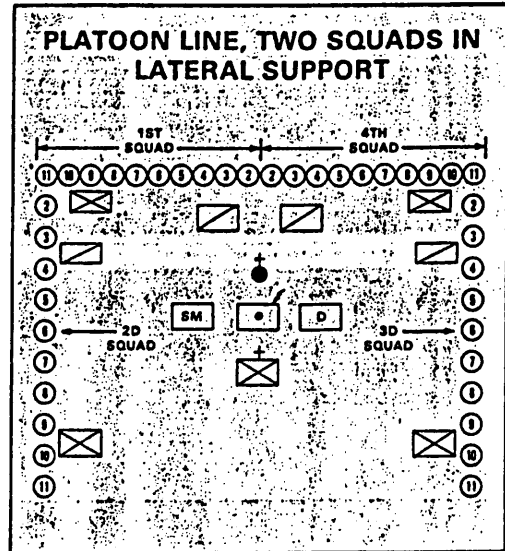

support at any time by the platoon leader. He commands, "Second and third squads, lateral support, move." To have the second and third squads join the line from either support position, the platoon leader commands, "Second and third squads, extend the line, move." The second and third squad leaders command, "Follow me." On the execution command, the squads set up individual lines, closing and dressing on the existing line.

To assemble the platoon from a platoon line with lateral support is the same as for the platoon line, except the number two men of the second and third squads do a right face and a left face, respectively, toward their squad leaders. On the execution command, the fourth and third squads move to the point designated by the platoon leader. As the fourth and third squads clear the formation, the first and second squads move.

**PLATOON LINE WITH CLOSE SUPPORT**

The command for forming a platoon line with two squads in close support is "Platoon as skirmishers, second and third squads in close support, move." The first



and fourth squads execute a line as before. The second and third squads execute a second line to the rear of the first line and close in on the first line. The men in the supporting line cover the intervals between men in the first line. To do this, the squad leaders of the second and third squads command, "Stand fast." After the first and fourth squads are in position, the second and third squads form lines as indicated.

To assemble the support squads from any position to general support, the platoon leader commands, "Second and third squads in support, move." The second and third squads then return to a column behind the line formed by the other two squads.

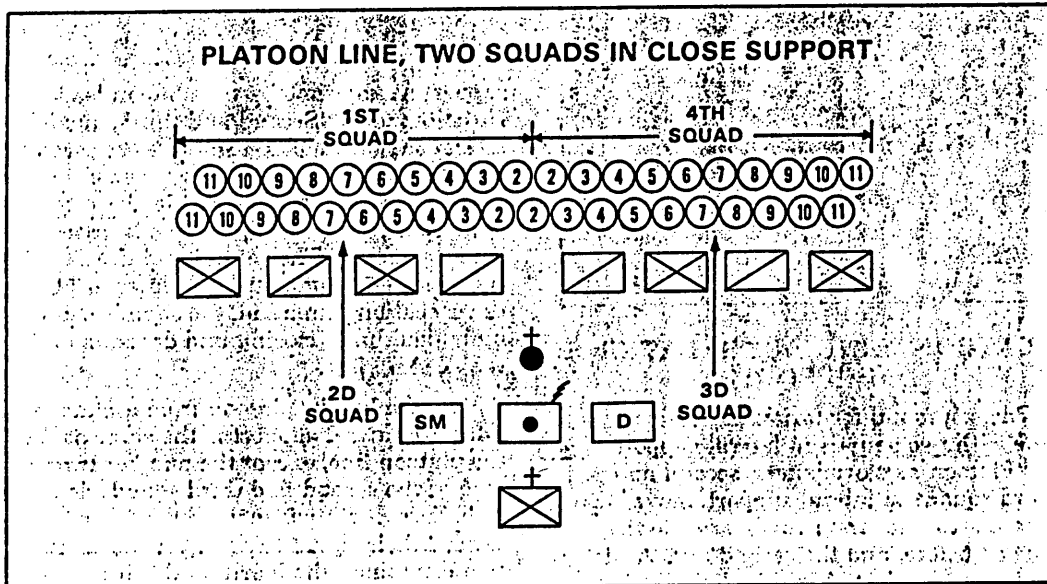

**PLATOON LINE WITH ONE SUPPORT SQUAD**

The command for forming a platoon line with one squad in support is "Platoon as skirmishers, third squad in support, move." The second squad moves out and executes a squad line right. The first and fourth squads form lines on the second squad to the left and the right, respectively. The third squad remains in column formation.

The support squad may be used in lateral support on one or both sides of the formation. It also can be used in close support of any segment of the formation.

To assemble the platoon, the commander takes his position as before. On the execution command, the third squad does a counter-column. The fourth squad moves and dresses to the right of the third squad. The first and second squads then move and dress to the left of the third squad. When the third squad is in lateral support, the commander assembles the third squad first. He then assembles the fourth, second, and first squads as before. The same procedure applies when the third squad is in close support.

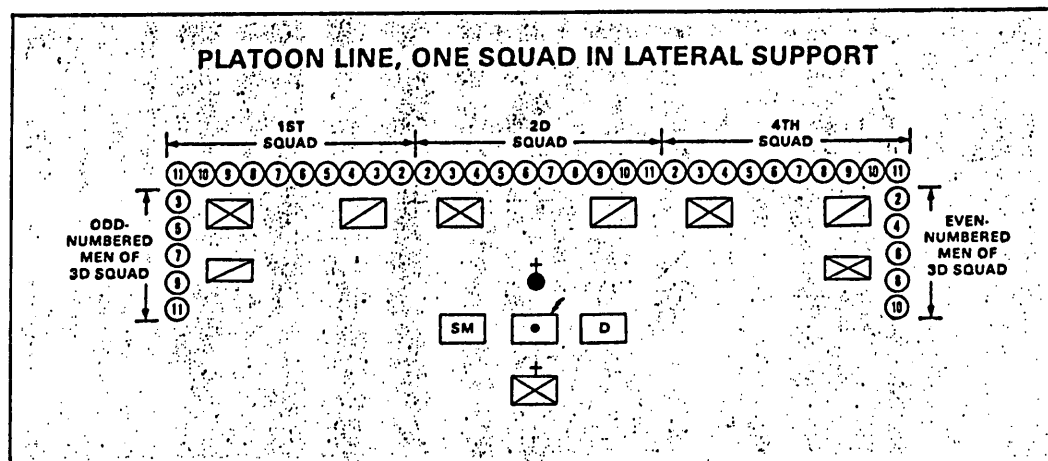

**PLATOON ECHELON RIGHT**

The command for forming a platoon echelon right is "Platoon echelon right, move." After the platoon leader's preparatory command, the squad leader of the first squad commands, "Follow me." The squad leaders of the second, third, and fourth squads command, "Stand fast." On the execution command, the first squad moves out and executes an echelon right at the location designated by the platoon leader. As each squad clears the column, the next successive squad moves out and extends the echelon that has been formed.

To assemble the platoon, the commander takes his position to the rear of the formation with the platoon HQ. On the preparatory command, "Platoon assemble," all squad leaders go to their number two men and face the platoon leader. The number two man of the first squad does an about-face. The number two men of the second, third, and fourth squads do a left face. All other platoon members do a half left face. On the command, "Move," the first squad moves first, then the second squad, third squad, and fourth squad. Each squad dresses as it reaches the column formation.

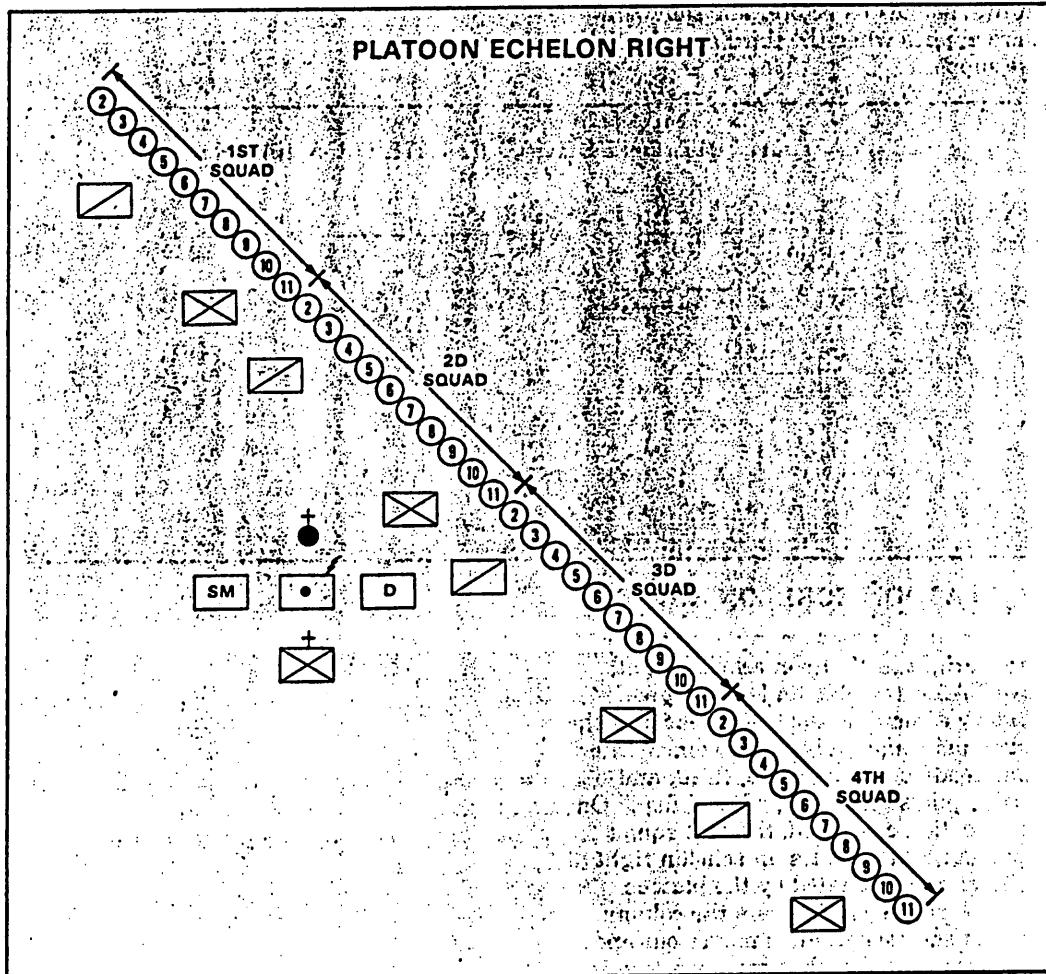

**PLATOON ECHELON LEFT**

The command for forming a platoon echelon left is "Platoon echelon left, move." The platoon echelon left is formed in the same manner as the echelon right, but in reverse order. The fourth squad is the base squad and the remaining squads extend the echelon in reverse sequence.

Assembly of the echelon left formation is the reverse of the echelon right. The fourth squad assembles first, followed by the third, second, and first squads.

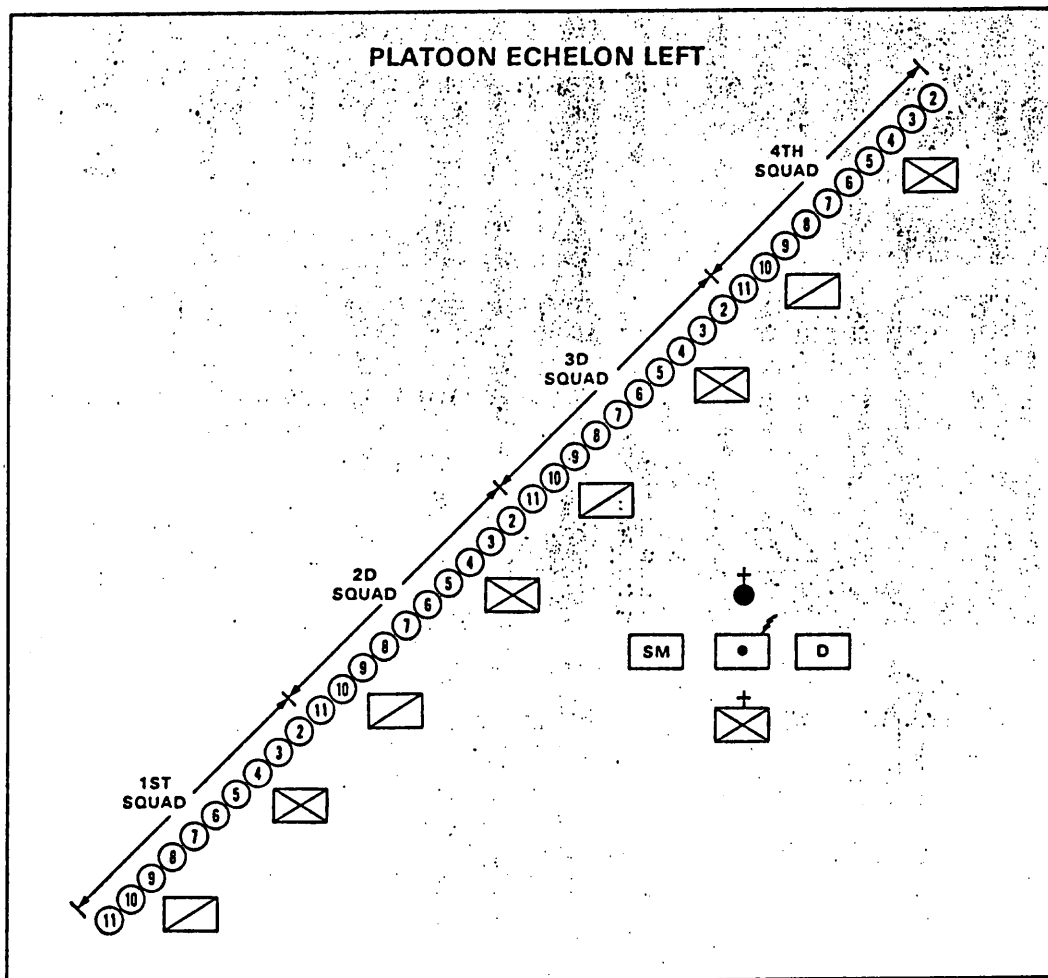

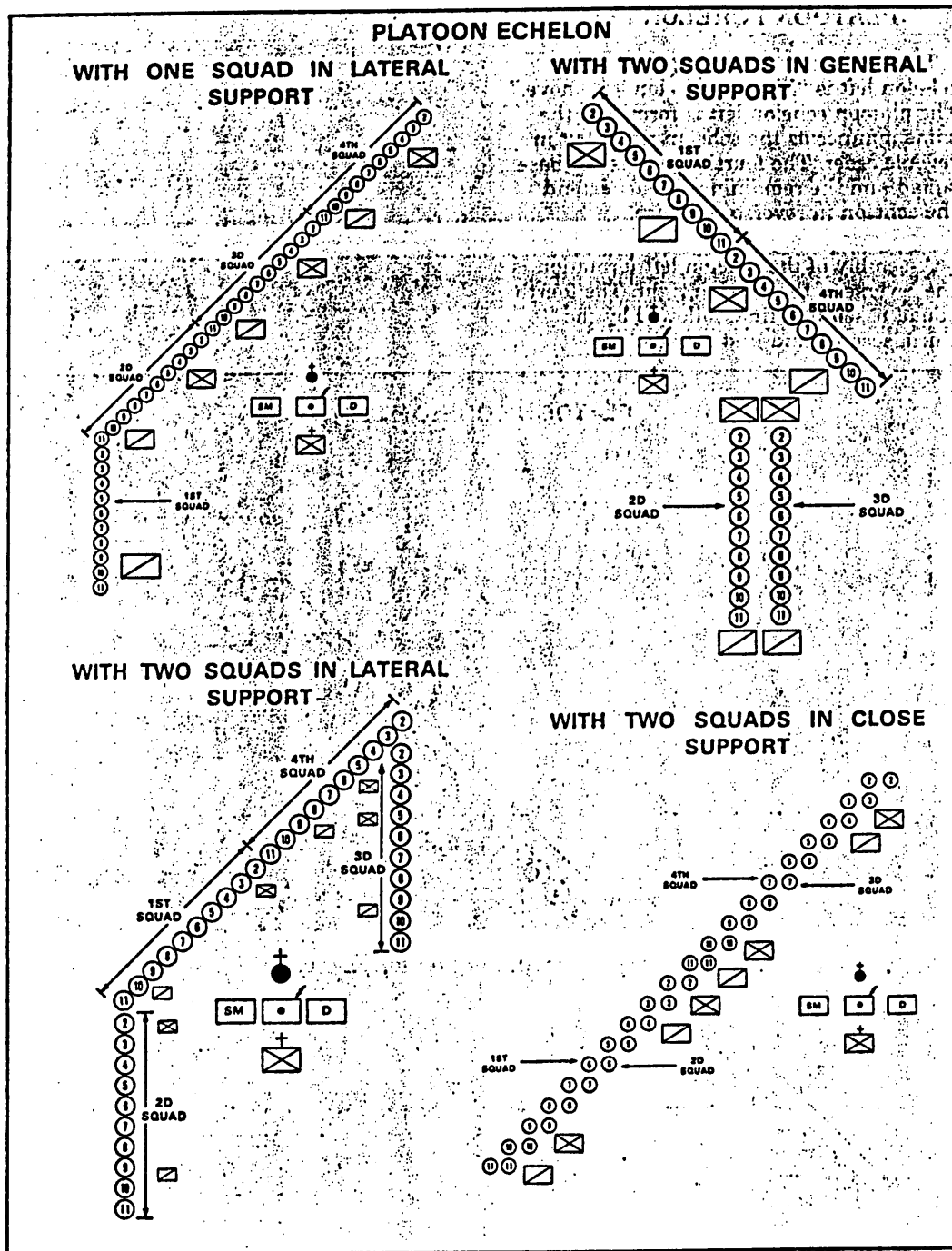

**PLATOON WEDGE**

The command for forming the platoon wedge is "Platoon wedge, move." After the platoon leader's preparatory command, the squad leaders of the first and fourth squads command, "Follow me." At the same time, the squad leaders of the second and third squads command, "Stand fast." On the platoon leader's execution command, the first and fourth squads move directly to the front. When the last men of the first and fourth squads clear the second and third squads, the squad leaders of the second and third squads command, "Follow me," and move out to the left and right, respectively. The number two man of the fourth squad is the base man for the formation. The fourth squad executes an echelon right. The first squad executes an echelon left on the base man. The second squad forms an echelon left on the last man of the first squad. The third squad forms an echelon right on the last man of the fourth squad, completing the wedge formation.

Assembling the wedge formation is basically the same as assembling the platoon line. The fourth and third squads assemble first. The first and second squads assemble to the left of the fourth and third squads.

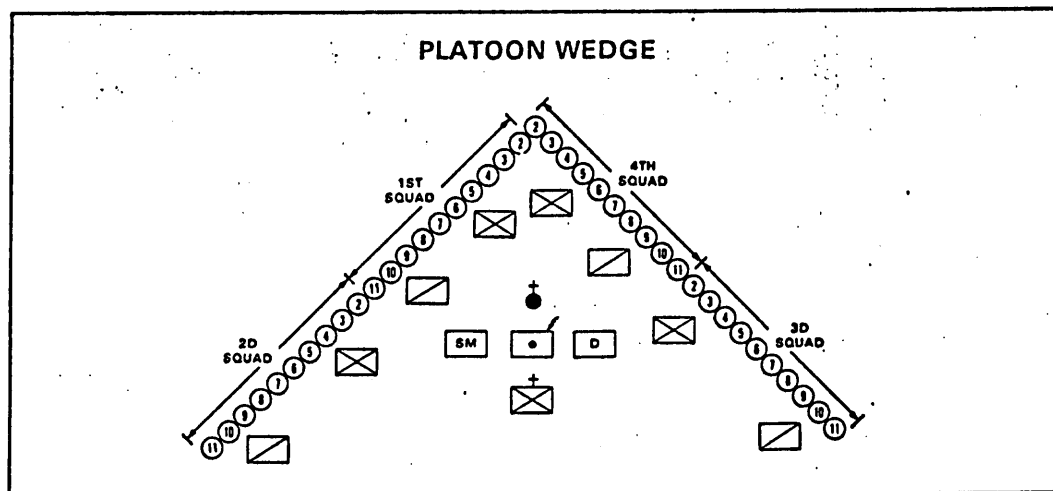

**PLATOON WEDGE WITH GENERAL SUPPORT**

The command for forming a platoon wedge with two squads in support is "Platoon wedge, second and third squads in support, move." The first and fourth squads execute the wedge while the second and third squads remain in column formation.

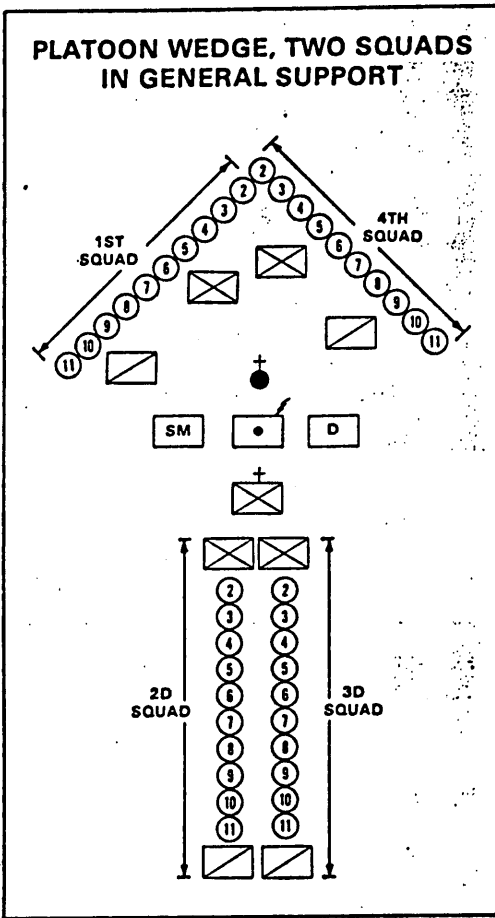

**PLATOON WEDGE WITH LATERAL SUPPORT**

The command for forming a platoon wedge with lateral support is "Platoon wedge, second and third squads in lateral support, move." The first and fourth

squads execute the wedge while the second and third squads stand fast. After the first and fourth squads have cleared the column, the second and third squad leaders command, "Follow me," and move out to the left and right, respectively. The second squad forms in column behind the last man of the first squad. The third squad forms in column behind the last man of the fourth squad.

To move the second and third squads from general support to lateral support, the platoon leader commands, "Second and third squads, lateral support, move." To have the second and third squads join the wedge from either general support or lateral support, the platoon leader commands, "Second and third squads, extend the wedge, move." The second and third squad leaders command, "Follow me," and move out to the left and right, respectively, to extend the wedge on the first and fourth squads.

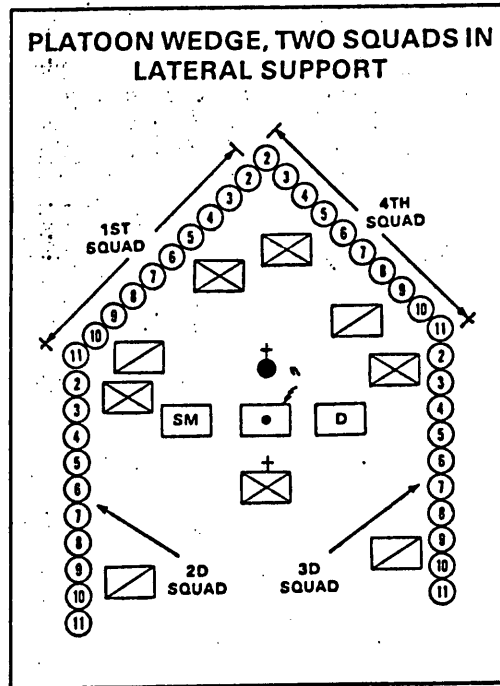

**PLATOON WEDGE WITH CLOSE SUPPORT**

The command for forming a platoon wedge with two squads in close support is "Platoon wedge, second and third squads in close support, move." The first and fourth squads execute a wedge. The second and third squads also execute a wedge and close in on the leading wedge. The men in the supporting wedge cover the intervals between men in the leading wedge. To do this, the squad leaders of the second and third squads command, "Stand fast." After the first and fourth squads are in position, the second and third squads then form a second wedge.

To assemble the support squads from any position to general support, the platoon leader commands, "Second and third squads in support, move." The second and third squads then form a column behind the wedge formed by the other two squads.

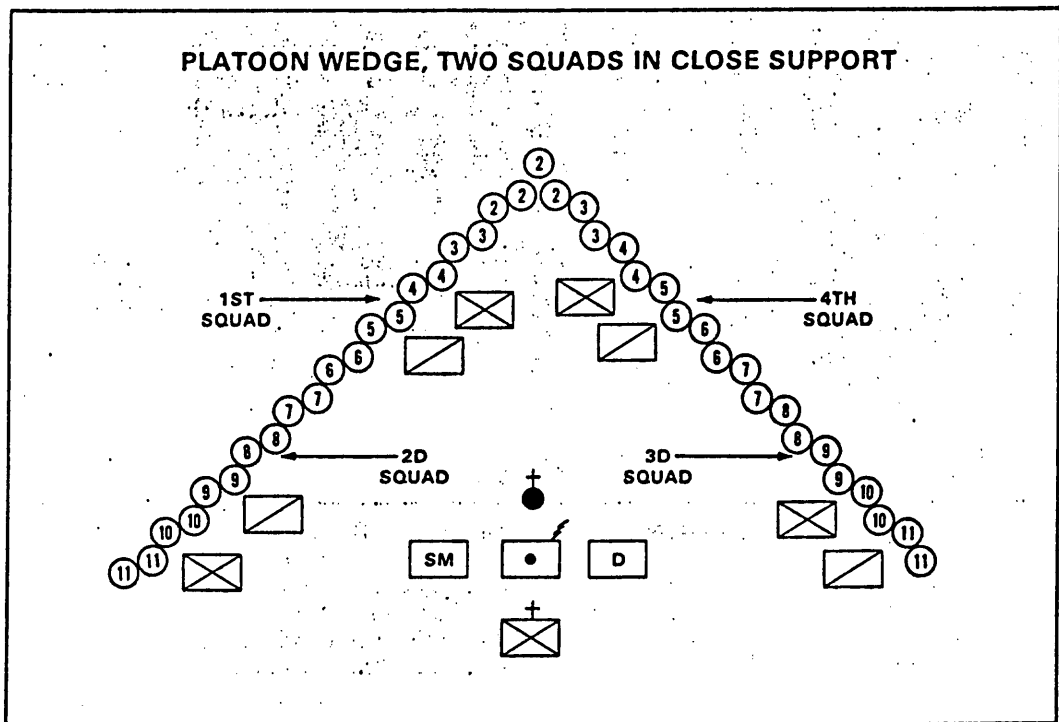



**PLATOON WEDGE WITH ONE SUPPORT SQUAD**

The command for forming a platoon wedge with one squad in support is "Platoon wedge, third squad in support,

move." The second squad moves out and executes a squad wedge. The first and fourth squads form echelons left and right, respectively, on the second squad. The third squad remains in the column formation.

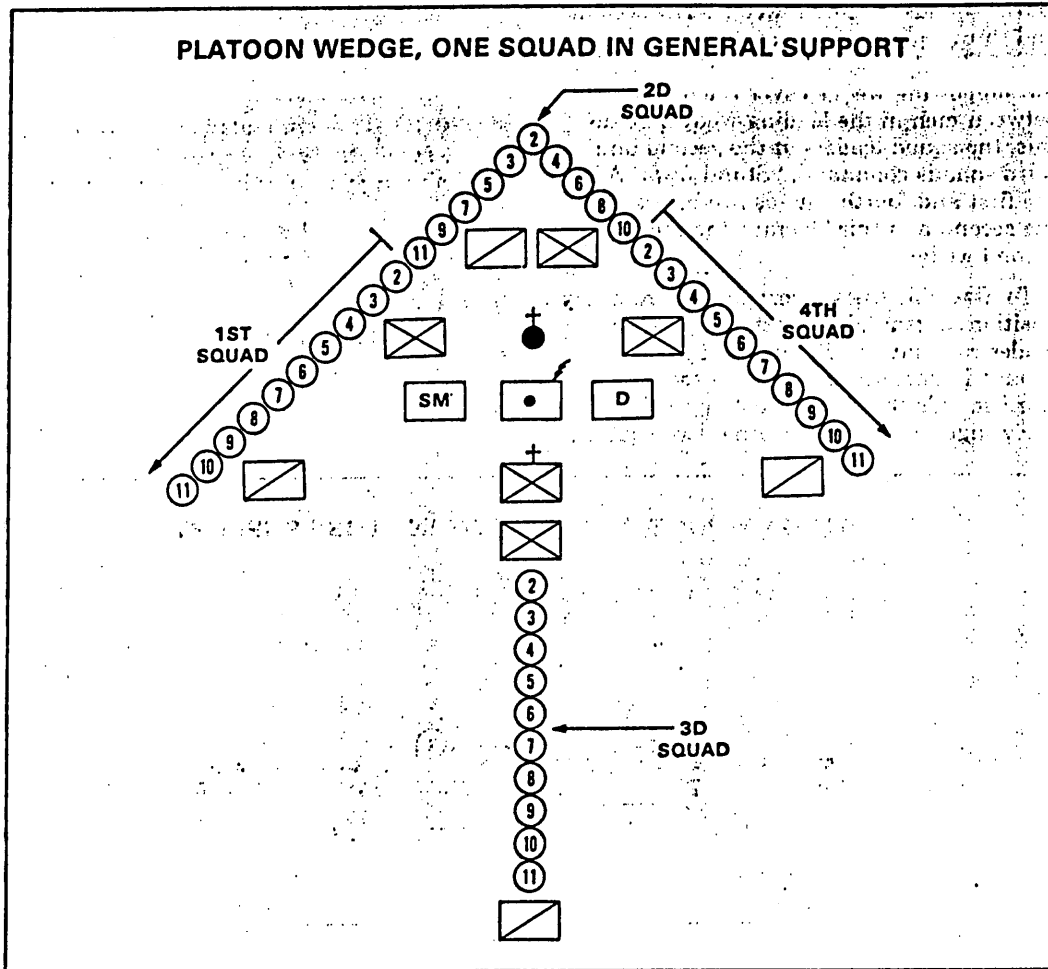

**FORMATION VARIATIONS**

During crowd control operations, the platoon leader may rotate his squads in the lead elements of the formation to give the squads a rest. He is not limited to using only those squads specified in the preceding examples as the lead elements of the

formations. By changing his preparatory command, he may choose other squads to lead his unit. If he wants the first and third squads to lead his platoon wedge, he issues the command, "Platoon wedge, second and fourth squads in support, move." By designating the support squad or squads in the preparatory

command, the platoon leader tells the remaining squads that they will lead the formation. The number two man of the third squad becomes the base man.

The platoon leader also may relieve squads in the lead element by forming the

same formation with the support squads. The support element then passes through the lead element. This procedure is often necessary when protective masks are donned for riot control agent employment.

### THREE-SQUAD PLATOON FORMATIONS

The execution of crowd control formations using a three-squad platoon is essentially the same as a four-squad platoon. The exceptions are that—

- The first and third squads usually are used as the lead element in all formations in which one squad provides general support or lateral support.
- The second squad is the base squad in a platoon line when all three squads are committed to the lead element.

- The support squad, usually the second squad, may be held in general support in single column or in column of two's.

The command for forming a platoon formation with one squad in support in a single column is "Platoon as skirmishers (echelon right, echelon left, or wedge), second squad in support, move." The first and third squads execute the formation while the second squad remains in column formation.

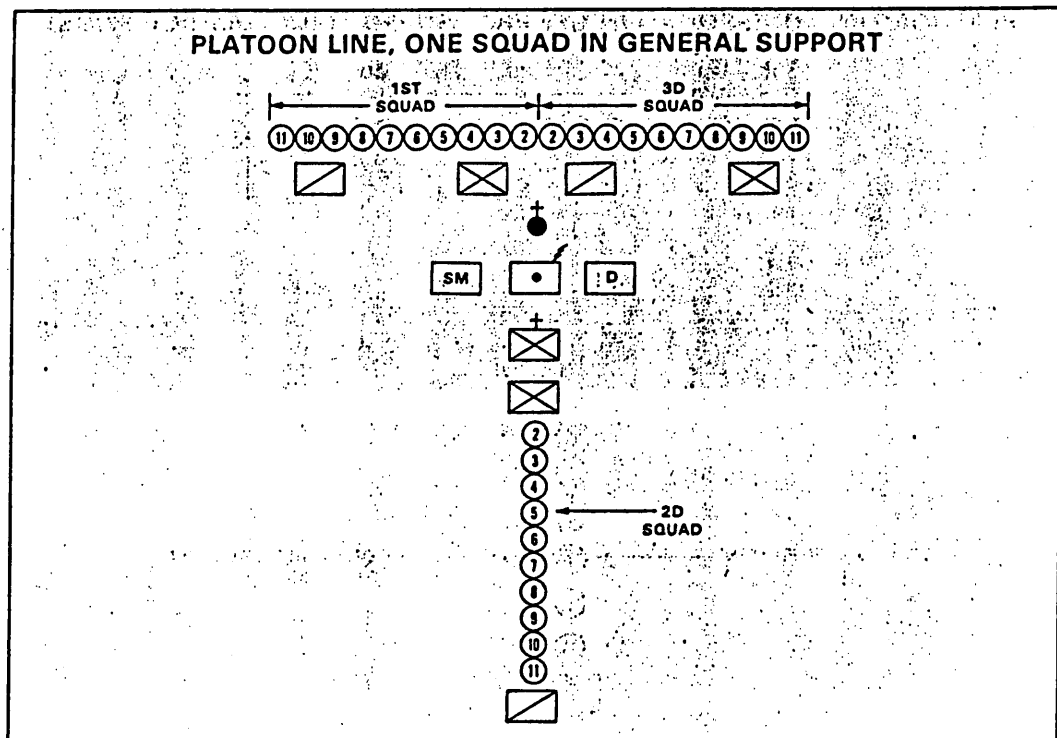

The command for forming a platoon formation with one squad in general support in a column of twos is "Platoon as skirmishers (echelon right, echelon left, or wedge), second squad in support in column of twos, move." The first and third squads execute the formation. The second squad, at the command of its squad leader, executes a column of twos to the right.

When the support squad moves to either lateral support or to extend the existing formation, the even-numbered men move to the right, and the odd-numbered men move to the left. They execute these movements in the same manner as the support squads for a four-squad platoon. The squad leader usually controls the even-numbered men, and the assistant squad leader controls the odd-numbered men.

A three-squad platoon is assembled in the same manner as a four-squad platoon.

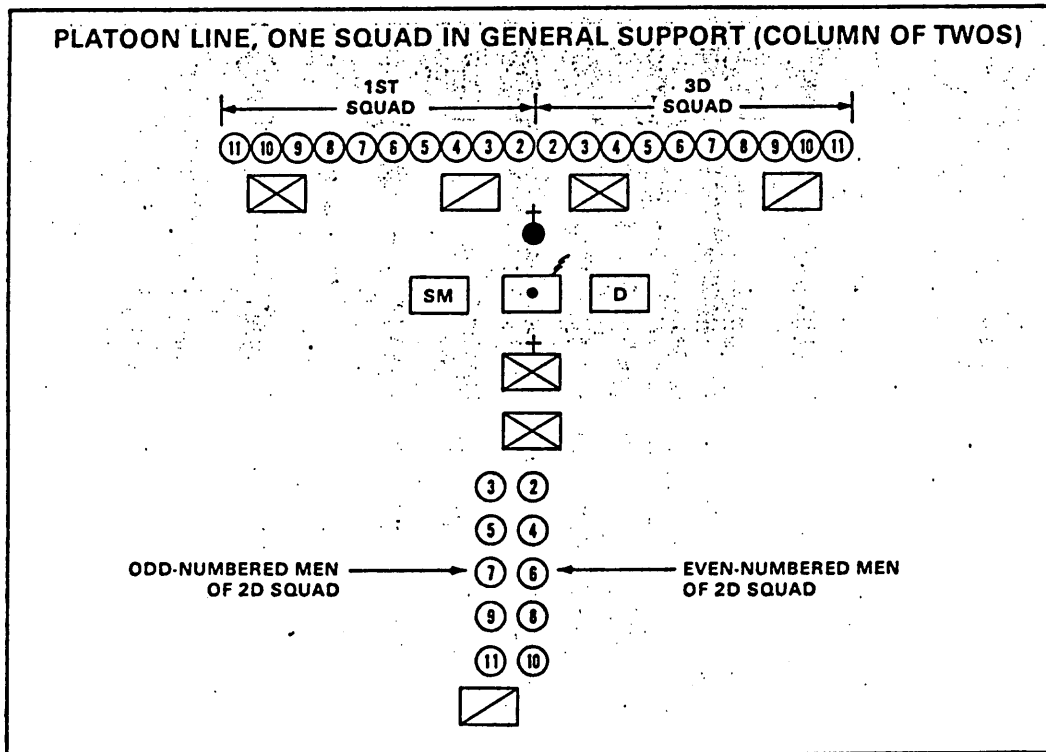

## COMPANY FORMATIONS

When a company commander orders his company into crowd control formations from a column, he moves to the left or the right near the head of the column so he can be seen by the platoon leaders. He then faces the company. As he gives his preparatory command, he points to where he wants the formation. If he does not indicate a location, the company forms immediately in front of the lead platoon.

### COMPANY LINE IN DEPTH

The command for forming a company line in depth is "Company as skirmishers in depth, move." After the company commander's preparatory command, each

platoon leader gives the command, "Platoon as skirmishers." The squad leaders follow with their respective commands to their squads to form the platoon line. On the execution command, each platoon establishes a platoon line immediately to its front.

If the company commander wants a more formidable formation, he commands, "Second platoon, close support, move." The second platoon moves forward and covers the intervals between the men of the lead platoon. The second platoon automatically assumes the same weapons position being used by the lead platoon, usually the on-guard position. The platoon leader of the

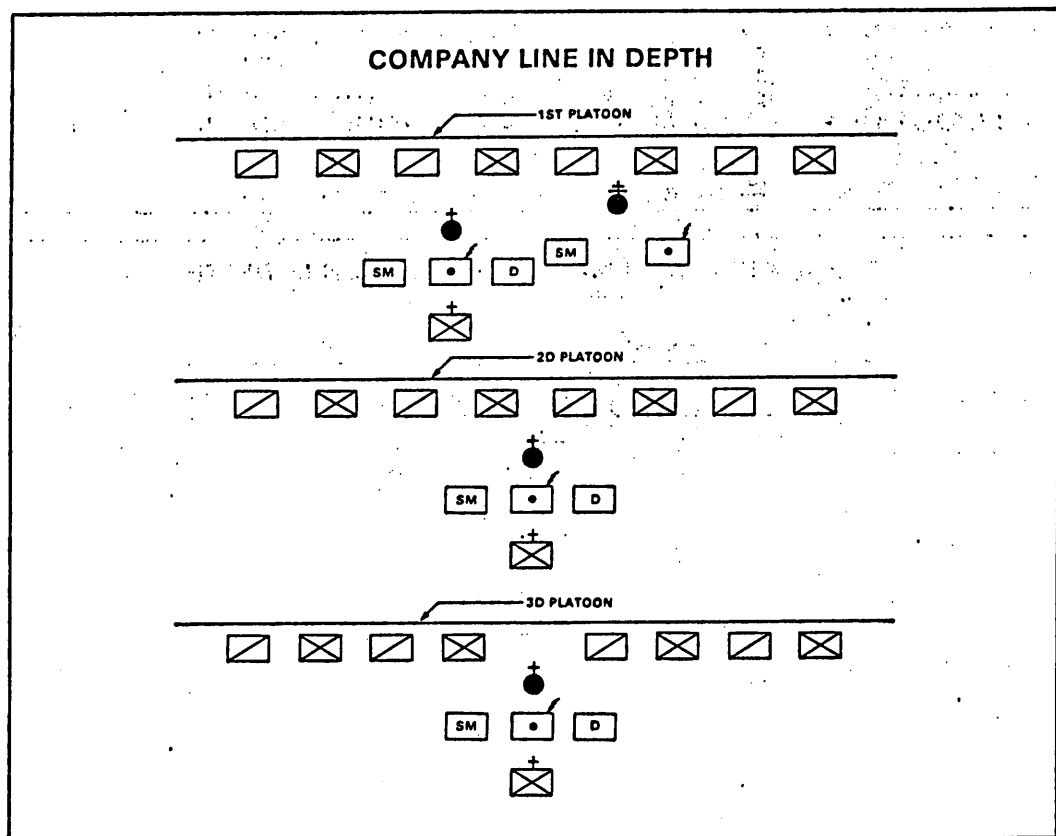

third platoon then moves his platoon forward to occupy the position formerly held by the second platoon.

If the third platoon is called on to support the company line, it moves forward and takes up a position directly behind the second platoon. The men of the third platoon hold their weapons at safe port. Platoon and squad leaders and their assistants help each other in controlling the company.

**COMPANY LINE IN MASS**

The command for forming a company line in mass is "Company as skirmishers in mass, move." The company line in mass is the same as a company line with both platoons in close support. Instead of forming it in stages, the company commander indicates his desire for this formation in his initial command. The platoons each form a line, and the second and third platoons close on the first platoon without further commands.

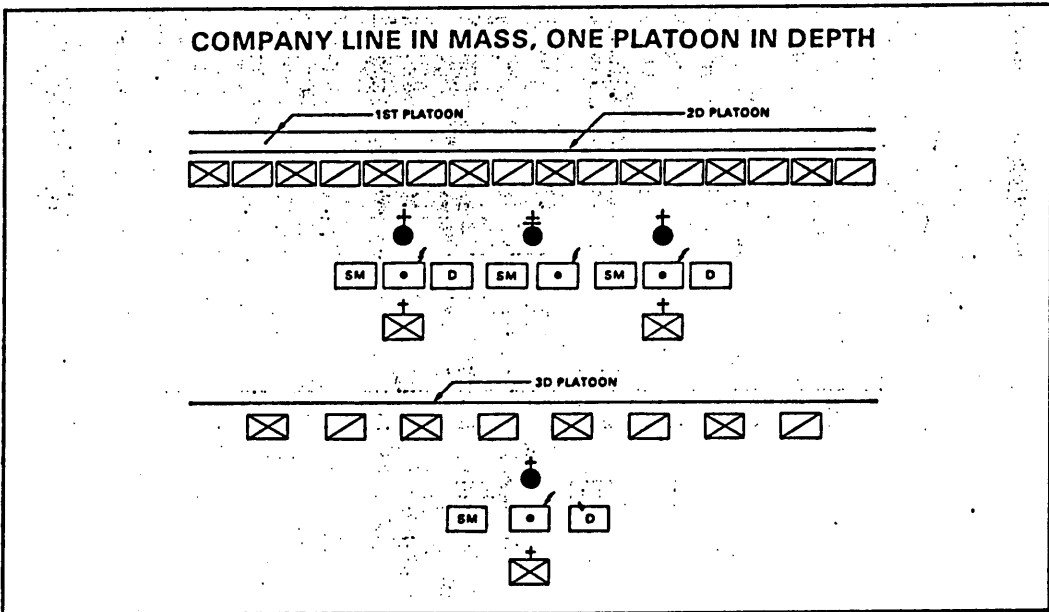
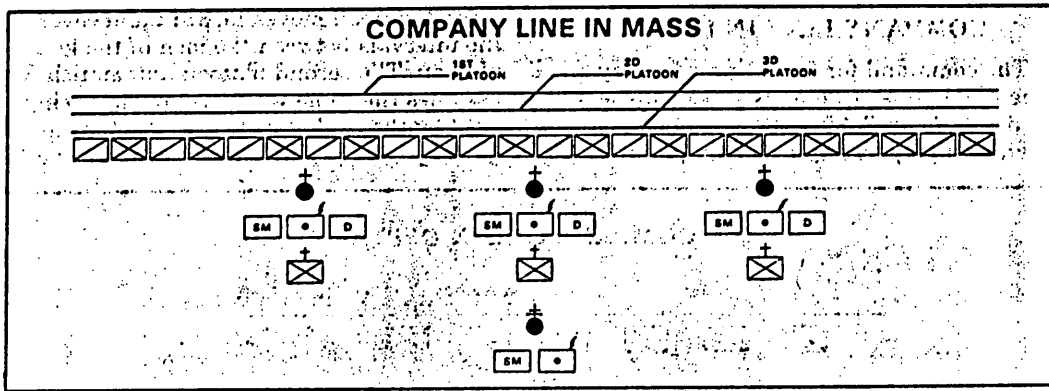

**COMPANY LINE WITH SUPPORT**

In company formations, the first platoon usually forms the lead element and the second and third platoons provide support. The support platoons can be employed in

the same manner as the support squads in platoon formations. One platoon can be relieved from the lead element by another platoon while in formation by having a support platoon pass through the lead platoon.

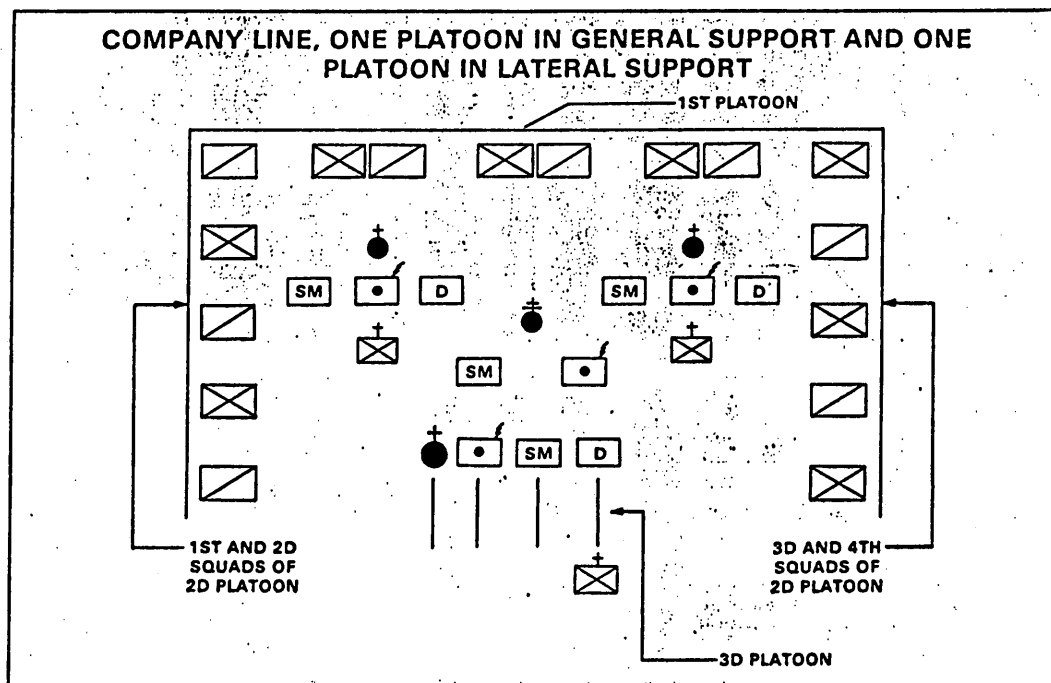
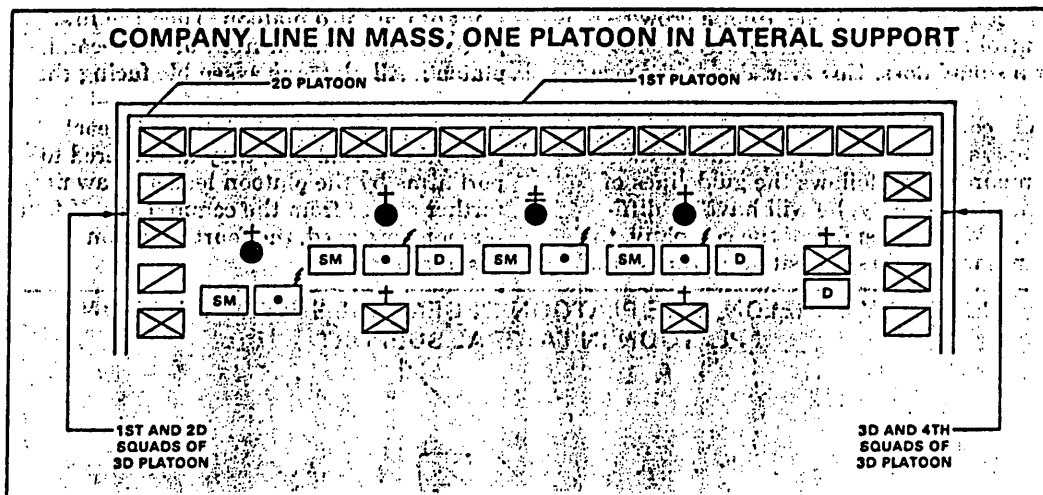

**COMPANY ECHELONS AND WEDGE**

Company echelons and the company wedge are formed in the same manner and with the same variations as the company line.

A company assembles from a crowd control formation the same way a platoon or a squad does. However, due to the size of company formations, the commander must consider the area that the company is operating in when he assembles the company. If he follows the guidelines of platoon assembly, he will have no difficulty. When assembling the company, the commander takes a position to the rear of

the formation and commands, "Company assemble." The platoon leaders take charge of their respective platoons. Usually, the third platoon assembles first, just behind the formation. After the third platoon is assembled, the second platoon assembles in front of the third platoon. Then the first platoon assembles in front of the second platoon. All platoons assemble facing the commander. The second and third platoons then dress on the first platoon. As each platoon is assembled, they are ordered to port arms by the platoon leader to await further orders from the commander. If four platoons are used, the fourth platoon assembles first.

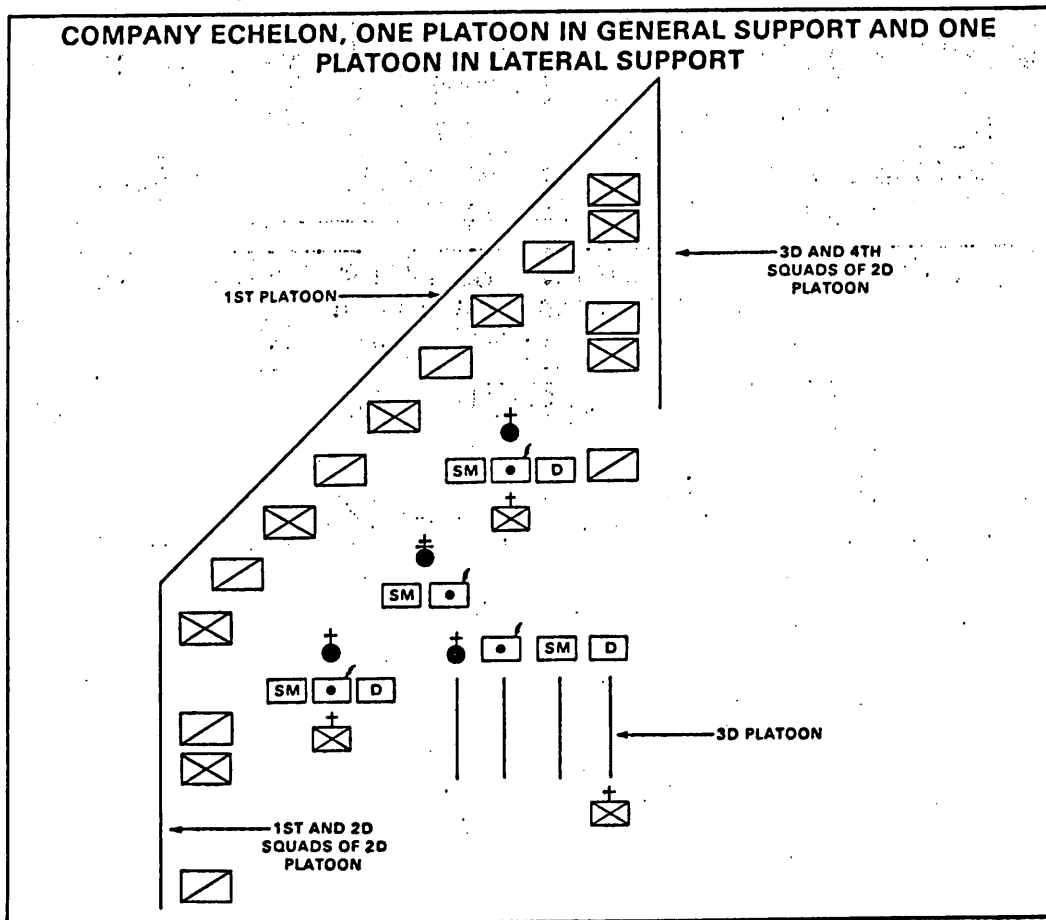

COMPANY WEDGE

WITH TWO PLATOONS IN  
GENERAL SUPPORT

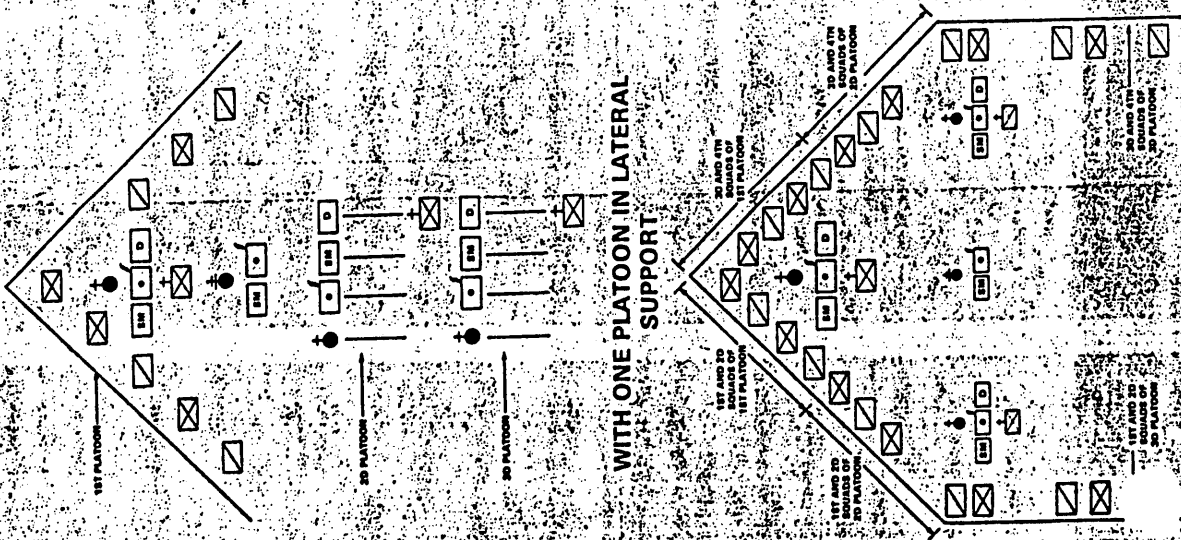

IN MASS, ONE PLATOON IN  
CLOSE LATERAL SUPPORT

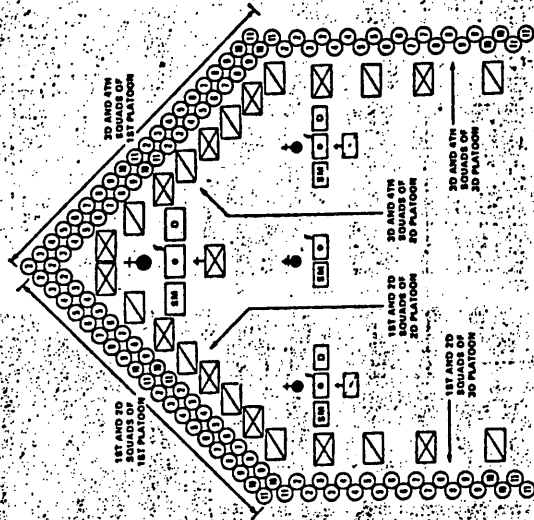

WITH ONE PLATOON IN  
GENERAL SUPPORT, ONE  
PLATOON IN LATERAL  
SUPPORT

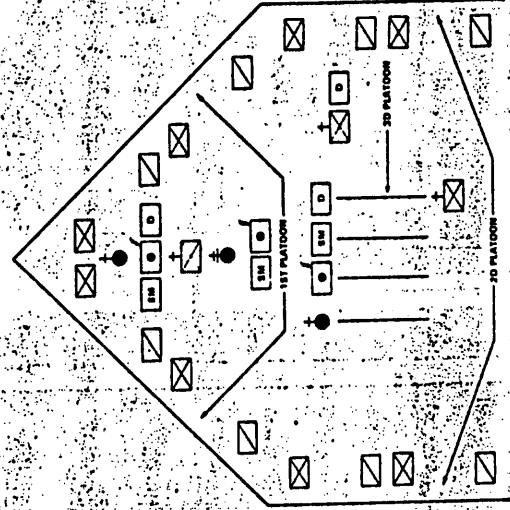

WITH ONE PLATOON IN LATERAL  
SUPPORT

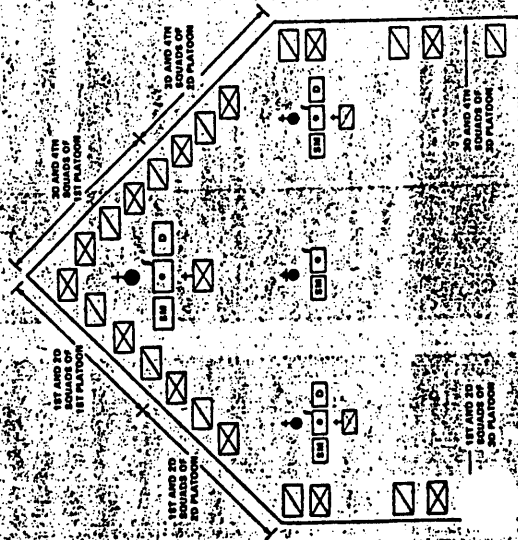



**COMPANY FORMATIONS WITH VEHICLES**

The commands for vehicles and foot troops are the same as for foot troops alone. Because of the additional noise and distances involved, the company commander gives the arm and hand signal for the line. The command and the signal apply to the lead platoon only. The other platoons remain in general support until further directed.

The motor section moves out first. The number two vehicle, moving to the right, passes the lead vehicle and establishes the position for the center of the line. At the same time, the third and fourth vehicles swing out to the left and right, respectively. They form to the left and right and slightly to the rear of the number two vehicle. The first and fourth squads of the lead platoon then move forward and form lines to the left and right, respectively, on the front end of the number two vehicle. As soon as the troops are in position, the third and fourth vehicles close in on the squads and tighten the formation. The second and third squads of the lead platoon then form a line to the left and right of the third and fourth vehicles to complete the company line. The command (number one) vehicle takes up a position behind the line where the commander can direct and control the unit. The second and third platoons move forward and are used in general, lateral, or close support. In some instances, the foot troops may move into position first, and the vehicles join the formation as needed.

To form company echelons or a company wedge with vehicles, the company follows the same procedures used for company formations without vehicles. Vehicles are moved into appropriate positions using procedures similar to those used for a company line.

To assemble troops and vehicles, the command vehicle moves to a position behind the formation. The commander

faces the formation and gives the vehicle section the hand signal for assembly. Immediately, the vehicles return to their proper positions in column behind the command vehicle while the troops stand fast. The second in command then assembles the troops in the usual manner.

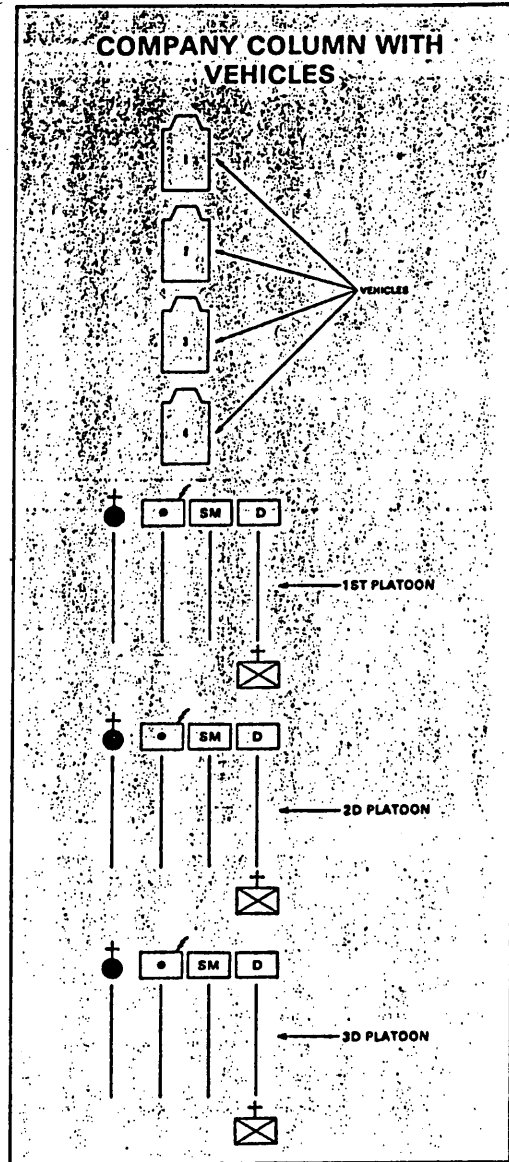

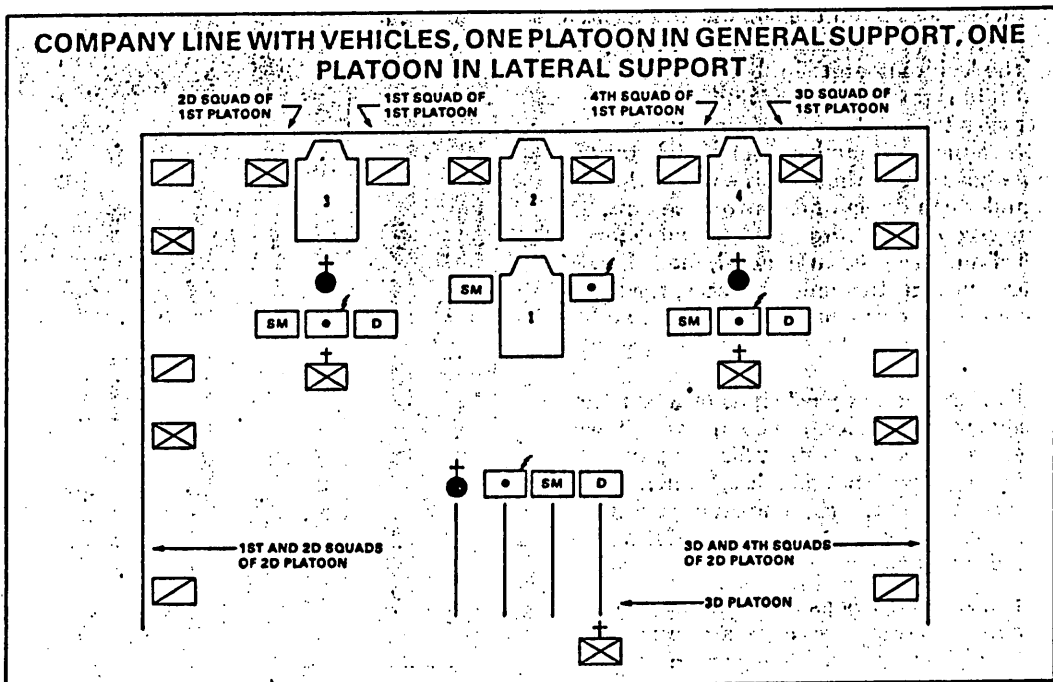
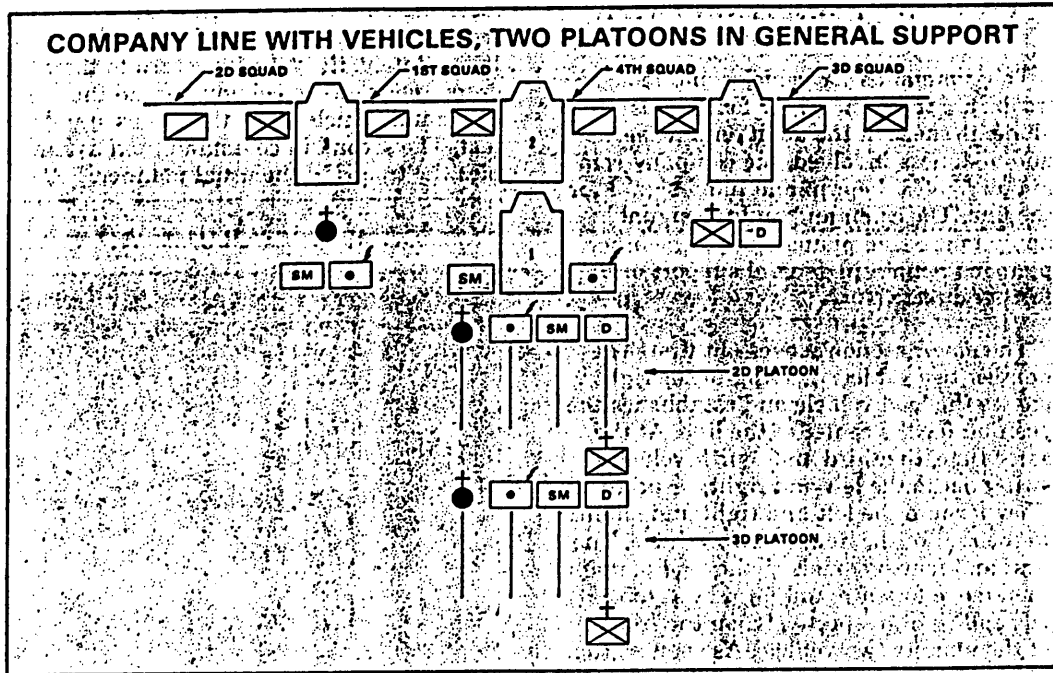

**COMPANY ECHELON WITH VEHICLES; ONE PLATOON IN GENERAL SUPPORT, ONE PLATOON IN LATERAL SUPPORT**

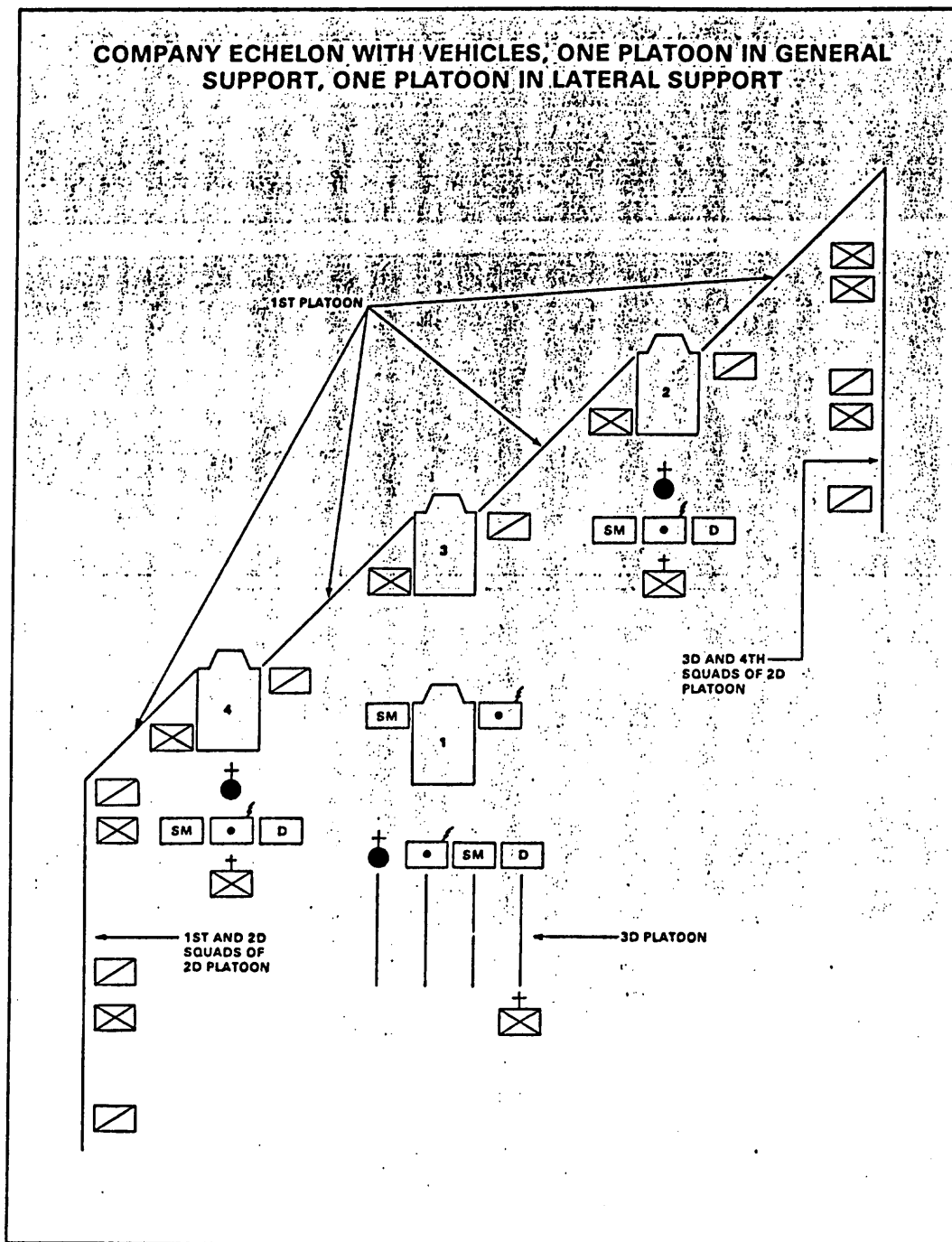

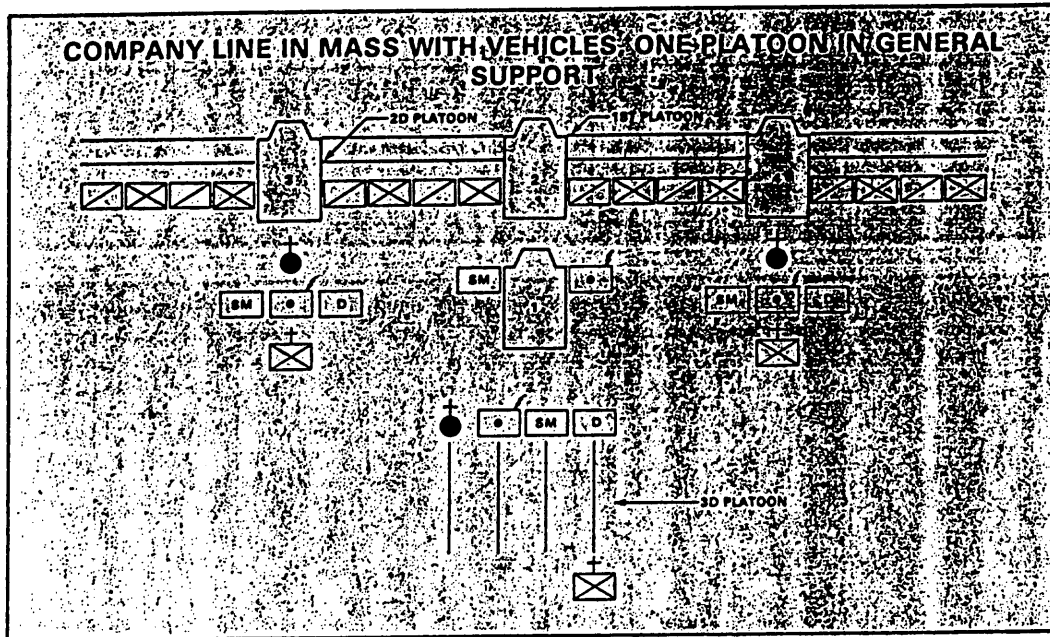

## CHAPTER 9

### Riot Control Agents

Riot control agents or water can be used to distract, deter, or disable disorderly people. Usually their effects are temporary and disappear within minutes of exposure. The choice of whether to use a particular riot control agent or water in a given situation is based on the physical characteristics of the target area. Weather, especially wind, affects the employment of riot control agents and water.

Planning is essential for the successful use of riot control agents. The plans must be flexible to accommodate changes in the situation and the weather. Above all, strict accountability and control of the employment of riot control agents is a must. Riot control agents are employed only when the task force commander specifically authorizes their use. Employment must be strictly controlled. Every instance of employment must be duly reported.

Other planning factors are the cause, nature, and extent of a disturbance and the crowd's demeanor and intent.

Based on an analysis of these factors, the commander makes an estimate of the situation. The estimate must be as thorough as time permits. Using the estimate, the commander considers courses of action, selects riot control agents, and determines munitions needs. The main factors in choosing a course of action are the desired effects, the crowd's demeanor and intent, the weather, and the types of munitions available.

Plans also must address security of riot control agents during storage, transportation, and employment. The use of riot control agents must be coordinated with all crowd control forces. Leaders who supervise the employment of riot control agents should have wireless communications equipment.

Civil disturbance operations in cities often take place either on narrow streets or in park areas. Standard control procedures do not work well in such instances. Wind direction, the size of the area, and the proximity of health facilities may preclude the use of large quantities of riot control agents. In such cases it may be necessary to use low concentrations to break a crowd into smaller groups.

The on-site commander obtains weather forecasts for the operational area. The forecasts must cover the times when dispersal operations will be performed. The commander evaluates the forecasts in conjunction with a map, a detailed reconnaissance, an aerial photograph, or a mosaic study of the terrain in the operational area. Through his evaluation, he estimates the effects of a dispersal operation.

When dealing with large crowds, the control force's objective is to disperse the crowd and to move it in a specific direction, usually away from the disturbance area. Against large crowds, riot control agents usually are employed to cover the target area with a cloud of sufficient strength to produce decisive results. Once the proper concentration is reached, the control force must maintain that concentration until the crowd has been dispersed. When dispersers are used, the dispersal team maintains the

FM 19-15

concentration by moving the disperser along the release line at an even rate. They maintain the concentration by repeating the application as necessary.

The control force must have a follow-up plan for exploiting the advantage gained by employment of riot control agents. Clear escape routes prevent panic and the melee that may result as the crowd scrambles for

an exit. Public address systems may be used to direct the crowd to the escape route. They also may be used to give first aid instructions. It may be necessary to move masked troops into the target area to disperse lingering groups, to prevent regrouping, or to prevent further illegal activity. During follow-up operations, troops must be ready to help unconscious or incapacitated people in the contaminated area.

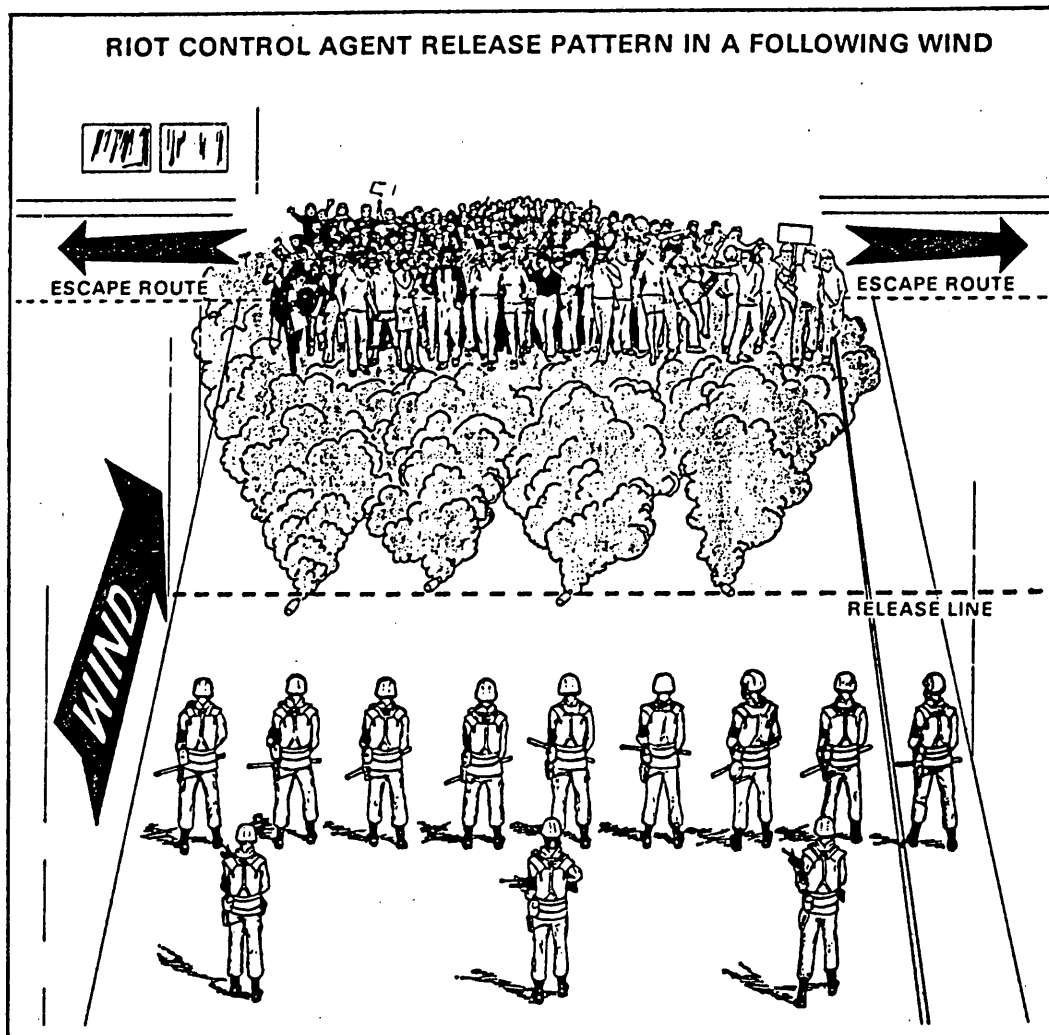

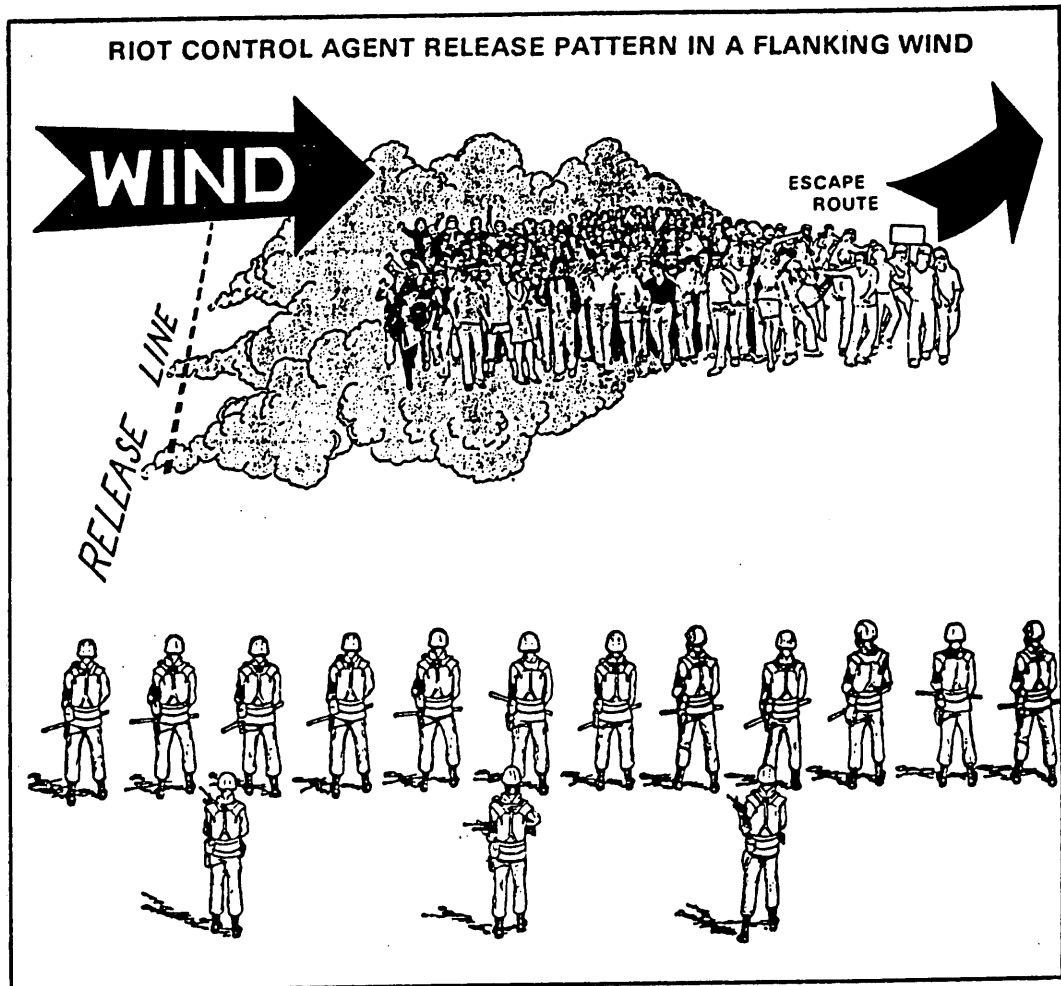

Small groups of 25 to 50 people may gather during disorders and throw objects at cars or congregate near stores that have been partially looted. Patrols can employ low-volume riot control grenades to break up small groups and temporarily prevent further misconduct. This low volume use of riot control agents enables a few troops to disperse a group without calling for more manpower and equipment. The limited use of an agent must be preceded by a careful assessment of the composition and mood of the group. If the group is highly motivated or inclined to violence, a small amount of

agent may only provoke an attack on the outnumbered patrol. High-pressure water can be effective for moving small groups on a narrow front, such as a street, and for defending a barricade or a roadblock.

When used against rioters, riot control agents must be used in sufficient quantities to produce an immediate, decisive effect. Troops using the agents must provide avenues of escape for the crowd. Except for extreme emergencies, riot control agents are not used when hospital patients or school children may be affected.

The riot control agent CS comes in two forms: a pyrotechnic mixture and a powder. It has a pungent pepperlike odor. Its persistency varies according to wind conditions. In powder form, it has greater persistency when there is no wind or when it is dispersed in wooded terrain. Its effects occur within a few seconds after exposure.

As a pyrotechnic mixture, CS is dispersed by means of an M47 hand grenade or a 40-millimeter cartridge and the M203 or M79 grenade launcher. When using the M203 or M79 and the 40-millimeter cartridge, the troops must be warned that, because of the projectile's high velocity, it can cause

serious injury or death at close range. Troops must exercise extreme caution when using this munition. In the powder form, CS is dispersed by means of the M47 hand grenade and by mechanical dispersers.

A protective mask and field clothing protect against the effects of CS. First aid for CS contamination is rendered by moving affected people to uncontaminated areas, facing them into the wind, and cautioning against rubbing the eyes or touching the genitals or mucous membranes. Showers provide further relief. Affected people should be kept away from each other.

RIOT CONTROL AGENT CHARACTERISTICS AND TREATMENT		
	CS	CR
DELIVERY MEANS	Delivered by hand grenade or 40-mm cartridge projectile or by M33A1 or M36 disperser	Delivered as a wet spray or stream by M33A1 or M36 disperser
EMPLOYMENT CONDITIONS	Has greatest effect when there is no wind; effectiveness greatly diminished by rain	Is effective under all conditions except high winds; effectiveness only slightly diminished by rain
PERSISTENCY	Varies according to wind conditions; powder form persists longer than pyrotechnic mixture; in both cases, it is most persistent in wooded terrain; in areas where it is used, contamination could cause problems	Lingers in air, long lasting, and less likely windblown; extremely persistent on surfaces Is not to be used in buildings, near hospitals, or in areas where lingering contamination could cause problems
TIME TO MAXIMUM EFFECT	Requires 20 to 60 seconds	Acts immediately on exposed areas
DURATION OF EFFECTS	Lasts 5 to 10 minutes	Lasts a few minutes when victim is moved to an uncontaminated area
EFFECTS	Causes extreme burning of eyes; abundant flow of tears; breathing difficulty; tightness in chest; involuntary closing of eyelids; sneezing; redness of skin; nasal drip; and nausea and vomiting; especially at high concentrations, especially when ingested	Causes irritation of nose and throat; stinging sensation of skin; and irritation of respiratory system, including coughing, chest pains, and feeling of suffocation
MINIMUM PROTECTION	Requires protective mask and field clothing	Requires protective mask, hood, and rubber gloves
FIRST AID	Move victim to uncontaminated area, facing victim into wind; caution victim not to rub eyes; keep affected people well apart; have victim shower first with cool water for 2 to 5 minutes; then proceed with showering (or gross contamination of body with large amounts of soap) and then wash with 2% sodium hypochlorite solution (except in areas where it is not available); flush again with water; 1% sodium bicarbonate or 1% sodium bisulfite solution may be substituted for sodium hypochlorite solution	Move victim to uncontaminated area, flush eyes with water, check eyes for abrasions, shower well or wash and scrub exposed areas with soap and water; get victim to doctor if reaction persists  <b>WARNING:</b> Household bleach (sodium hypochlorite solution) is NOT to be used in wash or rinse water to decontaminate clothing, equipment, or people. CR and household bleach react to produce a harmful vapor



## GRENADES

There are two types of riot control grenades in the Army inventory, a burning type and a bursting type. In a wind of about 6 miles per hour, a burning-type grenade can cover an area about 5 meters wide to a downwind distance up to 25 meters. At the same wind speed, a bursting-type grenade can cover an area about 10 meters wide to a downwind distance up to 25 meters.

Burning-type CS grenades and agent dispersers are the means usually employed against large crowds. Bursting-type grenades may be used for psychological effect or to discourage crowd members from trying to throw back grenades.

Burning grenades are thrown by hand or delivered by a grenade launcher to the upwind side of the crowd. Burning grenades must not be thrown into a crowd because they can be picked up and thrown back. Bursting grenades are thrown into the air so that they burst several feet above the crowd.

When the control force is in almost direct contact with the crowd, burning grenades are not used. Either the grenades will be thrown back at the control force or the front ranks of the crowd will be driven into the control force. In this situation, dispersers are used if conditions favor their use behind disturbance control lines.

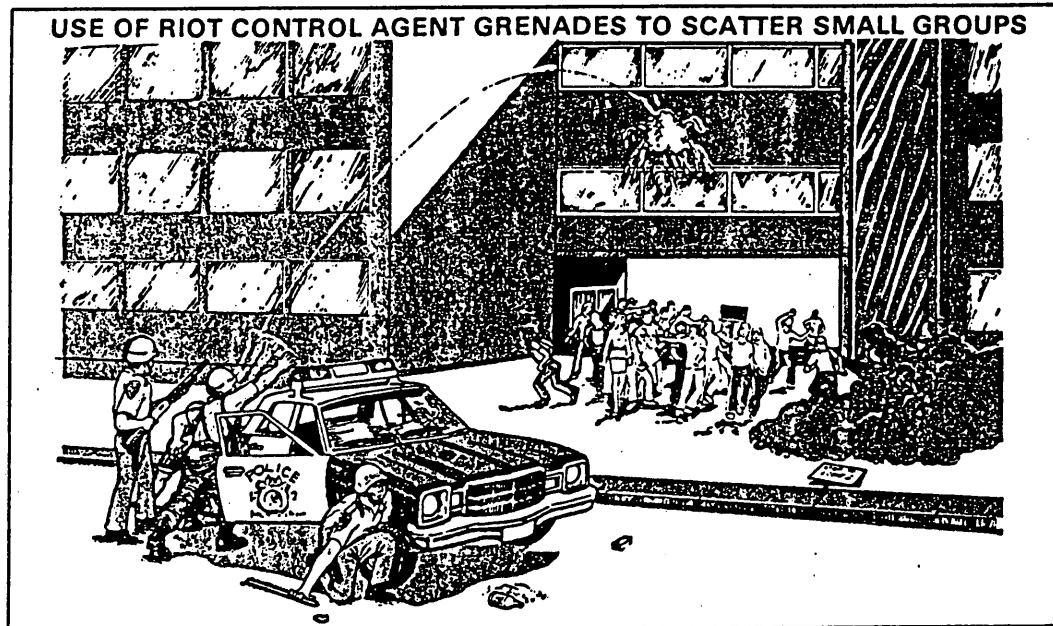

## DISPERSERS

Dispersers provide commanders with a means of disseminating riot control agents in sufficient quantities to provide effective coverage in a variety of situations and conditions. But their use is limited to outdoor areas. Control force leaders must

be careful when employing riot control agents in confined areas and in areas with restricted avenues of escape. Dispersers usually are transported by soldiers, by 1/4-ton or larger vehicles, or by helicopters. When transported on the ground, the

dispersers may be directly integrated into the crowd control formations. Or they may be operated in direct support of civil disturbance operations. Helicopter-mounted dispersers are used in close conjunction with the control force. The exact placement of the aircraft with respect to the formation is determined by current wind direction and speed and by physical obstacles that may restrict the movement and positioning of the aircraft.

All unit members should know the operation and employment capabilities of the riot control agent dispersers. But the unit must depend on specially selected and trained soldiers. The criteria for selecting disperser operators include initiative, ability to learn, and the ability to deal with large numbers of agitated people calmly.

The disperser operator works under the immediate control and direction of an officer or an NCO. Riot control agents are released only on the direct orders of the commander. If the commander is not fully qualified in employing riot control agents, a qualified officer must be designated to determine the appropriate time, place, and amount of agent to be released and to issue appropriate commands to the operators.

Disperser operators and dispersal team members must be well qualified in their primary MOS and thoroughly trained in riot control operations. Preferably, they should receive special training in the use of riot control agents.

Riot control agent dispersers can release a large amount of riot control agent in a very short time. Operators must be especially careful to avoid releasing intolerable concentrations of the agents. The operators must determine the average release rate for each disperser in terms of pounds of the agent released per second. The dispersers are not used to deliver riot control agents directly into a closed structure except in extreme circumstances.

Commands are given the disperser operators by voice or by hand and arm

signals. The troop commander maintains radio contact with the officer or NCO who is in command of the crowd control formation or of the disperser operators.

Troops who are involved in filling, operating, or transporting dispersers wear ordinary field uniforms with collar and cuffs buttoned and trouser legs tucked into their boots. They also wear a protective mask, a hood, and rubber gloves for protection.

The commander must decide which riot control agent will be used in each disperser before the mission begins. Wet and dry agents cannot be interchanged in the same disperser during a civil disturbance mission. Not only must nozzles be changed, but the whole system must be decontaminated before changing types of agents. For further information on decontamination procedures, see FM 3-5.

To ensure the dispersers operate properly, operators must perform inspections and maintenance systematically each time the equipment is used. They also service the equipment periodically whether it has been used or not. Because of the corrosive effects of some riot control agents, the agents must be removed from the surface of dispersers and the vehicles or helicopters that dispersed the agents. Detailed maintenance, inspection, and repair instructions can be found in the applicable technical publications.

### M36 DISPERSER

The M36 disperser, like other aerosol irritant dispersers, serves as an alternative to traditional weapons, such as nightsticks, riot batons, and firearms. As with other riot control weapons, the M36 must be backed at all times by troops with weapons of greater force.

The M36 disperser is a lightweight, aluminum and plastic container filled with pressurized CR solution. It is small enough to be carried and operated with one hand.

To use the M36, the soldier holds the can upright, aims at the person's face, and presses the activator button. The stream of wet CR vaporizes. It causes a temporary, reflexive closing of the eyes, tearing, and a burning sensation on the skin and in the upper respiratory tract.

The most effective way to use the M36 is in one-second bursts. The maximum range is 10 to 12 feet. This allows the soldier to adjust his aim with a minimum waste of the riot control agent. The soldier must *not spray* a person for more than five seconds when closer than 3 feet. After being subdued, the person can best be decontaminated by facing the wind or by generous flushing with water for several minutes.

See FM 8-285 for more information on first aid procedures.

Troops using the M36 must be thoroughly trained in the use and hazards of the disperser. Training must include situations in which the M36 may be used, how to use it, a demonstration of the stream trajectory, safety requirements, and decontamination procedures. Because the use of the M36 does not cause immediate incapacitation, training on tactics and disperser limitations is necessary.

The disperser is carried and stored in a compact vinyl case with a snap button and a belt loop. The ammo pouch may be used as a field expedient carrying case.

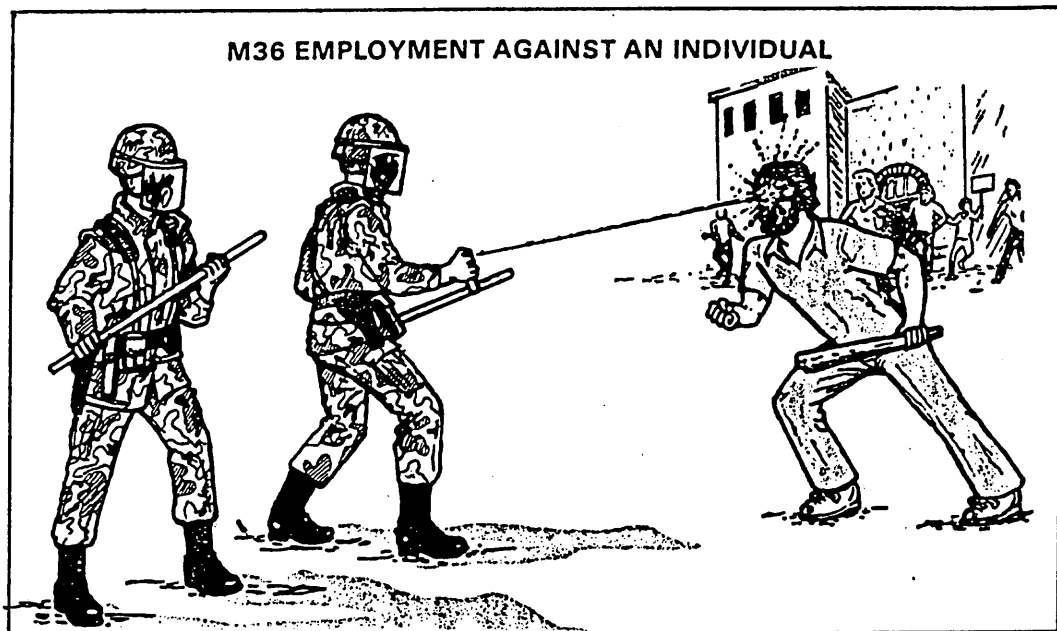

### M33A1 DISPERSER

The M33A1 disperser is a lightweight, portable riot control agent disperser that uses either dry or wet riot control agents. The agent is released through a nozzle on a hand-held gun assembly. Different nozzles are used for the powder and the liquid. The special nozzle for the wet agent allows the

operator to vary the amount and range of the solution by choosing spray or stream. The operator controls dispersal by varying the pressure on the trigger.

The hose and gun group controls the amount of riot control agent released. The agent may be released in a continuous

stream or spray or in short bursts ranging from less than one second to several seconds. Operators must determine the particular release rate for each disperser that they operate, both for talc and for riot control agents.

Worn as a backpack, the M33A1 looks and functions like the portable M33 disperser. The difference lies in the units' capabilities. The M33A1 disperser's modular design allows quick replacement of empty agent and pressure containers. The M33A1 can use either dry or wet agents without having to modify the unit itself. The M33A1 is replacing the M33 on a one-for-one basis as the M33s wear out.

The effective use of the M33A1 depends on a following or slightly quartering wind with a speed of less than 20 miles per hour.

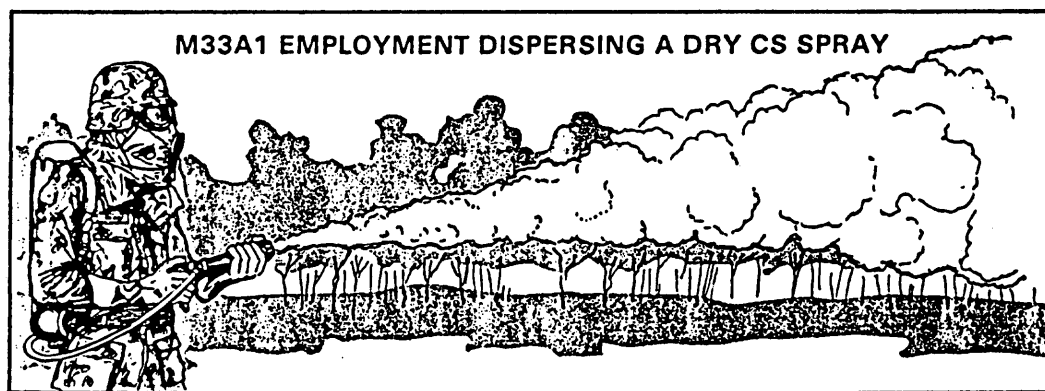
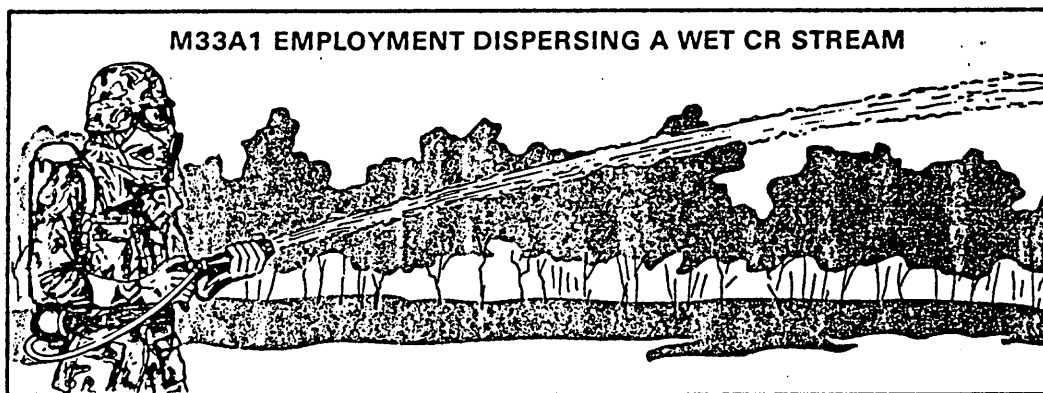

Optimum wind speed is 3 to 5 miles per hour. Usually, the use of this disperser is backed up by other dispersers to ensure adequate coverage of the target area.

**SOLDIER EQUIPPED WITH M33A1 RIOT CONTROL AGENT DISPERSER**

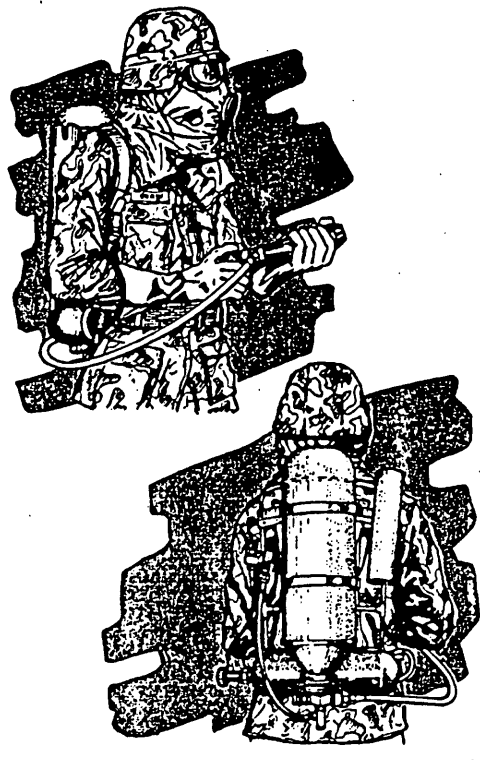

The agent tank and the air pressure bottle both have a quick-disconnect capability. But unless there are sufficient tanks and bottles available, the disperser may be out of action for a period of time, depending on the location of the compressor and the soldiers' ability to reload and repressurize the disperser. Because of its compactness, portability, and low cost, the M33A1 provides the user with an immediately available and very effective crowd control weapon.

The disperser operator may be positioned in front of, as a part of, or behind the crowd control formation. Proximity to the crowd and the disperser's role determine where the disperser is placed. When riot control agents are employed in advance of a close approach by the crowd control formation, the disperser operator may be a part of, or slightly in front of the formation. These positions give the operator the greatest freedom in using the disperser. It also minimizes troop exposure. Freedom to move right and left may help to disperse a more uniform cloud over the target. It also allows, to a limited extent, coverage over specific sections of the target area. If the disperser is to be held in reserve, the operator is positioned from one to several feet behind the center of the formation. From this position, the operator can quickly move to the front of the formation. When the disperser is not being used, the operator moves behind the formation for protection from thrown objects.

**POSITIONS OF RIOT CONTROL AGENT DISPERSER IN A CROWD CONTROL FORMATION**

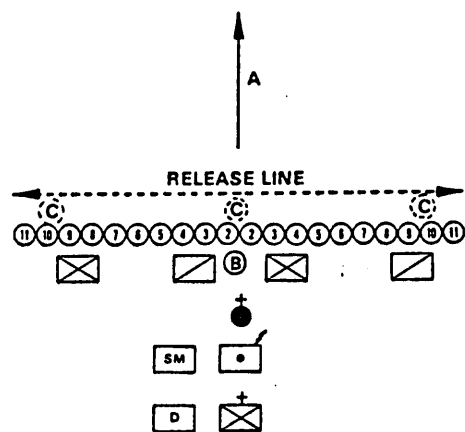

**LEGEND:**

- A WIND DIRECTION
- (B) POSITION WHEN IN RESERVE
- (C) POSITION WHEN FIRING

The optimum distance for firing the disperser to produce the greatest effect depends on the wind speed and the operator's freedom of movement across the front of the target area. Generally, the distance of the agent release point or line from the target area ranges from 15 meters to 100 meters or more depending on wind speed. As wind speed increases, dilution of the powder becomes more rapid. When this occurs, the distance between the target area and the release point must be reduced to place an effective concentration on the target.

Factors that affect the amount of a particular agent needed to produce an effective concentration are too varied to permit exact guidance. However, the operator must understand the agent's effectiveness, the amount that can be

released in a given time, and the makeup and determination of the crowd. The operator also must closely observe the agent's dispersal pattern and effect on the target. Too heavy a concentration may result in reaching a tolerance inconsistent with objectives. Too weak a concentration, particularly against an organized and determined group, may encourage more violence.

### M5 DISPERSER

The M5 riot control agent disperser consists of an M9 portable disperser gun for vehicles or a delivery hose for helicopters, a tank that holds approximately 50 pounds of CS, a hose assembly, a pressure tank, and a pressure regulator. These components are mounted on a tubular frame. The complete unit measures approximately 4 feet by 2.5 feet by 2 feet.

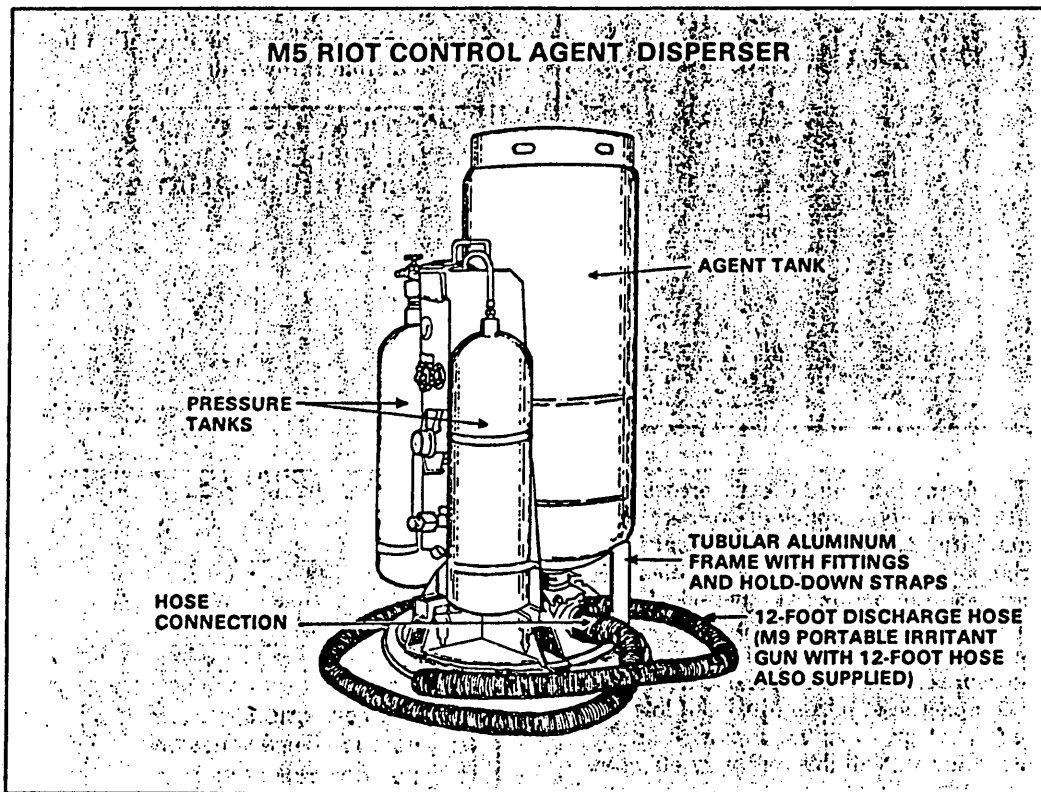

The M5 disperser has an effective range of 12 meters when dispersed with the M9 gun during calm winds. It is effective to 46 meters when dispersed from a helicopter at an absolute altitude of 24 to 30 meters. The duration of fire per fill is two minutes with the M9 gun and 20 seconds with the helicopter delivery hose. The disperser plus the agent weighs approximately 210 pounds. The M5 disperser can be mounted on a helicopter or on a 1/4-ton or larger vehicle. See TM 3-1040-220-12&P for more information.

The M5 disperser provides an air-to-ground dispersal capability when mounted in a helicopter. Situations best suited for the employment of the helicopter-mounted M5 include large-scale civil disturbances requiring large quantities of riot control agents and conditions that prevent its use on the ground.

When a helicopter is used, the agent can be released from either a hovering position above or on the windward side of the target area or along a line above or on the windward side of the target. When mounted on a vehicle and employed against open-area targets, the disperser is operated from positions slightly in front of or in the crowd control formation.

The release of riot control agents from a helicopter must be far enough in front of the crowd control formation that the agent dissipates shortly before the formation arrives. The location of the release point or line with respect to the target is determined by wind speed and direction and by physical obstacles. Other factors include the effects of the rotor wash on dispersal and the ground speed of the helicopter.

Initial release of the agent when hovering over the target is accomplished in short bursts of three to five seconds duration. The operator watches the crowd's reactions to determine the number and length of subsequent bursts. When hovering to the windward side of the target, the same procedure

is followed, except the agent may be released in slightly longer bursts. Release of an agent along a line must begin in time to assure coverage of the side of the target being approached. Dispersal must cease shortly before reaching the far side of the target. This helps avoid dispersal over areas other than the target. The exact moments for beginning and for ceasing the release are governed by the helicopter's speed and by wind speed and direction. Operating dispersers from a helicopter while it is hovering or flying at speeds less than effective translational lift speed when in ground effect may contaminate the helicopter, the crew, and the occupants due to circulation of the agent in the rotor wash. Therefore, either *the pilot or the co-pilot must wear a protective mask.*

The agent may be released from one or more stationary ground positions or along a line on the windward side of the target. When released from a stationary point, the agent is dispersed in intermittent bursts as the gun muzzle is swung through an approximately 160° arc to the front. When dispersed along a line, the agent may be released continuously or intermittently, depending on the agent used, the rate of movement, and the wind factors.

Commanders and disperser operators must ensure that the target area is not covered with an intolerable concentration of riot control agents. This is particularly true when the wind lies calm and when the target area is partially enclosed by buildings. Also, the operator must remember that 1 pound of CS is the equivalent of five bursting-type CS grenades and, further, that 50 pounds of CS can be released in two minutes or less with the M5.

The M9 gun group is used when mounted with the M5 on a vehicle. The M9 permits close control of the amounts of agent released. Operators must determine the release rate for each disperser that they operate.

Each M5 dispersal team has three members: a commander who is an officer, an operator who is an NCO, and an assistant

operator. Inclusion of the vehicle driver or the helicopter pilot as a member of the team is desirable, but not mandatory.

<b>DUTIES OF M5 DISPERSAL TEAM</b>	
<b>TEAM COMMANDER</b>	<ul style="list-style-type: none"> <li>• Supervises operation, employment, and maintenance of the M5 disperser.</li> <li>• Reconnoiters target area and prepares employment plans.</li> <li>• Supervises movement of equipment to operation site and assigns soldiers to specific jobs.</li> <li>• Selects the release point or line.</li> <li>• Controls the amount of riot control agent released.</li> <li>• Observes and evaluates dispersed agent to ensure proper coverage and concentrations without interfering with the control force's mission.</li> <li>• Teaches or demonstrates operating techniques and procedures.</li> <li>• Supervises and conducts team training.</li> <li>• Supervises the preparation of records and reports related to the disperser's operation.</li> </ul>
<b>OPERATOR AND ASSISTANT OPERATOR</b>	<ul style="list-style-type: none"> <li>• Operate and maintain the disperser.</li> <li>• Operate and adjust the disperser to get the best possible control agent dispersal pattern.</li> <li>• Inspect and test defective equipment or components to determine types and causes of malfunction, extent of repairs needed, and quality of repair work performed.</li> <li>• Clean, make minor adjustments, and replace defective parts using common hand tools.</li> <li>• Make final adjustments to equipment for optimum operation.</li> <li>• Estimate needs for maintenance supplies.</li> </ul>



## WATER

When using water, a number of factors must be considered. The Army does not have a water-dispersing system that is specifically designed for use in civil disturbance operations. Such a system can be improvised from existing equipment. The use of a large water tank—750 to 1,000 gallons—and a powerful water pump mounted on a truck with a high-pressure hose and a nozzle capable of searching and traversing enables troops to employ water as they advance. By having at least two such water trucks, one can be kept in reserve.

Employing water as a high-trajectory weapon, like rainfall, is highly effective

during cold weather. When using water, as with other measures of force, certain restraints must be applied. Troops try to avoid using water on innocent bystanders like women and children. When water is used, the troops must provide the crowd with escape routes. Troops employing water must be protected by formations and, in some instances, by shields. The more severe use of water, the flat trajectory application, is employed only when necessary. Because fire departments are associated with saving lives and property rather than maintaining law and order, *fire department equipment must not be used for crowd control and dispersal.*

## CHAPTER 10

### Riot Batons

The riot baton is an invaluable weapon in crowd control situations. Except for extremely violent crowds, the baton in the hands of well-trained troops is the most appropriate weapon. The riot baton is not meant to replace the rifle as the main weapon used by control forces. Rather, the riot baton is used in situations in which the rifle is not needed. The presence of rifles, with or without bayonets, tends to escalate the intensity of a civil disturbance. And unlike the rifle, the loss of a baton to the crowd does not present a serious threat.

Most control forces are armed with riot batons. This very versatile offensive weapon can be from 26 to 42 inches long. But the optimum length is 36 inches. The baton is made from any dense hardwood like rosewood or walnut that does not shatter or break easily. Both ends of the

baton are rounded to prevent unnecessary injury. The suggested diameter of the baton is 1.25 inches. A hole is drilled 9 inches from the grip end. The wrist thong is inserted through the hole. Either one or both ends of the baton should have a series of rounded ridges to aid gripping.

### EMPLOYMENT

The use of the baton is based on the commander's appraisal of the situation and his choice of a force option. Units committed with the baton must have marksmen and riot control agent teams in direct support. If the confrontation is intense, the commander also may elect to have reserve forces with rifles or shotguns, with or without bayonets, positioned for rapid reinforcement.

The riot baton is used by units that are employed defensively to protect people and property. During the termination phase of the disturbance when the violence has subsided and is expected to stay that way, troops are in a defensive posture. They may be equipped with the riot baton to perform their tasks.

The riot baton can be used in offensive crowd control formations. It can be employed so that the unit confronting the crowd is equipped with rifles and bayonets. Or it can be employed so that the element

in direct contact with the crowd is equipped with batons, and the supporting element is equipped with rifles and bayonets.

The riot baton is never the only weapon available to control forces. An element deployed with riot batons must have a marksman as a precaution against snipers. Reserve forces with rifles and bayonets must be available for immediate employment. The commander must be able to withdraw the riot baton elements, issue them other weapons, and redeploy them as a ready reserve force.

The riot baton, in the hands of trained troops, is a formidable weapon. But it must be used in conjunction with other measures to be most effective. The soldier who is skillful in using the riot baton can adequately cope with most situations that require physical restraint. Troops must be trained with the riot baton to the point that they use the various techniques automatically.

Troops using riot batons must have a thorough knowledge of the vulnerable points on the human body. Troops must deter, discourage, or disperse individuals threatening their position. But they must try to avoid blows that could kill or permanently injure.

When deployed, troops usually avoid any riot baton techniques that could result in

death or permanent injury. The riot baton is *never raised above the head* to strike an adversary in club fashion. Not only is this likely to cause permanent injury, it also projects an unfavorable image of the control force. Also, the soldier is vulnerable to an attack on his rib cage when his arm is raised.

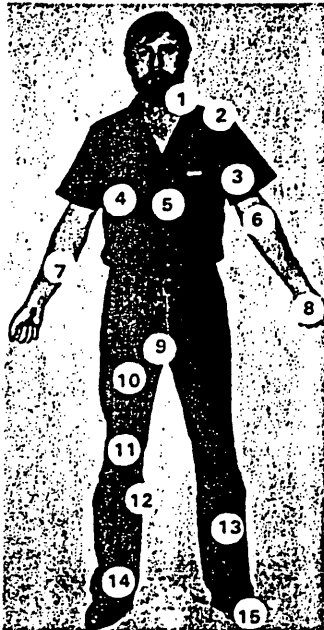
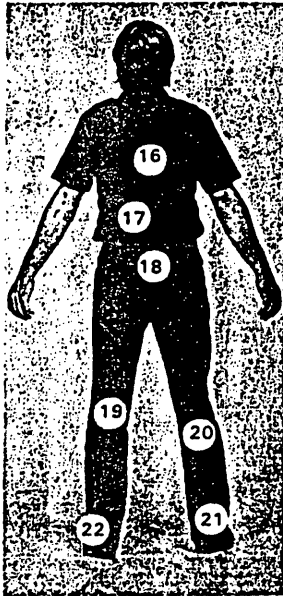
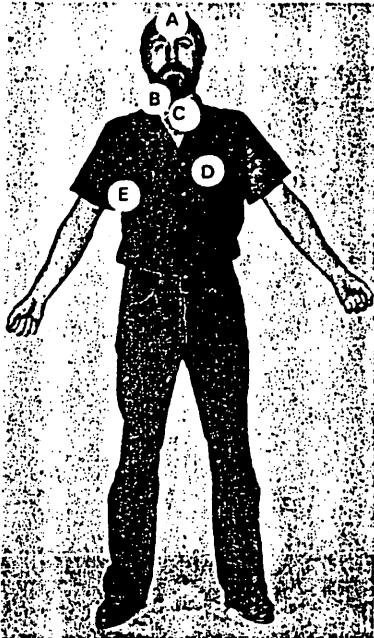
VULNERABLE BODY POINTS		FATAL IMPACT POINTS
 <p><b>FRONT OF BODY</b></p> <ul style="list-style-type: none"> <li>1 ABOVE CLAVICLE</li> <li>2 SHOULDER</li> <li>3 OUTER BICEP</li> <li>4 RIBS</li> <li>5 SOLAR PLEXUS</li> <li>6 INNER ELBOW</li> <li>7 FOREARM</li> <li>8 HAND</li> <li>9 GROIN</li> <li>10 THIGH</li> <li>11 KNEECAP</li> <li>12 SIDE OF CALF</li> <li>13 SHIN</li> <li>14 ANKLE FRONT</li> <li>15 TOES</li> </ul>	 <p><b>REAR OF BODY</b></p> <ul style="list-style-type: none"> <li>16 BEHIND SCAPULA</li> <li>17 KIDNEY</li> <li>18 COCCYX</li> <li>19 BEHIND KNEE</li> <li>20 CALF MUSCLE</li> <li>21 ANKLE TENDON</li> <li>22 ANKLE BONE</li> </ul>	 <ul style="list-style-type: none"> <li>A HEAD</li> <li>B SIDE OF NECK</li> <li>C THROAT</li> <li>D HEART AREA</li> <li>E ARMPIT</li> </ul>

## BATON GRIP AND POSITIONS

Three steps are necessary to obtain a secure grip on the riot baton. First, the thong of the baton is placed around the right thumb. Then the baton is held so the thong hangs over the back of the hand. Finally, the hand is rolled into the baton handle so that the thong is pressed into the palm of the hand. This method of gripping the baton provides a secure grasp. The baton can be released quickly by simply relaxing the hand.

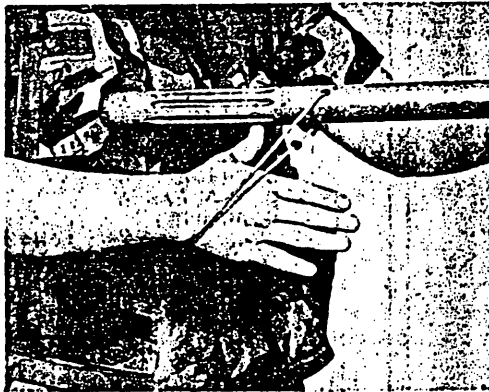
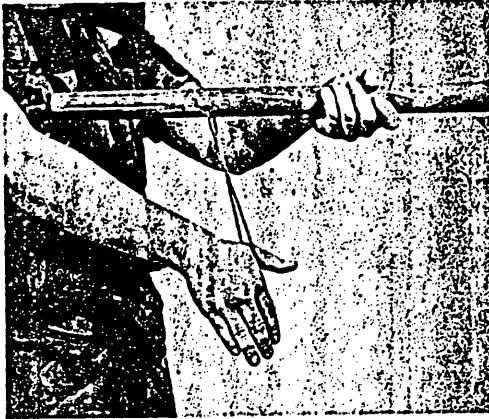
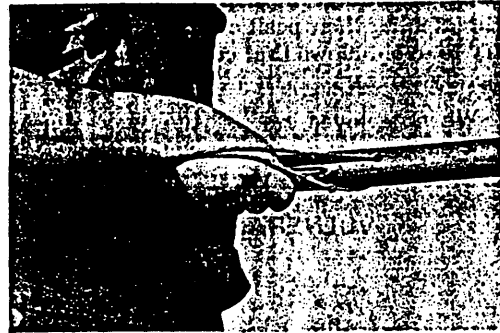

### PARADE-REST POSITION

Parade rest is the relaxed ready position. The feet are shoulder width apart. The left palm is facing out. The right palm is facing in toward the body. The hands are approximately 6 inches from the ends of the baton.



### PORT POSITION

The port position is a ready position. It is particularly well suited for individual defense. The right hand and forearm are parallel to the ground. The left hand is level with the left shoulder. The striking end of the baton bisects the angle between the neck and the left shoulder. The baton is held approximately 8 inches from the body. The feet are shoulder width apart.



### ON-GUARD POSITION

The on-guard position is the ready position. It should not be maintained for long periods of time because it is tiring. To assume the position, the left foot is placed forward of the right foot. The feet are spread apart, and the knees are slightly bent. The right hand and the butt end of the baton are placed snugly against the hip. The body is bent slightly forward at the waist. The left arm is bent so that the forearm protects the soldier's throat area, yet allows a thrust to be made.



## OFFENSIVE TECHNIQUES

Control forces use one of four techniques when employing riot batons in offensive operations. They perform the short thrust, the long thrust, the butt stroke, or the baton smash.

### SHORT THRUST

The short thrust is made from the on-guard position. The body is thrust forward rapidly by advancing the left foot. The left arm is snapped straight, driving the striking end of the baton into a selected vulnerable point of the opponent's body. The soldier must *never* direct the thrust directly at the central throat area because it can cause permanent injury or death. The soldier returns to the on-guard position after delivering the short thrust.



### LONG THRUST

The long thrust is made from the on-guard position. The body is thrust rapidly forward by advancing the right foot. The baton is held in the right hand. The baton

is snapped forward, driving the striking end of the weapon into a vulnerable point of the opponent's body. The soldier returns to the on-guard position after delivering the long thrust.

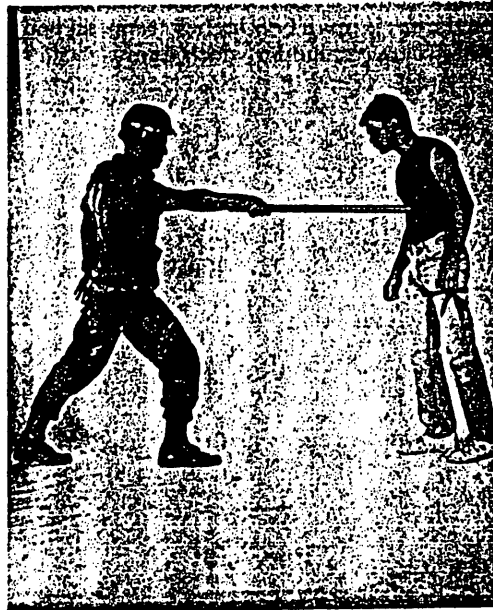

### BUTT STROKE

The butt stroke is delivered from the on-guard position. The right hand is elevated until the baton is almost parallel to the ground. The butt stroke is made by advancing the body rapidly off the right foot. The right arm is snapped straight. The butt end of the baton is driven to the left, striking the opponent's shoulder, chest, or jaw. The left hand is kept even with the left shoulder. The butt stroke may be fatal to the opponent if either the side of the neck or the head is struck. After delivering the butt stroke, the soldier returns to the on-guard position.



smash is executed by advancing the left foot rapidly. Both arms are snapped straight, smashing the length of the baton across the opponent's chest. After delivering the smash, the soldier returns to the on-guard position.



**BATON SMASH**

The baton smash can be delivered from the parade-rest, the port, or the on-guard positions. The baton is held horizontal to the ground, approximately chest high. The

## DEFENSIVE TECHNIQUES

In some situations, troops may have to employ the riot baton to defend themselves. They may have to defend against armed or unarmed attackers. The defensive techniques enable troops to defend against blows to the head, jabs to the body, stabs, and hand holds.

### DEFENSE AGAINST BLOWS TO THE HEAD

To defend against a blow to the left side of the head, the soldier starts from the parade-rest, port, or on-guard position. He smartly snaps the left hand to the left side of the body and the right hand up and to the left. The baton is then in a nearly vertical position that blocks the opponent's blow.

Immediately after blocking the opponent's blow, the soldier snaps both arms up and level with the baton. The left hand is near the left shoulder, and the right hand is in front of the left shoulder. The grip end of the baton is pointing towards the opponent. The soldier is now in position to execute a jab or a smash. The body is

driven forward. The right hand is snapped straight, driving the grip end of the baton into the opponent's upper body, avoiding the head. After delivering the jab or smash, the soldier returns to the on-guard position.





### DEFENSE AGAINST BACKHAND BLOWS

An opponent's backhand blow can be blocked from the parade-rest, port, or on-guard position. Both arms are snapped out and to the right front of the body. The left hand is raised above the right hand so that the grip end of the baton is pointing down. This position blocks the opponent's blow. After blocking the opponent's blow, the right hand is brought up near the right shoulder. The left hand is moved down and to the front of the chest. The striking end of the baton should be pointing slightly to the left front and toward the opponent. The soldier is now in position to execute the butt stroke. The body is rapidly advanced off the right foot. The right hand is driven forward and to the left. The left hand is held in place as the baton is driven against the opponent's shoulder, chest, or jaw. *This blow can result in a fatal injury if any other area of the head is struck.*



### DEFENSE AGAINST THE LONG THRUST

The long thrust can be countered from the parade-rest, port, or on-guard position. The left hand is moved toward the left. The right hand is moved smartly down and toward the left. The opponent's weapon is engaged and deflected to the left and away from the body. As soon as the opponent's weapon has been deflected, allow the left hand to slide down to the right hand. The body and baton are now in position for a counterblow against a vulnerable point.



### DEFENSE AGAINST OVERHEAD STABS

This defensive technique can best be accomplished from the parade-rest, port, or on-guard position. As the opponent stabs down, the body is moved to the rear by withdrawing the left foot. The left hand is allowed to slide down the baton to the right hand, and the baton is raised up over the left side of the body. The baton is brought down and snapped against the opponent's wrist or forearm, disarming him. After disarming the opponent, the left hand is slid back up to its original position on the baton, ready to execute the baton smash.





opponent drops his weapon, the soldier brings both hands up close to his shoulders. The baton is held across the chest. The counterblow is delivered by moving forward with the right foot and executing the baton smash.

**DEFENSE AGAINST THE UPWARD THRUST**

The upward thrust can be blocked effectively from the parade-rest, port, or on-guard position. The riot baton is brought quickly to a position parallel to the ground, about 6 inches away from the lower chest. Both arms are snapped straight down, driving the length of the baton downward to strike the opponent's wrist. As the



Once an opponent has been disarmed, he must not be allowed to recover his weapon. Any blow delivered to a vulnerable point of the body is effective.



**DEFENSE AGAINST AN UNARMED  
ATTACKER**

The riot baton is extremely effective when used against an aggressive or violent person. These defensive tactics may be performed from all three basic positions. The body is moved slightly to the rear by withdrawing the left foot. The left hand is slid down the riot baton to the right hand, and both hands are brought up to the left shoulder, the baton parallel to the ground. Against an opponent's left-handed blow, the soldier delivers a counterblow to the opponent's collar bone or shoulder. Against an opponent's right-handed blow, the soldier delivers a counterblow to the opponent's forearm.

If a soldier is grabbed by an opponent, the baton can be effectively employed as a defensive weapon. The baton can be jabbed into the groin or stomach of the opponent.



## CHAPTER 11

### Extreme Force Options

When a crowd engages in violent activities, a control force may have to resort to forceful measures to control the crowd. Strong measures of force are used only against crowds who employ defenses, arms, or tactics that make lesser measures of force ineffective or impractical. These measures include the use of firearms, the most extreme measure of force. The use of firearms ranges from the M234, which is a nondeadly force measure, to the machine gun, which is the most deadly force measure. The commander employs these firearms in a manner that is consistent with the principle of using minimum force. When employing firearms, the commander tries to ensure that they are used in a way that minimizes the chances for fatalities.

#### RING AIRFOIL SYSTEM

The M234 launcher is a riot control weapon that uses nondeadly force. The launcher, mounted on the M16 rifle, fires a projectile that causes pain on impact. The

force of the projectile's impact repels or distracts rioters while causing minimal injuries.

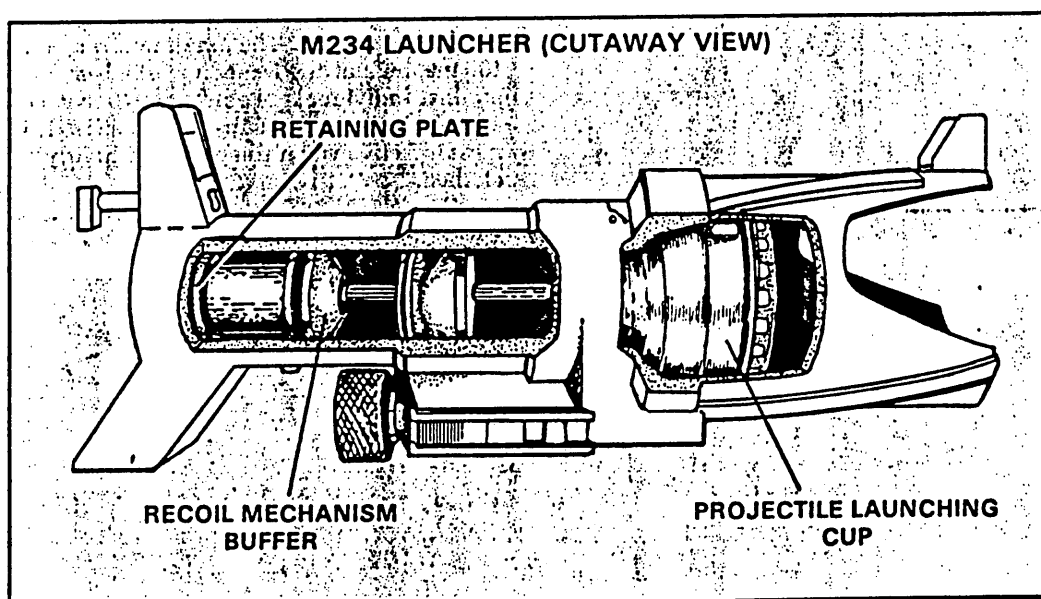

11-1

The ring airfoil projectile is shaped like a ring or doughnut. It is 2.5 inches in diameter. It consists of a one-piece, molded rubber body weighing approximately 1.25 ounces. The projectile is available in two variations: the soft projectile and the sting projectile. Both are identical in their external appearance. The sting projectile is a kinetic energy projectile that inflicts a painful blow. The soft projectile is identical to the sting projectile, but it contains riot control agent powder in small compartments in the projectile's body. On impact, the powder is spread directly on the person.

The M234 launcher is mounted on the closed-end flash suppressor of the M16 (if so equipped) or on the M16A1 rifle. An upper arm and a buffer housing on the rear of the launcher mate with the rifle's forward sight and bayonet stud to keep the launcher from moving on the barrel. The launcher is aimed using the launcher sights. The rifle is fired in the usual manner. The speed and flat trajectory of the spinning projectile make it extremely difficult to dodge, catch, or deflect.

The firing rate is about four to six projectiles per minute. The maximum range is 100 meters, but the weapon works best against individuals at ranges to 40 meters and against small groups to 60 meters. It is most effective when the person is lightly clothed.

M234 LAUNCHER MOUNTED ON AN M16A1

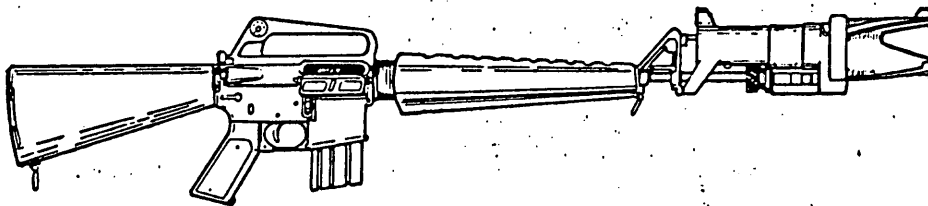

**EMPLOYMENT**

The M234 launcher is issued two per squad for each authorized company. The weapons may be deployed in several ways. Soldiers armed with the launcher may be used as members of foot or motor patrols. They also may be placed in or behind a crowd control formation. They must be positioned behind other squad members because they are vulnerable and make likely targets. Also, they must be positioned where they can easily hear the squad leader and fire team leader and react quickly to calls for fire support.

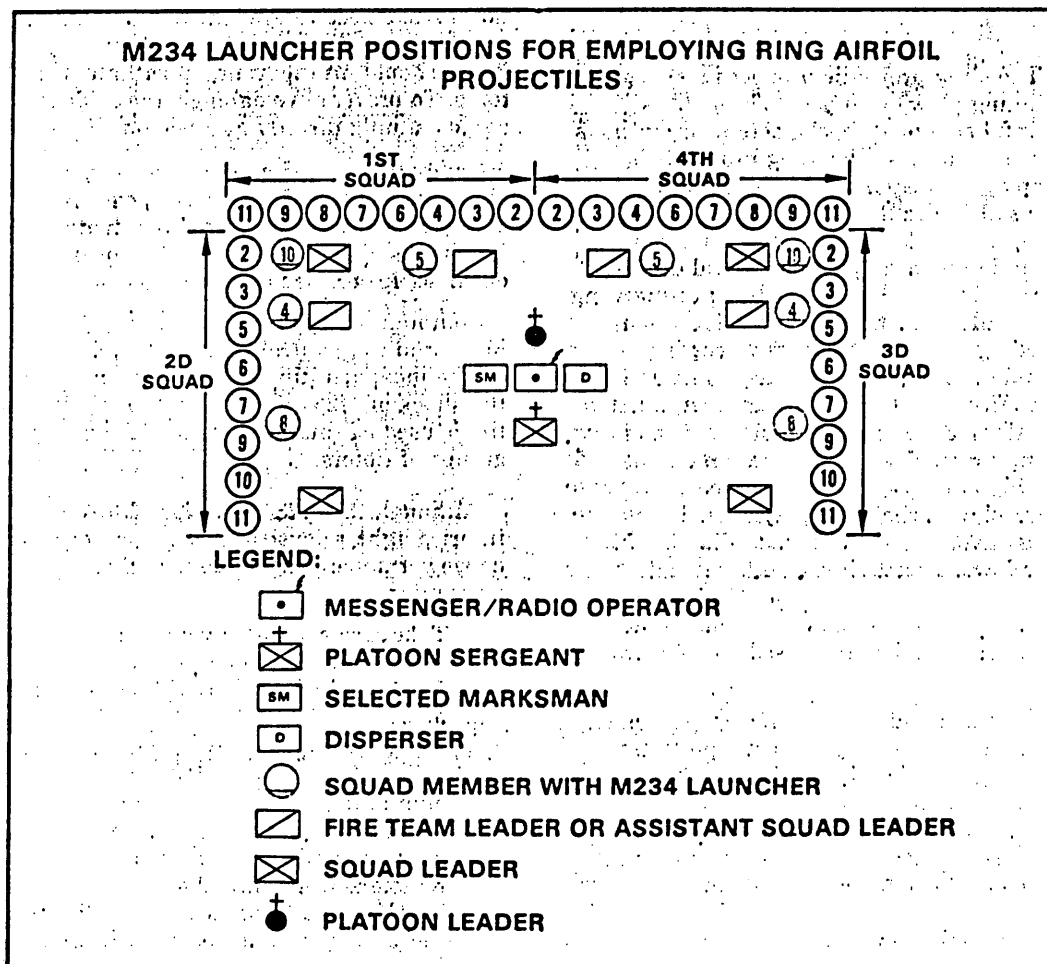

The soft projectile produces a CS agent cloud 4 to 5 feet in diameter. It is specifically designed to provide the commander with a less lethal means of engaging specific people or small groups under conditions in which other riot control weapons would be prohibited, undesirable, or ineffective. *Ball ammunition is used only in extreme circumstances.* Dispersing greater amounts of a riot control agent by other means is often undesirable or not possible. The soft projectile may be particularly useful against individuals or groups who are highly motivated, are wearing heavy clothing, or are using protective gear or shields.

The sting projectile produces a sharp stinging blow on impact. Through its painful effects, it repels, deters, or distracts crowd members. The sting projectile is employed in essentially the same way as the soft projectile. Whether the soft or the sting projectile is employed in a given situation is largely a judgmental decision. The sudden and painful impact of the sting projectile is particularly effective when used against lightly clothed people or people wearing masks that protect against the effects of the soft projectile. Against small area targets, employing soft and sting projectiles in combination can be highly effective. Troops must be very careful with the sting projectile. They must avoid accidental shots that can hit windows, streetlights, or other fragile structures. The sting projectile can easily break ordinary windows and may crack heavier glass like that used on store fronts.

Troops using M234 launchers also may be a part of security elements protecting critical facilities. Their positioning depends on the shape and physical limitations of the perimeter barrier. Whenever M234 firers are used, other members of the unit must be equipped with lethal firearms.

Use of the M234 must be controlled at all times. In crowd control formations,

authority to fire the M234 launcher is retained at the platoon or company level. In a patrol or a security element, that authority belongs to the person in charge. Its use must be limited to people who pose a serious threat to security forces or critical facilities or to people who are bent on violence or destruction. Any other use may incite more violence and destruction, thus promoting sympathy for the participants.

### FIRING TECHNIQUES

Firing techniques for the M234 launcher include selective, volley, and combination fires. Selective fire employs fire aimed at point targets. For greatest effect, the projectile should hit the front, upper half of the torso. To prevent eye damage, the soldier avoids aiming directly at a person's head.

Volley fire is used against area targets to cover as much of an area as possible. Volley fire must be restricted to situations in which serious destruction of property could occur or life is at stake.

Combination fire is the joint use of the M234 and riot control agents. It capitalizes on the incapacitating effects of agents and the shock of M234 projectiles. Combination fire is used against attacks by determined groups of rioters.

Although the M234 is designed to keep injuries light, misuse of the weapon can cause permanent injury. Follow these precautions:

- Take special care to avoid accidental use of ball ammunition. Ball ammunition *must not be issued to soldiers using the M234.*
- Avoid, if possible, using launchers for volley firing. An M16 firing blank ammunition sounds the same as it does when firing ball ammunition. To prevent panic and unfavorable crowd reaction, wait until the crowd realizes blank ammunition is being used. Then the launchers may be fired in greater numbers.



- Do not use the M234 launcher for indiscriminate or harassing firing.
- Do not fire at older people, pregnant women, or children.
- Do not aim at the head or the neck. The projectile's speed gives it enough force to severely damage an eye.
- Take every precaution to ensure a stray projectile does not hit an onlooker or the property of residents. Not only can the projectile cause pain, it also can damage windows, streetlights, or other fragile structures.
- Give annual training to all members of units using the M234. Training must include related equipment and the disassembly, assembly, and use of the launcher.

## SHOTGUNS

The riot shotgun is an extremely versatile weapon. Its appearance and capability have a strong psychological effect on rioters. It is particularly suited to certain applications in civil disturbance operations. When used with No. 00 buckshot, it is effective at a limited range. However, the use of No. 00 buckshot should be limited to specific missions. For example, it is ideally suited for use as a "covering" weapon in the antisniper role, during room-to-room searches, and at critical static posts that could be penetrated by a high-speed vehicle. By varying the ammunition from No. 00 to No. 7 1/2 or No. 9 birdshot, the shotgun can be used with considerably less possibility of serious injury or death. This gives the commander flexibility in choosing the ammunition that is most appropriate for the existing conditions.

When using No. 7 1/2 or No. 9 shot, the riot shotgun is suited to close-in firing against isolated targets like those encoun-

tered in antisniper operations. Because of the shotgun's short range, the danger of producing accidental casualties at ranges over 60 to 70 meters is much less than other types of weapons. However, the high lethality potential of the shotgun at shorter ranges places a severe restraint on its use during civil disturbance operations. The use of No. 00 buckshot, because of its high lethality at ranges beyond 100 meters, must be limited during civil disturbance operations.

Regardless of the type of shot used, the shotgun, like any other firearm, constitutes a deadly force that can be used only pursuant to the provisions of the rules on the use of deadly force. Positive control measures must be established to ensure that when shotguns are used, the commander specifically designates the type of ammunition to be used, and the troops armed with shotguns use only that type of ammunition.

## RIFLES

The rifle is the primary individual weapon used in civil disturbance operations. The exception is crowd control operations. The primary weapon for crowd control is the riot baton. The rifle also may be used for antisniper operations.

When arming his troops with rifles, the commander may, in keeping with the principle of minimum force, select from several options. The options consist of

various combinations of the rifle, the bayonet, the magazine, and the rifle's chamber. Each option represents an escalation in the level of force. The options are not sequential in the sense that a commander must start with the first option and proceed from one option to the next in order. As long as the option that he chooses is appropriate for the threat, he is in keeping with the principle of minimum force.

**RIFLE READINESS OPTIONS**

<p>RIFLE at sling BAYONET in scabbard MAGAZINE in pouch or on belt CHAMBER empty</p>	<p>RIFLE at port BAYONET in scabbard MAGAZINE in pouch or on belt CHAMBER empty</p>	<p>RIFLE at port BAYONET fixed MAGAZINE in pouch or on belt CHAMBER empty</p>	<p>RIFLE at port BAYONET fixed MAGAZINE in weapon CHAMBER empty</p>	<p>RIFLE at port BAYONET fixed MAGAZINE in weapon CHAMBER round in place</p>
--	---	---	---	--

\* This option is usually reserved for selected marksmen

The rifle and the rifle with bayonet affixed have very limited offensive use in civil disturbances as both can constitute deadly force. The main value of the rifle with bayonet affixed is its psychological impact on a crowd. However, the danger of accidental or intentional injury to demonstrators or other control force members precludes the use of fixed bayonets except against extremely violent crowds. The rifle with a round in the chamber is an option that usually is reserved for the commander of selected marksmen, such as an SRT leader.

The troops fix bayonets only on orders. The order to lock and load rifles can only be given when the criteria for the use of deadly force have been met. When the M16 rifle is used, a lock plate must be installed to prevent automatic fire. The lock plate, a prefabricated insert, fits between the pistol grip and the receiver group. It prevents the selector switch from being inadvertently flipped to the automatic mode. A soldier can install the lock plate in less than a minute using only a screwdriver. Once in place, it ensures that the selector switch stays in the semiautomatic mode.

**MACHINE GUNS**

All automatic weapons, especially machine guns, are closely controlled by the task force commander. It is almost inconceivable that machine guns would be used, short of guerilla warfare. Only the most drastic circumstances would justify their use. Individual automatic weapons must be modified so that they only fire semi-automatically.

Automatic weapons larger than 7.62 millimeter are not taken on a civil

disturbance mission. They usually are not needed or used. If a need develops, they can be obtained later.

Machine guns, 7.62 millimeter and below, may accompany units on civil disturbance missions. They are not taken on operations unless their use is imminent. Machine guns are available to the control force, but they are kept in a secure area.

## CHAPTER 12

### Apprehension and Detention Operations

During civil disturbances many people engage in unlawful behavior. The control force may be called upon to take into custody crowd members who have broken the law. Apprehension and detention operations are conducted to halt illegal acts and to deter future disorders. All apprehensions are made by the civil police force unless it is not possible for them to do so. If it becomes necessary for a military control force to apprehend or temporarily detain such lawbreakers, the offenders are turned over to the civil authorities at the earliest possible moment. Apprehension is justified only for a person who breaks the law. The person must be known to have committed an illegal act, or there must be "probable cause" to believe he or she has done so. When possible, the military limits its concerns to serious offenses involving injury or death.

When the military must detain or apprehend violators, certain policies must be observed. Apprehended people must be treated firmly, but with reasonable courtesy and dignity. The attitude and behavior of the apprehending officials is very important. Treating offenders with contempt, hostility, or excessive force increases the likelihood of resistance. And apprehending people without probable cause or without concern for their constitutional right to due process can prevent prosecution of the offender and, in some cases, result in prosecution of or a civil suit against the apprehending officials.

When it is at all possible, civil law enforcement agents are integrated with the military control force team making apprehensions. The team making apprehensions must carry out all procedures carefully. For each apprehension, the apprehension team must document the specific conduct that violates a law. The team must provide careful descriptive data for each offender. The description must be good enough that at a later time that person can be clearly

identified as the offender in question. The team must obtain and provide the names and addresses of witnesses. They should use DA Form 3316-R (Detainee Turnover Record) for this purpose. The team must retain and tag each item of physical evidence like a weapon or stolen goods that supports the apprehension. And the team must give the owner a receipt for each item of evidence that is retained.

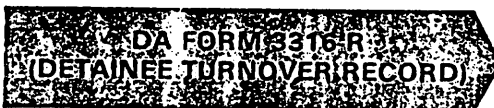

Troops must not question offenders at the scene. Failure to advise an offender of his rights and improper questioning about law violations can prevent a conviction. Troops must limit their questions to asking the offender's name, place of residence, and place of employment. If offenders must be questioned, civilian police are asked to conduct the interrogations. If civilian police are not available, CID agents or military police may conduct interrogations essential to the civil disturbance mission.

EXAMPLE OF COMPLETED DA FORM 3316-R

DETAINEE TURNOVER RECORD	
1. Detainee	3. Who made arrest/apprehension
SMITH, JOHN O.	Name JAMES P. JONES
Address 704 Central Ave Penrock, AR	Grade or Title SP4
Description Male, Cav, 5'10", 170 lbs brown hair, brown eyes	Unit 213 MPCo
2. What detainee did	4. Who escorted detainee to detention center
Describe Incident LARCENY (theft) B+W, General Electric, portable T.V. set, ser # 0143450, from Dept Store, Penrock, AR.	Billy D. DOE
When did incident occur (Date and Time) 1930 hrs, 20 Dec 1971	Grade or Title CPL
Where did incident occur Dept Sales Store 1115 Main St Penrock, AR	Unit 9 Inf Co
	Remarks: Attempting to avoid apprehension, Smith dropped the T.V. set, causing extensive damage.

DA FORM 3316-R, 1 MAR 68

(FRONT)

DETAINEE TURNOVER RECORD	
5. WITNESSES (Give name, grade or title if applicable and unit or address)	This card will be filled out on each person detained and will be turned in at the Detention Center with the detainee. When possible, the person making the detention should do this. If this is not possible, the person designated to escort the detainee to the Detention Center will fill out the card (preferably before accepting the detainee), based on verbal information from the person making the detention.
a PFC Sam L. Brown, 213 MPCo	
b	
6. WEAPONS AND ARTICLES REMOVED:	(Fold to fit in pocket)
1 TV set, 12", B+W, General Electric, serial # 0143450, with broken picture tube and a 4-inch crack on the right side of the cabinet. Property receipt for T.V. set given to store manager, Mr. Tom H. PUBLIC.	

DA FORM 3316-R, 1 MAR 68

(BACK)

## APPREHENSIONS

It is best to use apprehension teams, especially if it is likely that a lot of people will be apprehended. The teams provide an organized response to the situation. The teams can be organized at squad or platoon level, depending on the number of apprehensions expected.

Each team, if possible, consists of an apprehension officer, a movement element, and a recorder. If the control force cannot provide security for the team, a security element is added to the team. The team apprehension officer makes the actual apprehension with the help of the other elements. The TAO may be either an officer or an NCO. If possible, a civilian policeman or a US marshal serves as TAO. The TAO determines who is to be apprehended. He informs the offender of the reason for the apprehension. He supervises the handling of the offender. And he ensures that the apprehension process is properly conducted and documented. The TAO is responsible for the overall apprehension. This limits the number of people who will be subpoenaed to court to document the apprehension. The movement element helps the TAO handle the people being apprehended. This element moves, restrains, and searches the offenders under the supervision of the TAO. The security element watches the crowd and acts as a blocking element to keep the crowd from interfering with the apprehensions. The recorder helps the TAO document the event. He helps fill out the DA Form 3316-R. If possible, the recorder also photographs the TAO with each apprehended person. This aids the identification process. And it provides the TAO with documentation of the apprehension for use in court.

If people and equipment are available, a videotape or photographic element accompanies the team. This element records the scene before, during, and after the apprehensions. The element provides pictorial documentation for use in court.

And having control force members taking pictures can help control crowd reaction. It reduces the impact of anonymity on the crowd's behavior, making crowd members less prone to unruly acts.

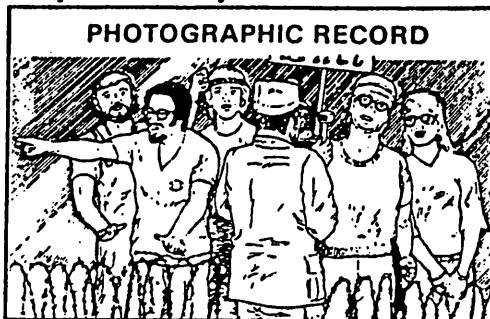

If apprehension teams are not used, each soldier must make a quick mental estimate of the situation as he approaches a person he intends to apprehend. He observes the scene carefully, noting details and conditions that relate to the incident. He considers what course of action to take. Each soldier considers the attitudes of the offender and the crowd in light of the manpower available. There must be sufficient manpower to cope with the situation, especially if the crowd might turn hostile. It is better to wait for help than to have too few troops to handle a situation. Trying to force an apprehension in a hostile environment can escalate violence and endanger the persons making the apprehension.

The behavior of the offender is observed to decide if the offender is violent, cooperative, or passive. Unless there is good reason to believe otherwise, the offender must be considered dangerous. The mood of the crowd is observed to estimate what they might do. The crowd may be just curious onlookers, or they may support the person to be apprehended.

The soldier selects a course of action that seems best in view of what the offender or the crowd may do. He bases his decisions on the nature and seriousness of the incident and the factors he used in estimating

the situation. Actions must be kept as simple as the situation allows. The element of surprise can give him an immediate advantage over the offender. But it is best not to use surprise if the offender might panic and injure someone. And it is wise to make the apprehension at a place offering the most advantages to the team and the fewest to the offender. Apprehensions in a crowded area are avoided if possible. Crowded areas provide avenues of escape. Also, the offender may have supporters in the crowd who will come to his aid.

Each soldier must give commands in a voice and manner appropriate for the purpose and the situation. He must state his commands in simple, concise language. His manner of speaking must be convincing. It must convey an expectation that his instructions will be obeyed. With frightened people, sympathy combined with an attitude of firm assurance on the soldier's part avoids trouble. With uncooperative people, an attitude of forceful authority may be needed. The soldier's commands must be of such a nature and content that the offender does what the soldier wants and only that.

The offender should be searched immediately. But circumstances may dictate postponing the search until a safer place can be found. The longer the apprehension takes, the greater the risk of drawing a hostile crowd. The crowd may sympathize with the offender and try to help him or to escalate the violence. The offender's actions may also incite the crowd to violence. The longer an offender is the focal point of an apprehension, the more easily he may stir

a crowd to violence. The team may choose to move the offender out of the crowd's view. If an uncooperative offender is moved only a very short distance, a come-along hold or carry may be used. If the distance is somewhat longer, flexcuffs or hand irons are applied.

After being searched, offenders are transported from the area. Vehicles like trucks, buses, or sedans that are used to transport apprehended offenders must be modified with barriers to separate the offenders from the driver. If a barrier cannot be provided, then a guard is placed in the vehicle. The passenger compartment is checked for items that could be used as weapons. When the guard must sit next to a prisoner, the guard always sits with his weapon *away* from the prisoner. Prisoners must be placed where they can best be controlled, but they are not fastened to the vehicle with hand irons or flexcuffs. Seat belts must be fastened.

When women are transported and no women are available as escorts, measures must be taken to avoid false charges of molestation. The names and addresses of witnesses must be taken before leaving the scene. The net control station must be notified of the departure time and the vehicle's mileage reading. And the arrival time and the mileage reading at the destination must be recorded. At least two male escorts must be present at all times when a female escort is not present. These procedures also apply when the male and female roles are reversed.

## SEARCHES

Apprehended offenders must be searched immediately for weapons and for evidence that can be easily destroyed or discarded. It is during the first contact with an apprehended person that the greatest caution is needed to prevent surprise and dangerous acts. Due caution, however, must be exercised constantly from the time a person is apprehended until proper disposition is

made. Searches must be conducted by at least two people. One person searches while the other person provides back-up or security. If the offender is thought to be armed, the searcher's assistant covers the offender with a weapon, and the searcher ensures that his own weapon, if he has one, is secure.

Searches of people and property that are not usually subject to military law may be made by military forces during a civil disturbance. When possible, *civilian police should search civilians and civilian property*. If police are not available, military personnel may search people incident to an apprehension. Either the stand-up search or the wall search may be used. The choice depends on the situation. The search is made not only of the person, but also of the immediate area. This prevents the person from grabbing a weapon or from destroying evidence. Control forces may search private property, including vehicles, if—

- Reasonable belief exists that a person has committed or is committing a violent crime and is hiding in a building or a vehicle.
- Reasonable belief exists that a vehicle contains weapons or instruments of violence.
- Probable cause exists for searching a building or a vehicle.
- Probable cause exists to believe that, unless immediate action is taken, evidence of a crime will be destroyed before a warrant can be obtained.

Control force members must *not* search a member of the opposite sex. The TAO must wait until a member of the opposite sex is available to make the search. If there are no female control force members available to search a female offender, any qualified woman, such as a medical professional, can be called on to conduct the search. A member of either sex can search items that can be easily removed, such as luggage, packages, shoes, hat, coat, and handbags. For more information on searches, see FM 19-10.

#### STAND-UP SEARCH

The stand-up search is a quick search of the offender for weapons and evidence. In making the search, the searcher has the offender stand with his back to the searcher. The searcher's assistant takes a position where he can watch the offender.

12-4

The searcher commands the offender to spread his feet and extend his arms above his head. The searcher then searches the offender from head to feet, crushing the clothing to locate any concealed weapons. When the search is complete, flexcuffs or hand irons are put on the offender.



#### WALL SEARCH

When a weapon is found, or when other factors indicate the need, a wall search is conducted. By rendering an offender helpless by placing him in an awkward position, the wall search affords safety to the searcher. Wall searches are particularly useful when searching several offenders. Any upright surface can be used.

To begin the search, the soldier has the offender face the wall or other surface and lean spread-eagled against it. The soldier makes sure the offender's feet are well apart. The offender's head must be kept down. The searcher's assistant stands on the side of the offender opposite the searcher and to the rear. When the searcher moves to the other side of the offender, the

assistant also changes position. The searcher walks around the assistant when changing sides to avoid coming between the offender and the assistant guarding the offender.



If the offender resists or tries to escape and must be restrained before the search is completed, the entire search is repeated from the beginning. If flexcuffs or hand irons are applied before the wall search is completed, the offender's forehead is placed against the wall to provide support in place of the hands. Flexcuffs or hand irons are applied when the wall search is complete.

When searching two or more offenders, the searcher has them lean spread-eagled against the same wall, but far enough apart so they cannot reach one another. The searcher's assistant takes a position a few paces to the rear of the offenders. The searcher begins the search with the offender on the right. After searching each offender, the searcher has him move to the left end of the line and resume the wall-search position. This keeps the searcher from coming between the assistant and an offender.

## COME-ALONG TECHNIQUES

Come-along techniques can be used to move resisting offenders. The apprehension team must be able to move the offender quickly and without the use of excess force. Flexcuffs or hand irons are placed on resisters before moving them. This reduces a resister's ability to fight if he or she suddenly tries to do so.

### CARRY METHODS

The two-person carry is the best come-along technique if there are enough troops available. This carry avoids injuries caused by excessive lifting. It also avoids injuries to an offender. A soldier stands on either side of the offender and grasps him under the legs and through his arms and around his back. The soldiers may grasp each other's arms to prevent their hold from slipping. They also can perform this carry using riot batons. They place one baton under the legs behind the knees and the other baton horizontally across the back. Both soldiers then grasp the batons, forming a cradle.







hands in front of the offender's chest for a more secure hold. The second soldier stands to one side of the offender and encircles the offender's legs at the knees with his arm.



The offender may try to resist by stiffening and forcing himself out of the cradle. To counteract this resistance, one soldier gets behind the offender and grasps the offender under the arms. He locks his



A one-person carry has a disadvantage. It involves lifting considerable weight. This can tire the carrier quickly or cause a back injury. The soldier lifts the offender from the rear by grasping him under the arms. The soldier locks his hands in front of the offender's chest. The soldier then pulls the

offender backward with the offender's heels dragging the ground. A riot baton also may be used for this technique. The soldier approaches the offender from behind. He lays the baton to the side of the offender, slightly behind the offender's buttocks. He then forces the offender into a sitting position, reaches under the offender's arms, and picks up the baton. He then rotates the baton to the front of the offender's chest. He places his free hand under the offender's arm and grasps the other end of the baton. Again, the soldier pulls the offender backward with the offender's heels dragging the ground.

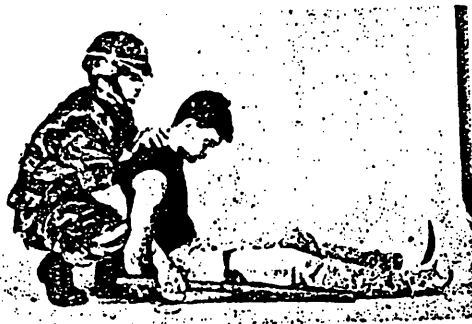

### COME-ALONG HOLDS

A come-along hold is used to move an unrestrained, unwilling person from one place to another. It controls the person's movements without injuring him. A come-along hold puts pressure on a sensitive part of the body and causes discomfort. The hold must be executed quickly and with as little commotion as possible. Speed is essential in applying these holds. Such holds are used only for short distances until the offender can be restrained. Each soldier must know which holds are best suited to his capabilities.

#### Baton as a Restraint and Come-Along

The riot baton may be used as a restraining device and as a come-along hold at the same time. The soldier has the offender cross his hands behind his back. He slips the offender's hand through the baton's leather thong. He then twists the baton until the slack in the thong is taken up. The thong can be tightened or loosened depending on the amount of pressure needed to secure the offender. With his left

FM 19-15

hand, the soldier grasps the left shoulder or the clothing over the shoulder of the offender. He pulls the offender slightly backward so that the offender cannot pull away from the baton end, which is pressed against the small of the offender's back.



### Gooseneck Come-Along

To apply a gooseneck come-along the soldier approaches the offender from the rear. He steps forward with his left foot along the outside of the offender's right foot. He grasps the inside of the offender's right arm at the elbow with his left hand. He then grasps the offender's right hand with his right hand, placing his thumb inside the bend of the offender's wrist and his fingers across the back of the offender's right hand. With both hands, the soldier sharply pulls the offender off balance and to the rear so the offender's weight falls on the soldier's left shoulder. The soldier then bends the offender's right arm at the elbow and locks the offender's right arm against his chest. He reinforces his right hand with his left hand, placing both thumbs inside the bend of the wrist and his fingers across the back of the offender's hand. He locks both his elbows tightly to his side and steps up beside the offender. He applies pressure as he steps up beside the offender. He presses down on the back of the offender's hand, bending it under toward the forearm.



12-8

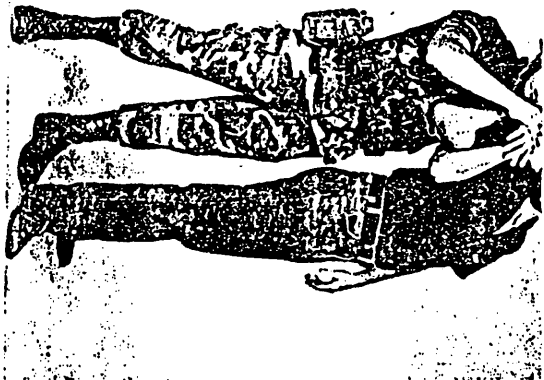

Front Hammerlock

For the front hammerlock the soldier faces the offender. He steps forward with his right foot to the outside of the offender's right foot. He grasps the offender's right arm at the elbow with the soldier's right hand palm up. The soldier breaks the offender's balance by pulling the offender's right arm slightly away from the offender's body. As he pivots behind the offender, he strikes the offender's right wrist with his left wrist and bends the offender's arm to the rear. As the soldier completes the pivot behind the offender, he drives his left fist straight up until the offender's right wrist rests in the bend of the soldier's left arm. He then rotates his left hand down, grasping the offender's right elbow. He pulls the offender's right elbow tightly against his stomach. The offender may be leaning forward in this position. The soldier completes the hold by reaching with his right hand over the offender's shoulder and grasping the left side of the offender's face.

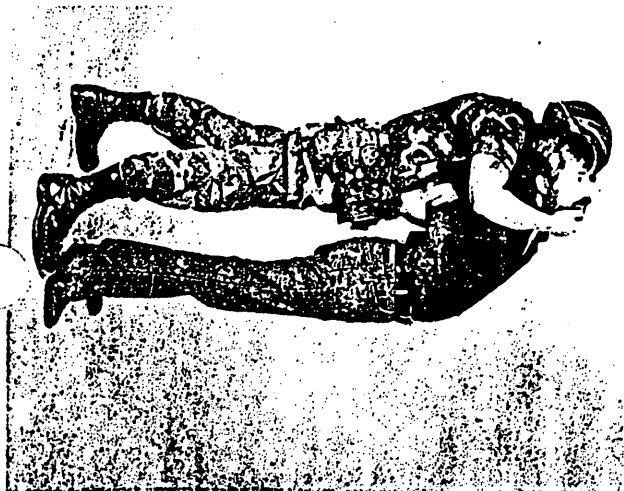
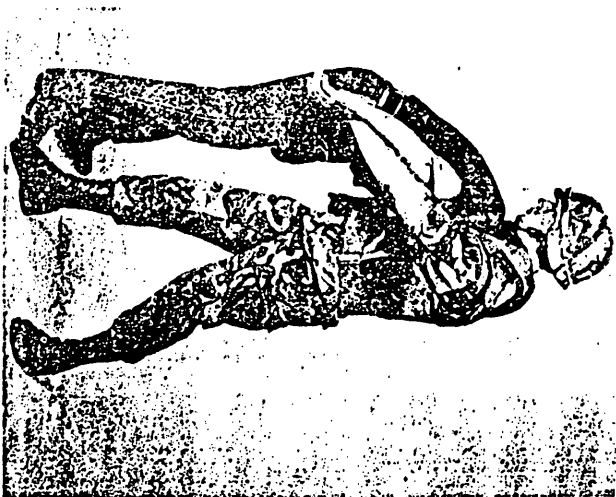
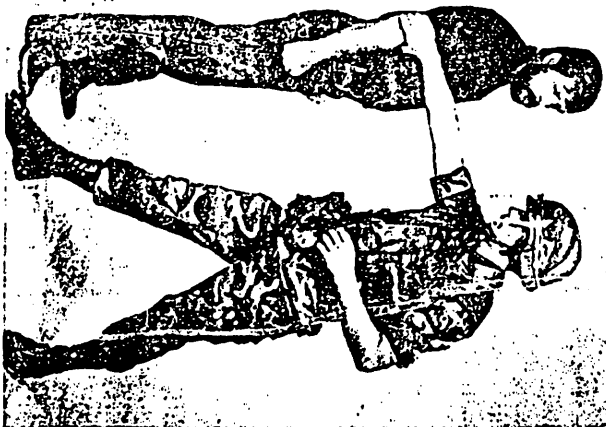

### Fingers Come-Along

The fingers come-along is tiring to maintain, but it is extremely useful in moving an offender for a short distance. The soldier faces the offender. He steps forward with his right foot to the outside of the offender's left foot. As he steps, he reaches with both hands and grasps the offender's left wrist with his left hand. He grasps two or three fingers with his right hand. He then pivots counterclockwise on his right foot until he is standing beside the offender. He thrusts the offender's arm straight out in front of him at shoulder height, maintaining a tight grip on the offender's wrist with his left hand and bending the offender's fingers down with his right hand. The soldier applies pressure by keeping the offender's arm locked straight and by pulling the offender's fingers straight back toward the offender's elbow. This hold can be applied on either hand.



### Groin Lift

The groin lift is used to remove a resisting offender from a wall or move him through a doorway. The soldier approaches the offender from the rear. He steps forward and places his left foot next to the offender's left foot. He grasps the offender's left wrist with his left hand, pulling the offender's hand sharply down between the offender's legs. The soldier then grasps the offender's left hand with his right hand and pulls the offender's arm up into the offender's groin. He reaches with his left hand and grabs the offender's shoulder or collar. He can then move the offender forward or backward by lifting the offender's arm against the offender's groin as he pushes down on the offender's shoulder with his left hand.

**Baton Come-Along**

For the baton come-along the soldier grasps the center of the baton with his right hand. He approaches the offender from behind. He rotates the baton to a position parallel with his right arm and pointed toward the offender. He thrusts the baton between the offender's legs. He rotates his right hand so that his palm is turned up. He then pulls back and up, placing the baton across the offender's upper thighs.

The soldier reaches up with his left hand and grasps the offender's collar near the back of his neck. To move the offender, the soldier keeps his right hand as straight as possible and exerts upward pressure from the shoulder. Simultaneously, he pushes forward with his left hand. This keeps the offender on his toes and off balance to his front.





**Hammerlock Come-Along**

For the hammerlock come-along the soldier holds the baton in his right hand. He steps forward with his right foot and tweek the offender's left arm and body. As the baton passes to the rear of the offender's body, the soldier pushes up and to the rear. He steps forward with his left foot to the outside of the offender's left foot. He then reaches across the offender's left shoulder with his left hand and grasps the striking end of the baton. Pivoting on the ball of his left foot, he moves to the offender's left rear. At the same time, he presses down with his left hand on the striking end of the baton in the direction of the offender's left front. He also presses up on the grip end of the baton with his right hand. This bends the offender well forward at the waist.





jaw bone and forces the offender's face to the left, straightening him up. To apply pressure, he presses down on the striking end of the baton with his left upper arm and pulls up on the grip of the baton with his right hand.



After the offender has been subdued, the soldier holds the baton firmly with his right hand and releases his left hand. He reaches across the striking end of the baton with his left hand and grasps the right side of the offender's face under the

## DETENTION FACILITY OPERATIONS

Civil authorities must provide adequate detention facilities for all apprehended people. Authorities must be prepared to detain large numbers of people. They may choose to expand existing detention facilities or to set up temporary facilities to accommodate the extra load. If possible, large-scale arrests are delayed until sufficient detention facilities have been provided.

When federal forces are committed, the commander coordinates with civil authorities to ensure adequate detention facilities are available and to learn their locations and capacities. If there are more detainees than civil detention facilities can

handle, civil authorities may ask the control forces to set up and operate temporary facilities. *Army correctional facilities cannot be used to detain civilians.* A temporary Army detention facility can be set up if—

- Federal troops have been employed under the provisions of AR 500-50.
- The task force commander has verified that available civilian detention facilities can no longer accommodate the number of prisoners who are awaiting arraignment and trial by civilian courts.
- Prior approval has been granted by the Army Chief of Staff.



## FM 19-15

Use of the temporary facility ends as soon as civil authorities can take custody of the detainees. The Army is responsible for the custody, health, comfort, and sustenance of all people detained in its facilities until custody is transferred to civil authorities. The temporary facilities cannot be used to confine people arraigned or convicted in civilian courts. Women are detained in these facilities only under the most extreme circumstances. And women must be transported to a civilian facility as soon as possible.

The same operational procedures that apply to the management of an installation confinement facility apply to the management of temporary detention facilities, except for training, employment, and administrative discipline. The facilities are supervised and controlled by MP officers and NCOs trained and experienced in Army correctional operations. Guards and support personnel under direct supervision and control of MP officers and NCOs need not be trained or experienced in Army correctional operations. But they must be specifically instructed and closely supervised in the proper use of force, their custodial procedures, and their completion of military and civilian forms and reports that they might have to use. Troops who may be tasked to operate a temporary detention facility should be familiar with the forms and reports used for civilian apprehensions.

The temporary facilities are set up on the nearest military installation or on suitable property under federal control. Ideally, the facility is close enough to the disturbance area to minimize transportation and escort needs. But it should be far enough away not to be endangered by riotous acts. Whenever possible, existing structures are adapted for this use. But construction may be needed to provide the segregation for ensuring effective control and administration.

12-14

The basic structure must include:

- Search areas.
- Holding areas for incoming men and women.
- A processing area.
- Holding areas for men and women who have committed misdemeanors.
- Holding areas for men and women who have committed felonies or are violent.
- A holding area for property and evidence.
- A holding area for administrative support and records.
- A medical station.
- Latrines.

Facility personnel must ensure that proper sanitation is maintained. When large numbers of people are detained or processed through a facility, sanitation becomes a problem. Medical personnel must conduct regular health inspections to detect unsanitary practices and conditions. (For more information on health inspections of detention facilities, see AR 190-38.)

The facility must be organized for a smooth flow of traffic. Processing stations must be set up so there is a linear or circular sequence of movement. Processing areas are set up out of sight of the holding areas. If possible, the areas are separated by a door to reduce noise in the processing area. To reduce distractions, each station may be partitioned. Detainees may be more cooperative if they are out of the sight of each other.

Injured people are given prompt medical treatment and transportation to medical facilities when necessary. A medical aid station for screening detainees and treating minor injuries is set up inside or next

to the detention facility. The treatment area, however, must be out of sight of the processing and holding areas. If possible, access to the medical facility bypasses the holding and processing areas. Facility personnel also may consider setting up a separate holding area for injured detainees.

Detention facility operation plans must contain emergency procedures. As a minimum, the following areas must be addressed:

- Fire evacuation.
- Detention facility disturbance control.
- Detention facility defense and security.

Other emergency procedures may be needed, depending on the situation.

On arrival at the detention facility, the detainee is logged in and searched. The search is conducted even if the apprehending team made a complete search in the field. Separate search areas are set up for men and women. Weapons, contraband, flame-producing devices, suspected evidence, money, and high-value items are confiscated. Medications also are confiscated. Detainees that have had medications confiscated are screened by medical personnel. Receipts are provided for any property or evidence that is confiscated. Confiscated items are tagged. The items are stored in a controlled property area.

When a detainee is brought to the facility, a file is initiated. The detainee's case number is used on all paperwork, such as logs, evidence tags, reports, and visual documentation. All paperwork, including photographs, begun outside the detention facility is marked with the case number. Facility personnel also may use hospital ID tags. Using indelible ink, they write the case number and attach the tag to the detainee's wrist. Different colors may be

used to identify different offender classifications, such as misdemeanor, felony, or violent. If opposing factions are involved, procedures are established to ensure members of opposing factions are not processed together or detained in the same holding area.

After a detainee has been searched and classified, he is taken to a processing station. There, his paperwork is processed. If offenders passively resist by going limp, they may be moved by wheelchair. This reduces the number of escorts needed and the fatigue to facility personnel.

Equipment like height charts, scales, fingerprinting equipment, and cameras must be available for completing the police report and for identifying the offender. Because detainees may use aliases and not carry identification, special attention is paid to obtaining as much information as possible about the detainee's physical characteristics. The paperwork is reviewed to ensure that information is complete, including charges, witnesses, and reasons for the apprehension.

After the processing is complete, the detainee is placed in an appropriate holding area. The paperwork is forwarded to the administrative section. The file is reviewed for completeness and to determine the disposition of the detainee. Information from the file may be placed into a computer to find repeat offenders. The computer may be used to file criminal information only.

Custody transfers and release procedures must be coordinated with civil authorities and appropriate legal counsel. Every effort must be made to arraign offenders quickly. The purpose of a detention facility is not to keep people off the streets, but to aid in processing offenders through the legal system. To speed up the release process, planners should consider issuing citations or subpoenas for minor offenses.

FM 19-15

Control force members may have to respond to writs of habeas corpus. These writs are court orders addressed to a prisoner's custodian. Such a writ directs the custodian to bring the prisoner to court to determine the legality of the prisoner's apprehension and detention. The custodian must be sure to bring all documentation concerning the case with him to court.

---

Military personnel must obey writs issued by federal courts. For writs issued by a state court, the custodian or his legal advisor should respectfully reply that the prisoner is being held by authority of the United States. The SJA can answer any questions and explain the correct procedures.

12-16

## CHAPTER 13

### Training for Civil Disturbances

Civil disturbance training must enable personnel to function effectively, as individuals and as members of a control force. To be effective, the training must be intensive, realistic, and continuous. Individual, team, and unit training are vital to develop personnel who are able to perform distasteful and dangerous duties with discipline and objectivity. A lack of training on the part of even one person can adversely affect the unit's performance. That person may not be able to fulfill his responsibilities as a team member. For this reason, the unit must conduct makeup training. The unit also must make provisions for training replacement personnel. Garden Plot's Annex A and AR 500-50 provide guidance on civil disturbance training requirements.

Each commander structures his unit's training program based on expected contingencies, prior training, the unit's degree of experience, and the degree of proficiency that the unit has attained. The unit must be trained, equipped, and maintained in readiness for rapid deployment. The training must cover all aspects of civil disturbance operations. And the training must entail more than just mechanical proficiency in crowd control formations. Training must also address the sensitivity and high visibility of civil disturbance operations. It must emphasize protection of firefighters and their equipment, area inhabitants, and other people trying to control the disturbance.

Training must include operational techniques for use in urban, suburban, and campus areas, as well as procedures for neutralizing special threats. Training must also include use of and functioning with personal equipment. For example, unit members may expect to be equipped with body armor, protective masks, or face-shields. Thus they should train wearing this equipment to help them become accustomed to wearing it for long periods of

time. And rehearsing alert plans, load plans, and operational plans must be done as often as necessary to reach and maintain the required degree of proficiency. Commanders should also consider training in courtroom procedures. After the event, soldiers may be called as witnesses in civilian trials.

Civil disturbance trainers can keep abreast of current developments from reports in the news media, after-action reports, and a number of other sources. Lessons learned from such reports and sources are useful for enhancing training and keeping it current. The following subjects are a guide for refresher training:

- Policies and legal considerations.
- Standards of conduct.
- Use of minimum force.
- Use of riot control agents and munitions.
- Use of riot batons.
- Search and seizure techniques.
- Apprehension and detention.
- Neutralization of special threats.
- Media relations.

## UNIT TRAINING

Unit training must be realistic. Field training exercises can be conducted in built-up areas on the installation or at mock-ups. The unit commander should try to include local government officials in FTXs. The officials can be either witnesses or participants. But care must be taken to prevent adverse psychological effects on the local populace, especially if tension is high. Exercises with local officials work best if based on a detailed scenario. Then participants have a chance to test command and staff relationships, communications, coordination, logistics, and joint development of intelligence. Experience has shown joint exercises can identify and help solve problems before a civil disturbance occurs. The task force headquarters staff must periodically test their organization and procedures with command post exercises. They also must establish a civil disturbance SOP. Proper training can reveal problems to be corrected before actual operations. This reduces confusion during civil disturbance operations.

### STRESS

Training can make it possible to function in a highly disciplined and organized manner under stressful conditions. Stress training has two goals: to improve understanding of crowd and mob behavior and to prepare troops to control their own actions and emotions. The troops study the typical causes of civil disturbances to gain a better understanding of their role in helping to control civil disturbances. Group behavior must be discussed in enough detail to show the troops what to expect. Also, the troops must learn how psychological factors influence their own behavior.

Troops must control their emotions and carry out their orders with determination and discipline when in formation, on patrol, or posted as guards. They must be physically and emotionally prepared for

crowd members shouting at them, insulting them, calling them abusive names, throwing objects at them, screaming and rushing at them, tearing off their own clothes, or deliberately injuring or maiming themselves. They cannot allow personal feelings to interfere with executing their mission. They must ignore these actions and use evasive movements to avoid thrown objects. They must never throw the objects back. Troops must understand that the well-disciplined execution of orders is the most effective measure against rioters.

A way to familiarize soldiers with confronting a mob is to conduct an exercise using part of the unit as violent demonstrators and part as the control force. This exercise must be realistic, but safe. This training, however, must not be conducted unless the soldier is also trained to deal with his internal stress. Installation mental health personnel may be available to help with stress training. They can teach methods to help reduce the soldiers' stress and fatigue. They may also be able to advise the commander on other factors that increase the soldiers' stress levels.

### WEAPONS AND SPECIAL EQUIPMENT

Every member of the control force must be trained to use his weapon and special equipment. Weapons and special equipment include riot batons, riot control agent dispersers and CS grenades, grenade launchers, shotguns, sniper rifles, cameras, portable videotape recorders, portable public address systems, night illumination devices, firefighting apparatus, grappling hooks, ladders, ropes, bulldozers, Army aircraft, armored personnel carriers, and roadblock and barricade materials. Training time can be used to construct some special equipment, such as wire barricades and wire coverings for vehicles.

Troops equipped with riot batons must be well trained in their use. Riot baton training covers employment, the human body's vulnerable and fatal points of impact, the basic positions, and defensive procedures and use of the baton in riot control formations. The procurement of riot batons depends on their availability in the Army's inventory. If they are unavailable through Army supply channels, they can be procured by local purchase at the installation level.

Each service is responsible for providing, organizing, equipping, and training its forces to use riot control agents in civil disturbances. The training includes individual and unit training. Individual training covers—

- Policy on the employment of riot control agents.
- Characteristics of riot control agents.
- Individual protection, first aid, and decontamination.
- Maintenance of riot control agent munitions and equipment.

Unit training covers—

- Riot control agent squad organization.
- Tactical employment of riot control agents in crowd control.

These are the minimum training needs. Other training may be added as needed.

Designated personnel also receive training in the operation, employment, and maintenance of riot control agent dispersers. They must know and be proficient with the following:

- The nomenclature and characteristics of the respective dispersers and the riot control agents.
- The effects of weather, terrain, and distance on the dispersal of riot control agents.

- Methods of operating the dispersers.
- Techniques that give the greatest assurance of placing an effective concentration on the target area with a minimum spillover outside the target area.
- Maintenance of dispersers.
- Use, care, and inspection of protective clothing.
- Decontamination of equipment.
- Safety precautions.

Practical exercises are conducted under varying weather conditions and differing crowd control situations. Whenever possible, training should be integrated with unit disturbance control exercises. Drills are conducted periodically to test the readiness and proficiency of the operators and the equipment. For training purposes, technical talc, T1, is used in place of CS.

Each unit must have an SOP that provides guidance to all soldiers, including drivers and helicopter pilots, who operate dispersers. The SOP must cover specific individual duties and actions to be performed before, during, and after operation of the disperser.

When special equipment training cannot be accomplished before a unit is committed to a civil disturbance, the unit commander must get qualified personnel to operate the equipment. If that cannot be done, the equipment should not be used.

During training with bayonets, the bayonets *must be encased in their scabbards* for safety. Trainers must emphasize that the only time the rifle is used with fixed bayonets is when the control force is confronted by a violent crowd, and the commander authorizes their use. Also, troops who will be armed with shotguns during civil disturbance operations must be well-trained in their use.

### COMMUNICATIONS SYSTEMS

Personnel must be trained in the use of communications systems. Communications operating procedures must be included in special instructions. The telephone system, for instance, is usually simple. But it can

be confusing because of various systems that exist in different areas. Troops must receive training on the telephone systems used in a projected disturbance area. They also must be provided a list of emergency numbers.

## LEADERSHIP

Civil disturbance operations place unusual demands on the leadership skills of members of a control force. The complex nature of a civil disturbance requires a combination of determined execution of duty and individual restraint. Soldiers and small-unit leaders must be aware of these demands and be prepared to deal with them. Training must include a careful review of military leadership.

Because effective employment of the unit is a goal of leadership, a good leader must thoroughly understand span of control. Task organizing for civil disturbance operations is more than usually dependent on span of control. Span of control is the number of people or groups that one leader can control effectively. A leader's span of control in civil disturbances is limited by his span of attention, the personal attitudes of unit members, and the interaction of human relationships.

A leader's span of attention—his ability to give equal attention to a number of tasks simultaneously—will be severely tested. Unit members often must learn new tasks for civil disturbance operations. Because these tasks are not part of the unit's usual mission, leaders must closely supervise these tasks to ensure they are properly performed.

How a soldier works within his unit or reacts to a civil disturbance is determined by his attitude. Emotions and preconceived views and attitudes can impair a soldier's ability to reason logically. Again, close supervision is the key to preventing improper behavior.

A leader with two subordinates has two relationships, one with each subordinate. As the span of control becomes greater, the interaction of relationships becomes more complex. Emotions and stress further compound the complexities of these relationships.

As the need for close supervision increases and relationships become more complex, the span of control a leader can effectively handle decreases. If a leader's span of control is overextended, bad decisions and improper behavior are likely to result. This, in turn, has an adverse effect on the unit's ability to perform its civil disturbance mission.

Other factors that must be understood concerning span of control include:

- Experience and training of the leader.
- Experience and training of subordinates.
- Amount of clearly understood communication between a leader and his subordinates.
- Degree of similarity among subordinates' jobs.
- Time available for the organization to translate the leader's decisions into actions.
- Distance by which the leader and his subordinates are separated.
- Leader's personality and the personality of each of his subordinates.
- Mental and physical conditions of the leader and his subordinates.
- Complexity of the organization.

## SPECIAL REACTION TEAM TRAINING

Past civil disturbance operations show that there is a need for personnel to be trained to deal with special threats, such as arson, sniping, and sabotage. Commanders, in planning their organization and training, must consider the need for special reaction teams to counteract special threats. SRT leaders and members must get intensive, specialized training in all areas of civil disturbance operations, with emphasis on counteracting and controlling special threats. This training also includes extensive training in combat in urban terrain, marksmanship, rappelling, physical fitness, first aid, and the use of specialized equipment.

The team must know their equipment's potential. They must know how to use their equipment properly. And they must develop confidence in their equipment. In most cases TOE or TDA military equipment and weapons are more than adequate to deal with special threats if the team's training is sufficient. The equipment available through supply channels or authorized by TOE or TDA must be used to the maximum extent possible to equip SRTs. However, local procurement may be needed to obtain special equipment that is deemed absolutely necessary for the safety of the SRT and for successfully resolving special threat situations. And SRT training must include the use of such equipment. An example of special equipment is soft body armor with ceramic-fiberglass inserts that is used at static positions.

The goal of civil disturbance planners is to have one SRT available at all times. They should consider training three or four 5-man SRTs so that one is available for standby. It may be necessary to alert or employ more than one team and to combine or augment teams to deal with threats that are beyond the capabilities of one team.

SRT training should be conducted in two phases. The first phase is the development stage. The team identifies team and individual weaknesses that require additional training. This stage requires frequent training sessions to achieve the desired response capability, to familiarize the members with individual and team responsibilities, to sharpen individual skills, to improve team cohesiveness, and to establish esprit de corps. The second phase is the maintenance stage. This stage requires fewer training sessions, but it is no less important. In this stage, members learn advanced skills, develop new techniques, and reinforce and hone the skills learned in the first phase.

SRTs must be thoroughly trained not only in basic soldiering skills but in specialized and unique skills that enhance team flexibility. This is vital because each special threat situation is different and must be dealt with individually.

The SRT is designed to neutralize or apprehend a barricaded offender with a minimum of danger to hostages, team members, control force members, and others. All team members must cross-train in the specialized duties of the other team members. SRTs must be tested in many varied scenarios so team and individual strengths and weaknesses can be identified and corrected. It is important that SRT members train in a manner that builds teamwork and develops confidence in themselves and their teammates. The capabilities of an SRT influence the commander's decision on how and when to employ the team. Therefore, commanders should be briefed on their teams' status after each training session.

Stress training is invaluable in preparing SRT members for situations in which they must use their weapons. Stress courses provide team members with training in firing their weapons while they are running.



**FM 19-15**

firing rapidly, firing from difficult firing positions, reloading rapidly, firing with accelerated heart and respiration rates, and in other perceived circumstances that might confront team members. How well the teams are trained in these areas can make the difference between life and death for team members, hostages, and offenders.

Training the marksman requires additional emphasis and consideration and must be oriented more to the individual. But it also must integrate the marksman's actions with those of the team. The

marksman must have self-discipline. He must be tested under many different and extreme conditions. He must always train with the same weapon and with the same grade of ammunition to ensure consistent round strikes. He must fully understand the capabilities of his weapon, how to identify targets, and how to engage targets rapidly. This training can only be accomplished by continuous practice under varying weather and visibility conditions. For a detailed discussion of individual and team training, see FM 21-75, FM 23-9, FM 90-10, TC 19-16, TC 23-14, and TC 90-6-1.

Appendix

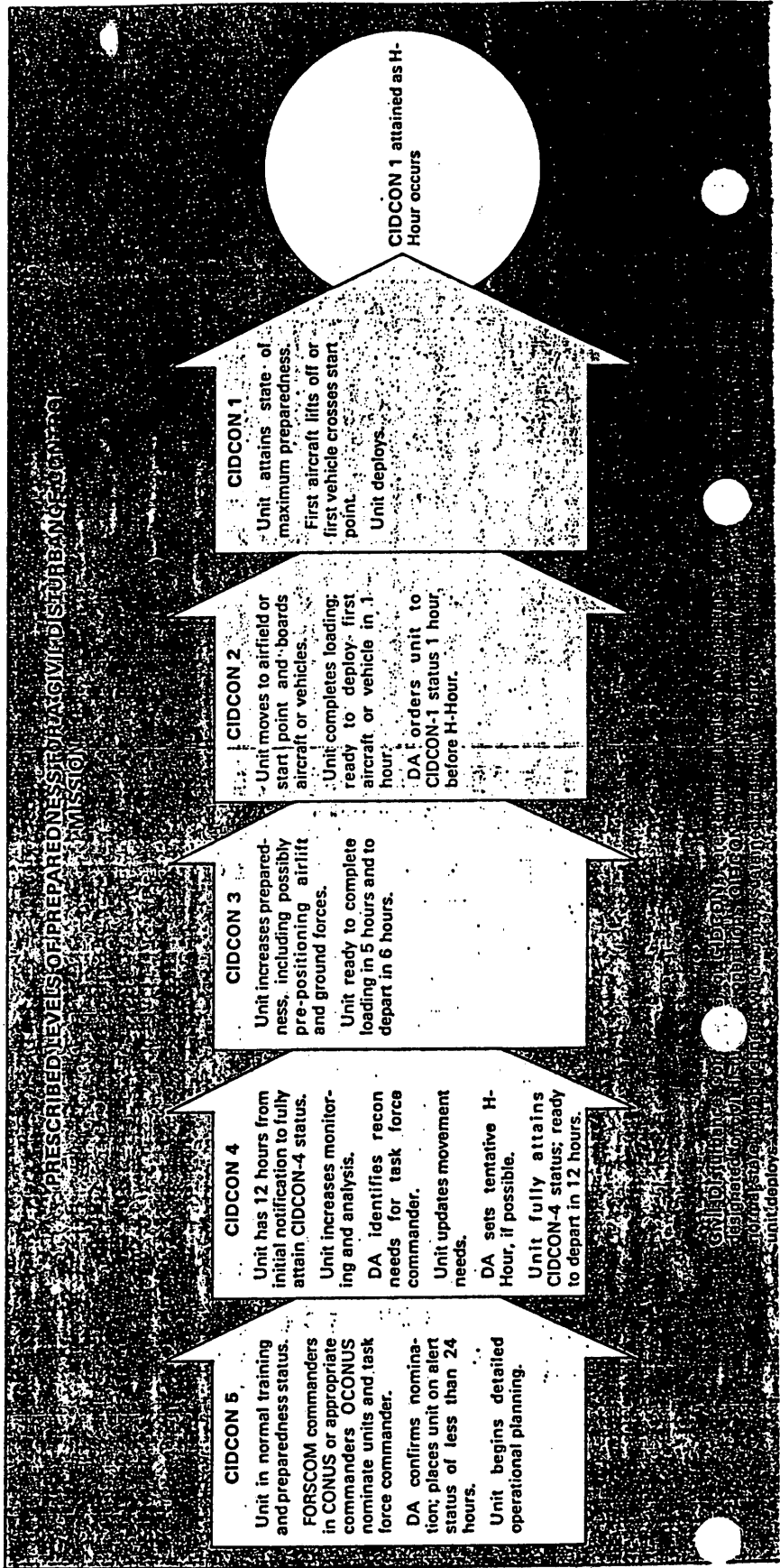

## Glossary

### ACRONYMS AND ABBREVIATIONS

AR - Army regulation  
CB - citizens band  
CID - Criminal Investigation Division  
CIDCON - civil disturbance condition  
CMT - crisis management team  
COMAAC - Commander, Alaskan Air Command  
CONUS - continental United States  
CP - command post  
CPXs - command post exercises  
CR - dibenz(1,4)oxazepine  
CS - chlorobenzalmalononitrile  
CSA - Army Chief of Staff  
A - common table of allowance  
- Department of the Army  
DOD - Department of Defense  
EOC - emergency operations center  
EOD - explosive ordnance disposal  
FM - field manual  
FORSCOM - Forces Command  
FTX - field training exercise  
GTA - graphic training aid  
HQ - headquarters  
HQDA - Headquarters, Department of the Army  
ID - identification  
IVDS - Installation Vulnerability Determining System  
JCS - Joint Chiefs of Staff  
MACOM - major Army command  
MDW - Military District of Washington  
MI - military intelligence  
MOS - military occupational specialty  
MP - military police  
NCO - noncommissioned officer  
OCONUS - outside continental United States  
OPCON - operational control  
OPLAN - operational plan  
OPs - observation posts  
PAO - public affairs officer  
REDCOM - Readiness Command  
ROTC - Reserve Officer Training Corps  
SJA - staff judge advocate  
SOPs - standing operating procedures  
SRT - special reaction team  
STANO - surveillance, target acquisition, and night observation  
TAO - team apprehension officer  
TC - training circular  
TDA - tables of distribution and allowance  
TM - technical manual  
TMF - threat management force  
TOE - table of organization and equipment  
TRADOC - Training and Doctrine Command  
TV - television  
UCMJ - Uniform Code of Military Justice  
US - United States  
USA - United States Army  
USACIDC - United States Army Criminal Investigation Command  
USAF - United States Air Force  
USCG - United States Coast Guard  
USMC - United States Marine Corps  
USN - United States Navy  
VIP - very important person

Glossary-0

## References

### RELATED PUBLICATIONS

Related publications are sources of additional information. They are not required in order to understand this publication.

#### DOD Regulations

4000.19-R Defense Regional Interservice Support (DRIS) Regulation

#### Army Regulations (ARs)

1-4 Employment of Department of the Army Resources in Support of the United States Secret Service

10-23 US Army Criminal Investigation Command

27-20 Claims

30-1 Army Food Service Program

30-7 Operational Rations

30-18 Army Troop Issue Subsistence Activity Operating Procedures

34-1 US Army Participation in Internal Military Rationalization, Standardization and Interoperability (RSI) Programs

37-111 Working Capital Funds - Army Stock Fund; Uniform Policies, Principles, and Procedures Governing Army Stock Fund Operations

40-3 Medical, Dental, and Veterinary Care

40-535 Worldwide Aeromedical Evacuation

500-5 Nuclear Surety

55-29 Military Convoy Operations in CONUS

55-36 DOD Use of Domestic Civil Transportation Under Emergency Conditions

55-113 Movement of Units Within Continental United States

55-162 Permits for Oversize, Overweight, or Other Special Military Movements on Public Highways in the United States

55-355 Military Traffic Management Regulation

References-1

**FM 19-15**

- 75-15**            **Responsibilities and Procedures for Explosive Ordnance Disposal**
- 95-1**            **General Provisions and Flight Regulations**
- 108-2**           **Army Training and Audiovisual Support**
- 190-28**           **Use of Force by Personnel Engaged in Law Enforcement and Security Duties**
- 190-30**           **Military Police Investigation**
- 190-38**           **Detention Cell Standards**
- 190-45**           **Records and Forms**
- 190-47**           **The US Army Correctional System**
- 190-52**           **Countering Terrorism and Other Major Disruptions on Military Installations**
- 195-1**           **Army Criminal Investigation Program**
- 195-2**           **Criminal Investigation Activities**
- 210-10**           **Administration**
- 220-15**           **Journals and Journal Files**
- 220-58**           **Organization and Training for Nuclear, Biological, and Chemical Defense**
- 230-81**           **Civilian Nonappropriated Funds and Related Activities**
- 310-25**           **Dictionary of United States Army Terms**
- 310-50**           **Catalog of Abbreviations and Brevity Codes**
- 350-7**            **Training and Evaluation of Forces for Civil Disturbances**
- 350-28**           **Army Exercises**
- 360-5**            **Public Information**
- 360-61**           **Community Relations**
- 360-81**           **Command Information Program**
- 380-5**            **Department of the Army Information Security Program**
- 380-13**           **Acquisition and Storage of Information Concerning Nonaffiliated Persons and Organizations**
- 381-10**           **US Army Intelligence Activities**
- 381-20**           **US Army Counterintelligence (CI) Activities**
- 385-63**           **Policies and Procedures for Firing Ammunition for Training, Target Practice and Combat**
- 500-50**           **Civil Disturbances**
- 500-51**           **Emergency Employment of Army and Other Resources - Support to Civilian Law Enforcement**
- 500-60**           **Disaster Relief**

**References-2**

500-70	Military Support of Civil Defense
525-10	Department of the Army Command and Control Reporting System
530-1	Operations Security (OPSEC)
530-2	Communications Security
530-3	(C) Electronic Security (U)
530-4	(C) Control of Compromising Emanations (U)
600-10	The Army Casualty System
600-20	Army Command Policy and Procedures
600-40	Apprehension, Restraint, and Release to Civil Authorities
638-40	Care and Disposition of Remains
672-5-1	Military Awards
700-49	Loan of DLA Stock Fund Materiel

**USACIDC Regulations (CIDRs)\***

195-5	Criminal Information Program
-------	------------------------------

**National Guard Regulations (NGRs)**

500-50	Civil Disturbance Control Operations
--------	--------------------------------------

**Department of the Army Pamphlets (DA PAMs)**

27-21	Military Administrative Law Handbook
108-1	Index of Army Motion Pictures and Related Audiovisual Aids
135-3	A Guide to Reserve Components of the Army
310-1	Consolidated Index of Army Publications and Blank Forms
360-524	Your Personal Affairs
360-525	Family Assistance Handbook for Mobilization

**Field Manuals (FMs)**

3-4	NBC Protection
3-5	NBC Decontamination
3-8	Chemical Reference Handbook
3-9	Military Chemistry and Chemical Compounds

\*CID Regulations are available, upon request, from Commander, USACIDC, ATTN: CIPA-AD, 5611 Columbia Pike, Falls Church, VA 22041

References-3

**FM 19-15**

100	NBC Operations
19-1	Military Police Support for the AirLand Battle
19-4	Military Police Team, Squad, Platoon Combat Operations
19-10	Military Police Operations
19-20	Law Enforcement Investigations
19-25	Military Police Traffic Operations
19-30	Physical Security
19-40	Enemy Prisoners of War, Civilian Internees and Detained Persons
19-60	Confinement and Correctional Treatment of Military Prisoners
20-60	Battlefield Illumination
21-10	Field Hygiene and Sanitation
21-11(TEST)	First Aid for Soldiers
21-60	Visual Signals
21-75	Combat Skills of the Soldier
21-150	Combatives
22-5	Drill and Ceremonies
22-6	Guard Duty
22-100	Military Leadership
23-8	M14 and M14A1 Rifles and Rifle Marksmanship
23-9	M16A1 Rifle and Rifle Marksmanship
23-30	Grenades and Pyrotechnic Signals
23-31	40mm Grenade Launchers M203 and M79
23-35	Pistols and Revolvers
24-1(HTF)	Combat Communications
24-16	Communications-Electronics: Operations, Orders, Records and Reports
24-18	Field Radio Techniques
25-1	Training
25-2	Unit Training Management
25-3	Training in Units
25-4	How to Conduct Training Exercises
27-10	The Law of Land Warfare
30-5	Combat Intelligence

**References-4**

33-1	Psychological Operations: US Army Doctrine
41-5	Joint Manual for Civil Affairs
41-10	Civil Affairs Operation
54-7	Theater Army Logistics
55-1	Army Transportation Services in a Theater of Operations
55-9	Unit Air Movement Plan
55-10	Army Movement Management Units and Procedures
55-12	Movement of Army Units in Air Force Aircraft
55-20	Army Rail Transport Operations and Units
55-30	Army Motor Transport Units and Operations
90-2(HTF)	Tactical Deception
90-10(HTF)	Military Operations on Urbanized Terrain (MOUT)
100-5(HTF)	Operations
100-10	Combat Service Support
100-20	Low Intensity Conflict
101-5	Staff Organization and Operations
101-5-1(HTF)	Operational Terms and Graphics
101-10-1	Staff Officers' Field Manual: Organizational, Technical, and Logistic Data
101-10-2	Staff Officers' Field Manual: Organizational, Technical, and Logistical Data Extracts of Nondivisional Tables of Organization and Equipment

#### Technical Manuals (TMs)

3-240	Field Behavior of Chemical, Biological, and Radiological Agents
3-250	Storage, Shipment, Handling, and Disposal of Chemical Agents and Hazardous Chemicals
3-1040-220-12&P	Operator's and Organizational Maintenance Manual: Disperser, Riot Control Agent, Helicopter or Vehicle Mounted, M5
3-1040-220-34&P	Direct Support and General Support Maintenance Manual: Disperser, Riot Control Agent, Helicopter or Vehicle Mounted, M5
3-1040-262-13&P	Operator's, Organizational, and Direct Support Maintenance Manual: Disperser, Riot Control Agent, Portable: M33A1
8-285	Treatment of Chemical Agent Casualties and Conventional Military Chemical Injuries



**FM 19-15**

- 9-1010-224-10 Operator's Manual for Launcher, Projectile,  
64-mm: Riot Control, M234
- 43-0001-26-1 Army Equipment Data Sheets: Chemical Defense Equipment
- 43-0001-26-2 Army Equipment Data Sheets: Chemical Weapons and Munitions

**Training Circulars (TCs)**

- 19-16 Countering Terrorism on US Army Installations
- 23-14 Sniper Training and Employment
- 90-6-1 Military Mountaineering

**Training Films (TFs)**

- TF 3-3203 Protective Mask Fitting and Drill
- TF 3-3372 Masking Procedures in Combat
- TF 3-4060 Components of the M17A1 Field Protective Mask
- TF 7-4584 The M16A1 Rifle
- TF 7-4586 The Pistol, Automatic, Cal .45, M1911A1
- TF 7-4589 Weapons Safety - Part V - The M203 Grenade Launcher
- TF 19-3950 Civil Disturbances - Principles of Control
- TF 19-3951 Civil Disturbances - Part II - Planning for Control
- TF 19-4605 The Riot Baton
- TF 19-4873 Crowd Control Formations
- TF 19-4882 Collective Behavior - Civil Disturbances - Part I - Evolution  
of Disorder and Crowd Psychological Factors
- TF 19-4884 Operational Doctrine - Civil Disturbances - Part I - Principles
- TF 19-4885 Operational Doctrine - Civil Disturbances - Part II - Tasks  
and Techniques
- TF 19-4886 Operational Doctrine - Civil Disturbances - Part III -  
Application of Force
- TF 19-4946 Unarmed Defense
- TF 19-6080 Management of Special Threat Situations
- MF 20-5829 Rumor
- TF 32-3589 Communications Security
- TF 33-3913 Loudspeakers in Psychological Operations
- TF 33-4177 Face to Face Persuasion
- TF 41-3443 Military Civic Action

**References-6**

TF 55-3667	Preparation and Planning
TF 55-3668	Loading Techniques
TF 55-3669	Lashing Techniques
TF 55-4178	Convoy Planning
TF 55-4276	Convoy Organization
TVT 19-54	The Military Police Club
TVT 19-55	The Come-Along

**Graphic Training Aids (GTAs)**

21-2-7 Special Orders for Civil Disturbance Operations

**Department of the Defense Forms (DD Forms)**

173/1	Joint Messageform
173/2(OCR)	Joint Messageform
173/3(OCR)	Joint Messageform
1387-2	Special Handling Data/Certification

**Department of the Army Forms (DA Forms)**

2028	Recommended Changes to Publications and Blank Forms
3316-R	Detainee Turnover Record

**Miscellaneous**

Department of the Army Civil Disturbance Plan (Garden Plot)  
Manual for Courts-Martial, United States 1984

References-7

## Index

Active-duty forces, 1-1  
Activists, 1-3, 2-1  
After-action reports, 4-1, 5-10, 5-11, 13-1  
  See also Situation reports; Spot reports  
Agitators, 1-2, 1-3, 2-4  
Alarms and alarm systems, 6-4  
Anonymity, 2-1, 2-2, 2-3  
  See also Psychological factors  
Apprehensions, 8-1, 12-1, 12-2, 12-3, 13-1  
  apprehension teams, 8-1, 12-2, 12-3  
  team apprehension officer, 12-2  
  See also Detention operations  
Area control, 6-9  
Area isolation, 6-0  
Armored vehicles, 6-13, 6-15, 8-1  
Armories, 6-4  
Arsenals, 6-4  
Arson, 2-4, 2-5, 6-10, 6-11, 13-5  
Assembly,  
  of company formations, 8-24, 8-27  
  of platoon formations, 8-8, 8-9, 8-10, 8-11,  
  8-12, 8-13, 8-15, 8-17, 8-20  
  of squad formations, 8-7  
  See also Crowd control formations  
Assembly areas, 5-5, 5-10  
Assistant Chief of Staff for Intelligence, 4-2  
Attacks,  
  on people, 2-4  
  on property, 2-4  
Attorney General, 3-0, 3-1  
Barricades, 2-4, 2-5, 6-9, 6-10, 9-3, 13-2  
  See also Barriers; Roadblocks  
Barriers, 6-0, 6-1, 6-3, 6-9, 11-4, 12-3  
  See also Barricades; Roadblocks  
Base man, 8-5, 8-6, 8-7, 8-8, 8-15, 8-19  
Baton come-alongs, 12-7, 12-8, 12-11  
  See also Come-along techniques;  
  Riot baton  
Bayonets, 8-0, 8-3, 10-0, 13-3  
  See also Rifles  
Block. See Crowd control options  
Blockades, 2-3, 2-4  
Body shield, 7-2  
Bomb dogs. See Explosives  
Bomb squad. See Explosives  
Bomb threat checklist, 6-17, 6-18  
Bombs. See Explosives  
Boundaries, Jurisdictional and legal, 5-2

Cadence, 8-4  
Causes of civil disturbances, 1-2  
Checkpoints, 6-4, 6-17  
CID agents, 12-1  
CIDCONs, 3-1, A-1  
Circular formation. See Crowd control  
  formations  
Citizens arrest, 5-2  
Civil disobedience, 1-1, 1-2  
  See also Tactics  
Civil disturbances, 1-1  
Civil laws and ordinances, 6-11, 6-12  
Close support,  
  for platoon line, 8-9  
  for platoon wedge, 8-17  
  See also Crowd control formations  
Collective behavior, 2-1  
Combination fire. See Ring airfoil system  
Come-along techniques, 12-5  
  carries, 12-5, 12-6, 12-7  
  one-person, 12-6, 12-7  
  two-person, 12-5, 12-6  
  holds, 12-7, 12-8, 12-9, 12-10, 12-11, 12-12,  
  12-13  
Command and control, 3-3, 5-7, 5-11, 7-3  
  See also Span of control  
Commander, Alaskan Air Command, 3-1  
Command group, 3-6  
Command post, 3-6, 5-7, 5-10, 5-11, 6-9, 6-14  
Command post exercises, 13-2  
Communications, 2-4, 5-6, 6-6, 13-4  
Company formations. See Crowd control  
  formations  
Computers, 4-1  
Conspiracy, 1-1  
Consulates, 1-3, 3-3  
Contain. See Crowd control options  
Control force, 2-3, 3-5, 3-6  
  operations,  
    establish area control, 6-9  
    exert control, 6-5  
    isolate area, 6-0  
    neutralize special threats, 6-13  
    protect likely targets, 6-4  
Cooperation, 6-5, 6-6  
Coordination, 5-1  
Coordinator. See Negotiation team  
Cordons, 6-9, 6-17

## Index-0

- CPXs. See Command post exercises  
 CR, 9-4, 9-6, 9-7  
 Crisis management team, 3-6  
 See also Threat management force  
 Crowd behavior, 2-1, 2-2, 2-3, 6-5  
 Crowd control formations, 8-0  
 company formations, 8-21  
 platoon formations,  
 four-squad, 8-7  
 three-squad, 8-19  
 squad formations, 8-5  
 types of, 8-1  
 Crowd control options, 6-5  
 block, 6-5, 6-9  
 contain, 6-5, 6-9  
 disperse, 6-5, 6-7, 6-8, 6-9  
 monitor, 6-5, 6-6, 6-7  
 Crowds, 2-1  
 CS, 9-4, 9-5, 9-10, 9-11, 11-4, 13-2, 13-3  
 Cultural differences, 1-2  
 Curfew. See Restrictions  
 Deadly force, 3-9, 6-10, 6-11, 6-14, 7-1,  
 7-4, 7-5  
 See also Force, degrees of; Minimum  
 force, principle of  
 Deployment, 3-1, 3-2  
 Detention operations, 12-13  
 facilities, 12-13, 12-14  
 processing, 12-14, 12-15, 12-16  
 Diamond formation. See Crowd  
 control formations  
 Director of Military Support, 3-0, 3-1,  
 3-2, 3-3, 3-4, 3-6  
 Discipline, 5-8  
 Disperse. See Crowd control options  
 Disperser,  
 M5, 9-10, 9-11, 9-12  
 M33A1, 9-7, 9-8, 9-9, 9-10  
 M36, 9-6, 9-7  
 operators, 9-6  
 Distance, 8-4  
 See also Interval  
 Drills, training, 13-3  
 Due process, 12-1  
 Echelon formation. See Crowd control  
 formations  
 Economic conflicts, 1-2  
 Embassies, 1-3  
 Emergency operations center, 3-6, 3-7,  
 5-10, 5-11  
 Emotional contagion, 2-2  
 See also Psychological factors  
 Emotional release, 2-2  
 See also Psychological factors  
 Employment,  
 of crowd control formations, 8-0  
 of machine guns, 11-6  
 of rifles and bayonets, 11-5  
 of ring airfoil system, 11-1  
 of riot batons, 10-0  
 of riot control agents, 9-1  
 of shotguns, 11-5  
 Environmentalists, 1-3, 2-1  
 EOC. See Emergency operations center  
 EOD. See Explosive ordnance disposal  
 Equipment exchanges, 5-7  
 Escape routes, 9-2  
 Ethnic groups, 1-2  
 Evacuation, 6-14, 6-17  
 Executive order, 3-0  
 Explosive ordnance disposal, 6-17  
 Explosives, 2-4, 2-5  
 bomb dogs, 6-18  
 bombs, 6-17, 6-18  
 bomb squad, 6-18  
 Faceshield, 7-2  
 Federal aid, 1-1, 1-2, 3-1  
 See also Mutual aid  
 Federal intervention, 1-1  
 Field training exercises, 13-2  
 Fingers come-along, 12-10  
 See also Come-along techniques  
 Firefighting task force, 6-11, 6-16  
 Fires, 6-13, 6-16, 6-17  
 See also Arson  
 First aid, 9-4, 13-3, 13-5  
 Flexcuffs, 7-3, 12-3, 12-4, 12-5  
 Force, Degrees of, 1-4  
 See also Deadly force; Minimum force,  
 principle of  
 Force options, 7-1  
 Foreign agents, 1-2  
 Foreign nations, 1-2  
 FORSCOM commander, 3-0, 3-1, 3-3, 3-4, 3-6  
 Front hammerlock, 12-9  
 See also Come-along techniques  
 FTXs. See Field training exercises  
 Funding for civil disturbance  
 operations, 5-2, 5-3

**FM 19-15**

Garden Plot, 3-5, 5-4, 5-9, 13-1  
General support,  
    for platoon line, 8-8  
    for platoon wedge, 8-16  
    See also Crowd control formations  
Gooseneck come-along, 12-8  
    See also Come-along techniques  
Grenades, 9-3, 9-4, 9-5, 13-2  
    CS burning-type, 9-5  
    CS bursting-type, 9-5  
    See also Riot control agent  
Grievances, Political, 1-2  
Groin lift, 12-10  
    See also Come-along techniques  
Guards, 3-3, 3-5, 6-4  
  
Hammerlock come-along, 12-12  
    See also Come-along techniques  
Hand irons, 7-3, 12-3, 12-4, 12-5  
Helicopters, 6-6, 6-8, 8-0, 9-5, 9-6, 9-10,  
    9-11, 9-12  
Hostage negotiators. See Negotiations  
    team  
Hostages, 3-7, 3-8, 3-9, 6-15, 6-16  
Host nation, 3-3  
  
ID. See Pass and ID systems  
Imitation, 2-2  
    See also Psychological factors  
Impersonality, 2-2  
    See also Psychological factors  
Information,  
    classified, 4-2  
    criminal, 4-1  
    restrictions, 4-1, 4-2  
    sources,  
        law enforcement, 4-0, 4-1  
        military, 4-0, 4-1  
        open, 4-0  
    threat, 4-2  
    See also Intelligence; Threat analysis  
Inner-city conflicts, 1-2  
Installation Vulnerability Determining  
    System, 4-3  
    See also Threat analysis  
Insurrection, 1-1  
Interval, 8-4  
    See also Distance  
Intelligence, 3-8, 3-9, 4-0, 4-1, 4-2, 6-15  
    See also Information; Military  
    intelligence  
Intrusion detection devices, 6-4

Joint Chiefs of Staff, 3-0, 3-1  
  
Lateral support,  
    for platoon line, 8-9  
    for platoon wedge, 8-16  
    See also Crowd control formations  
Laws. See Civil laws and  
    ordinances  
Leadership, 2-2, 13-4  
Letter of instruction, 3-1, 3-4  
Lighting, protective, 6-4  
Line formation. See Crowd control  
    formations  
Linguist. See Negotiation team  
Loans. See Federal aid  
Locations, civil disturbance, 1-3  
Logistical contact teams, 5-4  
Logistics, 5-3, 5-4, 5-5, 5-6  
Looting, 6-8, 6-10, 7-4, 8-0  
  
Machine guns, 11-6  
    See also Deadly force; Minimum force,  
    principle of  
Marksman, 3-9, 10-0, 11-6, 13-5, 13-6  
Martial rule, 6-11  
MDW commander, 3-3  
Media relations, 5-8, 5-9, 5-10  
Medical facilities, 12-14  
Military intelligence, 4-1, 4-2  
    See also Intelligence  
Military police, 3-7, 4-1, 12-1, 12-14  
Minimum force, principle of, 1-4, 5-9, 7-1, 7-4,  
    13-1  
    See also Deadly force  
Mission, 1-3, 1-4  
Monitor. See Crowd control options  
Moral attitudes, 2-2  
    See also Social factors  
Morale and welfare, 5-8  
MP. See Military police  
Mutual aid, 5-2, 6-16  
    See also Federal aid  
  
National Guard, 1-1, 1-2, 3-0, 3-4, 3-5, 6-11  
National Guard Bureau chief, 3-1  
Negotiation team, 3-7, 3-8, 3-9, 6-15  
News conferences and briefings.  
    See Media relations  
News media. See Media relations  
News releases. See Media relations  
Nuclear power plants, 1-3

**Index-2**

- Nuclear weapons,
  - facilities, 1-3
  - special threats involving, 3-9
- Observation posts, 5-10, 6-6, 6-17
- Observation teams, 6-6
- On-site commander, 3-4, 6-18, 9-1
- Operations. See Control force
- OPs. See Observation posts
- Options, crowd control. See Crowd control options
- Ordinances. See Civil laws and ordinances
- Organization, principles of, 3-5
- Panic, 2-2, 2-3
  - See also Psychological factors
- PAO. See Public affairs officer
- Participants, 2-1
- Pass and ID systems, 6-0
- Patrols, 1-4, 6-0, 6-3, 6-9, 6-10, 6-12, 6-13, 8-0, 11-4
- Perimeters, 6-1, 6-2, 6-14, 6-17
- Personal liaison officer, 3-1, 4-2
- Photographs, 6-7, 12-2, 13-2
  - See also Videotapes
- Physical security, 6-4
- Plan(s),
  - contingency, 5-10, 6-0
  - DA Civil Disturbance. See Garden Plot operational, 5-1
- Platoon formations. See Crowd control formations
- Police,
  - civil, 1-4, 3-5
  - DOD civilian, 3-3, 3-5
  - powers, 1-4
  - See also Guards; Military police
- President, 1-1, 3-0, 3-3, 3-4
- Press passes, 5-9
  - See also Media relations
- Probable cause, 12-1, 12-4
- Proclamations, 3-0, 6-7, 6-8
- Prohibited areas, 5-10
  - See also Restricted areas
- Protestors, 1-2
- Psychological factors, 2-1, 2-2
  - See also Social factors
- Public address systems, 5-4, 6-7, 6-9, 9-2, 13-2
- Public affairs officer, 5-9
- Public utilities, 6-0
- Quartering areas, 5-5
- Reconnaissance, 5-5, 5-7, 6-13, 9-1
- Record keeper. See Negotiation team
- REDCOM, 3-1
- Refugee camps, 1-3
- Refugees, 1-2, 1-3
- Relief measures, 1-4, 5-6, 5-7
- Resources,
  - federal, 1-1, 1-2
  - local, 5-1, 5-2
  - military, 5-2, 5-3
  - state, 5-2
- Restricted areas, 5-10
  - See also Prohibited areas
- Restrictions,
  - curfew, 6-11, 6-12
  - sales, 6-12
- Resupply, 5-4
- Rifles, 11-5
  - See also Bayonets; Deadly force
- Ring airfoil system, 11-1
- Riot baton,
  - as a restraint, 12-7
  - grip, 10-2
  - positions,
    - on guard, 10-3
    - parade rest, 10-2
    - port, 10-3
  - techniques,
    - defensive, 10-6
    - offensive, 10-4
- Riot control agent,
  - characteristics, 9-4
  - decontamination, 9-4, 9-7
  - release line, 9-2, 9-3
  - release rate, 9-6, 9-8, 9-10, 9-11
  - wind speed and direction, 9-8, 9-9, 9-10, 9-11
  - See also Disperser; Employment
- Roadblocks, 1-4, 5-10, 6-10, 6-17, 9-3, 13-2
  - See also Barricades; Barriers
- Rumor control, 5-9, 6-17
- Sabotage, 13-5
  - See also Special reaction team
- Searches,
  - for bombs, 6-18
  - of buildings, 6-18
  - of people, 12-3, 13-1
  - stand-up search, 12-4, 13-1
  - wall search, 12-4

FM 19-15

- Search teams, 6-18
  - See also Explosives
- Secretary of Defense, 3-0
- Secretary of the Army, 3-0, 3-4, 3-6
- Selective fire. See Ring airfoil system
- Self-defense, 7-4
- Shotguns, 7-3, 11-5, 13-2, 13-3
  - See also Deadly force
- Show of force, 1-4, 6-5, 6-7, 6-8, 8-0
- Signal security, 5-6
- Signals, arm and hand, 8-2, 9-6
- Situation reports, 3-2
  - See also After-action reports; Spot reports
- Snipers, 2-5, 6-13, 6-14, 7-4, 8-0, 10-0, 13-5
- Social factors, 2-2
  - See also Psychological factors
- Social issues, 1-2
- Social uniformity, 2-2
  - See also Social factors
- SOP, civil disturbance, 13-2
- Span of control, 13-4
  - See also Command and control
- Special orders, 7-1, 7-2
- Special reaction team,
  - employment, 3-9, 6-14, 6-15
  - training, 13-5
- Special threats, 3-9, 6-13, 6-14, 6-15, 6-16, 6-17, 6-18
- Spot reports, 4-1
  - See also After-action reports;
  - Situation reports
- Squad formations. See Crowd control formations
- SRT. See Special reaction team
- Staff judge advocate, 3-3, 4-1, 12-16
- Standards,
  - of appearance, 5-8
  - of conduct, 5-8, 6-13, 13-1
- STANO equipment, 5-4
- Status of forces agreement, 3-3
- Stress,
  - mental, 5-8, 13-2
  - physical, 5-8, 13-2
  - training, 13-2, 13-5
- Suggestion, 2-2
  - See also Social factors
- Surrogates, 1-2
- Surveillance, 6-13
- Tactics, Crowd, 2-3, 2-4, 2-5
- Task force,
  - action element, 3-6, 3-7, 3-8, 3-9
  - administration, 5-8
  - commander, 3-1, 3-2, 3-4, 3-5, 3-6, 4-2, 6-5, 6-6, 6-7, 6-9, 7-1, 7-3, 7-4, 7-5, 9-1, 11-1, 12-13
  - control element, 3-6
  - equipment, 5-3, 5-4
  - supplies, 5-3, 5-4
  - transportation, 5-5
- Task organization, 3-7, 13-4
- Team apprehension officer. See Apprehensions
- Terrorism, 1-1, 1-2, 2-4
- Threat analysis, 4-2, 5-10
  - See also Installation Vulnerability Determining System
- Threat management force, 3-6
  - See also Control force;
  - Negotiation team; Special reaction team
- Training, 13-1
- Uniform Code of Military Justice, 7-4
- Unit integrity, 3-7, 5-3
- Unity, 2-2
  - See also Psychological factors
- Unrest, community, 1-2
- Urban areas, 1-3
- US Army Criminal Investigation Command, 3-7, 4-1
  - See also CID agents
- US Code, 7-4
- US Constitution, 1-1
- US marshals, 3-5, 12-2
- Vests, flak or protective, 7-2
- Videotapes, 6-7, 12-2, 13-2
  - See also Photographs
- Violence, domestic, 1-1
- VIPs, 3-9, 6-4
- Volley fire. See Ring airfoil system
- Vulnerabilities, 4-0, 4-2, 4-3, 4-4
- Water, 9-3, 9-13
- Wedge formation. See Crowd control formations
- Welfare. See Morale and welfare

Index-4

**FM 19-15**  
**25 NOVEMBER 1985**

By Order of the Secretary of the Army:

**JOHN A. WICKHAM, JR.**  
*General, United States Army*  
*Chief of Staff*

Official:

**MILDRED E. HEDBERG**  
*Brigadier General, United States Army*  
*The Adjutant General*

**DISTRIBUTION:**

*Active Army, USAR, and ARNG:* To be distributed in accordance with DA Form 12-11A, Requirements for Civil Disturbance (Qty rqr block no. 138).

Additional copies may be requisitioned from the US Army Adjutant General Publications Center, 2800 Eastern Boulevard, Baltimore, MD 21220-2896.

✦ U.S. GOVERNMENT PRINTING OFFICE: 1986 164-373/50917