

~~CONFIDENTIAL~~

TECHNICAL REPORT
distributed by

DTIC



#817

DEFENSE TECHNICAL INFORMATION CENTER
8725 JOHN J. KINGMAN ROAD
SUITE 0944
FT. BELVOIR, VA 22060-6218

~~CONFIDENTIAL~~

~~CONFIDENTIAL~~

Policy on the Redistribution of DTIC-Supplied Information

As a condition for obtaining DTIC services, all information received from DTIC that is not clearly marked for public release will be used only to bid or perform work under a U.S. Government contract or grant or for purposes specifically authorized by the U.S. Government agency that is sponsoring access. Further, the information will not be published for profit or in any manner offered for sale.

Non-compliance may result in termination of access and a requirement to return all information obtained from DTIC.

NOTICE

We are pleased to supply this document in response to your request.

The acquisition of technical reports, notes, memorandums, etc., is an active, ongoing program at the **Defense Technical Information Center (DTIC)** that depends, in part, on the efforts and interest of users and contributors.

Therefore, if you know of the existence of any significant reports, etc., that are not in the **DTIC** collection, we would appreciate receiving copies or information related to their sources and availability.

The appropriate regulations are Department of Defense Directive 3200.12, DoD Scientific and Technical Information Program; Department of Defense Directive 5230.24, Distribution Statements on Technical Documents; National Information Standards Organization (NISO) Standard Z39.18-1995, Scientific and Technical Reports - Elements, Organization and Design; Department of Defense 5200.1-R, Information Security Program Regulation.

Our **Programs Management Branch, DTIC-OCP**, will assist in resolving any questions you may have concerning documents to be submitted. Telephone numbers for that office are **(703) 767-8040**, or **DSN 427-8040**. The **Reference and Retrieval Division, DTIC-BR**, will assist in document identification, ordering and related questions. Telephone numbers for that office are **(703) 767-8274** or **DSN 427-8274**.

**DO NOT RETURN THIS DOCUMENT TO DTIC
EACH ACTIVITY IS RESPONSIBLE FOR DESTRUCTION OF THIS
DOCUMENT ACCORDING TO APPLICABLE REGULATIONS.**

~~CONFIDENTIAL~~

AD- 515549

SECURITY REMARKING REQUIREMENTS

DOD 5200.1-R, DEC 73

REVIEW ON 30 APR 91

DISCLAIMER NOTICE

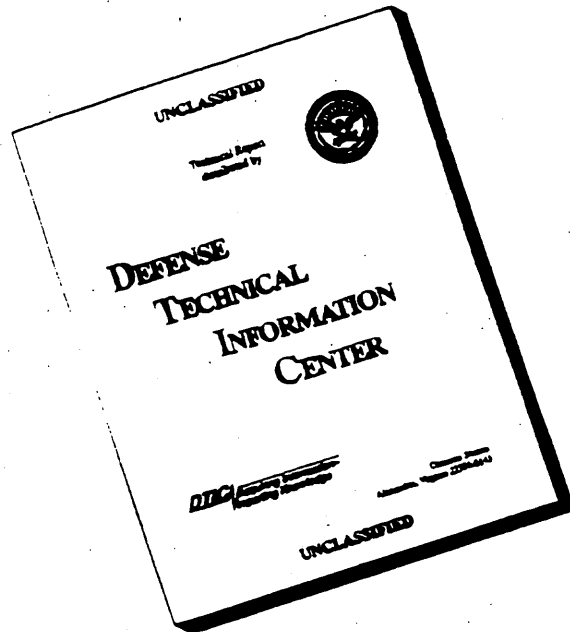

THIS DOCUMENT IS BEST QUALITY AVAILABLE. THE COPY FURNISHED TO DTIC CONTAINED A SIGNIFICANT NUMBER OF PAGES WHICH DO NOT REPRODUCE LEGIBLY.

SECURITY

MARKING

**The classified or limited status of this report applies to each page, unless otherwise marked.
Separate page printouts MUST be marked accordingly.**

THIS DOCUMENT CONTAINS INFORMATION AFFECTING THE NATIONAL DEFENSE OF THE UNITED STATES WITHIN THE MEANING OF THE ESPIONAGE LAWS, TITLE 18, U.S.C., SECTIONS 793 AND 794. THE TRANSMISSION OR THE REVELATION OF ITS CONTENTS IN ANY MANNER TO AN UNAUTHORIZED PERSON IS PROHIBITED BY LAW.

NOTICE: When government or other drawings, specifications or other data are used for any purpose other than in connection with a definitely related government procurement operation, the U.S. Government thereby incurs no responsibility, nor any obligation whatsoever; and the fact that the Government may have formulated, furnished, or in any way supplied the said drawings, specifications, or other data is not to be regarded by implication or otherwise as in any manner licensing the holder or any other person or corporation, or conveying any rights or permission to manufacture, use or sell any patented invention that may in any way be related thereto.

~~Confidential~~

ADVANCED
RESEARCH
PROJECTS
AGENCY

AD515649

**OVERSEAS
DEFENSE
RESEARCH**

D D C
JUN 15 1971

 **Battelle**
Columbus Laboratories

**RACIC
report**

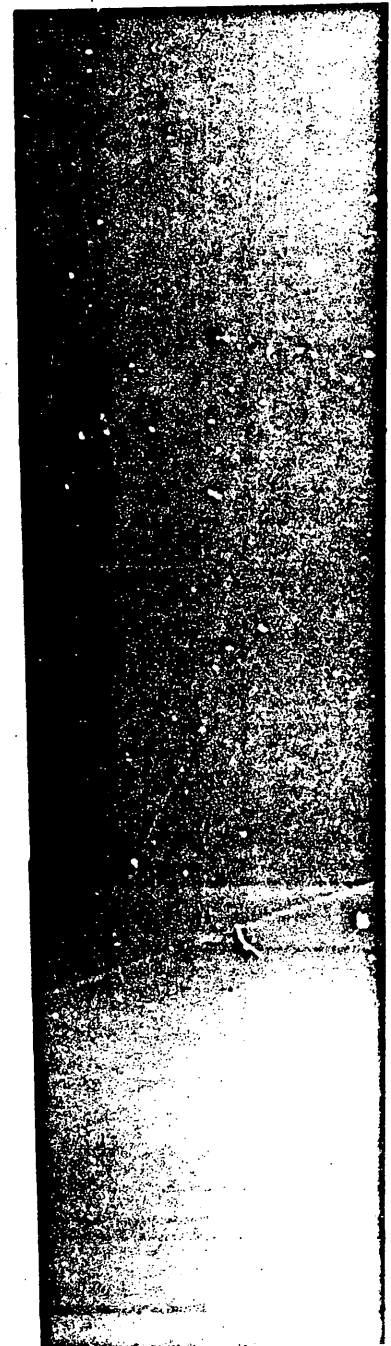

~~Confidential~~

AD515649

~~CONFIDENTIAL~~

BCL Document Control No. CUF-D71-002329

ADVANCED
RESEARCH
PROJECTS
AGENCY

OVERSEAS
DEFENSE
RESEARCH

~~GROUP 3~~
Downgraded at 5-year intervals; not
automatically declassified

~~WARNING~~
THIS MATERIAL CONTAINS INFORMATION AFFECTING
THE NATIONAL DEFENSE OF THE UNITED STATES
WITHIN THE MEANING OF THE ESPIONAGE LAWS,
TITLE 18, U.S.C. SECTION 793 AND 794, AS AMENDED.
ITS TRANSMISSION OR THE REVELATION OF ITS CON-
TENTS, IN ANY MANNER TO AN UNAUTHORIZED
PERSON, IS PROHIBITED BY LAW.

JUN 11

DOWNGRADED TO UNCLASSIFIED
PER AUTHORITY OF THE DIRECTOR
DEFENSE ADVANCED RESEARCH
PROJECTS AGENCY, S&IO

A BRIEF SURVEY OF NONLETHAL WEAPONS (U)

Battelle
Columbus Laboratories

Report No. RACIC-TR-66

Sponsored by

Advanced Research Projects Agency
ARPA Order No. 1509

**RACIC
report**

April 30, 1971

by

E. E. Westbrook and L. W. Williams

RACIC
BATTELLE
Columbus Laboratories
505 King Avenue
Columbus, Ohio 43201

~~CONFIDENTIAL~~

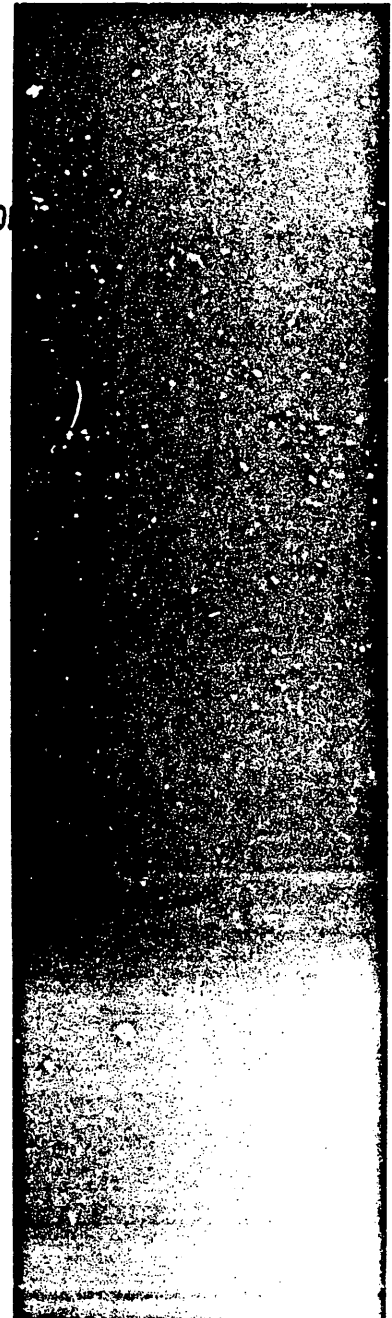

UNCLASSIFIED

PREFACE

(i) This study was supported by the Advanced Research Projects Agency (ARPA) of the Department of Defense and was monitored by the Foreign Technology Division, Wright-Patterson Air Force Base, Ohio, under Contract No. F33657-71-C-0529.

* * *

(ii) The views and conclusions contained in this document are those of the authors and should not be interpreted as necessarily representing the official position, either expressed or implied, of the Advanced Research Projects Agency or the Department of Defense.

i and ii

UNCLASSIFIED

UNCLASSIFIED

Table of Contents

.....	1
STATEMENT OF THE PROBLEM.	2
CHEMICAL INCAPACITATING SYSTEMS	6
Criteria for Selection of Nonlethal Chemical Agents.	7
The Search for Suitable Compounds.	9
Irritants	9
Analgesics.	10
Anticholinergics.	10
Emetics	10
Conclusions	11
Delivery Systems for Chemical Agents	11
Grenades.	11
Dispersers.	12
Liquid Stream Projectors.	12
Chemical Munitions	13
Military and Police Munitions	13
Darts.	14
Smoke.	17
USE OF THE ELECTROMAGNETIC SPECTRUM FOR INCAPACITATION.	18
Photic Driving and Incapacitation.	18
Visual Impairment.	20
The Visible Spectrum.	20
Infrared.	21
Ultraviolet	21
Laser Radiation	22
Microwaves.	22
SOUND AS AN INCAPACITANT.	23
BARRIERS AND MECHANICAL DETERRENDS.	24
Conventional Barriers.	26
Other Passive Impediments to Movement.	27
Mechanical Deterrents.	29
MISCELLANEOUS	31
REFERENCES.	32

UNCLASSIFIED

TABLE OF CONTENTS (continued)

APPENDIX TABLE AND FIGURES

	<u>Page</u>
Table 1. Characteristics of Chemical Incapacitating Agents.	A-1
Figure 1. Military M7As Grenade.	A-11
Figure 2. Northrop Rubber ball Grenade	A-12
Figure 3. Federal Triple Chaser Grenade.	A-13
Figure 4. Military XM47E1 Grenade.	A-14
Figure 5. Military M25A2 CSI Grenade	A-15
Figure 6. Federal Blast Dispersion Grenade	A-16
Figure 7. Military Dispenser, Riot Control Agent, Portable, M3	A-17
Figure 8. Military Dispenser, Riot Control Agent, Helicopter- or Vehicle-Mounted, M4	A-18
Figure 9. Military Dispenser, Riot Control Agent, Helicopter- or Vehicle-Mounted, M5	A-20
Figure 10. Military Dispenser, Riot Control Agent, Portable, M106 . . .	A-22
Figure 11. PTG-100 and -200 Dispenser	A-24
Figure 12. GOEC MK-XII Pepper Fog	A-25
Figure 13. AAI SGA-100 Barricade Projectile	A-26
Figure 14. Federal Mark 70 Projectile (CS); Federal Blast Dispersion Projectile (CU)	A-27
Figure 15. Federal Short Range Shell.	A-28
Figure 16. Flying Hypodermic Syringe.	A-29
Figure 17. Mercox-Dart and Injector Projectiles	A-30
Figure 18. Recovery Time From Flash Blindness as a Function of Brightness of Flash	A-31
Figure 19. Obstacle Material: Barbed Wire, German Barbed Tape, Barbed-wire Concertina, and German Barbed-Tape Concertina. . .	A-32

UNCLASSIFIED

UNCLASSIFIED

TABLE OF CONTENTS (Continued)

APPENDIX. TABLE AND FIGURES (Continued)

	<u>Page</u>
Figure 20. Obstacle Materiel: REAPO Tape and GPBTO Tape.	A-33
Figure 21. Obstacle Materiel: Caltrop.	A-33

* * *

ANNOTATED BIBLIOGRAPHY ON NONLETHAL WEAPONS

v and vi

UNCLASSIFIED

UNCLASSIFIED

A BRIEF SURVEY OF NONLETHAL WEAPONS (B)

by

E. E. Westbrook and L. W. Williams

Summary

This report resulted from a request by the HAI for general information of ARPA's interest in defense research efforts for a brief period and gathering of all available information in the area of nonlethal weapons, in particular military techniques and devices and their applications.

(I) It should be emphasized that the study was conducted within rather narrow time and cost constraints and, therefore, it is intended to provide only a general overview and not a comprehensive treatment of the subject area.

(II) It should also be noted that although the request specified nonlethal weapons and techniques employed by the military, nonlethal devices and techniques currently in use or under development by civilian agencies have been included. The technological dividing line between hardware and techniques developed for use by the military and those developed for civilian applications is so diffuse that it is virtually impossible to separate the two and still have a report that is fairly representative of the current art.

(III) Finally, recognizing the sensitivity of many of the topics covered in this report, it was not intended that inclusion of any technique or device should be considered an endorsement either by ARPA or PACIC, and in instances where proprietary equipment is discussed and/or illustrated, it has been selected merely as an example of what is currently available or in use and does not in any way constitute a recommendation for the particular item.

INTRODUCTION

(I) This brief survey of nonlethal weapons and the supplemental annotated bibliography (see Appendix following reference list at end of report) have been prepared by members of the PACIC staff. It has been organized into four sections:

- (1) Statement of the Problem. Summarizes the general criteria for the use of nonlethal weapons and the desirable and undesirable characteristics of such weapons.
- (2) Chemical Incapacitating Systems. Describes various types of chemical agents, their effects on the body, and various means of administration.

UNCLASSIFIED

UNCLASSIFIED

(3) Electromagnetic Spectrum for Incapacitation.

(4) Barriers and Mechanical Deterrents.

STATEMENT OF THE PROBLEM

(1) At the outset it should be stated that no weapon system, even one which has been very carefully contrived, can be made entirely nonlethal, partly because of the mechanical problems encountered in such systems and partly because of the difference in response of individuals to a given level of stress.

(2) The development and implementation of nonlethal weapons systems are usually premised upon at least three assumptions. First, it is assumed that the persons against whom a nonlethal weapon is to be directed are not already under the control of whoever is to use the weapon. The nonlethal weapon, like any other weapon, is intended to extend the operator's control over the behavior of individuals who otherwise would be relatively autonomous. More specifically, nonlethal weapons are generally intended to prevent an individual from engaging in undesirable acts. This brings the discussion to the second assumption underlying nonlethal weaponry. It is normally assumed that a nonlethal weapon will be employed in a tactical conflict between individuals or groups. This assumption imposes certain criteria upon the design and choice of weapons, such as the requirement for immediate effect. These criteria will be discussed further shortly. The third assumption behind nonlethal weaponry is that it is desirable not to have greater effect upon the target individual than is necessary to control his behavior in the immediate tactical situation. Thus, the use of deadly force, of force excessive to that required to accomplish the immediate task, or of force or control techniques which will have long-lasting or permanently damaging effects is deemed undesirable. Apart from the moral arguments in favor of the use of nonlethal weapons, public officials find it prudent to respond to public opinion and try to minimize the political and legal repercussions which often follow the use of deadly force. The desirability for nonlethal force is further accentuated when there is a danger of innocent bystanders being

UNCLASSIFIED

UNCLASSIFIED

5

...by the actions of law enforcement or internal security forces. Police, military, and other law enforcement agencies are especially sensitive to possible injury, temporary punishment and wrongful death and seek to maximize capture rates rather than kill criminals.

...while the precise physiological and psychological effects of nonlethal weapons will vary from item to item, it is possible to establish general criteria which can be used to assess the acceptability of particular weapons.

Nonlethality

(U) The desirability for nonlethality has already been noted. It is well, however, to stress that nonlethality is best stated in terms of what may be statistically expected when a particular weapon is used against some normal distribution of individuals. Nonlethal weapons, like lethal weapons, depend for their effects upon a number of factors all of which cannot be compensated for in the design of the weapon itself. Among these factors are operator skill, the conditions under which the weapon is employed, the response of the target individuals to the weapon, and the physical and psychological health of those against whom the weapon is employed. When designing a nonlethal weapon, it is necessary to optimize trade-offs between its nonlethality and its incapacitating potential. The ideal balance of absolute incapacitation reliability and absolute nonlethality (i.e., 100 percent of survival of persons affected) is probably beyond the present state of the art.

Incapacitation Potential

(U) Given restrictions on the employment of lethal force, the concern has been to discover ways to exercise nonlethal force which is readily applicable to tactical conflict situations, which can be used against an individual who is beyond arm's length from the operator (ruling out overpowering the individual physically), and which will prevent the target individual from engaging in undesired behavior. This latter ability to "incapacitate" might be defined as the ability of the weapon in question to prevent an individual from engaging in goal-directed behavior which the operator of the weapon finds undesirable. Ordinarily this class of undesirable behavior includes a range of violent and criminal acts. The mode of incapacitation is variable, depending on whether an attack is made upon a person's ability to concentrate attention on his

UNCLASSIFIED

UNCLASSIFIED

... his ability to perceive events around him, his ability to direct his own sight and mobility functions, or his ability to traverse terrain in order to reach a target which he might have selected for attack. In addition, there are degrees of incapacitation, ranging from minor discomforts and distractions to inert incapacitation. The most desirable degrees of incapacitation usually fall between these extremes, the first of which is probably not enough to prevent a strongly motivated act and the other posing problems of convenience for the person using the lethal weapon. Further, desirable characteristics of this incapacitation include immediacy of effects; temporariness of effects; reversibility of effects; minimal side effects; and predictability, obviousness, and reliability of principal effect.

(U) Immediacy of Effects. Given the intended use of nonlethal weapons in tactical conflict situations, it is usually desirable that their effects occur within a period of seconds or possibly a few minutes after they have been used. Otherwise, these weapons would be of little or no value in preventing specific violent or criminal acts.

(U) Temporariness of Effects. It is generally desired that the effects of nonlethal weapons have a duration great enough to allow their operators to gain control over the target individuals or over the terrain being contested or both. When used against groups of individuals as in riot control, it is desirable that nonlethal weapons disrupt group processes and thereby diminish the effectiveness of that group's goal-directed behavior long enough to either thwart the aims of the group, capture the members of the group, or achieve another similar purpose. However, incapacitation which endures for longer than is necessary to achieve immediate tactical aims is at best an inconvenience and might become an outright burden on those using the nonlethal weapon. This is more the case as incapacitation approaches 100 percent.

(U) Reversibility of Effects. Once a nonlethal weapon has been used and the operator's goal achieved (e.g., clearing a street, capturing a criminal), it might be desirable to "turn off" the effects if they are such as to endure for some time. Being able to reverse the effects of these types of nonlethal weapons might make it easier to transport or interrogate a prisoner, minimize the number of bystanders being affected, etc. The methods used to reverse

UNCLASSIFIED

UNCLASSIFIED

It will vary depending on the weapon used and how it is employed. The applications of CW require that individuals wash it off their faces and their clothing. The applications necessitate the decontamination of buildings. Ideally, it is desired that reversibility be a simple process and fairly immediate in its effect. Any nonlethal weapon whose effects can only be reversed after a long period of recuperation, or through extensive medical care, or which are not entirely reversible is not generally acceptable.

(c) The temporariness and reversibility of effects are desirable also for the reason that these features help to minimize the likelihood of accidents following employment of a nonlethal weapon. For example, a person who has been attacked with a disorienting chemical agent could injure himself, perhaps fatally. If this person happens to be a bystander who is not placed under care, and especially if the effects of the agent last for some time, then the probability of such accidents is multiplied. This is clearly an unacceptable outcome of the employment of nonlethal weapons.

(U) Minimal Side Effects. The less frequently that side effects occur with a given nonlethal weapon, the more it is possible to standardize procedures subsequent to its employment. In addition, the less extensive and enduring these side effects, the less probable that complications or death might result from using the weapon. The less likely are such side effects as disfigurement or lasting disablement, the more readily a given nonlethal weapon will be accepted, so long as it is an effective incapacitant.

(U) Predictability, Obviousness, and Reliability of Principal Effect. What was said above about minimal side effects is related to the need to be able to predict and rely upon the principal effect of a given nonlethal weapon. The user of a nonlethal weapon should know ahead of time how an affected person will behave and this behavior should be patently obvious to the user. This will help the user to fully exploit the advantages of the weapon and at the same time it will assist him to recognize when unusual and possibly dangerous secondary effects occur, signaling the possible need for professional medical aid. At the same time, if the operator does not have confidence in the effectiveness of the nonlethal weapon, resulting perhaps from its failure to adequately incapacitate persons or its inconsistency of function, then the nonlethal weapon will probably not be employed even when it is available.

UNCLASSIFIED

UNCLASSIFIED

CHEMICAL INCAPACITATING SYSTEMS

Chemical incapacitating agents appear to offer a great deal of promise for a non-lethal weapons system. It is quite possible that some form of incapacitating system could become the most common of all weapons. In any event, they are likely to remain one of the more versatile of the non-lethal weapons*.

In spite of the advances made in this area in recent years, the general public remains uninformed or ill-informed and places chemical weapons quite low on any "suitability" list of weapons (high explosives are most acceptable)^{(1,2)**}. Perhaps a measure of this public abhorrence has grown out of experience with German mustard gas in World War I; while this was, of course, much more severe than many of the agents now in use, much of the furor over its use was undoubtedly psychological in nature. Actual fatalities from mustard gas amounted to less than 2 percent of those who were exposed to it sufficiently to be listed as casualties. This was a lower percentage of deaths than that from all other causes. Polls have shown that where the public is made aware of the facts surrounding chemical agents, they are more agreeable to their use⁽¹⁾. As more confrontations on campuses and civil violence of the types experienced recently take place, chemical agents may well become a more readily accepted item in police and military arsenals.

(C) While many of the advantages and disadvantages of chemical weapons systems are specific to particular agents and systems, some general observations can be made:

* (1) In 1966, an extensive report on chemical incapacitating agents ["State-of-the-Art Study on Impairment of Voluntary Muscular Activity (U)", RACIC Report No. BAT-171-17 (AD 370 233)] was prepared for ARPA by Dr. G. A. Lutz, Associate Chief of the Organic Chemistry Division at Battelle-Columbus; Dr. M. S. Sadove, Head of the Division of Anesthesiology, University of Illinois College of Medicine, Chicago, Illinois; and Dr. J. L. Schmidt, Clinical Associate Professor at the University Medical School and Principal Physician at Cermak Memorial Hospital, Chicago, Illinois. This report provides a comprehensive study of three main classes of agents: (1) those that are skeletal-muscle depressants, (2) those that affect the central nervous system, and (3) those that affect the cardiovascular system. Miscellaneous additional chemical agents as well as biological agents are also discussed. The data presented in this report on the various agents which are in use today are still valid as are many of the conclusions and suggestions for future research, since the technology does not change rapidly. One of the reasons for this slow change is, of course, the necessity for long-term, highly complex screening and testing to determine safety before the agents are presented. The report may be obtained from the Defense Documentation

** See also pages 22 through 50.

UNCLASSIFIED

UNCLASSIFIED

Advantages:

- (1) A wide variety of agents are available for use in the appropriate tactical situation.
- (2) Chemical agents may be useful in situations where both combatants and non-combatants are present.
- (3) Many compounds, particularly those acting upon the central nervous system, are effective by several routes of administration including intravenously, subcutaneous, and respiratory. Thus, they can be disseminated as aerosols for administration via the respiratory tract or by means of a non-lethal dart for subcutaneous administration.
- (4) The effects of many agents may be reversed by the use of suitable antidotes.

Disadvantages:

- (1) Agents which are dispersed in the most common ways (fog, aerosol, powder smoke) are highly susceptible to unpredictable atmospheric phenomena.
- (2) Agents in these forms may be blown back to hamper friendly personnel.
- (3) Most agents now in use have a rather narrow margin of safety (that between the effective and dangerous dosage). Moreover, in the case of many agents now available, the condition produced within this margin of safety is not sufficient to deter all highly motivated individuals.
- (4) Action is not sufficiently rapid to successfully counter an opponent armed with a conventional lethal weapon.
- (5) In the case of some of the milder agents (such as CN) victims frequently develop a tolerance to its action which renders it much less useful on a continuing basis.
- (6) The effects of a chemical (often the difference between lethality and nonlethality) are often a function of dosage, and dosage is difficult to regulate accurately under riot or battle conditions.
- (7) As mentioned earlier, the use of chemical agents of any type is distasteful to many people. Recent executive decisions have indicated a national policy unfavorable toward the offensive use of some types of chemicals.

Criteria for Selection of Nonlethal Chemical Agents

(1) The following criteria, from the Police Chemical Agents Manual⁽²⁾, are representative of the constraints placed upon civilian law enforcement:

UNCLASSIFIED

UNCLASSIFIED

minimum criteria for the selection of a chemical agent. The criteria listed below are the minimum criteria for the selection of a chemical agent for police use.

- "1. *Safety* - The primary criteria in agent selection is safety. Although 'chemical agent safety' involves several factors which are discussed in greater detail later in this publication, the minimum criteria is that the agent be non-lethal in any concentration likely to be developed in police application.
- "2. *Effectiveness* - The agent should:
 - a. Produce rapid physiological action.
 - b. Produce desired effects in low concentrations, somewhere in the range of a few milligrams per cubic meter of air.
 - c. Permit rapid recovery without lasting effects when subject is removed from the contaminated area.
- "3. *Deliverability* - The agent must be deliverable in sufficient concentrations by delivery systems adaptable to police requirements arising from the nature of field operations.
- "4. *Non-Persistence* - The agent must be temporary in duration of its effectiveness and should not present major decontamination problems. Persistence is a product of several factors including the nature of the agent, method of dissemination, weather, and the area contaminated.
- "5. *Stability* - The agent should be stable over wide ranges of temperature variation and storage conditions. It must be compatible with selected delivery systems.
- "6. *Acceptability* - The use of the agent must be tolerated by the general public. A negative response on the part of most of the citizens in a community to a specific agent may well offset any advantages that the agent might otherwise offer.
- "7. *Cost Effectiveness* - The total cost of the delivered agent must be proportionate to its effectiveness and competitive with acceptable alternatives. In addition, the cost of chemical munitions must be reasonable in relation to police resources."

UNCLASSIFIED

~~CONFIDENTIAL~~

Various types of chemical agents which appear to be suitable for use in lethal weapons systems and summaries of their characteristics are presented in Table I. (See Appendix, pages A-1 through A-10, for Table I.)

The Search for Suitable Compounds

(c) Taking note that a relatively small number of compounds meet the dual requirements of effectiveness and safety, several of those from Table I which appear to show special promise are discussed below.

Irritants

(U) A sensory irritant produces a reversible incapacitation as a result of sensory stimulation following contact with skin, eyes, or mucous membranes. One of the obvious advantages of such an irritant is the speed with which it acts, since it acts directly upon the nerve endings.

(U) ~~(S)~~ Since World War I, the most widely used irritant has been CN (tear gas). Recently, however, it has been replaced in many instances with CS whose action is more rapid and whose effects are more severe. CS has had wide usage in Vietnam, although reports from there have most often dealt with the use of CS along with lethal weapons. The use of CS as an agent for softening the enemy so that he could more easily be engaged with conventional weapons is not the most effective indicator of its utility in a situation where lethality is not desired.

(U) ~~(S)~~ Other examples of respiratory irritants with approximately the same effectiveness as CS are: EA3547, Compounds 126312, EA3365, EA2542, EA1778, EA4922, and capsaicin. None of these compounds has any lasting effect once the victim is no longer breathing contaminated air.

(U) The possibility exists, however, that one of the aromatic arsenicals, such as DA, might be used to produce both short-term irritation and longer term systemic effects. These systemic effects which begin about 30 minutes after exposure and last for several hours involve headache, nausea, intestinal cramps, chills, and general depression.

(U) A number of agents, notably CX, produce intense pain almost immediately upon contacting the skin, but since response to pain is somewhat dependent upon motivation and other factors, CX might most effectively be used in combination with some of the other irritants.

~~CONFIDENTIAL~~

~~UNCLASSIFIED~~

~~CONFIDENTIAL~~

10

(U) Experiments conducted recently at Edgewood Arsenal indicated that the cutaneous reaction to CS was affected to some extent by skin pigment. Darker-skinned subjects appeared to be affected less violently than light-skinned subjects.

Analgesics

(U) ~~(S)~~ Possibly the best known of the analgesics is morphine. While highly effective, it does not have the desired safety margin for use as a chemical weapon. Research is being carried on to produce compounds which have a more favorable margin of safety without losing the desirable analgesia and paralysis effects⁽⁵⁾.

(U) ~~(S)~~ A typical example of a morphinelike analgesic is CS4640 (etonitazine), which can cause physical knockdowns of test animals at the microgram (of agent) per kilogram (of body weight) range. CS4640 as an analgesic is approximately 1000 times as potent as morphine. As the compound now exists, the safety margin is rather small in primates⁽⁵⁾.

Anticholinergics (Causing Prostration)

(U) ~~(S)~~ Probably the most promising of the anticholinergics (agents which block the passage of impulses through the parasympathetic nerves) are the glycolates. These compounds produce such symptoms as rapid heart rate, incoordination, blurred vision, delirium, high blood pressure, vomiting, and, in cases of higher dosages, coma. Moreover, these symptoms can be produced for a duration of from several hours to several weeks depending upon the agent chosen. Some of the more active of these compounds are listed in Table I along with BZ as producing prostration. They are effective at a dosage of 1 microgram/kilogram of body weight⁽⁶⁾.

Emetics

(U) ~~(S)~~ The agents which induce vomiting apparently act by stimulating a portion of the brain known as the chemoreceptor trigger zone. As incapacitants, they are fairly effective and work rapidly although not instantaneously. At present, the most promising of the vomiting agents is Compound 22892b (2-allyl-1-methylpyrrolidine)⁽⁷⁾.

~~CONFIDENTIAL~~

UNCLASSIFIED

~~CONFIDENTIAL~~

11

Conclusions

(U) It can be readily noted that there are a variety of possibilities for further development of chemical agent capability. Among the more promising agents are the glycolates because of their mode of action and safety ratio. At present, however, CS, CN, and related irritants are likely to remain the standard items in both the military and police arsenals.

Delivery Systems for Chemical Agents

(U) A number of effective devices exist for the delivery of presently used chemical agents. Many of these, with minor modifications, could accommodate the chemicals which are currently under development and testing.

(U) Among these devices are grenades, of both expulsion and pyrotechnic types, special ammunition, and man-portable or vehicle-mounted dispersers. There are also available a number of chemical shells, rockets, and bombs, but these have not been included since their size, weight, and velocity make them lethal weapons if only for mechanical reasons⁽⁸⁾. These could, of course, be considered in tactical situations where some casualties could be tolerated.

Grenades

(U) Probably the most common delivery device for both CN and CS in riot-control situations is some type of grenade launched either with a grenade launcher or, more commonly, thrown by hand.

(U) One common type of grenade is the expulsion type which utilizes an explosive charge to either emit the agent through a series of ports in the container, or through the rupture of a frangible container. Included in this type of grenade are those employing the new piston release technique which involves the use of a powder charge to activate a piston which literally pushes the agent out of an exit port located at the base of the grenade⁽³⁾. Some of these grenades are designed so that the escaping agent creates a rocket effect causing the grenade to skitter along the ground. Extensive tests at Edgewood Arsenal have shown that this type of grenade is not likely to cause serious injuries⁽⁹⁾.

(U) The pyrotechnic grenade releases its agent through a burning process. Usually this involves use of a coarsely granulated chemical agent combined with a pyrotechnic substance which will burn on ignition. This

~~CONFIDENTIAL~~

UNCLASSIFIED

~~CONFIDENTIAL~~

(U) A number of dispersed agents, that can be used in a variety of ways, are shown in Figures 1 through 4. (See Appendix, pages A-11 through A-14.) Explosive or incendiary grenades are shown in Figures 5 and 6 (pages A-15 and A-16).

Dispensers

(U) A number of dispensers, employing both external sources of compressed gas or an engine-powered blower to expel the chemical agent are in use. Weights vary from 20 to 50 pounds for man-portable units to several hundred pounds for helicopter- or truck-mounted devices. (U) Standard types of military dispensers are shown in Figures 7 through 10 (pages A-17 through A-23). Figures 11 and 12 (pages A-24 and A-25) show dispensers currently used by civil law enforcement agencies.

Liquid Stream Projectors

(U) Somewhat related to the dispensers are those devices which shoot a concentrated stream of some liquid incapacitant at an individual human target. Among the advantages of this type of weapon are a better selectivity of individual target and a somewhat more persistent effect from the agent since it is projected as a liquid stream rather than as a vapor. The main disadvantage of this type of weapon is its short range.

(U) In 1965 the Research Analysis Corporation published a report on a project carried out for ARPA/AGILE on the feasibility of designing a weapon which would project a stream of incapacitating liquid for a distance of at least 100 feet. Of the various materials studied, capsicum oleoresin, a derivative

of the pepper plant, is the most effective. This manual, provides an excellent review of the various systems and techniques relating to chemical agents. It covers the philosophy and legal aspects of using these agents; storage and transport; safety, including physiological and psychological effects; first aid and decontamination; and chemical munitions. Further information concerning this manual may be secured from the Association of Chiefs of Police, Inc., 1319 Eighteenth Street, N.W., Washington, D.C. 20036, AC 202 - 205-7227.

~~CONFIDENTIAL~~

CONFIDENTIAL

~~CONFIDENTIAL~~

13

red pepper was judged to have the most desirable characteristics. A gun was fabricated which demonstrated the proper valving and nozzle assembly. This weapon projected the liquid for a distance of up to 40 feet with a dispersion of about 12 inches in diameter⁽¹⁰⁾.

(U) Recently, a number of aerosol projectors have been marketed for police use. Among these are the first- and second-generation Chemical Mace. Most of these devices use CN in some type of halocarbon solvent⁽³⁾.

Chemical Munitions

Military and Police Munitions

(U) A variety of cartridges are available for use by both the military and police. Some, like the Federal Laboratories' Short Range Shell shoot a cloud of micropulverized CN or CS directly from the muzzle of the gun in the same manner as shot from a shotgun shell. Others fire pyrotechnic- or expulsion-type projectiles for as much as 500 yards although most have an effective range of around 150 yards. Several typical military cartridges are described below. Some munitions employed by the police are illustrated and described in Figures 13 through 15 (pages A-26 through A-28).

(U) Military XM674 CS Riot Control Cartridge. The item furnishes Army units engaged in riot control with a capability of employing small quantities of incapacitating riot control at ranges beyond that of existing riot-control grenades.

(U) The cartridge is contained in a 38-mm-diameter aluminum case approximately 9 inches long and can either be fired hand-held, with the M79 grenade launcher, or with the M8 flare pistol. It projects a nonhazardous rubber container, which is filled with a CS pyrotechnic mixture, for a distance of 65 to 90 meters when fired from the M79 or M8 weapons. Shorter distances are obtained when hand fired (approximately 45 meters). The container emits CS for approximately 10 to 40 seconds.

(U) The XM674 cartridge differs from the E20R3 and XM651E1 40-mm cartridges in that the E20R3 and XM651E1 can be fired only from the M79 grenade launcher and have higher velocity, and range, and better aimability. The XM674 cartridge contains approximately twice the amount of CS as the other

~~CONFIDENTIAL~~

~~CONFIDENTIAL~~

14

(U)

Military XM651E3 40-mm Tactical CS Cartridge. This cartridge can be fired from the M79 or XM103 single-shot launchers or from the XM174 automatic launcher. Weighing 185 grams with a payload of 75 grams, the cartridge utilizes a pyrotechnic fuse. This item is presently in engineering development.

(U) Military E8 CS Launcher and Cartridge. The E8 CS launcher consists of a launcher module with 16 firing tubes, each containing four E23 35-mm CS cartridges (64 E23 cartridges/launcher), a firing train, and a folding firing stand for ground emplacement. A carrying harness with adjustable, padded, shoulder straps, quick-release cord, and waist strap is provided for back-pack carry. Weight of the total assembly is about 35 pounds.

(U) The E8 launcher is fired electrically or manually. The E23 cartridges impact over an area 40 meters wide extending 80 to 230 meters in range, producing a uniform and effective CS aerosol within 15 to 30 seconds.

(U) The launcher platform has an elevating mechanism for firing at six different elevations from 0° to 90°. Range from launcher to center of target thus can be varied from point blank to 150 meters. After firing the entire unit is discarded.

(U) The range of this weapon is up to 230 meters. It is nonlethal in the impact area, but its high muzzle velocity creates a lethal hazard at the muzzle during firing⁽⁸⁾.

Darts

(U) The use of darts as a means for injecting an enemy with an incapacitating agent has been discussed as a possibility by a number of writers⁽¹²⁻¹⁴⁾. While darts have not actually been used sufficiently on human subjects to compile an accurate history on their use, several instances of their use have been recorded.

(U) Several years ago a psychotic prisoner who was trying to escape from the Athens, Georgia, jail was subdued by means of a dart loaded with sodium hyalate. The equipment used was that commonly used by veterinarians and conservationists in subduing animals^(14a). More recently, a number of tests have been made using mature student volunteers by a psychiatrist, Dr. William C. Conner of Emory University and the Palmer Chemical and Equipment

~~CONFIDENTIAL~~

~~UNCLASSIFIED~~

UNCLASSIFIED

15

nearby of Douglasville, Georgia. In these tests, a small dart with a needle 3/4 inch in length containing apomorphine was used. Within 75 seconds, the victim felt chilled and became glassy eyed, and his blood pressure dropped. In 5 minutes the victim was nauseated. For an hour after this, he was actually ill and nearly completely immobilized. Present forms of this equipment are quite limited as to range, but research is underway to improve the design.

(U) Tranquilizing darts have been used for a number of years in subduing wild or frightened animals until this practice has become quite routine. A large number of agents have been used for this purpose, none of which are entirely safe, since all require a rather accurate dosage based upon the weight of the animal (13).

(U) The advantages and disadvantages of darts as nonlethal weapons may be summarized as follows:

Advantages:

- (1) The use of a dart allows selection of an individual target - perhaps the leader of a group or a particularly destructive person - without injuring others around him.
- (2) The user can choose from a variety of agents to fit the specific situation.
- (3) The dart can more nearly represent a nonlethal substitute for a bullet than any other chemical delivery system.
- (4) Because of its selectivity and because the identity of the agent being used is not readily discernible, the dart possesses a psychological advantage not shared by many of the other systems. The victim may wonder what he has been hit with and whether or not it is essential that he find an antidote.

Disadvantages:

- (1) Certain mechanical hazards are present with any system which utilizes a sharp-pointed projectile propelled at fairly high velocity. The eyes would be particularly vulnerable to such a device as would certain of the arteries of the head and neck. Possibly a safer device would be one that fires a blunt rubber or gelatin

UNCLASSIFIED

UNCLASSIFIED

projectile directly at the target individual and releases a chemical agent on impact.

- (2) When used at close ranges, the needle of the dart may embed in bone causing severe pain without discharging the chemical agent. Presumably, this danger could be eliminated by using needles made of softer material.
- (3) The dosage is critical with chemical agents now in use. A person using such a weapon under battle or riot conditions cannot be expected to always choose the correct dosage based upon the size of his intended victim. The only practical solution to this problem is the discovery and use of drugs with a greater margin of safety which may be used safely on individuals of different sizes.
- (4) The darts now in use must depend upon their terminal velocity in order for penetration to take place. This requires the projectile to possess a very high initial velocity. Perhaps an answer to this problem would be a dart with a spring-loaded needle which is triggered and penetrates upon impact regardless of its terminal velocity.
- (5) Darts are not regarded by many as an "acceptable" weapon. Apparently, when a weapon or device is of recent development and is used initially on animals and gains acceptance in this use, it seems to render it "unsuitable" for use against humans however practical and humane it might be. Another example of this kind of thinking is the use of the electric cattle prod against human subjects.

(U) In short, systems using darts appear to show promise as nonlethal weapons especially if a number of problems surrounding their use can be resolved. The hazards connected with their use seem less important when considered against the alternative of lethal weapons.

(U) At present, tranquilizing darts are fired either by means of CO₂-activated guns or by means of blanks of the type used for driving nails into concrete floors.

(U) Figure 16 (page A-29) shows the "Cap-Chur" dart which is typical of the darts most often used. The "Cap-Chur Charge" is a small explosive charge which is triggered upon impact, forcing the drug into the target.

UNCLASSIFIED

(U) Figure 17 (page A-50) diagrams several types of darts which may be used with Smith and Wesson's Mercox system. This system utilizes a variety of projectiles, penetrating darts, and high-explosive shaped charges.

Smoke

(U) The use of smoke per se as a technique for obscuring the vision of members of crowds is currently out of vogue. This is probably due to the widespread availability of agents such as CN which more effectively achieve the desired results.

- (U) The chief advantage of smoke over tear gas is that upon dispersal or being blown by the wind it does not irritate bystanders, nor does it exhibit lingering contamination effects⁽¹⁵⁾.
- (U) Smoke is also generally less expensive than tear gas⁽¹⁵⁾.
- (U) Most of the tear-gas munitions incorporate a smoke component in order that crowd control forces can see which areas have been treated.
- (U) Many of the devices and techniques used to disseminate smoke are similar to those used for the dissemination of tear gas⁽¹⁵⁻¹⁷⁾. These devices and techniques generally exhibit the same advantages and disadvantages (e.g., fire hazards) whether used for disseminating smoke or tear gas.
- (U) While in some tactical situations it might be desirable to use colored smoke either as a signal or because of increased Total Obscuring Power (TOP), there is evidence that many components of colored smoke are carcinogenic^(18,19).

UNCLASSIFIED

USE OF THE ELECTROMAGNETIC SPECTRUM FOR INCAPACITATION

There are several proposed techniques for using visible light to incapacitate a person. The techniques to be discussed here are: (1) the use of visible light, (2) ultraviolet, laser radiation, and microwaves.

Photic Driving and Incapacitation

(1) The supposed utility of visible flickering light as an incapacitating technique is premised upon its effect on the electromagnetic behavior of the human brain. It has been noted that epileptics and certain otherwise normal individuals exhibit an abnormal alpha brain-wave signature when undergoing a seizure. The nature of the alpha brainwave is such that it has a frequency of about 10 cycles per second; it increases in frequency when an awake resting subject closes his eyes; it decreases in frequency when a subject engages in mental activity; it is blocked when a subject focuses visual attention on an object; and it can be "driven", i.e., a light flickered near the alpha frequency can cause the alpha frequency to entrain or adapt to that frequency⁽²⁰⁾. The assumption behind suggestions for using flickering light as a nonlethal weapon is that an altered alpha signature will produce altered overt behavior, i.e., a lessened capacity to engage in goal-directed behavior (e.g., as with an epileptic seizure). Without going into a detailed discussion of all the research literature, the following general points can be made about the effectiveness of flickering light as an incapacitating technique.

(a) Photic driving of the alpha signature is thought to be possible in approximately 30 percent of the population⁽²⁰⁾. Estimates of the portion of the population which can be "significantly" affected by flickering light range from about 1 to 5 percent, with most estimates at about 1 percent⁽²¹⁾.

(b) "Significant" reactions to flickering light tend to be predominantly symptoms of dizziness, sleep, drowsiness, or hypnotism. These reactions are generally subjective and exhibit little or no objective relevance⁽²¹⁾. Among epileptics, photic driving produces severe incapacitation, e.g., grand mal seizures, in only a portion of the subjects⁽²¹⁾. Even among these epileptics

... hypnotism, but not initially sleep can be achieved by

UNCLASSIFIED

UNCLASSIFIED

the effects are reliably produced only with the subject's cooperation and in the laboratory setting⁽²²⁾. Since it is estimated that approximately 10 percent of the population is severely incapacitated by flickering light, the probability of severely incapacitating a significant portion of the individuals in a real cross-section of the population by means of flickering light is quite low.

(C) Since the alpha wave is diminished by mental activity and inhibited by visual attention⁽²⁰⁾, it is expectable that even with a subject in whom flickering light can induce some degree of incapacitation task orientation would diminish the significance of this incapacitation⁽²¹⁾. Task performance is generally unimpaired under conditions of flicker. The researcher found that "there was no significant difference between performance with and without flicker of repeating digits, addition, or serial subtraction, and no change in tapping rate could be associated with either an increase or decrease in flicker frequency". Another experiment involved rifle aiming accuracy. Under conditions of no ambient lighting and a bright flickering-light performance was impaired; however, with a low level of ambient light the flickering light apparently had no effect on performance⁽²¹⁾. The first set of results might be attributable to the need for some minimal ambient illumination in order to use the standard sights on a rifle.

(U) Among pilots tested for the effects of flashing lights, the most common reactions were boredom and annoyance⁽²³⁾. Under normal stimulation, as in actually piloting an airplane, it is doubtful that boredom or this source of annoyance would be significant.

(U) The reported cases where otherwise normal individuals succumbed to flickering lights are quite rare and comprise an insignificant portion of the population, most of which has been exposed to many of the sources of flicker which are sometimes reported to incapacitate individuals (e.g., flashing lights, sunlight shining through trees, venetian blinds, etc.)⁽²¹⁾. Effects achieved among otherwise normal subjects in the laboratory might be attributable to the laboratory setting itself. Drowsiness might occur in any setting where there is low ambient lighting and little or no noise or other stimulation. Kinesthetics (the sensation of body movement) might result from eye movement and "drifting" of the retinal afterimage. This same eye behavior might produce a mild motion sickness, i.e., the "nausea" reported in the literature. The range of conditions reported as having elicited desired reactions in the laboratory (e.g., number of flashes per second, colors of lights) is so wide that it would be difficult

UNCLASSIFIED

UNCLASSIFIED

of the same treatment will be felt about every part of the same time even if the subjects were all known to respond to light flicker (20-24).

Visual Impairment

(c) The significant impairment of vision is difficult to achieve and at the same time frequently involves lasting physical damage.

The Visible Spectrum

(c) Most of the work on the use of the visible spectrum to impair vision has dealt with the effects of dazzle. The following conclusions have been reported:

- (1) The closer an object is to a source of glare, the more the glare interferes with the visibility of that object (24).
- (2) For a given flash brightness, the flash covering the fovea* will have its full dazzle effect only if its angular radius exceeds about 3 degrees. Smaller flashes yield progressively reduced disabling effects (24).
- (3) In general, the adaptation of a given part of the retina is independent of that of another part; e.g., dark readaptation in a part of the retina which is affected by moderate glare will occur independent of that part affected by extreme glare (24).
- (4) Recovery time after exposure to glare tends to be quite rapid, but the fovea tends to recover much more rapidly than does the peripheral retina (24).
- (5) There is a tendency toward linearity when recovery time is plotted against flash intensity, at least over certain ranges of intensity (21,25). (See Figure 18, page A-31.)
- (6) There is a highly significant difference in the recovery rate between subjects (24).
- (7) Recovery time to a given level of peripheral acuity appears to be the product of flash luminance and duration (24).

* The central area of the retina after losing acute vision.

UNCLASSIFIED

UNCLASSIFIED

21

Infrared

(U) Light sources with a high level of infrared can produce temporary glare blindness. However, the same luminance and exposure time without the infrared component will yield the same glare effect, and infrared in sufficient quantity can cause irreversible damage to the eye. Higher intensities of visible light can cause irreversible damage to the eye. It is believed that the resultant lesions are caused by the absorption of the visible light by the pigmented portion of the retina and the consequent degrading of the visible light into infrared or heat⁽²⁴⁾.

(U) The lenses of younger people transmit more infrared, making them more susceptible to retinal burns. The same is true of the aphakic or lensless eyes. Burns of this nature might be relatively painless. They probably occur most often from looking at the sun, as in a solar eclipse⁽²⁴⁾.

(U) One source of such retinal burns which is of interest to the military has been the nuclear fireball. It was concluded that in the worst circumstances, when the light from the fireball was focused directly on the fovea, it might still be possible for tasks to be performed by relying on off-center vision⁽²⁴⁾.

(U) A long-term effect associated with frequent exposure to light near or at sufficient intensity to cause retinal burns is the development of cataracts (the period before onset appears to vary from 2-1/2 months to several years). Less intense infrared exposure (e.g., temperature of 1500 C and 540 lux) is accredited with producing cataracts after a latent period of 20 to 40 years. Uncontrollable factors, such as general physiology, race origin, or dietary deficiencies might affect susceptibility to infrared cataracts⁽²⁴⁾.

(U) Infrared would probably be of limited utility in a tactical confrontation due to the possibility of an affected individual relying on off-center vision. If the criteria of temporariness and reversibility of effects are adhered to, the value of infrared for this type of application is further diminished.

Ultraviolet

(U) While ultraviolet rays can cause problems with the human eye, they generally are of limited significance for purposes of incapacitation. Both the longer and shorter ultraviolet rays are absorbed by the cornea and conjunctiva,

UNCLASSIFIED

UNCLASSIFIED

with only a little ultraviolet radiation penetrating to the vitreous humor and lens. Ultraviolet radiation does not penetrate the lens to any significant degree, it does not normally pose the problem of retinal lesions^(24,26).

(U) Exposure to ultraviolet radiation can result in the onset several hours later of conjunctivitis or retinitis. Exposure to a welder's arc or to snowfield glare can produce discomfort such as a feeling of grit in the eyes, photophobia, and watering of the eyes. There is normally a delayed onset and recovery is usually complete^(24,27).

(U) Due to the prolonged onset of symptoms, ultraviolet radiation would be of little significance in determining the outcome of a tactical confrontation.

Laser Radiation

(U) Laser radiation has been suggested as a source of flash blindness or chorioretinal burns. Laser radiation differs from conventional light sources in that it is a coherent beam and is from a narrow spectral band.

(U) In order to affect vision, the laser must be aimed directly at the eye⁽²⁵⁾. This diminishes its practicality in a confrontation situation. The greatest danger to the eye, i.e., chorioretinal burns, appears to occur from relatively prolonged exposure to the laser beam⁽²⁴⁾.

(U) It has been suggested that a stacked blinking system of lasers might be used to produce flash blindness of several seconds' duration⁽²⁸⁾. Flash blindness from laser radiation can be prevented by shielding the eyes with any opaque material. In addition, atmospheric dust, haze, or fog would reduce the effectiveness of a laser⁽²⁴⁾.

(U) The efficiency of optically pumped lasers is only 2 to 3 percent, meaning that energy requirements are inordinately great. Conventional light sources, such as the carbon arc lamp, should be approximately 100 times more efficient than the laser for the production of flash blindness⁽²⁴⁾.

Microwaves

(U) The possible use of microwaves to incapacitate individuals, as has been suggested in connection with personnel barriers, appears to be infeasible, if a high degree of nonlethality is desired. The action of microwaves is such as to raise the temperature of the body.

UNCLASSIFIED

UNCLASSIFIED

25

(U) The impairment of eye functions in a matter of seconds by near-ultraviolet waves (exemplified by the production of cataracts) would require energy levels of high enough intensity to kill an individual before the desired effects on the eyes could be achieved⁽²⁵⁾.

(U) Heating of the testes by microwave radiation has been suggested; however, the lethality risk with microwaves is much greater than if infrared were used to produce the same effect⁽²⁵⁾.

(U) Surface skin burns using microwaves would not form soon enough to be of tactical advantage. Expected nonthermal incapacitating effects of microwaves would not occur before lethal body heating took place. Even if desired effects were achievable without a lethal increase in body temperature, microwaves would apparently be ineffective against a person who is wearing heavy clothing or who is behind an object⁽²⁵⁾.

SOUND AS AN INCAPACITANT

(U) There have been numerous suggestions, especially in the popular literature, that sound at a range of frequencies and intensities might be used to control crowds while doing individuals no particular harm. Despite impressions to the contrary, this application of sound is less than an accomplished science.

(U) An immediate possibility for using sound to control crowds is the use of loud noises to scare people or to interfere with communications. The Teleshot cartridge developed by Colt Industries might scare members of a crowd with its loud report, but they would probably become accustomed to it. The use of high-intensity sound, such as is produced by sirens, to interfere with communications in the crowd has the disadvantage that control forces might also have difficulty in communicating and that hearing loss might occur.

(U) One device which was recently patented is reputed to generate sound "so offensive and repugnant that hearers leave the scene, but no permanent injury is caused"⁽²⁹⁾. No independent assessment of this device has been found.

(U) Most of the suggestions for using sound to control human behavior fail to solve one or more of such problems as operator protection, increased directivity of sound and selectivity of target, the problem of undesired effects (e.g., breaking windows along a city street), and the differential response of individuals to the same frequencies and intensities.

UNCLASSIFIED

UNCLASSIFIED

24

(U) Low-frequency sounds and infrasounds appear to have the greatest promise for controlling human behavior because human organs exhibit low-frequency resonance characteristics. It is reported that the chest and abdomen will resonate at about 3 cps, the head at about 20 cps, the arm and shoulder at about 3 cps, and the spine at about 5 cps. Subjects exposed to such sounds report a number of discomforts. Many exhibit physiological responses such as higher or lower blood pressure, increased heart beat, lasting interference with hormone secretion, and decreased visual acuity. At a pressure of 150 db small animals exhibit occasionally fatal damage to the ganglion cells⁽³⁰⁾.

(U) While there has been discussion of the use of low-frequency sound to cause members of crowds to lose control of their sphincter muscles, it appears that little work has been done to implement these suggestions⁽³¹⁾.

(U) The greatest danger of the use of sound to control humans appears to be hearing loss. At 90 to 120 db temporary and possibly permanent hearing loss occurs. Most subjects experience pain at about 140 db, and at about 160 db the eardrum is torn. In the range of approximately 120 to 140 db effects such as irritability, inefficiency, tiredness, sterility, headaches, insomnia, increased excitability, and increased blood pressure have been noted. At levels above approximately 135 to 140 db, it has been reported that equilibrium is disturbed, there is a feeling of oppression, the central nervous system is stimulated (e.g., nausea, tendencies to vomit, difficulty of orientation), there is decreased attention to correct work procedure, and efficiency is decreased^(30,32).

(U) Ultrasounds (i.e., >20 kc/sec) apparently pose a minimal threat to man at moderate-to-low intensities. They pose a greater threat to insects and animals due to their thermal effects⁽³⁰⁾.

BARRIERS AND MECHANICAL DETERRENTS

(U) This final general category of nonlethal weapons is described in functional terms. It includes barriers in the usual sense as well as devices which inflict physical discomfort through direct mechanical or electrical action.

(U) Barriers and mechanical deterrents have long been used as a means of controlling mobs and unruly individuals. Because of this long history of use and consequent familiarity, these devices can often be employed in situations

UNCLASSIFIED

UNCLASSIFIED

25

Even the use of more sophisticated means, such as chemical weapons, would be unacceptable to the general public. While the logic of this attitude might be subject to argument, the attitude itself must be considered in the process of choosing the precise type of nonlethal weapon system to be used. Thus an individual may well be forced to choose something less than the ideal system in favor of something more "acceptable".

(U) In addition to the fact that these are familiar devices for the control of violence, another advantage stems from the very simplicity of many of them. Even though a particular device may be rather severe in effect, it is likely to be more nearly acceptable if its mechanism and effect are immediately evident and well understood. Accordingly, while a device such as a billy club may be capable of inflicting more serious injury, it is likely to occasion less outcry than the use of chemical agents of the CS-CN type. A great variety of devices whose effect is largely mechanical are available, allowing the user a range of choice in fitting the weapon to the situation.

(U) It is difficult to generalize about the disadvantages of barriers and restraining devices as many of the disadvantages are peculiar to individual systems. However, several factors should be borne in mind when one considers their use. A number of the barrier systems (e.g., barbed wire, barbed tape, inflatable barriers) are costly. Some are quite cumbersome, requiring heavy expenditures of machine or manpower for their emplacement. In addition, most of them have no built-in decay mechanism, so a costly cleanup operation is required after the emergency situation has passed. If this cleanup is not accomplished promptly, persons not involved in the conflict are caused inconvenience. It is, perhaps, this lack of flexibility which is the most serious disadvantage of the barrier systems.

(U) The characteristics worthy of mention of the other items included in this section will be discussed individually.

(U) In summary, while many of the devices described in this section show less potential for flexibility of use than a number of the chemical weapons in use and under development, they are well known by the public and are currently in the police and military arsenals. For this reason, they are likely to remain in use for a long time.

(U) These devices serve, in general, to mechanically prevent rioters from accomplishing their purposes and may have the effect of discouraging all

UNCLASSIFIED

UNCLASSIFIED

26

of a group of highly motivated individuals. Many of these weapons have the advantage of selective application - they can be aimed toward individuals.

Conventional Barriers

(C) Physical barriers are barriers in the usual sense, intended to control or limit the movement of a crowd. The barriers most useful in crowd-control situations must be easily transported, readily emplaced, effective, resistant to damage or displacement, and convenient to remove when desired. Of course, they must be as inexpensive as possible. Three types of physical barriers will be considered here: (1) barbed wire, concertina wire, and barbed tape, (2) inflatable barriers, and (3) nets.

(U) Several examples of barbed wire and its variants have undergone testing by the U. S. Army in recent years on the basis of both barrier effectiveness and cost. Among those items which have been tested are:

- (1) Standard barbed wire consisting of two-strand No. 12 wire with four-point barbs spaced 4 inches apart (Figure 19A, page A-32).
- (2) German barbed tape which has four-point barbs spaced at 1-inch linear intervals (Figure 19B).
- (3) Barbed-wire concertina made up of single-strand coiled spring wire with four-point barbs spaced 2 inches apart; each roll opens to form a cylinder 50 feet long and 36 inches in diameter (Figure 19C).
- (4) German barbed-tape concertina consisting of a strip of barbed tape crimped around a core wire; rolls of this material open to form cylinders 40 feet long and 33 inches in height (Figure 19D).
- (5) Rapidly Emplaced Antipersonnel Obstacle (REAPO), which is formed from steel tape with 1-7/8-inch barbs located on 4-inch centers (Figure 20A, page A-33).
- (6) The General Purpose, Barbed-Tape Obstacle (GPBTO) which is fabricated from 5/8-inch tape with barbs located every 4 inches on center; this material opens to form a double helix with the outside coil

UNCLASSIFIED

UNCLASSIFIED

27

reverse wound and 180 degrees out of phase with the outer coil (Figure 20B).

(U) Neither the RLAPD nor the GPBTO have proven to be worthy of further testing at this time. The RLAPD has been judged poor from the standpoint of reliability and ruggedness, and in any case would be too expensive for most applications. The GPBTO has similar deficiencies and, in addition, does not meet command-control and booby-trap requirements⁽³³⁾.

(U) Inflatable barriers have been investigated, and a number of manufacturers have expressed interest in further developing them. At present, however, no agency appears interested in buying a number of units. Although seemingly vulnerable to knives, proper design can essentially eliminate this problem. Deployment and removal would be very quick. The barrier is completely passive, with no risk of such injuries as might be inflicted by barbed wire. The inflatable barrier's prime disadvantage is its probable high cost relative to other devices. In any case, such barriers are not currently available off-the-shelf.

(U) Finally, various nets can be used to constrain a crowd or riot. They have the advantage of being "see-through" and easily transported. Erection could be quick if supporting structures were available; otherwise, anchoring the net would be a major handicap. We know of no nets presently designed for the express purpose of crowd control. Those systems which we can envision would be relatively expensive⁽¹⁴⁾.

Other Passive Impediments to Movement

(U) Recognizing the limitations of conventional "barriers", as discussed above, a number of other passive means for controlling crowd movement have been studied. These include caltrops, slippery liquid, foams, and "spider web". Caltrops are four-pronged objects made of sharpened wire constructed so that one point is always vertical. Such devices can pierce shoes and inflict serious injury (Figure 21, page 33).

(U) Caltrops show some promise from the standpoints of cost and effectiveness. They have the advantage of being very rapidly emplaced. Some interest has gone into producing caltrops held together by a degradable material which would eventually render them ineffective.

UNCLASSIFIED

~~UNCLASSIFIED~~

(d) Although caltrops have proven to be fairly effective, especially in view of their rapid emplacement, there appear to have been some reservations about their use on the part of service personnel. Possibly some persons feel caltrops are not a "suitable" weapon -- that is, that the effects are potentially too severe. Certainly a caltrops barrier would have a cruel appearance -- and effect.

(e) A very interesting type of impediment is that created by the slippery, liquid polymers (sometimes called "instant banana peel"). These reduce friction to the point that walking or running on a surface coated with them is made very difficult. While this material presents some difficult cleanup problems, it is a very humane way to frustrate a crowd and therefore its application would not be psychologically counterproductive⁽³⁴⁾.

(f) Similar to "instant banana peel" in that it lowers the coefficient of friction making walking difficult, Teflon confetti may well have application in making any kind of purposeful movement difficult for the mob. This material would be particularly effective when spread two or more layers thick, since the material would be sliding on itself. Obviously it would find a more useful application on a paved street than on bare soil or grass. The material is rather expensive at this time because of its difficult working properties, but undoubtedly the price would drop as the substance becomes more widely used⁽³⁴⁾.

(g) Various foam machines, adaptations of the type used in firefighting, may have applications in controlling crowds. It is reported that individuals finding themselves in the midst of the substance become disoriented and lose motivation. Suffocation is not supposed to be a problem since the bubbles burst in the nose and mouth when inhaled. A fairly sizeable barrier may be formed relatively quickly⁽¹⁴⁾. The composition and generation of the foam determines its longevity and hence the degree of difficulty in cleanup. Foam could easily be used in combination with instant banana peel, but the already difficult cleanup problem would then be compounded. Foam shares some of the psychological advantages offered by instant banana peel, but would probably not be acceptable to quite the same degree. Being engulfed in foam would very likely be a frightening experience.

(h) "Spider web" is a type of adhesive which can be sprayed out of a nozzle to form very fine filaments which float through the air until they come in contact with a surface to which they attach. This material would appear to

~~UNCLASSIFIED~~

~~CONFIDENTIAL~~

...the... agents... the... of...
...the... of... the...
...the... in "..." items...

...recently, there have been a
...injured in falls resulting from
...plastic binders which had originally been
...bundles of produce. The victim apparently put both feet
...the binder and tripped. The item is in the form of a
...so that one of the loops is always upright. Conceivably
...when scattered in front of an onrushing group of persons might
...to impede their progress.

Mechanical Deterrents

(c) In this category are grouped those weapons which have a direct
mechanical effect and can be selectively employed against individuals and groups.
Among these are conventionally powered firearms which fire nonlethal projectiles
such as rubber bullets, wood pellets, or special shotgun pellets. The latter
devices have one thing in common: they incapacitate by impact. The victim is
either injured or subjected to enough pain to deter him from aggressive action.
Of course, some danger of serious injury is always present when these methods
of incapacitation are applied. The danger can be lessened, but not eliminated
by careful and thorough training in their use.

(U) Wooden pellets like those of the "Multiple Baton Shell" are
fired from a gun with a 1-1/2-inch-diameter barrel. The pellets are said to
produce about the same amount of punishment as a billy club⁽³⁶⁾. Rubber
projectiles are fired in the same manner and produce about the same effect.
There is no inherent difference in interior and exterior ballistics between
projectiles made of rubber and those made of wood. While there would be
differences in terminal ballistics due to differences in mechanical properties of
the two materials, it is doubtful that there would be significant differences

The Remington Arms Company has recently developed a new 12-gauge
shell filled with 5 plastic pellets called "Whiz-bits"; the shell has

~~CONFIDENTIAL~~

UNCLASSIFIED

range of 20 to 25 yards. The shell has been designed to produce a loud report and bright muzzle flash giving it some value as a psychological weapon⁽³⁷⁾.

(U) Research has also been carried out on weapons which project shot-filled bags, rubber or putty-like bullets⁽³⁸⁻⁴⁰⁾, and similar items. The literature indicates that, at present, none of these have a safety factor favorable enough for widespread use. Nevertheless, rubber bullets have been reported in use during recent riots in Northern Ireland. So far as is known, no detailed report has been published regarding their effectiveness.

(U) Water cannons and high-pressure fire hoses have been used against crowds with varying success. Variations in weather conditions and crowd desire vastly and obviously affect results. The initial cost can be low since fire-fighting equipment can be borrowed for riot-control purposes. Specially designed and built vehicles, on the other hand, would be relatively expensive.

(U) Electric prods, or electrified batons have been used quite successfully in the past for dispersing crowds⁽³⁴⁾. They are not as effective when the crowd has on dry, heavy clothing. Increase of voltage to overcome this disadvantage could make the device potentially harmful (heart arrest, etc.). Public acceptance of such devices seems low, perhaps because of an association with cattle prods.

(U) Many types of prods, clubs, batons, etc., have been used for riot-control purposes. All require significant training to fully realize their effectiveness. Quarter staffs, riot batons, nightsticks, billy clubs, saps, and flails all depend on skillful use to be effective and nonlethal or non-permanently injurious. The cost of the training required can offset the inexpensive purchase price. It does not appear practical to construct a club or prod which cannot produce permanent injury. Indeed, some command-type weapons are designed to be fatal and are not useful in less than critical situations. This general type of weapon has been used for centuries and is in some places highly refined today. Many examples of these weapons are used in oriental martial arts.

(U) Further development has taken place, however. In 1964, the Research Analysis Corporation, under contract to the Advanced Research Projects Agency, designed a billy club based on a Japanese weapon of similar design. The device was designed to a size which could be concealed on a person. Extending to full length rapidly, the device also featured an extensible self-locking section in the forward section⁽⁴¹⁾.

UNCLASSIFIED

51

MISCELLANEOUS

(C) Dogs have been used very successfully to control crowds where the animals and their handlers have been well trained. A few dogs with skilled handlers can effect control of a crowd which is out of proportion to their real strength⁽⁴²⁾. Indiscriminant, immoderate, and well-publicized use of dogs has, however, put them in a bad psychological light.

(U) A further disadvantage of dogs is that the dog and handler must be treated as an integral unit which tends to limit their usefulness. Then too, the dog requires continual care and training.

(U) Men on horseback have long been used successfully to control crowds and even riots. Horses do require substantial and continuous outlay for maintenance. When and how to employ horse-mounted men would depend somewhat on the degree of disorder, since a crowd could maim or otherwise disable a horse if sufficiently motivated⁽¹⁴⁾.

(U) The Research Analysis Corporation investigated the possibility of developing a liquid cold weapon. While it was determined that a small weapon of this type could be produced using cold brine as an agent, it was judged not to be practical since a small weapon would not have the required capacity⁽⁴³⁾.

(U) The marking of people for later apprehension is another technique which has been tried in some situations. In a hostile crowd, attempts to arrest individuals may provoke the crowd to more violent actions. Very often the police will not be physically able to make an arrest anyway. It may be possible to meet such situations by marking individuals or vehicles with some suitable material for later apprehension. The specific materials proposed range from visible dyes, to invisible markings (sensitive to ultraviolet light for example), to odor-identifying markings (sensed by dogs or gas chromatographs). Photography may facilitate identification but light conditions and identifying features limit the usefulness of photographs. Paint guns, such as Nel-Spot 707, are available but have not received extensive use to our knowledge⁽¹⁴⁾. Marking with a visible or colored dye seems to act as a deterrent for some individuals and will immediately leave the crowd to avoid being sprayed.

UNCLASSIFIED

UNCLASSIFIED

35

- (10) ... and ... HAZARD STUDY OF THE ... Report No. BAT-441, for the period February 1964 - June 1964, ... Laboratory, Edgewood Arsenal Research Laboratories, Edgewood Arsenal, Maryland (July 1964), 20 pp (FOR OFFICIAL USE ONLY) (PA 38,607), AD 860 553 L.
- (11) ... J. M., NON-LETHAL INCAPACITATING WEAPON: LIQUID STREAM PROJECTOR FEASIBILITY STUDY (U), Technical Paper No. PAC-TP-108, from Research Analysis Corporation, McLean, Virginia, to Advanced Research Projects Agency, Washington, D. C., Contract No. SD-212 (March 1965), 68 pp (CONFIDENTIAL/Group 3) (PA 38,801).
- (12) Peters, D. W. A., DELIVERY OF ANTI-RIOT AGENTS, Final Report No. 69-17, U. S. Army Limited War Laboratory, Aberdeen Proving Ground, Maryland (October 1969), 7 pp + appendices (FOR OFFICIAL USE ONLY) (PA 36,608), AD 860 545 L.
- (13) ... M., NEW DART GUNS FIGHT CRIME!, Guns and Ammo, Vol 10, No. 8, pp 36-39 (August 1966) (UNCLASSIFIED) (PA 25,419).
- (14) ... E. L., STUDY OF INCAPACITATING DARTS (U), Report No. BAT-171-31, from RADC, Battelle Memorial Institute, Columbus Laboratories, Columbus, Ohio, to Advanced Research Projects Agency, Washington, D. C., Contract No. SD-171 (June 30, 1965), 42 pp (CONFIDENTIAL/Group 3) (PA 12,958), AD 367 711 L.
- (15) ... J. F., NONLETHAL WEAPONS FOR USE BY LAW ENFORCEMENT OFFICERS, Study No. S-271, for the period October 1966 to January 1967, Institute for Defense Analyses, Science and Technology Division, Arlington, Virginia (November 1967), 125 pp (UNCLASSIFIED) (PA 30,432), AD 661 041.
- (16) ... Joseph F., SAFE POLICE WEAPONS, Science and Technology, No. 77, pp 52-59 (May 1968) (UNCLASSIFIED) (PSI-19).
- (17) ... Col. R. (USA, ret'd), CROWD AND RIOT CONTROL - INCLUDING: CLOSE-COMBAT TECHNIQUES FOR MILITARY AND POLICE; AN EXPANSION AND REVISION OF "KILL OR GET KILLED", The Stackpole Company, Harrisburg, Pennsylvania (1964), 528 pp (UNCLASSIFIED) (PA 9442).
- (18) ... S. M., AEROSOL SPRAY SMOKE DEVICE, Technical Memorandum No. 1610, Felman Research Laboratories, Picatinny Arsenal, Dover, New Jersey (May 1965), 9 pp (UNCLASSIFIED) (PA 17,898), AD 461 939.
- (19) SYMPOSIUM ON PARTICULATES, conducted by Chemical Corps Technical Command, Army Chemical Center, Edgewood Arsenal, Maryland (August 18, 1947), 283 pp (CONFIDENTIAL/Group 3) (PA 24,862), AD 372 797.
- (20) ... P. A., BIOLOGICAL EFFECTS OF COLORED SMOKE INGREDIENTS, CRDL Special Publication No. 4-59, U. S. Army Edgewood Arsenal, Chemical Research and Development Laboratories, Edgewood Arsenal, Maryland (September 1964), 10 pp (UNCLASSIFIED) (PA 13,580), AD 451 092.
- (21) ... A. E., THE HEALTH HAZARDS OF CERTAIN SMOKE DYES IN CURRENT USE, Technical Memorandum No. 1674, Picatinny Arsenal, Dover, New Jersey (September 1965), 29 pp (UNCLASSIFIED) (PA 21,562), AD 469 867.

UNCLASSIFIED

UNCLASSIFIED

44

- Christner, C. A., et al., MEDICAL EFFECTS OF FLUORESCENT LIGHT, Report No. BAT-171-1, Army Limited War Laboratory, Aberdeen Proving Ground, Maryland (February 1963), 1023 pp (CONFIDENTIAL/Group 4) (PA 19,318), AD 357 363.
- Christner, C. A., et al., STATE-OF-THE-ART STUDY ON THE FLASH-LIGHT EFFECTS, Report No. BAT-171-6 (December 4, 1964), 46 pp (UNCLASSIFIED) (PA 9415), AD 458 349, and THE DEVELOPMENT OF WEAPONS FOR PSYCHOLOGICAL WARFARE - A STUDY CONDUCTED BY THE FALCON RESEARCH AND DEVELOPMENT CO. (U), Appendix Report No. BAT-171-6-1 (January 15, 1965), 8 pp (CONFIDENTIAL/Group 4) (PA 9415), AD 357 119, from RACIC, Battelle Memorial Institute, Columbus, Ohio, to Advanced Research Projects Agency, Washington, D. C., Contract No. SD-171.
- 22) Zelensky, J., THE USE OF FLASHING LIGHT TO PERTURB HUMAN BEHAVIOR, Research Paper No. R-172, Institute for Defense Analyses, Research and Engineering Support Division (March 1965), 21 pp (UNCLASSIFIED) (PA 17,260), AD 460 538.
- 23) Walton, C. E., et al., EXPOSURE OF MEN TO INTERMITTENT PHOTIC STIMULATION UNDER SIMULATED IFR CONDITIONS, Report No. AM 66-39, Civil Aeronautical Institute, Oklahoma City, Oklahoma (October 1966), 7 pp (UNCLASSIFIED) (PA 27,463), AD 646 872.
- 24) Christner, C. A., et al., STATE-OF-THE-ART STUDY ON VISUAL IMPAIRMENT BY HIGH INTENSITY FLASH OF VISIBLE, INFRARED, OR ULTRAVIOLET LIGHT, Report No. BAT-171-9, from RACIC, Battelle Memorial Institute, Columbus, Ohio, to Advanced Research Projects Agency, Washington, D. C., Contract No. SD-171 (January 18, 1965), 93 pp (UNCLASSIFIED) (PA 9416), AD 458 313.
- 25) Lutz, G. A., et al., STATE-OF-THE-ART STUDY ON PERSONNEL BARRIERS (U), Report No. BAT-171-50, from RACIC, Battelle Memorial Institute, Columbus Laboratories, Columbus, Ohio, to Advanced Research Projects Agency, Washington, D. C. (August 12, 1966), 104 pp (SECRET/Group 1) (PA 24,482), AD 378 912.
- 26) Buchanan, A. R., M.D., Helm, H. C., Ph.D., and Stillson, D. W., Ph.D., BIOMEDICAL EFFECTS OF EXPOSURE TO ELECTROMAGNETIC RADIATION, PART I - ULTRAVIOLET, Report No. WADD-TR-60-376, from Physics, Engineering, Chemistry Corporation, Boulder, Colorado, to Life Support Systems Laboratory, Aerospace Medical Division, Wright-Patterson Air Force Base, Ohio, Contract No. AF 33(616)-6305 (May 1960), 181 pp (UNCLASSIFIED) (PA 13,474).
- 27) Cogan, D. G., M.D. (Boston), OCULAR EFFECTS OF RADIATION, A.M.A. Archives of Industrial Health, Vol 20, pp 293-296 (July-December 1959) (UNCLASSIFIED) (PA 13,605).
- 28) UNCONVENTIONAL WEAPONS FOR THE 1970 BATTLEFIELD, Melpar, Inc., Falls Church, Virginia (July 1964), 39 pp + appendixes (UNCLASSIFIED) (PA 13,261).
- 29) THE WRECK OF ZIG, The Cleveland Plain Dealer, Cleveland, Ohio (February 25, 1971) (UNCLASSIFIED) (PA 38,762).
- 30) De Groot, W., THE INFLUENCE OF HIGH INTENSITY SOUND ON THE HUMAN BODY, Report No. 125 19 C 7-13, Instituut voor Zintuigfysiologie, the Netherlands (February 17, 1969), 17 pp (UNCLASSIFIED) (PA 33,443), AD 825 066.

UNCLASSIFIED

UNCLASSIFIED

35

Letter concerning use of sonic systems as nonlethal weapons, RACIC R-1347, from D. L. Forward, RACIC, Battelle Memorial Institute, Columbus Laboratories, Columbus, Ohio, to R. Hoyt-Cameron, Defence Research Board, Department of National Defence, Ottawa, Ontario, Canada (March 11, 1968), 2 pp (UNCLASSIFIED).

- (33) Kryster, K. O., THE EFFECTS OF NOISE ON MAN, Report No. 1299, for the period January 1, 1962, to August 31, 1965, from Bolt Beranek and Newman, Inc., Cambridge, Massachusetts, to U. S. Army Medical Research and Development Command, Office of the Surgeon General, Washington, D. C. (UNCLASSIFIED) (PA 19,678), AD 465 636 L.
- (34) Smith, J. J., EVALUATION OF LIGHTWEIGHT, METAL ANTIPERSONNEL OBSTACLES, Report No. 1965, U. S. Army Mobility Equipment Research and Development Center, Fort Belvoir, Virginia (October 1969), 46 pp (UNCLASSIFIED) (PA 37,853), AD 865 076.
- (35) Samuels, D. W., Egner, D. O., and Campbell, D., RIOT CONTROL: ANALYSIS AND CATALOG, Final Report, Report No. 69-14, U. S. Army Limited War Laboratory, Research Analysis Branch, Aberdeen Proving Ground, Maryland (October 1969), 165 pp (FOR OFFICIAL USE ONLY) (PA 39,060), AD 861 296 L.
- (36) Forward, D. L., ADHESIVE RIOT-CONTROL WEAPON SYSTEM, Memorandum for the Record, RACIC, Battelle Memorial Institute, Columbus Laboratories, Columbus, Ohio (November 28, 1967), 1 p (UNCLASSIFIED) (PA 30,538).
- (37) NEWEST ANTI RIOT WEAPON: "PULLETS" OF WOOD, U. S. News and World Report, Vol LXIX, No. 3, p 36 (July 20, 1970) (UNCLASSIFIED) (PA 38,643).
- (38) Packard, H., REMINGTON'S NEW PLASTIC PELLETS, Guns and Ammo, Vol 15, No. 2, pp 52-53 (February 1971) (UNCLASSIFIED) (PA 38,761).
- (39) Young, R. B., NON-LETHAL INCAPACITATION WEAPON (U), Final Report No. LAL-CR-07B69, from AAI Corp., Cockeysville, Maryland, to U. S. Army Limited War Laboratory, Aberdeen Proving Ground, Maryland, Contract No. DAAD05-69-C-0117 (November 1969), 60 pp (CONFIDENTIAL/Group 4) (PA 38,005), AD 509 675 L.
- (40) Williams, L. W., and Hucek, H. J., A COMMENTARY ON SHOT-FILLED BAGS AS A NONLETHAL WEAPON FOR CROWD CONTROL, Reference CR-32, from Battelle Memorial Institute - Columbus Laboratories, Columbus, Ohio, to U. S. Army Land Warfare Laboratory, Aberdeen Proving Ground, Maryland, Contract No. DAAD05-71-C-0163 (December 4, 1970), 15 pp (FOR OFFICIAL USE ONLY).
- (41) Mainhardt, R., THE STUN GUN - A NON-LETHAL WEAPON, Law and Order, Vol 18, No. 10, pp 86-88 (October 1970) (UNCLASSIFIED) (PA 38,639).
- (42) Spring, W. O., NONLETHAL INCAPACITATING WEAPON: EXTENSIBLE BILLY CLUB, Technical Paper No. RAC-TP-194, from Research Analysis Corporation, McLean, Virginia, to Advanced Research Projects Agency, Washington, D. C. (November 1965), 20 pp (UNCLASSIFIED) (PA 19,988).

UNCLASSIFIED

UNCLASSIFIED

50

40. CONDUCT OF OPERATIONS IN MILITARY POLICE OPERATIONS (U), Final Report, for the period September 1, 1969 - October 31, 1969, ACTIV Project 140. ACTIVE, Army Concept Team in Vietnam (May 10, 1970), 89 pp (CONFIDENTIAL/Group 4) (PA 57,955).
41. Eaton, E. M., Seeger, H. G., and Sprang, W. O., A PRELIMINARY FEASIBILITY STUDY OF THE COLD LIQUID WEAPON, Technical Paper No. RAC-TP-178, Research Analysis Corporation, McLean, Virginia (May 1965), 13 pp (UNCLASSIFIED) (PA 16,699).

UNCLASSIFIED

~~CONFIDENTIAL~~

APPENDIX

TABLE AND FIGURES (U)

~~CONFIDENTIAL~~

~~CONFIDENTIAL~~

A-1 and A-2

TABLE 1. CHARACTERISTICS OF CHEMICAL AGENTS

Incapacitating Effect	Agent Symbol or Identification Number	Chemical and/or Common Name	Status	Time to Onset of Symptoms
Irritation	CN	Chloroacetophenone	Standard	Immediate
	CS	O-chlorobenzylidene malonitrile (super tear gas)	Standard	Immediate 10 sec, dependi on conc tration
	EA1277	1-chloro, 9-10 dihydroarsacridine (Excelsior)	Research	Immediate
	EA3625		Research	Almost immedi:
	BBC	Bromobenzyl cyanide	Standard	Immediat
	EA3547 126312 EA3365 EA2542 EA1778 EA4922 Capsaicin			

~~CONFIDENTIAL~~

Time to Onset of Symptoms	Duration of Symptoms	Summary of Characteristics and Remarks
Immediate	About 3 min in clean air	Produces lachrimation and general severe irritation of eyes, nose, throat and chest, together with burning of sweaty skin areas; until recently this was the standard 'tear gas' used for riot control and as a training aid in CB instruction; it is a relatively mild deterrent to motivated personnel
Immediate to 10 sec, depending on concentration	About 10 to 15 min in clean air	Produces choking sensation in throat and upper respiratory tract leading to violent coughing; difficulty in breathing (which tends to induce panic), immediate lachrimation and involuntary eye closure; dizziness, running nose and extreme burning irritation of sweaty skin; high concentrations induce nausea; CS is replacing CN as the standard agent for controlling riots; it is approximately 10 times as effective as CN
Immediate	1 to 5 min; incapacitation symptoms persist for 1 to 2 hr	General severe irritation of chest and throat; lachrimation, running nose, headache
Almost immediate	About 60 min	Effects very similar to those of CS but much longer lasting; the dose required is much higher than that for CS; recent clinical trials suggest that it may be necessary to reject this material
Immediate	Variable, minutes to hours	A liquid tear gas producing severe lachrimation and involuntary eye closure; there is some danger of permanent eye damage from liquid splash

The effects produced by each of these agents are similar in severity to those of CS

(U) ~~(CONFIDENTIAL)~~

Facilitating Effect	Agent Symbol or Identification Number	Chemical and/or Common Name	Status	Type of
Respiratory	DM	Diphenylamine chlorarsine (Adamsite)	Standard	1 to 5
	DC	Diphenyl cyanoarsine	Standard	Immediate
	CN-DM		Standard	Immediate
	228926	N-propylnor-apomorphine		
Cutaneous pain	CX	Phosgene oxime	Research	Immediate eye, skin
		Histamine Eledoisin Brad;kinin	Potential, no current status	Immediate
Temporary blindness	EA1972 (DC)	Dimethyl diglycolate	Research	Immediate
	30:071	N-benzoylpropyl-4-piperidyl phenylcyclopentyl glycolate hydrochloride	Research	
Balance of the		Dichloromethyl ether	Research	Immediate

UNCLASSIFIED

1

UNCLASSIFIED

Time of Onset	Duration of Symptoms	Summary of Characteristics and Remarks
1 to 3 min	15 min to several hours	This agent affects both the respiratory tract and the vomiting center; symptoms include extreme discomfort, nausea, severe coughing and sneezing, lachrimation, severe headache, pain and tightness of chest, continued vomiting; large doses cause diarrhea which may persist for long periods
Immediate	30 to 60 min	Effects very similar to those of DM with a shorter time to onset; large doses will extend nausea and diarrhea to many hours
Immediate	15 min to 2 hr	This mixture produces effects characteristic of both agents, giving immediate onset and symptoms extending over at least 2 hr, according to the dose received Structurally related to apomorphine; rapid acting
Immediate on eyes; 1 to 5 min on skin	Variable 1 to a few weeks	Nettlelike effects with severe burning pain on skin
Immediate Immediate Immediate	Undetermined	Severe incapacitating pain and swelling under skin similar to wasp sting
Immediate	2 to 3 days	Blurred vision, eye fogging, temporary partial blindness resulting from corneal opacity; the effects appear to be completely reversible
- Not known for man -		Clinical trials are required with this material
Undetermined	Undetermined	This effect produces symptoms of unsteady gait, dizziness

(U) ~~CONFIDENTIAL~~

~~CONFIDENTIAL~~

TABLE 1. (Continued)

Interrating Effect	Agent Symbol or Identification Number	Chemical and/or Common Name	Status	
Pronocionable odors		Skatole Mercaptans Pelargonyl morphalide		
	Paralysis	BZ/119902	No names yet assigned to these compounds	Research
		119902/EA3443		Research
		EA 3382		Research
	EA3382/220548		Research	
Anesthesia	EA2148A	Sernyl	Research	2 to
Sleep	302089	Triazaspirodecane	Research	
Orthostatic hypotension	EA2233	3-4, 2-dimethyl-heptyl tetrahydrocannabinol (O-acetyl derivative)	Research	Varia to

~~CONFIDENTIAL~~

Time to Onset of Symptoms	Duration of Symptoms	Summary of Characteristics and Remarks
---------------------------	----------------------	--

- Not known for man -

Some odors are particularly objectionable to certain people; it appears that there is a relationship between racial origin and the acceptability of particular types of odor

- Not known for man -

Anticholinergic effects with those of morphinelike materials will give rapid reversible and long-lasting paralysis as a result of disturbance in function of the central nervous system, impaired motor coordination and, possibly, convulsions; animal results suggest that in man symptoms might appear in 10 to 20 min and persist for several hours; all these mixtures will produce these effects, but clinical research is still awaited to support the use of any as an agent

- Not known for man -

- Not known for man -

- Not known for man -

2 to 10 min

6 to 8 hr

Symptoms induced include ataxia, spatial distortions, nausea, vomiting, and analgesia, leading to anesthesia; low doses produce psychotropic effects while high doses produce anesthesia.

- Not known for man -

Intravenous dose of 0.25 mg/kg produces quiet sleep from which subject can be easily awakened; intravenous dosage of 20 mg/kg produces sedation, allaying of anxiety and reduced motivation

Variable, 15 to 60 min

6 to 24 hr

Lowered blood pressure sufficient for casualty to remain aware of circumstances when prone, any attempt to rise produces immediate collapse; additional effects produced include hallucinations, euphoria ataxia and sluggishness

(U) (CONFIDENTIAL)

CONFIDENTIAL

~~CONFIDENTIAL~~

A-7 and A-8

TABLE 1. (Continued)

Provocating Effect	Agent Symbol or Identification Number	Chemical and/or Common Sense	Status	Time to of Sym
Mental effects	EA1729	D-lysergic acid diethylamide (LSD)	Research	15 min
Prostration	BZ	3-quinuclidinyl benzilate	Standard	1/2 to
	EA3834	4-methyl-4-piperidyl Di-isopropyl phenyl glycolate	Research	
	EA3695	N-methyl-4-piperidyl cyclopropyl phenyl glycolate	Research	
	302196	1-methyl-4-piperidyl cyclopropyl -1-propionyl glycolate	Research	
	226101	1-2-tropanyl-1-cyclopentyl-2-thienyl glycolate	Research	
	302668	4-(1-methyl-1,2,3,6-tetrahydropyridine) methyl α -isopropyl- α -phenylglycolate		
	CS4640	Etonitazine	Research	20 sec
	EA3580-A	N-methyl-4-piperidyl cyclo butyl phenyl glycolate hydrochloride	Research	1 to 2
EA3580-B	(Free base)			

~~CONFIDENTIAL~~

CONFIDENTIAL

Time to Onset of Symptoms Duration of Symptoms Summary of Characteristics and Remarks

15 min 10 to 12 hr The effects of LSD include illusions, mental confusion, faulty sense of time, euphoria, hallucinations and depression accompanied by the physiological effects of stimulation of the central nervous system, sweating, tremors, hypertension, ataxia and prostration

1/2 to 2 hr 2 to 4 hr, possibly up to 5 to 6 days according to dose All these compounds produce anticholinergic effects similar to those of BZ; central and peripheral effects include confusion, hallucination, rapid heart action, lachrimation, headache, extreme drowsiness, tremors, limb weakness and prostration; time to onset of symptoms varies with the several agents between almost immediate and several hours; similarly, duration of these symptoms ranges from minutes to several hours and possibly days; clinical trials are required with all these materials

- Not known for man -

- Not known for man -

- Not known for man -

- Not known for man -

- Not known for man -

20 sec 4 hr Not yet regarded as safe for primates; work is being done to find related compounds with more acceptable safety margin

1 to 2 hr 12 to 18 hr Awaiting further tests on man

- Not known for man - Awaiting further tests on man

(S) (CONFIDENTIAL)

2

100-100000

Incapacitating Effect	Agent Symbol or Identification Number	Chemical and/or Common Name	Status	Time to of Symp
	EA3443	4-methyl-4-piperidyl cyclo butyl phenyl glycolate	Research	5 to 8 h (peak)
	EA3167	3-quinuclidinyl phenyl cyclopentyl glycolate	Research	

(a) Adapted from data in Reference 1.

(b) Mydriasis is a long-continued or excessive dilation of the pupil of the eye.

1

	Time to Onset of Symptoms	Duration of Symptoms	Summary of Characteristics and Remarks
rod	5 to 8 hr (peak effect)	48 to 100 hr (mydriasis) (b)	Similar effects to BZ, but more toxic; no undesirable side effects
rod	- Not known for man -		

(U) (CONFIDENTIAL)

UNCLASSIFIED

A-11

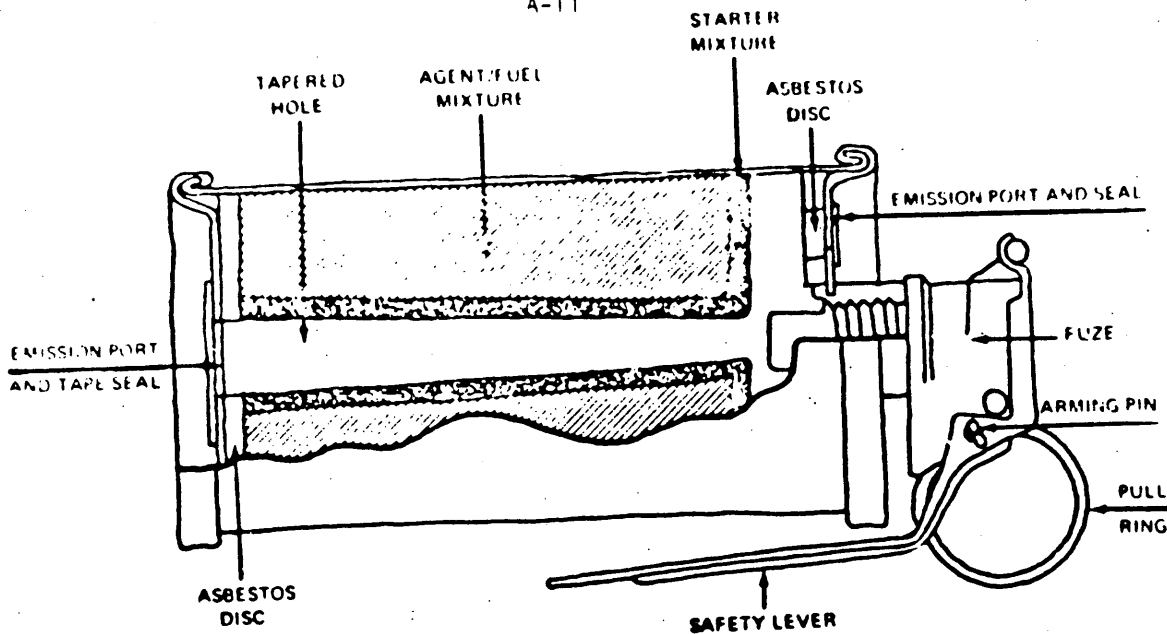

FIGURE 1. MILITARY M7A3 GRENADE (U)

(U) **Description:** The ARC-M7A2 and M7A3 CS riot hand grenade is a cylindrical metal container filled with pyrotechnic CS mixture and fitted with an M201A1 grenade fuze which is screwed into a fuze adapter in the top of the grenade. Three emission holes are located in the top of the grenade. The emission holes are covered with adhesive tape to protect the filling from moisture. The M7A2 differs from the M7A3 only in the way in which the fill is manufactured. The M7A2 is filled with a pyrotechnic mix and powdered CS agent in gelatin capsules. The M7A3 is filled with a pyrotechnic mix and pelletized CS agent.

(U) **Characteristics:**

Total Weight	16 oz	Fuze Time	0.7 to 2.0 sec
Filler Weight	9.5 oz	Burning Time	15 to 35 sec
Height	5-3/4 in.	Range	35 m (hand tossed)
Diameter	2-1/4 in.		145 m (rifle fired)
Container Body		Manufacturer	Military
Material	Steel		

UNCLASSIFIED

UNCLASSIFIED

A-12

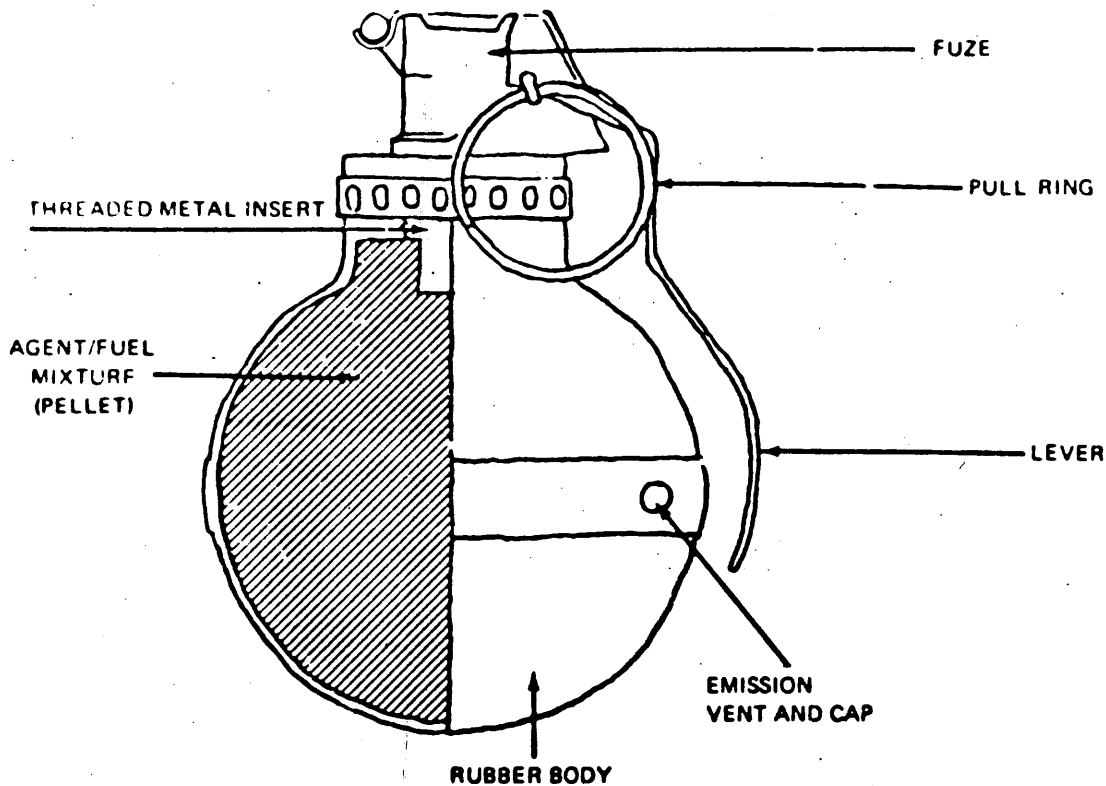

FIGURE 2. NORTHROP RUBBER BALL GRENADE (U)

(U) Description: This device, available to law enforcement agencies, contains 60 grams of CS and 40 grams of pyrotechnic agent. Four emission holes are located in the body of the grenade. During discharge the grenade moves rapidly along the ground, propelled by the escaping agent. There is no explosion or fragmentation of the grenade body.

(U) Characteristics:

Total Weight	0.46 lb	Fuze Time	2.5 sec
Filler Weight	100 g	Burning Time	10 sec
Height	4-3/4 in.	Range	Hand tossed
Diameter	3-1/4 in.	Manufacturer	Northrop Carolina, Inc.
Container Body Material	Rubber		

(Drawing and data from Reference 3.)

UNCLASSIFIED

UNCLASSIFIED

A-15

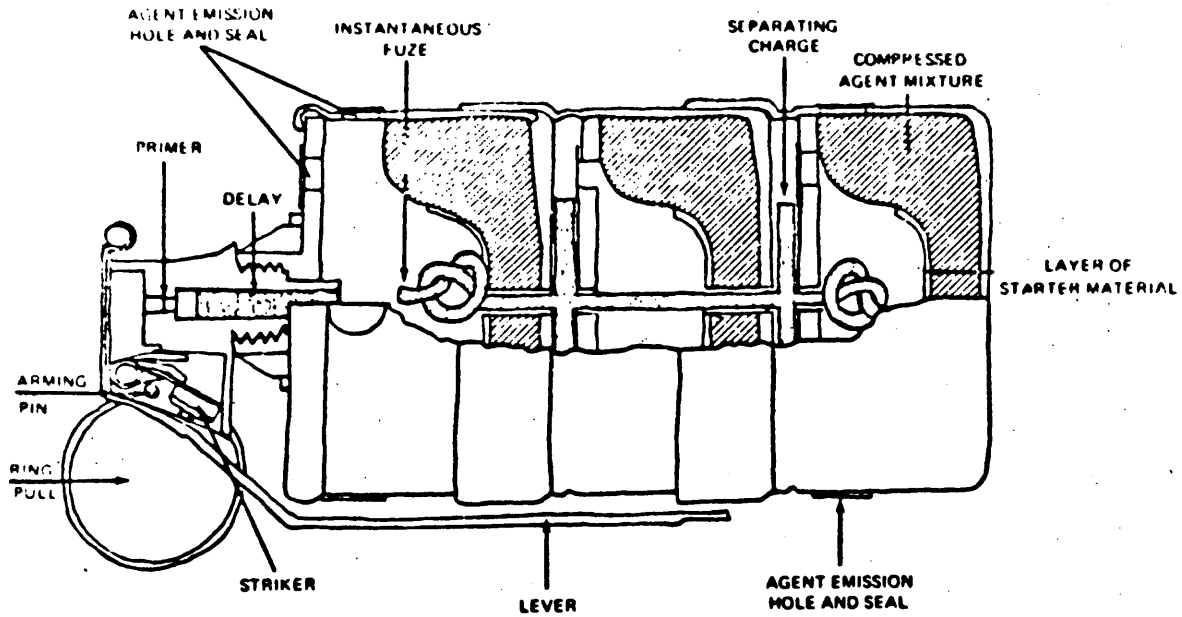

FIGURE 3. FEDERAL TRIPLE CHASER GRENADE (U)

(U) Description: Available to civil law enforcement agencies, this grenade separates into three parts which bounce along the ground, functioning like three separate grenades. Agent is discharged from the emission holes in each section. There is no further explosion or fragmentation of the three sections once initial separation has taken place⁽³⁾.

(U) Characteristics:

Total Weight	24 oz (CN) 20.5 oz (CS)	Fuze Time	2 sec
Filler Weight	290 g (CN) 265 g (CS)	Burning Time	25 sec
Height	6-1/4 in. (with fuze)	Range	Hand tossed
Diameter	2-5/8 in. (at base)	Manufacturer	Federal Laboratories, Inc.
Container Body Material	Aluminum		

(Drawing and data from Reference 3.)

UNCLASSIFIED

UNCLASSIFIED

VII

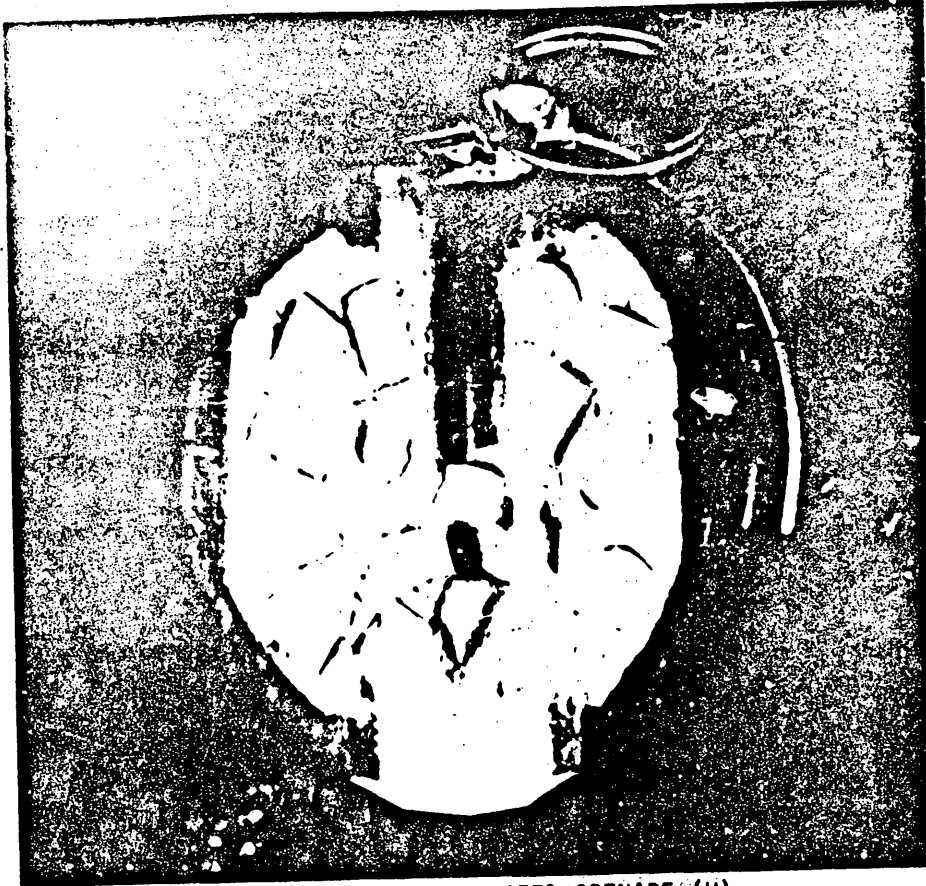

FIGURE 4. MILITARY XM47E1 GRENADE (U)

(U) Description: The XM47E1 is intended to replace the M7 series grenade now in use. The CS pyrotechnic mixture will effectively blanket an area of at least 150 square meters to a height of at least 2 meters. The range and the downwind area affected by the agent will vary somewhat with the velocity and direction of the wind. The XM227E1 fuze contains two safety features: the safety pin and the safety latch. The safety pin is located through the safety latch and the XM227E1 fuze body. The safety latch, a component of the safety lever, is engaged with a lock pin located through the XM227E1 fuze body.

(U) Characteristics:

Total Weight	350 to 400 g	Fuze Time	2 ± 7 sec
Filler Weight	200 g	Burning Time	
Shape	Spherical	Range	Hand tossed (approx. 35 to 45 m)
Diameter	3-1/2 in.	Manufacturer	Military
Material	Rubber		

UNCLASSIFIED

UNCLASSIFIED

A-15

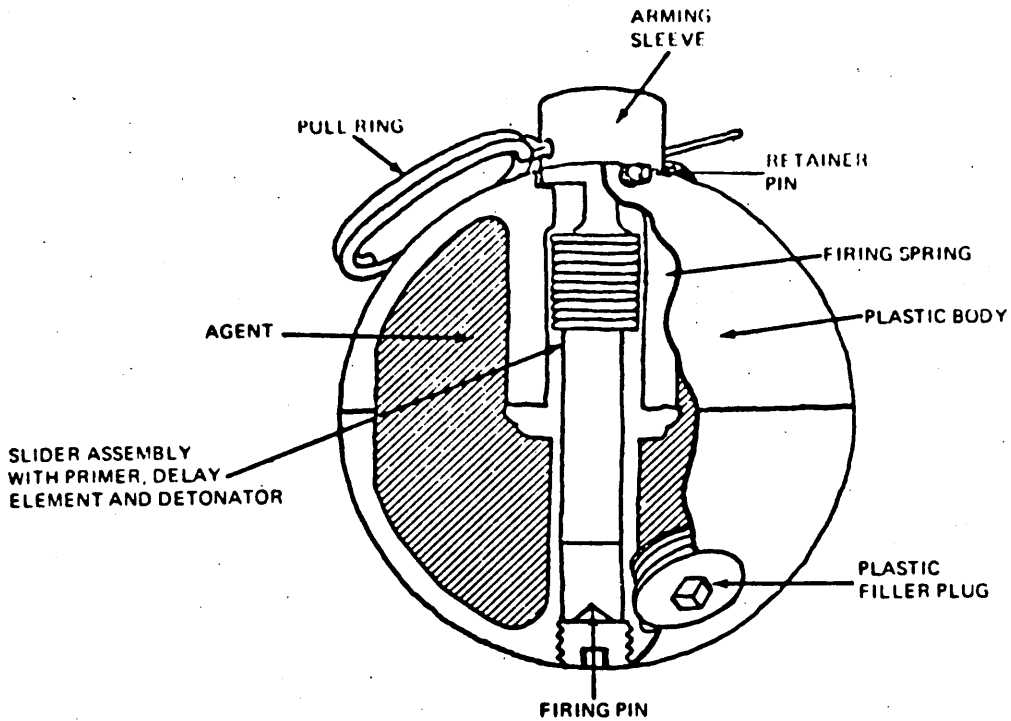

FIGURE 5. MILITARY M25A2 CS1 GRENADE (U)

- (U) **Description:** This grenade is a special-purpose, bursting-type used to control riots, mobs, and other disturbances. It is designed to minimize casualties from flying fragments by utilization of a frangible plastic body.
- (U) The spherical body of the grenade consists of two plastic hemispheres cemented together. The grenade is filled with approximately CSI (micropulverized CS) and is fitted with a detonator-type fuze. The fuze assembly is contained in a slider which moves in an integrally molded burster well. A safety pin retains an arming sleeve which controls the fuze action. After the safety pin is withdrawn, release of the arming sleeve permits the spring-loaded slider to travel the length of the burster well to impact on a firing pin at the bottom of the well, exploding the detonator, shattering the grenade, and dispersing the CSI filling.
- (U) **Characteristics:**
- | | | | |
|--------------------------------------|---------------------------|------------------------|-------------------------------|
| Total Weight | 8 oz | Fuze Time | 1.4 to 3 sec |
| Filler Weight | 2 oz | Burning Time | |
| Height | 3-5/16 in.
(with fuze) | Range | Hand tossed
(approx. 40 m) |
| Diameter | 2-7/8 in. | Manufacturer | Military |
| Container Body
Material | Plastic | | |

(Drawing from Reference 3; data from References 3 and 8.)

UNCLASSIFIED

UNCLASSIFIED

A-11.

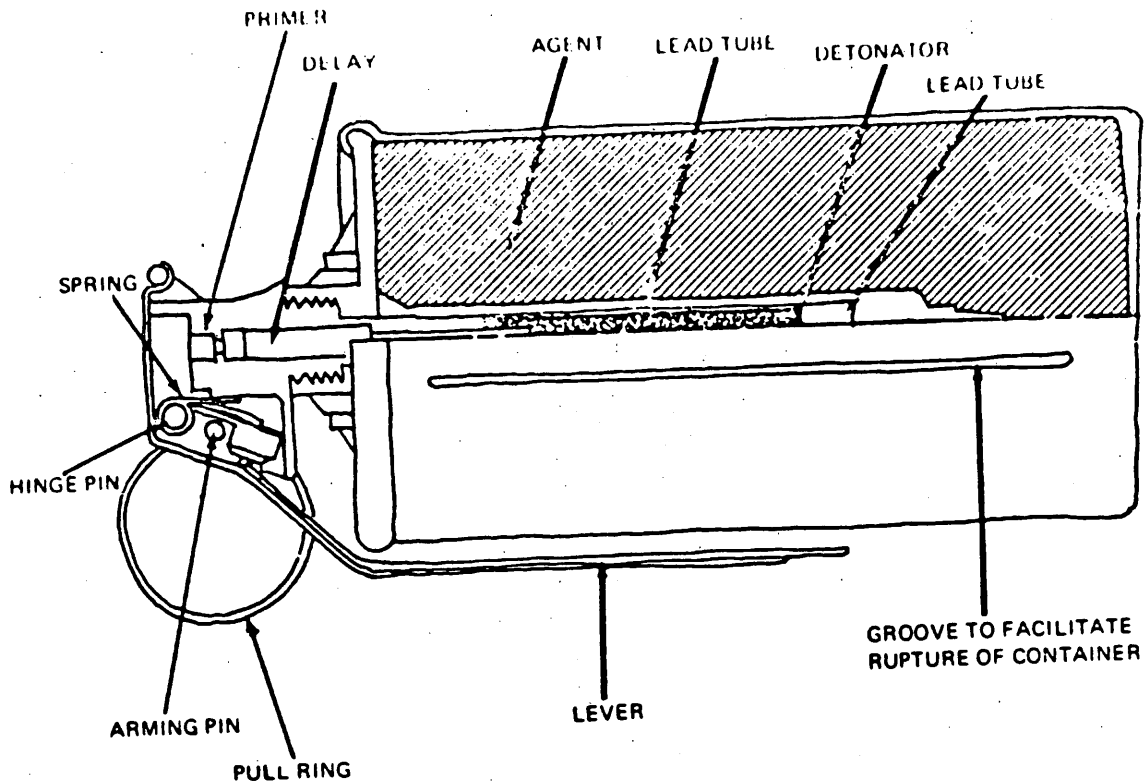

FIGURE 6. FEDERAL BLAST DISPERSION GRENADE (U)

(U) Description: This grenade, contains either CN or CS, has a fuze time of 2 seconds. Upon detonation, the container ruptures along the grooves its side and releases a cloud of agent. Discharge is instantaneous. The metal body remains in one piece, with only the fuze and top plate being thrown clear during the functioning of the grenade.

(U) Characteristics:

Total Weight	15-1/2 oz (CN) 15 oz (CS)	Fuze Time	2 sec
Filler Weight	220 g (CN) 220 g (CS)	Burning Time	
Height	6-1/4 in.	Range	Hand tossed
Diameter	2-5/8 in. (at base)	Manufacturer	Federal Laboratories, Inc.
Container Body Material	Aluminum		

(Drawing and data from Reference 3.)

UNCLASSIFIED

UNCLASSIFIED

A-17

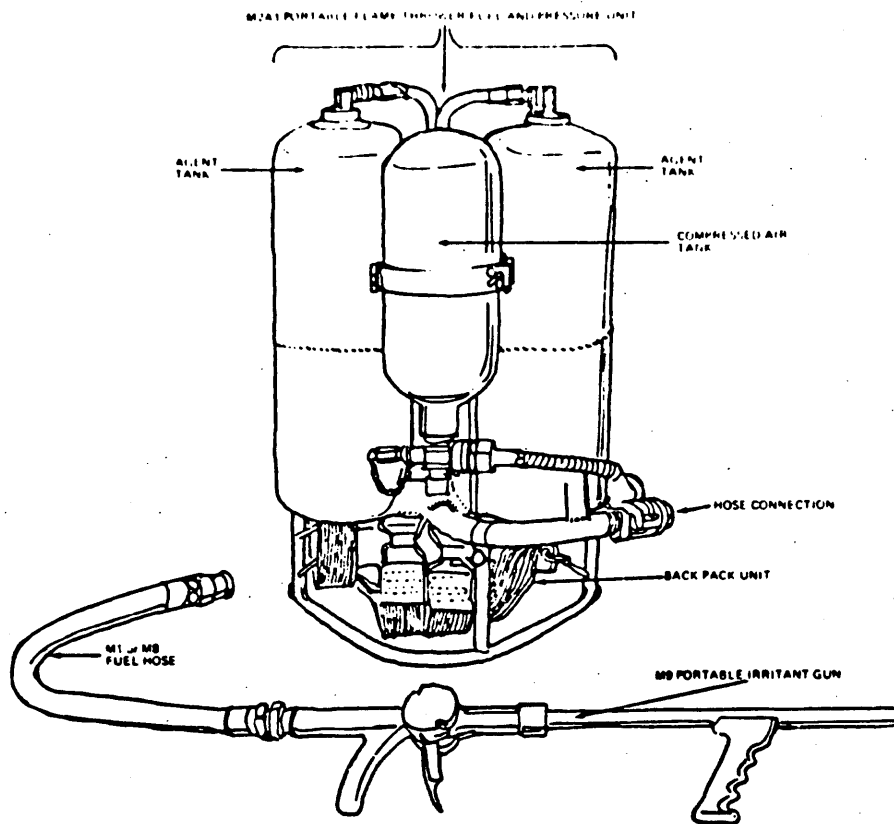

FIGURE 7. MILITARY DISPERSER, RIOT CONTROL AGENT, PORTABLE, M3 (U)

(U) Description: The M3 disperser is designed to disseminate micropulverized riot-control agents. It consists of an M9 disperser gun connected by an M8 hose to a modified M2A1 Portable Flamethrower Fuel and Pressure Unit. The M9 gun permits release of micropulverized CS (CS-1) in short bursts or in one continuous discharge. This is a military unit but may be loaned to civilian police agencies under emergency conditions.

(U) Characteristics:

Weight (Operational) . . .	55 lb (approx.)	Range	40 ft (in still air)
Operating Pressure .	30 to 90 psi (discharge)	Duration of Fire	20 sec
Available Air Pressure	1700 to 2100 psi (high pressure section)	Area Coverage . . .	2300 to 3800 m ²
Agent Capacity . . .	8 lb of CS1 (4 lb in each tank)	Manufacturer . . .	Military

(Drawing from Reference 3; data from References 3 and 8.)

UNCLASSIFIED

UNCLASSIFIED

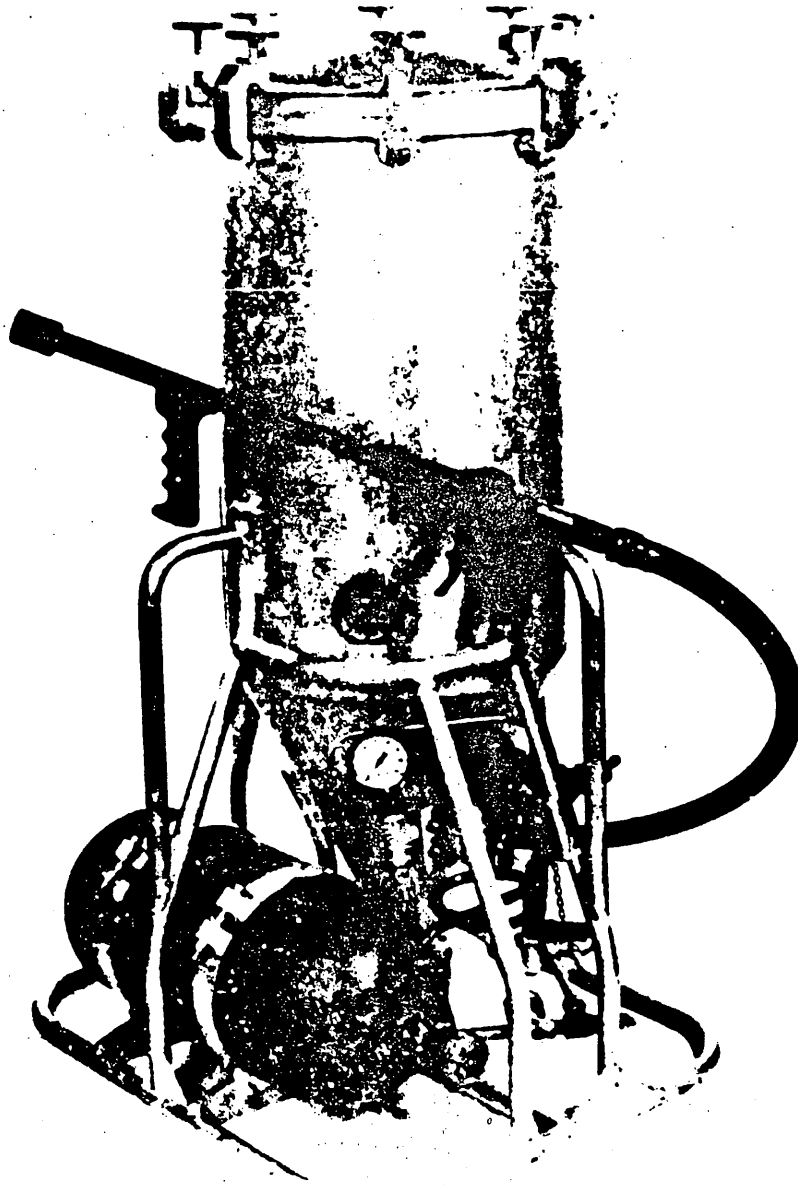

FIGURE 8. MILITARY DISPERSER, RIOT CONTROL AGENT,
HELICOPTER- OR VEHICLE-MOUNTED, M4 (U)

Description: The M4 riot control agent disperser is a helicopter- or vehicle-mounted riot control agent disperser. It is used to disperse riot control agents in the form of a gas, smoke, or tear gas. The disperser is used to disperse riot control agents in the form of a gas, smoke, or tear gas. It consists of a hopper, a pressure

UNCLASSIFIED

UNCLASSIFIED

This assembly, a pressure regulator, various controls and instruments, and a hose assembly mounted on a tubular frame. It is intended to be filled immediately before use. The container is a sheet aluminum cylinder. Self-stow straps are provided for securing the dispenser in the helicopter or vehicle. A 10-foot discharge hose is furnished for discharging the agent outside the helicopter or vehicle. A flexible nozzle (for helicopter hoisting) and an M9 irritant agent dispenser gun (for vehicle hoisting) are provided; either can be attached to the 10-foot discharge hose. The M4 dispenser may be mounted in the cargo compartment of the Army helicopters H-19 or larger. The major advantage of this means of dissemination is the large area coverage achieved and the ability of the helicopter to hover or fly slowly over a specific area while dispersing an agent.

(U) Characteristics:

Weight (Operational) . . .	208 lb	Duration of Fire . . .	2 min (gun) 20 sec (helicopter hose)
Operating Pressure .	45 ± 5 psi (discharge)	Area Coverage	Discharge distance: 1200 to 1500 m
Available Air Pressure	2000 psi (high- pressure section)	Manufacturer	Military
Agent Capacity . . .	50 lb of CS1		
Range	40 ft (in still air [with gun]) 50 to 150 ft from helicopter (helicopter elevation; 75 to 100 ft)		

(Photo and data from Reference 8.)

UNCLASSIFIED

UNCLASSIFIED

A-20

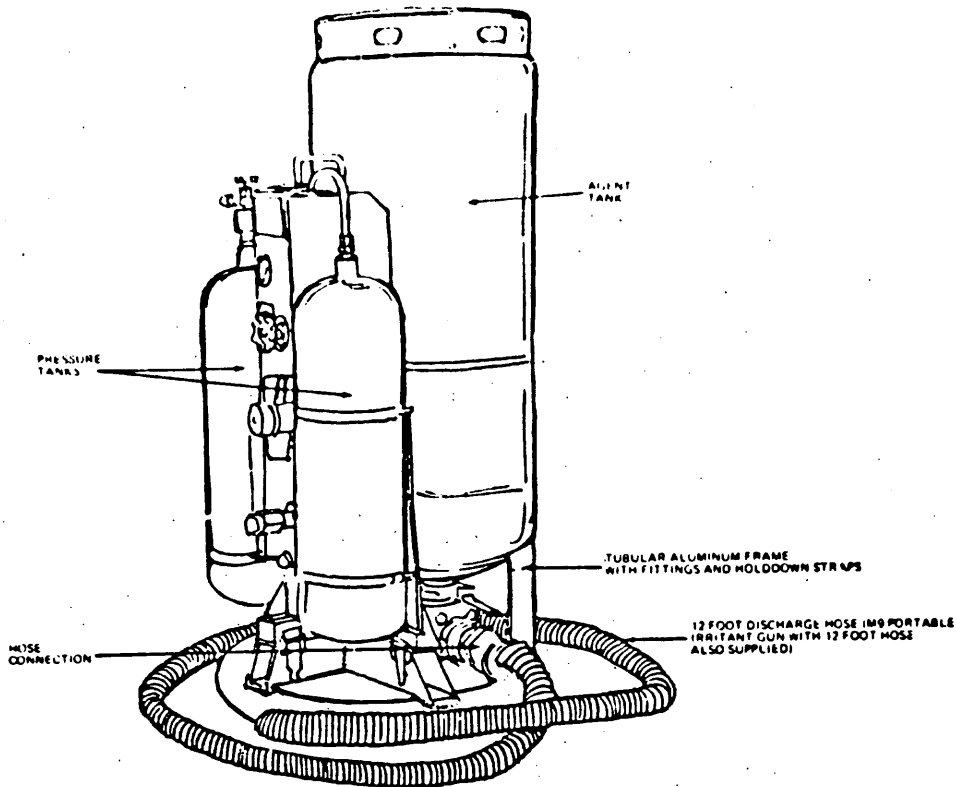

FIGURE 9. MILITARY DISPERSER, RIOT CONTROL AGENT, HELICOPTER- OR VEHICLE-MOUNTED, M5 (U)

- (U) Description: The M5 disperser is designed to disseminate micropulverized riot-control agents either from the air or from a vehicle. The M5 is a product improvement of the M4; it is lighter in weight, has a larger volume of discharge air, utilizes commercially available components, is simpler to operate, and can utilize prefilled agent containers. Field filling of the agent container can also be accomplished. The M5 disperser consists of an agent container tank, two air cylinders, a tubular aluminum frame, an M9 riot-control-agent disperser gun (for vehicle mounting) with a 12-foot hose, a 12-foot discharge hose (for helicopter mounting), and various controls and instruments. Fittings and holddown straps are provided for securing the disperser in a helicopter or ground vehicle.

UNCLASSIFIED

UNCLASSIFIED

A-21

(c) Characteristics:

Weight (Operational) . . .	200 lb	Duration of Fire . . .	2 min (gun) 20 sec (heli- copter hose)
Operating Pressure .	45 to 55 psi (discharge)	Area Coverage	50,000 m ² (est.)
Available Air Pressure	200 to 2000 psi (high-pressure section)	Manufacturer	Military
Agent Capacity . . .	40 lb of CS1		
Range	40 ft (in still air [with gun]) 50 to 150 ft from helicopter (helicopter elevation: 75 to 100 ft)		

(Drawing from Reference 3; data from Reference 8.)

UNCLASSIFIED

UNCLASSIFIED

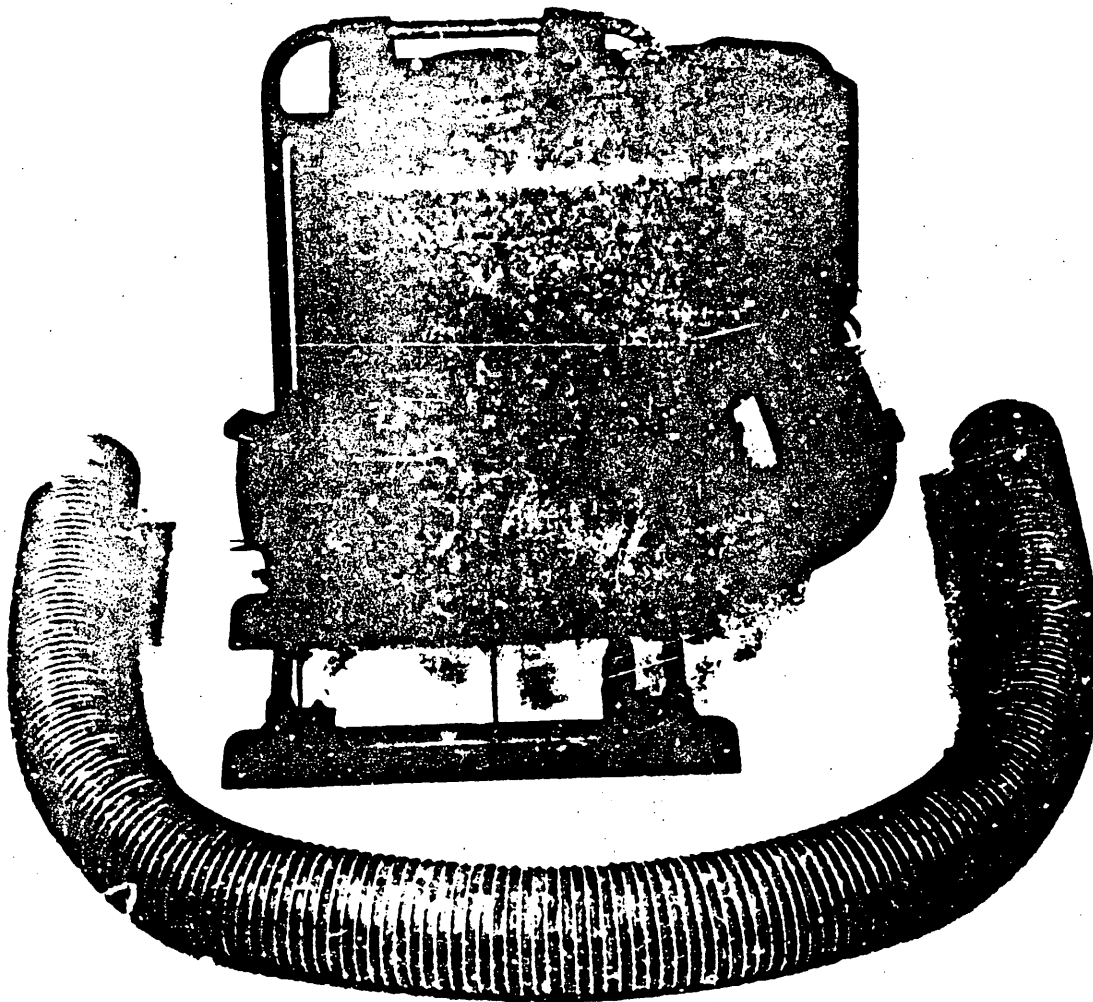

FIGURE 10. MILITARY DISPENSER, RIOT CONTROL AGENT, PORTABLE, M106(8) (U)

- (U) Description: The M106 dispenser is used to disseminate micropulverized riot-control agents for control of riots, mobs, or other disturbances or for such purposes as blowing riot-control agents into tunnels or underground fortifications to flush out personnel from subject area. The M106 dispenser is a commercial agricultural dust-sprayer adapted for military use. It consists of a 450-cfm axial-flow blower powered by a two-stroke gasoline engine. A hopper on the dispenser receives the micropulverized agent to be dispersed, and the blower can be utilized to blow the agent through a separator or plate which disperses agent in such as M7A3 CS grenades through a set area. The separator plate is 1/2, 1, 2, 3, 4, and 6 feet long, depending on the type of agent to be dispersed. The dispenser weighs 25 pounds and is 14 inches high.

UNCLASSIFIED

UNCLASSIFIED

A-15

(U) Characteristics:

Weight (Operational) . . . 35 to 37 lb	Range 40 ft (in still air)
Operating Volume . . . 450 cfm	Duration of Fire. . . 4 to 5 min
Agent Capacity . . . 8 lb of CS1	Manufacturer. Military

(Photo and data from Reference 8.)

UNCLASSIFIED

UNCLASSIFIED

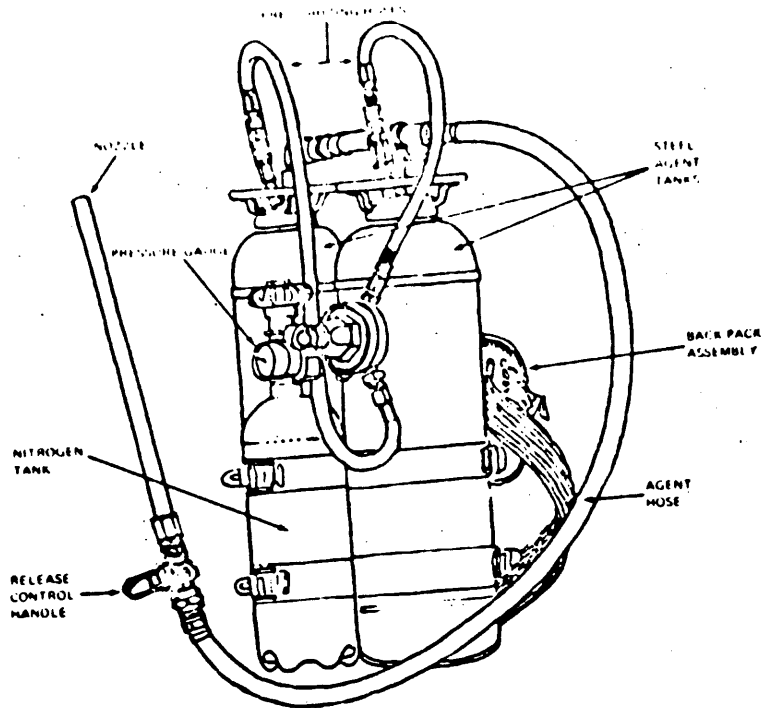

FIGURE 11. PTG-100 AND -200 DISPERSER (U)

(U) **Description:** This disperser (PTG-200 is illustrated above) utilizes either micropulverized CN or CS, with an agent capacity of 5 or 10 pounds, depending on whether one (PTG-100) or two (PTG-200) tanks are used. The unit employs dry nitrogen pressure to expel the chemical agents. The agent is released in short bursts utilizing a trigger located on the discharge hose nozzle. The unit is designed to be reloaded in the field without tools, and agent formulations are available in stainless steel containers to facilitate this operation.

(U) **Characteristics:**

Weight (Operational) . . .	37 lb (PTG-100) 46 lb (PTG-200)	Duration of Fire . . .	Variable
Agent Capacity . . .	5 lb (PTG-100) 10 lb (PTG-200)	Manufacturer	B & H Enterprises, Inc.
Range	75 ft (in still air)		

(Drawing and data from Reference 3.)

UNCLASSIFIED

UNCLASSIFIED

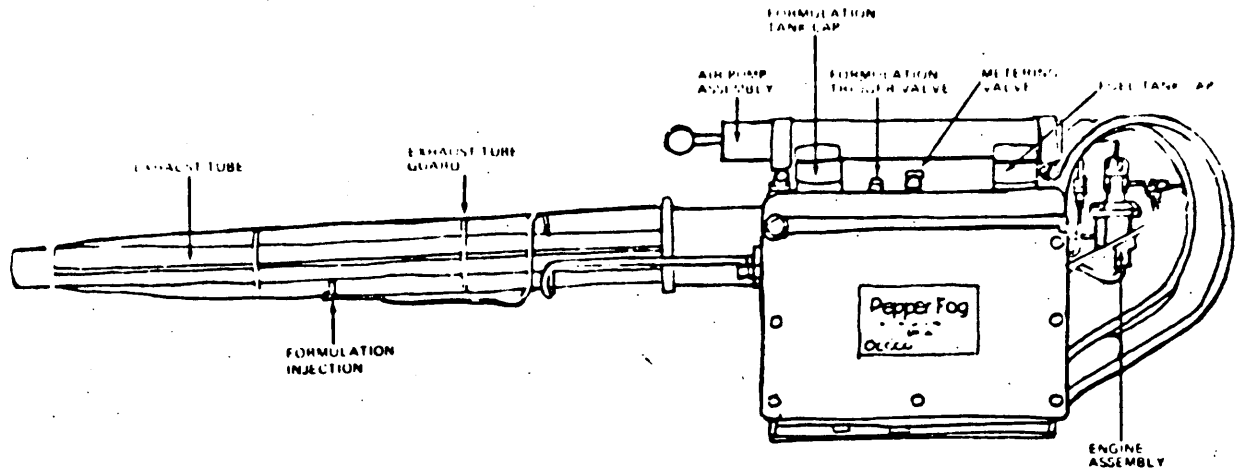

FIGURE 12. GOEC MK-XII PEPPER FOG (U)

(U) **Description:** The Mark XII-A Generator (Pepper Fog) employs the resonant pulse-jet principle to generate hot gases flowing at high velocity. The high-velocity gases atomize the liquid formulation (CS, CN) instantly so that it is vaporized and condensed so rapidly that thermal breakdown of the chemical is nonexistent or negligible. The fog particle size is controllable from 1 to 50 microns and beyond, with smaller particle sizes associated with lower formulation flow rates.

(U) **Characteristics:**

Weight (Operational).	27 lb	Duration of Fire.	10 to 20 min
Agent Capacity	1 gal (liquid)	Manufacturer	General Ordnance Equipment Corporation

(NOTE: specifications are for the newer Mk-XII-A which is shorter in overall length and slightly modified from the Mk-XII shown here.)

(Drawing and data from Reference 3.)

UNCLASSIFIED

FOR OFFICIAL USE ONLY

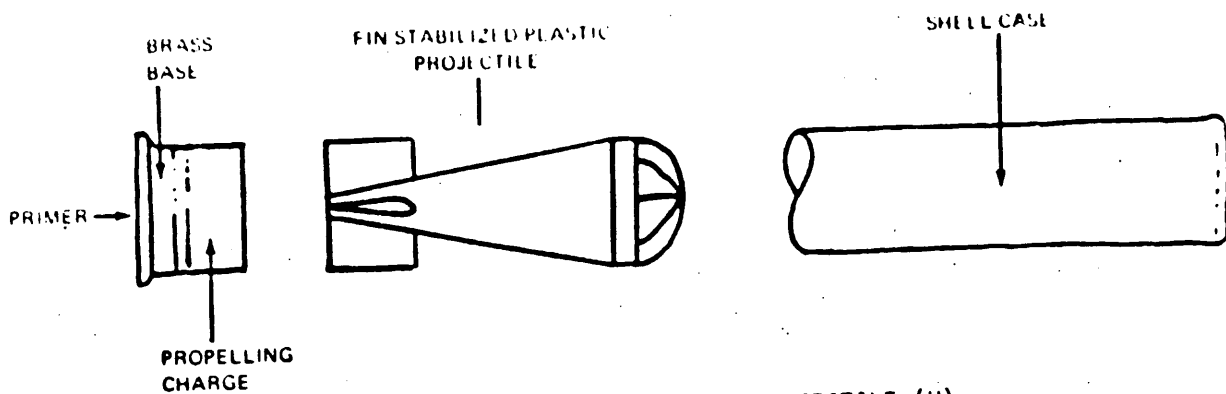

FIGURE 13. AAI SGA-100 BARRICADE PROJECTILE (U)

(U) **Description:** The AAI projectile may be fired from all unchoked 12-gauge shotguns. The injection-molded plastic projectile contains 3 cubic centimeters of CS in solution. One round will effectively contaminate a 9 x 12-foot room. Following impact and perforation of window or plate glass, the projectile disintegrates and instantaneously disseminates the liquid riot agent throughout the enclosed atmosphere in the form of a vapor-microparticle aerosol. The projectile has a flat trajectory out to 100 yards and is nonlethal beyond 250 yards. Tests indicate penetration capability against automotive safety glass at 100-foot range; 1/4-inch-thick plate glass or double window plus aluminum screen at 100-yard range.

(FOUO) This item was tested by Desert Test Center, Dugway Proving Ground, and given a safety release. It was then recommended that the U. S. Continental Army Command make further evaluation. It should be stressed that this can be a lethal weapon if inexpertly handled.

(U) **Characteristics:**

Total Weight	17.2 g	Maximum Range	500 yd
Filler Weight	3 cc	Muzzle Velocity	1000 fps
Fuze Time	Impact	Size	12 ga
Agent Emission Time	Instantaneous	Body Material	Plastic, injection molded
		Manufacturer	AAI Corporation

(Drawing from Reference 3; data from References 3 and 11.)

FOR OFFICIAL USE ONLY

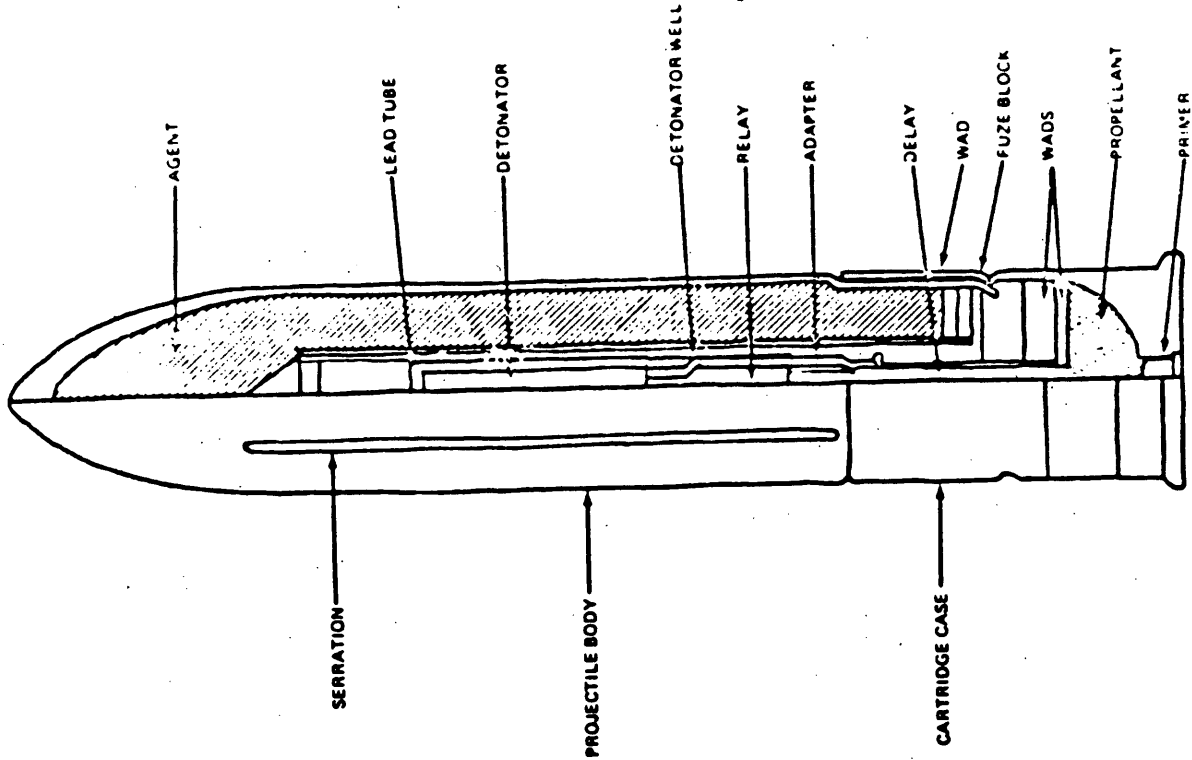

FIGURE 14. FEDERAL MARK 70 PROJECTILE (CS); FEDERAL BLAST DISPERSION PROJECTILE (CN) (U)

(U) **Description:** This munition can be fired from both 37- and 38-mm weapons. At 37.5° elevation the shell will hit the ground at about 90 yards. Shorter ranges are secured by bouncing the shell along the ground or by firing at very high elevation. When the gun is fired the projectile is propelled from the gun and the delay is ignited. Approximately 3 seconds later the delay ignites the burster, which ruptures the projectile along rupture grooves to instantaneously release a cloud of micropulverized agent. The aluminum projectile body will remain in one piece and no metal fragments are thrown off during discharge.

(U) **Characteristics:**

Total Weight . . . 8.5 oz (CS or CN)	Muzzle Velocity . . 140 fps
Filler Weight . . . 80 q (CS or CN)	Caliber 1-1/2 (38 mm)
Delay Time 3 sec	Body Material . . . Aluminum
Agent Emission Time Instantaneous	Manufacturer . . . Federal Laboratories, Inc.
Maximum Range . . . 90 yd	

(Drawing and data from Reference 3.)

UNCLASSIFIED

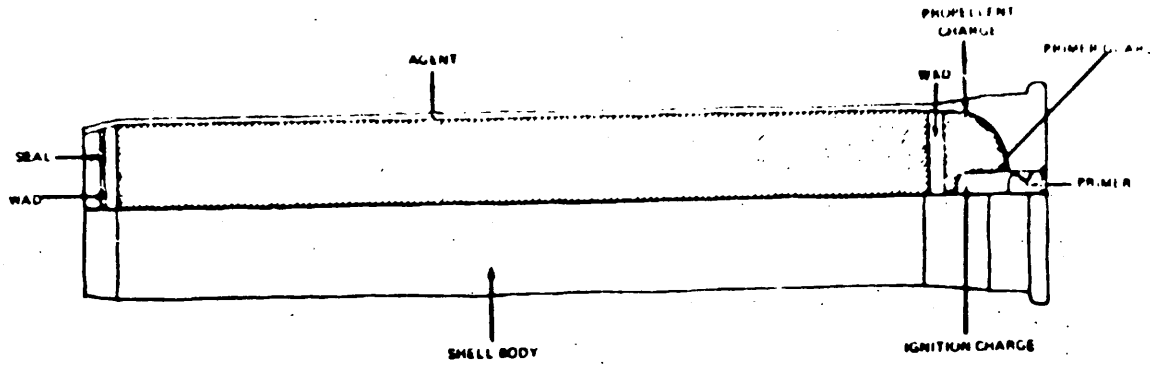

FIGURE 15. FEDERAL SHORT RANGE SHELL (U)

(U) **Description:** This shell is fired directly at the belt level of the target. In still air the maximum immediate range is about 50 feet, but a favorable wind will carry the agent to more than 50 yards. When this shell is fired a cloud of micropulverized agent (CS or CN) is blasted directly from the muzzle of the gun. With the exception of three light wads, the entire discharge consists of filler. This munition can be fired from both 37- and 38-mm weapons.

(U) **Characteristics:**

Total Weight	8 oz (CS or CN)	Caliber	1-1/2 (38 mm)
Filler Weight	8 oz (CS or CN)	Body Material .	Aluminum
Agent Emission Time	Instantaneous	Manufacturer . .	Federal Laboratories, Inc.
Maximum Range	25 to 30 ft (in still air)		

(Drawing and data from Reference 3.)

UNCLASSIFIED

UNCLASSIFIED

A-24

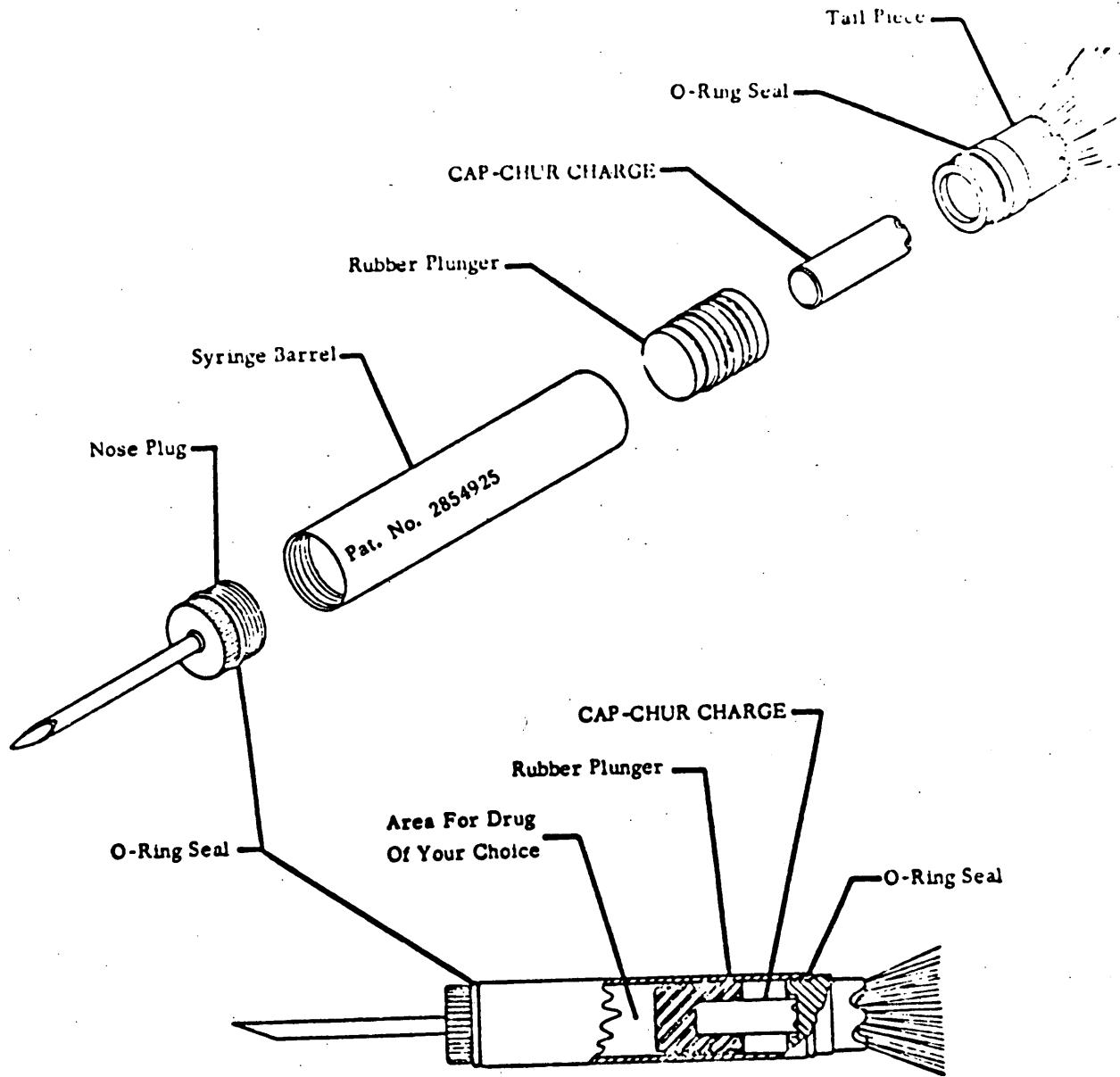
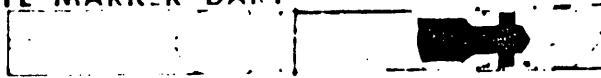

FIGURE 16. FLYING HYPODERMIC SYRINGE (U)

UNCLASSIFIED

UNCLASSIFIED

DYE MARKER DART



This dart is loaded with a non-toxic organic dye of bright yellow fluorescent color. It can be loaded with various liquids such as special stretch liquids or vomit inducers on special military requests.

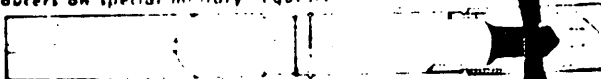

The uses of such a projectile are to mark or identify individuals in a crowd where contact and arrest are impractical. It has the effect of destroying anonymity.

HYPODERMIC SYRINGE PROJECTILE



Hypodermic syringes in dart form for animal control is a proved, practical, humane practice. This projectile can accurately deliver and inject a 1cc dose into unapproachable animals.



Pressurized ampules are available for loading by veterinarians. The serum is injected by compressed air behind a piston after the needle has come to rest in flesh. The dart's superb accuracy is a considerable factor in its usefulness.

TRAINING DART



This projectile is provided in similar weight and balance to the various "line" darts to give a similar trajectory pattern so that the trainee can get the feel of the gun without expending expensive rounds. It can be fired indefinitely at "soft" targets—a mat or pad is suggested as a backstop for training.

TEAR GAS DART



This dart is designed to carry 2 Sec of liquid tear gas that covers an area of 12" to 15" in diameter. It has a safety spring clip. The clip is withdrawn on loading, making the projectile ready for firing.



The tear gas is extremely effective when applied to the person even if the hit is not in the direct area of the eyes. It's practical to shoot at ranges from 10 to 50 yards.

FIGURE 17. MERCURY DART AND OTHER PROJECTILES (U)

UNCLASSIFIED

UNCLASSIFIED

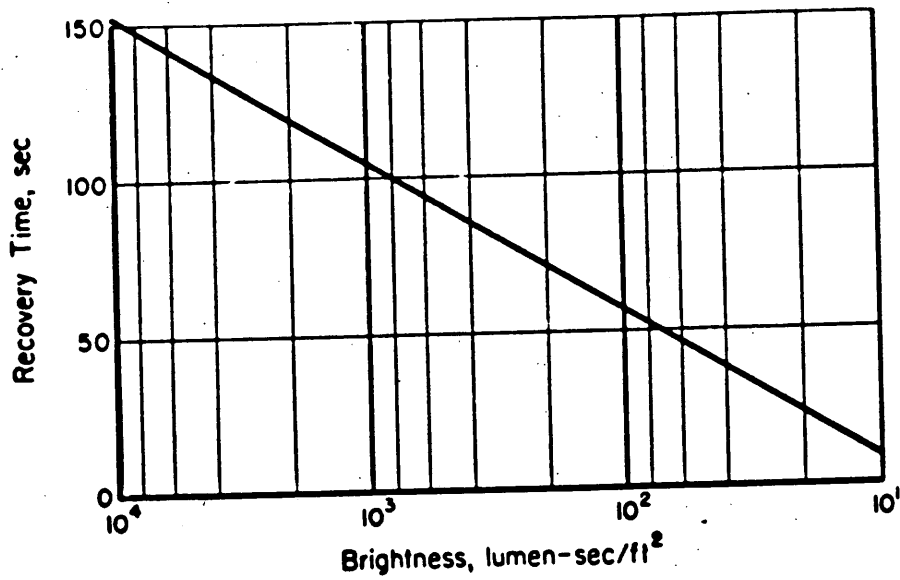
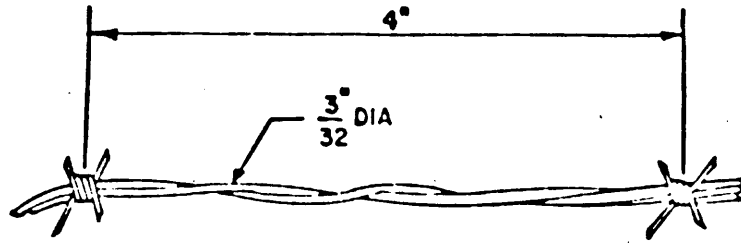

FIGURE 18. RECOVERY TIME FROM FLASH BLINDNESS AS A FUNCTION OF BRIGHTNESS OF FLASH(25)

UNCLASSIFIED

UNCLASSIFIED



A. BARBED WIRE

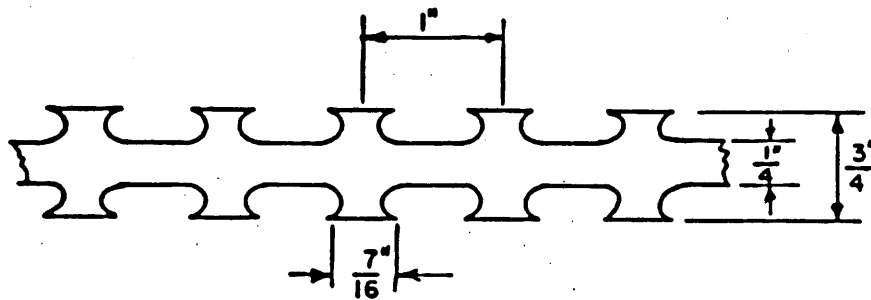

B. GERMAN BARBED TAPE

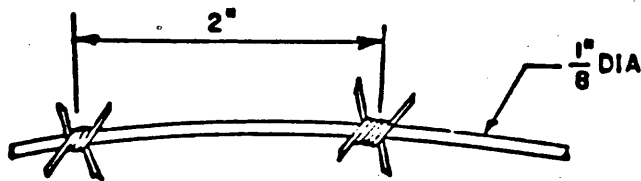

C. BARBED-WIRE CONCERTINA

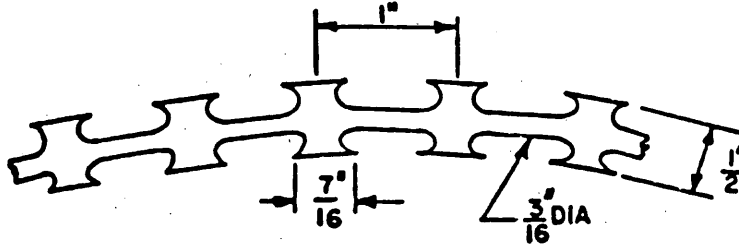

D. GERMAN BARBED-TAPE CONCERTINA

FIGURE 19. OBSTACLE MATERIEL: BARBED WIRE, GERMAN BARBED TAPE, BARBED-WIRE CONCERTINA, AND GERMAN BARBED-TAPE CONCERTINA (U) (33)

UNCLASSIFIED

UNCLASSIFIED

A-47 and A-54

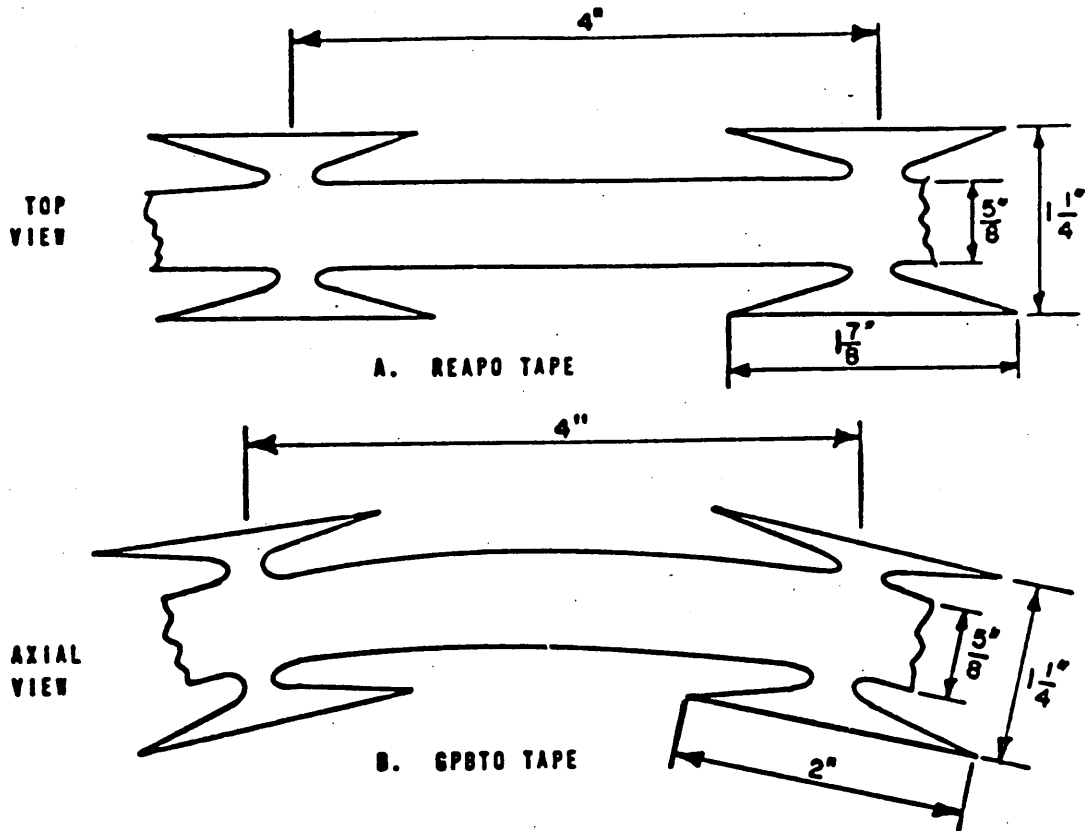

FIGURE 20. OBSTACLE MATERIEL: REAPO TAPE AND GPBTO TAPE (U)⁽³³⁾

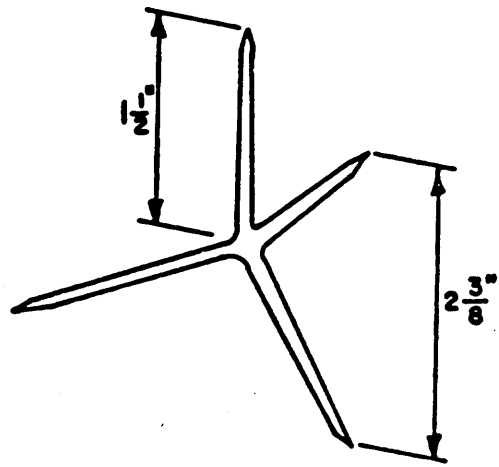

FIGURE 21. OBSTACLE MATERIEL: CALTROP (U)⁽³³⁾

UNCLASSIFIED

~~CONFIDENTIAL~~

ANNOTATED BIBLIOGRAPHY
ON
NONLETHAL WEAPONS (U)

~~GROUP 3~~

~~Downgraded at 5-year intervals; not
automatically declassified~~

~~WARNING~~

~~THIS MATERIAL CONTAINS INFORMATION AFFECTING
THE NATIONAL DEFENSE OF THE UNITED STATES
WITHIN THE MEANING OF THE ESPIONAGE LAWS,
TITLE 18, U.S.C., SECTION 793 AND 794, AS AMENDED.
ITS TRANSMISSION OR THE REVELATION OF ITS CON-
TENTS, IN ANY MANNER TO AN UNAUTHORIZED
PERSON, IS PROHIBITED BY LAW.~~

~~CONFIDENTIAL~~

~~UNCLASSIFIED~~

TABLE OF CONTENTS

	<u>Page</u>
Chemical Agents and Delivery Systems.	1
Electromagnetic Spectrum.	14
Sound	26
Barriers and Deterrent Devices.	35

~~UNCLASSIFIED~~

~~CONFIDENTIAL~~

ANNOTATED BIBLIOGRAPHY
ON
NONLETHAL WEAPONS (U)

Chemical Agents and Delivery Systems

1. Moxelson, M. S., CHEMICAL AND BIOLOGICAL WEAPONS, Scientific American, Vol. 222, No. 5, pp 15-25 (May 1970) (UNCLASSIFIED) (PA 38,134)*.

(U) This paper discusses both lethal and incapacitating chemical and biological weapons, including antiplant agents. An example of an incapacitating biological weapon is Venezuelan equine encephalitis. The risks of using such weapons are discussed and their military shortcomings are considered. Incapacitating chemical agents with both long-term effects (e.g., BZ) and short-term effects (e.g., CS) are discussed. The use of CS and of antiplant agents in Vietnam is reviewed, and the advantages and dangers of such use are discussed.

2. Wilsnack, R. W., et al., COMPREHENSIVE LAW AND ORDER ASSISTANCE RESEARCH AND DEVELOPMENT (CLOARAD PROGRAM), Report No. 70-08, U. S. Army Land Warfare Laboratory, Aberdeen Proving Ground, Maryland (May 1970), 97 pp (FOR OFFICIAL USE ONLY) (PA 38,039).

(U) (FOUO) This report summarizes information that suggests criteria that could serve as general guidelines for improving hardware and tactics for dealing with crowd-control problems. It is suggested that control options should make use of troop mobility, graduated levels of nonlethal force, selective removal of individuals, controlled dispersal, communication with the crowd, observation and identification of crowd participants, and self-policing by members of the crowd. The discussion of nonlethal forces includes consideration of chemical agents.

3. Sidell, F. R., COMPOUND 302,668: AEROSOL ADMINISTRATION TO MAN (U), Report No. EATR-4395, for the period July 1968 - September 1968, Medical Research Laboratory, Edgewood Arsenal, Maryland (May 1970), 27 pp (CONFIDENTIAL/Group 3) (PA 37,960).

(U) Compound 302,668 is a glycolate which has potent anticholinergic activity. In this study, human subjects inhaled an aerosol of the compound to estimate the

*PA numbers identify documents held in the RACIC data base, and PSI numbers identify documents from the Physical Security Information Analysis Center at Battelle; AD numbers indicate documents available from the Defense Documentation Center (DDC), Cameron Station, Alexandria, Virginia 22314. Neither RACIC nor DDC is able to make secondary distribution of these documents; however, they may be requested from the originating agency or DDC.

~~CONFIDENTIAL~~

~~CONFIDENTIAL~~

In a preliminary report by the same group, the LD₅₀ was determined as 1.7 mg/kg body weight, which is about 100 times the concentration of 1.7 mg/m³ (1.7 mg/l). The LD₅₀ for a man breathing normally is 1.7 mg/m³ x 50 x 60 = 61.2 mg. The concentration of 1.7 mg/m³ is maintained for 60 minutes and 1.7 mg/m³ is maintained for 30 minutes, respectively, and the concentration of 0.5 mg/m³ is maintained for 60 minutes and 0.5 mg/m³ is maintained for 30 minutes, respectively. Individual and physiological effects of the compound administered by inhalation are similar to those observed when this compound is given intravenously.

4. Jandart, B. J., STATUS REPORT ON RESEARCH FOR NEW AGENTS - II. INCAPACITATING AGENTS (I), Special Publication EA R-100-70 (May 1970), 77 pp (CONFIDENTIAL/Group 3) (PA 37,957).

(C) Investigations conducted over a 4-year period to identify chemical agents that produce incapacitating effects in 30 seconds to 5 minutes with a 6- to 8-hour duration are reviewed. Data presented include code numbers, chemical structures, toxicological screening data and, for selected compounds, physical constants. No distinction is made as to the relative military potential of one compound over another except insofar as mentioned in discussions of structure-activity relationships.

5. Witten, B., et al., MALODOROUS SUBSTANCES AS RIOT CONTROL AND TROOP TRAINING AGENTS, Report No. EATR-4370, for the period May 1969 - November 1969, Chemical Research Laboratory, Edgewood Arsenal, Maryland (March 1970), 33 pp (UNCLASSIFIED) (PA 37,727).

(U) WHO ME is a malodorous substance, developed during and after World War II, with the chemical composition, by volume: 20 percent phenyl mercaptan, 10 percent diethyl sulfide, 10 percent isovaleric acid, and 60 percent t-butyl mercaptan. This report discusses work to develop WHO ME as a riot-control and troop-training agent. This included work to thicken the substance and development of a frangible dissemination container. The container chosen was a hollow eggshell treated by immersion in a 10 percent waterglass (sodium silicate) solution for several days. The shell was sealed with epoxy cement and a small aluminum cap. Field tests were conducted and it was found that one egg containing about 40 ml of WHO ME readily contaminated the air in summer weather for a distance of at least 100 yards downwind. Psychological tests of the effectiveness of WHO ME are still needed.

- 1.7 mg/m³ - retained dosage which is incapacitating to 50 percent of the subjects.
1.7 mg/m³ - concentration which is incapacitating to 50 percent of the subjects.

~~CONFIDENTIAL~~

UNCLASSIFIED

3

6. Wolford, D. A., and Mershon, M. M., THE CUTANEOUS IRRITANT REACTION TO AGENT O-CHLOROBENZYLIDENE MALONITRILE (CS): I. QUANTITATION AND RACIAL INFLUENCE IN HUMAN SUBJECTS, Report No. EATR-4332, for the period September 1968 - April 1969, Clinical Research Department, Medical Research Laboratory, Edgewood Arsenal Research Laboratories, Edgewood Arsenal, Maryland (February 1970), 26 pp (UNCLASSIFIED) (PA 37,946), AD 865 136 L.

(U) This study confirmed that Negroes are less susceptible to irritant dermatitis from CS2 than are Caucasians. On both forearm and back, the production of minimal perceptible erythema required approximately twice the exposure time on Negroes. If the barrier layer of skin is removed, the difference is lost. There is no racial difference in the stinging sensation caused by CS penetrating through the transappendageal route. The difference in the melanin content of the barrier layer between the two races may account for the difference in reactivity, possibly by reacting with CS.

7. Rengstorff, Maj. R. H., TEAR GAS AND RIOT CONTROL AGENTS: A REVIEW OF EYE EFFECTS, Special Publication No. EASP-100-71, for the period March 1968 - November 1968, Medical Research Laboratory, Edgewood Arsenal, Maryland (February 1970), 16 pp (UNCLASSIFIED) (PA 37,652).

(U) This report summarizes current knowledge regarding the effects of CS and CN agents on human eyes. It draws both on experimental work and on reports resulting from the actual use of these agents. A summary of documented eye injuries involving CN are presented tabularly and discussed in some detail. Causes of these injuries, i.e., the CN or blast and fragments, cannot be determined because of imprecise reporting procedures. Experimental work related to distance from gun to pistol and to the age of pellets is discussed. Experimental work with CS on human volunteers at Edgewood is reviewed. Nothing other than transient effects on the eyes has been found and visual acuity has been found to return to normal several minutes after exposure.

8. Witten, B., THE SEARCH FOR TOXIC CHEMICAL AGENTS (U), Report No. EATR-42, for the period August 23, 1966 - June 1, 1967, Chemical Research Laboratory, Edgewood Arsenal Research Laboratories, Edgewood Arsenal, Maryland (November 1969), 369 pp (CONFIDENTIAL/Group 1) (PA 37,697).

(U) The status of research relating to toxic compounds and their possible role in chemical warfare is reviewed. It contains very detailed information on "standard" chemical agents, irritants, depressants, plant poisons, toxins, and poisonous marine and land animals. The report contains primarily data available up to July 1966.

UNCLASSIFIED

~~CONFIDENTIAL~~

(This Page Is for Official Use Only)

skittering canister to personnel against whom it might be employed. Two sources of hazards were identified: (1) trauma from blunt impact by the canister, and (2) contact burns from the ignited CS-pyrotechnic mix disseminated from the canister orifice.

(U)

(U) Canisters dropped from an altitude of 250 feet, the approximate distance of fall when the item is dropped from a low-flying aircraft, produced little damage when impacted against gelatin-filled and -coated human skulls and live-goat targets. Likewise, the risk of serious injury from skittering canisters is slight except in the case of the eyes.

13. Crockett, T. S., POLICE CHEMICAL AGENTS MANUAL, International Association of Chiefs of Police, Inc., Professional Standards Division, Washington, D. C. (1969), 196 pp (UNCLASSIFIED) (PSI-752).

(U) This report is one of the most complete works available on the chemical agents used by civilian police forces. The various chapters deal with policy and procedure; an introductory discussion of chemical agents; dissemination and delivery systems; the tactical use of chemical agents; aerosol irritant projectors; protective masks; first aid and decontamination; chemical agent training; and prestock, procurement and storage of chemical munitions. Numerous sketches and line drawings are used to represent employment techniques, equipment and munitions. The appendices contain information on legal decisions in cases stemming from the use of chemical munitions.

14. Evans, E. R., RIOT CONTROL DEVICE, VEHICLE CS DISPENSER, Final Report No. LWL-CR-09C68, from AAI Corporation, Cockeysville, Maryland, to U. S. Army Limited War Laboratory, Aberdeen Proving Ground, Maryland, Contract No. DAA05-68-C-0389 (December 1968), 9 pp (UNCLASSIFIED) (PA 34,548).

(U) Units have been developed for dispersing CS from the exhaust of a military jeep. These units are capable of delivering 1 quart of a 4 percent solution of CS in methylene chloride into the exhaust. They operate in 6 to 8 minutes with an engine speed of 1500 to 2000 rpm. When dispersed, the CS solution is completely vaporized by passing through the venturi and covers a large target area in a minimum time. The vehicle's engine and exhaust are not adversely affected by the operation.

15. Stange, H., et al., CAR PROJECT FINAL: INCAPACITATING AGENT RESEARCH (U), Report for the period April 1967 - July 1968, from FMC Corp., Chemical Research and Development Center, Princeton, New Jersey, and Hazeltine Laboratories, Inc., Falls Church, Virginia, to Chemical Research Laboratory, Edgewood Arsenal, Maryland, Contract No. DAA-15-67-C-0484 (October 1968), 74 pp (CONFIDENTIAL/Group 3) (PA 36,154), AD 395 208 L.

(U) The Chemical Agent Research (CAR) Project involved synthesizing or otherwise obtaining chemicals of value

(This Page Is for Official Use Only)

~~CONFIDENTIAL~~

~~CONFIDENTIAL~~

is incapacitants in man and screening them in animals for toxicity and general symptomatology. Compounds that had improved properties over known incapacitating agents, or with unusual biological effects, were studied in detail to qualify them for testing in humans. Seventy-eight new compounds were synthesized under this contract, making a total of 1357 compounds submitted under the CAR project since 1963. Evaluation of several active glycolates culminated in recommendation of CAR 302,775, 3-(1-azibicyclo[2.2.2]oct-2-ene) methyl α -cyclopentyl α -phenylglycolate, for preclinical evaluation. When compared with EA 3580 A, EA 3834, and CAR 302,668, it had the shortest onset time and in the rabbit mydriasis (a long-continued or excessive dilation of the pupil of the eye) test the longest duration. It was found more potent than CAR 302,668 but less potent than the other two compounds.

16. Stahl, C. J., et al., FORENSIC ASPECTS OF TEAR-GAS PEN GUNS, Journal of Forensic Sciences, Vol 13, No. 4, pp 442-469 (October 1968) (UNCLASSIFIED) (PSI-C-504), AD 680 558.

(U) The legal implications related to the offensive and defensive firing of tear-gas pens are discussed, and the pathologic findings in injuries in an experimental animal are presented, as well as an original method for quantitative determination of chloroacetophenone in tissues and body fluids by toxicologic methods.

17. 40-MM CS RIOT-CONTROL CARTRIDGE, XM674, AND 40-MM TRAINING CARTRIDGE, XM675, Technical Information Report No. 36.1.1.8(1), from Research Division, Governmental Affairs Institute, Washington, D. C., to Army Materiel Command, Washington, D. C., Contract No. DAAG39-69-C-0001 (July 1968), 4 pp (UNCLASSIFIED) (PA 33,983), AD 839 969.

(U) This report describes the XM674 40-mm CS riot-control cartridge and the XM675 40-mm red smoke training cartridge. Both can be projected by the M79 grenade launchers or the M8 pyrotechnic pistol or hand-fired to ranges of 70 to 100 meters. They will permeate an area of about 35 square meters to a height of approximately 2 meters.

18. Witten, B., NONLETHAL AGENTS IN CRIME AND RIOT CONTROL (U), Memorandum No. EATM 133-1, Chemical Research Laboratory, Edgewood Arsenal Research Laboratories, Edgewood Arsenal, Maryland (July 1968), 28 pp (CONFIDENTIAL/Group 3) (PA 33,928).

(U) ~~(C)~~ The two most promising classes of incapacitating agents for use in crime and riot control are the sensory irritants and compounds that act on the central nervous system. Sensory irritants are effective on direct contact with the eyes but are not suitable where

~~CONFIDENTIAL~~

UNCLASSIFIED

~~CONFIDENTIAL~~

7

Duration of a film longer than 15 minutes is required. Current research is designed to develop a long-lasting (up to 12 hours). The most promising agents in this second class are anesthetic, analgesic, tranquilizing agents, anti-hyperalgesic, and vomiting agents. These are not instantaneously effective since they must be transported to the site of action, and may take from several minutes to several hours to act. Their duration may vary from hours to days to weeks.

19. HELICOPTER DISPENSER AND BAGGED CS2 RIOT-CONTROL AGENT BY JEM, XMOA, Scientific Information Report No. 36.1:1.15, from Research Staff, University of Pittsburgh, to Army Materiel Command, Research and Development Directorate, Washington, D. C., Contract No. DA-49-186-AMC-214(D) (May 1968), 4 pp (UNCLASSIFIED) (PA 33,069).

(U) A dispenser system for delivering bagged CS2 from helicopters has been developed and tested. The system releases 2,090 0.35-pound bags of powdered CS2 from an altitude of 1500 feet or higher. This amount of CS2 creates an intolerable contamination level over an area about 30 meters wide and 150 to 200 meters long. The dispenser is made of lightweight aluminum and is suspended from the helicopter by means of a sling and cargo hook. Fully loaded, it weighs about 1,000 pounds and any helicopter equipped to lift this weight can be used as a carrier. It can be jettisoned by the pilot at any time.

20. Coates, J. F., SAFE POLICE WEAPONS, Science & Technology, pp 52-59 (May 1968) (UNCLASSIFIED) (PA 29,090).

(U) This short article explains how nonlethal weapons might aid in combatting crime more than does the conventional sidearm. Some of the candidate nonlethal weapons are the tranquilizer dart, tear-gas spray dispensers, and chemical dyes and marking agents. The article also deals somewhat with the philosophical desirability of nonlethal as opposed to lethal weapons.

21. Blumfeld, S. N., EMPLOYMENT OF THE RIOT CONTROL AGENT CS IN VIETNAM (U), Report No. MACV S 001260-68, Office of the Science Advisor, Military Assistance Command, Vietnam (April 30, 1968), 22 pp (SECRET/Group 4) (PA 34,415).

(U) This report traces the history of the employment of CS in Vietnam, and presents current usage practices and doctrine. It includes detailed examples of the actual use of CS weapons and provides a catalog of CS weapons available for use in Vietnam. A picture is given of the present and prospective employment of CS in Vietnam which has been developed from discussions in the field with troops and officers who have employed CS, from interviews and analysis of the use of CS in Hue during the Tet offensive period, from perusal of many after-action reports, including some in which detailed discussion with participants was possible, from news

~~CONFIDENTIAL~~

~~CONFIDENTIAL~~

8

... particularly those involving
... and from detailed inquiry into present
... for combating the enemy in and around the
... and hamlets of Vietnam.

22. H. G. and H. K., NEW IN A LIATIVE AGENT, FINAL SUMMARY
... PRIMARY AND SECONDARY (U), Report No. 655401-1-1, from
... Little, Inc., Cambridge, Massachusetts, and Sterling-Winthrop
... Institute, Rensselaer, New York, to Chemical Research Laboratory,
... Arsenal Research Laboratories, Edgewood Arsenal, Maryland,
... Contract No. DA18-108-AMC-103 (February 1968), 103 pp (CONFIDENTIAL/Group 3)
... (PA 34,758), AD 591 205.

(U) The purpose of this research program was to discover
chemical compounds that incapacitate or immobilize humans.
Approximately 700 numbered compounds were either synthesized
or acquired from other sources. They were examined by a
battery of tests in a variety of animal species and their
types of pharmacological activity and potency were determined.
More than 40 tests were used including the CRL mouse primary
screen and other standard pharmacological procedures. New
procedures were also designed and used to measure specific
types of activity. The compounds studied represented
about 20 chemical classes.

23. Redoff, I. G., and Thuman, W. C., RESEARCH STUDIES ON THE DISSEMINATION OF
SOLID AND LIQUID AGENTS, Final Report for the period April 1964 - December 1967,
from Stanford Research Institute, Menlo Park, California, to Physical
Research Laboratory, Edgewood Arsenal, Maryland (December 1967), 147 pp
(PA 33,090), AD 827 272.

(U) A literature search and a research program were conducted
to provide basic information necessary for an overall
improvement of chemical-agent dissemination techniques.
Emphasis was placed on explosive and pyrotechnic processes.
Material pretreatment, atomization, electrostatics, and
ultrasonic processes were also included. Natural aerosol
formation processes were studied as well to determine if
some aspect of these processes could be adapted to chemical
agent dissemination. This report summarizes the results
of that research and answers many questions that arise
regarding dissemination techniques.

24. 40-MM CS CARTRIDGE, XM651E1 (U), Technical Information Report No. 36.1.1.11,
from Research Staff, University of Pittsburgh, to Army Materiel Command,
Research and Development Directorate, Washington, D. C., Contract No.
DA-4-126-AMC-214(D) (November 1967), 5 pp (CONFIDENTIAL/Group 4) (PA 31,396).

(U) The XM651E1 40-mm CS cartridge is intended for use in
critical situations by conventional forces. It is fired
from the M79 grenade launcher and is effective in small,
critical, enclosed areas up to 5000 cubic feet in volume
and against command posts, gun emplacements, outpost
areas, unarmored troop-carrying vehicles, and similar

~~CONFIDENTIAL~~

CONFIDENTIAL

~~CONFIDENTIAL~~

targets. The round has a point-target CEP (circular error probable) of 2.5 feet when fired against a vertical target at a range of 100 meters.

26. ~~CONFIDENTIAL~~, NONLETHAL WEAPONS FOR USE BY LAW ENFORCEMENT OFFICERS, Study No. 601-1, for the period October 1966 to January 1967, Institute for Defense Analyses, Science and Technology Division, Arlington, Virginia (November 1967), UNCLASSIFIED (PA 30,452), AD 661 041.

(U) This report discusses the role of nonlethal weapons in law-enforcement activities. They are considered appropriate for two major classes of situations: those in which an organized group of officers is confronted with a large number of people who must be controlled or dispersed; and those in which one or a few officers must apprehend one or more criminals or suspects or are confronted with people who must be controlled. Recommendations are made regarding research and development that is needed in the areas of weapon development, problem analysis, determination of objectives, test and evaluation, and reportage and training. Chemical weapons discussed include Mace, long-range spray guns, specific agents, darts, and methods of indirect incapacitation, such as vomiting agents and sneezing powders.

26. RIOT-CONTROL-AGENT CS, MUNITIONS, AND DISPENSERS (U), Technical Memorandum No. EATM 601-1, Customer Relations and Commodity Management Office, Edgewood Arsenal, Maryland (October 1967), 39 pp (CONFIDENTIAL/Group 3) (PA 31,982), AD 384 192 L.

(U) This report reviews the characteristics and effects of CS agent. It also discusses the standard CS munitions and dispenser systems.

27. CHARACTERISTICS OF RIOT CONTROL AGENT CS, Special Publication No. EASP-600-1, Edgewood Arsenal, Maryland (October 1967) (UNCLASSIFIED) (PSI-C-440), AD 661 319.

(U) This is a brief report summarizing current knowledge on the riot-control agent CS, its history, its characteristics, its dispersal, its effects, and its safety factor.

28. CS RIOT HAND GRENADE, XM47, AND SIMULANT RIOT HAND GRENADE, XM48, Technical Information Report No. 36.1.1.9, from Research Staff, University of Pittsburgh, to Army Materiel Command, Research and Development Directorate, Washington, D. C., Contract No. DA-49-186-AMC-214(D) (June 1967), 3 pp (UNCLASSIFIED) (PA 28,593).

(U) This report describes the XM47 nonlethal CS riot hand grenade and the XM48 PS/WS (red or white smoke) training version of it. Both grenades are spherical casings of rubber, about 3-1/2 inches in diameter, containing about thirteen 1/2-grain capsulated submunitions and equipped with pushbutton initiators. At a range of 35 to 45 meters, their contents will permeate an area of 150 square meters to a height of about 2 meters.

~~CONFIDENTIAL~~

~~CONFIDENTIAL~~

30. Ellis, R. H., LEADERSHIP EVALUATION OF THE USE OF INCAPACITATING CHEMICAL AND BIOLOGICAL WEAPONS IN LOW-INTENSITY WARFARE (U), Technical Paper No. DA-44-188-1, from Research Analysis Corporation, McLean, Virginia, to Department of the Army, Washington, D. C., Contract No. DA-44-188-ARG-1 (April 1967), 90 pp (SECRET/Group 3) (PA 35,762), AD 585 694 1.

(U) This study analyzes the use of incapacitating chemical and biological weapons in a counterinsurgency situation within the 1945-1971 time frame, with reference to the following broad areas of policy concern: escalation, command and control problems, and political constraints. Implications are derived in the following policy-related areas: (a) limitations on conflict intensity and related limitations on and opportunities for chemical and biological weapon use, (b) the possibility of an overextension of Free World forces in the face of a growing threat of insurgency and instability, and (c) the development of multinational counterinsurgency forces and its implications for the use of chemical and biological weapons.

30. Mombasse, R. M., RIOTS, REVOLTS AND INSURRECTIONS, Springfield, Illinois, Charles C. Thomas (1967), 523 pp (UNCLASSIFIED) (PSI-159).

(U) Chapter 25 deals with the use of the baton, chemical agents, smoke, water, dogs, and sound to combat crowds.

31. Ellis, R. H. (TRC), and Kellogg, J. C. (TPC), IMPLICATIONS OF THE USE OF INCAPACITATING AGENTS IN WARFARE (U), Report No. 7675-2225, from The Travelers Research Center, Inc., Hartford, Connecticut, and Technology Planning Center, Inc., Ann Arbor, Michigan, to Headquarters, U. S. Air Force, Washington, D. C., Contract No. AF 49(638)-1584 (September 1966), 490 pp (SECRET/Group 3) (PA 25,492).

(U)

(U) The purpose of the study is to assess the implications of the use of incapacitating weapons in limited war and counterinsurgency operations by an investigation in accordance with the following study objectives: (1) identify probable developments in incapacitating chemical and biological weapons and agents appearing to offer greatest potential; (2) analyze military utility for limited war and counterinsurgency and present concepts for exploitation; (3) assess political-psychological implications based on a historical survey of expressed attitudes within the leadership element of the U. S., and on informed public opinion; and (4) examine military and political usefulness by comparison with the domestic attitudes toward lethal weapons.

~~CONFIDENTIAL~~

UNCLASSIFIED

UNCLASSIFIED

11

Smith and Wesson, Inc., and Wessco, Inc., UNCLASSIFIED DART-MUNITION, Patent No. 3,122,777, assigned to the United States of America and represented by the Secretary of the Army, filed January 18, 1965, Serial No. 429,444, patented August 11, 1965 (PA 25,419).

(U) This patent covers a device for delivering a number of tear-gas dispensers in a frangible canister. After dispersal from the canister, each sub-munition is to burn a propellant and tear-gas mixture. The advantages of this device for dispersing a tear-gas agent is that each sub-munition is propelled along the ground and becomes hot as the propellant burns. These two factors make it difficult for a person to pick it up and throw it back at control personnel.

23. Neesee, M., NEW DART GUNS FIGHT CRIME!, Guns and Ammo, Vol 10, No. 8, pp 36-39 (August 1966) (UNCLASSIFIED) (PA 25,419).

(U) The Smith and Wesson-Mercox Dart Projectile Gun is designed for special-situation police and military use where conventional weapons are not desirable. The gun uses .22-caliber blanks to propel a dartlike projectile at various velocities. The darts may carry any of several payloads or warheads, including marking dyes, shaped charges, and hypodermic syringes.

24. PROGRESS REPORT, U. S. Army Limited War Laboratory, Aberdeen Proving Ground, Maryland (June 30, 1966), 182 pp (CONFIDENTIAL/Group 4) (PA 26,286), AD 374 723 L.

(U) This document presents a description and status report of all tasks included in the FY 66 program of the U. S. Army Limited War Laboratory. A number of nonlethal weapon studies are included: application of selected CW agents in unconventional warfare; miniature CS disseminator and personnel marking.

25. Sadove, M. S., Schmidt, J. L., and Lutz, G. A., STATE-OF-THE-ART STUDY ON IMPAIRMENT OF VOLUNTARY MUSCULAR ACTIVITY (U), Report No. BAT-171-17, from PACIO, Battelle Memorial Institute, Columbus Laboratories, Columbus, Ohio, to Advanced Research Projects Agency, Washington, D. C., Contract No. SD-171 (February 15, 1966), 155 pp (SECRET/NOFORN/Group 1) (PA 9417), AD 370 233.

(U) A study was conducted to provide guidelines for obtaining incapacitating agents that act by impairing voluntary muscular activity. Although many such drugs are available, an agent is needed that will be practical where subjects are not under control. A wide variety of agents are discussed. These include curariform drugs, sedatives, tranquilizers, analgesics, hallucinogens, antihistamines, seizure-producing drugs, tremor-producing drugs, myalgia-producing drugs, cholinergic agents, neurotoxins, and venoms. Also discussed are the potency,

UNCLASSIFIED

~~UNCLASSIFIED~~

...ability, weight, portability, economy, stability, ease of use, reliability, safety, and self-purging features. The author also discusses the suitability in this application, the potential for future research and development.

36. WOODMAN, E. J., TEAR GAS MUNITIONS: AN ANALYSIS OF COMMERCIAL MERTSAR, CS, TEAR GAS PROJECTILES, BOMBES, SMALL ARMS AMMUNITION, AND RELATED TEAR GAS DEVICES, Springfield, Illinois, Charles C. Thomas, (1966), 509 pp (UNCLASSIFIED) (CS1-129).

(U) This is probably the most thorough descriptive text available on the range of tear gas munitions used by the military and sold on the commercial market. It is somewhat out of date, as new commercial developments have become available since it was written.

37. Breit, J. M., and Smith, B. J., NONLETHAL INCAPACITATING WEAPON: GAS-PROPELLED IMPACT-PROJECTILE FEASIBILITY AND DEVELOPMENT STUDY, Technical Paper No. RAP-TP-188, from Research Analysis Corp., McLean, Virginia, to Advanced Research Projects Agency, Washington, D. C., Contract No. SD-212 (September 1965), 12 pp (UNCLASSIFIED) (PA 22,468).

(U) This study describes a feasible prototype system that can accurately deliver an incapacitating agent or a marking material 40 to 50 feet. The launcher is designed for simplicity of operation and portability. It utilizes CO₂ to propel a projectile at muzzle velocities below 100 fps. The noise accompanying launching is minimal, making it difficult to detect the firing source. The prototype projectile is a 4.5-inch machined steel cylinder, 0.5 inch in diameter, which contains a .22-caliber blank cartridge and a 0.042-inch³ gelatine capsule as the incapacitating agent or marking material. It is relatively stable in flight and detonates with a sharp report and startling flash under an impact force of less than 2 pounds. On impact the detonation disperses the agent or marking medium.

(U) Optimization of the system would require lighter-weight expendable projectiles with a larger capsule for the agent. For temperatures less than 40 F, added thermal energy for the CO₂ such as body warmth or a heated holster is required.

38. THE TOXICOLOGY OF CN, CS & DM, Special Summary Report, U. S. Army Edgewood Arsenal, Chemical Research and Development Laboratories, Edgewood Arsenal, Maryland (September 1965), 35 + pp (UNCLASSIFIED) (PA 22,436).

(U) The effects of CN, CS, and DM and their toxicity are discussed. DM produces systemic effects in addition to its irritant action and in one case, one of 22 men exposed to DM while asleep in an Army barracks died. This victim

~~UNCLASSIFIED~~

~~CONFIDENTIAL~~

was trapped inside and his exposure lasted 5 to 30 minutes. The medical literature describes four deaths from C1, all resulting from pulmonary infection against individuals in enclosed spaces. No deaths have been attributed to C2. There are considerable data on animal deaths following exposure to each of the three agents. It is concluded that C1 is the most effective and least toxic of the three and that the safety factor is greater with C2. It is also concluded that C2 may have a persistent action not shared by C1 or C3.

39. Coates, J., Smith, C., M.D., and Truitt, E., Ph.D., ORGAN-SYSTEM ANALYSES: A RATIONAL APPROACH FOR DEVELOPING NON-LETHAL CHEMICAL WARFARE AGENTS (U), Study No. S-196, from Institute for Defense Analyses, Arlington, Virginia, to Advanced Research Projects Agency, Washington, D. C., Contract No. SD-50 (September 1965), 176 pp (CONFIDENTIAL/Group 4) (PA 19,128).

(U) The design of chemical warfare agents is basically outside the main stream of conventional pharmacologic research. Consequently, the new rationality of pharmacology has been principally directed at therapeutics, prophylaxis, and other problems of health. Some potentially useful areas of physiological disruption are, therefore, not likely to get attention in the conventional pharmacological investigations unless specific support is supplied in those areas by the military.

(U) An exhaustive analysis of the biochemical and physiological functions of the organ systems of the body would provide the necessary basis for a comprehensive rational research program for non-lethal agents, which would be not only strong in the short term, but fruitful and innovative in the long term. This systematic approach to the biochemistry and physiology of incapacitation is here called organ-system analysis.

(U) Organ-system analysis can result in several kinds of conclusions by drawing attention (1) to potentially toxic disruptions for which agents could be designed by a rational approach to the biochemistry of the system in question; (2) to agents whose effects warrant further structure-function studies; and (3) to agents whose utility is now neglected. In the present study, the detailed organ-system analyses are limited to the visual system and to voluntary muscle systems.

40. Kropp, E. L., STUDY OF INCAPACITATING DARTS (U), Report No. BAT-171-31, from PACIC, Battelle Memorial Institute, Columbus Laboratories, Columbus, Ohio, to Advanced Research Projects Agency, Washington, D. C., Contract No. SD-171 (June 30, 1965), 42 pp (CONFIDENTIAL/Group 3) (PA 12,958), AD 367 711 L.

(U) The characteristics and effects of curariform drugs and delivery systems for these drugs are reviewed. It is concluded that for the maximum degree of immobilization without catastrophic nervous and cardiovascular side effects, the curarimetric compounds might have to be combined with

~~CONFIDENTIAL~~

~~CONFIDENTIAL~~

... of the power may be retained. ... itself approximates the idealized composition, provided that means of resuscitation are available for use in the field. A variety of other compositions such as fast-acting hypnotic agents, rapidly acting analgesics, and compositions leading to a grand mal seizure might be considered. ... presents its own problems, in that as a liquid it would have to be delivered by syringe.

41. Cohen, M., THE EFFECT OF NEW CHEMICAL AGENTS ON VARIOUS PHYSIOLOGICAL SYSTEMS OF THE BODY, PART I - SCREENING PROGRAM (U), Final Report No. IITRI-C-229-9, from IIT Research Institute, Chicago, Illinois, to Chemical Research and Development Laboratories, Edgewood Arsenal, Maryland, Contract No. DA-18-108-CML-7166 (December 1964), 370 pp (CONFIDENTIAL/Group 4) (PA 15,506), AD 355 698 L.

(U) The objective of this program was to study the effects of new chemicals on the overt behavior and on various physiological systems of dogs and cats. The effectiveness of several pharmacological agents as antagonists to these compounds was also studied. A phase of the program devoted to the evaluation of test systems for measuring BZ antagonists was developed. The test systems studied were food consumption in rats, spontaneous activity of rats in jiggle cages, observation of unanesthetized dogs, measurement of blood-pressure responses in anesthetized dogs, and measurement of respiratory and cardiac responses in spinal cats.

42. Miller, LTC W. L., Jr., RIOT CONTROL WITH CHEMICAL AGENTS, Marine Corps Gazette, Vol 45, No. 3, pp 28-31 (March 1961) (UNCLASSIFIED) (PSI-C-653).

(U) This is a short article which describes how the military has had occasion to use CN, DM, and CS in riot-control situations. It notes the reactions of persons subjected to these agents.

Electromagnetic Spectrum

43. Beavers, J. L., II, BRIGHT LIGHT MOB DISPERSAL CANDLE (RC), Final Report for the period May 1969 - November 1969, Report No. LWL-CR-11F69, from Thiokol Chemical Corp., Wasatch, Division, Ogden, Utah, to U. S. Army Land Warfare Laboratory, Aberdeen Proving Ground, Maryland, Contract No. DAAD05-69-C-0394 (April 1970), 17 pp (UNCLASSIFIED) (PA 37,891).

(U) Illuminating candles containing colored flame-producing wafers that provided alternating colors as well as white light have been developed, fabricated, and tested. Seventeen Bright Light Mob Dispersal Candles were burned in Thiokol's light tunnel and four others ignited by hand outside in daylight. The candle consists of a one-inch wafer each of green and red-flame-producing compositions followed by standard TRICOLITE B-B white light illuminant.

~~CONFIDENTIAL~~

(U) In the transition from green to red flame is a mild one, it does not prepare the observer for the transition from red flame to white light. Even the most professional observer commented on the visually violent change from red flame to 4-8. Ignition of the 4-8 produces such a sudden and drastic increase in light intensity that it seems certain to have a frightening effect on unprepared observers.

44. Backus, B., REMOTE ENVIRONMENTAL STIMULATION (U), Final Report for the period April 25, 1968 - January 25, 1969, from Meipar, Inc., Falls Church, Virginia, to Naval Air Systems Command, Washington, D. C., Contract No. N00019-68-C-0260 (April 1969), 27 pp (CONFIDENTIAL/Group 3) (PA 35,797).

(U) The incidental observations of human subjects in a "flicker" environment and the difficulties often encountered by the observers in following the actions of primate subjects who were being exposed to stimuli (after the observers were under considerable discomfort, while the squirrel monkeys were showing little concern) suggests the susceptibility of man to stimuli is greater than that of the lower primates.

(U) Most of the primate subjects were able to deliberately minimize the effects of flicker by the simple expedients of remaining motionless, moving very slowly, or shielding their eyes. Experiments showed that flicker is more effective in creating vertiginous effects in human subjects who are moving than in those who are standing still.

45. INDUSTRY OBSERVER, Aviation Week & Space Technology, Vol 90, No. 2, p 13 (January 13, 1969) (UNCLASSIFIED) (PA 34,499).

(U) At 6 to 8 cycles per second, the flashing apparently produces an out-of-phase response of the Iris and optic nerve. Resulting loss of depth perception leads to an inability to avoid visible obstacles or to aim weapons effectively at moving targets. At 25 cycles per second, the flashing interferes with alpha waves which control the ability of the brain to concentrate.

46. Melton, C. E., et al., EXPOSURE OF MEN TO INTERMITTENT PHOTIC STIMULATION UNDER SIMULATED IFR CONDITIONS, Civil Aeromedical Institute, Oklahoma City, Oklahoma (October 1966), 7 pp (UNCLASSIFIED) (PA 27,463), AD 646 872.

(U) The purpose of this study was to determine whether or not a group of normal young men showed any electroencephalographic changes during and following photic stimulation as it might occur in flight. Ten young men, all volunteers, who had no history of syncope or seizure were exposed to intermittent photic stimulation at each of three frequencies. Analysis of the records taken in Experiment I revealed no evidence of seizure, no nystagmus, and no photic driving.

~~CONFIDENTIAL~~

(U) It appears that susceptible people are sensitive to only a narrow range of frequencies, generally between 8 and 30 flashes per second. Laboratory studies have shown that photically induced paroxysms occur most readily when the eyes are closed and the flash frequency is close to the resting rhythm.

47. BEHAVIORAL RESPONSE TO ENVIRONMENTAL FLIMMER, Second Quarterly Report, for the period May 20 - August 19, 1966, from Welpar, Inc., Falls Church, Virginia, to Naval Air Systems Command, Washington, D. C., Contract No. N00 66-0274 (Undated), 19 pp (UNCLASSIFIED) (PA 24,069).

(U) This study on human response to light flicker found that in the experiments conducted appreciable ambient light enormously reduced the observed effects. The observed effects were:

- (1) Motor coordination was markedly impaired in most cases within a frequency range of from 4.5 to 5.5 Hz. This was observed during walking around obstacles on the laboratory floor and similar activity.
- (2) Men seemed more affected than women and younger women more than older ones.
- (3) Some subjects experienced a sense of giddiness. In a few instances this began immediately on exposure and in others progressed with continued exposure.
- (4) In a few cases there were distortions of perspective in that there was difficulty in determining the relative distances of objects along the line of sight.
- (5) There was a wide variation in terms of persistence of giddiness, when induced, following cessation of exposure. Maximum persistence was about 15 minutes and the minimum about 30 seconds.
- (6) The most effective duty cycle was about 20 percent. Duty cycles approximating 50 percent and exceeding this were markedly less effective.
- (7) No noticeable effects were observed within the alpha rhythm range of 8 to 12 Hz.

(This Page is Unclassified)

~~CONFIDENTIAL~~

UNCLASSIFIED

17

(8) At 19 Hz there was induced a curious optical effect best described as a multiplicity of crawling black shapes in the visual field. This effect occurred at virtually the same frequency for those subjects reporting it and was quite sharply "tunable" in that a frequency change of 1 Hz reduced it considerably.

(9) Most subjects stated that they believed it would be difficult or impossible for them to perform relatively high-skill-type tasks with accuracy during flicker exposure.

48. Lutz, G. A., et al., STATE-OF-THE-ART STUDY ON PERSONNEL BARRIERS (U), Report No. BAT-171-50, from RACIC, Battelle Memorial Institute, Columbus Laboratories, Columbus, Ohio, to Advanced Research Projects Agency, Washington, D. C., Contract No. SD-171 (August 12, 1966), 104 pp (SECRET/Group 1) (PA 24,482), AD 378 912.

(U) This report includes an evaluation of the use of high- and low-power radio waves to effect barriers through which personnel could not penetrate.

49. Dahlke, A. E., et al., A STUDY OF EFFECTS OF VISUAL FLICKER AND AUDITORY FLUTTER ON HUMAN PERFORMANCE, Report No. AFATL-TR-67-12, for the period June 28, 1965 - March 28, 1966, from University of Oklahoma Research Institute, Norman, Oklahoma, to Air Force Armament Laboratory R&TD, Eglin Air Force Base, Florida, Contract No. AF 08(635)-5256 (February 1967), 58 pp (UNCLASSIFIED) (PA 26,553).

(U) Results of nine laboratory experiments are contained in this report. The purpose of the research was to assess the feasibility of using dual-source flickering lights and fluttering tones as harassment devices or as nonlethal weapons. Performance was measured on depth perception, manual dexterity, aiming and tracking, vigilance and cognitive-motor task. Psychophysical judgments of the apparent movement effect produced by two lights flickering out of phase were obtained in one experiment. Post-experimental interviews were given to assess the psychological and somatic symptoms associated with exposure to flicker and flutter.

(U) It was concluded that while dual-source flickering lights produce performance decrement from optimum conditions, they are no more effective than a single light.

UNCLASSIFIED

UNCLASSIFIED

51. G. W. Moore, Jr., THE EFFECTS OF STROBE LIGHT EFFECTS (Final Report, AF 08(635)-10018 (AW-10), V. III (Experimental Studies), Dept. of Psychology, University of North Carolina Institute, Chapel Hill, North Carolina, Directorate of Armament Development, R&D, Eglin Air Force Base, Florida, Contract No. AF 08(635)-10018 (January 1966), 187 pp (UNCLASSIFIED) (PA 22,813), AD 491 104.

(U) A number of experiments designed to investigate effects of multiple flickering light are summarized. Results indicate a small, but statistically reliable, detrimental effect of lights flickering out of phase on various psychomotor performances.

52. Rupp, C. E., PSYCHOLOGICAL PHENOMENA APPLICABLE TO THE DEVELOPMENT OF PSYCHOLOGICAL WEAPONS, Final Report No. AD-60-10/65-Tr, from American Institutes for Research, Washington Office, Silver Spring, Maryland, to Directorate of Armament Development, R&D, Eglin Air Force Base, Florida, Contract No. AF 08(635)-4238 (December 1965), 70 pp (UNCLASSIFIED) (PA 22,056), AD 477 004 L.

(U) This document comprises a compilation of data, in catalog form, of psychological phenomena applicable to the development of psychological weapons. The information is presented for the use of weapon designers for the express purpose of enhancing the psychological effects of nonlethal weapons. Section Three summarizes the major psychological effects of environment, including the effects of light.

53. Orlansky, J., THE USE OF FLASHING LIGHT TO PERTURB HUMAN BEHAVIOR, Research Paper No. P-172, Institute for Defense Analyses, Arlington, Virginia (March 1965), 21 pp (UNCLASSIFIED) (PA 17,260), AD 460 538.

(U) The value of flashing light as a nonlethal military weapon is examined in this report. Anecdotal reports suggest that flashing light can produce effects such as confusion, nausea, disorientation, hypnosis, loss of consciousness, and convulsions. These effects occur only under certain controlled conditions in a laboratory or clinic and affect only a limited portion of the population. The available data indicate that these effects cannot be exploited for military use. There have been no field trials or tests outside a laboratory setting.

54. Kornfield, A. T., SOME PHYSIOLOGICAL EFFECTS OF FLICKER AND RELATED PHYSICAL STIMULI (U), U. S. Army Limited War Laboratory, Aberdeen Proving Ground, Maryland (February 1965), 103 pp (CONFIDENTIAL/Group 4) (PA 19,008), AD 361 980.

(U) A number of interesting phenomena of responsiveness to light flicker and other physical stimuli have been turned up, which do not yet appear to have been studied

UNCLASSIFIED

Hammer, A. S., and Arkins, W. J. (University of Sydney, Sydney, N.S.W., Australia), THE ROLE OF PHOTIC STIMULATION IN THE INDUCTION OF HYPNOTIC TRANCE, International Journal of Clinical and Experimental Hypnosis, Vol XII, No. 2, pp 81-87 (1964) (UNCLASSIFIED) (PA 12,657).

(U) The relative effectiveness of the ordinary verbal method of trance induction is compared with 2 forms of induction utilizing mechanical photic stimulation, and with methods combining the personal and mechanical features. The criterion of trance adopted was the compulsive carrying out of a difficult suggestion. Results show that mechanical procedures alone are ineffective. On the other hand, the addition of a particular sort of photic driving probably improves trance induction, which suggests that induction is a complex matter involving both social interactions and relatively nonmeaningful impacts on the brain.

61. Ham, W. T., Jr., et al., ELECTRONICALLY PULSED LIGHT SOURCE FOR THE PRODUCTION OF RETINAL BURNS, The American Journal of Medical Electronics, Vol 2, No. 4, pp 308-315 (October-December 1963) (UNCLASSIFIED) (PA 14,324).

(U) A method is described for pulsing electronically an Osram XBO 2001 high-pressure xenon lamp. The instrument is being used to investigate the optical hazards accompanying short pulses of radiant energy similar to those emitted by nuclear weapons when exploded at high altitudes.

62. Bredemeyer, H. G., M.D., et al., RADIATION THRESHOLDS FOR CHORIORETINAL BURNS, Report No. AMRL-TDR-63-71, from Institute for Research in Vision and Department of Ophthalmology, The Ohio State University, Columbus, Ohio, to Biophysics Laboratory, 6570th Aerospace Medical Research Laboratories, Aerospace Medical Division, Air Force Systems Command, Wright-Patterson Air Force Base, Ohio, Contract No. AF 33(616)-7583 (July 1963), 38 pp (UNCLASSIFIED) (PA 13,970), AD 416 652.

(U) The data of this and related experiments are used to derive relations between burn diameter, exposure duration, and burn threshold. A calculational method is described which permits calculation of whether or not a burn is to be expected, based upon physical data on the source such as intensity, size, distance, duration, and spectral composition.

63. Severin, Capt. S. L., Newton, Capt. N. L., and Culver, LTC J. F. (USAF, MC), AN EXPERIMENTAL APPROACH TO FLASH BLINDNESS, Aerospace Medicine, Vol 33, No. 10, pp 1199-1205 (1962) (UNCLASSIFIED) (PA 14,081).

(U) This article describes an experimental approach to the study of flash blindness. Two apparently normal subjects may differ by as much as 40 seconds in their recovery from a dazzling flash of 232,000 lux. The mean figures demonstrate that the 16 subjects had

UNCLASSIFIED

...the time required to reach 50 percent for a flash of light intensity, and that a curve could be plotted to show the recovery pattern of each subject over the entire range of test. The individuality of the responses led to the belief that healthy people vary considerably in their ability to handle the sensory overload of this situation.

A few data also demonstrate that pupillary size has a significant effect upon the time required for recovery from dazzle. In many instances, a subject's recovery time was shortened by as much as 40 percent when the pupillary size was decreased. The explanation of this phenomenon is that the amount of light admitted to the eye varies inversely to the area of the pupillary aperture. Therefore, a smaller pupil admits less light and permits a more rapid recovery.

44. Erwin, C. W., M.D., et al. (Department of Neurology and Psychiatry, University of Texas Medical Branch, Galveston, Texas), SOME FURTHER OBSERVATIONS ON THE SPATIALLY ELICITED AROUSAL RESPONSE, EEG Clinical Neurophysiology, Vol 13, pp 391-394 (1961) (UNCLASSIFIED) (PA 12,655).

(U) Observations on the effects of intensity and wavelength of light on electroencephalographic arousal responses have been studied. In addition arousal response durations of the left and right hemispheres of left- and right-handed individuals have been investigated. Results of studies related to hemispheric dominance indicate that although there was a tendency for the right cerebral hemisphere to show a longer response, statistical analysis of the data revealed no significant difference between the sides.

45. Barron, Col. R. D. (Canadian Forces Medical Service, Ottawa, Canada), OCCUPATIONAL INJURIES TO THE EYE RESULTING FROM EXPOSURE TO THE ELECTROMAGNETIC SPECTRUM, Medical Services Journal, Canada, Vol XVI, pp 487-500 (June 1960) (UNCLASSIFIED) (PA 12,615 N).

(U) This paper has attempted to review the physical properties of the major divisions of the electromagnetic spectrum, to relate the known hazards to the visual organs from these major divisions to current occupational problems and injuries, and to review the cause, effect, and prevention of such injuries.

46. Wiltshire Squadron Leader T. C. D. (FLYING PERSONNEL RESEARCH COMMITTEE), THE PERCEPTION AND LUMINANCE OF A NUCLEAR EXPLOSION, Institute of Aviation Medicine, Royal Air Force, Farnborough, England (March 1960), 27 pp (UNCLASSIFIED) (PA 13,614).

(U) Considering the whole problem of the ocular hazard, it leads to the conclusion that with mild stimuli, that a small explosion or a large distant explosion, there is virtually no problem especially if white floodlighting is provided. Some degree of dark adaptation

UNCLASSIFIED

will be lost if it is true, but this is usually regarded as acceptable since the aircrew of today rely less on night visual functions which have been taken over by instruments and by radar. Stimuli of moderate severity can also be regarded as giving rise to little difficulty, but in this case one has to place more importance on training the pilot not to look at the source after detonation.

67. Rabinoff, A. R., M.D., Heim, H. C., Ph.D., and Stilson, D. W., Ph.D., BIOMEDICAL EFFECTS OF EXPOSURE TO ELECTROMAGNETIC RADIATION, PART I - ULTRAVIOLET, Report No. WADD-TR-60-376, from Physics, Engineering, Chemistry Corporation, Boulder, Colorado, to Life Support Systems Laboratory, Aerospace Medical Division, Wright-Patterson Air Force Base, Ohio, Contract No. AF 33(616)-6305 (May 1960), 181 pp (UNCLASSIFIED) (PA 13,474).

(U) Literature concerning the biomedical effects of ultraviolet radiation is reviewed. Ultraviolet absorption results in mitotic alterations and abnormal cell divisions, regressive changes in the somatic structures of some lower animals, and skin and eye tumors in mammals. Damage to the eye from high-intensity ultraviolet is probably limited to the cornea and, to a slight extent, the lens.

68. Makarov, P. O. (Zhdanov State University, Leningrad), EFFECT OF VERY INTENSE OPTICAL STIMULATION ON THE VISUAL, AUDITORY AND SKIN ANALYSERS OF MAN, Biophysics, Vol 5, No. 6, pp 769-777 (1960) (UNCLASSIFIED) (PA 12,611).

(U) The object of this investigation was to measure the refractory period in the human visual system due to brief very intense stimulation by light from impulse gas-discharge lamps.

69. Cogan, D. G., M.D. (Boston), OCULAR EFFECTS OF RADIATION, A.M.A. Archives of Industrial Health, Vol 20, pp 293-296 (July-December 1959) (UNCLASSIFIED) (PA 13,605).

(U) Short infrared rays of the order of 1,000 to 2,000 μ will pass through the lens and be approximately focused on the retina. They are the ones most liable to cause retinal burns with exposures to intense source, such as the sun, atomic explosions, and, possibly arc flashes.

(U) Visual radiation is, of course, the most interesting from a physiologic point of view, but there is little quantitative information about its hazards. There is no basis for the widespread belief that commonly available light, or flickering light, or glare (or insufficient light, for that matter) causes organic damage to the eye. Nevertheless, there are theoretically sound reasons for thinking that the energy absorbed could, if excessive, cause the same type of damage as that caused by infrared radiation.

UNCLASSIFIED

W. N. S. (Editor), 1991-1992 SYMPOSIUM ON FLICKER, JOHN WILEY, NEW YORK, LOUISIANA (April 7, 1957), 203 pp (UNCLASSIFIED) (PA 12,111).

(U) These flicker effects which interfere with consciousness appear at frequencies related to the alpha rhythm of the EEG, or at 10 cps. Annoying or irritating sensations seem to occur with aperiodic flashes or with rhythmic flashes at 3 to 5 cps. Visual illusions appear to be produced by frequencies above 10 to 12 cps. It appears likely that high intensities of light will be more effective in producing the desired effects of flicker although much remains to be done to determine the optimum light and dark intervals, background contrasts, and effects of stray light.

71. Bach, L. M. N., Sperry, C. J., Jr., and Ray, J. T., EFFECT OF FLICKERING LIGHT ON HUMAN SUBJECTS, Report No. 1, Department of Physiology, Tulane University Station, New Orleans, Louisiana, Contract No. DA-44-009 ENG-2448 (March 31, 1955), 41 pp (UNCLASSIFIED) (PA 32,412), AD 671 759.

(U) Adverse sensations including those directly referable to the eye, general unpleasant sensations, twitchings and blinkings as well as those implying interference with consciousness were reported by more subjects and with a greater total of intensities (but not a larger average intensity) with an impressed flicker frequency of 10 cycles per second. Nine, sixteen, and twenty-four cycles were only slightly less effective in this regard. These events were more often reported during the fifth (and last) minute of exposure to the flickering light.

72. Ulett, G. A. (Washington University, School of Medicine), FLICKER SICKNESS, A. M. A. Archives of Ophthalmology, Vol 50, pp 685-687 (1953) (UNCLASSIFIED) (PA 13,255).

(U) Exposure to intermittently flashing light can result in a variety of untoward symptoms including dizziness and nausea, as well as psychic phenomena. Some of these may persist for several hours after stimulation.

73. Marshall, C., M.D., Walker, E., M.D., and Livingston, S. (The Johns Hopkins University School of Medicine, Baltimore, Maryland), PHOTOGENIC EPILEPSY: PARAMETERS OF ACTIVATION, A. M. A. Archives of Neurology and Psychiatry, Vol 69, pp 760-765 (1953) (UNCLASSIFIED) (PA 13,251).

(U) It was demonstrated that red light was at least 10 times as effective in triggering attacks in a case of photogenic epilepsy as were other colored lights tried. Minus red glasses were of considerable aid to the patient.

UNCLASSIFIED

UNCLASSIFIED

25

74. Miles, W. S. (National Physical Laboratory, Teddington, England), WARTIME PROBLEMS OF GLARE AND DAZZLE, British Medical Bulletin, Vol 5, pp 50-52 (1947-48) (UNCLASSIFIED) (PA 14,328).

(U) The idea that dazzle could be used as a weapon was constantly recurring during World War II. On a very bright moonlit night a pilot well caught in the beam of a searchlight is prevented by dazzle from seeing objects on the ground within some 2 miles [3.2 km] of the searchlight. By constantly holding an enemy aircraft in several beams spaced at the corners of a square pattern of 4 miles [6.4 km] side, we might expect to obscure the ground completely. Schemes of this kind fail for two main reasons: (i) the enormous amount of electric power demanded, (ii) in the presence of cloud the light reflected back on the ground is insufficiently intense to make objects more visible than if the lights were extinguished. More modest schemes were a little more hopeful. Experiments were made to see if comparatively weak, steady but directional lights of the type of motorcar headlights could be used at spacings of the order of 100 feet [30.5 m] to provide a kind of dazzle-screen against ground attackers. It was found that such a screen, while of some value in concealing ground objects such as men, vehicles, low buildings, etc., produced a useful effect in only a limited period of about 1/2 hour during nightfall.

(U) On the whole, it may be said that dazzle as an actual weapon of war has proved disappointing, while in those cases where it interferes in some measure with efficiency it is not particularly easy to eliminate.

75. Ham, W. T., Jr., et al. (Medical College of Virginia), OPTICAL MASERS (LASERS), Acta Ophthalmologica, Supplementum, Vol 76, pp 60-78 (Undated) (UNCLASSIFIED) (PA 14,506).

(U) The purpose of this paper is threefold: (1) To give a brief and elementary discussion of the ruby laser, (2) to describe some preliminary experiments with a ruby laser and its associated optical equipment as designed to produce thermal lesions of size and shape comparable to those produced by other methods in this laboratory, (3) to present current data obtained from research on retinal burns which can be useful in the evaluation of ocular hazards from lasers.

UNCLASSIFIED

UNCLASSIFIED

Sound

76. ARIE F. RINOL DEVICE, The Cleveland Plain Dealer, Cleveland, Ohio (January 30, 1971) (UNCLASSIFIED) (PA 38,761).

(U) This news article describes a riot control device, patented by two Missourians, which relies on sonic waves to disperse crowds. Edward G. Luginette and Charles W. Porter, both of St. Louis, say the only effective devices now available to law-enforcement officers are the nightstick, riot gun, and cattle prod.

(U) In the patented instrument, which can be portable or attached to a police car, waves from a speaker called a "tweeter" are directed by parabolic reflectors at a crowd. The waves are said to be so offensive and repugnant that hearers leave the scene, but no permanent injury is caused.

(U) The frequency of the stimulus is a modulated multiple of the human "brain resting frequency", which in most people is 10 or 11 cycles per second. Actual frequency used, which may be 1,000 times those figures, does not interfere with speech.

77. Oscar, K. J., and Bordelon, T. T., PROPAGATION OF HIGH-INTENSITY, LOW-FREQUENCY SOUND WITHOUT LOSS, Report No. 1980, for the period November 10, 1969 - December 11, 1969, U. S. Army Mobility Equipment Research and Development Center, Fort Belvoir, Virginia (April 1970), 52 pp (UNCLASSIFIED) (PA 37,918), AD 869 978.

(U) This report describes the first phase of a research program whose objective is to demonstrate the feasibility of utilizing low-frequency, high-intensity sound, in barrier applications. The first phase of this program covers the experimental effort to transmit low-frequency sound over large distances without great losses of sound-pressure level. To accomplish this goal, reflectors and lenses were studied and tested as methods of focusing or collimating the generated sound.

78. Beck, E. J., AN INTENSE NOISE GENERATOR FOR POSSIBLE USE IN TUNNEL CLEARANCE, Technical Note No. N-994, U. S. Naval Civil Engineering Laboratory, Port Hueneme, California (October 1968), 10 pp (UNCLASSIFIED) (PA 34,461), AD 843 468.

(U) This brief report is an account of the first results of tests with a small pulse-jet aeroplane engine used to, in this case, generate an intense noise. It was recognized at NCEL that the small pulse-jet engine, manufactured as a model airplane or boat engine, would not produce sufficient noise for the purpose under

UNCLASSIFIED

~~CONFIDENTIAL~~

27

consideration - tunnel clearance in Vietnam. It is concluded that infrequent (10 to 100 times per second) but intense explosions from a large pulse tube should provide an intolerable noise level.

79. NOISE: EFFECTS ON MAN AND MATERIALS A SELECTIVE BIBLIOGRAPHY, Report No. GP-464, John F. Kennedy Space Center, NASA, Washington, D. C. (February 15, 1968), 50 pp (UNCLASSIFIED) (PA 33,736).

(U) All entries in this bibliography include a short annotation except those that carry a "Confidential" security classification.

80. Backus, B. T., and Hoster, S. F., BEHAVIORAL RESPONSE TO PSYCHONEURAL STIMULATION (U), Third Quarterly Report, for the period November 5, 1967 - February 5, 1968, from Melpar, Inc., Falls Church, Virginia, to Naval Air Systems Command, Washington, D. C., Contract No. N00019-67-C-0328 (1968), 33 pp (CONFIDENTIAL/Group 3), 33 pp (PA 32,273).

(U) Studies were made using rodent and squirrel monkey subjects, the drugs DS-2, DS-3, and sound and light stimuli. The principal effort with the rodent subjects included observation and tabulation of the effects of DS-2 and DS-3 while the subjects were under sound and light stimuli, the purpose of which was to ascertain whether there was an enhancement effect in their behavioral responses with below-normal threshold dosages of these agents. The squirrel monkeys were used in an effort to determine the threshold of the observable effects of DS-3 in a primate under normal conditions.

81. Pols, L. C. W., THE INFLUENCE OF HIGH INTENSITY SOUND ON THE HUMAN BODY, Report No. IZF 19 C 7-13, Instituut voor Zintuigfysiologie, the Netherlands (January 17, 1968), 17 pp (UNCLASSIFIED) (PA 33,443), AD 825 066.

(U) A standard literature study was conducted concerning the effects of very high sound pressures on the human body. The effects of sound on man are discussed on the basis of the symptoms developing in people working under actual noise conditions. Since very high- and very low-frequency sounds, especially, seem to exert a negative effect, they are considered apart in this study. The influence of low-frequency mechanical vibrations on man is discussed also. Finally, a number of conclusions are drawn. On this basis, some careful suggestions are made concerning standard rules on the effects of high-intensity sounds on the human body.

~~CONFIDENTIAL~~

~~CONFIDENTIAL~~

(This Page is Unclassified)

28

82. McGarvey, J. W., and Backrop, R. L., THE FEASIBILITY OF USING ACOUSTIC ENERGY FOR MILITARY APPLICATIONS (U), Report No. 67-2484, U. S. Army Medical Command, Rock Island Arsenal, Rock Island, Illinois (October 1967), 12 pp (CONFIDENTIAL/Group 4) (PA 33,516), AD 388 128 L.

(U) Von Gierke in 1943 established the threshold for pain as approximately 175 db for static pressures, 165 db at 3 cps and decreasing to the range of 140 db from 15 to well above 100 cps. Experiences with whole-body exposures to intense low-frequency noise occurred in submarines during both World Wars. In these cases, middle-ear changes noted among German submarine diesel-room personnel were attributed to the infrasonic and very low sonic noise fields caused by the suction strokes of the engine cylinders.

(U) In a series of tests conducted with the NASA-LRC Low Frequency Noise Facility (140 to 150 db at mid-band frequencies of 2 to 40 cps), subjects reported an uncomfortable pressure buildup in the middle ear. This effect, however, was almost entirely absent when earplugs were in place.

(U) Maximum-intensity low sonic exposures (140 to 145 db at mid-band frequencies of 22 to 40 cps) produced moderate chest-wall vibration, a sensation of gagging and perceptible visual-field vibration in all subjects. Post-exposure fatigue was generally present after a day of repeated testing.

(U) In another test, the USAF-RTD Sonic Fatigue Facility was operated at frequencies in the 50 to 100 cps range and voluntary tolerance was reached in 2 minutes at the following intensities and frequencies: 153 db at 50 cps; 154 db at 60 cps; 150 db at 73 cps, and 153 db at 100 cps. Exposures were stopped at these intensity levels because of the following subjectively alarming responses: mild nausea, giddiness, subcostal discomfort; cutaneous flushing and tingling at 100 cps; severe coughing and substernal pressure, choking respiration, salivation, pain on swallowing, gagging and giddiness at 60 and 73 cps. One subject also developed testicular aching at 73 cps. At 50 cps, one subject developed a transient headache. All subjects exhibited marked fatigue.

83. Vogel, H. H., Bird, H. P., and Williams, H. C., ANNOTATED BIBLIOGRAPHY: DEVELOPMENTS IN ACOUSTICS AND HYDROMECHANICS WITH POSSIBLE APPLICATIONS IN OFFENSIVE ACOUSTIC WARFARE (U), Final Report, Report No. 124, from Presearch Inc., Silver Spring, Maryland, to U. S. Navy Electronics Laboratory, Contract No. N123(953)56123A (June 1, 1967), 100 pp (SECRET/Group 3) (PA 31,728), AD 385 063.

(U) This bibliography provides supporting documentation to the final report prepared under this same contract as well

(This Page is Unclassified)

~~CONFIDENTIAL~~

an additional information in some peripheral areas of potential interest.

84. Lipke, A. L., et al., A STUDY OF EFFECTS OF VISUAL FLICKER AND AUDITORY FLUTTER ON HUMAN PERFORMANCE, Final Report, Report No. AFATL-Tr-67-12, from University of Oklahoma, Research Institute, Norman, Oklahoma, to Air Force Armament Laboratory, Eglin Air Force Base, Florida, Contract No. AF 34(635)-5256 (February 1967), 58 pp (UNCLASSIFIED) (PA 26,553), AF 408 275.

(U) Results of nine laboratory experiments are contained in this report. The purpose of the research was to assess the feasibility of using dual-source flickering lights and fluttering tones as harassment devices or as nonlethal weapons. Performance was measured on depth perception, manual dexterity, aiming and tracking, vigilance and cognitive-motor tasks. Psychophysical judgments of the apparent movement effect produced by two lights flickering out of phase were obtained in one experiment. Post-experimental interviews were given to assess the psychological and somatic symptoms associated with exposure to flicker and flutter. Few quantitative data were obtained with regard to fluttering tones, however, informal observation led to the conclusion that flutter did not show promise as a harassment device at the intensities investigated.

85. BEHAVIORAL RESPONSE TO PSYCHONEURAL STIMULATION (U), Third Quarterly Report for the period August 20 - November 19, 1966, from Melpar, Inc., Falls Church, Virginia, to Naval Air Systems Command, Washington, D. C., Contract No. Ncw 66-0274d (December 19, 1966), 4 pp (CONFIDENTIAL/Group 3) (PA 25,502).

(U) This report on the current research program dealing with responses of rodents to acoustic and visual stimulation. Included completion of the preparatory phase and initiation of the experimental program. Categorically, the rodent species tested so far appear to be less "disturbed" by the stimulatory techniques employed so far than did human subjects in earlier casual experiments. It was not, however, anticipated that results with rodent subjects would necessarily have direct applicability to subsequent human studies, but that such studies would be helpful in developing experimental techniques.

86. COMING: FANTASTIC DEVICES TO END RIOTS, Nation's Business, pp 62-64 (July 1966) (UNCLASSIFIED) (PA 23,629).

(U) Electronics experts have found in the laboratory that an audio note of 12 to 14 cycles per second has a profoundly disturbing emotional effect. Its precise impact on any given person is somewhat unpredictable. Some people are immune to it; others are not. Most react with an inexplicable feeling of deep anxiety

~~CONFIDENTIAL~~

...ability to ... start ... will tend to dissipate energy. The ... to ... and oscillation is So it ... or ... as the ... of To be effective in riot control, it must reach a very high intensity like that produced by a rocket motor. For this reason, physicists question its practicality, certainly for the immediate future.

(b) Other sonic devices are of proven value and could be used at once. Powerful bull-horns that emit ear-splitting blating and shrieking noises are one form of anti-riot weapon. They can be used to drown out the rhythmic chanting, singing, and handclapping that some agitators use to whip up a crowd to fever pitch. Helicopters, equipped with these powerful portable sound projectors, can hover over a hostile mob or a menacing crowd of demonstrators. Some electronics experts foresee a more futuristic and fantastic type of sonic riot-buster: It is a low-vibration sound which would have the extraordinary ability to resonate the human viscera and thus affect the colon. The effect on a screaming, rock-throwing mob would be the same as a mass attack of uncontrollable dysentery. It should bring any riot to a quick halt.

(c) A revolving, car-roof-mounted flashing spotlight of such brilliance that it will temporarily affect the vision of the rioters is under development. Another device is an inexpensive portable system to electrify a car body. It can be installed on any car, police or military vehicle. A painful, but harmless, shock of high-voltage, low-amperage electricity will shock rioters bent on overturning the vehicle. Persons inside the vehicle are unaffected. Under experimentation is a vehicle-mounted high-pressure system which shoots an electrified stream of water. It gives a harmless but unpleasant high-voltage shock.

97. Upper, C. E., and Lehrer, S., DEVELOPMENT OF PSYCHO-PHYSIOLOGICAL AUDITORY STIMULI AIRBORNE WEAPONS (U), report for the period May 8, 1964 - April 7, 1965, Report No. ATL-TR-65-44, from Astrosystems International, Inc., Fairfield, New Jersey, to Air Force Armament Laboratory, Eglin Air Force Base, Florida, Contract No. AF 08(635)-4370 (March 1966), 172 pp (CONFIDENTIAL/Group 4) (PA 24,682), AD 373 061.

(u) There were two main objectives to this program. One was to conduct a literature search into the psycho-physiological effects of high-intensity sound on man. The other was to fabricate and demonstrate a sound generator capable of producing 130 decibels (re: 0.0002 microbar) at 500 feet within the frequency range of 2 to 100 cps.

~~CONFIDENTIAL~~

~~CONFIDENTIAL~~

51

88. T. E. BIBLIOGRAPHY, Vol 4, Report No. TIL/RIB/75/Vol 4, Technical Information and Library Services (July 1965), 32 pp (UNCLASSIFIED) (PA 21,505).

(U) This bibliography contains references to published and unpublished documents on noise. Nearly all the documents relate theory or practice directly allied to aircraft noise.

89. Reppel, R. M., Austen, B. G., and Veazie, W. H., Jr., STATE-OF-THE-ART STUDY ON BALANCE DISRUPTION (U), Report No. BAT-171-12, from PACIC, Battelle Memorial Institute, Columbus, Ohio, to Advanced Research Projects Agency, Washington, D. C., Contract No. SD-171 (January 20, 1965), 62 pp (SECRET/Group 3) (PA 9418), AD 360 189.

(U) On the basis of the literature reviewed and discussions with investigators generally considered to be most knowledgeable in balance disruption, it appears that none of the presently known chemical, mechanical, disease, radiation, or electrical effectants provide an efficient means of human incapacitation.

90. Christner, C. A., et al., SUMMARY OF THE DEVELOPMENT OF WEAPONS FOR PSYCHOLOGICAL WARFARE - A STUDY CONDUCTED BY THE FALCON RESEARCH AND DEVELOPMENT CO. (U), Addendum Report No. BAT-171-6-1, from RACIC, Battelle Memorial Institute, Columbus, Ohio, to Advanced Research Projects Agency, Washington, D. C., Contract No. SD-171 (January 15, 1965), 8 pp (CONFIDENTIAL/Group 4) (PA 9415).

(U) (S) This report reviews a 1964 study conducted by the Falcon Research and Development Company under contract with the Directorate of Armament Development, Aeronautical Systems Division, at Eglin Air Force Base. The stated purpose of the research was to "investigate the potential of flickering light, sound, and suggestion, singly and in combination, for use in psychological weaponry".

91. Kryter, K. D., HAZARDOUS EXPOSURE TO INTERMITTENT AND STEADY-STATE NOISE - REPORT OF WORKING GROUP 46, from National Academy of Sciences - National Research Council Committee on Hearing, Bioacoustics, and Biomechanics, Washington, D. C., to Office of Naval Research, Washington, D. C., Contract No. NONR 2300(05) (January 1965), 39 pp (UNCLASSIFIED) (PA 17,282), AD 458 244.

(U) This report contains graphs of maximum sound pressure levels and durations of exposures that the Working Group believes would be tolerable and examples of the use of these graphs. This material is followed with background information and a discussion of the rationale, assumptions, limitations, and general problems pertinent to the development and application of a damage risk criterion and related exposure contours.

~~CONFIDENTIAL~~

~~CONFIDENTIAL~~

23. Vogel, H. H., ON THE STATE OF WEAPON DEVELOPMENT, Report No. AF-117-4-61, from Falcon Research and Development Company, Orlando, to Directorate of Armament Development, Eglin Air Force Base, Florida, Contract No. AF 08(15)-3635 (October 1964), 72 pp (UNCLASSIFIED) (PA 15,453), AD 355 592.

(U) The purpose for this research was to investigate the potential of flickering light, sound, and suggestion, singly and in combination, for use in psychological weaponry. A search of the pertinent literature was performed followed by individual and group experimentation. The results obtained demonstrate that potential exists for the use of photic flicker as a weapon. Suggestion was effective in the laboratory but ineffective with military groups in an unemotional setting. Further experimentation with photic flicker singly and in combination with suggestion is warranted. Recommendations for further specific research are provided.

23. Vogel, H. H., THE APPLICABILITY OF ACOUSTIC ENERGY AS A BATTLEFIELD WEAPON, from American Machine and Foundry Co., Alexandria, Virginia, to the U. S. Army Limited War Laboratory, Aberdeen Proving Ground, Maryland, Contract No. DA-18-001-AMC-551(X) (September 1964), 55 pp (UNCLASSIFIED) (PA 14,673), AD 451 239.

(U) A study of the past and current literature on the subject was accomplished and analysis based on best currently available data was made to determine the device size and complexity required to achieve the desired effects at reasonable ranges. The study covered not only the use and effects of audible sound but also the effects of infrasonic and ultrasonic energy.

24. Shatalov, N. N., Saitanov, A. O., and Glotova, K. V., ON THE STATE OF THE CARDIOVASCULAR SYSTEM UNDER CONDITIONS OF EXPOSURE TO CONTINUOUS NOISE, Higiena Truda i Professional'nyye Zabolevaniya (Labor Hygiene and Occupational Diseases), Vol 6, pp 7, 10-14 (1962), translated by E. R. Hope, Directorate of Scientific Information Services, DRB Canada, Translation No. T 411 R (September 1964), 5 pp (UNCLASSIFIED) (PA 14,284), AD 607 705.

(U) It is concluded that:

- (1) In persons exposed to the effect of continuous industrial medium- and high-frequency noise of intensity 85 to 120 db, functional disturbances of the cardiovascular system were frequently observed.
- (2) Very often the subjects exhibited an instability of the arterial blood pressure. The electrocardiographic data showed bradycardia with a tendency to retardation of the intravesicular conductivity, plus a depression of the T-wave that was most frequently observed after physical stress and at the end of the work period.

~~CONFIDENTIAL~~

UNCLASSIFIED

... high intensity, functional changes in the cardiovascular system were also entered into the data and were more strongly expressed.

(4) The above deviation rate, it would seem, due to disturbance of neuroreflex regulation developing under the influence of noise.

36. W. R. ... RESEARCH AND DEVELOPMENT PROGRAM TO DEMONSTRATE THE FEASIBILITY OF A HIGH-INTENSITY SOUND GENERATOR, Report No. TR 63002-01, from Astron Systems International, Inc., New Jersey, to Advanced Research Projects Agency, Washington, D. C., Contract No. SD-169 (August 15, 1963), 11 pp (UNCLASSIFIED) (FA 25,987).

(1) The primary technical objectives were to establish the characteristics of a gaseous phase detonation system as a source of controlled acoustic power and to demonstrate certain practical aspects of the operation of a single high-frequency gaseous phase detonation tube such as life, reliability, efficiency, and other operational characteristics.

37. Tolonen, A. H., Arees, E., and Peilly, R. (University of Massachusetts, Amherst, Massachusetts), NOISE AND HUMAN PERFORMANCE, A PSYCHOPHYSIOLOGICAL APPROACH, Ergonomics, No. 1, pp 83-97 (January 1963) (UNCLASSIFIED) (FA 14,672).

(2) Distraction studied in terms of changes in ambient noise levels was found to be a function of the amount of change. When adaptation of the ear is controlled by use of on-off sound sequences, ignoring distraction, performance is directly related to the on-off ratio early in exposure and inversely related to the ratio later in exposure. At all sound ratio performance in noise is better than in quiet. When distraction is taken into account, these results are influenced by the differences in rate and amount of adaptation of loudness and rate of habituation to distraction so that at any given time performance may seem to be decreased, increased or unaffected.

37. Plutchik, R., PHYSIOLOGICAL RESPONSES TO HIGH INTENSITY INTERMITTENT SOUND, from Hofstra College, Hempstead, New York, to Office of Naval Research, Washington, D. C., Contract No. NONR-2252(01) (May 1962), 12 pp (UNCLASSIFIED) (FA 21,615), AD 467 525.

(3) Eighteen subjects were exposed to brief periods of high-intensity intermittent sound at 3 pulses per second and at levels of from 100 to 120 db. Skin temperature, skin impedance, EKG and continuous systolic blood pressure from the finger were recorded. The results indicated little or no effect on all the measures except GSR which showed a linear increase in magnitude of response with an increase in intensity of sound. Comparisons with previous reports and some tentative explanations are presented.

UNCLASSIFIED

UNCLASSIFIED

... (1958) (UNCLASSIFIED) (PA 17,084).
... (1958) (UNCLASSIFIED) (PA 17,084).
... (1958) (UNCLASSIFIED) (PA 17,084).
... (1958) (UNCLASSIFIED) (PA 17,084).

... during the early period of this research program, ...
... research was accomplished on the use of high
... intensity ultrasound for investigations on the central
... nervous system of mammals. Ultrasonic instrumentation
... was designed and built for precision irradiation of
... tissues of the central nervous system. Comprehensive
... histological studies were made of lesions in the brains
... of cats and monkeys produced by ultrasonic irradiation.

... (1958) (UNCLASSIFIED) (PA 15,943).

(c) The nature of noises in relation to their circumstances,
to the physiological and psychophysiological state and to
the past training of the hearer was studied. The measure-
ments of the noise levels between 15 and 160 ph* according
to the sources, the normal and pathological physiological
effects of noise on the ear and on other sense organs, the
general physiological effects on the organism, as well as the
effects of ultrasonics, of vibrations and infrasonics, of
shockwaves and of sudden variations in pressure were
examined. Noises are harmful above 86 ph, and dangerous
above 110 ph.

27. Jerison, H. J. (USAF Aero Medical Laboratory), Crannell, C. W., and
Ewbank, D. (Miami University), ACOUSTIC NOISE AND REPEATED TIME JUDGMENTS
IN A VISUAL MOVEMENT PROJECTION TASK, Report No. WADC-TR-57-54, Air
Research and Development Command, Wright-Patterson Air Force Base, Ohio
(March 1957), 26 pp (UNCLASSIFIED) (PA 13,057).

(b) The effect of noise on time judgments was studied by
having four groups of 50 subjects work on a visual-
movement projection task in which a moving target
disappeared and a guess had to be made as to when the
target was under a crosshair. Effects of noise programs
(groups) and of trials were significant beyond the
.01 level of confidence. The effect appeared to be
the same regardless of noise programs and is a fairly
smooth negatively accelerated rising curve in which
judgment time increases with succeeding trials. The
results suggest that appropriately programmed noise
distorts subjective time.

... the unit of loudness level on a scale beginning at zero for the
... faintest audible sound and corresponding to the decibel scale of sound intensity
... with the number of phons of a given sound being equal to the decibels of a
... 1000-cycle tone judged by the listener to be equally loud.

UNCLASSIFIED

UNCLASSIFIED

55

101. M. A. (Massachusetts Institute of Technology), EFFECTS OF
NOISE ON MAN: A REVIEW FOR STUDY, Noise Control, pp 22-27 (July 1955) (UNCLASSIFIED)
(PA 21,9 2).

(U) The effects of noise on man are not so simple that they may be studied on the basis of stimulus and response. The effective stimulus may occur during a major portion of a lifetime. The response may not become apparent for years.

(U) Attitudes and even emotional reactions toward sounds are often more closely related to context and past associations than to decibels or even sones. Significant hearing loss can be demonstrated long before the exposure noise reaches or even approaches the level of aural pain. This hearing loss is progressive in the sense that longer exposures produce more loss. Hearing loss is greatest at frequencies above that frequency range in the exposure noise in which there is the greatest concentration of acoustic energy. For a large variety of complex industrial spectra, hearing loss starts in the 4 to 6 kcps region. Individuals differ greatly in their ability to take noise exposures; the hearing losses they suffer seem unrelated to their psychological attitude toward the noise.

102. Ensminger, D., CONCEPTS FOR THE POSSIBLE USE OF SOUND IN CROWD CONTROL, Enclosure 2, Report No. R-3567, from RACIC, Battelle Memorial Institute, Columbus Laboratories, Columbus, Ohio, to U. S. Army Land Warfare Laboratory, Aberdeen Proving Ground, Maryland (July 16, 1970), 1 p (UNCLASSIFIED).

(U) Sound at the transition between audible and ultrasonic frequencies causes nausea and severe headaches. This transition range varies with the individual. Warbling through a frequency range of 14 through 22 kHz would cover the cut-off frequencies of most people. The effects are produced at low intensities but high intensities would insure quicker response. The operator is easily protected from these sounds by ear protectors built into riot helmets. Such sound is effective in causing nausea and headaches without exceeding a damaging intensity level. It would seem that this phenomenon could be useful in riot control and the cost of equipment would be only nominal.

Barriers and Deterrent Devices

103. Packard, H., REMINGTON'S NEW PLASTIC PELLETS, Guns and Ammo, Vol 15, No. 2, pp 52-53 (February 1971) (UNCLASSIFIED) (PA 38,761).

(U) Remington's "Modi-Pac" is a 12-gauge shot-type shell in which the lead shot is replaced by polyethylene plastic pellets. These pellets are approximately 0.12 inch in diameter and have a deterrent effect on

UNCLASSIFIED

104. The maximum range of the pellets is 20 to 25 yards, but at this distance the pellets will not penetrate a raw paper. At close range, the performance is much higher and at ranges under 5 yards, an officer under attack is provided with more than adequate protection. The shell has a deliberately loud report and a prominent muzzle flash for psychological effect.

105. Williams, L. W., and Hucok, H. J., A COMMENTARY ON SHOT-FILLED BAGS AS A NONLETHAL WEAPON FOR CROWD CONTROL, from Battelle Memorial Institute, Columbus Laboratories, Columbus, Ohio, to U. S. Army Land Warfare Laboratory, Aberdeen Proving Ground, Maryland, Contract No. DAAD05-71-C-0163 (December 4, 1970), 15 pp (FOR OFFICIAL USE ONLY) (PA 38,647).

(U) This report consists of a discussion of the use of shot-filled bags as nonlethal weapons, six simple scenarios, and a short test outline of some factors that may affect their use. It is concluded that a shot-filled spin-stabilized bag might be an effective control weapon for a range of about 15 feet to 150 or 200 feet. However, it should be used only after a demonstration of its non-lethality, range accuracy, knockdown capability, and wound potential. Its use should be with actively forward tactics rather than in a defensive or passive mode.

106. Mainhardt, R., THE STUN GUN - A NON-LETHAL WEAPON, Law and Order, Vol 18, No. 10, pp 86-88 (October 1970) (UNCLASSIFIED) (PA 38,639).

(U) Any standard police or military weapon may be easily converted to fire the Stun Bag which consists of a flat, circular disc of woven material filled with bird shot. After folding to one-third its normal size, it is ejected from a shoulder launcher. It assumes its normal size shortly after ejection. It conforms to the shape of the target on contact and is capable of knocking down or stopping an on-coming person. The blow intensities are well below those believed necessary to produce serious brain injury. It is not anticipated that blows to the chest would cause pulmonary or cardiovascular injury. There is little doubt that a glancing blow will produce tearing and bruising of exposed skin areas.

107. NEWEST ANTIRIOT WEAPON: 'BULLETS' OF WOOD, U. S. News and World Report, Vol LXIX, No. 3, p 36 (July 20, 1970) (UNCLASSIFIED) (PA 38,643).

(U) Wooden pellets, fired by compressed gas from rifle-style launchers, proved to be an effective crowd-dispersal weapon during disturbances at Berkeley. The device, known as the Multiple Baton Shell, was described by Berkeley police as apparently more effective than tear gas. The pellets strike with a stinging impact and have about the same effect as a billy club, but from a range of 40 or more yards, and they are too light to be thrown back with force. In most cases, the pellet does not break the skin, but could break bones at close range.

~~CONFIDENTIAL~~

37

107. WOOD PELLETS USED AGAINST CALIFORNIA RIOTERS, Washington Post, p A-3 (July 8, 1970) (UNCLASSIFIED) (PA 38,644).

(U) This article describes the same pellets reported on in PA 38,643 (Item 106, on preceding page) and presents much of the same information. The pellets are stacked five deep in a metal cartridge like a shotgun shell. They cost about \$7 a piece, compared to \$13 for a tear-gas canister.

108. Young, R. B., NON-LETHAL INCAPACITATION WEAPON (U), Final Report, Report No. LWL-CR-07B69, from AAI Corp., Cockeysville, Maryland, to U. S. Army Limited War Laboratory, Aberdeen Proving Ground, Maryland, Contract No. DAAD05-69-C-0117 (November 1969), 60 pp (CONFIDENTIAL/Group 4) (PA 38,005), AD 509 675 L.

(U) (S) The design of a weapon that will produce nonlethal incapacitation has been accomplished. A low-signature, closed-gas launch system, compatible with the M79 grenade launcher or M16 rifle, is used to fire a deformable, spin-stabilized projectile. This projectile is made of a silicone-rubber material, RTV. Head impact causes short-term loss of consciousness. Tests conducted with subhuman primates have demonstrated the feasibility of the concept and defined the system operating characteristics.

109. Schulman, W., Hansen, D. T., and Shukis, S. P., RED SMOKE GRENADE PRODUCTION: DATA COLLECTION AND ANALYSIS, Report for the period September 1968 - March 1969, Report No. EATR-4330, Weapons Development and Engineering Laboratories, Edgewood Arsenal, Maryland (November 1969), 45 pp (UNCLASSIFIED) (PA 36,863).

(U) At present, there is little scientifically supported knowledge about the parameters which influence burning time. The majority of the knowledge concerning what affects burning time has been obtained empirically or through trial and error. In order to control the burning time in an efficient manner, the relevant variables must be known. Identifying both these variables and their importance is the purpose of this data collection and analysis.

110. Smith, J. J., EVALUATION OF LIGHTWEIGHT, METAL ANTIPERSONNEL OBSTACLES, Report No. 1965, U. S. Army Mobility Equipment Research and Development Center, Fort Belvoir, Virginia (October 1969), 46 pp (UNCLASSIFIED) (PA 37,853), AD 865 076.

(U) This report covers an evaluation of seven types of lightweight anti-personnel obstacles: the double-apron fence, constructed of barbed wire and German barbed tape; triple standard concertina (TCS), constructed from barbed wire concertina and German barbed-wire concertina; the rapidly emplaced anti-personnel obstacle (REAPO); the general-purpose, barbed-tape obstacle (GPBTO); and the caltrop.

~~CONFIDENTIAL~~

~~CONFIDENTIAL~~

(This Page is For Official Use Only)

38

111. Samuels, David W., Egner, Donald O., and Campbell, Donald, RIOT CONTROL: ANALYSIS AND CATALOG, Final Report, Report No. 69-14, Research Analysis Branch, U. S. Army Limited War Laboratory, Aberdeen Proving Ground, Maryland, (October 1969), 165 pp (FOR OFFICIAL USE ONLY) (PA 39,060), AD 861 296 L.

(U) (FOUO) A systematic analysis of some types of civil disturbances and a survey of related developmental materiel are provided. The major limitation of the analysis is its restriction to "ghetto"-type riots, necessitated by limitations in time and available information; however, the materiel items described are universal in application to various forms of civil disturbances. The first part of the report analyzes such riots by identifying common characteristics of a number of disturbances which have occurred in the United States and describing the experiences of various security forces in their control. The latter part of the report serves as a catalog of materiel items, not already in the Army inventory, which may be useful in providing a more flexible response to the special requirements of riot control.

112. COMPENDIUM COUNTERMINE SYMPOSIUM (U), held March 14, 1968, U. S. Army Mobility Equipment Research and Development Center, Fort Belvoir, Virginia (May 1, 1969) (SECRET/NOFORN/Group 3) (PA 36,694), AD 502 129.

(U) The proceedings of this symposium include a discussion of "caltrops". These are two pieces of wire joined together so that when thrown they land on three points and the other point sticks up so that it will pierce the foot. The delay time which these produce, not counting the surprise effect, is better than current standard wire- and concertina-type obstacles. Caltrops could be air emplaced.

113. GENERAL BASE DEFENSE SYSTEMS. VOLUME VII: COMPONENT CHARACTERISTICS (FACT SHEETS) (U), Part I, Final Report, Phase Two, for the period July 3, 1967 - July 2, 1968, Report No. LMSC-B095482, from Lockheed Missiles and Space Company, Sunnyvale, California, to Advanced Research Projects Agency, Washington, D. C., Contract No. DAAH01-67-C-1384 (July 1968), 346 pp (SECRET/NOFORN/Group 3) (PA 33,700.4), AD 392 301 L.

(U) Fact sheets are presented on a variety of barriers for base defense including double-apron fence, high-wire entanglement, cattle fence, chain-link fence, caltrops (barbed impediment), barbed wire, and barbed tape.

114. Gluckstein, M. E., SCREENING AND SIGNALING SMOKES, Ethyl Corporation, Research Laboratories, Ferndale, Michigan (January 8, 1968), 1 p (UNCLASSIFIED) (PA 32,149).

(U) Readily disseminated agents for producing either dense screening smokes or chemiluminescent signaling and marking smokes have been developed by Ethyl Corporation. Both types are liquids that react with air and moisture to form heavy, noncorrosive, nontoxic, nonirritating smokes.

(This Page is For Official Use Only)

~~CONFIDENTIAL~~

115. Sirvin, R. A., et al., INTERDICTION SYSTEM (U), Final Report No. LWL-CR-08666, from General Dynamics, Pomona Division, Pomona, California, to Aberdeen Proving Ground, Maryland, Contract No. DA-18-001-AMC-1120(X) (September 1967), 150 pp (CONFIDENTIAL/Group 4) (PA 32,703).

(U) The purpose of this program was to develop for operational evaluation an airborne system for effectively interdicting enemy overland infiltration and supply routes. The emphasis was placed on a caltrop device and a simple dispenser to be employed from low-performance, high-payload Army aircraft. Tactical considerations in the use of this device are described.

116. Applegate, R., WEAPONS FOR RIOT CONTROL, ORDNANCE, Vol 51, No. 282, pp 604-609 (May-June 1967) (UNCLASSIFIED) (PSI-C-688).

(U) This article reviews some of the nonlethal riot-control equipment developed since about 1964. Among the devices which are discussed are the shock baton, the MPG-100 grenade which expels a tear-gas charge without fragmenting, the Smith & Wesson Mercox dart/projectile revolver, the Chemical Mace, a projectile which produces a flash and loud bang, another projectile designed for use against barricades, the "banana peel" concept, and foam.

117. Gibson, C. T., IMPROVED INTEGRAL SMOKE GENERATOR (ACA-35/671), Final Report for the period March 15 to May 15, 1967, U. S. Army Concept Team in Vietnam (June 20, 1967), 16 pp (UNCLASSIFIED) (PA 28,243).

(U) The purpose of this evaluation was to determine the operational suitability of an integral screening smoke generator mounted on the UH-1 helicopter and to record the methods used for its employment.

118. Styles, M. F. E., INTEGRAL SMOKE GENERATOR, AIRBORNE, CARGO HOOK COMPARTMENT VERSION, TYPE 53E00-62B, Final Report No. LWL-CR-02C65B, from The Bendix Corporation, Fluid Power Division, Utica, New York, to U. S. Army Limited War Laboratory, Aberdeen Proving Ground, Maryland, Contract No. DA-18-001-AMC-1155(X) (June 1967), 176 pp (UNCLASSIFIED) (PA 29,749), AD 819 602 L.

(U) A method of dispersing a small quantity of fog oil into the hot jet-engine exhaust gases of a helicopter was devised. This method consisted of dispersing the fog oil into small droplets through an atomizing nozzle and directing the droplets into the exhaust area where they were vaporized. As the vapor passed into the cooler air beyond the engine, the vapor condensed, forming a very dense cloud of white smoke or fog.

~~CONFIDENTIAL~~

(This Page is Unclassified)

40

119. Styles, M. F. E., INTEGRAL SMOKE GENERATOR, AIRBORNE, HEATER COMPARTMENT VERSION, TYPE 53E00-62A, Final Report No. LWL-CR-02C65A, from The Bendix Corporation, Fluid Power Division, Utica, New York, to U. S. Army Limited War Laboratory, Aberdeen Proving Ground, Maryland, Contract No. DA-18-001-AMC-1155(X) (May 1967), 223 pp (UNCLASSIFIED) (PA 29,750), AD 819 601 L.

(U) The purpose of this work was to develop an effective, safe, and economical method of generating a smoke screen to provide cover during operations.

120. ENGINEERING DESIGN HANDBOOK, MILITARY PYROTECHNICS SERIES, PART ONE: THEORY AND APPLICATION, Report No. AMCP 706-185, Headquarters, U. S. Army Materiel Command, Washington, D. C. (April 1967), 242 pp (UNCLASSIFIED) (PA 31,518), AD 817 071 L.

(U) This handbook includes a chapter on the history of the pyrotechnic art, a chapter giving a general introduction to the application of pyrotechnic devices to military problems, and chapters on Physical-Chemical Relationships, Visibility, Production of Heat, Production of Light, and Production of Smoke. Chapter 7 deals with the production of tactically useful smoke.

121. Stanley, A. T., CALTROP, TACTICAL ANTIPERSONNEL OBSTACLES, Interim Report No. 1871, for the period May 6 - August 4, 1966, from U. S. Army Engineer Research and Development Laboratories, Fort Belvoir, Virginia, to U. S. Army Materiel Command, Washington, D. C. (October 1966), 72 pp (UNCLASSIFIED) (PA 26,251), AD 802 059.

(U) This report covers an investigation of caltrops used as anti-personnel obstacles. The conclusions reached included:

- (1) Caltrops will penetrate footgear to inflict puncture injuries on all types and conditions of soil considered except in areas where walking would be difficult because of the depth to which a foot would sink.
- (2) The delay time caused by caltrops will exceed that created by triple standard concertina.
- (3) Incapacitation results from swelling and pain approximately 30 minutes after injury.

(This Page is Unclassified)

~~CONFIDENTIAL~~

122. Rosenberg, E. J., and Mingenstern, P., FEASIBILITY AND EXPLORATORY DEVELOPMENT OF PROCEDURES AND INSTRUMENTATION FOR THE FIELD EVALUATION OF MILITARY OBLITERATION AGENTS, Fourth Quarterly Progress Report for the period April-July 1966, Report No. 66-15-3, from GCA Corp., Bedford, Massachusetts, to Assessment Technology Branch, U. S. Army Directorate of Technical Support, Edgewood Arsenal, Maryland, (Contract No. DA-18-035-AMC-706(A) (August 1966), 53 pp (UNCLASSIFIED) (PA 26,889), AD 804 963.

(U) This program was established to determine the feasibility of and to develop procedures and instrumentation for the field evaluation of obscuration agents. Field testing of munitions and analysis of the data were begun. Initial results indicate that obscuration is a rapidly varying function of time with a power spectrum that conforms closely to that of the vertical component of wind velocity near the ground. A number of instrument and procedural modifications were accomplished; recommendations for additional modifications were made.

123. McLain, W. H., and Evans, R. W., A NEW SMOKE SCREENING CHEMICAL FOR USE IN AERIAL SMOKE TANKS, Final and Summary Report No. 6, from University of Denver, Mechanics Division, to U. S. Army Chemical Research and Development Laboratories, Edgewood Arsenal, Maryland, Contract No. DA 18-035-AMC-127(A) (December 1965), 219 pp (UNCLASSIFIED) (PA 22,868), AD 479 680.

(U) A review of the literature for chemical smoke agents is presented. Based on this review an experimental program to evaluate new liquid smoke agents was formulated. The results of this experimental program indicated that liquid agents possessing an obscuring power greater than FS can be developed using selected mixtures, solutions, and compounds of phosphorus.

124. Sprang, W. O., NONLETHAL INCAPACITATING WEAPON: EXTENSIBLE BILLY CLUB, Paper No. RAC-TP-194, from Research Analysis Corporation, McLean, Virginia, to Advanced Research Projects Agency, Washington, D. C., Contract No. SD-212 (November 1965), 20 pp (UNCLASSIFIED) (PA 19,988).

(U) The Japanese have developed a three-section telescopic billy club, which in the collapsed position can be concealed on a person but is quickly flicked into the extended position. RAC has found it is feasible to incorporate an extensible self-locking knife blade in the forward tubular section of a similar club. It is feasible to lock the tubular club sections positively to prevent collapse of the club while in operation. No conclusion was drawn as to the lethality of the extensible blade.

UNCLASSIFIED

42

125. KAYE, S. M., THE HEALTH HAZARDS OF CERTAIN SMOKE DYES IN CURRENT USE, Technical Memorandum No. 1674, Picatinny Arsenal, Dover, New Jersey (September 1965), 29 pp (UNCLASSIFIED) (PA 21,562), AD 469 867.

(U) The toxic and carcinogenic health hazards associated with the currently used smoke dyes, and also with possible candidates for smoke dyes, are discussed with reference to effects of exposure, chemical structure, hazardous impurities, and pyrolysis reaction products. Recommendations for avoiding these health hazards are also presented.

126. Kaye, S. M., AEROSOL SPRAY SMOKE DEVICE, Technical Memorandum No. 1610, Feltman Research Laboratories, Picatinny Arsenal, Dover, New Jersey (May 1965), 9 pp (UNCLASSIFIED) (PA 17,898), AD 461 989.

(U) An aerosol spray smoke device for dispensing white smoke has been developed for use in signaling, in target marking, and for screening purposes. The device consists of a steel cylinder (6 inches long and 3-1/2 inches in diameter) containing titanium tetrachloride, white phosphorus in solution with carbon disulfide and carbon tetrachloride, and Freon-12 propellant. In the prototype developed, a brass needle valve is screwed into a threaded opening at one end of the cylinder. When the manually operated valve is opened, a dense, high-quality white smoke is discharged for from 2 to 5 minutes. This smoke is formed by the reaction of the titanium tetrachloride with the moisture in the air to form white titanium hydroxide.

127. Shidlovsky, A. A., FUNDAMENTALS OF PYROTECHNICS, Technical Memorandum No. 1615, translated by U. S. Joint Publication Research Service from a Russian textbook, Osnovy Pirotekhniki (1964), Feltman Research Laboratories, Picatinny Arsenal, Dover, New Jersey (May 1965), 414 pp (UNCLASSIFIED) (PA 18,621), AD 462 474.

(U) Chapters XVIII and XIX deal with masking smoke compositions and colored smoke compositions, respectively.

128. Szten, E. M., Seeger, H. G., and Sprang, W. O., A PRELIMINARY FEASIBILITY STUDY OF THE COLD LIQUID WEAPON, Technical Paper No. RAC-TP-178, Research Analysis Corporation, McLean, Virginia (May 1965), 13 pp (UNCLASSIFIED) (PA 16,699).

(U) This study indicated that a weapon can be designed to eject a stream of salt water propelled by CO₂. However, it was regarded as doubtful that a weapon of this type would produce a positive deterrent to a determined attack. The gun designed was portable but was limited to an effective distance of 30 feet. To be effective beyond this distance, a weapon would have to be larger and, thus, no longer portable.

UNCLASSIFIED

129. TYPICAL FOREIGN UNCONVENTIONAL WARFARE WEAPONS (U), Report No. FSTC 381-5012, U. S. Army Foreign Science and Technology Center, Munitions Building, Army Materiel Command, Washington, D. C. (September 1964), 56 pp (CONFIDENTIAL/Group 4) (PA 15,317).

(U) This study describes and presents illustrations of typical foreign unconventional warfare weapons and devices, including caltrops.

130. Parent, P. A., BIOLOGICAL EFFECTS OF COLORED SMOKE INGREDIENTS, Special Publication No. 4-59, U. S. Army Chemical Research and Development Laboratories, Edgewood Arsenal, Maryland (September 1964), 35 pp (UNCLASSIFIED) (PA 13,580), AD 451 092.

(U) The toxicity values, or ratings by various, but usual routes are reported for the colored smoke ingredients 1-(methylamino)anthraquinone, auramine, kerosene, potassium chlorate, colloidal sulfur, potassium nitrate, magnesium carbonate and charcoal. Tests for carcinogenic action are tabulated for benzanthrone, indanthrene Golden Yellow GK (dibenzo[a,n]pyrene-7,14-dione), 2-(4-dimethylamino-phenylazo)-naphthalene and auramine. Other biological effects of many of the compounds or elements are given.

131. Applegate, R., NEW RIOT CONTROL WEAPONS, Ordnance, Vol 49, No. 265 (July-August 1964), pp 67-70 (UNCLASSIFIED) (PSI-C-687).

(U) Some of the nonlethal weapons or agents mentioned in this article include electrically charged vehicles, ultraviolet marking material, electric shocks administered down streams of water, sound projectors, blinding lights, and tranquilizing and "nerve gases".

132. Kracke, R. D., SUMMARY REPORT ON SMOKE AND INCENDIARY PROJECTILES (U), Technical Memorandum No. 63-15, U. S. Army Chemical Research and Development Laboratories, Edgewood Arsenal, Maryland (January 1964), 24 pp (CONFIDENTIAL/Group 4) (PA 22,899), AD 370 825.

(U) WP and the modified forms of WP (PWP, PWPV and SWP) in projectiles in general produce better ground smoke screens than any known nonphosphorus screening smoke material. Modified WP fillings for projectiles have been developed which are capable of more than doubling the ground smoke screening of effectiveness of the standard WP-filled projectiles. However, under some conditions, the modified WP fillings produce ballistically unstable rotating-type munitions. It is recommended that a research study be initiated to seek new incendiary fillings for munitions.

~~CONFIDENTIAL~~

(This Page Is Unclassified)

44

133. Applegate, R., CROWD AND RIOT CONTROL, The Stackpole Company, Harrisburg, Pennsylvania (1964) (UNCLASSIFIED) (PA 9442).

(U) Chapter 5 is entitled "Obscuring Smoke for Crowd and Riot Control" and is a quite thorough treatment of smoke munitions and techniques of employment.

134. GENERATOR, SMOKE, MECHANICAL, PULSE JET, M3A3, Manual No. TM 3-1040-292-12, Headquarters, Department of the Army, Washington, D. C. (December 1963), 64 pp (UNCLASSIFIED) (PA 34,646).

(U) This manual is published for the use of the personnel to whom the Generator, Smoke, Mechanical, Pulse Jet, ABC-M3A3 is issued. It contains information on the operation and maintenance of the equipment as well as descriptions of major groups and their functions in relation to the operation of the smoke generator.

135. Finklestein, L., HISTORY OF RESEARCH AND DEVELOPMENT OF THE CHEMICAL WARFARE SERVICE IN WORLD WAR II (JULY 1, 1940 - DECEMBER 31, 1945), Special Publication No. 1-42, U. S. Army Chemical Research and Development Laboratories, Edgewood Arsenal, Maryland (June 1964) (UNCLASSIFIED) (Part I, 172 pp [PA 17,629], AD 461 128; Part II, 171 pp [PA 17,653], AD 461 129; Part III, 396 pp [PA 17,657], AD 461 130; Part IV, 180 pp [PA 17,654], AD 461 131).

(U) This report on screening smokes is one of a series of historical monographs. It covers not only research and development of the Chemical Warfare Service in the area of screening smokes during World War II, but it also presents theoretical and mathematical material pertinent to the subject, regardless of its source.

136. Hahn, Col. P. H. (USMC), EVALUATION OF THE HAND HELD WIRE GUN, Final Report, U. S. Marine Corps Landing Force Development Center, Quantico, Virginia, Project No. 44-62-04 (Undated), 16 pp (UNCLASSIFIED) (PA 7802).

(U) The Marine Corps tested the Hand Held Wire Gun for possible use as an anti-personnel or riot-control weapon for unconventional warfare. This cylindrical gun is 10 inches long, 3-3/4 inches in diameter, and weighs about 11 pounds. The 450-foot wire coil is wound with sufficient energy to be propelled about 80 feet upon release. It is activated by retracting a pull ring, similar to that on a hand grenade, which is attached to a sear. The wire coil plugs itself out in essentially a straight line in from 6 to 7 seconds. In the tests described here, the gun did not meet Marine Corps requirements.

(This Page is Unclassified)

~~CONFIDENTIAL~~

DOCUMENT CONTROL DATA - R&D

(Security classification of title, body of abstract and indexing annotation must be entered when the overall report is classified)

1. ORIGINATING ACTIVITY (Corporate author) Columbus Laboratories, Columbus, Ohio 43201		2a. REPORT SECURITY CLASSIFICATION CONFIDENTIAL	
		2b. GROUP 5	
3. REPORT TITLE Aerial Survey of Nonlethal Weapons (U)			
4. DESCRIPTIVE NOTES (Type of report and inclusive dates) Task report			
5. AUTHOR(S) (Last name, first name, initial) Westbrook, Edwin E., and Williams, Larry W.			
6. REPORT DATE 30 Apr 71		7a. TOTAL NO. OF PAGES	7b. NO. OF REFS
8a. CONTRACT OR GRANT NO. F33657-71-C-0529		9a. ORIGINATOR'S REPORT NUMBER(S) RACIC-TR-66	
A. PROJECT NO.		9b. OTHER REPORT NO(S) (Any other numbers that may be assigned this report)	
c.			
d.			
10. AVAILABILITY/LIMITATION NOTICES None other than security			
11. SUPPLEMENTARY NOTES		12. SPONSORING MILITARY ACTIVITY Overseas Defense Research Office Advanced Research Projects Agency Arlington, Virginia 22209	
13. ABSTRACT (U) Nonlethal weaponry is surveyed and an annotated bibliography on the subject is presented. Irritants, analgesics, anticholinergics, and emetics are the chemical incapacitating systems discussed. Delivery systems for the chemical agents are given. Visible, IR and UV light, laser radiation, microwave radiation, and sound are used for distracting and disorientating victims. Barriers and mechanical deterrents are discussed which inflict physical discomfort through direct mechanical or electrical means. The techniques presented in this survey are of value to military and police activities.			

END

DATE
FILMED

7-71