

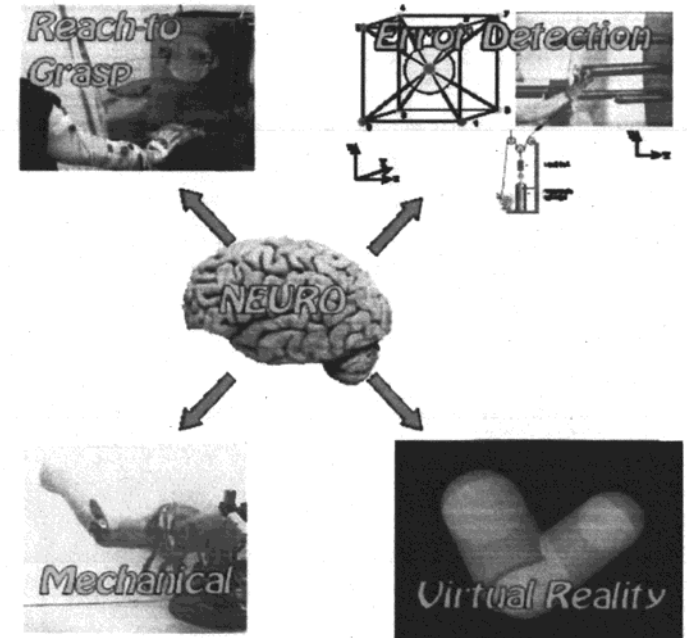

Central File
Account # GEA00017E

Advanced Neural Implants and Control

DARPA Bio:Info:Micro Annual PI Meeting
San Francisco, CA
November 5-6, 2003

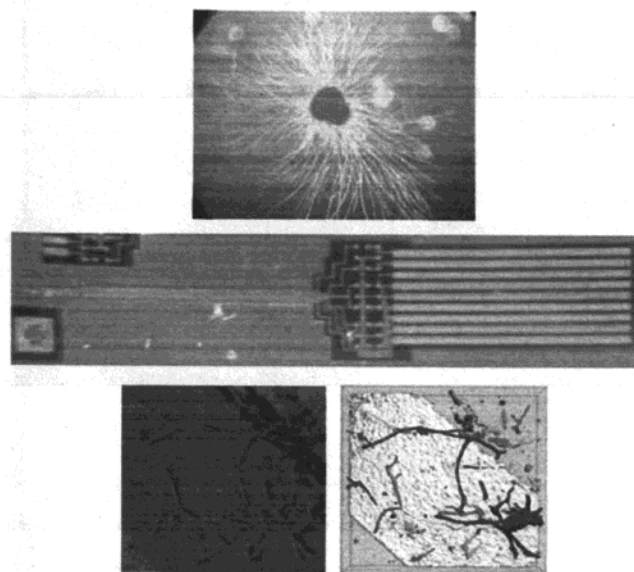

The Grand Challenge

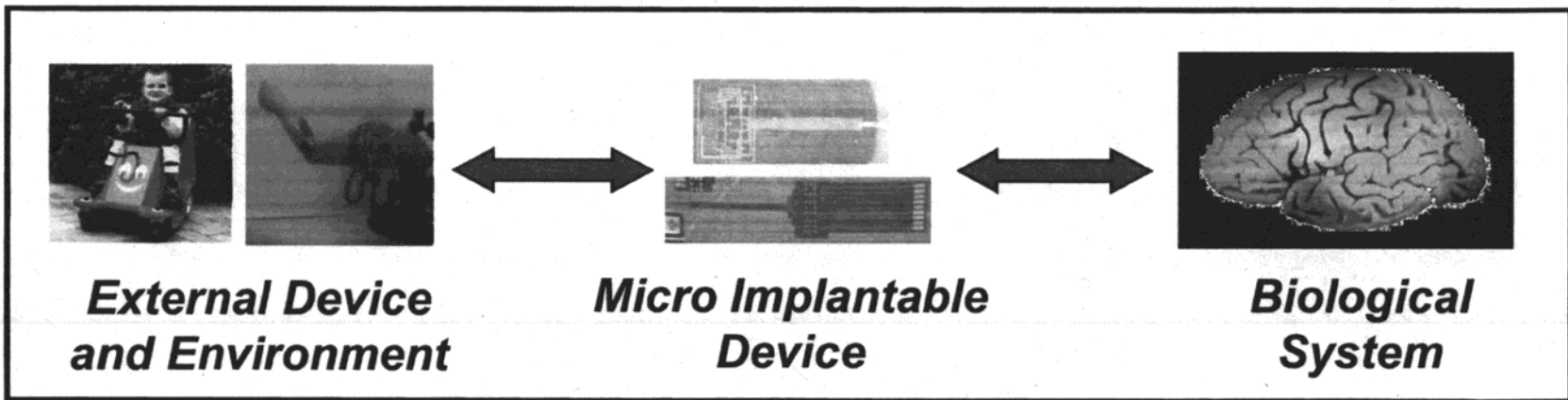

Exploit synergy at interface of Biology, Information Science and Microelectronics Technology to realize revolutionary advances in high capacity and reliable brain - external world interfaces

Minimal Invasiveness Strategy

Key Implications for Program Focus:

Long term biocompatible, stable, high S/N neural implants

Minimum number of neural signals for reliable system
operation



**Part I:
Signal/Data Acquisition**

**Advanced Polymer Neural Interface
Design, Fabrication and Testing**

Neural Interface Team

Design and Fabrication

- Jiping He, BE
- Bruce Kim, EE
- Jit Muthuswamy, BE
- Amarjit Singh, BE
- Kee-Keun Lee, EE
- Jing Hu, EE
- Greg Raupp, CME

Biocompatibility

- Steve Massia, BE
- Alyssa Panitch, BE
- Gholam Ehteshami, BE
- Lijiang Wang, CME

Visualization

- Greg Nielson, CSE
- Gerald Farin, CSE
- Anshuman Razdan, CSE
- Jiuxiang Hu, CSE
- Dave Capco, LS

Data Acquisition

- Steve Helms-Tillery, BE
- Byron Olson, BE

Advanced Polymer Interfaces: Objectives and Approach

Polymer-based
flexible micro-devices

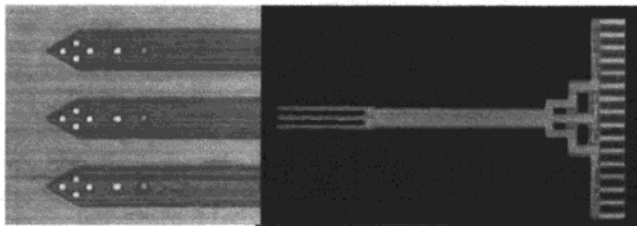

Long-term stable high S/N
neural implants

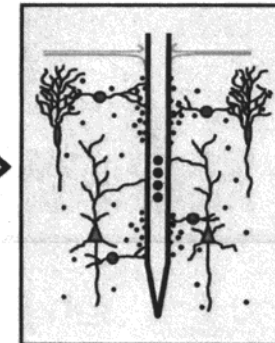

*Material, design and
surface modification*

- Bulk polymer substitution / modification to enhance device stability
- Flexibility compliance with brain tissue
- Coatings to enhance biocompatibility
- Embedded neurotrophic factors to promote neural interfacing

Bio:Info:Micro/Nano Technology Fusion

**Cellular and biochemical
response characterization
(BIO, NANO, INFO)**

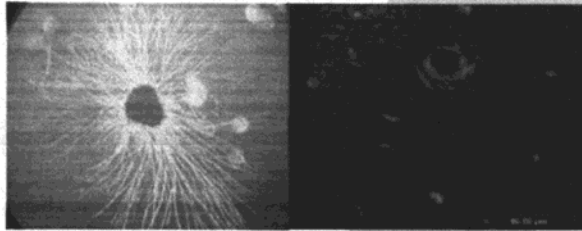

**Advanced micro-device
biomaterials and designs
(BIO, MICRO)**

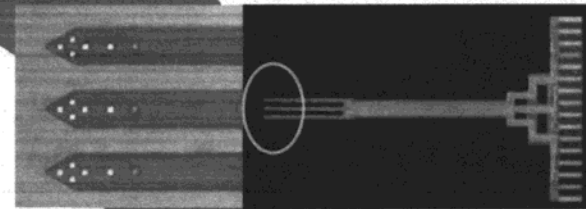

**Imaging / 3D visualization of
sensor-tissue dynamics
(BIO, INFO)**

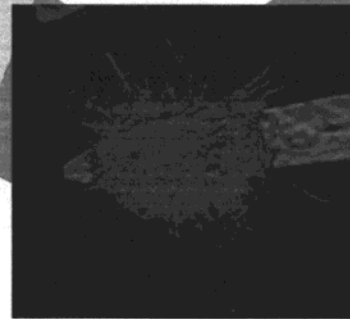

Principal Technical Advances

- New material for flexible neural implants
 - Microfabrication process developed
 - Flexible / implantable design developed and proven
 - Biocompatibility verified
- Advanced design elements incorporated
 - Integrated flexible headstage and op amp buffer circuitry
 - Dual function action potential / field potential “butterfly” design
 - Microfluidic channels for controlled biologic delivery
- Demonstrated HA-based bioactive gels promoted neurite extension and stability
- Surgical implantation and neural recording

In Search of New Materials: Principal Technical Requirements

- ◆ **Biocompatibility**
 - toxicity
 - immune response
- ◆ **Long-term stability**
 - water uptake / moisture barrier properties
 - chemical stability
- ◆ **Electronic and mechanical properties**
 - dielectric constant, dissipation factor
 - bulk and tensile moduli, stiffness, CTE
- ◆ **Processing and materials integration properties**
 - process flow complexity/simplicity and reliability
 - thermal stability
 - thin film adhesion properties
 - external connectivity

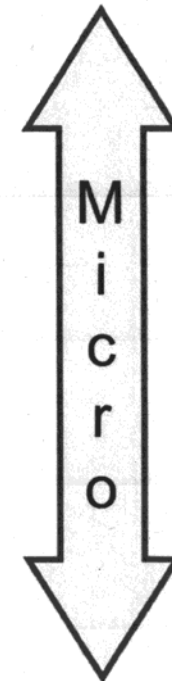
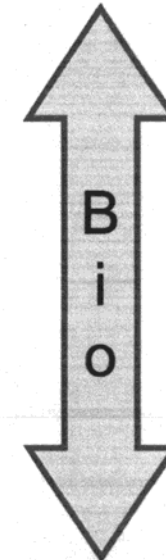

Photoimageable DVS-BCB vs. Polyimide

Property	BCB	Polyimide
Water uptake (wt%)	< 0.2%	4-6%
Dielectric constant	2.65	3.4 – 3.8
Cure time	minutes	hours
Cure byproducts	none	H ₂ O
Metal barrier	none	Ti/TiN

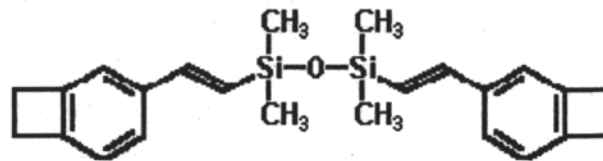

Tailored Mechanical Design

- Flexible to comply with brain tissue mechanical properties
- Flexible to accommodate micromotion
- Reinforced tip for surgical handling

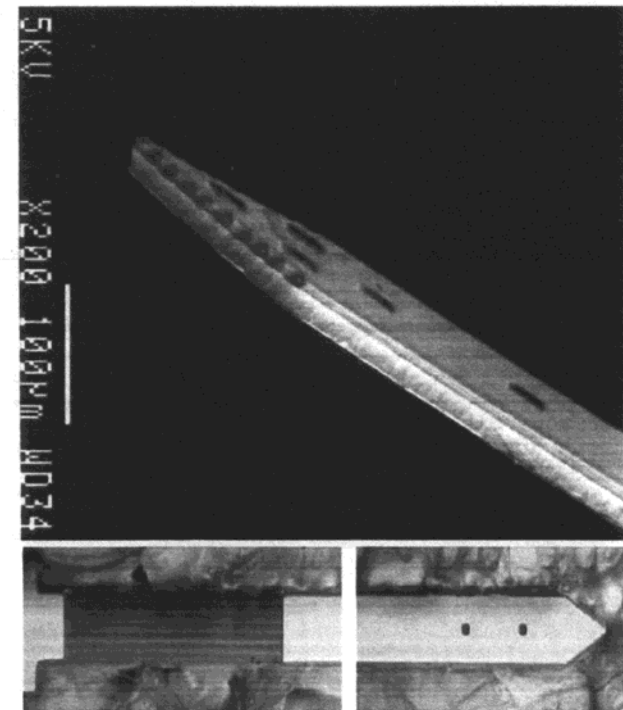
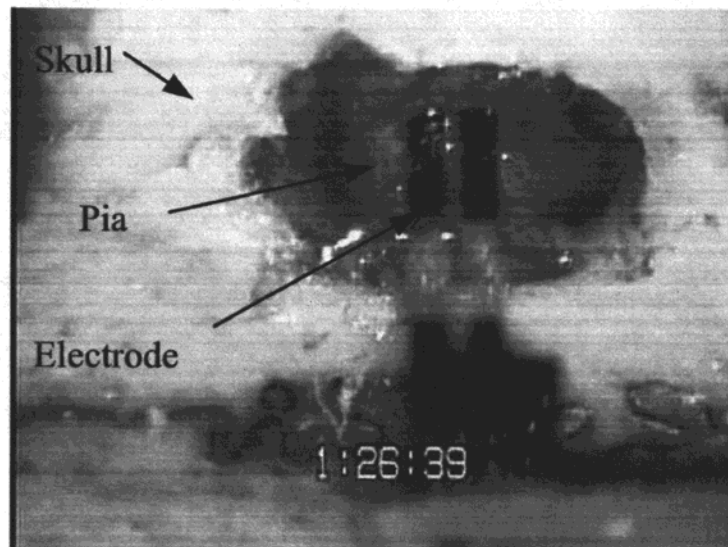
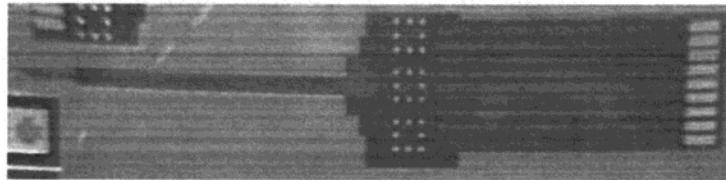

Bottom view

Process Flow on Thinned SOI Substrates

Etch SOI Si backbone layer

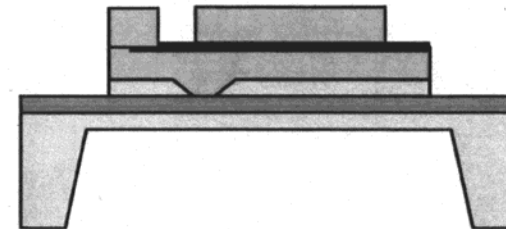
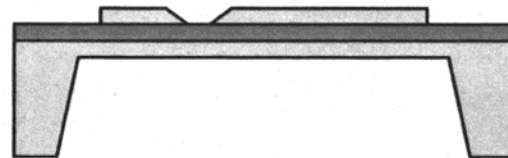

Deposit and pattern upper BCB layer

Deposit and pattern base BCB layer

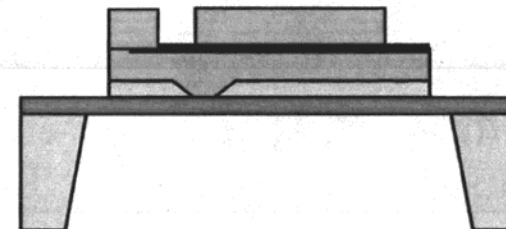
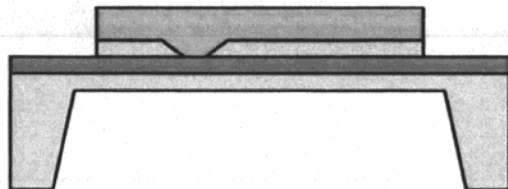

Backside Si etch

Deposit and pattern gold

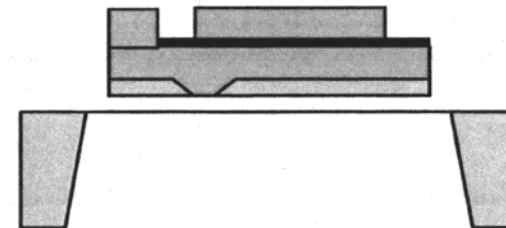
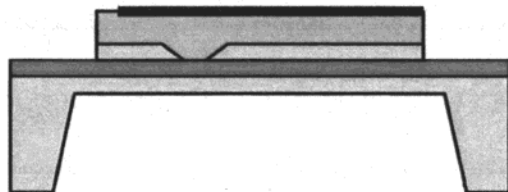

**Electrode release:
etch buried SiO₂**

Si Backbone Strength Enhancement

	Young's Modulus (GPa)	Rat pia penetration
BCB	2.8	No
BCB + 2 μm Si	10	No
BCB + 5 μm Si	32	Yes
BCB + 10 μm Si	58	Yes
Si	110	Yes

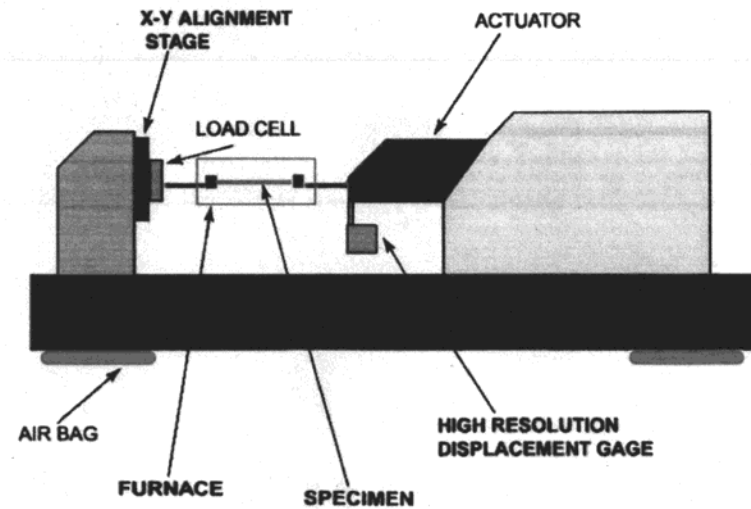
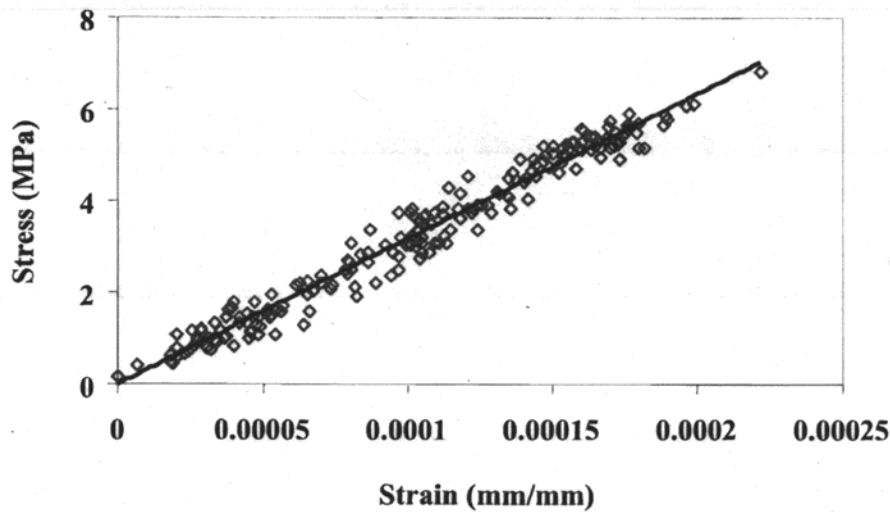

Micro-Force Thermo-Mechanical Test

Surgical Insertion Test

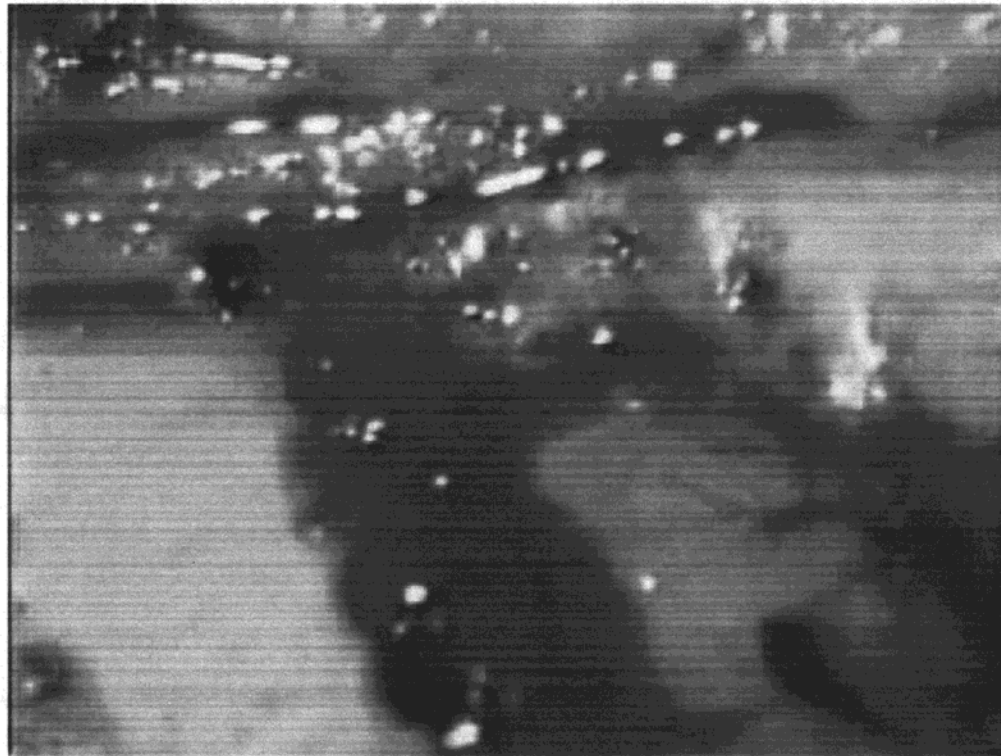

*Video clip of BCB neural interface
penetrating rat pia*

Recording Site Impedance

Channel	1	2	3	4	5	6
Z (K Ω)	210	206	290	295	240	255
θ °	-63	-64	-58	-62	-63	-61

**Impedance at 1KHz for 20 μ m \times 20 μ m gold recording sites
measured in 0.9% saline solution at room temperature**

In vitro Biocompatibility Test

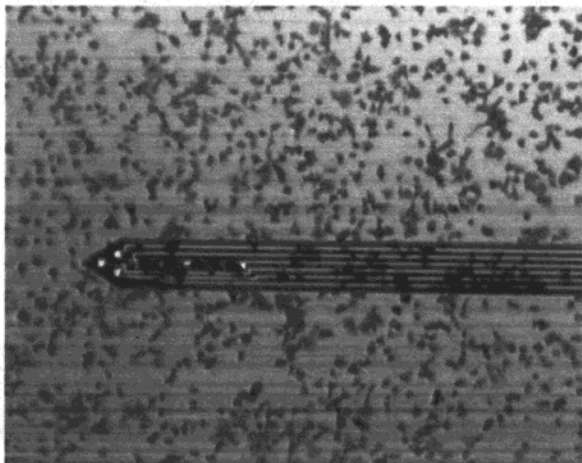

Morphology of adherent 3T3 cells on BCB electrode shank and surrounding wafer surface

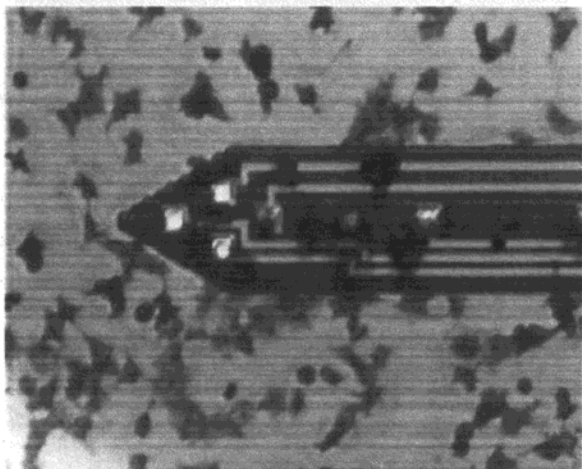

Cell area coverage on Tissue Culture Plastic and BCB Electrode

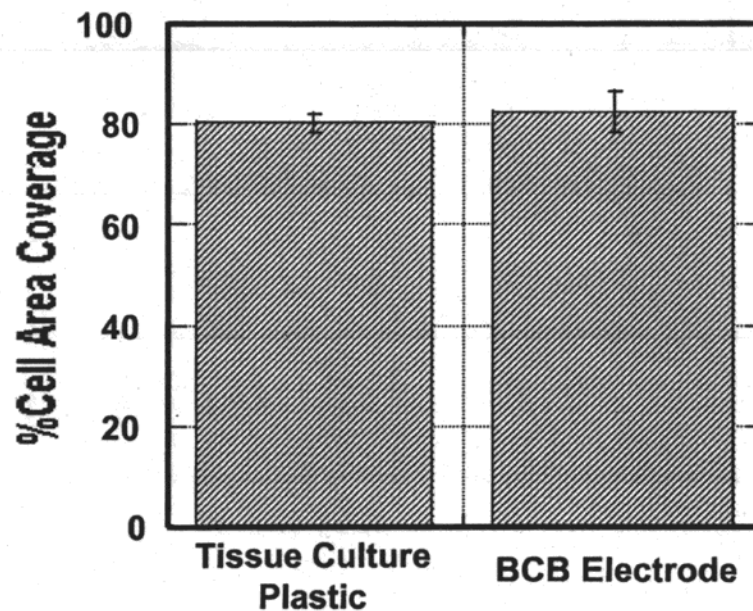

BCB / GFAP Confocal Microscopy Image Analysis

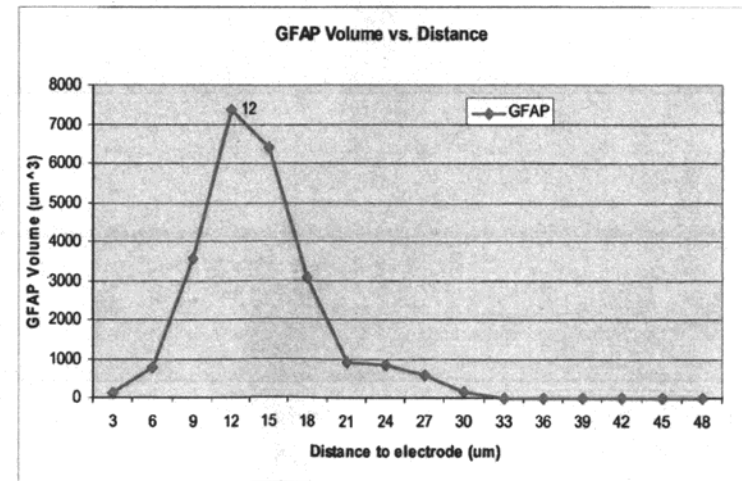
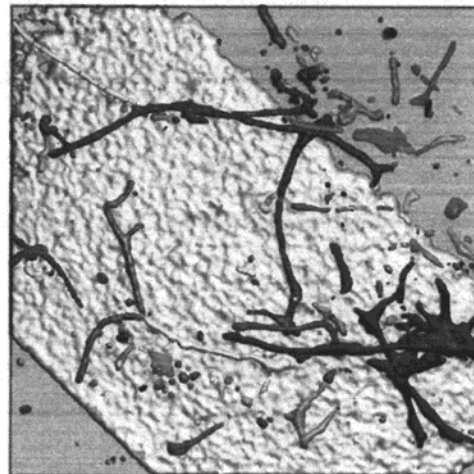
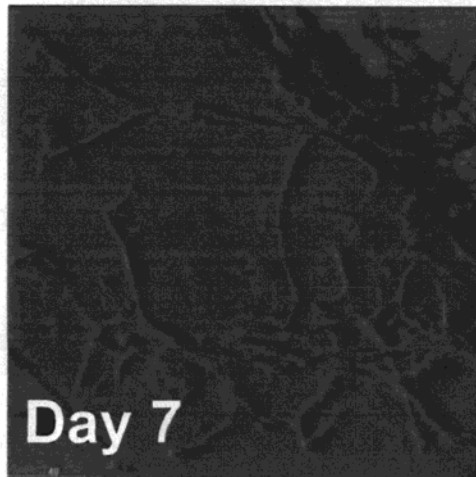
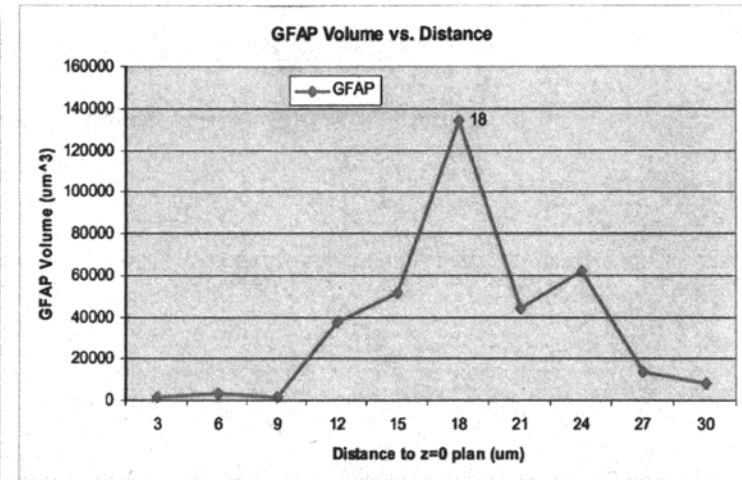
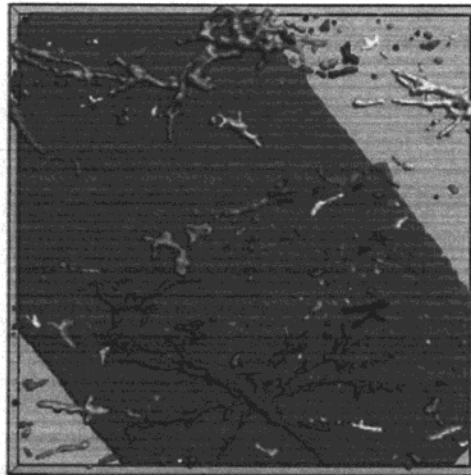
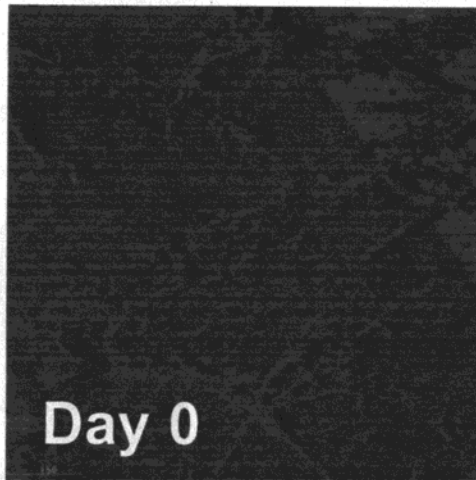

Cell Attachment and Scarring

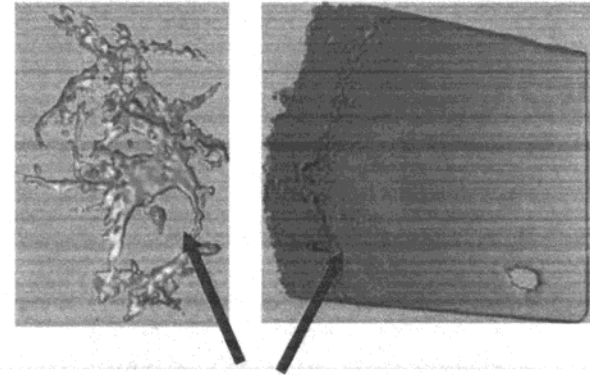
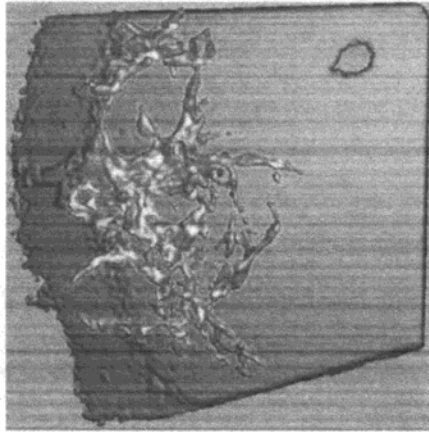
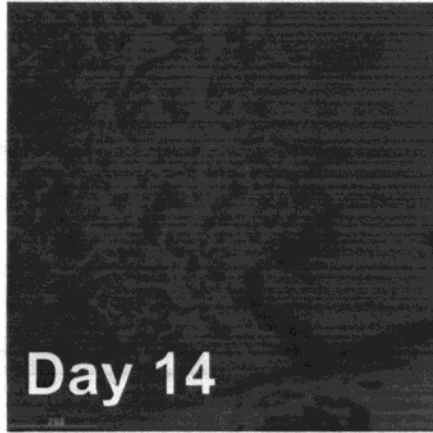

Cell Attachment

Electrode substrate	GFAP Scar Size: Electrode Size
BCB	0.25
Silicon	0.74

Bioactive Coating and Bioactive Gel Improve Biocompatibility

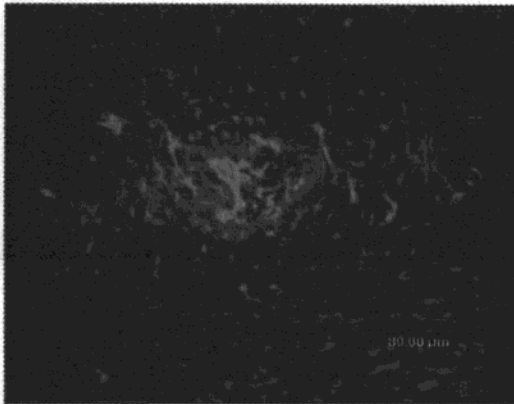

Bare W wire

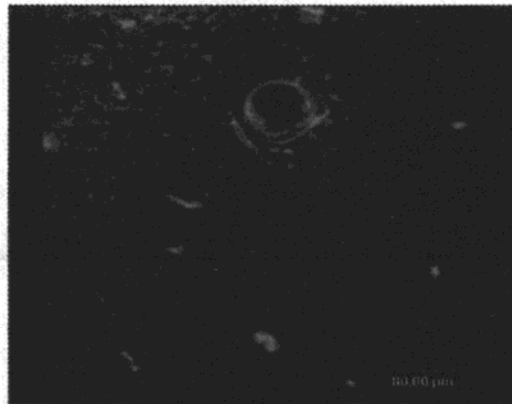

Dextran Coated

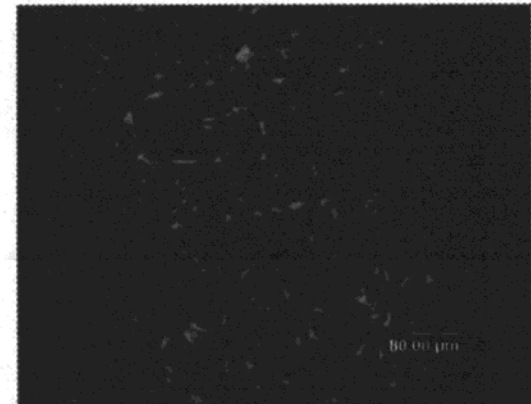

Dextran + P20

Reduced scar tissue density

Principal Technical Advances

- **Advanced design elements incorporated**
 - Integrated flexible headstage and op amp buffer circuitry
 - Dual function action potential / field potential “butterfly” design
 - Microfluidic channels for controlled biologic delivery
- **Advanced design elements incorporated**
- **Advanced design elements incorporated**
- **Advanced design elements incorporated**

BCB Neural Interface with Flexible Headstage and Integrated Buffers

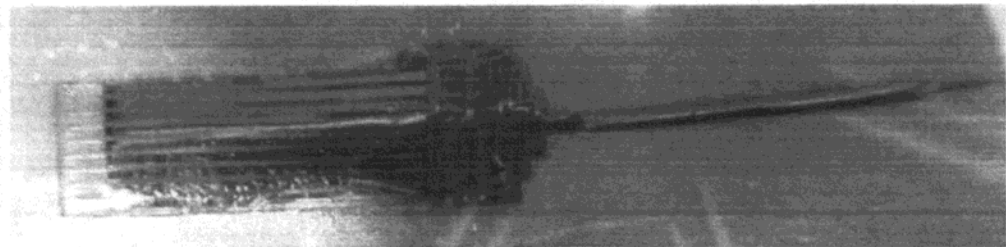
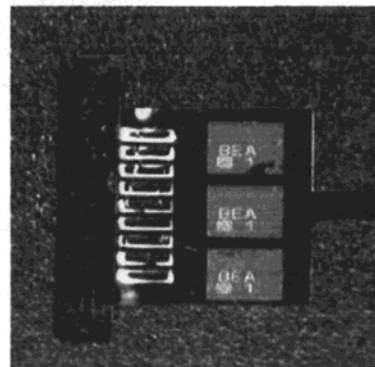
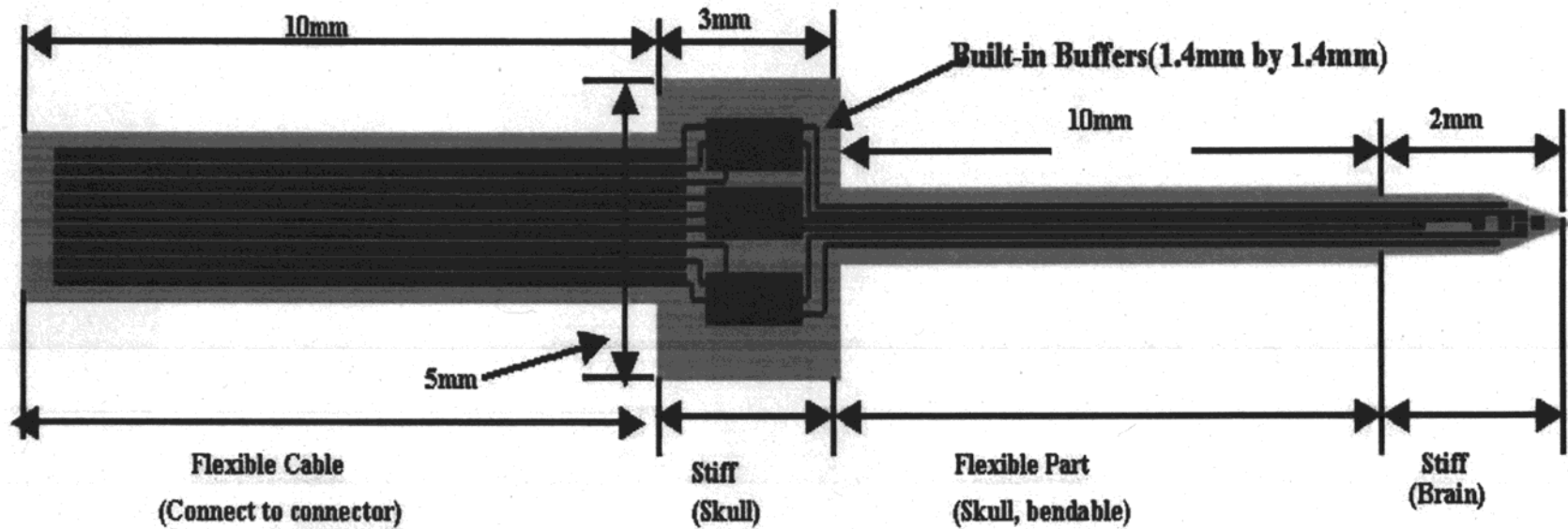

Butterfly Neural Interface Design

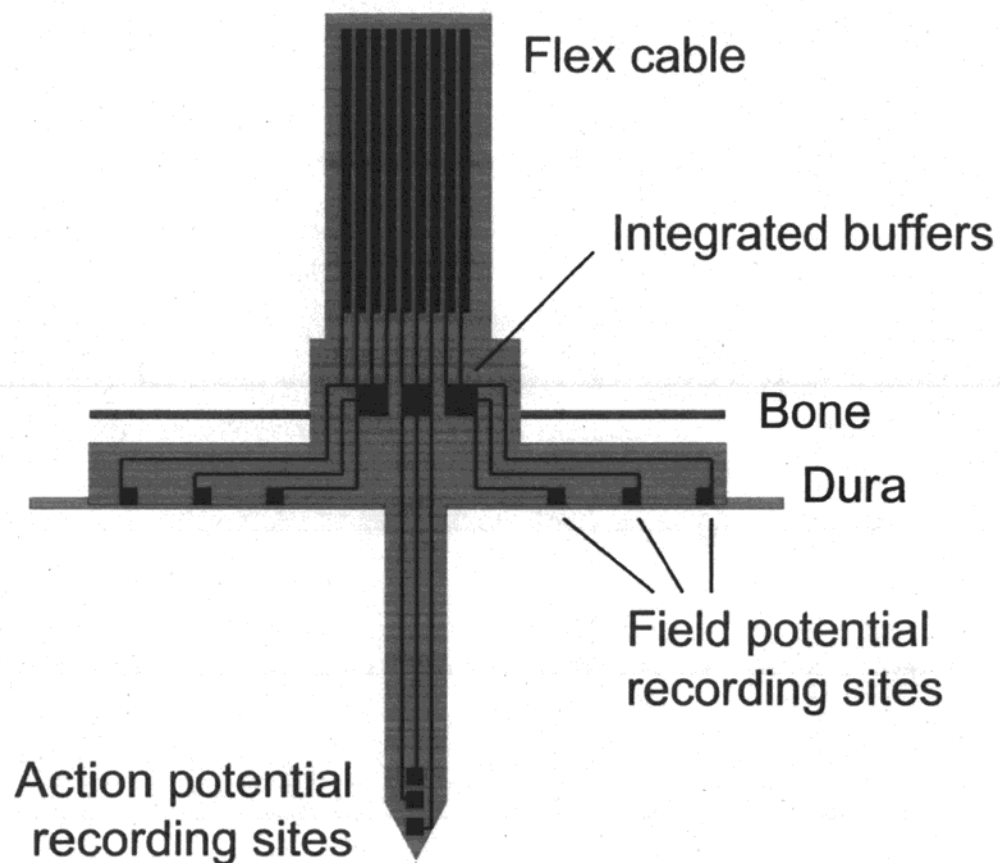

Microfluidic Channels Fabricated in BCB

Si backbone
layer

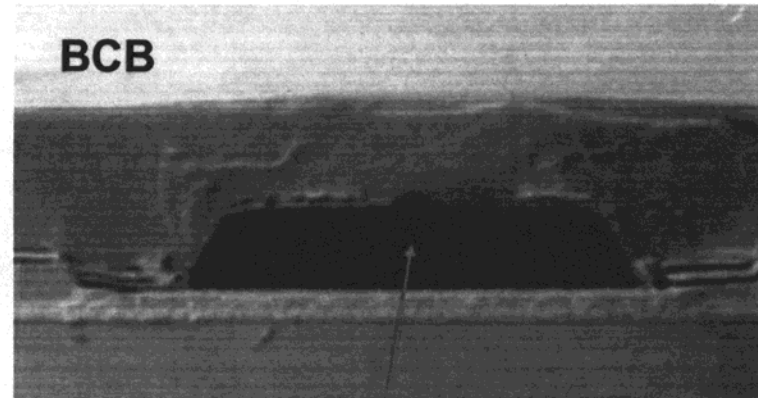

Microfluidic
channel

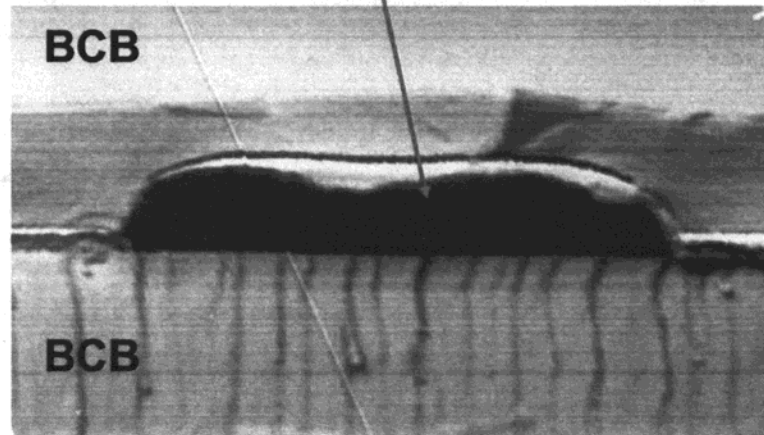

BCB Interface with Microfluidic Channel

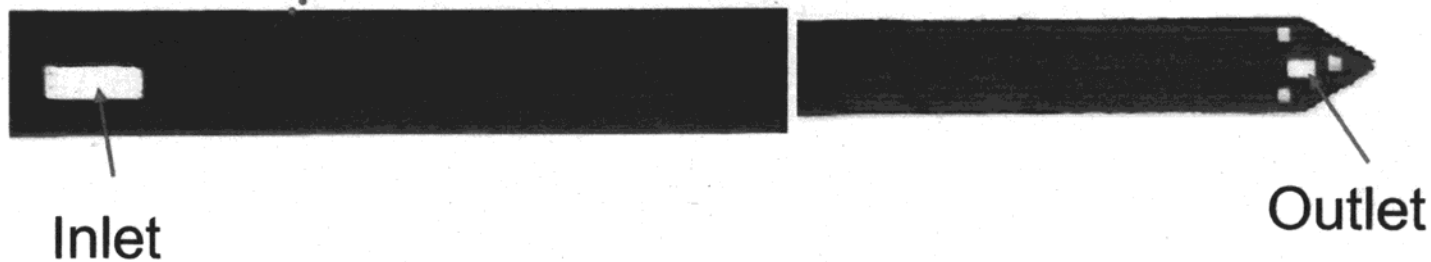
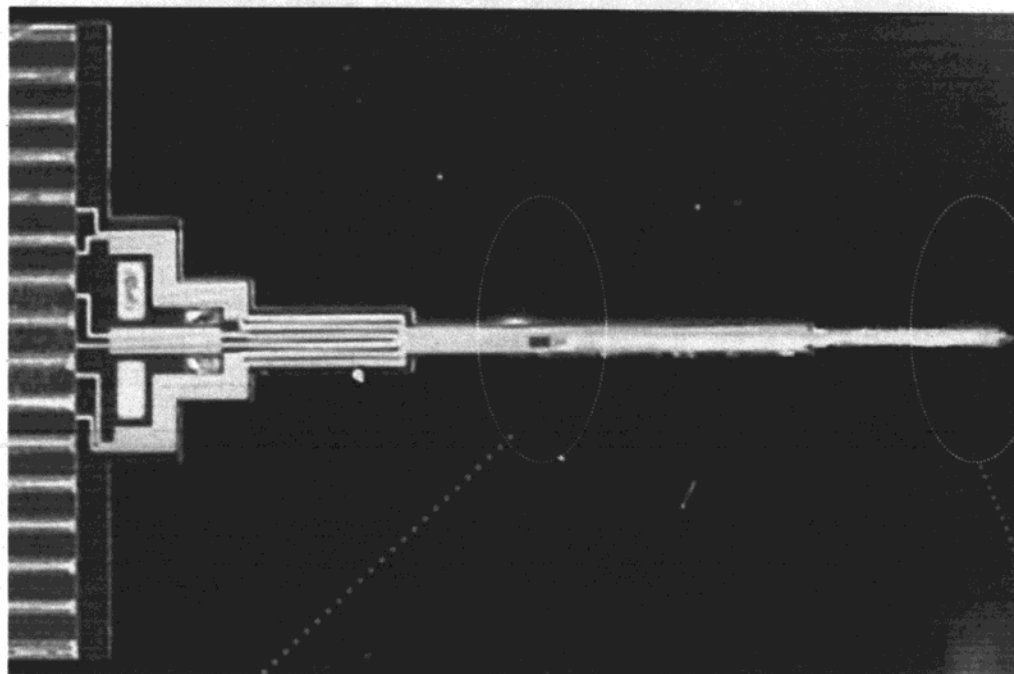

Tri-shank BCB Interface with Microfluidic Channel

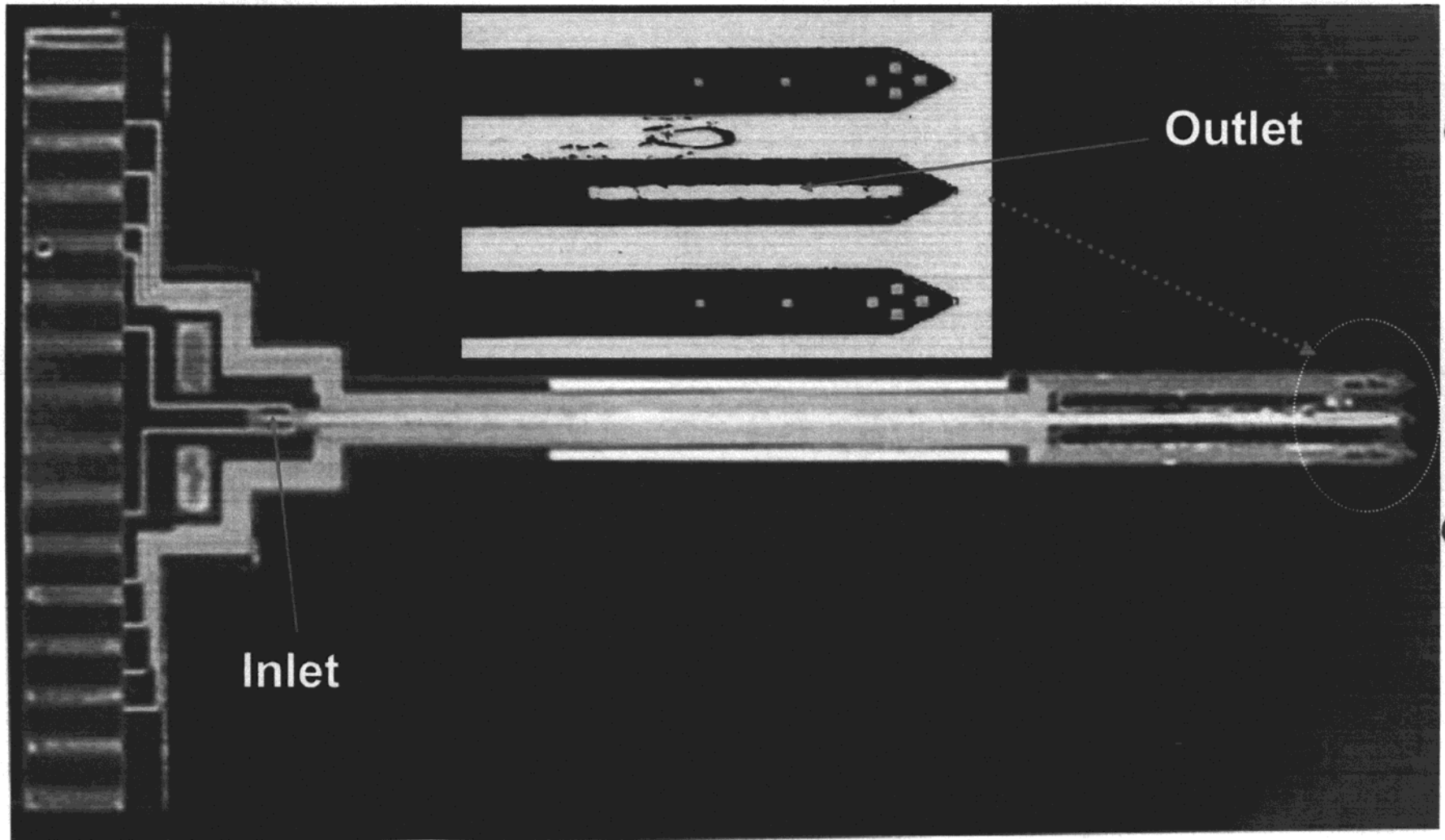

Microfluidic Channel Liquid Flow Test

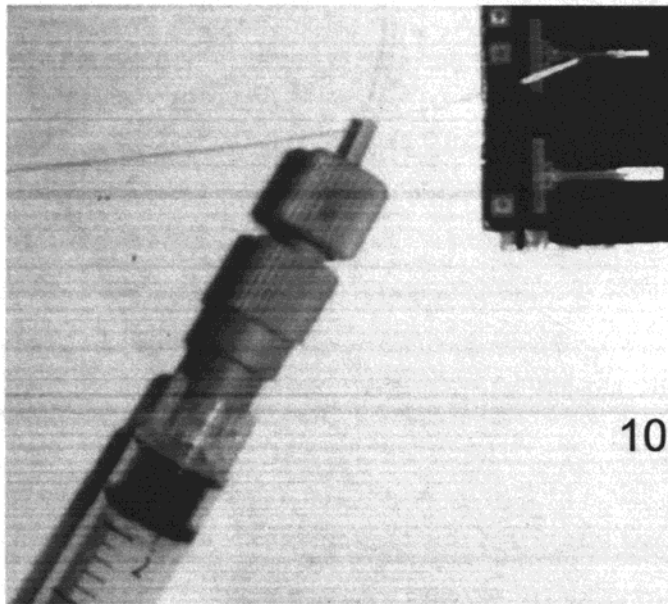

10 μ m dia
tube

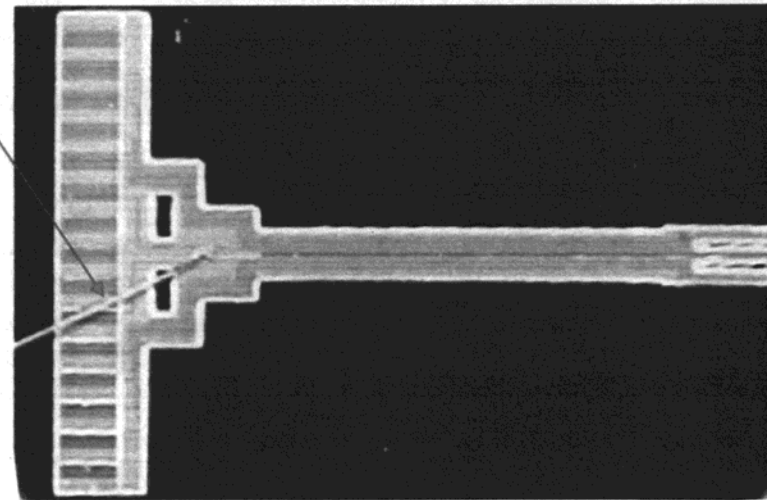
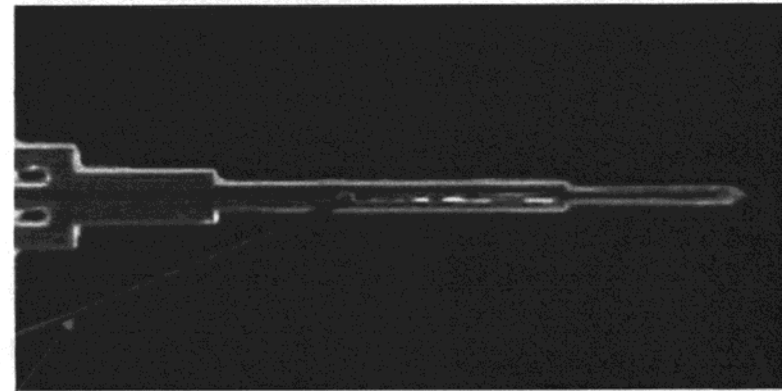

Neurite Outgrowth Quantified

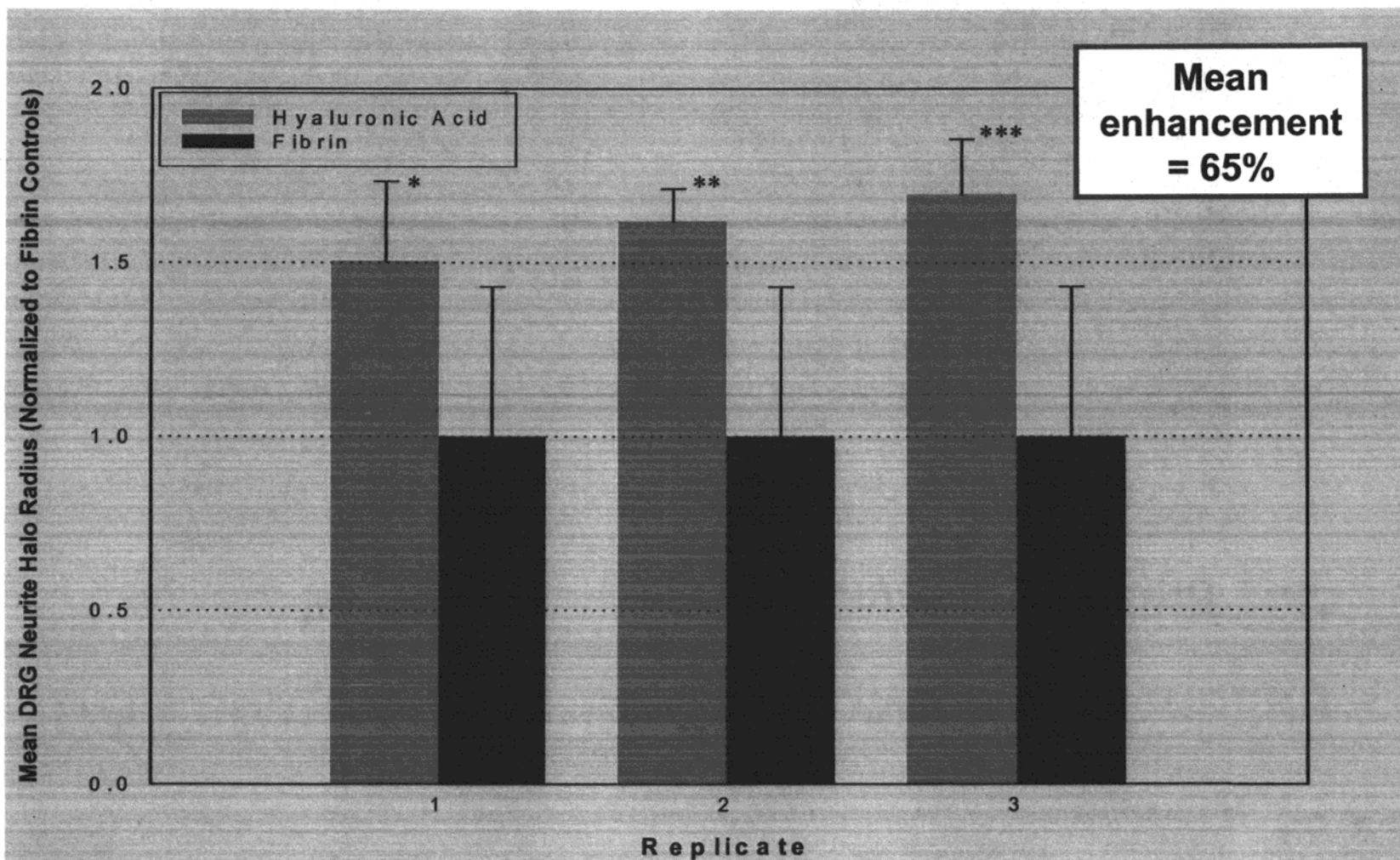

* $p < 0.02$, ** $p < 0.0005$, *** $p < 0.002$

Principal Technical Advances

- Developed a novel microfabricated neural interface that provides a high density of electrical contacts and is compatible with chronic implantation in the brain
- Demonstrated that the neural interface supports long-term stable recording and stimulation of neural activity in the brain
- Demonstrated that the neural interface supports long-term stable recording and stimulation of neural activity in the brain
- Demonstrated that the neural interface supports long-term stable recording and stimulation of neural activity in the brain
- Demonstrated that the neural interface supports long-term stable recording and stimulation of neural activity in the brain
- Demonstrated that the neural interface supports long-term stable recording and stimulation of neural activity in the brain
- Demonstrated HA-based bioactive gels promoted neurite extension and stability
- Demonstrated that the neural interface supports long-term stable recording and stimulation of neural activity in the brain

Hyaluronic Acid

- Non-sulfated, unbranched glycosaminoglycan (GAG) comprised of repeating disaccharides (D-glucuronic acid(β 1-3)N-acetyl-D-glucosamine(β 1-4))
- Ubiquitously present in connective tissue -- forms loose hydrated matrices for cell division and migration during embryonic development
- Plays a role in intracellular signaling

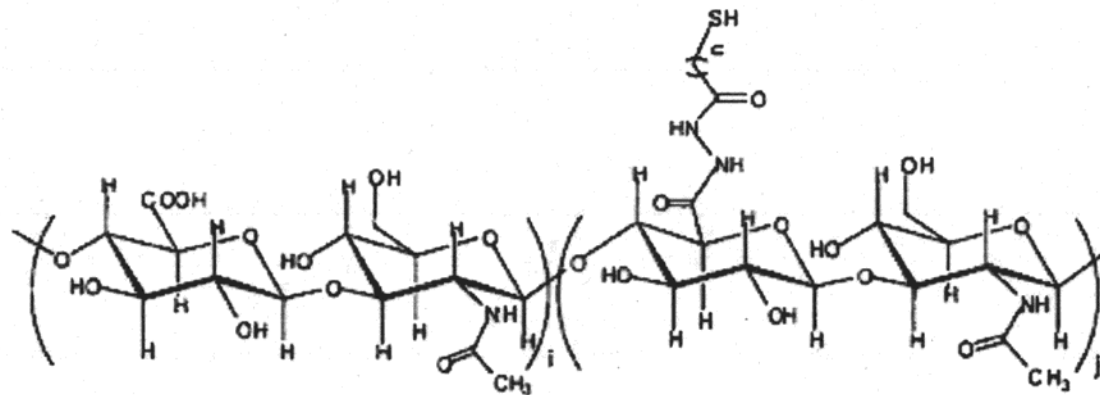

HA Enhances Neurite Outgrowth and Stability

Fibrin

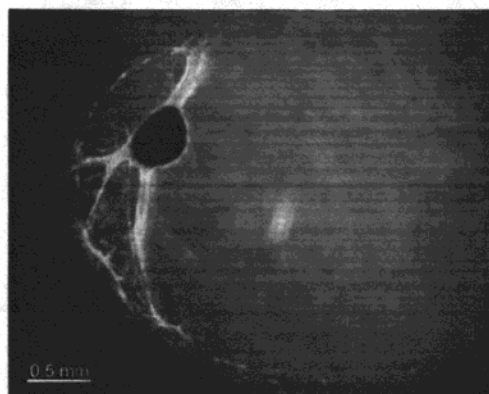

48 hours

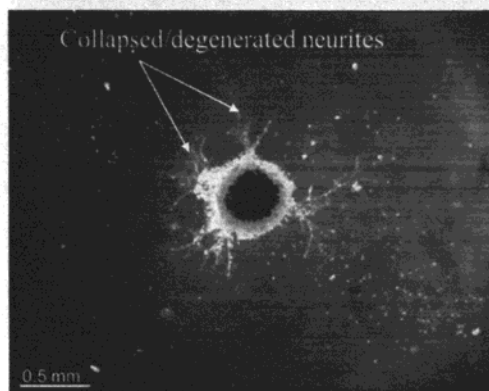

60 hours

Hyaluronic Acid

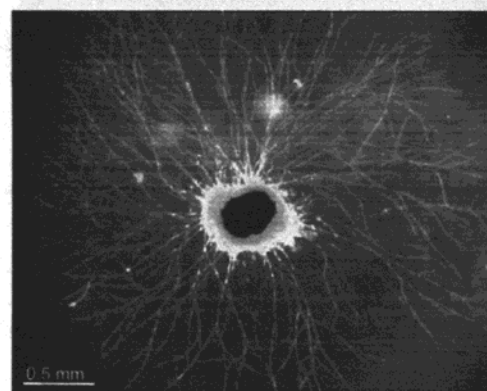
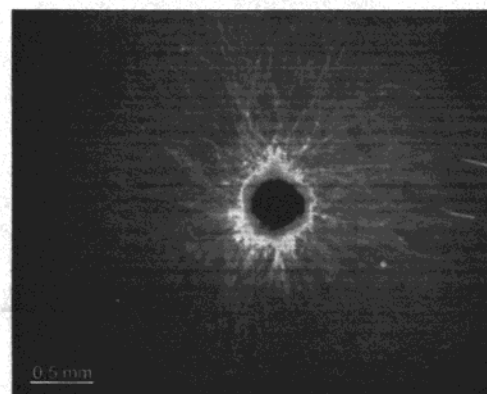

HA Provides Long-term Structural Stability

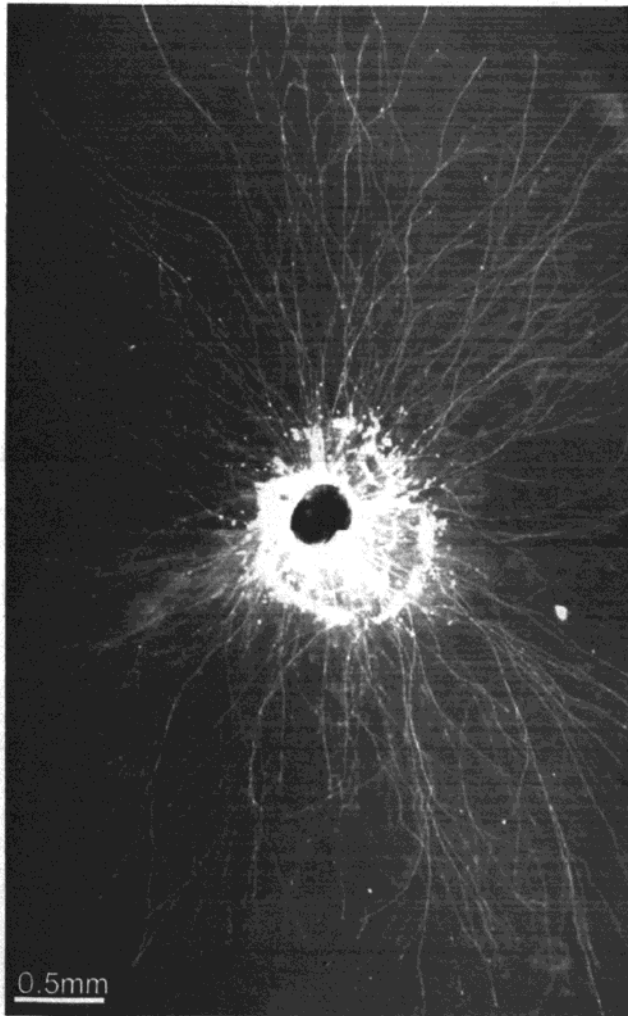

192 hours

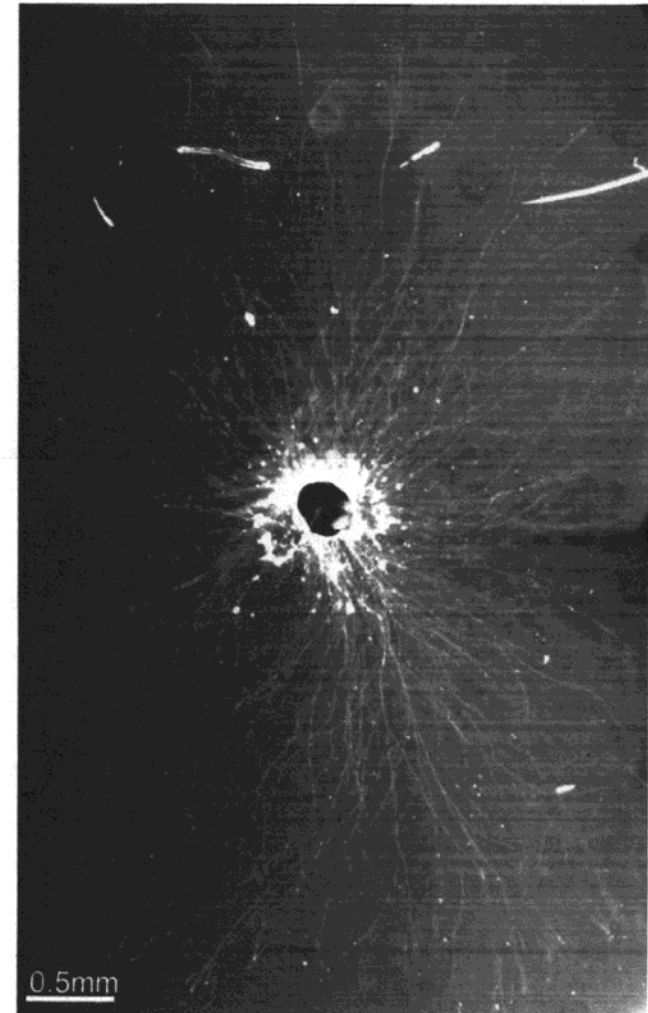

Principal Technical Advances

- New material for flexible neural implants
 - Microfabrication techniques for flexible substrates
 - Flexible substrates for high resolution and precision
 - Biocompatibility verified
- Advanced design capabilities created
 - Integrated flexible electronics for on-chip amp/buffer circuitry
 - Dual function active/passive field potential "control" design
 - Microfluidic channels for drug/bio-logic delivery
- Demonstrated HA-SiO₂ hydrogel provides neural extension and stability
- Surgical implantation and neural recording

Surgical Implantation and Neural Recording

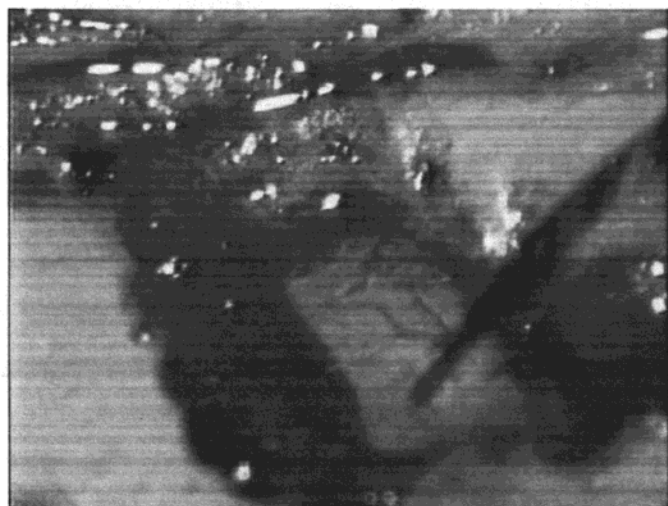

Single shaft BCB neural interface inserted into right rat barrel cortex

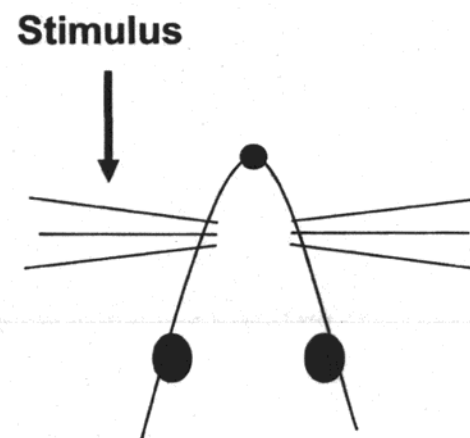

Stimuli were delivered by manually brushing a small rod over the left whisker patch at different rates

Neural Recording Responses Modulated in Proportion to Stimulus Rate

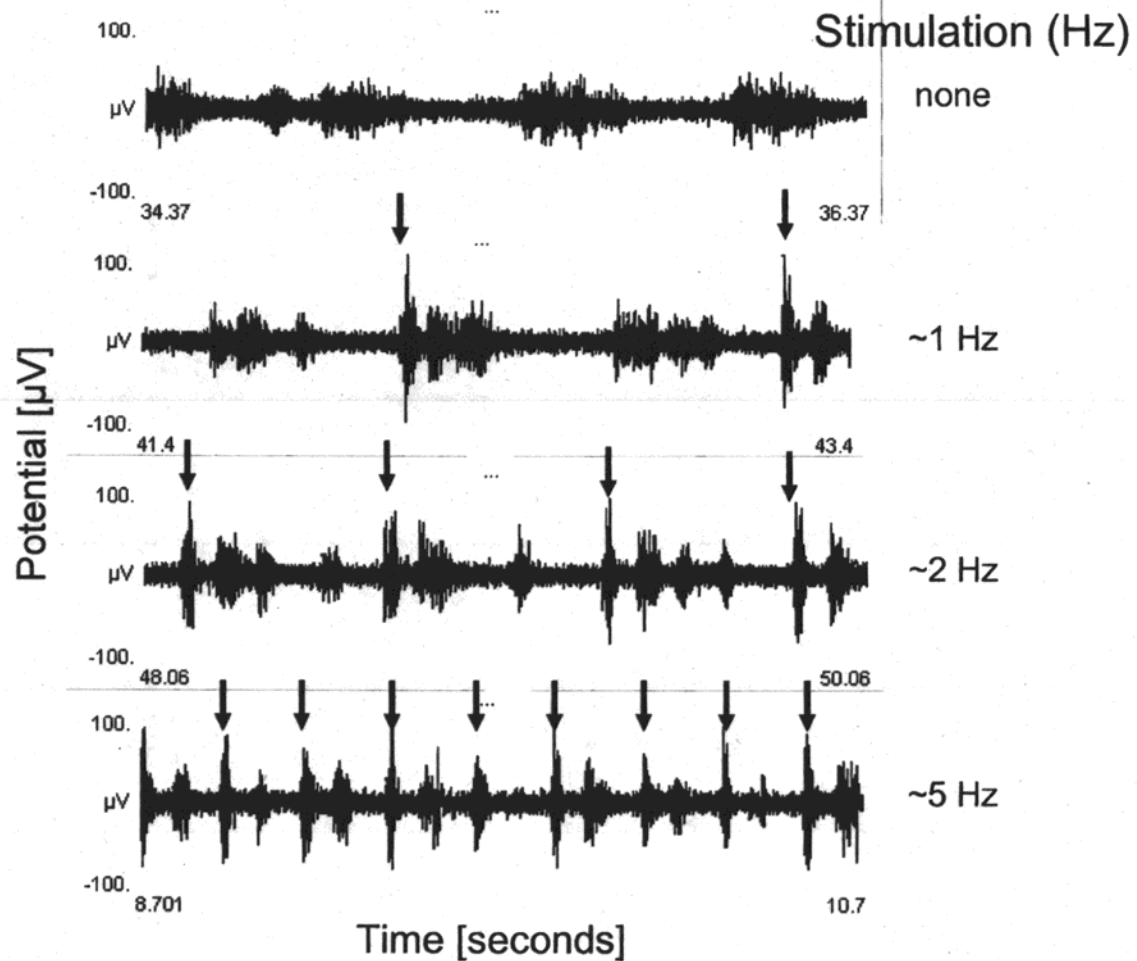

Immediate Future Goals

- Long term (>6 months) BCB neural interface evaluation
 - Recording stability
 - Neural cell responses to
- Establish procedures for routine integrated processing of bioactive coatings with neural interfaces
- Develop and implement integrated controlled bioactive gel release systems



2003-04 Publications

"An *Ex Vivo* Method for Evaluating the Biocompatibility of Neural Electrodes in Rat Brain Slice Cultures", B. A. Koeneman, K.-K. Lee, A. Singh, J. He, G. B. Raupp, A. Panitch, D.G. Capco, submitted to *Journal of Neuroscience Methods*.

"Glial Cell and Fibroblast Cytotoxicity Study on 4026-Cyclotene Photosensitive Benzocyclobutene (BCB) Polymer Films", G. Ehteshami, A. Singh, G. Coryell, S. Massia, J. He and G. B. Raupp, accepted for publication in *Journal of Biomaterials Research - Polymers*.

"Benzocyclobutene (BCB) Based Intracortical Neural Implant", A. Singh, K.-K. Lee, J. He, G. Ehteshami, S. Massia and G. B. Raupp, submitted to *Proc. IEEE Engineering in Medicine and Biology Society*.

"Glial Cell and Fibroblast Cytotoxicity Study on Plasma-deposited Diamond-like Carbon Coatings", A. Singh, G. Ehteshami, S. Massia, J. He, R. G. Storer and G. B. Raupp, accepted for publication in *Journal of Biomaterials Research - Polymers*.

"Polyimide-based Intracortical Neural Implant with Improved Structural Stiffness", K.-K. Lee, J. He, A. Singh, S. Massia, G. Ehteshami, B. Kim and G. B. Raupp, *Journal of Micromechanics and Microengineering* 14, 32-37 (2004).



Advanced Neural Implants & Control



Part II: Decoding/Modeling/Application

Neuronal Interactions

Brain-controlled Neuroprosthetic Arm

Brain-controlled Autonomous Robot

Principal Technical Advances

- Plasticity and adaptability of neural networks in motor and sensory cortices
- Brain control feasibility demonstrated

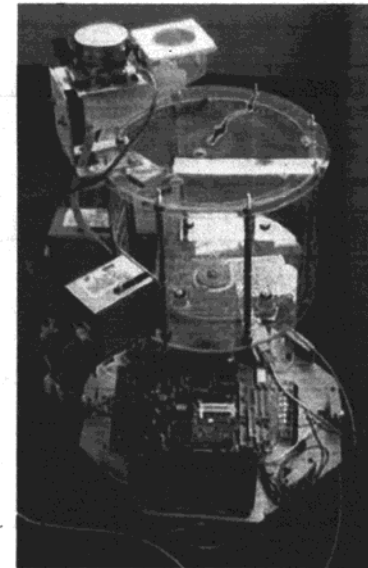
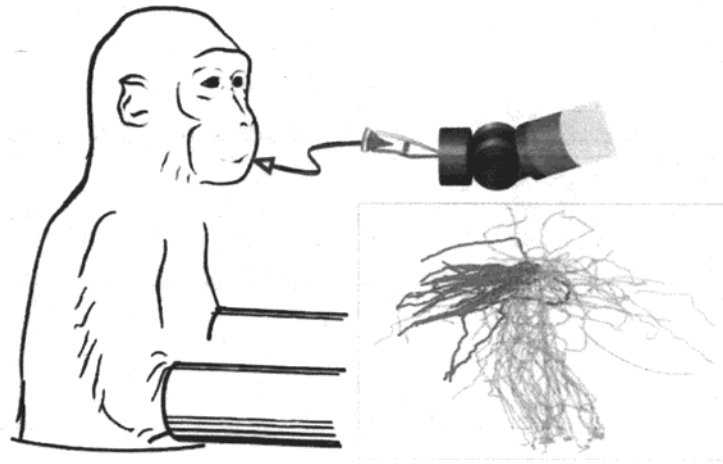



Motor and Sensory Cortical Interactions during Learning and Adaptation in Primates

Dr. Narayanan Krishnamurthi

Dr. Doug Weber

Prof. Jiping He

Prof. Leon Iasemidis

Brain Dynamics Lab

Neuro-Mechanical Control and Rehabilitation Research Lab



Neural Control Team

Applications

- Jiping He, BE
- Steve Helms-Tillery, BE
- Byron Olson, BE
- Chris Jennings, BE
- Matt Holecko, BE

Visualization

- Greg Nielson, CSE
- Gerald Farin, CSE
- Anshuman Razdan, CSE
- Wei Chen, CSE

Analysis

- Jennie Si
- Narayanan Krishnamurthi
- Doug Weber
- Leon Iasemidis
- Frank Hoppensteadt

Motor and Sensory Cortical Interactions during Learning and Adaptation in Primates

1. Is plasticity observed in neuronal interactions?

Identify/quantify existence of significant changes of interaction between and within motor and sensory cortices during learning and adaptation

2. What is the underlying mechanism of observed plasticity?

Individual vs. Spatial Patterns of neuronal firing rates over time

3. Are the neuronal interactions global or local?

Identify set of neurons responsible for a particular learning and behavioral pattern

Experimental Design

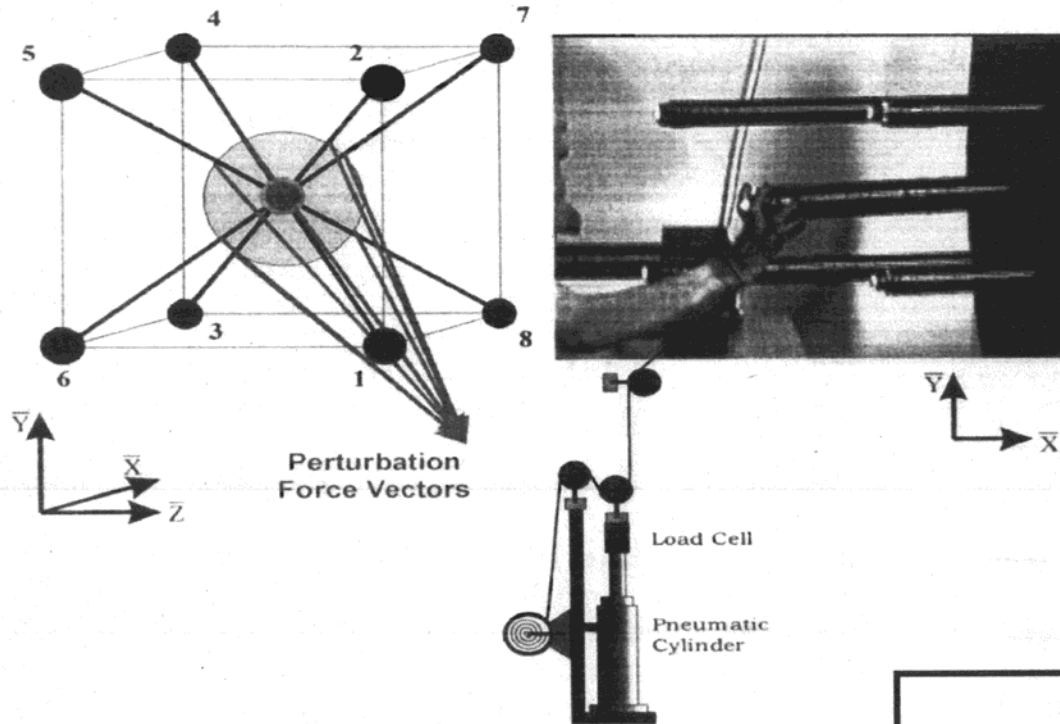

Experimental Phases

- Training (2-8 weeks)
- Normal reaching in 3D space (1 week)
- Short duration pulling force perturbation force (1-1.5 weeks)

Neural Recording

- Four 16-channel microwire arrays
- Simultaneous spike train recordings from sensory, motor, and pre-motor regions

Spike Trains → Spike Count Time Series

SPIKE TRAINS



SPIKE COUNT

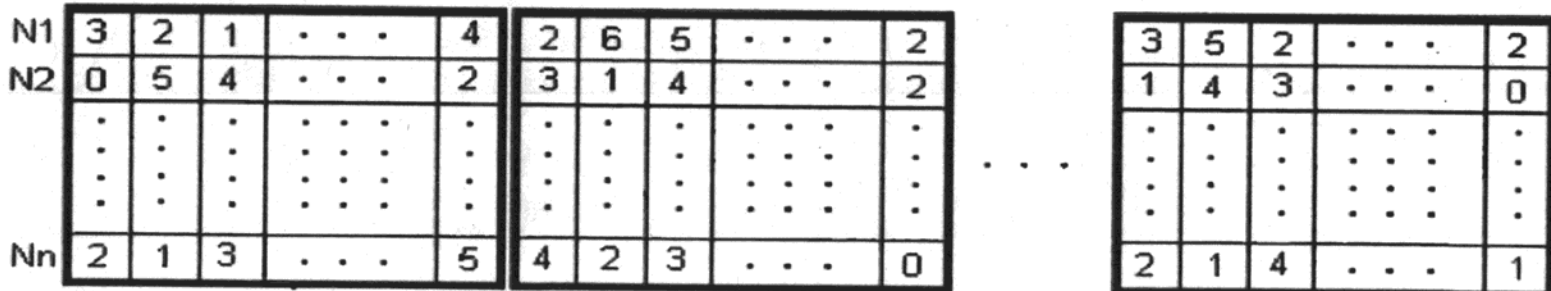

Mutual Information (MI) Methodology

- **Nonparametric measure of statistical similarity between two systems --**

Information gained (or reduction of uncertainty, i.e., entropy) about the unknown state of one of the systems by observing the state of the other system

- **MI is estimated on the basis of individual and joint system entropies, which in turn are estimated through their corresponding individual and joint probabilities**

$$MI(N_i, N_j) \approx H(N_i) + H(N_j) - H(N_i, N_j)$$

$$- \sum_{m=1}^M P(N_{i_m}) \log_2(P(N_{i_m}))$$

$$- \sum_{m=1}^M \sum_{m=1}^M P(N_{i_m}, N_{j_m}) \log_2(P(N_{i_m}, N_{j_m}))$$

Mutual Information Measures

Average Mutual Information (AMI) between cortices A and B

$$AMI(A, B) = \frac{1}{(N_A - 1)(N_B - 1)} \sum_{i=1}^{N_A-1} \sum_{\substack{j=1 \\ \text{For } i \neq j}}^{N_B-1} MI(N_i, N_j)$$

Number of distinct neurons

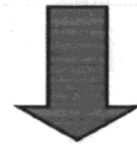

Optimal Average Mutual Information (OAMI)

Averaged over top $\alpha\%$ of all possible neuronal interactions



Normalized Optimal Average Mutual Information (NOAMI)

Monkey 1 – [^SMC(M),^SMC(M)]

Observed Success Rate

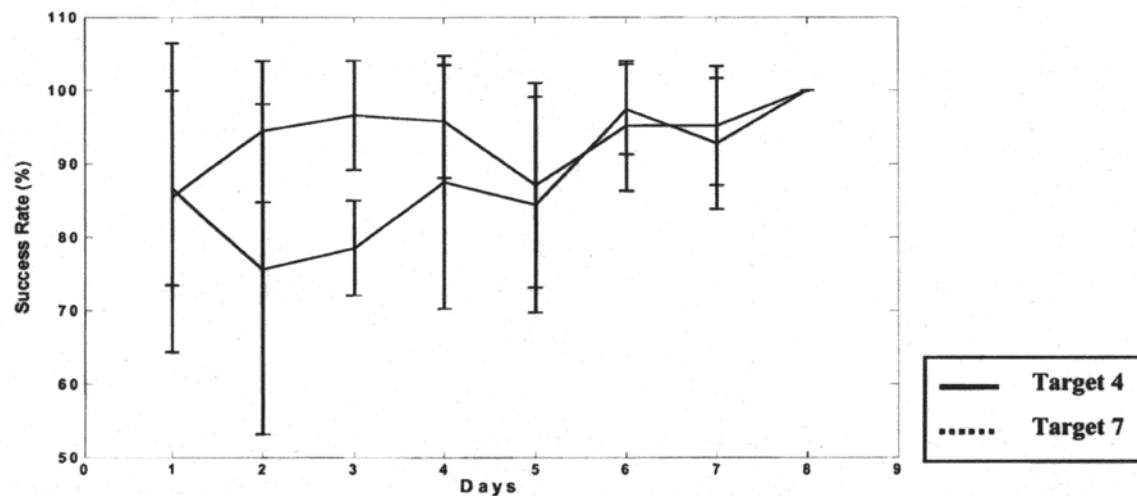

Normalized Optimal AMI

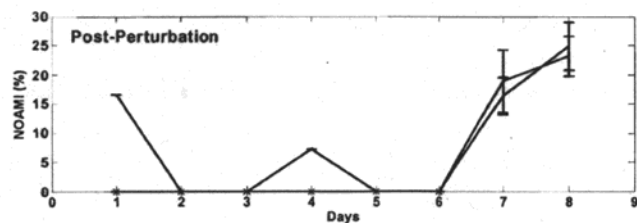
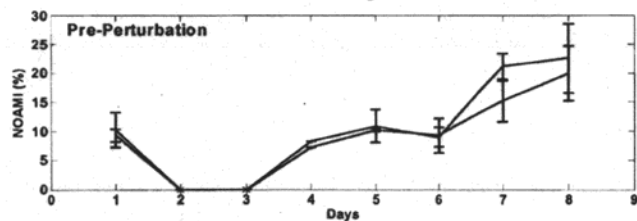

Optimal Average Firing Rate

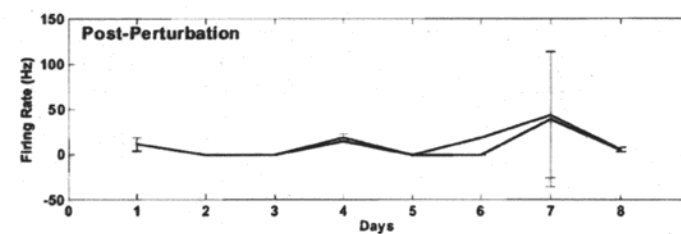
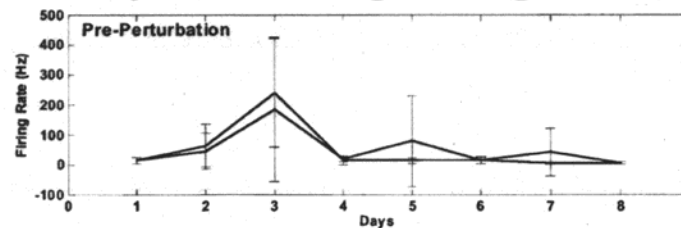

Monkey 2 – [HSC(L), HSC(L)]

Observed Success Rate

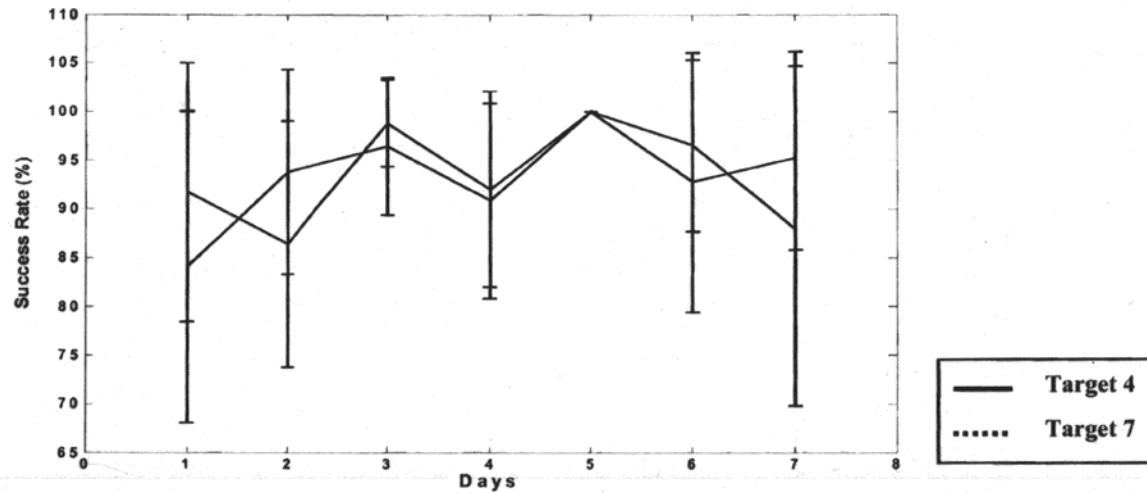

Normalized Optimal AMI

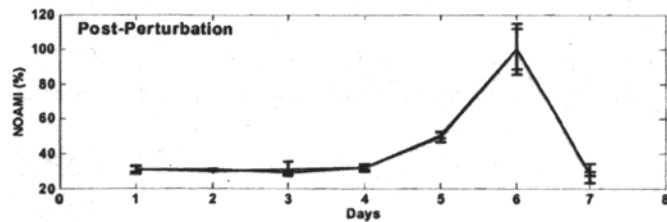
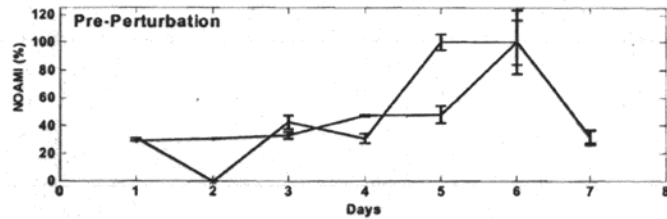

Optimal Average Firing Rate

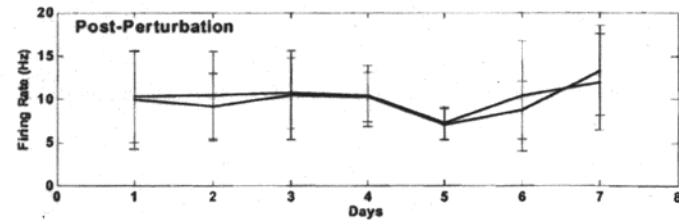
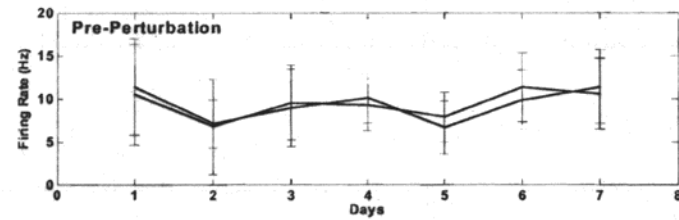

Monkey 3 – [^SMC(L),^SMC(L)]

Observed Success Rate

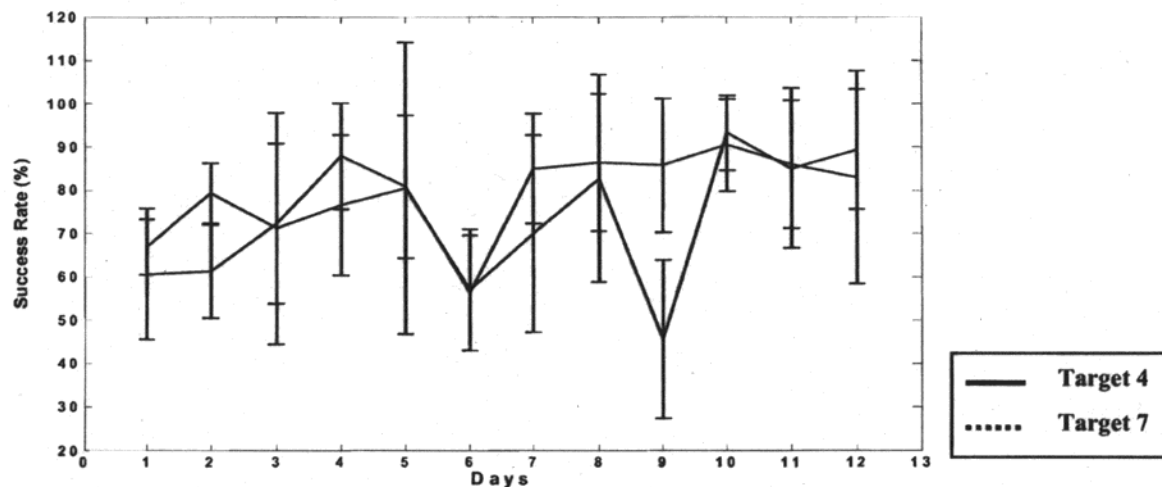

Normalized Optimal AMI

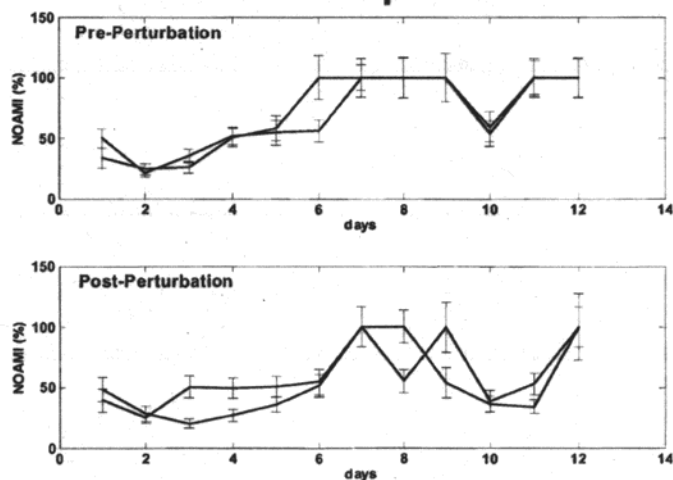

Optimal Average Firing Rate

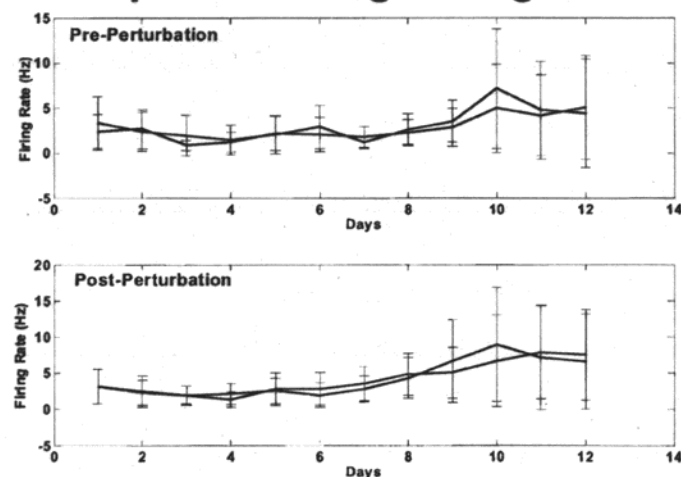

Total Optimal Average Mutual Information (OAMI) Between All Pairs of Cortices

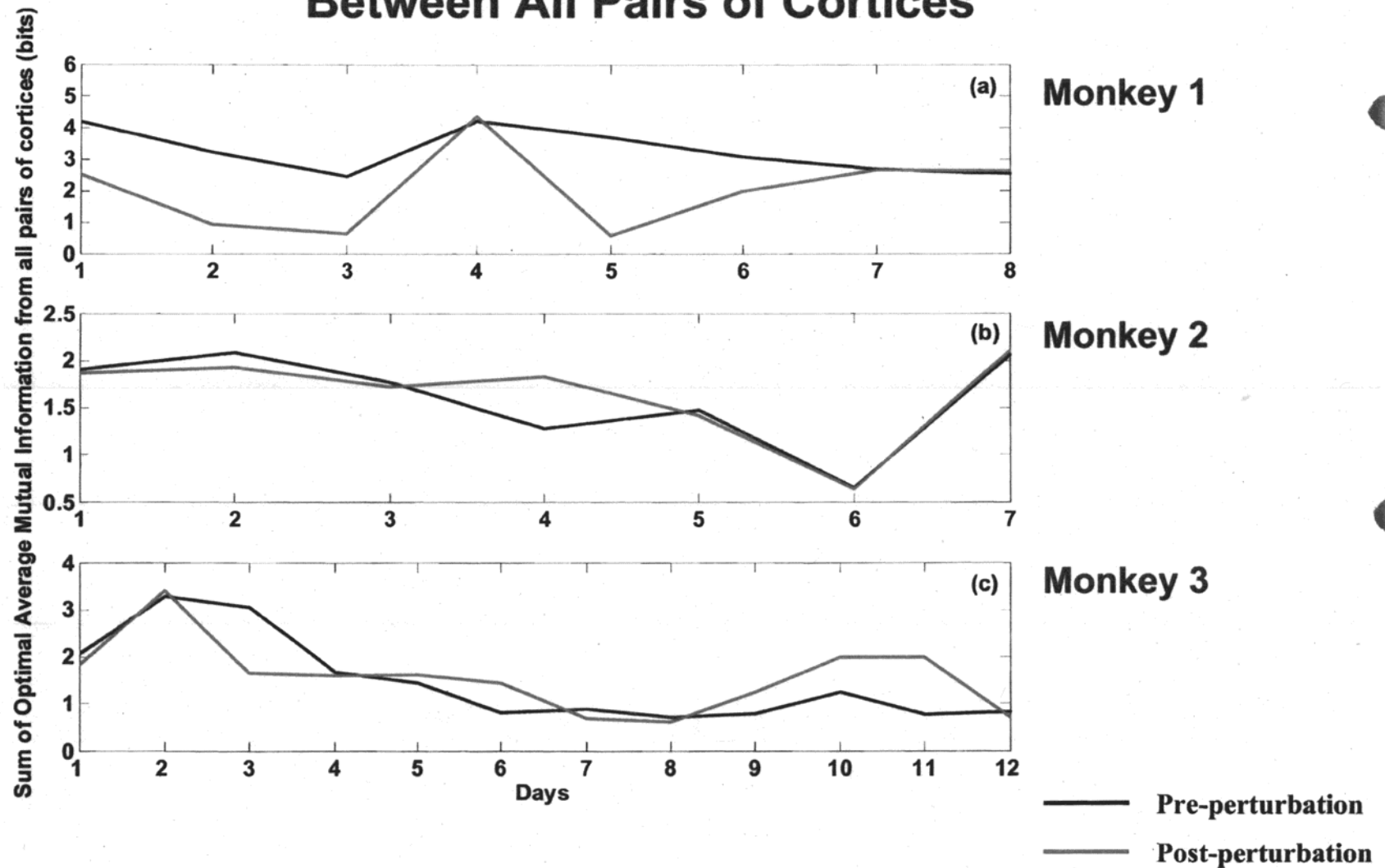

Cortical pairs that show plasticity via NOAMI

Pairs of cortices	Monkey 1	
	pre-ps	post-ps
[^S MC(M), ^S MC(M)]	1 ⁱ	1 ⁱ
[^S MC(M),SC(L)]	1 ⁱ	1 ⁱ
[^S MC(M), ^S SC(M)]	1 ⁱ	1 ⁱ
[^S MC(M), ^H MC(L)]	0	0
[SC(L),SC(L)]	1 ^d	0
[SC(L), ^S SC(M)]	0	-1
[SC(L), ^H MC(L)]	1 ^d	-1
[^S SC(M), ^S SC(M)]	0	0
[^S SC(M), ^H MC(L)]	0	-1
[^H MC(L), ^H MC(L)]	0	-1

Pairs of cortices	Monkey 2	
	pre-ps	post-ps
[^A MC(L), ^A MC(L)]	-1	-1
[^A MC(L), ^H SC(L)]	-1	-1
[^A MC(L),SC(M)]	-1	-1
[^A MC(L), ^S MC(M)]	-1	-1
[^H SC(L), ^H SC(L)]	1 ⁱ	1 ⁱ
[^H SC(L),SC(M)]	-1	-1
[^H SC(L), ^S MC(M)]	0	0
[SC(M),SC(M)]	-1	-1
[SC(M), ^S MC(M)]	-1	-1
[^S MC(M), ^S MC(M)]	1 ^d	1 ^d

Pairs of cortices	Monkey 3	
	pre-ps	post-ps
[MC(M),MC(M)]	-1	-1
[MC(M),PMC(L)]	-1	-1
[MC(M), ^S MC(L)]	-1	-1
[MC(M),MC(M)]	-1	-1
[PMC(L),PMC(L)]	-1	-1
[PMC(L), ^S MC(L)]	-1	-1
[PMC(L),MC(M)]	-1	-1
[^S MC(L), ^S MC(L)]	1 ⁱ	1 ⁱ
[^S MC(L),MC(M)]	0	0
[MC(M),MC(M)]	-1	-1

1ⁱ – statistically significant increasing trend
 1^d – statistically significant decreasing trend

Neuronal Interactions -- Conclusions

- **Neuronal plasticity across days was observed between particular areas of motor and sensory cortices in all (3) monkeys**
- **The estimated NOAMI trends corresponded with observed success rate**
- **The Normalized Optimal Average Mutual Information (NOAMI) between neuronal firing rates progressively increases or decreases over days at specific cortical areas of the monkeys' brain, denoting strengthening / weakening of particular interactions between cortical sensori-motor areas**
- **The sum of NOAMI did not exhibit any particular trend over days; Individual neuronal firing rates did not show plasticity over days**
- **Implication -- spatial synchronization of neuron firing rates is the cause of strengthening / weakening of interactions that eventually leads to cortical plasticity**

Future Goals

- **Validate preliminary results**
- **Design new experiments and develop complementary methods with better temporal and spatial resolution (at the level of neurons versus cortical areas) to further investigate the observed plasticity trends**
- **Identify main neurons and interactions in the motor and sensory cortices that are responsible for motor learning and adaptation**
- **Apply results to motor control**



2003-2004 Publications

- "Analysis of neuronal interactions during adaptation and learning in motor control of primates: A model independent approach using information theory", K. Narayanan, D.J. Weber, J. He, A. Prasad & L.D. Iasemidis, *IEEE Engineering in Medicine and Biology Society*, Annual Meeting, Houston, Texas, pp. 2552-2553, 2002.
- "Learning and Adaptation in the Cortex of Primates: Information Analysis of Motor Control Tasks", K. Narayanan, D.J. Weber, Jiping He and L.D. Iasemidis, submitted to the *Journal of Neuroscience*, 2003.



Advanced Neural Implants & Control

