

Measure Guideline: Managing the Drivers of Air Flow and Water Vapor Transport in Existing Single-Family Homes

J. Cummings, C. Withers, E. Martin, and N. Moyer
Building America Partnership for Improved Residential Construction

February 2012

NOTICE

This report was prepared as an account of work sponsored by an agency of the United States government. Neither the United States government nor any agency thereof, nor any of their employees, makes any warranty, express or implied, or assumes any legal liability or responsibility for the accuracy, completeness, or usefulness of any information, apparatus, product, or process disclosed, or represents that its use would not infringe privately owned rights. Reference herein to any specific commercial product, process, or service by trade name, trademark, manufacturer, or otherwise does not necessarily constitute or imply its endorsement, recommendation, or favoring by the United States government or any agency thereof. The views and opinions of authors expressed herein do not necessarily state or reflect those of the United States government or any agency thereof.

Available electronically at <http://www.osti.gov/bridge>

Available for a processing fee to U.S. Department of Energy
and its contractors, in paper, from:

U.S. Department of Energy
Office of Scientific and Technical Information
P.O. Box 62
Oak Ridge, TN 37831-0062
phone: 865.576.8401
fax: 865.576.5728
email: <mailto:reports@adonis.osti.gov>

Available for sale to the public, in paper, from:

U.S. Department of Commerce
National Technical Information Service
5285 Port Royal Road
Springfield, VA 22161
phone: 800.553.6847
fax: 703.605.6900
email: orders@ntis.fedworld.gov
online ordering: <http://www.ntis.gov/ordering.htm>



Printed on paper containing at least 50% wastepaper, including 20% postconsumer waste

Measure Guideline: Managing the Drivers of Air Flow and Water Vapor Transport in Existing Single-Family Homes

Prepared for:

Building America

Building Technologies Program

Office of Energy Efficiency and Renewable Energy

U.S. Department of Energy

Prepared by:

James Cummings, Charles Withers, Eric Martin, and Neil Moyer

Building America Partnership for Improved Residential Construction

Florida Solar Energy Center

1679 Clearlake Rd

Cocoa, Florida, 32922

NREL Technical Monitor: Stacey Rothgeb

Prepared under Subcontract No. KNDJ-0-40339-02

February 2012

[This page left blank]

Contents

List of Figures	vi
List of Tables	ix
Definitions.....	x
Introduction	xii
1 Background: An Overview of Driving Forces That Transport Water Vapor and Air	1
1.1 Water Vapor Drive.....	1
1.2 Location of Vapor Retarders.....	2
1.3 Moisture Capacitance.....	3
1.4 Attic Humidity	4
1.5 Airflow Drive (and Associated Water Vapor Transport)	7
1.5.1 Mechanical Drivers.....	7
1.6 Duct Leakage	7
1.7 Unbalanced Return Air	10
1.8 Exhaust Fans and Equipment.....	14
1.9 Natural Drivers—Wind and Stack Effects.....	16
1.10 Natural Drivers—Wind Washing.....	17
1.11 Natural Drivers—Mechanical and Natural Infiltration Interaction.....	18
1.12 House Envelope Airtightness	19
2 Home Inspection and Testing	20
3 Selection of Retrofit Options.....	25
3.1 House Envelope Airtightening.....	25
3.2 Duct System Airtightening	26
3.3 Remediation of Unbalanced Return Air	29
3.4 Repair of Wind Washing	31
3.5 Exhaust Fans and Equipment.....	32
4 Implementation	33
4.1 House Airtightness Repairs.....	33
4.2 Wind Washing Repairs	33
4.2.1 Wind Washing Repair by Means of Foam Application to Knee Walls and Floor Cavity Openings.....	34
4.2.2 Wind Washing Repair by Sealing Floor Cavities Connected to Vented Eaves.....	37
4.2.3 Caution About Low-Density Foam Around Cold Supply Ducts.....	41
4.3 Duct System Improvements	43
4.3.1 Move the Duct System Inside the House.....	43
4.3.2 Modify the Attic So the Ducts Are Inside the Air and Thermal Boundary	44
4.3.3 Sealing Air Handling Unit Leakage.....	45
4.3.4 Sealing Building Cavities Used as Ducts.....	49
4.3.5 Sealing Flex to Duct Board Connections.....	52
4.3.6 Sealing Duct Leak Gaps Greater Than One Fourth Inch.....	54
4.3.7 Aerosol Duct Sealing System	55
4.4 Balanced Return Air Implementation.....	56
References	60

List of Figures

Figure 1. Attic dry bulb and dew point temperatures, attic RH, and outdoor dew point temperature in a Florida home.....	5
Figure 2. Attic dew point temperature swings widely as the attic temperature rises and falls (Florida home October 4, 1998).....	6
Figure 3. Return leaks in a mechanical room create depressurization which causes air to be drawn into the room from outdoors and potential combustion safety problems.	8
Figure 4. Cooling energy efficiency ratio versus the return leak percent (from attic), assuming attic conditions of 120°F dry bulb and 75°F dew point temperature.	8
Figure 5. Duct leakage from attic is pulled through pathways in walls. In one extreme case, 55% of the return leakage originated from the attic.	9
Figure 6. A supply leak of 400 CFM produces space depressurization, which causes 400 CFM of air to be drawn into the house from outdoors and attic.....	10
Figure 7. Hybrid ducted return transfer shown from two rooms to a return intake box (Withers)...	13
Figure 8. Pressure mapping results in a house with a central return and closed interior doors.....	13
Figure 9. Air infiltration impacts of duct leakage, unbalanced return air, and incremental closing of interior doors.	14
Figure 10. Wind-driven attic air is pushed into the space between floors.....	17
Figure 11. Flex ducts going from an attic space into the interstitial floor cavity under a portion of the second story conditioned space.	17
Figure 12. Photograph of stairwell. Floor cavity begins under the hung picture at top.....	18
Figure 13. Infrared image of stairwell showing elevated wall temperature from hot air in an interstitial floor cavity. Note location of pictures and light fixture.....	18
Figure 14. Climate zone map of the United States (DOE)	26
Figure 15. Interior duct system under construction. Metal framing is used to construct a chase that will hide the ducts from view once covered with drywall. The chase should be tight to the attic and leakier to the room.....	27
Figure 16. An insulated garage closet located will house an AHU. A weather stripped door will isolate the closet from the garage. A vent from the closet to indoors would also further enhance the system operating efficiency.	28
Figure 17. Pressure mapping can be performed using a manometer.	29
Figure 18. Achievable airflow rates using various return air paths from closed rooms for a given supply at a room pressure of 0.01 in. w.c. (2.5 Pa) with respect to the return zone. For example, an 8-in. jumper duct could be used to maintain 2.5 Pa in rooms with supply air up to 60 CFM. Excerpt from www.ba-pirc.org/casestud/return_air/index.htm	30
Figure 19. A supply duct is located within the interstitial floor cavity of an upstairs bonus room. The floor cavity is open to an adjacent attic space allowing high dew point air to contact the cool outer jacket of the duct.....	31
Figure 20. Home with one attic space over garage that abuts second floor wall and floor cavity...	34
Figure 21. View of kneewall and portions of open floor cavity as seen from inside the garage attic.	34
Figure 22. Close-up view of entry to open floor cavity.	35
Figure 23. IR image from inside attic before repair shows much cooler area at the bottom where air from floor cavity is displaced into attic.....	35
Figure 24. IR image inside floor cavity shows thermal stratification of air, with hotter air at top against second-story floor and cooler air at bottom.	35
Figure 25. View of kneewall and floor cavity after being sealed with low density expansive foam.	36
Figure 26. Before sealing the floor cavity, surface temperatures just inside the floor cavity averaged about 85.4°F (inside the Ar1 box).....	36
Figure 27. After sealing, the average temperature of the insulation sealing the floor space is about 110.6°F as seen from the attic.....	36
Figure 28. Soffit vent panels removed for inspection and access to seal air pathways from eave into floor cavity.	37
Figure 29. View from the vented eave cavity that is well-connected to second-story floor cavity. .	37

Figure 30. View from eave toward floor cavity shows pathway to floor under joist braced at back, which would be the ideal place for the air and thermal barrier in this construction..... 38

Figure 31. Opening to floor cavity is sealed by application of foam to create an insulating air barrier between each floor joist. 38

Figure 32. Floor joist cavity is sealed from vented eave. 38

Figure 33. Spray foam expands considerably and conforms effectively around the end of a floor truss section within a floor joist. 39

Figure 34. Second-story floor cavity has cantilevered section that was vented on the back side of home. 39

Figure 35. Oval shaped soffit vents can be seen on the underside of cantilevered floor section. .. 40

Figure 36. Connection from vented eave to floor cavity where no insulation was found..... 40

Figure 37. Insulation batts were present in most of the eave areas providing some thermal protection for the floor above. However, because the batts did not fit tightly between the joists, they allow airflow to move into the floor cavity. 40

Figure 38. First, the foam spray gun is inserted into the soffit vent hole to apply foam insulation to the floor deck above, beyond the top of the exterior wall..... 41

Figure 39. The next step is to complete the seal from floor deck vertically down to the bottom of the soffit surface. This is done between each joist section..... 41

Figure 40. Batt placed against supply duct by homeowner. 42

Figure 41. Batt pulled away from duct shows it is soaked where dark areas are seen on paper facing. 42

Figure 42. 3/8-in. beadboard insulation with foil face on one side and plastic film on the other.... 43

Figure 43. Supply duct from attic into floor cavity has insulation wrapped around duct before blown foam is applied. 43

Figure 44. To encapsulate the attic space, spray foam is applied to vents and roof deck. Foam application starts low, at the top of exterior wall, sealing off the vented eave from the attic then continues to completely cover the entire roof deck. 44

Figure 45. AHU panel leaks are strong enough to hold sheets of paper. 46

Figure 46. Close-up view of lower corner AHU panel leakage. 46

Figure 47. Loose-fill insulation has been sucked into condensate drain penetration leak. 46

Figure 48. Leaky thermostat wire penetration. 47

Figure 49. Black cork tape applied around refrigerant line penetration. 47

Figure 50. Black cork tape applied around condensate line penetrations and rope putty applied over seams. Expanding foam seals refrigerant line penetration into return support plenum. .. 48

Figure 51. Blue cloth has been pulled under AHU cabinet to illustrate air pathway where the return plenum and the AHU join together. 48

Figure 52. Duct mastic applied in a continuous seal from return duct air barrier to the AHU air barrier. Use care not to get mastic on the coil or any removable panel seam. 48

Figure 53. A gas furnace is located on a support platform used as the return plenum located inside a garage next to a gas water heater. Return leakage can depressurize the garage and interfere with proper venting of these atmospherically vented gas appliances..... 49

Figure 54. Front panel of furnace is removed for inspection inside the return plenum. Because of limited plenum access, part of the drywall has to be removed to provide access for plenum sealing. 49

Figure 55. View inside a return plenum located in a second floor closet shows lack of effective duct air or thermal barrier. Attic air could be drawn down leaks in wall cavities and through the floor cavity, which is also well connected to an attic space..... 50

Figure 56. View inside a return plenum located in a garage. Air leaks are drawn primarily from the garage, but a small portion comes from the attic down through the wall cavity where the insulation is located. The block wall in the background is an exterior wall. 50

Figure 57. View inside a support platform sealed using ductboard with foil (which is the air barrier) facing inward so seams can be sealed at the foil air barrier with mastic..... 50

Figure 58. Penetrations in the return plenum are sealed using expansive foam..... 51

Figure 59. All seams in this support platform return plenum have been sealed using mastic. 51

Figure 60. All penetrations and junctions between duct board, structural, and panel components of the return plenum have been sealed..... 51

Figure 61. The interior of a return plenum, located under an AHU, can be accessed through the return grille for inspection..... 52

Figure 62. Grille transfer through a wall has leakage into wall cavities that need to be sealed..... 52

Figure 63. To make this repair, pull back the outer insulation jacket of the flex duct to expose the inner duct connection. Remove the strap and inner duct from metal collar. Remove any loose tape. 53

Figure 64. Apply mastic from the foil surface of duct board over and around the metal collar. Mastic can be applied over any securely bound tape. 53

Figure 65. While the mastic is still moist, pull the inner duct liner over the metal collar, then secure tightly with a strap. The strap will pull the inner liner into the mastic and thereby create an airtight seal..... 54

Figure 66. Finally, pull the insulation jacket over the duct inner liner and secure the outer jacket tightly against the foil surface of the duct board. If any sections of the inner duct remain exposed, this may result in unwanted energy losses and potentially moisture condensation when the system is cooling..... 54

Figure 67. A gap between two sections of duct board was first covered using foil tape. Next, mesh is applied and coated with mastic that overlaps the mesh by 1-1/2–2 in. on each side. 55

Figure 68. Supply plenum connection being sealed using foil tape, fiberglass mesh tape, and mastic. 55

Figure 69. Patented sealing process injects an aerosolized material that builds up on leaks eventually sealing leaks up to about 1/4 in. wide..... 56

Figure 70. Sealant can be seen building on a demonstration leak. 56

Figure 71. This house has supply ducts to each room, but only a central return grille. Door closure without adequate return air pathway results in negative pressure in the central zone wrt to outside and positive pressure in the closed rooms. 57

Figure 72. Approaches to providing return air pathways. 58

Figure 73. Through-the-wall return transfer from bedroom to hallway. 58

Figure 74. Illustration of return jump duct..... 59

Unless otherwise noted, all figures were created by BA-PIRC.

List of Tables

Table 1. Change in Dew Temperature, Humidity Ratio (W), and Enthalpy (Btu/lb) per 10°F Rise in Air Temperature, With RH Held Constant	5
Table 2. Dry Bulb Temperature, Dew Point Temperature, RH, Enthalpy (H), and Humidity Ratio (W) of Representative Air	6

Unless otherwise noted, all tables were created by BA-PIRC.

Definitions

A/C	Air conditioning
ACH	Air changes per hour
Adsorption	Process by which water vapor molecules attach themselves to the surface of materials. Adsorption is driven by an increase in relative humidity at the surface of the material.
AHU	Air handling unit
ASHRAE	American Society of Heating, Refrigerating and Air-Conditioning Engineers
BA-PIRC	Building America Partnership for Improved Residential Construction
Btu	British thermal unit
CAZ	Combustion appliance zone
CFM	Cubic feet per minute
CO	Carbon monoxide
Desorption	Process by which water vapor molecules are removed from the surface of materials. Desorption is driven by a decrease in relative humidity at the surface of the material.
Enthalpy	Total energy contained in air, reflecting both the dry bulb temperature and the absolute humidity (e.g., dew point temperature). Typical indoor enthalpy at 75°F and 50% RH is 28.14 Btu/lb of dry air. Enthalpy of outdoor air at 90°F and 60% RH (dew point temperature of 75°F) is 41.79 Btu/lb. An A/C system would need to deliver 13.65 Btu/lb (41.79–28.14) of cooling energy to transform that outdoor air to conditioned indoor air at 75°F/50% RH.
FSEC	Florida Solar Energy Center
HVAC	Heating, ventilation, and air conditioning
Hygroscopic	Material property indicating the propensity of that material to adsorb water vapor from the surrounding air
IAQ	Indoor air quality
in. w.c.	Inches of water column
IR	Infrared

Pa	Pascal – unit of pressure
Q _{n,out}	Normalized duct leakage from outside ($Q_{25,out}/ft^2$)
Q _{n,total}	Normalized duct leakage outside plus inside ($Q_{25,total}/ft^2$)
RH	Relative humidity
RLF	Return leak fraction
SMACNA	Sheet Metal and Air Conditioning Contractors' National Association, Inc.
wrt	With respect to

Introduction

Air and water vapor are transported into and within single-family homes as a result of pathways and driving forces. Without pathways, no air or water vapor transport could occur. Likewise, without driving forces, little or no air or water vapor transport will occur. Homes always have pathways and driving forces. This report focuses on managing the driving forces that move air and water vapor across the building envelope.

Managing the drivers of air transport is important because houses will always have airflow pathways. In fact, there are significant risks in attempting to eliminate all airflow pathways (i.e., making a house super-airtight). These risks include excessive house pressure when air moving devices are active, combustion safety problems, and lack of necessary ventilation (more on these risks later).

Airflow is driven by pressure differential. Although natural infiltration (induced by wind and temperature differential) is generally driven by pressure differentials of 0.2–2.0 Pa, mechanically induced pressure differentials (produced by air handling units [AHUs], duct leaks, unbalanced return air, exhaust fans, clothes dryers, etc.) are often 10 times greater. Water vapor is transported via diffusion through building materials and air. In most circumstances, airflow transports an order of magnitude more water vapor than vapor diffusion. For these reasons, it is important to understand and manage drivers (especially airflow drivers).

Previously published Measure Guidelines focus on eliminating air pathways; the ultimate goal of this Measure Guideline is to manage drivers that cause airflow and water vapor transport across the building envelope (and within the home), control air infiltration, keep relative humidity (RH) within acceptable limits, avoid combustion safety problems, improve occupant comfort, and reduce house energy use. One of the major goals of Building America is to reduce energy use in new and existing homes by 30%–50%.

To that end, a number of airflow management issues addressed in this report have the potential to substantially reduce home energy use, especially heating, ventilation, and air conditioning (HVAC) energy use (both cooling and heating). Elimination of air leakage into and out of duct systems can, depending on duct location and ambient thermal conditions, result in large HVAC savings. Repair of wind washing, a phenomenon observed especially two-story homes, can yield substantial energy savings.

Water vapor management can also affect home energy use. Control of the entry of water vapor into and removal of water vapor from homes can help to keep indoor RH levels within an acceptable range. In cold weather, this may avoid the need to add humidity to the room air, which evaporatively cools the space and increases the space heating load. During hot and humid weather, better control of indoor RH will lower the operational sensible heat ratio of the cooling system (leaving more cooling energy available for sensible cooling) and may obviate the need for specialized water vapor removal technologies, some of which substantially increase HVAC energy use.

1 Background: An Overview of Driving Forces That Transport Water Vapor and Air

1.1 Water Vapor Drive

Vapor diffusion occurs based on the difference in water vapor pressure between indoors and outdoors. It can drive water vapor across elements of the building envelope. The rate at which water vapor moves across the house envelope, based on vapor diffusion, depends on the vapor pressure differential and the vapor pressure resistance of the envelope materials.

In most circumstances, nothing can be done to modify this vapor pressure gradient. Some steps can be taken, however, to modify the vapor resistance of the building envelope. In new construction, vapor retarders (also sometimes called vapor barriers) can be installed to reduce vapor diffusion into the home or building assemblies. In existing buildings, it is generally difficult to add a vapor retarder. In some cases, exterior treatments (e.g., elastomeric paint on block walls, stucco exterior, or siding with panel insulation underlayment) can add significant vapor resistance. In other cases, interior treatments (e.g., vinyl wallpaper or oil-based paints) can increase wall assembly vapor resistance.

The International Residential Code describes three classes of water vapor retarders.

Class I vapor retarders (less than 1 perm):

- Glass
- Sheet metal
- Polyethylene sheet
- Rubber membrane

Class II vapor retarders (between 1 and 10 perms):

- Unfaced expanded or extruded polystyrene
- 30 pound asphalt coated paper
- Plywood
- Bitumen coated kraft paper

Class III vapor retarders (greater than 10 perms):

- Gypsum board
- Fiberglass insulation (unfaced)
- Cellulose insulation
- Board lumber
- Concrete block
- Brick
- 15 pound asphalt coated paper
- House wrap

If vapor retarders are added (intentionally or unintentionally), they must be located properly (e.g., on the warm side of the wall assembly). Vapor retarders should be located at or near the wall exterior surface in hot and humid climates. They should be located at or near the wall interior surface in cold climates (DOE climate zones 5 and higher). Improper location can lead to moisture condensation within building cavities and an inability of interstitial cavities to dry to indoors or outdoors.

Air movement can transport water vapor across the building envelope at a rate that is one (or more) orders of magnitude greater than vapor diffusion through the building envelope. Therefore, in most homes, managing air infiltration (and exfiltration) will be more important than installing improved water vapor retarders in controlling the entry of water vapor into the home. Similarly, during cold weather, air infiltration will more effectively remove water vapor from the house than vapor diffusion. Nevertheless, it is important to understand and manage water vapor entry via diffusion.

Furthermore, when water vapor has entered interstitial cavities of the house envelope, it can change phase, going from vapor to liquid and even

solid (ice) states, and then back again, as the daily cycles of outdoor temperature change and solar radiation exposure occur, and as the moisture travels through the wall assembly. Although it may be desirable to have vapor retarders in our wall assemblies, it is critical that they be located properly, so that moisture accumulation does not persist and cause damage to building materials and/or produce mold growth. In milder climates (DOE climate zones 1A–3A), it is often acceptable and prudent to construct the building envelope without vapor retarders, because the consequences of not having a vapor retarder (in the mild climate) are slight and the effects of inappropriately located vapor retarders can be great.

By contrast, the location and construction of air barriers are more straightforward than for vapor retarders. The building air barrier consists of an assembly of materials, including sealants that connect those materials, which resist the movement of air between outdoors (including unconditioned portions of the building) and indoors. This report focuses on the driving forces that move air and water vapor within homes, so a detailed discussion of air barriers is not included. Other Building America publications specifically address production of airtight envelopes (Pacific Northwest National Laboratory [PNNL] & Oakridge National Laboratory [ORNL], 2010).

1.2 Location of Vapor Retarders

As indicated, vapor retarders should be located on the warm side of the house envelope assembly—toward the wall exterior in hot climates and toward the wall interior in cold climates. Ideally, vapor retarders should be located in such a way that its surface temperature remains warmer than the air dew point temperature, at least most of the time. Generally, intermittent moisture accumulation (interspersed by intermittent drying) does not create a serious problem. By contrast, persistent moisture accumulation can lead to serious problems of material damage and mold growth.

For example, vinyl wallpaper in hot/humid climates, with extended periods of high outdoor dew point temperature, is an invitation to moisture accumulation and mold growth in wall assemblies during the cooling season. This is especially true if indoor temperatures are sufficiently low. In Orlando, Florida, for example, keeping the house interior temperature at 72°F for extended periods with vinyl wallpaper invites moisture condensation problems, as the outdoor dew point temperature is typically 73°–77°F during a four-month summer period. Application of vinyl wallpaper violates the rule of not locating vapor retarders on the cold side of the wall systems. In Orlando, Florida, the vapor retarder—if used at all—should be toward the outside of the wall assembly. In Chicago, Illinois, by contrast, the vapor retarder should be located toward the inside surface of the wall assembly.

Uncontrolled airflows can produce negative pressure in a house which can exacerbate problems associated with inappropriately located vapor retarders, especially during hot and humid weather. Uncontrolled airflows—such as dominant supply duct leakage, operation of exhaust fans and clothes dryers, operation of attic exhaust fans, and unbalanced return air—can cause persistent space depressurization. This negative pressure can (during periods of high dew point temperatures) draw high water vapor content air into exterior wall cavities, which can cause condensation on various surfaces, depending on the vapor permeability of the wall materials and the temperature of wall assembly members.

Locating vapor retarders at two locations within the wall assembly can magnify moisture accumulation problems. In this circumstance, vapor retarders on both the cold and warm sides of the wall can trap moisture that enters through wind-driven rain or by air transport. Once the moisture has accumulated in this interior location, it cannot readily dry by diffusion toward a dry source (indoors in a hot and humid climate or outdoors in a cold climate), because it is captured and contained on both sides.

Moisture transport (by vapor diffusion) is, however, more complex than the simple movement of water vapor from one side of an exterior wall assembly to the other. Moisture can enter into wall assemblies by diffusion, air transport, or in the form of liquid water (wind-driven rain or landscape irrigation striking the wall exterior). Depending on temperatures within the walls, water vapor can condense within wall assemblies. Later, this liquid water can become a vapor again, move within the wall assembly, and strike other materials with various levels of vapor resistance and temperature. The temperature of the wall exterior can vary dramatically depending upon solar radiation exposure and surface colors. Dark colored brick, for example, can warm to 20°F above the ambient under full sun exposure. Moisture that accumulates in the brick from moisture condensation (dew) at night, from rain exposure, or landscape irrigation can be driven into the wall assembly (by solar radiation) creating high interstitial dew point temperatures. Dew point temperatures in the cavity behind the brick veneer can exceed 100°F, under some circumstances, and greatly enhance the potential for vapor diffusion, air transport of water vapor, moisture accumulation in wall materials, and mold growth.

Airflow simultaneously occurs within wall assemblies and transports water vapor. Air movement can go from outdoors toward indoors, and vice versa. As a result, vapor diffusion and airflow transport of water vapor come together as driving forces. There will be more on airflow transport of water vapor in later sections.

1.3 Moisture Capacitance

Once water vapor enters the house, it is stored within interior building materials. This occurs through mechanisms referred to as *adsorption* and *desorption*. Adsorption is the process whereby water vapor molecules attach themselves to the surfaces of “soft” (hygroscopic) materials (carpets, furniture, draperies, wood, paper products, etc.) in the home. Desorption is the process of detaching water vapor molecules from the surfaces of “soft” materials in the home and putting them back into the air. RH at material surfaces drives adsorption and desorption. An increase in RH in the room air—or more specifically, at the surface of materials—causes adsorption. A decline in RH in the room—or at the surface of materials—causes desorption. Consider a sheet of your daily newspaper. When exposed to low indoor RH, that paper will be relatively stiff and light. If that same sheet of newspaper is left on the back porch during a humid overnight period, in the morning it will be limp and weigh considerably more, having taken on a considerable amount of water vapor. The moisture was added not by condensation but by adsorption. If the sheet of newspaper is left in place, desorption will occur as the day warms and RH declines, eventually becoming relatively stiff and light again. Some materials can vary in weight by 30%–50% as adsorption and desorption occur.

Because of adsorption and desorption, the interior materials of a house have moisture capacitance that is 10–15 times greater than that in the indoor air alone. This relatively large moisture capacitance allows indoor RH to remain relatively stable when water vapor is added to (from air infiltration, showering, cooking) or removed from the space (by the air-conditioning [A/C] system). Because of moisture capacitance, dryness produced by the HVAC system during hotter hours of the day, for example, can be stored until cooler hours of the day, helping to control indoor RH when the A/C system runs less.

1.4 Attic Humidity

A considerable portion of the air entering a typical house comes from the attic. This can occur because return ducts and AHUs are sometimes located in the attic space, and air leakage into these air distribution system components can transport considerable high water vapor content attic air into the house. This can also occur because the ceiling is generally leakier than the walls and floor of a slab-on-grade house. The leakage pathways from the attic to the house include “canned” (recessed) lights, gaps at top plates connecting the attic and interior wall cavities, interior wall penetrations (e.g., electrical outlets, floor-to-wall gaps, plumbing penetrations) that connect interior walls to the conditioned space, and gaps around ceiling fixtures (e.g., lights, ceiling fans, air distribution registers). Various driving forces, including mechanically induced pressures (from duct leakage, unbalanced return air, and unbalanced exhaust air) and natural driving forces (wind and stack effect) can draw attic air into the house.

The attic space is an important source for water vapor, especially during hot and humid weather. Because attics are normally ventilated, their average daily dew point temperature approximates outdoor levels. There can, however, be large swings in attic dew point temperature resulting from adsorption and desorption, driven by changes in attic air temperature. Desorption can greatly increase dew point temperature in an attic space during hot hours of the day. Figure 1 shows attic RH declining sharply as the attic (dry bulb) temperature increases, in an attic with typical ventilation and with an asphalt shingle roof on a hot summer day.

Hotter air can hold more water vapor, so RH goes down as air temperature goes up. For each 10°F increase in air temperature, RH goes down by about 26%, assuming that the absolute water vapor content of the air remains constant. The water vapor capacity of the air increases by about 38% for each 10°F rise in air temperature (Table 1). When RH is held constant at 50%, total energy (enthalpy; H) contained in the air also increases substantially as temperature and humidity ratio increase, by almost exactly 23% per 10°F rise. This sharp rise in enthalpy, as the attic becomes hotter, has important implications for cooling loads created by attic air transported into the house.

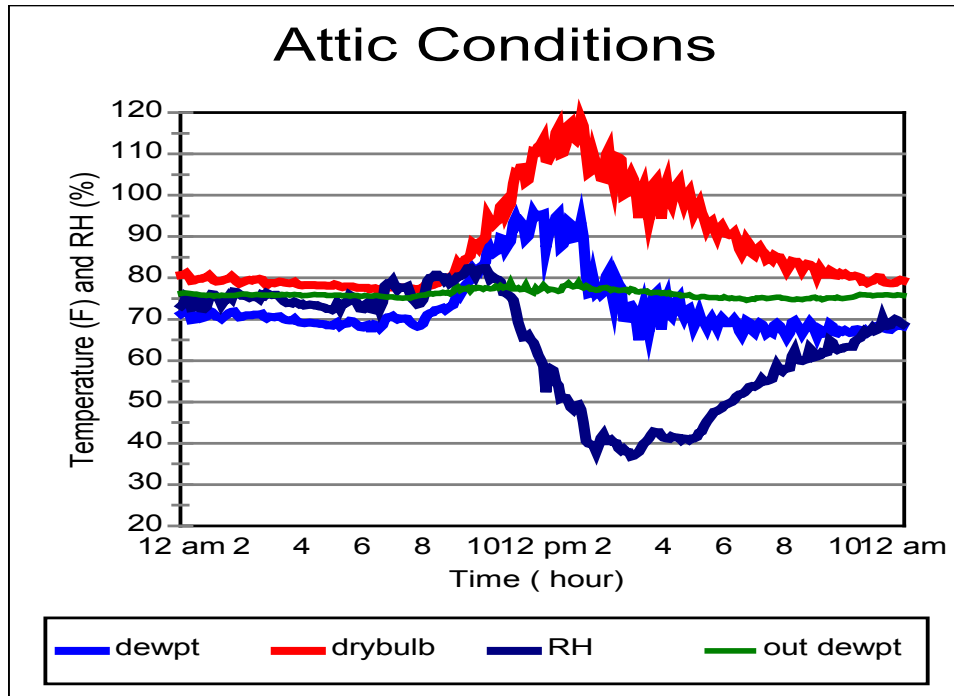

Figure 1. Attic dry bulb and dew point temperatures, attic RH, and outdoor dew point temperature in a Florida home.

Table 1. Change in Dew Temperature, Humidity Ratio (W), and Enthalpy (Btu/lb) per 10°F Rise in Air Temperature, With RH Held Constant

Air T/RH	Dew Point Temperature (°F)	W (lb-H ₂ O/lb-air)	Increase in Moisture Capacity	H (Btu/lb-air)	Increase in H (Btu/lb-air)	Delta-H (Btu/lbda) Versus Room at 75/50%
55/50%	36.7	.0046		18.17	–	–
65/50%	45.9	.0066	43.5%	22.75	25.2%	–
75/50%	55.1	.0093	40.9%	28.14	23.7%	0.00
85/50%	64.3	.0129	38.7%	34.61	23.0%	6.47
95/50%	73.5	.0178	38.0%	42.48	22.7%	14.34
105/50%	82.6	.0244	37.1%	52.18	22.8%	24.04
115/50%	91.7	.0330	35.2%	64.27	23.2%	36.13
125/50%	100.8	.0443	34.2%	79.46	23.6%	51.32

As attic temperature rises and RH declines, the rate of desorption increases, which has the effect of drawing adsorbed moisture away from attic building materials. Water vapor removed from wood and other materials in the attic enters the attic air, pushing up the attic dew point temperature (Figure 2). In this particular Florida home, dew point temperature rises to about 95°F when outdoor dew point temperature is about 77°F. This spike occurs during a time of day when the A/C system runtime is increasing, thus creating the potential for substantial increases in cooling energy use and indoor RH, as attic air finds its way into the house from duct leakage and other forms of uncontrolled airflow.

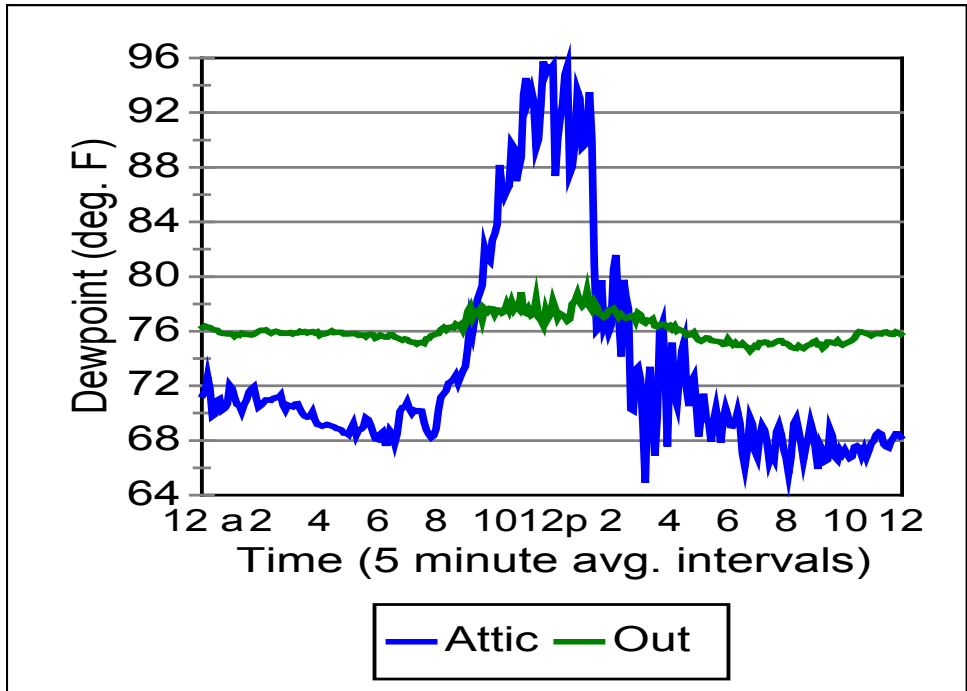

Figure 2. Attic dew point temperature swings widely as the attic temperature rises and falls (Florida home October 4, 1998)

The spike in attic dew point temperature creates the potential for significant increases in cooling load and water vapor entry into the house, when attic air is transported into the house. Table 2 shows the total energy (enthalpy) contained in 1 lb air (which is equal to approximately 13.5 ft³ of air) for a variety of temperature and humidity conditions. The cooling energy required to cool and dry air at conditions of 120°F and 95°F dew point temperature (enthalpy = 69.73 Btu/lb) down to 75°F and 50% RH is essentially twice the energy required to cool and dry air at conditions of 120°F and 75°F dew point temperature (enthalpy = 49.77 Btu/lb) down to 75°F and 50% RH. Thus, water vapor can represent a substantial fraction of the cooling load brought into the house from outdoors.

Table 2. Dry Bulb Temperature, Dew Point Temperature, RH, Enthalpy (H), and Humidity Ratio (W) of Representative Air

T (dry bulb)	T _{dp} (°F)	RH	Conditions Represented	H (Btu/lb _{da})	H (Btu/lb _{da}) If 75/50% Is the Base	W (lb H ₂ O/lb _{da})	Incremental Increase in Moisture Capacity
75°F	55	50%	Typical indoors	28.14	0.00	.0093	–
85°F	75		Average summer	40.46	12.32	.0183	97%
120°F	75		Average attic (low T _{dp})	49.77	21.63	.0189	3.3%
120°F	95		Peak attic (high T _{dp})	69.73	41.00	.0367	94%

Table 2 also shows the total water vapor content of air expressed as humidity ratio (pounds of water vapor per pound of air). Attic air at 120°F and 75°F dew point temperature has water vapor content that is 1.89% by weight. By contrast, attic air at 120°F and 95°F dew point temperature has water vapor content that is 3.67% by weight. Figure 2 and Table 2 show that the attic has the potential to greatly increase water vapor transport by amplifying the water vapor content of the attic air during hotter hours of the day. Conversely, Figure 1 shows that if we operate the A/C system more during nighttime periods, water vapor transport from attic to house (by duct leakage or other forms of uncontrolled airflow) will be substantially decreased because the attic dew point temperature falls considerably below outdoor levels during nighttime hours.

1.5 Airflow Drive (and Associated Water Vapor Transport)

Airflow occurs based on difference in air pressure between one location and another; between indoors and outdoors, between indoors and house buffer zones, between rooms of a house, and between indoors and interstitial cavities. The quantity of airflow is a function of the size of the leakage pathway and the strength of the pressure differential acting across that pathway.

Differences in air pressure result from mechanical and natural drivers. Air infiltration, which is defined as unintended—and generally uncontrolled—airflow into a house, may be produced by either mechanical drivers or natural drivers.

1.5.1 Mechanical Drivers

There are a number of mechanical driving forces at work in homes. These include duct leakage, unbalanced return air, exhaust fans, attic exhaust fans, and operation of clothes dryers.

1.6 Duct Leakage

Duct leakage is often the largest of the mechanical airflow drivers in homes. Duct systems commonly have holes (leak pathways) that are relatively small compared to the holes in the building envelope. In one study of 99 wide age-range homes (Cummings, Tooley, & Moyer, 1991), 12.7% of the house leaks (in terms of leak area) were in the air distribution system. However, because the duct system is under substantial pressure produced by the AHU fan, the air leakage into and out of ductwork is often considerably greater than leakage through the building envelope. In those 99 homes, the natural infiltration rate (measured by tracer gas decay) was 0.30 under a range of typical central Florida weather conditions, which represent airflow across the house envelope of 63 CFM. When the AHU was operated, the house infiltration rate increased to 1.09 ACH, which represents airflow across the house envelope of 225 CFM. So although holes in the ducts represent only 12.7% of the total house leak area, they produce air infiltration that is nearly 4 times greater than the natural air leakage entering through the much larger house envelope holes.

Return leaks often draw air from outdoors or unconditioned spaces (e.g., attic, garage, crawlspace) into the HVAC system and create positive pressure in the house. (In the following discussion, all duct leakage is assumed to be to or from outdoors or unconditioned spaces, unless stated otherwise.) If the return leaks draw air from a zone inside the house (e.g., mechanical closet or utility room), this can produce an indirect return leak. It occurs like this. The return leak depressurizes that zone, and this depressurization in turn draws air into the house. If a vented combustion device is located in that depressurized room, air can be drawn down the atmospheric

vent (Figure 3). In addition to creating a combustion safety hazard, this introduces heat from outdoors and retains combustion heat in the house. Return leaks can create small or large energy impacts depending upon the temperature and water vapor content of the air drawn into the leak. At one extreme, air drawn from a hot attic can overwhelm the cooling capacity of an A/C system. A 15% return leak from an attic with peak conditions of, say, 125°F and 75°F dew point temperature can diminish the cooling capacity and efficiency of an A/C system by more than 50% (Figure 4).

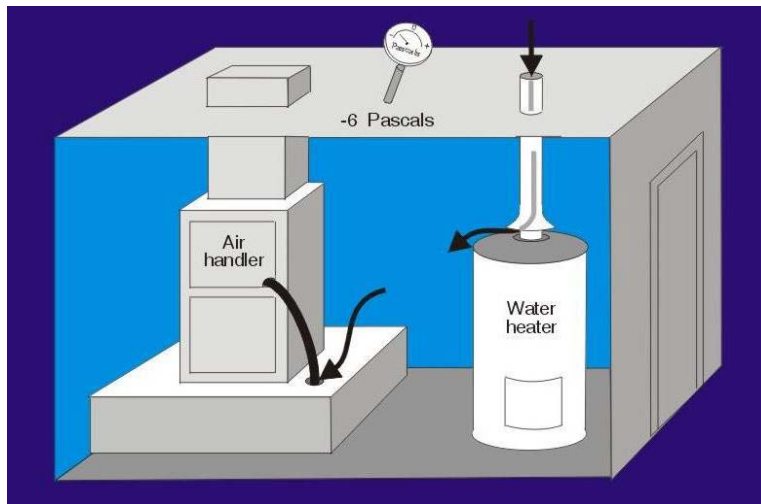

Figure 3. Return leaks in a mechanical room create depressurization which causes air to be drawn into the room from outdoors and potential combustion safety problems.

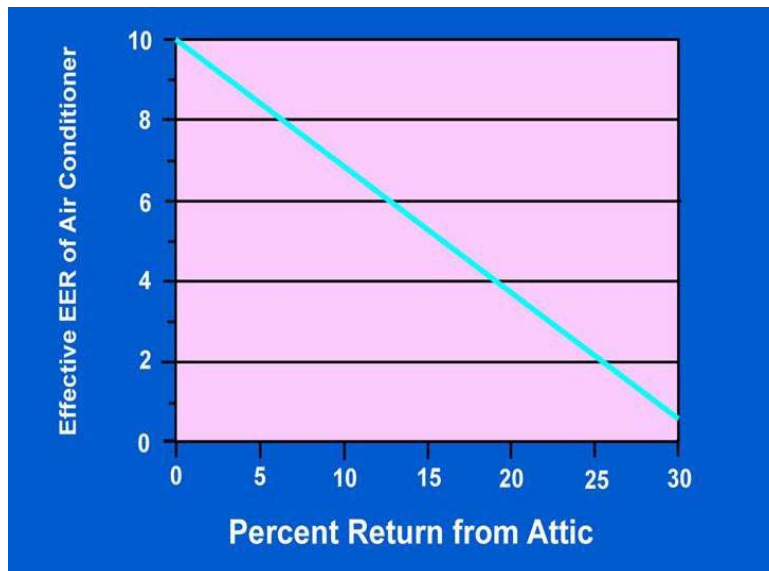

Figure 4. Cooling energy efficiency ratio versus the return leak percent (from attic), assuming attic conditions of 120°F dry bulb and 75°F dew point temperature.

Supply leaks discharge air from the duct system to outdoors or to unconditioned spaces. If supply leaks are larger than return leaks, they create negative pressure in the house. The space depressurization produced by this dominant supply leakage will draw air into the house from

outdoors from various buffer zones (attached garage, basement, crawlspace, attic, etc.), in proportion to the size of the air leakage pathways in respective portions of the building envelope. In many Florida homes, approximately 65% of the house air leakage occurs in the ceiling plane. Therefore, a large proportion of the air drawn into the house by the dominant supply duct leaks is from the attic space.

The effects of duct leakage are amplified by the duct leaks themselves; in other words, they exhibit a negative feedback. Large duct leaks introduce large amounts of unanticipated heating or cooling load to the space, and this in turn causes the system runtime to increase. Increased runtime leads to increased operation of the air leak losses of the air distribution system. In extreme cases, the cooling system may run nearly 100% of the time throughout the day. In one extreme case, a 16-year-old home in Orlando had a 55% return leak fraction (RLF) (45% of the return air originated from indoors and 55% originated from the attic; see Figure 5). The homeowners found that running the A/C during the day caused an accelerated rise in indoor temperature. Their adaptation was to run the system at night and then turn it off during the day.

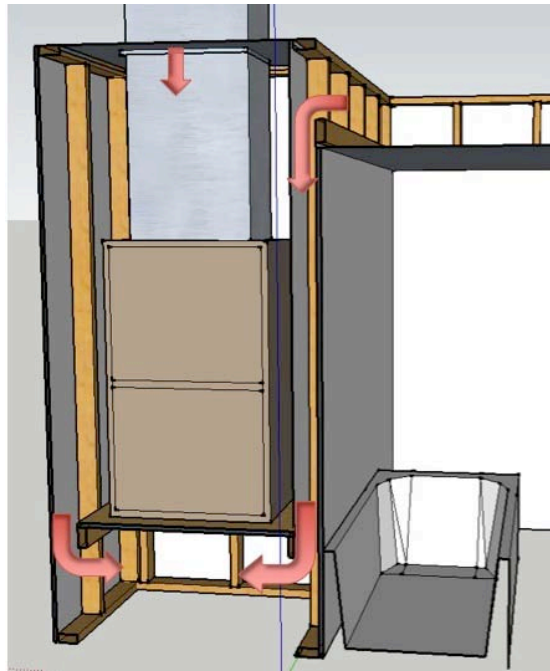

Figure 5. Duct leakage from attic is pulled through pathways in walls. In one extreme case, 55% of the return leakage originated from the attic.

Return leaks can draw large amounts of water vapor into the cooling system. Although this substantially increases the A/C system energy use, that water vapor does not—in most cases—enter the house. The high water vapor content air introduced by the return leak passes across the cold cooling coil where most is removed prior to its discharge into the conditioned space. On the other hand, if the AHU fan control is changed from AUTO to ON, so the fan runs continuously, the outcome is very different. Water vapor in the return leak air passes through a warm cooling coil (some of the time) and then into the conditioned space, often raising indoor RH by 15–20 percentage points.

By contrast, dominant supply leaks can cause a substantial increase in indoor RH, because the supply leakage creates space depressurization, which in turn draws air into the house through all pathways in the envelope. Figure 6 shows that a supply leak of 400 CFM causes space depressurization of -4.9 Pa, which in turn draws 400 CFM of air into the house from outdoors and the attic. During hot and humid weather, high dew point air can be drawn into the house from various sources; outdoors, from the crawlspace or basement, from an attached garage, or from the attic. Depending on the quantity of the net supply leakage (net supply leakage = total supply leakage – return leakage), indoor RH can rise as much as 10 percentage points.

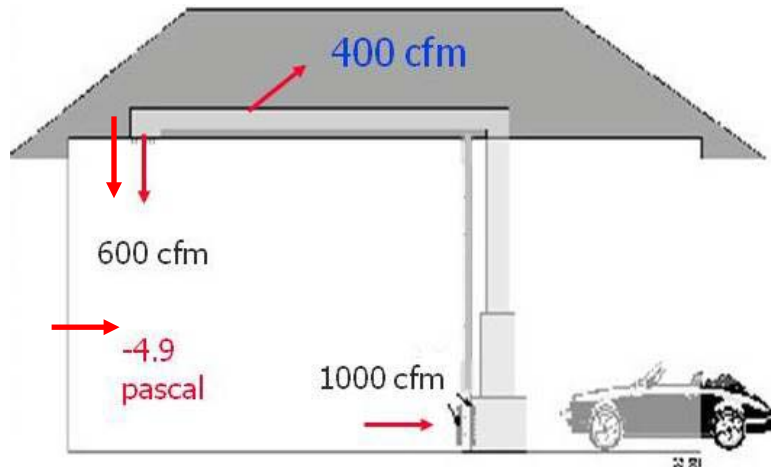

Figure 6. A supply leak of 400 CFM produces space depressurization, which causes 400 CFM of air to be drawn into the house from outdoors and attic.

1.7 Unbalanced Return Air

Unbalanced return air is a common problem associated with heating and cooling systems. It occurs when the amount of air drawn from a zone (by a return grille) is less than or greater than the supply air delivered to that zone, and the door that separates that zone from the remainder of the house is closed. In many homes, return air is located only in the central zone and individual rooms do not have return air. When the doors to those rooms are closed, those rooms go to substantial positive pressure and the central zone (where the central return is located) goes to negative pressure. In a 1990 study of 70 new to 5-year-old homes, pressure drop across the closed doors averaged 9.2 Pa, while the central zone was at -2.8 Pa with respect to (wrt) outdoors (Cummings & Withers, 2006a). The tighter the house envelope and the larger the imbalance between return and supply airflows, the greater will be the resulting pressure differentials. In the most extreme cases, individual rooms have been found at 57 Pa and central zones have been found at -14.7 Pa. In the latter case, closing only the master bedroom door took the remainder of the house to -7 Pa. Return air can be provided by a number of pathway types. Return transfers are commonly used. They require a pressure differential to drive airflow. In Florida, the mechanical code was modified in March 2002 to require that pressure drop across closed doors not exceed 2.5 Pa (with some exceptions; note that no other state or national codes contain specific return air performance criteria). Return transfers can be configured in a number of ways. In its simplest form, door undercuts or grilles can be implemented. Typically, door undercuts are not practicable, because the amount of needed undercut can be excessive. A general rule states that 70 in.² of net free area of transfer opening is required for each 100 CFM

of supply air to that closed room. A master bedroom suite with 300 CFM of supply air would then require a return transfer of approximately 250 in.² (16-in. × 16-in. grille assuming a net free area fraction of 0.85) to stay within the 2.5 Pa requirement. The door undercut, in this instance, would need to be 8 in.!

Return transfer can also be provided by various pathway arrangements, such as specialized door grilles with light and sound attenuation, by through-the-wall openings with grilles on either side, by through-the-wall openings with grilles high on one side of the wall and low on the other, by jump ducts (flex duct or rigid duct) with ceiling grilles on each side of the wall, and by specialized transfer vents located above the door frame and hidden by the door frame molding. Figure 72, found in Section 3 of this report, presents a variety of return air options that can be implemented to produce balanced return air.

A study of 40 central Florida homes built after March 2002, when the Florida mechanical code was modified to require return air, found a significant reduction in unbalanced return air problems (Swami, Cummings, Sharma, Withers, & Basarkar, 2006). Although only 11 of the 40 homes (28%) were in complete compliance with the modified code, 87 of 147 rooms (59%) that were required to meet Section 601.4 of the code were in compliance (Cummings & Withers, 2006b). Even with only partial compliance, the results can be considered largely successful. The 1990 study found an average pressure drop across closed doors of 9.2 Pa, but this pressure drop declined to 2.5 Pa in those built after 2002. The house infiltration rate with interior doors closed was 23% greater than with doors open (AHU operating in each case). In the earlier 70 home study, air infiltration increased by 30% when interior doors were closed (AHU operating in each case). In the houses where 80%–100% of the rooms were in compliance, average pressure drop was only 0.7 Pa across closed doors. This indicates that the code, when implemented, is able to largely eliminate unwanted pressure differentials (and related air infiltration). By contrast, in houses where only 0%–20% of the rooms were in compliance, the average pressure drop was 5.5 Pa (or 8 times greater) across closed doors.

Return air can also be “hard-ducted,” meaning that ductwork goes directly from the AHU to grilles in individual rooms. A hard-ducted return does not require a pressure differential across the door to move air back to the AHU. The return plenum operates at significant depressurization (often in the range of –30 to –60 Pa), which provides the driving force to move return air from the room to the AHU. If the return duct is sized properly, the closed room can operate at neutral pressure with respect to the central zone. Ducted returns are, however, often improperly sized. If the return is undersized, the closed room will operate at positive pressure. If the return is oversized, the closed room will operate at negative pressure. In some worst-case scenarios, the return can be dramatically oversized, causing severe depressurization of the closed room. Ideally, the return duct should be slightly oversized with a damper, which can be used to adjust the return airflow rate to produce return-supply balance.

When houses are served by two (or more) A/C systems, improper return and supply locations can create serious pressure problems when partitions separate the A/C zones. In rare cases, the return may be improperly located so it draws air from the wrong zone, creating excessive negative and positive pressure fields within the home (when partition doors are closed) that fluctuate up and down as the individual systems cycle on and off. A more common failure occurs when supply air

is improperly located and delivers air to another zone. When partitions separating those zones are closed, portions of the house may operate at positive or negative pressure for extended periods, creating energy, indoor air quality (IAQ), humidity, and moisture damage problems.

Consider the following case study. Two 2.5-ton AC systems serve two zones of a house; zone A serves a portion of the house that includes the living room and zone B serves a portion of the house that includes the master bedroom. French doors that separate the two zones are closed most of the time. When the A/C systems were installed, one supply duct from zone B (representing about 20% of the system airflow) was routed to the living room, which is in zone A. Because the French doors restricted airflow back to the central return of zone B, zone A operated at positive pressure and zone B operated at negative pressure, when the zone B system was operating. The negative pressure in zone B caused more than 100 CFM of air to flow from the attic and outdoors into zone B, causing a sharp rise in cooling load and indoor RH. Additionally, significant return leaks were drawing unfiltered air into the air distribution system and soiling the AHU and duct surfaces of zone B. With the zone B A/C system already 20% short on capacity (that supply air was being delivered to zone A), with return leaks drawing some hot and humid attic air into the system, and with a dramatic increase in cooling load caused by negative pressure drawing unconditioned air into zone B, the zone B A/C system ran almost continuously. This leads to substantial mold growth in the air distribution system of zone B and poor IAQ.

Besides return transfers and hard-ducted returns, there are hybrid return systems. A hybrid return system is one that has a ducted return from the AHU to a return grille in a room or hallway. Additionally, ducts from individual rooms are connected to the return intake box (Figure 7). These room-to-return box duct connections are distinguished as a hybrid ducted return, because the room-to-return box ducts are under significantly less pressure than if it is ducted directly to the main return duct or plenum. Because of the small pressure in the return intake box, it is often difficult to properly size the ducts from individual rooms. In general, hybrid returns are not recommended. A hybrid return can, however, effectively balance airflows as long as the return ducts are sized correctly.

Pressure differentials created by unbalanced return air can greatly increase the house infiltration rate. Consider a case study of a 1750 ft² Florida home with a single return in the central zone. Pressure mapping found that the central zone was operating at -6 Pa wrt outdoors when all interior doors were closed. Pressure drop across the closed doors averaged 18 Pa; therefore the average closed room was at 12 Pa wrt outdoors (Figure 8). Based on tracer gas decay testing, this house had a natural infiltration rate of 0.16 ACH. When the AHU was turned on with interior doors open, the infiltration rate increased to 0.42 ACH as a result of duct leakage. When the six interior doors were closed incrementally, two at a time, the infiltration rate increased to 0.62 ACH, 0.94 ACH, and 1.15 ACH, respectively (Figure 9). 1.15 ACH is equal to 268 CFM of air exchange between the house and outdoors (including the attic).

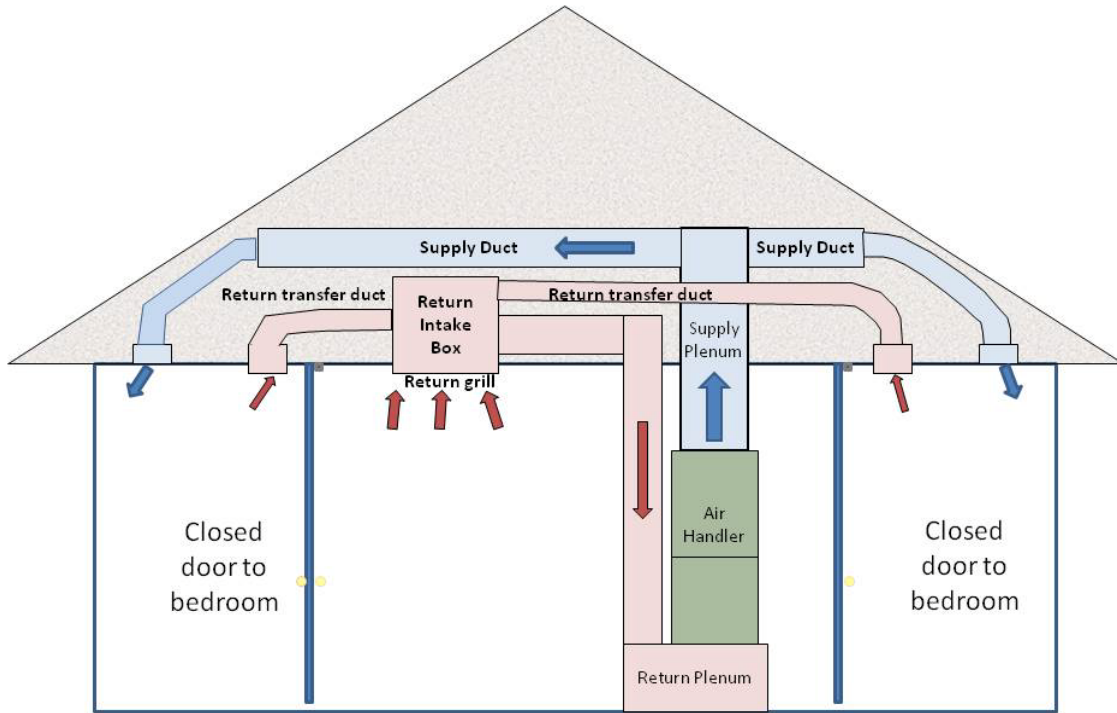

Figure 7. Hybrid ducted return transfer shown from two rooms to a return intake box (Withers).

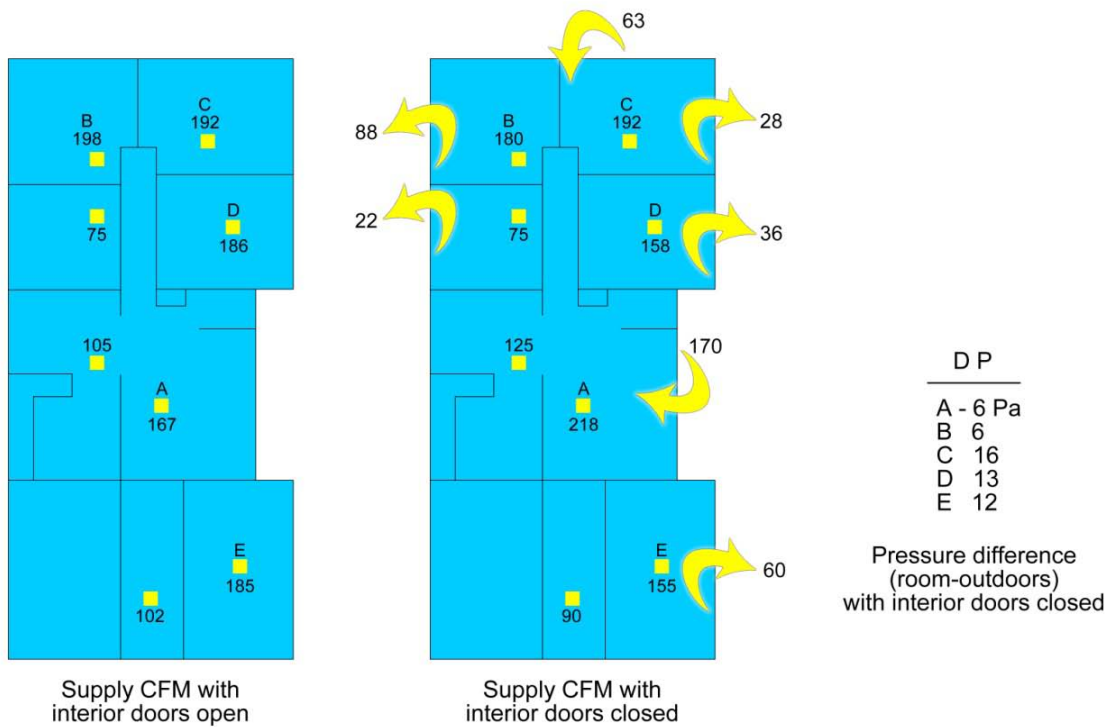

Figure 8. Pressure mapping results in a house with a central return and closed interior doors.

Impact upon infiltration of closing interior doors when air conditioner blower is running

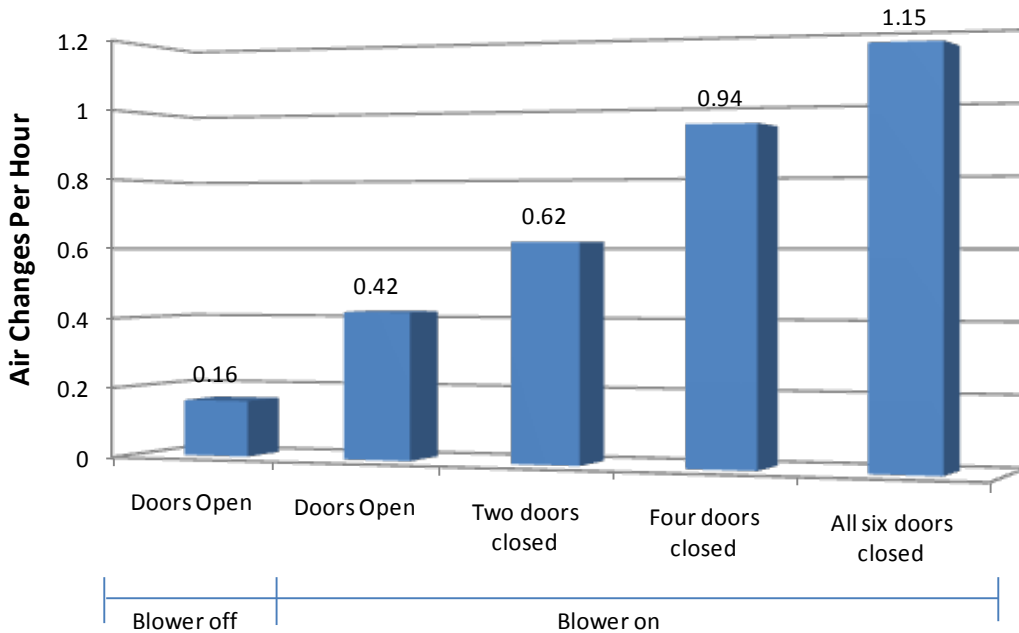

Figure 9. Air infiltration impacts of duct leakage, unbalanced return air, and incremental closing of interior doors.

These tracer gas decay infiltration measurements agree, generally, with calculations based on measured house airtightness and pressure mapping. A blower door test found airtightness of 6.8 ACH50 (CFM50 = 1587). House airtightness is characterized by the general formula $Q = C (dP)^n$, where Q is the airflow rate across the envelope, C is an airflow constant, dP is pressure differential between indoors and out, and “ n ” is an airflow exponent. For this house, airtightness is defined by the specific formula $Q = 140.4 (dP)^{0.62}$. If we assume that half of the house envelope leakage occurs in the depressurized zone of the house, the infiltration rate calculated from the airtightness equation would be 213 CFM (0.91 ACH).

Problems can arise when a single A/C system has zoning dampers to control supply airflows. In most cases, the return air is not zoned. When the thermostat to an individual room is satisfied, supply air to that zone is shut off, but the AHU may continue to operate, in which case the return would continue to draw air from the space. The closed room may be depressurized for extended periods. In this circumstance, hard ducted returns have a disadvantage (compared to return transfers) because of room depressurization created when the supply air is shut down. By contrast, the return transfer works more effectively because the closed room remains at (slight) positive pressure whenever the A/C system is operating.

1.8 Exhaust Fans and Equipment

Bathroom exhaust fans, kitchen exhaust fans, and clothes dryers draw air from the house when they operate. They have the effect of depressurizing the house (or reducing the level of positive pressure in the house) when they operate. Alternatively, they can depressurize a specific zone of the house, when interior doors to that zone are closed. Exhaust fans and equipment transport

various quantities of air; bathroom exhaust at 30–60 CFM, standard kitchen exhaust at 50–250 CFM, cooktop grille fans in the range of 250 to 400 CFM, central vacuums at 40–150 CFM, and clothes dryers at 100–180 CFM (Cummings, Tooley, & Moyer, 1990).

During periods of hot and humid weather, space depressurization draws high water vapor content air into the house, raising indoor RH. Furthermore, moist air drawn into interstitial cavities of the house tends to accumulate in those cavities, especially where vapor retarder surface temperatures are below the air dew point temperature. This moisture accumulation can lead to degradation of building materials and mold growth.

Continuous operation of exhaust fans can lead to serious mold problems. In hot and humid climates, it is important to introduce ventilation into homes without producing extended periods of space depressurization. On the other hand, exhaust fans help to lower indoor RH during cold weather, because low dew point temperature air is drawn into the house. Continuous operation of exhaust fans during cool or cold weather or when outdoor dew point temperatures are below 58°F is an effective and acceptable way to ventilate the house.

Note that a tight house envelope will not significantly reduce mechanically induced air infiltration. For each cubic foot of air exhausted from a house, another cubic foot of air is drawn into the house as a result of negative pressure. When a nominal 400 CFM cook-top grille exhaust, for example, operates in a leaky house, a small level of depressurization is produced and approximately 400 CFM of air will be drawn from the house. If the same fan operates in a tight house, a substantial level of depressurization will result and the airflow rate will likely decline somewhat, to perhaps 380 CFM.

A tight house envelope does, however, make a difference when considering the effects of attic or crawlspace exhaust fans. Attic exhaust fans may draw from 1000 to 4000 CFM from the attic. Depending on the size of attic vents and total attic exhaust airflow, the attic space may be depressurized by less than 1 Pa to more than 10 Pa. If the house is airtight (especially at the ceiling plane), the pressure field in the attic will remain isolated and not greatly impact pressure and infiltration in the occupied space. On the other hand, if there are substantial pathways between indoors and the attic, that negative pressure field may spill substantially into the house. This, in turn, will substantially increase air infiltration into the home.

Consider the following case study. A house in Jacksonville, Florida, built in the 1970s, was experiencing elevated RH and mold growth during the summer. By September, the indoor environment was musty and one of the exterior doors had swollen shut. A contractor had to physically disassemble the door frame assembly and remove it from the wall to gain access to that doorway. The secondary cause was house space depressurization, which in turn was drawing high water vapor-content air into the house and into exterior wall cavities from outdoors. Continuous exposure to high humidity air caused swelling of lumber. The causes of the house depressurization were an air boundary failure in a new addition and operation of attic exhaust fans. In the new addition, a rectangular light shelf had been constructed above the new master bedroom sleeping area. In the process of construction of this light shelf, large gaps were left open between the bedroom and the attic. The combination of continuous attic exhaust fan operation and large openings from house to attic allowed attic pressure to spill into the house, causing a

continuous 5 Pa depressurization in the house, which was sufficient to introduce large quantities of water vapor into exterior wall cavities and the conditioned space.

Crawlspaces are sometimes vented to control their humidity. This practice typically produces negative pressure in the crawlspace, which can then depressurize the house and cause increased infiltration and elevated RH in the house. As with the attic exhaust fan operation, the degree of impact depends on the tightness of the crawlspace wrt outdoors, the airflow rate of the exhaust fan, and the tightness of the plane between crawlspace and house. If crawlspace exhaust fans are to be installed, it is important to test house indoor pressure with the fan on and off, preferably under light winds.

With crawlspace and attic exhaust systems, pressure and air infiltration impacts depend upon the exhaust fan size (CFM), the tightness of the attic to outdoors, and the airtightness of the floor or ceiling plane of the house (including pathways through ductwork). The impacts also depend on the persistence of the exhaust fan operation, which depends on the hours of operation (e.g., attic exhaust fan thermostat set point or if solar powered, the hours of solar radiation).

1.9 Natural Drivers—Wind and Stack Effects

Wind and stack effects (produced by temperature differential between indoors and outdoors) create pressure differentials and move air across the building envelope. Stronger winds and larger temperature differentials between indoors and outdoors produce larger pressure differentials, which increase natural infiltration.

As wind blows across the surfaces of a house, the house is usually depressurized. In some circumstances, the wind will create positive pressure, especially if the wind is blowing toward larger leak openings in the building envelope.

Stack effect produces pressure fields within a house. If indoors is warmer than outdoors, pressure at the lower level of the house will be negative wrt outdoors and pressure at the upper level of the house will be positive wrt outdoors. Conversely, if indoors is cooler than outdoors, pressure at the lower level of the house will be positive wrt outdoors and pressure at the upper level of the house will be negative wrt outdoors. The strength of the stack-induced pressure differentials depends on two factors: the height of the house and the temperature differential between indoors and outdoors. Taller houses will have greater stack effect pressures and infiltration, and greater temperature differential will produce greater stack effect pressures and infiltration.

Field testing has found a useful rule-of-thumb relationship between house airtightness and natural infiltration. In a sample of 99 central Florida homes, both tracer gas decay infiltration tests and blower door airtightness tests were performed. From these data, a “divide by 40 rule” was developed (Cummings, Moyer, & Tooley, 1990). It was found that dividing the airtightness value of ACH50 by 40 yields a good ballpark estimate of natural infiltration. It should be emphasized that this natural infiltration is the air exchange rate that occurs when all of the mechanical air moving systems are off; it is only the result of wind and stack effects. In colder and windier climates, the “divide by” rule typically falls in the range of “divide by 15 to 25,” depending on delta-T, wind speed, house height, and whether the house rests on a slab, crawlspace, or basement.

1.10 Natural Drivers—Wind Washing

Wind washing—air from outdoors penetrating into the interstitial cavities of the house—is a variation on natural drivers. In this case, the primary driver is wind and the pathway is typically openings from attic spaces or outdoors into interstitial cavities. Figure 10 illustrates a particular form of wind washing that is rather common in homes in the southeastern United States. In this case, wind can drive air from an attic space above a first-floor portion of the house into floor cavities that are located between the first and second stories of the house (Figure 11). In many cases, wind washing airflow does not directly enter into the conditioned space of the house. Rather, the air remains largely contained within these interstitial cavities and at least partially separated from the conditioned air. Once the hot or cold air penetrates into the interstitial cavities, it bypasses the thermal envelope of the house and can readily conduct heat or cold into the conditioned space (Figures 12 and 13). To some extent, however, air can also flow from the interstitial cavities into the conditioned space through openings in the floor of the second story or the ceiling of the first story. Alternatively, duct leakage may interact with wind washing and draw air from these cavities and deliver it into the space.

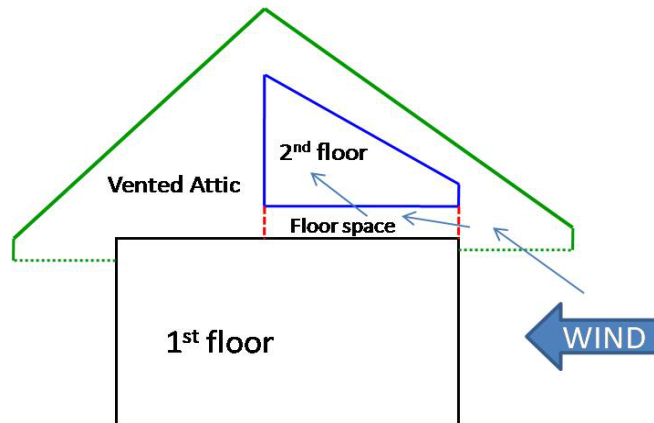

Figure 10. Wind-driven attic air is pushed into the space between floors.



Figure 11. Flex ducts going from an attic space into the interstitial floor cavity under a portion of the second story conditioned space.



Figure 12. Photograph of stairwell. Floor cavity begins under the hung picture at top.



Figure 13. Infrared image of stairwell showing elevated wall temperature from hot air in an interstitial floor cavity. Note location of pictures and light fixture.

The entry of hot or cold unconditioned air into these interstitial cavities can lead to substantial increases in heating and cooling loads. In some cases, wind washing can increase those loads beyond the capacity of the HVAC system, leading to comfort problems and high electricity bills. In some cases, cold air penetrating into the house can also freeze water pipes. The magnitude of the wind washing problem in a specific house depends on the strength of the wind driving air into the attic, the size of the vent openings from outdoors into the attic, the temperature of the attic, the size of the openings between the attic and interstitial floor cavities, and the presence or absence of complementary openings on the opposite side of the floor cavity or into the house conditioned space.

1.11 Natural Drivers—Mechanical and Natural Infiltration Interaction

When mechanical systems are turned off, natural infiltration operates exclusively. When mechanical systems are turned on, the dominant effect (whether natural or mechanical driving forces) depends on certain variables: 1) the tightness of the house envelope, 2) the strength of stack and wind driving forces, and 3) the degree of airflow imbalance induced by the mechanical

systems. In general, mechanically induced pressure differentials and infiltration dominate naturally induced pressure differentials and infiltration, except during periods of large temperature differentials or strong winds, especially in homes with tight envelopes. If duct leaks are large and unbalanced (supply leaks much larger than return leaks or return leaks much larger than supply leaks), house pressures and infiltration are largely controlled by the operation of the mechanical systems except under conditions of large temperature differentials (in a tall house) or high wind speeds. If zone return and supply airflows are substantially unbalanced (with interior doors closed), house pressures and infiltration are again largely controlled by the operation of the mechanical systems. When exhaust systems are operating, and the exhaust airflows are substantial (say 100 CFM or greater), house pressure and infiltration are likely to be controlled by the exhaust fan operation unless makeup air is provided (rare).

1.12 House Envelope Airtightness

The tightness of the building envelope complements the natural and mechanical drivers to determine the degree of air infiltration and concomitant pressure differentials. Natural infiltration is, of course, controlled in large part by the envelope airtightness. Pressure differentials from wind or stack effect drive airflow across the building envelope in variable quantities depending upon the size of the holes in the envelope, the location of the holes in the envelope, and whether complementary holes are located on opposing sides of the building (the Coke bottle effect—tight on the bottom and sides but very leaky at the top).

In general, houses need a tight envelope to contain the conditioned air produced by the heating and cooling systems. Without a reasonably tight envelope, the warmth, coolness, and dryness produced by the HVAC system will drift away. On the other hand, a certain level of ventilation is required to maintain good IAQ. ASHRAE Standard 62.2 provides guidance on ventilation. There are differences of opinion about how to achieve proper ventilation of homes. Some advocate “build tight, ventilate right.” According to this school of thought, very tight envelopes are good, perhaps 0.5–2 ACH50. Mechanical ventilation is then designed and installed to meet the house ventilation needs. Another school of thought is that natural infiltration can be relied on, in large part, to meet the house ventilation requirements. Section 2 of this report provides airtightness guidance under the assumption that natural infiltration should be relied on for a significant portion of the house ventilation.

Following is a discussion of the pros and cons of these two approaches. There are two major arguments against relying on natural infiltration to provide most or all of the ventilation needed. The two reasons are related to variability in natural infiltration caused by variability in outdoor temperature and wind.

1. During some periods, there will be too little ventilation. Although this no doubt causes some IAQ problems, homeowners do have the opportunity to increase ventilation by opening windows, which can for a specific period of time require additional HVAC energy use.
2. There will be other periods when natural infiltration exceeds the minimum ventilation requirement. On days when heating or cooling is needed, this excess ventilation will require additional energy to meet the space conditioning load.

There are two major arguments against “build tight, ventilate right.”

1. If the envelope is very tight, achieving acceptable ventilation depends almost entirely on a mechanical system providing the necessary ventilation air. This mechanical ventilation system must be maintained and repaired over a long period (e.g., as long as people occupy the house). Field experience often finds that homeowners do not maintain these systems, in part because there is no strong feedback mechanism. If, for example, an A/C system or heating system stops working, occupants will take note and within hours call for a service technician. By contrast, the ventilation system (an energy recovery ventilator, for example) can fail in a house and occupants may not notice. Some researchers have found a number of maintenance problems such as the following: 1) homeowner did not know there were filters that required cleaning, 2) the homeowner did not know they had a ventilation system, 3) belts or motors on energy recovery ventilator or heat recovery ventilator systems had failed, or 4) fans had stopped working. If the house is very tight or even extremely tight, and the ventilation system fails, the home occupants may experience extremely poor air quality.
2. Pressure differentials produced by unbalanced airflows from mechanical systems are exaggerated when a house is very tight. Consider, for example, that a clothes dryer exhausting 200 CFM from the house would produce negative pressure of -23 Pa in a 2000 ft² house with an airtightness of 1.0 ACH50. This level of negative pressure can cause slamming of doors and combustion safety problems such as spillage and backdrafting of vented combustion devices (e.g., gas furnaces, gas water heaters, fireplaces, and wood stoves), incomplete combustion accompanied by high carbon monoxide (CO) production, and flame rollout from water heaters. A cook-top grille exhausting 400 CFM would produce negative pressure of about -60 Pa in that same house.

A compromise between the two positions seems in order. Build it “reasonably tight” and provide mechanical ventilation. “Reasonably tight” might be 5 ACH50 in Florida and 3 ACH50 in Illinois, for example. In each of these locations, natural infiltration might fall between 0.10 to 0.20 ACH during most hours of the year. In case the ventilation system stops working, the house occupants will receive a substantial portion of the ventilation that they need. On the other hand, the envelope will be sufficiently tight so that natural infiltration will not exceed the ventilation requirements of ASHRAE Standard 62.2 for very many hours per year. And by producing a “reasonably tight” envelope, pressure differentials produced by unbalanced airflows will not be excessive.

2 Home Inspection and Testing

Diagnostic testing and visual inspection can be performed to identify the driving forces and pathways for air and water vapor transport. A variety of diagnostic tests can be employed to understand uncontrolled airflows.

A blower door test will characterize the tightness of the house envelope. Typically a multipoint test is performed that yields envelope airtightness in terms of both ACH50 and an airtightness equation. ACH50 allows us to predict natural infiltration using a simplified “divide by” method. It also allows airtightness comparison to other homes. The airtightness equation ($Q = C (dP)^n$) allows prediction of building pressure given net airflow across the envelope or net airflow across the envelope if delta-pressure is known. This equation is useful for interpreting pressure mapping

results and assessing combustion safety risks. During the blower door test, interstitial cavity zone pressures can also be measured, which can yield an understanding of the location of the house primary air boundary. If, for example, the house is at -50 Pa and the floor cavity between the first and second stories is at 40 Pa wrt indoors, then this measurement advises the tester that this interstitial cavity is more outdoors than indoors. This can be helpful in understanding whether duct leaks are occurring inside or outside of the house air boundary. It can also be helpful in diagnosing wind washing (more on that later).

A $Q_{25,\text{out}}$ duct system airtightness test will define the tightness of the air distribution system. This test measures air leakage of the ductwork to outdoors when the ducts are depressurized by a calibrated blower. It is performed by sealing off supplies and returns (AHU turned off), depressurizing the ductwork to -25 Pa, and simultaneously depressurizing the house to -25 Pa. From this the tester learns the air leakage rate of the entire duct system to outdoors ($Q_{25,\text{out}}$; leakage at 25 Pa), or the $Q_{25,\text{out}}$ split between return and supply. If the tester either measures or assumes operational duct pressures, actual return and supply duct leakage can be predicted at actual duct operational pressures. Testing methods can be implemented according to ASHRAE Standard 152-2004.

A pressure pan duct system airtightness test also reveals duct leakage. This alternative to the $Q_{25,\text{out}}$ test is a quicker and simpler duct test. With the AHU off and the house depressurized to 50 Pa by a blower door, a pan with gasket is placed over each register, one at a time. Pressure inside the pan is measured indicating pressure in the ductwork. If the duct were completely disconnected, the pressure pan reading would be 50 Pa wrt indoors. If the ductwork were completely airtight, the pressure pan reading would be 0 Pa wrt indoors. The pressure pan test results indicate the approximate size of duct leaks near each register and help to identify the approximate location of duct leaks.

An RLF test can be performed if tracer gas detection equipment is available. In this test, a tracer gas is mixed into the house air. Tracer gas concentration is measured entering the return grille(s) and discharging from a supply register. From these measurements, an RLF can be calculated (Cummings, 1989). If the return or AHU airflow rate is also measured, the return leak airflow rate can be calculated.

Understanding the conditions of the source of duct leakage induced air infiltration is critical. A visual inspection should identify the thermal conditions of the zone where the AHU, return ductwork/plenum, and supply ducts are located. In many cases, the duct zone (attic, crawlspace, etc.) temperature and humidity characteristics are important. Does the roof have asphalt shingles, colored or white metal, or tile? Has a radiant barrier or insulation material be located at the roof deck? Is the attic or crawlspace vented? All these factors determine the degree of amplification (of temperature and humidity) that occurs within the duct zone.

The location of the AHU is especially important. When the AHU is located in an attic, the proportion of return ducts (and return leaks) that are located in the attic increases substantially. Furthermore, the AHU itself has substantial air leakage. Even though the absolute size of leak openings in AHUs may be relatively small, because the AHU is under maximum pressure (often about -140 Pa), air leakage may be greater than expected. In a study of 69 AHUs in new Florida

homes, 4% of the system airflow was return leakage into the AHU cabinet (Cummings, Withers, McIlvaine, Sonne, & Lombardi, 2003). Just that 4% AHU leakage can yield a 15% reduction in A/C system capacity and efficiency under peak conditions (Cummings & Withers, 2008) (also see Figure 4).

When AHUs are located in crawlspaces, basements, and garages, the air that is in those spaces is transported (by return leaks) into the house. This can have significant IAQ impacts. Crawlspaces may contain pesticides and mold. Basements may contain radon. Air from the garage may contain various fuels, cleaners, herbicides, and vehicle outgassing. Backdrafting of combustion appliances can introduce combustion byproducts into the house. In the worst case, automobiles can be left running in the garage (usually by accident) and combustion fumes can be transported into the house. Each year, a number of people in the United States are killed by CO poisoning when the AHU transports CO from the garage into the house.

Pressure mapping is a type of test that identifies pressure differentials when various natural and mechanical driving forces are operating. (In the following discussion, pressures are measured wrt outdoors unless otherwise stated.) A typical pressure mapping sequence might go like this: 1) measure house pressure with all mechanical systems off, 2) measured house pressure with the AHU on and interior doors open, 3) measure pressure in individual rooms (wrt indoors) with the AHU on and interior doors closed one at a time, 4) measure the central zone pressure with the AHU on and all interior doors closed simultaneously, 5) measure house pressure when exhaust systems are turned on and off (AHU off), and with relevant interior doors closed, and 6) measure worst-case zone pressure especially in combustion appliance zones (CAZs; rooms with gas water heater, gas furnace, fire place, or wood stove) when all configurations of fan and door status are implemented.

Interpreting the pressure mapping test results is important, because air pressure differential is, of course, the largest single driver of airflow and airflow impacts. If the AHU is turned on and house pressure does not change, this can mean one of three things:

- The air distribution system has no leaks.
- There are return leaks and supply leaks, in approximately equal size.
- The house envelope is sufficiently leaky so that dominant duct leakage cannot “pump up” the air pressure by a detectable amount.

By examining the results of the Q_{25} or pressure pan duct testing, you can know if there is little or no duct leakage. By examining the results of the ACH50 envelope airtightness test, you can know if the envelope is excessively leaky. If pressures across closed doors are large, then unbalanced return air may create combustion safety risks and generate high levels of air infiltration. If persistent, the negative pressure in the central zone may create interstitial moisture accumulation problems, increased levels of air infiltration and HVAC energy use, and elevated indoor RH during hot and humid weather.

In an ideal house, there would be no duct leakage, so turning on the AHU should not change house pressure. In an ideal house, return air would be provided. If the return air is hard-ducted, pressure drop across closed doors may be close to zero. If the return is provided by return transfers, then pressure drop across closed doors will be 3 Pa or less.

A cooling system (or heating system) performance test can be useful in characterizing the performance of the space conditioning system. The key elements are airflow, delta-temperature, and delta-humidity. The AC system test is performed by turning on the system, letting it operate for 8–10 minutes to achieve steady-state operation, and then recording return and supply air conditions (T/RH). System airflow at the return grille or AHU should be measured. If the tester has performed an RLF test, the airflow measured at the grille should be divided by “one minus the RLF to obtain the true system airflow rate. For example, if the RLF is equal to 0.10, and the return grille airflow measurement is 900 CFM, the total system airflow is 1000 CFM ($900 \text{ CFM} / (1 - 0.10) = 1000 \text{ CFM}$). Outdoor T/RH should also be measured. For an A/C system, the analyst would expect a temperature drop (from return to supply) of 16°–20°F, depending on indoor and outdoor conditions, or greater if the system airflow rate is significantly lower than 400 CFM per ton. Total cooling capacity can be computed by converting CFM to a mass flow rate and T/RH to enthalpy (using a psychrometric chart or calculator). The analyst can compare cooling capacity to nominal capacity. (Note that capacity can change by $\pm 15\%$ as a function of outdoor temperature and return air entering conditions. The tester can also look to see that supply air is sufficiently cold (57°F or lower) to provide good RH control during hot and humid weather.

Inspection and testing for wind washing in two-story and split-level homes can be implemented using several tools. Inspection in attic spaces above first-floor portions of the house can identify openings between the attic space and interstitial floor cavities between the first and second stories of the house. The inspection should note whether materials blocking entry to the interstitial floor cavities are actually air barriers. For example, insulation batts may or may not produce significant airflow resistance, depending how carefully the batts have been installed. As indicated earlier, when the house is depressurized to -50 Pa , measurement of pressure in the interstitial floor cavity (through canned lights or other pathways) can indicate whether that cavity is primarily inside or outside the house air boundary. This can provide important evidence about wind washing potential.

It is also useful to inspect for complementary pathways, where air that is pushed into the floor cavity on one side of the house can flow out on the opposite side of the house. An IR camera is a useful tool for identifying cold or hot wind washing air during periods of significant wind and delta-T (a wind washing IR image can be seen in Figure 13). It is also valuable to take visible image photos (such as Figure 12) to complement the IR images so the viewer can readily interpret the meaning of the heat signatures.

Combustion safety testing and inspection should be implemented in homes with combustion devices. Inspect for visual clues of combustion problems such as soot around the vent, scorch marks on walls around the combustion chamber of the water heater, gaps in vent pipe, and improper vent termination at roof level. Test for worst-case CAZ depressurization. This involves turning on the AHU and various exhaust fans, and closing various interior doors to determine the maximum possible level of CAZ depressurization. If the CAZ is depressurized to -3 Pa or more, take steps to remediate.

It should be emphasized that combustion safety testing is a very important step in building diagnostics. It is beyond the scope of this document to cover this topic in full detail. Any time

combustion appliances are present, combustion safety testing should be conducted. This is especially important if air exchange reduction is a component of the work scope. Failure to conduct a combustion safety inspection and test may result in serious health and safety problems from spillage, backdrafting, or flame rollout. An example of combustion safety testing procedures and acceptable limits can be found on the Building Performance Institute website (www.bpi.org/documents/Gold_Sheet.pdf). Combustion safety should most certainly be considered when implementing retrofits. Furthermore, after the retrofits have been implemented, it is critical to “test on the way out” to confirm that changes made to the house envelope, duct system, system airflows, etc. have not created or retained combustion safety problems.

Water vapor transport inspection and testing can complement airflow and airtightness diagnostics. Inspection or review of construction documents can verify whether vapor retarders are in the wrong location. As indicated in the Background Section, vapor retarders should be located on the warm side of wall assemblies. Vinyl wall paper on the inside surfaces of walls in hot and humid climates can cause moisture accumulation problems, especially in cases where the indoor temperature is cold (e.g., 74°F and colder). Additionally, vinyl flooring will often have low vapor permeance, which can cause moisture condensation or substantial water vapor adsorption when in contact with high dew point air in a crawlspace. This is especially true in cases where the indoor dry bulb temperature is lower than the outdoor dew point temperature. Moisture meters can, in many cases, be used to sample wall and floor materials to detect moisture accumulation problems.

3 Selection of Retrofit Options

3.1 House Envelope Airtightening

House envelope airtightness is not a driver, but it is an important variable in air and water vapor flows. It controls much of the natural and some of the mechanically induced air infiltration. It greatly affects pressure differentials that result when various driving forces are imposed on the house. Two important intertwined questions arise: 1) How tight should we make the house envelope? and 2) Should envelope airtightening be implemented in this house? The answers to these questions involve a number of variables. An envelope should be fairly airtight so that natural infiltration (that produced by wind and temperature differential) exceeds the ventilation requirements of the house (e.g., ASHRAE Standard 62.2) for only a small to moderate percentage of the time.

There are risks associated with a leaky building envelope; excessive natural infiltration can waste heating and cooling energy, require larger heating and cooling equipment, cause comfort problems related to air temperature and drafts, cause increased energy use and peak demand, produce high indoor RH during hot and humid weather, and produce low indoor RH in the winter. It is important to achieve a reasonably tight envelope so the indoor climate produced by the HVAC system can be maintained without excessive energy consumption.

There are also risks associated with an excessively airtight house envelope (if no mechanical ventilation is provided) because it can produce 1) too little ventilation, which may lead to poor IAQ and produce high levels of indoor RH during cold weather (if the heating system is not operating or there are no duct leaks to provide ventilation), and 2) a tight envelope can produce excessive levels of indoor air pressure when unbalanced mechanical airflows occur (duct leakage, restricted return air, and exhaust system operation), which can draw soil or sewer gases into the space or produce combustion drafting problems including spillage, backdrafting, high CO production, and flame rollout.

So, when should airtightening be implemented in an existing home? The following guidance for house airtightness is provided.

- Whether to implement house envelope airtightening depends on the level of measured airtightness and the climate in which the house is located, where the leaks are located, how much difficulty and cost will be associated with tightening the house envelope, whether utility or government incentives are available, and whether alternative means for providing adequate and reliable ventilation will be available.
- Measured airtightness and climate zone. If house airtightness is 6 ACH50 or less in a mild climate (climate zones 1, 2, and 3), 4.5 ACH50 or less in a moderate climate (climate zones 4 and 5), or 3 ACH50 or less in a harsh climate (climate zones 6 and 7), additional house envelope airtightening may not be cost effective unless the leaks are easily accessed and repaired (Figure 14). If houses are 6–8 ACH50, 4.5–6 ACH50, and 3–4.5 ACH50 in mild, moderate, and harsh climate areas, respectively, then reasonably inexpensive airtightening may be justified. If houses are leakier than this, considerable airtightening is recommended.

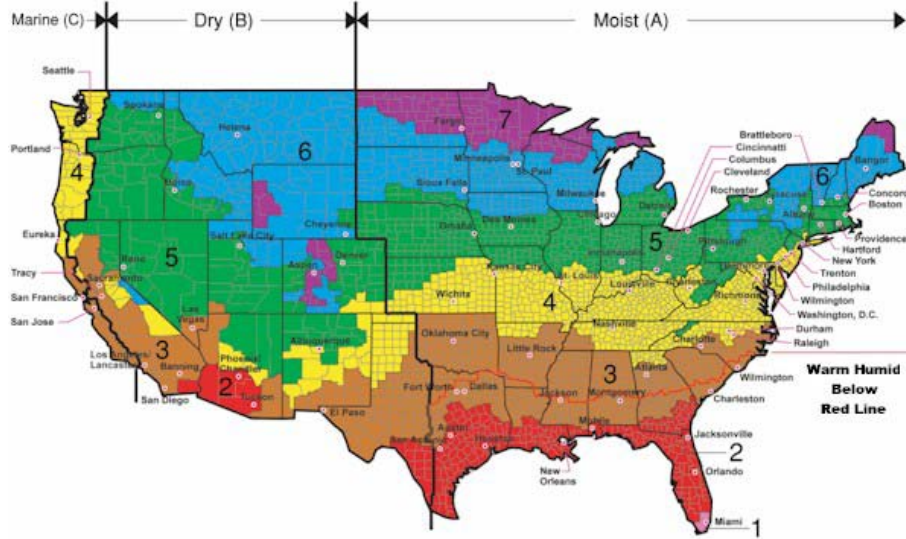

Figure 14. Climate zone map of the United States (DOE)

3.2 Duct System Airtightening

Good construction practice should aim for installation of an airtight air distribution system. Although duct systems are now being commissioned in some new homes, relatively few existing homes have undergone testing to ensure airtight ducts. Research has found that production of airtight ductwork is readily achievable and repeatable (Fonorow, Chandra, McIlvaine, & Colon, 2007).

In a substantial majority of homes, the air distribution system is leaky. A number of studies have been conducted that identify “typical” duct leakage in existing homes, and average numbers for $Q_{25,out}/\text{floor area}$ ($Q_{n,out}$) vary from 0.06 (Swami, Cummings, Sharma, Withers, & Basarkar, 2006) to 0.14 (McIlvaine, Sutherland, Schleith, & Chandra, 2010). Repairing duct leakage saves considerable energy, especially if the air introduced into the house by duct leakage has a dry bulb temperature considerably different from indoors or a high dew point temperature.

So, when should duct system airtightening be implemented in an existing home? The following guidance is provided based in part on established programs and codes. ENERGY STAR (version 2.5) has the following requirements in its HVAC checklist; $Q_{n,out} = 0.04$ and $Q_{n,total} = 0.06$. The State of Florida Energy Code defines a “leak-free” duct system to have $Q_{n,out} = 0.03$ or tighter. In January 2012, the Florida code will require $Q_{n,out} = 0.03$ for all new homes. Whether duct repair should be implemented in a specific house depends on the measured value of $Q_{n,out}$, the difficulty of accessing the ducts (this is related to the cost of repair), and the climate zone. In general, duct leakage should be repaired if $Q_{n,out}$ is greater than 0.06. More specifically, ducts that are readily accessible could be tightened to $Q_{n,out} = 0.03$ or even tighter, especially if the house is located in a harsh climate or the ducts are located within a hot attic in a hot climate. If the pressure pan test has been used to measure duct leakage to out, repairs are warranted when pressure pan readings are greater than 1.5 Pa (when the house is at -50 Pa).

Duct repair should be implemented using materials that will adhere effectively to the duct surfaces and be durable for the life of the building. In general, duct tapes are not suitable for

repair of ductwork in existing homes, in part because existing duct surfaces have dust and other contamination that may inhibit durable adhesion. Details about duct repair methods and materials are found in Section 3.

In cases where access to the ductwork is limited, three additional approaches may be considered:

- In two-story homes, where wind washing exists, it has been demonstrated that repair of wind washing (improving the integrity of the house air boundary) will help to contain the air leaking to and from ductwork located in interstitial floor cavities. In effect, wind washing repair can reduce the impacts of duct leakage significantly.
- Abandon the leaky duct system and install a new duct system internal to the house air and thermal barrier(s). Figure 15 illustrates construction of a soffit space within the home that can house the interior duct system. The interior ducts will, in all likelihood, experience some air leakage, so it is important that the soffit space be tight to the attic and leakier to indoors. Therefore, the existing ceiling gypsum board surfaces should not be compromised during the construction process. It is also important to minimize pressure drops within the duct system. Therefore, the interior ducts should be sized sufficiently large. Ideally, metal duct with graduated turns will be used. If flex duct is used, it is important that this ductwork be stretched tight while also avoiding sharp bends. Laboratory research has found that fully stretched flex duct performed essentially as well as metal duct. However, when a 25-ft flex duct was stretched to only 24 ft, pressure drop increased by an approximate factor of 2 (Weaver & Culp, 2006). A properly constructed interior duct system improves the energy efficiency of the air distribution system because energy losses that occur because of conductive exchange and air leakage are largely captured and returned to the conditioned space. Furthermore, any unbalanced airflows that occur because of supply or return duct leakage are contained within the home's air barrier, and thus do not act as drivers.

Even if it is not practical to move the supply/return ducts to indoors, consider moving the AHU indoors (typically only cost effective if already undergoing a system replacement). Alternatively, the AHU could be located in a sealed, insulated closet in an attached garage, where the closet is tight to the garage but leaky to the house (Figure 16) (Fonorow, Chandra, Martin, & McIlvaine, 2006).



Figure 15. Interior duct system under construction. Metal framing is used to construct a chase that will hide the ducts from view once covered with drywall. The chase should be tight to the attic and leakier to the room.



Figure 16. An insulated garage closet located will house an AHU. A weather stripped door will isolate the closet from the garage. A vent from the closet to indoors would also further enhance the system operating efficiency.

- “Encapsulate” the existing duct system inside a sealed and insulated attic (or crawlspace). This is typically implemented by applying a foam insulation product onto the bottom of the roof deck and sealing off attic vents. Best practice would leave the attic insulation on the floor of the attic. The products chosen to seal the attic must be carefully selected to avoid moisture condensation and entrapment problems that could lead to rotting of building materials. Some cautions are in order. In any climate, application of an open cell foam can make finding roof leaks difficult. In a cold—or even mixed—climate, application of an open cell foam can allow moisture condensation on the bottom surface of the roof decking, which can lead to rotting of the roof wood materials.

Even if the attic ductwork is airtight, an interior duct system can yield considerable energy savings. In a study performed at the Florida Solar Energy Center, interior supply ducts produced cooling energy savings of 18% compared to an essentially airtight attic supply ductwork (R6 flex duct) (the return ducts and AHU were already in the conditioned space) (Moyer, Stroer, Hoak, McIlvaine, & Chandra, 2008). Savings could be substantially greater if the original duct system had typical levels of duct leakage, depending on the climate and duct location. In a study of 46 central Florida homes, repair of duct leaks (with typical attic ducts) found average cooling energy savings of 17.2% when 64% of the leakage was sealed (Cummings, Tooley, & Moyer, 1991). If all of the duct leakage in those homes had been repaired, by extrapolation, the savings from sealing of duct air leakage would have been 27%. If these leaking ducts had been relocated to indoors, it can be concluded (combining conductive and duct air leakage effects) that the overall cooling energy savings would have been 40%. Heating energy savings would likely be a comparable percentage. Under the assumption that relocating the ducts to indoors would cost about \$3500, heating and cooling energy saving might pay for the improvement cost in about 6 years. Duct repairs in milder climates (e.g., many of the large population centers of California) or in basements (where conditions are moderated compared to outdoors) will yield much less savings. As with other air and water vapor drivers, duct repairs can also improve IAQ and

prevent unwanted contaminants such as dirt, dust, pollen, and fumes from being driven into the living environment by reducing or eliminating uncontrolled airflow.

There are risks, however, associated with duct repair. In fact, when making almost any change to the house's air and water vapor boundaries and drivers, it is important to consider the house as a system. Otherwise, a variety of unwanted and unanticipated outcomes may occur. These include poor IAQ, building materials degradation, and health and safety issues. It is important to “test on the way in” and to “test on the way out.” When deciding which measures to implement and how to make those changes, inspection and testing results are necessary. However, after the improvements have been implemented, it is important to verify that new problems have not been introduced. It will be important to determine the house and duct system airtightness, and perform pressure mapping. From these tests, one can determine if the ventilation rate will be sufficient and verify that pressure differentials will not create humidity, moisture condensation, or combustion safety problems.

3.3 Remediation of Unbalanced Return Air

Good HVAC design and practice aims to balance return air. However, due to industry misconceptions as to the impact of unbalanced returns, good HVAC design practices have not been widely applied. As previously discussed, codes have only recently begun to require good design practices. And when code compliance is assessed, it is generally based only on visual inspection. Unfortunately, a visual inspection cannot always identify problems. Pressure mapping, as described in Section 1, is typically required to verify balanced airflow (Figure 17).



Figure 17. Pressure mapping can be performed using a manometer.

Good practice should achieve 3.0 Pa or less of pressure differential across interior partitions within the home. There are a number of off-the-shelf and customized solutions available to resolve this air/water vapor driver. On March 1, 2002, the Florida mechanical code was modified to require that houses constructed after that date would have to meet a 2.5 Pa (across walls) pressure limit requirement (with a couple of exceptions). A study of 40 such homes constructed after that date found that pressure drop across interior doors had declined by 73%, on average,

from 9.1 Pa to 2.5 Pa with all interior doors closed compared to a study of 70 homes built between 1985 and 1989, and this was achieved when only 59% of the rooms requiring return air were in compliance (Cummings & Withers, 2006b).

Implementation of unbalanced return air solutions is presented in Section 3. Airflow rates that can be obtained by using various ducts and other return pathways are presented in Figure 18. Data are available for 6-in. and 8-in. jumper ducts; five different sized wall openings in different configurations including straight through with and without sleeves, straight through with sleeve and privacy baffle, and high/low offset using the wall cavity as a duct; and three different slots simulating three different size undercut doors.

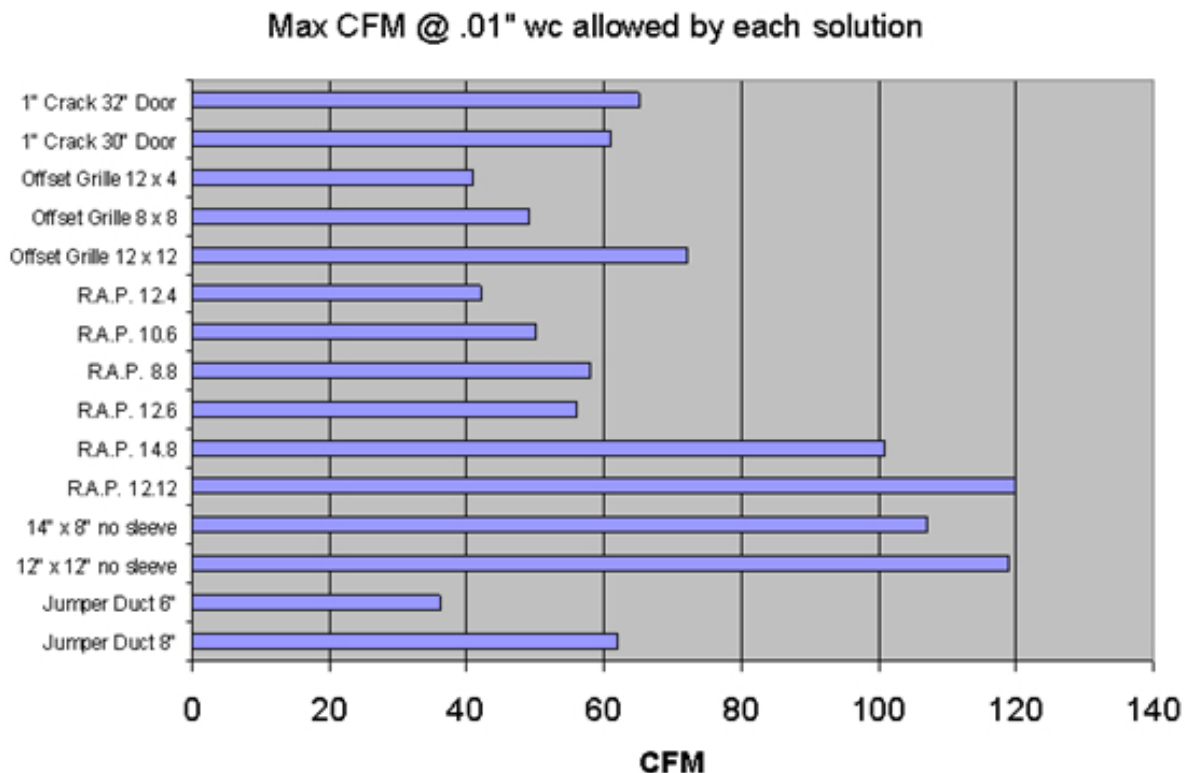

Figure 18. Achievable airflow rates using various return air paths from closed rooms for a given supply at a room pressure of 0.01 in. w.c. (2.5 Pa) with respect to the return zone. For example, an 8-in. jumper duct could be used to maintain 2.5 Pa in rooms with supply air up to 60 CFM. Excerpt from www.ba-pirc.org/casestud/return_air/index.htm.

When choosing a balanced airflow solution, it is important to consider the pros and cons of various retrofits solutions. On one hand, reduction in unbalanced return air will reduce air infiltration and pressure differential when interior doors are closed. On the other hand, return pathways (either transfers or ducted return air) that pass through unconditioned spaces will introduce conductive heat losses and potential air leakage losses, which may diminish the energy benefits of balanced return air.

3.4 Repair of Wind Washing

In general, wind washing should be repaired to the extent possible and practicable. The factors to consider when making this decision are the size of the wind washing openings into interstitial cavities, the types of materials that are currently “blocking” the wind washing opening, the existence of complementary holes (on the other side of the house) that allow air to flow freely through the house structure, the relative exposure of the house to wind, the harshness of the climate or temperature of the attic, the degree to which wind washing is causing occupant comfort complaints, and the ease of access to the location where the repairs need to be implemented.

In hot and humid climates, the need to prevent high dew point air from entering the house and condensing on cool surfaces (e.g., ducts and registers) can be an additional important factor (Figure 19). In climates where outdoor temperatures fall to 20°F and colder, avoiding the freezing of water pipes is a good reason for making wind washing repairs. Sealing wind washing openings will often cost \$600–\$1200 per house, so the potential gains should be weighed against the cost of the repair. There are other benefits from elimination of wind washing, such as improved comfort and better humidity control, so repair of wind washing will often be considered a good choice.

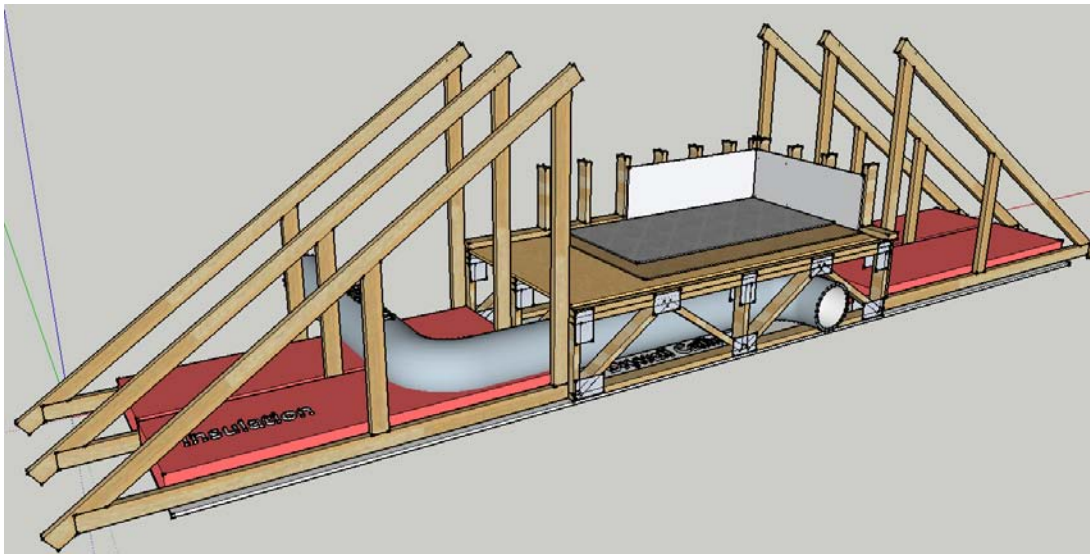

Figure 19. A supply duct is located within the interstitial floor cavity of an upstairs bonus room. The floor cavity is open to an adjacent attic space allowing high dew point air to contact the cool outer jacket of the duct.

In general, there are many benefits from wind washing repair and few risks. Wind washing repair can reduce the house heating and cooling loads, save energy, and improve comfort. In a recent study, wind washing problems were found in approximately 40% of the two-story homes examined (Withers & Cummings, 2010). Wind washing was mostly related to open or partially open second story floor cavities adjacent to an attic space. Data from repair and monitoring of 6 homes show that annual cooling energy savings and summer peak demand reductions averaged 15.3% and 12.6%, respectively. In some cases, wind washing repair reduces the house air

infiltration rate, by reducing pathways from outdoors to the conditioned space and by reducing air exchange between indoors and outdoors produced by duct leakage.

Two risks have been identified from wind washing repair:

- In some cases, wind washing repair can dramatically reduce cooling and heating loads, which leads to reduced A/C system operation time. This in turn could reduce duct leak-induced infiltration to the point where the house may not receive sufficient ventilation.
- In many cases, supply ducts run into and out of the floor cavity between the first and second stories. The application of a foam product to the wind washing leak opening could create condensation where the foam and duct are in contact. Special steps should be taken to avoid that condensation problem (see Section 3).

3.5 Exhaust Fans and Equipment

In general, most exhaust systems in homes can be operated without creating undue air and water vapor driving forces. Kitchen exhaust fans, bathroom exhaust fans, and clothes dryers can normally operate intermittently without serious side effects. In some cases, however, these devices can cause space depressurization (especially clothes dryers in closed utility rooms), which can cause backdrafting of combustion appliances. If pressure mapping finds space depressurization in any CAZ of 3 Pa or greater, steps should be taken to modulate that pressure. If a clothes dryer produces -3 Pa or more negative pressure in a mechanical room that has atmospherically vented combustion appliances, that space needs to be vented to the house (vent in door or wall) or to outdoors. According to the National Fire Protection Association 54:10.4.3.1, “make-up air shall be provided for Type 1 clothes dryers in accordance with the manufacturers’ installation instructions (NFPA 2009).”

Cooktop grille exhaust fans can draw 400–600 CFM from the house and create whole-house depressurization of 5 Pa or more. In homes with atmospherically vented combustion devices, including fireplaces and wood stoves, it may be necessary to introduce makeup air simultaneously to avoid combustion problems.

Attic exhaust fans can create depressurization and air infiltration problems in some homes. Depending on the size and number of attic exhaust fans, the total airflow drawn from the attic space (to outdoors) can be 1000–4000 CFM. The operation of the attic exhaust fan(s) can produce attic depressurization depending on the size of attic vent openings. A depressurized attic can draw substantial air from the house. In one-story homes with slab-on-grade construction, it is estimated that 65% or more of the house envelope leak openings are located in the ceiling plane. The degree to which attic depressurization spills into the house depends on the airtightness of the ceiling plane. The Florida Solar Energy Center recommends passive attic venting over mechanical venting. As a retrofit option, therefore, the attic exhaust fan(s) could be removed and passive vents installed. If attic exhaust fans are desired, consider solar-powered fans, which often have lower flow rates and cannot operate for more than about 8 hours per day. This should help to avoid excessive and persistent house depressurization. If the attic exhaust fans are to remain operational, measure house pressure with the fans on and off, and make sure that they do not run 24 hours per day. Additionally, inspect for air leakage between house and attic, seal significant ceiling leakage pathways, and check that the attic has ample venting.

4 Implementation

4.1 House Airtightness Repairs

House airtightening can be implemented through a variety of measures. Generally, tightening should focus on sealing the large leaks that are most accessible, but it may be important to seal large leaks that are less accessible. Effective airtightening may involve installing more airtight windows (e.g., replacing jalousie windows); sealing significant holes in floors, walls, and ceilings (at ceiling fans, light fixtures, plumbing penetrations, etc.); installing more airtight attic or crawlspace attic access panels; and sealing at interior wall top plates.

4.2 Wind Washing Repairs

Wind washing is a form of uncontrolled airflow that often occurs when attic air is driven into interstitial cavities between the first and second stories of a house. Figures 20 and 21 illustrate a typical wind washing case. Figures 22 and 23 show visible and infrared (IR) images of the wind washing openings to the floor cavity. The cooler temperatures indicated in the IR image show that the floor cavity is at a considerably cooler temperature than the attic. Even when wind-driven airflow is small, thermal buoyancy can circulate hot air from the attic space into the interstitial floor cavity, as is illustrated in Figure 24. Cool air flows from the floor cavity into the attic and is replaced by hot attic air. Foam insulation is an effective means to seal the floor cavity opening and to provide improved insulation R-value to the knee wall (Figure 25). The penetration of attic heat into the floor cavity is eliminated when the foam insulation application seals openings to the floor cavities (Figures 26 and 27).

Wind washing can also occur when vented soffit areas (such as mini-attics) are connected to floor cavities. Access to the pathways between attic or soffit space and interstitial floor cavities is critical to being able to repair or limit wind washing. When attic spaces are accessible, complete repair will normally be possible. Very small attic spaces or small vented eave areas, however, may severely limit the repair potential, short of intrusive removal of drywall sections. Repairs requiring drywall removal for access will be much more costly. That type of solution will generally be reserved for homes with large wind washing, air quality, or building damage, because the payback period would otherwise be much longer.

The key to successful wind washing repair is to install a continuous air barrier at the entry to the floor cavity. It is also ideal to install the thermal barrier in the same location. The use of insulation batts to provide the desired air and thermal barrier typically falls short of achieving these objectives. In Figure 22, one can see that insulation batts at the floor cavity entrance have failed to isolate that space from the attic. The batts on the kneewall are snugly in place, but are still vulnerable to airflow that may transfer heat from the attic to the wall gypsum board surface. The acting air barrier of this system is the kraft paper facing and drywall, neither of which is visible. Several sections of the second story interstitial cavity are open to the attic, allowing attic air to be driven by wind into the house structure.

The actual cost of repairing wind washing can vary greatly. The primary factors affecting cost are the difficulty of access to the repair location and the total area required to be sealed. Homes with garage attic space next to second-story conditioned space generally have easy access and often require less than 40 ft² of material to seal and insulate the floor cavity from the attic. On

the other hand, homes with open floor construction into very small attic or soffit areas require considerably more time. Working within these tight spaces can also limit the options of material used. For example, a very small attic space far from the attic access would make working with rigid board stock very time consuming and difficult. The rigid board stock might be inexpensive, but the labor would be very expensive and require considerable skill and agility.

All the wind washing repairs shown below were completed using a blown low-density, open-cell foam (Figure 25). With proper care, other materials can be used. It will often be the case that less expensive materials will require longer labor time. The foam method requires only about 2 hours on site for easy access locations and about twice as long when access is more difficult. A spray insulating contractor new to this type of repair may charge about \$750 per house (approximately \$6.93/ft² sealed). However, a contractor experienced in such repair could profitably repair three to four houses per day with one crew at an average cost around \$600 per house.

4.2.1 Wind Washing Repair by Means of Foam Application to Knee Walls and Floor Cavity Openings



Figure 20. Home with one attic space over garage that abuts second floor wall and floor cavity.



Figure 21. View of kneewall and portions of open floor cavity as seen from inside the garage attic.



Figure 22. Close-up view of entry to open floor cavity.

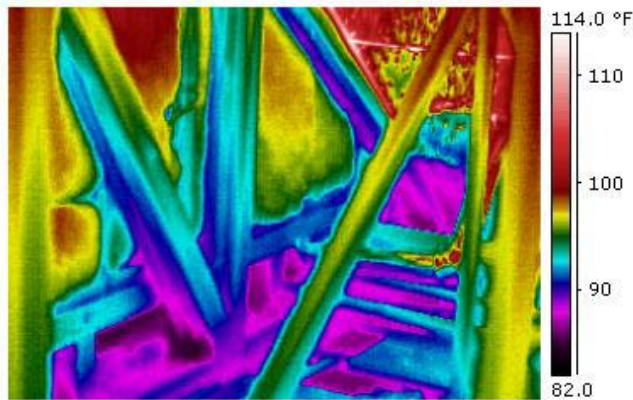

Figure 23. IR image from inside attic before repair shows much cooler area at the bottom where air from floor cavity is displaced into attic.

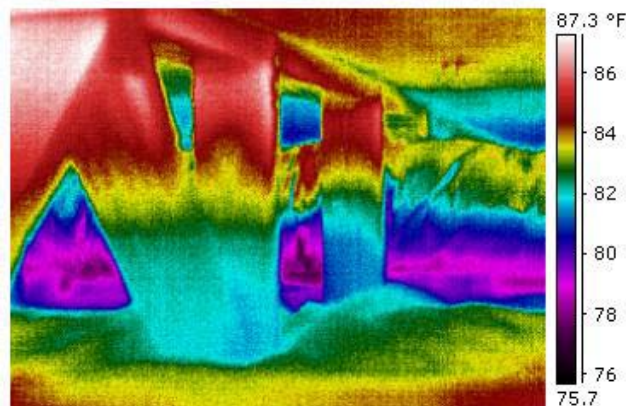

Figure 24. IR image inside floor cavity shows thermal stratification of air, with hotter air at top against second-story floor and cooler air at bottom.



Figure 25. View of kneewall and floor cavity after being sealed with low density expansive foam.

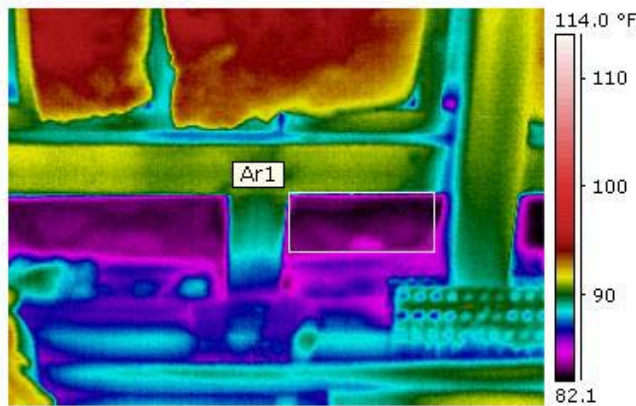

Figure 26. Before sealing the floor cavity, surface temperatures just inside the floor cavity averaged about 85.4°F (inside the Ar1 box).

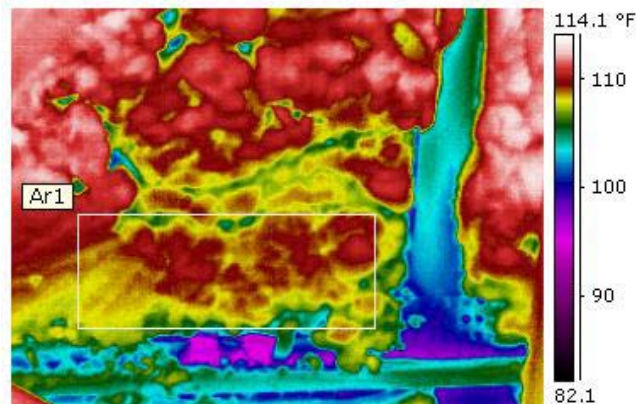

Figure 27. After sealing, the average temperature of the insulation sealing the floor space is about 110.6°F as seen from the attic.

4.2.2 Wind Washing Repair by Sealing Floor Cavities Connected to Vented Eaves

Sometimes floor cavities have unintended pathways to intentionally vented spaces. Generally, access into eaves is severely limited and this in turn limits access to repair the adjacent floor cavities. The repairs shown in Figures 28 to 33 were done where the only access was through the soffit vents. Although the repairs shown will stop airflow, they may not always isolate the interstitial floor cavity from unconditioned portions of the house structure. The repairs illustrated were a compromise that provided an effective air and thermal barrier that blocks air and heat transport from the eave into the floor cavities. Although it effectively blocks wind driving forces, it does not provide a thermal barrier to heat entering from the solar-heated roof deck above. The best location for the air and thermal barrier would be at the structural joist between each floor joist section separating it from a six foot section of exterior deck floor. To accomplish this repair would require removal of the finished exterior decking, obviously an undesirable approach.



Figure 28. Soffit vent panels removed for inspection and access to seal air pathways from eave into floor cavity.



Figure 29. View from the vented eave cavity that is well-connected to second-story floor cavity.



Figure 30. View from eave toward floor cavity shows pathway to floor under joist braced at back, which would be the ideal place for the air and thermal barrier in this construction.



Figure 31. Opening to floor cavity is sealed by application of foam to create an insulating air barrier between each floor joist.



Figure 32. Floor joist cavity is sealed from vented eave.



Figure 33. Spray foam expands considerably and conforms effectively around the end of a floor truss section within a floor joist.

Another challenging repair sequence is shown in Figures 34 through 39. In this case, the second-story floor cavity of this split level house could be accessed only through small soffit vents. Foam was sprayed into these openings without direct view of the foam application. Photos were used to confirm that the foam had in fact sealed the floor cavities, stopping outdoor air from flowing freely through the floor cavities.



Figure 34. Second-story floor cavity has cantilevered section that was vented on the back side of home.



Figure 35. Oval shaped soffit vents can be seen on the underside of cantilevered floor section.



Figure 36. Connection from vented eave to floor cavity where no insulation was found.



Figure 37. Insulation batts were present in most of the eave areas providing some thermal protection for the floor above. However, because the batts did not fit tightly between the joists, they allow airflow to move into the floor cavity.



Figure 38. First, the foam spray gun is inserted into the soffit vent hole to apply foam insulation to the floor deck above, beyond the top of the exterior wall.



Figure 39. The next step is to complete the seal from floor deck vertically down to the bottom of the soffit surface. This is done between each joist section.

4.2.3 Caution About Low-Density Foam Around Cold Supply Ducts

In hot and humid climates, dew point temperatures during peak summer months are often 73°–77°F. It is not uncommon for light to moderate levels of moisture condensation to occur on the exterior of ductwork in attics or crawlspaces. In some cases, moisture can build up enough to drip on to the ceiling or other building materials, causing staining and even mold growth.

Condensation on ducts can be accentuated when insulation materials come into contact with the exterior of the duct or duct insulation. In one of the wind washing repair homes, the homeowner became aware of the wind washing problem, and had taken steps to partially block openings into the floor cavity. Specifically, the homeowner had placed insulation batts with kraft paper backing into the floor cavity gap. In places where these batts were in contact with supply flex ducts (that were going from the attic space into the floor cavity), moisture condensation was observed on the batts (Figures 40 and 41).

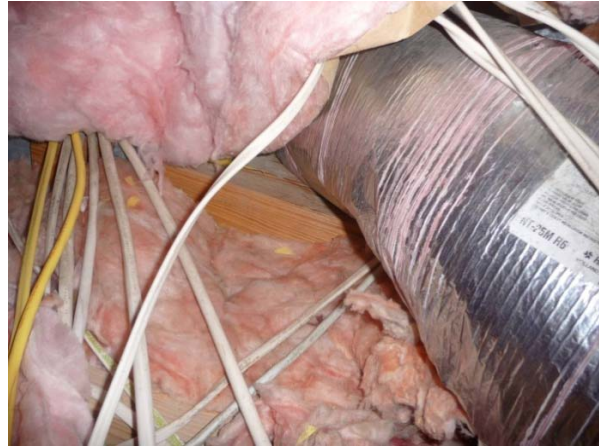

Figure 40. Batt placed against supply duct by homeowner.



Figure 41. Batt pulled away from duct shows it is soaked where dark areas are seen on paper facing.

Moisture condensation was an issue that had to be considered when foam application repairs were done. Open-cell, low-density foam has relatively high vapor permeability of about 6.6 perms at 3.5 in. thickness. One solution that can be employed to avoid condensation where the exterior of supply ducts contact the foam insulation is to wrap a layer of semirigid foil-faced insulation material around the flex duct prior to application of the foam. The insulation wrap is 3/8-in. to 1-in. thick and has foil on one side of a closed-cell polyethylene foam center and a plastic membrane on the other (Figures 42 and 43). Thus, the spray foam insulation does not come into direct contact with the outer surface of the duct. Insulation wrap material with R-value of about 1 and vapor resistance of 0.033 $\text{gr}/\text{m}^2\text{-kPa}$ or less has been found to be effective.

Low-density foam qualities to note:

Air leakage through 3.-in. thickness @75 Pa is 0.001 $\text{L}/\text{s}/\text{m}^2$.

Water vapor permeability of 3.5-in. thick product is 6.6 perms.



Figure 42. 3/8-in. beadboard insulation with foil face on one side and plastic film on the other.



Figure 43. Supply duct from attic into floor cavity has insulation wrapped around duct before blown foam is applied.

4.3 Duct System Improvements

If a duct test or inspection, as previously discussed in Section 2, identifies that the duct system is leaky, the next step is to develop a duct repair plan. This section discusses approaches to air sealing of ducts. The descriptions provided in this section are intended to provide general guidance, but not necessarily detailed steps for duct repair. This may be helpful in communicating critical steps that the repair contractor should take to produce successful and durable repairs. It will also provide some basis for post-repair inspection. Those seeking guidance about specific duct tightness standards should refer to documents such as Sheet Metal and Air Conditioning Contractors National Association, Inc. (SMACNA) (2005) HVAC Duct Construction Standards Metal and Flexible or North American Insulation Manufacturers Association (2002) Fibrous Glass Duct Construction Standards.

4.3.1 Move the Duct System Inside the House

Before air tightening a duct system, first consider the possibility of moving the air distribution system inside the house air and thermal barriers, as discussed in Section 2. Although the costs of

producing an indoor duct system are considerably higher than duct repair, the benefits are also much greater, for two reasons:

- Some air leakage losses will remain after duct repairs have been implemented, and the indoor duct system will capture those air leakage savings.
- Even if the ducts were completely sealed, they would continue to experience considerable conductive heat losses since they will continue to be located in unconditioned space.

4.3.2 Modify the Attic So the Ducts Are Inside the Air and Thermal Boundary

Another way to move the ductwork inside the air and thermal boundary of the house is to encapsulate the entire attic space in a foam insulation cocoon. Foam insulation can be applied to the bottom of the roof deck and also seal attic venting (Figure 44). Sealing the attic venting and providing continuous insulation on the underside of the roof deck (to the top of exterior wall insulation) creates an attic space whose thermal conditions will be greatly moderated compared to the vented attic. During summer, this space will be warm and relatively dry compared to its previous condition of hot and humid. This is typically implemented by professionals with adequate experience in such retrofits. Even if the attic is encapsulated in a foam cocoon, any large duct leaks should still be sealed. The reader should note the cautions related to attic space encapsulation in Section 3.2.



Figure 44. To encapsulate the attic space, spray foam is applied to vents and roof deck. Foam application starts low, at the top of exterior wall, sealing off the vented eave from the attic then continues to completely cover the entire roof deck.

The decision about whether to implement duct repair depends on several considerations:

- The measured airtightness of the ductwork
- The thermal conditions in which the ducts are located
- Ductwork accessibility
- Cost of repair and availability of utility or government incentives
- Resulting house ventilation and pressure impacts.

Sealing duct leaks in existing homes can be challenging due to limited access to all parts of the duct system. Cost of repair varies based on size of duct system, severity of leakage, and

difficulty of access. In many homes, the cost of repair will be \$300–\$600. Utility or government rebate programs can help decrease the expense of duct repair where available.

Following are descriptions of repair of common duct leaks. An air distribution system is made up of return ducts and plenum, the AHU, and supply ducts and plenum. Attached to the end of return and supply ducts are return grilles and supply registers. Sealing ducts located in unconditioned space should have the highest priority, but all large obvious duct leaks should be sealed, even if they are located within conditioned space. Ductwork with just average tightness (approximately 7% on return and 7% on supply) may have the appearance of being tight, but one should keep in mind that leak sites are visibly hard to detect. The size of the leak openings is not the only factor to consider. Operating pressures vary considerably from one location to another and play a crucial role in deal leak airflow. The AHU may have operating pressure of -160 Pa, and the return and supply plenums may have pressures of -40 Pa to 60 Pa, respectively. The main trunks and branch ducts will operate at lower pressure, and supply boots may experience 10 Pa or less. Because of this pressure distribution, leakage is potentially larger closest to the AHU and smaller at grilles and registers. Therefore, repair efforts should not disregard leakage at the AHU.

Keep in mind that the primary objective of duct repair is to produce an air distribution system that:

- Does not cause air quality or combustion safety problems.
- Delivers cool or hot air in an energy efficient manner (good thermal and airtightness properties).
- Is mechanically secured and fastened so it will remain airtight for the life of the house.

4.3.3 Sealing Air Handling Unit Leakage

Even small cracks and seams can add up in this location, because the pressures are highest here. A field study examined the airtightness of AHUs. The study found that about 5% of all duct leakage occurs at the AHU, approximately 90% of air leakage occurring in gas furnaces is through the panel seams and the other 10% is through wire penetrations, and cooling system AHUs have about 50% leakage through panel seams and the other 50% through the wire and refrigerant line penetrations (Cummings, Withers, McIlvaine, Sonne, & Lombardi, 2003; Cummings, Withers, McIlvaine, Sonne, & Lombardi, 2002). Figures 45 to 48 illustrate various types of gaps, penetrations, and openings in typical AHUs and furnaces.

A 5% return leak may not sound like much, but consider this:

A 5% return leak from an attic can reduce the cooling system capacity by 16% and increase cooling energy use by 20% during peak conditions.



Figure 45. AHU panel leaks are strong enough to hold sheets of paper.



Figure 46. Close-up view of lower corner AHU panel leakage.



Figure 47. Loose-fill insulation has been sucked into condensate drain penetration leak.



Figure 48. Leaky thermostat wire penetration.

Sealants applied at AHU service panels must be removable to allow access. Tapes are commonly used on panel seams, but may leave messy residues over time. Furthermore, tapes do not effectively seal penetrations. HVAC cork tape or putty is effectively seals around wiring and refrigerant line penetrations. Rope putty (found at hardware and home improvement stores) can be applied neatly over seams in thin strips and will not leave a residue when removed. Figures 49 to 52 show typical AHU sealing methods and materials.



Figure 49. Black cork tape applied around refrigerant line penetration.



Figure 50. Black cork tape applied around condensate line penetrations and rope putty applied over seams. Expanding foam seals refrigerant line penetration into return support plenum.



Figure 51. Blue cloth has been pulled under AHU cabinet to illustrate air pathway where the return plenum and the AHU join together.



Figure 52. Duct mastic applied in a continuous seal from return duct air barrier to the AHU air barrier. Use care not to get mastic on the coil or any removable panel seam.

4.3.4 Sealing Building Cavities Used as Ducts

Building cavities are sometimes used as a portion of the air distribution system. Examples of such building cavities include floor joist cavities (such as a pan floor joist duct located in a basement), wall cavities, and AHU/furnace support platform plenums. Building cavities used as part of the duct system should be changed (replaced) to an independent duct if possible, because these building cavities in most cases experience considerable air leakage (they are not generally built to the same airtightness standards as ducts). If the building cavity must be used, it should be insulated and made airtight, with a continuous air barrier from one section of material to another. Figures 53 to 56 illustrate typical problem areas and Figures 57 to 62 illustrate suggested repair solutions for support platforms used as return plenums.



Figure 53. A gas furnace is located on a support platform used as the return plenum located inside a garage next to a gas water heater. Return leakage can depressurize the garage and interfere with proper venting of these atmospherically vented gas appliances.

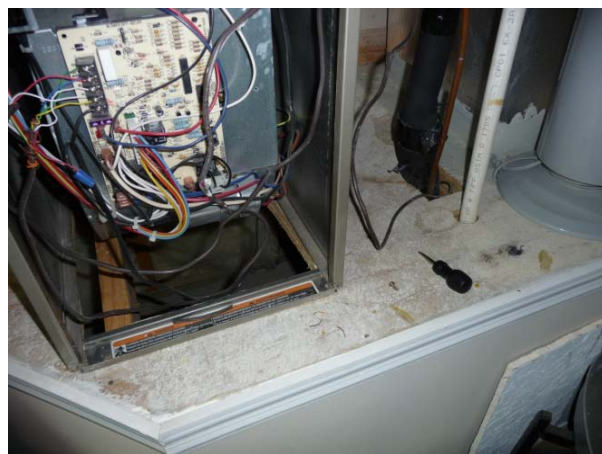

Figure 54. Front panel of furnace is removed for inspection inside the return plenum. Because of limited plenum access, part of the drywall has to be removed to provide access for plenum sealing.



Figure 55. View inside a return plenum located in a second floor closet shows lack of effective duct air or thermal barrier. Attic air could be drawn down leaks in wall cavities and through the floor cavity, which is also well connected to an attic space.



Figure 56. View inside a return plenum located in a garage. Air leaks are drawn primarily from the garage, but a small portion comes from the attic down through the wall cavity where the insulation is located. The block wall in the background is an exterior wall.



Figure 57. View inside a support platform sealed using ductboard with foil (which is the air barrier) facing inward so seams can be sealed at the foil air barrier with mastic.



Figure 58. Penetrations in the return plenum are sealed using expansive foam.



Figure 59. All seams in this support platform return plenum have been sealed using mastic.



Figure 60. All penetrations and junctions between duct board, structural, and panel components of the return plenum have been sealed.



Figure 61. The interior of a return plenum, located under an AHU, can be accessed through the return grille for inspection.



Figure 62. Grille transfer through a wall has leakage into wall cavities that need to be sealed.

4.3.5 Sealing Flex to Duct Board Connections

Flexible duct is commonly used in modern house construction because it costs less than rigid duct to install, particularly in spaces that were not designed to accommodate rigid duct systems. Flexible duct to rigid fibrous glass duct board connections are very common in many regions of the United States. It is also very common for those connections to be incorrectly fabricated, leading to duct leakage and spillage of conditioned air into the space between the inner liner and the exterior jacket of the flex duct.

When completing an air seal, it is important to recognize where the air barrier on each duct component is located. The foil facing is the functional air barrier on duct board. By contrast, the inner liner of flexible duct is the air barrier. Sealants must be effectively applied to connect one air barrier to the other.

The best way to ensure continuity of the air barrier is to use duct mastic. Water-based mastic with the consistency of mashed potatoes will stick well to surfaces and conform easily around

nonlinear materials. Mastic should be applied generously enough to provide a complete seal with no voids. A mastic thickness of approximately 1/8 in. should be adequate for typical connections not having cracks or holes exceeding 1/16 in. Tapes should not be used for these connections. Underwriters Laboratories-approved tapes are technically considered acceptable by some codes, but they do not conform well to the irregular geometry of the flex duct connection. It is difficult for adhesion-based tapes to comply with code requirements because there are very specific application practices and conditions that are not very practical in a retrofit environment. Figures 63 to 66 show recommended steps to make a flex duct-to-duct board repair.



Figure 63. To make this repair, pull back the outer insulation jacket of the flex duct to expose the inner duct connection. Remove the strap and inner duct from metal collar. Remove any loose tape.



Figure 64. Apply mastic from the foil surface of duct board over and around the metal collar. Mastic can be applied over any securely bound tape.

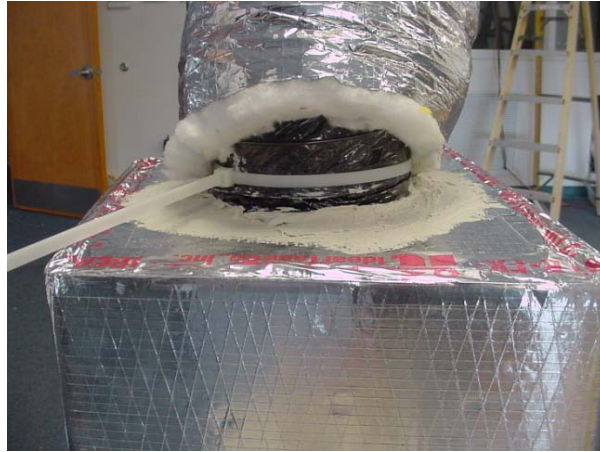

Figure 65. While the mastic is still moist, pull the inner duct liner over the metal collar, then secure tightly with a strap. The strap will pull the inner liner into the mastic and thereby create an airtight seal.



Figure 66. Finally, pull the insulation jacket over the duct inner liner and secure the outer jacket tightly against the foil surface of the duct board. If any sections of the inner duct remain exposed, this may result in unwanted energy losses and potentially moisture condensation when the system is cooling.

4.3.6 Sealing Duct Leak Gaps Greater Than One Fourth Inch

Gaps greater than $\frac{1}{4}$ in. should be sealed with mastic and an embedded fiberglass mesh tape. Without the fiberglass mesh, the repair may lack the strength to remain airtight for the life of the house and mastic could be accidentally pushed into the duct system during application. Some type of backing material such as foil tape may be needed. The tape and mesh will provide mechanical stability to the duct leak repair area and reduce the likelihood of the mastic cracking as it dries. Mastic should be applied generously over the mesh tape and overlapping the mesh edges by $1\frac{1}{2}$ –2 in. Figures 67 to 68 illustrate this repair procedure.

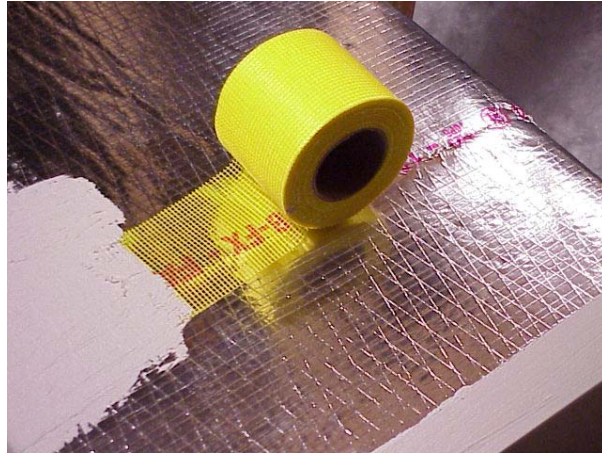

Figure 67. A gap between two sections of duct board was first covered using foil tape. Next, mesh is applied and coated with mastic that overlaps the mesh by 1-½–2 in. on each side.



Figure 68. Supply plenum connection being sealed using foil tape, fiberglass mesh tape, and mastic.

4.3.7 Aerosol Duct Sealing System

A patented technology exists to seal duct leaks using a system that blows an aerosolized sealant through the duct system that sticks to the edges of leaks while the ducts are under positive pressure (Figure 69). During the application period, the leaks fill in with the sealant (Figure 70). The system is operated until the desired duct tightness is achieved. This system works well on ducts with less than ¼-in. wide leaks and provides a way to seal duct leaks located in inaccessible areas. Larger leaks found in return support plenums and other locations would still have to be sealed by manual repair methods as discussed in Section 5.8.

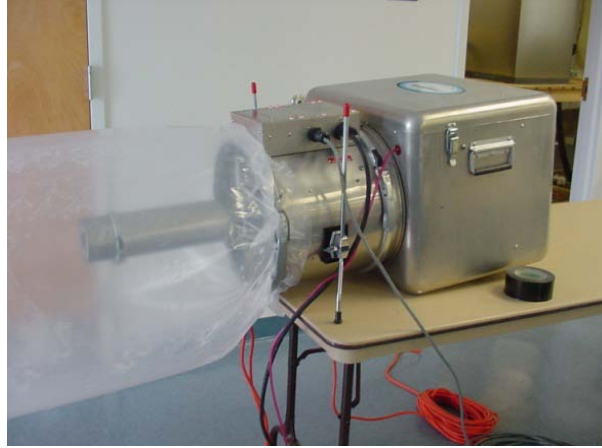

Figure 69. Patented sealing process injects an aerosolized material that builds up on leaks eventually sealing leaks up to about ¼ in. wide.



Figure 70. Sealant can be seen building on a demonstration leak.

4.4 Balanced Return Air Implementation

Measurement of pressure differentials with the AHU on and interior doors closed will determine the potential for unbalanced return air impacts (Figure 71). Once it has been determined that return air pathways need to be installed, some decisions have to be made. First, will it be a ducted return (connected back to the AHU) or will it be a return transfer (return air driven by room to room pressure differential)? If a ducted return is provided, it will be important to make the ductwork completely airtight and to use materials that will last the life of the house (e.g., mastic with embedded fabric). A ducted return has the following advantage; if sized properly, it can produce pressure drop across closed doors at or very near 0 Pa, whereas return transfers operate only when the closed room is at a positive pressure. On the other hand, a ducted return has the disadvantage of significant energy losses from conductive heat gains when located in an attic or other unconditioned space, even if the ductwork is made completely airtight.

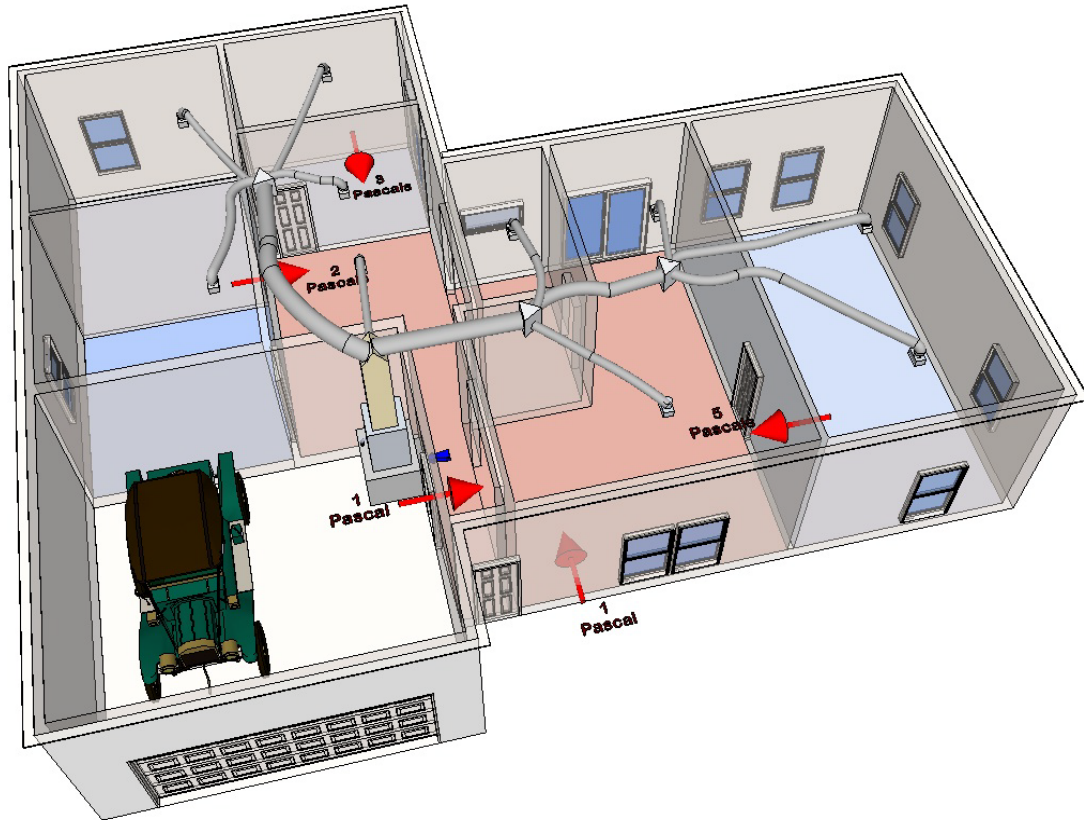
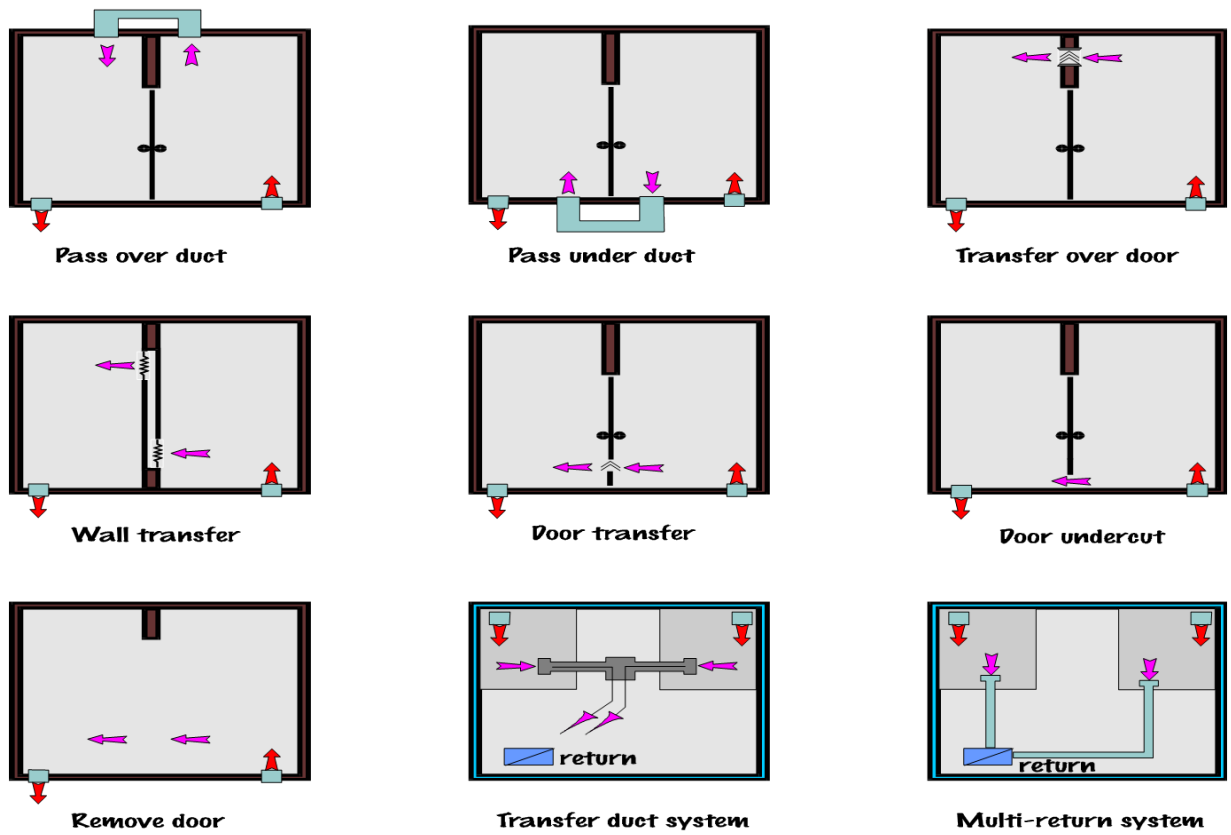

Figure 71. This house has supply ducts to each room, but only a central return grille. Door closure without adequate return air pathway results in negative pressure in the central zone wrt to outside and positive pressure in the closed rooms.

Return transfers experience essentially no air leakage, because the pressure drop between inside the duct and the unconditioned space is very slight. Although a typical return duct may operate at -25 Pa, a return transfer duct will experience pressure differential only on the order of 1 or 2 Pa. Jump ducts (see “Pass over duct” in Figure 72) will also experience conductive heat gains from the hot attic, but that gain occurs only when the room door is closed (and the AHU is operating). By contrast, the ducted return will experience conductive gains whenever the AHU is operating. On the other hand, return transfers that go under the floor will experience little heat gain or loss (“Pass under duct”) because of the typically milder conditions in a crawlspace or basement, and those that pass through the wall, over the door, or through the door, will experience essentially no conductive losses. It is important that the wall cavity used in these applications be sealed so that airflow pathways to attics, crawlspaces, basements, etc. are not introduced. Figure 73 shows a through-the-wall return transfer and Figure 74 illustrates a return transfer jump duct.



Pressure relief techniques

Figure 72. Approaches to providing return air pathways.

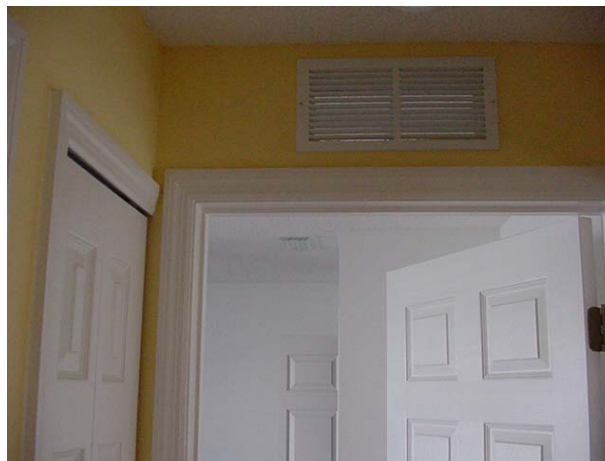

Figure 73. Through-the-wall return transfer from bedroom to hallway.

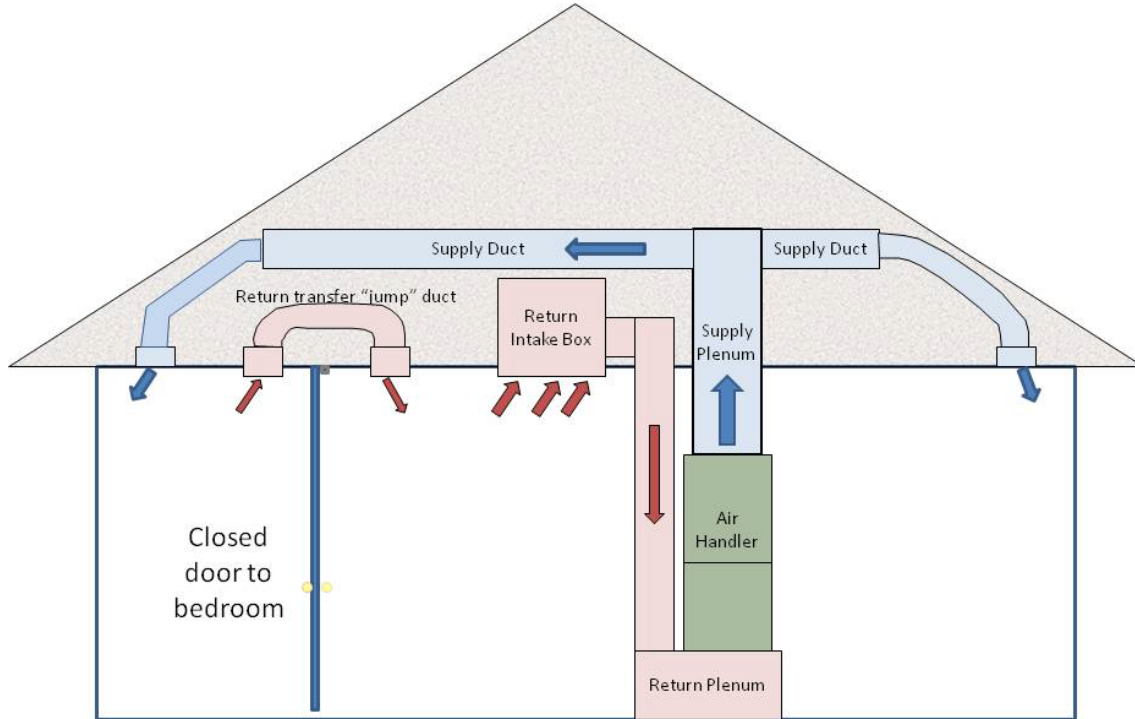

Figure 74. Illustration of return jump duct.

Door undercuts can be used, but only in cases where the total supply air being provided to a room is relatively small. This is not, however, a totally impractical solution when combined with a high-efficiency building envelope, a right-sized A/C system, and reduced CFM per ton. If steps are taken to make the envelope very energy efficient so cooling and heating loads are reduced to low levels, total supply air to closed rooms can be substantially downsized. If the AHU fan flow is reduced to, say, 320 CFM per ton (which can be advantageous for improved humidity control during hot and humid weather), total supply air to closed rooms can be reduced even further. Under these circumstances pressure differentials across closed doors may be kept to small levels while using only small door undercuts to transfer return air to the central zone.

Sizing of return air is important. If using a ducted return, duct sizes should be selected based on the Air Conditioning Contractors of America (2009) Manual D Residential Duct Design methodology or similar. Dampers can also be installed in the ductwork to allow balancing. If using return transfers, a general rule states that 70 in.² of net free area will allow the transfer of 100 CFM with a 2.5 Pa pressure differential.

References

- Air Conditioning Contractors of America. (2009). *ACCA's Manual D Residential Duct Design* (3rd ed.). Arlington, VA.
- ASHRAE Standard 62.2-2007. (2009). *Ventilation and Acceptable Indoor Air Quality in Low-Rise Residential Buildings*. Atlanta, Georgia: American Society of Heating Refrigerating and Air-conditioning Engineers.
- ASHRAE Standard 152-2004. (2004). *A Method of Test for Determining the Design and Seasonal Efficiencies of Residential Thermal Distribution Systems*. Atlanta, Georgia: American Society of Heating Refrigerating and Air-conditioning Engineers.
- Cummings, J.B. (1989). Proceedings of 6th Annual Symposium on Improving Building Systems in Hot and Humid Climates: *Tracer Gas as a Practical Field Diagnostic Tool for Assessing Duct System Leaks*. Dallas, TX: FSEC-PF-195-90.
- Cummings, J.B., Moyer, N., & Tooley, J.J. (1990). *Radon Pressure Differential Project, Phase II: Infiltration*. Cocoa, FL: Florida Solar Energy Center, FSEC-CR-370-90.
- Cummings, J.B., Tooley, J.J., & Moyer, N. (1990). *Radon Pressure Differential Project, Phase I*. Cocoa, FL: Florida Solar Energy Center, FSEC-CR-344-90.
- Cummings, J.B., Tooley, J.J., & Moyer, N. (1991). *Investigation of Air Distribution System Leakage and Its Impact in Central Florida Homes*. Cocoa, FL: Florida Solar Energy Center, FSEC-CR-397-91.
- Cummings, J.B., & Withers, C.R., Jr. (2006a). Unbalanced Return Air in Residences: Causes, Consequences, and Solutions. *ASHRAE Transactions*, 112(1), 650-655.
- Cummings, J., & Withers, C. (2006b). *Balanced Return Air, Duct Airtightness, and Combustion/Dilution Air Code Compliance in 40 Central Florida Homes*. Cocoa, FL: Florida Solar Energy Center, FSEC-CR-1789-06.
- Cummings, J., & Withers, C. (2008). Problems Related to Air Handler Leakage. *ASHRAE Journal*, January, 36-46.
- Cummings, J.B., Withers, C., McIlvaine, J., Sonne, J., & Lombardi, M. (2002). *Field Testing and Computer Modeling to Characterize the Energy Impacts of Air Handler Leakage*. Cocoa, FL: Florida Solar Energy Center, FSEC-CR-1357-02.
- Cummings, J. B., Withers, C., McIlvaine, J., Sonne, J., & Lombardi, M. (2003). Air Handler Leakage: Field Testing Results in Residences. *ASHRAE Transactions*, 109(1).
- Fonorow, K., Chandra, S., Martin, E., & McIlvaine, J. (2006) Proceedings of the 2006 Summer Study on Energy Efficiency in Buildings, American Council for an Energy Efficient Economy:

Energy and Resources Efficient Communities through Systems Engineering: Building America Case Studies in Gainesville, FL. Asilomar, CA.

Fonorow, K., Chandra, S., McIlvaine, J., & Colon, C. (2007). 7th International Conference for Enhanced Building Operations: *Commissioning High Performance Residences in Hot, Humid Climates*. San Francisco, CA.

McIlvaine, J., Sutherland, K., Schleith, K., & Chandra, S. (2010). Seventeenth Symposium on Improving Building Systems in Hot and Humid Climates: *Exploring Cost-Effective, High Performance Residential Retrofits for Affordable Housing in the Hot Humid Climate*. Austin, TX.

Modera, M.P. (1993). Characterizing the performance of residential air distribution systems. *Energy and Buildings*, 20(1), 65–75.

Moyer, N., Stroer, D. Hoak, D., McIlvaine, J., & Chandra, S. (2008). Sixteenth Symposium on Improving Building Systems in Hot and Humid Climates: *Research Results from a Few Alternate Methods of Interior Duct Systems in Factory Built Housing Located In the Hot Humid Climate*. Dallas, TX.

National Fire Protection Association. (2009). *NFPA 54: National Fuel Gas Code*.

North American Insulation Manufacturers Association. (2002). *Fibrous Glass Duct Construction Standards* (5th ed.). Alexandria, VA.

PNNL, & ORNL. (2010). *Retrofit Techniques & Technologies: Air Sealing - A Guide for Contractors to Share with Homeowners*. Retrieved from http://apps1.eere.energy.gov/buildings/publications/pdfs/building_america/ba_airsealing_report.pdf

Sheet Metal and Air Conditioning Contractors National Association, Inc. (SMACNA). (2005). *HVAC Duct Construction Standards - Metal and Flexible* (3rd ed.). Chantilly, VA.

Swami, M.V., Cummings, J., Sharma, R.J., Withers, C., & Basarkar, M. (2006). *Florida Building Code - Enhance Florida's Building To Next- Generation Energy & Mechanical Codes and Enrich Compliance*. . Cocoa, FL: Florida Solar Energy Center, FSEC-CR-1678-06.

Weaver, K., & Culp, C. (2006). Proceedings of the Sixth International Conference for Enhanced Building Operations: *Static Pressure Losses in 6", 8", and 10" Non-Metallic Flexible Duct*. Shenzhen, China: Texas A&M University.

Withers, C., & Cummings, J. (2010). Seventeenth Symposium on Improving Building Systems in Hot and Humid Climates: *Opportunities for Energy Conservation and Improved Comfort From Wind Washing Retrofits in Two-Story Homes – Part I*. Austin, TX.

EERE Information Center

1-877-EERE-INFO (1-877-337-3463)

www.eere.energy.gov/informationcenter

U.S. DEPARTMENT OF
ENERGY

Energy Efficiency &
Renewable Energy

DOE/GO-102012-3480 - February 2012

Printed with a renewable-source ink on paper containing at least 50% wastepaper, including 10% post-consumer waste.