

# **SHELL LYDONIA CANYON BLOCK 410 No. 1R WELL**

## **Geological and Operational Summary**

Edited by:

Gary M. Edson  
Donald L. Olson  
Andrew J. Petty

U. S. Department of the Interior  
Minerals Management Service  
Gulf of Mexico OCS Region  
Office of resource Evaluation

New Orleans  
May 2000



# CONTENTS

|                               |
|-------------------------------|
| Abbreviations, vi             |
| Introduction, 1               |
| Operational Summary, 2        |
| Well Velocity Profile, 10     |
| Lithologic Interpretation, 16 |
| Biostratigraphy, 19           |
| Formation Evaluation, 23      |
| Geothermal Gradient, 26       |
| Kerogen Analysis, 28          |
| Petroleum Geochemistry, 33    |
| Company-submitted Data, 41    |
| Selected References, 42       |

## ILLUSTRATIONS

- Figure
1. Map of the North Atlantic offshore area showing well locations, 3
  2. Location plat for the Shell Block 410 No. 1R well on the OCS Lydonia Canyon NK 19-12 protraction diagram, 4
  3. Daily drilling progress for the Shell Lydonia Canyon Block 410 No.1R well, 5
  4. Casing diagram for the Shell Lydonia Canyon Block 410 No. 1R well, 7
  5. Well velocity profile for the Shell Lydonia Canyon Block 410 No. 1R well, plotted against depth, 13
  6. Well velocity profile for the Shell Lydonia Canyon Block 410 No. 1R well, plotted against two-way travel time, 14
  7. Columnar chart of the lithology, biostratigraphy, and paleobathymetry of the Shell Lydonia Canyon Block 410 No. 1R well, 17
  8. Well temperatures and geothermal gradient for the Shell Lydonia Canyon Block 410 No. 1R well, 27
  9. Relationships among coal rank, percent  $R_o$ , TAI, spore color, and thermal zones of hydrocarbon generation, 29
  10. Graph of kerogen types, total organic carbon, and organic thermal maturity for the Shell Lydonia Canyon Block 410 No. 1R well, 30
  11. Hydrocarbon evolution window, geothermal gradient, and vitrinite reflectance values plotted against well depth for the Shell Lydonia Canyon Block 410 No. 1R well, 37
  12. Burial diagram for the Shell Lydonia Canyon Block 410 No.1R well, 39

## TABLES

|       |   |
|-------|---|
| Table | 1. Well statistics, 6                                 |
|       | 2a. Well velocity data, 10                            |
|       | 2b. Well velocity data averaged below 12,000 feet, 11 |
|       | 3. Well velocity intervals, 12                        |
|       | 4. Well logs, 23                                      |
|       | 5. Well log interpretation summary, 23                |
|       | 6. Sidewall core analysis summary, 24                 |
|       | 7. Conventional cores, 24                             |
|       | 8. Hydrocarbon shows, 25                              |
|       | 9. Total organic carbon analysis, 32                  |
|       | 10. Molecular geochemical analysis results, 35        |

## ABBREVIATIONS

|                |  |
|----------------|--|
| API            | -- American Petroleum Institute            |
| bbl            | -- barrels                                 |
| BOP            | -- Blow out preventer                      |
| CNL            | -- Compensated neutron log                 |
| CPI            | -- Carbon Preference Index                 |
| COST           | -- Continental Offshore Stratigraphic Test |
| DST            | -- drill stem test                         |
| EQMW           | -- equivalent mud weight                   |
| FDC            | -- compensated formation density log       |
| FEL            | -- from east line                          |
| FNL            | -- from north line                         |
| FSL            | -- from south line                         |
| FWL            | -- from west line                          |
| k              | -- permeability                            |
| KB             | -- kelly bushing                           |
| LS             | -- limestone                               |
| m              | -- meter (s)                               |
| md             | -- millidarcy                              |
| MYBP           | -- million years before present            |
| OCS            | -- Outer Continental Shelf                 |
| ppf            | -- pounds per foot                         |
| ppg            | -- pounds per gallon                       |
| ppm            | -- parts per million                       |
| psi            | -- pounds per square inch                  |
| R <sub>o</sub> | -- vitrinite reflectance                   |
| SS             | -- sandstone                               |
| Sw             | -- water saturation                        |
| TAI            | -- thermal alteration index                |
| TD             | -- total depth                             |
| TIOG           | -- threshold of intense oil generation     |
| TOC            | -- total organic carbon                    |
| UTM            | -- Universal Transverse Mercator           |
| φ              | -- porosity                                |

## INTRODUCTION

The Shell Lydonia Canyon (LC) Block 410 No. 1R well was the second to be spudded and third to be completed of the eight industry wildcat wells drilled on Georges Bank. Spudded on July 24, 1981, this is the most seaward of the eight wells. It is about 25 miles southeast of the Continental Offshore Stratigraphic Test (COST) G-2 well and about 150 miles east-southeast of Nantucket Island. The Shell LC Block 410 No. 1R well was drilled by a semi-submersible rig in 381 feet of water at the seaward edge of the continental shelf.

Shell Offshore, Inc., was the designated operator for the well, and the company's drilling target was a Jurassic closure between 12,000 and 16,000 feet inferred from seismic data. Well data showed that these rocks are oolitic limestones of indeterminate age. These carbonates generally have poor porosity with the exception of zones below 14,200 feet, where dolomitization has created some voids. The Shell LC Block 410 No. 1R well bottomed in continental clastics of undetermined age at 15,568 feet. The oldest identified microfossils are Middle Jurassic, Bajocian? to early Bathonian, at 10,340 to 11,420 feet. Shell plugged and abandoned the well as a dry hole on March 31, 1982.

This report relies on geologic and geophysical data provided to the Minerals Management Service (MMS) by Shell, according to Outer Continental Shelf (OCS) regulations and lease stipulations. The data were released to the public after the Shell LC Block 410 Lease No. OCS-A-0218 was relinquished on December 28, 1982. Interpretations of the data contained in this report are those of MMS and may differ from those of Shell. Well depths are relative to kelly bushing (measured depths), unless otherwise stated.

The material contained in this report is from unpublished, undated MMS, internal interpretations. No attempt has been made to provide more recent geologic, geochemical, or geophysical interpretations or data, published or unpublished.

This report is initially released on the Minerals Management Service Internet site <http://www.gomr.mms.gov>, and, together with the other Georges Bank well reports, on a single compact disk (CD). At a later date, additional technical data, including well "electric" logs will be added to the CD.

## OPERATIONAL SUMMARY

Taken and adapted from F. Adinolfi, MMS internal report

The Shell Lydonia Canyon (LC) Block 410 No. 1R well is located about 150 miles east-southeast of Nantucket, Massachusetts (figure 1) in North Atlantic Official Protraction Diagram NK 19-12 (Lydonia Canyon). Shell Oil Company and its partners bid \$34,733,000 for LC Block 410 in OCS Lease Sale 42, held on December 18, 1979. Before drilling operations started, Shell Oil and Cities Service assigned their entire interests in the lease (OCS-A-0218) to Shell Offshore Inc. The well is located in the northeast quadrant of the lease block (figure 2) in 381 feet of water (453 feet from kelly bushing to mud line). Shell and partners relinquished the lease on December 28, 1982.

Shell Offshore Inc. was designated as the operator for the well, which was drilled by the semisubmersible rig the *Zapata Saratoga*. The rig was inspected and operations were observed by MMS personnel throughout the drilling period to ensure compliance with Department of the Interior regulations and orders.

Data from the well include “electric” logs, a “mud” log, cuttings samples, sidewall cores, and conventional cores. No drill stem tests were performed. These data, along with geologic information and operational reports, were provided to the MMS. The well data and reports failed to confirm the presence of commercial hydrocarbons in this well.

## DRILLING PROGRAM

The *Zapata Saratoga* arrived on location July 10, 1981, and the original well was spudded on July 24. Daily drilling progress is shown in figure 3, and well information is presented in table 1. Zapata encountered problems with stuck drill pipe at a depth of 686 feet and cut off the pipe at 632 feet. The hole was spotted to the mud line with 100 sacks of class H cement, and a hole opener, crossover sub, and bit were left in the hole. The rig was skidded 35 feet southeast and a second attempt was made to spud the well, on July 28. Zapata set 30-inch casing at 629 feet and drilled to a total depth of 1,400 feet. On the third of August, 775 feet of 20-inch casing were dropped in the hole. The top of the fish was 100 feet below the mudline. The 30-inch casing was retrieved, but the 20-inch casing was cut 18 feet below the mudline. The hole was then plugged with cement at 115 feet below the mudline and abandoned.

Zapata moved the rig about 40 feet southeast and the Shell LC Block 410 No. 1R (redrill) well was spudded on August 11, 1981. Figure 4 is a casing and abandonment diagram. Total depth (TD) of 15,568 feet was reached in 221 days on March 19, 1982. The well was plugged and abandoned at 12:00 noon on March 31, 1982, and the rig towed to a new location on April 1. It was reported that total exploratory well costs were about \$31 million dollars.



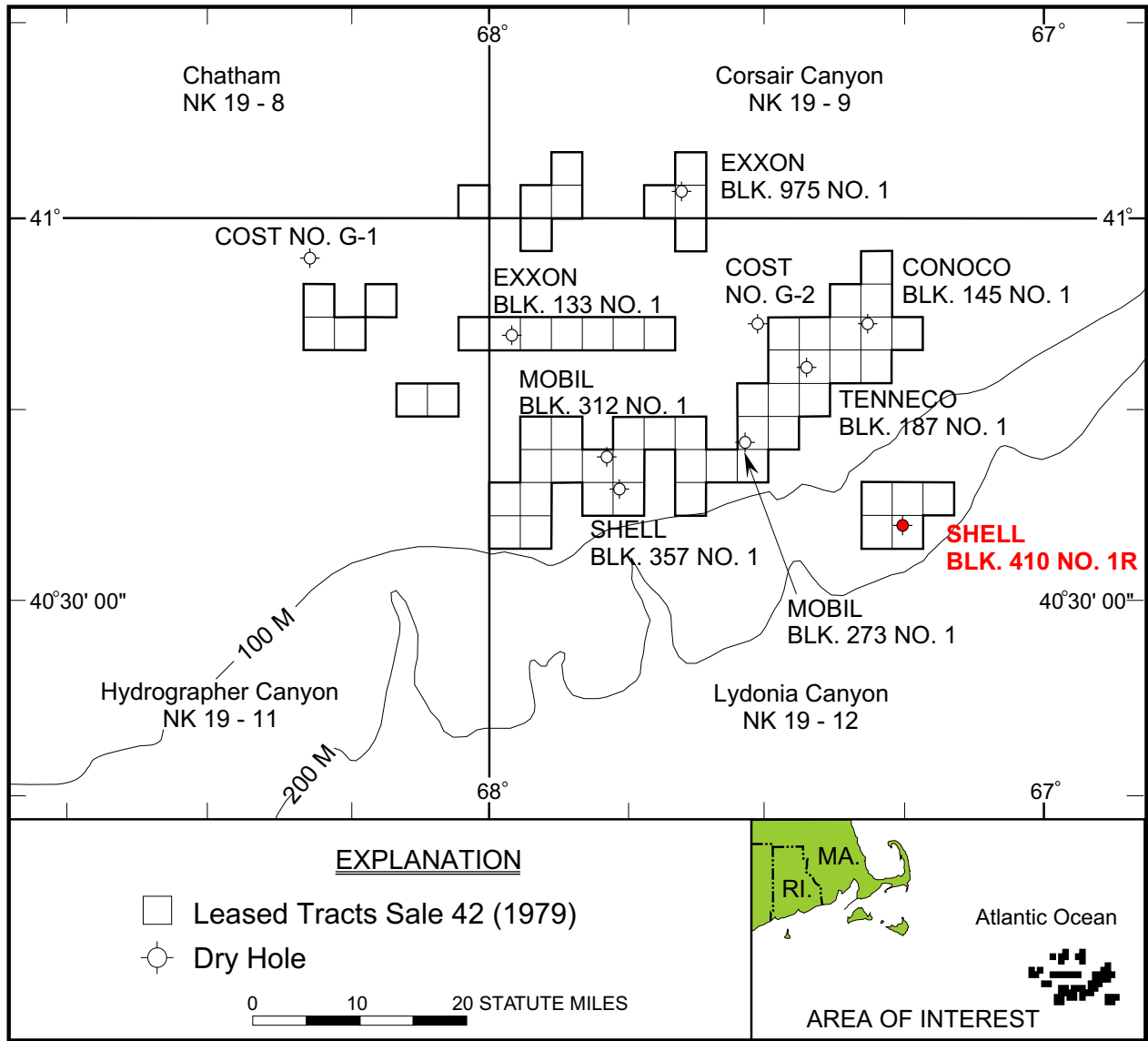

Figure 1. Map of the North Atlantic offshore area showing well locations. The Shell Lydonia Canyon Block 410 No. 1R well is highlighted in red. No. 1R bathymetry is in meters.

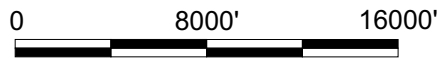
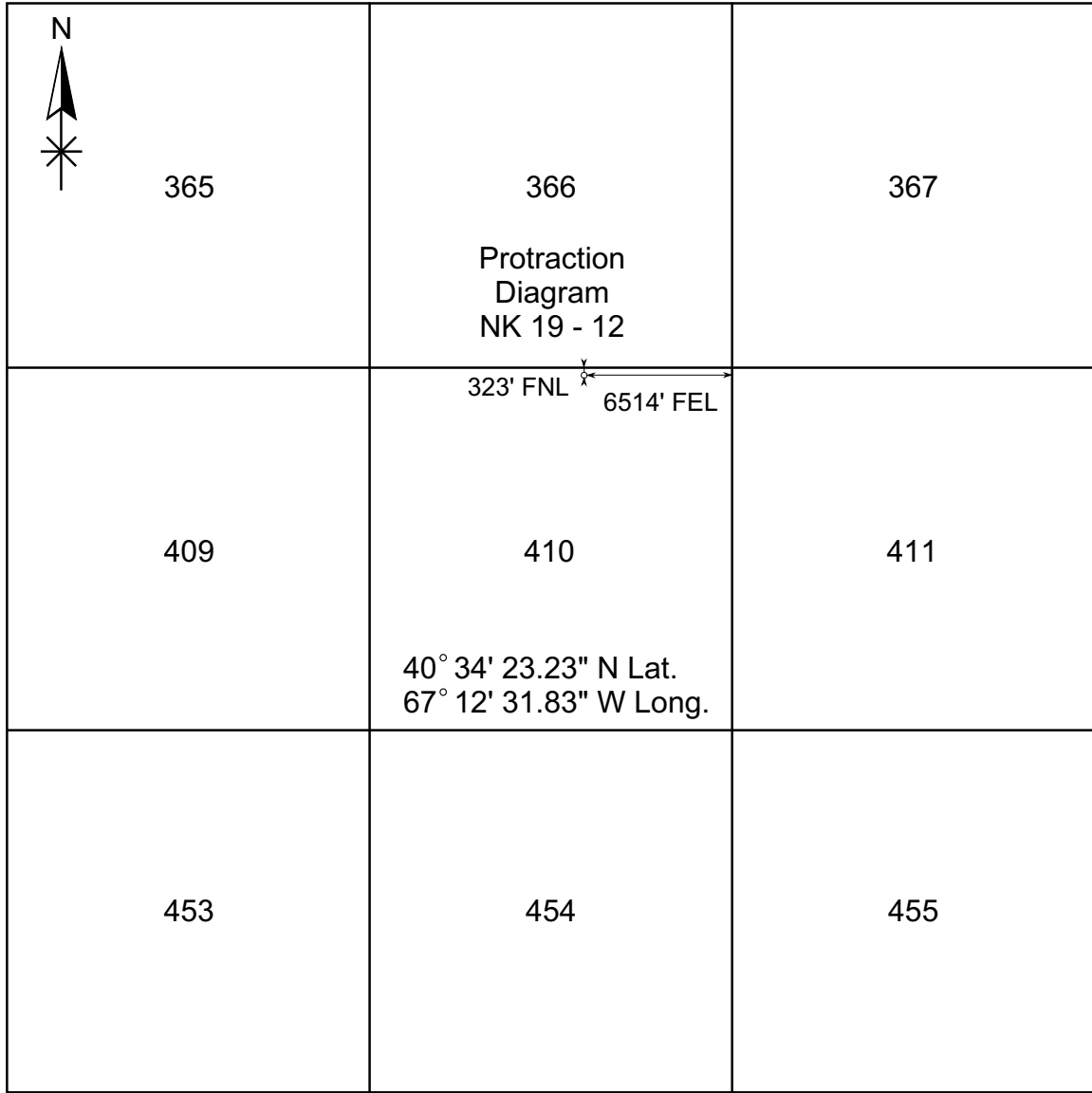

Figure 2. Location plat for the Shell Block 410 No. 1R well on the OCS Lydonia Canyon NK 19-12 protraction diagram.

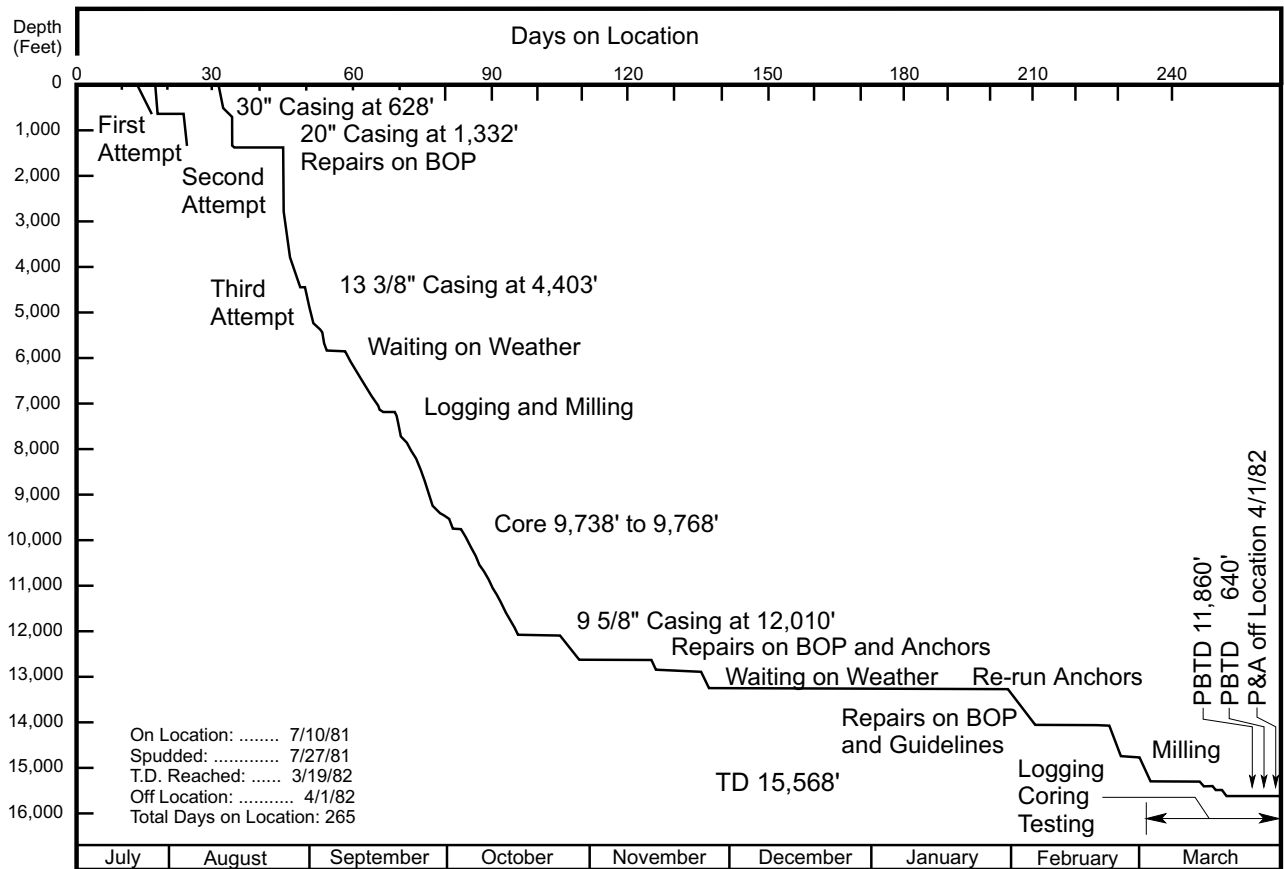

Figure 3. Daily drilling progress for the Shell Lydonia Canyon Block 410 No. 1R well.

**Table 1. Well statistics**

|                          |  |
|--------------------------|--|
| Well identification:     | API No. 61-040-00003<br>Lease No. OCS-A-0218   |
| Surface location:        | Lydonia Canyon NK 19-12<br>LC Block 410<br>323 feet FNL<br>6,514 feet FEL<br><br>Latitude: 40 <sup>o</sup> 34' 23.23" N<br>Longitude: 67 <sup>o</sup> 12' 31.83" W<br><br>UTM coordinates:<br>X = 651,615m<br>Y = 4,492,702m |
| Bottomhole location:     | 67 feet N 54 <sup>o</sup> W of surface location  |
| Proposed total depth:    | 17,000   |
| True vertical depth:     | 15,556   |
| Measured depth:          | 15,568   |
| Kelly bushing elevation: | 72 feet  |
| Water depth:             | 381 feet   |
| Spud date:               |  |
| First attempt:           | July 24, 1981  |
| Redrill:                 | August 11, 1981  |
| Reached TD:              | March 19, 1982   |
| Moved off site:          | April 1, 1982  |
| Final well status:       | Plugged and abandoned  |

Note: All well depths indicated in this report are measured from the kelly bushing, unless otherwise indicated. Mean sea level is the datum for the water depth.

The surface hole was drilled and the 30-inch casing was set at 628 feet and cemented with 1,200 sacks of class H cement. The 20-inch casing was set at 1,332 feet and cemented with 1,150 sacks of class H cement. After approximately 10 days were spent in repairing the blowout preventer, Zapata continued with a 17 1/2-inch bit to 4,455 feet and 13 3/8-inch casing was run and cemented at 4,403 feet with 3,780 cubic feet of class H cement. Zapata drilled ahead using 12 1/4-inch bits, until an early September storm slowed operations for about four days.

A show was encountered during the drilling of a sandstone-shale sequence from 6,805 to 6,850 feet. Eight units total gas were recorded on the mud log. The 12 1/4-inch hole was continued to 12,060 feet, pausing routinely for well surveys, logging, coring, and testing the blowout preventer. Approximately two days were lost milling junk in the hole. After logging and setting 9 5/8-inch casing at 12,010 feet with 1,940 sacks of class H cement, the blowout preventer was tested and Zapata drilled ahead to 12,578 feet.

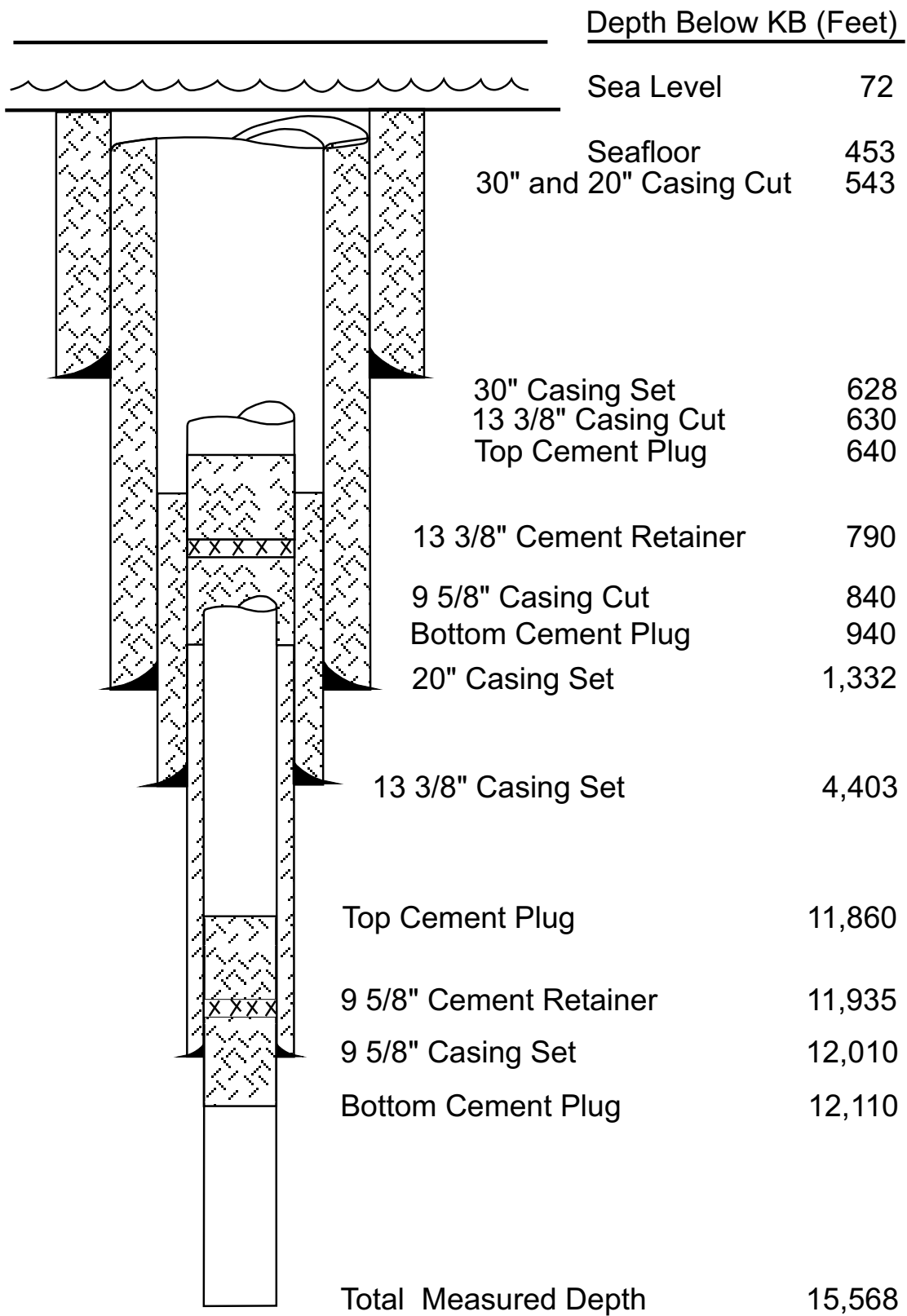

Figure 4. Casing diagram for the Shell Lydonia Canyon Block 410 No. 1R well.

At this point, Shell experienced numerous operational problems. Repairs on the blowout preventer stack were delayed while Zapata waited on parts and retrieved a broken anchor chain. After the hole was drilled to 12,769 feet, the No. 6 anchor chain broke again in rough seas. Zapata drilled to 13,122 feet and a 50-knot wind broke the Nos. 2 and 3 anchor chains and the No. 4 guideline. Rough seas and wind delayed the drilling through December 1981 and January 1982. All eight anchor lines were replaced and, beginning January 30, 1982, drilling continued for six days to 13,981 feet. A leaking hydraulic hose in the blowout preventer stack, re-establishing guidelines, and waiting on weather delayed drilling another 14 days in February. After the milling operations on junk (bit cones) in the hole and more bad weather, a 12-foot core was cut (15,229 to 15,241 feet), and Schlumberger logged the well. Zapata then drilled ahead and reached total depth (TD) of 15,568 feet on March 19, 1982. At total depth, Schlumberger again logged the well and ran pressure tests.

Zapata used five 17 1/2-inch bits, seventeen 12 1/4-inch bits, and eighteen 8 1/2-inch bits to drill the well. Drilling rates varied considerably, but averaged about 10 feet per hour through limestone below 5,700 feet and sometimes exceeded 400 feet per hour through sandstones and clay above 5,700 feet. Maximum penetration rate was 1,358 feet per day, which occurred from 1,445 feet to 2,803 feet (figure 3). Maximum borehole deviation from vertical is 3 1/2 degrees.

The well was spudded with seawater spud mud from the mudline (453 feet) to a depth of 1,400 feet. Shell carried a mud weight of 8.9 pounds per gallon (ppg) with

a viscosity of above 100 seconds. At 1,400 feet, the mud was gelled with freshwater and conditioned to a mud weight of 10.3 ppg with a viscosity of 80 seconds. The same mud system was used for surface casing hole to 4,403 feet. Fluid loss was adjusted as required for seepage control with Drispac.

Mud weight in this section ranged from 8.9 to 9.4 ppg with a viscosity between 40 and 46 seconds. In the 12 1/4-inch hole from 4,403 to 12,060 feet, Shell ran a nondispersed saltwater/freshwater system with Drispac and maintained a mud weight of 9.3 ppg with a viscosity between 40 and 53 seconds. Below 12,060 feet a lightly treated lignosulfonate system (a more inhibitive mud with higher temperature stability) was required. Mud weight ranged from 9.3 to 9.8 ppg with a viscosity between 37 and 45 seconds to a depth of 13,122 feet, when drilling was suspended on November 27, 1981. Drilling continued on January 25, 1982, and mud weight ranged from 9.5 to 9.9 ppg, with a viscosity between 43 and 57 seconds down to total depth. Mud pH averaged 11.5, but fluctuated between 10.0 and 12.0. Chloride concentrations began at 7,300 parts per million (ppm); increased to 18,000 ppm between 4,000 and 5,500 feet; and decreased to 3,400 ppm at 13,981 feet. Chloride concentrations increased to 7,500 ppm at total depth.

Figure 4 also shows the abandonment procedure. No open-hole cement plugs were required. A 9 5/8-inch cement retainer was set at 11,935 feet and tested to 1,000 psi. Twenty barrels of cement were squeezed below the retainer to 12,110 feet and an additional five barrels were set on top, with the top of the cement plug at 11,860 feet. The plug was tested to 1,000

psi and the 9 5/8-inch casing was cut and pulled from 840 feet. A 13 3/8-inch cement retainer was set at 790 feet and tested to 1,000 psi. Fourteen barrels of cement were squeezed below the retainer to 940 feet and an additional 22 barrels were set on top, with the top of the cement plug at 640 feet. The 13 3/8-inch casing was cut and pulled from 630 feet. After pulling the risers and the BOP stack, the 30-inch and 20-inch casings were cut and pulled from 543 feet. Anchors and piggybacks were pulled and the rig was released on March 31, 1982.

A post-abandonment well site survey was conducted in April 1982, using sidescan sonar. The data revealed numerous anchor-impact craters and drag scars across the study area, as well as five sonar targets that may represent possible debris lost during operations and abandoned on the seafloor.

### **SAMPLES AND TESTS**

Cutting samples were collected from 790 to 15,568 feet in the well, and aliquots were provided for analysis. Dry samples were provided from 790 to 3,410 feet as 30-foot composited samples and as 10-foot composited samples below 3,410 feet. Cutting samples were used for lithologic studies and processed for paleontologic examination and interpretations. Thin sections were also prepared from cuttings for selected intervals below 9,700 feet. Canned composited wet drill cuttings were

also provided by Shell for geochemical analyses.

Shell cut two conventional cores, and pretests were made with Schlumberger's Repeat Formation Tester from 13,273 to 15,000 feet at 17 intervals. One cubic centimeter of condensate was collected at 14,071 feet. According to Shell, the condensate probably came from the tool itself. No other fluids were detected. The conventional cores were cut from 9,738 to 9,767 feet and from 15,229 to 15,241 feet, with good recovery on both cores. Between the depths of 13,060 and 15,484 feet, Shell attempted 59 sidewall cores and recovered 45 samples. Core Laboratories, Inc. made lithologic descriptions of the samples and analyzed 26 samples for porosity and permeability.

Schlumberger Ltd. ran "electric" log suites to provide information for stratigraphic correlation, lithologic analysis, and the evaluation of potential hydrocarbon-bearing zones (see **Formation Evaluation** chapter). Exploration Logging, Inc. provided a physical formation "mud" log from 781 to 15,568 feet. No drill stem tests were run

A final directional survey was completed from a measured depth of 15,568 feet by Sperry-Sun, Inc. of Harvey, Louisiana. True vertical depth is 15,556 feet and the bottomhole location is 67 feet from the surface location along a N 54° W line.

## WELL VELOCITY PROFILE

Schlumberger, Ltd. Wireline Testing ran a velocity checkshot survey between 4,378 and 15,128 feet in the Shell LC Block 410 No. 1R well. All depths cited are subsea. The checkshot data, together with that for the other nine wells drilled on Georges Bank, were given to Velocity Databank, Inc. at their request after all leases had been relinquished or had expired. Velocity Databank calculated interval, average, and

RMS velocities, plotted time-depth curves, and tabulated the data. Tables 2a and 2b present well depth, two-way travel time, and the calculated velocities for the Shell LC Block 410 No. 1R well. Figures 5 and 6 show interval velocity, average velocity, and RMS velocity, as well as averaged interval velocity, plotted against depth and against two-way travel time, respectively.

**Table 2a. Well velocity data**

| <b>Depth<br/>(feet)</b> | <b>Two-way<br/>Travel Time<br/>(seconds)</b> | <b>Interval Velocity<br/>(feet/sec.)</b> | <b>Average Velocity<br/>(feet/sec.)</b> | <b>RMS<br/>Velocity<br/>(feet/sec.)</b> |
|-------------------------|--|--|---|---|
| 4,378                   | 1.202  | 7,284                                    | 7,284                                   | 7,284                                   |
| 5,128                   | 1.346  | 10,416                                   | 7,619                                   | 7,680                                   |
| 5,628                   | 1.444  | 10,204                                   | 7,795                                   | 7,877                                   |
| 6,128                   | 1.520  | 13,157                                   | 8,063                                   | 8,222                                   |
| 6,728                   | 1.610  | 13,333                                   | 8,357                                   | 8,588                                   |
| 7,103                   | 1.672  | 12,096                                   | 8,496                                   | 8,743                                   |
| 7,778                   | 1.776  | 12,980                                   | 8,759                                   | 9,046                                   |
| 8,958                   | 1.948  | 13,720                                   | 9,197                                   | 9,551                                   |
| 9,478                   | 2.026  | 13,333                                   | 9,356                                   | 9,724                                   |
| 9,828                   | 2.068  | 16,666                                   | 9,504                                   | 9,914                                   |
| 10,448                  | 2,136  | 18,235                                   | 9,782                                   | 10,283                                  |
| 10,848                  | 2.184  | 16,666                                   | 9,934                                   | 10,465                                  |
| 11,378                  | 2.242  | 18,275                                   | 10,149                                  | 10,739                                  |
| 11,928                  | 2.300  | 18,965                                   | 10,372                                  | 11,022                                  |
| 12,028                  | 2.312  | 16,666                                   | 10,404                                  | 11,059                                  |
| 12,128                  | 2.322  | 20,000                                   | 10,446                                  | 11,113                                  |
| 12,228                  | 2.332  | 20,000                                   | 10,487                                  | 11,166                                  |
| 12,328                  | 2.344  | 16,666                                   | 10,518                                  | 11,201                                  |
| 12,428                  | 2.352  | 25,000                                   | 10,568                                  | 11,276                                  |
| 12,528                  | 2.364  | 16,666                                   | 10,598                                  | 11,310                                  |
| 12,628                  | 2.380  | 12,499                                   | 10,611                                  | 11,319                                  |
| 12,728                  | 2.386  | 33,334                                   | 10,668                                  | 11,427                                  |
| 12,828                  | 2.394  | 24,999                                   | 10,716                                  | 11,499                                  |
| 12,928                  | 2.406  | 16,666                                   | 10,746                                  | 11,531                                  |
| 13,028                  | 2.416  | 20,000                                   | 10,784                                  | 11,579                                  |
| 13,228                  | 2.436  | 19,999                                   | 10,860                                  | 11,673                                  |
| 13,328                  | 2.448  | 16,666                                   | 10,888                                  | 11,702                                  |
| 13,428                  | 2.456  | 24,999                                   | 10,934                                  | 11,770                                  |

*Continued*



**Table 2a. Well velocity data --continued**

| <b>Depth<br/>(feet)</b> | <b>Two-way<br/>Travel Time<br/>(seconds)</b> | <b>Interval Velocity<br/>(feet/sec.)</b> | <b>Average Velocity<br/>(feet/sec.)</b> | <b>RMS<br/>Velocity<br/>(feet/sec.)</b> |
|-------------------------|--|--|---|---|
| 13,528                  | 2.464  | 25,000                                   | 10,980                                  | 11,837                                  |
| 13,648                  | 2.480  | 14,999                                   | 11,006                                  | 11,860                                  |
| 13,728                  | 2.486  | 26,666                                   | 11,044                                  | 11,918                                  |
| 13,828                  | 2.496  | 20,000                                   | 11,080                                  | 11,961                                  |
| 13,928                  | 2.508  | 16,666                                   | 11,106                                  | 11,988                                  |
| 14,028                  | 2.516  | 24,999                                   | 11,151                                  | 12,052                                  |
| 14,128                  | 2.524  | 25,000                                   | 11,194                                  | 12,115                                  |
| 14,178                  | 2.530  | 16,666                                   | 11,207                                  | 12,127                                  |
| 14,328                  | 2.544  | 21,428                                   | 11,264                                  | 12,198                                  |
| 14,378                  | 2.550  | 16,666                                   | 11,276                                  | 12,210                                  |
| 14,528                  | 2.564  | 21,428                                   | 11,332                                  | 12,280                                  |
| 14,628                  | 2.576  | 16,666                                   | 11,357                                  | 12,304                                  |
| 14,728                  | 2.586  | 20,000                                   | 11,390                                  | 12,343                                  |
| 14,828                  | 2.594  | 24,999                                   | 11,432                                  | 12,402                                  |
| 14,928                  | 2.604  | 20,000                                   | 11,465                                  | 12,440                                  |
| 15,028                  | 2.616  | 16,666                                   | 11,489                                  | 12,462                                  |
| 15,128                  | 2.622  | 33,333                                   | 11,539                                  | 12,550                                  |

**Table 2b. Well velocity data averaged below 12,000 feet**

| <b>Average Depth<br/>(feet)</b> | <b>Average Two-Way<br/>Travel Time*<br/>(seconds)</b> | <b>Average Interval<br/>Velocity*<br/>(feet/second)</b> |
|---------------------------------|---|---|
| 12,178                          | 2.3275  | 18,333.00   |
| 12,278                          | 2.3375  | 20,416.50   |
| 12,378                          | 2.3480  | 19,583.00   |
| 12,478                          | 2.3600  | 17,707.75   |
| 12,578                          | 2.3705  | 21,874.75   |
| 12,678                          | 2.3810  | 21,874.50   |
| 12,778                          | 2.3915  | 21,874.50   |
| 12,878                          | 2.4005  | 23,749.75   |
| 12,978                          | 2.4130  | 20,416.00   |
| 13,078                          | 2.4265  | 18,332.75   |
| 13,178                          | 2.4390  | 20,416.00   |
| 13,378                          | 2.4510  | 21,666.00   |
| 13,478                          | 2.4620  | 20,416.00   |
| 13,578                          | 2.4715  | 22,916.00   |
| 13,678                          | 2.4815  | 21,666.25   |
| 13,798                          | 2.4925  | 19,582.75   |
| 13,878                          | 2.5015  | 22,082.75   |
| 13,978                          | 2.5110  | 21,666.25   |
| 14,078                          | 2.5195  | 20,832.75   |

*Continued*

**Table 2b. Well velocity data averaged--continued**

| <b>Average Depth<br/>(feet)</b> | <b>Average Two-Way<br/>Travel Time*<br/>(seconds)</b> | <b>Average Interval<br/>Velocity*<br/>(feet/second)</b> |
|---------------------------------|---|---|
| 14,178                          | 2.5285  | 22,023.25   |
| 14,278                          | 2.5370  | 19,940.00   |
| 14,328                          | 2.5470  | 19,047.00   |
| 14,478                          | 2.5585  | 19,047.00   |
| 14,528                          | 2.5690  | 18,690.00   |
| 14,678                          | 2.5800  | 20,773.25   |
| 14,778                          | 2.5900  | 20,416.25   |
| 14,878                          | 2.6000  | 20,416.25   |
| 14,978                          | 2.6090  | 23,749.50   |

\*Running averages of data,  $\frac{n_1 + \dots + n_4}{4}$ ;  $\frac{n_2 + \dots + n_5}{4}$ ; etc

The interval velocity range below 12,000 feet (and below 2.3 seconds, two-way travel time) is anomalous in magnitude (12,499 to 33,334 feet per second) and in the repetition of particular values (e.g., 16,666, 20,000, and 25,000 feet per second). However, the average velocities and RMS velocities appear reasonable, owing to the small influence of each successive interval, compared to that of the overlying rock, sediment, and water column.

Figures 5 and 6 also show the interval velocity differences smoothed below

12,000 feet, and below 2.3 seconds, by taking a running average of four data points at a time. The averaged data are also shown in table 2b. This procedure yields a more reasonable velocity profile and may be more true to the general reliability of the data in representing the interval of 12,000 feet to total depth.

A lithologic column is also shown in figure 5, and four velocity intervals are indicated, which generally correlate with lithologic intervals penetrated by the well:

**Table 3. Well velocity intervals**

| <b>Interval</b> | <b>Depth range<br/>(feet)</b> | <b>Interval Velocity Range<br/>(feet/second)</b> | <b>Average Interval Velocity<br/>(feet/second)</b> |
|-----------------|-------------------------------|--|--|
| I               | 0-4,600                       | 7,284  | 7,284  |
| II              | 4,600-9,600                   | 10,204-13,720                                    | 12,405   |
| III             | 9,600-12,000                  | 16,666-18,965                                    | 17,761   |
| IV              | 12,000-15,128                 | 18,333-23,750*                                   | 20,697*  |

\* Averaged data.

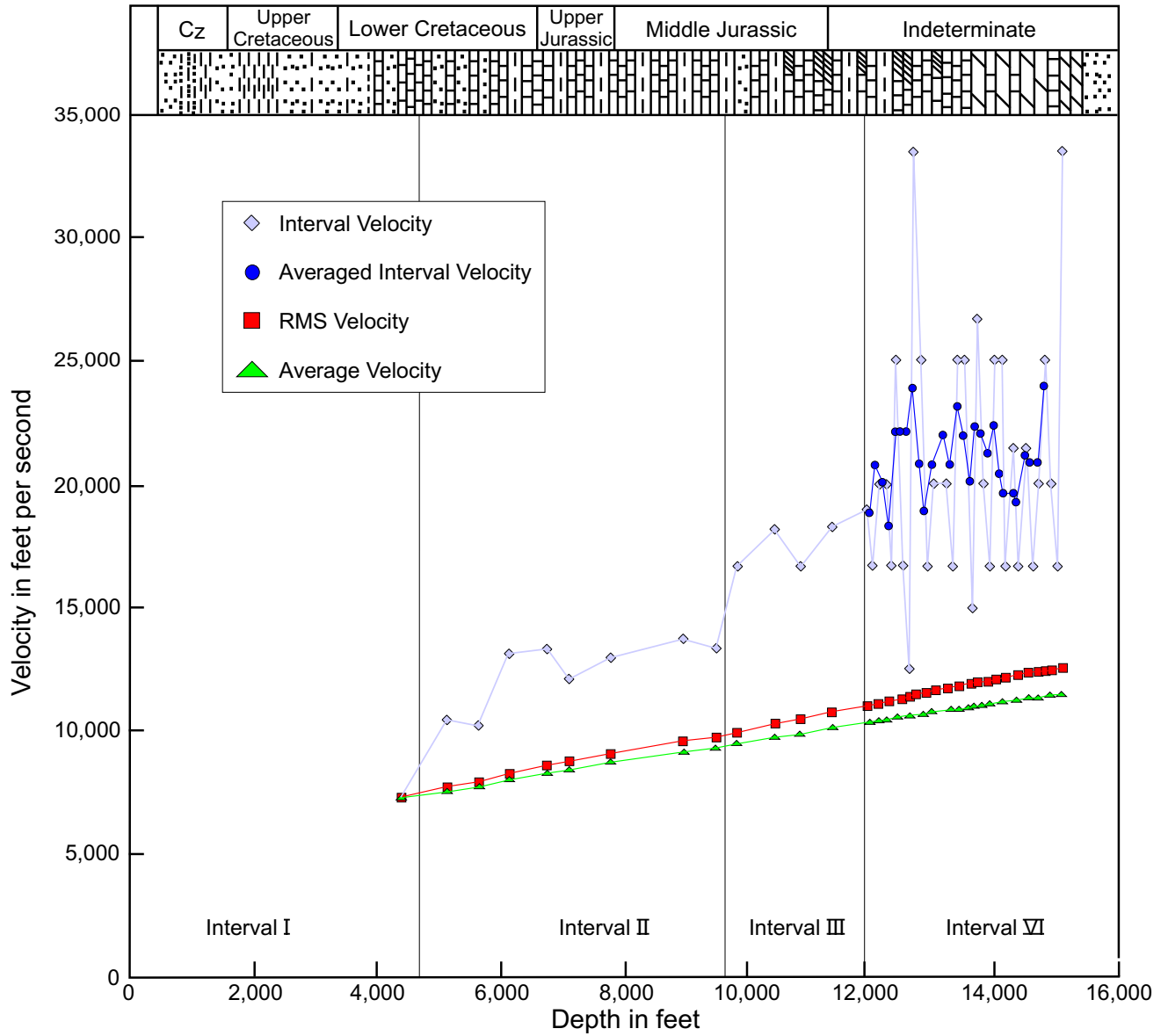

Figure 5. Well velocity profile for the Shell Lydonia Canyon Block 410 No. 1R well, plotted against depth, with biostratigraphic ages and generalized lithologies. Intervals and averaged interval velocities are explained in text.

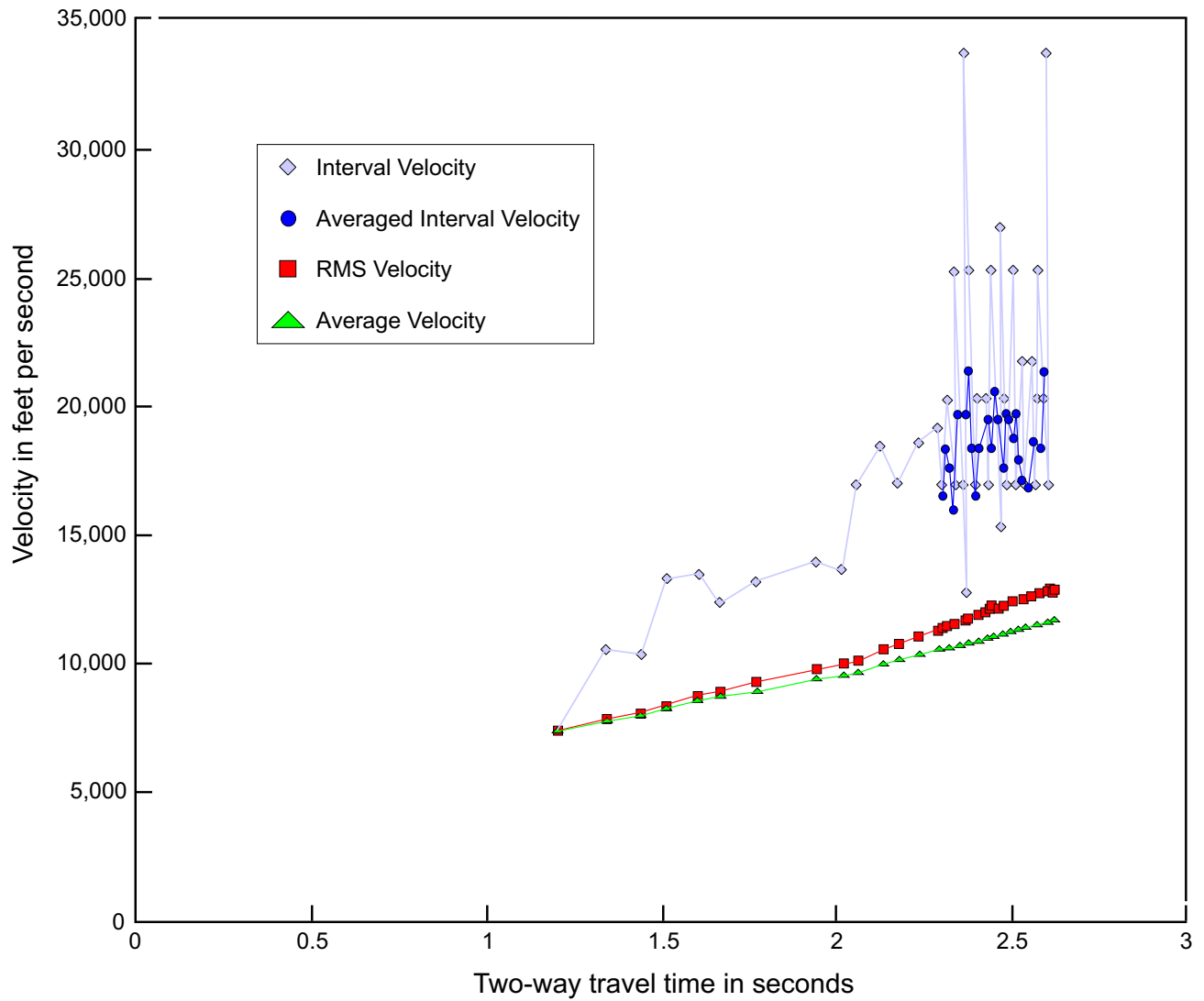

Figure 6. Well velocity profile for the Shell Lydonia Canyon Block 410 No. 1R well, plotted against two-way travel time. Averaged interval velocities explained in text.

**Interval I** This interval has limited practical value because it is very large and is represented by a single data point. The interval velocity of 7,284 feet per second is for the entire section from the ocean surface to the depth of 4,378 feet. Interval I contains Cenozoic and Upper and Lower Cretaceous mixed lithologies and has low to moderate interval velocities.

**Interval II** This interval is identified on the basis of moderate interval velocities, averaging about 12,405 feet per second. Included are Lower Cretaceous and Upper and Middle Jurassic mixed lithologies with an increasing proportion of limestone with depth.

**Interval III** This interval has interval velocities averaging about 17,761 feet per second and contains mostly Middle Jurassic limestones with some siliciclastic interbeds and anhydrite.

**Interval IV** This is the interval of the anomalous interval velocity data. However, the calculated average velocity of 20,697 feet per second agrees with checkshot data from the same depth range in neighboring wells. The rocks are limestone, dolomite, and anhydrite, with minor siliciclastic interbeds.

## LITHOLOGIC INTERPRETATION

Taken and adapted from A. C. Giordano, MMS internal report

Samples were collected at 30-foot intervals from 790 feet to 3,410 feet and 10-foot intervals to total depth, 15,568 feet in the Shell LC Block 410 No. 1R well. Sample quality ranged from fair to good, based on amounts of cavings and degree of washing. Additional lithologic control was provided by two conventional cores, at 9,738 to 9,767 feet and 15,229 to 15,241 feet, and descriptions of 45 successful sidewall cores by Core Laboratories, Inc.

The lithologic descriptions of this report are interpretations derived mainly from examination of drill cuttings, supplemented by viewing thin sections. Depths of lithologic boundaries are adjusted with reference to “electric” and “mud” logs. All depths are from kelly bushing. Rocks penetrated are divided into gross lithologic-stratigraphic units, and a lithologic column appears as figure 7.

### LITHOLOGIC DESCRIPTION

From 790 to 1,520 feet, the section consists of sandy pebble conglomerate with minor clay and glauconite. A mixed assemblage of pelecypods, sponge spicules, and planktonic and benthonic foraminifera is present throughout the interval. The sand grains are clear and light gray to pinkish red, fine to coarse in texture, and angular. Metamorphic rock fragments, reworked sedimentary clasts, abundant pyrite, and traces of coal are also present. The clay is gray to greenish gray, unconsolidated, sticky, and calcareous.

From 1,520 to 1,700 feet, the section consists of subrounded-to-rounded, frosted sand grains, sandstone fragments, and abundant pyrite. From 1,640 to 1,700 feet, glauconitic sand marks an unconformity between the Eocene and the Upper Cretaceous.

Between 1,700 to 2,510 feet, the section consists of medium-to-very dark-gray, sticky clay, becoming calcareous with depth. Occasional glauconite and pyrite grains are also present.

Between 2,510 and 4,070 feet, the section consists of sandstone, siltstone, limestone, and clay. The sandstone is clear to white, soft, friable, medium grained, subrounded, poorly sorted, and calcareous. The siltstone is calcareous with poor porosity and contains traces of glauconite, pyrite, and lignite. The limestone is white to gray, coarse grained, firm, and slightly oolitic, with blocky to angular fragments. The clay is light to medium gray, moderately sticky, and calcareous, with abundant glauconite and fossil fragments.

From 4,070 to 5,650 feet, the section consists of limestone, shale, and sandstone. The limestone is gray to white and contains abundant spherical or flat oolites and pellets with variable amounts of intrapartical and interpartical porosity. Dolomite crusting is seen at the top of limestone intervals and is attributed to groundwater penetration. The shale is medium to dark gray, platy, variably calcareous, and has earthy luster. The sandstone is composed of clear, fine- to-coarse grains, fines upward, and is

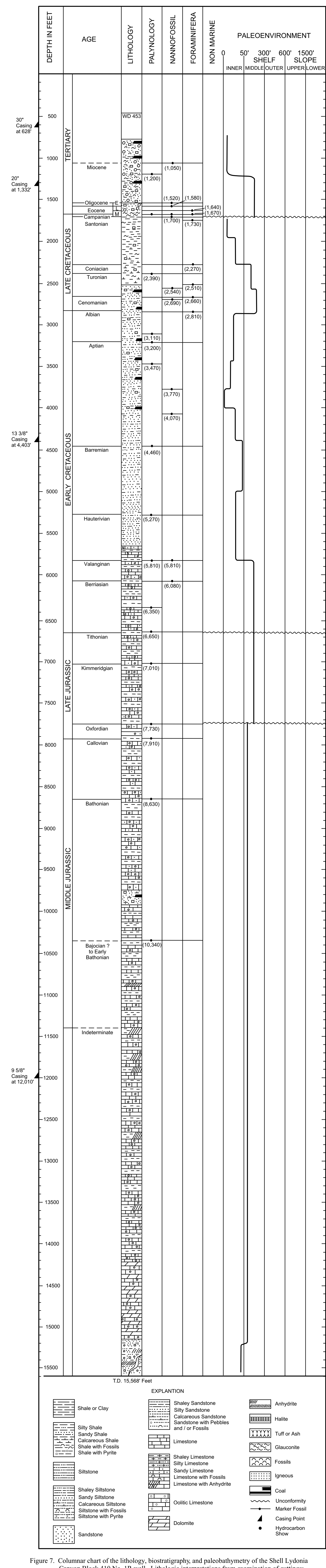

Figure 7. Columnar chart of the lithology, biostratigraphy, and paleobathymetry of the Shell Lydonia Canyon Block 410 No. 1R well. Lithologic interpretations from examination of cuttings; lithologic breaks picked from well logs. Within columns, depths refer to uppermost occurrence of index fossils listed in Biostratigraphy chapter. Stage tops based on palontology. Biostratigraphy and bathymetric interpretations show less reliability with increasing depth.

unconsolidated to consolidated, poorly sorted, and variably calcareous.

The interval from 5,650 to 9,750 feet consists of interbedded limestone and shales. The limestone is white to brown to gray, oolitic and slightly sandy, and exhibits little or no visible interpartical or intrapartical porosity. The shale is light to dark gray, soft to firm, calcareous, and slightly silty with traces of pyrite.

From 9,750 to 9,920 feet, the section consists of a white, fine- to very fine, poorly sorted, relatively unconsolidated, calcareous sandstone with clear to frosted, subangular to subrounded grains. There is no visible porosity. Present also are traces of pyrite and lignite.

From 9,920 to 14,220 feet, the section consists of limestone and interbedded shales. The limestone is white to brown to medium gray, massive, microcrystalline, and oolitic or pelletal or oncolitic. Interpartical porosity is mostly filled with sparry calcite, but some interpartical porosity exists in sucrosic limestone. A trace of chicken-wire-to-bladed anhydrite is observed as a replacement of some micritic limestone. The shale is dark gray.

From 14,220 to 15,160 feet, the section consists of limestone and dolomite. The limestone is white to light brown, microcrystalline, finely sucrosic, and nonporous. The dolomite is light gray to brown, medium to coarse, and sucrosic. Coarse replacement dolomite (euhedral, rhombic crystals) exhibits intercrystalline porosity and is a replacement of micritic

limestone, perhaps through freshwater leaching.

From 15,160 to 15,568 feet (TD), the section consists of sandstone, red siltstone, anhydrite, and schist. The sandstone is white to red, fine to medium, and silica cemented with subrounded to subangular grains. Fragments of pyrite and hematite are also present.

### RESERVOIR POTENTIAL

Analyses of rock cuttings, core data, and well logs (see **Formation Evaluation** chapter) indicate that the best reservoir characteristics are associated with clastic rocks above 5,650 feet. Porosities average 32 percent, based on log analysis, but these rocks are thermally immature. From 5,650 feet to 9,550 feet, interbedded carbonates and shales have moderate to poor reservoir potential and are still thermally immature. From 9,550 to 14,220 feet, the limestone is massive, dense, and tight with slight dolomitization. Log analysis indicates 15 percent average porosity in the best zones above 9,888 feet and 8 to 9 percent in the most porous zones below this depth. In general, however, microscopic sample examination reveals poor porosity among these alternating carbonate and shale sequences. Anhydrite beds below 11,250 feet have no measurable porosity. Borderline thermal maturity is not reached until 13,300 feet, according to MMS optical thermal maturation studies (see **Kerogen analysis** chapter). From 14,220 to 15,120 feet, freshwater leaching occurred, resulting in a dolomitized zone with secondary porosity. From 15,200 feet to total depth, the clastic sediments are tightly cemented by silica and exhibit no visible porosity.



## BIOSTRATIGRAPHY

Taken and adapted from W. E. Steinkraus, H. L. Cousminer, and C. E. Fry,  
MMS internal report

The biostratigraphic and paleoenvironmental interpretations of the Shell LC Block 410 No. 1R well are based on foraminifera, spores, pollen, dinoflagellates, and calcareous nannofossils from well-cutting samples (figure 7). This report includes the results of three separate investigations by the paleontological staff of the Atlantic OCS office of the MMS.

Foraminiferal analyses were based on 112 samples at 30-foot intervals collected from 790 to 4,130 feet. Palynological studies were made from 160 slides prepared from composited 90-foot intervals from 1,200 to 15,560 feet. Nannofossil studies were made from the examination of 212 slides representing 30-foot intervals from 770 to 7,130 feet. No core samples were used. Well depths are relative to kelly bushing.

Two factors limit the reliability of the paleontologic data. (1) Analyses are made from drill cuttings, which are often heavily contaminated by cavings from higher in the drill hole. For this reason, only "tops," or the uppermost (last) appearances of species, are used. (2) Reworked, older fossil assemblages and individual specimens are commonly reincorporated in detrital sedimentary rocks. These fossils must be recognized so that intervals are not dated older than they really are. In addition, in U. S. offshore Atlantic wells, biostratigraphic control is poor in pre-Late Jurassic strata. Calcareous nannofossils and foraminifera are sparse. Palynomorphs are more common, but their biostratigraphic distribution is not fully

documented with reference to the European type-stage localities.

This investigation relies on the Jurassic palynostratigraphy of offshore eastern Canada (Bujak and Williams, 1977) because many of their palynomorph marker species are also present in the U. S. offshore Atlantic subsurface. Although the European stage equivalence of many species is not fully resolved, several species have recently been documented in European type-sections (Woollam and Riding, 1983; Riding, 1984; Davies, 1985).

### CENOZOIC

#### TERTIARY

No samples above 790 are available. The age of the interval between 790 and 1,050 feet is indeterminate because no age-diagnostic fossils were recognized.

#### Miocene (1,050-1,520 feet)

The highest occurrence of the nannofossil species Coccolithus miopelagicus at 1,050 feet indicates a Miocene age for this interval. Pollen species were recovered at 1,200 feet, including Pinus, Picea, Tsuga, and Carya. The depositional environment is characterized by shallow-water benthonic foraminiferal species, including Cibicides, Nonionella, Gyroidina, Anomalina, Siphonina, Uvigerina, Dentalina, Lenticulina, Bulimina, Pseudoglandulina, and Lagena. Microgastropods were observed in this

interval. The nannoflora is very sparse. An inner shelf (0-50 feet) environment of deposition is interpreted for the interval 1,050 to 1,200 feet. Foraminiferal evidence indicates middle shelf (50 to 300 feet) from 1,200 to 1,670 feet.

#### **Early Oligocene (1,520-1,580 feet)**

The highest occurrence of the nannofossil species Reticulofenestra umbilica and Chiasmolithus oarmaruensis indicates an Early Oligocene age for this interval.

#### **Late Eocene (1,580-1,640 feet)**

The entire Eocene section is characterized by sparse nannoflora. A Late Eocene age was determined by the joint occurrence of Discoaster saipanensis, which extends no higher than the top of the Eocene, and Istmolithus recurvus, which ranges from the Late Eocene to the base of the Oligocene.

#### **Middle Eocene (1,640-1,670 feet)**

Rare specimens of Mesozoic nannofossils in this interval represent reworked species. A Middle Eocene age for this interval is based on the planktonic foraminifer Globigerina primitiva.

### **MESOZOIC**

#### **CRETACEOUS**

##### **Late Cretaceous**

#### **Campanian (1,670-1,700 feet)**

A Campanian age for this interval is based on the highest occurrence of the palynomorph Lejeunia hyalina, the

foraminifer Globotruncana linneiana, and the nannofossil Gartnerago obliquum. Other palynomorph species recovered from this interval include Hystrichsphaeropsis ovum, Deflandrea echinoidea, and Hystrichokolpoma ferox. An inner shelf environment of deposition is indicated.

#### **Santonian (1,700-2,270 feet)**

The highest occurrence of the nannofossil species Marthasterites furcatus at 1,700 feet indicates a Santonian age for this interval. The planktonic foraminifer Globotruncana renzi was recovered at 1,730 feet. A significant nannofloral assemblage was noted in the lower part of the Santonian interval from 2,150 to 2,270 feet. The foraminifera and nannoflora suggest deposition in a shallow marine, inner shelf environment of deposition from the Campanian through Santonian interval.

#### **Coniacian (2,270-2,390 feet)**

The top of the Coniacian is based on the highest occurrence of the foraminifer species Globotruncana imbricata. This species is restricted to the Turonian-Coniacian ages. A middle shelf environment of deposition is indicated through the Cenomanian.

#### **Turonian (2,390-2,660 feet)**

The Turonian is based on the highest occurrence of the dinoflagellate species Surculosphaeridium longifurcatum at 2,390 feet. The planktonic foraminifer Globotruncana helvetica was recovered at 2,510 feet. The nannofossil species Corollithion achylosum and Lithastrinus floralis were identified at 2,540 feet.

### **Cenomanian (2,660-2,810 feet)**

The top of Cenomanian stage at 2,660 feet is based on the planktonic foraminifera Rotalipora cushmani and R. greenhornensis. The nannofossil Corollithion kennedyi was recovered at 2,690 feet. A rich nannofossil assemblage is present in the Cenomanian and the lower part of the Turonian (2,540-2,810 feet).

### **Early Cretaceous**

#### **Albian (2,810-3,200 feet)**

The Albian is based on the highest occurrence of the planktonic foraminifer Rotalipora ticinensis. The dinoflagellate species Spinidinium vestitum, recovered from 3,110 feet, supports an Albian age. The Albian section is characterized by abundant planktonic foraminiferal assemblages. An inner shelf environment of deposition is indicated from Hauterivian through Albian.

#### **Aptian (3,200-4,460 feet)**

The top of the Aptian is based on the highest occurrence of the dinoflagellate Apteodinium conjunctum at 3,200 feet. The presence of Astrocysta cretacea at 3,470 feet supports the age for this interval. The nannofossil species Cyclagelospharea margerili has its highest occurrence at 3,770 feet and Nannoconus globulus is present at 4,070 feet. Foraminifer species of known stratigraphic significance are rare below the Albian section.

#### **Barremian (4,460-5,270 feet)**

The dinoflagellate species Pseudoceratium pelliferum and Tenua anaphrissa, identified at 4,460 feet, are not known to occur in post-Barremian strata.

#### **Hauterivian (5,270-5,810 feet)**

The top of the Hauterivian has been placed at 5,270 feet, on the basis of Bebout's Trilobosporites sp. 133 and the dinocyst Kleithriasphaeridium corrugatum. According to Bebout (1981), Trilobosporites sp. 133 does not range above this stage in the Mid-Atlantic. Muderongia simplex and Canningia cf. C. reticulata are also present.

#### **Valanginian (5,810-6,080 feet)**

The Valanginian section is characterized by the dinoflagellate species Oligosphaeridium perforatum (asterigerum) at 5,810 feet. The nannofossil indicator Crucellipsis cuvillieri, which may range above this stage, was also found in this interval. A middle shelf environment of deposition was interpreted from the Middle Jurassic through the Valanginian on the basis mainly of the palynomorph assemblages.

#### **Berriasian (6,080-6,650 feet)**

The top of the Berriasian is placed at 6,080 feet on the basis of the nannofossil Polycostella senaria. This species does not range above the Berriasian. Palynomorph index species were identified at 6,350 feet, including the dinocyst Occisucysta evittii and the spore species Bebout sp. 139, 140, and Reticulatisporites simireticulatus.

## JURASSIC

### Late Jurassic

#### Tithonian (6,650-7,010 feet)

The top of the Tithonian section is based on the highest occurrence of the dinoflagellate Ctenidodinium panneum at 6,650 feet. Gonyaulacysta cladophora is also present in this interval.

#### Kimmeridgian (7,010-7,730 feet)

The Kimmeridgian top is based on the dinocyst species Gonyaulacysta longicornis and Gonyaulacysta sp. "A" at 7,010 feet.

#### Oxfordian (7,730-7,910 feet)

An Oxfordian age for this interval is based on the palynomorph Surculosphaeridium vestitum at 7,730 feet, which does not range above the Oxfordian. Gonyaulacysta jurassica, Meiourgonyaulax pila, and M. staffinensis were also present.

## Middle Jurassic

### Callovian (7,910-8,630 feet)

The top of this age at 7,910 feet is based on the highest occurrence of the dinocyst Valensiella vermiculata. Other longer-ranging palynomorphs include Adnatosphaeridium aemulum and A. caullyeri.

### Bathonian (8,630-10,340) feet)

The top of this stage is based on the dinoflagellate Gonyaulacysta filapicata at 8,630 feet. Other species recovered in the interval include Ctenidodinium ornatum and C. pachyderma.

### Bajocian? to early Bathonian (10,340-11,420 feet)

Gonyaulacysta filapicata is present throughout this interval. No evidence is available for Triassic or Early Jurassic deposits in this well. The interval from 11,420 feet to total depth (15,568 feet) is barren and, therefore, the age is indeterminate.

## FORMATION EVALUATION

Taken and adapted from R. Nichols, MMS internal report

Schlumberger Ltd. ran the following geophysical “electric” logs in the Shell LC Block 410 No. 1R well to provide

information for stratigraphic correlation and for evaluation of formation fluids, porosity, and lithology:

**Table 4. Well logs**

| Log Type  | Depth Interval<br>(feet below KB) |
|---|-----------------------------------|
| DISFL/Sonic (dual induction spherically focused log/sonic)      | 627-15,564                        |
| FDC/GR (compensated formation density/gamma ray)                | 627-1,399 and<br>12,018-15,564    |
| CNL/FDC (compensated neutron log/compensated formation density) | 627-15,564                        |

Exploration Logging Inc. provided a formation evaluation “mud” log, which includes a rate of penetration curve, sample description, and graphic presentation of any hydrocarbon shows encountered (629 to 15,568 feet).

potential reservoirs, average porosities, and feet of hydrocarbons present.

Reservoir rocks with porosities less than 5 percent were not included. A combination of logs was used in the analysis, but a detailed lithologic and reservoir property determination from samples, conventional cores, and sidewall cores is necessary to substantiate the following estimates as shown in table 5.

The electric logs, together with the “mud” log and other available data, were analyzed in detail to determine the thickness of

**Table 5. Well log interpretation summary**

| Series | Depth Interval (Feet) | Potential Reservoir <sup>1</sup> (feet) | Avg $\phi$ | SW% | Feet of Hydrocarbon |
|--------|-----------------------|---|------------|-----|---------------------|
| LK     | 4,668-5,625           | 315                                     | 32         | NC* | NC                  |
|        | 5,827-5,966           | 72                                      | 13         | NC  | NC <sup>2</sup>     |
| MJ     | 9,747-9,888           | 81                                      | 15         | NC  | NC                  |
|        | 11,040-11,106         | 57                                      | 8          | NC  | NC                  |
|        | 13,058-13,068         | 10                                      | 9          | NC  | NC                  |
|        | 13,068-15,561         | --                                      | --         | NC  | NC                  |

\*Not calculated

<sup>1</sup>Generally in beds > 10 feet thick and  $\phi > 5\%$

<sup>2</sup>Carbonate, thinly bedded

The electric logs were of acceptable quality. However, the SP was very spiky from 4,450 to 15,561 feet and the CNL/FDC repeat section from 12,100 to 12,300 does not compare favorably to the final log.

## SIDEWALL CORES

Fifty-nine sidewall cores were attempted in the well and 45 were successful and are summarized in table 6.

**Table 6. Sidewall core analysis summary**

| Depth Interval (feet) | Lithology | Porosity Range (%) | Permeability Range (md) |
|-----------------------|-----------|--------------------|-------------------------|
| 13,060-13,900         | Limestone | 5.2-14.9           | <0.1-2.9                |
| 14,046-14,800         | Limestone | 8.9-15.3           | <0.1-4.6                |
| 14,848-15,090         | Limestone | 4.4-11.5           | <0.1-1.1                |
| 15,236-15,385         | Siltstone | 7.2-19.3           | <0.1-7.2                |

## CONVENTIONAL CORES

Two conventional cores were taken in this well, No. 1 at 9,738 to 9,767 feet and No. 2 at 15,229 to 15,241 feet. The conventional core properties are described in table 7. Core No. 1 compares favorably with the porosities calculated from the

sonic log, especially in the interval 9,746 to 9,762 feet. However, the core porosities do not compare well with the density or neutron porosities. Core porosity values are substantially lower than those from the density log, particularly in the interval 9,746 to 9,762 feet.

**Table 7. Conventional cores**

| Core No. | Depth Interval (feet) | Lithology       | Porosity Range (%) | Permeability Range (md) |
|----------|-----------------------|-----------------|--------------------|-------------------------|
| 1        | 9,738-9,767           | SS <sup>1</sup> | 3.1-13.6           | <0.1-26.5               |
| 2        | 15,229-15,241         | SS <sup>1</sup> | 1.0-2.6            | 0.031-0.21              |

<sup>1</sup>Lithology and mud sample description and from photographs

## SIGNIFICANT SHOWS

As summarized in table 8, there were no significant shows of hydrocarbon

encountered in this well. No tests of any zone were made.

Table 8. Hydrocarbon shows

| Depth (Feet)    | Drilling Break | Sample Description (Mud Log)   | Total Gas bk. grd. | Chromatograph                                      | Cuttings Gas | Conventional Cores                                 | Sidewall Cores  | Well Log Interpretation | Test |
|-----------------|----------------|--|--------------------|--|--------------|--|---|-------------------------|------|
| 4,300 - 4,500   | -              | LS, no vis. $\phi$ , some w. sl tr brn stn, brt / yel-wht flu, vy sl creme-wht cut   | 0<br>0             | -  | -            | -  | -   | $\phi \approx 16\%$     | -    |
| 6,800 - 6,980   | -              | SS, no vis. $\phi$ no stn, dull yel flu, no cut  | 0<br>10            | C <sub>1</sub> , 2, 3,                             | 3            | -  | -   | $\phi \approx 11\%$     | -    |
| 9,738 - 9,767   | -              | SS, vy calc, no vis. $\phi$ , dull yel flu, occ lt brn stn, no cut   | 0<br>0             | -  | -            | Core #1<br>K=<0.1 - 26.5md<br>$\phi$ =3.1 - 13.6%  | -   | $\phi \approx 5\%$      | -    |
| 13,200 - 13,850 | -              | LS, pr $\phi$ , tr mini flu, no cut. @13,550 - occ dull-br yel mini flu, sl crush cut @13,850-occ dull-br yel mini flu, sl crush cut | 0<br>2             | -  | 2            | -  | LS, shly,<br>K=<.1 - .8md<br>$\phi$ =5.8 - 12%          | $\phi \leq 5\%$         | -    |
| 14,800 - 15,000 | -              | Dol. xln, tr intergr $\phi$ @14,850 @14,975  | 0<br>0<br>5<br>5   | C <sub>1</sub> , 2, 3,<br>C <sub>1</sub> , 2, 3, 4 | -<br>2       | -  | LS, shly<br>K=<0.1 - 3.0md<br>$\phi$ =4.4 - 13.5%       | $\phi \leq 5\%$         | -    |
| 15,229 - 15,241 | -              | SS and siltstn, tr anhydrite, no flu, no cut   | 0<br>0             | -  | -            | Core #2<br>K=0.031 - 0.21 md<br>$\phi$ =1.0 - 2.6% | Silt, vy shly,<br>K=<0.1 - 0.8md<br>$\phi$ =5.8 - 12.0% | $\phi \leq 5\%$         | -    |

## GEOHERMAL GRADIENT

Figure 8 shows bottomhole temperatures for seven logging runs in the Shell LC Block 410 No. 1R well plotted against depth. A temperature of 60 °F is assumed at the seafloor at an indicated depth of 453 feet (381-foot water depth plus 72-foot kelly bushing elevation). Shown also is a

straight-line graph between the seafloor and total-depth temperatures in order to represent an overall geothermal gradient for the well, which is 1.25 °F/100 ft. Calculated geothermal gradients for all Georges Bank wells range from 1.06 to 1.40 °F/100 ft.



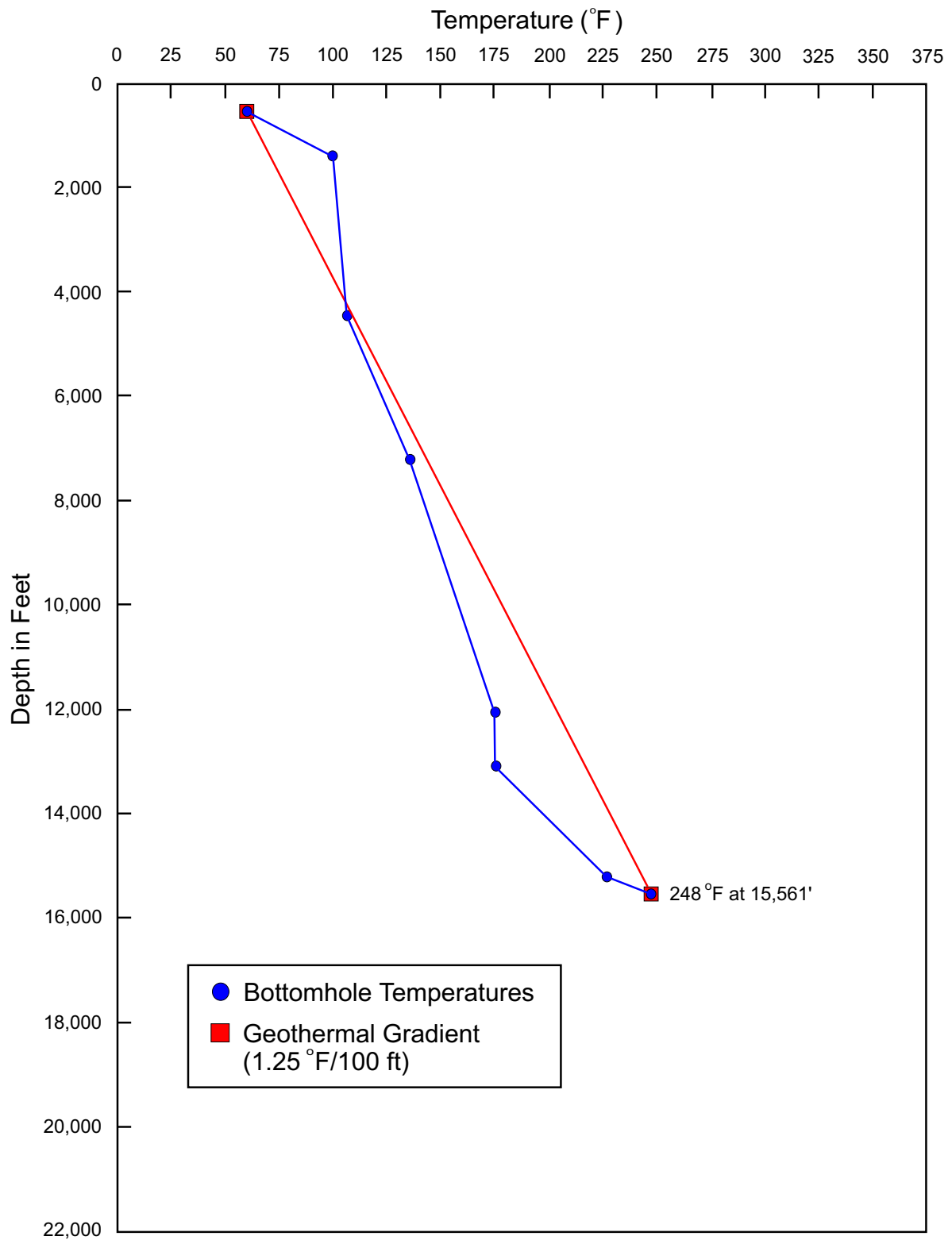

Figure 8. Well temperatures and geothermal gradient for the Shell Lydonia Canyon Block 410 No. 1R well. Well temperatures from bottomhole temperatures of logging runs. Geothermal gradient based on bottomhole temperature of deepest logging run.

## KEROGEN ANALYSIS

Taken and adapted from C. E. Fry and H. L. Cousminer, MMS internal report

Kerogen types and thermal maturation levels were determined by microscopic examination of kerogen slides and palynology slides made from cutting samples from the Shell LC Block 410 No. 1R well. Vitrinite-reflectance data are included in a geochemical report submitted by Shell Offshore, Inc. Cuttings samples were also analyzed for total organic carbon (TOC) by R. E. Miller and others (see **Petroleum Geochemistry** chapter). Well depths cited here are relative to kelly bushing.

In this analysis, organic material is classified as one of four major types: algal-amorphous, organic material of marine origin, either recognizable algae or the unstructured remains of algal material; herbaceous, leafy portions of plants, including spores and pollen; woody, plant detritus with a lignified, ribbed structure; coaly, black opaque material, thought to be chemically inert. Visual estimates are made for the percentage of each type, relative to the total abundance of kerogen, contained in each of the slides. Algal material is generally considered the best source for oil; more structured terrestrial kerogen is primarily a gas source.

Thermal maturity of the organic material is estimated by comparing the color of various palynomorphs contained in the kerogen slides to the thermal alteration index (TAI) scale taken from Jones and Edison (1978). Measuring the exact amount of light reflected from a piece of vitrinite (a humic coal maceral commonly disseminated in sedimentary rocks) provides additional maturation data that can be compared to TAI determinations.

Relationships among various maturity indicators are shown in figure 9.

Kerogen type and thermal alteration rank are used with total organic carbon abundances to evaluate whether sediments in a well are prospective as petroleum source rocks.

### KEROGEN TYPE

Figure 10 shows the MMS kerogen-type analysis for the Shell LC Block 410 No. 1R well. Algal-amorphous kerogen is most abundant at five depths: 1,300 feet (10 percent), 3,300 (5 percent), 4,800 (25 percent), 5,900 (30 percent), and 10,700 (5 percent). Below 7,000 feet, samples are dominated by terrestrial kerogens (herbaceous, woody, and coaly). From 7,000 to 11,400 feet, herbaceous kerogen averages about 30 percent, decreasing to 20 percent below 11,400 feet. A lens of oxidized and decomposed herbaceous material appears at 12,100 feet. Woody and coaly kerogens together dominate most of the stratigraphic section penetrated by the well, especially from 1,800 to 3,500 feet, 6,100 to 7,000 feet, and below 12,500 feet, where they account for more than 75 percent of the organic matter present.

### MATURITY

Judging thermal maturity from cuttings must be done with great care to ensure that the material being analyzed is indigenous to the level sampled. Caved or reworked material or sample contamination will give false indications of maturity. Oxidation in

| Coal Rank                  | % Ro. | TAI | Spore Color        | Principal Zones of Hydrocarbon Generation |
|----------------------------|-------|-----|--------------------|---|
| Peat                       |       | 1.0 | Very Pale Yellow   | Immature                                  |
| Lignite                    |       | 2.0 | Pale Yellow        |   |
|                            |       |     | Yellow             |   |
| Sub-Bituminous             |       |     | Yellow-Orange      |   |
|                            |       |     |                    |   |
|                            | 0.5   | 2.5 |                    |   |
| C                          |       |     | Orange-Brown       | Oil                                       |
| B                          |       |     |                    |   |
| A                          |       |     |                    |   |
| High Volatile Bituminous   |       |     | Reddish-Brown      |   |
|                            | 1.0   | 3.0 |                    |   |
|                            |       |     | Dark Reddish-Brown | Condensate and Wet Gas                    |
| Medium Volatile Bituminous |       |     |                    |   |
|                            | 1.5   | 3.5 |                    |   |
| Low Volative Bituminous    |       |     | Dark Brown         | Dry Gas                                   |
|                            | 2.0   | 3.7 |                    |   |
| Semi - Anthracite          |       |     |                    |   |
|                            | 2.5   |     |                    |   |
|                            | 3.0   |     |                    |   |
|                            | 3.5   |     |                    |   |
| Anthracite                 |       |     | Black              |   |
|                            | 4.0   | 4.0 |                    |   |

Figure 9. Relationships among coal rank, percent R<sub>o</sub>, TAI, spore color, and thermal zones of hydrocarbon generation (after Jones and Edison, 1978).

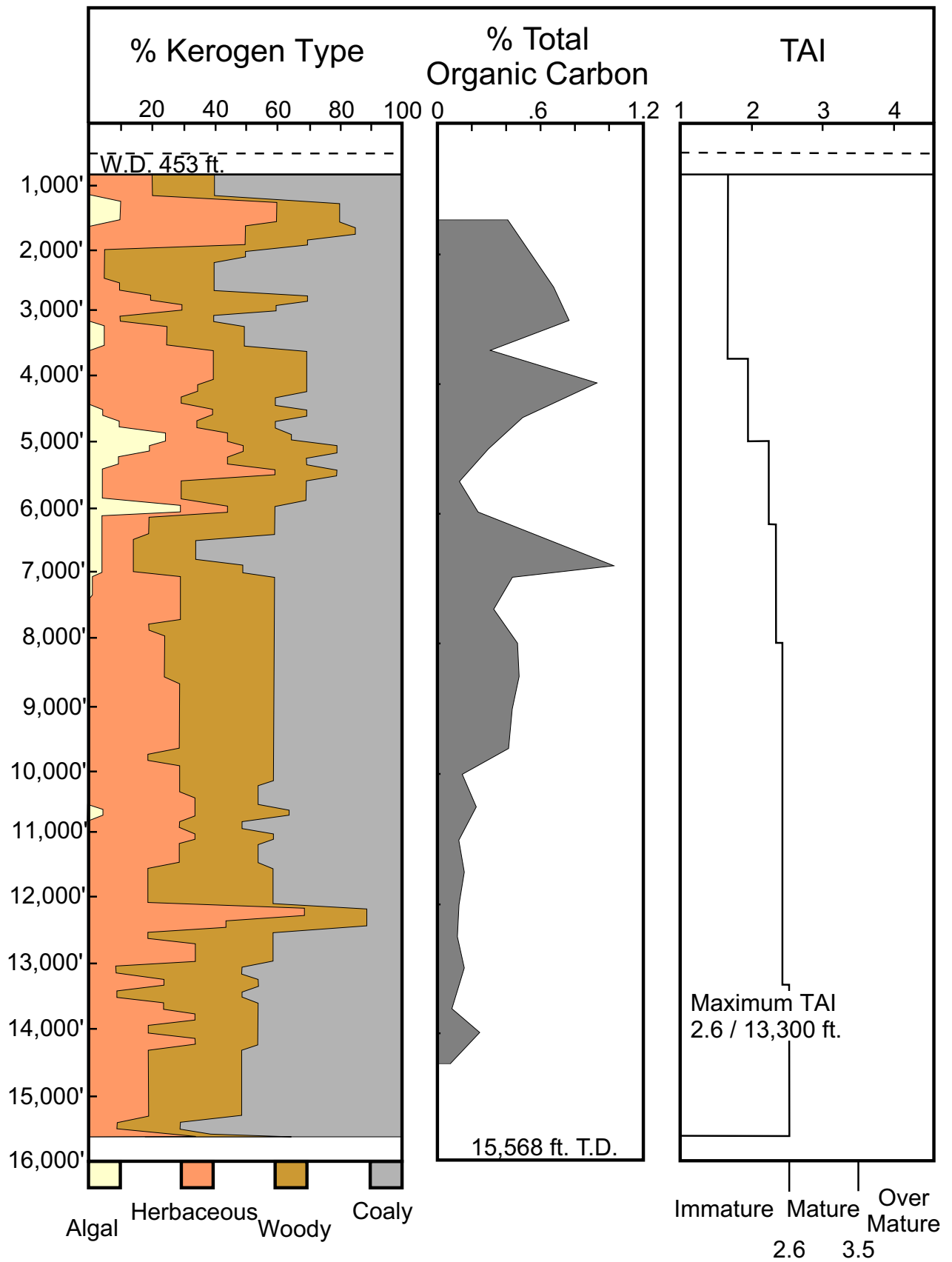

Figure 10. Graph of kerogen types, total organic carbon, and organic thermal maturity for the Shell Lydonia Canyon Block 410 No. 1R well.

a high-energy environment of deposition can also alter the appearance of organic material. Two methods were used to determine organic thermal maturity in this well: vitrinite reflectance and visual estimation of TAI. These methods serve as a check on one another and should generally agree. However, in this case, the Shell vitrinite reflectance data and the TAI estimation done by MMS personnel do not match. The vitrinite reflectance data indicate sufficient thermal maturity to generate hydrocarbons at 9,000 feet and peak generation at approximately at 13,000 feet. However, TAI does not show maturity until 13,300 feet, and even then the colors are borderline (2.6 TAI) (figure 10). The exact method and material Shell used to generate the vitrinite reflectance data are unknown, with only the results presented in their report. For the MMS TAI analysis, in as many cases as possible, the palynomorphs used for visual color determination were fossil markers to ensure the material analyzed was indigenous. However, molecular geochemical analysis (see **Petroleum Geochemistry** chapter) by MMS suggests thermal maturity/depth relationships in closer agreement with Shell's vitrinite analysis.

### **TOTAL ORGANIC CARBON**

Sedimentary organic material must be present in sufficient quantity if rocks are to be considered potential hydrocarbon sources. In general, shales in which total

organic carbon is less than 0.5 percent are not prospective source rocks. TOC measurements were taken from the well between 1,300 and 14,500 feet (table 9, figure 10). The interval from 1,460 to 6,780 feet ranges from poor to good with three samples having 0.77, 0.93, and 1.03 percent, respectively. From 6,980 to 9,600 feet, most samples are between 0.4 and 0.5 percent TOC, which is marginal at best. From 10,000 feet to total depth, TOC abundance is 0.25 percent or less, insufficient to generate hydrocarbons.

### **CONCLUSIONS**

Using the more optimistic option of Shell's vitrinite reflectance assessment, rocks above 9,000 feet in the Shell LC Block 410 No. 1R well are not thermally mature for hydrocarbon generation and, using the MMS TAI assessment, rocks above 13,000 feet are immature. Only a few hundred feet of sedimentary rock immediately below 9,000 feet approach sufficient organic richness for hydrocarbon generation. Rocks below 13,000 feet are entirely too lean to produce any hydrocarbons. Using Shell's more optimistic thermal maturity interpretation, about 600 feet of section, from 9,000 to 9,600 feet, is marginally thermally mature and approaches marginal organic richness. On the basis of the TOC data and the MMS thermal profile of the Shell LC Block 410 No. 1R well, there is no well interval that can be considered effective source rock

**Table 9. Total organic carbon analysis**

| <b>Depth</b> | <b>%TOC</b> |
|--------------|-------------|
| 1,460        | 0.41        |
| 2,480        | 0.68        |
| 2,990        | 0.77        |
| 3,470        | 0.31        |
| 3,950        | 0.93        |
| 4,500        | 0.50        |
| 5,000        | 0.30        |
| 5,500        | 0.13        |
| 5,980        | 0.24        |
| 6,780        | 1.03        |
| 6,980        | 0.44        |
| 7,490        | 0.33        |
| 8,000        | 0.47        |

| <b>Depth</b> | <b>%TOC</b> |
|--------------|-------------|
| 8,500        | 0.48        |
| 9,000        | 0.44        |
| 9,600        | 0.42        |
| 10,000       | 0.15        |
| 10,500       | 0.23        |
| 11,000       | 0.13        |
| 11,490       | 0.16        |
| 12,000       | 0.13        |
| 12,500       | 0.12        |
| 12,990       | 0.16        |
| 13,630       | 0.09        |
| 14,000       | 0.25        |
| 14,490       | 0.08        |

# PETROLEUM GEOCHEMISTRY

Taken and adapted from R. E. Miller, H. E. Lerch, D. K. Owings, D. T. Ligon, W. Walker, C. Fry, D. M. Schultz, and H. Cousminer, MMS internal report

## INTRODUCTION

### Purpose And Scope

The objectives of this geochemical study are to assess source-rock potential, thermal maturity, and types of organic matter encountered in the Shell LC Block 410 No. 1R well and to compare these characteristics to those of equivalent stratigraphic units in the Georges Bank COST G-1 and G-2 wells.

### Concepts And Terminology

The basic principles and terminology in this report were established by Vassoyevich and others (1969), Dow (1977), Tissot and Welte (1978), and Hunt (1974, 1978, 1979). Terminology to define source-rock richness, maturity, and potential follow these principles and interpretive concepts used by Claypool and others (1977) and Miller and others (1979, 1980, 1982). Briefly, the organic richness of a source bed and its potential to generate petroleum hydrocarbons may be indicated by (1) a minimum amount of total organic carbon (TOC) (0.7 to 1.0 weight percent for shales) and (2) solvent-extractable hydrocarbon concentrations considerably greater than 100 ppm. The total organic carbon required to constitute an excellent, good, or poor source bed is not as well defined for fine-grained, medium- to dark-gray limestones and dolomites (Miller and others, 1982). Hunt (1979) states that "Because of the amorphous nature of the organic matter derived from hydrogen-rich marine algae,

dark-gray carbonates may have the potential to generate more hydrocarbons than shales with equivalent amounts of total organic matter." Thus, limestones and dolomites with as little as 0.3 weight percent organic carbon may be considered to be potential source rocks (Hunt, 1967). This classification does not apply to limestones containing primarily allochthonous, terrigenous herbaceous, woody, and coaly kerogens.

Thermally immature potential source rocks are defined here as sedimentary rocks that contain an abundance of organic matter that, when subjected to thermal heating (pyrolysis), are capable of generating petroleum hydrocarbons. However, these rocks have not been thermally altered by natural reactions to yield a significant amount of petroleum. A source rock is defined as mature, or effective, when thermochemical processes have converted the indigenous extractable hydrocarbons to petroleum, and when extractable hydrocarbons are present with concentrations of about 1 to 2 percent of the total organic carbon.

### Geochemical Methods And Procedures

Geochemical analyses for C<sub>15</sub>+ heavy hydrocarbons are run on washed cuttings samples greater than 10 - 20 Tyler mesh size. Composite samples having a minimum weight of 40 grams are used to ensure that sufficient rock material is available to give reliable results. Each sample is examined under a binocular

microscope, the lithology is described, and foreign substances such as plastic, rubber, walnut husks, iron filings, and mica are removed. Composite samples are ground to finer than 60 mesh and aliquots are set aside for total-organic-carbon determinations.

Procedures for solvent-extraction liquid-column chromatography and gas-chromatography for C<sub>15</sub>+ liquid-hydrocarbon analyses used by the MMS Petroleum Geochemistry Group may be summarized as follows. Soxhlet-solvent

extraction in chloroform is followed by removal of free sulfur by passing the extract over a column of activated copper. The sulfur-free extract is separated into paraffin-naphthenes, aromatics, and nitrogen-sulfur-oxygen (NSO) compounds using elution-column chromatography (gravimetrics) on silica gel. The saturated paraffin-naphthene fractions are analyzed both quantitatively and qualitatively on Perkin Elmer Sigma 2B and 3920 gas chromatographs, respectively. The Carbon Preference Index (CPI) calculations were modified from Hunt (1974):

$$\text{CPI} = \frac{(\%n\text{-C}_{25} + \%n\text{-C}_{27} + \%n\text{-C}_{29} + \%n\text{-C}_{31})}{(\%n\text{-C}_{24} + \%n\text{-C}_{26} + \%n\text{-C}_{28} + \%n\text{-C}_{30})} + \frac{(\%n\text{-C}_{25} + \%n\text{-C}_{27} + \%n\text{-C}_{29} + \%n\text{-C}_{31})}{(\%n\text{-C}_{26} + \%n\text{-C}_{28} + \%n\text{-C}_{30} + \%n\text{-C}_{32})}$$

2

Total organic carbon (TOC) is a basic measure of the organic richness of a potential source rock. Triplicate organic-carbon analyses are performed on dried, weighed aliquots of carbonate-free residue produced by leaching with hot, 6-normal hydrochloric acid approximately 0.07 oz of ground sample smaller than 60 mesh. The samples are combusted in a Perkin Elmer model 240 carbon, hydrogen and, nitrogen analyzer.

### **Kerogen Analysis Methodology**

Organic petrology, to determine organic material types and maturation state, was done by microscopic examination of kerogen and palynology slides (see **Kerogen Analysis** chapter).

## **RESULTS AND DISCUSSION**

### **Source-Rock Richness and Quality**

Upper Cretaceous rocks of the Shell LC Block 410 No. 1R well from 1,670 to 2,810 feet have total organic carbon values in the 0.7 weight percent range (table 9). Total extractable hydrocarbons for these rocks are in the poor to fair range (161 ppm) (table 10), so the Upper Cretaceous is not considered to be a viable exploration target. Lower Cretaceous strata from 2,810 to 6,650 feet have total organic carbon values that average 0.50 weight percent, which is minimal for petroleum hydrocarbon generation. Extractable hydrocarbons average 239 ppm, which suggests, according to Philippi (1957) and Hunt (1979), only fair source rock quality.



Table 10. Molecular geochemical analysis results

| Sample Interval (Feet)       | Total Saponifiable Sediment Weight (ppm) | Paraffin-naphthene Sediment Weight (ppm) | Aromatic Sediment Weight (ppm) | Eluted N.S.O. Sediment Weight (ppm) | Total Organic Carbon (%) | Total Organic Carbon (mg/g) | Total Hydrocarbon Organic Carbon (%) | Total Saponifiable Organic Carbon (mg/g) | Paraffin-naphthene Aromatic | Total Hydrocarbon Saponifiable Gravimetric | Paraffin-naphthene Total Saponifiable Gravimetric | Total Hydrocarbon (ppm) | Total Hydrocarbon Saponifiable Gravimetric | C.P.I. A | C.P.I. B | Pristane Phytane | Pristane n-C <sub>17</sub> | Pristane n-C <sub>18</sub> | Pristane ± Phytane n-Alkane |
|------------------------------|--|--|--------------------------------|-------------------------------------|--------------------------|-----------------------------|--------------------------------------|--|-----------------------------|--|---|-------------------------|--|----------|----------|------------------|----------------------------|----------------------------|-----------------------------|
| 2,330 - 2,600                | 300.0                                    | 136.0                                    | 25.0                           | 154.0                               | 0.68                     | 6.8                         | 2.4                                  | 44.1                                     | 5.4                         | 0.54                                       | 0.45  | 161.0                   | 0.54                                       | 1.05     | 1.03*    | 1.86             | 0.43                       | 0.41                       | 0.14                        |
| 3,410 - 3,560                | 235.0                                    | 98.5                                     | 24.0                           | 119.5                               | 0.31                     | 3.1                         | 4.0                                  | 75.8                                     | 4.1                         | 0.52                                       | 0.42  | 122.5                   | 0.52                                       | 1.11     | 1.23*    | 1.89             | 0.52                       | 0.43                       | 0.15                        |
| 4,480 - 4,530                | 849.1                                    | 396.5                                    | 67.8                           | 299.6                               | 0.50                     | 5.0                         | 9.3                                  | 169.8                                    | 5.9                         | 0.55                                       | 0.47  | 464.4                   | 0.55                                       | 2.49     | 1.75*    | 1.61             | 0.41                       | 0.44                       | 0.11                        |
| 5,470 - 5,530                | 263.0                                    | 116.5                                    | 21.0                           | 164.0                               | 0.13                     | 1.3                         | 10.6                                 | 202.3                                    | 5.6                         | 0.52                                       | 0.44  | 137.5                   | 0.52                                       | 1.03     | 1.61*    | 1.87             | 0.58                       | 0.43                       | 0.16                        |
| 6,700 - 6,940 <sup>a</sup>   | 435.1                                    | 190.8                                    | 42.7                           | 211.4                               | 1.03                     | 10.3                        | 2.3                                  | 42.3                                     | 4.5                         | 0.54                                       | 0.44  | 233.5                   | 0.54                                       | 1.07     | 0.91*    | 2.02             | 0.48                       | 0.41                       | 0.16                        |
| 7,450 - 7,530                | 235.2                                    | 127.2                                    | 21.3                           | 67.3                                | 0.33                     | 3.3                         | 4.5                                  | 71.3                                     | 6.0                         | 0.63                                       | 0.54  | 148.5                   | 0.63                                       | 1.04     | 1.46*    | 2.08             | 0.53                       | 0.42                       | 0.14                        |
| 8,460 - 8,550                | 205.9                                    | 84.4                                     | 15.1                           | 142.9                               | 0.48                     | 4.8                         | 2.1                                  | 42.9                                     | 5.6                         | 0.48                                       | 0.41  | 99.5                    | 0.48                                       | 0.98     | 0.74*    | 2.10             | 0.52                       | 0.42                       | 0.22                        |
| 9,560 - 9,650                | 240.5                                    | 93.5                                     | 34.5                           | 177.5                               | 0.42                     | 4.2                         | 3.1                                  | 57.3                                     | 2.7                         | 0.53                                       | 0.39  | 128.0                   | 0.53                                       | 0.97     | 1.65     | 2.10             | 0.49                       | 0.41                       | 0.20                        |
| 10,470 - 10,540              | 240.8                                    | 87.2                                     | 23.7                           | 132.5                               | 0.23                     | 2.3                         | 4.8                                  | 104.7                                    | 3.7                         | 0.46                                       | 0.36  | 110.8                   | 0.46                                       | 0.97     | 0.90*    | 2.04             | 0.51                       | 0.43                       | 0.16                        |
| 10,970 - 11,040              | 217.4                                    | 64.2                                     | 10.5                           | 92.0                                | 0.13                     | 1.3                         | 5.7                                  | 167.2                                    | 6.1                         | 0.34                                       | 0.30  | 74.6                    | 0.34                                       | 1.07     | 1.15     | 1.96             | 0.48                       | 0.43                       | 0.12                        |
| 11,460 - 11,540              | 182.6                                    | 62.2                                     | 7.5                            | 147.3                               | 0.16                     | 1.6                         | 4.4                                  | 114.1                                    | 8.3                         | 0.38                                       | 0.34  | 69.7                    | 0.38                                       | 1.10     | 0.97*    | 2.08             | 0.62                       | 0.40                       | 0.25                        |
| 11,970 - 12,050              | 185.6                                    | 64.5                                     | 30.8                           | 102.7                               | 0.13                     | 1.3                         | 7.3                                  | 142.8                                    | 2.1                         | 0.51                                       | 0.35  | 95.3                    | 0.51                                       | 1.06     | 0.94*    | 1.79             | 0.65                       | 0.42                       | 0.15                        |
| 12,450 - 12,650 <sup>b</sup> | 585.0                                    | 312.5                                    | 31.5                           | 216.5                               | 0.12                     | 1.2                         | 28.7                                 | 487.5                                    | 9.9                         | 0.59                                       | 0.53  | 344.0                   | 0.59                                       | 0.89     | 0.83*    | 1.89             | 0.63                       | 0.43                       | 0.18                        |
| 12,960 - 13,040              | 197.5                                    | 93.1                                     | 17.3                           | 130.2                               | 0.16                     | 1.6                         | 6.9                                  | 123.5                                    | 5.4                         | 0.56                                       | 0.47  | 110.4                   | 0.56                                       | 0.99     | 1.22*    | 1.90             | 0.59                       | 0.42                       | 0.17                        |
| 13,630 - 13,640              | 122.3                                    | 34.9                                     | 7.6                            | 117.7                               | 0.09                     | 0.9                         | 4.7                                  | 124.8                                    | 4.6                         | 0.38                                       | 0.31  | 42.5                    | 0.38                                       | 1.20     | 0.78*    | 2.22             | 0.36                       | 0.32                       | 0.09                        |
| 13,980 - 14,030              | 298.4                                    | 176.7                                    | 30.2                           | 116.3                               | 0.25                     | 2.5                         | 8.3                                  | 119.4                                    | 5.9                         | 0.69                                       | 0.59  | 206.9                   | 0.69                                       | 0.99     | 0.87*    | 2.09             | 0.37                       | 0.38                       | 0.11                        |
| 14,440 - 14,510              | 85.8                                     | 31.8                                     | 4.4                            | 101.7                               | 0.08                     | 0.8                         | 4.5                                  | 107.2                                    | 7.3                         | 0.42                                       | 0.37  | 36.2                    | 0.42                                       | 1.04     | 1.09     | 2.19             | 0.53                       | 0.37                       | 0.11                        |

<sup>a</sup> excludes 6,810 - 6,820

<sup>b</sup> excludes 12,570 - 12,580

\* unresolved peaks not included in ratio

Jurassic sediments range from 6,650 feet to at least 11,420 feet. Below this, the rock units could not be conclusively dated because of the lack of diagnostic index fossils (see **Biostratigraphy** chapter). For the purpose of source-rock characterization, rock units from 11,420 feet to total well depth of 15,568 feet will be included with the Jurassic. The average total organic carbon for this interval is 0.14 weight percent (table 9). The average extractable hydrocarbon for this interval is only 130 ppm (table 10). These source-rock richness parameters suggest that the concentration of organic matter in Jurassic strata penetrated by the well is in the poor range.

In predominantly carbonate or calcareous shale potential source beds, the degree of preservation of organic matter is critical in assessing hydrocarbon source potential. During the Late Jurassic, a strongly oxidizing environment may have affected organic matter deposited in the Georges Bank Basin. The isoprenoid hydrocarbon ratio of pristane-to-phytane ranges from 1.79 to 2.22 (table 10), which is consistent with oxidizing environments. If low sedimentation rates existed within the basin near the Shell LC Block 410 No. 1R well, these conditions would favor the destruction rather than preservation of organic matter and may explain, in part, why the total organic carbon values are poor. The organic richness of time-equivalent rocks in the COST G-1 well is slightly better than in the Shell LC Block 410 No. 1R well.

### **Thermal Maturity**

The two optical methods used to determine thermal alteration for kerogen, vitrinite reflectance done by Shell (figure 11) and thermal alteration index (TAI) (figure 10) by Minerals Management Service, do not agree. Differences such as these are not uncommon and can be caused by sample caving, reworking, oxidation, sample contamination, or the lack of an indigenous vitrinite population in a carbonate section.

The vitrinite reflectance data indicate that kerogen has reached sufficient thermal maturity to generate hydrocarbons at 9,000 feet with peak generation occurring at approximately 13,000 feet (figure 11). TAI data do not show maturation until 13,300 feet, and even then the TAI values are borderline.

The concept of a thermal maturation window for hydrocarbon generation was first suggested by Larskaya and Zhabrev (1964). These authors observed that the generation of hydrocarbons from shales increases logarithmically with depth of burial and higher temperature. The same increase in hydrocarbon generation with depth in other sedimentary basins was observed in Philippi (1965), Louis and Tissot (1967), and Albrecht (1970). Vassoevich and others (1969) described the generation zone as the principal phase of oil formation or oil window. Connan (1974) defined the depth at which the first significant hydrocarbon generation occurs as the “threshold of intense oil generation” (TIOG).

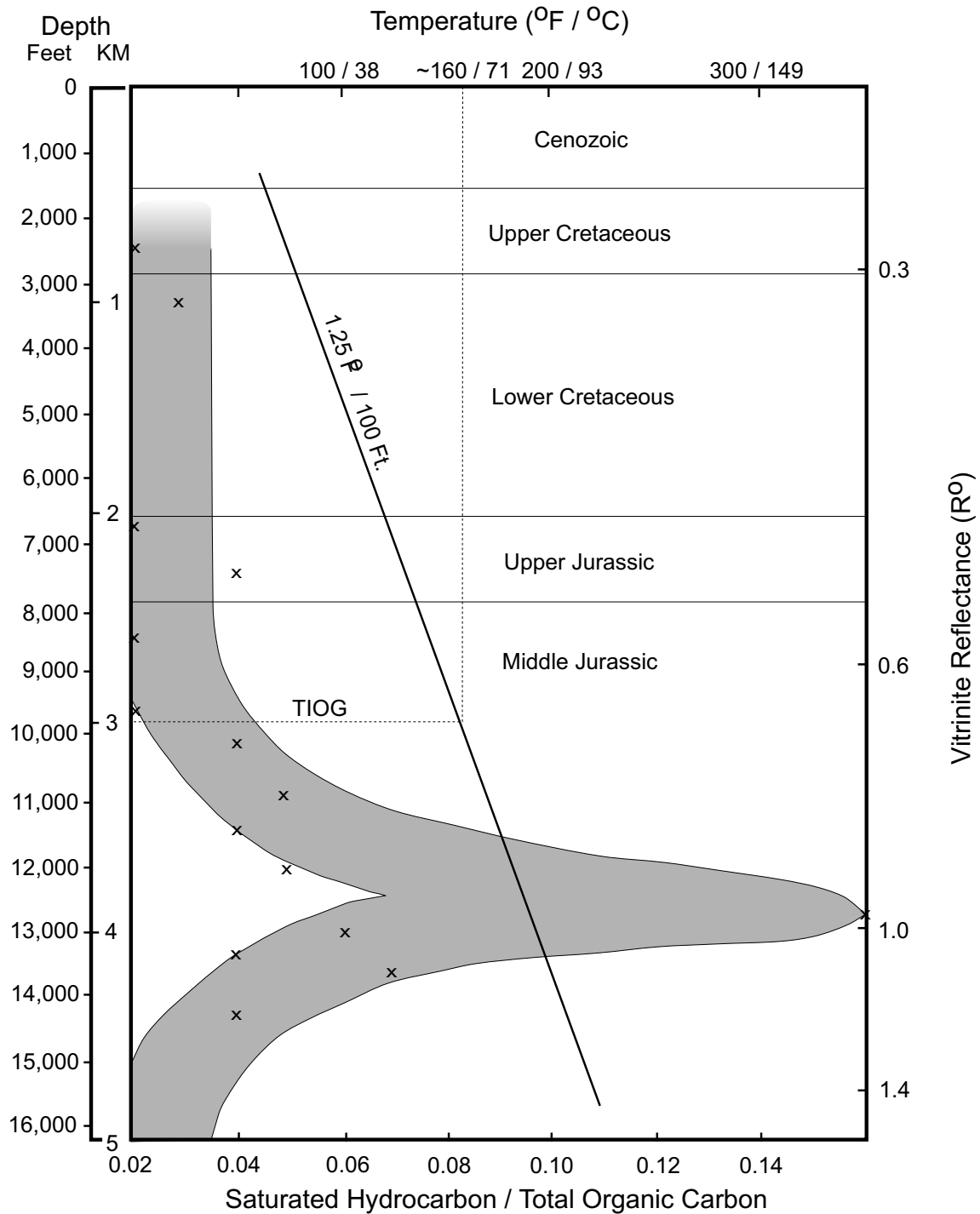

Figure 11. Hydrocarbon evolution window, geothermal gradient, and vitrinite reflectance values plotted against well depth for the Shell Lydonia Canyon Block 410 No. 1R well. Vitrinite reflectance data from Shell.

The petroleum window, described in the preceding paragraph, is applied to the Shell LC Block 410 No. 1R well in figure 11, which presents a plot of the ratio of the concentration of saturated paraffin-naphthene hydrocarbons to total-organic carbon as a function of well depth. The illustration also shows the present geothermal gradient of 1.25 °F/100 ft. This hydrocarbon evolution curve shows that the TIOG begins at approximately 9,800 feet at a temperature of 160 °F. Peak thermal evolution occurs between 12,792 and 13,776 feet. The transition phase from mature oil to condensates would be expected below about 14,760 feet.

The hydrocarbon evolution window for this well, determined by molecular geochemical means, is in closer agreement with Shell's vitrinite reflectance data than the MMS TAI results. Further, the molecular geochemical-based hydrocarbon evolution window for the well is in close agreement with the windows for the COST G-1 and G-2 wells. However, in both COST wells the vitrinite and TAI data indicate a much shallower zone of thermal organic maturity than the molecular geochemical data (Miller and others, 1982). Because of the low organic content and poor kerogen preservation in the Shell LC Block 410 No. 1R well, the accuracy of conventional organic petrologic techniques is limited.

### **Time-Temperature Burial Model**

The burial model for the sedimentary units of the Shell LC Block 410 No. 1R well (figure 12) is based on biostratigraphic determinations of the MMS

paleontological staff (figure 7) and the Cretaceous and Jurassic time scale of Van Hinte (1976a and 1976b). The burial model for this well is similar to those of the COST G-1, G-2, and the other exploratory wells on Georges Bank. The oldest rocks identified in the Shell well are Middle Jurassic Bajocian ?- early Bathonian. Below 11,420 feet, the section is indeterminate, owing to absence of age-diagnostic fossils. Based on well temperatures, the identified early Bathonian strata are barely into the present-day zone of borderline thermal maturity for petroleum generation. Peak generation, at about 13,000 feet, is in the indeterminate interval of the lowermost 4,148 feet of the well.

The burial history curve for the Shell LC Block 410 No. 1R well shows decreasing subsidence and sediment loading through geologic time. The Triassic-Early Jurassic rifting stage, shown in diagrams for other Georges Bank wells, is not seen here because of the indeterminate section. Rapid Middle Jurassic subsidence is shown in the Bathonian, decreasing slightly through the rest of the Jurassic and through the Early Cretaceous, including the Aptian age. Finally, a Late Cretaceous-Cenozoic quiet period has even less subsidence, which has continued to the present. For other Georges Bank wells, on the basis of the present-day geothermal gradient, Upper Triassic and perhaps lower Lower Jurassic sediments became thermally mature for petroleum generation 60 to 70 million years ago. Rocks of these ages were not identified in the Shell LC Block 410 No. 1R well. However, the lower part of the indeterminate-age section should have

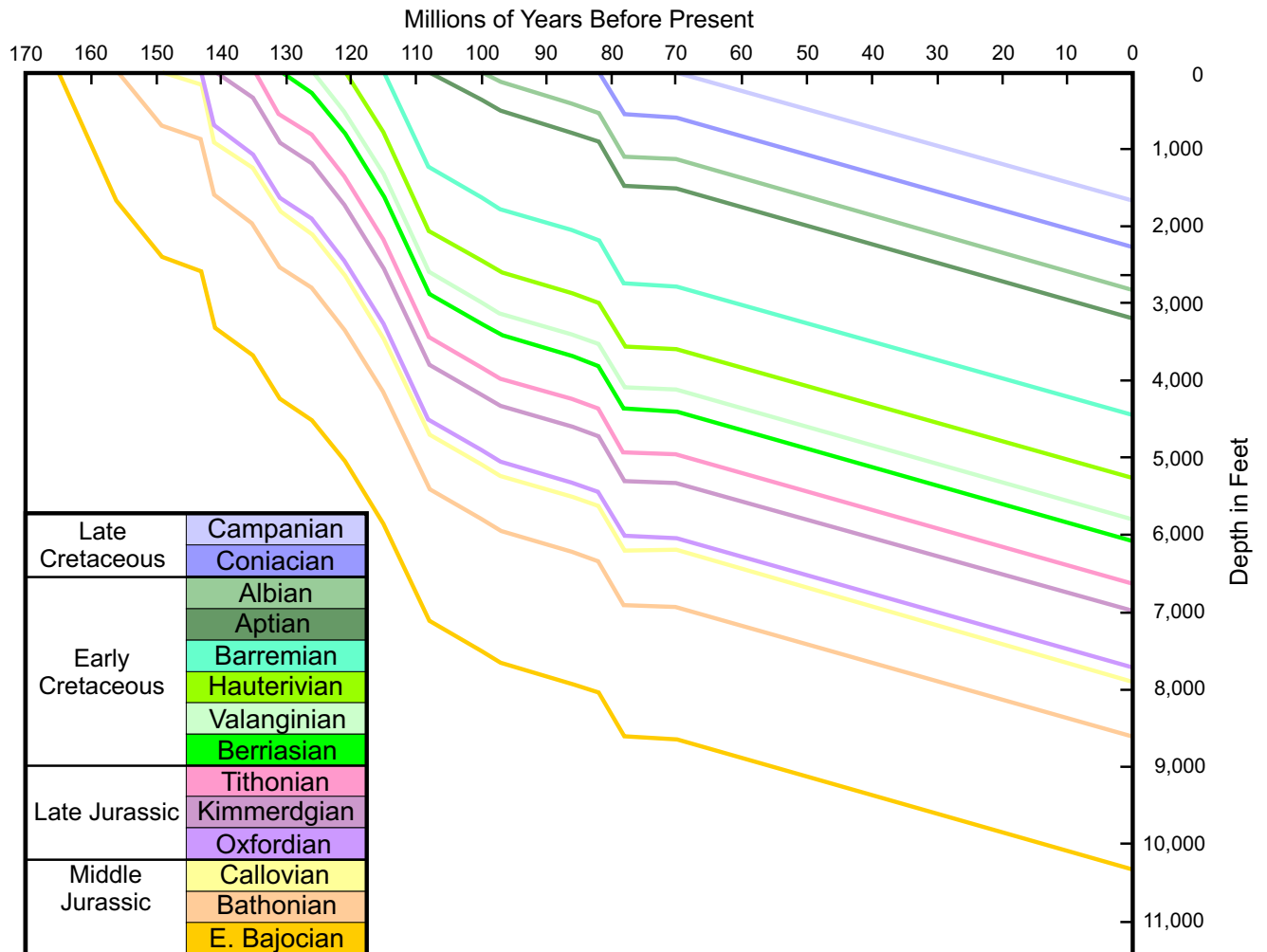

Figure 12. Burial diagram for the Shell Lydonia Canyon Block 410 No. 1R well.

become thermally mature in the last 60 to 70 million years. However, these rocks are organically very lean.

### **CONCLUSIONS**

Samples to a depth of 8,500 feet contain intervals where algal-amorphous kerogens are present. Below 7,000 feet, however, terrestrial Type-III kerogens predominate.

Total organic carbon data suggest that organic richness is poor for Upper Jurassic and deeper rocks. Comparison with source-rock quality of the COST G-1 and G-2 wells indicates slightly higher values in the COST wells for rocks of equivalent time-stratigraphic ranges.

Thermal-maturity profiles generated by vitrinite-reflectance and molecular-geochemical data indicate that the threshold of intense oil generation begins at a depth near 9,800 feet. Below this depth kerogens are mature enough to generate hydrocarbons; however, the organic richness of the shales and carbonates is low to the point of being nonprospective.

Thermal maturation determinations based on the concept of hydrocarbon evolution as a function of increasing temperature and burial time, and measured by the ratio of saturated hydrocarbons-to-total organic carbon, show that peak hydrocarbon generation occurs between 12,792 and 13,776 feet. The transition from oil to wet gas and condensates will most likely occur below about 14,760 feet.

## COMPANY-SUBMITTED DATA

Data and reports were submitted by Shell Offshore, Inc., to MMS when the Shell Lydonia Canyon Block No. 1R well was drilled, as required by Federal regulations and lease stipulations. Items of general geological, geophysical, and engineering usefulness are listed below. Items not listed include routine required submittals, such as the Exploration Plan, Application for Permit to Drill, and daily drilling reports, and detailed operations information, such as drilling pressure and temperature data logs. Well "electric" logs are listed in the **Formation Evaluation** chapter. Listed and unlisted company reports and data are available through the Public Information Unit, Minerals Management Service, Gulf of Mexico

OCS Region, 1201 Elmwood Park Boulevard, New Orleans, Louisiana 70123-2394; telephone (504)736-2519 or 1-800-200-GULF, FAX (504)736-2620. Well logs are available on microfilm from the National Geophysical Data Center, 325 Broadway Street, Boulder CO 80303-3337, attn. Ms Robin Warnken; telephone (303) 497-6338, FAX (303)497-6513; e-mail rwarnken@NGDC.NOAA.GOV.

At a later date, additional original technical data, including well logs, will be added to the compact disk (CD) version of the Georges Bank well reports. The CD will be available from the Gulf of Mexico OCS Region Public Information Unit.

## SELECTED COMPANY-SUBMITTED DATA

Velocity survey computation (well velocity and well seismic tool data), Schlumberger Ltd., Wireline Testing, Houston TX, undated.

Physical formation ("mud") log, Exploration Logging of U.S.A., Inc., undated.

Core analysis (sidewall core), Core Laboratories, Inc., Dallas TX, undated.

Core analysis data (porosity, permeability, and grain density, cores 1 and 2), Shell development Co., Petrophysical Services Laboratory (PSL), 10/12/81, core 1, 04/22/81, core 2.

Photographs, cores 1 and 2, PSL, 10/81, core 1, date unknown for core 2.

## SELECTED REFERENCES

This list is compiled from published and unpublished Minerals Management Service and USGS Conservation Division reports on Georges Bank wells. Not all of the references could be located and verified.

- Albrecht, P., 1970, Etude de constituents organiques des series sedimentaries de Logbaba et Messel. Transformations deagenetiques: Universite de Strasbourg, Memoires du Service de la Charge Geologique d'Alsac et de Lorraine, no. 32, 119 p.
- Amato, R.V. and J.W. Bebout, 1978, Geological and Operational Summary, COST No. GE-1 Well, Southeast Georgia Embayment Area, South Atlantic OCS: U. S. Geological Survey Open-File Report 78-668, 122 p.
- Amato, R. V. and J. W. Bebout (eds.), 1980, Geologic and Operational Summary, COST No. G-1 Well, Georges Bank Area, North Atlantic OCS: U. S. Geological Survey Open-File Report 80-268, 112 p.
- Amato, R.V., and E.K. Simonis (eds.), 1979, Geologic and Operational Summary, COST No. B-3 Well, Baltimore Canyon Trough Area, Mid-Atlantic OCS: U.S. Geological Survey Open-File Report 79-1159, 118 p.
- Amato, R.V. and E.K. Simonis,(eds.), 1980, Geologic and Operational Summary, COST No. G-2 Well, Georges Bank Area, North Atlantic OCS: U. S. Geological Survey Open-File Report 80-269, 116 p.
- BBN-Geomarine Services Co., 1975, COST wellsite G-1, Georges Bank, engineering geology interpretation of high-resolution geophysical data: Houston, Texas, 11 p.
- Ballard, R. D. and E. Uchupi, 1975, Triassic rift structure in Gulf of Maine: American Association of Petroleum Geologists Bulletin, v. 59, no. 7, p. 1041-1072.
- Bayliss, G. S., 1980, Source-rock evaluation reference manual: Houston, Texas, Geochem Laboratories, Inc., 80 p.
- Bebout, J. W., 1980, Observed stratigraphic distribution of spores, pollen, and *incertae sedis* palynomorphs in the Tertiary section of the COST No. B-2 well, Baltimore Canyon, Atlantic Outer Continental Shelf: Palynology, v. 4, p. 181-196.
- Bebout, J. W., 1981, An informal palynologic zonation for the Cretaceous System of the United States Mid-Atlantic (Baltimore Canyon area) Outer Continental Shelf: Palynology, v. 5, p. 159-194.
- Berggren, W.A., D.V. Kent, C.C. Swisher III, and M.P. Aubry, 1995, A revised Cenozoic geochronology and chronostratigraphy; in Geochronology Time Scales and Global Stratigraphic Correlation, SEPM Special Publication no. 54, p. 129-212.
- Bhat, H., N. J. McMillan, J. Aubert, B. Porthault, and M. Surin, 1975, North American and African drift--the record in Mesozoic coastal plain rocks, Nova Scotia and Morocco, in Yorath, C. J., E. R. Parker, and D. J. Glass, (eds.), Canada's Continental Margins and Offshore Petroleum Exploration: Canadian Society of Petroleum Geologists Memoir 4, p. 375-389.
- Brideau, W. W. and W. C. Elsick, (eds.), 1979, Contributions of stratigraphic palynology (v. 2), Mesozoic Palynology: American Association of Stratigraphic Palynologists Contributions Series No. 4.



- Bronnimann, P., 1955, Microfossils *incertae sedis* from the Upper Jurassic and Lower Cretaceous of Cuba: *Micropaleontology*, v. 1, pp. 28, 2 pl., 10 text.
- Bujak, J. P., M. S. Barss, and G. L. Williams, 1977, Offshore east Canada's organic type and color and hydrocarbon potential: *Oil and Gas Journal*, v. 75, no. 15, p. 96-100.
- Bujak, J. P. and M. J. Fisher, 1976, Dinoflagellate cysts from the Upper Triassic of Arctic Canada: *Micropaleontology*, v. 22, p. 44-70, 9 pls.
- Bujak, J. P. and G. L. Williams, 1977, Jurassic palynostratigraphy of offshore eastern Canada, *in* Swain, F. M., (ed.), *Stratigraphic Micropaleontology of Atlantic Basin and Borderlands*: New York, Elsevier Scientific Publishing Co., p. 321-339.
- Bukry, D., 1969, Upper Cretaceous coccoliths from Texas and Europe: *University of Kansas Paleontological Contributions*, Art. 5 (Protista 2), p. 1-9, 50 pl., 1 text.
- Burk, C. A. and C. L. Drake, (eds.), 1974, *Geology of Continental Margins*: New York, Springer-Verlag, 1,009 p.
- Burke, K., 1975, Atlantic evaporites formed by evaporation of water spilled from Pacific, Tethyan, and southern oceans: *Geology*, v. 3, no. 11, p. 613-616.
- Cepek, P. and W. W. Hay, 1970, Zonation of the Upper Cretaceous using calcareous nannoplankton: *Palaontologische Abhandlungen, Abteilung B Palabotanik, Band III, Heft 3/4*, p. 333-340.
- Cita, M. B. and S. Gartner, 1971, Deep Sea Upper Cretaceous from the western North Atlantic: *in* *Proceedings II International Planktonic Conference, Roma, 1970*: Rome, Edizioni Tecnoscienza, v. 1, p. 287-319.
- Clarke, R. F. A. and J. P. Verdier, 1967, An investigation of microplankton assemblages from the chalk of the Isle of Wight, England: *Verhandelingen der Koninklijke Nederlandse Akademie van Wetenschappen, Afdeling Natuurkunde, and Eerste Reeks*, 24, p. 1-96.
- Claypool, G. E., C. M. Lubeck, J. P. Baysinger, and T. G. Ging, 1977, Organic geochemistry, *in* Scholle, P. A., (ed.), *Geological studies on the COST No. B-2 well, U. S. Mid-Atlantic Outer Continental Shelf area*: U. S. Geological Survey Circular 750, p. 46-59.
- Connan, J. 1974, Time-temperature relation in oil genesis: *American Association of Petroleum Geologists Bulletin*, v. 58, no. 12, p. 2516-2521.
- Core Laboratories, Inc., 1976, *Core studies, COST Atlantic well No. G-1, Georges Bank, Offshore Atlantic Ocean*: Dallas, Texas, 153 p.
- Core Laboratories, Inc., 1977a, *Core studies, COST Atlantic well No. G-2, Georges Bank, Offshore Atlantic Ocean*: Dallas, Texas, 298 p.
- Core Laboratories, Inc., 1977b, *Geochemical service report, COST G-2 Atlantic well, Georges Bank, offshore Massachusetts, U. S. A.*: Dallas, Texas, 147 p.
- Council on Environmental Quality, 1974, *OCS oil and gas--An environmental assessment--A report to the President by the Council on Environmental Quality*: Washington, D. C. (U. S. Government Printing Office), Stock No. 4000-00322, v. 1, 214 p.

- Cousminer, H. L., 1984, Canadian dinoflagellate zones (Middle Jurassic to Middle Eocene) in Georges Bank Basin (abstract): Proceedings of the American Association of Stratigraphic Palynologists, Arlington, Virginia, v. 9, p. 238.
- Cousminer, H. L., W. E. Steinkraus, and C. E. Fry, 1982, Biostratigraphy and thermal maturation profile, Exxon 133 No. 1 (OCS-A-0170) well section: Unpublished Report, Minerals Management Service.
- Cousminer, H. L., W. E. Steinkraus, and R. E. Hall, 1984, Biostratigraphic restudy documents Triassic/Jurassic section in Georges Bank COST G-2 well (abstract): Proceedings of the American Association of Petroleum Geologists, Annual Meeting, San Antonio, Texas, v. 68, no. 4, p. 466.
- Davey, R. J., 1979, The stratigraphic distribution of dinocysts in the Portlandian (latest Jurassic) to Barremian (Early Cretaceous) of northwest Europe: American Association of Stratigraphic Palynologists Contributions, Series No. 5B, p. 49-81.
- Davey, R. J. and J. P. Verdier, 1974, Dinoflagellate cysts from the Aptian type sections at Gargas and La Bedoule, France: Paleontology, v. 17, pt. 3, p. 623-653.
- Davies, E. H., 1985, The miospore and dinoflagellate cyst zonation of the Lias of Portugal: Palynology, v. 9, p. 105-132.
- Dorhofer, G. and E. H. Davies, 1980, Evolution of archeopyle and tabulation in Rhaetogonyaulacian dinoflagellate cysts: Royal Ontario Museum, Life Sciences Miscellaneous Publications, p. 1-91, fig. 1-40.
- Dow, W. G., 1974, Application of oil-correlation and source-rock data to exploration in Williston Basin: American Association of Petroleum Geologists Bulletin, v. 58, no. 7, p. 1253-1262.
- Dow, W. G., 1977, Kerogen studies and geological interpretations: Journal of Geochemical Exploration, v. 7, p. 79-99.
- Drake, C. L., J. I. Ewing, and H. Stockard, 1968, The continental margin of the eastern United States: Canadian Journal of Earth Science, v. 5, no. 4, p. 993-1010.
- Drake, C. L., M. Ewing, and G. H. Sutton, 1959, Continental margins and geosynclines--The east coast of North America north of Cape Hatteras, in Aherns, L. H., and others, (eds.), Physics and Chemistry of the Earth, v. 3: New York, Pergamon, p. 110-198.
- Eliuk, L. S., 1978, the Abenaki Formation, Nova Scotia, Canada--A depositional and diagenetic model for a Mesozoic carbonate platform: Bulletin of Canadian Petroleum Geology, v. 26, no. 4, p. 424-514.
- Emery, K. O. and E. Uchipi, 1972, Western North Atlantic Ocean--Topography, rocks, structure, water, life, and sediments: American Association of Petroleum Geologists Memoir 17, 532 p.
- Evitt, W. R., (ed.), 1975, Proceedings of a forum on dinoflagellates: American Association of Stratigraphic Palynologists Contributions, Series No. 4, 76 p.
- Folger, D. W., 1978, Geologic hazards on Georges Bank--an overview: Geological Society of America Abstracts with Programs, v. 10, no. 1, p. 42.
- Fry, C. E., 1979, Geothermal gradient, in Amato, R. V. and E. K. Simonis (eds.), Geologic and Operational Summary, COST No. B-3 well, Baltimore Canyon Trough Area, Mid-Atlantic OCS: U. S. Geological Survey Open-File Report 79-1159, p. 64-65.

- Gartner, S., Jr., 1968, Coccoliths and related calcareous nannofossils from Upper Cretaceous deposits of Texas and Arkansas: University of Kansas Paleontological Contributions, no. 48, Protista, v. 48, Art. 1, p. 1-56.
- GeoChem Laboratories, Inc., 1976, Hydrocarbon source facies analysis, COST Atlantic G-1 well, Georges Bank, offshore Eastern United States: Houston, Texas, 10 p.
- GeoChem Laboratories, Inc., 1977, Hydrocarbon source facies analysis, COST Atlantic G-2 well, Georges Bank, offshore eastern United States: Houston, Texas, 66 p.
- Gibson, T. G., 1970, Late Mesozoic-Cenozoic tectonic aspects of the Atlantic coastal margin: Geological Society of America Bulletin, v. 81, no. 6, p. 1813-1822.
- Gitmez, G. U. and W. A. S. Sarjeant, 1972, Dinoflagellate cysts and acritarchs from the Kimmeridgian (Upper Jurassic) of England, Scotland and France: Bulletin of the British Museum of Natural History: Geology, v. 21, p. 171-257.
- Given, M. M., 1977, Mesozoic and Early Cenozoic geology of offshore Nova Scotia: Bulletin of Canadian Petroleum Geology, v. 25, p. 63-91.
- Gocht, H., 1970, Dinoflagellaten-Zysten aus dem Bathonium des erdolfeldes Aldorf (Northwest-Setuschland): Palaeontographica, Abt. B., v. 129, p. 125-165.
- Gorka, H., 1963, Coccolithophorides, Dinoflagellates, Hystrichosphaerides et microfossiles *incertae sedis* du Cretace superier de Pologne: Acta Palaeontologica Polonica, v. 8, p. 1-82.
- Gradstein, F.M., F.P.Achterberg, J.G. Ogg, J.Hardenbol, P. van Veen, and Z. Huang, 1995, A Triassic, Jurassic, and Cretaceous time scale; *in* Geochronology Time Scales and Stratigraphic Correlation, SEPM Special Publication no. 54, p. 95-126.
- Grose, P. L. and J. S. Mattson, 1977, The Argo Merchant oil spill--A preliminary scientific report: National Oceanic and Atmospheric Administration Environmental Research Laboratories, 129 p.
- Grow, J. A., R. E. Mattick, and J. S. Schlee, 1979, Multichannel seismic depth sections and interval velocities over continental shelf and upper continental slope between Cape Hatteras and Cape Cod, *in* Watkins, J. S., L. Montadert, and P. W. Dickerson, (eds.), Geological and Geophysical Investigations of Continental Margins: American Association of Petroleum Geologists Memoir 29, p. 65-83.
- Harwood, R. J., 1977, Oil and gas generation by laboratory pyrolysis of kerogen: American Association of Petroleum Geologists Bulletin, v. 61, no. 12, p. 2082-2102.
- Hill, M. E., III, 1976, Lower Cretaceous Nannofossils from Texas and Oklahoma: Paleontographica, Abteilung B, 156, Lfg. 4-6, p. 103-179.
- Hunt, J. M., 1967, The origin of petroleum in carbonate rocks: *in* G. V. Chilingar, H. S. Bissell, and R. W. Fairbridge, (eds.), Carbonate Rocks: New York, Elsevier, p. 225-251.
- Hunt, J. M., 1974, Hydrocarbon and kerogen studies, *in* C. C von der Borch and others, Initial Reports of the Deep Sea Drilling Project, v. 22: Washington, D. C., U. S. Government Printing Office, p. 673-675.
- Hunt, J. M., 1978, Characterization of bitumens and coals: American Association of Petroleum Geologists Bulletin, v. 62, no. 2, p. 301-303.
- Hunt, J. M., 1979, Petroleum Geochemistry and Geology: San Francisco, W. H. Freeman Co., p. 273-350.

- Hurtubise, D. O. and J. H. Puffer, 1985, Nepheline normative alkalic dolerite of the Georges Bank Basin, North Atlantic, part of an Early Cretaceous eastern North American alkalic province: Geological Society of America, Northeastern Section, 20th Annual Meeting, 1985, v. 17, no. 1, p. 25.
- Hurtubise, D. O., J. H. Puffer, and H. L. Cousminer, 1987, An offshore Mesozoic igneous sequence, Georges Bank Basin, North Atlantic: Geological Society of America Bulletin, v. 98, no. 4, p. 430-438.
- International Biostratigraphers, Inc., 1976, Biostratigraphy of the COST G-1 Georges Bank test: Houston, Texas, 16 p.
- International Biostratigraphers, Inc., 1977, Biostratigraphy of the COST G-2 Georges Bank test: Houston, Texas, 16 p.
- Jansa, L. F. and J. A. Wade, 1975, Geology of the continental margin off Nova Scotia and Newfoundland, *in* W. J. M van der Linden and J. A. Wade (eds.), Offshore Geology of Eastern Canada: Geological Survey of Canada Paper 74-30, v. 2, p. 51-105.
- Jansa, L. F. and J. Wiedmann, 1982, Mesozoic-Cenozoic development of the eastern North American and northwest African continental margins: a comparison, *in* V. von Rad, K. Hinz, M. Sarnthein, and E. Seibold (eds.), Geology of the Northwest African Continental Margin: Berlin, Springer-Verlag, p. 215-269.
- Jansa, L. F., G. L. Williams, J. A. Wade, and J. P. Bujak, 1978, COST B-2 well (Baltimore Canyon) and its relation to Scotian Basin (abstract): American Association of Petroleum Geologists Bulletin, v. 62, no. 3, p. 526.
- Jones, R. W. and T. A. Edison, 1978, Microscopic observations of kerogen related to geochemical parameters with emphasis on thermal maturation, *in* D. F. Oltz (ed.), Geochemistry: Low Temperature Metamorphism of Kerogen and Clay Minerals: Society of Economic Paleontologists and Mineralogists, Pacific Section, Annual Meeting, Los Angeles, p. 1-12.
- Kent, D. V. and F. M. Gradstein, 1986, A Jurassic to Recent chronology, *in* P. R. Vogt and B. E. Tucholke (eds.), The Geology of North America, vol. M, The Western North Atlantic Region: Geological Society of America, p. 45-50.
- King, L. H. and B. MacLean, 1975, Geology of the Scotian Shelf and adjacent areas: Canadian Geological Survey Paper 74-23, p. 22-53.
- Kinsman, D. J. J., 1975, Rift Valley basins and sedimentary history of trailing continental margins, *in* A. G. Fisher and S. Judson, (eds.), Petroleum and Global Tectonics: Princeton, Princeton University Press, p. 83-126.
- Kjellstrom, G., 1973, Maastrichtian microplankton from the Hollviken borehole No. 1 in Scania, southern Sweden: Sveriges Geologiska Undersokning, Afhandlingar och Uppsatser, v. 7, p. 1-59.
- Landes, K. K. 1967, Eometamorphism and oil and gas in time and space: American Association of Petroleum Geologists Bulletin, v. 51, no. 6, p. 828-841.
- LaPlante, R. E., 1974, Hydrocarbon generation in Gulf Coast tertiary sediments: American Association of Petroleum Geologists Bulletin, v. 58, no. 7, p. 1281-1289.

- Larskaga, Ye. S. and D. V. Zhabreu, 1964, Effects of stratal temperatures and pressures on the composition of dispersed organic matter (from the example of the Mesozoic-Cenozoic deposits of the Western Ciccaspian region): Dokl. Akad. Nauk SSSR, v. 157, no. 4, pp. 135-139.
- Lentin, J. K. and G. L. Williams, 1981, Fossil Dinoflagellates, Index to Genera and Species: Bedford Institute of Oceanography Report Series B1-R-81-12, p. 1-345.
- Louis, M. C. and B. P. Tissot, 1967, Influence de la temperature et de la pression sur la formation des hydrocarbures dans les argiles a kerogen [Influence of temperature and pressure on the generation of hydrocarbons in shales containing kerogen], *in* 7th World Petroleum Congress, Proceedings, (Mexico), v. 2: Chichester, International, John Wiley and Sons, p. 47-60.
- Lowell, J. D., G. J. Genik, T. H. Nelson, and P. M. Tucker, 1975, Petroleum and plate tectonics of the southern Red Sea, *in* A. G. Fisher and S. Judson, (eds.), Petroleum and Global Tectonics: Princeton University Press, Princeton, p. 129-153.
- McIver, N. L., 1972, Cenozoic and Mesozoic stratigraphy of the Nova Scotia shelf: Canadian Journal of Earth Sciences, v. 9, p. 54-70.
- MacLean, B.C., and J.A. Wade, 1992, Petroleum geology of the continental margin south of the islands of St. Pierre and Miquelon, offshore eastern Canada; Bulletin of Canadian Petroleum Geology, v. 40, no. 3, p. 222-253.
- Maher, J. C., 1971, Geologic Framework and Petroleum Potential of the Atlantic Coastal Plain and Continental Shelf: U. S. Geological Survey Professional Paper 659, 98 p.
- Martini, E., 1971, Standard Tertiary and Quaternary calcareous nannoplankton zonation *in* Proceedings II International Planktonic Conference, Roma, 1970: Rome, Edizioni Tecnoscienza, p. 739-785.
- Mattick, R. E., R. Q. Foote, N. L. Weaver, and M. S. Grim, 1974, Structural framework of United States Atlantic Outer Continental Shelf north of Cape Hatteras: American Association of Petroleum Geologists Bulletin, v. 58, no. 6, 1179-1190.
- Miller, R. E., H. E. Lerch, G. E. Claypool, M. A. Smith, D. K. Owings, D. T. Lignon, and S. B. Eisner, 1982, Organic geochemistry of the Georges Bank basin COST Nos. G-1 and G-2 wells, *in* P. A. Scholle and C. R. Wenkam (eds.), Geological Studies of the COST Nos. G-1 and G-2 Wells, Unites States North Atlantic Outer Continental Shelf: U. S. Geological Survey Circular 861, p. 105-142.
- Miller, R. E., R. E. Mattick, and H. E. Lerch, 1981, Petroleum geochemistry and geology of Cenozoic and Mesozoic sedimentary rocks from Georges Bank basin (abstract): American Association of Petroleum Geologists Bulletin, v. 65, no. 9, p. 1667.
- Miller, R. E., D. M. Schultz, G. E. Claypool, H. E. Lerch, D. T. Lignon, C. Gary, and D. K. Owings, 1979, Organic geochemistry, *in* , P. A. Scholle (ed.), Geological Studies of the COST GE-1 Well, United States South Atlantic Outer Continental Shelf Area: U. S. Geological Survey Circular 800, p. 74-92.
- Miller, R. E., D. M. Schultz, G. E. Claypool, M. A. Smith, H. E. Lerch, D. Ligon, D. K. Owings, and C. Gary, 1980, Organic geochemistry, *in* P.A. Scholle (ed.), Geological Studies of the COST No. B-3 Well, United States Mid-Atlantic Continental Slope Area: U. S. Geological Survey Circular 833, p. 85-104.
- Miller, R. E., D. M. Schultz, H. E. Lerch, D. T. Lignon, and P. C. Bowker, 1986, *in* Edson, G. M.(ed.), Shell Wilmington Canyon 586-1 Well, Geological and Operation Summary: Minerals Management Service, OCS Report MMS 86-0099, p. 37-44.

- Miller, R. E., D. M. Schultz, H. E. Lerch, D. T. Lignon, and P. C. Bowker, 1987, *in* Edson, G. M. (ed.), Shell Wilmington Canyon 587-1 Well, Geological and Operation Summary: Minerals Management Service, OCS Report MMS 87-0074, p. 39-46.
- Momper, J. A., 1978, Oil migration limitations suggested by geological and geochemical considerations, *in* Physical and Chemical Constraints on Petroleum Migration: American Association of Petroleum Geologists, Continuing Education Course Note Series No., 8, p. B1-B60.
- Morbey, S. J., 1975, The palynostratigraphy of the Rhaetian Stage Upper Triassic in the Kerdelbachgraben Austria: *Paleontographica Abt. B*, v. 152, p. 1-75, p. 1-19.
- Murray, G. E., 1961, *Geology of the Atlantic and Gulf Coastal Provinces of North America*: New York, Harper, 692 p.
- Orr, W. L., 1974, Changes in sulfur content and isotopic ratios of sulfur during petroleum maturation--study of Big Horn Basin Paleozoic oils: *American Association Petroleum Geologists Bulletin*, v. 58, no. 11, p. 2295-2318.
- Perry, W. J., J. P. Minard, E. G. A. Weed, E. I. Robbins, and E. C. Rhodehamel, 1975, Stratigraphy of the Atlantic continental margin of the United States north of Cape Hatteras--brief survey: *American Association of Petroleum Geologists Bulletin*, v. 59, no. 9, p. 1529-1548.
- Phillipi, G. T., 1957, Identification of oil-source beds by chemical means, *in* 20th International Geological Congress Proceedings: Mexico City (1956), Sec. 3, p. 25-38.
- Phillipi, G.T., 1965, On the depth, time, and mechanism of petroleum generation: *Geochim. Cosmochim. Acta*, v. 29, p. 1021.
- Postuma, J. A., 1971, *Manual of Planktonic Foraminifera*: New York, Elsevier, 420 p.
- Pusey, W. C., III, 1973, The ESR-kerogen method--how to evaluate potential gas and oil source rocks: *World Oil*, v. 176, no. 5, p. 71-75.
- Reinhardt, P., 1966, Zur taxonomie und biostratigraphie des fossilen nannoplanktons aus dem Malm, der Kreide und dem Alttertiar Mitteleuropas [Taxonomy and biostratigraphy of Malm, Cretaceous, and early Tertiary nannoplanktonic faunas of central Europe], *Frieberger Forschungshefte, Reihe C: Geowissenschaften, Mineralogie-Geochemie*, 196 Paleont.: Leipzig, Bergakademie Freiberg, p. 5-61.
- Ricciardi, K. (ed.), 1989, Exxon Lydonia Canyon 133-1 Well, Geological and Operational Summary: Minerals Management Service OCS Report MMS 89-0007, 46 p.
- Riding, J. B., 1984, Dinoflagellate cyst range-top biostratigraphy of the uppermost Triassic to lowermost Cretaceous of northwest Europe: *Palynology*, v.8, p. 195-210.
- Robbins, E. I. and E. C. Rhodehamel, 1976, Geothermal gradients help predict petroleum potential of Scotian Shelf: *Oil & Gas Journal*, v. 74, no. 9, p. 143-145.
- Rona, P. A., 1973, Relations between rates of sediment accumulation on continental shelf, sea-floor spreading, and eustasy inferred from central North Atlantic: *Geological Society of America Bulletin*, v. 84, no. 9, p. 2851-2872.
- Ryan, W. B. F., M. B. Cita, R. L. Miller, D. Hanselman, B. Hecker, and M. Nibbelink, 1978, Bedrock geology in New England submarine canyons: *Oceanologia Acta*, v. 1, no. 2, p. 233-254.

- Sarjeant, W. A. S., 1979, Middle and Upper Jurassic dinoflagellate cysts--the world excluding North America: American Association of Stratigraphic Palynologists Contributions Series no. 5-B, p. 133-157.
- Schlee, J. S., J. C. Behrendt, J. A. Grow, J. M. Robb, R. E. Mattick, P. T. Taylor, and B. J. Lawson, 1976, Regional geologic framework off northeastern United States: American Association of Petroleum Geologists Bulletin, v. 60, no. 6, p. 926-951.
- Schlee, J. S., W. P. Dillon, and J. A. Dillon, 1979, Structure of the continental slope off the eastern United States, *in* L. J. Doyle and O. H. Pilkey, (eds.), Geology of Continental Slopes: Society of Economic Paleontologists and Mineralogists Special Publication 27, p. 95-117.
- Schlee, J.S. and K.D. Klitgord, 1988, Georges Bank basin: a regional synthesis; *in* R.E. Sheridan and J.A. Grow (eds.), The Geology of North America, vol. I-2, The Atlantic Continental Margin, Geological Society of America, p. 243-268.
- Schlee, J. S., R. G. Martin, R. E. Mattick, W. P. Dillon, and M. M. Ball, 1977, Petroleum geology of the U. S. Atlantic--Gulf of Mexico margins, *in* V. S. Cameron (ed.), Exploration and Economics of the Petroleum Industry--New Ideas, Methods, New Developments: Southwestern Legal Foundation: New York, Mathew Bender and Co., v. 15, p. 47-93.
- Schlee, J. S., R. E. Mattick, D. J. Taylor, O. W. Girard, E. C., Rhodehamel, W. J. Perry, and K. C. Bayer, 1975, Sediments, structural framework, petroleum potential, environmental conditions and operation considerations of the United States North Atlantic Outer Continental Shelf: U. S. Geological Survey, Open-File Report 75-353, 179 p.
- Scholle, P. A. and C. R. Wenkam (eds.), 1982, Geological studies of the COST Nos. G-1 and G-2 wells, United States North Atlantic OCS: U. S. Geological Survey Circular 861, 193 p.
- Schultz, L. K. and R. L. Grover, 1974, Geology of Georges Bank Basin: American Association of Petroleum Geologists Bulletin, v. 58, no. 6, p. 1159-1168.
- Schwab, K.W., P. van Gijssel, and M.A. Smith, 1990, Kerogen evolution and microscopy workshop short course, International Symposium on Organic Petrology, Zeist, the Netherlands, January 10 and 11, 1990 (unpublished).
- Shell Canada Limited, 1970a, Well history report, Oneida O-25, 50 p.
- Shell Canada Limited, 1970b, Well history report, Mohawk B-93, 25 p.
- Shell Canada Limited, 1972, Well history report, Mohican I-100, 76 p.
- Sheridan, R. E., 1974a, Conceptual model for the block-fault origin of the North American Atlantic continental margin geosyncline: Geology, v. 2, no. 9, p. 465-468.
- Sheridan, R. E., 1974b, Atlantic continental margin of North America, *in* C. A. Burk and C. L. Drake, (eds.), Geology of Continental Margins: New York, Springer-Verlag, p. 391-407.
- Sheridan, R. E., 1976, Sedimentary basins of the Atlantic margin of North America: Tectonophysics, v. 36, p. 113-132.
- Sherwin, D. F., 1973, Scotian Shelf and Grand Banks, *in* R. G. McCrossan (ed.), Future Petroleum Provinces of Canada--Their Geology and Potential: Canadian Society of Petroleum Geologists Memoir 1, p. 519-559.

- Singh, C., 1971, Lower Cretaceous microfloras of the Peace River area, northwestern Alberta: Research Council of Alberta Bulletin 28, 2 volumes, 542 p.
- Smith, H. A., 1975, Geology of the West Sable structure: Bulletin of Canadian Petroleum Geology, v. 23, no. 1, p. 109-130.
- Smith, M. A., 1979, Geochemical analysis, *in* R. V. Amato and E. K. Simonis (eds.), Geologic and Operational Summary, COST No. B-3 Well, Baltimore Canyon Trough Area, Mid-Atlantic OCS: U. S. Geological Survey Open-File Report 79-1159, p. 81-99.
- Smith, M. A., 1980, Geochemical analysis, *in* R.V. Amato and E.K. Simonis (eds.), Geologic and Operational Summary, COST No. G-2 Well, Georges Bank Area, North Atlantic OCS: U. S. Geological Survey Open-File Report, 80-269, p. 77-99.
- Smith, M. A., 1995, Assessment of U.S. Atlantic hydrocarbon resources using new geochemical technology: U.S. Geological Society of America, Abstracts with programs, 1995 Annual Meeting, New Orleans, LA.
- Smith, M.A., R.V. Amato, M.A. Furbush, D.M. Pert, M.E. Nelson, J. S. Hendrix, L.C. Tamm, G. Wood, Jr., and D.R. Shaw, 1976, Geological and Operational Summary, COST No. B-2 Well, Baltimore Canyon Trough Area, Mid-Atlantic OCS: U. S. Geological Survey Open-File Report 76-774, 79 p.
- Smith, M. A. and D. R. Shaw, 1980, Geochemical analysis, *in* R. V. Amato and J. W. Bebout (eds.), Geologic and Operational Summary, COST No. G-1 well, Georges Bank Area, North Atlantic OCS: U. S. Geological Survey Open-File Report 80-268, p. 81-94.
- Smith, M.A., and P. van Gijzel, 1990, New perspectives on the depositional and thermal history of Georges Bank; *in* W.J.J. Fermont and J.W. Weegink (eds.), Proceedings, International Symposium on Organic Petrology, Zeist, the Netherlands.
- Smith, R. A., J. R. Stack, and R. K. Davis, 1976, An oil spill risk analysis for the Mid-Atlantic Outer Continental Shelf lease area: U. S. Geological Survey Open-File Report 76-451, 24 p.
- Staplin, F. L., 1969, Sedimentary organic matter, organic metamorphism, and oil and gas occurrence: Bulletin of Canadian Petroleum Geology, v. 17, no. 1, p. 47-66.
- Steinkraus, W. E., 1980, Biostratigraphy, *in* R. V. Amato and J. W. Bebout, (eds.), Geologic and Operation Summary, COST No. G-1 Well, Georges Bank, North Atlantic OCS: U. S. Geological Survey Open-File Report 80-268, p. 39-51.
- Stewart, H. B., Jr. and G. F. Jordan, 1964, Underwater sand ridges on Georges Shoal, *in* R. L. Miller (ed.), Papers in Marine Geology, Shepard Commemorative Volume: New York, Macmillan, p. 102-114.
- Tamm, L. C., 1978, Electric log interpretations, *in* R. V. Amato and J. W. Bebout (eds.), Geological and Operational Summary, COST No. GE-1 Well, Southeast Georgia Embayment Area, South Atlantic OCS: U. S. Geological Survey Open-File Report 78-668, 61-75.
- Thierstein, H. R., 1971, Tentative Lower Cretaceous calcareous nannoplankton zonation: *Eclogae Geologicae Helveticae*, v. 64, p. 459-487.
- Tissolt, B. P. and D. H. Welte, 1978, Petroleum Formation and Occurrence, A New Approach to Oil and Gas Exploration: Berlin, Springer-Verlag, p. 123-201.



- Tissot, B., B. Durand, J. Espitalie, and A. Combaz, 1974, Influence of nature and diagenesis of organic matter in formation of petroleum: American Association of Petroleum Geologists Bulletin, v. 58, no. 3, p. 499-506.
- Tschudy, R. H., 1973, *Complexiopollis* Pollen Lineage in Mississippi Embayment Rocks: U. S. Geological Survey Professional Paper 743-C, p. C1-C15.
- Uchupi E. and K. O. Emery, 1967, Structure of continental margin off Atlantic coast of United States: American Association of Petroleum Geologists Bulletin, v. 51, no. 2, p. 223-234.
- U. S. Department of Commerce, 1973, Environmental Conditions within Specified Geographical Regions-- Offshore East and West Coast of the United States and in the Gulf of Mexico: Washington, D. C., National Oceanographic Data Center, National Oceanographic and Atmospheric Administration, 735 p.
- Van Gijzel, P., 1990, Transmittance colour index (TCI) of amorphous organic matter: a new thermal maturity indicator for hydrocarbon source rocks, and its correlation with mean vitrinite reflectance and thermal alteration index (TAI); in W.J.J. Fermont and J.W. Weegink, eds., Proceedings, International Symposium on Organic Petrology, Zeist, the Netherlands.
- Van Hinte, J. E., 1976a, A Jurassic time scale: American Association of Petroleum Geologists Bulletin, v. 60, no. 4, p. 489-497.
- Van Hinte, J. E., 1976b, A Cretaceous time scale: American Association of Petroleum Geologists Bulletin, v. 60, no. 4, p. 498-516.
- Vassoyevich, N. B., Yu. I. Korchagina, N. V. Lopatin, and V. V. Chernyshev, 1969, Glavanaya faza nefteobrazovaniya [Principal phase of oil formation]: Moskovskogo Universiteta Vestnik, Ser. 4, Geologii, v. 24, no. 6, p. 3-27: English translation in International Geology Review, 1970, v. 12, no. 11, p. 1,276-1,296.
- Wade, J.A., 1977, Stratigraphy of Georges Bank Basin-- interpretation from seismic correlation to the western Scotian Shelf: Canadian Journal of Earth Science, v. 14, no. 10, p. 2274-2283.
- Wade, J.A., G.R.Campbell, R.M. Proctor, and G.C. Taylor, 1989, Petroleum Resources of the Scotian Shelf, Geological Survey of Canada Paper 88-19.
- Walper, J. L. and R. E. Miller, 1985, Tectonic evolution of Gulf Coast basins, in B. F. Perkins and G. B. Martin (eds.), Habitat of Oil and Gas, Program and Abstracts, Fourth Annual Research Conference, Gulf Coast Section: Austin, Society of Economic Paleontologists and Mineralogists Foundation, Earth Enterprises, p. 25-42.
- Waples, D. W., 1980, Time and temperature in petroleum formation--application of Lopatin's method to petroleum exploration: American Association of Petroleum Geologists Bulletin, v. 64, no. 6, p. 916-926.
- Weed, E. G. A., J. P. Minard, W. J. Perry, Jr., E. C. Rhodehamel, and E. I. Robbins, 1974, Generalized pre-Pleistocene geologic map of the northern United States Atlantic continental margin: U. S. Geological Survey Miscellaneous Geologic Investigations Map I-861, Scale 1:1,000,000.
- Williams, G. L., 1974, Dinoflagellate and spore stratigraphy of the Mesozoic-Cenozoic offshore Eastern Canada, in Offshore Geology of Eastern Canada: Geological Survey of Canada Paper 74-30, v. 2, p. 107-161.
- Williams, G. L., 1977, Dinocysts--their classification, Biostratigraphy, and paleoecology, in A. T. S. Ramsay (ed.), Oceanic Micropaleontology, v. 2, New York, Academic Press, p. 1,231-1,326.

Williams, G. L. and W. W. Brideaux, 1975, Palynologic analyses of Upper Mesozoic and Cenozoic rocks of the Grand Banks, Atlantic Margin: Geological Survey of Canada Bulletin, v. 236, p. 1-163.

Woollam, R. and J. B. Riding, 1983, Dinoflagellate cyst zonation of the English Jurassic: Institute of Geological Sciences Report, v. 83, No. 2, p. 1.

Worsley, T. R., 1971, Calcareous nannofossil zonation of Upper Jurassic and Lower Cretaceous sediments from the Western Atlantic, *in* Proceedings II, International Planktonic Conference, Roma, 1970: Rome, Edizioni Tecnoscienza, p. 1301-1321 .