

# RECLAMATION

*Managing Water in the West*

Technical Memorandum No. 86-68220-07-05

## Inspection and Cleaning Manual for Equipment and Vehicles to Prevent the Spread of Invasive Species

2010 Edition



U.S. Department of the Interior  
Bureau of Reclamation  
Denver, Colorado

May 2010

Technical Memorandum No. 86-68220-07-05

# **Inspection and Cleaning Manual for Equipment and Vehicles to Prevent the Spread of Invasive Species**

2010 Edition

Prepared by:

**Joe DiVittorio, Bureau of Reclamation, Policy and Administration, Denver,  
Colorado**

**Michael Grodowitz, U.S. Army Corps of Engineers, Engineer Research and  
Development Center (ERDC), Vicksburg, Mississippi**

and

**Joe Snow, ERDC Contractor**



U.S. Department of the Interior  
Bureau of Reclamation  
Policy and Administration  
Denver, Colorado

May 2010

## MISSION STATEMENTS

The mission of the Department of the Interior is to protect and provide access to our Nation's natural and cultural heritage and honor our trust responsibilities to Indian tribes and our commitments to island communities.

---

The mission of the Bureau of Reclamation is to manage, develop, and protect water and related resources in an environmentally and economically sound manner in the interest of the American public.

## DISCLAIMER

This manual is intended as an introduction to its subject matter and as a reference tool. It does not create or alter policy or otherwise implement any law and should not be cited as a source of authority.

The information contained herein, regarding commercial products or firms, may not be used for advertising or promotional purposes and is not to be construed as an endorsement of any product or firm by the Bureau of Reclamation or the Department of the Interior. Firms, brands, or products that are not listed are not deemed unsatisfactory.

Invasive and pest species listed herein do not constitute a complete list of such species.

For more information on this manual, contact:

Joe DiVittorio, CPAg/CCA  
Integrated Pest Management Program Coordinator  
Bureau of Reclamation  
Policy and Administration  
Phone: 303-445-3639  
E-mail: [jdivittorio@usbr.gov](mailto:jdivittorio@usbr.gov)

## NOTICE OF AVAILABILITY

This manual is available and intended as an online resource. The manual uses many live hyperlinks that take the reader to additional information sites and video training. Frequent updating of the manual is expected, made necessary by new research findings and development of better methods. Although hard copies of the manual may be printed by the reader from the online source, any printed information may become rapidly obsolete without notice and would lack hyperlink usability.

**Cover photo: Precleaning heavy soil accumulations on tractor tracks, mussels covering a penstock gate at Davis Dam, and adult quagga mussels covering a rope used in the Lower Colorado River (photos courtesy of Fred Nibling, Dave Arend, and Joe DiVittorio, respectively).**



# Acknowledgments

Appreciation is extended to the following individuals and agencies.

## **Bureau of Reclamation**

Contributions by Tim Dewey, Cindy Gray, Teri Manross, Fred Nibling, Allen Skaja, Brent Tanzy, and the Socorro Field Office; reviewed by Steven Anderson, Deb Boggess, Nancy Coulam, Ned Gruenhagen, Scott Lund, Salvador Martinez, Marc Maynard, Robert Radtke, Nancy Umbreit, and Kristi Walters

## **U.S. Army Corps of Engineers**

Contributions by Lavon Jeffers, graphics; and Sherry Whitaker, compilation and review; Engineer Research and Development Center

## **U.S. Department of Agriculture**

Contributions by Joe Fleming, U.S. Department of Agriculture, Forest Service Technology and Development Center; reviewed by Mike Ielmini, Forest Service, Washington DC

## **U.S. Navy**

Contributions by John Breuer, Naval Facilities Engineering Command, Engineering and Acquisition Division, Philadelphia, Pennsylvania; Brian Nixon, Naval Facilities Engineering Command, Northwest, Silverdale, Washington; and Evan Stauffer, Naval Facilities Engineering Command, MIDLANT, Philadelphia, Pennsylvania

## **Non-Governmental Organizations**

Stephen Phillips, Pacific States Marine Fisheries Commission, Portland, Oregon; Bill Zook, contractor, Pacific States Marine Fisheries Commission, Shelton, Washington; Wen Baldwin, contractor, Pacific States Marine Fisheries Commission, Henderson, Nevada; and Jim Jota, Imes, Inc. - Water Weights, Montclair, California



# Authorities

Federal Noxious Weed Act of 1974 (sections 1 and 15)

Federal Insecticide, Fungicide and Rodenticide Act, as amended by the Food Quality Protection Act of 1996, 7 U.S.C. 136

National Invasive Species Act of 1996, 16 U.S.C. 4701

Nonindigenous Aquatic Nuisance Prevention and Control Act of 1990, 16 U.S.C. 4701

Plant Protection Act of 2000, 7 U.S.C. 7701 et seq. (supersedes the Federal Noxious Weed Act of 1974, except Sections 1 and 15)

Executive Order 13112, Invasive Species, *Federal Register*, February 3, 1999.

## **U.S. Department of the Interior's *Departmental Manual***

517 DM 1: *Integrated Pest Management Policy: Pesticides*

[http://elips.doi.gov/app\\_dm/act\\_getfiles.cfm?relnum=3742](http://elips.doi.gov/app_dm/act_getfiles.cfm?relnum=3742)

(Provides policy to all U.S. Department of the Interior bureaus, including the Bureau of Reclamation, for Integrated Pest Management activities involving the prevention, detection, and management of native and nonnative pest species, including invasive species, on Interior properties)

609 DM 1: *Policy and Responsibilities: Weed Control Program*

[http://elips.doi.gov/app\\_dm/act\\_getfiles.cfm?relnum=3042](http://elips.doi.gov/app_dm/act_getfiles.cfm?relnum=3042)

(Prescribes the policy to control undesirable or noxious weeds on the lands, waters, or facilities under its jurisdiction to the extent economically practicable, and as needed for resource protection and accomplishment of resource management objectives and the protection of human health)

## **Bureau of Reclamation's *Reclamation Manual***

ENV PO2 (Policy), *Pest Management*, December 23, 1996

<http://www.usbr.gov/recman/env/env-p02.pdf>

(Reclamation is responsible for the identification and proper management of pests on Reclamation lands and at Reclamation-owned facilities in accordance with the national policies set out in Federal Insecticide, Fungicide and Rodenticide Act; Federal Noxious Weed Act; Carlson-Foley Act; and applicable State and local laws and standards. This responsibility is to be fully considered in the development of a local Integrated Pest Management Program.)

ENV 01-01 (Directives and Standards), *Pest Management – Resource Protection (Integrated Pest Management) Program*, October 17, 1996

<http://www.usbr.gov/recman/env/env01-01.pdf>

(Provides directives and standards for Reclamation personnel involved with the implementation of Pest Management/Resource Protection plans for the operation and maintenance of Reclamation lands and facilities)

PEC 10-29 (Directives and Standards), *Reclamation Standard Water-Related Contract Articles, Article 29: Pest Management*, PEC 10-29, December 21, 2006

<http://www.usbr.gov/recman/pec/pec10-29.pdf>

(This article requires contractors to effectively control undesirable plants and animals on Federal project lands, project waters, and project works for which they have operation and maintenance responsibilities.)



# Definition of Terms

**Best Management Practice:** A practice or combination of practices that is determined to be the most effective and practicable means of preventing or reducing undesirable results.

**Desiccation:** The state of extreme dryness or the process of extreme drying.

**Exotic:** Introduced from another country; not native to the place where found.

**Flocculation:** To cause to aggregate into a flocculent (loosely aggregated particles) mass.

**Invasive species:** Executive Order 13112, “Invasive species” means an alien species whose introduction does or is likely to cause economic or environmental harm, or harm to human health.

**Invertebrate:** Animals without a vertebral column.

**Ion:** An electrically charged atom or molecule due to the loss (a net positive charge) or gain (a net negative charge) of electrons. Metal ions such as copper and zinc have a net positive electrical charge.

**Macrophyte:** An aquatic emergent, submerged, or floating plant.

**Mollusk** (also spelled mollusc): A type of shellfish, such as a clam, scallop, or mussel. Mollusks having two hinged shells are referred to as a bivalve mollusk.

**Nonindigenous species:** Any species or other viable biological material that enters an ecosystem beyond its historic range, including any such organism transferred from one country into another.

**Noxious weed:** Any living stage, such as seeds and reproductive parts, of any parasitic or other plant of a kind, which is of foreign origin, is new to or not widely prevalent in the United States, and can directly or indirectly injure crops, other useful plants, livestock, or poultry or other interests of agriculture, including irrigation, or navigation, or the fish or wildlife resources of the United States or the public health. The term is usually defined as part of law, statute, or regulation.

**Organism:** Any living thing.

**Pest:** Any insect, rodent, nematode, fungus, weed, or any other form of terrestrial or aquatic plant or animal life or virus, bacteria, or other micro-organism (except viruses, bacteria, or other micro-organisms on or in living man or other living animals) which the Administrator (of the U.S. Environmental Protection Agency) declares to be a pest. . . which is injurious to health or the environment.

**Propagate:** The biological process of reproduction, may be sexual or asexual.

**Propagule:** Any plant material used for the purpose of plant propagation.

**Rhizome:** A horizontal stem of a plant that is usually found underground, often sending out roots and shoots from its nodes.

**Species:** A group of related organisms capable of interbreeding and producing fertile offspring.

**Stolon:** A specialized type of horizontal above-ground shoot, a colonizing organ that arises from an axillary bud near the base of the plant.

**Veliger:** The free-swimming immature life stage of a mollusk.

**Weed:** A native or non-native plant that is unwanted in a particular place at a particular time.

# Executive Summary

Procedures have been developed in this manual to address the transport of invasive species and pests through equipment movement. This manual provides guidance for inspecting and cleaning vehicles and equipment to help prevent the spread of noxious invasive species during Bureau of Reclamation (Reclamation) activities. The general types of equipment described in this manual are:

- Rubber-tired land vehicles
- Tracked land vehicles
- Personal use equipment
- Construction and facility equipment
- Watercraft

Reclamation operates water management facilities throughout the 17 Western States. Reclamation's mission objectives are the delivery of water, currently to more than 31 million people, and the generation of hydroelectric power, currently at approximately 44 billion kilowatthours of electricity produced annually. Preventing the spread of invasive species has a direct effect on these objectives, since pests and invasive species have the potential to adversely impact the flow of water and damage facilities.

The majority of Reclamation facilities were designed and constructed nearly 50 years ago, with some facilities now over 100 years old. Roughly coinciding with this period during the past 50 years, and as a consequence of improved transportation, the rate of invasive species colonization in the United States sharply increased, resulting from huge numbers of invasive species arriving from foreign locations. Early during the period of invasive species spread, the impact from invasive species alone could not have been predicted as becoming a threat to Reclamation facility operations or mission. However, when combined with aging facilities and periodic drought, infrastructure that was once designed specifically to deliver water and generate electrical power was not intended to cope with these unforeseen, multiple impacts. Clearly, the weather conditions that cause drought are outside our control; aging facilities can be mitigated somewhat through continued preventative maintenance and replacement of components. Preventing invasive species spread, however, is a tool fully within our reach for limiting impacts to Reclamation's mission. Preventing the spread of invasive species is a cost-effective approach because once an invasive species becomes established or widespread, controlling it may require significant and sustained budget expenditures for facility redesign, retrofitting, monitoring, and increased maintenance requirements.



**Live adult quagga mussels taken from a wet well at a Lower Colorado River facility (photo courtesy of Joe DiVittorio, 2008).**

The spread of invasive species from one location to another has been linked to the use and movement of contaminated equipment. The recent introduction of the invasive zebra and quagga mussel from the Eastern watersheds of the United States into the Western watersheds is thought to be almost entirely by cross country movement of

contaminated watercraft and other equipment, and highlights the importance of inspection and cleaning of all types of equipment.

As discussed in greater detail later in the manual, the concept of successful prevention is the goal of all equipment inspection and cleaning processes and is the main purpose of this manual. Prevention actions deny the entry of invasive species into uninfested locations. This factor underpins all equipment inspection and cleaning methods to be discussed: through prevention, the spread of invasive species from one place to another can be limited.

# Contents

	<i>Page</i>
Organization of the Manual .....	1
Introduction.....	1
Background.....	4
Spread of Invasive Species Associated with Vehicles and Equipment .....	5
Facility Equipment Used in Water.....	10
Overview of Inspection Procedures .....	14
Overview of Cleaning Procedures .....	16
Overview of Species of Concern .....	19
Bibliography .....	21
Appendix A: Inspection Standards .....	A-1
Appendix B: Cleaning and Decontamination Procedures .....	B-1
Appendix C: Species of Concern.....	C-1

## Tables

	<i>Page</i>
1 Summary of inspection and cleaning for personal gear, watercraft, trailers, vehicles, and other equipment .....	18

## Figures

	<i>Page</i>
1 Daily interstate system traffic in the United States, 2002.....	6
2 Zebra and quagga mussel finds in the United States, 2009 .....	6
3 Dozing operations taking place in Socorro, New Mexico, in an area occupied by the invasive species saltcedar .....	7
4 Mud encrusted on a shoe sole .....	7
5 Potential areas of invasive species deposits on a tractor trailer .....	8
6 Plant material carried on brush mowing equipment .....	8
7 Precleaning heavy accumulations can help reduce water use when washing.....	9
8 Rental equipment may be delivered to a worksite with mud accumulations .....	9
9 Underwater photo showing mussels covering the Davis Dam domestic water intake grate .....	10

**Figures** (continued)

	<i>Page</i>
10 Raw water fire protection sprinkler system contaminated with aquatic organisms and debris.....	11
11 Crane testing at Glen Canyon Dam .....	12
12 Crane being tested at a Tennessee Valley Authority powerplant using water weight bags™.....	12
13 Mud and debris on pump and hydrilla on boat trailer.....	13
14 Infestation of hydrilla, probably introduced via boat trailer .....	14
15 Tracked military equipment wash bay with hardstand surface and access underneath equipment.....	15
16 Postcleaning inspection found remaining contamination on this tracked vehicle .....	15
17 Snails directly attached to wheel and tire .....	19

# Organization of the Manual

This manual provides guidance for inspecting and cleaning vehicles and equipment to help prevent the spread of noxious invasive species during Bureau of Reclamation (Reclamation) activities. The general types of equipment described in this manual are:

- Rubber-tired land vehicles
- Tracked land vehicles
- Personal use equipment
- Construction and facility equipment
- Watercraft

This manual is organized to present equipment inspection techniques first, because inspection will determine the need for later cleaning. Equipment cleaning methods and protocols are explained next, including a discussion on the use of various equipment cleaning methods and products. Finally, the manual offers information on the identification and habitats of some common invasive plant and animal species that are of high importance in Reclamation, which may be transferred by equipment use.

## Introduction

This manual provides uniform guidelines for inspection and thorough cleaning of vehicles and equipment that come in contact with invasive species during Reclamation work. The information in this manual will help personnel to thoroughly understand how noxious and invasive plants and animals are spread and will provide instructions and recommendations to reduce their spread.

Equipment inspection and cleaning are examples of sanitation actions. Sanitation is identified as an Integrated Pest Management (IPM) cultural control tool in the Department of the Interior's *Departmental Manual 517 DM 1* (U.S. Department of the Interior, 2007). In addition, cultural control is an IPM tool requirement found in the Food Quality Protection Act of 1996, Public Law 104-170, amendment to the Federal Insecticide, Fungicide, and Rodenticide Act, which states in part:

Integrated Pest Management is a sustainable approach to managing pests by combining biological, cultural, physical, and chemical tools in a way that minimizes economic, health, and environmental risks," and "Federal agencies shall use Integrated Pest Management techniques in carrying out pest management activities and shall promote Integrated Pest Management through procurement and regulatory policies, and other activities.

Further, Executive Order 13112 on Invasive Species (Order) of February 3, 1999 requires Federal agencies to “use relevant programs and authorities to: (i) prevent the introduction of invasive species.”

The Order also established the National Invasive Species Council, which developed the National Invasive Species Management Plan, 2008-2012 (National Invasive Species Council, 2008). The findings of the National Invasive Species Council and the National Invasive Species Management Plan included the importance of preventing the spread of invasive species to minimize the staggering costs of management and control of widespread invasions:

Prevention is the first-line of defense. It can be the most cost-effective approach because once a species becomes widespread; controlling it may require significant and sustained expenditures. Therefore, public investment in prevention tools, resources and infrastructure is indispensable in protecting human health, agriculture and natural resources.

Long-term success in prevention will reduce the rate of introduction, the rate of establishment and the damage from additional invasive species in the United States.

The use of this manual satisfies the National Invasive Species Management Plan performance element CM. 2.1.1., which calls for increased cleaning treatments to slow the spread of invasive species.

Limiting the spread of invasive species on Reclamation work sites can be a significant challenge. Invasive species can be spread in numerous ways. For example, soil and mud that may accumulate on undersides of vehicles can carry seeds or viable fragments of exotic invasive plants. Lodged material from plants or animals is often not easily recognizable by casual inspection of equipment and vehicles. In addition, foreign material can become lodged in areas of limited sight and access. Also, the use of watercraft, pumps, in-water equipment, and even waders in waters infested with exotic plants and animals can easily become sources for spread of invasive species. Therefore, it is vital that Reclamation personnel working in areas where invasive species are present have sufficient training in inspecting and cleaning equipment used in such areas.

The Colorado Division of Wildlife has provided guidelines on watercraft cleaning procedures to prevent the spread of invasive species. These guidelines, known as the “Clean, Drain, and Dry” system, are adapted from Colorado Division of Wildlife (2009) and shown below.

Properly conducted inspection and cleaning of equipment prior to entry at a new location limits introduction of invasive species. Inspection of equipment is the primary tool for preventing the introduction of an invasive organism into an uninfested location.



## **Inspecting and Cleaning Equipment**

- Generally, equipment of all types should be cleaned at the location of last use before being moved to a new location. If this is not possible, arrange for cleaning at a facility that is specifically designed for equipment cleaning.
- If equipment is used at a location known to be infested with an invasive species, the equipment should undergo a preinspection, followed by thorough cleaning, and a final inspection before being moved off the worksite.
- At the new location, the equipment should be inspected again, preferably by someone other than the original inspector before the equipment is placed into service.
- If, on reinspection, contamination is found on the equipment, do not allow the equipment entry on the new worksite; either return the equipment to the location of last use for additional cleaning or arrange for cleaning at a location that is specifically designed for equipment cleaning.

## **Clean, Drain, and Dry!**

Properly follow these guidelines. While on land, but before leaving a body of water:

### **Clean:**

- Remove any visible plant or plant fragments, as well as mud or other debris. Plant material, mud, and other debris routinely contain other organisms that may be an aquatic nuisance species. Some plant species are aquatic nuisance species.
- Check trailer, including axel and wheel areas - in and around the boat itself: anchor, props and jet engines, ropes, boat bumpers, paddles.
- Clean and check and dry off all parts and equipment that came in contact with water.
- Using a car wash or home power water sprayer is not adequate to kill and/or remove zebra or quagga mussels.

### **Drain:**

- Drain every conceivable space or item that can hold water.
- Follow factory guidelines for eliminating water from engines. All engines hold water, but jet drives on personal watercraft and other boats can hold extra water.
- Remove the drain plug from boats and put boat on an incline so that the water drains out.
- Drain live-wells, bilge, ballast tanks, and transom wells.
- Empty water out of kayaks, canoes, rafts, etc.

### **Dry:**

- Allow everything to completely dry before launching into another body of water.

# Background

Prior to preparing this manual, each Bureau of Reclamation region was asked to briefly describe the diverse kinds of equipment that were used for Reclamation work. The equipment types were identified and broadly grouped together. It is not possible to discuss all of the many and varied types of equipment in use throughout Reclamation. However, this manual does provide the process to preinspect, clean, and reinspect all equipment before moving or placing the equipment into service. During preparation of the manual, many concepts, methods, and products were discussed, and information was made available by other Federal agencies and other organizations.

Reclamation's mission objectives are the delivery of water and generation of hydroelectric power. Reclamation's 58 hydroelectric powerplants annually produce nearly \$1 billion in power revenues and provide electricity to serve 6 million homes. In addition, Reclamation manages approximately 16,000 miles of canals, 280 miles of water transmission tunnels, 1,400 miles of pipelines, 37,500 miles of laterals, 17,000 miles of project drains, 348 storage reservoirs, 254 diversion dams, and 268 pumping plants rated at over 1,000 horsepower. Pests and invasive species can adversely impact mission objectives by disrupting waterflow or damaging water management infrastructure.

Approximately 50,000 nonindigenous species have been introduced to the United States, and many of them create serious economic and environmental damage (Pimentel et al., 2000). Economic implications include direct losses of agricultural and forestry assets, land-use capability, and human health, as well as escalating costs associated with managing the problems caused by invasions.

Invasive species can cause numerous environmental impacts from loss of functional habitat to loss of many native species, including rare plants and animals. The adaptive and competitive nature of exotic species, particularly in disturbed habitats, often leads to rampant spread. Many invasive species are spreading at alarming rates throughout the Western United States. Human activity facilitates spread, and infestations often start in areas where plants or animals have been moved by human activity. Boat ramps, highways, and recently disturbed areas are often the sites of early infestations.

Environmental impacts from invasive species are difficult to quantify in economic terms, but direct economic damages from the effects and control efforts of exotic species has been estimated at \$137 billion per year in the United States (Pimentel et al., 2000). The way to mitigate further escalating costs to people and the ecosystem is to halt the further spread and introduction of invasive species in Reclamation project areas. Otherwise, environmental and economic impacts could greatly increase, causing more difficult challenges in the future.

# Spread of Invasive Species Associated with Vehicles and Equipment

Invasive species are often spread when humans move equipment to new areas. A comparison of figures 1 and 2 shows that the most heavily populated traffic routes in the United States correlate with increased zebra and quagga mussel sightings throughout the West (U.S. Department of Transportation, 2002; U.S. Geological Survey, 2009). For these mussels, the general pattern of infestation is overland transport by watercraft and in-water equipment via the highway system, then to a water body system, where the invasive species move with downstream waterflow.

Watercraft, vehicles, earth-moving equipment, pumps, trailers, and other equipment are particularly troublesome avenues of spread (figure 3). Clothing, shoes, and waders can become vectors of spread when personnel leave infested areas that contain soil or mud laden with seed or plant fragments (figure 4). Invasive species can also be deposited on fuel tanks, wheel wells, and behind the bumpers of vehicles (figure 5). Pathogens, insects, and other animals can be transported in the same manner.

Tractors and mowers collect plant materials during operations in the field (figure 6). Tracked vehicles pick up large amounts of soil, mud, and debris, making them more of a challenge to clean than smaller vehicles and other equipment. Similarly, drivetrain belly pans of bulldozers accumulate large amounts of soil and debris, which might require physical removal of foreign material before washing. Physical removal of accumulated material (precleaning) before washing operations can help reduce water demand when cleaning certain equipment (figure 7).

Equipment use might involve not only Reclamation-owned equipment, but also rented equipment and equipment used by contractors and subcontractors (figure 8). Equipment also is brought in from other areas of the United States and may be transferred out to locations where new invasions may inadvertently accompany contaminated equipment.

Reclamation-owned, managing partner, contractor, subcontractor, and rental equipment used at Reclamation worksites must be inspected, and cleaned if necessary, to ensure that equipment arrives and leaves clean to prevent introduction or spread of invasive species.

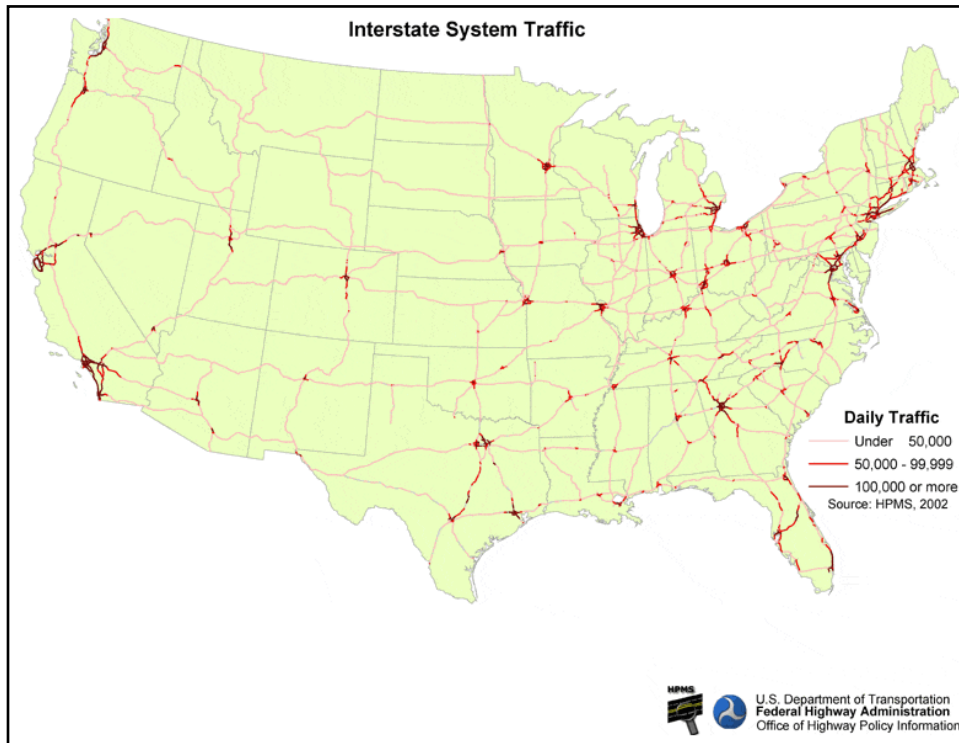

**Figure 1. Daily interstate system traffic in the United States, 2002.**

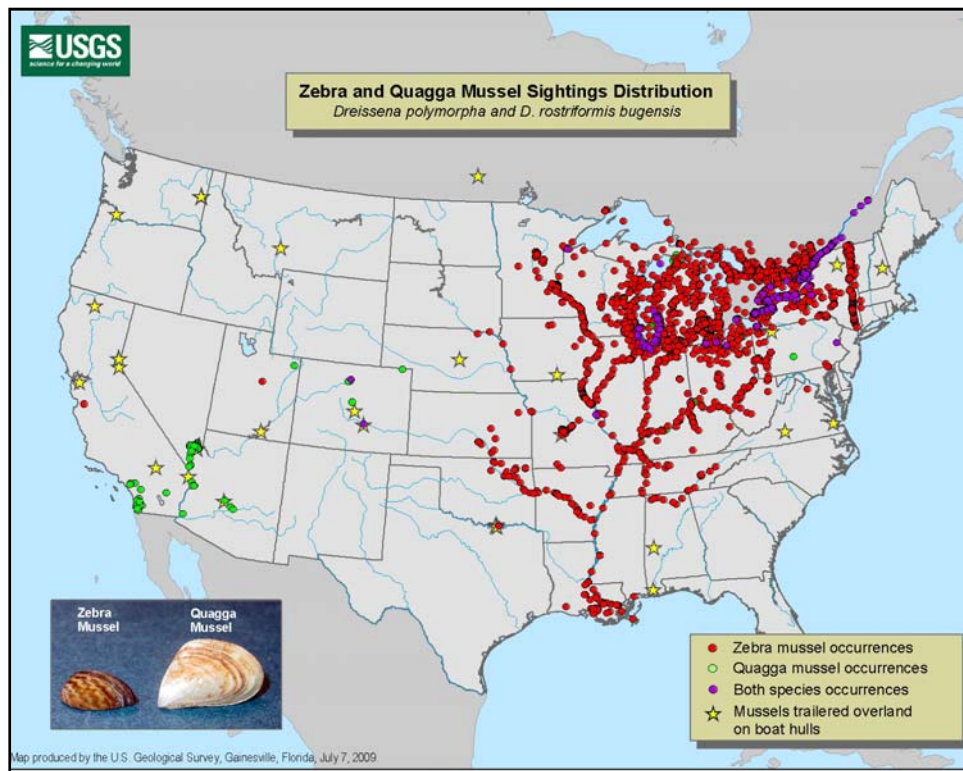

**Figure 2. Zebra and quagga mussel finds in the United States, 2009.**



**Figure 3. Dozing operations taking place in Socorro, New Mexico, in an area occupied by the invasive species saltcedar (Bureau of Reclamation photo).**



**Figure 4. Mud encrusted on a shoe sole (U.S. Army Corps of Engineers photo).**



Fuel tank



Wheel well and back bumper

**Figure 5. Potential areas of invasive species deposits on a tractor trailer (U.S. Army Corps of Engineers photo).**



**Figure 6. Plant material carried on brush mowing equipment (photo courtesy of Fred Nibling).**



**Figure 7. Precleaning heavy accumulations can help reduce water use when washing (photo courtesy of Fred Nibling).**



**Figure 8. Rental equipment may be delivered to a worksite with mud accumulations. Consider including equipment cleaning in the equipment rental contract (U.S. Army Corps of Engineers photo).**

## Facility Equipment Used in Water

Many facilities throughout Reclamation share common designs and components. Where these components have the potential of being used interchangeably at facilities from one location to another, there is a pathway of invasive species spread, particularly by zebra or quagga mussels. Any parts, components, or equipment being considered for use at another facility must be fully inspected for invasive mussels and thoroughly decontaminated before transport to the new location. Gates, valves, pumps, and structural components are examples of such items (figure 9).



**Figure 9. Underwater photo showing mussels covering the Davis Dam domestic water intake grate (photo courtesy of LC Diving and Marine Operations, 2008).**

In addition to the many in-water components that may be used interchangeably among Reclamation facilities, permanently installed out-of-water components that use raw water for various functions and processes may be vulnerable to zebra or quagga mussel infestation. This type of component is not likely to be disassembled and moved to another facility; therefore, it does not pose a mussel spread risk to other locations. However, a mussel infestation involving these components is likely to adversely impact facility operations in some way. Examples can include cooling water systems for mechanical or electrical components.



Raw water fire suppression sprinkler systems are another example of permanently installed systems at facilities that may be susceptible to mussel infestation. The immature life stage of the zebra or quagga mussel (veliger) is microscopic and can enter standard screened or grated raw water intakes during regular sprinkler system performance testing. If you are not familiar with the life cycle of these mussels, refer to appendix C, pages C-103 through C-111, for more information. Once inside an unprotected sprinkler system, it is possible for the veliger mussel to grow into an adult mussel. There, even years after initial infestation of the sprinkler system takes place, the shells of dead mussels can block sprinkler openings or clog pipes if the system is triggered during a fire emergency (figure 10). It is highly recommended that raw water intakes supplying fire sprinkler systems be equipped with reliable mussel prevention measures.



**Figure 10. This raw water fire protection sprinkler system, located on the former Philadelphia Naval Shipyard, is contaminated with aquatic organisms and debris. Raw water that contains zebra or quagga mussels can enter a sprinkler system intake, where the mussels can grow and clog the sprinkler heads (photos courtesy of John Breuer, 2000).**



In particular, attention should be given to water bags used during crane testing and calibration at various Reclamation facilities (figures 11 and 12). Crane testing companies often use water bags by filling the bag with water to the corresponding weight for the testing process. These bags can be used at various locations across the country and might be filled with untreated raw water at the location of last use. At the end of crane testing, the bag is drained and can be moved to a new location. If not properly handled, water bags can become a pathway of aquatic invasive species spread.



**Figure 11. Crane testing at Glen Canyon Dam (photo by Gerry Jarin; photo courtesy of Jim Jota, Imes, Inc., 2005).**



**Figure 12. Crane being tested at a Tennessee Valley Authority powerplant using water weight bags™ (photo by Mike Hoffman; photo courtesy of Jim Jota, Imes, Inc., 2002).**

Remember to follow the “Clean, Drain, and Dry” recommendations supplied in the Introduction section of this manual. Further information can also be obtained by visiting the 100<sup>th</sup> Meridian Web site (100<sup>th</sup> Meridian Initiative, 2008).

Work in aquatic environments, whether reservoirs, rivers, or conveyance channels, presents different challenges than in terrestrial areas. Invasive species can become lodged in or on personal gear, watercraft, and other conveyances, as well as associated equipment, trailers, and towing vehicles (figures 13 and 14). Since invasive aquatic plants often spread from fragments, special care must be taken to identify and address these issues before leaving a water body. Invasive aquatic species, such as the zebra and quagga mussel, can spread relentlessly and require special inspection and cleaning methods. Rigorous inspection must be used to find problems, and total removal of potential invaders must take place before moving to other aquatic systems.



**Figure 13. Mud and debris on pump (above) and hydrilla on boat trailer (below) (photo courtesy of Fred Niblina).**



**Figure 14. Hydrilla can block the flow of water in rivers, creeks, and channels. It can be spread to new locales by vegetative fragments and propagules carried on contaminated equipment and watercraft. Lower Rio Grande River (photo courtesy of Fred Nibling, 2001).**

## Overview of Inspection Procedures

This section briefly discusses inspection procedures. These procedures can be used in the field. Appendix A contains more detailed information on inspection standards and protocols.

Inspection procedures are developed in this manual to systematically address transport of invasive species and pests through equipment movement. This manual provides personnel with necessary information to identify areas of concern on vehicles and many types of equipment. In addition, personnel may require inspection training for specific invasive species. Inspection should include prewashing, monitoring cleaning procedures, and postcleaning.

**Best Management Practice:**

Properly conduct inspection of equipment prior to entry at a new location to prohibit introduction of invasive organisms.

First inspections of equipment, especially at field sites, could potentially overlook hard to find areas. Therefore, after equipment is cleaned, a more detailed inspection could reveal overlooked soil and mud (potentially laden with invasive plant seeds or other invasive propagules) in hard to reach areas of equipment. For example, on vehicles and tractors, look under wheel wells, behind bumpers, on radiators, on tracks, or above drivetrain belly pans.

Each equipment type has its own particular requirements for inspection. There are many similarities among rolling stock vehicles, whether wheeled or tracked, that have common design features that are prone to accumulating soil, mud, and other foreign material. The vehicle depicted in figure 15 appears to be clean on casual inspection, but upon closer examination (figure 16), the mud deposits on



**Figure 15. Tracked military equipment wash bay with hardstand surface and access underneath equipment (U.S. Department of Defense photo, 2004).**

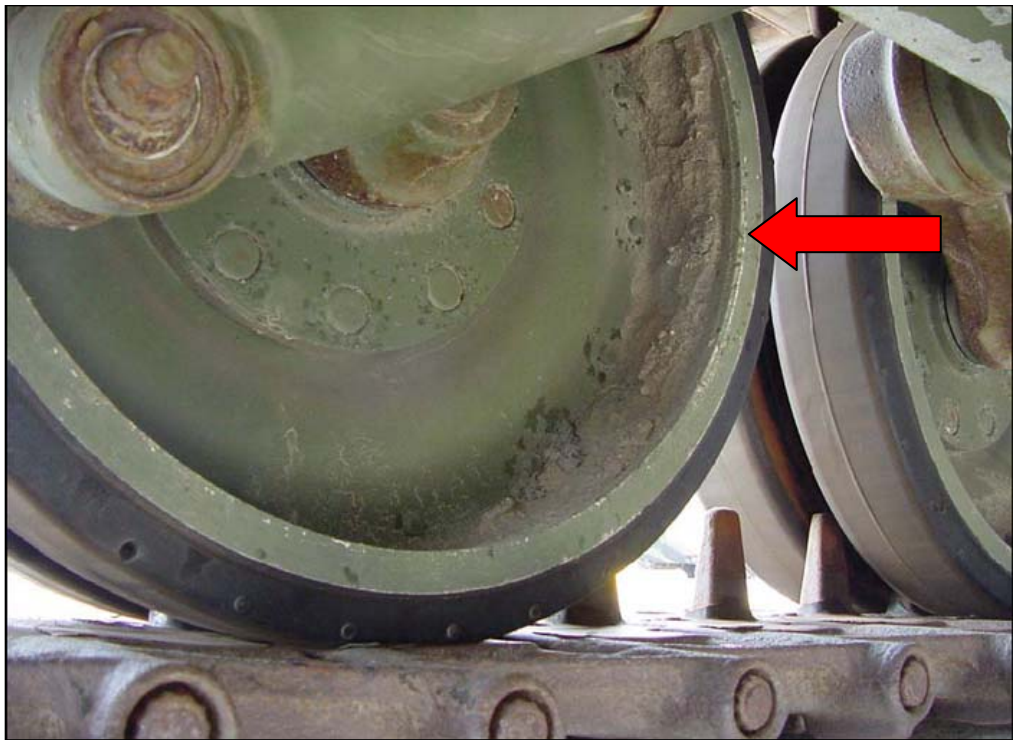

**Figure 16. Postcleaning inspection found remaining contamination on this tracked vehicle(U.S. Department of Defense photo, 2004).**

the track rollers can be a source of infestation. Casual observation will not address hidden areas of concern. Figure 16 illustrates the value of an equipment postcleaning inspection.

- Watercraft, other in-water equipment, and facility equipment have specific inspection needs and will be covered more extensively in appendix A.
- Even the most careful inspection of any equipment will not guarantee that the equipment is absolutely free of contamination.

## Overview of Cleaning Procedures



**Prior to beginning any cleaning or decontamination action, be sure to first review appendices A and B.**

This section briefly discusses the procedure for cleaning personal gear, vehicles, and equipment. These procedures can be used in the field. Appendix B contains more detailed information on cleaning and decontamination, as well as recommendations for selecting a washdown location.

**Best Management Practice:**

Equipment of all types should be cleaned at the location of last use before being moved to a new location.

Watercraft, other in-water equipment, and facility equipment have specific cleaning needs and will be covered more extensively in appendix B.

Precleaning, by removing heavy accumulations of soil and debris with appropriate tools, will save water during later washing operations. Effective cleaning to eliminate invasive species materials and prevent their spread can be accomplished by thoroughly removing soil and debris using pressurized water. In certain situations, cleaning with compressed air, rather than water, could prevent damage to certain equipment areas such as engine wiring systems and vehicle cabs.

Controlling other invasive species may require chemical treatment. Chlorine, flocculation, and ozone are substances that have been used to kill certain invasive species. Use of chemical treatments sometimes poses disposal and wastewater concerns. If chemical treatments are used, local standards of waste disposal must be followed. In addition, States may require certification or licensing for personnel who use chemical treatments for these purposes.

Despite very careful efforts to capture and quarantine materials from cleaning operations, site-specific invasions are likely to occur. For example, perimeters of

remote cleaning areas could benefit from silt fencing to filter wash water when cleaning certain kinds of equipment. Part of the cleaning process should involve inspecting such areas for the spread of invasive species and using appropriate control methods early to prevent additional spread.

Ideally, equipment for cleaning operations should be portable, with the built-in ability to move cleaning stations to remote sites. Progress has been made in developing and deploying portable cleaning systems. Several examples of current technology and use are given in appendix B for information only (not as endorsements), and the list is not to be considered exhaustive or complete.

Table 1 shows the general types of invasive species that can cling to personal gear, watercraft, trailers, vehicles, and other equipment and provides a summary for inspection and cleaning processes.

Personnel who use equipment during cleaning operations are responsible for properly using Personal Protective Equipment (PPE) that is appropriate to the cleaning activity. Using cleaning and disinfectant chemicals, power washers, air compressors, and other types of cleaning equipment may present unique working hazards. PPE items to protect such things as hearing, skin, eyes, and respiration may be required. For example, certain types of cleaning equipment may require electrical power and may present electrical hazards to the operator. Power washers operate at very high pressures and are capable of causing serious bodily injury.

- Users of all cleaning equipment must become completely familiar with operating the equipment before attempting its use.
- Not only must the user be familiar with inspection and cleaning equipment, but also with the equipment item to be inspected and cleaned. Use extreme care when working with and around all unfamiliar equipment.
- Consult all appropriate information sources and follow all manufacturers' notices, as well as *Reclamation Safety and Health Standards* (Reclamation, 2001).

Even the most careful cleaning of any equipment, however, will not guarantee that the equipment is absolutely free of contamination. Successful cleaning is dependent upon many factors, such as the amount of care taken during the cleaning operation, the type of cleaning equipment being used, the level of training of the cleaning operator, the type of equipment being cleaned, and the particular invasive species.

Table 1. Summary of inspection and cleaning for personal gear, watercraft, trailers, vehicles, and other equipment

What Needs to be Inspected and Cleaned				
		Personal Gear	Watercraft and Trailers	Vehicles and Equipment
Types of Confirmed or Suspected Invasive Species	Submersed and floating aquatic plants	Inspect: Look for plant material, stalks, or fragments on all surfaces, inside and out. See appendix A.  Clean: Various methods depending on the equipment. See appendix B.	Inspect: Look for plant material, stalks, or fragments on all surfaces, inside and out. See appendix A.  Clean: See appendix B.	Inspect: Preclean to remove large debris to provide better visual access to inspect equipment for foreign matter. See appendix A.  Clean: Various methods depending on the equipment, see appendix B.
	Emergent aquatic	Inspect: See above.  Clean: See above.	Inspect: See above.  Clean: See above.	Inspect: See above.  Clean: See above.
	Wetland	Inspect: See above.  Clean: See above.	Inspect: See above.  Clean: See above.	Inspect: See above.  Clean: See above.
	Riparian plants	Inspect: See above.  Clean: See above.	Inspect: See above.  Clean: See above.	Inspect: See above.  Clean: See above.
	Mollusks	Inspect: See appendix A.  Clean: See appendix B.	Inspect: See appendix A.  Clean: Drain bilge water and dry watercraft and trailer. See appendix B.	Inspect: Search for veligers attached to surfaces. See appendix A.  Clean: Wash surfaces with water heated to a minimum 140 °F. See appendix B.
	Terrestrial plants (dry habitat only)	Inspect: For all clothing, turn out pockets; remove seeds and burrs from all socks, shoelaces, and shoe tongues. See appendix A.  Clean: Clean as indicated. See appendix B.	Inspect: See appendix A.  Clean: See appendix B.	Inspect: Prior to inspection, preclean to remove large debris with tools. See appendix A.  Clean: Various methods depending on the equipment. See appendix B.



## Overview of Species of Concern

Plants and animals spread through a variety of mechanisms. For plants, seeds, fragments, roots, tubers, rhizomes, and stolons are common materials which facilitate reproductive and migratory strategies. Invertebrates, clams, mussels, snails, and other animals often accompany plants, mud, and other materials. Many animals can attach directly to personnel and equipment (figure 17) (Cofrancesco et al., 2007). Regardless of mode of transport, unintentional spread of all invasive species can be managed by removing and isolating them before moving into uninfested areas. Therefore, rigorous inspection and cleaning before leaving a worksite is the best approach, no matter which species are of concern.



**Figure 17. Snails directly attached to wheel and tire (photo courtesy of Al Cofrancesco, 2006).**

More detailed information on invasive species that are known to be problematic in the Western United States and are likely to present invasive species issues for Reclamation are listed in appendix C.



# Bibliography

Breuer, J. 2000. Sprinkler system photographs and information. U.S. Navy. Naval Facilities Engineering Command, Engineering and Acquisition Division, Philadelphia, Pennsylvania.

Bureau of Reclamation. 1996a. *Reclamation Manual. Policy: Pest Management.*, December 23, 1996. <http://www.usbr.gov/recman/env/env-p02.pdf>, accessed May 9, 2008.

Bureau of Reclamation. 1996b. *Reclamation Manual. Directives and Standards: Pest Management – Resource Protection (Integrated Pest Management) Program.* ENV 01-01, October 17, 1996. <http://www.usbr.gov/recman/env/env01-01.pdf>, accessed May 9, 2008.

Bureau of Reclamation. 2001. *Reclamation Safety and Health Standards.* U.S. Department of the Interior, Bureau of Reclamation, Safety and Occupational Health Office, Denver, Colorado.

Bureau of Reclamation. 2006a. *Reclamation Manual. Directives and Standards: Reclamation Standard Water-Related Contract Articles, Article 29: Pest Management.* PEC 10-29, December 21, 2006. <http://www.usbr.gov/recman/pec/pec10-29.pdf>, accessed May 9, 2008.

Bureau of Reclamation. 2006b. Personal communication. Socorro Field Office personnel.

Cofrancesco, Jr., A.F., D.R. Reaves, and D.E. Averett. 2007. *Transfer of Invasive Species Associated with the Movement of Military Equipment and Personnel.* U.S. Army Corps of Engineers – Engineer Research and Development Center.

Colorado Division of Wildlife. 2009. “Clean, Drain, and Dry: Watercraft Cleaning to Prevent the Spread of Invasive Species.” July 2, 2009. <http://wildlife.state.co.us/WildlifeSpecies/Profiles/InvasiveSpecies/WatercraftCleaning.htm?Print=true>, accessed August 28, 2009.

Dewey, T. Personal communication. Bureau of Reclamation. September 7, 2007.

Executive Order No. 13112, Invasive Species, *Federal Register*, February 3, 1999. [http://frwebgate.access.gpo.gov/cgi-bin/getdoc.cgi?dbname=1999\\_register&docid=99-3184-filed.pdf](http://frwebgate.access.gpo.gov/cgi-bin/getdoc.cgi?dbname=1999_register&docid=99-3184-filed.pdf), accessed May 9, 2008.

Food Quality Protection Act. 1996. Public Law 104-170.  
<http://www.epa.gov/pesticides/regulating/laws/fqpa/gpogate.pdf>, accessed May 9, 2008.

Jota, Jim. 2009. Personal communication. Imes, Inc. - Water Weights, Montclair, California.

National Invasive Species Council. 2008. National Invasive Species Management Plan. <http://www.invasivespeciesinfo.gov/council/mp2008.pdf>, accessed August 28, 2009.

Nibling, Fred. 2006. Personal communication. Bureau of Reclamation.

Nixon, B. Personal communication. U.S. Navy, Naval Facilities Engineering Command, Northwest, Silverdale, Washington, September 10, 2007, and April 21, 2010.

Pimentel, D., L. Lach, R. Zuniga, and D. Morrison. 2000. Environmental and Economic Costs of Nonindigenous Species in the United States. *Bioscience* 50: 53-65.

Stauffer, E.E. Personal communication. U.S. Navy, Naval Facilities Engineering Command, MIDLANT, Philadelphia, Pennsylvania, April 29, 2010.

U.S. Department of Defense. 2004. Armed Forces Pest Management Board Technical Guide 31, *Retrograde Washdowns: Cleaning and Inspection Procedures*. <http://www.afpmb.org/pubs/tims/tg31/tg31.pdf>, accessed May 9, 2008.

U.S. Department of the Interior. 1995. *Departmental Manual, 609 DM-1, Policy and Responsibilities, Weed Control Program*, June 26, 1995.  
[http://elips.doi.gov/app\\_dm/act\\_getfiles.cfm?relnum=3042](http://elips.doi.gov/app_dm/act_getfiles.cfm?relnum=3042), accessed May 9, 2008.

U.S. Department of the Interior. 2007. *Departmental Manual 517 DM-1. Part 517: Pesticides, Chapter 1: Integrated Pest Management Policy*.  
[http://elips.doi.gov/app\\_dm/act\\_getfiles.cfm?relnum=3742](http://elips.doi.gov/app_dm/act_getfiles.cfm?relnum=3742), accessed May 9, 2008.

U.S. Department of Transportation. 2002. "Daily Interstate System Traffic in the United States." Federal Highway Administration. <http://www.fhwa.dot.gov/>, accessed August 19, 2009.

U.S. Geological Survey. 2009. Zebra and Quagga Mussel Sightings Distribution.” <http://www.usgs.gov/>, accessed August 19, 2009.

100<sup>th</sup> Meridian Initiative. 2008. Cooperative Federal, State, and provincial agency Web site: <http://www.100thmeridian.org>, accessed August 19, 2009.



**Appendix A**

# **Inspection Standards**





# Contents

	<i>Page</i>
<b>Appendix A: Inspection Standards .....</b>	<b>A-1</b>
How to Inspect .....	A-1
Level of Inspection .....	A-1
Tools for Inspection .....	A-5
Inspection Protocols for Personal Gear.....	A-6
What to Look For.....	A-6
Specific Areas of Concern .....	A-6
Inspection Protocols for Watercraft and Facility Equipment .....	A-7
Amphibious or Water Vehicles.....	A-9
Facility Equipment, In-Water Construction Equipment, and Water Weight Bags used for Crane Testing .....	A-12
Inspection Protocols for Rubber-Tired and Tracked Vehicles .....	A-14
Specific Areas of Concern .....	A-14
Typical Rubber Tired Land Vehicle .....	A-16
Typical Tracked Land Vehicle.....	A-22
Bibliography .....	A-25

## Figures

	<i>Page</i>
A-1 Fill materials separated by type – soil, broken concrete, pavements, etc. – temporarily stored at a barrow site.....	A-2
A-2 Separated stockpiled fill materials .....	A-3
A-3 Stockpiled broken concrete.....	A-4
A-4 Stockpiled fill material at a construction site enclosed by silt fencing to help control soil loss and the potential spread of foreign species.....	A-5
A-5 Aquatic weeds (macrophytes) caught on a boat trailer at a Lake St. Clair boat access .....	A-8
A-6 Mussels on the lower unit of an inboard/outboard engine .....	A-8
A-7 Adult quagga mussels covering a rope used in the Lower Colorado River .....	A-9
A-8 Closeup view of outboard motor shaft housing showing adult quagga mussels living inside the engine and plugging the water intake ports of the outboard motor .....	A-10
A-9 Adult quagga mussels found living inside a disassembled watercraft engine water pump .....	A-11
A-10 Simplified cooling system of an outboard motor .....	A-11
A-11 Mussels covering a penstock gate at Davis Dam .....	A-12
A-12 The ‘Betty L’ Barge Crane, Morrison Knudsen Company, during water weight bag™ testing, Baltimore, Maryland .....	A-13



## **Appendix A**

# **Inspection Standards**

Personnel must be trained to look for problem areas that are not apparent upon casual observation. Effective inspections require good lighting conditions (preferably daylight hours), training of personnel to use systematic techniques, and developing checklists of potential problems. Effective inspections also require persons who have the task of inspecting vehicles, equipment, and personnel to be dedicated and accountable for their actions. The process of inspection must include all areas defined for inspection, including areas difficult to reach and see, driver's compartments, and storage areas.

### **How to Inspect**

Identify and train personnel to be responsible for inspections at field sites. Training for watercraft inspection and cleaning is periodically announced on the 100<sup>th</sup> Meridian Initiative Web site (<http://www.100thmeridian.org>). Inspections should be carried out on personal gear, equipment, and vehicles at a staging area dedicated to equipment and vehicle cleaning. Precleaning inspections can identify problem areas and determine whether hand removal of large accumulations of soil and debris is necessary before washing. Postcleaning inspections can verify that all materials deemed capable of spreading invasive species have been eliminated.

Include an inspection process for vehicles and equipment that arrive onsite from other areas. Equipment from rental agencies, outside contractors, and managing partners are subject to inspection as well.

Furnish appropriate equipment for inspections. Items may include flashlights, under-vehicle mirrors, checklists of known invasive species likely to be onsite, portable lighting if night-time inspections are necessary, and specific checklists of protocols to ensure systematic inspections.

Budget work to account for rigorous inspections as a component of costs. Preventing the spread of invasive species is much less expensive than controlling and managing costs after inadvertent spread of invasive species.

### **Level of Inspection**

Costs and time considerations will likely conflict with the ability to consistently perform rigorous inspections at all field sites. Contingencies, such as inclement weather, field emergencies, and other unknown factors, can further hamper the

ability to perform rigorous inspections. Protocols for dealing with contingencies need to be defined and included in the inspection process.

Equipment used at certain worksites may demand more, or sometimes less, stringent inspection attention than at other worksites, depending on site-specific conditions. Consider the following scenarios as examples:

- **Scenario 1.** Since most weed plant fragments and seeds are found in the topsoil, when working in a barrow site where no topsoil is left, and only subsoil or gravel remains, it would be less likely that vehicle movement out of such an area would be contributing greatly to the spread of weed plant species (figures A-1 and A-2).



**Figure A-1. Fill materials separated by type – soil, broken concrete, pavements, etc. – temporarily stored at a barrow site (photo courtesy of Joe Divittorio, 2010).**



**Figure A-2. Separated stockpiled fill materials (photo courtesy of Joe DiVittorio, 2010).**

- **Scenario 2.** If equipment is used at a location known to be infested with a high risk invasive species, the equipment should undergo vigorous inspection, followed by thorough cleaning, and a final inspection before being moved off the worksite. At the new worksite location, the equipment should be inspected again, preferably by someone other than the original inspector before the equipment is placed into service. This situation would be especially true for watercraft or in-water equipment previously used in zebra or quagga mussel infested waters.
  
- **Scenario 3.** Even with carefully inspected and cleaned equipment, imported fill material (such as rock, soil, broken concrete, and gravel) needed during certain types of construction and maintenance work may become the source of foreign species infestation, rather than the equipment. Keep the following points in mind:
  - Fill materials obtained in close locality to the work site would usually have a lower potential to introduce a foreign species, compared to materials brought in from more distant locations.
  
  - It may be possible to select barrow locations that have been determined through inspection to have low risk for harboring foreign species.
  
  - Certain fill materials that are processed away from the work site, such as washed crushed rock and gravel, can reduce the potential of foreign species transfer.

- Recycled fill materials, such as broken concrete and pavements, often have adhering residue soils that can harbor foreign species. Prior to transport to the work site, reduce the risk of transporting foreign species by having these materials cleaned at an off-work site location (figure A-3).
- Stockpiled fill materials suspected of harboring foreign species at the work site may be covered by black plastic and enclosed by silt fencing to help control their spread (figure A-4).



**Figure A-3. Stockpiled broken concrete – note contact surfaces with adhering residue soils. These surfaces can harbor foreign species from the site of previous use (photo courtesy of Joe DiVittorio, 2010).**



**Figure A-4. Stockpiled fill material at a construction site enclosed by silt fencing to help control soil loss and the potential spread of foreign species. Black plastic covering (seen in upper right corner) has been pulled back to allow machine work (photo courtesy of Joe DiVittorio, 2010).**

The above scenarios are highly situational, as will be the decisions to be made by the individual in actual field locations. Careful review of the potential for spread should be left up to knowledgeable personnel, and the level of inspection, as well as the location of inspection staging areas, should be determined on a case by case basis. It is possible that when moving between nearby sites that are infested with the same invasive species, inspections may not be necessary until leaving the final site.

## **Tools for Inspection**

The following is a list of some sources providing specialized inspection equipment. No endorsement of these products or companies is implied.

### **Under-vehicle inspection mirrors:**

Reflection Products, Inc.  
1505 N. Richmond Rd.  
McHenry, IL 60050  
815-344-0002 x231  
<http://www.reflectionproducts.com/>

## **Under-vehicle inspection cameras:**

Con-Space Communications

1160 Yew Avenue, PO Box 1540

Blaine, WA 98231

1-800-722-2824

<http://www.con-space.com/searchcam/searchcam-overview>

## **Inspection Protocols for Personal Gear**

### **What to Look For**

Seeds, plant material, soil, mud, insects, and other invertebrates.

Snails, mussels, algae, aquatic plant fragments, and other aquatic species.

For in-water equipment, inspect for zebra and quagga mussel infestations. Look for adult mussels and feel by hand for very small veligers (the mussel immature life stage) attached to anything that has made contact with raw water.

Clothing, hats, socks, shoes, gloves, and jackets should be thoroughly inspected for above-listed materials. Pockets should be turned inside out to remove debris. Shoelaces and shoe tongues should be checked.

Upon inspection, preclean personal gear by physical removal of contaminated material with a stiff brush, lint remover, compressed air, or pressurized hot water.

Note: Some of the information in the following lists has been adapted from the *Plant Dispersal Information System* (U.S. Army Corps of Engineers - Engineer Research and Development Center, 2006) and the 100<sup>th</sup> Meridian Web site (100<sup>th</sup> Meridian Initiative, 2008).

### **Specific Areas of Concern**

Particular attention must be given to places where foreign material could become accidentally trapped, such as in the cuffs and folds of clothing, treads of boots or waders, or closures such as zippers or ties.

#### **Closures:**

Zippers, belts, laces or ties, buckles, straps, Velcro grips, buttons and fasteners, rivets

#### **Loose Particle Fabric:**

Canvas, nylon, cotton, poly blend, wool, fleece, netting, suede



**Other:**

Socks and ankle grips, treads of footwear, cuffs and folds, seams, flaps, pockets, collars and hoods, ventilation openings

For more information, consult your State’s Fish and Wildlife agency, as well as the 100<sup>th</sup> Meridian Web site: <http://www.100thmeridian.org/>.

## **Inspection Protocols for Watercraft and Facility Equipment**

Watercraft and trailers are probably major contributors to the spread of invasive aquatic plants and animals (figures A-5 and A-6). New infestations of exotic aquatic plants and animals are often first discovered near boat ramps. Detailed inspections must be made before watercraft, trailers, and facility equipment in contact with raw water are moved from one water body to another.

Zebra mussels and quagga mussels are a complex inspection problem. Plant material is likely to be visually identified; however, the mussel veliger (the immature life stage) can attach to watercraft hulls, trailers, anchor ropes, and anything else that contacts an infested water body without being visually identified. Since the veliger is microscopic and cannot be seen without laboratory equipment, do not rely on visual inspection alone. Veligers can attach to a surface when they are “as small as a sesame seed”; therefore, they are detectable only by feeling by hand along all surfaces and inside holes and crevices. On a smooth surface, mussel veligers will feel gritty, like sandpaper. As the veliger ages and grows, it may become visible to the unaided eye, appearing as a nondescript speck. Equipment that has been in water for a long period of time can become infested with adult mussels (figure A-7).

**Remember:**

- Zebra and quagga mussel inspections can be an involved and complex process.
- The life stage of the mussel will influence inspections; adult mussels can be seen, veligers must be detected by feel.
- If you are not familiar with the life cycle of these mussels, refer to appendix C, pages C-103 through C-111 for more information.

A guidance video presentation produced by the Pacific States Marine Fisheries Commission, in conjunction with the Washington Department of Fish and Wildlife and the U.S. Fish and Wildlife Service, entitled, “Don’t Move a Mussel!” [http://100thmeridian.org/Video/DMAM2008\\_WM.asp](http://100thmeridian.org/Video/DMAM2008_WM.asp) presents methods to inspect watercraft for mussels. The following is a synopsis of material presented in the video (Pacific States Marine Fisheries Commission, 2008).



**Figure A-5.** It is possible for mussel veligers and adults to attach to aquatic weeds; this photo shows aquatic weeds (macrophytes) caught on a boat trailer at a Lake St. Clair boat access.



**Figure A-6.** Mussels on the lower unit of an inboard/outboard engine.



**Figure A-7. Adult quagga mussels can be seen covering a rope used in the Lower Colorado River. More than likely, this rope also has unseen veliger life stage mussels as well (photo courtesy of Joe DiVittorio, 2008).**

## **Amphibious or Water Vehicles**

Follow the same protocol shown in the video “Don’t Move a Mussel!”

Inspect bilge compartments, raw water holding tanks such as ballast water tanks, wet and live wells, propellers, trailers, anchors, chains, ropes and ties, tread mats, and traction grids.

### **General Considerations:**

- **LOOK** for attached adult mussels on all surfaces.
- **FEEL** by hand for attached veliger mussels on all surfaces.
- **CHECK** all components, such as the hull, in live wells, motor, axle, dock line, trailer lights, rollers, runners, and any other parts in contact with water.

### ***Outboard Engine Watercraft***

Look especially at the bottom drain holes, propeller, cooling water intake ports, and motor mounts.

### ***Inboard/Outboard Engine***

***Watercraft*** Look especially at propeller, steering components, cooling water intake ports, and under trim tabs.

### ***Inboard Engine Watercraft***

Look especially at trim tab, rudder, crevices, water intake ports, propeller, and input cap.

### ***All Watercraft Engines***

If the watercraft engine is not a closed cooling system configuration (if the engine intakes its cooling water from the environment), the following applies. Although it may seem counterintuitive, it is possible for zebra and quagga mussels to live inside the cooling system of watercraft engines and become a source of contamination when it is operated in un-infested waters. Mussel veligers can enter the engine cooling system through the cooling water intake, become attached inside the system, and grow into the adult (reproductive) life stage mussels. The mussels can survive on the “cool” side of the cooling system—that portion of the cooling system beginning at the water intake ports flowing to the engine’s water jacket (heat exchanger)—for the long term in between uses (figures A-8 and A-9).

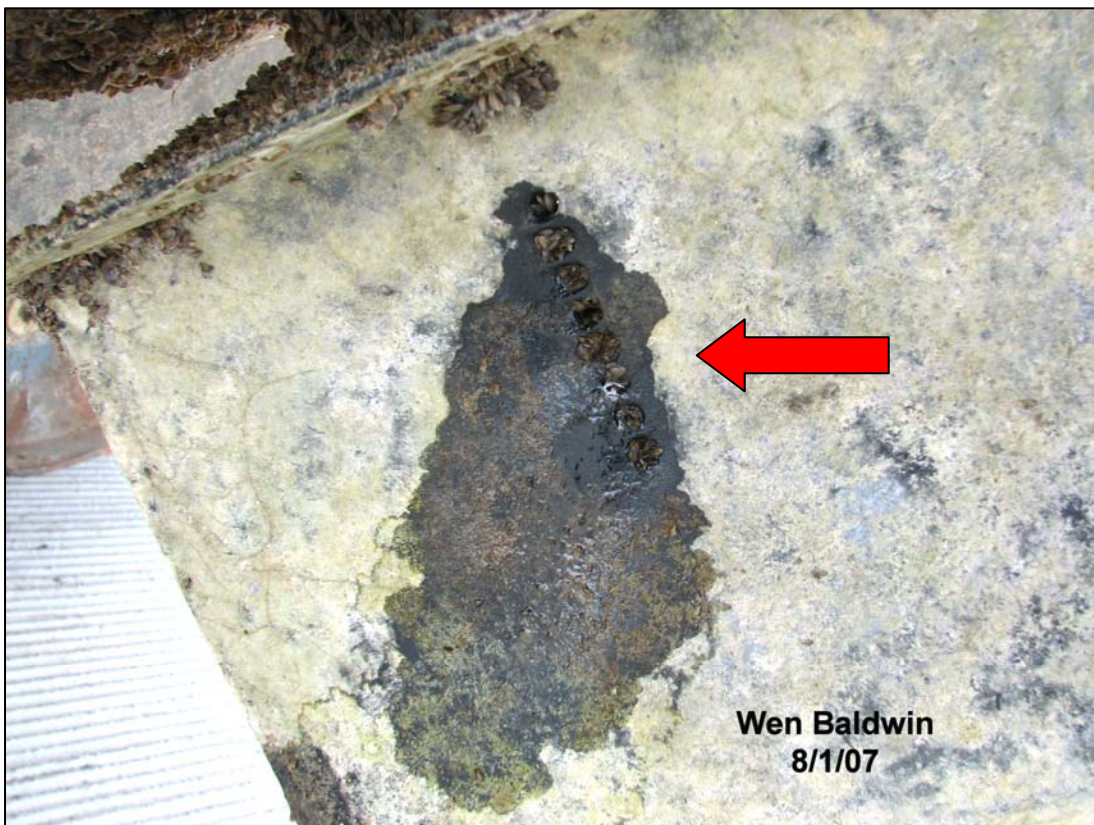

**Figure A-8. Closeup view of outboard motor shaft housing. Adult quagga mussels living inside the engine and plugging the water intake ports of this outboard motor.**

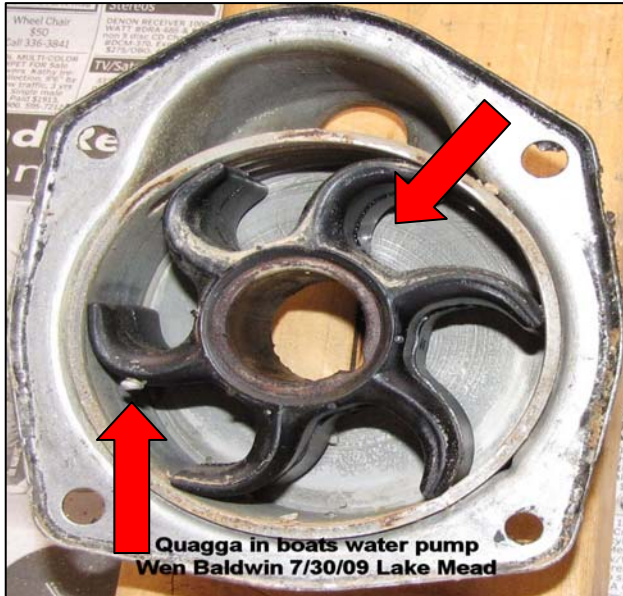
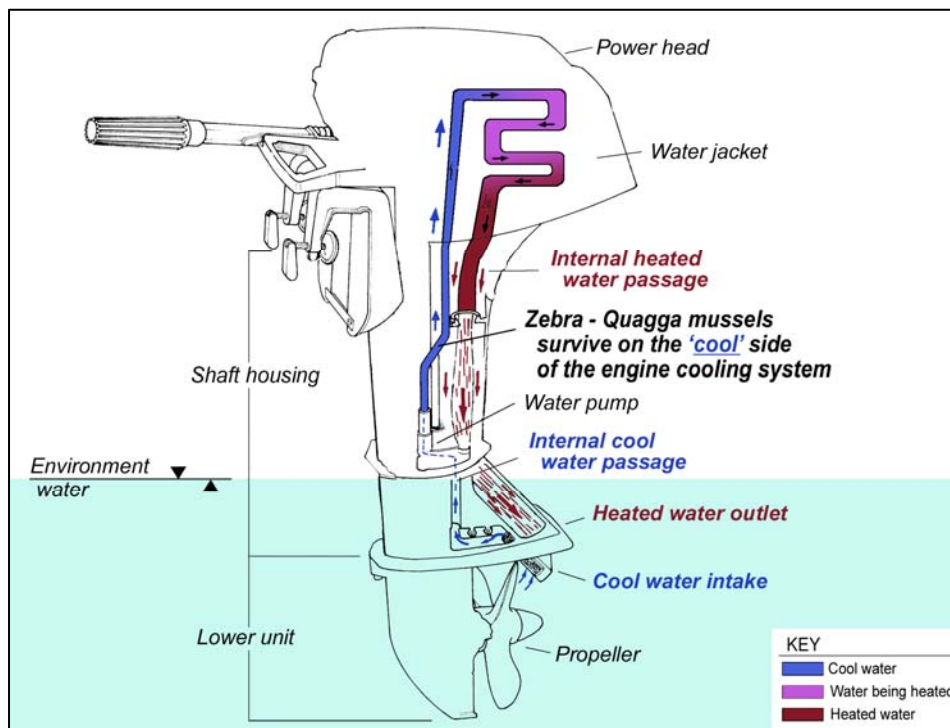

**Figure A-9. Adult quagga mussels found living inside a disassembled watercraft engine water pump.**

At the water jacket, engine heat is transferred to the cooling water. Now heated to at least 140 °F, the circulating cooling water is on the “hot” side of the cooling system—from the water jacket to the water outlet ports—where the heated cooling water will kill any mussels present (figure A-10). See appendix B for specific decontamination procedures for watercraft engines.

The Colorado Department of Water Resources *Aquatic Nuisance Species (ANS) Watercraft Inspection Handbook*

contains a High-Risk Inspection Form for use on high-risk trailered watercraft (Colorado Department of Water Resources, 2009). It can be accessed at: <http://www.wildlife.state.co.us/NR/ronlyres/12EE2395-90A2-48E4-BCCD-A25996DFD50D/0/COANSInspectionHandbook2009.pdf>.



**Figure A-10. Simplified cooling system of an outboard motor (courtesy of Joe DiVittorio and Cindy Gray, 2010).**

## Facility Equipment, In-Water Construction Equipment, and Water Bags used for Crane Testing

Inspect facility equipment (figure A-11) and in-water construction equipment (figure A-12) in much the same way watercraft would be inspected. Figure A-12 shows water weight™ bag testing on an in-water barge. Note that both the water bags and the barge itself may be contaminated during use. Be sure to inspect all equipment that comes into contact with raw water. Any equipment item that has been in contact with raw water has the potential to become the source of contamination if it is placed into service at a new location. Remember that both adult and veliger life stages of mussels can hide in inconspicuous equipment recesses. A thorough inspection is necessary using the following points:

- If equipment is used at a location known to be infested with an invasive species, the equipment should undergo a preinspection, followed by thorough cleaning and a postcleaning inspection, before being moved off the worksite.
- At the new location, the equipment should be inspected again, preferably by someone other than the original inspector before the equipment is placed into service.
- If, on reinspection, contamination is found on the equipment, do not allow the equipment entry on the new worksite; either return the equipment to the location of last use for additional cleaning or arrange for cleaning at a location that is specifically designed for equipment cleaning.



**Figure A-11. Mussels covering a penstock gate at Davis Dam (photo courtesy of Dave Arend, 2008).**

Water bags used for crane testing generally cannot be easily inspected at the level required to find the mussel veliger life stage. Therefore, rather than inspecting it, if the water bag was filled with raw water during its prior use and was not decontaminated, assume it is contaminated. See appendix B for more information regarding water bag decontamination procedures. If the crane testing company can provide certification that the water bag was filled only with potable water at its last location, or was filled with raw water and properly decontaminated, the bag can be assumed to be free of contamination. However, if there is any doubt, insist upon decontamination of the water bag before allowing its use at the facility.



**Figure A-12. The 'Betty L' Barge Crane, Morrison Knudsen Company, during water weight bag™ testing, Baltimore, Maryland (photo courtesy of Jim Jota, Imes, Inc., 1994).**

# Inspection Protocols for Rubber-Tired and Tracked Vehicles

Note: The following has been excerpted from the *Plant Dispersal Information System*, Version 1 (U.S. Army Corps of Engineers – Engineer Research and Development Center, 2006).

The following is a suggested inspection protocol for vehicles that have been exposed to invasive weed material. In the field, all vehicles should be inspected and all visible material should be removed.

## Specific Areas of Concern

Particular attention must be given to places where foreign material could become accidentally trapped, such as in cracks and crevices, in undercarriages, and in the treads of tracks or tires. The following is a list of areas that warrant special attention and where plant material could most easily become lodged.

Drawings and/or photos of specific types of vehicles are provided on the following pages.

### ***Rubber Tired Land Vehicles*** (see “Typical Rubber Tired Land Vehicle” detail)

- Crevices in upper surface and panels
- Tires, rims, and fender wells
- Spare tire mounting area
- Bumpers
- Front and rear quarter panels
- Around and behind grills
- Bottom of radiator vent openings
- Brake mechanisms
- Transmission
- Stabilizer bar
- Shock absorbers
- Front and rear axles
- Beds
- Suspension units
- Exhaust systems
- Light casings and mirrors

### ***Tracked Land Vehicles*** (see “Typical Tracked Land Vehicle” detail)

- Crevices in upper surface and panels
- Top of axles and tensioners
- Support rollers



- Between rubber or gridded areas
- Beneath fenders
- Hatches
- Under casings
- Grills

***Interiors of All Vehicles***

- Beneath seats
- Beneath floor mats
- Upholstery
- Beneath foot pedals
- Inside folds of gear shift cover

The Armed Forces Pest Management Board publication Technical Guide-31 (U.S. Department of Defense, 2004) offers some useful guidelines and considerations for inspecting vehicles. The following illustrations are taken from that guide. It can be accessed at the following Web site:

<http://www.afpmb.org/pubs/tims/tg31/tg31.pdf>

## Typical Rubber Tired Land Vehicle

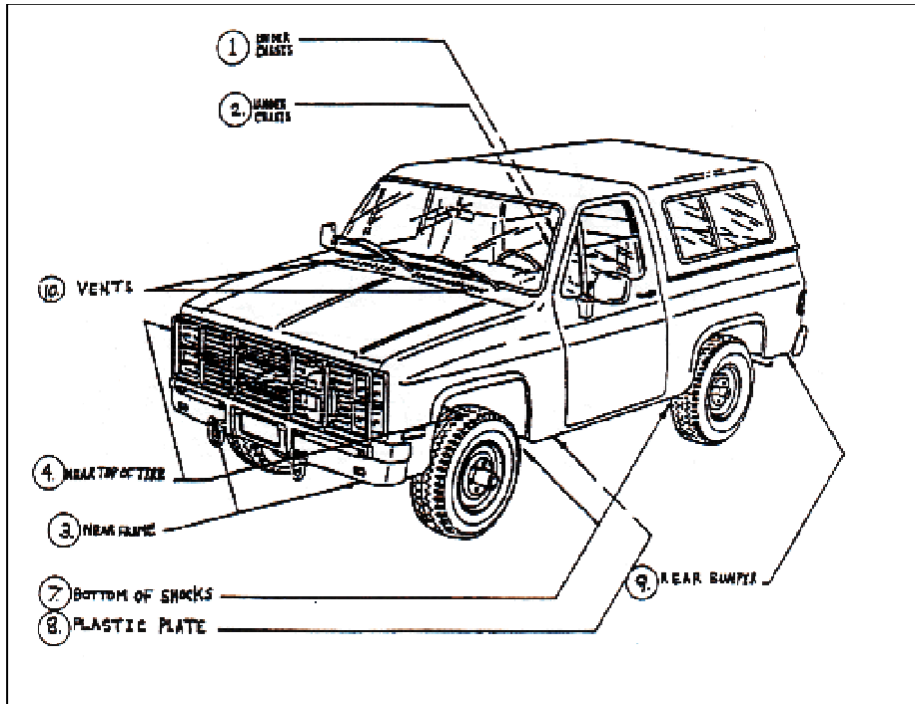

### Problem Areas

1. Fuel tank filler tube where it enters the vehicle body.
2. On top of the fuel tank protector.
3. Shackles on stabilizer bar.
4. Top of the front brake calipers.
5. Inside the cab, underneath the edge of the floor mats and the spare tire area.
6. On top of the transmission.
7. Bottom of the shock absorbers where they join the axles.
8. Above the plastic protective plate behind the vehicle's front tires.
9. Rear bumper area (electrical wiring and tail lights).
10. Hood vents.

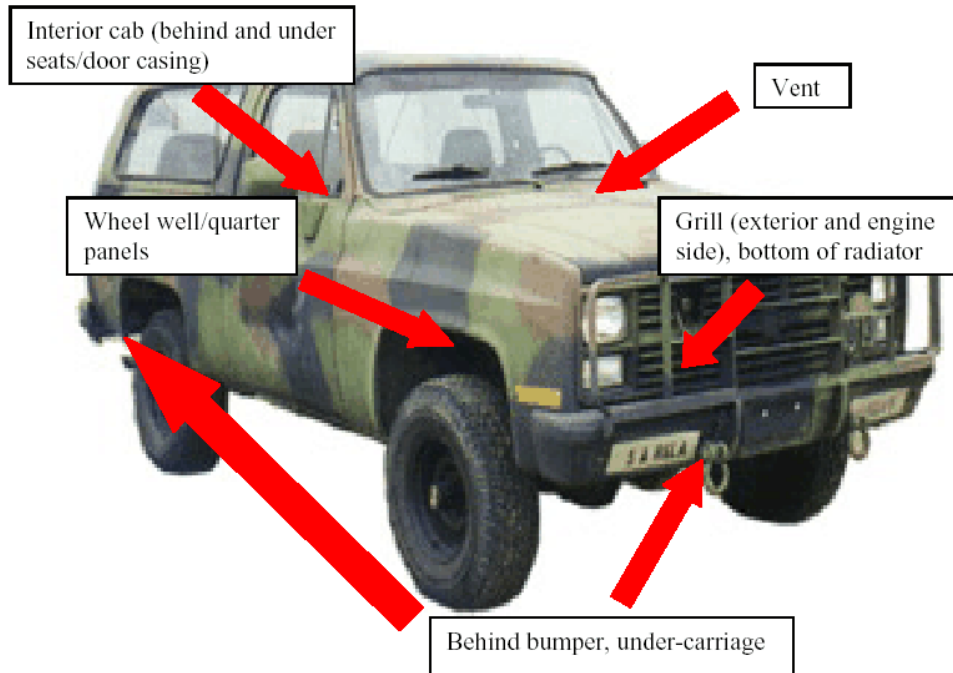

### Problem Areas

1. Inside the cab, underneath the vehicle floor mat edge.

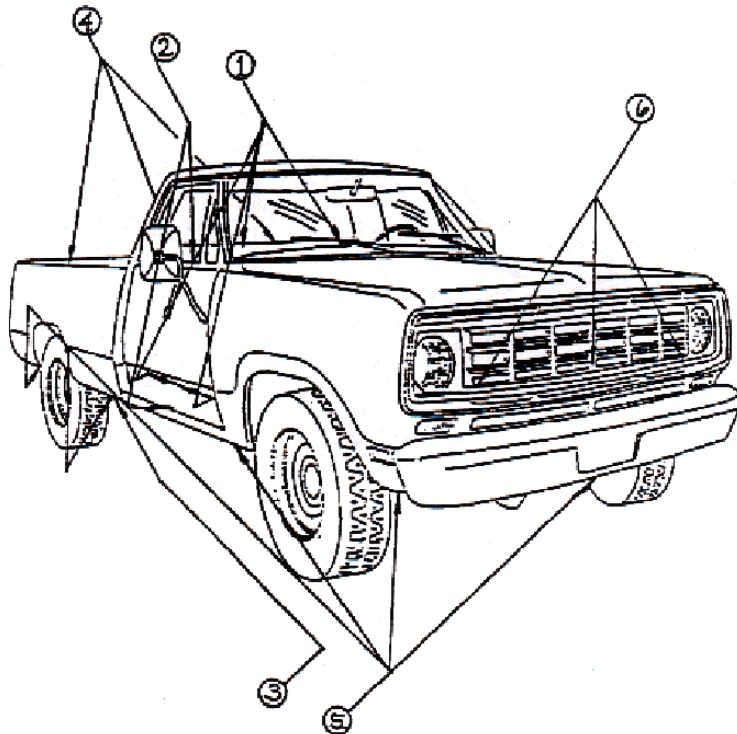

2. Underneath the seat.

3. On top of the rim of the spare tire.

4. The rear bed.

5. Ledges underneath the bumpers, front and rear quarter panels.

6. Front of the grill and tray under the radiator.

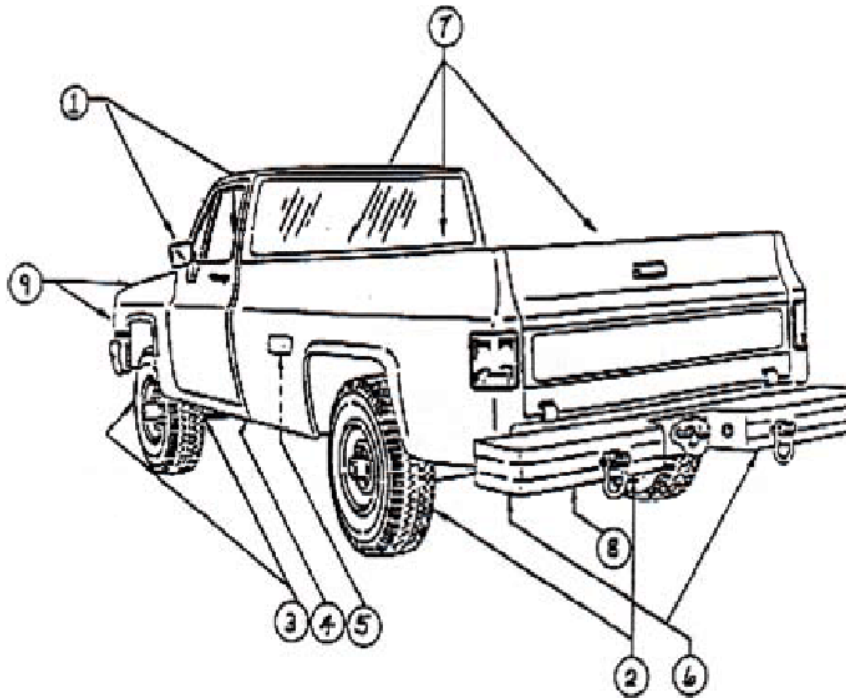

### **Problem Areas**

1. Twigs and/or debris in vent openings.
2. Between the rear wheel brake drums and the steel rim of the wheel.
3. On top of the front suspension components.
4. On top of the transmission.
5. At the bend of the fuel inlet tube, just before it comes in contact with the body of the vehicle; view it from underneath.
6. Rear bumper area, especially behind the U-shaped protective plate that protects tail light electrical wiring.
7. Twigs and/or debris in bed of vehicle.
8. On top of the rim of the spare tire.
9. Front area of the grill.



Wheel well of a pickup

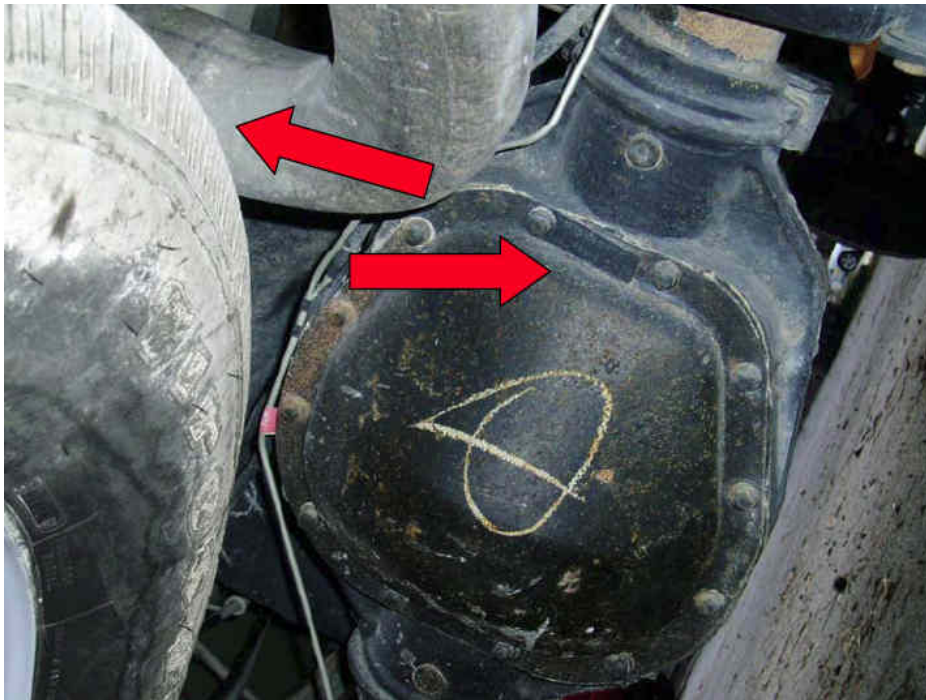

Rear differential (undercarriage) and spare tire

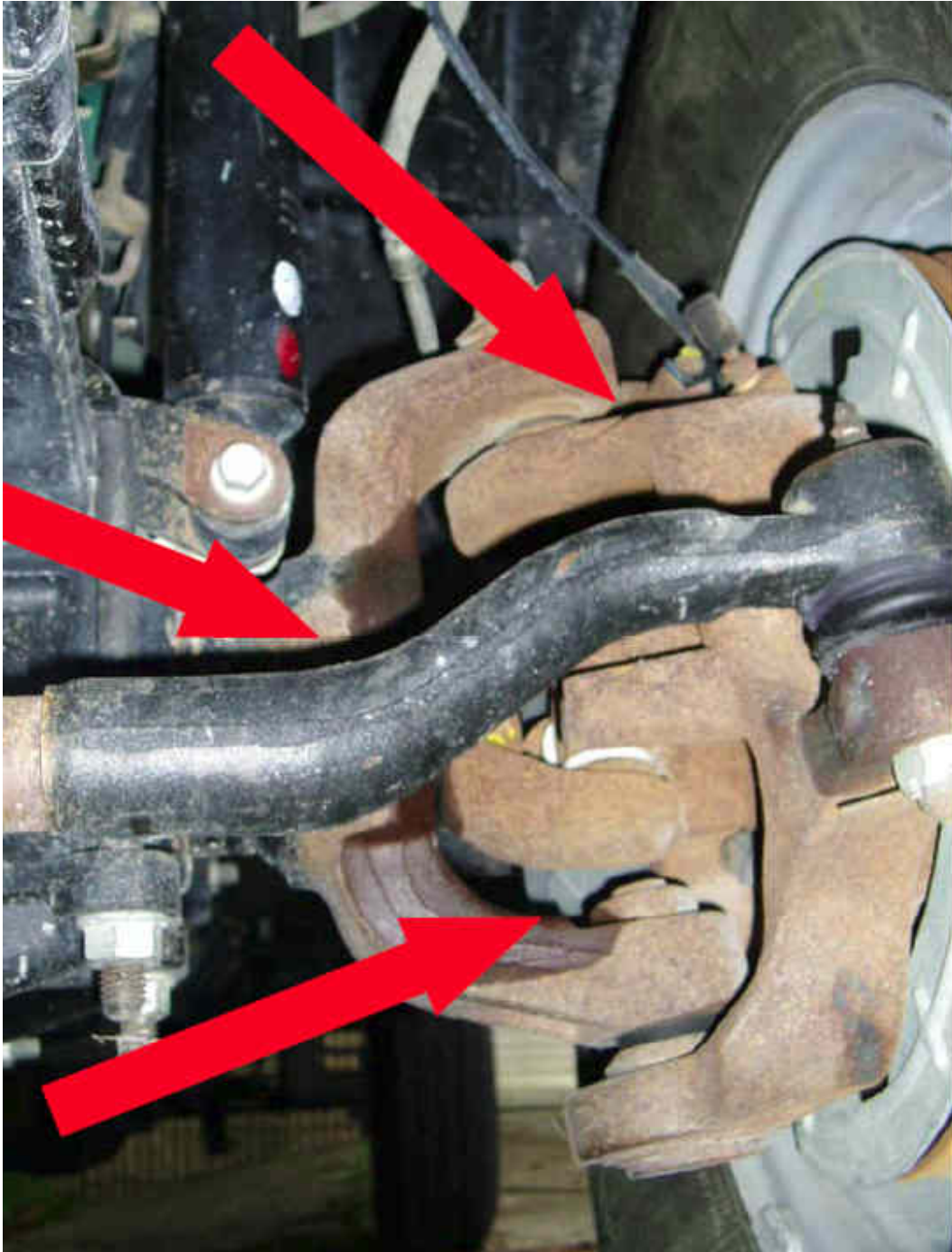

Front wheel, spindle and kingpin

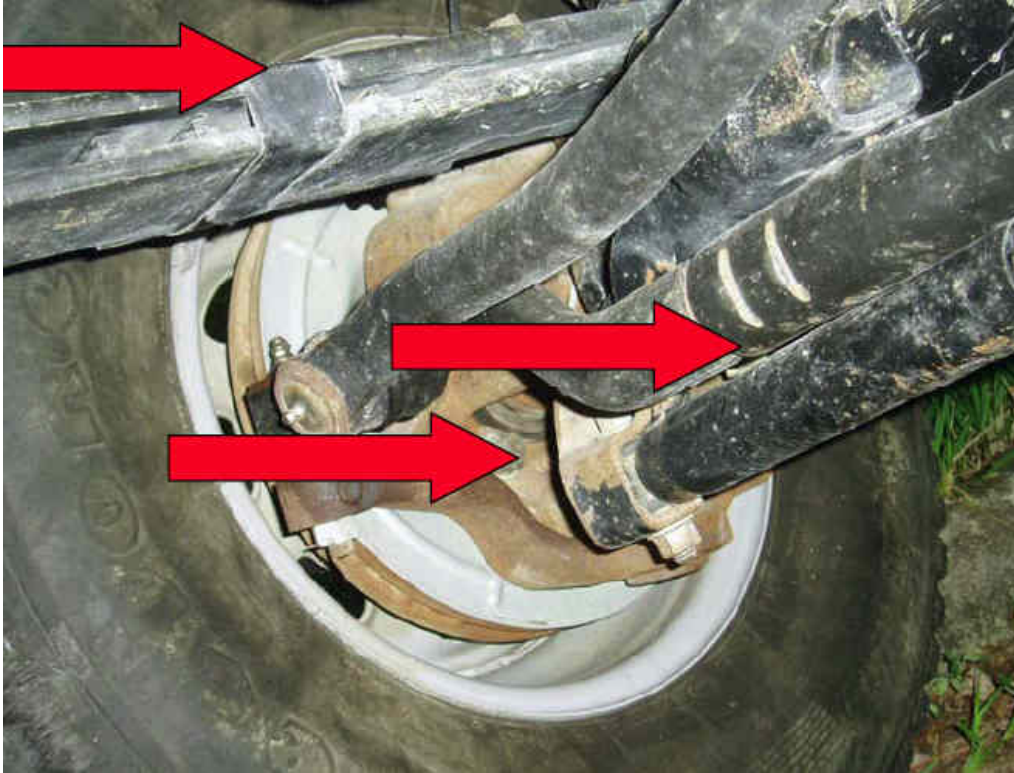

Front spindle and steering cross tube



Cowl under windshield and all engine compartment components

## Typical Tracked Land Vehicle



All tracked land vehicles share many common components such as tracks, rollers, idlers, tensioners, and sprockets.

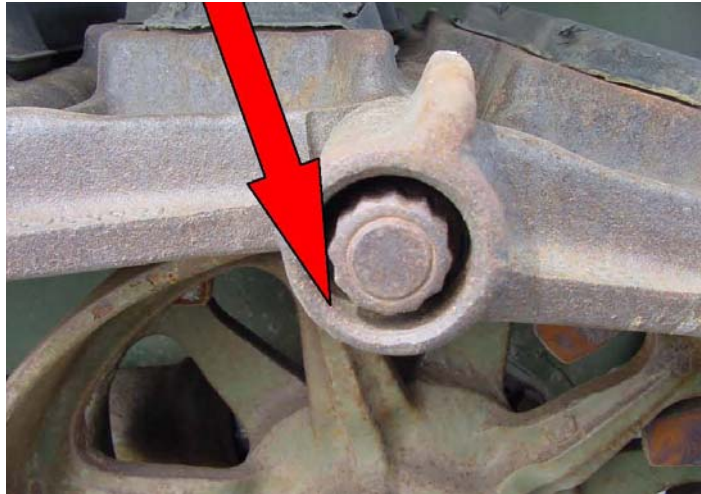

Typical track plate link pin

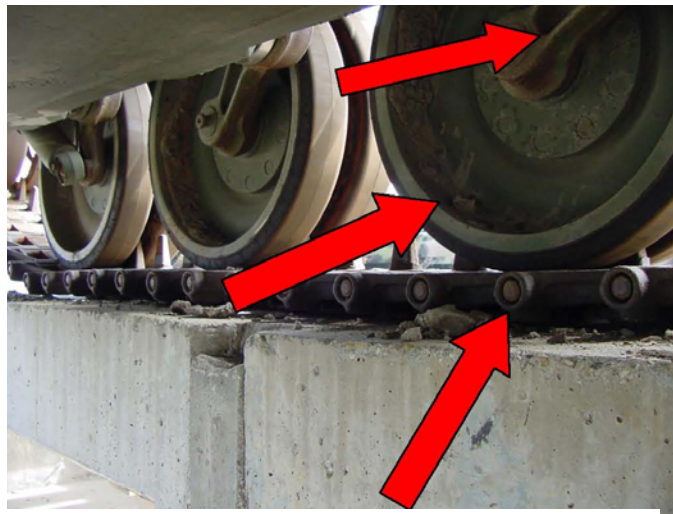

Inner view of track roller, roller support, and track.



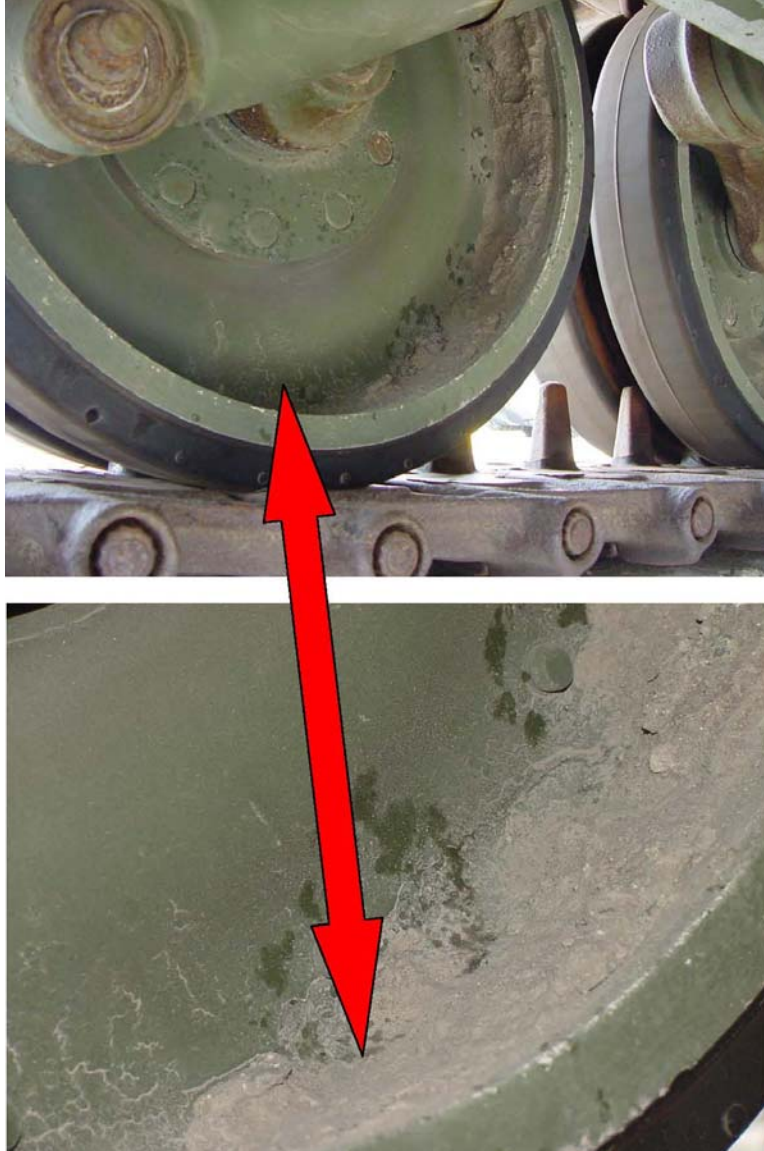

**Inner view of track roller. Postcleaning inspection on a previously cleaned vehicle noted remaining mud accumulation. This photo illustrates the value of an equipment postcleaning inspection.**



# Bibliography

Baldwin, Wen. 2009. Personal communication. Contractor, Pacific States Marine Fisheries Commission, Henderson, Nevada.

Colorado Department of Water Resources. 2009. *Aquatic Nuisance Species (ANS) Watercraft Inspection Handbook*.  
<http://www.wildlife.state.co.us/NR/rdonlyres/12EE2395-90A2-48E4-BCCD-A25996DFD50D/0/COANSInspectionHandbook2009.pdf>, accessed July 13, 2009.

Jota, Jim. 2009. Personal communication. Imes, Inc. - Water Weights, Montclair, California.

Pacific States Marine Fisheries Commission. 2008. "Don't Move a Mussel!" Video presentation produced in conjunction with the U.S. Fish and Wildlife Service and Washington Department of Fish and Wildlife. Available at Web site: [http://100thmeridian.org/Video/DMAM2008\\_WM.asp](http://100thmeridian.org/Video/DMAM2008_WM.asp), accessed July 2, 2008.  
Phillips, Stephen. 2009. Personal communication. Pacific States Marine Fisheries Commission, Portland, Oregon.

U.S. Army Corps of Engineers – Engineer Research and Development Center, 2006. *Plant Dispersal Information System – Version 1.0 (CD-ROM)*. Whitaker, S., M. Grodowitz, A. Cofrancesco, J Shearer, and L. Jeffers (eds.), Vicksburg, Mississippi.

U.S. Department of Defense, 2004. Armed Forces Pest Management Board Technical Guide 31, *Retrograde Washdowns: Cleaning and Inspection Procedures*. <http://afpmb.org/pubs/tims/tg31/tg31.pdf>, accessed May 9, 2008.

Zook, Bill. 2009. Personal communication. Contractor, Pacific States Marine Fisheries Commission, Shelton, Washington.

100<sup>th</sup> Meridian Initiative. 2008. Zebra/quagga mussel information. <http://www.100thmeridian.org>, accessed July 9, 2008.



## **Appendix B**

# **Cleaning and Decontamination Procedures**



# Contents

	<i>Page</i>
<b>Appendix B: Cleaning and Decontamination Procedures</b>	
Cleaning and Decontaminating Personal Gear .....	B-1
Precogning Methods.....	B-1
Water Washing in Conjunction with Physical Removal Technique.....	B-2
Cleaning and Decontaminating Vehicles and Equipment .....	B-2
Precogning Methods.....	B-2
Water Washing with High-Pressure Wash and With or Without Thermal Treatment .....	B-3
Selecting a Washdown Location.....	B-4
Currently Available Systems .....	B-7
Cleaning and Decontaminating in Zebra/Quagga Mussel Infested Areas .....	B-10
Acceptable Decontamination Methods .....	B-11
Use of Decontamination Methods for Small In-Water Equipment .....	B-13
Use of Decontamination Methods for Large In-Water Equipment .....	B-14
Product Vendors.....	B-26
Bibliography .....	B-29

## Figures

	<i>Page</i>
B-1 Bermed portable mat system with sump pump for water recycling .....	B-4
B-2 Another example of portable mat systems.....	B-5
B-3 Water for vehicle cleaning was pumped from conveyance channel at Socorro, New Mexico field site .....	B-6
B-4 Trailer-mounted washing system field tested by Forest Service for cleaning land use vehicles and other equipment .....	B-8
B-5 InterClean Equipment's heavy duty washing system .....	B-8
B-6 Little Red Hen, LLC, Bozeman, Montana vehicle washing Service. Filtered mud and debris are compacted and packaged for landfill .....	B-9
B-7 Inboard/outboard engine flushing .....	B-18
B-8 Water jetting spin nozzle for cleaning out small diameter pipe infested with quagga mussels .....	B-20
B-9 Copper plate submerged for 18 months in Lake Havasu; notice there are no mussels on the rope or on the plate .....	B-21
B-10 Brass plate submerged for 18 months in Lake Havasu; notice there are no mussels on the rope or on the plate .....	B-22
B-11 Bronze plate submerged for 18 months in Lake Havasu; notice the rope has mussels attached while the plate is mussel free ...	B-22

**Figures** (continued)

*Page*

- B-12 This 90-10 copper nickel fish screen has been exposed for 4 months; notice the amount of mussels attached to the surface ..... B-23
- B-13 Antifouling coating test panel has been in the Lower Colorado River at Parker Dam for 4 months; notice the attached adult quagga mussels on the test panel and anchoring ropes ..... B-24
- B-14 An example of a foul release coating that has been in the water for 18 months. Mussels and algae growth may attach to the surface under certain flow rates; however, they are easily removed ..... B-24



## Appendix B

# Cleaning and Decontamination Procedures



**Prior to beginning any cleaning or decontamination action, be sure to first review and thoroughly conduct an inspection of the equipment as discussed in “Overview of Inspection Procedures” and in appendix A.**

Note: Some of the following procedures have been adapted from the *Plant Dispersal Information System*, V.1.0 (U.S. Army Corps of Engineers – Engineer Research and Development Center, 2006).

## Cleaning and Decontaminating Personal Gear

### Precleaning Methods

#### ***Brushing (Physical Removal)***

Used in conjunction with another physical removal method, such as vacuuming, or when in the field, this method is considered to be moderately effective in removing the majority of plant material from clothing, footwear, or other personnel gear. The use of a brush will remove most surface soil, plant material, and foreign matter from clothing. If there is a nap, brush with the nap rather than against it. Brushing against the nap could further embed small seeds into the weave of fabric. A combination of soft and stiff bristles of varying length is recommended for footwear and tread, while medium length and stiffness is desired for removal of soil and other matter from clothing. Follow up with a water wash or as recommended by the manufacturer.

#### ***Vacuuming (Physical Removal)***

Vacuuming the article of clothing with a brush attachment is suggested to remove most loose particle matter, but care should be given, as small seed may become embedded in materials. To prevent contained plant and soil matter from being redeposited or redispersed following the cleaning process, collected matter should be double bagged and disposed of in a sanitary landfill. Follow up with a water wash or as recommended by the manufacturer.

#### ***Use of Adhesive Roller (Physical Removal) in Conjunction with Other Physical Removal Technique***

Used in conjunction with other physical removal methods, such as brushing or vacuuming, or when in the field, this method is considered to be moderately effective in removing the majority of plant material from clothing, equipment, and

gear. Proper attention and care given during removal is a direct reflection of the potential efficiency of this technique. Seed and fragment materials readily attach to the adhesive sheets and are effectively lifted out of seams and the weave of loose particle fabrics. Roller sheets should be double bagged and disposed of in a sanitary landfill.

## **Water Washing in Conjunction with Physical Removal Technique**

General water washing, or other cleaning methods as recommended by the manufacturer, can be used in conjunction with a physical removal technique such as brushing or vacuuming and is moderately effective in removing residual foreign materials, although small and embedded seeds are capable of persisting. In addition, seed may remain viable following a wash treatment. In extreme situations, where known invasive materials are present, wastewater can be treated or filtered, and the waste materials double bagged and disposed of in a sanitary landfill.

### ***Thermal Treatment***

Thermal treatments involve the use of extremely hot temperatures in order to kill all invasive material. Applying steam, hot air, or hot water has proven to be especially effective.

Disadvantages to the use of thermal treatments, such as steam and hot water, are the apparent risk of burns, its labor-intensive nature, and the initial investment cost of equipment.

## **Cleaning and Decontaminating Vehicles and Equipment**

### **Precleaning Methods**

#### ***Brushing (Physical Removal)***

Used in conjunction with another physical removal method such as vacuuming, or when in the field, this method is moderately effective in removing the majority of plant material from equipment and gear. Brushing will remove most surface soil, plant material, and foreign matter. If there is a nap to fabric, such as upholstery or carpeting, brush with the nap rather than against it. Brushing against the nap could further embed small seeds into the material.

A combination of soft and stiff bristles of varying length is recommended for use on carpeting or components made of rubber, nylon, or plastic. Bristles of medium length and stiffness are desired for removal of soil and other matter from fabrics and upholstery. Stiff bristles are recommended for the tread of wheels that

become encrusted with soil and mud. Metal bristles may also be used to remove soil or concrete in treads, but heavier wear and tear to the equipment will result. High-pressure compressed air blasting may be used to assist soil removal.

Followup with vacuuming, high-pressure air blasting, or high-pressure wash is recommended as applicable.

### ***Vacuuming (Physical Removal)***

Vacuuming equipment with a brush attachment is suggested to remove most loose particle matter, but care should be taken because small seed may become further embedded in materials. To prevent contained plant and soil matter from being redeposited or redispersed following the cleaning process, collected matter should be double bagged and disposed of in a sanitary landfill. Followup with water washing, high-pressure air blasting, or high-pressure wash is recommended as applicable.

### **Water Washing with High-Pressure Wash and With or Without Thermal Treatment**

General water washing with high-pressure wash or thermal treatment is the most effective method for removing residual foreign materials, although small and embedded seeds are capable of persisting. Where known invasive materials are present, wastewater can be treated or filtered, and the waste materials double bagged and disposed of in a sanitary landfill.

### ***High-Pressure Wash***

Improvement in the design of high-pressure washing makes it the most effective means of cleaning heavily soiled and contaminated items. Not all items are capable of withstanding the pressure of this treatment, and it should only be used where applicable.

There are many models of high-pressure washers, from simple hand-held nozzles to laser guided, robotic control systems. In some cases, containment and operation sheds are portable. The water systems can be fresh or recycled and use hot or cold water.

### ***Thermal Treatment***

Thermal treatments involve the use of extremely hot temperatures in order to kill all invasive material. Applying steam, hot air, or hot water has proven to be especially effective.

Disadvantages to the use of thermal treatments, such as steam and hot water, are the apparent risk of burns, its labor-intensive nature, and the initial investment cost of equipment.

## Selecting a Washdown Location

The U.S. Department of Defense Armed Forces Pest Management Board Technical Guide 31 (Department of Defense, 2004) presents criteria regarding the location and equipment to be used for washing land vehicles.

To avoid reaccumulation of soil on cleaned vehicles, the Department of Defense recommends supplying a paved area for washing, offloading, and staging vehicle cleaning operations, with paved roads between. This type of facility will often not be a viable option for activities in remote areas. Elevating the washing areas (see figure 15 under “Overview of Inspection Procedures”) enables cleaning personnel to access the underside of vehicles and equipment, where contaminants are otherwise difficult to reach.

Water runoff carrying soil, seeds, animals, and petroleum contaminants must be managed with the use of berms or other containment (figures B-1 and B-2). Silt fence installed along perimeters of work areas can also aid in preventing spread of contaminated materials outside of the washdown location.



**Figure B-1.**  
**Bermed portable**  
**mat system**  
**with sump pump**  
**for water recycling**  
**(U.S. Department of**  
**Agriculture, Forest**  
**Service site).**

### **Best Management Practice:**

Do not locate the cleaning site adjacent to storm water drains that allow untreated effluent to enter surface water bodies.

The area must be large enough to safely accommodate all vehicles and personnel before, during, and after cleaning operations. Considerations should include weather protection when necessary. An efficient site design should make it easy for vehicles to move into and out of the area (U.S. Department of Defense, 2004).



**High-wall portable berm with wall supports in place. High-wall berms might offer better overflow protection when conducting equipment washing. Remove the wall supports on one side to move equipment onto the berm. All wall supports can be removed, and the entire berm rolled up for easy moving and storage. Bung openings can be positioned to fit specific need when ordering from the company (Interstate Products, Inc.).**



**Secured bungs are tied in place (Interstate Products, Inc.).**

**Figure B-2. Another example of portable mat systems (photo courtesy of Joe DiVittorio, 2003).**

Water availability is another major consideration. Fresh water in a quantity suitable for all cleaning operations is necessary. When this is not possible, consideration should be given to other water options such as water recycling systems (figure B-1) or use of compressed air to remove soil. The benefit of compressed air is that there is no contaminated cleaning water to process.

Raw water, or even gray water, is sometimes used, but potential health issues may require precautions such as immunizations or specialized safety equipment for personnel (figure B-3). When pumping water from field sources, unintentional movement of exotic plants, problematic algae, or other invasive aquatic species must be addressed. Proper placement of pumps away from aquatic or shoreline vegetation that is known to be invasive is a prudent first step. Heating field source water to 140 °F is required to prevent invasive mussel spread while washing with field source water.



**Figure B-3. Water for vehicle cleaning was pumped from conveyance channel at Socorro, New Mexico field site (Bureau of Reclamation photo).**

Minimum water pressure for land vehicle cleaning should be at least 90 pounds per square inch (psi) (U.S. Department of Defense, 2004). Electricity or alternate power for pressure sprayers must be made available. Adequate hoses (with repair and spare supplies) should be on hand.

Water can be supplied as high volume and low pressure or low volume and high pressure. Each option has advantages and disadvantages based on specific cleaning needs and water availability. Heavy accumulations of soil and debris on large land-use equipment can best be cleaned using high volumes of water, but it may create water treatment or disposal issues. Still, some currently available cleaning systems can effectively remove large accumulations of soil with

relatively low-volume water delivery. Cleaning watercraft and other in-water equipment usually requires lower volume, high-pressure washing systems.

Water storage tanks, filters, and recapture systems can offer adequate onsite water supplies with less water use than would otherwise be necessary without recycling. By using sand or cartridge filters, many contaminated substances can be captured during cleaning operations to be safely handled later. In addition to soil and invasive species, wash water and used wash water filters may also contain oily residues from cleaning certain types of equipment. Such items may require handling, treatment, and disposal according to State and local standards.

### **Currently Available Systems**

Some options that are available to paved surfaces and are currently in use by some agencies include portable runoff containment systems and elevated washracks. Geotextile cloth, rubber flexible mats with berms, and modular elevated washracks that can be moved into position with a forklift are also available. Some suppliers of currently available equipment for designing a washing system are listed in *Vehicle Cleaning Technology for Controlling the Spread of Noxious Weeds and Invasive Species* (Fleming, 2005).

The Forest Service has also built and field tested a portable vehicle washer mounted on a flatbed trailer (figure B-4). That system includes two high-pressure wands to wash sides of vehicles, an underbody high-pressure nozzle system, portable rubber mat system with side berms, settling tanks, and filtration system coupled with a 550-gallon holding tank, powered by a 5,000-watt gasoline generator. This portable system can wash at 800 psi, using 20 gallons of water per minute. Field tests demonstrated the ability to wash standard vehicles in 2 to 3 minutes. Further details about this portable vehicle washer can be found in *MTDC Portable Vehicle Washer* (U.S. Department of Agriculture, 2002).

InterClean Equipment offers several commercially available systems to wash and decontaminate vehicles and heavy equipment (figure B-5). The portable tire wash, “Red Wolf PT-15,” can be installed at remote sites. Ground excavation, water supply, and 70-kilowatt-hour (460-volt) electrical service are required for this installation. Their HT series system includes chassis washing. More information on InterClean’s vehicle washing and decontaminating systems is provided on their Web site: <http://www.interclean.com/Default.htm> (InterClean, 2008).

Little Red Hen, LLC, is based in Bozeman, Montana, offers onsite services for vehicle and equipment washing (figure B-6), and has worked with the Forest Service on equipment cleaning projects. Further details about Little Red Hen, LLC, services are provided on their Web site:



**Figure B-4. Trailer-mounted washing system field tested by Forest Service for cleaning land use vehicles and other equipment (U.S. Department of Agriculture, Forest Service photo).**



**Figure B-5. InterClean Equipment's heavy duty washing system (InterClean, 2008).**

<http://www.rrmobileservices.com/janda/inner.php?PageID=23> (Little Red Hen, 2008).





Figure B-6. Little Red Hen, LLC, Bozeman, Montana vehicle washing service. Filtered mud and debris are compacted and packaged for landfill.

### **General Considerations:**

- Set up the best staging area possible for cleaning operations. A paved area with accommodations to elevate vehicles or otherwise allow easy access to the undersides of vehicles and equipment is the best setting. Otherwise, using geotextile access and exit areas, bermed water recovery areas, and portable vehicle lifts are the next best option.
- Equipment of all types should be cleaned at the location of last use. If this is not possible, arrange for cleaning at a facility that is specially designed for equipment cleaning.
- Preclean equipment that contains heavy accumulations by hand to reduce water demand.
- Make pressurized water available with pressure and nozzles capable of removing all soil and debris.
- Recapture invasive materials by using fine-mesh filters and dispose of invasives in a manner that ensures no spread. Do not allow wash waters to flow into storm drains because these drains often directly flow untreated into surface water bodies.
- At remote sites, install silt fence or otherwise contain materials left behind. Monitor sites closely and eradicate exotic species.
- Clean vehicles and equipment thoroughly, and ensure that they remain clean when leaving the site. Follow up cleaning operations with final inspections.
- Clean, drain, and dry all equipment.

## **Cleaning and Decontaminating in Zebra/Quagga Mussel Infested Areas**

Note: Some of the following information has been adapted from the *Zebra Mussel Identification System* (U.S. Army Corps of Engineers – Engineer Research and Development Center, 2000) and from the 100<sup>th</sup> Meridian Initiative Web site (100<sup>th</sup> Meridian Initiative, 2008). Various other sources used in the preparation of this manual are listed in the Bibliography section of this appendix.

**Remember:**

- Zebra and quagga mussel cleaning operations can be an involved and complex process.
- The life stage of the mussel will influence cleaning actions.
- If you are not familiar with the life cycle of these mussels, refer to appendix C, pages C-103 through C-111 for more information.
- Chemical decontamination as a means to kill adult mussels may require as long as 10 days' contact time. Because of this resistance action, when associated with equipment, chemical solutions are usually better suited for veliger treatment.

**Acceptable Decontamination Methods*****Chemical Decontamination***

The successful use of chemical decontamination depends on the mussel life stage, the kind of decontamination chemical, the chemical concentration used, and contact time. Since adult zebra and quagga mussels can close up and survive for extended periods of time under toxic external conditions, chemical decontamination as a means to kill adult mussels may require as long as 10 days' contact time. Because of this resistance action, when associated with equipment, chemical solutions are usually better suited for veliger (immature life stage) treatment. Decontamination chemicals are somewhat difficult to use, and successful results can be difficult to achieve. Generally, chemical decontamination materials are divided into two groups: (1) oxidizing, and (2) nonoxidizing.

Commonly used decontamination chemicals are: (1) one percent solution of table salt (2/3 cups of salt into 5 gallons of water) for 24 hours contact time,<sup>1</sup> (2) undiluted white vinegar for 20 minutes contact time,<sup>1</sup> (3) a diluted household bleach solution (> five percent sodium hypochlorite at a concentration of 3 ounces of bleach into 5 gallons of water) for a minimum of 1 hour,<sup>2</sup> (4) potassium permanganate solutions,<sup>3</sup> or (5) various quaternary ammonium and poly-quaternary ammonium compounds.<sup>3</sup>

- Be aware that some of these solutions may cause corrosion on metal surfaces and electrical connections.

---

<sup>1</sup> Refer to Protect Your Waters (2010).

<sup>2</sup> Refer to U.S. Fish and Wildlife Service (2010).

<sup>3</sup> Refer to Sprecher and Getsinger (2000).

- Any use of decontamination chemicals will involve disposal concerns and may pose user safety issues.
- Before using any of the decontamination chemicals listed, be sure to refer to Protect Your Waters (2010), U.S. Fish and Wildlife Service (2010), and Sprecher and Getsinger (2000) for more detail.

### ***Heat***

Heating is generally regarded by most authorities as the most effective and easy to use of the control methods. Temperature and exposure time determine the effectiveness of temperature treatments. Live steam, autoclaving, or boiling are all believed to be 100-percent effective against all zebra and quagga mussel life stages. Water temperature used during hot water washing or rinsing must be maintained at >140 °F at surface contact for 1-3 minutes' exposure time to bring the surface temperature up to 140 °F for 30 seconds.<sup>4</sup> Use a hand-held infrared temperature reader to verify 140 °F surface temperature.

### ***Hot Water, High-Pressure Washing***

Using hot water, high-pressure washing is the most widely accepted method of cleaning invasive mussels from surfaces. The combination of lethal temperature water (at least 140 °F), combined with the mechanical action of high pressure is most effective. The following measures are recommended:

- Use a power washer unit that is capable of applying a flow rate of at least 4 gallons per minute with a nozzle pressure of 3,000 psi, and that is able to supply water at 140 °F or hotter at the surface point of contact.
- To begin the cleaning process, reduce the nozzle water pressure by adjusting the power washer or using reduced pressure attachments. Do not attempt to remove or detach mussels from the surface using high water pressure at this point in the cleaning process. The goal is to kill adult mussels with hot water while they remain attached to the surface.
- Rinse the entire surface to be treated with heated water for at least 30 seconds' exposure time at 140 °F to effectively kill all mussel life stages. To achieve this surface temperature, the operator may have to spray the surface for 1-3 minutes, depending on the size of the working area and the material composition of the surface.

---

<sup>4</sup> Certain early literature references cited water temperatures at 104 °F as being an effective temperature to kill zebra and quagga mussels; however, most current authorities support using the higher 140 °F water temperature for greater lethal effect on mussels. This manual recommends using 140 °F minimum temperature throughout for heat treatment.

- After rinsing the surface at reduced water pressure, and having achieved a surface temperature of 140 °F for 30 seconds, maintain a hot water temperature and increase the nozzle pressure high enough to detach the mussels from the surface.
- Continue treatment on all exposed surfaces of the equipment..

### **Freezing**

Adult zebra mussels have a relatively low tolerance to freezing. McMahon, Ussery, and Clarke (1993) reported 100-percent mortality when individual mussels were exposed to 14 °F for as little as 1.3 hours. However, clusters of mussels were more tolerant than individuals, and the corresponding freezing mortality exposure time at 14 °F appears to be at least 4 hours.

### **Physical**

Crushing is an effective way to kill individual adult mussels, but it is not effective against the attached veliger or juvenile life stage, nor is it practical for use over a large surface area. Any crushed adult remains should also be exposed to a hot water soak treatment prior to final disposal.

### **Desiccation**

Desiccation is effective if sufficient time is allowed. In cool and highly humid settings, it is estimated that mussels can survive for over 40 days out of water. Drying times capable of killing mussels vary according to the month of the year, location, and relative humidity; therefore, no single drying time estimate can ensure a complete kill for all situations, unless a set maximum time is used. For specific information for a given month, location, and prevailing conditions, refer to the 100<sup>th</sup> Meridian *Quarantine Estimator for Zebra Mussel Contaminated Boats* drying schedule at the following Web site: <http://www.100thmeridian.org/Emersion.asp> (100<sup>th</sup> Meridian Initiative, 2008).

## **Use of Decontamination Methods for Small In-Water Equipment**

The following methods should be employed when decontaminating small in-water equipment such as nets, waders, boots, buckets, etc.).

Field equipment used in bodies of water known or suspected to contain live zebra or quagga mussels at any life stage, all field equipment used to collect any samples, or equipment in contact with the body of water should be thoroughly cleaned before moving to another site outside the known range of these mussels. When possible, keep equipment at the same project area for use in that project area only to prevent cross contamination of other lands or water bodies. Whenever practical, the least infested (or least likely to be infested) sites should be visited first to reduce the risk of accidentally infecting a new area during field

work. If sampling is being performed to determine whether invasive mussels are present at a given site, assume that they are present and thoroughly clean all sampling equipment before moving to another site outside the known range.

- All field equipment must be inspected, and all visible mussels must be removed and killed. However, since the mussel immature life stages are microscopic and cannot be seen without laboratory equipment, do not rely on visual inspection alone; feel by hand for surface roughness.
- All field equipment can then be cleaned by soaking, dipping in, or scrubbing with hot water, or in one of the chemical decontamination solutions listed (see “Acceptable Decontamination Methods, Chemical Decontamination”) if chemical decontamination is permitted by the manufacturer. If adult mussels are found during inspection, the equipment should be steam cleaned, washed with hot, high-pressure water, or dipped treated in hot water, and allowed to dry completely before the next use.
- Particular attention must be given to places where the mussels could be accidentally trapped, such as the treads of boots and waders, items of clothing or other cloth materials, and hinges of benthic grabs.

### **Use of Decontamination Methods for Large In-Water Equipment**

The following methods should be employed when decontaminating large in-water equipment; for example, watercraft, construction and facility equipment, and water bags used during crane testing.

#### **Compartments**

- Bilge compartments, raw water holding tanks, such as a ballast tank, wet wells, live wells, and any other compartments that could hold water from an infested field site should be drained of water at the boat ramp before leaving the area. If it is not possible to drain all water held in holding tanks or compartments, a suction hose connected to a vacuum pump or a wet/dry shop vacuum can be used to remove remaining water. If a watercraft has carried water in these compartments from another location, remove all water into a container and heat it to at least 140 °F, or treat it with one of the decontamination solutions noted above. If adult mussels are found in these compartments, use the recommended hot water treatment (see “Acceptable Decontamination Methods, Heat.”)
- After draining contained water, all water holding compartments should be filled with hot water for the appropriate contact time as noted above.
- If the compartment is too large to make filling practical, high pressure wash the compartment thoroughly with hot water as noted above.

### **Watercraft Hull Surfaces, Anchors, and Trailers**

- Wash down with hot, high-pressure water. Then, visually inspect and feel by hand to remove any remaining foreign material.
- When using high-pressure, hot water washing, use a flushing attachment at reduced pressure to rinse all hard to reach areas and areas where high pressure may damage the equipment (such as the rubber booted gimbal of an inboard/outboard unit). Maintain a hot water contact time of 2-3 minutes with these areas to ensure that mussels are killed on the surface, since it may not be possible to remove them from hidden or sensitive areas
- Watercraft hulls, anchors, or trailers will be assumed to be free of live mussels if they have been thoroughly scrubbed, inspected, and any visible foreign materials have been removed or if they have remained dry and out of the water according to the 100th Meridian Quarantine Estimator for Zebra-Mussel Contaminated Boats drying schedule located at the following Web site: <http://www.100thmeridian.org/Emersion.asp> (100th Meridian Initiative, 2008).

#### **Advisory on Cleaning Watercraft and Other In-Water Equipment:**

There have been several anecdotal reports of boats that have been professionally cleaned, inspected, and certified as mussel free, then reinspected days later only to find additional live mussels. More than likely, these boats had been harboring adult mussels in hidden recesses of the boat. During cleaning, the hidden surfaces did not reach the required 140 °F temperature for 30 seconds, which is needed for mussel kill. Instead, the hot water irritated the mussels, causing them to migrate out of these hidden recesses and onto visible areas of the boat surface. This finding reinforces the following points:

- If equipment is used at a location known to be infested with an invasive species, the equipment should undergo a preinspection, followed by thorough cleaning, and a final inspection before being moved offsite.
- At the new location, the equipment should be inspected again, preferably by someone other than the original inspector before the equipment is placed into service.
- If, on reinspection, contamination is found on the equipment, do not allow the equipment entry on the new site; either return the equipment to the location of last use for additional cleaning or arrange for cleaning at a location that is specifically designed for equipment cleaning.

**Best Management Practice:**

Remember to use a flushing attachment at reduced pressure to rinse all hard to reach areas and those areas where high pressure may damage the equipment (such as the rubber booted gimbal of an inboard/outboard unit). Maintain a hot water contact time of 2 or 3 minutes with these areas to ensure that mussels are killed on the surface, since it may not be possible to remove them from hidden or sensitive areas.

When inspecting and cleaning, special attention should be given to the following: (1) cracks and crevices in which mussels may become trapped, and (2) aquatic plants harboring mussels that may be present on trailers or propellers. Particular attention must be paid to trailer pads made of carpet and foam rubber, which could trap tiny mussels. If possible, such material should be removed from trailers before doing work in invasive mussel-infested waters.

***Watercraft Engine***

If the watercraft engine is not a closed cooling system configuration (if the engine intakes its cooling water from the environment), the following applies:

- A hot water treatment is recommended for engine decontamination.
- Running a chemical solution, such as a bleach solution, through an engine to decontaminate it may violate the terms of the engine's warranty, or otherwise damage the engine, unless specified by the manufacturer.
- Chemical treatments are not well-suited for engine decontamination because the adult mussel is able to sense a toxic external environment and close up for extended periods of time.

**Outboard.** All outer surfaces of the motor must be cleaned to remove any clinging foreign material by washing with hot, high-pressure water. Then, visually inspect, feel by hand, and remove any remaining foreign material. Finally, decontaminate the engine cooling system by either: (1) placing the outboard motor into a barrel filled with 140 ° F to 160 ° F water and operating the engine for 5 to 10 minutes, or (2) using the appropriate flushing attachment, such as an "earmuff" attachment. Operate the engine according to the "Engine Decontamination Instructions" below.



**Inboard/Outboard.** All outer surfaces of the outboard unit must be cleaned to remove any clinging foreign material by washing with hot, high-pressure water (figure B-7). Then, visually inspect, feel by hand, and remove any remaining foreign material. Finally, decontaminate the engine cooling system by using the appropriate flushing attachment, such as an “earmuff” attachment. Operate the engine according to the “Engine Decontamination Instructions” below.

**Inboard Engine.** All surfaces of the propeller, driveshaft, driveshaft bearing supports, rudder, and driveshaft bearings must be cleaned to remove any clinging foreign material by washing with hot, high-pressure water. Then, visually inspect, feel by hand, and remove any remaining foreign material. Finally, decontaminate the engine cooling system by using the appropriate flushing attachment. Operate the engine according to the “Engine Decontamination Instructions” below.



Figure B-7. Inboard/outboard engine flushing.

**Read the following instructions completely before using this procedure.**

- Use the appropriate attachment, such as an “ear muff” attachment, to flush the watercraft engine cooling system. Refer to the manufacturer’s directions for flushing attachment hookup to the engine.
- Stay clear of the propeller and keep other persons away too during the flushing process.
- Set the watercraft transmission in neutral gear.
- Connect the flushing attachment to the power wash unit or other hot water source.
- Start hot water flowing through the engine and wait for water to exit from the cooling system outlet ports as a steady stream of water. If water does not flow as a strong, continuous stream from the outlet ports, there may be some debris or mussels already inside the cooling system that are blocking the free outflow of water. Examine the water intake ports closely, and check the intake filter screens for any evidence of mussels or other blockage. After this concern is resolved, resume the flushing procedure.
- Check the outflow water temperature with a handheld thermometer, or a handheld infrared temperature reader. If the engine is cold, the outflow water temperature maybe much cooler than the required 140 degree F. required to kill mussels. If this occurs, heat is probably being transferred from the flushing water to the cold engine mass. Wait for the outflow water to reach 140 degrees F. before proceeding.
- Some watercraft motor manufacturers allow engines to be operated during the flush procedure, while some do not. In addition, some manufacturers limit the input pressure of the flushing system. For example, certain models of Mercury™ engines specify a flushing system pressure limit of 45 psi. Refer to the manufacturer’s directions prior to attempting engine flushing.

**If the manufacturer allows flushing with engine running:** Start the engine and run at the lowest idle speed for 2 minutes. Make sure the required 140 °F temperature is maintained in the outflow water. Also make sure the engine does not reach an overheated condition. On certain engines, it is possible that a low coolant volume in the cooling system will not properly register an overheat condition on the engine temperature gauge; therefore, it is very important to monitor the temperature of the outflow water. When completed, shut down the engine first, and then shut off the water supply. Disconnect all flushing attachments.

**Warning:**

Most hot water power washers have a flow rate of 4 gallons per minute or less. Be sure to check the flow rating of your washer! Using less than 5 gallons per minute flow rate when flushing the engine cooling system may cause engine damage if the 2-minute engine run time requirement is exceeded! Operate the engine at only low idle speed during flushing.

**If the manufacturer does not allow flushing with engine running:** Proceed according to the manufacturer’s directions with engine shut down. Make sure the required 140 °F temperature is maintained in the flushing outflow water. When completed, shut off the water supply and disconnect all flushing attachments. Hot water flushing on an engine that is not running can usually exceed the 2-minute limit imposed for an engine that is running.

### **Construction and Facility Equipment**

As discussed previously, special attention must be given to inspecting and cleaning construction and facility equipment. Decontaminate construction and facility equipment using much the same approach for watercraft cleaning where a hot water, high-pressure cleaning method is indicated. For cleaning encrusted mussels from the interior of pipes, water jetting systems using high pressure attachments, such as a water jetting spin nozzle can be used (figure B-8).

Depending on the equipment item, desiccation or freezing may be the preferred decontamination method. Abrasive sand blasting may also be an appropriate cleaning measure, depending on the particular equipment item, or the coating properties of the item. If desiccation is used, proceed according to the drying time calculated by the 100th Meridian Quarantine Estimator for Zebra-Mussel Contaminated Boats drying schedule located at the following Web site: <http://www.100thmeridian.org/Emersion.asp> (100th Meridian Initiative, 2008).

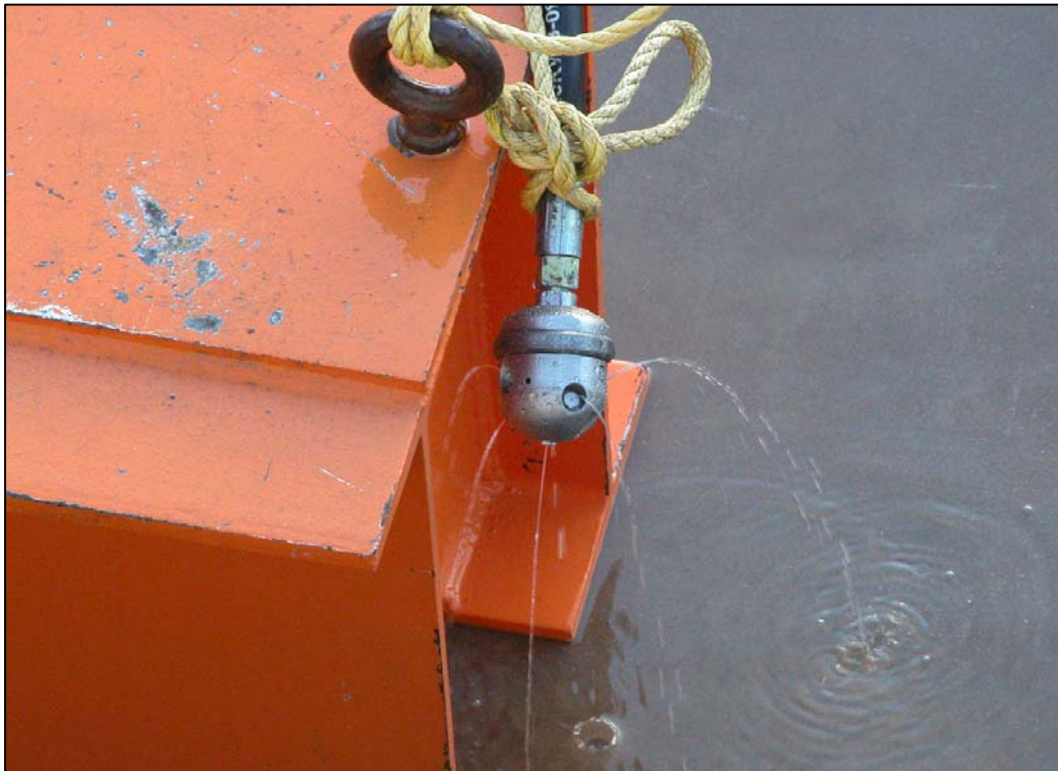

**Figure B-8. Water jetting spin nozzle for cleaning out small diameter pipe infested with quagga mussels (photo courtesy of Allen Skaja, 2009).**

### **Facility Equipment Materials for Mussel Control.**

*Metals.* Copper and many copper alloys prevent the attachment of mussels due to the toxicity of available copper ions to the mussels (figures B-9 through B-11). In general, as the copper content of an alloy increases, corrosion resistance decreases; and, as the copper content decreases, the effectiveness to repel mussels also decreases due to the lack of copper ions at the metal's surface, as shown by the 90-10 copper-nickel alloy in figure B-12. The gradation of copper ion availability in metals, and their ability to resist mussel infestation, is dramatically illustrated in figures B-9 through B-12. The test panel in figure B-9 has the greatest available copper ions; while figure B-12 has the least. In particular, note that in figures B-9 and B-10, even the ropes attached to the test panels are free of mussels, due to copper ions in solution in the surrounding water. In addition to the corrosion concerns, copper or copper alloy in-water facility components have the tendency to contribute available copper to fresh-water systems that may cause concerns for elevated copper levels. Zinc has also been shown to prevent the attachment of mussels in soft water (U.S. Army Corps of Engineers, 1994), but has been proven ineffective in hard water on the Colorado River (Bureau of Reclamation, 2009). Hard water has a high carbonate concentration which reacts with the zinc ions to form a precipitate zinc carbonate. Thus, the carbonate consumes the zinc ions before they can repel mussel attachment.



**Figure B-9.** This copper plate has been submerged for 18 months in Lake Havasu, notice there are no mussels on the rope or on the plate (photo courtesy of Allen Skaja, 2009).



**Figure B-10.** This brass plate has been submerged for 18 months in Lake Havasu; notice there are no mussels on the rope or on the plate (photo courtesy of Allen Skaja, 2009).



**Figure B-11.** This bronze plate has been submerged for 18 months in Lake Havasu; notice the rope has mussels attached while the plate is mussel free (photo courtesy of Allen Skaja, 2009).



**Figure B-12. This 90-10 copper nickel fish screen has been exposed for 4 months; notice the amount of mussels attached to the surface (photo courtesy of Allen Skaja, 2009).**

*Coatings.* There are two types of coatings that potentially resist mussel attachment, antifouling and foul release coatings (Hellio and Yebra, 2009). Antifouling coatings rely on the release of a biocide to keep the mussels from attaching (figure B-13). The most common antifouling paint contains copper, but there are some products available that have organic biocides. The service life of these coating systems depends upon flow rates, water chemistry, pH, temperature, and coating thickness. Foul release coatings rely on surface chemistry to form a slick surface to prevent the mussels to attach firmly to the coating (figure B-14). Foul release coatings are nontoxic. In static or low water flowing conditions the mussels will attach, however can easily be cleaned with a garden hose or low pressure waterjetting. In general, the foul release coatings are not as durable as the antifouling coatings and could be damaged by abrasion, gouging, or mechanical cleaning.



**Figure B-13.** Antifouling coating test panel has been in the Lower Colorado River at Parker Dam for 4 months; notice the attached adult quagga mussels on the test panel and anchoring ropes (photo courtesy of Joe DiVittorio, 2008).



**Figure B-14.** This is an example of a foul release coating that has been in the water for 18 months. Mussels and algae growth may attach to the surface under certain flow rates; however, they are easily removed (photo courtesy of Allen Skaja, 2009).



### ***Water Bags Used During Crane Testing***

As discussed previously, special attention must be given to inspecting and cleaning water bags used during crane testing. Crane testing companies often use water bags by filling the bag with water to the corresponding weight for the testing process. These bags can be used at various locations across the country. At the end of crane testing, the bag is drained and can be moved to a new location. Water bags used for crane testing generally cannot be easily inspected at the level required to find the mussel veliger life stage. If the water bag was filled with raw water during its prior use and was not decontaminated, assume it is contaminated. During the crane testing procedure, the water bag will be filled with water for only several hours, and then it will be drained. Therefore, the main risk factor is veliger mussel contamination in the bag's residue water.

If the crane testing company can provide certification that the water bag was filled only with potable water at its last use location or was otherwise properly decontaminated, the bag can be assumed to be free of contamination.

Decontamination of a water bag may include the general treatment methods described below for all other equipment, provided the treatment complies with the water bag manufacturer's specifications. Treatments such as chemical decontamination, heat, freezing, physical, and desiccation may be considered for use based upon the bag's materials, construction, design, and specifications. All water bag decontamination treatments are the responsibility of the crane testing company.

**Chemical Decontamination.** If allowed by the manufacturer's specifications, the bag may be decontaminated for veliger mussels using the chemicals listed for the appropriate contact time. However, any chemical treatment would produce large quantities of wastewater and require special handling and disposal.

**Heat.** Heating a water bag directly is not a recommended treatment option unless specifically allowed by the water bag manufacturer. Hot water pressure washing may be an acceptable option as allowed by the manufacturer's specifications.

**Freezing.** Freezing a fully drained water bag is a promising treatment option when allowed by the manufacturer's specifications. Adult zebra mussels have a relatively low tolerance to freezing. Mussel veligers are thought to be more susceptible to freezing; however, more research is needed. A 100-percent mortality when individual adult mussels were exposed to 14 °F for as little as 1.3 hours has been reported in recent scientific literature (McMahon, Ussery, and Clarke, 1993). Clusters of adult mussels were more tolerant than individuals, and the corresponding freezing mortality exposure time at 14 °F appears to be at least 4 hours.

**Physical.** Water microfiltration, capable of removing immature mussel life stages is a physical treatment measure. If using a raw water source, a portable microfiltration unit, with associated connectors could be used for bag filling. Of course, all connections in contact with raw water would require decontamination prior to use in the next water body to prevent potential mussel transfer.

**Desiccation.** Desiccation as a treatment option might include air drying the bag, assisted by fan circulation using room temperature or moderately heated air. Using dehumidified air will assist the desiccation process and shorten time requirements. If air drying is used, the length of treatment must be according to the *100<sup>th</sup> Meridian Quarantine Estimator for Zebra-Mussel Contaminated Boats* drying schedule for successful treatment. See the following Web site: <http://www.100thmeridian.org/Emersion.asp> (100<sup>th</sup> Meridian Initiative, 2008).

## **Product Vendors**

A list of vendors that provide products and services for cleaning equipment and vehicles follows. No endorsement of listed vendors or products is implied.

### **Spill containment berms and water tanks:**

Berg Containment Systems  
16124 E. Euclid Avenue  
Spokane WA 99216  
1-800-228-8277  
<http://bergco.com>

Interstate Products, Inc.  
3921 Sawyer Road  
Sarasota FL 34233  
1-800-474-7294  
1-800-448-6329 (fax)  
<http://www.interstateproducts.com>

Polystar, Inc.  
2030 Midway Drive  
Twinsburg OH 44087  
330-963-5100  
1-800-275-3453 (toll-free)  
330-405-6186 (fax)  
<http://www.polystarcontainment.com>

**Wash water recycling systems:**

Hydro Tek Systems  
10418 Enterprise Drive  
Redlands CA 92374-4546  
1-800-274-9376  
<http://www.hydroteksystems.com/recycle.htm>

InterClean Equipment, Inc.  
3939 Bestech Drive, Suite B  
Ypsilanti MI 48197  
734-975-2967  
<http://www.interclean.com/Default.htm>

**Watercraft decontamination vendors:**

H<sub>2</sub>O Power Equipment  
6057 E. 49<sup>th</sup> Avenue  
Commerce City CO 80022  
<http://h2opowerinc.reachlocal.net/>

Hydro Engineering, Inc.  
865 W. 2600 S.  
Salt Lake City UT 84119  
<http://www.hydroblaster.com>

Industrial Equipment  
830 Cherry Street  
Chico CA 95928  
<http://www.industrial-equipment.biz/>  
1-800-287-8306

Little Red Hen, LLC  
13360 Rose Creek Road  
Bozeman MT 59715  
406-585-5858

Prefix  
1300 West Hamlin Road  
Rochester Hills MI 48309  
248-650-1330  
<http://www.prefix.com>

S-K Environmental  
PO Box 4  
Okanogan WA 98840  
509-322-6909  
<http://s-k-enviro.com/>

# Bibliography

Baldwin, Wen. 2009. Personal communication. Contractor, Pacific States Marine Fisheries Commission, Henderson, Nevada.

Bureau of Reclamation. 2009. Interim Reports. January 20.

Fleming, Joe. 2005. *Vehicle Cleaning Technology for Controlling the Spread of Noxious Weeds and Invasive Species*. U.S. Department of Agriculture, Forest Service, Technology and Development Program, San Dimas, California. <http://www.fs.fed.us/eng/pubs/pdf/05511203.pdf>, accessed May 9, 2008.

Hellio, Claire, and Diego Yebra. 2009. *Advances in Marine Antifouling Coatings and Technologies*. Woodhead publishing in Materials.

InterClean Equipment, Inc. 2008. Information on vehicle cleaning systems. Ypsilanti, Michigan. <http://www.interclean.com/Default.htm>, accessed May 9, 2008.

Jota, Jim. 2009. Personal communication. Imes, Inc. - Water Weights, Montclair, California.

Little Red Hen. 2008. Information on noxious weed containment. Bozeman, Montana.

McMahon, Robert F., Thomas A. Ussery, and Michael Clarke, 1993. *Use of Emersion as a Zebra Mussel Control Method*. U.S. Army Corps of Engineers Waterways Experiment Station.

Phillips, Stephen. 2009. Personal communication. Pacific States Marine Fisheries Commission, Portland, Oregon.

Protect Your Waters. 2010. *General Prevention Procedures for Stopping Aquatic Hitchhikers*. [http://www.protectyourwaters.net/prevention/prevention\\_generic.php#1](http://www.protectyourwaters.net/prevention/prevention_generic.php#1), accessed April 28, 2010.

Skaja, Allen. 2010. Personal communication.

Sprecher, S.L., and K.D. Getsinger. 2000. *Zebra Mussel Chemical Control Guide*. Publication No. ERDC/EL TR-00-1, U.S. Army Corps of Engineers – Engineer Research and Development Center.

Tait, Cynthia K. 2009. Personal Communication. Intermountain Regional Aquatic Ecologist, U.S. Forest Service.

- U.S. Army Corps of Engineers. 1994. Technical note ZMR-2-01.
- U.S. Army Corps of Engineers - Engineer Research and Development Center. 2000. *Zebra Mussel Identification System*.
- U.S. Army Corps of Engineers – Engineer Research and Development Center. 2006. *Plant Dispersal Information System – Version 1.0 (CD-ROM)*. Whitaker, S., M. Grodowitz, A. Cofrancesco, J Shearer, and L. Jeffers (eds.), Vicksburg, Mississippi.
- U.S. Army Corps of Engineers. 2010. *Zebra Mussel Chemical Control Guide*. [http://el.erd.c.usace.army.mil/zebra/zmis/zmishelp3/the\\_zebra\\_mussel\\_chemical\\_control\\_guide\\_wes\\_document.htm](http://el.erd.c.usace.army.mil/zebra/zmis/zmishelp3/the_zebra_mussel_chemical_control_guide_wes_document.htm), accessed April 28, 2010.
- U.S. Department of Agriculture. 2002. *MTDC Portable Vehicle Washer*. USDA Forest Service, Technology and Development Program, Missoula, Montana, December 2002. <http://www.fs.fed.us/invasivespecies/documents/MTDC-PortVehWash.pdf>, accessed May 9, 2008.
- U.S. Department of Defense. 2004. Armed Forces Pest Management Board Technical Guide 31, *Retrograde Washdowns: Cleaning and Inspection Procedures*. <http://www.afpmb.org/pubs/tims/tg31/tg31.pdf>, accessed May 9, 2008.
- U.S. Fish and Wildlife Service. 2010. *Western Quagga Mussels, Background Information, Decontamination Protocol*. Compiled by David K. Britton, Ph.D., U.S. Fish and Wildlife Service, Arlington TX. Taken from the 100th Meridian Web site: <http://www.100thmeridian.org/Documents/Talking%20Points%20Regarding%20Western%20Quagga%20Mussels.pdf>
- Zook, Bill. 2009. Personal communication. Contractor, Pacific States Marine Fisheries Commission, Shelton, Washington.
- 100<sup>th</sup> Meridian Initiative. 2008. Zebra/quagga mussel information. <http://www.100thmeridian.org>, accessed July 9, 2008.

**Appendix C**

**Species of Concern**





# Contents

*Page*

## **Appendix C: Species of Concern**

### Submersed and Floating Aquatic Plants

Hydrilla .....	C-3
Curlyleaf Pondweed.....	C-7
Sago Pondweed.....	C-11
Eurasian Watermilfoil.....	C-15
Giant Salvinia.....	C-19
Waterhyacinth.....	C-23

### Emergent Aquatic, Wetland, and Riparian Plants

Alligatorweed.....	C-27
Floating Primrose Willow.....	C-31
Parrotfeather.....	C-35
Flowering Rush.....	C-39
Purple Loosestrife .....	C-41
Giant Reed .....	C-45
Common Reed .....	C-47
Saltcedar.....	C-51

### Terrestrial Plants

Brazilian Pepper.....	C-55
Russian Olive, Autumn Olive, Cherry Silverberry.....	C-57
Russian Knapweed.....	C-61
Spotted Knapweed .....	C-63
Diffuse Knapweed .....	C-65
Leafy Spurge.....	C-67
Yellow Starthistle.....	C-71
Perennial Pepperweed.....	C-73
Canada Thistle .....	C-75
Bull Thistle.....	C-77
Plumeless Thistle .....	C-79
Musk Thistle .....	C-83
Whitetop.....	C-87
Cheatgrass.....	C-89

# Contents (continued)

*Page*

## Mollusks

Asian Clam ( <i>Corbicula Fluminea</i> ) .....	C-91
New Zealand Mudsail ( <i>Potamopyrgus Antipodarum</i> ) .....	C-97
Zebra Mussel ( <i>Dreissena Polymorpha</i> ).....	C-103
Quagga Mussel ( <i>Dreissena Rostiformis Bugensis</i> ).....	C-107

## Appendix C

# Species of Concern

The following list of exotic and undesirable native plants and animals represents a partial listing of common species that have caused serious problems in the western United States. Although these examples do not constitute a complete list of problematic plants and animals, the inspection and cleaning protocols that prevent the spread of these species is equally applicable to other species you may encounter in the field.

### Submersed and Floating Aquatic Plants

Hydrilla (*Hydrilla verticillata*) (L.f) Royle)  
Curlyleaf pondweed (*Potamogeton crispus* L.)  
Sago pondweed (*Stuckenia pectinatus* (L.) Boerner)  
Eurasian watermilfoil (*Myriophyllum spicatum* L.)  
Giant salvinia (*Salvinia molesta* Mitchell)  
Waterhyacinth (*Eichornia crassipes* (Mart.) Solms)

### Emergent Aquatic, Wetland, and Riparian Plants

Alligatorweed (*Alternanthera philoxeroides* (Mart.) Griseb)  
Floating primrose willow (*Ludwigia peploides*)  
Parrotfeather (*Myriophyllum aquaticum aquaticum* (Vell.) Verd)  
Flowering rush (*Butomus umbellatus* L.)  
Purple loosestrife (*Lythrum salicaria* L.)  
Giant reed (*Arundo donax* L.)  
Common reed (*Phragmites australis* spp.)  
Saltcedar (*Tamarix* spp.)

### Terrestrial Plants

Brazilian pepper (*Schinus terebinthifolius* Raddi)  
Russian olive, autumn olive, cherry silverberry (*Eleagnus* spp.)  
Russian knapweed (*Acroptilon repens* spp.)  
Spotted knapweed (*Centaurea biebersteinii* spp.)  
Diffuse knapweed (*Centaurea diffusa* spp.)  
Leafy spurge (*Euphorbia esula* L.)  
Yellow starthistle (*Centaurea solstitialis* L.)  
Perennial pepperweed (*Lepidium latifolium* L.)  
Canada thistle (*Cirsium arvense* spp.)

Bull thistle (*Cirsium vulgare* spp.)  
Plumeless thistle (*Carduus acanthoides* spp.)  
Musk thistle (*Carduus nutans* spp.)  
Whitetop (*Cardaria* spp.)  
Cheatgrass (*Bromus tectorum* )

## **Mollusks**

Asian clam (*Corbicula fluminea* Muller)  
New Zealand mudsnail (*Potamopyrgus antipodarum* Gray)  
Zebra mussel (*Dreissena polymorpha* Pall.)  
Quagga mussel (*Dreissena rostriformis bugensis* Andrusov)

Notes: Cleaning watercraft, trailers, motors could also limit the introduction of other invasive species, such as the Spiny water flea (*Bythotrephes cederstroem*), an organism of great concern in the Great Lakes.

Plant information is excerpted from the U.S. Army Corps of Engineers, Engineer Research and Development Center, "Aquatic Plant Information System," version 2.99, and "Noxious and Nuisance Plant Management Information System," version 5.3, fall 2003. Some plant pictures come from other sources, and are cited as such. Information on other species comes from various sources.

# Hydrilla



## Family

Hydrocharitaceae

## Home Range/U.S. Introduction

*Hydrilla verticillata* (L.f.) Royle is an introduction from the Old World (Cook & Luond 1982) that was first discovered in the United States in 1960 and is now abundantly naturalized in many parts of the United States (Langeland 1996). Plants have attractive foliage and are planted in aquaria which are often emptied into freshwater habitats. Hydrilla is easily confused with *Egeria densa* Planch., Brazilian elodea or Egeria, and *Elodea canadensis* Michx., Canadian elodea, Waterweed.

## U.S. Range Map

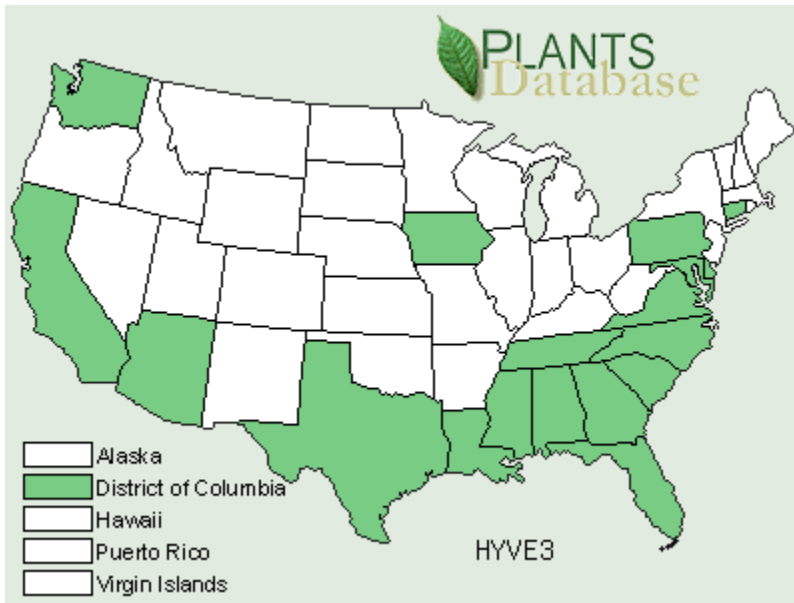

## Species Description

The plants grow submersed, are mostly perennial but sometimes annual, and have horizontal stems in the substrate forming tubers under certain conditions. Stems are ascending and usually are sparsely branched until the plants near the water surface and then become profusely branched. Under certain conditions, turions (actually bulbil-like structures) form in the leaf axils. Stems can be up to 8.5 m long and grow to the surface of the water where the branchlets extend horizontally. Leaves are 1-nerved, sessile, whorled, 3 to 12 at a node but mostly 5 or more, mostly shorter than 1.5 cm long, linear to lanceolate or rarely widely ovate, broadest at the base, the sides nearly paralleling to near the acute tip that terminates in a single spine cell. Leaf margins are serrate, the teeth visible to the naked eye. Fresh leaves are notably rough to the touch. The midrib on the upper surface is often tinged with red and on the lower surface, usually, has 1-celled sharp teeth or spines. Flowers are unisexual, arising from the leaf axil; plants are monoecious or dioecious. The flowers are small, less than 6 mm in diameter, translucent to white; female flowers are usually produced in the fall and are on long thread-like stalks 2 to 4 cm long from leaf axils of the upper branches that carry the flowers to the water surface. Male flowers are solitary, small, on short stalks in the leaf axil and break off as buds, opening explosively on the water surface.

*Hydrilla* can usually be differentiated from Canadian elodea (*Elodea canadensis* Michx.) and egeria (*Egeria densa* Planch.) by the following characters:

Leaves mostly in whorls of 4 at sterile nodes, leaves 1.4 to 2.5 cm long. *Egeria densa*

Leaves of stems at growing tips at water's surface usually in whorls of 3 or 5 or more; leaves not or mostly not exceeding 1.5 cm long, the longest sometimes to 2 cm

Leaves mostly in whorls of 5 or more; margins of the leaves with teeth perceptible to the naked eye; midribs on lower leaf surface (when fresh) with a few conical protuberances tipped by sharp 1-celled teeth; fresh leaves notably rough to the touch. *Hydrilla verticillata*

Leaves mostly in whorls of 3; margins of the leaves not having teeth perceptible to the naked eye; midribs of lower leaf surface not pronounced, not bearing teeth; fresh leaves not rough to the touch. *Elodea canadensis*

## **Habitat/Growth Characteristics**

Plants grow in canals, springs, streams, ponds, lakes and reservoirs. Most populations of hydrilla in the United States are dioecious. However, populations of monoecious hydrilla occur in North Carolina and northward into the Mid-Atlantic States (Langeland 1996). Hydrilla can reproduce by four methods: fragmentation, tubers, turions, and seed. Tubers in the hydrosol can remain viable for several years (Langeland 1996) and allow the plant to survive cold temperatures and periods of drought (Tarver *et al.* 1986). Although the importance of seed production in the spread of hydrilla has not been researched extensively, it is probably of minor importance compared to vegetative reproduction (Langeland 1996). Hydrilla has a high growth rate and lower light requirement for photosynthesis than most other submersed plants (Langeland 1996) which allows it to grow at greater depths and outcompete most other species. It also forms a dense canopy at the surface of the water and "shades out" other submersed plants (Tarver *et al.* 1986).

## **Problems**

This species is probably the worst submersed aquatic weed in the United States. Plants form large, dense populations which displace native species, restrict flow, and impair small boat navigation and other recreational uses (Tarver *et al.* 1986, Langeland 1996). In addition to being spread by natural fragmentation, plants are sometimes spread from lake to lake by fragments attached to boat motors and trailers. Hydrilla also is thought to be intentionally introduced into "new" water bodies in an effort to enhance sport fishing for black bass.

## References

Cook, C. D. K. and R. Luond. 1982. A revision of the genus *Hydrilla* (Hydrocharitaceae). *Aquatic Botany* 13:485-504.

Langeland, K. A. 1996. *Hydrilla verticillata* (L.f.) Royle (Hydrocharitaceae), the perfect aquatic weed. *Castanea* 61(3):293-304.

Tarver, D. P., J. A. Rogers, M. J. Mahler, and R. L. Lazor. 1986. *Aquatic and Wetland Plants of Florida*. Third Edition. Florida Department of Natural Resources, Tallahassee, Florida.



# Curlyleaf Pondweed



## Family

Potamogetonaceae

## Home Range/U.S. Introduction

Curly pondweed, *Potamogeton crispus* L., is native to Eurasia and apparently was introduced into the United States in the mid 1800's (Stuckey 1979). Prior to 1900, the distribution of *P. crispus* was the northeastern United States. By 1930 curly pondweed had spread westward to several states of the Great Lakes region. The species has since spread across much of the United States (see distribution map), presumably by migrating waterfowl, intentional planting for waterfowl and wildlife habitat, and possibly even as a contaminant in water used to transport fishes and fish eggs to hatcheries (Stuckey 1979).

## U.S. Range Map

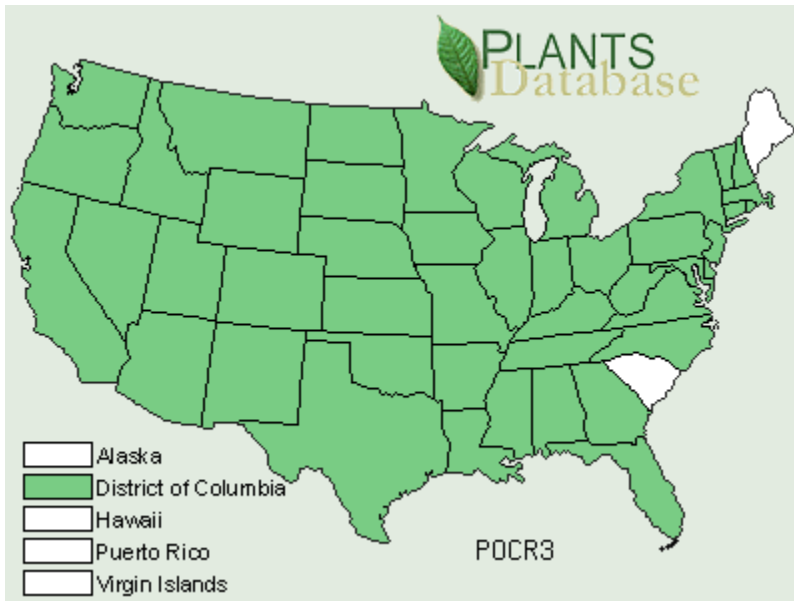

## Species Description

Curly pondweed is a perennial and has elongate, slender rhizomes that are buff or reddish. The stems of curly pondweed are flattened. Leaves are entirely submersed, sessile, oblong to broadly linear, 3 to 8 cm long and 5 to 12 mm wide. The leaf tip is usually rounded and sometimes minutely cuspidate. The leaf margins are finely toothed, undulate and crisped. Stipules are translucent and soon disintegrating. Bur-like turions that are up to about 5 cm long often form during the spring and late summer months and consist of three to seven small, thickened leaves that project from the stem at a slight upward angle. Flowers are borne on a short spike that extends above the surface of the water. The fruits are flat, 4 to 6 mm long (including the beak) and have a distinct, pointed beak that is erect or somewhat curved and about 2 to 3 mm long.

## Habitat/Growth Characteristics

*Potamogeton crispus* grows in lakes, reservoirs, ponds, rivers, streams, and springs. It can grow in clear to turbid and polluted waters and in alkaline or brackish waters (Stuckey 1979). Curly pondweed produces seed, but the importance of seed in the spread and maintenance of populations is unknown (Stuckey 1979) and is assumed to be less important than turions (Sastroutomo 1981). In most portions of its range, *Potamogeton crispus* typically reaches peak biomass in the late spring or early summer months, forms turions, then declines and “survives” the warmer months in a dormant state (i.e., as a turion) (Cypert 1967, Stuckey 1979, Sastroutomo 1981, Tobiessen and Snow 1984, Nichols and Shaw 1986). As water temperatures cool during the late summer or fall months,

the turions germinate, grow through the winter months with the plants reaching peak biomass in the spring before most other submersed macrophytes begin their growth cycle. Once established, the plants regrow and form colonies from rhizomes.

## Problems

Dense colonies of curly pondweed can restrict access to docks and sport fishing areas during spring and early summer months. Because populations of curly pondweed usually decline during the summer months, it does not directly compete with many of the native submersed species.

## References

- Cypert, E. 1967. The curly-leaved pondweed problem at Reelfoot Lake. *Journal of the Tennessee Academy of Science* 42:10-11.
- Nichols, S. A. and B. H. Shaw. 1986. Ecological life histories of the three aquatic nuisance plants, *Myriophyllum spicatum*, *Potamogeton crispus*, and *Elodea canadensis*. *Hydrobiologia* 131: 3-21.
- Sastroutomo, S. S. 1981. Turion formation, dormancy and germination of curly pondweed, *Potamogeton crispus* L. *Aquatic Botany* 10: 161-173.
- Stuckey, R. L. 1979. Distributional history of *Potamogeton crispus* (curly pondweed) in North America. *Bartonia* 46: 22-42.
- Tobiessen, P. and P. D. Snow. 1984. Temperature and light effects on the growth of *Potamogeton crispus* in Collins Lake, New York State. *Canadian Journal of Botany* 62: 2822-2826.



# Sago Pondweed



(Photo: John Madsen)

## Synonym(s)

*Stuckenia* (formerly *Potamogeton*) *pectinatus* L.

## Family

Potamogetonaceae

## Home Range/U.S. Introduction

Sago pondweed, *Stuckenia pectinatus*, is native and occurs throughout most of the United States. Sago pondweed lacks floating leaves and can be distinguished from other species of pondweed having only narrow underwater leaves by stipules that are adnate to the leaf blade for 90 percent of their length and by fruits that have an evident beak (Haynes 1978).

## U.S. Range Map

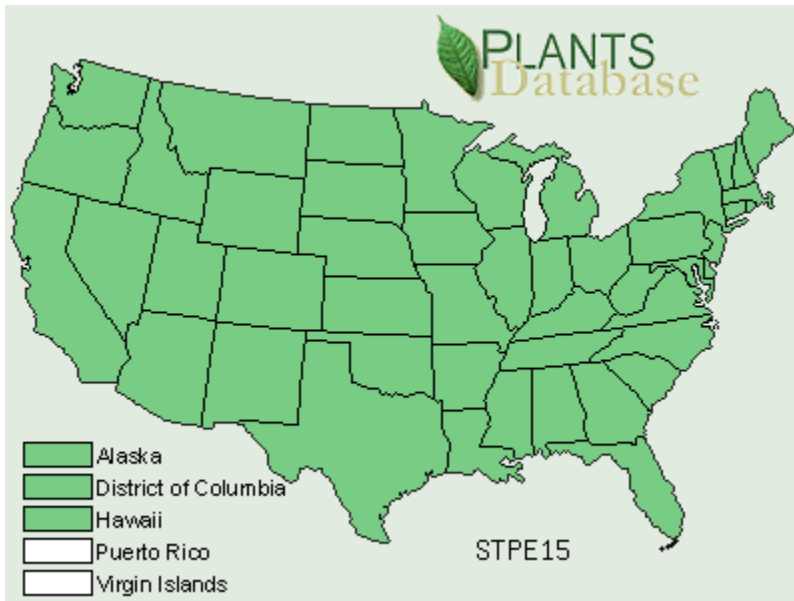

## Species Description

Sago pondweed is a perennial and has thin, creeping rhizomes that are matted and often end in tuberos bulblets. The stem is slender, about 1 mm in diameter, simple at the base but much branched toward the summit. All the leaves are submersed, linear to filiform, 3 to 10 cm long, about 1 mm wide. Each leaf has one to three nerves and an acute to attenuate apex. The stipules are 2 to 5 cm long and are adnate to the leaf for approximately 90 percent of stipule length. Flowering stalks (peduncles) arise from the leaf axils and are from 3 to 10 cm long. The flowers are sessile, in whorls of 2 to 5 and on spikes 1 to 4 cm long. Fruits are plump, 2.5 to 4 mm long with a rounded dorsal keel and a short beak.

## Habitat/Growth Characteristics

*Stuckenia pectinatus* grows in fresh, alkaline, brackish, or saline waters of lakes, ponds, rivers, streams, irrigation canals and coastal marshes. Sago pondweed reproduces by seed and vegetatively by rhizome growth and from bulblets (tubers). Environmental conditions influencing the formation and germination of tubers have been studied by several investigators (Spencer 1987, Madsen and Adams 1988, Spencer and Ksander 1992). Spencer and Ksander (1992) found that tubers collected from canals in California germinated in response to water-saturated substrate at temperatures of 15, 20, and 25 degrees C. These data suggest that flooding of canals could induce the germination of sago pondweed tubers during periods when ambient temperatures were within this range. After the removal of water, the “terrestrial” form of the plant would likely be produced and could be more easily controlled with other techniques (e.g., herbicides).

## Problems

Sago pondweed sometimes grows in dense colonies that can impede boating and interfere with other types of recreational activities (Tarver *et al.* 1986, Hoyer *et al.* 1996). Waterfowl consume the seeds, rhizomes, and tubers (tubers) of sago pondweed. Because sago pondweed is considered to be a valuable food plant for waterfowl, it has been widely planted beyond its original range (Muenscher 1944).

## References

- Haynes, R. R. 1978. The Potamogetonaceae in the southeastern United States. *Journal of the Arnold Arboretum* 59:170-191.
- Hoyer, M. V., D. E. Canfield, Jr., C. A. Horsburgh, and K. Brown. 1996. Florida Freshwater Plants - A Handbook of Common Aquatic Plants in Florida Lakes. University of Florida, Institute of Food and Agricultural Sciences, Gainesville, Florida
- Madsen, J. D. and M. S. Adams. 1988. The generation of *Potamogeton pectinatus* tubers: Environmental control by temperature and light. *The Canadian Journal of Botany* 66: 2523-2526.
- Muenscher, W. C. 1944. Aquatic Plants of the United States. The Vail-Balrow Press, Inc., Binghamton, New York.
- Spencer, D. F. 1987. Tuber size and planting depth influence on growth of *Potamogeton pectinatus* L. *American Midland Naturalist* 118:77-84.
- Spencer, D. F. and G. G. Ksander. 1992. Influence of temperature and moisture on vegetative propagule germination of *Potamogeton* species: Implications for aquatic plant management. *Aquatic Botany* 43:351-364.
- Tarver, D. P., J. A. Rogers, M. J. Mahler, and R. L. Lazor. 1986. Aquatic and Wetland Plants of Florida. Third Edition. Florida Department of Natural Resources, Tallahassee, Florida.





# Eurasian Watermilfoil

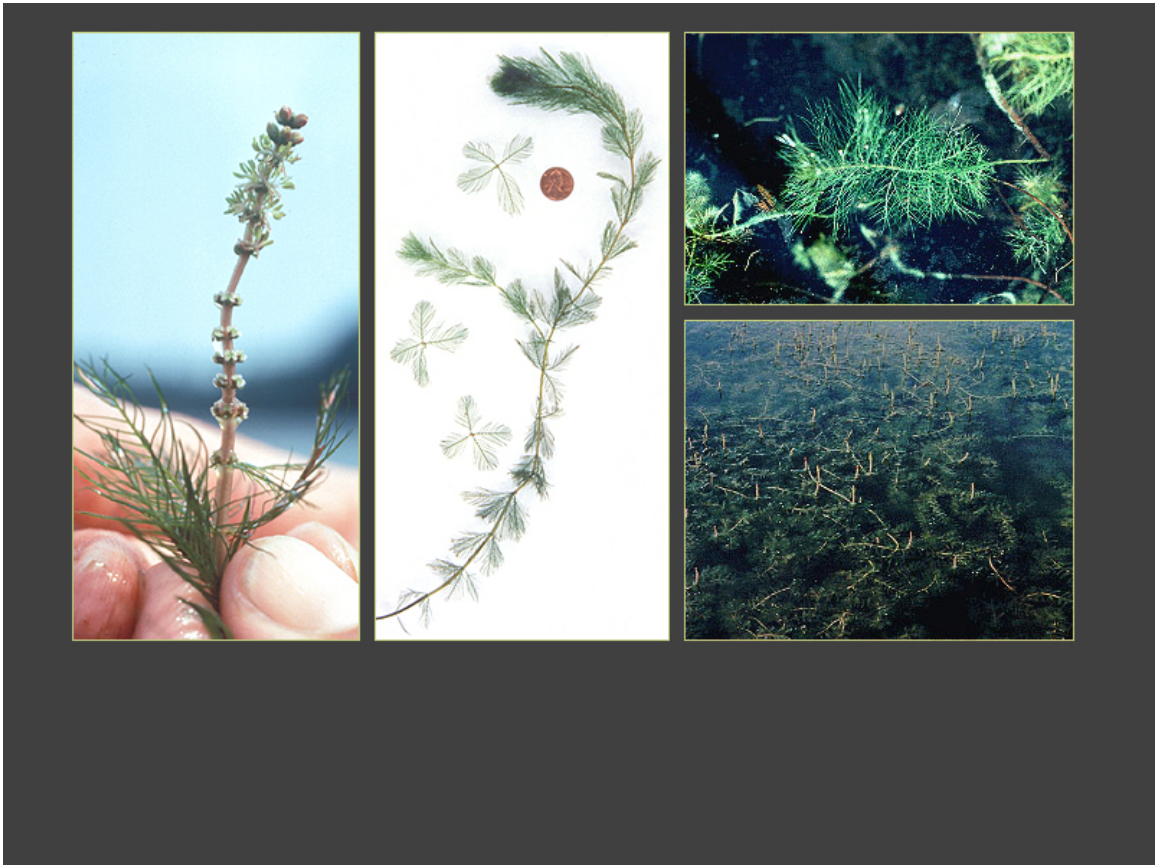

## Family

Haloragaceae

## Home Range/U.S. Introduction

*Myriophyllum spicatum* L. is an aggressive weed that is native to Europe, Asia, and North Africa. Because of morphological similarities and past taxonomic confusion between Eurasian watermilfoil and the native, northern watermilfoil (*Myriophyllum sibiricum* Komarov), it is difficult to determine the exact time of introduction. A study of herbarium specimens by Couch and Nelson (1985) indicate Eurasian watermilfoil was established in the United States by the 1940's, while other investigators report that Eurasian watermilfoil may have been in the United States since about 1900 or even earlier (Reed 1977).

## U.S. Range Map

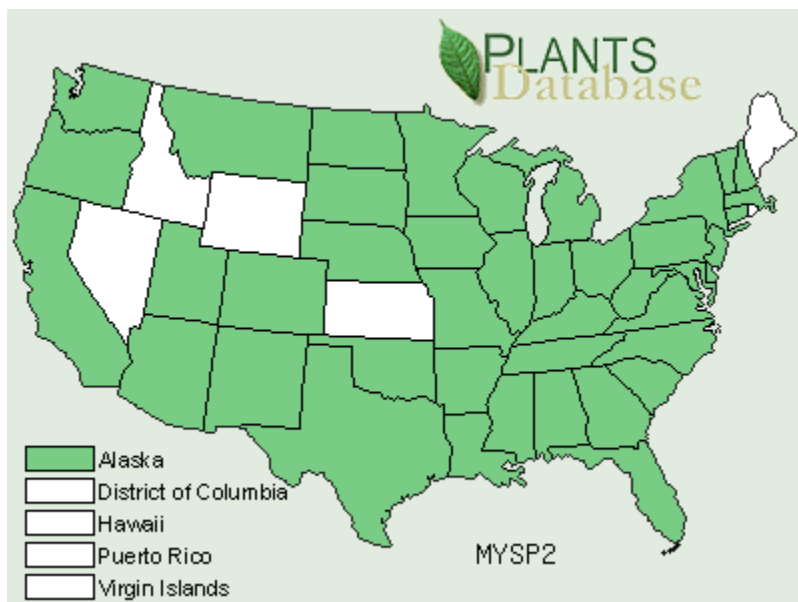

## Species Description

Plants of Eurasian watermilfoil are rooted and submersed except for a short (3 to 8 cm) emerged flowering spike. Primary stems are generally branched and often form a dense canopy on the water's surface. Leaves are whorled, 4 or rarely 5 leaves per node, each leaf pinnately dissected into narrow, linear segments. The number of pairs of leaf segments is highly variable, ranging from 5 to 24 for each leaf. Leaves cling to the stem above each node when removed from the water. Turions are absent. The flowers are whorled and in spikes with the pistillate flowers at the lower nodes of the spike and staminate flowers at the upper nodes. The stem below the flowering spike is curved to lie parallel with the water surface and is about twice the diameter of the lower stem. Floral bracts subtending the pistillate flowers are equal or slightly longer than the flowers.

The following set of characters is used by Aiken (1981) in distinguishing Eurasian watermilfoil from northern watermilfoil:

Stem thickened below the inflorescence to almost double the width of the lower stem, usually curved to lay parallel with the water surface; scales at the inflorescence nodes 2-3, black, distinct in fresh material; plants never forming turions. *Eurasian watermilfoil*

Stem not thickened below the inflorescence, straight; scales at the inflorescence nodes 0-2, black or brown, indistinct; plants forming turions of black green leaves from October to June. *Northern watermilfoil*

## **Habitat/Growth Characteristics**

Eurasian watermilfoil is a highly invasive and aggressive species that colonizes reservoirs, lakes, ponds, streams, small rivers and brackish waters of estuaries and bays. As stems of Eurasian watermilfoil near the water surface, they branch profusely and often form a dense canopy that reduces light availability for “understory” species. *Myriophyllum spicatum* dies back to propagating root crowns during the winter months and does not form turions as does *M. sibiricum*. Spread of Eurasian watermilfoil is primarily by asexual means. Long range dispersal is primarily by fragmentation that results from mechanical breakage or autofragmentation which occurs after flowering and at the end of the growing season. Fragments produced by either method may be transported over long distances by water currents. Fragments may also be transported from one water body to another when fragments become attached to boat trailers. Once established, individual plants may expand for distances of a few meters by the production of stolons. Although Eurasian watermilfoil produces large quantities of viable seed, very few seedlings have been observed in field situations, and seed are considered to be of minor importance in dispersal of *M. spicatum* (Smith and Barko 1990).

## **Problems**

Eurasian watermilfoil may “shade out” and outcompete desirable native species and form monospecific colonies over large areas of some water bodies. Dense mats and colonies of *M. spicatum* can restrict swimming, boating, bank fishing, and negatively impact aesthetic appeal. Fragments and floating mats may clog water intakes at power generation facilities and potable water intakes. Dense stands of Eurasian watermilfoil provide habitat for mosquitoes and may increase populations of some species of mosquitoes (Aiken *et al.* 1979, Smith and Barko 1990). Because of the problems caused by Eurasian watermilfoil, large-scale management programs have been implemented by the Tennessee Valley Authority, the U.S. Army Corps of Engineers, and governmental agencies in Canada.

## References

- Aiken, S. G. 1981. A conspectus of *Myriophyllum* (Haloragaceae) in North America. *Brittonia* 33: 57-69.
- Aiken, S. G., P. R. Newroth, and I. Wile. 1979. The biology of Canadian weeds. 34. *Myriophyllum spicatum* L. *Canadian Journal of Plant Science* 59: 201-215.
- Couch, R. and E. Nelson. 1985. *Myriophyllum spicatum* in North America. In: L. W. J. Anderson (ed.), *Proceedings of the First International Symposium on watermilfoil (*Myriophyllum spicatum*) and related Haloragaceae species*. Aquatic Plant Management Society, Washington, D.C. pp. 8-18.
- Reed, C. F. 1977. History and distribution of Eurasian watermilfoil in United States and Canada. *Phytologia* 36: 417-436.
- Smith, C. S. and J. W. Barko. 1990. Ecology of Eurasian watermilfoil. *Journal of Aquatic Plant Management* 28: 55-64.

# Giant Salvinia

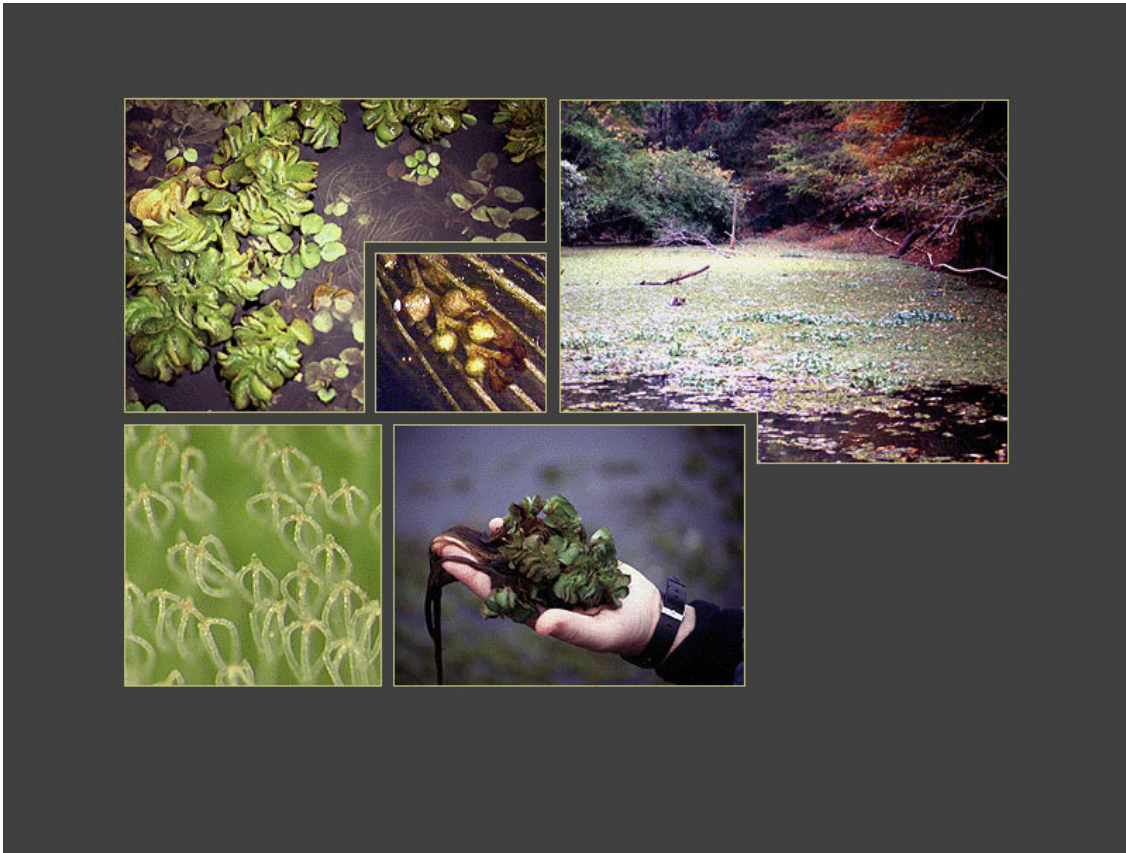

## Family

Salviniaceae

## Home Range/U.S. Introduction

*Salvinia molesta* is native to southeastern Brazil. Introduction of the mat forming fern is thought to have arisen from the water gardening and/or aquarium trade where plants are either sold directly or occur as contaminants in water garden stock. Infestations have been reported from several states including Texas, Alabama, Mississippi, Louisiana, Florida, and Hawaii. The predicted range of the plant in the U.S. approximates the current distribution of water hyacinth.

## U.S. Range Map

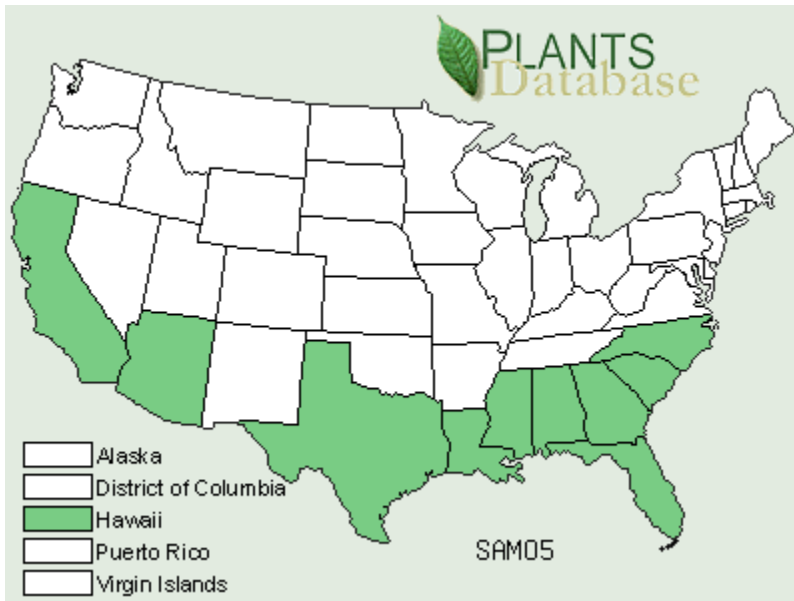

## Species Description

Giant salvinia is a free floating aquatic fern. An individual plantlet consists of a horizontal stem that produces two floating leaves (fronds) up to 25 cm long and a highly dissected submerged frond up to 25 cm. The floating leaves are green, sessile to short petiolate, broadly ovate in shape with entire margins. The midrib extends from the base to the apex of the leaf. The upper surface of the floating fronds is covered with parallel rows of hairs that have a characteristic “cagelike” structure at the apex. When plants are young, these leaves are small and float on the water surface. As plants age, the floating leaves become crowded and fold against one another resulting in a more vertical leaf position. The brown, feathery submerged leaf resembles and functions as a root. This frond bears the sporocarps or spore forming structures. The globose sporocarps are densely hairy; short stalked and 2-3 mm in diameter. Spores are rarely formed and if present are deformed and infertile.

## Growth Characteristics

Giant salvinia grows best in stagnant or slow flowing water. Quiet waters of lakes, ponds, bays, oxbows, ditches, swamps, and marshes may be susceptible to invasion. In Ceylon, the species has proven to be problematic in rice fields. The rhizomatous plant can rapidly form dense floating mats of vegetation. Disturbance usually results in fragmentation and any fragment having an axillary bud can give rise to a new plant. The optimum temperature range for growth is 25-28 C and under these conditions plants can double within 1 week.

## **Problems**

Giant salvinia can impact irrigation systems, navigable waters, fisheries, electric power production, and rice farming. Giant mats reduce light penetration and result in oxygen depletion. As light becomes limiting, it affects the growth and survival of phytoplankton and vascular plants. Oxygen depletion may be so severely reduced beneath a mat that it influences fish survival. Extensive mats may exacerbate a situation because they prevent water circulation and mixing.





# Waterhyacinth



## Synonym(s)

*Eichhornia speciosa* Kunth  
*Piaropus crassipes* (Mart.) Raf.

## Family

Pontederiaceae

## Home Range/U.S. Distribution

*Eichhornia crassipes* (Mart.) Solms. is native to South America, probably Brazil. Plants are thought to have been first introduced into the United States at the 1884 Cotton States Exposition in New Orleans, Louisiana (Sculthorpe 1967). Because of its showy flowers, waterhyacinth is sold as an ornamental for small fish ponds and sometimes escapes or is intentionally introduced into larger water bodies such

as lakes and reservoirs. The distribution of *E. crassipes* shown on the map in this system depicts where populations are expected to “overwinter” and regrow during most years.

Another species of waterhyacinth, *Eichhornia azurea* (Sw.) Kunth, has been introduced into south Texas from Latin America (Correll and Johnson 1970, Tarver *et al.* 1986). It can be distinguished from *E. crassipes* by a lack of inflated petioles and the presence of an obvious stem with leaves along its entire length that are separated by distinct internodes.

## U.S. Range Map

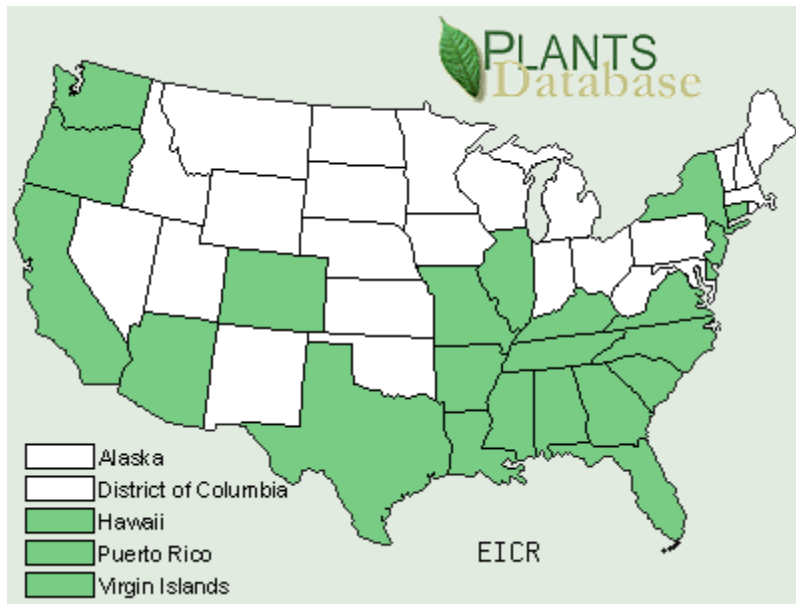

## Species Description

Waterhyacinth floats on the surface of the water or is sometimes stranded on mud and appears rooted. The individual plants consist of several leaves in rosettes and are connected by stolons. Prominent, black roots hang from each rosette. The leaf petiole is usually inflated, spongy, and up to 20 cm long. The leaf blades are thickened, leathery, 2 to 15 cm long and 2 to 10 cm wide, suborbicular, ovate or broadly elliptic with parallel veins. The leaf bases are heart-shaped, square or rounded the leaf apices rounded to flattened. The inflorescence is a spike with several light-blue to bluish-purple flowers that have a yellow blotch. The fruit is a many seeded capsule.

## **Habitat/Growth Characteristics**

Waterhyacinth grows in ponds, canals, freshwater and coastal marshes, lakes, and back water sloughs and oxbows along rivers. Reproduction is primarily by vegetative means from runners or stolons. This method of vegetative reproduction allows the plant to quickly colonize large areas in relatively short periods of time. During periods of drought, waterhyacinth can survive as seed that remain dormant until reflooding occurs. Because waterhyacinth is free-floating, wind and water currents function to distribute plants within a water body (Tarver et al. 1986). The large, robust plants of waterhyacinth are often referred to a “bull hyacinths”. Populations of waterhyacinth are dramatically influenced by climatic conditions, expanding during years with mild winters and contracting or being eliminated from areas of the interior United States during particularly harsh winters.

## **Problems**

Dense growth of waterhyacinth can clog canals and water intakes and restrict navigation along rivers and lakes. It can also negatively impact water quality and exclude native vegetation. Problems caused by this species far outweigh any benefits it provides in natural aquatic and wetland habitats.

## **References**

- Correll, D. S. and M. C. Johnston. 1970. *Manual of the Vascular Plants of Texas* Research Foundation, Renner, Texas.
- Sculthorpe, C. D. 1967. *The Biology of Aquatic Vascular Plants*. St. Martin's Press, New York.
- Tarver, D. P., J. A. Rogers, M. J. Mahler, and R. L. Lazor. 1986. *Aquatic and Wetland Plants of Florida*. Third Edition. Florida Department of Natural Resources, Tallahassee, Florida.



# Alligatorweed



## Synonym(s)

*Alternanthera philoxeroides* (Mart.) Standl.

## Family

Amaranthaceae

## Home Range/U.S. Introduction

*Alternanthera philoxeroides* (Mart.) Griseb. is native to South America and was introduced into the United States around 1900 (Spencer & Coulson 1976).

Alligatorweed is now widely distributed from Virginia to Florida, west to Texas. Populations of the weed also are reported from California.

## U.S. Range Map

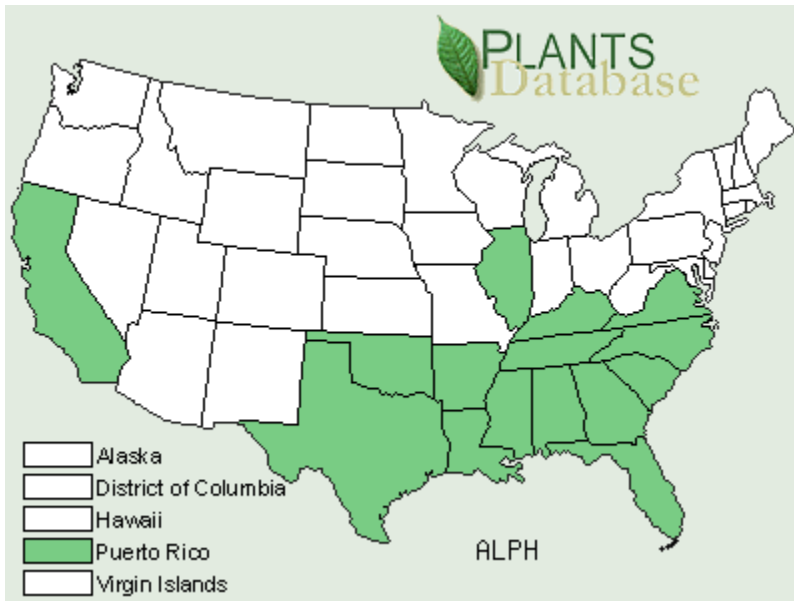

## Species Description

Plants are perennial with stems usually bent toward the bottom and rooting at the nodes. Stems are glabrous except for a narrow band of hairs within the leaf bases. The stems become hollow and slightly flattened with age, often pink when fresh. Leaves are opposite, simple, sessile, usually thick and fleshy, linear-elliptic, to 9 cm long and 1.5 cm wide, apices acute, tipped with a tiny spine, tapering to the base to clasp the stem. One leaf joins with the opposite leaf to form a narrow sheath. The inflorescence is a several-flowered, whitish head on a stalk. Petals are lacking; the sepals are whitish.

## Habitat/Growth Characteristics

Alligatorweed grows in ponds, lakes, streams, canals, ditches and wet soil of agricultural lands. The stems form dense, tangled masses in the water or in moist soil along shorelines. Stems may be a several meters long and extend from the shoreline into shallow water. Alligator weed in the United States apparently does not produce viable seed (Spencer & Coulson 1976) and reproduction is vegetative. Each node is capable of producing a new plant.

## Problems

Dense mats of alligatorweed may impede flow in irrigation canals, restrict small boat navigation, and hinder fishing and other forms of recreation (Tarver *et al.* 1986, Chester 1988). Biological control of this species with insects has been spectacularly successful; in 1963 there were over 38,800 problem ha in the United

States but in 1981 there were less than 400 ha and all states, except North Carolina, now rely on this method to keep populations at acceptable levels.

## References

Chester, E. W. 1988. Alligatorweed, *Alternanthera philoxeroides* (Mart.) Griseb. in Kentucky. Transactions of the Kentucky Academy of Science 49: 140-142.

Spencer, N. R. and J. R. Coulson. 1976. The biological control of alligatorweed, *Alternanthera philoxeroides*, in the Unites States of America. Aquatic Botany 2:177-190.

Tarver, D. P., J. A. Rogers, M. J. Mahler, and R. L. Lazor. 1986. Aquatic and Wetland Plants of Florida. Third Edition. Florida Department of Natural Resources, Tallahassee, Florida.





# Floating Primrose Willow

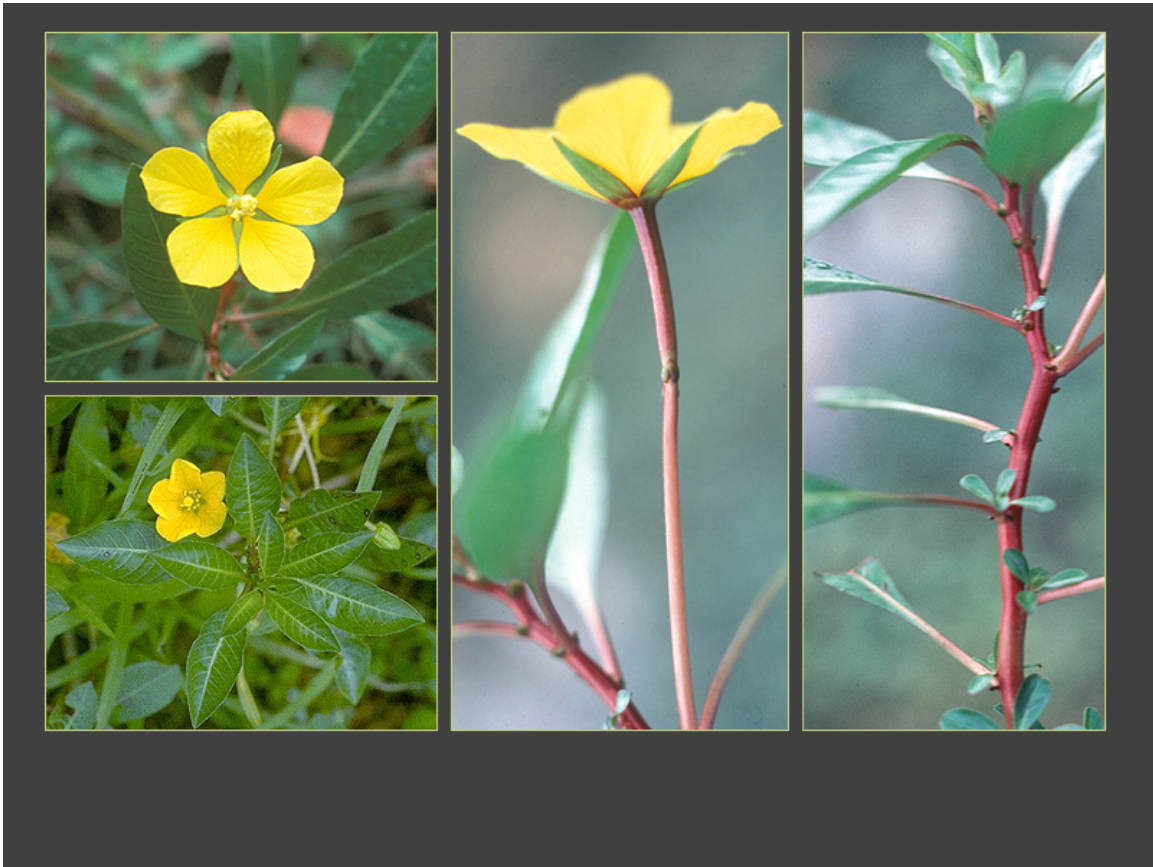

## Family

Onagraceae

## Home Range/U.S. Introduction

*Ludwigia peploides* (HBK.) Raven is common in some portions of the southeastern United States and occurs sporadically from eastern United States westward to California. It ranges over much of the warmer portions of the New World including the West Indies, Mexico, and Central and South America. Although most manuals indicate it to be native to the United States, Godfrey and Wooten (1981) note *L. peploides* to be “questionably native” to the southeastern United States. Plants in the southeastern (Godfrey and Wooten 1981) and southwestern United States (Correll and Correll 1975) are considered to be subspecies *peploides*. Some of the older taxonomic treatments place *L. peploides* and several other species of *Ludwigia* in the genus *Jussiaea* L.

## U.S. Range Map

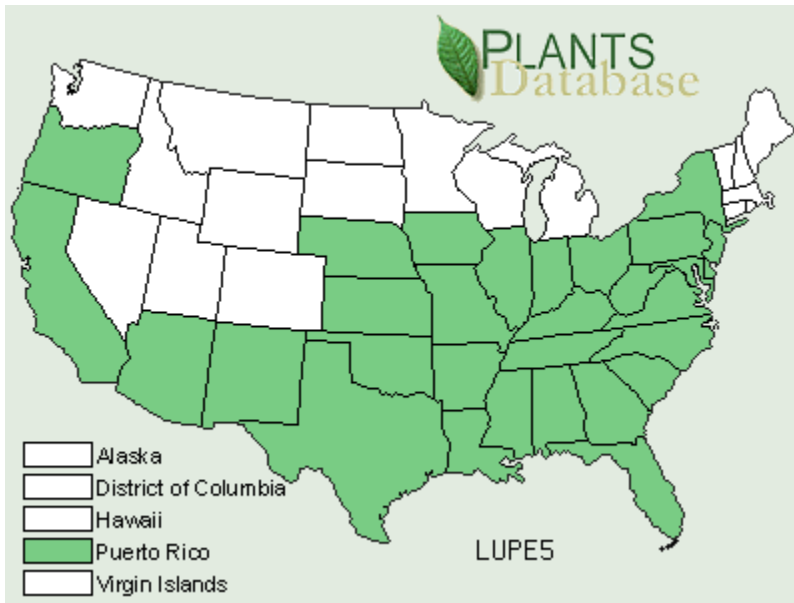

## Species Description

Creeping water primrose is a creeping or floating aquatic perennial herb that sometimes forms mats. Stems and leaves are usually glabrous or sometimes sparsely pubescent. The leaves are alternate, simple, and net-veined. Leaves of the floating stems are oblanceolate to spatulate, or sometimes orbicular in shape. Stems bearing flowers are usually weakly upright with lanceolate to narrowly elliptic leaves. Leaf petioles are 1 to 5 cm long. Flowers are axillary, perfect, and solitary on stalks 1 to 5 cm long. The five petals of the flower are yellow. The fruit is a cylindrical capsule with numerous seeds. Seeds are ellipsoid, yellowish, and less than 1 mm long.

In general appearance and growth form, *Ludwigia peploides* is similar to *L. uruguayensis* (Camb.) Hara. The erect flowering stems, and long, shaggy hairs along the stem and on the leaves of *L. uruguayensis* are characters that can be used to separate it from *L. peploides* which typically is glabrous to sparsely pubescent and has flowering stems that are weakly ascending.

## Habitat/Growth Characteristics

*Ludwigia peploides* grows in ditches, ponds, slow moving streams, rice fields, and along margins of lakes and reservoirs. It is a fast growing plant that can reproduce by seed and asexually by rooting at the nodes.

## **Problems**

The floating stems of creeping water primrose may form mats in shallow water along shorelines or cover the entire surface of small ponds. Colonies can restrict bank fishing, swimming, and boat access.

## **References**

Correll, D. S. and H. B. Correll. 1975. Aquatic and Wetland Plants of Southwestern United States. Stanford University Press, Stanford, California.

Godfrey, R. K. and J. W. Wooten. 1981. Aquatic and Wetland Plants of Southeastern United States. Dicotyledons. The University of Georgia Press, Athens, Georgia.



# Parrotfeather



## Synonym(s)

*Myriophyllum brasiliense* Camb.

*Myriophyllum proserpinacoides* Gillies ex Hook. & Arn.

## Family

Haloragaceae

## Home Range/U.S. Distribution

*Myriophyllum aquaticum* (Vell.) Verdc. is native to South America. The first known collection of parrotfeather in the United States was in 1890 (Nelson and Couch 1985). Parrotfeather is sporadically naturalized across much of the United States, likely as a result of plants escaping or being discarded from aquaria or ornamental pools. Its spread may have been further enhanced by intentional placement in water bodies to provide a source of plants for sale.

In many of the older manuals and taxonomic literature parrotfeather is referred to as *Myriophyllum brasiliense* Camb., which is a synonym for *M. aquaticum*.

## U.S. Range Map

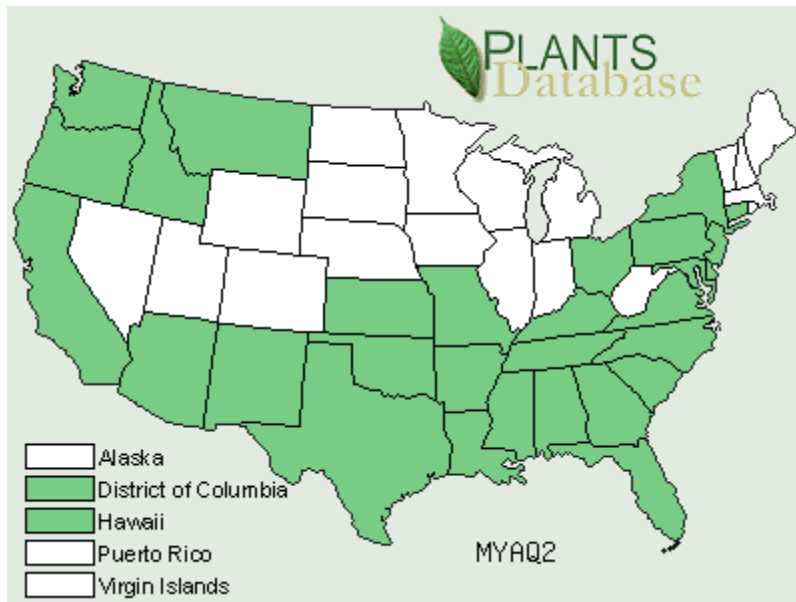

## Species Description

The stems of parrotfeather are moderately elongate, relatively stout, partially submersed but with a considerable portion of the leafy branches erect. The leaves are in whorls of 3 to 6, pinnately dissected, stiffish, and with 6 to 18 linear-filiform divisions on each side of the leaf. Leaves on the erect stems are grayish-green, 2.5 to 5 cm long, feather-like, the leaf divisions 4 to 8 mm long toward the leaf apex, reduced basally. Flowers of North American plants all female, whitish and in the axils of essentially unreduced leaves.

## Habitat/Growth Characteristics

Parrotfeather grows in sluggish waters, edges of streams, lakes, ponds, irrigation ditches, canals, sloughs, and spring-fed runs. It is rooted in the substrate with part of the stem beneath the surface of the water and a portion of the stem emersed. Parrotfeather forms creeping rhizomes which may give rise to multiple stems. Stems branch and root at the nodes allowing for the formation of fragments. Because only pistillate (female) plants occur in North America, all reproduction is asexual.

## Problems

Populations of parrotfeather may become quite dense and completely colonize small ponds and sloughs and impede water flow in drainage ditches and irrigation canals. It may also out-compete and replace native species that are of more value to fish and wildlife.

## References

Aiken, S. G. 1981. A conspectus of *Myriophyllum* (Haloragaceae) in North America. *Brittonia* 33: 57-89.

Nelson, E. N. and R. W. Couch. 1985. History of the introduction and distribution of *Myriophyllum aquaticum* in North America. In: L. W. J. Anderson (ed.), Proceedings of the First International Symposium on watermilfoil (*Myriophyllum spicatum*) and related Haloragaceae species. Aquatic Plant Management Society, Washington, D.C. pp. 19-26.





# Flowering Rush



© 2005 Louis-M. Landry

## Family

Butomaceae

## Home Range/U.S. Introduction

Flowering rush (*Butomus umbellatus* L.), native to Europe and western Asia, was first observed in 1897 on the St. Lawrence River and has since naturalized in several northern states.

## U.S. Range Map

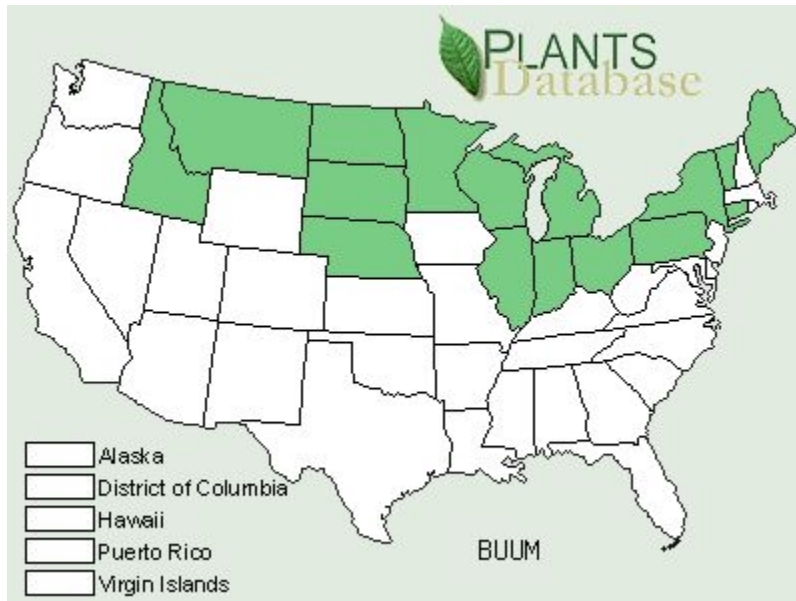

## Species Description

Perennial herb, rush-like emergent, flowering in mid-summer, or grows submersed in deeper water up to 2m deep or more. Flowers grow in umbrella shaped clusters and each individual flower has 3 whitish pink petals. Plants only produce flowers in very shallow water or on dry sites. Flowering rush has green stems that resemble bulrushes but are triangular in cross section. The leaf tips may be spirally twisted. Along shore, flowering rush has erect leaves and grows to about 3 feet in height. Under water, the leaves are limp.

## Problems

Flowering rush spreads readily by rhizomes and root pieces. Movement by wildlife is believed to be a vector of spread, as well as unintentional transport by boaters. It is difficult to control with herbicides.

## References

<http://www.seagrant.umn.edu/exotics/rush.html>

# Purple Loosestrife



## Family

Lythraceae

## Home Range/U.S. Introduction

*Lythrum salicaria* L. is native to Eurasia and is now naturalized over large areas of the United States. It apparently was introduced into coastal areas of the northeastern United States in the early 1800's (Stuckey 1980). Due to its attractive flowers, it has been planted as an ornamental garden species and has escaped from cultivation; it is now in at least 40 states and Canada.

## U.S. Range Map

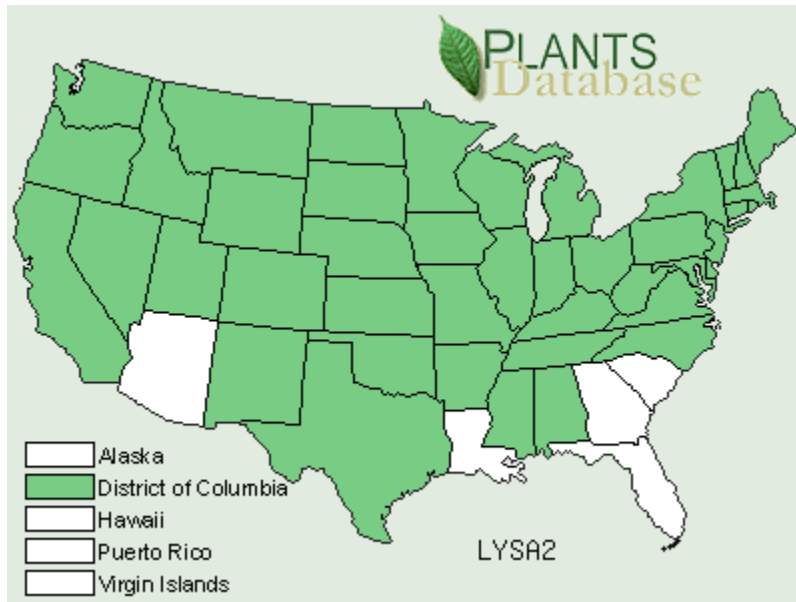

### Species Description

Plants are erect, emersed, much-branched perennials, glabrous to often pubescent, growing to 2 m tall. The stems are 4-angled. The leaves are opposite or whorled, sessile, mostly longer than the internode above, 2 to 10 cm long, 0.5 to 1.5 cm wide, and the base obtuse to cordate. Flowers are whorled in showy terminal bracteate spike-like inflorescences. The 6 petals are rose-purple, up to 10 mm long. There are usually 12 stamens.

### Habitat/Growth Characteristics

Purple loosestrife grows in marshes, along pond, lake and river margins, canals, wet meadows, prairies and ditches. The plant regrows from a strong root stock, and a single plant can produce 2.5 million seeds annually (Malecki *et al.* 1993). In many wetland areas purple loosestrife produces large colonies.

### Problems

Populations of purple loosestrife often spread so aggressively that native vegetation is suppressed and the structure and function of wetlands are altered (Thompson *et al.* 1987) and the value of wetlands for wildlife is reduced. Purple loosestrife may also degrade the quality of pasture and hay (Thompson *et al.* 1987) and impede the flow of water in irrigation canals (Malecki *et al.* 1993). It is estimated that 200,000 ha of wetlands in the United States are degraded annually through invasion of purple loosestrife.

## References

Malecki, R. A., B. Blossey, S. D. Hight, D. Schroeder, L. T. Kok, and J. R. Coulson. 1993. Biological control of purple loosestrife. *Bioscience* 43(10):680-686.

Stuckey, R. L. 1980. Distributional history of *Lythrum salicaria* (purple loosestrife) in North America. *Bartonia* 47:3-20.

Thompson, D. Q., R. L. Stuckey, and E. B. Thompson. 1987. Spread, impact, and control of purple loosestrife (*Lythrum salicaria*) in North American wetlands. U.S. Fish and Wildlife Research Report 2.



# Giant Reed



## Family

Poaceae

## Home Range/U.S. Introduction

Giant reed (*Arundo donax* L) is a native of Europe and has become naturalized throughout southern United States.

## U.S. Range Map

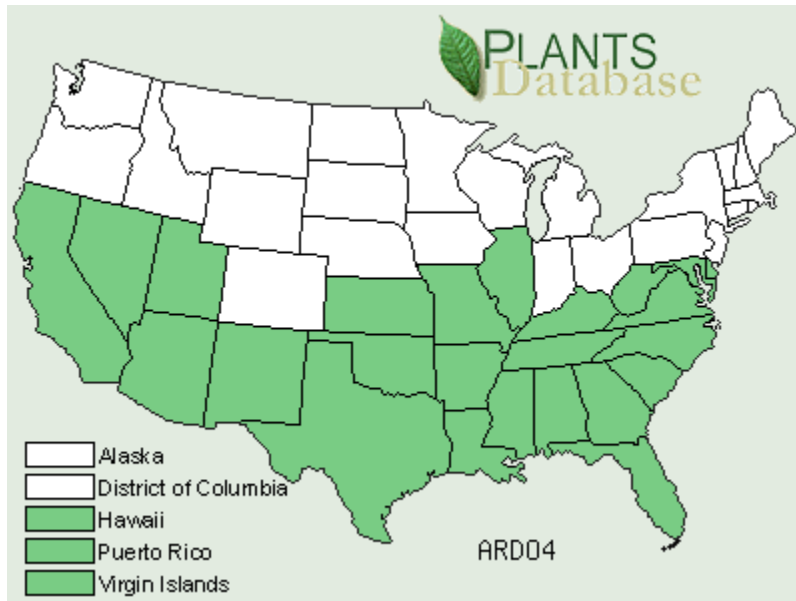

## Species Description

Giant reed is a perennial clump-forming grass that can attain heights of 7-8 meters. The leaves are chiefly cauline, long tapering to a sharply acute tip. The blades are flat 2-6 cm wide with scabrous margins. The ligule is membranous and minutely ciliate. The panicles are large and plummy and may reach a length of 0.6 m. Long hairs on the lemmas give the plumes a feathery appearance.

## Growth Characteristics

Giant reed grows rapidly and can readily propagate from rhizomes, thereby forming tall dense stands. Fertile caryopses seldom develop. The grass commonly invades areas along streambeds.

## Problems

Giant reed easily displaces native species and forms monospecific stands along waterways. These monocultures consume more water than native plants; create flood-control problems, and the large biomass that dies back each season creates a fire hazard.



# Common Reed



## Synonym(s)

*Phragmites communis* Trin.  
*Phragmites phragmites* (L.) Karst.

## Family

Poaceae (Gramineae)

## Home Range/U.S. Introduction

*Phragmites australis* (Cav.) Trin. ex Steud. is widespread in temperate and tropical regions of the world and is native to the United States (Gould 1968).

## U.S. Range Map

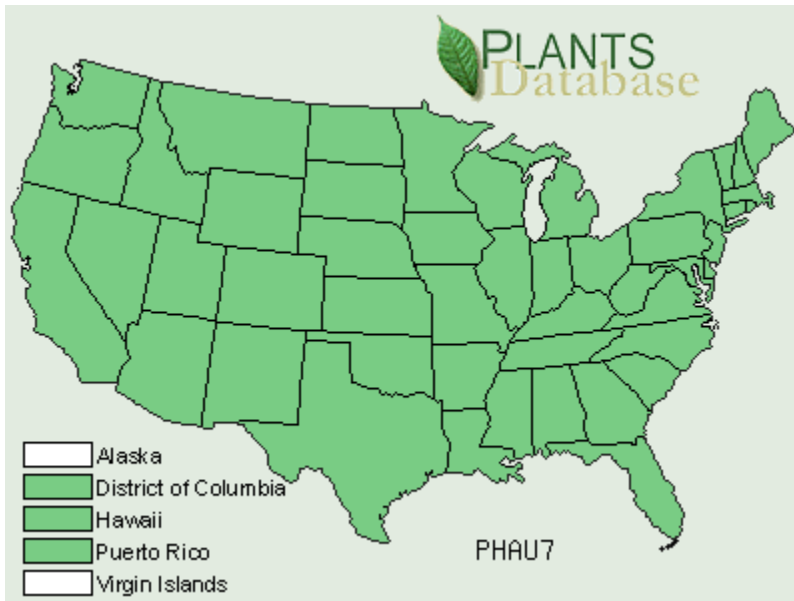

## Species Description

Common reed is a tall, coarse perennial with stout rhizomes to 2 cm across, deep seated in the substrate. Stems are up to 4.5 m tall, 5 to 15 mm thick, leafy throughout, the sheaths overlapping with a large, dense, terminal panicle. The leaves are flat, stiff, 1 to 6 cm broad and up to 6 dm long, tapering to long-attenuate tips. Leaf margins are serrate. The ligule is a ring of dense short stiff hairs. The panicle is terminal, plume-like, tawny to purplish or silvery, 15 to 50 cm long, 2 dm broad, with many branches. The flowers have long, silky hairs.

## Habitat/Growth Characteristics

*Phragmites* is found in marshes and in shallow water along the shoreline of lakes, ponds, swamps, ditches, streams, canals, rivers, and estuaries. It may produce large quantities of seed, but in many cases very few are viable. The seed will not germinate in more than about 5 cm of water (Marks *et al.* 1994). Once established, *Phragmites* spreads by rhizomes and stolons and often forms dense, monospecific colonies along shorelines and shallow water areas. Rhizomes are reported to grow up to about 2 m per year and be as long as 20 m (Batterson & Hall 1984).

## Problems

Dense colonies of common reed may impede water flow, recreational activities such as fishing, and restrict view from shoreline areas (Tarver *et al.* 1986). In some parts of the world, *Phragmites* is cultivated for the production of fiber and is

sometimes used in constructed wetlands for the removal of nutrients and pollutants (Batterson & Hall 1984).

## References

Batterson, T. R. and D. W. Hall. 1984. Common reed - *Phragmites australis* (Cav.) Trin. ex Steudel. *Aquatics* 6(2): 16-17, 20.

Gould, F. W. 1968. *Grass Systematics*. McGraw-Hill, Inc., New York

Marks, M, B. Lapin, and J. Randall. 1994. *Phragmites australis* (*P. communis*): Threats, management, and monitoring. *Natural Areas Journal* 14(4): 285-294.

Tarver, D. P., J. A. Rogers, M. J. Mahler, and R. L. Lazor. 1986. *Aquatic and Wetland Plants of Florida*. Third Edition. Florida Department of Natural Resources, Tallahassee, Florida.



# Saltcedar



## Family

Tamaricaceae

## Home Range/U.S. Introduction

The genus *Tamarix* consists of about 50 species in the Old World, several of which are cultivated in the United States as ornamentals (Correll and Johnston 1970; Correll and Correll 1975). Salt cedar also is sometimes planted as a wind break and for stabilizing sand and sandy soils. Species of salt cedar are very much alike, and in many instances difficult to distinguish without examining minute characteristics of the flowers under high magnification (20X). According to Baum (1967), the most common species of *Tamarix* in the United States are *T. chinensis* Lour. (Chinese tamarisk), *T. parviflora* DC., *T. ramosissima* Ledeb., *T. gallica* L. (salt cedar), *T. africana* Poir., and *T. aphylla* (L.) Karst. If species determination is required, a regional flora manual or Baum (1967) should be consulted.

## U.S. Range Map

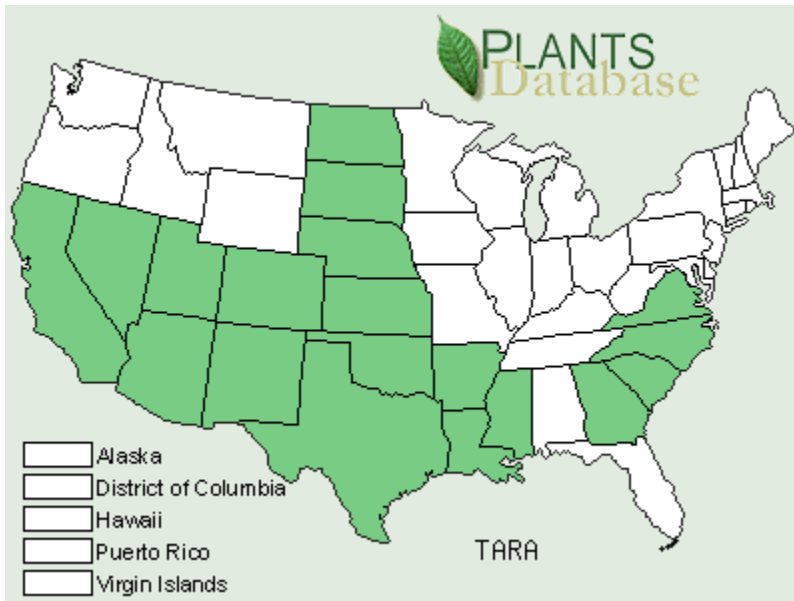

## Species Description

The species of *Tamarix* are shrubs or small trees with irregularly spreading-ascending, elongate branches with leafy branchlets that are very slenderly flexuous. The leaves are alternate, small, scale-like, a few millimeters long, sessile, broadest basally and more or less clasping or sheathing. Leaves are usually deciduous but may persist through mild winters. Flowers are small, short-pedicel or sessile with 4 or 5 pink or white petals inserted under a staminal disk. The fruit is a capsule that opens into 3 to 5 valves. Seeds are minute, densely bearded, or rarely winged.

Some species of salt cedar resemble opposite or whorled-leaved *Juniperus* (juniper or redcedar) but can be distinguished by the alternate leaves of *Tamarix*.

## Habitat/Growth Characteristics

Several species of *Tamarix* have become naturalized along rivers, streams, irrigation ditches, around lakes, coastal areas, salt flats, and waste places. Salt cedar can tolerate saline and alkaline conditions and is often found in such areas.

## Problems

These trees and shrubs provide shade and are excellent providers of nectar, which is important in the production of honey. However, in many regions they have become a serious problem because they form extensive stands and cause great water loss. In some areas of the southwestern United States and California, native

plant communities have been displaced and desert wetlands have been desiccated. Native vegetation on some islands of the Gulf also has been eliminated or greatly reduced by the abundance of salt cedar (Duncan & Duncan 1988).

## References

Baum, B. R. 1967. Introduced and naturalized tamarisks in the United States and Canada (Tamaricaceae). *Baileya* 15:19-25.

Correll, D. S. and H. B. Correll. 1975. *Aquatic and Wetland Plants of Southwestern United States*. Stanford University Press, Stanford, California.

Correll, D. S. and M. C. Johnston. 1970. *Manual of the Vascular Plants of Texas*. Texas Research Foundation, Renner, Texas.

Duncan, W.H. and M.D. Duncan. 1988. *Trees of the Southeastern United States*. The University of Georgia Press, Athens, Georgia.





# Brazilian Pepper



## Family

Anacardiaceae

## Other Common Names

Christmas Berry

## Home Range/U.S. Introduction

Brazilian pepper (*Schinus terebinthifolius* Raddi) is native to Argentina, Paraguay, and Brazil. In the United States, it has been introduced into Florida, Texas, and California as well as Hawaii, Puerto Rico and the Virgin Islands.

## U.S. Range Map

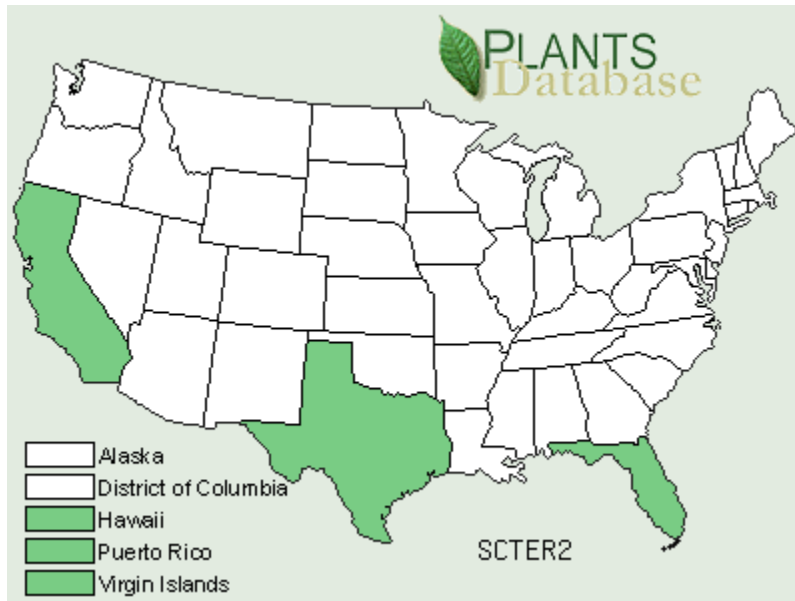

## Species Description

Brazilian pepper is a dioecious shrub or small tree reaching 10 meters. The short trunk is topped by a dense growth of contorted intertwining branches. The alternate leaves are compound with 3-13 sessile, oblong finely toothed leaflets. The rachis is distinctly winged. When crushed, the leaves smell of turpentine. The white flowers are very small and develop in tightly branched terminal and axillary clusters. The fruit is a bright red globose drupe.

## Growth Characteristics

The semitropical to tropical shrub invades hammocks, pine flatlands, and mangrove forest communities. The seeds are easily dispersed by birds and mammals and retain high viability for several months.

## Problems

Brazilian pepper is an aggressive invader that out-competes and displaces native plants. It readily forms monocultures, thereby destroying the native ecologically productive communities.

**Eleagnus spp.**  
**Russian Olive**  
**Autumn Olive**  
**Cherry Silverberry**



**Family**

Elaeagnaceae

**Home Range/ U.S. Introduction**

Russian olive, autumn olive, and cherry silverberry all native to either Europe or Asia have been introduced into the United States and have become persistent and/or escaping and becoming naturalized. Russian olive is found primarily in the central and western U. S., as well as in the East where it occurs with autumn olive. In the West, Russian olive occurs mainly in the Great Basin Desert and is also abundant in riparian zones of the Great Plains. Cherry silverberry is found from Missouri east to the Atlantic coast.

## U.S. Range Map

*Elaeagnus angustifolia*

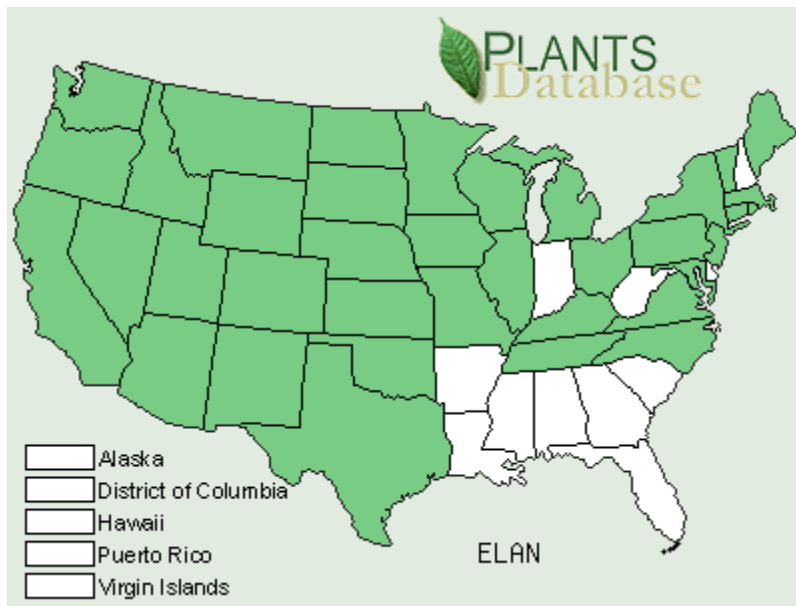

*Elaeagnus umbellata*

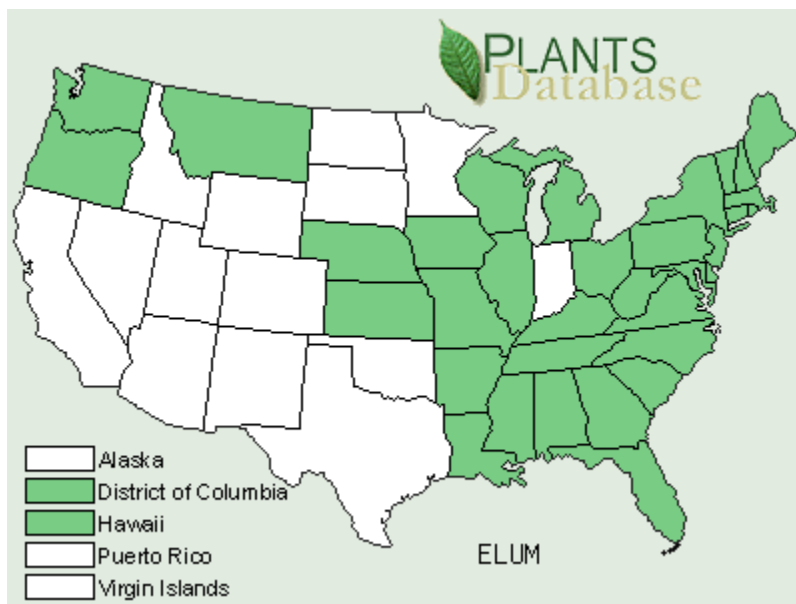

## Generic Description

The *Elaeagnus* species described herein are small trees to many branched shrubs. Young branches are often covered with a silvery gray or golden-brown hairy pubescence but with age develop a scaly gray-brown bark. In some species the branches are armed with spines. The ovate to lanceolate leaves are alternate,

petioled, and densely covered with a silvery, scaly or stellate pubescence. The fragrant flowers are solitary or in small clusters of one to three on twigs of the current year. The perfect flowers lack petals but have 4 spreading sepals that are yellowish on the interior surface and white to silvery on the outside, 4 stamens and a single pistil. The fruit is a mealy drupelike achene, round to ovoid, densely covered with a silvery gray pubescence.

## **Growth Characteristics**

Many *Elaeagnus* spp. are capable of nitrogen fixation and have been recommended for companion planting because of this characteristic. Plants are capable of flowering and producing fruit after reaching only three years of age. The yellowish fragrant flowers appear in June and July and are later replaced by abundant silvery fruit. Bird species are probably the primary vector for dispersal although raccoons, skunks, and opossums also feed on the fruit. Some vegetative propagation has been reported. Once established, *Elaeagnus* spp. are highly invasive and difficult to control. They are found in disturbed areas, successional fields, pastures, roadsides, and shelter belts where they have been widely planted. They also have escaped to invade prairies, open woodlands, and forest edges.

## **Problems**

The fast growing persistent habit allows *Elaeagnus* spp. to outcompete native plants, interfere with natural plant succession and nutrient cycling, and reduce water reserves in the soil. The species are drought tolerant and their nitrogen fixing ability allows them to grow in a wide range of soils. Plants can resprout vigorously following cutting or burning.



# Russian Knapweed



<http://www.cdfa.ca.gov/phpps/ipc/weedinfo/acroptilon-repens.htm>

## Family

Asteraceae

## Synonym

*Centaurea repens*

## Home Range/U.S. Introduction

Russian knapweed (*Acroptilon repens*), native to Eurasia, was introduced into North America in the late 1800's. Absent only from southeastern U.S., it has become widespread in other regions.





# Spotted Knapweed



<http://www.cdfa.ca.gov/phpps/ipc/weedinfo/centaurea-maculosa.htm>

## Family

Asteraceae

## Synonym

*Centaurea maculosa*

## Home Range/U.S. Introduction

Spotted knapweed (*Centaurea biebersteinii*) was introduced from Eastern Europe in the early 1900's as a contaminant in crop seed. It has become widespread in northern and western U.S. and in Canada.

## U.S. Range Map

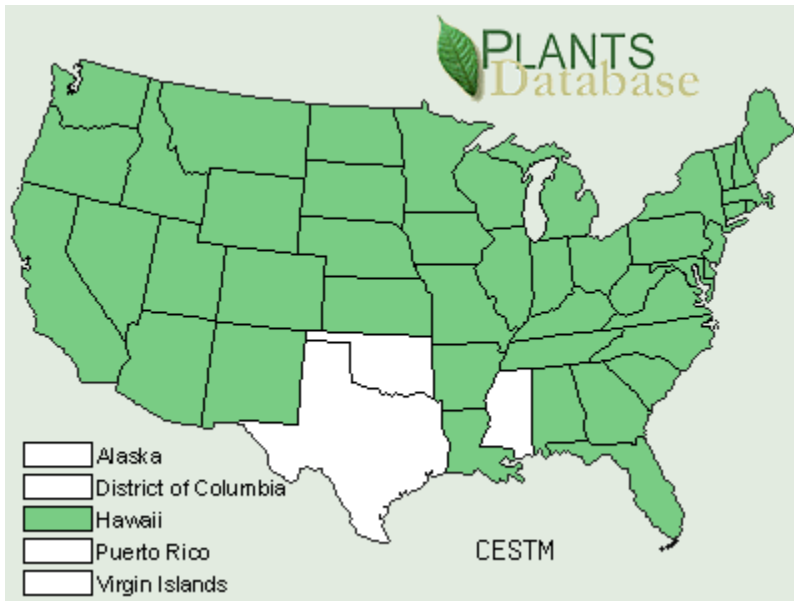

## Species Descriptions

Spotted knapweed is a biennial or short lived perennial with a stout taproot. The plant grows 3-12 dm tall having multiple branching stems that are smooth to scabrous. The leaves are pinnatifid with narrow lobes, scabrous puberulent and usually arachnoid-tomentose. Upper leaves may become linear and entire. The pink to light purple flowers are in solitary heads terminating the branches. The involucral bracts are stiff, striate; the outer and middle ones having short dark pectinate tips. Pappus up to 3 mm long. The fruit is a brown or blackish achene with longitudinal lines, glabrous or sparsely pilose.

## Growth Characteristics

Spotted knapweed is an aggressive plant that rapidly invades pastures, rangeland, dry meadows, flood plains, roadsides and any other dry, gravelly or sandy sites. Early spring growth makes knapweeds very competitive for soil moisture and nutrients.

## Problems

Seeds are produced prolifically and remain viable for a number of years. Infestations crowd out desirable native vegetation. Rangelands are severely impacted because grazing animals pass over knapweed in favor of native grasses and herbs. Hence it is the number one rangeland weed in Montana.

# Diffuse Knapweed



<http://www.cdfa.ca.gov/phpps/ipc/weedinfo/centaurea-diffusa.htm>

## Family

Asteraceae

## Home Range/U.S. Introduction

Diffuse knapweed (*Centaurea diffusa*) is native to Eurasia. Introduced into North America in the late 1800's, it is naturalized across western United States and has a scattered distribution in the midwestern and northeastern states.

## U.S. Range Map

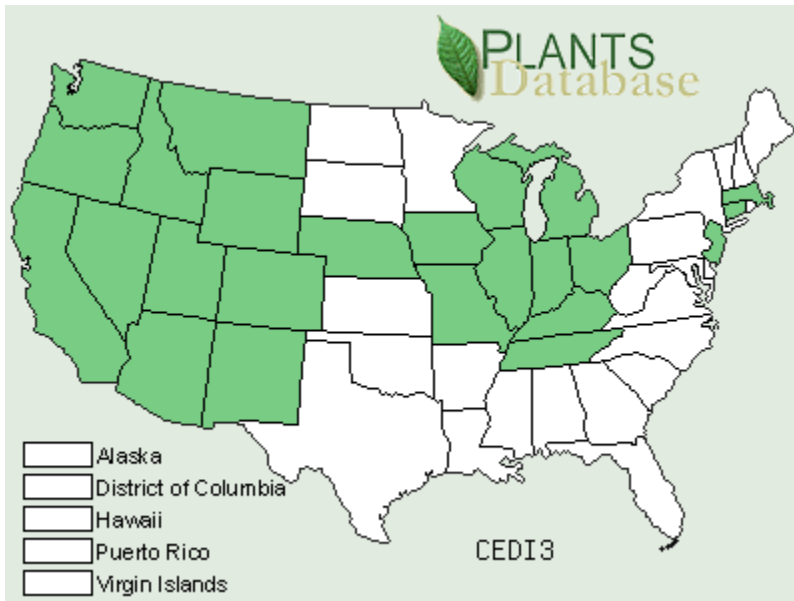

## Species Description

Diffuse knapweed is an annual or biennial herb with a taproot. The stems are erect, 1-6 dm tall, highly branched, angled, scabrous to puberulent. The basal leaves are early deciduous, obovate, pinnatifid, and covered with a thin tomentum; the cauline leaves are alternate, pinnatifid to entire and becoming much reduced toward the plant apex. Flowers are in discoid heads (lack strap shaped petals); corollas white or creamy to purplish. Involucral bracts are stiff, glabrous with an apical spine 1.5-7 mm long with 4-6 pairs of shorter lateral spines. The fruit is a small brown, usually glossy, achene. Pappus absent or greatly reduced.

## Growth Characteristics

Reproduction is exclusively by seed. Being allelopathic, it can dominate disturbed areas almost to the exclusion of other species. It can be distinguished from spotted knapweed which it closely resembles by its spine tipped involucral bracts.

## Problems

By the late 1980's, 1.3 million ha were infested with diffuse knapweed in western U.S. It rapidly invades overgrazed rangeland and other disturbed sites, and is capable of establishing in undisturbed communities. The foliage contains cnicin and is highly unpalatable resulting in overgrazing of remaining vegetation in rangelands where diffuse knapweed has become established.

# Leafy Spurge



## Family

Euphorbiaceae

## Home Range/U.S. Introduction

Leafy spurge (*Euphorbia esula* L) is a native of Eurasia. The first record of its presence in North America was in Massachusetts in 1827. By the early 1900s, plants were in the Western U.S. and Canada.

There are many species of *Euphorbia* in North America. Diagnostic characters are found in the number and shape of the glands or appendages of the involucre, the number of staminate flowers in the cyathium and the structure of the seed. Most of these are scarcely observable under 10x magnification. If specific delineation of members of this genus is desired, it would be best to consult a regional manual for help.

## U.S. Range Map

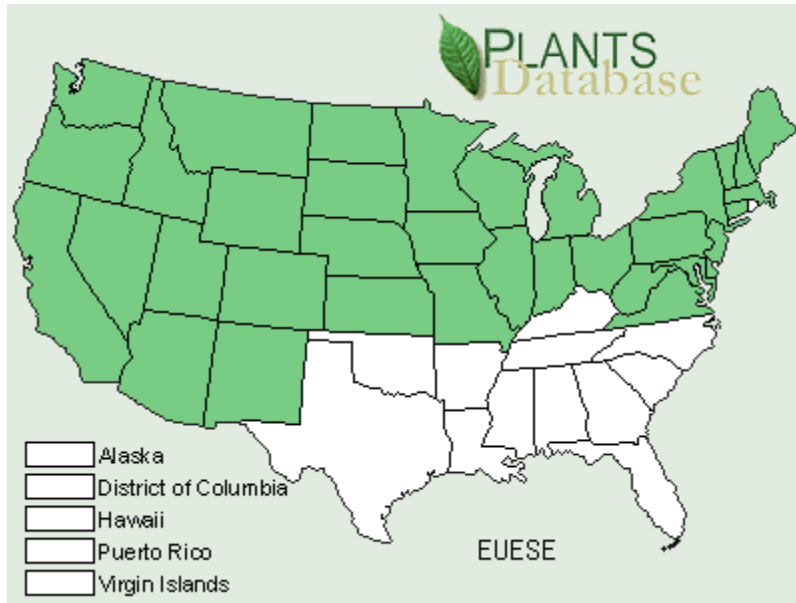

## Species Description

Plants are perennial from a deep root with slender creeping rootstocks. The stem is glabrous, containing milky acrid juice, usually with numerous alternate flowering branches below the umbel. The leaves are alternate, broadly linear to narrowly lanceolate-oblong, 3-7 cm long, <1 cm wide, essentially 1-nerved, apices obtuse to mucronate. The leaves subtending the umbel are shorter and broader, lanceolate to ovate. The umbel is comprised of 7 or more rays subtended by a whorl of leaves. The inflorescence is termed a cyathium but appears as a single flower with an involucre resembling a calyx or corolla with united lobes. The involucre has 1-5 nectar-bearing glands on its margin; these are strongly 2-horned. There are greenish-yellow petal-like appendages from beneath the glands. The capsule is warty, ca. 5 mm high; seeds are smooth, round-obovoid, 2 mm long.

## **Growth Characteristics**

It is reported that the roots of this species may be up to 5 m deep. It is widely spread in grazing lands. Plants reproduce by rhizomes and seeds which, when ripe, are dispersed up to 5 m from the parent plants. It is believed that water and animals also disperse the seeds.

## **Problems**

This species tends to outcompete other species. It is reported to occupy more than 1 million ha of land. The plants contain a milky juice that is an irritant to some animals.





# Yellow Starthistle



## Family

Asteraceae

## Home Range/U.S. Introduction

Yellow starthistle (*Centaurea solstitialis*), native of Eurasia, was introduced into western North America in the mid 1800's and has become naturalized across most of the U.S. Highest densities occur in California, Oregon, Washington, and Idaho.

## U.S. Range Map

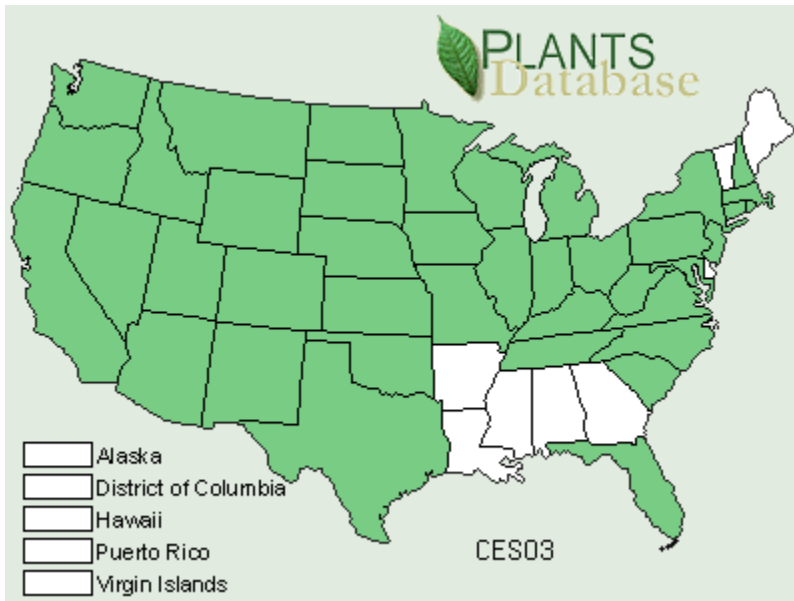

## Species Descriptions

Yellow starthistle is a gray-green to blue-green annual or biennial with a deep taproot. The stems are erect, 2-10 dm tall, freely branching, covered with a thin tomentum and prominently winged by decurrent leaf bases. The basal leaves are lyrate or pinnatifid, early deciduous, 4-5 cm wide to 20 cm long; middle and upper leaves are smaller becoming linear and entire. The yellow flowers are in heads that terminate the branches. The middle and outer involucral bracts are spine tipped, the larger central spines commonly 11-30 mm long; inner bracts unarmed. Pappus lacking on marginal flowers, that of others 3-5 mm long. The fruit is a yellowish achene with brown marbling.

## Growth Characteristics

The plant develops a deep taproot allowing it to proliferate on dry sites. It reproduces exclusively by seed, estimated to be as high as 29,000 seeds per square meter with about 95% viability. Yellow starthistle frequents fields, roadsides, rangelands, pastures, and waste areas.

## Problems

Yellow starthistle is a rapid colonizer that can form dense stands. Production of allelochemicals prevents growth of other plant species. It is poisonous to horses, causing the nervous disorder "chewing disease".

# Perennial Pepperweed



## Family

Brassicaceae

## Host Range/U.S. Introduction

Pepperweed is native to Europe and is widely scattered in many parts of the United States.

## U.S. Range Map

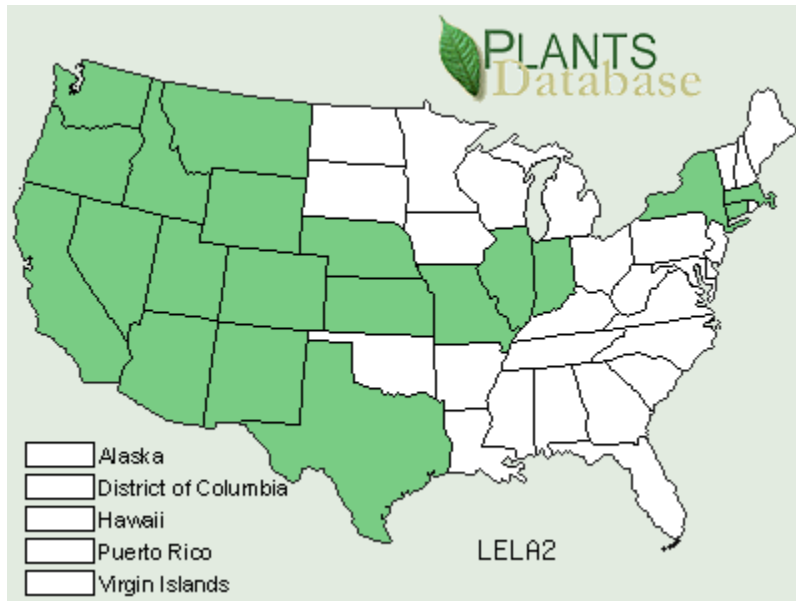

## Species Description

Pepperweed (*Lepidium latifolium*) is a glaucous perennial herb to 1.3 m tall with a widely spreading root system. The entire to toothed leaves are oblong and petiolate at the base, becoming smaller and almost sessile at the plant apex. The flowers are perfect and produced in a many flowered raceme. The petals are spatulate, white. The fruit is a silicle on a pedicel approximately twice as long as the silicle.

## Growth Characteristics

Pepperweed is common in fields and waste places.

## Problems

The aggressive nature of this plant allows it to displace native species. It is difficult to control because of its perennial root system and deep-seated rhizomes.

# Canada Thistle



Canada thistle infestation along 1-90

## Family

Asteraceae

## Home Range/U.S. Introduction

Canada thistle (*Cirsium arvense*) is native to Eurasia. It has become established in all but the southeastern part of the United States.

## U.S. Range Map

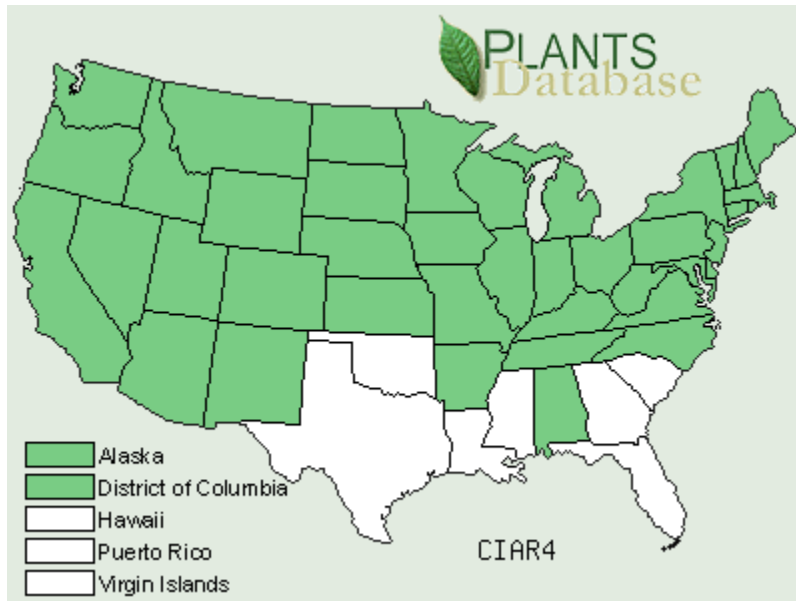

## Species Descriptions

Canada thistle is a dioecious perennial that spreads from deep horizontal lateral roots bearing adventitious shoots. Stems may reach up to 10 dm tall, branching near the top. The leaves are alternate, oblong to oblanceolate, usually lobed with the margins bearing fine to strong spines. The leaf bases are sessile, clasping to short decurrent. The blades are glabrous to pubescent. The inflorescence is a head of unisexual flowers occurring in loose clusters terminating the branches. The flowers are pink to purple, rarely white. The involucral bracts are 1-2 cm, at most with a weak spine tip ca. 1 mm long. The pappus is composed of plumose bristles united in a ring at the base.

## Growth Characteristics

Canada thistle is dioecious with male and female flowers on separate plants. It flowers from Jun-Aug. It occurs in pastures, ditches, bottomlands and other moist areas.

## Problems

The plant is difficult to control because it spreads aggressively from horizontal roots. Plowing also breaks the root into fragments each of which can develop into a new plant.

# Bull Thistle



Patrick J. Alexander @ USDA-NRCS PLANTS Database

## Family

Asteraceae

## Home Range/U.S. Introduction

Bull thistle (*Cirsium vulgare*), native to Eurasia, is widely established in the United States.

## U.S. Range Map

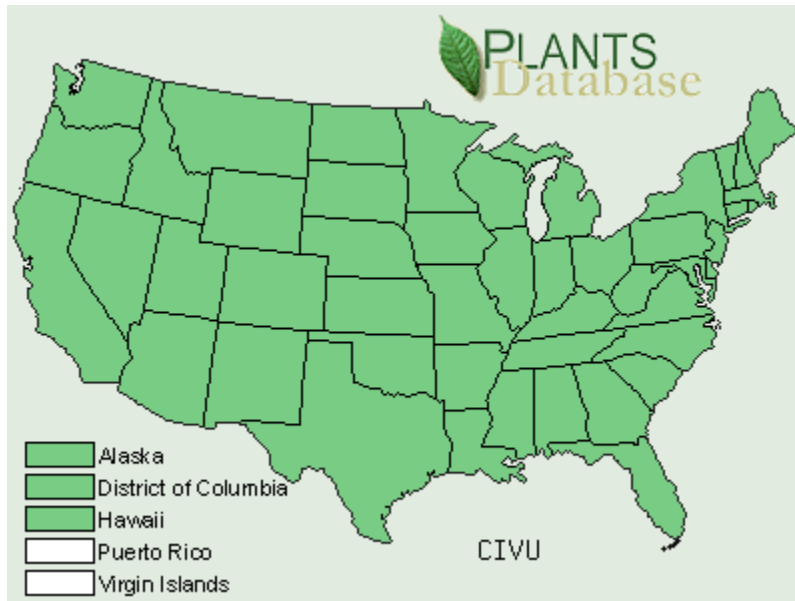

## Species Descriptions

Bull thistle is a biennial from a short, fleshy taproot. The green to brownish stems are spreading often reaching 2 m tall. The leaves are green, the upper surface bearing yellowish prickles, the lower surface villose. The rosette leaves are oblanceolate to elliptic, deeply pinnatifid and tipped with a spine to about 10 mm long. The cauline leaves are similar to the rosette leaves but smaller, the lobes bearing stouter spines and the leaf bases strongly decurrent. The heads are numerous, terminal and solitary on the branches, appearing clustered. The flowers are dark purple. The involucral bracts are lanceolate, up to 30 mm long, and tipped with a spine. The white to tawmy pappus is composed of plumose bristles.

## Growth Characteristics

Bull thistle is found in pastures, fields, along roadsides, edges of meadows, log landings, and in waste areas.

## Problems

The plant is a prolific seed producer and can form dense stands. The spiny nature of the plant, its size, and its rapid spread allows it to displace other plant species and makes revegetation difficult.



# Plumeless Thistle



*Photo by WI DNR*

## **Family**

Asteraceae

## Home Range/U.S. Introduction

Plumeless thistle (*Carduus acanthoides*) is a native of Eurasia and is now widely established across northern United States.

## U.S. Range Map

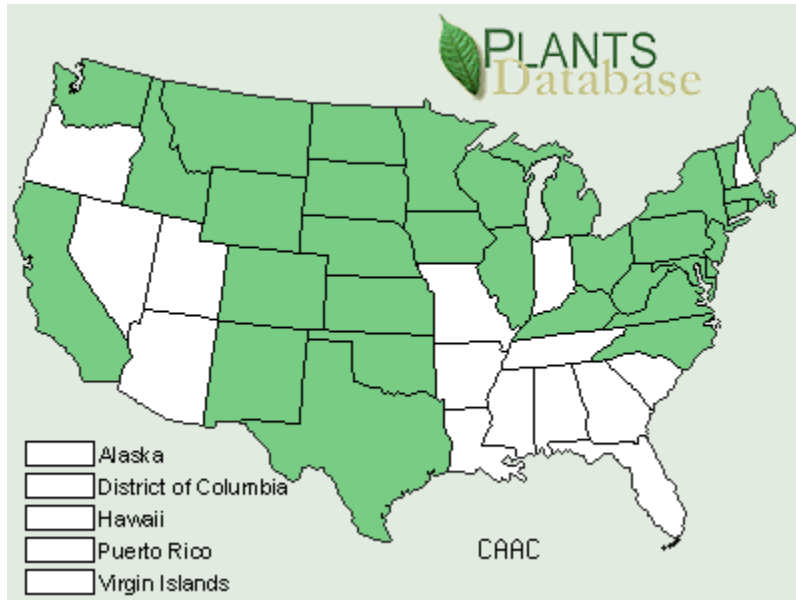

## Species Descriptions

Plumeless thistle is a winter annual or biennial herb 3-10 dm tall with a stout fleshy taproot. The stems are freely branching with spiny wings extending to the flowering heads. The leaves are alternate, deeply lobed or pinnatifid with spiny margins. They are sessile, decurrent, elliptic to lanceolate or oblong in shape. The blade surface may be glabrous or pubescent. The flowers are purple in discoid heads surrounded by involucre bracts < 2 mm wide. The heads are erect, single or clustered at the ends of the branches. The pappus is composed of numerous capillary bristles 1-1.2 cm long.

## Growth characteristics

The plant rarely flowers the first year. The second year, flowering occurs from May - August. It is infrequent to locally abundant in pastures, stream valleys, fields, roadsides, and waste places.

## **Problems**

The spiny plant invades fields and pastures competing with native species or forage crops.



# Musk Thistle



## Family

Asteraceae

## Home Range/U.S. Introduction

Musk thistle (*Carduus nutans*), a native of Eurasia is now widely established throughout the United States and Canada.

## U.S. Range Map

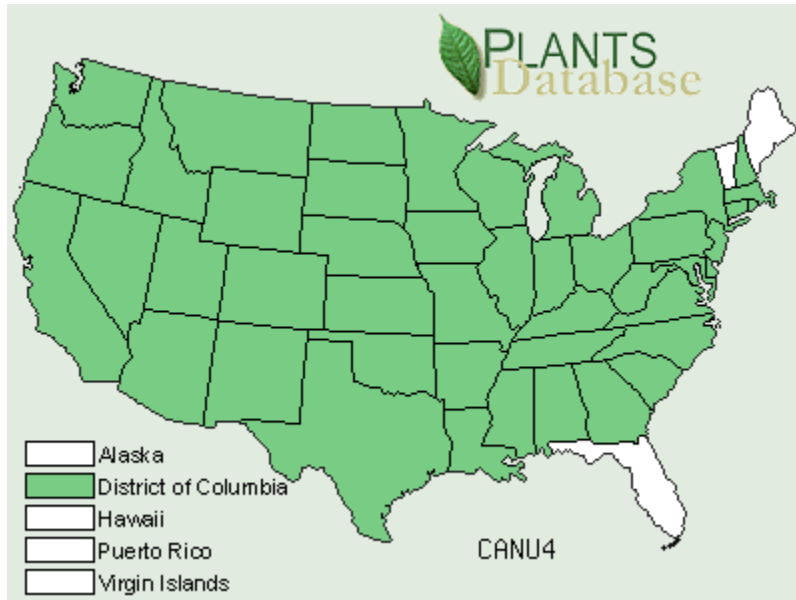

## Species Descriptions

Musk thistle is a winter annual or biennial herb with a stout fleshy taproot. The stems are erect up to 3 m tall, much branched, with spiny wings from the decurrent leaf bases. The rosette leaves are broadly elliptic to lanceolate, pinnatifid with spinose margins that are silvery white to purplish. The cauline leaves are alternate, sessile, decurrent, with spiny margins. The blade surface is glabrous to pubescent. The flowers are purple in discoid heads surrounded by involucral bracts 2-10 mm wide. The heads are single, terminal, and usually nodding. The pappus is composed of numerous capillary bristles 1- 2 cm long.

## Growth Characteristics

The plant rarely flowers the first year. The second year, flowering occurs from May - July and sporadically to frost. It is found in pastures, stream valleys, open wooded areas, fields, roadsides, and waste places.

## **Problems**

Musk thistle can form extremely dense stands that crowd out desirable forage species.





# Cardaria spp. – Whitetop



## Family

Brassicaceae

## Home Range/U.S. Introduction

Whitetop, (*Cardaria spp*), are native to Eurasia and are widespread throughout the United States except in the Southeast.

## U.S. Range Map

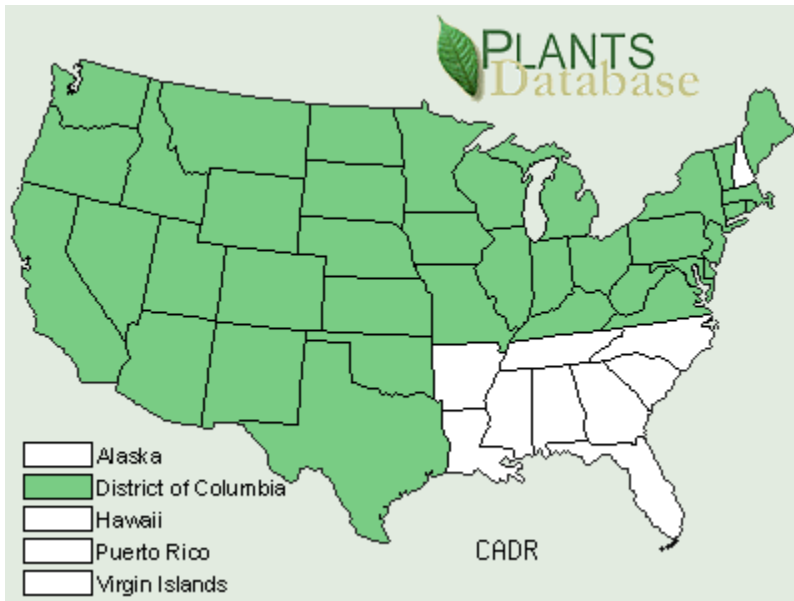

## Species Description

*Cardaria* spp. are erect perennial herbs, usually pubescent, which spread by horizontal rootstocks. Basal leaves are petiolate, lyrate when young. Upper leaves are sessile, elliptical to lanceolate, with auriculate or sagittate bases which clasp the stem. The flowers are perfect and produced in numerous dense racemes. The petals are white to cream colored and clawed. The 3 *Cardaria* species are distinguished by their texture and the shape of their fruits.

Species	Surface	Shape of fruit
<i>C. pubescens</i> obovate	pubescent	inflated, subreniform to
<i>C. draba</i>	glabrous	compressed, cordate
<i>C. chalepensis</i> obovate	glabrous	compressed, subreniform to

## Growth Characteristics

*Cardaria* spp. are aggressive perennials that can reproduce by seeds or rhizomes. They are common in fields, pastures, roadsides, and waste areas.

## Problems

The aggressive nature of the plants allows them to outcompete and displace native species.

# Cheatgrass



## Family

Poaceae

## Home Range/U.S. Introduction

This species (*Bromus tectorum* L.) was introduced from Europe, probably for forage. *Bromus* is a large genus of grasses of temperate regions of the world, many cultivated for hay or forage.

## U.S. Range Map

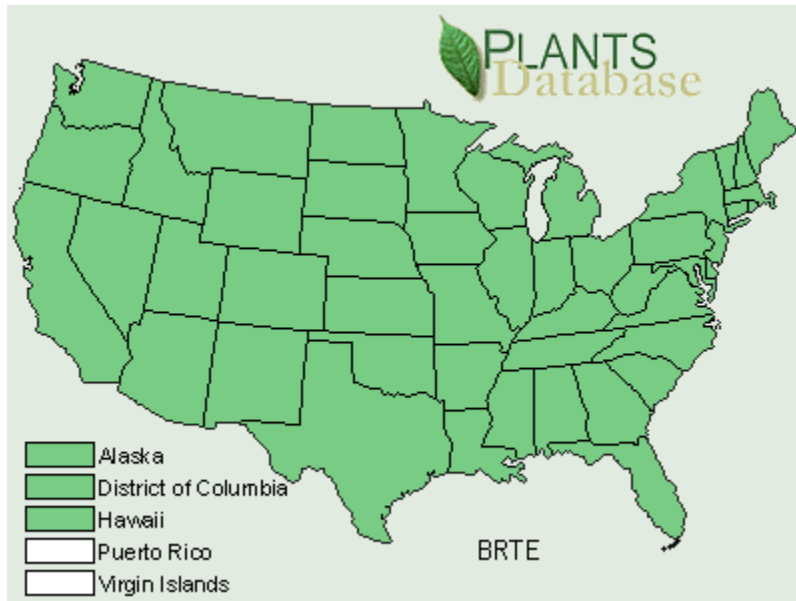

## Species Description

The plants are slender annuals with stems 30-60 cm tall. The stem nodes are glabrous. Leaf blades are up to 20 cm long, 1-6 mm wide, both surfaces and margins pubescent; sheaths are usually pubescent. The panicle is open, 5-20 cm long, 3-15 cm broad with flexuous, pubescent branches. The flowering and fruiting structures have narrow, sharp-pointed, 12- to 14-mm-long barbed points.

## Growth Characteristics

Plants are tufted annuals. Plants grow along roadsides, banks, fields and waste places, commonly on the Pacific coast. They are also found throughout the U.S.

## Problems

They are, at maturity, a serious pest because the pointed, barbed fruits can work into the eyes, nostrils and mouths of livestock, causing inflammation and often serious injury. Sometimes the intestines are pierced and death results. In some areas, the dry plants are fire hazards.

## Asian Clam (*Corbicula Fluminea*)



Noel Burkhead - USGS

The following information has been provided by Invasive Species Specialist Group (<http://www.issg.org/database> )

### **Taxonomic name**

*Corbicula fluminea* (Muller, 1774)

### **Synonyms**

*Corbicula leana* (Prime), *Corbicula fluminalis* (Muller, 1774), *Corbicula manilensis* (Philippi, 1884)

### **Common Names**

Asian clam (English), Asiatic clam (English), prosperity clam (English)

### **Organism Type**

Mollusk

*Corbicula fluminea* is a freshwater clam that has caused millions of dollars worth of damage to intake pipes used by power, water, and other industries. Many native clams are declining as *C. fluminea* outcompetes them for food and space. *C. fluminea* requires well-oxygenated waters and prefers fine, clean sand, clay, and coarse sand substrates. *C. fluminea* spreads when it is attached to boats or carried in ballast water, used as bait, sold through the aquarium trade, and carried with water currents.

## Description

*C. fluminea* has a yellowish brown to black shell with concentric, evenly spaced ridges on the shell surface (INHS 1996). They are usually less than 25 mm but can grow up to 50 to 65 mm in length (Aguirre and Poss 1999).

Occurs in: estuaries, lakes, water courses

## Habitat Description

*C. fluminea* is found in lakes and streams of all sizes with silt, mud, sand, and gravel substrate (INHS 1996). They can tolerate salinities of up to 13 ppt for short periods (Aguirre and Poss 1999) and temperatures between 2 and 30 degrees Celsius, or 86 degrees Fahrenheit, (Balcom 1994). It prefers fine, clean sand, clay, and coarse sand substrates (Aguirre and Poss 1999). It is usually found in moving water because it requires high levels of dissolved oxygen. *C. fluminea* is generally intolerant of pollution.

## General Impacts

Ecologically, *C. fluminea* can outcompete many native clam species for food and space (PNNL 2003). The introduction of *C. fluminea* into the United States has resulted in the clogging of water intake pipes, affecting power, water, and other industries. Nuclear service water systems (for fire protection) are very vulnerable, jeopardizing fire protection. In 1980, the costs of correcting this problem were estimated at 1 billion dollars annually. *C. fluminea* causes these problems because juveniles are weak-swimmers, and consequently they are pushed to the bottom of the water column where intake pipes are usually placed. They are pulled inside the intakes, where they attach, breed, and die. The intake pipes become clogged with live clams, empty shells, and dead body tissues. Buoyant, dead clams can also clog intake screens.

## Uses

In *C. fluminea's* native range, it is marketed for human consumption and as feed for domestic fowl (Aguirre and Poss 1999). In the United States, it is sold as fish bait (Aguirre and Poss 1999), and it is sold through the aquarium trade where they are known as "pygmy" or "gold" clams.

## Geographical Range

### Native Range

*C. fluminea* is native to southeastern China, Korea, southeastern Russia, and the Ussuri Basin (Aguirre and Poss 1999).

### Known Introduced Range

In the United States, *C. fluminea* has been introduced to 38 states and the District of Columbia (Foster *et al.* 2000).

### U.S. Range (from USGS)

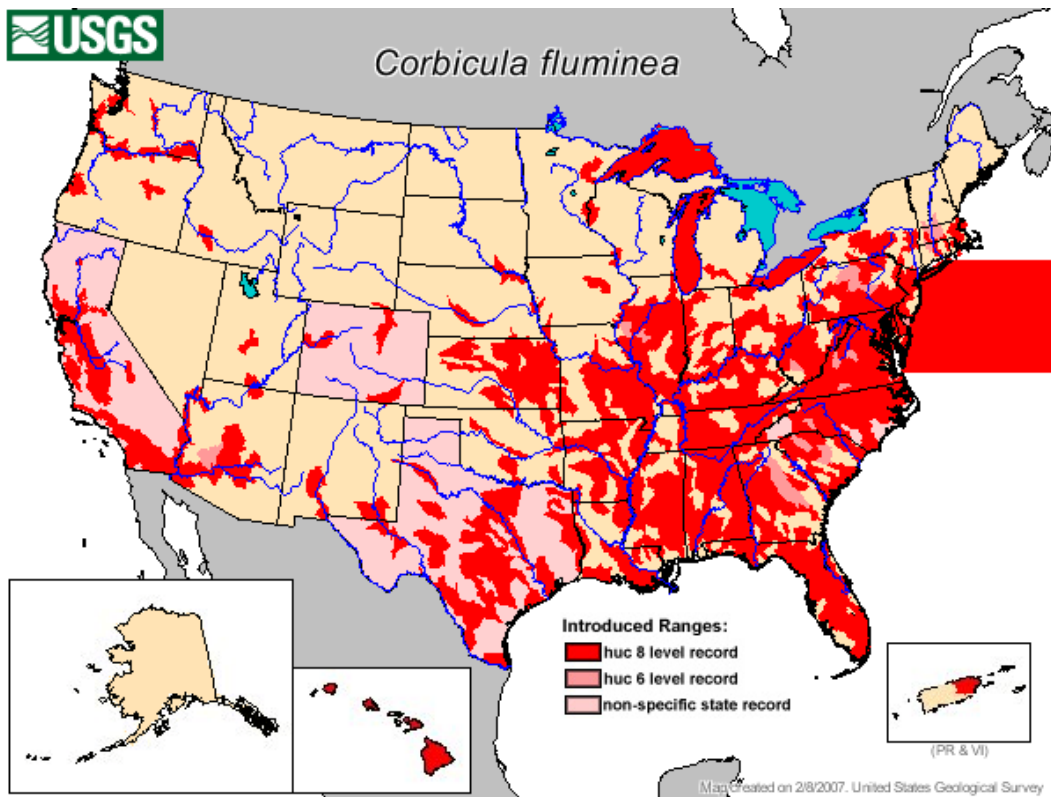

## **Invasion Pathways to New Locations**

*Other:* Used as live bait throughout the United States. The clams sometimes escape into the water alive.

*Pet/aquarium trade:* *C. fluminea* is known as "pygmy" or "gold" clams in the aquarium trade.

*Ship ballast water:* Juvenile clams can be carried in ballast water all over the world.

*Ship/boat hull fouling:*

## **Local Dispersal Methods**

*Boat:*

*Escape from confinement:* Researchers sometimes inadvertently release *C. fluminea* into non-native waters.

*Water currents:* Water currents spread juveniles throughout a water body.

## **Management Information**

*C. fluminea* populations are controlled by a variety of methods. Where intakes pipes are fouled, thermal regulation is employed, whereby water in the pipes is heated to temperatures exceeding 37 degrees Celsius. But this method is not possible in most existing water systems. Mechanical measures, such as using screens and traps, can effectively eliminate older clams and remove body tissue and shells from the system. Chemicals, such as small concentrations of chlorine or bromine, are used to kill juveniles and sometimes adults. This method is very effective, but because of increasing restrictions on the amounts of these chemicals that may be released from a facility, facility managers have been moving away from this method. Some states have legislation prohibiting the introduction of *C. fluminea* into their waters.

## **Nutrition**

*C. fluminea* feeds on plankton.

## **Reproduction**

*C. fluminea* is a hermaphrodite (both sexes are found on one organism) and is capable of self-fertilization. Sperm is released into the water, caught by another clam, and brooded in the gills. The larvae are released through the excurrent siphon and sent out into the water column. Spawning can continue year around in water temperatures higher than 16 degrees Celsius. The water temperature must be above 16 degrees Celsius for the clams to release their larvae. In North America, spawning occurs from spring to fall (Aguirre and Poss 1999). Maximum



densities of *C. fluminea* can range from 10,000 to 20,000 per square meter, and a single clam can release an average of 400 juveniles a day (PNNL 2003) and up to 70,000 per year. Reproductive rates are highest in fall (Aguirre and Poss 1999).

## **Lifecycle Stages**

Larvae spawned late in spring and early summer can reach sexual maturity by the next fall (Aguirre and Poss 1999). *C. fluminea* maximum lifespan is 7 years, but it varies according to habitat (Aguirre and Poss 1999), with an average lifespan of 2 to 4 years (PNNL 2003).

**Reviewed by:** Anon

**Principal sources:** [Balcom, N. C. 1994. \*Aquatic Immigrants of the Northeast, No. 4: Asian Clam, Corbicula fluminea.\* Connecticut Sea Grant College Program.](#)

**Compiled by:** National Biological Information Infrastructure (NBII) and Invasive Species Specialist Group (ISSG)

**Last Modified:** Monday, 24 January 2005



## New Zealand Mudsnail (*Potamopyrgus Antipodarum*)



*Photo by D.L. Gustafson*

The following information has been provided by Global Invasive Species Database, 2005, *Potamopyrgus antipodarum* (mollusk), available from: <http://www.issg.org/database/species/ecology.asp?si=449&fr=1&sts> [Accessed 8 February 2007]

## Taxonomic Name

*Potamopyrgus antipodarum* (Gray, 1843)

## Synonyms

*Hydrobia jenkinsi* (Smith, 1889), *Potamopyrgus jenkinsi* (Smith, 1889)

## Common Names

Jenkin's spire shell, New Zealand mudsnail

## Organism Type

Mollusk

*Potamopyrgus antipodarum* is an aquatic snail native to New Zealand and introduced to Australia, Europe, and North America. It can inhabit a wide range of ecosystems, including rivers, reservoirs, lakes, and estuaries. *P. antipodarum* can comprise over 95% of the invertebrate biomass in a river and it is suspected that it can alter primary production in some streams. They can spread rapidly in introduced areas and are able to withstand desiccation, a variety of temperature regimes, and are small enough that many types of water users could be the source of introduction to new areas.

## Description

*P. antipodarum* is a small, aquatic snail. Richards et al. (2002) state that the operculum is like all prosobranchs but that *P. antipodarum* "has an operculum to block the shell aperture when the animal is withdrawn into its shell. This is easily seen on live snails, but the operculum is lost from dead shells and it is normally withdrawn beyond view in shells that are directly preserved in alcohol or formalin." The authors also state that "the shell is normally horn colored but ranges from light to dark brown. Encrusted shells can be any color. Almost all western populations reach a maximal size very near 5 mm. One population in Idaho (Cassia Creek of the Raft River) regularly pushes 6 mm. The shell is rather elongate compared to most western species. Like most snails, it is dextral (opening to the animal's right). A full-grown shell normally has 5 or 6 whorls, which is higher than most western species. In some western populations, a weak keel is present about mid whorl in some to most individuals. Many populations lack this keel entirely. This keel is not present on any native western snail species."

Occurs in: estuaries, lakes, water courses

## Habitat Description

Richards *et al.* (2002) state that *P. antipodarum* has "a wide range of tolerances: rivers, reservoirs, lakes, and estuaries. Densities are usually highest in systems with high primary productivity, constant temperatures, and constant flow." In rivers it is found in all habitat substrates; silt, sand, gravel, cobbles, and vegetation (Richards *et al.* 2001, In Richards *et al.* 2002). In estuaries *P. antipodarum* can tolerate up to 17-24% salinity (Bondesen and Kaiser 1949, in Richards *et al.* 2002). Mud snails are able to withstand desiccation and a variety of temperature regimes (National Park Service, Undated).

## General Impacts

USGS-FISC (Undated) states that *P. antipodarum* "densities of over one-half million per meter square in western streams are a cause for concern. Because the West is known for abundant trout and productive fishing spots, there is concern that *P. antipodarum* will impact the food chain for native trout and the physical characteristics of the streams themselves." Richards *et al.* (2002) report that "frequently, *P. antipodarum* will comprise over 95% of the invertebrate biomass in a river. To date, limited research has documented decreases in native macroinvertebrate populations in several rivers where *P. antipodarum* has invaded. *P. antipodarum* has also been shown to drastically alter primary production in some streams. Its invasion has generated much concern about the potential impacts it may have on native species, fisheries, and aquatic ecosystems in the western USA." The National Park Service (Undated) states that "these small mollusks have the potential to 'cover the stream bottom,' similar to impacts observed with the Zebra mussel (*Dreissena polymorpha*) in the midwestern U.S. Preliminary baseline surveys indicate that *P. antipodarum* may be impacting the invertebrate community in the Madison, Firehole, and Gibbon rivers not only through physical displacement or crowding, but also through competitive interactions such as food availability. These streams not only support world famous recreational fisheries, but they also historically contained an abundance of native aquatic insects that form an important part of the aquatic food chain. Reductions in the insect species diversity or abundance could diminish the availability of this critical food resource to fish. Mud snails are a poor substitute for the traditional food base, yielding as little as 2% of their nutritional value when eaten by trout."

**Notes:** Lively (Undated) reports that "genetic studies have shown that asexual lines are derived from sympatric sexual females and that clonal diversity in mixed populations is very high (Dybdahl & Lively 1995, in Lively, Undated).

## Geographical Range

*Native range:* New Zealand (USGS-FISC, Undated).

*Known introduced range:* Europe, Australia, and North America (USGS-FISC, Undated)

## Range Map

Provided by: USGS

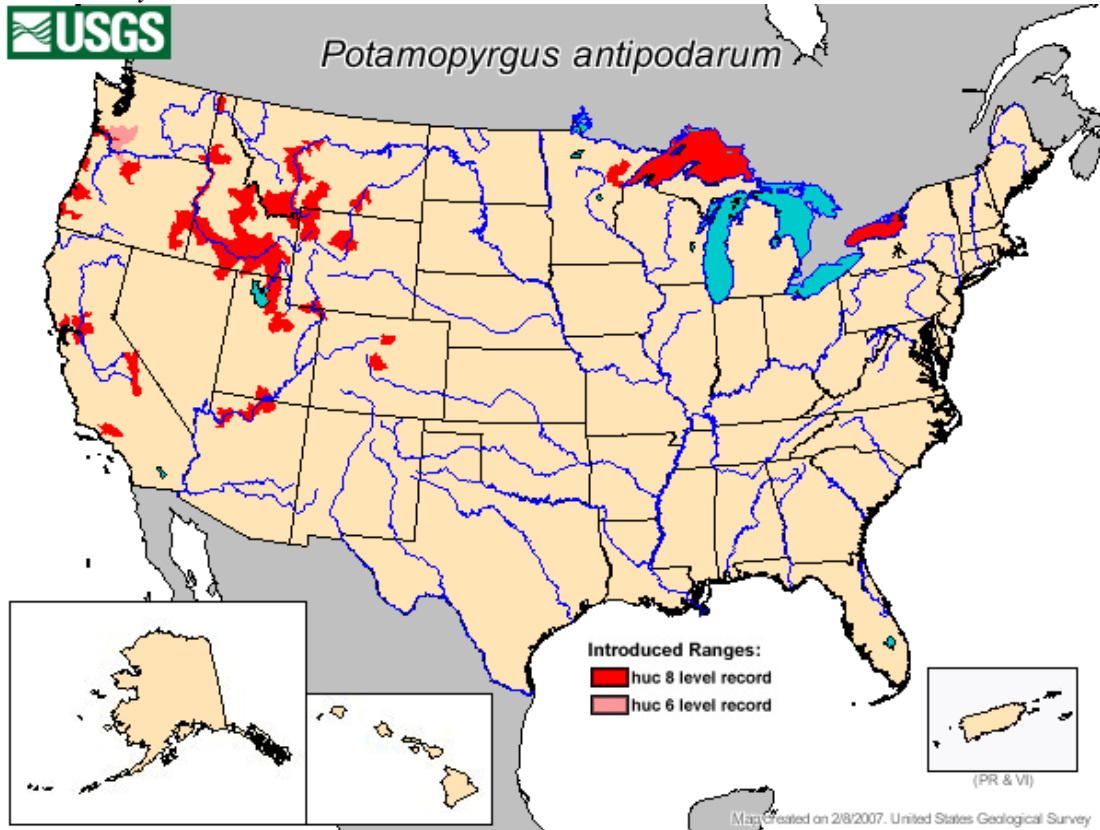

<http://nas.er.usgs.gov/queries/FactSheet.asp?SpeciesID=1008>

## Invasion Pathways to New Locations

### Ignorant Possession

The National Park Service (Undated) states that "the rapid spread of *P. antipodarum* throughout the Madison River watershed may have been assisted by human transport. Mud snails are able to withstand desiccation, a variety of temperature regimes, and are small enough that many types of water users (anglers, swimmers, picnickers, pets) could inadvertently be the mechanism for interbasin transfer of this nuisance species."

## **Seafreight (container/bulk)**

JNCC (2002) states that *P. antipodarum* "was introduced in drinking water barrels in ships from Australia (Ponder 1988, in JNCC, 2002). The snails were probably liberated while washing or filling water barrels or tanks and, because they can survive in brackish water, they could probably survive liberation into estuarine areas such as the River Thames."

## **Local Dispersal Methods**

### **Hikers' Clothes/Boots**

The National Park Service (Undated) states that "the rapid spread of *P. antipodarum* throughout the Madison River watershed may have been assisted by human transport. Mud snails are able to withstand desiccation, a variety of temperature regimes, and are small enough that many types of water users (anglers, swimmers, picnickers, pets) could inadvertently be the mechanism for interbasin transfer of this nuisance species."

## **Management Information**

### **Preventative Measures**

Expanding US National Park Service efforts to increase public awareness of potential threats to existing aquatic communities may be one of the best tools for containing *P. antipodarum*.

### **Physical**

The National Park Service (Undated) states that "there are few effective treatments to completely eliminate *P. antipodarum*." The authors go on to state that "attempts at crushing or physical removal of the snails may only exacerbate the problem by spreading eggs to new sites."

### **Chemical**

Chemical treatment would not necessarily be selective for snails only and could eliminate remnant invertebrate populations.

### **Nutrition**

Richards *et al.* (2002) state that *P. antipodarum* is "classified as a scraper/grazer. It prefers diatoms, plant and animal detritus, and attached periphyton."

## Reproduction

Richards *et al.* (2002) states that *P. antipodarum* “ranges from 20-120 embryos per female.” The authors go on to state that young are born every three months in New Zealand (Winterbourn 1970, in Richards *et al.* 2002) but that they can bear young at any time of year in spring habitats in the Western United States (Richards unpublished data, in Richards *et al.* 2002), but overall they will bear young in the summer and autumn. Lively (Undated) reports that “most populations of this gastropod consist solely of triploid parthenogenetic females, but many populations also contain diploid, sexual females and males.”

## Lifecycle Stages

Richards *et al.* (2002) report that the lifespan of *P. antipodarum* has been observed at over a year in several marked individuals. Its growth rate depends on size. Richards *et al.* (2002) report that *P. antipodarum* “can grow 0.1 mm/day at 21 degrees C under laboratory conditions. The author also states that “in western USA *P. antipodarum* reaches sexual maturity at 3.0 mm.”

**Reviewed by:** Dr Sabine Schreiber, Arthur Rylah Institute for Environmental Research Department of Sustainability and Environment. Australia

**Principal sources:** [New Zealand Mudsail in the Western USA \(Richards \*et al.\*, 2002\)](#)

**Compiled by:** National Biological Information Infrastructure (NBII) and Invasive Species Specialist Group (ISSG)

**Last Modified:** Wednesday, 26 January 2005



# Zebra Mussel (*Dreissena Polymorpha*)



Benson, A. J. and D. Raikow. 2007. *Dreissena polymorpha*. USGS Nonindigenous Aquatic Species Database, Gainesville, FL. <http://nas.er.usgs.gov/queries/FactSheet.asp?speciesID=5> Revision Date: 1/10/2007

The following description is from Global Invasive Species database, 2005. *Dreissena polymorpha* Available from <http://www.issg.org/database/species/ecology.asp?si=50&fr=1&sts=sss> [accessed 08 February, 2007]

## Taxonomic Name

*Dreissena polymorpha* (Pallas, 1771)

## Synonyms

*Mytilus polymorpha* Pallas 1771

## Common Names

Moule zebra (French), racicznica zmienna (Poland), zebra mussel (English), Zebra-Muschel (German)

## Organism Type

Mollusk

Zebra mussels (*Dreissena polymorpha*) are native to the Caspian and Black Seas. They are now established in the UK, Western Europe, Canada and the USA. They compete with zooplankton for food, thus affecting natural food webs. They also interfere with the ecological functions of native mollusks and cause great economic damage.

## Description

Black or brown and white striped bivalve mollusk with byssal attachment to hard substrates. Maximum size approx. 3 cm long. Shell is highly carinate, having an angle between the ventral and dorsal surfaces. Color patterns highly polymorphic, from almost pure black to unpigmented, with a variety of striped forms.

Occurs in: estuaries, lakes, urban areas, water courses

## Habitat Description

Tolerates salinity to 6 ppt, temperatures to approx. 29 C, will not settle in currents greater than 2 m/sec.

## General Impacts

Zebra mussels filter organic and inorganic particles between 7 and 400 microns, competing with native planktivores for food. The net result is a sedimentation of previously suspended organic matter in the form of feces and pseudofeces, shifting energy and nutrient balances from the pelagic to the benthic zone. Increases in water clarity favor increased photosynthesis by rooted aquatic macrophytes, and negatively effect fish species that prefer slightly turbid conditions, such as walleye. Removal of green algae gives cyanobacteria a competitive advantage, as zebra mussels will stop filtering in the presence of cyanobacteria. Zebra mussels settle in high numbers on native mussels (Unionidaceae), causing suffocation, starvation, and energetic stress leading to death. Loss of native mussel populations has increased dramatically where zebra mussels are present, particularly in the Great Lakes and Hudson and Mississippi rivers. Dense colonization of hard substrates is beneficial to benthic invertebrates, as habitat complexity increases as does availability of organic matter. Spawning reefs of fishes such as lake trout are negatively affected by zebra mussel colonies.

Conroy *et al.* (2005) whilst discussing implications for Lake Erie ecosystem change state that: "Dreissenid mussels represent a dynamic link between the benthic and pelagic regions of a lake ecosystem (Ackerman *et al.* 2001)". (the

benthic zone is the lowest level of all aquatic biomes. It includes the sea floor and bottom-dwelling organisms, pelagic refers to living in the water of the ocean above the bottom) The authors observe that dreissenid mussels are both a sink and source of nutrients through consumption and excretion processes, respectively and thus have an impact on the nutrient regime of the Lake.

**Notes:** Tolerates salinity to 6 ppt, temperatures to approx. 29 C, will not settle in currents greater than 2 m/sec.

## **Geographical Range**

### **Native Range**

Native range includes the Black, Caspian, and Azov seas;

Known introduced range: Since the 1700's its range has expanded westward to most of western Europe, UK, and North America, where it is found in the Great Lakes and all of the major river drainages east of the Rocky Mountains. See the USGS Nonindigenous Aquatic Species Database at Web site:

[http://nas.er.usgs.gov/taxgroup/mollusks/zebramussel/maps/current\\_zm\\_quag\\_map.jpg](http://nas.er.usgs.gov/taxgroup/mollusks/zebramussel/maps/current_zm_quag_map.jpg)

## **Invasion Pathways to New Locations**

Floating vegetation/debris:

Pet/aquarium trade: Possibly via aquarium dumping.

Ship:

*Ship ballast water:* Introduced between continents and among Great Lakes in ballast water.

*Ship/boat hull fouling:* Introduced to smaller lakes by overland transport on boat hulls and trailers.

*Translocation of machinery/equipment:*

## **Local Dispersal Methods**

*Aquaculture (local):* Larvae may be transported during fish stocking.

*Boat:* Adults may attach to anchors and boat hulls and be transported.

*On animals:* Ducks could theoretically transport larvae in wet feathers.

*Other (local):* Larvae may be transported on scuba diver's wetsuits, or in scientific sampling equipment.

*Water currents:* Range expansion within North America has been very rapid due to downstream transport of planktonic larvae.

## Management Information

Numerous control methods are available to remove mussels from substrates or kill them within infested water intakes or on fouled man-made substrates; none of these methods is useful for control in the wild. Controls include mechanical removal (scraping, mechanical scrubbers in pipes), chemical (chlorine, bromine, deoxygenation), thermal, UV light, electric current, and antifouling paints (containing zinc or copper, or slick surfaces such as epoxy that make removal of mussels easier). Natural predators include diving ducks, crayfish, muskrats, and fishes with grinding teeth (carp, freshwater drum, pumpkinseed, round goby, bream, roach), eel, sturgeon, flounder.

## Nutrition

Filter a wide range of size particles, but select algae and zooplankton between 15-40 microns. Larval stages feed on bacteria.

## Reproduction

Zebra mussels are dioecious and fertilize externally; larvae are planktonic for several weeks before settling and attaching to substrate

Estimated at up to 1.5 million eggs per female per year; survival to adult stage may be less than 1%.

## Lifecycle Stages

Fertilized egg hatches into trocophore (40-60 microns, 1-2 days), several stages of free-swimming planktonic veliger lasting 8-180 days (or longer in cold water), then at 350 micron size the larvae settle as plantigrade mussels, attach to substrate as juveniles, and may mature within the first year of life under optimal conditions; maturity in the second year is more usual. Zebra mussels live 3-5 years.

This species has been nominated as among 100 of the "World's Worst" invaders.

**Reviewed by:** J. Ellen Marsden, School of Natural Resources, University of Vermont, Burlington, USA.

**Compiled by:** J. Ellen Marsden, School of Natural Resources, University of Vermont, Burlington, USA.

**Last Modified:** Wednesday, 22 June 2005

# Quagga Mussel (*Dreissena Rostiformis Bugensis*)

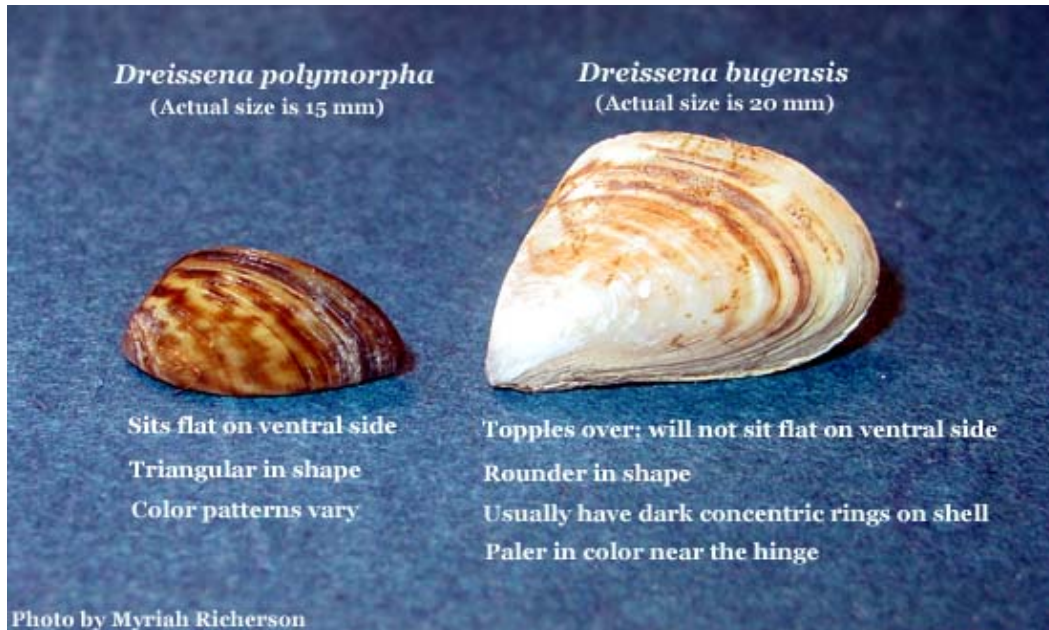

<http://nas.er.usgs.gov/queries/FactSheet.asp?speciesID=95>

The following description is from Global Invasive Species database, 2005.  
*Dreissena bugensis* Available from  
<http://www.issg.org/database/species/ecology.asp?si=918&fr=1&sts=sss>  
[accessed 07 November, 2007]

## Taxonomic Name

*Dreissena bugensis* Andrusov, 1987

## Common Names

Quagga mussel

## Organism Type

Mollusk

*Dreissena bugensis* is an introduced mussel native to the Ukraine. It was transported to the Great Lakes system through ballast water. It has since begun to replace *D. polymorpha* as the most dominant invasive *Dreissena* and is able to colonize at much deeper depths. This species is impacting zooplankton

abundance, biomass, and species composition causing decreases in native diversity and the extirpation of marine species. They have a major negative impact on recreational boating and commercial shipping as well as on raw water-using industries, potable water treatment plants, and electric power stations.

## Description

*D. bugensis* and *D. polymorpha* are very similar in appearance but can be differentiated morphologically by their shells. *D. bugensis* has a round carina, while *D. polymorpha* has a distinct carina between the ventral and dorsal surfaces. The ventral side of *D. bugensis* is convex, while the ventral side of the shell of zebra mussels is flattened. (This can sometimes be distinguished by placing shells on their ventral side: a zebra mussel will remain upright whereas *D. bugensis* will topple over). *D. bugensis* is in general more round in shape than *D. polymorpha* which is often described as having a triangular shape. *D. bugensis* has a small byssal groove on the ventral side near the hinge and *D. polymorpha* has a larger groove in the middle of the ventral side. Identification by color patterns on the shell is more difficult. Both species shells vary widely with black, cream, or white bands of dark concentric rings on the shell and some have been found that are pale or completely white. If *D. bugensis* is viewed from the front or from the ventral side, the valves are clearly asymmetrical; however, *D. polymorpha* shells are bilaterally symmetrical and join together in the midventral (Richardson 2002).

There are two phenotypes of *D. bugensis* that have now been reported in the Great Lakes: the “epilimnetic” form, which has a high flat shell, and the “profunda” form, which has an elongate modioliform shell and has invaded soft sediments in the hypolimnion. The epilimnetic form uses its byssal threads to attach to objects and particles and form druses or colonies. The profunda morph can form colonies and attach to objects with its byssal threads or it can partially bury itself in soft sediments and extend its very long incurrent siphon above itself to bring suspended food particles (Vanderloeg et al. 2002).

## Similar Species

*Dreissena rostriformis*

Occurs in: estuaries, lakes, water courses, wetlands

## Habitat Description

Adult *D. bugensis* attach to natural hard substrata such as rocks, wood, and macrophytic plants and to man-made structures constructed of concrete, metal piping, steel, nylon, fiberglass, and wood. Attachment is by a holdfast of

proteinaceous byssal threads produced from a gland just posterior to the foot. *D. bugensis* typically occur in fresh water but thrive in salinities up to 1‰ and can reproduce in salinities below 2-3‰. Saline intrusion exceeding 6‰ will cause mortality (Ussery and McMahon, 1995 and Wright *et al.* 1996).

## General Impacts

*D. bugensis* causes changes in the structural characteristics of zooplankton like total abundance, biomass, and species composition. The general trend is a decrease in these characteristics in areas that support massive populations of *Dreissena*. There is an inverse relationship between zooplankton abundance and biomass and density of *Dreissena* mussels, which exert pressure on zooplankton (Grigorovich and Shevtsova, 1995).

Individual's byssally attach to the shells of other mussels, forming encrusting mats many shells thick (10-30cm). When such thick encrustations of mussels form on man-made structures or within raw water systems, they negatively impact their operation and efficiency. This species can have major detrimental impacts on recreational boating and commercial shipping as well as on raw water-using industries, potable water treatment plants, and electric power stations (Ussery and McMahon, 1995). A study conducted by Ricciardi *et al.* (1995) revealed that, given temperate summer conditions, adult *D. bugensis* may survive overland transport (e.g. on small trailered boats) to any location within 3-5 days drive of infested water bodies.

**Notes:** In both North America and its original range in Europe, *D. bugensis* is slowly dominating *D. polymorpha* populations. Some industries even built their intake structures and piping at depths too low for *D. polymorpha* colonization; however, when *D. bugensis* were discovered at lower water depths these new structures became vulnerable to colonization (Mills *et al.* 1999: and Richerson and Maynard, 2004).

## Geographical Range

*Native range:* Ukraine: Dnieper-Bug estuary (Mills *et al.* 1996).

*Known introduced range:* North America: Great Lakes (Vanderploeg *et al.* 2002). See the USGS Nonindigenous Aquatic Species Database at Web site: [http://nas.er.usgs.gov/taxgroup/mollusks/zebramussel/maps/current\\_zm\\_quag\\_map.jpg](http://nas.er.usgs.gov/taxgroup/mollusks/zebramussel/maps/current_zm_quag_map.jpg)

## **Invasion Pathways to New Locations**

### **Ship Ballast Water**

Its release into Great Lakes waters is linked to discharge of ship ballast water (Mills *et al.* 1999).

### **Translocation of Machinery/Equipment**

A study conducted by Ricciardi *et al.* (1995) revealed that, given temperate summer conditions, adult *D. bugensis* may survive overland transport (e.g. on small trailered boats) to any location within 3-5 days drive of infested water bodies.

## **Management Information**

Richerson and Maynard (2004) state that, “A chemical toxicant for lake-wide control of *Dreissena* has not been developed mainly because it would be deadly to other aquatic life forms. Prechlorination has been the most common treatment for control, and it has found that *D. bugensis* is more sensitive to chlorination than *D. polymorpha*. This means that chlorination programs currently in use to combat *D. polymorpha* are more than sufficient to simultaneously control *D. bugensis*. Another alternative has been potassium permanganate, especially for drinking water sources, even though chemical controls are not the most environmentally sound solution.” The authors list a variety of other chemical controls uses or being developed: oxygen deprivation, thermal treatment, exposure and dessication, radiation, manual scraping, high-pressure jetting, mechanical filtration, removable substances, molluscicides, ozone, antifouling coatings, electric currents, and sonic vibration.

Decreasing water levels and allowing the desiccation of *D. bugensis* is an effective, readily applied, and environmentally neutral techniques used against invasive mussels. It would be effective in raw water systems such as navigation locks and water intake structures, which are designed to be periodically dewatered for maintenance. This is a particularly attractive method of control because it could be utilized to mitigate fouling not just by *D. bugensis* but also mixed populations of this species and *D. polymorpha* (Brady *et al.* 1996; and Ussery and McMahan, 1995).

Fears and Mackie (1995) investigated the use of low-voltage A-C currents for preventing settlement and attachment by *D. bugensis* by using steel rods and plates with the current running through them placed near the intake of a pulp and paper plant. The results of this study showed that complete prevention of settlement of both new recruits and translocators at 8 volts/in with steel rods on both wood and concrete surfaces and with steel plate trash bars could be achieved,





and that partial prevention of settlement at 6 volts/in with steel rods on both wood and concrete surfaces and steel plates (Fears and Mackie, 1995).

## **Nutrition**

*D. bugensis* are filter feeders; they use their cilia to pull water into their shell cavity where it passes through an incurrent siphon and it is here that desirable particulate matter is removed. Each adult mussel is capable of filtering one or more liters of water each day, where they remove phytoplankton, zooplankton, algae, and even their own veligers (Snyder *et al.* 1997). Any undesirable particulate matter is bound with mucus, known as psuedofeces, and ejected out the incurrent siphon. The particle-free water is then discharged out the excurrent siphon (Richerson, 2002).

## **Reproduction**

*D. bugensis* is a prolific breeder. This species is dioecious and exhibit external fertilization. A fully mature female mussel is capable of producing up to one million eggs preseason. After fertilization, pelagic microscopic larvae, or veligers, develop within a few days and these veligers soon acquire minute bivalve shells. Free-swimming veligers drift with the currents for three to four weeks feeding by their hair-like cilia while trying to locate suitable substrata to settle and secure byssal threads. Mortality in this transitional stage from planktonic veliger to settled juveniles may exceed 99% (Richerson, 2002).

**Reviewed by:** Gerald L. Mackie, Professor, Department of Zoology, University of Guelph, Guelph, Ontario Canada

**Principal sources:** Ussery and McMahon, 1995. Comparative study of the desiccation resistance of zebra mussels (*Dreissena polymorpha*) and (*D. bugensis*) and Richerson, 2002. DREISSENA Species FAQs, A closer look.

**Compiled by:** National Biological Information Infrastructure (NBII) and Invasive Species Specialist Group (ISSG)

**Last Modified:** Monday, 27 February 2006