

Consideration of Advances in Synthetic Biology in Relation to the NSABB Report "Addressing Biosecurity Concerns Related to Synthetic Biology"

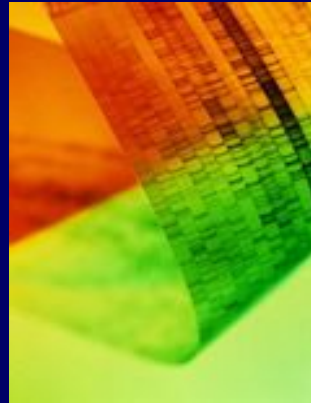

David A. Relman, Stanford University
October 19, 2010

Consideration of Advances in Synthetic Biology in Relation to the NSABB Report "Addressing Biosecurity Concerns Related to Synthetic Biology"

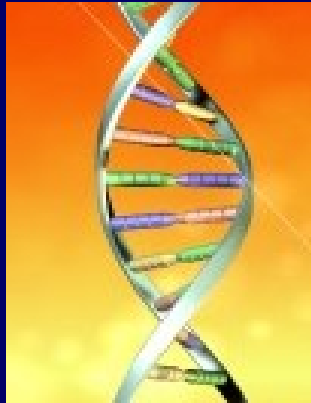
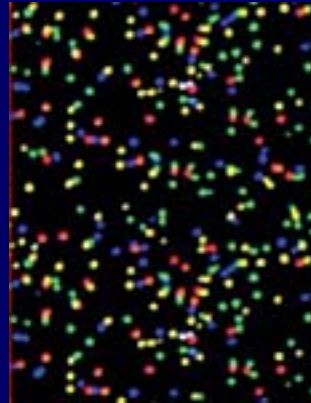
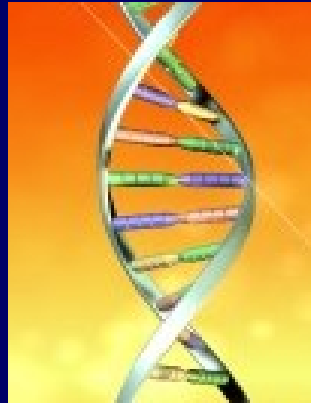

David A. Relman, Stanford University
October 19, 2010

Synthetic Genomics Working Group Charge

Phase 1: Examine the potential biosecurity concerns raised by synthesis of Select Agents

(see Report of December 2006)

- Assess the adequacy of the current regulatory and oversight framework
- Recommend potential strategies to address any biosecurity concerns

Phase 2: Identify, assess, and recommend strategies to address potential dual use concerns that may arise from work being performed in the field of synthetic biology
(see Report of April 2010)

NATIONAL
SCIENCE
ADVISORY
BOARD FOR
BIOSECURITY

ADDRESSING BIOSECURITY CONCERNS
RELATED TO THE SYNTHESIS OF
SELECT AGENTS

DECEMBER 2006



NSABB recommended:

- Development and dissemination of harmonized guidance
- Development of standards & practices for sequence providers to include nucleic acid screening
- A review of current biosafety guidelines to ensure that they are adequate for synthetically derived DNA
- Consultation with experts to develop a predictive framework for determining pathogenicity

**NATIONAL
SCIENCE
ADVISORY
BOARD FOR
BIOSECURITY**

**ADDRESSING BIOSECURITY CONCERNS RELATED
TO SYNTHETIC BIOLOGY**

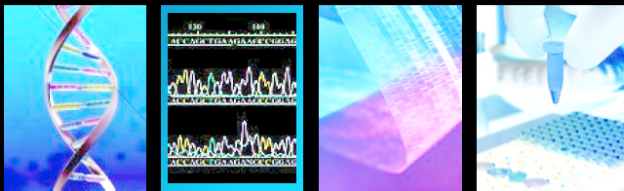

**Report of the National Science Advisory Board for
Biosecurity (NSABB)**

April 2010

NSABB recommended:

- NSABB oversight paradigm should adequately address dual use research issues associated with synthetic biology*
- Oversight should extend beyond the boundaries of life sciences and academia
- Outreach and education strategies should engage the diverse research communities
- USG should include advances in synthetic biology in "tech-watch" endeavors

* Proposed framework for the oversight of dual use life sciences research: strategies for minimizing the potential misuse of research information, NSABB 2007

Recommendation 1

Oversight: Framework

- Synthetic biology should be subject to institutional review and oversight since some aspects of this field pose biosecurity risks.
 - ...To the extent that synthetic biology may present biosecurity or dual use research concerns, the NSABB has proposed an oversight paradigm that should adequately address such issues..

October 2010:

Does this recommendation still apply?

Relevant advances in science and technology...

Isoprenoid Pathway Optimization for Taxol Precursor Overproduction in *Escherichia coli*

Parayil Kumaran Ajikumar,^{1,2} Wen-Hai Xiao,¹ Keith E. J. Tyo,¹ Yong Wang,³ Fritz Simeon,¹ Effendi Leonard,¹ Oliver Mucha,¹ Too Heng Phon,² Blaine Pfeifer,^{3*} Gregory Stephanopoulos^{1,2*}

Taxol (paclitaxel) is a potent anticancer drug first isolated from the *Taxus brevifolia* Pacific yew tree. Currently, cost-efficient production of Taxol and its analogs remains limited. Here, we report a multivariate-modular approach to metabolic-pathway engineering that succeeded in increasing titers of taxadiene—the first committed Taxol intermediate—approximately 1 gram per liter (~15,000-fold) in an engineered *Escherichia coli* strain. Our approach partitioned the taxadiene metabolic pathway into two modules: a native upstream methylerythritol-phosphate (MEP) pathway forming isopentenyl pyrophosphate and a heterologous downstream terpenoid-forming pathway. Systematic multivariate search identified conditions that optimally balance the two pathway modules so as to maximize the taxadiene production with minimal accumulation of indole, which is an inhibitory compound found here. We also engineered the next step in Taxol biosynthesis, a P450-mediated 5 α -oxidation of taxadiene to taxadien-5 α -ol. More broadly, the modular pathway engineering approach helped to unlock the potential of the MEP pathway for the engineered production of terpenoid natural products.

Isoprenoid Pathway Optimization for Taxol Precursor Overproduction in *Escherichia coli*

Parayil Kumaran Ajikumar,^{1,2} Wen-Hai Xiao,¹ Keith E. J. Tyo,¹ Yong Wang,³ Fritz Simeon,¹ Effendi Leonard,¹ Oliver Mucha,¹ Too Heng Phon,² Blaine Pfeifer,^{3*} Gregory Stephanopoulos^{1,2*}

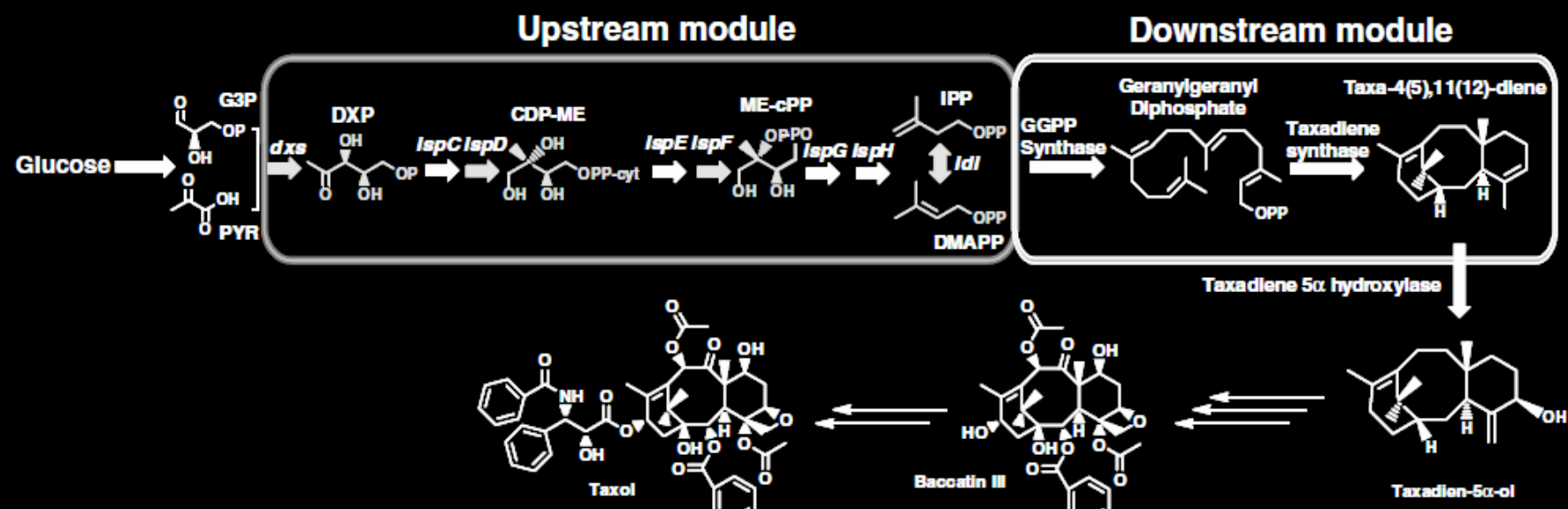

J | A | C | S A R T I C L E S

Published on Web 04/20/2009

Synthesis of Methyl Halides from Biomass Using Engineered Microbes

Travis S. Bayer,[†] Daniel M. Widmaier,^{†,‡} Karsten Temme,^{†,§} Ethan A. Mirsky,^{†,||}
Daniel V. Santi,[†] and Christopher A. Voigt^{*,†,‡,§,||}

*Department of Pharmaceutical Chemistry, Chemistry and Chemical Biology Program, UCSF/
UCB Joint Graduate Group in Bioengineering, and Biophysics Program, University of
California, San Francisco, MC 2540, Room 408C, 1700 4th Street,
San Francisco, California 94158-2330*

Received December 11, 2008; E-mail: cavoigt@picasso.ucsf.edu

Abstract: Methyl halides are used as agricultural fumigants and are precursor molecules that can be catalytically converted to chemicals and fuels. Plants and microorganisms naturally produce methyl halides, but these organisms produce very low yields or are not amenable to industrial production. A single methyl halide transferase (MHT) enzyme transfers the methyl group from the ubiquitous metabolite S-adenoyl methionine (SAM) to a halide ion. Using a synthetic metagenomic approach, we chemically synthesized all 89 putative MHT genes from plants, fungi, bacteria, and unidentified organisms present in the NCBI sequence database. The set was screened in *Escherichia coli* to identify the rates of CH₃Cl, CH₃Br, and CH₃I production, with 56% of the library active on chloride, 85% on bromide, and 69% on iodide. Expression of the highest activity MHT and subsequent engineering in *Saccharomyces cerevisiae* results in productivity of 190 mg/L-h from glucose and sucrose. Using a symbiotic co-culture of the engineered yeast and the cellulolytic bacterium *Actinotalea fermentans*, we are able to achieve methyl halide production from unprocessed switchgrass (*Panicum virgatum*), corn stover, sugar cane bagasse, and poplar (*Populus* sp.). These results demonstrate the potential of producing methyl halides from non-food agricultural resources.

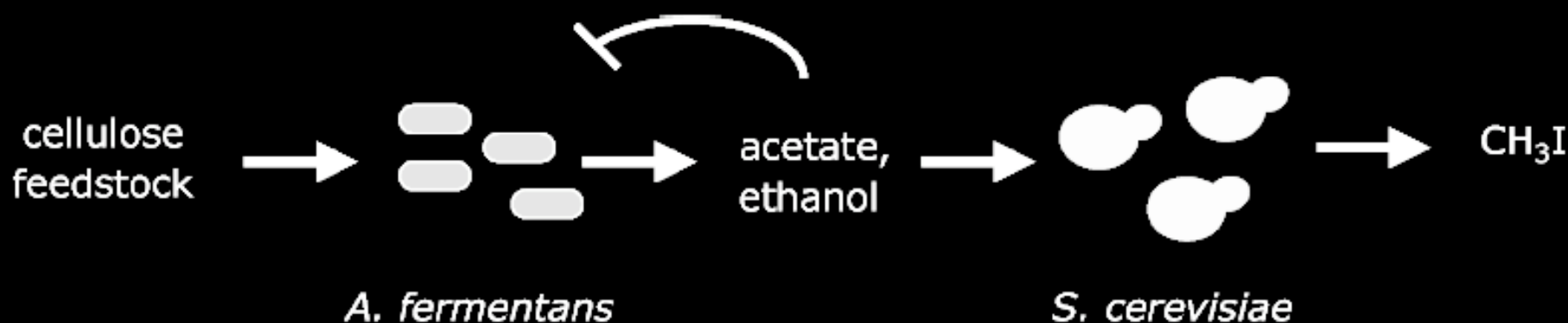

Tracking, tuning, and terminating microbial physiology using synthetic riboregulators

Jarred M. Callura^{a,b,c,1}, Daniel J. Dwyer^{a,b,c,1}, Farren J. Isaacs^d, Charles R. Cantor^{b,2}, and James J. Collins^{a,b,c,e,2}

^aHoward Hughes Medical Institute, ^bDepartment of Biomedical Engineering and Center for Advanced Biotechnology, Boston University, Boston, MA 02215; ^cCenter for BioDynamics, Boston University, Boston, MA 02215; ^dDepartment of Genetics, Harvard Medical School, Boston, MA 02215; and ^eWyss Institute for Biologically Inspired Engineering, Harvard University, Boston, MA 02215

15898–15903 | PNAS | September 7, 2010 | vol. 107 | no. 36

Automated design of synthetic ribosome binding sites to control protein expression

Howard M Salis¹, Ethan A Mirsky² & Christopher A Voigt¹

VOLUME 27 NUMBER 10 OCTOBER 2009 NATURE BIOTECHNOLOGY

A Synthetic Genetic Edge Detection Program

Jeffrey J. Tabor,¹ Howard M. Salis,¹ Zachary Booth Simpson,^{2,3} Aaron A. Chevalier,^{2,3} Anselm Levskaya,¹ Edward M. Marcotte,^{2,3,4} Christopher A. Voigt,^{1,*} and Andrew D. Ellington^{2,3,4}

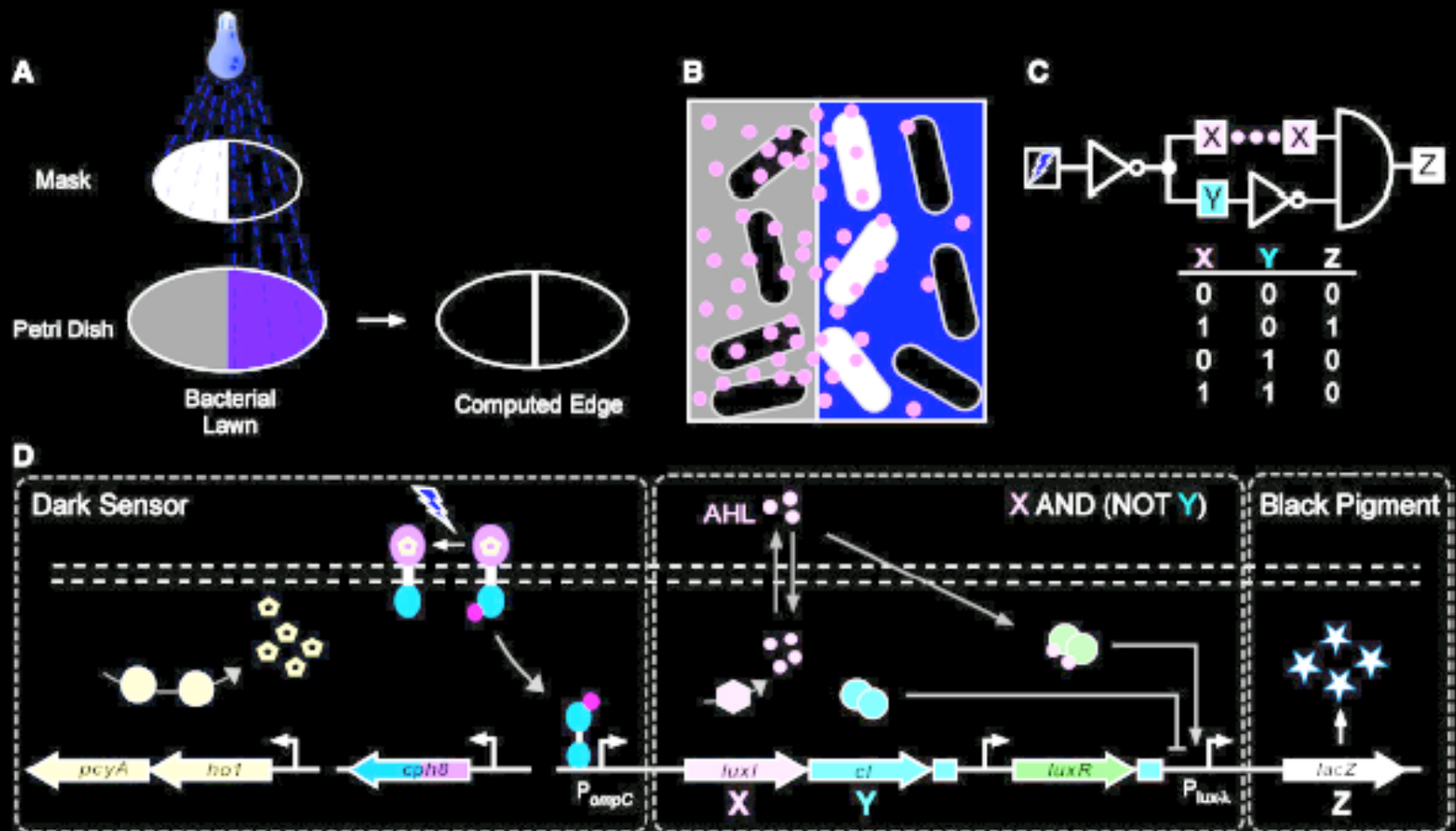

A Synthetic Genetic Edge Detection Program

Jeffrey J. Tabor,¹ Howard M. Salis,¹ Zachary Booth Simpson,^{2,3} Aaron A. Chevalier,^{2,3} Anselm Levskaya,¹ Edward M. Marcotte,^{2,3,4} Christopher A. Voigt,^{1,*} and Andrew D. Ellington^{2,3,4}

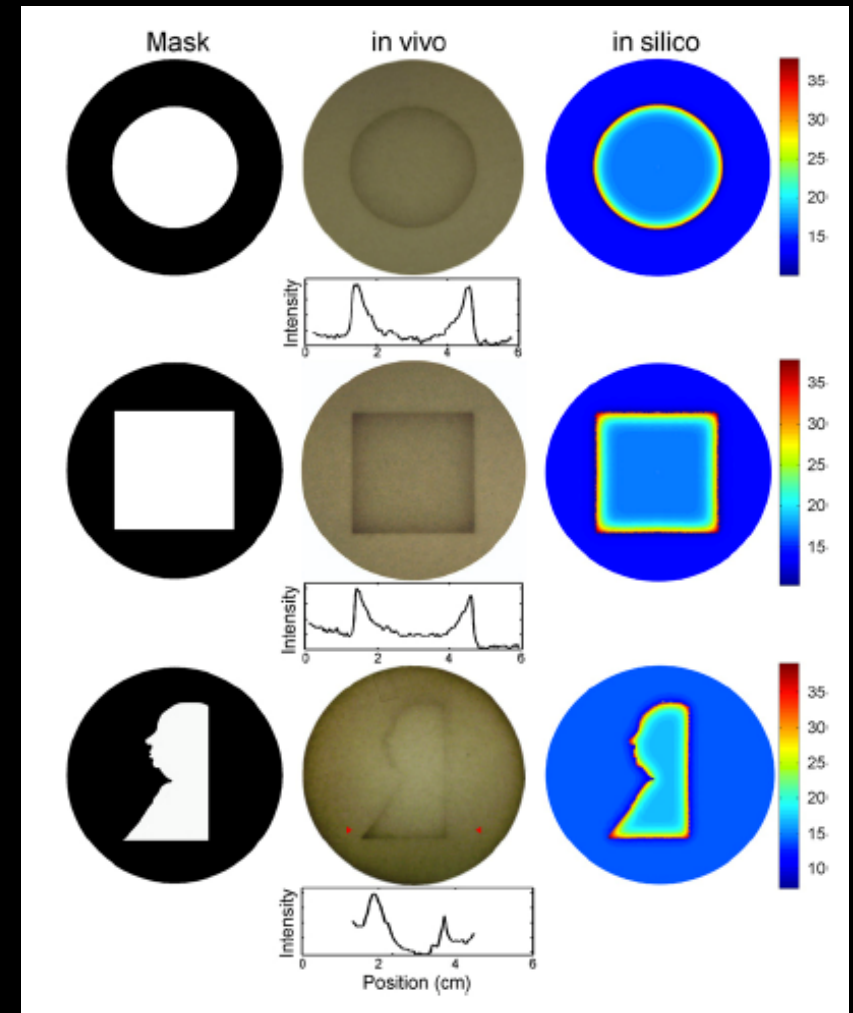
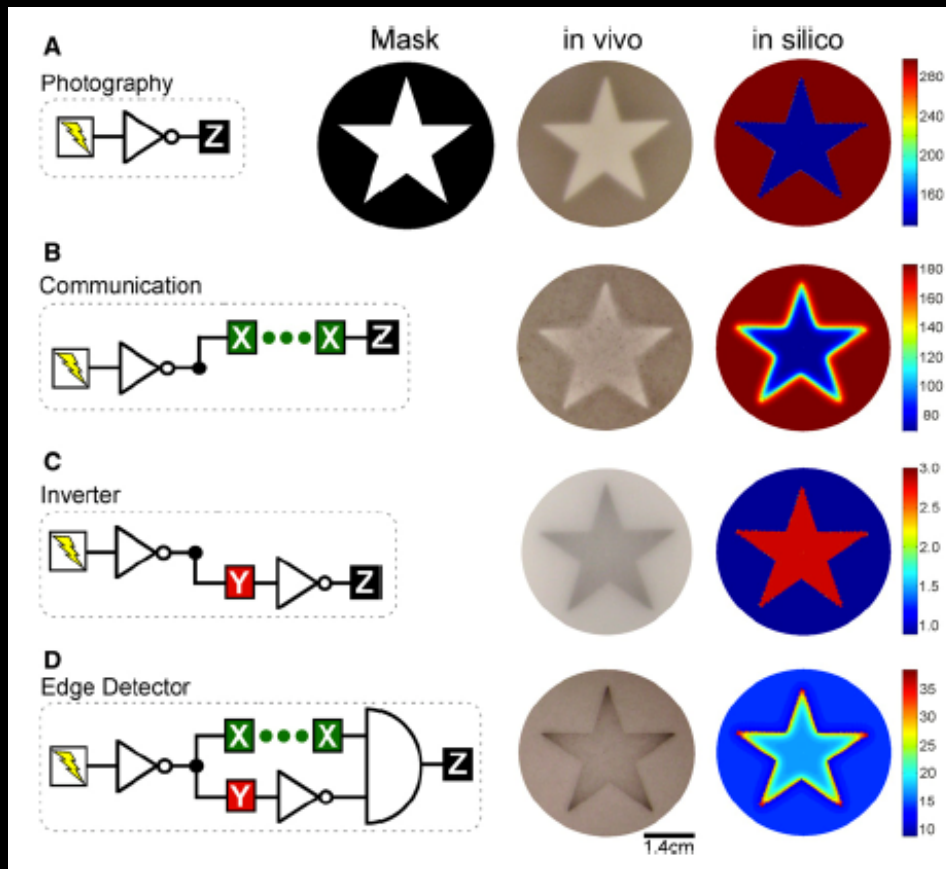

Chemical synthesis of the mouse mitochondrial genome

Daniel G Gibson¹, Hamilton O Smith²,
Clyde A Hutchison III², J Craig Venter^{1,2} &
Chuck Merryman¹

We describe a one-step, isothermal assembly method for synthesizing DNA molecules from overlapping oligonucleotides. The method cycles between *in vitro* recombination and amplification until the desired length is reached. As a demonstration of its simplicity and robustness, we synthesized the entire 16.3-kilobase mouse mitochondrial genome from 600 overlapping 60-mers.

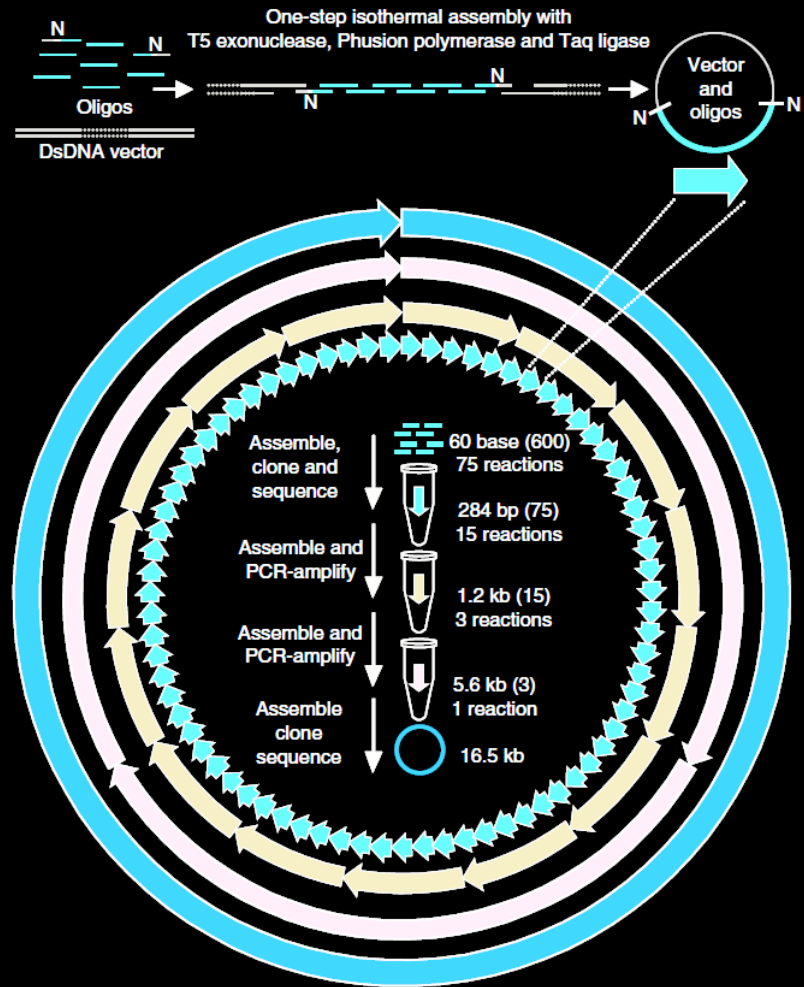

Applications

- Disease mechanism
 - Synthetically reconstructing natural biological systems to explore how pathological behaviors may emerge
- Drug, chemical production
 - Engineering organisms to produce drugs or industrially valuable chemicals
- Biosensing
 - Designing plants to monitor hazardous substances in the environment

Recent advances in science and technology: summary

- Growing number of genetic circuits and modules; small number that are robust and that have predictable behavior
- Growing number of successful applications, but ~all based on re-engineered naturally-occurring organisms (more "top-down" than "bottom-up")
- Novel scenarios: e.g., combinations of synergistic engineered cells
- Capabilities in DNA construction have far outpaced capabilities in design

Creation of a Bacterial Cell Controlled by a Chemically Synthesized Genome

Daniel G. Gibson,¹ John I. Glass,¹ Carole Lartigue,¹ Vladimir N. Noskov,¹ Ray-Yuan Chuang,¹ Mikkel A. Algire,¹ Gwynedd A. Benders,² Michael G. Montague,¹ Li Ma,¹ Monzia M. Moodie,¹ Chuck Merryman,¹ Sanjay Vashee,¹ Radha Krishnakumar,¹ Nacyra Assad-Garcia,¹ Cynthia Andrews-Pfannkoch,¹ Evgeniya A. Denisova,¹ Lei Young,¹ Zhi-Qing Qi,¹ Thomas H. Segall-Shapiro,¹ Christopher H. Calvey,¹ Prashanth P. Parmar,¹ Clyde A. Hutchison III,² Hamilton O. Smith,² J. Craig Venter^{1,2*}

We report the design, synthesis, and assembly of the 1.08–mega–base pair *Mycoplasma mycoides* JCVI-syn1.0 genome starting from digitized genome sequence information and its transplantation into a *M. capricolum* recipient cell to create new *M. mycoides* cells that are controlled only by the synthetic chromosome. The only DNA in the cells is the designed synthetic DNA sequence, including “watermark” sequences and other designed gene deletions and polymorphisms, and mutations acquired during the building process. The new cells have expected phenotypic properties and are capable of continuous self-replication.

Genome of a Bacterial Cell Controlled by a Chemically Synthesized Genome

Daniel G. Gibson,¹ John I. Glass,¹ Carole Lartigue,¹ Vladimir N. Noskov,¹ Ray-Yuan Chuang,¹ Mikkel A. Algire,¹ Gwynedd A. Benders,² Michael G. Montague,¹ Li Ma,¹ Monzia M. Moodie,¹ Chuck Merryman,¹ Sanjay Vashee,¹ Radha Krishnakumar,¹ Nacyra Assad-Garcia,¹ Cynthia Andrews-Pfannkoch,¹ Evgeniya A. Denisova,¹ Lei Young,¹ Zhi-Qing Qi,¹ Thomas H. Segall-Shapiro,¹ Christopher H. Calvey,¹ Prashanth P. Parmar,¹ Clyde A. Hutchison III,² Hamilton O. Smith,² J. Craig Venter^{1,2*}

We report the design, synthesis, and assembly of the 1.08–mega–base pair *Mycoplasma mycoides* JCVI-syn1.0 genome starting from digitized genome sequence information and its transplantation into a *M. capricolum* recipient cell to create new *M. mycoides* cells that are controlled only by the synthetic chromosome. The only DNA in the cells is the designed synthetic DNA sequence, including “watermark” sequences and other designed gene deletions and polymorphisms, and mutations acquired during the building process. The new cells have expected phenotypic properties and are capable of continuous self-replication.

Creation of a Bacterial Cell Controlled by a Chemically Synthesized Genome

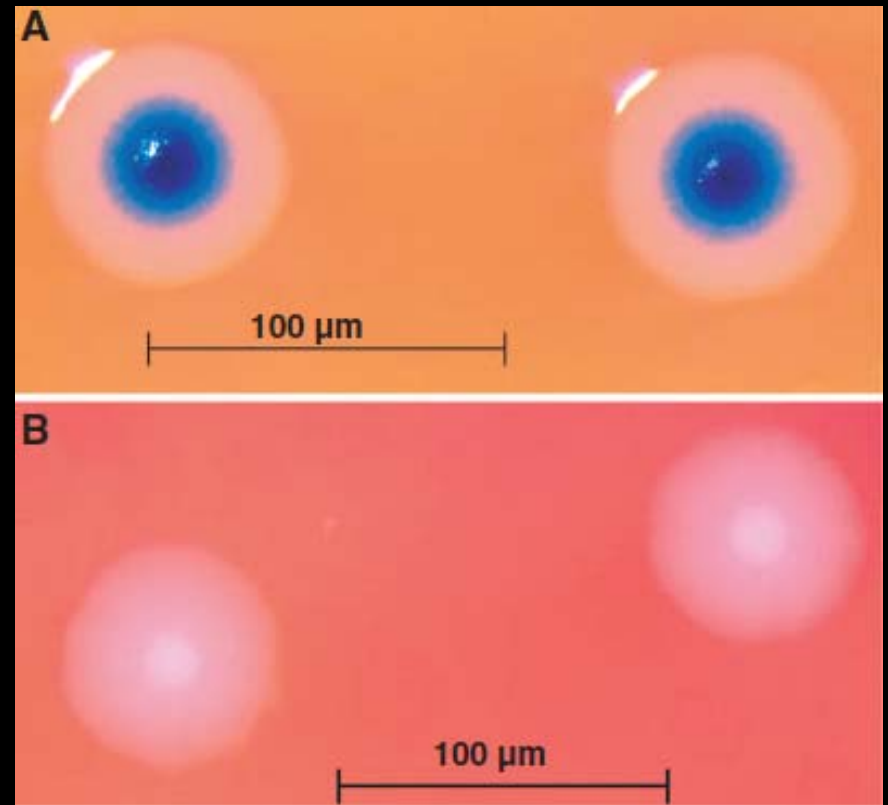
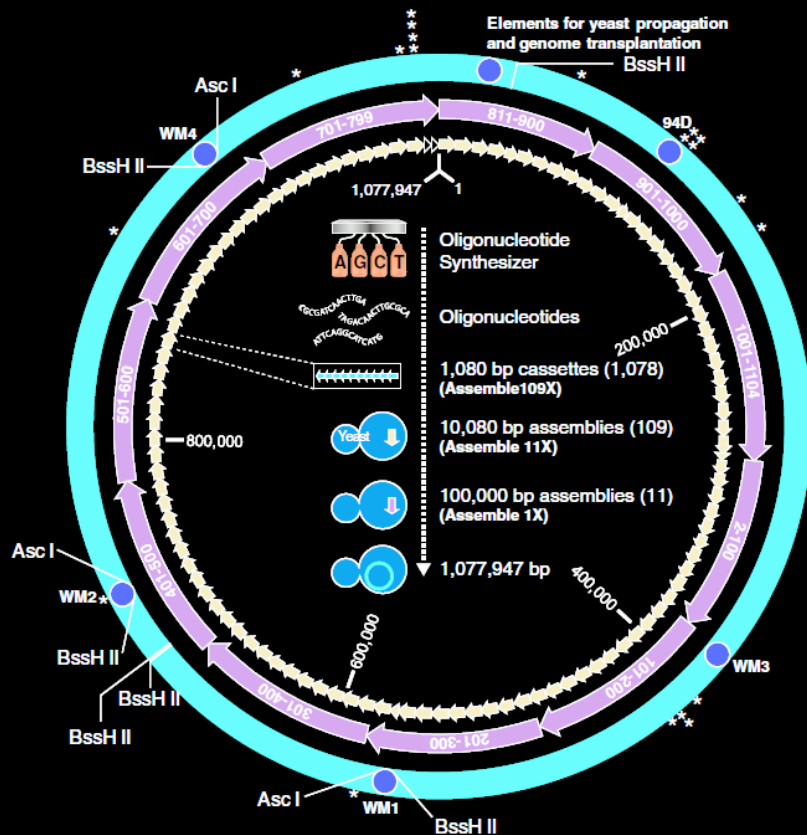

Creating Bacterial Strains from Genomes That Have Been Cloned and Engineered in Yeast

Carole Lartigue,¹ Sanjay Vashee,^{1†} Mikkel A. Algire,¹ Ray-Yuan Chuang,¹ Gwynedd A. Benders,² Li Ma,¹ Vladimir N. Noskov,¹ Evgeniya A. Denisova,¹ Daniel G. Gibson,¹ Nacyra Assad-Garcia,¹ Nina Alperovich,¹ David W. Thomas,^{1*} Chuck Merryman,¹ Clyde A. Hutchison III,² Hamilton O. Smith,² J. Craig Venter,^{1,2} John I. Glass¹

We recently reported the chemical synthesis, assembly, and cloning of a bacterial genome in yeast. To produce a synthetic cell, the genome must be transferred from yeast to a receptive cytoplasm. Here we describe methods to accomplish this. We cloned a *Mycoplasma mycoides* genome as a yeast centromeric plasmid and then transplanted it into *Mycoplasma capricolum* to produce a viable *M. mycoides* cell. While in yeast, the genome was altered by using yeast genetic systems and then transplanted to produce a new strain of *M. mycoides*. These methods allow the construction of strains that could not be produced with genetic tools available for this bacterium.

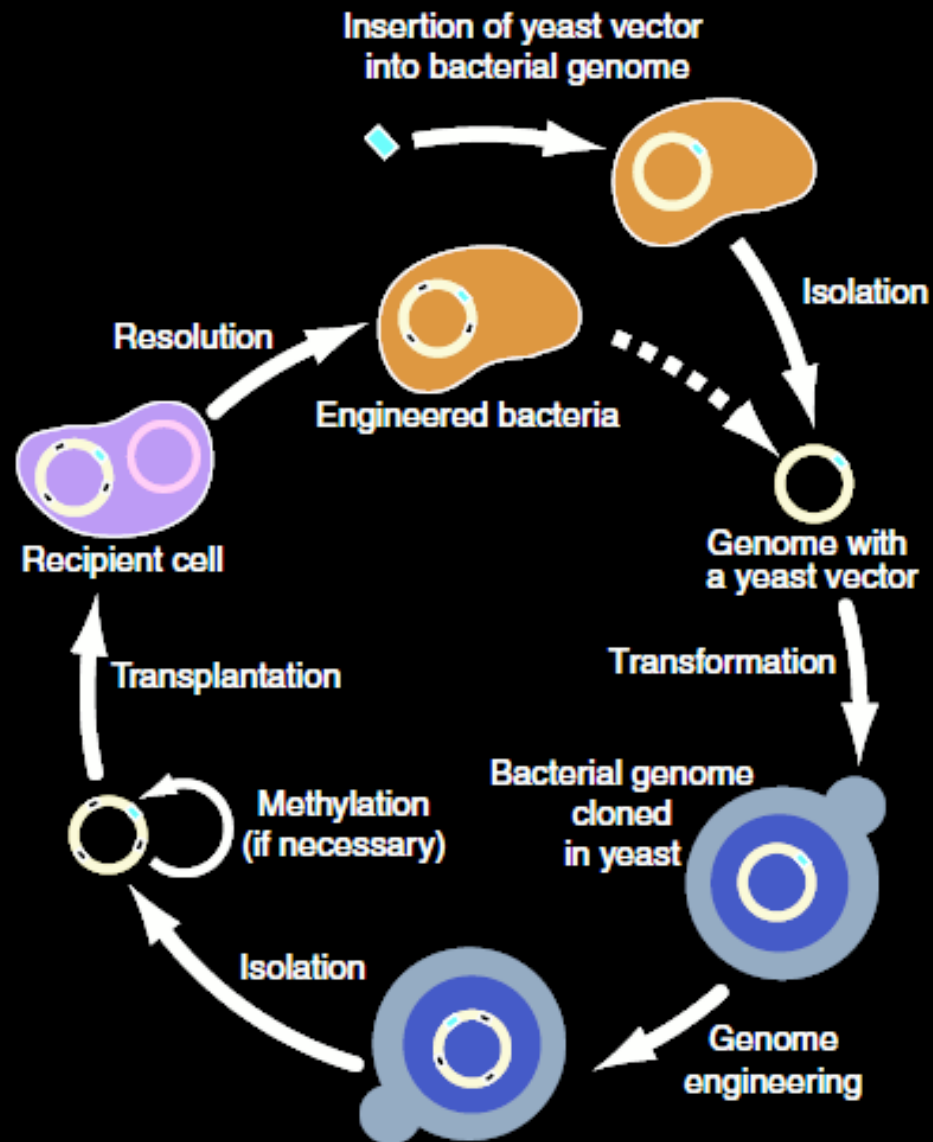

Gibson et al: Observations

- Synthetic bacterial genome,
reverse-engineered
- Transplanted into pre-existing cell
- Mycoplasma (cell wall-deficient)

- Incremental (predicted) advance?
- Limited (direct) applicability?
 - Cell type?
 - Design issue

“Dual Use Research of Concern”

Research that, based on current understanding, can be reasonably anticipated to provide knowledge, products, or technologies that could be **directly misapplied** by others to pose a threat to public health and safety, agricultural crops and other plants, animals, the environment, or materiel

What is "synthetic biology" (in practical terms)?

- Re-synthesis
- \pm Modification ("Genetic engineering")
- Novel design ("Bottom-up")

Where are the risks ?

What is "synthetic biology" (in practical terms)?

Re-synthesis

± Modification ("Genetic engineering")

- Novel design ("Bottom-up")

Where are the risks ?

Now...

What is "synthetic biology" (in practical terms)?

Re-synthesis

± Modification ("Genetic engineering")

Novel design ("Bottom-up")

Where are the risks ?

Later...

Programming cells: towards an automated 'Genetic Compiler'

Kevin Clancy¹ and Christopher A Voigt²

One of the visions of synthetic biology is to be able to program cells using a language that is similar to that used to program computers or robotics. For large genetic programs, keeping track of the DNA on the level of nucleotides becomes tedious and error prone, requiring a new generation of computer-aided design (CAD) software. To push the size of projects, it is important to abstract the designer from the process of part selection and optimization. The vision is to specify genetic programs in a higher-level language, which a genetic compiler could automatically convert into a DNA sequence. Steps towards this goal include: defining the semantics of the higher-level language, algorithms to select and assemble parts, and biophysical methods to link DNA sequence to function. These will be coupled to graphic design interfaces and simulation packages to aid in the prediction of program dynamics, optimize genes, and scan projects for errors.

Programming cells: towards an automated 'Genetic Compiler'

Kevin Clancy¹ and Christopher A Voigt²

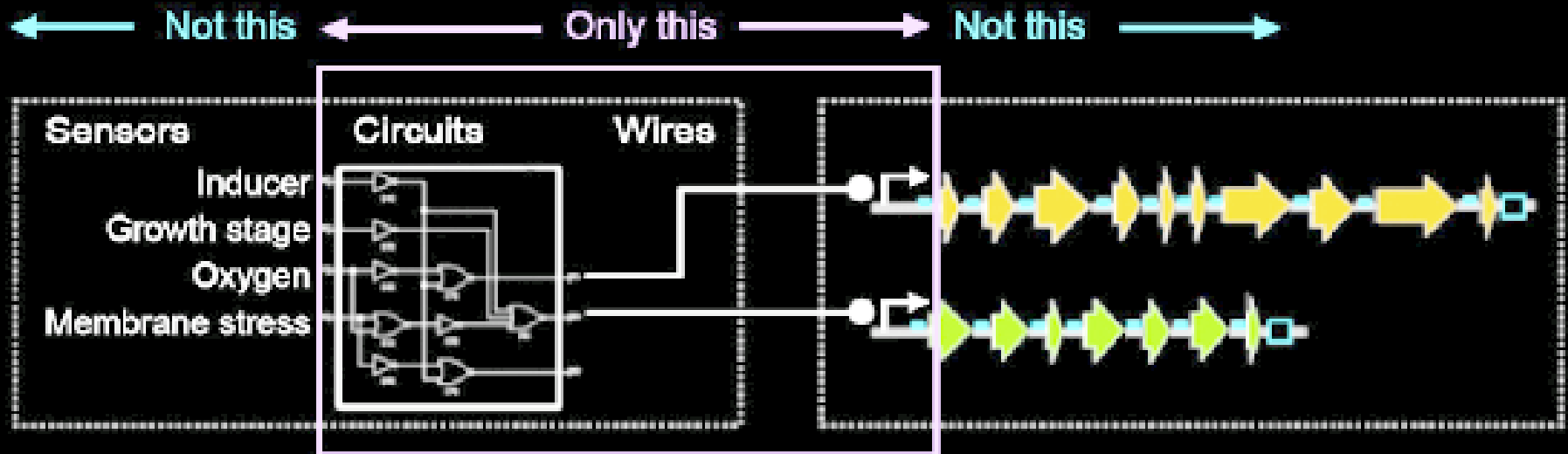

85. Ellis T, Wang X, Collins JJ: **Diversity-based, model-guided**
●● **construction of synthetic gene networks with predicted**
functions. *Nat Biotechnol* 2009, 27:465-471.

A parameterized set of parts was used to construct a large library of feedforward and toggle switch circuits that implement logic and time delay functions. Mathematical models of the combinations of parts accurately predicted the circuit dynamics.

A Bacterial Cell Controlled by a Chemically Synthesized Genome

Daniel G. Gibson,¹ John I. Glass,¹ Carole Lartigue,¹ Vladimir N. Noskov,¹ Ray-Yuan Chuang,¹ Mikkel A. Algire,¹ Gwynedd A. Benders,² Michael G. Montague,¹ Li Ma,¹ Monzia M. Moodie,¹ Chuck Merryman,¹ Sanjay Vashee,¹ Radha Krishnakumar,¹ Nacyra Assad-Garcia,¹ Cynthia Andrews-Pfannkoch,¹ Evgeniya A. Denisova,¹ Lei Young,¹ Zhi-Qing Qi,¹ Thomas H. Segall-Shapiro,¹ Christopher H. Calvey,¹ Prashanth P. Parmar,¹ Clyde A. Hutchison III,² Hamilton O. Smith,² J. Craig Venter^{1,2*}

We report the design, synthesis, and assembly of the 1.08–mega–base pair *Mycoplasma mycoides* JCVI-syn1.0 genome starting from digitized genome sequence information and its transplantation into a *M. capricolum* recipient cell to create new *M. mycoides* cells that are controlled only by the synthetic chromosome. The only DNA in the cells is the designed synthetic DNA sequence, including “watermark” sequences and other designed gene deletions and polymorphisms, and mutations acquired during the building process. The new cells have expected phenotypic properties and are capable of continuous self-replication.