

# **Reserve Components of the Armed Forces**



## **Reserve Component Categories**

**Office of the  
Assistant Secretary of Defense  
for  
Reserve Affairs**

**Reserve Component Categories  
of the**

**Reserve Components of  
the Armed Forces**

**Office of the Assistant Secretary of Defense  
Reserve Affairs  
1500 Defense Pentagon  
Washington, DC 20301-1500  
*(703) 693-7490***

(Rev. September 2005)

# CONTENTS

	<b>Page</b>
Introduction	1
Reserve Component Categories	2
Ready Reserve	3
Selected Reserve	4
Selected Reserve Units	5
Individual Mobilization Augmentees	6
Active Guard / Reserve	7
Full Time Support	8
Individual Ready Reserve/ Inactive National Guard	9
Individual Ready Reserve	9
Inactive National Guard	11
Standby Reserve	11
Retired Reserve	13
Retired Regulars	16
Definitions	23

## **FIGURES AND TABLE**

<b>Figure</b>	<b>Page</b>
1. Total Reserve Manpower	2
2. Ready Reserve	3
3. Selected Reserve	5
4. Individual Ready Reserve	10
5. Standby Reserve	12
6. Retired Reserve	15
7. Retired Reserve	16
8. Regular Retired List	17
9. Total Reserve Manpower	18

### **Table**

1. Authorized Reserve, Training and Retirement Categories	19
--	----

## **INTRODUCTION**

The structure and relationships of the various Reserve components (RCs), reserve categories and their mobilization responsibilities are complex. This pamphlet is intended to simplify the understanding of reserve categories and responsibilities of Reservists.

DoD Directive 1215.6, “Uniform Reserve, Training and Retirement Categories” and DoD Instruction 1215.19, “Uniform Reserve, Training and Retirement Category Administration,” provide official DoD policies and outline laws pertaining to management of members of the Reserve components of the Armed Forces. These documents establish DoD policy guidance for maintaining and reporting personnel data, designate uniform Reserve Component Categories (RCCs) and Training and Retirement Categories (TRCs), establish minimum training criteria for each category of the Reserve components, and provide uniform planning policies and procedures for training these members.

## Reserve Component Categories - Definitions

The Reserve components of the Armed Forces are: The Army National Guard of the United States, The Army Reserve, The Navy Reserve, The Marine Corps Reserve, The Air National Guard of the United States, The Air Force Reserve, and The Coast Guard Reserve (10 U.S.C 10101).

All Reserve and Guard manpower is assigned to one of three Reserve component categories – the Ready Reserve, the Standby Reserve and the Retired Reserve (10 U.S.C. 10141(a)). (All National Guard members, including those in the Inactive National Guard (ING), are in the Ready Reserve.) (See Figure 1.)

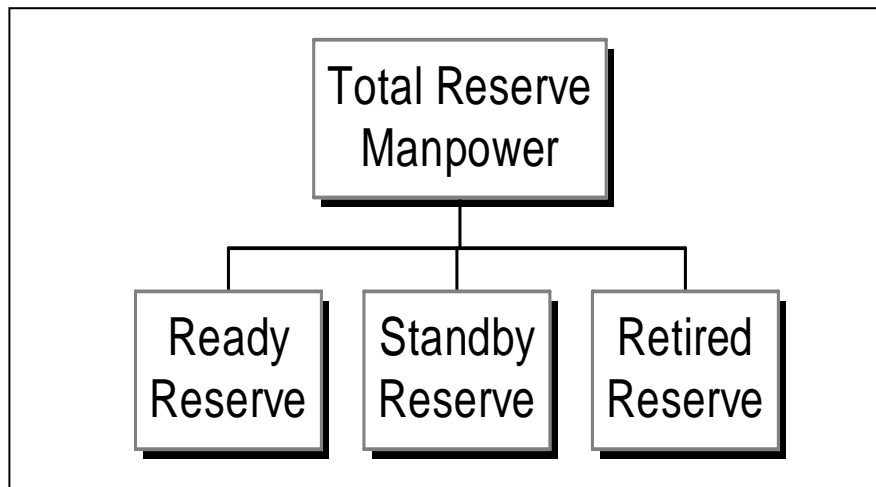

Figure 1

# I Ready Reserve

The Ready Reserve is comprised of military members of the Reserve and National Guard, organized in units, or as individuals, liable for recall to active duty to augment the active components in time of war or national emergency (10 U.S.C. 12301(a), 12302). The Ready Reserve consists of three Reserve component subcategories: the Selected Reserve, the Individual Ready Reserve (IRR), and the Inactive National Guard (ING). (See Figure 2.)

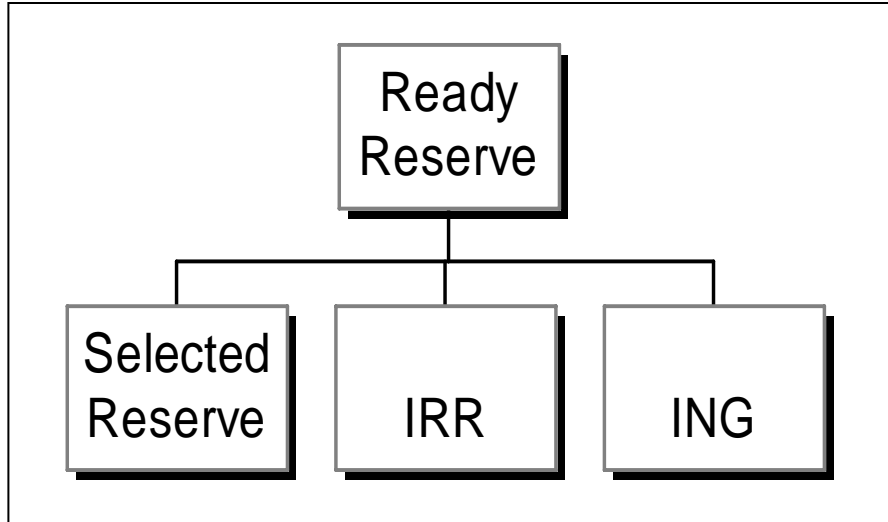

Figure 2

## **A. Selected Reserve (10 U.S.C. 10143)**

The Selected Reserve consists of those units and individuals within the Ready Reserve designated by their respective Services and approved by the Chairman, Joint Chiefs of Staff, as so essential to initial wartime missions that they have priority over all other Reserves. All Selected Reservists are in an active status.

The President may order up to 200,000 of the Selected Reserve to active duty involuntarily for any operational mission for not more than 270 days without declaring a national emergency (10 U.S.C 12304). The emergency nature of a mobilization may require a rapid capability to assemble and deploy forces. Therefore, the Selected Reserve must be prepared to mobilize within 24 hours.

This category includes all Guard and Reserve personnel who have Selected Reserve agreements, whether trained or not. Those who have not yet completed required training would not be available for deployment on land outside the United States with their own unit or other units until completion of training. Active Guard or Reserve members, including those on full-time National Guard duty under 32 U.S.C. 502(f), who are assigned to Guard or Reserve units will deploy with those units upon mobilization. (see Figure 3.)



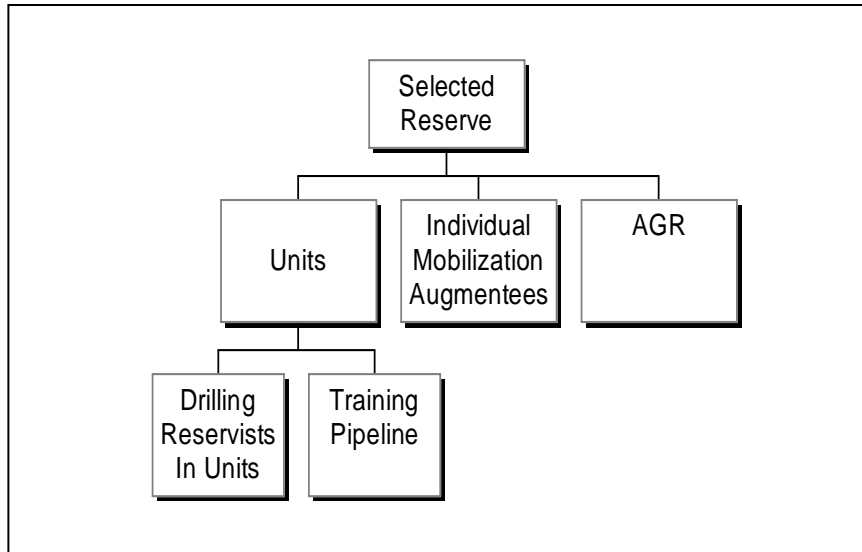

Figure 3

**The Selected Reserve Consists of the Following Subcategories:**

1. Selected Reserve Units – Units manned and equipped to serve and/or train either as operational or as augmentation units. Operational units train and serve as units; augmentation units train together, but when mobilized, lose their unit identity, being subsumed into an active unit or activity. Selected Reserve units include:
  - a. Drilling Reservists In Units – Trained unit members who participate in unit training activities on part-time basis. (SA)\*

\* All Reserve Component subcategories are assigned a two letter Authorized Reserve, Training and Retirement Code. The Codes are described in the table on page 19.

- b. Training Pipeline (Non-deployable Account) – Selected Reserve enlisted members who have not yet completed initial active duty for training (IADT) and officers who are in training for professional categories or in undergraduate flying training. IADT is that basic military training and technical skill training required for all enlisted accessions in accordance with 10 U.S.C. 671.
  - (1) IADT Trainees – Enlisted members who are currently on or are awaiting IADT, including the second part of split IADT. (UF) (UP) (UQ)
  - (2) Other Selected Reserve Untrained Personnel in Training Programs – These personnel include chaplain candidates, health profession students, and early commissioning program participants. (UX)
  - (3) Simultaneous Membership Program (SMP) - Those are Senior Reserve Officers Training Corps (ROTC) cadets or Marine Corps Platoon Leader Class members who are also permitted to be members of a Selected Reserve Unit. (UT)
- 2. Individual Mobilization Augmentees (IMAs) - trained individuals assigned to an active component, Selective Service System or Federal Emergency Management Agency (FEMA) organization's billet which must be filled on or shortly after mobilization. IMAs participate in training activities on a part-time basis with an active component unit in preparation for recall in a mobilization. (TB)

3. Active Guard / Reserve (AGR) – National Guard or Reserve members of the Selected Reserve who are ordered to active duty or full-time National Guard duty for the purpose of organizing, administering, recruiting, instructing or training the Reserve component units or duties as prescribed in 10 U.S.C.12310. All AGR members must be assigned against an authorized mobilization position in the unit they support. (Includes Navy TARs, Marine Corps ARs and Coast Guard RPAs). (SG)

There are certain trained Selected Reserve members who perform Active Duty or Full Time National Duty for more than 180 days in a fiscal year, but who are exempted from counting against Active Duty strength in accordance with 10 U.S.C. 101 (d)(6)(B)(ii) and (iii). Specifically, this includes U.S. Property and Fiscal Officers and members performing duty for the purpose of interdiction and counter-drug activities. (SX)

To help ensure the readiness of the Reserve Components, Full-Time Support assets, as described below, are employed.

Full-Time Support – Other than AGR, personnel who provide full-time support to the Reserve components include:

1. Military Technicians:
  - a. Military Technicians Dual Status (MT) – Federal civilian employees who provide full-time support for administration, training and maintenance to the unit. These employees must maintain their status as Selected Reservists, often referred to as dual status individuals, and are counted in the drilling Reservist subcategory. All dual status military technicians must be in mobilization positions. (Excludes National Guard civilian or contract “technicians” hired under 32 U.S.C. and personnel identified as Status Quo.)
  - b. Non-Dual Status Technicians (NDST) – Civilian employees employed as technicians but who are not required to maintain positions in the Selected Reserve.
2. Active Component (AC) - Active duty members who are assigned or attached to Reserve units by their respective services to provide advice, liaison, management, administration, training and/or maintenance support in the category of full-time support. These personnel are not part of the Selected Reserve, but would deploy with the unit to which assigned after mobilization. They are identified here for full-time support reporting and readiness purposes.
3. Civil Service Employees – These personnel are hired under 5 U.S.C. and 32 U.S.C. to provide administrative support to the Reserve Components. They are in the category of full-time support to the Reserve Components, but are not part of the Selected Reserve, and they do not have mobilization assignments. Also included are National Guard contract technicians and “status quo” personnel.

## **B. Individual Ready Reserve/Inactive National Guard (10 U.S.C. 10144)**

1. The Individual Ready Reserve (IRR) (See Figure 4) and Inactive National Guard (ING) consist of those Ready Reservists who are not in the Selected Reserve. The IRR is a manpower pool comprised principally of individuals having had training, having served previously in the AC or in the Selected Reserve, and having some period of their military service obligation (MSO) remaining. (RE)

There are some individuals voluntarily serving in the IRR for special non-pay programs providing a variety of professional assignments and opportunities for earning retirement points and military benefits. Those personnel all have an obligation to complete either MSO or another contractual commitment. Members may voluntarily participate in training for retirement points and promotion with or without pay. IRR members may be (but are not presently) required to meet the same training requirements as Selected Reservists. Required training (involuntary) may not exceed 30 days a year under 10 U.S.C. 10147. The President may order up to one million Ready Reservists to active duty involuntarily for up to 24 months upon the President's declaration of a national emergency (10 U.S.C. 12302). When Congress declares a state of war or national emergency, the President may order all Ready Reservists to active duty involuntarily for the duration of the war or emergency plus six months (10 U.S.C.12301 (a)).

2. The IRR also includes some personnel participating in officer training programs or in the Armed Forces Health Program (AFHP) Stipend Program. Members in that stipend program are required to perform 45 days of active duty for training (ADT) a year. (PJ) (PK)

3. Also included in the IRR are those personnel who are awaiting IADT and are assigned to units but serving without pay. (RU)
4. The IRR also includes members of the Delayed Entry Program (DEP) enlisted under 10 U.S.C. 513. Currently, there is no requirement to account for those untrained members of the IRR in the Reserve Components Common Personnel Data System. (RH)
5. Within the IRR there is a special category of members who have volunteered to be called to Active Duty under 10 U.S.C. 12304 (PRC) when needed. (RM)

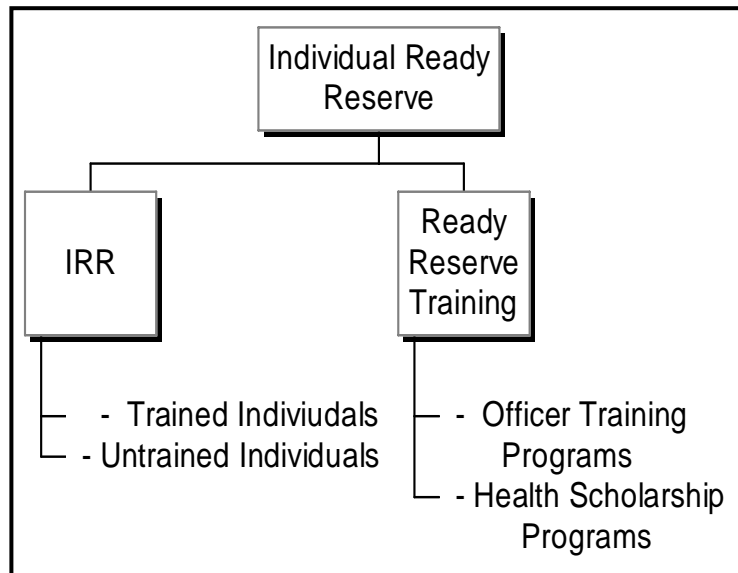

Figure 4

6. The Inactive National Guard (ING) – The ING consists of National Guard personnel in an inactive status in the Ready Reserve, not in the Selected Reserve, attached to a specific National Guard unit. To remain ING members, members must muster once a year with their assigned unit, but they do not participate in training activities. On mobilization, ING members mobilize with their units. Similar to other IRR, some ING members have legal and contractual obligations. ING members may not train for points or pay and are not eligible for promotion. Currently, the ING category is used only by the ARNG. (II)

## **II Standby Reserve (10 U.S.C. 10151, 10152, 10153)**

The Standby Reserve (See Figure 5) consists of personnel who maintain their affiliation without being in the Ready Reserve, who have been designated key civilian employees, or who have a temporary hardship or disability. These individuals are not required to perform training or be part of units. The Standby Reserve is a pool of trained individuals who could be mobilized if necessary to fill manpower needs in specific skills. The Standby Reserve is managed in accordance with DoD Directive 1235.9.

In time of war or national emergency declared by Congress, or when otherwise authorized by law, the Standby Reserve may be involuntarily mobilized for the duration of the war or emergency and for six months afterward. However, a member of the Standby Reserve may not be ordered to active duty involuntarily unless the Secretary concerned, with the approval of the Secretary of Defense, determines that there are not enough qualified Reservists in the Ready Reserve or in the Inactive National Guard who are readily available (10 U.S.C.12306).

1. Active Status List – Those Standby Reservists temporarily assigned for hardship or other cogent reason; those not having fulfilled their MSO, those retained in active status under the provisions of 10 U.S.C. 12646; or those members of Congress and others identified by their employers as “Key Personnel” and have been removed from the Ready Reserve because they are critical to the national security in their civilian employment. (YC) (YD)
2. Inactive Status List – Those Standby Reservists who are not required by law or regulation to remain in an active program and who retain their Reserve affiliation in a nonparticipating status and those who have skills which may be of possible future use to the Armed Force concerned. Inactive status list members may not train for points or pay, and are not eligible for promotion. Includes members transferred to inactive status in lieu of separation under 10 U.S.C. 1209. (YL) (YN)

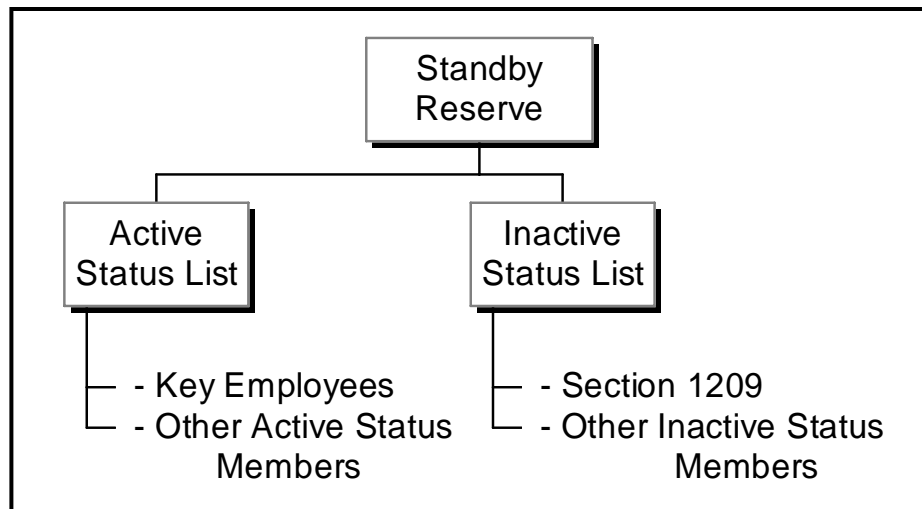

Figure 5



### **III Retired Reserve (10 U.S.C. 10154)**

The Retired Reserve (See Figure 6) is comprised of all Reserve officers and enlisted personnel who receive retired pay on the basis of active duty and/or reserve service; all Reserve officers and enlisted personnel who are otherwise eligible for retired pay but have not reached age 60 and who have not elected discharge and are not voluntary members of the Ready or Standby Reserve; and other retired reservists as further detailed below.

All retired members who have completed at least 20 years active duty (Regular or Reserve), regardless of the retired list to which assigned, may be ordered to active duty whenever required as determined by the Secretary of the Military Department in accordance with 10 U.S.C. 688.

At any time, the Secretary of the Military Department may order regular or Reserve 20 year active duty retirees and members of the Fleet Reserve and the Fleet Marine Corps Reserve to active duty without their consent in the interest of national defense (10 U.S.C. 688). In time of war or national emergency declared by congress, the respective Secretary may recall any other retired members of the Reserve Components, with approval of the Secretary of Defense, when it is determined there are insufficient qualified Reservists in an active status or in the Inactive National Guard (10 U.S.C. 12307). Anyone retiring under transition assistance or other similar program also may be ordered to active duty under 10 U.S.C. 688 or 12307.

Retired personnel are a resource of trained individuals who may be used to augment support and

training facilities, to relieve both Active Component or Ready Reserve members for other duties, or to accomplish operational missions as needed. Retired Reserves can be categorized as follows for all purposes other than mobilization.

1. Reserve 20+ Qualifying Years Retirees (Drawing Pay) – These Reserve members completed 20 qualifying years creditable for non regular retired pay, are 60 years of age, or older, and are drawing retired pay. (RCC and TRC: V1, Table 1, page 19.)
2. Reserve 20+ Qualifying Years Retirees (Not Drawing Pay) – These Reserve members completed 20 qualifying years creditable for non regular retired pay, but are not yet 60 years of age, or are age 60 and have not applied for retired pay. (RCC and TRC: V2, Table 1, page 19.)
3. Reserve Physical Disability Retirees – These Reserve members retired for physical disability under sections 1201, 1202, 1204, or 1205 of title 10 U.S.C. (RCC and TRC: V3, Table 1, page 19.)
4. Reserve Active Duty Retirees – These are Reserve members who have completed 20 or more years of active duty service. (RCC and TRC: V4, Table 1, page 19.)
5. Other Retired Reservists – These Reserve members are drawing Reserve retired pay based on retirement for reasons other than age, service requirements or physical disability. Also temporarily includes certain VSI recipients ineligible for retention in an active or inactive Reserve status. (RCC and TRC: V5, Table 1, page 19.)

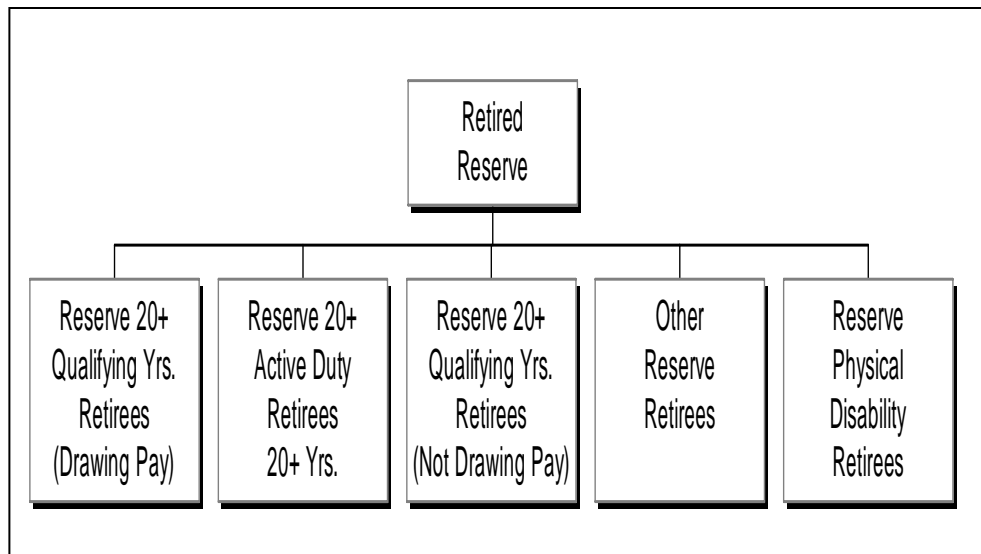

Figure 6

For mobilization purposes, it is DoD policy (DoD Directive 1352.1) that all military retirees be categorized by age, the length of time after retirement, and whether or not an individual has a disability. Category I military retirees are those within their first five years of retirement, under age 60, and not disabled. Category II, those who have been retired more than five years, under age 60, and not disabled; Category III includes all others, including those who are disabled. All Category I and II retirees should be considered for preassignment to mobilization positions, and, as mobilization assets, are counted as part of the total DoD mobilization base. Category II Reservists are mobilized after Category I Reservists. Category III retirees with selected skills, primarily medical personnel, are considered as mobilization assets on a case-by-case basis. (See Figure 7.)

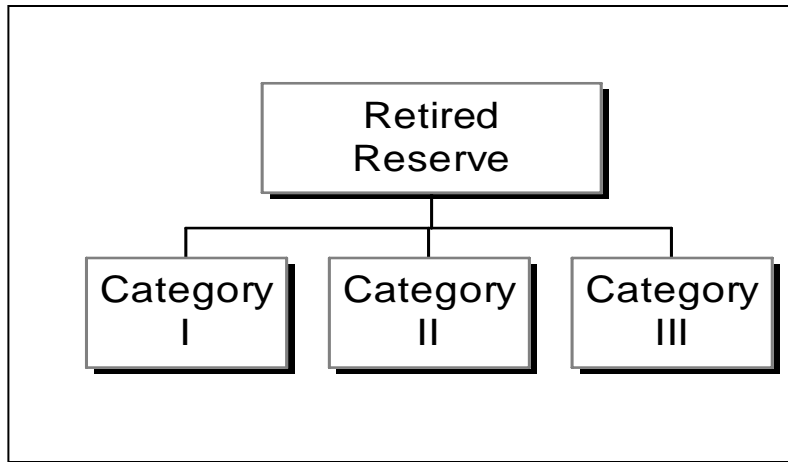

Figure 7

## **IV Retired Regulars**

Retired Regular Officers and Retired Regular Enlistees are not a part of total Reserve manpower as currently defined by statute. Mobilization of Retired Regulars and Reserves has, however, been standardized by Public Law 96-513, Sep 1983, as described above. Because all retired personnel, Regular or Reserve, are a part of the trained mobilization base and pretrained Individual Manpower pool, a description of these categories is included herein for completeness and to provide a clear understanding of the relationship of the various retired categories.

**Regular Officer Retirees** – These are regular officers who have completed at least 20 years of active duty and are retired with pay, or were retired with pay by reason of disability.

**Regular Enlisted Retirees** – These are regular enlisted retirees who have completed at least 20 years of active service. Navy and Marine Corps regular enlisted retirees with between 20 and 30 years of active service are assigned to the Fleet Reserve and Fleet Marine Corps Reserve, but are not members of the Reserve components.

Regular retirees are also categorized for the purpose of estimating mobilization resources (as described in paragraph III above). (See Figure 8.)

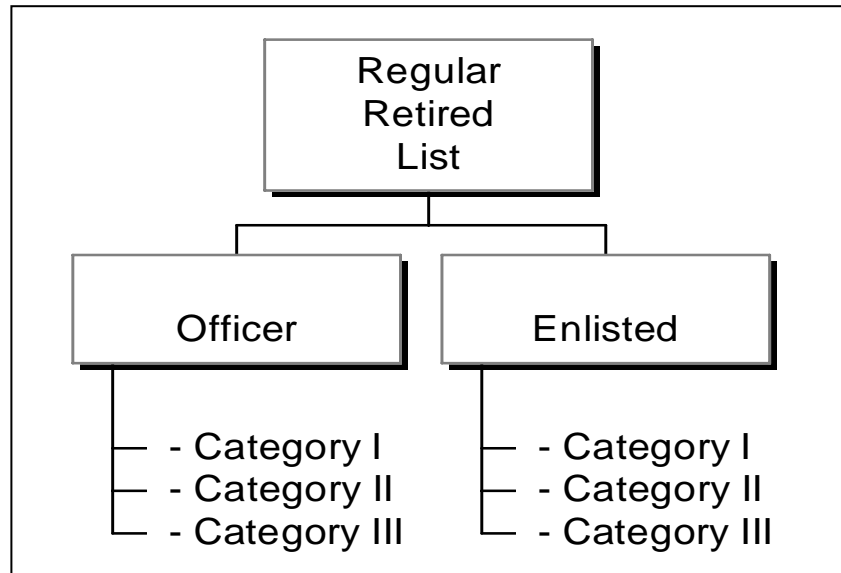

Figure 8

Retired Personnel who are either judged permanently or temporarily disabled are assigned to Disabled and Temporary Disabled lists. They would be identified as Category III mobilization assets.

A comprehensive organizational chart, showing all of the categories discussed herein, is attached as Figure 9.

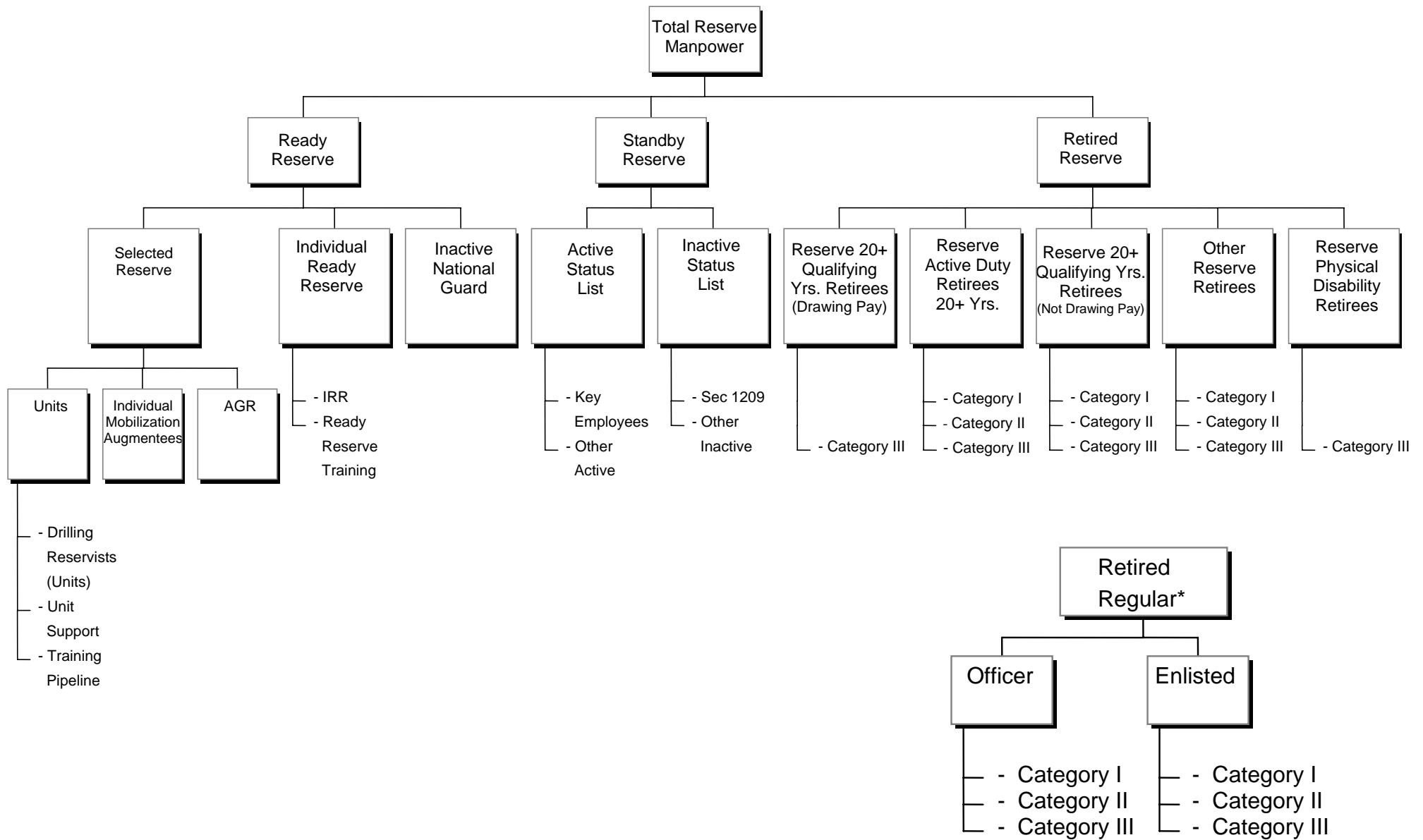

Figure 9

\* Retired Regular personnel are not included as part of the Reserve manpower categories, but are a pool of trained personnel available for mobilization consistent with the Retired Reserve.

**Table 1  
Authorized Reserve, Training and  
Retirement Categories**

RCC	RC SUB-CATEGORY	RCC DESIGNATOR	TRC DESIGNATOR	COMPRISED OF	MINIMUM NUMBER OF IDT PERIODS REQUIRED ANNUALLY	MINIMUM NUMBER OF DAYS OF AT REQUIRED ANNUALLY	REMARKS	CURRENTLY USED BY							
								ARNG	USAR	USNR	USMCR	ANG	USAFR	USCGR	
READY RESERVE	SELECTED RESERVE	S  TRAINED IN UNITS	A	INDIVIDUALS IN UNITS	48	RESERVE, 14 DAYS (EXCLUDE TRAVEL)  GUARD, 15 DAYS (INCLUDE TRAVEL)	10 U.S.C. 10147 (REFERENCE (e)). REQUIRES 14 DAYS AT.  32 U.S.C. 502 (REFERENCE (i)). REQUIRES 15 DAYS AT.		X	X	X		X	X	
			G	AGR	N/A	USCGR 12 DAYS (EXCLUDE TRAVEL)	AGR MAY BE REQUIRED TO ATTEND DRILLS. (INCLUDES USNR TARs, USCGR RPAs (14 U.S.C. 276 (REFERENCE (k)), USMCR ARs, AND ALL STATUTORY TOURS).	X	X	X	X	X	X	X	
			V	USPFO & RC MEMBERS ON AD IN SUPPORT OF COUNTER-DRUG ACTIVITIES	N/A	N/A	MEMBERS ARE ON AD FOR MORE THAN 180 DAYS AND COUNT AGAINST SELRES STRENGTH, BUT DO NOT COUNT AGAINST AGR STRENGTH	X	X	X	X	X	X	X	
		T	B	IMAs	IDT VARIES BETWEEN 0 AND 48 PERIODS EACH YEAR, AS DETERMINED BY DOD POLICY	RESERVE - 12 TO 14 DAYS (EXCLUDE TRAVEL)	UNLESS TRAINING CAN BE ACCOMPLISHED ON WEEKENDS, AT IS LIMITED TO 12 DAYS BY POLICY.		X	X	X		X	X	
		U  TRAINING PIPELINE, NON-DEPLOYABLE ACCOUNT	F	PERSONNEL CURRENTLY ON IADT	O	N/A	N/A	INCLUDES SECOND PART OF SPLIT TRAINING AND ARMY ONE-STATION UNIT TRAINING (APPLIES TO TRCs F, P, AND Q).	X	X	X	X	X	X	X
			P	PERSONNEL AWAITING IADT AND AUTHORIZED TO PERFORM IDT		N/A	MINIMUM IDT TO BE DETERMINED BY DoD COMPONENT POLICY	INCLUDES PERSONNEL WITH OR WITHOUT PAY.	X	X	X	X	X	X	X
			Q	PERSONNEL AWAITING SECOND PART OF IADT	48	N/A			X	X	X	X	X	X	X

**Table 1  
Authorized Reserve, Training and  
Retirement Categories (Continued)**

RCC	RC SUB-CATEGORY	RCC DESIGNATOR	TRC DESIGNATOR	COMPRISED OF	MINIMUM NUMBER OF IDT PERIODS REQUIRED ANNUALLY	MINIMUM NUMBER OF DAYS OF AT REQUIRED ANNUALLY	REMARKS	CURRENTLY USED BY						
								ARNG	USAR	USNR	USMCR	ANG	USAFR	USCGR
READY RESERVE	SELECTED RESERVE	U  TRAINING PIPELINE,  NON-DEPLOYABLE ACCOUNT	S	AGR CURRENTLY ON, OR AWAITING IADT	DETERMINED BY DoD COMPONENT POLICY	N/A	INCLUDES NPS AGR (NAVY TAR) PERSONNEL.			X				
			T	INDIVIDUALS IN A SIMULTANEOUS MEMBERSHIP	48	SAME AS TRC A	SENIOR ROTC CADETS OR MARINE CORPS PLATOON LEADER CLASS MEMBERS WHO ARE ALSO PERMITTED TO BE MEMBERS OF A SELECTED RESERVE UNIT.	X	X		X	X	X	
			X	PERSONNEL IN OTHER TRAINING PROGRAMS	48	SAME AS TRC A	SELECTED RESERVE UNTRAINED MEMBER IN OTHER TRAINING PROGRAMS INCLUDING CHAPLAINS, MEDICAL, HEALTH PROFESSIONAL STIPEND, AND EARLY COMMISSIONING. MUST MEET THE SAME TRAINING REQUIREMENTS. AS TRC A RESERVISTS.	X	X		X			
	IRR and ING	R  IRR	E	INDIVIDUAL MEMBERS OF THE READY RESERVE NOT IN SELECTED RESERVE (INCLUDES OFFICERS AWAITING AD OR SELECTED RESERVE ASSIGNMENT)	N/A	I	IRR MEMBERS MAY VOLUNTARILY PARTICIPATE IN TRAINING FOR RETIREMENT POINTS AND PROMOTION WITH OR WITHOUT PAY. REQUIRED TRAINING MAY NOT EXCEED 30 DAYS EACH YEAR. (10 U.S.C. 10147, REFERENCE (e)).		X	X	X		X	X
			M	SPECIAL CATEGORY WITHIN THE IRR SUBJECT TO INVOLUNTARY CALL TO AD IAW 10 USC 12304 (REFERENCE (e)).	N/A	N/A	MEMBERS MUST VOLUNTEER FOR THIS CATEGORY, AND MAY ONLY REMAIN IN THIS CATEGORY FOR 48 MONTHS AFTER LEAVING ACTIVE SERVICE.		X	X	X		X	X
			H	UNTRAINED MEMBERS OF THE IRR. (DEP) 10 U.S.C. 513, REFERENCE (e)					X	X	X		X	X
			U	PERSONNEL AWAITING IADT	NOT AUTHORIZED TO PERFORM IDT	N/A			X	X	X	X	X	X



**Table 1  
Authorized Reserve, Training and  
Retirement Categories (Continued)**

RCC	RC SUB-CATEGORY	RCC DESIGNATOR	TRC DESIGNATOR	COMPRISED OF	MINIMUM NUMBER OF IDT PERIODS REQUIRED ANNUALLY	MINIMUM NUMBER OF DAYS OF AT REQUIRED ANNUALLY	REMARKS	CURRENTLY USED BY						
								ARNG	USAR	USNR	USMCR	ANG	USAFR	USCGR
READY RESERVE	IRR And ING	P	J	PERSONNEL NOT IN THE SELECTED RESERVE - PARTICIPATING IN OFFICER TRAINING PROGRAMS	0	AS REQUIRED BY SPECIFIC PROGRAM	CHAPLAIN AND JUDGE ADVOCATE GENERAL (JAG) SCHOOLING, EDUCATION DELAY, ROTC ASSIGNMENT DELAY, ARMY EARLY COMMISSIONING PROGRAM, COAST GUARD DIRECT COMMISSION CANDIDATES, MARINE PLATOON LEADER CLASS, MERCHANT MARINE CADETS (USNR).		X	X	X		X	X
		P	K	PERSONNEL NOT IN THE SELECTED RESERVE - PARTICIPATING IN THE AFHPSP	0	45 DAYS	AFHPSP REQUIRES 45 DAYS AD ANNUALLY. 10 U.S.C. 2121(C) (REFERENCE (e)).		X	X			X	
		I	I	ING	0	1	MUST MEET ANNUAL MUSTER WITH ASSIGNED UNIT. MAY NOT TRAIN FOR POINTS OR PAY AND ARE NOT ELIGIBLE FOR PROMOTION.	X						
STANDBY RESERVE		Y STANDBY	C	ACTIVE STATUS LIST	0	0	KEY EMPLOYEES, ONLY, PER DoD DIRECTIVE 1200.7 (REFERENCE (r)). ACTIVE STANDBY MEMBERS MAY VOLUNTARILY TRAIN FOR POINTS WITHOUT PAY AND ARE ELIGIBLE FOR PROMOTION.		X	X	X		X	X
			D	ACTIVE STATUS LIST PROGRAMS	0	0	OTHER ACTIVE STATUS MEMBERS.		X	X	X		X	X
			L	INACTIVE STATUS LIST	0	0	MEMBERS TRANSFERRED TO INACTIVE STATUS LIST INSTEAD OF SEPARATION UNDER 10 U.S.C. 1209, CHAPTER 61 (REFERENCE (e)). INACTIVE STAND-BY MEMBERS MAY NOT TRAIN FOR POINTS WITH OR WITHOUT PAY AND ARE NOT ELIGIBLE FOR PROMOTION.		X	X	X		X	X
			N	INACTIVE STATUS LIST	0	0	OTHER INACTIVE STATUS MEMBERS.		X	X	X		X	

**Table 1  
Authorized Reserve, Training and  
Retirement Categories (Continued)**

RCC	RC SUB- CATEGORY	RCC DESIGNATOR	TRC DESIGNATOR	COMPRISED OF	MINIMUM NUMBER OF IDT PERIODS REQUIRED ANNUALLY	MINIMUM NUMBER OF DAYS OF AT REQUIRED ANNUALLY	REMARKS	CURRENTLY USED BY						
								ARNG	USAR	USNR	USMCR	ANG	USAFR	USCGR
RETIRED RESERVE		V  RETIRED	1	DRAWING NON-REGULAR RETIRED PAY UNDER 10 U.S.C. 12731 (REFERENCE (e))	N/A	N/A	RESERVE MEMBERS WHO HAVE COMPLETED 20 QUALIFYING YEARS CREDITABLE FOR NON-REGULAR RETIRED PAY, ARE 60 YEARS, OR MORE, OF AGE, AND ARE DRAWING NON-REGULAR RETIRED PAY		X	X	X		X	X
			2	NOT DRAWING NON-REGULAR RETIRED PAY, BUT ELIGIBLE AT AGE 60, UNDER SECTION 10 U.S.C. 12731 (REFERENCE (e))	N/A	N/A	RESERVE MEMBERS WHO HAVE COMPLETED 20 QUALIFYING YEARS CREDITABLE FOR NON-REGULAR RETIRED PAY, BUT ARE NOT YET 60 YEARS OF AGE, OR ARE AGE 60 AND HAVE NOT APPLIED FOR NON-REGULAR RETIRED PAY		X	X	X		X	X
			3	RESERVE MEMBERS RETIRED FOR PHYSICAL DISABILITY	N/A	N/A	RESERVE MEMBERS RETIRED FOR PHYSICAL DISABILITY UNDER 10 U.S.C. 1201, 1202, 1204, OR 1205 (REFERENCE (e)). MEMBERS WHO HAVE 20 YEARS OF SERVICE CREDITABLE FOR NON-REGULAR RETIRED PAY OR ARE 30-PERCENT OR MORE DISABLED.		X	X	X		X	X
			4	RESERVE MEMBERS WHO HAVE COMPLETED 20, OR MORE, YEARS OF AD	N/A	N/A	RESERVE MEMBERS WHO HAVE COMPLETED 20, OR MORE, YEARS OF AD SERVICE AND RETIRED UNDER 10 U.S.C. 3911, 3914, 6323, 6330, 8911, OR 8914 (REFERENCE (e)). DOES NOT INCLUDE REGULAR ARMY AND AIR FORCE ENLISTED PERSONNEL WITH BETWEEN 20 AND 30 YEARS OF MILITARY SERVICE; AND REGULAR AND RESERVE NAVY AND MARINE CORPS ENLISTED PERSONNEL IN THE FLEET RESERVE (NAVY) AND FLEET MARINE CORPS RESERVE WITH BETWEEN 20 AND 30 YEARS OF SERVICE.		X	X	X		X	X
			5	DRAWING NON-REGULAR RETIRED PAY UNDER OTHER THAN 10 U.S.C. 12731 (REFERENCE (e)), OR OTHER THAN REASONS OF PHYSICAL DISABILITY	N/A	N/A	RESERVE PERSONNEL RETIREMENT PAY BASED ON RETIREMENT FOR REASONS OTHER THAN AGE, SERVICE REQUIREMENTS OR PHYSICAL DISABILITY, AS AUTHORIZED BY THE ASD(RA). CERTAIN VSI RECIPIENTS INELIGIBLE FOR RETENTION IN ACTIVE OR INACTIVE RESERVE STATUS.		X	X	X		X	X

## Definitions

1. **Active Duty (AD)** – Full-time Duty in the active Military Service of the United States. A general term applied to all active Military Service, but not including full-time National Guard duty.
2. **Active Guard Reserve (AGR)** – RC members of the Selected Reserve ordered to AD or full-time National Guard duty with their consent, and consent of the Governor in the case of the National Guard, for the purpose of organizing, administering, recruiting, instructing, or training RC units or performing duties as prescribed in 10 U.S.C. 12310.
3. **Active Status** – Status of all Reserves, except those on an inactive status list or in the Retired Reserve. Reservists in an active status may train with or without pay, earn retirement points, and may earn credit for and be considered for promotion.
4. **Active Duty for Special Work (ADSW)** – A tour of AD for Reserve personnel authorized from military or Reserve personnel appropriations for work on AC or RC programs respectively. That includes annual screening, training camp operation, training ship operation, and unit conversions to new weapons systems when such duties are essential. ADSW may also be authorized to support groups, training sites and exercises, short-term projects, and administrative or support functions.

5. **Active Duty for Training (ADT)** – AD that is used for training members of the RCs to provide trained units and qualified persons to fill the needs of the Armed Forces in time of war or national emergency and such other times as the national security requires. ADT includes Annual Training (AT), special tours of ADT, school tours, and the initial duty for training performed by Non-prior Service enlistees.
6. **Annual Screening** – One-day ADT or Muster Duty required each year for IRR members so the Armed Forces can keep current on each member’s physical condition, dependency status, military qualifications, civilian occupation skills, availability for service, and other information.
7. **Annual Training (AT)** – The minimal period of training Reserve members must perform each year to satisfy the training requirements associated with their RC assignment.
8. **IMA Detachments** – An administrative unit organized to assist in training and to manage IMAs.
9. **Inactive Duty Training (IDT)** – Authorized training performed by a member of an RC not on AD or ADT, and consisting of regularly scheduled unit training periods, additional training periods (ATP), or equivalent training, and performed by RC members in connection with the prescribed activities of the RC of which they are a member.

- 10. Inactive Status** – Status of Reserve members on an inactive status list of RC or assigned to the ING. Those in an inactive status may not train for retirement points or pay, and may not receive credit for or be considered for promotion or be promoted.
- 11. Individual Mobilization Augmentees (IMAs)** – An individual Selected Reservist who receives training and is preassigned to an AC organization, a Selective Service System (SSS) or a FEMA billet that must be filled on, or shortly after, mobilization. The IDT requirement for IMAs is decided by DoD Component Policy and can vary from 0 to 48 drills a year. A minimum of 12 days AT is required of all IMAs.
- 12. Initial ADT (IADT)** – Basic military training and technical skill training required for all enlisted accessions. For Nonprior Service personnel between the ages of 18 ½ and 26 years, that IADT shall be not less than 12 weeks and start, insofar as practical, within 270 days after enlistment. IADT for all other enlistees and inductees shall begin within 360 days after entry into Service. Military members may not be assigned to AD on land outside the United States or its territories and possessions until basic training or its equivalent has been completed.
- 13. Key Employee** – Any Reservist filling a key position as defined by the employer and approved by the appropriate military service.
- 14. Key Position** – A civilian position, public or private (designated by the employer and approved by DoD IAW DoD Directive 1200.7) that cannot be vacated during war or national emergency.

- 15. Multiple IDT Periods (MIDTPs)** – Two scheduled IDT periods performed in one calendar day, each at least four hours in duration. No more than two IDT periods may be performed in one day.
- 16. Nondeployable Account** – An account where Reservists (officer and enlisted), either in units or as individuals, are assigned to an RCC or a TRC when the individual has not completed IADT or its equivalent. Reservists in a nondeployable account are not considered as trained strength assigned to units or mobilization positions and are not deployable overseas on land with those units or mobilization positions. See also “training pipeline,” definition 25, below.
- 17. Nonprior Service (NPS) Personnel** – Individuals without any prior Military Service, who have not completed IADT or its equivalent, and who receive a commission or warrant in, or enlist directly into, a U.S. Armed Force.
- 18. Operational Support** - Active duty, other than Active Guard and Reserve duty, under 12301(d) of title 10; full-time National Guard duty, other than Active Guard and Reserve duty, under section 502(f)(2) of title 32, United States Code; and active duty for training performed at the request of an organizational or operational commander, or as a result of reimbursable funding.
- 19. Qualifying Years Creditable for Non Regular Retired Pay** – The time guardsmen or Reservists must serve to be eligible for non regular retired pay at age 60 years. Individuals must have at least 20 years of service in which they received at least 50 retirement points, and the last eight years of service must have been served in an RC.

**20. Reserve Component (RC)** – RCs of the U.S. Armed Forces are as follows:

- a. The Army National Guard (ARNG) of the United States.
- b. The U.S. Army Reserve (USAR).
- c. The U.S. Navy Reserve (USNR).
- d. The U.S. Marine Corps Reserve (USMCR).
- e. The Air National Guard (ANG) of the United States.
- f. The U.S. Air Force Reserve (USAFR).
- g. The U.S. Coast Guard Reserve (USCGR).

**21. Reserve Component Category (RCC)** – The category that identifies an individual’s status in a RC. The three RCCs are Ready Reserve, Standby Reserve, and Retired Reserve. Each Reservist is identified by a specific RCC designation.

**22. Secretary of Military Department** – The Secretaries of the Army, the Navy, and the Air Force; or the Secretary of Homeland Security, when the Coast Guard is operating as a DHS Agency.

**23. Trained Strength in Units** – Those personnel (Reservists, AGR and AC) assigned to units who, in the case of enlisted members, have completed IADT of 12 weeks, or its equivalent, and are eligible for deployment overseas on land when mobilized under proper authority. Excludes personnel in non-deployable accounts or a training pipeline.

**24. Training and Retired Category (TRC)** – The Category identifying (by specific TRC designator) a Reservist’s training or retirement status in an RCC or an RC.

- 25. Training Period** – An authorized and scheduled regular IDT period. A training period, for pay purposes, must be at least four hours. Previously used interchangeably with other common terms such as drills, drill period, assemblies, or periods of instructions, etc.
- 26. Training Pipeline** – An RCC designation that identifies officers in professional or flying training and untrained enlisted personnel who have not completed IADT of 12 weeks, or its equivalent. See also “nondeployable account,” definition 16, above.
- 27. Training Unit** – A unit established to provide military training to individual Reservists or to RC units.
- 28. Unit** – For an RC of the Armed Forces, denotes a Selected Reserve unit organized, equipped, and trained for mobilization to serve on AD as a unit or that augments or shall be augmented by another unit. Headquarters and support functions without war-time missions are not considered units for accounting for units and individuals in the Selected Reserve.



**29. Voluntary Training** – Training in a nonpay status for IRRs and active status Standby Reservists.

Participation in voluntary training is for retirement points only and may be achieved by training with Selected Reserve or voluntary training units; by ADT; by completion of authorized military correspondence courses; by attendance at designated courses of instruction; by performing equivalent duty; by participating in special military and professional events designated by the Military Department; or by participating in authorized civil defense activities. Retirees may voluntarily train with organizations to which they are properly preassigned by orders for recall to AD in a national emergency or declaration of war. Such training shall be limited to that training made available within the resources authorized by the Secretary concerned.

**30. Voluntary Training Unit or Reinforcement**

**Training Unit** – A unit formed by volunteers to provide RC training in a nonpay status for IRRs and active status standby Reservists attached under competent orders and participating in such unit for retirement points. Also called a “reinforcement training unit.”