



Profile of The Rubber And Plastics Industry, 2nd Edition

EPA Office of Compliance Sector Notebook Project



EPA Office of Compliance Sector Notebook Project

**Profile of the Rubber and Plastics Industry
2nd Edition**

February 2005

Office of Compliance
Office of Enforcement and Compliance Assurance
U.S. Environmental Protection Agency
401 M St., SW (MC 2221-A)
Washington, D.C. 20460

This report is one in a series of volumes published by the U.S. Environmental Protection Agency (EPA) to provide information of general interest regarding environmental issues associated with specific industrial sectors. The documents were developed under contract by Eastern Research Group, Inc. (ERG) (Lexington, MA), Abt Associates (Cambridge, MA), GeoLogics Corporation (Alexandria, VA), Science Applications International Corporation (McLean, VA), and Booz-Allen & Hamilton, Inc. (McLean, VA). A list of available Sector Notebooks is included on the following page.

Obtaining copies:

Electronic versions of all Sector Notebooks are available on the EPA's web site at <http://www.epa.gov/compliance/sectornotebooks.html>.

A limited number of **complimentary volumes** are available to certain groups or subscribers, including public and academic libraries; federal, state, tribal, and local governments; and the media. You can order from EPA's National Service Center for Environmental Publications at **(800) 490-9198** or www.epa.gov/ncepihom. When ordering, use the applicable EPA publication number from those listed on the following page.

The Sector Notebooks were developed by the EPA's Office of Compliance. Direct general questions about the Sector Notebook Project to:

Coordinator, Sector Notebook Project
U.S. EPA Office of Compliance
1200 Pennsylvania Ave., NW (2224-A)
Washington, D.C. 20460
(202) 564-2310

AVAILABLE SECTOR NOTEBOOKS

Direct questions and comments regarding the individual documents to the Compliance Assistance and Sector Programs Division at (202) 564-2310 unless otherwise noted below. **See the Notebook web page at: <http://www.epa.gov/compliance/sectornotebooks.html> for the most recent titles and links to refreshed data.**

EPA Publication Number	Industry
EPA/310-R-95-001.	Profile of the Dry Cleaning Industry
EPA/310-R-95-002.	Profile of the Electronics and Computer Industry*
EPA/310-R-95-003.	Profile of the Wood Furniture and Fixtures Industry
EPA/310-R-95-004.	Profile of the Inorganic Chemical Industry*
EPA/310-R-95-005.	Profile of the Iron and Steel Industry
EPA/310-R-95-006.	Profile of the Lumber and Wood Products Industry
EPA/310-R-95-007.	Profile of the Metal Fabrication Industry*
EPA/310-R-95-008.	Profile of the Metal Mining Industry
EPA/310-R-95-009.	Profile of the Motor Vehicle Assembly Industry
EPA/310-R-95-010.	Profile of the Nonferrous Metals Industry
EPA/310-R-95-011.	Profile of the Non-Fuel, Non-Metal Mining Industry
EPA/310-R-95-013.	Profile of the Petroleum Refining Industry
EPA/310-R-95-014.	Profile of the Printing Industry
EPA/310-R-95-017.	Profile of the Stone, Clay, Glass, and Concrete Industry
EPA/310-R-95-018.	Profile of the Transportation Equipment Cleaning Industry
EPA/310-R-97-001.	Profile of the Air Transportation Industry
EPA/310-R-97-002.	Profile of the Ground Transportation Industry
EPA/310-R-97-003.	Profile of the Water Transportation Industry
EPA/310-R-97-004.	Profile of the Metal Casting Industry
EPA/310-R-97-005.	Profile of the Pharmaceuticals Industry
EPA/310-R-97-006.	Profile of the Plastic Resins and Man-made Fibers Industry
EPA/310-R-97-007.	Profile of the Fossil Fuel Electric Power Generation Industry
EPA/310-R-97-008.	Profile of the Shipbuilding and Repair Industry
EPA/310-R-97-009.	Profile of the Textiles Industry
EPA/310-R-98-001.	Profile of the Aerospace Industry
EPA/310-R-99-006.	Profile of the Oil and Gas Extraction Industry
EPA/310-R-00-001.	Profile of the Agricultural Crop Production Industry Contact: Ag Center, (888) 663-2155
EPA/310-R-00-002.	Profile of the Agricultural Livestock Production Industry Contact: Ag Center, (888) 663-2155
EPA/310-R-00-003.	Profile of the Agricultural Chemical, Pesticide and Fertilizer Industry Contact: Agriculture Division, (202) 564-2320
EPA/310-R-02-001.	Profile of the Organic Chemical Industry, 2 nd Edition*
EPA/310-R-02-002.	Profile of the Pulp and Paper Industry, 2 nd Edition
EPA/310-R-05-002.	Profile of the Healthcare Industry
EPA/310-R-05-003.	Profile of the Rubber and Plastics Industry, 2 nd Edition
Government Series	
EPA/310-R-99-001.	Profile of Local Government Operations
EPA/300-B-96-003.	Profile of Federal Facilities
EPA/310-R-05-001.	Profile of Tribal Government Operations

*Spanish translations of 1st Editions available in electronic format only.

DISCLAIMER

This Sector Notebook was created for employees of the U.S. Environmental Protection Agency (EPA) and the general public for informational purposes only. This document has been extensively reviewed by experts from both inside and outside EPA, but its contents do not necessarily reflect the views or policies of EPA or any other organization mentioned within. Mention of trade names or commercial products or events does not constitute endorsement or recommendation for use. In addition, these documents are not intended and cannot be relied upon to create any rights, substantive or procedural, enforceable by any party in litigation with the United States.

Rubber and Miscellaneous Plastics Products (SIC Code 30)

TABLE OF CONTENTS

	Page
LIST OF ACRONYMS	viii
I. INTRODUCTION TO THE SECTOR NOTEBOOK PROJECT	1
I.A. Summary of the Sector Notebook Project	1
I.B. Additional Information	2
II. INTRODUCTION TO THE RUBBER AND MISCELLANEOUS PLASTICS PRODUCTS INDUSTRY	3
II.A. Introduction, Background, and Scope of the Notebook	3
II.B. Characterization of the RMPP Industry	4
II.B.1. Product Characterization	4
II.B.2. Industry Size and Geographic Distribution	7
II.B.3. Economic Trends	12
III. INDUSTRIAL PROCESS DESCRIPTION	15
III.A. Industrial Processes in the RMPP Industry	15
III.A.1. Plastic	15
III.A.2. Rubber	23
III.A.3. Tires	28
III.B. Raw Material Inputs and Pollution Outputs in the Production Line ...	31
III.B.1. Plastic	31
III.B.2. Rubber	35
III.C. Management of Chemicals in Waste Stream	41
IV. CHEMICAL RELEASE AND OTHER WASTE MANAGEMENT PROFILE	43
IV.A. EPA TRI for the RMPP Industry	46
IV.B. Summary of the Selected Chemicals Released	68
IV.C. Other Data Sources	72
IV.D. Comparison of TRI Between Selected Industries	73
V. POLLUTION PREVENTION OPPORTUNITIES	76
V.A. Identification of Pollution Prevention Activities in Use	76
V.A.1. Plastic	76
V.A.2. Rubber	78
V.A.3. Tires	80

TABLE OF CONTENTS (Continued)

	Page
VI.	SUMMARY OF FEDERAL STATUTES AND REGULATIONS 83
	VI.A. General Description of Major Statutes 83
	VI.B. Industry-Specific Requirements 104
	VI.C. Pending and Proposed Regulatory Requirements 109
VII.	COMPLIANCE AND ENFORCEMENT PROFILE 111
	VII.A. The RMPP Industry Compliance History (1999 to 2004) 114
	VII.B. Comparison of Enforcement Activity Between Selected Industries (1999 to 2004) 115
	VII.C. Review of Major Legal Actions 125
	VII.C.1. Review of Major Cases 125
	VII.C.2. Supplementary Environmental Projects 125
VIII.	COMPLIANCE ACTIVITIES AND INITIATIVES 127
	VIII.A. Sector-Related Environmental Programs and Activities 127
	VIII.B. EPA Voluntary Programs 127
	VIII.C. Trade Association-/Industry-Sponsored Activities 134
	VIII.C.1. Environmental Programs 134
	VIII.C.2. Summary of Trade Associations 136
IX.	CONTACTS/ACKNOWLEDGMENTS/RESOURCE MATERIALS/ BIBLIOGRAPHY 140

LIST OF FIGURES

	Page
1	Diversity of the Miscellaneous Plastics Products Industry (SIC Code 308) 6
2	Diversity of the Rubber Products Industry 7
3	Geographic Distribution of the Miscellaneous Plastics Products Industry (Number of Facilities) 8
4	Geographic Distribution of the Rubber Products Industry (Number of Facilities) 10
5	Geographic Distribution of the Tire Industry 11
6	North American Tire Sales 12
7	Plastics Products Manufacturing Process 16
8	Injection Molding 18
9	Extrusion 19
10	Thermoforming 20
11	Transfer Molding 21
12	Encapsulation 22
13	Rubber Manufacturing Process 24
14	Processes Used to Manufacture Various Rubber Products 27
15	Tire Manufacturing Process 29
16	Tire Formation 31
17	Plastics Products Manufacturing Process Pollution Outputs 33
18	Rubber Products Manufacturing Process Pollution Outputs 36
19	Tire Manufacturing Process Pollution Outputs 40
20	Summary of 2002 TRI Data: Releases and Transfers by Industry (SIC Code) 74

LIST OF TABLES

	Page
1	SIC and NAICS Codes 4
2	Facility Size Distribution of the Miscellaneous Plastics Products Industry 8
3	Facility Size Distribution of the Rubber Products Industry 9
4	Facility Size Distribution of the Tire Industry 11
5	Quantity of Production-Related Waste Managed by the RMPP Industry 42
6	Top 10 TRI Releasing RMPP Facilities (SIC Code 30 Only Facilities) 47
7	Top 10 TRI Releasing RMPP Facilities (SIC Code 30 and Other SIC Code Facilities) 47
8	TRI Reporting RMPP Facilities (SIC Code 30) by State 48
9	Releases for RMPP Facilities (SIC Code 30) in TRI, by Number of Facilities (releases reported in pounds/year) 49
10	Transfers for RMPP Facilities (SIC Code 30) in TRI, by Number of Facilities (transfers reported in pounds/year) 55
11	Releases by Subsector for RMPP Facilities (SIC Code 30) in TRI 62
12	Pollutant Releases (Short Tons/Years) 72
13	Toxic Release Inventory Data for Selected Industries 75
14	Scrap Tire Usage 81
15	Summary of Potentially Applicable EPA Regulations 84
16	Five-Year Enforcement and Compliance Summary for the Rubber and Plastics Industry (1999 - 2004) 116
17	Five-Year Enforcement and Compliance Summary for Selected Industries (1999 - 2004) 117
18	Two-Year Enforcement and Compliance Summary for Selected Industries (2002 - 2004) 119
19	Five-Year Inspection and Enforcement Summary by Statute for Selected Industries (1999 - 2004) 121
20	Two-Year Inspection and Enforcement Summary by Statute for Selected Industries (2002 - 2004) 123
21	Supplemental Environmental Projects in RMPP Facilities (SIC Code 30) 126

LIST OF ACRONYMS

AFS	AIRS Facility Subsystem (CAA database)
AHERA	Asbestos Hazard Emergency Response Act
AIRS	Aerometric Information Retrieval System (CAA database)
BACT	Best Available Control Technology
BEHP	Bis(2-ethylhexyl) phthalate
BIF	Boilers and Industrial Furnaces (RCRA)
BOD	Biochemical Oxygen Demand
CAA	Clean Air Act
CAAA	Clean Air Act Amendments of 1990
CERCLA	Comprehensive Environmental Response, Compensation and Liability Act
CESQG	Conditionally Exempt Small Quantity Generator
CERCLIS	CERCLA Information System
CFC	Chlorofluorocarbons
CO	Carbon Monoxide
COD	Chemical Oxygen Demand
CTG	Control Techniques Guidelines
CWA	Clean Water Act
CZARA	Coastal Zone Act Reauthorization Amendments
CZMA	Coastal Zone Management Act
DfE	Design for the Environment Program
ELP	Environmental Leadership Program
EPA	United States Environmental Protection Agency
EPCRA	Emergency Planning and Community Right-to-Know Act
FFDCA	Federal Food, Drug, and Cosmetic Act
FIFRA	Federal Insecticide, Fungicide, and Rodenticide Act
FQPA	Food Quality Protection Act
FRP	Facility Response Plans
FRS	Facility Registry Systems
GSN	Green Suppliers Network
HAP	Hazardous Air Pollutants (CAA)
HSDB	Hazardous Substances Data Bank
HSWA	Hazardous and Solid Waste Amendments
IDEA	Integrated Data for Enforcement Analysis
IRIS	Integrated Risk Information System
LDR	Land Disposal Restrictions (RCRA)
LEPC	Local Emergency Planning Committees
LQG	Large Quantity Generator
MACT	Maximum Achievable Control Technology (CAA)
MCLG	Maximum Contaminant Level Goals
MCL	Maximum Contaminant Levels
MEK	Methyl Ethyl Ketone
MS4	Municipal Separate Storm Sewer Systems
MSDS	Material Safety Data Sheets
NAAQS	National Ambient Air Quality Standards (CAA)
NAICS	North American Industrial Classification

NCDB	National Compliance Database (for TSCA, FIFRA, EPCRA)
NCP	National Oil and Hazardous Substances Pollution Contingency Plan
NEIC	National Enforcement Investigations Center
NESHAP	National Emission Standards for Hazardous Air Pollutants
NIST	National Institute of Standards and Technology
NOA	Notice of Arrival
NOAA	National Oceanic and Atmospheric Agency
NO ₂	Nitrogen Dioxide
NOV	Notice of Violation
NO _x	Nitrogen Oxide
OCS	Operation Clean Sweep
NPDES	National Pollutant Discharge Elimination System (CWA)
NPL	National Priorities List
NRC	National Response Center
NSPS	New Source Performance Standards (CAA)
NSR	New Source Review
OAR	Office of Air and Radiation
OECA	Office of Enforcement and Compliance Assurance
OMB	Office of Management and Budget
OPA	Oil Pollution Act
OSHA	Occupational Safety and Health Administration
OSWER	Office of Solid Waste and Emergency Response
PCB	Polychlorinated Biphenyl
PCS	Permit Compliance System (CWA Database)
POTW	Publicly Owned Treatments Works
PSD	Prevention of Significant Deterioration
RCRA	Resource Conservation and Recovery Act
RMA	Rubber Manufacturers Association
RMP	Risk Management Plan
RMPP	Rubber and Miscellaneous Plastics Products
SARA	Superfund Amendments and Reauthorization Act
SDWA	Safe Drinking Water Act
SEP	Supplemental Environmental Projects
SERC	State Emergency Response Commissions
SIC	Standard Industrial Classification
SIDS	Screening Information Data Set
SIP	State Implementation Plan
SPI	The Society of the Plastics Industry, Inc.
SO ₂	Sulfur Dioxide
SPCC	Spill, Prevention, Control, and Countermeasure
SQG	Small Quantity Generator
SWAP	Source Water Assessment Programs
SWPPP	Storm Water Pollution Prevention Plan
TCLP	Toxicity Characterization Leaching Procedure
TOC	Total Organic Carbon
TRI	Toxic Release Inventory
TRIS	Toxic Release Inventory System
TSCA	Toxic Substances Control Act

TSS	Total Suspended Solids
UIC	Underground Injection Control (SDWA)
UST	Underground Storage Tanks (RCRA)
VCCEP	Voluntary Children's Chemical Evaluation Program
VOC	Volatile Organic Compounds

I. INTRODUCTION TO THE SECTOR NOTEBOOK PROJECT**I.A. Summary of the Sector Notebook Project**

Environmental policies based upon comprehensive analysis of air, water, and land pollution (such as economic sector and community-based approaches) are becoming an important supplement to traditional single-media approaches to environmental protection. Environmental regulatory agencies are beginning to embrace comprehensive, multistatute solutions to facility permitting, compliance assurance, education/outreach, research, and regulatory development issues. The central concepts driving the new policy direction are that pollutant releases to each environmental medium (air, water and land) affect each other, and that environmental strategies must actively identify and address these interrelationships by designing policies for the "whole" facility. One way to achieve a whole facility focus is to design environmental policies for similar industrial facilities. By doing so, environmental concerns that are common to the manufacturing of similar products can be addressed in a comprehensive manner. Recognition of the need to develop the industrial "sector-based" approach within EPA's Office of Compliance led to the creation of this document.

The Office of Compliance within the Office of Enforcement and Compliance Assurance (OECA) initiated the Sector Notebook Project to provide its staff and managers with summary information for 18 specific industrial sectors. As other EPA offices, states, the regulated community, environmental groups, and the public became interested in this project, the scope of the original project was expanded. The ability to design comprehensive, common-sense environmental protection measures for specific industries is dependent on knowledge of several interrelated topics. The key elements chosen for inclusion in this project are: general industry information (economic and geographic); a description of industrial processes; pollution outputs; pollution prevention opportunities; federal statutory and regulatory framework; compliance history; and a description of partnerships that have been formed between regulatory agencies, the regulated community, and the public.

For any given industry, each topic listed above could alone be the subject of a lengthy volume. However, to produce a manageable document, this project focuses on providing summary information for each topic. This format provides the reader with a synopsis of each issue, and references where more in-depth information is available. EPA used a variety of sources to compile each profile and usually condensed the information from more detailed sources pertaining to specific topics. This approach allows for a wide coverage of activities that can be further explored using the references listed at the end of this profile. As a check on the information included, each Notebook went through an external document review process. The Office of Compliance appreciates the efforts of all those that participated in this process and enabled us to develop more complete, accurate and up-to-date summaries. Many of those who reviewed this Notebook are listed as contacts in Section IX and may be sources of additional information. The individuals and groups on this list do not necessarily concur with all statements within this notebook.

I.B. Additional Information*Providing Comments*

OECA's Office of Compliance plans to periodically review and update the notebooks and will make these updates available both in hard copy and electronically. If you have any comments on any of the existing notebooks, or if you would like to provide additional information, please send a hard copy and computer disk to: EPA Office of Compliance, Sector Notebook Project (2224-A), 1200 Pennsylvania Ave., NW, Washington, D.C. 20460. Comments can also be sent via the Sector Notebooks web page at: <http://www.epa.gov/compliance/sectornotebooks.html>. If you are interested in assisting in the development of new Notebooks, or if you have recommendations on which sectors should have a Notebook, please contact the Office of Compliance at (202) 564-2310.

Adapting Notebooks to Particular Needs

The scope of the industry sector described in this Notebook approximates the national occurrence of facility types within the sector. In many instances, industries within specific geographic regions or states may have unique characteristics that are not fully captured in these profiles. The Office of Compliance encourages state and local environmental agencies and other groups to supplement or repackage the information included in this Notebook to include more specific industrial and regulatory information that may be available. Additionally, interested states may want to supplement the "Summary of Applicable Federal Statutes and Regulations" section with state and local requirements. Compliance or technical assistance providers may also want to develop the "Pollution Prevention" section in more detail.

II. INTRODUCTION TO THE RUBBER AND MISCELLANEOUS PLASTICS PRODUCTS INDUSTRY

This section provides background information on the size, geographic distribution, employment, production, sales, and economic condition of the Rubber and Miscellaneous Plastics Products industry. The type of facilities described within the document are also described in terms of their Standard Industrial Classification (SIC) codes. Additionally, this section contains a list of the largest companies in terms of sales.

II.A. Introduction, Background, and Scope of the Notebook

The Rubber and Miscellaneous Plastics Products (RMPP) industry, as defined by the SIC code 30, includes establishments that manufacture products from plastic resins, natural and synthetic rubber, reclaimed rubber, gutta percha, balata, and gutta siak. The production of the rubber mixture is commonly performed in facilities manufacturing rubber products and is covered under SIC code 30; however, the production of plastic resins is at plastic resin (polymer and resin) manufacturing facilities (SIC code 28). The majority of plastics products facilities purchase plastic resins to manufacture products.

Although this SIC code covers most rubber and plastics products, some important rubber and plastics products are classified elsewhere. These products include boats, which are classified under SIC code 37 (Transportation Equipment), and buttons, toys, and buckles, which are classified under SIC code 39 (Miscellaneous Manufacturing Industries). Buttons, toys, and buckles are grouped according to the final product rather than by process because not all of these products are made out of rubber or plastic. The RMPP industry does include tire manufacture; however, tread manufacturing and associated recapping and retreading are classified under SIC code 7534. EPA recognizes the recapping and retreading process for passenger and truck tires as similar to original equipment tire operation, specifically, tire production. An in-depth discussion of the recapping and retreading industry is not included here. The operations and materials used in retreading tires are similar to the original equipment tire rubber compounding for treads, tire building, grinding for carcass preparation, vulcanizing, and finishing as described in the new tire manufacturing process herein.

Although SIC code 30 groups rubber and plastics products together under some of the three-digit industry codes (e.g., rubber and plastic footwear under SIC code 302), the majority of economic and process information separates plastic from rubber products. In addition, because tire manufacturing accounts for such a large portion (almost 50 percent) of all rubber product manufacturing, tire process and economic information is often discussed separately from that of other rubber products. Therefore, this industry profile often discusses plastics products, rubber products, and rubber tires separately.

The Office of Management and Budget (OMB) established SIC codes to track the flow of goods and services within the economy. OMB has changed the SIC code system to a system based on similar production processes called the North American Industrial Classification System (NAICS). Because most of the EPA data systems still compile data based on SIC codes, this Notebook continues to use the SIC system to define this sector. Table 1 presents the SIC codes for the RMPP industry and the corresponding NAICS codes.

Table 1: SIC and NAICS Codes

1987 SIC	SIC Description	1997 NAICS	NAICS Description
3011	Tires & inner tubes	326211	Tire mfg (except retreading)
3021	Rubber & plastics footwear	316211	Rubber & plastics footwear mfg
3052	Rubber & plastics hose & belting	326220	Rubber & plastics hose & belting mfg
3053	Gaskets, packing, & sealing devices	339991	Gaskets, packing & sealing devices mfg
3061	Mechanical rubber goods	326291	Rubber product mfg for mechanical use
3069	Fabricated rubber products, n.e.c.	313320	Fabric coating mills (pt)
		326192	Resilient floor covering mfg (pt)
		326299	All other rubber product mfg
3081	Unsupported plastics film & sheet	326113	Unsupported plastics film & sheet (except packaging) mfg
3082	Unsupported plastics profile shapes	326121	Unsupported plastics profile shape mfg
3083	Laminated plastics plate & sheet	326130	Laminated plastics plate, sheet, & shape mfg
3084	Plastics pipe	326122	Plastics pipe & pipe fitting mfg
3085	Plastics bottles	326160	Plastics bottle mfg
3086	Plastics foam products	326140	Polystyrene foam product mfg
		326150	Urethane & other foam product (except polystyrene) mfg
3087	Custom compound purchased resins	325991	Custom compounding of purchased resin
3088	Plastics plumbing fixtures	326191	Plastics plumbing fixture mfg
3089	Plastics products, n.e.c.	326122	Plastics pipe & pipe fitting mfg
		326199	All other plastics product mfg
		335121	Residential electric lighting fixture mfg

II.B. Characterization of the RMPP Industry

The following subsections describes the types of products produced by rubber and miscellaneous plastics products facilities, the size and distribution of these types of facilities, and the current and projected economic trends for the RMPP industry.

II.B.1. Product Characterization

The Bureau of the Census divides SIC code 30 into industry groups according to the type of product manufactured. The following is a list of all the three-digit industry groups under SIC code 30:

- SIC Code 301 - Tires and Inner Tubes;
- SIC Code 302 - Rubber and Plastics Footwear;
- SIC Code 305 - Hose and Belting and Gaskets and Packing;

- SIC Code 306 - Fabricated Rubber Products, Not Elsewhere Classified; and
- SIC Code 308 - Miscellaneous Plastics Products, Not Elsewhere Classified.

Several of these three-digit classifications group rubber and plastics products together. However, the four-digit classifications clearly segregate the two industries. The following are four-digit SIC code breakdowns of the rubber and plastics products industries as shown in Figure 1 for SIC code 308:

- Plastics Products, Not Elsewhere Classified (N.E.C.) (SIC code 3089) account for approximately 55 percent of all plastic product production in the United States;
- Unsupported Plastics Film & Sheet (SIC code 3081) account for approximately 12 percent;
- Plastics Foam Products (SIC code 3086) account for approximately 10 percent;
- Custom Compound Purchased Resins (SIC code 3087) account for approximately 6 percent;
- Plastics Bottles (SIC code 3085) account for approximately 5 percent;
- Unsupported Plastics Profile Shapes (SIC code 3082) account for approximately 4 percent;
- Plastics Pipe (SIC code 3084) and Laminated Plastics Plate & Sheet (SIC code 3083) account for approximately 3 percent each; and
- Plastics Plumbing Fixtures (SIC code 3088) for approximately 2 percent.

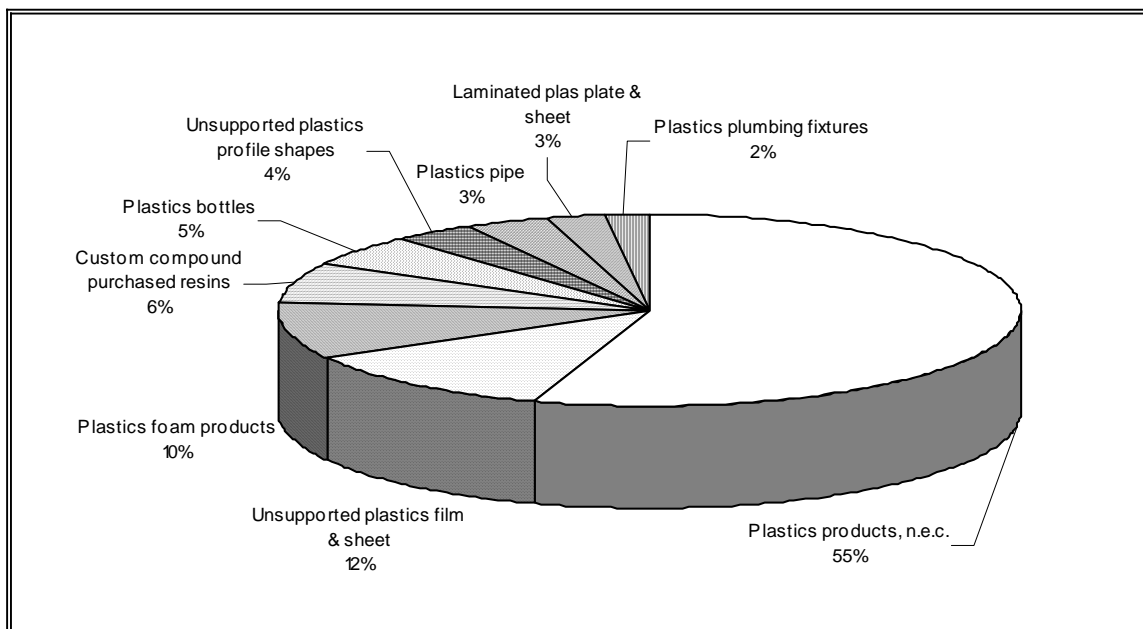
Figure 1: Diversity of the Miscellaneous Plastics Products Industry (SIC Code 308)

Source: 1997 Bureau of the Census Data.

As shown in Figure 2, in the rubber industry:

- Tire & Inner Tubes (SIC code 3011) manufacturing accounts for approximately 36 percent of all rubber product production in the United States;
- Fabricated Rubber Products, Not Elsewhere Classified (SIC code 3069) account for approximately 22 percent;
- Mechanical Rubber Goods (SIC code 3061) account for approximately 16 percent;
- Gaskets, Packing, & Sealing Devices (SIC code 3053) account for approximately 13 percent;
- Rubber & Plastics Hose & Belting (SIC code 3052) account for approximately 10 percent; and
- Rubber & Plastics Footwear (SIC code 3021) account for 3 percent.

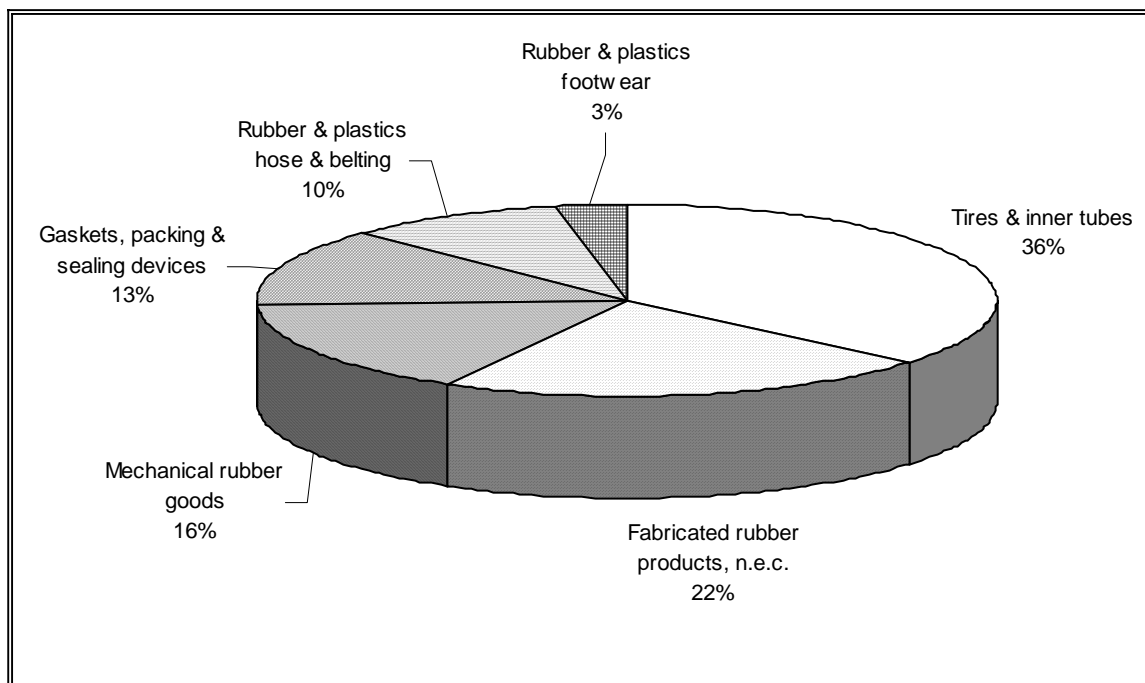
Figure 2: Diversity of the Rubber Products Industry

Source: 1997 Bureau of the Census data.

II.B.2 Industry Size and Geographic Distribution

Variation in facility counts occur across data sources due to many factors, including reporting and definitional differences. This document does not attempt to reconcile these differences, but rather reports the data as they are maintained by each source.

The Bureau of the Census estimates that in 1997, 789,200 people were employed by the miscellaneous plastics products industry and 247,800 were employed by the rubber products industry, of which the tire industry employed 64,400. The value of shipments (revenue associated with product sales) totaled \$120.3 billion in 1997 for the miscellaneous plastics products industry and \$40.4 billion for the rubber products industry, of which the tire industry contributed \$14.7 billion.

Plastic

Because of the wide range of products produced, plastics products are manufactured in all parts of the country. As shown in Table 2, approximately 47 percent of miscellaneous plastics products establishments have fewer than 20 employees. This indicates that there are a large number of small businesses in this industry. Approximately 37 percent of the industry have between 20 and 100 employees, and only 1 percent have more than 500 employees.

Although miscellaneous plastics products facilities are not concentrated in any particular region, a few states account for a large percentage of the facilities, as shown in

Figure 3. These states include California, Ohio, Texas, Michigan, New York, Pennsylvania, and New Jersey.

Table 2: Facility Size Distribution of the Miscellaneous Plastics Products Industry

Employees per Facility	Number of Facilities	Percentage of Facilities
1 to 4	2649	19
5 to 9	1719	12
10 to 19	2182	16
20 to 49	3107	22
50 to 99	2058	15
100 to 249	1685	12
250 to 499	485	3
500 to 999	117	0 (0.8)
1,000 to 2,499	20	0 (0.1)
2,500 or more	1	0 (0.007)
Total	14,023	100

Source: 1997 Bureau of the Census data.

Figure 3: Geographic Distribution of the Miscellaneous Plastics Products Industry (Number of Facilities)

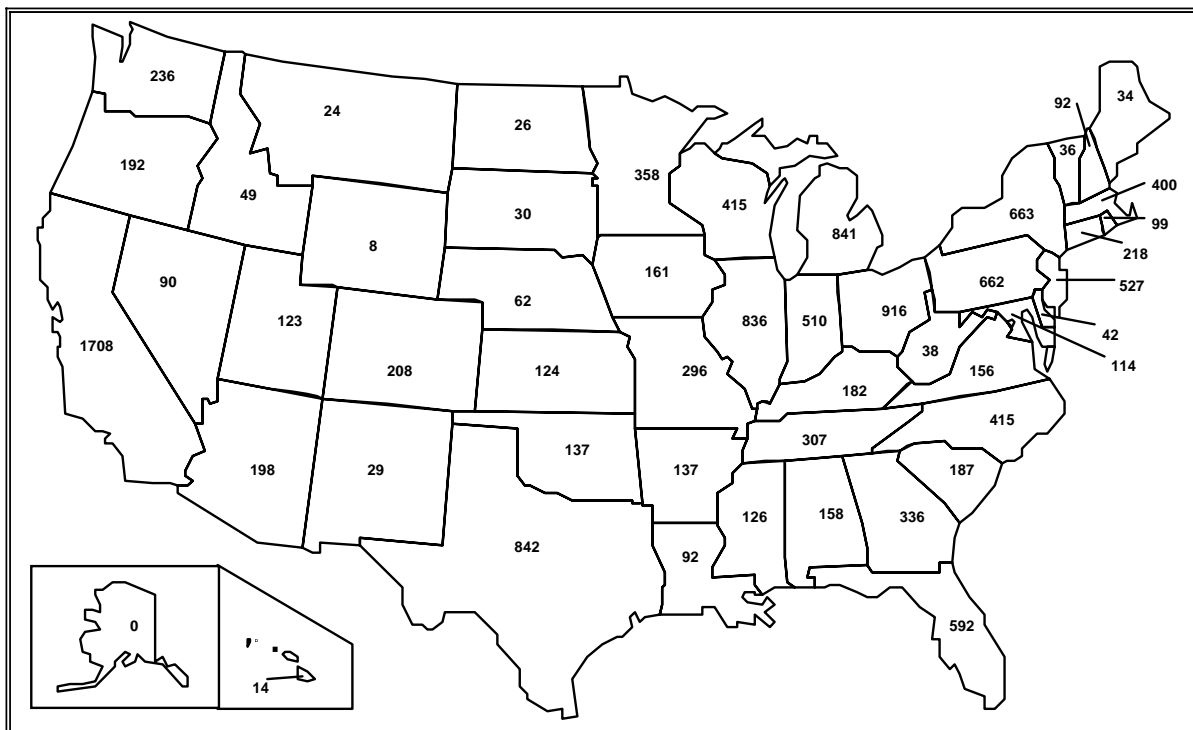

Source: 1997 Bureau of the Census data.

Rubber

Like the miscellaneous plastics products industry, the rubber products industry produces a wide range of products. Rubber products manufacturing establishments are located all across the country. As shown in Table 3, approximately 57 percent of rubber products establishments, not including tire manufacturers, have fewer than 20 employees. This indicates that there are a large number of small businesses in this industry. Approximately 26 percent of the industry have between 20 and 100 employees and only 3 percent have more than 500 employees.

Although these facilities are not concentrated in any particular region, a few states account for a large percentage of the facilities, as shown in Figure 4. These states include California, Ohio, Texas, Indiana, Pennsylvania, Florida, Michigan, and Georgia.

Table 3: Facility Size Distribution of the Rubber Products Industry

Employees per Facility	Number of Facilities	Percentage of Facilities
1 to 4	770	27
5 to 9	401	14
10 to 19	460	16
20 to 49	520	18
50 to 99	237	8
100 to 249	246	9
250 to 499	103	4
500 to 999	44	2
1,000 to 2,499	31	1
2,500 or more	2	0 (0.07)
Total	2,814	100

Source: 1997 Bureau of the Census data.

Figure 4: Geographic Distribution of the Rubber Products Industry (Number of Facilities)

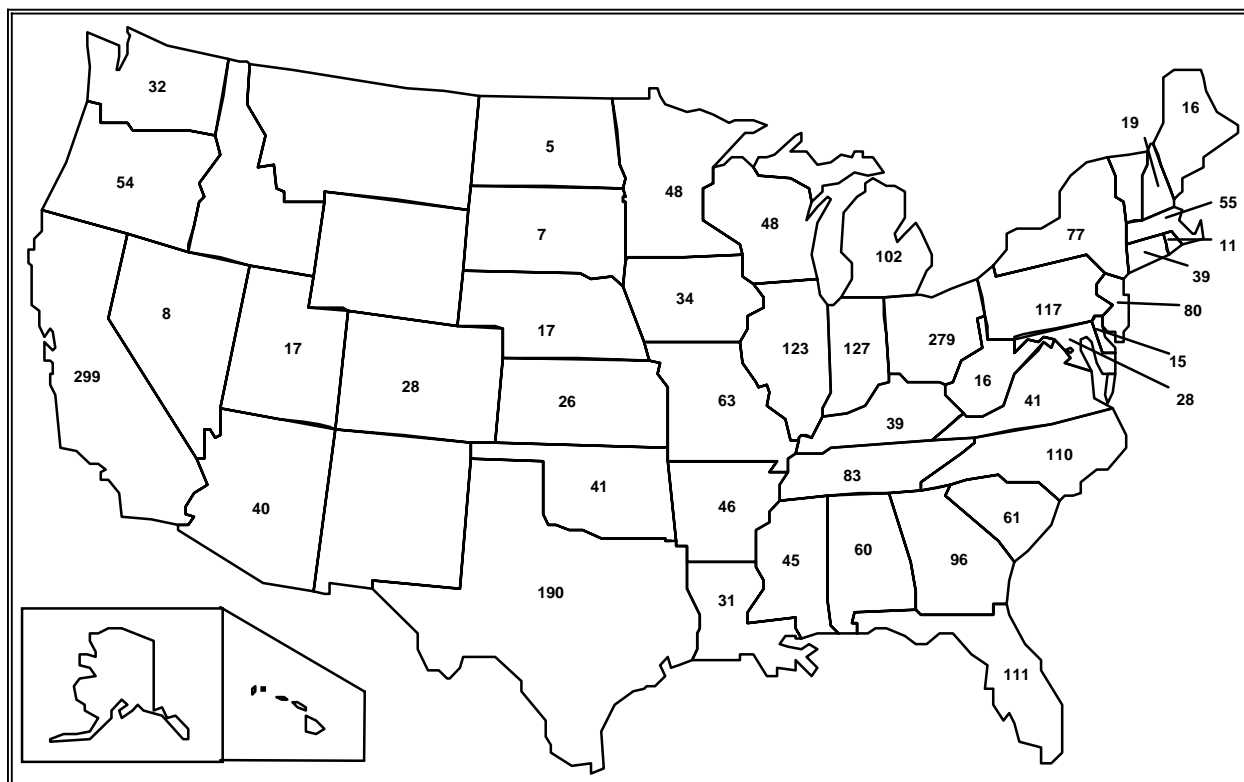

Source: 1997 Bureau of the Census data.

Tires

According to the 1997 Census of Manufacturers, there are 160 tire-manufacturing plants (SIC code 3011) in the United States. During the 2002 National Emission Standards for Hazardous Air Pollutants (NESHAP) development for tire manufacturing, EPA identified 112 major facilities along with 19 reporting retreading operations. As shown in Table 4, 46 percent of the identified 160 facilities have less than 20 employees. Labor costs currently represent about 26 percent of the cost of tire and tube production for U.S. manufacturers. States that account for a large percentage of facilities include Ohio, Pennsylvania, and Alabama.

Table 4: Facility Size Distribution of the Tire Industry

Employees per Facility	Number of Facilities	Percentage of Facilities
1 to 4	30	19
5 to 9	21	13
10 to 19	23	14
20 to 49	16	10
50 to 99	8	5
100 to 249	15	9
250 to 499	10	6
500 to 999	9	6
1,000 to 2,499	26	16
2,500 or more	2	1
Total	160	100

Source: 1997 Bureau of the Census data.

Figure 5: Geographic Distribution of the Tire Industry



Source: 1997 Bureau of the Census data.

The two largest producers of tires, Goodyear and Michelin, accounted for approximately 54 percent of tire production in 2001. As shown in Figure 6, the five largest producers, Goodyear, Michelin, Bridgestone/Firestone, Continental, and Cooper, accounted for 87 percent of production.

Figure 6: North American Tire Sales

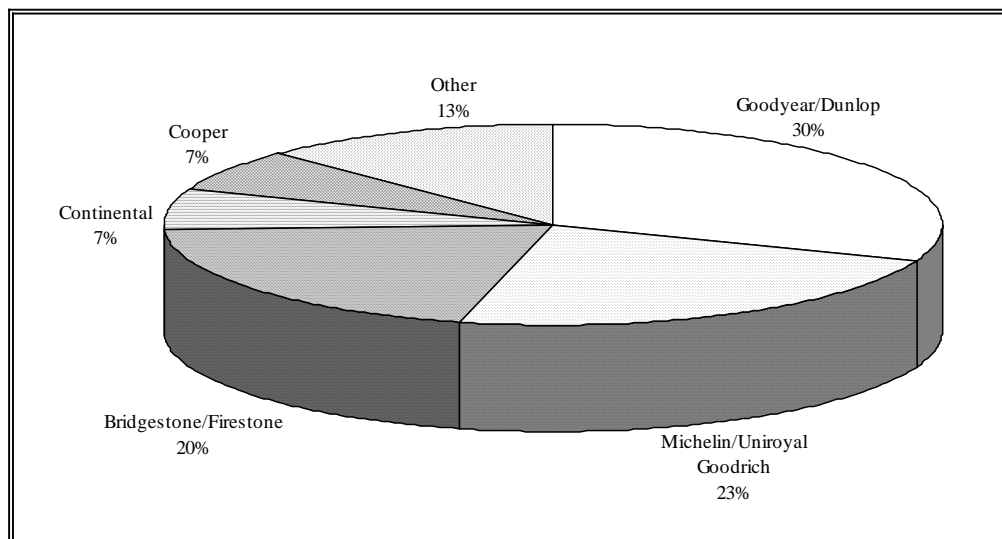

Source: *Tire Business 2001 Annual Report*

II.B.3. Economic Trends

Plastic

Consumption of miscellaneous plastics products is highest in the electronics, health care, construction, transportation, automotive, and food packaging industries. According to Plastics Data Source, shipments in the U.S. plastics industry decreased 6.6 percent from 2000 to 2002. The compound annual growth rate (CAGR) from 1995 to 2000 was 2.2 percent and the CAGR from 2000 to 2002 was -5.4 percent, signifying a downturn in the domestic plastics industry. Categories accounting for the largest increases in growth included Polystyrene Foam Products (16.2 percent) and Plastics Bottles (14.5 percent). Categories accounting for the largest decreases included Resilient Floor Covering (15.5 percent) and Urethane and Other Foam Products (13.9 percent). Long-term, the aging population in the United States will make plastics in healthcare a growth industry but pressures to cut costs will squeeze margins. Plastics in the construction industry will continue to be strong as maintenance, repair, and remodeling expenditures grow, even as new housing construction might slow. Packaging demand growth has slowed during the economic downturn but plastics have continued to gain on other materials based on performance, price, and convenience.

The three largest export markets for the U.S. plastics industry are Canada, Mexico, and Japan. In 2000, the U.S. had a trade surplus in plastics products of \$894 million. That surplus turned into a deficit of \$132 million in 2001 and a deficit of \$1.38 billion in 2002 with the deficit expected to continue to increase. In 2002, the trade deficit in plastics products with China was \$3.72 billion. Plastics products from China had been mostly consumer goods

like cups, plates, curtains, and kitchenware. Now, products like doors, windows, shutters, and builders' ware are hitting the U.S. market. In 2002, Canada accounted for 28.9 percent of U.S. plastics products imports while China accounted for 27 percent. U.S. plastics products exports no longer compete favorably against lower cost producers in many third-country markets.

Rubber

The sales of industrial rubber products are expected to rise 5.7 percent per year to more than 18 billion in 2006, outpacing growth in the general economy. This market is closely linked to durable goods shipments. Sales for mechanical rubber goods, hose, and belting will be aided by the auto industry. The trend to create quieter and more comfortable cars is promoting sales of weather stripping and vibration control materials. Slower growth is expected in the construction industry through 2006, resulting in lower demands for industrial rubber products such as roofing, flooring, and weatherstripping. The U.S. industrial rubber products industry has been undergoing a major restructuring process for over a decade.

Trading patterns reflect the U.S. rubber industry's position as a moderately competitive producer; the United States is both a major exporter to industrialized nations and an importer of lower-cost products from developing countries. Imports continue to make inroads in the domestic market and stand at a nearly 2:1 ratio to exports.

Tires

The tire industry shows signs of stabilizing after undergoing a period characterized by massive restructuring, the effects of recession in the domestic market, and consistently high levels of imports. With tire durability pushed to what many consider the practical limit, industry strategy has shifted to servicing the fast-growing emerging markets for high-performance, light truck, and recreational vehicle tires.

Replacement tires for passenger cars dropped 4 percent in 2001 while replacement tires for commercial truck tires dropped 10 percent. These declines were offset by 10.6 percent growth in high-performance tires and 10.2 percent growth in light truck tires. The tire industry saw a 2.6 percent growth (anticipated negligible growth) in 2002 and a slight increase of 0.6 percent over 2002 and 2003 (but anticipated growth of over 4 percent in 2003). Industry shipments reached record levels in 2000, with higher than average growth expected for the high-performance, truck, and light truck tires and little or no growth projected for passenger tires installed on new cars.

Key growth figures for segments in the tire industry include the following:

- Original Equipment Passenger Tires - Little or no growth is anticipated from 2004 through 2009 (growth through 2007 expected to be less than 0.3 percent annualized), partially due to greater light vehicle production outside the United States.
- Original Equipment Light Truck Tires - Growth through 2009 expected to be 2.7 percent annualized.

- Original Equipment Medium/Wide-Base Truck Tires - Growth through 2006 expected to be 50 percent from 2003 level, topping out in 2006 due to EPA restrictions on emission standards for these trucks.
- Replacement Passenger Tires - Growth through 2009 expected to be slightly over 2 percent annualized.
- Replacement Light Truck Tires - Growth through 2009 expected to be just under 3 percent annualized.
- Replacement Medium/Wide-Base Truck Tires - The market grew at a 5.5 percent rate in 2003. This growth rate is expected to continue through 2006 and then remain at this level through 2009.
- Tread rubber for retread tires rebounded in the second half of 2003. Shipments through 2005 are expected to increase with an annual growth rate of 2.7 percent through 2005.

During the 1980s, corporate restructuring, mergers, and acquisitions resulted in the globalization of the tire industry. More than half of domestic production capacity is now owned by foreign-based tire manufacturers, mainly European and Japanese. Among the advantages realized by the surviving companies are increased resources for research and development, and economies of scale across procurement, manufacturing, distribution, and service.

All four of the major tire producers in the United States are involved in the production of the synthetic rubber used in tire production, and two of these producers own and operate natural rubber plantations. More than 80 percent of the sales revenue of the four major producers (both foreign and domestic) is derived from tires and related transportation products such as rubber belts and hoses.

III. INDUSTRIAL PROCESS DESCRIPTION

This section describes the major industrial processes within the RMPP industry, including the materials, equipment, and processes used. The section is designed for those interested in gaining a general understanding of the industry, and for those interested in the interrelationship between the industrial process and the topics described in subsequent sections of this profile - pollutant outputs, pollution prevention opportunities, and federal regulations. This section does not attempt to replicate published engineering information that is available for this industry. Refer to Section IX for a list of reference documents that are available.

This section describes commonly used production processes, associated raw materials, the by-products produced or released, and the materials either recycled or transferred off site. Coupled with schematic drawings of the identified processes, this section concisely describes where wastes may be produced in the process and also describes the potential fate (air, water, land) of these waste products.

III.A. Industrial Processes in the RMPP Industry

The processes used to manufacture plastic and rubber are very diverse; therefore, this section presents them individually.

III.A.1. Plastic

The production of plastics products, both solid and foam, is a relatively diverse industry. Simpler processes consist of: (1) imparting the appropriate characteristics to the plastic resin with chemical additives; (2) converting plastic materials in the form of pellets, granules, powders, sheets, fluids, or preforms into either intermediate or final formed plastic shapes or parts via molding operations; and (3) finishing the product, as shown in Figure 7.

There are also several methods of reacting plastic resin and catalyst materials to form a thermoset plastic material into its final shape, as shown in Figure 8.

Additives are often mixed with the plastic materials to give the final product certain characteristics (some of these additives can also be applied to the shaped product during the finishing process). These plastic additives and their functions, in terms of their effect on the final product, are listed below.

- **Additive Lubricants** assist in easing the flow of the plastic in the molding and extruding processes by lubricating the metal surfaces that come into contact with the plastic.
- **Antioxidants** inhibit the oxidation of plastic materials that are exposed to oxygen or air at normal or high temperatures.

Figure 7: Plastics Products Manufacturing Process

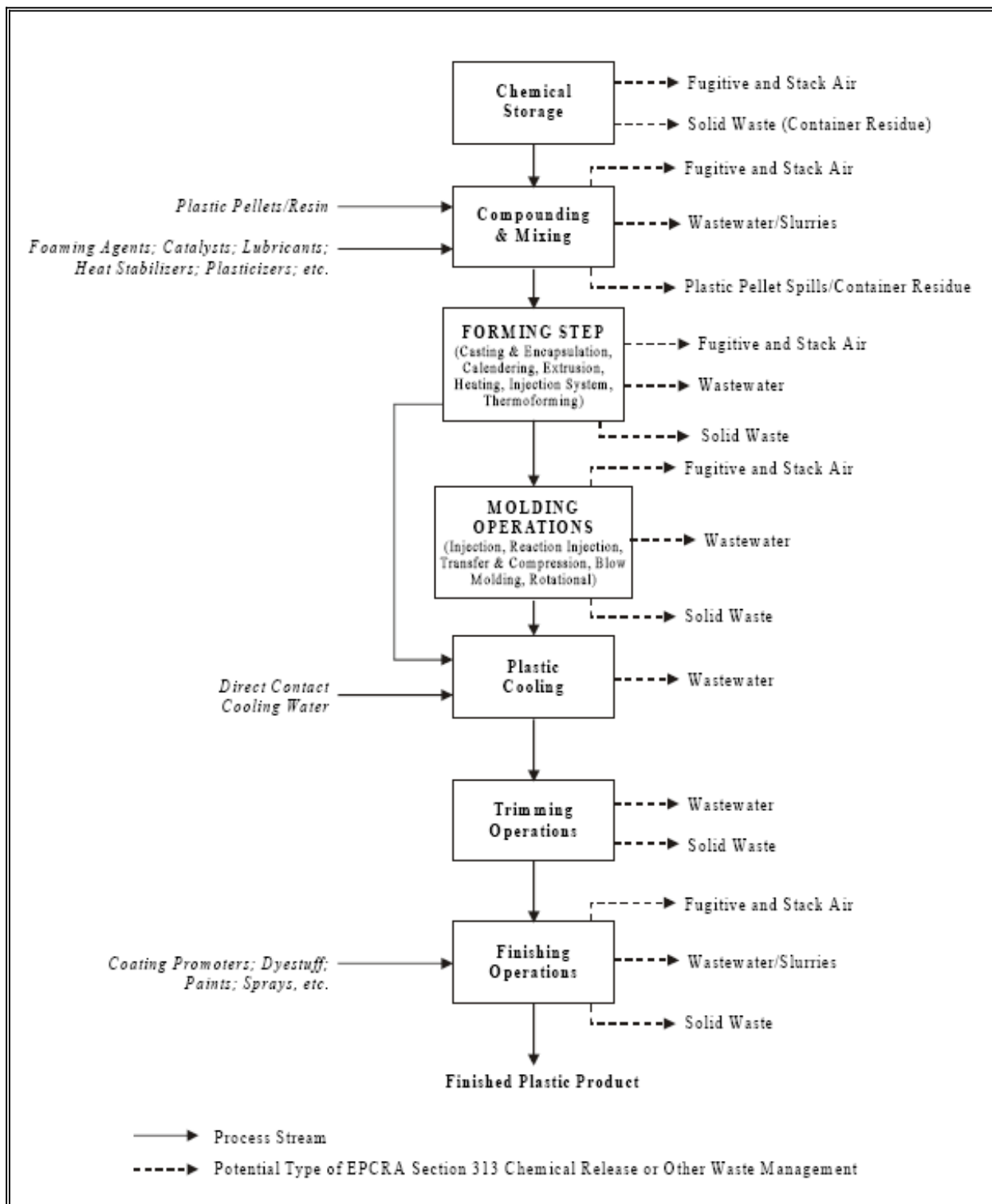

Source: Emergency Planning and Community Right-To-Know Act (EPCRA) Section 313 Reporting Guidance for Rubber and Plastics Manufacturing, May 2000.

- **Antistats** impart a minimal to moderate degree of electrical conductivity to the plastic compound, preventing electrostatic charge accumulation on the finished product.
- **Blowing Agents (foaming agents)** produce a cellular structure within the plastic mass and can include compressed gases that expand upon pressure release, soluble solids that leach out and leave pores, or liquids that change to gases and, in the process, develop cells.
- **Colorants** impart color to the plastic resin.
- **Flame Retardants** reduce the tendency of the plastic product to burn.
- **Heat Stabilizers** assist in maintaining the chemical and physical properties of the plastic by protecting it from the effects of heat such as color changes, undesirable surface changes, and decreases in electrical and mechanical properties.
- **Impact Modifiers** prevent brittleness and increase the resistance of the plastic to cracking.
- **Organic Peroxides** initiate or control the rate of polymerization in thermosets and many thermoplastics.
- **Plasticizers** increase the plastic product's flexibility and workability.
- **Ultraviolet Stabilizers (UV light absorbers)** absorb or screen out ultraviolet radiation, thereby preventing the premature degradation of the plastic product.

After adding the necessary additives to the plastic pellets, granules, powders, etc., the plastic mixture is formed into intermediate or final plastics products. To form solid plastics products, a variety of molding processes are used, including injection molding, reaction injection molding, extrusion, blow molding, thermoforming, rotational molding, compression molding, transfer molding, casting, encapsulation, and calendering. Slightly different processes are used to make foamed plastics products. The choice of which plastic forming process to use is influenced by economic considerations, the number and size of finished parts, the adaptability of particular plastic to a process (various plastic will mold, process, etc., differently), and the complexity of the post-forming operations. Below are brief descriptions of the most common molding and forming processes for creating solid plastics products.

Injection Molding: In the injection molding process, plastic granules or pellets are heated and homogenized in a cylinder until they are fluid enough to be injected (by pressure) into a relatively cold mold where the plastic takes the shape of the mold as it solidifies. Advantages of this process include speed of production, minimal post-molding requirements, and simultaneous multipart molding. The reciprocating screw injection machine is the dominant technology used in injection molding. The screw acts as both a material plasticizer and an

injection ram. The buildup of viscous plastic at the nozzle end of a cylinder forces the screw backwards as it rotates. When an appropriate charge accumulates, rotation stops and the screw moves forward, thereby becoming an injection ram, forcing the melt (liquefied plastic) into the mold. The screw remains forward until the melt solidifies and then returns to repeat the cycle, as shown in Figure 8. Products made in this way include CDs, DVDs, kitchen utensils, automotive components, garbage cans, and countless others.

Figure 8: Injection Molding

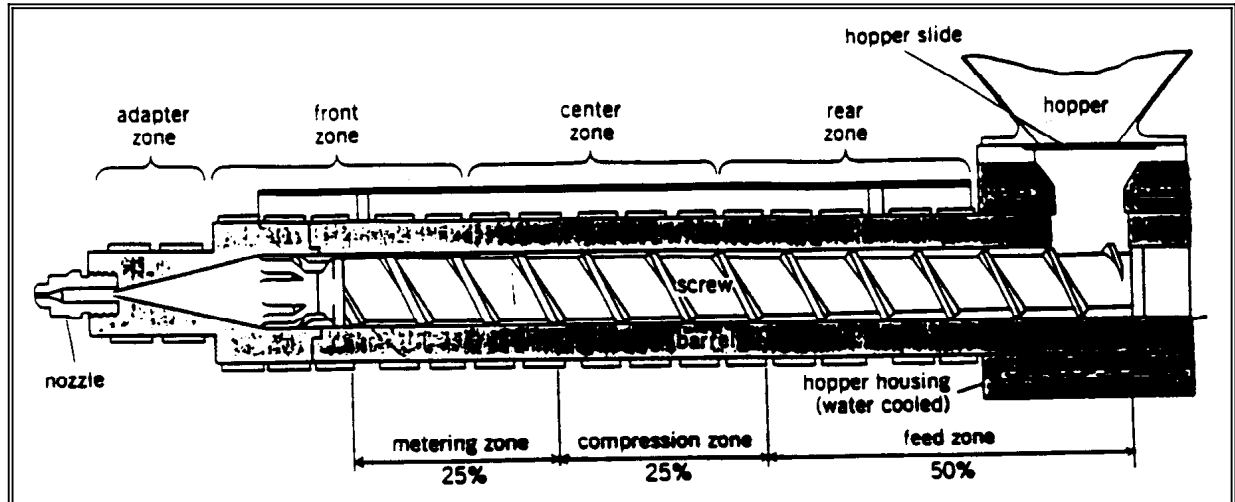

Source: McGraw-Hill Encyclopedia of Science and Technology.

Reaction Injection Molding: In the reaction injection molding process, two liquid plastic components, polyols and isocyanates, are mixed at relatively low temperatures (75 - 140 degrees F) in a chamber and then injected into a closed mold to form polyurethane products. The parts molded using this process can be foams or solids, and they can range from being flexible to extremely rigid. Products include large polyurethane foams for noise abatement and large panels for any indoor or outdoor application. Polyurethane is also used to encapsulate items and protect them from the environment.

Reaction injection molding requires far less energy than other injection molding systems because an exothermic reaction occurs when the two liquids are mixed. Reaction injection molding is a relatively new processing method that is quickly becoming common in the industry. Reinforced reaction injection molding involves placing long fibers or fiber mats in the mold before injection.

Extrusion: In the extrusion process, plastic pellets or granules are fluidized, homogenized, and formed continuously as the extrusion machine feeds them through a die, as shown in Figure 9. The result is a very long plastic shape such as a tube, pipe, sheet, or coated wire. Extruding is often combined with post-extruding processes such as blowing, thermoforming, or punching. Extrusion molding has an extremely high rate of output (e.g., pipe can be formed at a rate of 2,000 lb/hr (900 kg/hr)).

Figure 9: Extrusion

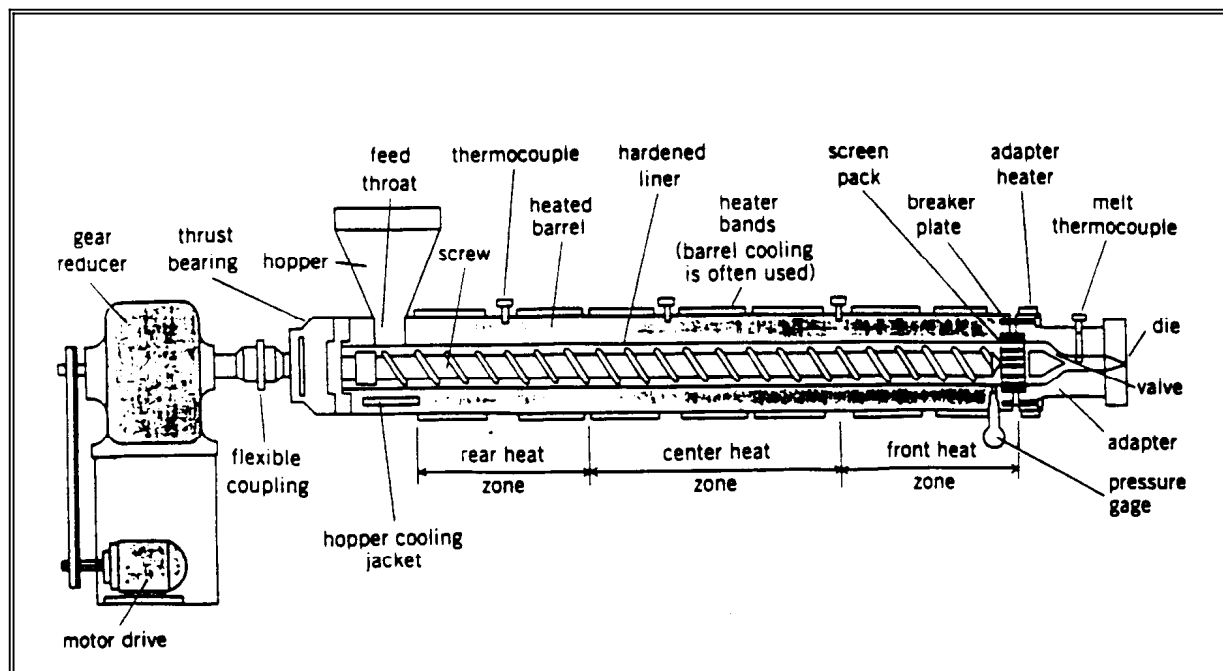

Source: McGraw-Hill Encyclopedia of Science and Technology.

Blow Molding: Blow molding describes any forming process in which air is used to stretch and form plastic materials. In one method of blow molding, a tube is formed (usually by extrusion molding) and then made into a free-blown hollow object by injecting air or gas into the tube. Blow molding can also consist of putting a thermoplastic material in the rough shape of the desired finished product into a mold and then blowing air into the plastic until it takes the shape of the mold, similar to blowing up a balloon. Examples of products include a wide variety of beverage and food containers.

Thermoforming: In the thermoforming process, heat and pressure are applied to plastic sheets, which are then placed over molds and formed into various shapes. The pressure can be in the form of air, compression, or a vacuum, as shown in Figure 10. This process is popular because compression is relatively inexpensive. Products include clam shells and blister packaging for the shipping industry as well as thin plastic components for retail packaging.

Rotational Molding: In the rotational molding process, finely ground plastic powders are heated in a rotating mold to the point of either melting and/or fusion. The inner surface of the rotating mold is then evenly coated by the melted resin. The final product is hollow and produced scrap-free. Products include fuel tanks, side paneling for vehicles, and carrier cases.

Figure 10: Thermoforming

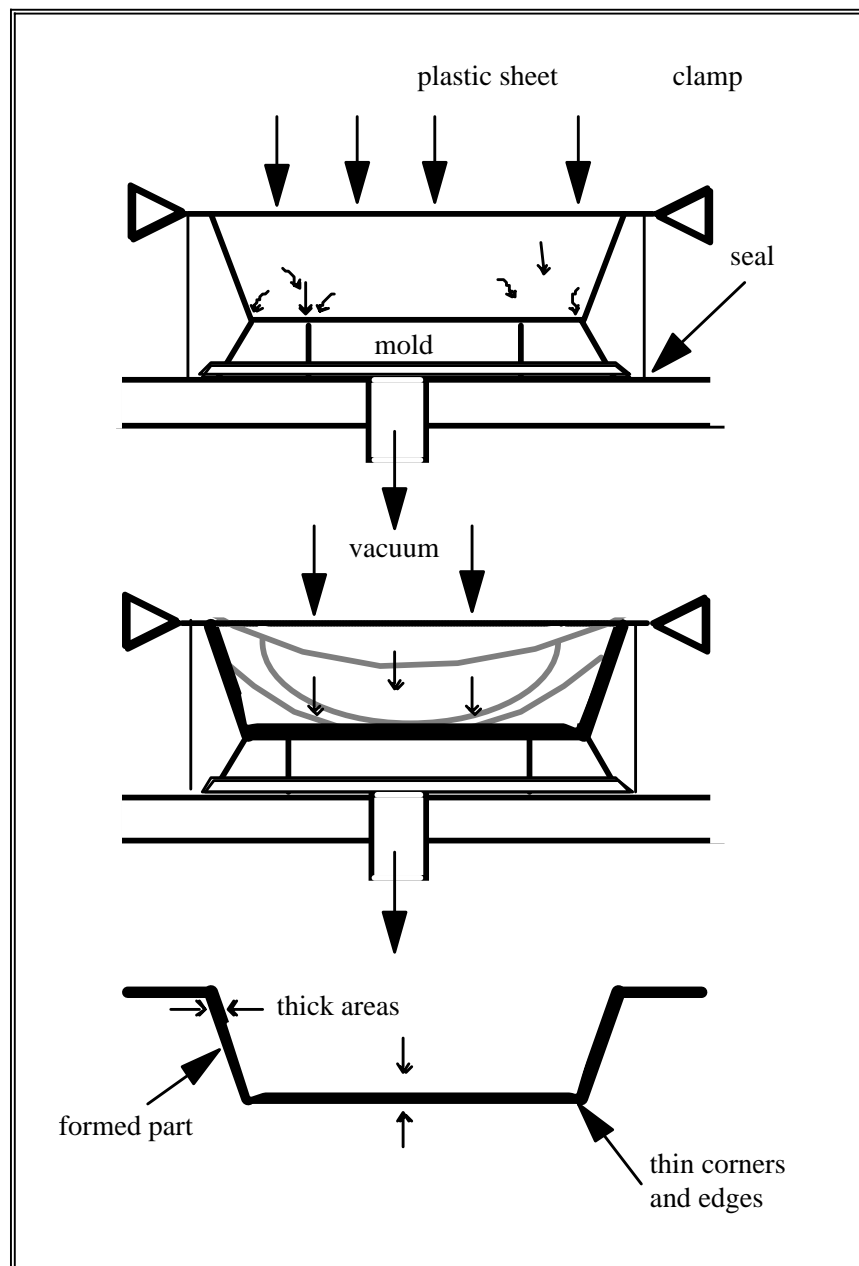

Source: McGraw-Hill Encyclopedia of Science and Technology.

Compression and Transfer Molding: In the compression molding process, plastic powder or a preformed plastic part is plugged into a mold cavity and compressed with pressure and heat until it takes the shape of the cavity. Transfer molding is similar, except that the plastic is liquefied in one chamber and then injected into a closed mold cavity by a hydraulically operated plunger, as shown in Figure 11. Transfer molding was developed to facilitate the molding of intricate plastics products that contain small deep holes or metal inserts because compression molding often ruins the position of the pins that form the holes and the metal inserts.

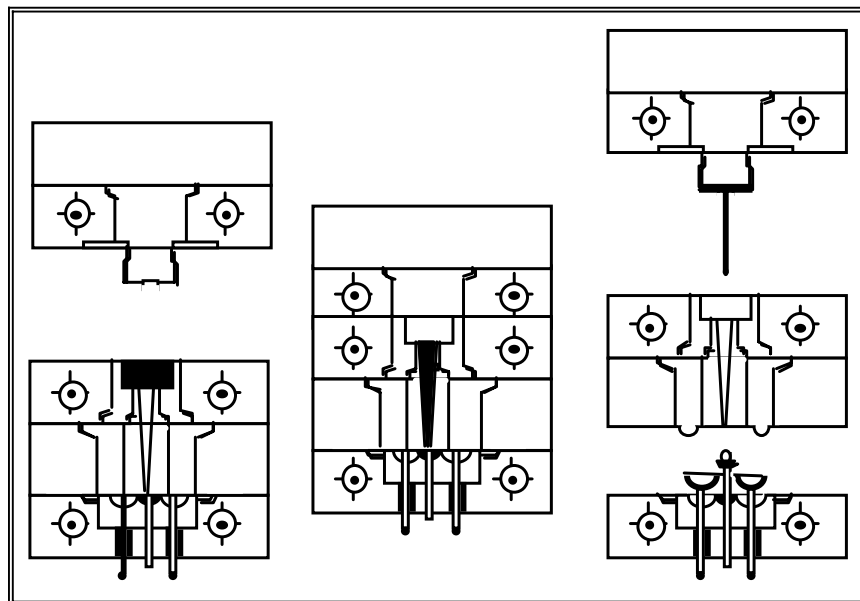
Figure 11: Transfer Molding

Source: McGraw-Hill Encyclopedia of Science and Technology.

Casting and Encapsulation: In the casting process, liquid plastic is poured into a mold until it hardens and takes the shape of the mold. In the encapsulation or potting process, an object is encased in plastic and then hardened by fusion or a chemical reaction, as shown in Figure 12.

Calendering: In the calendering process, plastic parts are squeezed between two rolls to form a thin, continuous film.

Foamed Plastic: Manufacturing foamed plastics products involves slightly different forming processes than those described above. The three types of foam plastic are blown, syntactic, and structural. Blown foam is an expanded matrix, similar to a natural sponge; syntactic foam is the encapsulation of hollow organic or inorganic micro spheres in the plastic matrix; and structural foam is a foamed core surrounded by a solid outer skin. All three types of foam plastic can be produced using processes such as injection, extrusion, and compression molding to create foam products in many of the same shapes as solid plastics products. The difference is that creating foam products requires processes such as chemical blowing agent addition, different mixing processes that add air to the plastic matrix, or a unique injection molding process used to make structural plastic.

Figure 12: Encapsulation

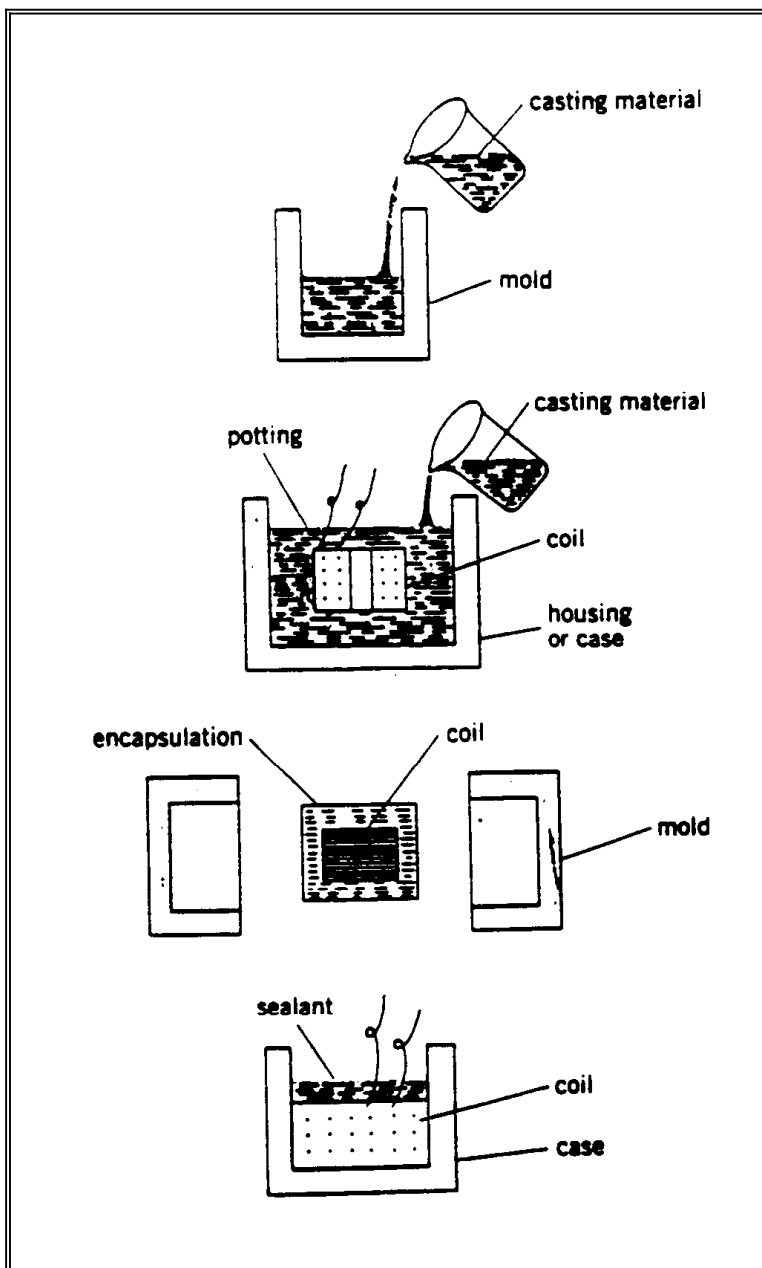

Source: McGraw-Hill Encyclopedia of Science and Technology.

The following are some basic processes that occur in conjunction with the standard molding and forming operations to produce blown foam plastic and syntactic foam plastic:

- A chemical blowing agent that generates gas through thermal decomposition is incorporated into the polymer melt;
- Gas that is under pressure is injected into the melt and then expands during pressure relief;

- A low-boiling liquid hydrocarbon is incorporated into the plastic compound and volatilized through the exothermic heat of reaction;
- Nonchemical gas-liberating agents (adsorbed gas on finely divided carbon) are added to the resin mix and released during heating;
- Air is dispersed by mechanical means within the polymer (similar to whipping cream); or
- The external application of heat causes small beads of thermoplastic resin containing a blowing agent to expand.

Structural foam plastic is made by injection molding liquid resins that contain chemical blowing agents. Less mixture is injected into the mold than is needed to mold a solid plastic part. At first the injection pressure is very high, causing the blowing agent mixture to solidify against the mold without undergoing expansion. As the outer skin is formed, the pressure is reduced and the remaining resin expands to fill the remainder of the mold. Structural foam plastic parts have a high strength-to-weight ratio and often have three to four times greater rigidity than solid plastic molded parts of equal weight that are made of the same material.

After the solid or foam plastic shape is created, post-forming operations such as welding, adhesive bonding, machining, applying of additives, and surface decorating (painting and metalizing) are used to finish the product.

Thermoset Resin: To produce a thermoset plastic material, liquid resins are combined with a catalyst. Resins used for thermoset plastic products include urethane resins, epoxy resins, polyester resins, and acrylic resins. Fillers are often added to the resin-catalyst mixture prior to molding to increase product strength and performance and to reduce cost. Most thermoset plastic products contain large amounts of fillers (up to 70 percent by weight). Commonly used fillers include mineral fibers, clay, glass fibers, wood fibers, and carbon black. After the thermoset material is created, a final or intermediate product can be molded.

Various molding options can be used to create the intermediate or final thermoset product. These processes include vacuum molding, press molding, rotational molding, hand lamination, casting and encapsulation, spray-up lamination, resin transfer molding, filament winding, injection molding, reaction injection molding, and pultrusion.

III.A.2. Rubber

Rubber product manufacturing is as diverse as the number of rubber products produced. Even with this diversity, there are several basic, common processes. This profile focuses on the basic processes of mixing, milling, extruding, calendaring, building, vulcanizing, and finishing, as shown in Figure 13.

Figure 13: Rubber Manufacturing Process

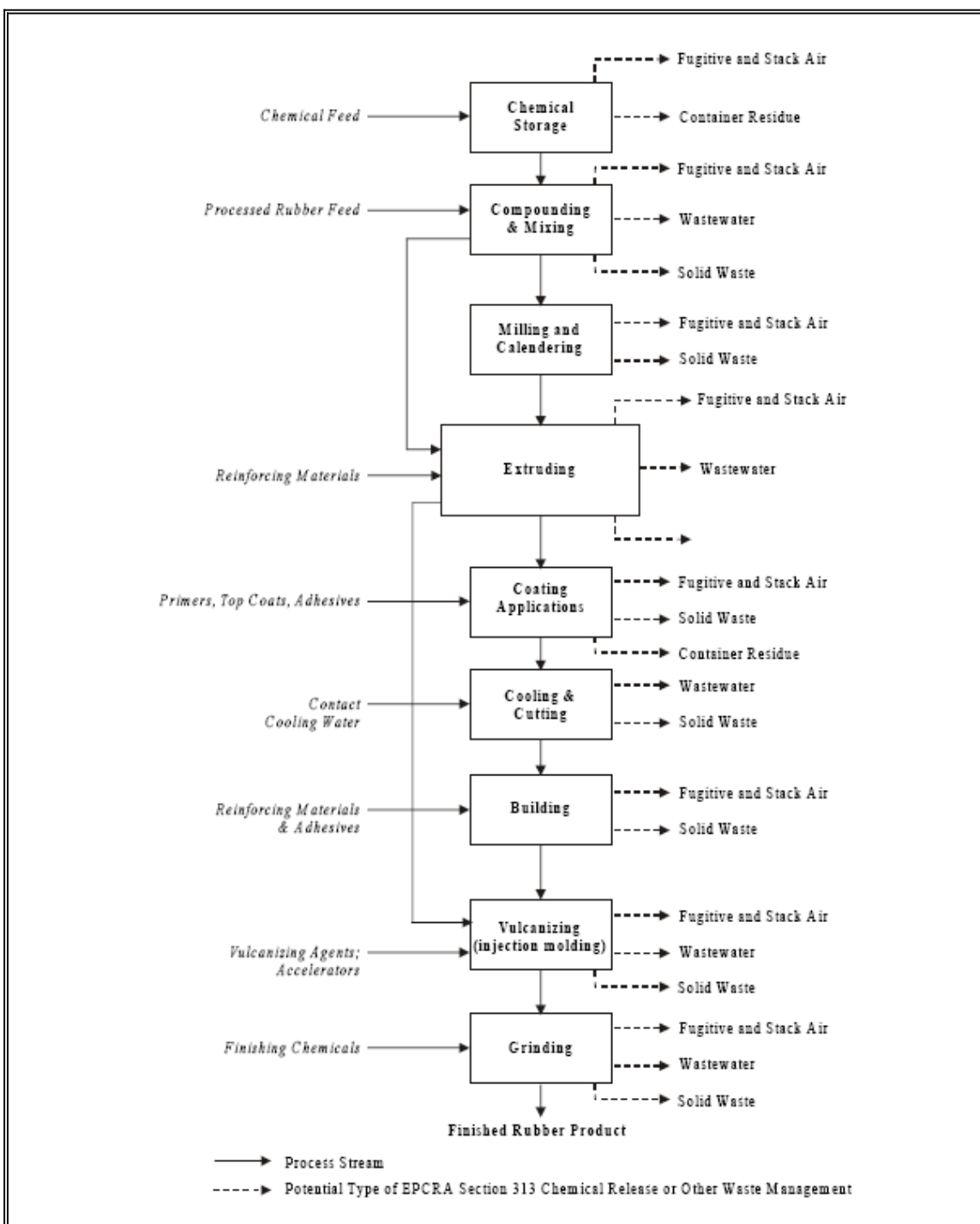

Source: Emergency Planning and Community Right-To-Know Act (EPCRA) Section 313 Reporting Guidance for Rubber and Plastics Manufacturing, May 2000.

Mixing: The rubber product manufacturing process begins with the production of a rubber mix from polymers (i.e., raw and/or synthetic rubber), carbon black (the primary filler used in making a rubber mixture), oils, and miscellaneous chemicals. The miscellaneous chemicals include processing aids, vulcanizing agents, activators, accelerators, age resistors,

fillers, softeners, and specialty materials. The following is a list of these miscellaneous chemicals and the functions they perform:

- **Processing Aids** modify the rubber during the mixing or processing steps, or aid in a specific manner during the extrusion, calendaring, or molding operations.
- **Vulcanizing Agents** create cross links between polymer chains.
- **Activators**, in combination with vulcanizing agents, reduce the curing time by increasing the rate of vulcanization.
- **Accelerators** form chemical complexes with activators and thus aid in maximizing the benefits from the acceleration system by increasing vulcanization rates and improving the final product's properties.
- **Age Resistors** slow down the deterioration of the rubber products that occurs through reactions with materials that may cause rubber failure (e.g., oxygen, ozone, light, heat, radiation).
- **Fillers** reinforce or modify the physical properties of the rubber, impart certain processing properties, and reduce costs by decreasing the quantity of more expensive materials needed for the rubber matrix.
- **Softeners** either aid in mixing, promote greater elasticity, produce tack, or extend (replace) a portion of the rubber hydrocarbon (without a loss in physical properties).
- **Specialty Materials** include retarders, colorants, blowing agents, dusting agents, odorants, etc. Specialty materials are used for specific purposes, and are not required in the majority of rubber compounds.

Rubber mixes differ depending upon the desired characteristics of the product being manufactured. The process of rubber mixing includes the following steps - mixing, milling (or other means of sheeting), antitack coating, and cooling. The appropriate ingredients are weighed and loaded into an internal mixer known as a "Banbury" mixer, which then combines these ingredients. The area where the chemicals are weighed and added to the Banbury is called the compounding area. The polymers and miscellaneous chemicals are manually introduced into the mixer hopper, while carbon black and oils are often injected directly into the mixing chamber from bulk storage systems. The mixer creates a homogeneous mass of rubber using two rotors that shear materials against the walls of the machine's body. The rubber is then cooled as this mechanical action also adds considerable heat to the rubber.

Milling: The mixed rubber mass is discharged to a mill or other piece of equipment that forms it into a long strip or sheet. The hot, tacky rubber then passes through a water-based "antitack" solution that prevents the rubber sheets from sticking together as they cool to ambient temperature. The rubber sheets are placed directly onto a long conveyor belt

that, through the application of cool air or cool water, lowers the temperature of the rubber sheets.

After cooling, the sheets of rubber are sent through another mill. These mills "warm up" the rubber for further processing on extruders and calenders. Some extruders can be "cold fed" rubber sheets, making this milling step unnecessary.

Extruding: Extruders transform the rubber into various shapes or profiles by forcing it through dies via a rotating screw. Extruding heats the rubber, which remains hot until it enters a water bath or spray conveyor where it cools.

Calendering: Calenders receive hot strips of rubber from mills and squeeze them into reinforcing fibers or cloth-like fiber matrices, thus forming thin sheets of rubber-coated materials. Calenders are also used to produce nonreinforced, thickness-controlled sheets of rubber.

Building: Extruded and calendered rubber components are combined (layered, built-up) with wire, polyester, aramid, and other reinforcing materials to produce various rubber products. Adhesives, called cements, are sometimes used to enhance the bonding of the various product layers. This assembling, reinforcing, precuring, and bonding process is called building.

Vulcanizing: All rubber products undergo vulcanization (curing). This process occurs in heated compression molds, steam-heated pressure vessels (autoclaves), hot air and microwave ovens, or various molten and fluidized bed units. During the curing process, the polymer chains in the rubber matrix cross-link to form a final product of durable, elastic, thermoset rubber. Increasing the number of cross-links in the rubber matrix gives rubber its elastic quality. One way to visualize this is to think of a bundle of wiggling snakes in constant motion. If the bundle is pulled at both ends and the snakes are not entangled, then the bundle comes apart. The more entangled the snakes are (like the rubber matrix after vulcanization), the greater the tendency for the bundle to bounce back to its original shape.

Finishing: Finishing operations are used to prepare the products for delivery to the end user. Finishing operations might include balancing, grinding, printing, washing, wiping, and buffing.

Due to the diversity of products and facilities, not all of the processes shown in Figure 13 are necessary for every product. For example, many plants do not mix rubber but purchase uncured rubber from other facilities.

Figure 14 illustrates the processes used to manufacture the following rubber products:

- **Belts** - A typical belt plant does not have an extruder but uses many layers of calendered material assembled on a lathe type builder to produce a rubber cylinder from which individual belts can be cut.

Figure 14: Processes Used to Manufacture Various Rubber Products

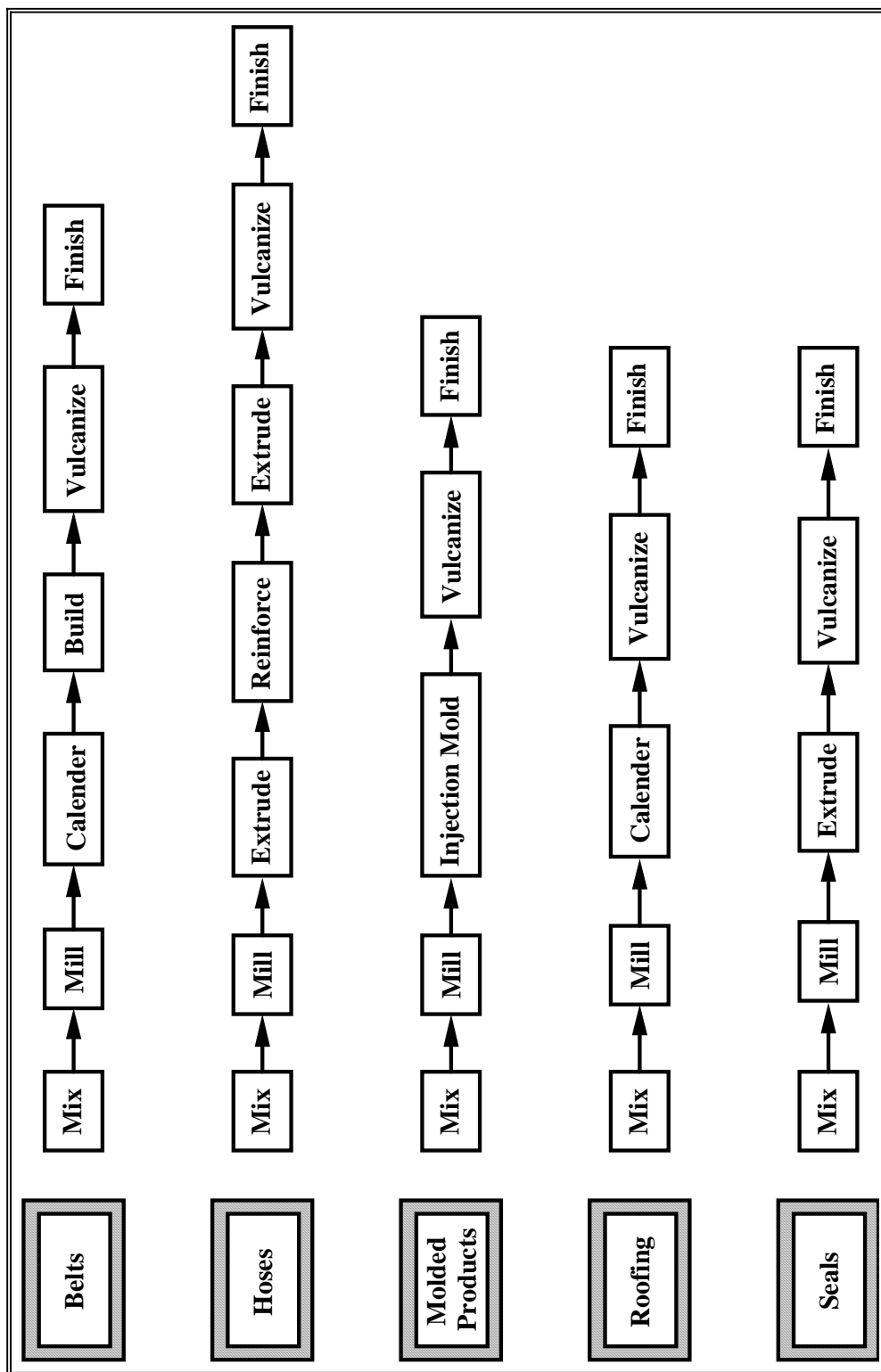

- **Hoses** - A hose plant uses an extruder to produce a tube that is reinforced with cord or wire and covered with a layer of rubber applied by an extruder. The same extruder may be used to produce the initial tube and then to extrude the final "cover" layer onto the reinforced tube.
- **Molded Products** - A molded products plant uses extruded material to feed compression molds, or may cut strips directly from the mixing process to feed the molds.
- **Roofing** - Roofing manufacturers processes rubber through mills and calenders to produce the necessary sheeting.
- **Sealing** - Sealing products manufacturing plants uses extrusion and continuous vulcanization in hot air ovens.

III.A.3. Tires

The tire manufacturing process is similar to that of manufacturing other rubber products. The main difference between the two processes is that the building process for manufacturing tires is generally more complex because there are many rubber components.

As shown in Figure 15, the tire production process in its most basic form consists of the following sequential steps:

- **Compounding and mixing** elastomers, carbon blacks, pigments, and other chemicals such as vulcanizing agents, accelerators, plasticizers, and initiators. The process begins with mixing basic rubbers with process oils, carbon black, pigments, antioxidants, accelerators and other additives, each of which contributes certain properties to the compound. These ingredients are mixed in Banbury mixers operating under tremendous heat and pressure. They blend the many ingredients into a hot, black gummy compound that will be milled again and again.
- **Milling.** The cooled rubber takes several forms. Most often it is processed into carefully identified slabs that will be transported to breakdown mills. These mills feed the rubber between massive pairs of rollers, over and over, feeding, mixing, and blending to prepare the different compounds for the feed mills, where they are slit into strips and carried by conveyor belts to become sidewalls, treads or other parts of the tire.
- **Extruding** operations use warming mills and either a hot or cold extruder. The equipment forces the rubber compound through dies that create individual or a continuous sidewall and tire tread components for future tire building.

Figure 15: Tire Manufacturing Process

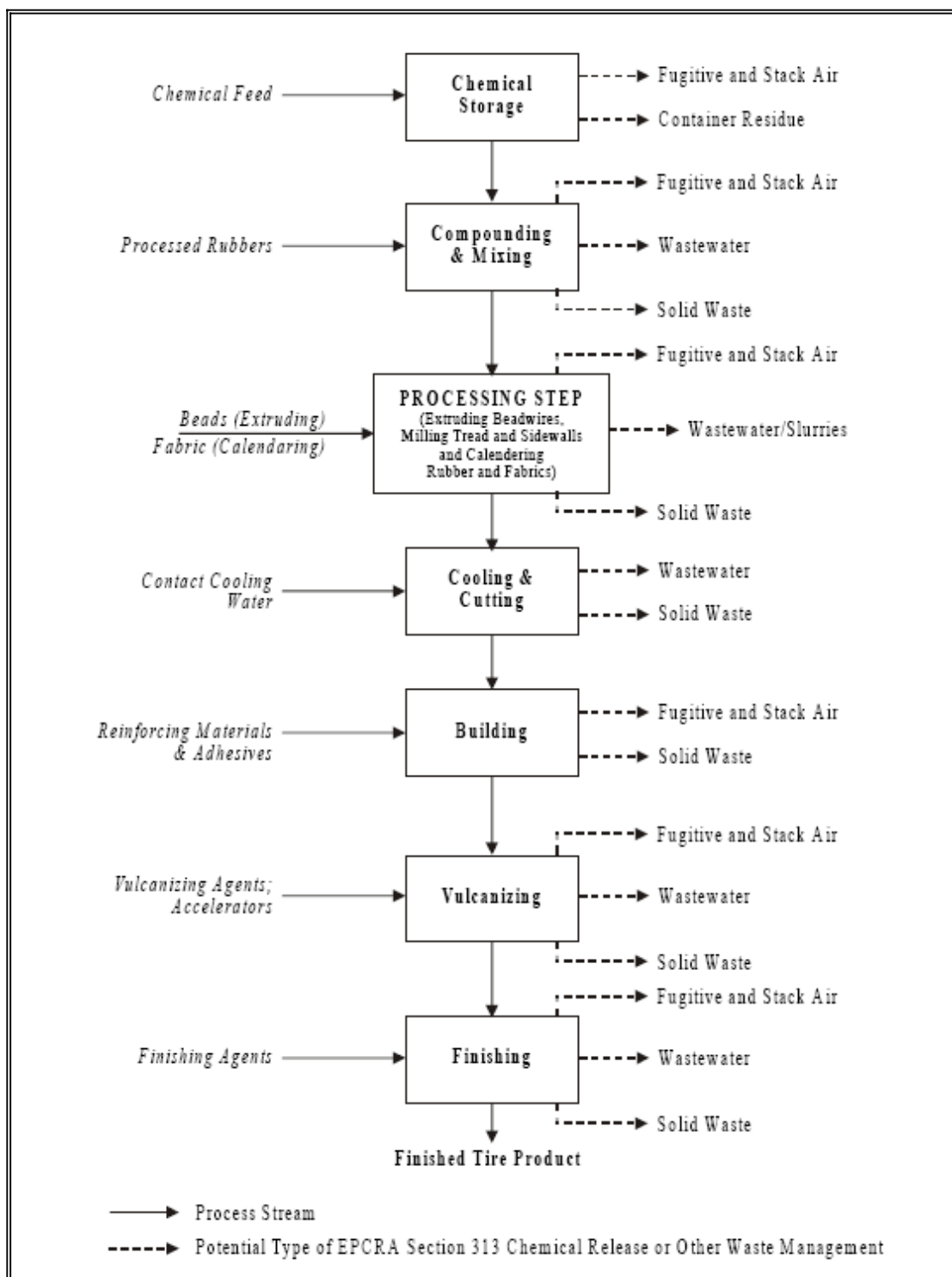

Source: Emergency Planning and Community Right-To-Know Act (EPCRA) Section 313 Reporting Guidance for Rubber and Plastics Manufacturing, May 2000.

- **Tire cord manufacturing and calendering.** Processing fabrics and coating them with rubber is a calendering operation. A specific rubber coats the fabric that is used to make up the tire's body. The fabrics come in huge rolls, and they are as specialized and critical as the rubber blends. Many kinds of fabrics are used, including polyester, rayon, and nylon.
- **Bead wire processing.** It has high-tensile steel wire forming its backbone, which will fit against the vehicle's wheel rim. The strands are aligned into a ribbon coated with rubber for adhesion, then wound into loops that are then wrapped together to secure them until they are assembled with the rest of the tire.
- **Tire building.** Tires are manually built on one or two tire machines. The tire starts with a double layer of synthetic gum rubber called an inner liner that will seal in air and make the tire tubeless. The operator uses the tire building machine to preshape tires into a form very close to their final dimension to make sure the many components are in proper position before the tire goes into the mold. The resulting tire is called a “green” tire, which is uncured.
- **Lubricating.** The lubrication or spraying system provides a coating, primarily silicon, on the green tire to afford mold release after curing.
- **Vulcanizing and molding.** The curing press is where tires get their final shape and tread pattern. Hot molds like giant waffle irons shape and vulcanize the tire. The molds are engraved with the tread pattern, the sidewall markings of the manufacturer, and those required by law.
- **Finishing and quality assurance.** The operation includes balancing, grinding, and painting and marking the tire.

The main piece of equipment used in tire-building is the drum, which is a collapsible cylinder shaped like a wide drum that the tire builder can turn and control. The building process begins when carcass plies, also known as rubberized fabric, are placed on a drum one at a time, after which the cemented beads (rubber coated wires) are added and the plies are turned up around them. Narrow strips of fabric are then cemented on for additional strength. At this stage, the belts, tread, and sidewall rubber are wrapped around the drum over the fabric. The drum is then collapsed and the uncured (green) tire is coated with a lubricant (green tire spray) and loaded into an automatic tire press to be molded and cured. Prior to curing, the tire looks like a barrel that is open at both ends. The curing process converts the rubber, fabric, and wires into a tough, highly elastic product while also bonding the various parts of the tire into one single unit, as shown in Figure 16. After curing, the tire is cooled by mounting it on a rim and deflating it to reduce internal stress. Finishing the tire involves trimming, buffing, balancing, and quality control inspection.

Figure 16: Tire Formation

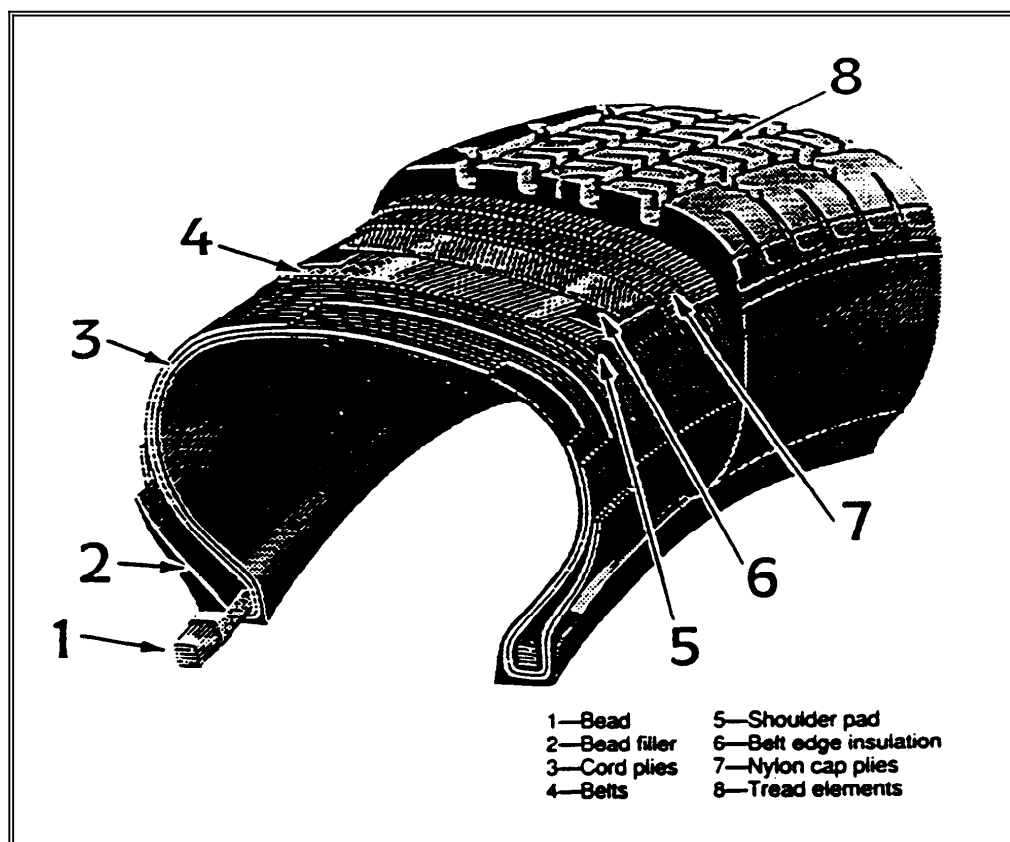

Source: "Tire Materials and Construction" in *Automotive Engineering*, October 1992.

III.B. Raw Material Inputs and Pollution Outputs in the Production Line

III.B.1. Plastic

Most plastic products are grouped into one of three classifications:

- **Thermoplastics.** Thermoplastics are plastics that can be heated to become soft and harden when cooled. This process can be done repeatedly and the plastics do not normally undergo a chemical change during the forming process. Thermoplastic products are usually manufactured from solid pellets purchased from resin manufacturers. Includes: polyethylene - (HDPE, LDPE, LLDPE, PET); polypropylene - (PP); polystyrene - (PS); polyvinyl chloride - (PVC); and saturated polyester.
- **Thermosets.** Thermosets undergo a chemical reaction to make them permanently solid from heating, pressurizing or reacting with a hardening agent. They are usually available in liquid or powder form for reacting into products. Unlike thermoplastics, thermosets are not easily remelted or refabricated. Includes: epoxy, phenolic, polyurethanes, unsaturated polyester, and urea-formaldehyde.

- Foamed Plastics (formed using either thermoplastics or thermosets). Includes: polyurethane foam, polystyrene foam, and polyethylene foam.

Four general types of pollution and resource material outputs can occur at one or more stages of the plastics products manufacturing process. In addition, there are some plastics products disposal concerns. Manufacturing outputs include spills, leaks, and fugitive emissions of chemicals when additives are applied prior to molding or during finishing; wastewater discharges during cooling and heating, cleaning, and finishing operations; plastic pellet releases to the environment prior to molding; and fugitive emissions from molding and extruding machines, as shown in Figure 17. Each of these is discussed below. Section 4.2 of the Emergency Planning and Community Right-To-Know Act (EPCRA) Section 313 Reporting Guidance for Rubber and Plastics Manufacturing contains a good description of pollution sources for this industry.

Chemicals

One concern during the plastics products manufacturing process is the potential release of the additive chemicals prior to molding and during the finishing process. Releases could be in the form of: spills during weighing, mixing, and general handling of the chemicals; leaks from chemical containers and molding machines; or fugitive dust emissions from open chemical containers. It should be noted that not all plastics products manufacturers use additives because many purchased pellets already contain the necessary additives. The chemicals used in the plastics products manufacturing process are usually added in such small amounts that most manufacturers do not track them closely; however, some of the additives could be toxic and therefore releases of even small quantities could present significant problems. According to a National Enforcement Investigations Center (NEIC) inspector, the plastic industry is currently looking into both the characteristics of plastic additives and their releases so they can better understand and address any related environmental or worker safety issues. The following is a list of some of the typical chemicals used as additives in the plastics products manufacturing process:

- **Lubricants** - stearic acid, waxes, fatty acid esters, and fatty acid amines.
- **Antioxidants** - alkylated phenols, amines, organic phosphites and phosphates, and esters.
- **Antistats** - quaternary ammonium compounds, anionics, and amines.
- **Blowing/foaming agents** - azodicarbonamide, modified azos, and 4,4'-Oxybis(benzenesulfonyl hydrazide). Auxiliary blowing agents are used to modify foaming and insulation properties. In the past, they were CFCs such as CFC-11, CFC-12, 113, and 114. CFCs are being replaced by butane, pentane, HCFC-22, 134a, 142, and liquid CO₂. A 1992 EPA rule that implemented the CAA Section 604 gradually phased out methyl chloroform and CFCs.

Figure 17: Plastics Products Manufacturing Process Pollution Outputs

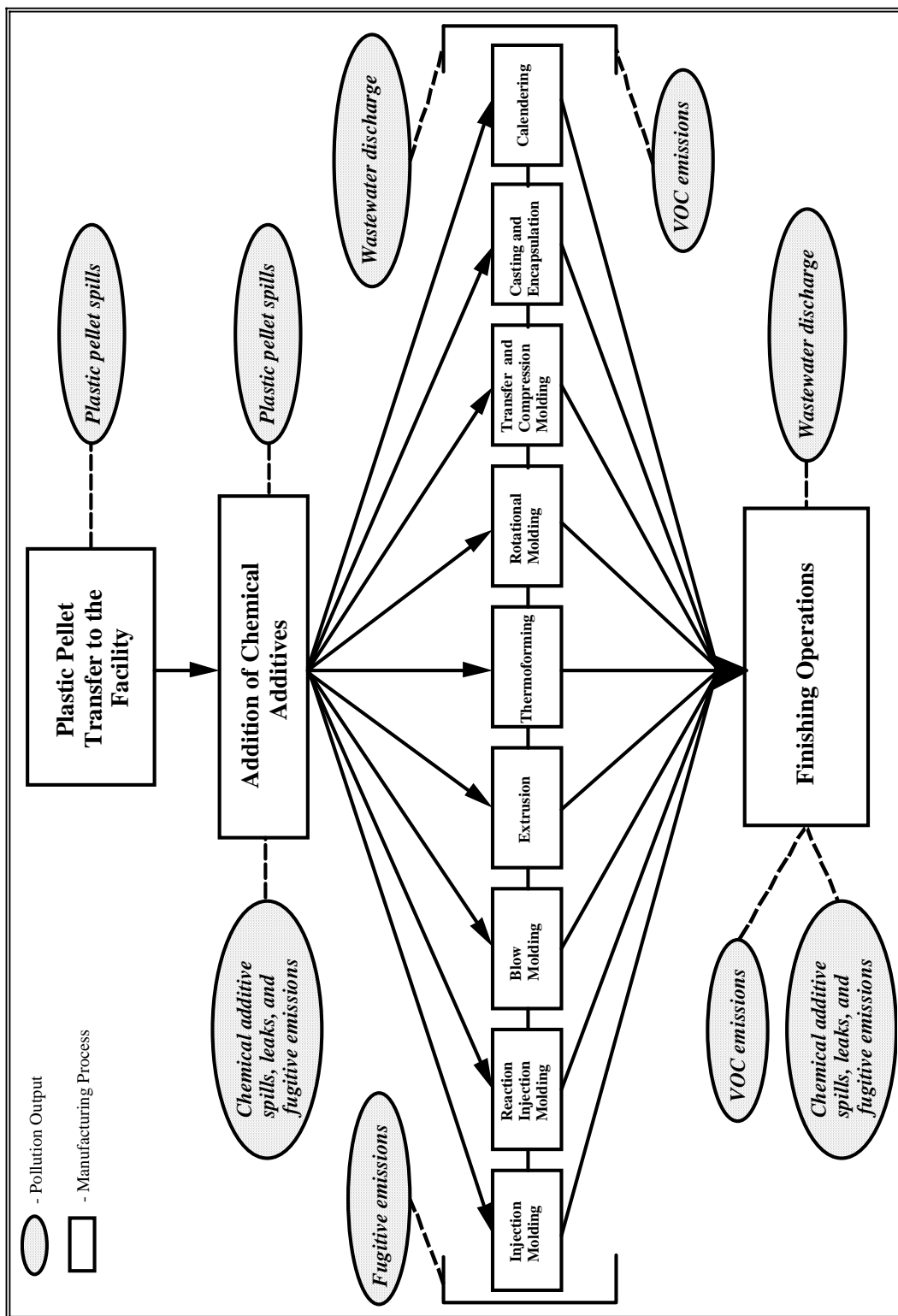

- **Colorants** - titanium dioxide, iron oxides, anthraquinones, and carbon black.
- **Flame Retardants** - antimony trioxide, chlorinated paraffins, and bromophenols.
- **Heat Stabilizers** - lead, barium-cadmium, tin, and calcium-zinc.
- **Organic Peroxides** - methyl ethyl ketone (MEK) peroxide, benzoyl peroxide, alkyl peroxide, and peresters.
- **Plasticizers** - adipates, azelates, trimellitates, and phthalates.
- **Ultraviolet Stabilizers (UV light absorbers)** - benzophenones, benzotriazole, and salicylates.

Wastewater

Contaminated wastewater is another concern in the miscellaneous plastics products industry. Water used in the plastic molding and forming processes falls into three main categories: (1) water to cool or heat the plastics products; (2) water to clean the surface of both the plastics products and the equipment used in production; (3) and water to finish the plastics products.

Cooling and heating water usually comes into contact with raw materials or plastics products during molding and forming operations for the purpose of heat transfer. The only toxic pollutant that is found in a treatable concentration in some wastewater discharged by contact cooling and heating processes is bis(2-ethylhexyl) phthalate (BEHP). Since many facilities do not process materials containing BEHP, this is not an issue for those manufacturers.

Cleaning water includes water that is used to clean the surface of the plastic product or the molding equipment that is or has been in contact with the formed plastic product. The types of pollution resulting from cleaning water in treatable concentrations are biochemical oxygen demand (BOD₅), oil and grease, total suspended solids (TSS), chemical oxygen demand (COD), total organic carbon (TOC), total phenols, phenol, and zinc.

Finishing water consists of water used to carry away waste plastic material or to lubricate the product during the finishing operation. TSS, BEHP, di-n-butyl phthalate, and dimethyl phthalate are the pollutants identified in finishing water in treatable concentrations.

Of the pollutants found in all three types of process water, BOD₅, oil and grease, TSS, and pH are considered conventional pollutants, TOC and COD are considered non-conventional pollutants, and BEHP, di-n-butyl phthalate, dimethyl phthalate, phenol, and zinc are considered priority toxic pollutants.

Pellet Release

The third concern in the miscellaneous plastics products industry is the release of plastic pellets into the environment. Plastic pellets and granules used to mold intermediate and final plastics products are often lost to floor sweepings during transport or while being loaded into molding machines, and may end up in wastewater. Although they are inert, plastic pellets are an environmental concern because of the harm they can cause if runoff carries them to wetlands, estuaries, or oceans where they may be ingested by seabirds and other marine species. EPA stormwater regulations classify plastic pellets as "significant materials," and therefore the discovery of a single pellet in stormwater runoff is subject to federal regulatory action.

Fugitive Emissions

Fugitive emissions from the molding processes may be an environmental concern because of the many additives, including cadmium and lead, that can be released during the application of high heat and pressure. Officials from trade associations (e.g., American Plastic Council and The Society of the Plastics Industry, Inc. (SPI)) are currently researching the composition of these emissions and their possible effects on air quality.

Solid Waste Disposal

Plastics products also pose solid waste disposal concerns. Discarded plastics products and packaging make up a growing portion of municipal and solid waste. Because only a small percentage of plastic is recycled (less than one percent), virtually all discarded plastics products are put into landfills or incinerated. Current estimates show that plastic constitutes 14 to 21 percent of the waste stream by volume and 7 percent of the waste stream by weight. Because of its resistance to degradation, improper plastic disposal can have particularly serious ecological risks and aesthetic effects in the marine environment.

In terms of landfill disposal, the slow degradation of plastic is not a significant factor in landfill capacity; research has shown that other constituents (e.g., metals, paper, wood, food wastes) also degrade very slowly. However, the additives contained in plastic, such as colorants, stabilizers, and plasticizers, may include toxic constituents such as lead and cadmium, which can leach out into the environment as the plastic degrades. Plastics contribute 28 percent of all cadmium and approximately 2 percent of all lead found in municipal solid waste. Data are too limited to determine whether these and other plastic additives contribute significantly to the leachate produced in municipal solid waste landfills. Plastic that contains heavy metal-based additives may also contribute to the metal content of incinerator ash.

III.B.2. Rubber

In the rubber products industry, the primary environmental concerns are fugitive emissions, solid wastes, wastewater, and hazardous wastes, as shown in Figure 18. Each of these is discussed below.

Figure 18: Rubber Products Manufacturing Process Pollution Outputs

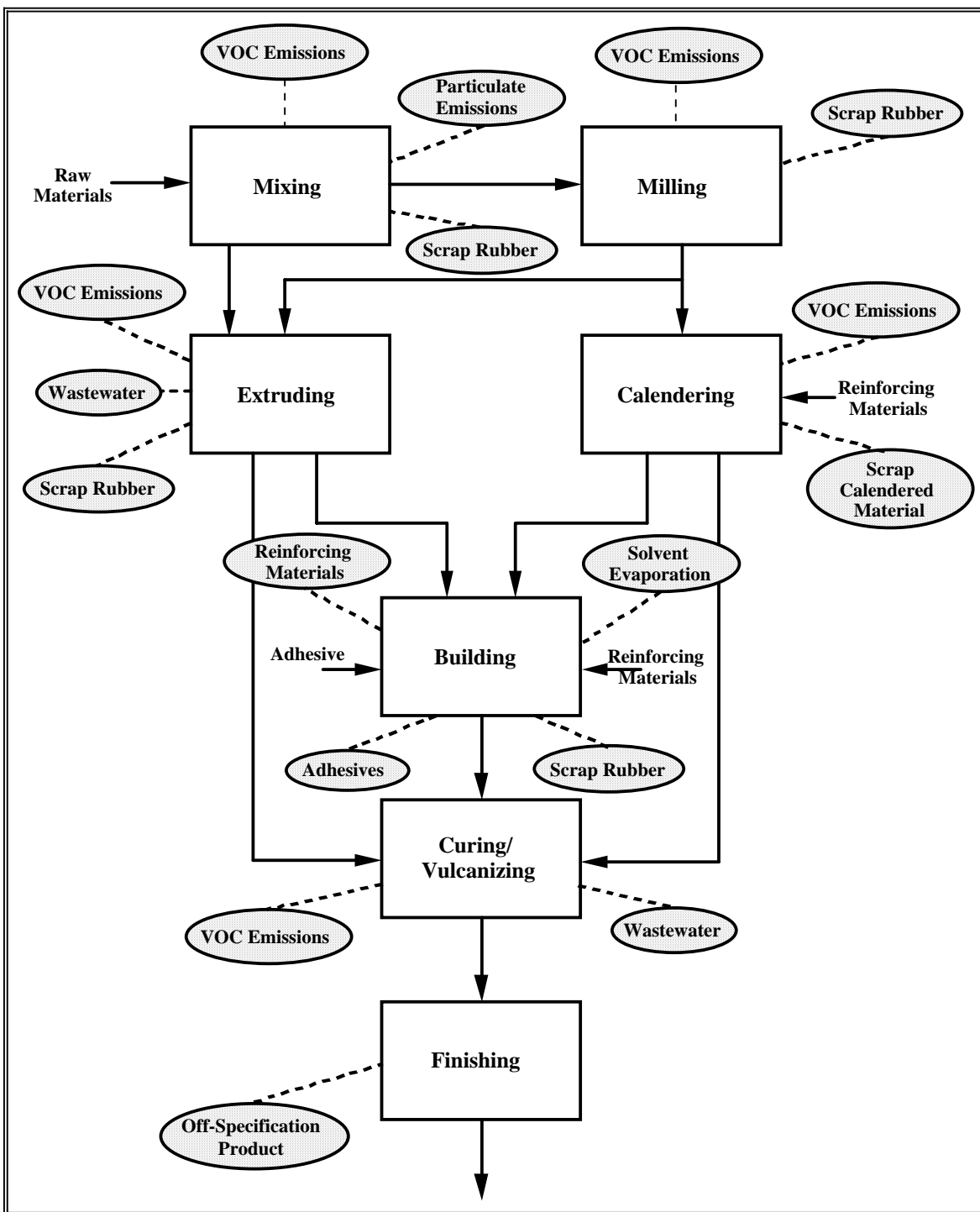

Fugitive Particulate Matter (PM) and Volatile Organic Compound (VOC) Emissions

The compounding area, where dry chemicals are weighed and put into containers prior to mixing, can be a source of fugitive emissions and possibly spills and leaks. Because additives must be preweighed, in some facilities the chemicals sit in big open bins on the scales or while waiting to get on the scales, thus increasing the potential for significant fugitive dust emissions. Most mixing facilities have eliminated this problem by purchasing their chemicals in small, preweighed, sealed polyethylene bags. The sealed bag is put directly into the Banbury mixer thus eliminating a formerly dusty operation. If chemicals are not in preweighed bags, fugitive emissions are also produced as the chemicals are loaded into the mixer. Emissions from the internal mixers are typically controlled by baghouses. Exhausts from the collection hoods are ducted to the baghouses to control particulate and possibly particle-bound semivolatiles and metals. The following is a list of the major chemicals used in the rubber compounding and mixing processes that can constitute these fugitive emissions:

- **Processing Aids** - zinc compounds.
- **Accelerators** - zinc compounds, ethylene thiourea, and diethanolamine.
- **Activators** - nickel compounds, hydroquinone, phenol, alpha naphthylamine, and p-phenylenediamine.
- **Age Restorers** - selenium compounds, zinc compounds, and lead compounds.
- **Initiator** - benzoyl peroxide.
- **Accelerator Activators** - zinc compounds, lead compounds, and ammonia.
- **Plasticizers** - dibutyl phthalate, dioctyl phthalate, and bis(2-ethylhexyl) adipate.
- **Miscellaneous Ingredients** - titanium dioxide, cadmium compounds, organic dyes, and antimony compounds.

VOC and hazardous air pollutant (HAP) emissions are also an environmental concern in the rubber product manufacturing processes. A 1994 Rubber Manufacturers Association (RMA) Emissions Factors study analyzed data on VOC and HAP emissions resulting from the mixing, milling, extruding, calendering, vulcanizing, and grinding processes. The findings showed extremely low VOC and HAP emissions for each pound of rubber processed. A facility must process 100,000 pounds of rubber to produce 10 pounds of VOCs during the mixing process. These emissions may add up, however, at large tire facilities producing 50,000 tires a day. The average weight of finished passenger and light truck tires is 23.5 pounds (approximately 21 pounds without steel and beads); thus, a 50,000 tire per day production facility must process at least 1,050,000 pounds of rubber compound.

The RMA VOC emissions factors have been sent to EPA for review and are included in Chapter 4 of the AP-42, in draft. EPA used the emission factors, which include individual HAP emission factors, in establishing the Maximum Achievable Control Technology (MACT) standards subpart XXXX for rubber tire manufacturing.

Solvent, cement, and adhesive evaporation is another source of VOC and HAP emissions. Solvents are used in various capacities during the rubber product manufacturing process. For example, solvents are used to degrease equipment and tools and as a type of adhesive or cement during building. Typically, releases of solvents occur either when the spent solvent solutions are disposed of as hazardous wastes or when degreasing solvents are allowed to volatilize. Solvent use is decreasing as water, silicon, and non-solvent-based release compounds are now common.

Wastewater

Wastewater from cooling, heating, vulcanizing, and cleaning operations is an environmental concern at many facilities. Contaminants can be added to wastewater in direct contact cooling applications such as extruder cooling conveyors and from direct contact steam used in vulcanizing operations. The residual in adhesive-dispensing containers and contaminated adhesives can also be sources of contaminated wastewater.

Zinc is of particular concern as a constituent of stormwater for the facilities involved in manufacturing and processing rubber products. A study by the RMA identified several processes through which zinc might be introduced into stormwater. Inadequate housekeeping is considered to be the primary source of zinc. Inefficient, overloaded, or malfunctioning dust collectors and baghouses are another source of zinc.

Studies have shown that concern about the leaching potential of rubber products in landfills is unfounded. The RMA assessed the levels of chemicals, if any, leached from waste rubber products using EPA's June 13, 1986 proposed Toxicity Characterization Leaching Procedure (TCLP). TCLP tests were performed on 16 types of rubber products to assess the leaching potential of over 40 different chemicals, including volatile organics, semivolatile organics, and metals. Results of the TCLP study indicate that none of the rubber products tested, cured or uncured, exceeded proposed TCLP regulatory levels. Most compounds detected were found at trace levels (near method detection limits) from 10 to 100 times less than proposed TCLP regulatory limits. The TCLP regulatory levels adopted after June 13, 1986 were even less stringent than the original proposal.

Solid Waste

Solid wastes are also an issue at rubber products manufacturing facilities. Surface grinding activities that generate dust and rubber particles are typically controlled by a primary cyclone and a secondary baghouse or electrostatic precipitator. This baghouse-captured PM (e.g., chemicals, ground rubber) from compounding areas, Banburys, and grinders is a source of solid waste. Used lubricating, hydraulic, and process oils are also prevalent at most manufacturing facilities.

Scorched rubber from mixing, milling, calendaring, and extruding is a major solid waste source within rubber products manufacturing facilities, as is waste rubber produced during rubber molding operations. A rubber is scorched when chemical reactions begin to take place in the rubber as it is being heated. A scorched rubber is no longer processable. Waste rubber can be classified into three categories: (1) uncured rubber waste; (2) cured rubber waste; and (3) off-specification products. Currently, much of the uncured rubber waste is recycled at the facility. Cured rubber waste is either recycled at the facility or sold to other companies that use it to make products such as mud flaps and playground mats. Off-specification products can be sold to other companies that make products from shredded or scrap rubber or it can be disposed of. Much of the off-spec, uncured rubber is sold, reprocessed, or recycled. These practices are discussed further in Section V.

Tires

The resource material and pollution outputs from the tire manufacturing process include all of the outputs discussed above in the rubber products manufacturing process. There is, however, an emphasis on the VOC and HAP emissions that result from solvent use in cementing and spraying operations, as shown in Figure 19, and on scrap tire disposal.

Volatile Organic Compound Emissions

VOC and HAP emissions from the rubber tire manufacturing process are caused by solvent application, as a process aide, to the different tire components before, during, and after the building process (these VOC and HAP emissions can also result from the manufacture of other rubber products that require cementing or gluing). The principal VOC and HAP emitting processes affected by New Source Performance Standards (NSPS) and NESHAP regulations are undertread cementing operations, sidewall cementing operations, tread end cementing operations, bead cementing operations, green tire spraying operations, Michelin-B operations, Michelin-C automatic operations, and processes that use solvents and cements in tire production and puncture sealant operations.

All cementing operations refer to the system used to apply cement to any part of the tire. The green tire spraying operation refers to the system used to apply a mold release agent and lubricant to the inside and/or outside of green tires as a process aide during the curing process and to prevent rubber from sticking to the curing press. VOCs and HAPs are also emitted in very limited amounts from operations where rubber is heated, including mixing, milling, extruding, calendaring, vulcanizing, and grinding.

Figure 19: Tire Manufacturing Process Pollution Outputs

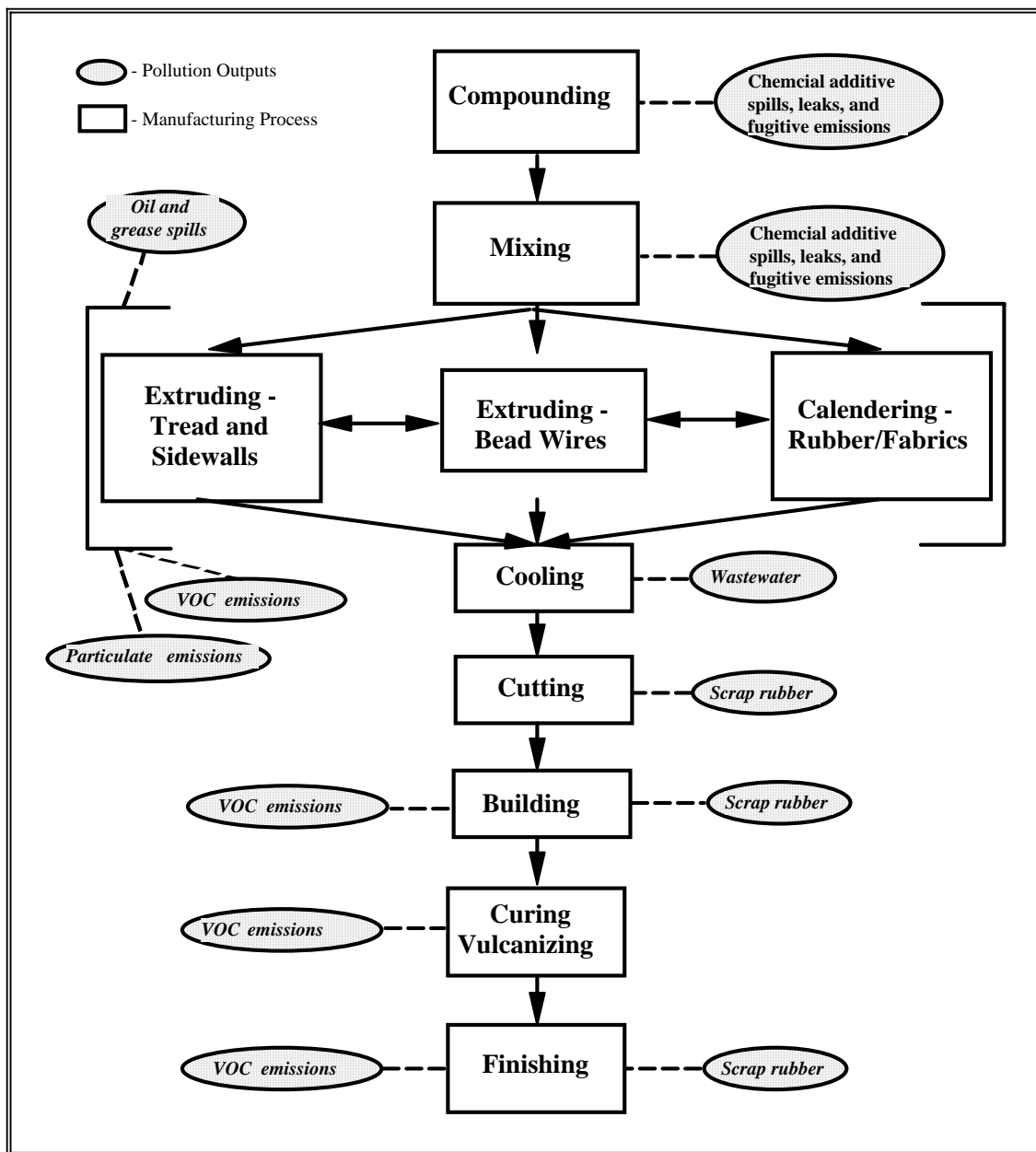

Scrap Tires

Probably the biggest environmental concern related to rubber tires is the disposal of scrap tires. In 2001, it was estimated that the United States generated approximately 300 million scrap tires. Approximately 80 percent of these tires were recycled, reused, or recovered. Scrap tires pose three environmental threats. One is that tire piles are a fire hazard and burn with an intense heat that gives off dense black smoke. These fires are extremely difficult to extinguish in part because tire casings form natural air pockets that supply the oxygen that feeds the flames. The second threat is that the tires trap rain water, which serves as a nesting ground for various insects such as mosquitoes; areas where there are scrap tire piles tend to have severe insect problems. The third and most important environmental threat associated with scrap tires is that discarded tires are bulky, virtually indestructible, and, when buried, tend to work their way back to the surface as casings compressed by the dirt slowly spring back into shape and "float" the tire upward. This problem has led to either extremely high tipping fees for scrap tires in landfills - at least twice the fee for municipal solid waste - or total bans on whole tires in landfills. As discussed above, the RMA has conducted testing to verify that tires are not hazardous wastes based on TCLP analysis. The many efforts underway to address this problem are discussed in Section V of this profile.

III.C. Management of Chemicals in Waste Stream

The Pollution Prevention Act of 1990 requires facilities to report information about the management of Toxic Release Inventory (TRI) chemicals in waste and efforts made to eliminate or reduce those quantities. EPA has collected these data annually in Section 8 of the TRI reporting Form R beginning with the 1991 reporting year. The data summarized below cover the years 1998-2001 and is meant to provide a basic understanding of the quantities of waste handled by the industry, the methods typically used to manage this waste, and recent trends in these methods. TRI waste management data can be used to assess trends in source reduction within individual industries and facilities and for specific TRI chemicals. This information could then be used as a tool in identifying opportunities for pollution prevention compliance assistance activities.

The quantities reported for 1998 to 2001 are estimates of quantities already managed. EPA requires these projections to encourage facilities to consider future waste generation and source reduction of those quantities as well as movement up the waste management hierarchy.

Table 5 shows that the RMPP industry managed approximately 250,000,000 pounds of production-related waste (total quantity of TRI chemicals in the waste from routine production operations) in 2001 (column B). Approximately 40 percent of the industry's TRI wastes were managed on site through recycling, energy recovery, or treatment, as shown in columns D, E, and F, respectively. The majority of waste that is released or transferred off site can be divided into portions that are recycled off site, recovered for energy off site, or treated off site as shown in columns G, H, and I, respectively. The remaining portion of the production-related wastes (43.0 percent), shown in column J, is either released to the environment through direct discharges to air, land, water, and underground injection, or it is disposed of off site.

Table 5: Quantity of Production-Related Waste Managed by the RMPP Industry

A	B	D	E	F	G	H	I	J
Year	Production-Related Waste Volume (10 ⁶ lbs.)	On Site			Off Site			Remaining Releases and Disposal
		% Recycled	% Energy Recovery	% Treated	% Recycled	% Energy Recovery	% Treated	
1998	263	19.53%	7.26%	17.14%	6.66%	3.15%	3.68%	42.57%
1999	251	19.49%	5.77%	15.78%	7.54%	3.23%	3.74%	44.46%
2000	229	18.78%	6.68%	15.16%	6.66%	2.97%	4.12%	45.63%
2001	205	17.07%	11.38%	14.23%	6.48%	3.66%	4.23%	42.95%

Source: Reduction and Recycling Activity for SIC code 30.

The yearly data presented in Table 5 show that the portion of TRI wastes reported as recycled on site has decreased slightly and the portions treated or managed through energy recovery on site have increased slightly between 1998 and 2001.

IV. CHEMICAL RELEASE AND OTHER WASTE MANAGEMENT PROFILE

This section provides background information on the pollutant releases that are reported by this industry in correlation with other industries. The best source of comparative pollutant release and other waste management information is the TRI. Pursuant to the Emergency Planning and Community Right-to-Know Act (EPCRA), TRI includes self-reported facility release and other waste management data for over 650 toxic chemicals and chemical categories. Facilities within SIC codes 10 (except 1011, 1081, and 1094); 12 (except 1241); 20-39; 4911, 4931, and 4939 (limited to facilities that combust coal and/or oil for the purpose of generating electricity for distribution in commerce); 4953 (limited to facilities regulated under the Resource Conservation and Recovery Act (RCRA) Subtitle C, 42 U.S.C. section 6921 *et seq.*); 5169; 5171; and 7389 (limited to facilities primarily engaged in solvents recovery services on a contract or fee basis) that have more than 10 employees, and that manufacture, process or otherwise use listed chemicals in quantities greater than the established threshold in the course of a calendar year are required to report to TRI release and other waste management quantities (on and off site) annually. The information presented in this Sector Notebook is derived from the most recently available (2002) TRI reporting year (which includes over 650 chemicals and chemical categories), and focuses primarily on the on-site releases reported by each sector. Because TRI requires consistent reporting regardless of sector, it is an excellent tool for drawing comparisons across industries.

Although this Sector Notebook does not present historical information regarding TRI chemical releases over time, note that, in general, toxic chemical releases have been declining. According to the 2000 Toxic Release Inventory Public Data Release, reported on-site and off-site releases of toxic chemicals to the environment from original TRI reporting industries (SIC codes 20-39) decreased by more than 8 percent (644 million pounds) between 1999 and 2000 (not including chemicals added and removed from the TRI chemical list during this period). Reported on-site releases dropped by almost 57 percent between 1988 and 2000. Reported transfers of TRI chemicals to off-site locations for disposal increased by almost 7 percent (28 million pounds) between 1988 and 2000. More detailed information is available in EPA's annual Toxics Release Inventory Public Data Release Report (which is available through the EPCRA Call Center at (800) 424-9346) or from the Internet at <http://www.epa.gov/tri>.

Wherever possible, the sector notebooks present TRI data as the primary indicator of chemical release within each industrial category. TRI data provide the type, amount, and media receptor of each chemical released or otherwise managed as waste. When other sources of pollutant release data have been obtained, EPA included the data to augment the TRI information.

TRI Data Limitations

Certain limitations exist regarding TRI data. Within some sectors (e.g., printing and transportation equipment cleaning), the majority of facilities are not subject to TRI reporting either because they do not fall under covered SIC codes, or because they are below the TRI reporting threshold amounts. However, EPA lowered threshold amounts for persistent bioaccumulative toxic (PBT) chemicals starting in reporting year 2000. For these chemicals,

EPA included release information from other sources. In addition, many facilities report to TRI under more than one SIC code, reflecting the multiple operations carried out on site whether or not the operations are the facilities' primary area of business as reported to the U.S. Census Bureau. Reported chemicals are limited to the approximately 650 TRI chemicals and chemical categories. A portion of the emissions from the RMPP industry, therefore, are not captured by TRI. Also, reported releases and other waste management quantities may or may not all be associated with the industrial operations described in this Sector Notebook.

Note that TRI "pounds released" data presented within the sector notebooks are not equivalent to a "risk" ranking for each industry. Weighting each pound of release equally does not factor in the relative toxicity of each chemical that is released. EPA has assigned toxicological weightings and population exposure levels to chemicals so that one can differentiate between pollutants with significant differences in toxicity. This project, the Risk Screening Environmental Indicators Model, is discussed at <http://www.epa.gov/opptintr/rsei/>.

As a preliminary indication of the environmental impact of the industry's most commonly released chemicals, this Sector Notebook briefly summarizes the toxicological properties of the top five chemicals (by weight) reported by this sector.

Definitions Associated With Section IV Data Tables

General Definitions

SIC Code -- A statistical classification standard used for all establishment-based federal economic statistics. The SIC codes facilitate comparisons between facility and industry data. (See Section II.)

TRI Facilities -- Facilities that are within specified SIC codes that have 10 or more full-time employees and are above established threshold amounts for manufacture or process or otherwise use activities in the course of a calendar year. These facilities are in SIC codes 10 (except 1011, 1081, and 1094), 12 (except 1241), 20-39, 4911 (limited to facilities that combust coal and/or oil for the purpose of generating electricity for distribution in commerce), 4931 (limited to facilities that combust coal and/or oil for the purpose of generating electricity for distribution in commerce), 4939 (limited to facilities that combust coal and/or oil for the purpose of generating electricity for distribution in commerce), 4953 (limited to facilities regulated under the RCRA Subtitle C, 42 U.S.C. section 6921 *et seq.*), 5169, 5171, and 7389 (limited to facilities primarily engaged in solvents recovery services on a contract or fee basis), and federal facilities. Facilities must submit release and other waste management estimates for all chemicals that are on the EPA's defined list and are above manufacturing or processing or otherwise use thresholds.

Data Table Column Heading Definitions

The following definitions are based upon standard definitions developed by EPA's TRI Program. The categories below represent the possible pollutant destinations that can be reported.

On-Site Releases (Table 9) -- An on-site discharge of a toxic chemical to the environment. This includes emissions to the air, discharges to bodies of water, releases at the facility to land, as well as contained disposal into underground injection wells.

Fugitive Air and Point Air Emissions -- All air emissions from industry activity. Point emissions occur through confined air streams as found in stacks, ducts, or pipes. Fugitive emissions include losses from equipment leaks or evaporative losses from impoundments, spills, or leaks.

Water (Surface Water) Discharges -- Any releases going directly to streams, rivers, lakes, oceans, or other bodies of water. Any estimates for stormwater runoff and nonpoint losses must also be included.

Underground Injection -- A contained release of a fluid into a subsurface well for the purpose of waste disposal.

Land Disposal -- Disposal of toxic chemicals in waste to on-site landfills, land treatment or incorporation into soil, surface impoundments, spills, leaks, or waste piles. These activities must occur within the facility's boundaries for inclusion in this category.

Transfers (Table 10) -- A transfer of toxic chemicals in wastes to a facility that is geographically or physically separate from the facility reporting under TRI. The quantities reported represent a movement of the chemical away from the reporting facility. Except for off-site transfers for disposal, these quantities do not necessarily represent entry of the chemical into the environment.

POTW Discharges -- Wastewaters transferred through pipes or sewers to a publicly owned treatment works (POTW). Treatment and chemical removal depend on the chemical's nature and treatment methods used. Chemicals not treated or destroyed by the POTW are generally released to surface waters or land filled within the sludge. Metals and metal compounds transferred to POTWs are considered as released to surface water.

Disposal -- Wastes taken to another facility for disposal, generally as a release to land or as an injection underground.

Recycling -- Wastes sent off site for the purposes of regenerating or recovering still valuable materials. Once these chemicals have been recycled, they may be returned to the originating facility or sold commercially.

Treatment -- Wastes moved off site for either neutralization, incineration, biological destruction, or physical separation. In some cases, the chemicals are not destroyed but prepared for further waste management.

Energy Recovery -- Wastes combusted off site in industrial furnaces for energy recovery. Treating a chemical by incineration is not considered to be energy recovery.

IV.A. EPA TRI for the RMPP Industry

This subsection provides TRI data for those facilities categorized under SIC code 30, the RMPP industry. According to the TRI data, the manufacture of rubber and miscellaneous plastics products results primarily in the release of solvents. Commonly released solvents include methanol, toluene, MEK, xylene, and dichloromethane. According to the TRI Public Data Release for 2002, the RMPP industry released over 71 million pounds of pollutants and transferred over 59 million pounds of pollutants. Of pollutants released, approximately 77 percent were released as point source air emissions, approximately 22 percent were released as fugitive air emissions, approximately 0.1 percent were released to water, and approximately 1 percent were disposed of on land.

The TRI database is a detailed compilation of self-reported, facility-specific chemical releases. The top reporting facilities for this sector are listed below. Table 6 presents data for facilities that have reported only the SIC codes covered under this Sector Notebook. Table 7 presents data for additional facilities that have reported the SIC code covered in this Sector Notebook, and one or more SIC codes that are not within the scope of this notebook. Therefore, Table 7 includes data for facilities that conduct multiple operations — some that are under the scope of this notebook, and some that are not. Currently, the facility-level data do not allow pollutant releases to be broken apart by industrial process. Table 8 lists the number of RMPP facilities by state.

The RMPP industry air releases can be traced primarily to the curing, mixing component preparation, and building/assembly stages of the rubber products manufacturing process and to the solvent cleaning and finishing stages of the plastics products manufacturing process. Major pollutants released to air include styrene, toluene, dichloromethane, and carbon disulfide. As discussed in Section III.B., releases of pollutants to water and transfers of pollutants to POTWs occur primarily from machinery cleaning and cooling in both the rubber and plastics products manufacturing processes and from rubber cooling and heating during the rubber products manufacturing process. Major pollutants released to water include nitrate compounds, zinc compounds, ethylene glycol, and ammonia. Major pollutants transferred to POTWs include nitrate compounds, formaldehyde, N,N-dimethylformamide, and methanol. Releases of pollutants to land occur from the use of various chemicals in the rubber and plastic mixing processes. Major releases of pollutants to land include sodium nitrite, zinc compounds, methyl acrylate, and acrylonitrile.

The RMPP industry releases and transfers a number of metals in large quantities (i.e., transfers as high as millions of pounds and releases as high as hundreds of thousands of pounds). These metals include zinc compounds, lead compounds, lead, and zinc. Both zinc and lead are used in the rubber mixing process as vulcanizing agents, accelerators, activators, and processing aids (zinc only). Lead and zinc are bound within the rubber matrix and are sent off site for recycling or disposal. Tables 9, 10, and 11 present releases and transfers for SIC code 30 TRI reporting facilities.

Table 6: Top 10 TRI Releasing RMPP Facilities (SIC Code 30 Only Facilities)

Rank	Total TRI Releases in Pounds	Facility Name	City	State
1	3,113,500	Teepak LLC	Danville	IL
2	3,106,018	Nevamar Co. LLC	Hampton	SC
3	2,291,539	Viskase Corp.	Loudon	TN
4	1,755,043	Aqua Glass Main Plant	Adamsville	TN
5	1,443,305	Viskase Corp.	Osceola	AR
6	1,113,389	Texas Recreation Corp.	Wichita Falls	TX
7	1,109,555	Pactiv Corp.	Winchester	VA
8	1,092,955	Daramic Inc.	Corydon	IN
9	1,004,422	Spontex Inc.	Columbia	TN
10	768,075	Owens Corning Tallmadge	Tallmadge	OH

Source: U.S. EPA, Toxics Release Inventory Database, 2002.

Note: Being included on this list does not mean that the release is associated with noncompliance with environmental laws.

Table 7: Top 10 TRI Releasing RMPP Facilities (SIC Code 30 and Other SIC Code Facilities)

SIC Codes	Total TRI Releases in Pounds	Facility Name	City	State
3089	3,113,500	Teepak LLC	Danville	IL
3083	3,106,018	Nevamar Co. LLC	Hampton	SC
3089	2,291,539	Viskase Corp.	Loudon	TN
3088	1,755,043	Aqua Glass Main Plant	Adamsville	TN
3086, 2821	1,590,889	Dow Chemical Co. Riverside Site	Pevely	MO
3089	1,443,305	Viskase Corp.	Osceola	AR
2822, 3087	1,202,360	Kraton Polymers U.S. LLC	Belpre	OH
3086	1,113,389	Texas Recreation Corp.	Wichita Falls	TX
3086	1,109,555	Pactiv Corp.	Winchester	VA
3089	1,092,955	Daramic Inc.	Corydon	IN

Source: U.S. EPA, Toxics Release Inventory Database, 2002.

Note: Being included on this list does not mean that the release is associated with noncompliance with environmental laws.

Table 8: TRI Reporting RMPP Facilities (SIC Code 30) by State

State	Number of Facilities
AL	34
AR	29
AZ	26
CA	110
CO	12
CT	24
DE	10
FL	69
GA	70
IA	29
ID	1
IL	91
IN	136
KS	25
KY	35
LA	13
MA	40
MD	15
ME	7
MI	88
MN	34
MO	58
MS	28
NC	91

State	Number of Facilities
ND	4
NE	14
NH	17
NJ	35
NM	4
NV	8
NY	37
OH	195
OK	23
OR	19
PA	92
PR	5
RI	12
SC	51
SD	4
TN	81
TX	133
UT	6
VA	36
VT	4
WA	21
WI	60
WV	15
WY	

Source: U.S. EPA, Toxics Release Inventory Database, 2002.

Table 9: Releases for RMPP Facilities (SIC Code 30) in TRI, by Number of Facilities (releases reported in pounds/year)

Chemical Name	# Facilities Reporting Chemical	Fugitive Air Emissions	Point Source Air Emissions	Water Discharges	Under-ground Injection	Land Disposal	Total Releases	Average Release per Facility
Styrene	675	5,461,024	19,892,568	532	0	80,789	25,434,913	37,681
Zinc Compounds	442	36,549	86,236	14,232	0	102,952	239,969	543
Lead Compounds	291	8,274	20,050	218	0	3,353	31,895	110
Diisocyanates	274	10,676	9,873	0	0	181,245	201,794	736
Toluene	197	2,288,190	5,059,580	512	0	260	7,348,542	37,302
Methyl Ethyl Ketone	163	1,538,639	2,870,242	5	0	676	4,409,562	27,053
Bis(2-ethylhexyl) Phthalate	155	88,637	471,389	440	0	5,207	565,673	3,650
Antimony Compounds	154	37,554	5,072	262	0	24,918	67,806	440
Xylene (Mixed Isomers)	108	490,844	2,696,529	7	0	3,267	3,190,646	29,543
Polycyclic Aromatic Compounds	85	58	6,967	0	0	1,902	8,927	105
Lead	80	709	112	97	0	9,539	10,457	131
Chromium Compounds (Except Chromite Ore Mined in the Transvaal Region)	79	973	878	10	0	1	1,862	24
Toluene Diisocyanate (Mixed Isomers)	78	5,589	18,348	0	0	0	23,936	307
Certain Glycol Ethers	72	67,105	606,644	14	0	10,887	684,650	9,509
1,1-dichloro-1-fluoroethane	65	793,732	1,130,128	0	0	21,421	1,945,281	29,927
Barium Compounds	62	900	2,126	168	0	1,756	4,950	80
Methyl Methacrylate	59	169,660	725,407	0	0	0	895,067	15,171
Benzo(g,h,i)perylene	59	41	114	0	0	0	155	3
Decabromodiphenyl Oxide	55	2,762	5,845	58	0	30,243	38,908	707
Methyl Isobutyl Ketone	51	194,762	1,244,271	0	0	170	1,439,203	28,220
Thiram	49	1,435	2,074	31	0	9,729	13,269	271
Methanol	47	284,936	2,453,282	635	0	355	2,739,208	58,281
Phenol	43	68,348	1,064,463	18	0	0	1,132,829	26,345

**Table 9: Releases for RMPP Facilities (SIC Code 30) in TRI, by Number of Facilities
(releases reported in pounds/year) (Continued)**

Chemical Name	# Facilities Reporting Chemical	Fugitive Air Emissions	Point Source Air Emissions	Water Discharges	Under-ground Injection	Land Disposal	Total Releases	Average Release per Facility
Dichloromethane	43	456,421	1,585,297	5	0	0	2,041,723	47,482
Ethylbenzene	42	76,514	375,431	17	0	616	452,579	10,776
Cobalt Compounds	38	25	5,648	287	0	13	5,974	157
Chlorodifluoromethane	37	333,349	344,881	0	0	0	678,230	18,331
Ethylene Glycol	35	4,256	55,581	0	0	0	59,837	1,710
N-hexane	35	293,776	166,683	0	0	0	460,458	13,156
Manganese Compounds	30	531	277	0	0	0	808	27
Copper	29	92,217	566	3	0	2,718	95,504	3,293
N-methyl-2-pyrrolidone	28	9,414	218,983	0	0	38	228,435	8,158
Diethanolamine	26	1,648	1,111	0	0	0	2,759	106
Nitrate Compounds	26	505	8,043	68,084	0	0	76,632	2,947
Formaldehyde	24	10,003	106,164	0	0	0	116,166	4,840
Trichloroethylene	21	1,223,894	126,851	1	0	0	1,350,746	64,321
N-butyl Alcohol	20	46,259	168,677	0	0	900	215,836	10,792
Nickel Compounds	19	45	540	0	0	0	585	31
Chromium	18	251	10	0	0	0	261	15
Dimethylformamide	18	12,931	142,731	1,902	0	0	157,564	8,754
Ammonia	18	173,651	810,755	14,040	0	0	998,446	55,469
2-mercaptobenzothiazole	18	141	647	5	0	0	793	44
1,2,4-trimethylbenzene	16	49,583	159,940	0	0	1,794	211,317	13,207
Dibutyl Phthalate	16	96,520	3,168	0	0	5	99,693	6,231
4,4-methylene bis(2-chloroaniline)	15	1	6	0	0	0	7	0
Cadmium Compounds	15	200	356	5	0	0	561	37
Dimethyl Phthalate	14	4,751	58,569	0	0	86	63,406	4,529

**Table 9: Releases for RMPP Facilities (SIC Code 30) in TRI, by Number of Facilities
(releases reported in pounds/year) (Continued)**

Chemical Name	# Facilities Reporting Chemical	Fugitive Air Emissions	Point Source Air Emissions	Water Discharges	Under-ground Injection	Land Disposal	Total Releases	Average Release per Facility
Sodium Nitrite	14	250	10,136	250	0	234,000	244,636	17,474
Nickel	13	250	750	0	0	0	1,000	77
Copper Compounds	13	48	70	253	0	0	371	29
Toluene-2,4-diisocyanate	12	1,806	611	0	0	0	2,417	201
Nitric Acid	11	716	615	0	0	0	1,331	121
Zinc (Fume or Dust)	11	481	3,875	250	0	0	4,606	419
Tetrabromobisphenol A	10	11	38	4	0	0	53	5
Mercury Compounds	10	0	10	0	0	0	10	1
1-chloro-1,1-difluoroethane	10	625,482	3,302,675	0	0	0	3,928,157	392,816
Antimony	9	500	0	0	0	167	667	74
Vinyl Acetate	9	13,167	50,397	0	0	0	63,564	7,063
Ethylene Thiourea	8	10	91	5	0	0	106	13
Hydrochloric Acid (1995 and after "Acid Aerosols" Only)	8	49,651	467,071	0	0	0	516,722	64,590
Toluene-2,6-diisocyanate	8	385	133	0	0	0	518	65
Tetrachloroethylene	7	36,735	83,426	0	0	0	120,161	17,166
Chlorine	7	3,017	304	473	0	0	3,794	542
Aluminum (Fume or Dust)	7	186	6	0	0	0	192	27
Carbon Disulfide	7	505,604	7,430,918	556	0	0	7,937,078	1,133,868
Cumene Hydroperoxide	7	7,616	2,226	0	0	0	9,842	1,406
Phthalic Anhydride	7	753	332	0	0	1,838	2,922	417
Aluminum Oxide (Fibrous Forms)	6	250	39	0	0	0	289	48
Benzoyl Peroxide	6	5	5	0	0	0	10	2
Acrylonitrile	6	102	657	0	0	250	1,009	168

**Table 9: Releases for RMPP Facilities (SIC Code 30) in TRI, by Number of Facilities
(releases reported in pounds/year) (Continued)**

Chemical Name	# Facilities Reporting Chemical	Fugitive Air Emissions	Point Source Air Emissions	Water Discharges	Under-ground Injection	Land Disposal	Total Releases	Average Release per Facility
Cumene	6	131	1,076	0	0	0	1,207	201
Sulfuric Acid (1994 and after "Acid Aerosols" Only)	6	30,557	137,049	0	0	0	167,606	27,934
4,4'-methylene dianiline	5	750	256	0	0	0	1,006	201
Ozone	5	5	142,068	0	0	0	142,073	28,415
Manganese	5	250	0	0	0	0	250	50
Bisphenol A	5	75	6,339	0	0	0	6,414	1,283
Cyclohexane	4	1,050	21,977	0	0	0	23,027	5,757
Butyl Acrylate	4	718	341	0	0	0	1,059	265
1,3-phenylenediamine	4	0	0	0	0	0	0	0
Mercury	4	2	0	0	0	0	2	1
Maleic Anhydride	4	505	5	0	0	0	510	128
Ethylene Oxide	4	561	1,987	0	0	0	2,548	637
Cadmium	4	0	0	0	0	0	0	0
Butyraldehyde	3	13,664	23,147	0	0	0	36,811	12,270
Chloroprene	3	0	0	0			0	0
Barium	3	2	1	0	0	0	3	1
1,1,1-trichloroethane	3	255	5	0	0	0	260	87
Dicyclopentadiene	3	98	25	0	0	0	123	41
Mixture	3	0	955	0	0	0	955	318
Dioxin and Dioxin-like Compounds	3	0	210	0	0	0	210	70
Ethyl Acrylate	3	1,154	2,057	0	0	0	3,211	1,070
Methyl Acrylate	3	1,186	1,784	0	0	0	2,970	990
Hexachlorobenzene	3	388	0	0	0	0	388	129

**Table 9: Releases for RMPP Facilities (SIC Code 30) in TRI, by Number of Facilities
(releases reported in pounds/year) (Continued)**

Chemical Name	# Facilities Reporting Chemical	Fugitive Air Emissions	Point Source Air Emissions	Water Discharges	Under-ground Injection	Land Disposal	Total Releases	Average Release per Facility
1,4-dioxane	2	360	254	0	0	0	614	307
N,N-dimethylaniline	2	0	0	0	0	0	0	0
Benzene	2	0	0	0	0	0	0	0
Silver	2	5	250	0	0	0	255	128
Acetaldehyde	2	2,330	40,000	0	0	0	42,330	21,165
Acetonitrile	2	2,317	0	0	0	0	2,317	1,159
Propylene Oxide	2	44	31	0	0	0	75	38
Acrylic Acid	2	8	11	0	0	0	19	10
2-methoxyethanol	2	0	293,562	0	0	0	293,562	146,781
1,3-butadiene	2	0	250	0	0	250	500	250
Cresol (Mixed Isomers)	2	56	55,826	0	0	0	55,882	27,941
Formic Acid	2	90	0	0	0	0	90	45
Cobalt	2	0	0	0			0	0
Chloroethane	2	283,170	188,240	0	0	0	471,410	235,705
Diphenylamine	2	200	105	0	0	0	305	153
Arsenic Compounds	2	0	0	0			0	0
Vinyl Chloride	2	0	0	0			0	0
1,2-butylene Oxide	1	0	0	0			0	0
Vinylidene Chloride	1	145	880	0	0	0	1,025	1,025
Tert-butyl Alcohol	1	2,231	9,196	0	0	0	11,427	11,427
Trifluralin	1	238	0	0	0	0	238	238
4,4'-diaminodiphenyl Ether	1	0	0	0			0	0
Trichlorofluoromethane	1	0	0	0			0	0
1,2-dichloroethane	1	0	0	0			0	0

**Table 9: Releases for RMPP Facilities (SIC Code 30) in TRI, by Number of Facilities
(releases reported in pounds/year) (Continued)**

Chemical Name	# Facilities Reporting Chemical	Fugitive Air Emissions	Point Source Air Emissions	Water Discharges	Under-ground Injection	Land Disposal	Total Releases	Average Release per Facility
Triethylamine	1	0	2,927	0	0	0	2,927	2,927
Selenium Compounds	1	0	0	0			0	0
Tetramethrin	1	1,577	11,023	0	0	0	12,600	12,600
N-nitrosodiphenylamine	1	0	0	0	0	0	0	0
Dimethipin	1	250	0	0	0	0	250	250
Epichlorohydrin	1	0	0	0			0	0
Chloroform	1	0	0	0			0	0
Chlorobenzene	1	0	16,007	0	0	0	16,007	16,007
Freon 113	1	13,078	0	0	0	0	13,078	13,078
Methyl Isocyanate	1	1	1	0	0	0	2	2
Methyl Tert-butyl Ether	1	0	0	0	0	0	0	0
Arsenic	1	0	0	0	0	0	0	0
Naphthalene	1	0	0	0			0	0
Selenium	1	0	0	0			0	0
Diazinon	1	0	0	0			0	0
Asbestos (Friable)	1	0	1	0	0	0	1	1
Ethylene	1	97	0	97	0	0	194	194
O-toluidine	1	0	0	0			0	0
Polychlorinated Alkanes	1	0	0	0	0	0	0	0
Aniline	1	0	0	0	0	0	0	0
Quinone	1	0	0	0	0	0	0	0
M-xylene	1	0	0	0			0	0
Total	1,952	16,042,856	55,025,345	103,476	0	731,344	71,903,021	36,836

Source: U.S. EPA, Toxics Release Inventory Database, 2002.

**Table 10: Transfers for RMPP Facilities (SIC Code 30) in TRI, by Number of Facilities
(transfers reported in pounds/year)**

Chemical Name	# Facilities Reporting Chemical	POTW Discharges	Disposal	Recycling	Treatment	Energy Recovery	Total Transfers	Average Transfers per Facility
Styrene	675	3,946	859,569	8,792	290,121	1,137,561	2,299,989	3,407
Zinc Compounds	442	42,128	5,631,888	2,869,577	0	1,700	8,545,293	19,333
Lead Compounds	291	723	183,920	321,365	0	0	506,008	1,739
Diisocyanates	274	5	235,018	3,986	100,619	56,824	396,452	1,447
Toluene	197	594	58,387	548,813	435,972	2,107,294	3,151,060	15,995
Methyl Ethyl Ketone	163	321	8,806	2,380,041	1,420,252	1,788,074	5,597,494	34,340
Di(2-ethylhexyl) Phthalate	155	2,601	605,431	1,499,732	39,571	162,697	2,310,032	14,903
Antimony Compounds	154	1,124	292,392	71,779	0	0	365,295	2,372
Xylene (Mixed Isomers)	108	20	4,462	239,371	1,475,502	600,687	2,320,042	21,482
Polycyclic Aromatic Compounds	85	6,747	161,942	121,595	1,239	2,129	293,652	3,455
Lead	80	78	5,747,333	201,591	8	0	5,949,010	74,363
Chromium Compounds(Except Chromite Ore Mined in the Transvaal Region)	79	913	246,967	14,207	0	0	262,087	3,318
Toluene Diisocyanate (Mixed Isomers)	78	0	24,874	0	82,982	68,032	175,888	2,255
Certain Glycol Ethers	72	19,474	81,917	52,397	258,880	151,039	563,707	7,829
1,1-dichloro-1-fluoroethane	65	2,430	106,287	49,770	6,382	40,063	204,932	3,153
Barium Compounds	62	63	43,997	14,376	5	0	58,441	943
Methyl Methacrylate	59	38,188	9,824	0	23,535	969,523	1,041,070	17,645
Benzo(g,h,i)perylene	59	0	174	514	52	133	873	15
Decabromodiphenyl Oxide	55	279	367,722	46,546	3,834	1,655	420,036	7,637
Methyl Isobutyl Ketone	51	6,591	4,182	62,847	57,896	306,258	437,774	8,584

55

**Table 10: Transfers for RMPP Facilities (SIC Code 30) in TRI, by Number of Facilities
(transfers reported in pounds/year) (Continued)**

Chemical Name	# Facilities Reporting Chemical	POTW Discharges	Disposal	Recycling	Treatment	Energy Recovery	Total Transfers	Average Transfers per Facility
Thiram	49	1,495	61,124	36,640	9,481	1,182	109,922	2,243
Methanol	47	554,954	2,130	1,432,879	68,837	1,071,039	3,129,839	66,592
Phenol	43	372	104,825	23,334	20,939	31,921	181,391	4,218
Dichloromethane	43	250	250	27,124	24,498	35,400	87,522	2,035
Ethylbenzene	42	56	133	34,370	137,642	232,799	405,000	9,643
Cobalt Compounds	38	702	47,854	13,887	0	0	62,443	1,643
Chlorodifluoromethane	37	0	6,887	1,208	0	4,137	12,232	331
Ethylene Glycol	35	62,827	3,557	1,276,345	226,706	57,641	1,627,076	46,488
N-hexane	35	0	205	0	28,057	63,608	91,870	2,625
Manganese Compounds	30	267	12,657	3,904	0	0	16,828	561
Copper	29	65	106,504	2,671,557	0	0	2,778,126	95,797
N-methyl-2-pyrrolidone	28	172,324	755	204,959	43,123	129,743	550,904	19,675
Diethanolamine	26	0	0	0	270	1,087	1,357	52
Nitrate Compounds	26	5,397,797	343,938	350	1,359	0	5,743,444	220,902
Formaldehyde	24	2,413,754	15,096	374	15,944	7,475	2,452,643	102,193
Trichloroethylene	21	42	521	51,085	25,906	250	77,804	3,705
N-butyl Alcohol	20	150,000	0	6,034	142,462	103,915	402,411	20,121
Nickel Compounds	19	582	225,073	42,920	0	0	268,575	14,136
Chromium	18	5	902	420,575	0	0	421,482	23,416
N,N-dimethylformamide	18	3,584,844	0	0	2,229	219,616	3,806,689	211,483
Ammonia	18	14,470	20,698	0	0	0	35,168	1,954
2-mercaptobenzothiazole	18	10	31,919	500	0	24	32,453	1,803

Table 10: Transfers for RMPP Facilities (SIC Code 30) in TRI, by Number of Facilities
(transfers reported in pounds/year) (Continued)

Chemical Name	# Facilities Reporting Chemical	POTW Discharges	Disposal	Recycling	Treatment	Energy Recovery	Total Transfers	Average Transfers per Facility
1,2,4-trimethylbenzene	16	0	1	19,095	30,254	29,577	78,927	4,933
Dibutyl Phthalate	16	41	6,666	1,904	393	853	9,857	616
4,4'-methylene bis(2-chloroaniline)	15	0	1,440	0	12,269	1,547	15,256	1,017
Cadmium Compounds	15	41	2,264	0	0	0	2,305	154
Dimethyl Phthalate	14	160	1,100	0	86	35,551	36,897	2,636
Sodium Nitrite	14	335,137	7,224	5	11,549	1,110	355,025	25,359
Nickel	13	256	23,497	143,149	0	0	166,902	12,839
Copper Compounds	13	887	217,815	60,114	0	0	278,816	21,447
Toluene-2,4-diisocyanate	12	0	5,488	0	614	0	6,102	509
Nitric Acid	11	5	0	0	22,133	0	22,138	2,013
Zinc (Fume or Dust)	11	0	12,670	0	0	0	12,670	1,152
Tetrabromobisphenol a	10	9	9,654	0	250	98	10,011	1,001
Mercury Compounds	10	0	34	0	0	0	34	3
1-chloro-1,1-difluoroethane	10	0	9,498	0	0	0	9,498	950
Antimony	9	0	15,243	3,865	0	0	19,108	2,123
Vinyl Acetate	9	20,525	1,938	0	28,397	7,517	58,377	6,486
Ethylene Thiourea	8	1	2,005	2,005	5,470	14	9,495	1,187
Hydrochloric Acid (1995 and after "Acid Aerosols" Only)	8	0	0	0	141	0	141	18
Toluene-2,6-diisocyanate	8	0	1,372	0	154	0	1,526	191
Tetrachloroethylene	7	0	33	746	7,917	4,850	13,546	1,935
Chlorine	7	750	0	0	0	0	750	107

**Table 10: Transfers for RMPP Facilities (SIC Code 30) in TRI, by Number of Facilities
(transfers reported in pounds/year) (Continued)**

Chemical Name	# Facilities Reporting Chemical	POTW Discharges	Disposal	Recycling	Treatment	Energy Recovery	Total Transfers	Average Transfers per Facility
Aluminum (Fume or Dust)	7	5	2,553	0	5,464	0	8,022	1,146
Carbon Disulfide	7	123,100	0	0	0	0	123,100	17,586
Cumene Hydroperoxide	7	0	0	0	0	571	571	82
Phthalic Anhydride	7	0	8,611	1,732	0	0	10,343	1,478
Aluminum Oxide (Fibrous Forms)	6	5	19,250	0	0	0	19,255	3,209
Benzoyl Peroxide	6	0	2,700	0	0	0	2,700	450
Acrylonitrile	6	5	8,103	0	0	68,027	76,135	12,689
Cumene	6	0	3,923	0	13,931	13,218	31,072	5,179
Sulfuric Acid (1994 and after "Acid Aerosols" Only)	6	0	0	0	0	0	0	0
4,4'-methylene dianiline	5	0	0	0	4,346	0	4,346	869
Ozone	5	0	0	0	0	0	0	0
Manganese	5	0	4,343	17,600	0	0	21,943	4,389
Bisphenol A	5	250	2,130	70	0	250	2,700	540
Cyclohexane	4	0	0	0	500	250	750	188
Butyl Acrylate	4	401	20	0	388	8,864	9,673	2,418
1,3-phenylenediamine	4	54,502	0	0	0	0	54,502	13,626
Mercury	4	0	18	0	0	0	18	5
Maleic Anhydride	4	0	250	0	5,398	0	5,648	1,412
Ethylene Oxide	4	0	5,674	7,800	0	0	13,474	3,369
Cadmium	4	0	11	0	0	0	11	3
Butyraldehyde	3	310,490	14	0	16,316	0	326,820	108,940

**Table 10: Transfers for RMPP Facilities (SIC Code 30) in TRI, by Number of Facilities
(transfers reported in pounds/year) (Continued)**

Chemical Name	# Facilities Reporting Chemical	POTW Discharges	Disposal	Recycling	Treatment	Energy Recovery	Total Transfers	Average Transfers per Facility
Chloroprene	3	0	0	0	0	0	0	0
Barium	3	0	0	0	0	0	0	0
1,1,1-trichloroethane	3	0	5	5	0	5,388	5,398	1,799
Dicyclopentadiene	3	0	1,873	0	17,100	0	18,973	6,324
Mixture	3	0	0	0	0	0	0	0
Dioxin and Dioxin-like Compounds	3	4	0	0	0	0	4	1
Ethyl Acrylate	3	1,322	0	0	1,110	2,977	5,409	1,803
Methyl Acrylate	3	365	1	0	1,001	103,663	105,030	35,010
Hexachlorobenzene	3	0	21	0	0	0	21	7
1,4-dioxane	2	88,954	0	0	20,708	2,544	112,206	56,103
N,N-dimethylaniline	2	0	0	0	0	0	0	0
Benzene	2	0	0	0	0	0	0	0
Silver	2	15	0	0	0	0	15	8
Acetaldehyde	2	2,610	0	0	5	0	2,615	1,308
Acetonitrile	2	0	0	0	45,303	0	45,303	22,652
Propylene Oxide	2	0	0	0	0	0	0	0
Acrylic Acid	2	67	0	0	403	0	470	235
2-methoxyethanol	2	28,836	0	0	0	7,216	36,052	18,026
1,3-butadiene	2	5	250	0	0	0	255	128
Cresol (Mixed Isomers)	2	0	0	0	3,848	67	3,915	1,958
Formic Acid	2	300	0	0	61	0	361	181
Cobalt	2	0	0	0	0	0	0	0

**Table 10: Transfers for RMPP Facilities (SIC Code 30) in TRI, by Number of Facilities
(transfers reported in pounds/year) (Continued)**

Chemical Name	# Facilities Reporting Chemical	POTW Discharges	Disposal	Recycling	Treatment	Energy Recovery	Total Transfers	Average Transfers per Facility
Chloroethane	2	0	3,799	0	0	0	3,799	1,900
Diphenylamine	2	637	1,111	1,368	0	0	3,116	1,558
Arsenic Compounds	2	0	0	0	0	0	0	0
Vinyl Chloride	2	0	0	0	0	0	0	0
1,2-butylene Oxide	1	0	0	0	0	0	0	0
Vinylidene Chloride	1	0	0	0	0	0	0	0
Tert-butyl Alcohol	1	5,513	0	0	4,370	0	9,883	9,883
Trifluralin	1	0	345	0	0	0	345	345
4,4'-diaminodiphenyl Ether	1	0	0	0	0	0	0	0
Trichlorofluoromethane	1	0	0	0	0	0	0	0
1,2-dichloroethane	1	0	0	0	0	0	0	0
Triethylamine	1	0	0	0	5,762	0	5,762	5,762
Selenium Compounds	1	0	0	0	0	0	0	0
Tetramethrin	1	0	0	0	0	0	0	0
N-nitrosodiphenylamine	1	0	0	0	0	0	0	0
Dimethipin	1	0	0	2,548	0	0	2,548	2,548
Epichlorohydrin	1	0	0	0	0	0	0	0
Chloroform	1	0	0	0	0	0	0	0
Chlorobenzene	1	0	0	0	750	0	750	750
Freon 113	1	0	0	0	2,141	0	2,141	2,141
Methyl Isocyanate	1	0	0	0	0	0	0	0
Methyl Tert-butyl Ether	1	0	0	0	0	0	0	0

**Table 10: Transfers for RMPP Facilities (SIC Code 30) in TRI, by Number of Facilities
(transfers reported in pounds/year) (Continued)**

Chemical Name	# Facilities Reporting Chemical	POTW Discharges	Disposal	Recycling	Treatment	Energy Recovery	Total Transfers	Average Transfers per Facility
Arsenic	1	0	0	0	0	0	0	0
Naphthalene	1	0	0	0	0	0	0	0
Selenium	1	0	0	0	0	0	0	0
Diazinon	1	0	0	0	0	0	0	0
Asbestos (Friable)	1	0	0	0	0	0	0	0
Ethylene	1	0	0	0	0	0	0	0
O-toluidine	1	0	0	0	0	0	0	0
Polychlorinated Alkanes	1	0	85	0	0	1,374	1,459	1,459
Aniline	1	0	0	0	0	0	0	0
Quinone	1	0	0	0	0	0	0	0
M-xylene	1	0	0	0	0	0	0	0
Total	1,952	13,456,239	16,043,153	15,017,350	5,212,835	9,649,032	59,378,609	30,419

Source: U.S. EPA, Toxics Release Inventory Database, 2002.

Table 11: Releases by Subsector for RMPP Facilities (SIC Code 30) in TRI**SIC Code 3011: Tires and Inner Tubes**

Chemical Name	CAS No.	Carcinogenicity (by source)			TRI Release (lbs)
		IARC ¹	NTP ²	OSHA-Z ³	
Zinc Compounds	N982	—	—	—	3,038,118
N-hexane	110-54-3	—	—	—	372,293
Hydrochloric Acid (1995 and after "Acid Aerosols" Only)	7647-01-0	—	—	—	341,531
Polycyclic Aromatic Compounds	N590	2A or 2B	P	—	180,743
Sulfuric Acid (1994 and after "Acid Aerosols" Only)	7664-93-9	—	—	—	137,049
Methyl Isobutyl Ketone	108-10-1	—	—	—	106,339
Toluene	108-88-3	—	—	—	105,590
Di(2-ethylhexyl) Phthalate	117-81-7	—	P	—	66,233
Tetrachloroethylene	127-18-4	2B	P	—	65,424
Cobalt Compounds	N096	2B	—	—	50,530
Total release of top TRI chemicals:					4,463,850
Total release of all TRI chemicals:					4,624,503
Percentage contributed by top TRI chemicals:					96.5%
Total release of top carcinogens:					362,930
Total release of all carcinogens:					419,907
Percentage contributed by top carcinogens:					86.4%

SIC Code 3052: Rubber and Plastics Hose and Belting

Chemical Name	CAS No.	Carcinogenicity (by source)			TRI Release (lbs)
		IARC ¹	NTP ²	OSHA-Z ³	
Zinc Compounds	N982	—	—	—	774,149
Toluene	108-88-3	—	—	—	699,290
Di(2-ethylhexyl) Phthalate	117-81-7	—	P	—	197,362
Carbon Disulfide	75-15-0	—	—	—	158,920
1,2,4-Trimethylbenzene	95-63-6	—	—	—	114,954
Dichloromethane	75-09-2	2B	P	—	78,611
Methyl Ethyl Ketone	78-93-3	—	—	—	77,858
Trichloroethylene	79-01-6	2A	P	—	49,990
Certain Glycol Ethers	N230	—	—	—	46,827
Tetrachloroethylene	127-18-4	2B	P	—	26,785
Total release of top TRI chemicals:					2,224,746
Total release of all TRI chemicals:					2,311,986
Percentage contributed by top TRI chemicals:					96.2%
Total release of top carcinogens:					352,748
Total release of all carcinogens:					364,655
Percentage contributed by top carcinogens:					96.7%

**Table 11: Releases by Subsector for RMPP Facilities
(SIC Code 30) in TRI (Continued)**

SIC Code 3053: Gaskets, Packing, and Sealing Devices

Chemical Name	CAS No.	Carcinogenicity (by source)			TRI Release (lbs)
		IARC ¹	NTP ²	OSHA-Z ³	
Toluene	108-88-3	—	—	—	480,187
Methyl Ethyl Ketone	78-93-3	—	—	—	286,562
Zinc Compounds	N982	—	—	—	265,518
Methanol	67-56-1	—	—	—	180,766
Copper	7440-50-8	—	—	—	91,786
Methyl Isobutyl Ketone	108-10-1	—	—	—	75,955
Xylene (Mixed Isomers)	1330-20-7	—	—	—	37,222
Trichloroethylene	79-01-6	2A	P	—	9,724
Di(2-ethylhexyl) Phthalate	117-81-7	—	P	—	6,360
Ethylene Oxide	75-21-8	1	K	Z	5,674
Total release of top TRI chemicals:					1,439,753
Total release of all TRI chemicals:					1,457,021
Percentage contributed by top TRI chemicals:					98.8%
Total release of top carcinogens:					21,758
Total release of all carcinogens:					29,552
Percentage contributed by top carcinogens:					73.6%

SIC Code 3061: Mechanical Rubber Goods

Chemical Name	CAS No.	Carcinogenicity (by source)			TRI Release (lbs)
		IARC ¹	NTP ²	OSHA-Z ³	
Toluene	108-88-3	—	—	—	909,839
Xylene (Mixed Isomers)	1330-20-7	—	—	—	723,208
Methyl Isobutyl Ketone	108-10-1	—	—	—	632,816
Zinc Compounds	N982	—	—	—	518,060
1,1-dichloro-1-fluoroethane	1717-00-6	—	—	—	125,764
Ethylbenzene	100-41-4	2B	—	—	117,803
1-chloro-1,1-difluoroethane	75-68-3	—	—	—	68,000
Methyl Ethyl Ketone	78-93-3	—	—	—	67,698
Di(2-ethylhexyl) Phthalate	117-81-7	—	P	—	52,213
Chlorodifluoromethane	75-45-6	—	—	—	45,000
Total release of top TRI chemicals:					3,260,401
Total release of all TRI chemicals:					3,497,059
Percentage contributed by top TRI chemicals:					93.2%
Total release of top carcinogens:					170,016
Total release of all carcinogens:					247,761
Percentage contributed by top carcinogens:					68.6%

**Table 11: Releases by Subsector for RMPP Facilities
(SIC Code 30) in TRI (Continued)**

SIC Code 3069: Fabricated Rubber Products, Not Elsewhere Classified (N.E.C.)

Chemical Name	CAS No.	Carcinogenicity (by source)			TRI Release (lbs)
		IARC ¹	NTP ²	OSHA-Z ³	
Toluene	108-88-3	—	—	—	2,480,705
Zinc Compounds	N982	—	—	—	1,274,649
Xylene (Mixed Isomers)	1330-20-7	—	—	—	890,444
Ammonia	7664-41-7	—	—	—	472,159
Methyl Ethyl Ketone	78-93-3	—	—	—	327,665
Sodium Nitrite	7632-00-0	—	—	—	310,594
Di(2-ethylhexyl) Phthalate	117-81-7	—	P	—	216,756
Methyl Isobutyl Ketone	108-10-1	—	—	—	177,287
Nitrate Compounds	N511	—	—	—	133,273
Dibutyl Phthalate	84-74-2	—	—	—	91,884
Total release of top TRI chemicals:					6,375,416
Total release of all TRI chemicals:					6,804,311
Percentage contributed by top TRI chemicals:					93.7%
Total release of top carcinogens:					216,756
Total release of all carcinogens:					457,039
Percentage contributed by top carcinogens:					47.4%

SIC Code 3081: Unsupported Plastics Film and Sheet

Chemical Name	CAS No.	Carcinogenicity (by source)			TRI Release (lbs)
		IARC ¹	NTP ²	OSHA-Z ³	
Methyl Ethyl Ketone	78-93-3	—	—	—	717,958
Toluene	108-88-3	—	—	—	596,016
Xylene (Mixed Isomers)	1330-20-7	—	—	—	411,099
Certain Glycol Ethers	N320	—	—	—	179,770
Methyl Methacrylate	80-62-6	—	—	—	164,349
Methyl Isobutyl Ketone	108-10-1	—	—	—	143,373
Ammonia	7664-41-7	—	—	—	109,852
Methanol	67-56-1	—	—	—	102,783
Ozone	10028-15-6	—	—	—	94,251
Ethylbenzene	100-41-4	2B	—	—	81,390
Total release of top TRI chemicals:					2,600,841
Total release of all TRI chemicals:					3,264,037
Percentage contributed by top TRI chemicals:					79.7%
Total release of top carcinogens:					81,390
Total release of all carcinogens:					311,221
Percentage contributed by top carcinogens:					26.2%

**Table 11: Releases by Subsector for RMPP Facilities
(SIC Code 30) in TRI (Continued)**

SIC Code 3084: Plastics Pipe

Chemical Name	CAS No.	Carcinogenicity (by source)			TRI Release (lbs)
		IARC ¹	NTP ²	OSHA-Z ³	
Styrene	100-42-5	2B	—	—	193,741
Dichloromethane	75-09-2	2B	P	—	36,660
Di(2-ethylhexyl) Phthalate	117-81-7	—	P	—	6,353
Trifluralin	1582-09-8	—	—	—	583
Lead Compounds	N420	2B	—	Z	448
Bisphenol A	80-05-7	—	—	—	164
Zinc (Fume or Dust)	7440-66-6	—	—	—	50
4,4'-methylene dianiline	101-77-9	2B	P	Z	1
Zinc Compounds	N982	—	—	—	0
Cobalt Compounds	N096	2B	—	—	0
Total release of top TRI chemicals:					238,000
Total release of all TRI chemicals:					238,000
Percentage contributed by top TRI chemicals:					100.0%
Total release of top carcinogens:					237,203
Total release of all carcinogens:					237,203
Percentage contributed by top carcinogens:					100.0%

SIC Code 3085: Plastics Bottles

Chemical Name	CAS No.	Carcinogenicity (by source)			TRI Release (lbs)
		IARC ¹	NTP ²	OSHA-Z ³	
1,1-Dichloro-1-fluoroethane	1717-00-6	—	—	—	12,499
Ethylene Glycol	107-21-1	—	—	—	11,000
Certain Glycol Ethers	N230	—	—	—	27
Total release of top TRI chemicals:					23,526
Total release of all TRI chemicals:					23,526
Percentage contributed by top TRI chemicals:					100.0%
Total release of top carcinogens:					NA
Total release of all carcinogens:					NA
Percentage contributed by top carcinogens:					NA

**Table 11: Releases by Subsector for RMPP Facilities
(SIC Code 30) in TRI (Continued)**

SIC Code 3086: Plastics Foam Products

Chemical Name	CAS No.	Carcinogenicity (by source)			TRI Release (lbs)
		IARC ¹	NTP ²	OSHA-Z ³	
1-Chloro-1,1-difluoroethane	75-68-3	—	—	—	3,869,313
Dichloromethane	75-09-2	2B	P	—	1,726,324
1,1-Dichloro-1-fluoroethane	1717-00-6	—	—	—	1,599,017
Methyl Ethyl Ketone	78-93-3	—	—	—	686,688
Toluene	108-88-3	—	—	—	662,689
Chlorodifluoromethane	75-45-6	—	—	—	579,762
Chloroethane	75-00-3	—	—	—	475,229
Diisocyanates	N120	—	—	—	276,876
Xylene (Mixed Isomers)	1330-20-7	—	—	—	247,903
Di(2-ethylhexyl) Phthalate	117-81-7	—	P	—	113,906
Total release of top TRI chemicals:					10,237,708
Total release of all TRI chemicals:					10,761,266
Percentage contributed by top TRI chemicals:					95.1%
Total release of top carcinogens:					1,840,230
Total release of all carcinogens:					2,029,742
Percentage contributed by top carcinogens:					90.7%

SIC Code 3089: Plastics Products, Not Elsewhere Classified (N.E.C.)

Chemical Name	CAS No.	Carcinogenicity (by source)			TRI Release (lbs)
		IARC ¹	NTP ²	OSHA-Z ³	
Styrene	100-42-5	2B	—	—	12,594,826
Carbon Disulfide	75-15-0	2B	—	—	7,762,922
Methyl Ethyl Ketone	78-93-3	—	—	—	1,391,619
Trichloroethylene	79-01-6	2A	P	—	1,099,186
Toluene	108-88-3	—	—	—	1,072,741
Xylene (Mixed Isomers)	1330-20-7	—	—	—	893,011
Nitrate Compounds	N511	—	—	—	540,805
Methyl Methacrylate	80-62-6	—	—	—	480,135
Ammonia	7664-41-7	—	—	—	428,283
Certain Glycol Ethers	N230	—	—	—	401,291
Total release of top TRI chemicals:					26,664,820
Total release of all TRI chemicals:					29,435,198
Percentage contributed by top TRI chemicals:					90.6%
Total release of top carcinogens:					13,694,012
Total release of all carcinogens:					14,535,784
Percentage contributed by top carcinogens:					94.2%

**Table 11: Releases by Subsector for RMPP Facilities
(SIC Code 30) in TRI (Continued)**

Footnotes

¹IARC: International Agency for Research on Cancer - from "Monographs."

1 - The chemical is known to be carcinogenic to humans.

2A - The chemical is probably carcinogenic to humans.

2B - The chemical is possibly carcinogenic to humans.

²NTP: National Toxicology Program - from "Annual Report on Carcinogens."

K - The chemical is known to be carcinogenic.

P - The chemical may reasonably be anticipated to be carcinogenic.

³OSHA-Z: 29 CFR 1910, Subpart Z, Toxic and Hazardous Substances, Occupational Safety and Health Administration.

Z - The chemical appears at 29 CFR Part 1910 Subpart Z.

NA - Not Applicable

Source of TRI data: US EPA, Toxic Release Inventory Database, Reporting Year 2002.

Source of HPV data: EPA Office of Pollution Prevention and Toxics, HPV Challenge Program Chemical List.

Source of HAP data: EPA Office of Air Quality Planning and Standards, Air Toxics Web Site.

Source of carcinogenicity data: Appendix C, "Basis of OSHA Carcinogen Listing for Individual Chemicals," 2001 TRI Public Data Release Report.

IV.B. Summary of the Selected Chemicals Released

This subsection summarizes current scientific toxicity and fate information for the top chemicals (by weight) that facilities within the RMPP sector self-reported as released to the environment based upon 2002 TRI data. Because this subsection is based upon self-reported release data, it does not provide information on management practices used by the sector to reduce the release of these chemicals. Information regarding pollutant release reductions over time might be available from EPA's TRI program or from the industrial trade associations that are listed in Section IX of this document. Because these descriptions are cursory, consult the sources referenced below for a more detailed description of both the chemicals described in this section and the chemicals that appear on the full list of TRI chemicals appearing in Section IV.A.

The brief descriptions provided below were taken from the *1993 Toxics Release Inventory Public Data Release* (EPA, 1994), the Hazardous Substances Data Bank (HSDB), and the Integrated Risk Information System (IRIS), both accessed via TOXNET¹. The information contained below is based upon exposure assumptions that have been made using standard scientific procedures. The effects listed below must be taken in context of these exposure assumptions that are more fully explained within the full chemical profiles in HSDB.

The top 10 chemicals released by the RMPP industry in 2002 were:

1. 1,1-Dichloro-1-Fluoroethane;
2. 1-Chloro-1,1-Difluoroethane;
3. Carbon Disulfide;
4. Dichloromethane;
5. Methanol;
6. Methyl Ethyl Ketone (MEK);
7. Styrene;
8. Toluene;
9. Xylene (Mixed Isomers); and
10. Zinc Compounds.

Some of the health and environmental impacts of several of these chemicals are discussed below.

¹ TOXNET is a computer system run by the National Library of Medicine that includes a number of toxicological databases managed by EPA, the National Cancer Institute, and the National Institute for Occupational Safety and Health. For more information on TOXNET, contact the TOXNET help line at (800) 231-3766. Databases included in TOXNET are: CCRIS (Chemical Carcinogenesis Research Information System), DART (Developmental and Reproductive Toxicity Database), DBIR (Directory of Biotechnology Information Resources), EMICBACK (Environmental Mutagen Information Center Backfile), GENE-TOX (Genetic Toxicology), HSDB (Hazardous Substances Data Bank), IRIS (Integrated Risk Information System), RTECS (Registry of Toxic Effects of Chemical Substances), and TRI (Toxic Release Inventory). HSDB contains chemical-specific information on manufacturing and use, chemical and physical properties, safety and handling, toxicity and biomedical effects, pharmacology, environmental fate and exposure potential, exposure standards and regulations, monitoring and analysis methods, and additional references.

1,1-Dichloro-1-Fluoroethane

Toxicity. Exposure to 1,1-dichloro-1-fluoroethane can have an anesthetic effect on the central nervous system, irritate the eyes, cause asphyxiation and defatting of skin.

Inhaling 1,1-dichloro-1-fluoroethane may cause dizziness, weakness, fatigue, nausea, and headaches. Ingesting of the same may cause gastrointestinal irritation, nausea, vomiting, and diarrhea. Overexposure may result in impaired cardiovascular functions.

Carcinogenicity. There is currently no evidence to suggest that this chemical is carcinogenic.

Environmental Fate. 1,1-dichloro-1-fluoroethane is expected to exist solely as vapor in the ambient atmosphere. Vapor phase 1,1-dichloro-1-fluoroethane will be degraded in the atmosphere by reaction with photochemically produced hydroxyl radicals. It may be partially removed from the atmosphere by rain.

If released to soil, 1,1-dichloro-1-fluoroethane has limited mobility and it may volatilize from dry soil surfaces based on its vapor pressure. Its biodegradability in soil is low. If released in water, it is expected to adsorb moderately to suspended solids and sediment. Its potential for bioconcentration in aquatic organisms is low.

Carbon Disulfide

Toxicity. Short-term (acute) exposure of humans to carbon disulfide can cause headache, dizziness, fatigue, and irritation of eye, nose, and throat. Exposure to high concentrations may result in trouble breathing or respiratory failure. Contact with skin can cause severe burns.

Long-term (chronic) exposure to high levels in excess of regulatory standards may result in peripheral nerve damage (involving the nerves that control feet, legs, hands, and arms) and cardiovascular effects. A few studies contend that chronic exposure may also result in potential reproductive effects.

Carcinogenicity. There is currently no evidence to suggest that this chemical is carcinogenic.

Environmental Fate. If released on land, carbon disulfide will be primarily lost to volatilization and it may leach into the ground where it would be expected to biodegrade. The chemical will also volatilize if released to water and does not adsorb to sediment. In air, carbon disulfide reacts with atomic oxygen to produce hydroxyl radicals with half-lives of a few days. Carbon disulfide gas is adsorbed and degraded by soil, which demonstrates that soil may be a natural sink for this chemical. The general population may be exposed to carbon disulfide primarily from ambient air as it is released not only from industrial sources, but also from a wide variety of natural sources.

Methanol

Toxicity. Methanol is readily absorbed from the gastrointestinal tract and the respiratory tract, and is toxic to humans in moderate to high doses. In the body, methanol is converted into formaldehyde and formic acid. Methanol is excreted as formic acid. Observed toxic effects at high-dose levels generally include central nervous system damage and blindness. Long-term exposure to high levels of methanol via inhalation cause liver and blood damage in animals.

Ecologically, methanol is expected to have low toxicity to aquatic organisms. Concentrations lethal to half the organisms of a test population are expected to exceed 1 mg methanol per liter water. Methanol is not likely to persist in water or to bioaccumulate in aquatic organisms.

Carcinogenicity. There is currently no evidence to suggest that this chemical is carcinogenic.

Environmental Fate. Liquid methanol is likely to evaporate when left exposed. Methanol reacts in air to produce formaldehyde, which contributes to the formation of air pollutants. In the atmosphere, it can react with other atmospheric chemicals or be washed out by rain. Methanol is readily degraded by microorganisms in soils and surface waters.

Physical Properties. Methanol is highly flammable.

Methyl Ethyl Ketone (MEK)

Toxicity. Breathing moderate amounts of MEK for short periods of time can cause adverse effects on the nervous system ranging from headaches, dizziness, nausea, and numbness in the fingers and toes to unconsciousness. Its vapors are irritating to the skin, eyes, nose, and throat and can damage the eyes. Repeated exposure to moderate to high amounts may cause liver and kidney effects.

Carcinogenicity. No agreement exists over the carcinogenicity of MEK. One source believes MEK is a possible carcinogen in humans based on limited animal evidence. Other sources believe that there is insufficient evidence to make any statements about possible carcinogenicity.

Environmental Fate. Most of the MEK released to the environment will end up in the atmosphere. MEK can contribute to the formation of air pollutants in the lower atmosphere. It can be degraded by microorganisms living in water and soil.

Physical Properties. MEK is a flammable liquid.

Toluene

Toxicity. Inhalation or ingestion of toluene can cause headaches, confusion, weakness, and memory loss. Toluene may also affect the way the kidneys and liver function.

Reactions of toluene (see environmental fate) in the atmosphere contribute to the formation of ozone in the lower atmosphere. Ozone can affect the respiratory system, especially in sensitive individuals such as asthma or allergy sufferers.

Some studies have shown that unborn animals were harmed when high levels of toluene were inhaled by their mothers, although the same effects were not seen when the mothers were fed large quantities of toluene. Note that these results may reflect similar difficulties in humans.

Carcinogenicity. There is currently no evidence to suggest that this chemical is carcinogenic.

Environmental Fate. The majority of releases of toluene to land and water will evaporate. Toluene may also be degraded by microorganisms. Once volatilized, toluene in the lower atmosphere will react with other atmospheric components contributing to the formation of ground-level ozone and other air pollutants.

Physical Properties. Toluene is a volatile organic chemical.

Xylene (Mixed Isomers)

Toxicity. Xylenes are rapidly absorbed into the body after inhalation, ingestion, or skin contact. Short-term exposure of humans to high levels of xylenes can cause irritation of the skin, eyes, nose, and throat, difficulty in breathing, impaired lung function, impaired memory, and possible changes in the liver and kidneys. Both short- and long-term exposure to high concentrations can cause effects such as headaches, dizziness, confusion, and lack of muscle coordination. Reactions of xylenes (see environmental fate) in the atmosphere contribute to the formation of ozone in the lower atmosphere. Ozone can affect the respiratory system, especially in sensitive individuals such as asthma or allergy sufferers.

Carcinogenicity. There is currently no evidence to suggest that this chemical is carcinogenic.

Environmental Fate. The majority of releases to land and water will quickly evaporate, although some degradation by microorganisms will occur.

Xylenes are moderately mobile in soils and may leach into groundwater, where they may persist for several years.

Xylenes are volatile organic chemicals. As such, xylenes in the lower atmosphere will react with other atmospheric components, contributing to the formation of ground-level ozone and other air pollutants.

Zinc Compounds

Toxicity. Zinc is a nutritional trace element; toxicity from ingestion is low. Severe exposure to zinc might give rise to gastritis with vomiting due to swallowing of zinc

dusts. Short-term exposure to very high levels of zinc is linked to lethargy, dizziness, nausea, fever, diarrhea, and reversible pancreatic and neurological damage. Long-term zinc poisoning causes irritability, muscular stiffness and pain, loss of appetite, and nausea. Zinc chloride fumes cause injury to mucous membranes and to the skin. Ingestion of soluble zinc salts may cause nausea, vomiting, and purging.

Carcinogenicity. There is currently no evidence to suggest that this chemical is carcinogenic.

Environmental Fate. Significant zinc contamination of soil is only seen in the vicinity of industrial point sources.

Zinc bioconcentrates in aquatic organisms.

IV.C. Other Data Sources

The Aerometric Information Retrieval System (AIRS) contains a wide range of information related to stationary sources of air pollution, including the emissions of a number of air pollutants that may be of concern within a particular industry. With the exception of VOCs, there is little overlap with the TRI chemicals reported above. Table 12 summarizes annual releases of carbon monoxide (CO), ammonia (NH₃), nitrogen oxides (NO_x), particulate matter of 10 microns or less (PM₁₀), sulfur dioxide (SO₂), and VOCs from the RMPP industry.

Table 12: Pollutant Releases (Short Tons/Years)

Industry	CO	NH ₃	NO _x	PM ₁₀	SO ₂	VOC
U.S. Total	4,200,454	87,445	8,664,338	1,662,730	15,511,867	1,681,011
Metal Mining	7,402	1.4	58,450	26,701	22,308	1,714
Nonmetal Mining	32,729	2,629	16,383	33,540	9,029	6,793
Lumber and Wood Products	160,262	218	62,420	78,592	5,144	106,331
Wood Furniture and Fixtures	5,158	4.3	3,461	7,673	1,771	70,669
Pulp and Paper	499,750	2,339	301,487	115,084	450,669	118,828
Printing	1,346	25	4,030	2,310	3,430	57,119
Inorganic Chemicals	127,815	5,430	58,982	19,573	100,105	13,446
Organic Chemicals	136,885	949	185,159	24,540	130,679	92,594
Petroleum Refining	187,404	15,815	243,757	42,107	417,048	144,252
Rubber and Misc. Plastics Products	4,240	170	9,485	9,938	18,516	88,585
Stone, Clay, Glass, and Concrete	199,381	103	373,658	118,838	268,524	28,859
Iron and Steel	783,961	4,754	108,721	84,416	102,103	42,304
Nonferrous Metals	544,482	176	30,973	28,968	266,104	10,008

Table 12: Pollutant Releases (Short Tons/Year) (Continued)

Industry	CO	NH ₃	NO _x	PM ₁₀	SO ₂	VOC
Fabricated Metals	6,510	83	10,584	9,361	6,770	74,920
Electronics	27533	91	5543	7432	8184	19873
Motor Vehicles, Bodies, Parts, and Accessories	11,514	1,302	10,797	6,299	8,556	81,151
Dry Cleaning	72	4.4	228	62	125	2161

Source: U.S. EPA, National Emission Inventory Database, 1999.

IV.D. Comparison of TRI Between Selected Industries

This subsection compares pollutant release and transfer data across industrial categories. The information gives a general sense as to the relative scale of releases and transfers within each sector profiled under this project. Note that Table 13 does not contain releases and transfers for industrial categories that are not included in this project, and thus cannot be used to draw conclusions regarding the total release and transfer amounts that are reported to TRI. Similar information is available within the annual TRI Public Data Release book.

Figure 20 summarizes the 2002 TRI data in graphical form for the RMPP industry and the other sectors profiled in separate notebooks. The bar graph presents the total TRI releases and total transfers on the left axis and the triangle points show the average releases per facility on the right axis. The graph is based on the data in Table 13 and helps compare the relative amounts of releases and transfers per facility both within and between these sectors. Note, however, that differences in the proportion of facilities captured by TRI exist between industry sectors. This can be a factor of poor SIC matching and relative differences in the number of facilities reporting to TRI from the various sectors. The 2002 TRI data presented for the RMPP industry covers 1,952 facilities. These facilities listed SIC code 30, the RMPP industry, as a primary SIC code.

Figure 20: Summary of 2002 TRI Data: Releases and Transfers by Industry (SIC Code)

74

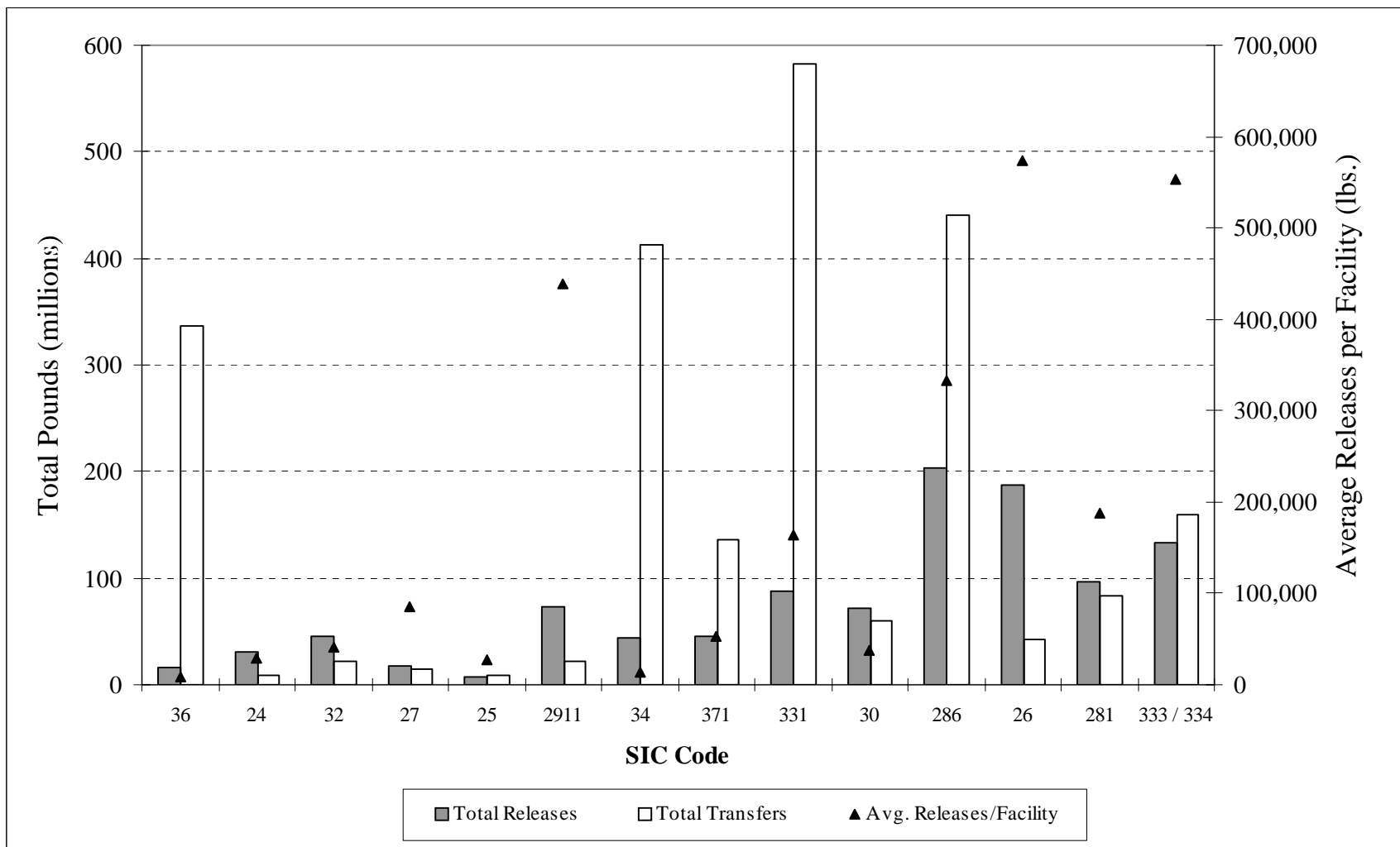

Table 13: Toxic Release Inventory Data for Selected Industries

Industry Sector	SIC Range	# TRI Facilities	Releases		Transfers		Total		Carcinogens	
			Total Releases (10 ⁶ pounds)	Avg. Releases per Facility (pounds)	Total Transfers (10 ⁶ pounds)	Avg. Transfers per Facility (pounds)	Releases + Transfers (10 ⁶ pounds)	Avg. Release+ Transfers per Facility (pounds)	Total Releases (10 ⁶ pounds)	Avg. Releases per Facility (pounds)
Stone, Clay, and Concrete	32	1,124	45.6	40,546	21.4	19,060	67.0	59,606	7.2	6,432
Lumber and Wood Products	24	1,040	30.4	29,202	8.2	7,838	38.5	37,040	7.0	6,770
Furniture and Fixtures	25	284	7.9	27,830	8.4	29,548	16.3	57,379	0.5	1,668
Printing	2711-2789	200	17.2	85,779	15.3	76,343	32.4	162,121	0.05	240
Electronics/Computers	36	1,747	15.5	8,892	336.7	192,724	352.2	201,616	3.2	1,823
Rubber and Misc. Plastics	30	1,952	71.2	36,836	59.4	30,419	131.3	67,255	32.0	16,406
Motor Vehicle, Bodies, Parts and Accessories	371	863	45.2	52,322	135.5	157,029	180.7	209,361	7.8	9,033
Pulp and paper	2611-2631	326	187.2	574,531	42.5	130,347	229.7	704,698	12.3	37,615
Inorganic Chem. Mfg.	2812-2819	518	96.9	187,129	83.5	161,173	180.4	348,301	14.3	27,604
Petroleum Refining	2911	167	73.4	439,439	21.6	129,072	94.9	568,511	4.9	29,341
Fabricated Metals	34	3,098	43.8	14,143	412.8	133,250	456.6	147,393	9.3	3,001
Iron and Steel	3312-3313 3321-3325	534	87.4	163,666	582.8	1,091,406	670.2	1,255,072	24.0	44,918
Nonferrous Metals	333, 334	240	132.6	552,362	159.9	666,350	292.5	1,218,713	35.9	149,389
Organic Chem. Mfg.	2861-2869	610	203.4	333,511	439.8	720,934	643.2	1,054,445	34.5	56,529
Metal Mining	10	Industry sector not subject to TRI reporting								
Nonmetal Mining	14	Industry sector not subject to TRI reporting								
Dry Cleaning	7215, 7216, 7218	Industry sector not subject to TRI reporting								

Source: U.S. EPA, Toxics Release Inventory Database, 2002.

75

V. POLLUTION PREVENTION OPPORTUNITIES

The best way to reduce pollution is to prevent it in the first place. Some companies have creatively implemented pollution prevention techniques that improve efficiency and increase profits while at the same time minimizing environmental impacts. This can be done in many ways such as reducing material inputs, reengineering processes to reuse by-products, improving management practices, and using substitutes for toxic chemicals. Some smaller facilities are able to get below regulatory thresholds just by reducing pollutant releases through aggressive pollution prevention policies.

To encourage these approaches, this section provides both general and company-specific descriptions of pollution prevention advances that have been implemented within the RMPP industry. While the list is not exhaustive, it does provide information that can be used as the starting point for facilities interested in beginning their own pollution prevention projects. When possible, this section provides information from real activities that can, or are being implemented by this sector - including a discussion of associated costs, time frames, and expected rates of return. This section summarizes information from activities that may be, or are being implemented by this sector. When possible, information is provided that gives the context in which the techniques can be effectively used. Note that the activities described in this section do not necessarily apply to all facilities that fall within this sector. When evaluating pollution prevention options, facilities must carefully consider facility-specific conditions and how each option might affect air, land, and water pollution releases.

V.A. Identification of Pollution Prevention Activities in Use**V.A.1. Plastic**

In the miscellaneous plastics products industry, there are substantial pollution prevention options for most environmental concerns including chemical spills, process wastewater (including solvents in wastewater), plastic pellet loss, and plastic product disposal. According to one NEIC inspector, pollution prevention for leaks and spills of chemical additives during compounding or finishing operations can be as simple as covering the chemical containers as often as possible and training employees to properly handle and dispose of chemicals.

Wastewater

The pollution prevention options for process wastewater from the miscellaneous plastics products manufacturing industry are slightly more complex. As discussed in Section III.B.1, wastewater can be divided into three categories: contact cooling and heating water; cleaning water; and finishing water. The technologies identified by EPA as appropriate for contact cooling and heating water are good housekeeping practices and the activated carbon process. The activated carbon process uses activated (powered or granulated) carbon to remove soluble organics from air and water. The organics are removed as they become physically/chemically attached to the carbon (i.e., adsorbed to the carbon surface). EPA analysis indicates that only one pollutant of concern, BEHP, is present in contact cooling and heating water in treatable concentrations, and the only technology identified to control BEHP is the activated carbon process. To maintain low concentrations of other pollutants currently discharged in

contact cooling and heating water, EPA advises applying good housekeeping practices. For example, routine segregation of raw materials and lubricating oils from the cooling and heating water will keep pollutants not actually generated during the plastic molding and forming operation out of the cooling and heating water.

In cleaning water, the data indicate that there are three conventional pollutants (BOD₅, oil and grease, and TSS), three nonconventional (COD, TOC, and total phenols), and two priority pollutants (phenol and zinc) present in treatable concentrations. For the cleaning water category, EPA proposes pollution prevention technologies based on in-process controls. One control is recycling process water through a sedimentation tank designed to remove the suspended solids so the process water can be reused. The other control is end-of-pipe treatment of the discharge from the recycle unit.

In finishing water, the data indicate that the only pollutants present in treatable concentrations are TSS and three phthalates. The only pollution prevention technology EPA has identified to remove TSS is a settling unit, and the only technology identified to remove phthalates present in finishing water is an activated carbon process.

Pellet Release

The issue of plastic resin pellet loss to the environment during the manufacturing process is being addressed by many manufacturers through participation in "Operation Clean Sweep" (OCS). All participating facilities take measures to minimize spills, promptly and thoroughly clean up spills, and properly dispose of pellets. Such measures include employee education, extra conscientious sweeping efforts, enhanced pellet capture methods, and disposal precautions. Currently, SPI and the American Plastics Council are working together on this industry education project.

Solid Waste Disposal

Miscellaneous plastics products solid waste disposal, as discussed earlier, is a concern because plastics make up a significant portion of the nation's waste stream. The most common pollution prevention method currently used is recycling. Both single plastic resins and mixtures of plastic resins can be recycled, but the end products from mixtures are often lower in quality than those from just one type of resin. Therefore, the success of plastic recycling will depend on the development of technologies to separate mixed plastic into single resins, and on increasing the markets for products made of mixed plastic resins. Although recycling is the most common method of plastic waste pollution prevention, at present, less than one percent of all plastics products are recycled. Only a few plastic consumer items such as soft drink bottles and milk jugs are being recycled on a wide scale in the United States, and food container and cup recycling is just getting started. Enhancing the degradation of plastic has been offered as a solution to both the waste stream and marine environmental problems; however, EPA believes source reduction and recycling will most significantly reduce the impact of plastic in the environment. EPA is conducting a study of substitutes for lead- and cadmium-based additives as a possible pollution prevention action for metal leaching at landfills and metal releases from incinerator ash.

V.A.2. Rubber

As discussed in Section III.B.2, pollution outputs from the rubber products industry occur at many stages of the manufacturing process. Most facilities are reducing these outputs by using the many reasonable and effective pollution prevention options that exist.

Chemicals

The compounding and mixing area of a rubber products manufacturing facility, where dry chemicals are weighed, put into small containers, and loaded into the rubber mixer, is generally a minor source of particulate emissions. Some mixing facilities have practically eliminated particulate emissions by purchasing their chemicals in small preweighed, sealed polyethylene bags. The sealed bags are put directly into the Banbury mixer and the bag itself becomes part of the rubber matrix, thus eliminating this formerly dusty operation. For facilities not purchasing their chemicals in preweighed bags, a variety of other pollution prevention options exist. The following pollution prevention methods have been used by various facilities:

- **Careful Transportation Mechanisms** - Receiving chemicals in closed docks in sealed containers or in bulk rail or truck shipments with a minimal history of spills. Storing chemical piles inside the facility to ensure that any fugitive emissions can be contained within the facility.
- **Sealed Containers** - Providing sealed containers for all open materials. Sealed containers should have air space between the chemical and the container cover to minimize "puffing" losses when the container is opened. Similarly, placing secondary containment mechanisms around all storage containers provides further protection from spills and leaks.
- **Automatic Dispensing** - Utilizing automatic dispensing and weighing equipment whenever possible. Automatic dispensing minimizes waste due to spills from manual dispensing and provides quality control.
- **Reduced Toxic Chemical Usage** - Reducing the use of toxic chemicals via reformulation. Rubber manufacturers continually research opportunities for pollution prevention through product reformulation. However, rubber manufacturers must adhere to stringent product performance requirements. Therefore, pollution prevention opportunities must be balanced with product specifications.
- **Computer Inventories** - Providing computer inventory control methods to minimize the amount of stock purchased.
- **Spills and Sweeping Protocols** - Providing protocols for cleaning up spills and sweeping to ensure the proper segregation of waste.

Wastewater

Contaminated wastewater is another pollution concern at many rubber products manufacturing facilities. All but the largest rubber products manufacturing facilities participate in wastewater pretreatment programs with local POTWs. Many plants meet pretreatment standards without treating their wastewater. Some facilities, however, require solids settling, pH adjustment, or oil removal. To address the wastewater issue, many facilities have implemented water reuse and recycling programs. Options for wastewater reuse and recycling include installing a closed-loop water cooling or heating system. Another problem is that wastewater is often contaminated by oil and grease. To prevent spilling and leaking waste oil and grease, which contaminates wastewater, EPA suggests the following pollution prevention methods:

- **Substituting lubricating grease for oil, especially for milling equipment.** Grease has been shown to reduce substantially the amount of manifested waste.
- **Performing preventive maintenance of processing, molding, and curing equipment.** Such practices can further reduce the volume of manifested oil and grease waste by reducing waste from worn seals and gaskets.
- **Removing oil from oily wastewaters prior to disposal to reduce the volume of wastewater disposal.** For instance, oily wastewaters collected from equipment engine pits could be routed through a centrally located oil/water separator prior to discharge.

Spent Solvents

Spent solvents known to contribute to ozone depletion is not a problem in rubber products manufacturing facilities. A major initiative by the rubber products industry to eliminate ozone-depleting chemicals in 1994 and early 1995 resulted in many innovative spent solvent pollution prevention activities. Among the accomplishments were replacing solvent cleaning applications with high pressure water systems, using caustic cleaning solutions, and substituting old solvents with cleaner, citrus-based solvents. Many mold release compounds, coatings, and adhesives that formerly used ozone-depleting chemicals as carriers were reformulated to eliminate the offending chemicals. In some cases, process changes directly eliminated the chemicals of concern. Most rubber products are now free from having been manufactured with ozone-depleting chemicals.

Disposal

A significant issue in the rubber products industry is the disposal of waste rubber. To prevent the improper disposal of scrap rubber, facilities can segregate and recycle rubber wastes. Properly segregating waste streams may be as simple as placing a screen over part of the molding equipment so that waste rubber stock produced during preforming operations can be segregated from the oily wastewaters and recycled back into the process. Other segregation processes may include separating cured from uncured rubber, and recycling the uncured portion back into the process.

Reclaiming and recycling cured, off-specification rubber is also a waste minimization option. Reprocessing rubber involves taking used rubber products and processing them in a manner such that they can be incorporated into virgin rubber compounds.

Scrap rubber that cannot be recycled within the manufacturing process is being used in the following manner:

- Adding it to coal and wood waste fuels for firing process boilers;
- Making it into sheets and various shapes to use as athletic area surfaces and other floor coverings;
- Making it into sheet gasket material; and
- Making it into loading dock bumpers.

An important factor that limits recycling post-consumer and post-production scrap into products is the increased performance requirements of the materials. Automobile components are continuously being designed for greater endurance (e.g., automobiles capable of 150,000 miles without maintenance or a tune-up). Such performance standards require manufacturers to use high-purity chemicals and quality, precision manufacturing processes. These rubber products, whether they are tires, belts, hoses, motor mounts, gaskets, or seals, turn out to be highly engineered entities with strict quality standards. Introducing used, off-specification, or unknown quality ingredients into the dynamically stressed, high-performance rubber product can be a problem. As a result, recycling of the post-consumer and post-production waste applies to materials used in less demanding applications.

To better understand how much waste is being produced by their facility in comparison to other facilities, many rubber product manufacturers are monitoring waste indices (i.e., pounds of waste per 100 pounds of product) with the goal of continuously reducing the index. Index criteria include the following:

- Total pounds of nonrecyclable waste shipped off site per 100 pounds of product; and
- Total pounds of solid and hazardous water generated per 100 pounds of product.

V.A.3. Tires

All of the pollution prevention options discussed in Section V.A.2 also apply to tire production. In addition, the two pollution issues that apply specifically to the tire industry are VOC and HAP emissions from the building and assembly process and scrap tire disposal.

Volatile Organic Compound Emissions

In terms of pollution prevention for VOC and HAP emissions from tire cementing and spraying operations, the EPA NESHAP requires 99 percent reduction in the amount of HAP

use in the solvents and cements used in the tire manufacturing industry. This requirement also applies to retread and recapping industries. The primary recommendation is eliminating or substituting the HAPs used in the solvents and cements. Many of the major manufacturers have begun eliminating all solvents and cements from the tire building process as the compatibility of the rubber compound components allows for adhesion without the solvent and cement aides. Some capture and control technologies for undertread cementing operations, tread end-cementing operations, bead cementing operations, and green tire spraying operations where organic solvent-based sprays are used. Most of the major tire manufacturing plants in the United States commonly use silicone and water-based sprays for green tire spraying operations (i.e., any green tire spray that contains 12 percent or less, by weight, of VOC as sprayed) or organic solvent-based sprays.

Scrap Tires

While not technically a "pollution" output from the tire manufacturing process, scrap tire disposal has been a big waste disposal issue in the United States. Recently, legislation and initiatives have been finding innovative ways to address this issue. The RMA is leading the effort to find and expand markets for the environmentally and economically sound uses of scrap tires. According to the RMA, in 2001, an estimated 78 percent of the 281 million tires scrapped annually were utilized in a positive manner. This represents a 50-percent increase of scrap tire use since 1994, and more than a seven-fold increase since 1990. The principal use of scrap tires is as a fuel and fuel supplement in a variety of utility and industrial applications. Other major uses include ground rubber as an additive to asphalt paving materials, whole and processed tire uses in civil engineering, and utilization of cut, split, and ground tires in new products. In addition, approximately 33 million passenger and light duty truck tires are recycled (i.e., recapped for resale each year). The tires not utilized are landfilled or stockpiled.

In 2001, 115 million tires were used in energy recovery. Civil engineering utilized nearly 20 million tires and paving utilized 15 million tires. The equivalent of 8 million tires were used to manufacture various new products. Table 14 shows the trends in the number of scrap tires used in various capacities.

Table 14: Scrap Tire Usage

Scrap Tire Uses (Millions of Units)						
	1990	1992	1994	1996	1998	2001
Fuel	24.5	57	101	115	114	115
Ground Rubber	0.0	5.0	1.5	7.5	7	21
Paving	N/A	N/A	3	5	8	12
Civil Engineering	N/A	5	9	10	20	40
Products	N/A	N/A	8	8	8	8
Other	N/A	1	16	19	20.5	22
Total Usage	24.5	68	138.5	164.5	177.5	218

Source: RMA U.S. Scrap Tire Markets 2001.
 N/A - Not available.

The first line of defense against increasing scrap tire numbers is tire retreading. The figures presented in Table 14 do not include retreaded tires because tire casings that are capable of being retreaded are not, by definition, scrap tires. Only tires that can no longer be used for their original intended purpose, even if retreaded, are considered scrap tires.

The Federal Government is working to identify and implement pollution prevention strategies to decrease the number of scrap tires and the economic and environmental problems that accompany scrap tire disposal. If the retread markets could be developed so that all passenger and light truck tires suitable for retreading were actually retreaded, approximately 20 million fewer new replacement tires would be needed annually. This would reduce the number of scrap tires generated per year by almost 10 percent.

As of January 1991, 36 states regulated scrap tires as a form of waste, up from only one state in 1985. Twenty-four states have final regulations in place that address storage of tires; typical provisions include requiring permits for tire piles over a certain size and requiring fire lanes in large tire piles. Funds may also be used to provide grants or loans to entrepreneurs who are recycling tires or incinerating them for energy recovery. At least four states (Oregon, Wisconsin, Utah, and Oklahoma) have developed rebate systems for scrap tires in which users of scrap tires are paid rebates of one cent per pound or more for recycling tires or burning them for energy recovery.

Additional Initiatives to Improve Environmental Performance Within the RMPP Industry

Many dry chemicals are purchased in sealed preweighed poly-logs that can be put directly into the manufacturing process, thus eliminating fugitive emission. Fluorescent lamps and pressurized spray cans are managed to minimize adverse impact on the environment. Also, packaging materials are being reduced, returnable containers are being used, and waste oil recycled. General production improvements include upgrading and adding plant ventilation systems, which provides cleaner air in the workplace, improving solvent application efficiency to decrease the amount of solvents needed, using more efficient coating equipment that speeds the production process, and refining preventive maintenance programs that often virtually eliminate unplanned shutdowns. Solvent use in the rubber industry has been reduced through the development of water-based adhesives and coatings and astute raw material substitution.

Enhanced personnel training, product substitution, and process alternations have reduced the amount of hazardous waste generated. The recycling of paper, wood, skids, plastic shrink wrap, cardboard, cord, wire, fabric, and white office paper has increased. Some manufacturing plants have reduced wastewater discharges by installing closed-loop water cooling systems. Some manufacturing plants have removed their underground storage tanks (USTs) and replaced them with aboveground tanks that are easier to monitor for leaks.

VI. SUMMARY OF FEDERAL STATUTES AND REGULATIONS

This section discusses the federal regulations that may apply to the RMPP sector. The purpose of this section is to highlight and briefly describe the applicable federal requirements, and to provide citations for more detailed information. The three following subsections are included:

- Section VI.A contains a general overview of major statutes;
- Section VI.B lists regulations specific to this industry; and
- Section VI.C lists pending and proposed regulatory requirements.

The descriptions in Section VI are intended solely for general information. Depending upon the nature or scope of the activities at a particular facility, these summaries may or may not necessarily describe all applicable environmental requirements. Moreover, they do not constitute formal interpretations or clarifications of the statutes and regulations. For example, some facilities in the RMPP industry are co-located with facilities that manufacture the plastic resins used by the RMPP industry. The resin manufacturing facilities have additional regulatory requirements. These requirements can be found in the Profile of the Plastic Resins and Man-made Fibers Industry located at: <http://www.epa.gov/compliance/resources/publications/assistance/sectors/notebooks/> and on EPA's Air Toxics website for National Emission Standards for Hazardous Air Pollutants located at: <http://www.epa.gov/ttn/atw/mactfnlalph.html>. For further information, consult the Code of Federal Regulations and other state or local regulatory agencies. EPA Hotline contacts are also provided for each major statute.

To search the CFR, go to the Electronic Code of Federal Regulations (e-CFR) at <http://www.gpoaccess.gov/ecfr/>. The e-CFR consists of two linked databases: the "current Code" and "amendment files." The Office of Federal Register updates the current Code database according to the effective dates of amendments published in the *Federal Register*. The *Federal Register* is the official daily publication for rules, proposed rules, and notices of federal agencies and organizations, as well as executive orders and other presidential documents. The *Federal Register* can be searched at <http://www.gpoaccess.gov/fr/index.html>.

VI.A. General Description of Major Statutes

The RMPP industry is affected by multiple federal environmental statutes. In addition, the industry is subject to numerous laws and regulations from state, tribal, and local governments designed to protect and improve the nation's health, safety, and environment. Table 15 summarizes the major federal regulations affecting air, water, and waste outputs from the RMPP industry.

Table 15: Summary of Potentially Applicable EPA Regulations

Water Programs (CWA and SWDA)	
40 CFR Part 112	Oil Pollution Prevention
40 CFR Part 122	EPA-administered Permit Programs: The National Pollutant Discharge Elimination System
40 CFR Part 141	National Primary Drinking Water Regulations
40 CFR Part 142	National Primary Drinking Water Regulations Implementation
40 CFR Part 143	National Secondary Drinking Water Regulations
40 CFR Part 144	Underground Injection Control (“UIC”) Program
40 CFR Part 145	State UIC Program Requirements
40 CFR Part 146	UIC Program: Criteria and Standards
40 CFR Part 147	State UIC Programs
40 CFR Part 148	Hazardous Waste Injection Restrictions
40 CFR Part 403	General Pretreatment Regulations for Existing and New Sources of Pollution
Solid and Hazardous Wastes (RCRA)	
40 CFR Part 260	Hazardous Waste Management System
40 CFR Part 261	Identification and Listing of Hazardous Waste
40 CFR Part 262	Standards Applicable to Generators of Hazardous Waste
40 CFR Part 263	Standards Applicable to Transporters of Hazardous Waste
40 CFR Part 264	Standards for Owners and Operators of Hazardous Waste Treatment, Storage, and Disposal Facilities
40 CFR Part 265	Interim Status Standards for Owners and Operators of Hazardous Waste Treatment, Storage, and Disposal Facilities
40 CFR Part 266	Standards for the Management of Specific Hazardous Wastes and Specific Types of Hazardous Waste Management Facilities
40 CFR Part 268	Land Disposal Restrictions
40 CFR Part 273	Standards for Universal Waste Management
40 CFR Part 279	Standards for the Management of Used Oil
40 CFR Part 280	Technical Standards and Corrective Requirements for Owners and Operators of Underground Storage Tanks (USTs)
Hazardous Substances and Chemicals, Environmental Response, Emergency Planning, and Community Right-to-Know Programs (CERCLA and EPCRA)	
40 CFR Part 302	Designation, Reportable Quantities, and Notification
40 CFR Part 355	Emergency Planning and Notification
40 CFR Part 370	Hazardous Chemical Reporting: Community Right-to-Know
40 CFR Part 372	Toxic Chemical Release Reporting: Community Right-to-Know

Table 16: Summary of Applicable EPA Regulations (Continued)

Air Programs (CAA)	
40 CFR Section 52.21	Prevention of Significant Deterioration of Air Quality
40 CFR Part 60	Standards of Performance for New Stationary Sources
40 CFR Part 61	National Emission Standards for Hazardous Air Pollutants, Subpart M, National Emission Standard for Asbestos
40 CFR Part 63	National Emission Standards for Hazardous Air Pollutants for Source Categories (all applicable provisions)
40 CFR Part 68	Chemical Accident Prevention Provisions
40 CFR Part 70	State Operating Permit Programs
40 CFR Part 82	Protection of Stratospheric Ozone
All applicable provisions of State Implementation Plan Regulations (promulgated pursuant to Section 110 of the Clean Air Act) including the New Source Review regulations	
Toxic Substances (TSCA)	
40 CFR Part 745	Lead-Based Paint Poisoning Prevention in Certain Residential Structures
40 CFR Part 761	Polychlorinated Biphenyls (PCBs) Manufacturing, Processing, Distribution in Commerce, and Use Prohibitions
40 CFR Part 763	Asbestos
Pesticide Programs (FIFRA)	
40 CFR Part 160	Good Laboratory Practice Standards
40 CFR Part 162	State Registration of Pesticide Products
40 CFR Part 170	Worker Protection Standard
40 CFR Part 171	Certification of Pesticide Applicators
40 CFR Part 172	Experimental Use Permits

Note that, in the RMPP industry, compliance with environmental regulations may be handled in many different ways. Though ideally all employees should help comply, official responsibility could lie at the corporate level, it could lie within the RMPP facility as either a centrally or non-centrally organized activity, or it could be part of a function for vendored-out services. EPA observes that the organizations that successfully achieve compliance engage all or many employees in the various facility operations.

Clean Water Act

The primary objective of the Federal Water Pollution Control Act, commonly referred to as the Clean Water Act (CWA), is to restore and maintain the chemical, physical, and biological integrity of the nation's surface waters. Pollutants regulated under the CWA are classified as either "toxic" pollutants; "conventional" pollutants, such as BOD, TSS, fecal coliform, oil and grease, and pH; or "nonconventional" pollutants, including any pollutant not identified as either conventional or priority.

The CWA regulates both direct and indirect dischargers (those who discharge to POTWs). The National Pollutant Discharge Elimination System (NPDES) permitting program (CWA section 402) controls direct discharges into navigable waters. Direct discharges or “point source” discharges are from sources such as pipes and sewers. NPDES permits, issued by either EPA or an authorized state (EPA has authorized 43 states and one territory to administer the NPDES program), contain industry-specific, technology-based and water-quality-based limits and establish pollutant monitoring and reporting requirements. A facility that proposes to discharge into the nation's waters must obtain a permit prior to initiating a discharge. A permit applicant must provide quantitative analytical data identifying the types of pollutants present in the facility's effluent. The permit will then set forth the conditions and effluent limitations under which the facility may discharge.

Water-quality-based discharge limits are based on federal or state water quality criteria or standards that were designed to protect designated uses of surface waters, such as supporting aquatic life or recreation. These standards, unlike the technology-based standards, generally do not take into account technological feasibility or costs. Water quality criteria and standards vary from state to state and site to site, depending on the use classification of the receiving body of water. Most states follow EPA effluent guidelines, which propose aquatic life and human health criteria for many of the 126 priority pollutants.

As stated in Section I of this document, wastewater sources for RMPP facilities include heating, cooling, cleaning, and finishing process waters as well as stormwater. The RMPP industry is subject to various provisions of the CWA including:

- **Wastewater Discharges:** NPDES effluent limitations and guidelines for direct dischargers and general pretreatment standards.
- **Stormwater Permits:** Municipal separate storm sewer systems (MS4), such as those from RMPP facilities, and construction activities are subject to stormwater permitting requirements.
- **Oil Pollution Prevention Requirements:** RMPP facilities that have aboveground oil storage capacity exceeding 660 gallons individually or 1,320 gallons total or an underground storage capacity exceeding 42,000 gallons are subject to spill prevention control and countermeasure (SPCC) plan requirements.

Wastewater Discharges

As stated above, the water regulations establish different permitting programs for direct and indirect wastewater discharges. Most facilities in the RMPP industry are indirect dischargers.

- **Indirect Dischargers:** RMPP facilities that are indirect dischargers are subject to regulations by the local sewer authority. At present, approximately 1,500 of the nation's largest municipalities are required to implement industrial pretreatment programs that include issuing industrial

user permits to significant industrial users. Some municipalities have determined RMPP facilities to be significant industrial users.

Federal pretreatment regulations prohibit discharges of fire or explosion hazards; corrosive discharges (pH < 5.0); solid or viscous pollutants; heat (in amounts that cause the treatment plant influent to exceed 104 degrees F); pollutants that cause toxic gases, fumes, or vapors; and any other pollutant (including oil and grease) that will interfere with or pass through the treatment plant.

- **Direct Dischargers:** Facilities that directly discharge process and sewer wastes must be permitted (i.e., obtain a permit) for any point source discharge of pollutants to waters of the United States. These permits are issued either by U.S. EPA or the state, where the state has been authorized to implement the NPDES permit program. The federal regulations establish the permit application and permit requirements. Specific numeric limitations that apply to a RMPP facility depend on the receiving stream of the discharge. EPA Regional pretreatment coordinators can provide detailed information on numeric limitations. Contact information can be found at the following web site: http://cfpub.epa.gov/npdes/contacts.cfm?program_id=3&type=REGION/.

Stormwater Discharges

EPA's NPDES web site <http://cfpub.epa.gov/npdes> provides technical and regulatory information about the NPDES) permit program. The stormwater program is part of the NPDES program and is designed to prevent the discharge of contaminated stormwater into navigable waters http://cfpub.epa.gov/npdes/home.cfm?program_id=6

EPA promulgated Phase I of the stormwater program in 1990 and applied it to medium and large municipal separate storm sewer systems (MS4), certain industrial facilities, and any construction activity disturbing greater than 5 acres (large construction sites).

The Agency promulgated Phase II of the stormwater program in 1999; Phase II applies to small municipal separate storm sewer systems (MS4) and construction activity greater than 1 acre and less than 5 acres (small construction sites).

The term MS4 does not solely refer to municipally owned storm sewer systems, but rather has a much broader application that can include, in addition to local jurisdictions, state departments of transportation, universities, local sewer districts, hospitals, military bases, and prisons. A MS4 also is not always just a system of underground pipes - it can include roads with drainage systems, gutters, and ditches. RMPP facilities in urban areas should consult with their state NPDES authority to evaluate whether a permit authorization is required.

The regulatory definition of an MS4 is provided in 40 CFR 122.26(b)(8). General stormwater information can be found at http://cfpub.epa.gov/npdes/home.cfm?program_id=6 and the Stormwater Phase II Compliance Assistance Guide, at <http://www.epa.gov/npdes/pubs/comguide.pdf>.

EPA's Office of Water operates a Water Resource Center with a 24-hour voice mail system for publication orders or reference questions at (202) 566-1729 (e-mail address: center.water-resource@epa.gov). Long-distance callers in the United States may also use the Wetlands Helpline ((800) 832-7828), operating weekdays from 8:30 a.m. to 4:30 p.m., EST, excluding federal holidays. Visit the Office of Water web site (<http://www.epa.gov/OW/index.html>) and the NPDES web site (<http://cfpub.epa.gov/npdes/>) for additional material.

Wetlands

Wetlands, commonly called swamps, marshes, fens, bogs, vernal pools, playas, and prairie potholes, are a subset of "waters of the United States," as defined in Section 404 of the CWA. The placement of dredge and fill material into wetlands and other water bodies (i.e., waters of the United States) is regulated by the U.S. Army Corps of Engineers (Corps) under 33 CFR Part 328. The Corps regulates wetlands by administering the CWA Section 404 permit program for activities that impact wetlands. EPA's authority under Section 404 includes veto power of Corps permits, authority to interpret statutory exemptions and jurisdiction, enforcement actions, and delegating the Section 404 program to the states.

The EPA Wetlands Helpline ((800) 832-7828, or (202) 566-1730 for international calls) provides information and referral services on wetland topics (e-mail address: wetlands.helpline@epa.gov). The helpline operates weekdays from 8:30 a.m. to 4:30 p.m., EST, excluding federal holidays. Visit the Office of Water Wetlands web site at <http://www.epa.gov/owow/wetlands/> for additional material.

Oil Pollution Prevention Regulation

Section 311(b) of the CWA prohibits the discharge of oil, in such quantities as may be harmful, into the navigable waters of the United States and adjoining shorelines. The EPA Discharge of Oil regulation, 40 CFR Part 110, provides information regarding these discharges. The Oil Pollution Prevention regulation, 40 CFR Part 112, under the authority of Section 311(j) of the CWA, requires regulated facilities to prepare and implement spill prevention, control, and countermeasure (SPCC) plans. The intent of an SPCC plan is to prevent the discharge of oil from onshore and offshore non-transportation-related facilities. In 1990, Congress passed the Oil Pollution Act (OPA), which amended Section 311(j) of the CWA to require facilities, that because of their location could reasonably be expected to cause "substantial harm" to the environment by a discharge of oil, to develop and implement Facility Response Plans (FRP). The intent of an FRP is to provide for planned responses to discharges of oil.

A facility is SPCC-regulated if the facility, due to its location, could reasonably be expected to discharge oil into or upon the navigable waters of the United States or adjoining shorelines, and the facility meets one of the following criteria regarding oil storage: (1) the capacity of any aboveground storage tank exceeds 660 gallons, or (2) the total aboveground storage capacity exceeds 1,320 gallons, or (3) the underground storage capacity exceeds 42,000 gallons. When determining facility capacity, the following exemptions apply:

- Completely buried tanks subject to the Underground Storage Tank rules;
- Containers with less than 55-gallon capacity;

- Wastewater treatment facilities; and
- Permanently closed tanks.

40 CFR Part 112.7 contains the format and content requirements for an SPCC plan. In New Jersey, SPCC plans can be combined with discharge prevention, containment, and countermeasures plans, required by the state, provided there is an appropriate cross-reference index to the requirements of both regulations at the front of the plan.

According to the FRP regulation, a facility can cause “substantial harm” if it meets one of the following criteria: (1) the facility has a total oil storage capacity greater than or equal to 42,000 gallons and transfers oil over water to or from vessels; or (2) the facility has a total oil storage capacity greater than or equal to one million gallons and meets any one of the following conditions: (i) does not have adequate secondary containment, (ii) a discharge could cause “injury” to fish and wildlife and sensitive environments, (iii) shut down a public drinking water intake, or (iv) has had a reportable oil spill greater than or equal to 10,000 gallons in the past five years. Appendix F of 40 CFR Part 112 contains the format and content requirements for an FRP. FRPs that meet EPA’s requirements can be combined with U.S. Coast Guard FRPs or other contingency plans, provided there is an appropriate cross-reference index to the requirements of all applicable regulations at the front of the plan.

For additional information regarding SPCC plans, contact EPA’s RCRA, Superfund, and EPCRA Call Center, at (800) 424-9346 (or e-mail at epacallcenter@bah.com). Additional documents and resources can be obtained from the call center’s homepage at <http://www.epa.gov/epaoswer/hotline>. The call center operates weekdays from 9:00 a.m. to 5:00 p.m., EST, excluding federal holidays. Visit EPA’s Oil Program web site (<http://www.epa.gov/oilspill/index.htm>) for further material.

Safe Drinking Water Act

The Safe Drinking Water Act (SDWA) mandates that EPA establish regulations to protect human health from contaminants in drinking water. The law authorizes EPA to develop national drinking water standards and to create a joint federal-state system to ensure compliance with these standards. The SDWA also directs EPA to protect underground sources of drinking water by controlling underground injection of fluid wastes.

EPA has developed primary and secondary drinking water standards under its SDWA authority. EPA and authorized states enforce the primary drinking water standards, which are contaminant-specific concentration limits that apply to certain public drinking water supplies. Primary drinking water standards consist of maximum contaminant level goals (MCLGs), which are nonenforceable health-based goals, and maximum contaminant levels (MCLs), which are enforceable limits set generally as close to MCLGs as possible, considering cost and feasibility of attainment.

Part C of the SDWA mandates EPA to protect underground sources of drinking water from inadequate injection practices. EPA has published regulations codified at 40 CFR Parts 144 to 148 to comply with this mandate. The Underground Injection Control (UIC) regulations break down injection wells into five different types, depending on the fluid injected and the formation that receives it. The regulations also include construction, monitoring, testing,

and operating requirements for injection well operators. All injection wells have to be authorized by permit or by rule depending on their potential to threaten Underground Sources of Drinking Water. RCRA also regulates hazardous waste injection wells, and a UIC permit is considered to meet the requirements of a RCRA permit. EPA has authorized delegation of the UIC for all well classes in 34 states, implements the program in 10 states and all Native American lands, and shares responsibility with 6 states.

The SDWA also provides for a federally implemented Sole Source Aquifer program, which prohibits federal funds from being expended on projects that may contaminate the sole or principal source of drinking water for a given area, and for a state-implemented Wellhead Protection program, designed to protect drinking water wells and drinking water recharge areas.

The SDWA Amendments of 1996 require states to develop and implement source water assessment programs (SWAP) to analyze existing and potential threats to the quality of the public drinking water throughout the state. Every state is required to submit a program to EPA and to complete all assessments within 3½ years of EPA approval of the program. SWAP include: (1) delineating the source water protection area, (2) conducting a contaminant source inventory, (3) determining the susceptibility of the public water supply to contamination from the inventory's sources, and (4) releasing the results of the assessments to the public.

EPA's Safe Drinking Water Hotline, at (800) 426-4791 (or (703) 412-3330 for local and international calls), answers questions and distributes guidance pertaining to SDWA standards (e-mail: hotline-sdwa@epa.gov). The Hotline operates from 9:00 a.m. to 5:00 p.m., EST, excluding federal holidays. Visit the web site at <http://www.epa.gov/ogwdw> for additional material.

Resource Conservation and Recovery Act

The Solid Waste Disposal Act (SWDA), as amended by the RCRA of 1976, addresses solid and hazardous waste management activities. The Act is commonly referred to as RCRA. The Hazardous and Solid Waste Amendments (HSWA) of 1984 strengthened RCRA's waste management provisions and added Subtitle I, which governs USTs.

Although RCRA is a federal statute, many states administer the RCRA hazardous waste program in lieu of the federal program. Currently, EPA has authorized 48 of the 50 states and two U.S. territories to administer various provisions of RCRA Subtitle C. States must have regulations consistent with and at least as stringent as the federal program; some states have additional reporting requirements. RMPP facilities should contact their state or tribal authority to determine which state or tribal requirements apply to their business. RCRA does not enable EPA to authorize tribal hazardous waste programs in lieu of the federal program; therefore, EPA directly implements RCRA hazardous waste programs in Indian country, but tribes may have their own, independent hazardous waste programs.

RCRA assigns each hazardous waste reporting facility a generator status. Reporting requirements are different for each generator type. Hazardous waste generators are divided into three categories, according to how much they generate in a calendar month:

- **Large Quantity Generators (LQG)** generate greater than or equal to 1,000 kg (approximately 2,200 lbs) of hazardous waste per month, or greater than 1 kg (approximately 2.2 lbs) of acutely hazardous waste per month. EPA considers acute hazardous wastes the P-listed wastes. If facilities generate more than 1 kg (approximately 1 quart) of acutely hazardous waste, then they are LQGs and must comply with all LQG reporting requirements.
- **Small Quantity Generators (SQG)** generate greater than 100 kg (approximately 220 lbs) but less than 1,000 kg of hazardous waste per month and/or less than 1 kg (approximately 2.2 lbs) of acutely hazardous waste per month.
- **Conditionally Exempt Small Quantity Generators (CESQG)** generate less than or equal to 100 kg of hazardous waste per month, and less than or equal to 1 kg of acutely hazardous waste per month. Not all states recognize the CESQG class.
- **Large Quantity Handler of Universal Waste** store greater than 5,000 kg of universal waste on site.
- **Small Quantity Handler of Universal Waste** store less than 5,000 kg or about 11,000 lbs of universal waste (all types combined) on any given day during the calendar year.

Regulations promulgated pursuant to Subtitle C of RCRA (40 CFR Parts 260-299) establish a “cradle-to-grave” system governing hazardous waste from the point of generation to disposal. RCRA defines hazardous waste as a subset of solid waste. Solid waste is defined as garbage, refuse, sludge, or other discarded material (including solids, semisolids, liquids, and contained gaseous materials). Once a waste is considered solid waste, facilities must determine if it is hazardous waste. RCRA hazardous wastes include the specific materials listed in the regulations (discarded commercial chemical products, designated with the code “P” or “U”; hazardous wastes from specific industries/sources, designated with the code “K”; or hazardous wastes from nonspecific sources, designated with the code “F”) or materials that exhibit a hazardous waste characteristic (ignitability, corrosivity, reactivity, or toxicity and designated with the code “D”).

Subtitle C permits are required for treatment, storage, or disposal facilities. These permits contain general facility standards such as contingency plans, emergency procedures, recordkeeping and reporting requirements, financial assurance mechanisms, and unit-specific standards. RCRA also contains provisions (40 CFR Subparts I and S) for conducting corrective actions that govern the cleanup of releases of hazardous waste or constituents from solid waste management units at RCRA treatment, storage, or disposal facilities.

Entities that generate hazardous waste are subject to Federal standards applicable to generators of hazardous waste (e.g., hazardous waste manifest, pre-transportation, recordkeeping and reporting, etc). Storage of hazardous waste generally requires a permit under RCRA hazardous waste regulations, but provisions under RCRA do allow generators to

"accumulate" hazardous waste on site without a permit or interim status as long as they comply, among other things, with the technical standards for the containment unit(s). The length of time a generator is allowed to accumulate hazardous waste on site without a permit or interim status depends on the generator's classification. For instance, Large Quantity Generators may accumulate any quantity on-site for 90 days or less without a permit or interim status. Small Quantity Generators may accumulate no more than 6,000 kg of hazardous waste without a permit or interim status for 180 days or less (or for 270 days or less depending on transport distance). CESQGs may accumulate 1,000 kg of waste, 1kg acute waste, or 100 kg residue or contaminated soil from a cleanup of an acute hazardous waste spill. Generators also may treat hazardous waste in accumulation tanks or containers (in accordance with the requirements of 40 CFR Part 262.34) without a permit or interim status. Facilities that treat, store, or dispose of hazardous waste generally are required to obtain a RCRA permit.

Generator status is determined by calendar month; therefore, one month a facility may be a CESQG, and the rest of the year it may be an SQG. In this case, it might be easier to comply with SQG reporting requirements for consistency. On the other hand, if the facility is usually an SQG, a store room or laboratory cleanout might push it into being an LQG. In exceptional cases like this when it is a one time occurrence, some states have made exceptions so that the cleanout does not trigger LQG status.

Generators "count" the amount of waste generated, by adding up the total weight of all quantities of characteristic and listed waste generated at a particular facility. Certain wastes, such as those that are reclaimed or recycled continuously on site, are not counted under the federal regulations but might be counted under some state regulations.

Most RCRA requirements are not industry-specific but apply to any company that generates, transports, treats, stores, or disposes of hazardous waste. Below are some important RCRA regulatory requirements:

- **Criteria for Classification of Solid Waste Disposal Facilities and Practices** (40 CFR Part 257) establish the criteria for determining which solid waste disposal facilities and practices pose a reasonable probability of adverse effects on health or the environment. The criteria were adopted to ensure nonmunicipal, nonhazardous waste disposal units that receive CESQG waste do not present risks to human health and environment.
- **Criteria for Municipal Solid Waste Landfills** (40 CFR Part 258) establish minimum national criteria for all municipal solid waste landfill units, including those that are used to dispose of sewage sludge.
- **Identification of Solid and Hazardous Wastes** (40 CFR Part 261) establishes the standard to determine whether the material in question is considered a solid waste and, if so, whether it is a hazardous waste or is exempted from regulation.
- **Standards for Generators of Hazardous Waste** (40 CFR Part 262) establishes the responsibilities of hazardous waste generators including obtaining an EPA identification number, preparing a manifest, ensuring

proper packaging and labeling, meeting standards for waste accumulation units, and recordkeeping and reporting requirements. Generators can accumulate hazardous waste on site for up to 90 days (or 180 days depending on the amount of waste generated) without obtaining a permit.

- **Land Disposal Restrictions (LDRs)** (40 CFR Part 268) prohibit the disposal of hazardous waste on land without prior treatment. Under the LDR program, materials must meet treatment standards prior to placement in a RCRA land disposal unit (landfill, land treatment unit, waste pile, or surface impoundment). Generators of waste subject to the LDRs must provide notification of such to the designated TSD facility to ensure proper treatment prior to disposal.
- **Used Oil Management Standards** (40 CFR Part 279) impose management requirements affecting the storage, transportation, burning, processing, and re-refining of used oil. For parties that merely generate used oil, regulations establish storage standards. A party considered a used oil processor, re-refiner, burner, or marketer (one who generates and sells off-specification used oil directly to a used oil burner) must meet additional tracking and paperwork requirements.

RCRA contains unit-specific standards for all units used to store, treat, or dispose of hazardous waste, including **Tanks and Containers**. Tanks and containers used to store hazardous waste with a high volatile organic concentration must meet emission standards under RCRA. Regulations (40 CFR Part 264-265, Subpart CC) require generators to test the waste to determine the concentration of the waste, to satisfy tank and container emissions standards, and to inspect and monitor regulated units. These regulations apply to all facilities that store such waste, including large quantity generators accumulating waste prior to shipment off site.

- **Underground Storage Tanks (USTs)** containing petroleum and hazardous substances are regulated under Subtitle I of RCRA. Subtitle I regulations (40 CFR Part 280) contain tank design and release detection requirements, as well as financial responsibility and corrective action standards for USTs. The UST program also includes upgrade requirements for existing tanks that were to be met by December 22, 1998.
- **Boilers and Industrial Furnaces (BIFs)** that use or burn fuel containing hazardous waste must comply with design and operating standards. BIF regulations (40 CFR Part 266, Subpart H) address unit design, provide performance standards, require emissions monitoring, and, in some cases, restrict the type of waste that may be burned.

Some wastes have special exclusions for practices that are not considered to be hazardous, as determined by federal policy. Several exclusions and exemptions pertain specifically to RMPP facilities. Keep in mind that some states do not recognize the federal exclusions. Some federal exclusions that are relevant to RMPP facilities are listed below:

- **Domestic Sewage Exclusion.** Mixtures of domestic sewage and other wastes that discharge to a sewer system and then to a POTW for treatment are excluded from the definition of solid waste. For example, an employee may generate a hazardous waste by washing hands with a soap containing listed hazardous waste. The mixture will be going through a POTW; therefore, it is excluded from the facility's hazardous waste "count." Generators need to contact their local POTW for prior approval. Note that wastes must actually reach the POTW to be covered by this exclusion. Waste that volatilizes in the drain or corrodes the pipes does not reach the POTW.
- **Point Source Exclusions.** Point source discharges of industrial waste waters that are subject to regulation under Section 402 of the CWA are excluded from the definition of solid waste.
- **Wastewater Treatment Unit.** Any hazardous waste tank system used to store or treat the wastewater that is managed at an on-site wastewater treatment facility with an NPDES permit or that discharges to a POTW is exempt from the RCRA regulations. Most RMPP facilities do not perform this type of wastewater treatment but instead perform elementary neutralization, discussed below.
- **Elementary Neutralization Unit.** Tanks used for neutralizing waste that is hazardous solely because of its corrosive characteristic are excluded from the permitting requirements.
- **De Minimis Exclusion.** Small quantities of some solvents and other chemicals are exempt from the regulations when they are mixed with wastewater in a wastewater treatment system discharging, according to the Clean Water Act.

RCRA defines lead-based paint debris as hazardous waste, unless generated during abatement, renovation, and remodeling of homes or other residences. Lead-based paint debris may be generated at a facility during renovations. Regardless of the debris source, facilities cannot dump or open-burn lead-based paint debris. See the Toxic Substances Control Act (TSCA) for further lead rules. *For more information on lead regulations, visit the web site <http://www.epa.gov/lead/regulation.htm>.*

EPA's RCRA, Superfund, and EPCRA Call Center, at (800) 424-9346, responds to questions and distributes guidance regarding all RCRA regulations. Additional documents and resources can be obtained from the hotline's homepage at <http://www.epa.gov/epaoswer/hotline>. The RCRA Hotline operates weekdays from 9:00 a.m. to 5:00 p.m., EST, excluding federal holidays. Visit the web site (<http://www.epa.gov/epaoswer/osw/laws-reg.htm>) for additional material.

Universal Waste Rule

EPA created the Universal Waste Rule to encourage and streamline recycling efforts. It allows facilities to count wastes as universal instead of hazardous, which does not count toward generator status. Segregating universal wastes from the rest of the hazardous waste streams can save RMPP facilities money on disposal costs, as well as on recordkeeping. Federal universal wastes include certain batteries, mercury-containing thermostats, and fluorescent light bulbs. Facilities should make sure that their state or territory has adopted these universal wastes. Section VI.C also discusses this rule.

Comprehensive Environmental Response, Compensation, and Liability Act

The Comprehensive Environmental Response, Compensation, and Liability Act (CERCLA), a 1980 law commonly known as Superfund, authorizes EPA to respond to releases, or threatened releases, of hazardous substances that may endanger public health, welfare, or the environment. CERCLA also enables EPA to force parties responsible for environmental contamination to clean it up or to reimburse the Superfund for response or remediation costs incurred by EPA. The Superfund Amendments and Reauthorization Act (SARA) of 1986 revised various sections of CERCLA, extended the taxing authority for the Superfund, and created a free-standing law, SARA Title III, also known as EPCRA.

The CERCLA hazardous substance release reporting regulations (40 CFR Part 302) direct the person in charge of a facility to report to the National Response Center (NRC) any environmental release of a hazardous substance that equals or exceeds a reportable quantity. Reportable quantities are listed in 40 CFR Part 302.4. A release report may trigger a response by EPA or by one or more federal or state emergency response authorities.

EPA implements hazardous substance responses according to procedures outlined in the National Oil and Hazardous Substances Pollution Contingency Plan (NCP) (40 CFR Part 300). The NCP includes provisions for cleanups. The National Priorities List (NPL) currently includes 1,240 sites (as of January 2004). Both EPA and states can act at other sites; however, EPA provides responsible parties the opportunity to conduct cleanups and encourages community involvement throughout the Superfund response process.

EPA's RCRA, Superfund, and EPCRA Call Center, at (800) 424-9346, responds to questions and distributes guidance pertaining to the Superfund program. Additional documents and resources can be obtained from the hotline's homepage at <http://www.epa.gov/epaoswer/hotline>. The Superfund Hotline operates weekdays from 9:00 a.m. to 5:00 p.m., EST, excluding federal holidays. Visit the Superfund web site (<http://www.epa.gov/superfund/index.htm>) for additional material.

Emergency Planning And Community Right-To-Know Act

The SARA of 1986 created EPCRA (also known as SARA Title III), a statute designed to improve community access to information about chemical hazards and to facilitate the development of chemical emergency response plans by state and local governments. Under EPCRA, states establish State Emergency Response Commissions (SERC), responsible for

coordinating certain emergency response activities and for appointing Local Emergency Planning Committees (LEPC).

EPCRA establishes the following types of reporting obligations for facilities that store or manage specified chemicals:

- **EPCRA Section 302** requires facilities to notify the SERC and LEPC of the presence of any extremely hazardous substance at the facility in an amount in excess of the established threshold planning quantity. The list of extremely hazardous substances and their threshold planning quantities is found at 40 CFR Part 355, Appendices A and B.
- **EPCRA Section 303** requires that each LEPC develop an emergency plan. The plan must contain (but is not limited to) the identification of facilities within the planning district, likely routes for transporting extremely hazardous substances, a description of the methods and procedures to be followed by facility owners and operators, and the designation of community and facility emergency response coordinators.
- **EPCRA Section 304** requires the facility to notify the SERC and the LEPC in the event of a release exceeding the reportable quantity of a CERCLA hazardous substance (defined at 40 CFR Part 302) or an EPCRA extremely hazardous substance.
- **EPCRA Sections 311 and 312** require a facility at which a hazardous chemical, as defined by the Occupational Safety and Health Act, is present in an amount exceeding a specified threshold to submit to the SERC, LEPC, and local fire department material safety data sheets (MSDS) or lists of MSDSs and hazardous chemical inventory forms (also known as Tier I and II forms). This information helps the local government respond in the event of a spill or release of the chemical.
- **EPCRA Section 313** requires certain covered facilities to submit an annual toxic chemical release report. This report, commonly known as Form R, covers releases and transfers of toxic chemicals to various facilities and environmental media. EPA maintains the data reported in the TRI database. Covered facilities meet the following requirements: (1) have 10 or more employees; (2) are included in one of the following SIC codes:
 - 10 (except 1011, 1081, and 1094),
 - 12 (except 1241),
 - 20 through 39,

- 4911, 4931, or 4939 (limited to facilities that combust coal and/or oil for the purpose of generating electricity for distribution in commerce),
- 4953 (limited to facilities regulated under RCRA Subtitle C),
- 5169,
- 5171, and
- 7389 (limited to facilities primarily engaged in solvents recovery services on a contract or fee basis); and

(3) manufacture, process, or use specified chemicals in amounts greater than threshold quantities. Starting with reporting year 2000, EPA lowered the threshold quantities on PBT chemicals. Visit the TRI web site (<http://www.epa.gov/tri/>) for additional material.

All information submitted pursuant to EPCRA regulations is publicly accessible, unless protected by a trade secret claim.

EPA's RCRA, Superfund, and EPCRA Call Center, at (800) 424-9346, responds to questions and distributes guidance regarding the emergency planning and community right-to-know regulations. Additional documents and resources can be obtained from the hotline's homepage at <http://www.epa.gov/epaoswer/hotline>. The EPCRA Hotline operates weekdays from 9:00 a.m. to 5:00 p.m., EST, excluding federal holidays.

Clean Air Act

The Clean Air Act (CAA) and its amendments are designed to “protect and enhance the nation's air resources so as to promote the public health and welfare and the productive capacity of the population.” The CAA consists of six sections, known as Titles, which direct EPA to establish national standards for ambient air quality and for EPA and the states to implement, maintain, and enforce these standards through a variety of mechanisms. Under the CAA, many facilities are required to obtain operating permits that consolidate their air emission requirements. State and local governments oversee, manage, and enforce many of the requirements of the CAA. CAA regulations appear at 40 CFR Parts 50-99.

VOC and PM emissions are the main concern for this industry, which accounts for approximately 5 percent of total emissions for these pollutants. VOC emissions result from the mixing, milling, extruding, calendaring, vulcanizing, and grinding processes as well as solvent use. Although VOC emissions are low per mass of material processed, the facilities processing large quantities of materials face the potential of significant VOC emissions. PM emissions result from mixing, milling, cutting, and grinding processes; many of these processes produce fugitive emissions that are difficult to quantify.

Pursuant to Title I of the CAA, EPA has established national ambient air quality standards (NAAQSs) to limit levels of “criteria pollutants,” including CO, lead, nitrogen dioxide

(NO₂), particulate matter, ozone, and SO₂. Geographic areas that meet NAAQSs for a given pollutant are designated as attainment areas; those that do not meet NAAQSs are designated as nonattainment areas. Under Section 110 and other provisions of the CAA, each state must develop a State Implementation Plan (SIP) to identify sources of air pollution and to determine what reductions are required to meet federal air quality standards. Revised NAAQSs for particulates and ozone became effective in 2004.

Title I also authorizes EPA to establish NSPS, which are nationally uniform emission standards for new and modified stationary sources falling within particular industrial categories. NSPSs are based on the pollution control technology available to that category of industrial source (see 40 CFR Part 60).

Under Title I, EPA establishes and enforces NESHAPs, nationally uniform standards oriented toward controlling specific HAPs. Section 112(c) of the CAA further directs EPA to develop a list of source categories that emit any of 188 HAPs, and to develop regulations for these categories of sources. To date, EPA has listed 185 source categories and developed a schedule for establishing emission standards. The emission standards are being developed for both new and existing sources based on MACT. The MACT is defined as the control technology achieving the maximum degree of reduction in the emission of the HAPs, taking into account cost and other factors.

Title II of the CAA pertains to mobile sources, such as cars, trucks, buses, and planes. Reformulated gasoline, automobile pollution control devices, and vapor recovery nozzles on gas pumps are a few of the mechanisms EPA uses to regulate mobile air emission sources.

Title IV-A establishes a SO₂ and NO_x emissions program designed to reduce the formation of acid rain. Sulfur dioxide releases will be reduced by granting to certain sources limited emissions allowances that are set below previous levels of SO₂ releases.

Title V of the CAA establishes an operating permit program for all “major sources” (and certain other sources) regulated under the CAA. One purpose of the operating permit is to include in a single document all air emissions requirements that apply to a given facility. States have developed the permit programs in accordance with guidance and regulations from EPA. Once a state program is approved by EPA, the state issues and monitors permits.

Title VI is intended to protect stratospheric ozone by phasing out the manufacture of ozone-depleting chemicals and restricting their use and distribution. Production of Class I substances, including 15 kinds of chlorofluorocarbons (CFCs), was phased out (except for essential uses) in 1996.

EPA's Clean Air Technology Center, at (919) 541-0800 (in Spanish: (919) 541-1800) or <http://www.epa.gov/ttn/catc>, provides general assistance and information on CAA standards (e-mail: catcmail@epamail.epa.gov). The Stratospheric Ozone Information Hotline, at (800) 296-1996, or the Ozone Depletion web site (<http://www.epa.gov/ozone>), provides general information about regulations promulgated under Title VI of the CAA. The RCRA, Superfund, and EPCRA Call Center, at (800) 424-9346 or <http://www.epa.gov/epaoswer/hotline>, responses to questions about accidental release prevention under CAA Section 112(r).

Information on air toxics can be accessed through the Unified Air Toxics web site at <http://www.epa.gov/ttn/atw/>. In addition, the Clean Air Technology Center's web site includes recent CAA rules, EPA guidance documents, and updates of EPA activities.

Federal Insecticide, Fungicide, and Rodenticide Act

The Federal Insecticide, Fungicide, and Rodenticide Act (FIFRA) was first passed in 1947 and amended numerous times, most recently by the Food Quality Protection Act (FQPA) of 1996. FIFRA provides EPA with the authority to oversee, among other things, the registration, distribution, sale and use of pesticides. The Act applies to all types of pesticides, including insecticides, herbicides, fungicides, rodenticides, and antimicrobials. FIFRA covers both intrastate and interstate commerce.

Establishment Registration

Section 7 of FIFRA requires that establishments producing pesticides, or active ingredients used in producing a pesticide subject to FIFRA, register with EPA. Registered establishments must report the types and amounts of pesticides and active ingredients they produce. FIFRA also provides EPA inspection authority and enables the Agency to take enforcement actions against facilities that are not in compliance with FIFRA.

Product Registration

Under Section 3 of FIFRA, all pesticides (with few exceptions) sold or distributed in the United States must be registered by EPA. Pesticide registration is very specific and generally allows use of the product only as specified on the label. Each registration specifies the use site (i.e., where the product may be used) and the amount that may be applied. The person who seeks to register the pesticide must file an application for registration. The application process often requires either the citation or submission of extensive environmental, health, and safety data.

To register a pesticide, the EPA Administrator must make a number of findings, one of which is that the pesticide, when used in accordance with widespread and commonly recognized practice, will not generally cause unreasonable adverse effects on the environment.

FIFRA defines "unreasonable adverse effects on the environment" as "(1) any unreasonable risk to man or the environment, taking into account the economic, social, and environmental costs and benefits of the use of the pesticide, or (2) a human dietary risk from residues that result from a use of a pesticide in or on any food inconsistent with the standard under section 408 of the Federal Food, Drug, and Cosmetic Act (FFDCA) (21 U.S.C. 346a)."

Under FIFRA section 6(a)(2), after a pesticide is registered, the registrant must also notify EPA of any additional facts and information concerning unreasonable adverse environmental effects of the pesticide. Also, if EPA determines that additional data are needed to support a registered pesticide, registrants may be requested to provide additional data. If EPA determines that the registrant(s) did not comply with their request for more information, the registration can be suspended under FIFRA section 3(c)(2)(B).

Use Restrictions

As a part of the pesticide registration, EPA must classify the product for general use, restricted use, or general for some uses and restricted for others. For pesticides that may cause unreasonable adverse effects on the environment, including injury to the applicator, EPA may require that the pesticide be applied either by, or under the direct supervision of, a certified applicator.

Reregistration

Due to concerns that much of the safety data underlying pesticide registrations becomes outdated and inadequate, in addition to requiring that registrations be reviewed every 15 years, FIFRA requires EPA to reregister all pesticides that were registered prior to 1984 (section 4). After reviewing existing data, EPA may approve the reregistration, request additional data to support the registration, cancel, or suspend the pesticide.

Tolerances and Exemptions

A tolerance is the maximum amount of pesticide residue that can be on a raw product and still be considered safe. Before EPA can register a pesticide that is used on raw agricultural products, it must grant a tolerance or exemption from a tolerance (40 CFR Parts 163.10 through 163.12). Under the FFDCA, a raw agricultural product is deemed unsafe if it contains a pesticide residue, unless the residue is within the limits of a tolerance established by EPA or is exempt from the requirement.

Cancellation and Suspension

EPA can cancel a registration if it is determined that the pesticide or its labeling does not comply with the requirements of FIFRA or causes unreasonable adverse effects on the environment.

In cases where EPA believes that an “imminent hazard” would exist if a pesticide were to continue to be used through the cancellation proceedings, EPA may suspend the pesticide registration through an order, and thereby halt the sale, distribution, and usage of the pesticide. An “imminent hazard” is defined as an unreasonable adverse effect on the environment or an unreasonable hazard to the survival of a threatened or endangered species that would be the likely result of allowing continued use of a pesticide during a cancellation process.

When EPA believes an emergency exists that does not permit a hearing to be held prior to suspending, EPA can issue an emergency order that makes the suspension immediately effective.

Imports and Exports

Under FIFRA section 17(a), pesticides not registered in the United States and intended solely for export are not required to be registered, provided that the exporter obtains and submits to EPA, prior to export, a statement from the foreign purchaser acknowledging that the purchaser is aware that the product is not registered in the United States and cannot be sold

for use there. EPA sends these statements to the government of the importing country. FIFRA sets forth additional requirements that must be met by pesticides intended solely for export. The enforcement policy for exports is codified at 40 CFR Parts 168.65, 168.75, and 168.85.

Under FIFRA section 17(c), imported pesticides and devices must comply with U.S. pesticide law. Except where exempted by regulation or statute, imported pesticides must be registered. FIFRA section 17(c) requires that EPA be notified of the arrival of imported pesticides and devices. To do this, an importer must complete the Notice of Arrival (NOA) (EPA Form 3540-1) prior to importation and submit it to the EPA Regional office applicable to the intended port of entry. U.S. Customs regulations prohibit importing pesticides without a completed NOA. The EPA-reviewed and signed form is returned to the importer to present to U.S. Customs when the shipment arrives in the United States. NOA forms can be obtained from contacts in the EPA Regional offices or <http://www.epa.gov/oppfead1/international/noalist.htm>.

Additional information on FIFRA and the regulation of pesticides can be obtained from a variety of sources, including EPA's Pesticide Program at <http://www.epa.gov/pesticides>, EPA's Office of Compliance, Agriculture and Ecosystem Division at <http://www.epa.gov/compliance/assistance/sectors/agriculture.html>, or The National Agriculture Compliance Assistance Center, (888) 663-2155 or <http://www.epa.gov/agriculture/> (e-mail: agcenter@epa.gov). Other sources include the National Pesticide Information Center, (800) 858-7378 or <http://npic.orst.edu/>, and EPA's Antimicrobial hotline, (703) 308-0127, operating weekdays from 9:00 a.m. to 4:00 p.m., EST, excluding federal holidays (e-mail: info_antimicrobial@epa.gov) or web site, <http://www.epa.gov/oppad001/>.

Toxic Substances Control Act

The Toxic Substances Control Act (TSCA) granted EPA authority to create a regulatory framework to collect data on chemicals in order to evaluate, assess, mitigate, and control risks that may be posed by their manufacture, processing, and use. TSCA provides a variety of control methods to prevent chemicals from posing unreasonable risk. It is important to note that pesticides as defined in FIFRA are not included in the definition of a "chemical substance" when manufactured, processed, or distributed in commerce for use as a pesticide. RMPP facilities may be subject to TSCA through:

- Lead hazard reduction regulations;
- Polychlorinated Biphenyls (PCB) hazard reduction regulations; and
- Asbestos hazard reduction regulations.

TSCA Regulations for Lead

- **National Lead Laboratory Accreditation Program** (TSCA section 405(b)) establishes protocols, criteria, and minimum performance standards for laboratory analysis of lead in paint, dust, and soil.
- **Hazard Standards for Lead in Paint, Dust, and Soil** (TSCA section 403) establishes standards for lead-based paint hazards and lead dust cleanup levels in most pre-1978 housing and child-occupied facilities.

- **Training & Certification Program for Lead-Based Paint Activities** (TSCA section 402/404) ensures that individuals conducting lead-based paint abatement, risk assessment, or inspection are properly trained and certified, that training programs are accredited, and that these activities are conducted according to reliable, effective, and safe work practice standards.
- **Pre-Renovation Education Rule** (TSCA section 406(b)) ensures that owners and occupants of most pre-1978 housing are provided information concerning potential hazards of lead-based paint exposure before beginning certain renovations on that housing.
- **Lead-Based Paint Disclosure Rule** (TSCA section 1018) requires disclosure of known lead-based paint and/or lead-based paint hazards by persons selling or leasing housing constructed before the phase-out of residential lead-based paint use in 1978.

TSCA Regulations for PCBs

The PCB regulations and requirements apply to both PCB waste materials and PCBs still in use. Because of potential harmful effects on human health and the environment, federal law banned U.S. production of PCBs as of July 2, 1979. However, PCB-containing materials may be present at facilities and PCB-laden wastes may be generated during renovations.

Items with a PCB concentration of 50 ppm or greater are regulated for disposal under 40 CFR Part 761. Some potential sources of PCBs include:

- Mineral-oil filled electrical equipment such as motors or pumps manufactured prior to July 2, 1979;
- Capacitors or transformers manufactured prior to July 2, 1979;
- Plastics, molded rubber parts, applied dried paints, coatings or sealants, caulking, adhesives, paper, Galbestos, sound-deadening materials, insulation, or felt or fabric products such as gaskets manufactured prior to July 2, 1979;
- Fluorescent light ballasts manufactured prior to July 2, 1979;
- Waste or debris from the demolition of buildings and equipment manufactured, serviced, or coated with PCBs; and
- Waste containing PCBs from spills, such as floors or walls contaminated by a leaking transformer.

The general requirements for handling PCB materials and equipment include identifying and labeling the material, notifying EPA, properly storing the material, and properly disposing of the material.

TSCA Regulations for Asbestos

EPA and the Occupational Safety and Health Administration (OSHA) have promulgated rules regulating asbestos production, use, and disposal. OSHA regulates private sector and some public sector employees' exposure to asbestos and specifies work practices and engineering controls for removing and handling asbestos. Along with EPA and OSHA, some states also have established asbestos requirements that extend the federal requirements. Asbestos programs implemented under TSCA include the Asbestos Hazard Emergency Response Act (AHERA), which regulates asbestos contained in schools and all public and commercial buildings including RMPP facilities. It requires the development of management plans; specifies work practices and engineering controls for removing and handling asbestos; and sets emissions limitations in schools after an abatement activity is completed. EPA Region 6 lists suspected asbestos-containing materials at <http://www.epa.gov/Region06/6pd/asbestos/asbmatl.htm>.

EPA's TSCA Assistance Information Service, at (202) 554-1404 (e-mail: tsc hotline@epa.gov), responds to questions and distributes guidance pertaining to TSCA standards. The Service operates from 8:30 a.m. through 5:00 p.m., EST, excluding federal holidays.

Coastal Zone Management Act

The Coastal Zone Management Act (CZMA) encourages states/tribes to preserve, protect, develop, and where possible, restore or enhance valuable natural coastal resources such as wetlands, floodplains, estuaries, beaches, dunes, barrier islands, and coral reefs, as well as the fish and wildlife using those habitats. It includes areas bordering the Atlantic, Pacific, and Arctic Oceans, Gulf of Mexico, Long Island Sound, and Great Lakes. A unique feature of this law is that participation by states/tribes is voluntary.

In the Coastal Zone Management Act Reauthorization Amendments (CZARA) of 1990, Congress identified nonpoint source pollution as a major factor in the continuing degradation of coastal waters. Congress also recognized that effective solutions to nonpoint source pollution could be implemented at the state/tribe and local levels. In CZARA, Congress added section 6217 (16 U.S.C. section 1455b), which calls upon states/tribes with federally approved coastal zone management programs to develop and implement coastal nonpoint pollution control programs. The Section 6217 program is administered at the federal level jointly by EPA and the National Oceanic and Atmospheric Agency (NOAA).

Section 6217(g) of CZARA called for EPA, in consultation with other agencies, to develop guidance on "management measures" for sources of nonpoint source pollution in coastal waters. Under section 6217, EPA is responsible for developing technical guidance to assist states/tribes design coastal nonpoint pollution control programs. On January 19, 1993, EPA issued its *Guidance Specifying Management Measures For Sources of Nonpoint Pollution in Coastal Waters*, which addresses five major source categories of nonpoint pollution: (1) urban runoff, (2) agriculture runoff, (3) forestry runoff, (4) marinas and recreational boating, and (5)

hydromodification. This document is available online at the following web site:

<http://www.epa.gov/owow/nps/MMGI/index.html>.

Additional information on coastal zone management can be obtained from EPA's Office of Wetlands, Oceans, and Watersheds, <http://www.epa.gov/owow>, or from the Watershed Information Network, <http://www.epa.gov/win>. The NOAA web site, <http://www.ocrm.nos.noaa.gov/czm/>, also contains additional information on coastal zone management.

VI.B. Industry-Specific Requirements

Although the RMPP manufacturing industries are grouped together under SIC code 30, current federal regulations separate the two industries. The environmental issues directly addressed for rubber products manufacturing are recycling mandates, air emissions, and hazardous waste disposal. Recycling requirements exist at the state and local level for plastics products and will be expanded upon later. Based on their pollutant outputs, both plastics and rubber products manufacturing processes have the potential to be regulated under the CAA, the CWA, and RCRA. The specific requirements of each of these statutes on the RMPP sector are discussed in this subsection.

Clean Air Act

Under Title I of the Clean Air Act Amendments of 1990 (CAAA) and under previous legislation, EPA has provided guidance and other information to state and local agencies on reducing VOC emissions from existing sources in ozone nonattainment areas. These documents are referred to as Control Techniques Guidelines (CTG) and Alternative Control Techniques (ACT). EPA issued a CTG for rubber tire manufacturing in 1978 (*Control of Volatile Organic Compound Emissions from Manufacture of Pneumatic Rubber Tires*, EPA-450/2-78/030). The Agency also issued an ACT for coating of plastic parts in 1994 (*Alternative Control Techniques Document: Surface Coating of Automotive/Transportation and Business Machine Plastic Parts*, EPA - 453/R-94/017).

National Ambient Air Quality Standards

At rubber and plastics products manufacturing facilities, air emissions from both process and combustion units are regulated under the NAAQS and the State Implementation Plans (SIP) that enforce the standards. States may implement controls to limit emissions of PM, NO_x, VOC, and SO₂.

Although many limits are implemented at the state level, there are national guidelines that serve as a basis for more specific limits. Sources that are considered "major" under the CAA are subject to prevention of significant deterioration (PSD) or new source review (NSR). Both PSD and NSR are permit programs for facilities that were constructed or modified after a certain date.

Facilities in NAAQS attainment areas must follow PSD requirements by demonstrating that the construction/modification project will not cause a violation of air quality limits and by implementing the best available control technology (BACT).

New or modified facilities in nonattainment areas must follow NSR requirements, which require the source to meet the lowest achievable emission rate and to obtain emission offsets to ensure that the nonattainment problem is not made worse by the new/modified source.

In addition to the PSD/NSR preconstruction obligations, there are process-specific operational standards, NSPS. 40 CFR 60 lists these standards, which serve as minimum requirements in states SIPs. Individual states may impose requirements that are more strict. The following NSPSs are particularly relevant to the RMPP industry:

Subparts D, Db, Dc	Industrial Boilers (Regulates PM, NO _x , and SO ₂ from new boilers)
Subpart GG	Gas-Fired Turbines (Regulates PM, NO _x , and SO ₂ from new gas-fired turbines)
Subpart Kb	Volatile Organic Liquid Storage Vessels (Including Petroleum Liquid Storage Vessels) (Regulates VOCs from applicable storage tanks containing volatile organic liquids)
Subpart BBB	Rubber and Tire Manufacturing Industry (Regulates VOC emissions from undertread cementing, sidewall cementing, tread end cementing, bead cementing, and green tire spraying operations)
Subpart TTT	Industrial Surface Coating: Surface Coating of Plastic Parts for Business Machines (Regulates VOC emissions from prime coats, color coats, texture coats, and touch-up coats)
Subpart VVV	Polymeric Coating of Supporting Substrates (Regulates VOC emissions from coating operations)

Hazardous Air Pollutants

Air toxics regulations apply to rubber and plastics products manufacturing industries. EPA has developed NESHAPs expressly for several processes in these industries. The NESHAPs establish process-based MACT for "major sources," which are defined as facilities that emit or have the potential to emit 10 tons per year or more of any HAP or 25 tons per year or more of any combination of HAPs. The following NESHAPs are particularly relevant to the RMPP industry:

40 CFR 61 Subpart M	Controlling asbestos emissions from demolition or renovation activities.
40 CFR 63 Subpart H	Controlling HAP emissions from equipment leaks, "Leak Detection and Repair."

40 CFR 63 Subpart Q	Controlling chromium emissions from cooling towers.
40 CFR 63 Subpart III	Controlling HAP emissions from facilities that make flexible polyurethane foam products, targeting methylene chloride in particular.
40 CFR 63 Subpart MMMM	Controlling HAP emissions from facilities that coat miscellaneous metal parts and products.
40 CFR 63 Subpart PPPP	Controlling HAP emissions from facilities that coat plastic parts and products.
40 CFR 63 Subpart WWWW	Controlling HAP emissions from facilities that make reinforced plastic composites products, targeting styrene in particular.
40 CFR 63 Subpart XXXX	Controlling HAP emissions from all rubber tire manufacturing industry facilities that make rubber tire products.
40 CFR 63 Subpart MMMMM	Controlling HAP emissions from facilities that cut, glue, and/or laminate pieces of flexible polyurethane foam.

Some NESHAPS such as 40 CFR 63 Subpart J Polyvinyl Chloride and Copolymers Production and 40 CFR 63 Subpart U Group 1 Polymers and Resins Production apply to facilities that manufacture the plastic resins used by the RMPP industry. Since these facilities are sometimes co-located with facilities in the RMPP industry, these regulations may also apply. Additional information concerning potentially applicable NESHAPS can be found in the Profile of the Plastic Resins and Man-made Fibers Industry located at: <http://www.epa.gov/compliance/resources/publications/assistance/sectors/notebooks/> and on EPA's Air Toxics website for National Emission Standards for Hazardous Air Pollutants located at: <http://www.epa.gov/ttn/atw/mactfnlalp.html>. Unlike the industry-specific NESHAP standards, chemical-specific NESHAPS may apply to all facilities regardless of their size.

Risk Management Program

RMPP manufacturing facilities are subject to section 112(r) of CAA, which states that stationary sources using extremely hazardous substances have a "general duty" to initiate specific activities to prevent and mitigate accidental releases. The general duty requirements apply to stationary sources that produce, process, handle, or store these substances, regardless of the quantity managed at the facility. Although there is no list of "extremely hazardous substances," EPA's Chemical Emergency Preparedness and Prevention Office provides some guidance at its web site: <http://yosemite.epa.gov/oswer/ceppoweb.nsf/content/index.html>. The general duty clause requires facilities to identify hazards that may result from accidental

releases, to design and maintain a safe facility, and to minimize the consequences of releases when they occur.

Many large RMPP manufacturing facilities are subject to additional, more explicit risk management requirements. Facilities that have more than a threshold quantity of any of the 140 regulated substances in a single process are required to develop a risk management program and to summarize their program in a risk management plan (RMP). Facilities subject to the requirements were required to submit a registration and RMP in 1999 or whenever they first exceed the threshold for a listed regulated substance after that date.

All facilities meeting the RMP threshold requirements must follow Program 1 requirements:

- Conduct off-site consequence analysis that evaluates specific potential release scenarios, including worst-case and alternative scenarios;
- Maintain a five-year history of certain accidental releases of regulated substances from covered processes; and
- Prepare an RMP, revised at least once every five years, that describes and documents these activities for all covered processes.

In addition, many RMPP manufacturing facilities may be subject to the requirements of Program 2 or 3. These additional requirements include:

- An integrated prevention program to manage risk. The prevention program will include hazards identification, written operating procedures, training, maintenance, and accident investigation.
- An emergency response program.
- An overall management system to put these program elements into effect.

The list of chemicals that trigger RMP requirements can be found in 40 CFR 68.130; information to determine the required program level also can be found in 40 CFR 68.

Title V Permits

Title V requires that all "major sources" (and certain minor sources) obtain an operating permit. Many RMPP facilities are required to have a Title V permit, and may be required to submit information about emissions, control devices, and the general processes at the facility in the permit application. Permits may limit pollutant emissions and impose monitoring, recordkeeping, and reporting requirements.

Title VI Stratospheric Ozone Protection

Many RMPP facilities operate industrial process refrigeration units, such as chillers for chlorine dioxide plants. For those units that utilize ozone-depleting chemicals, such as CFCs, facilities are required under Title VI to follow leak repair requirements.

Clean Water Act

There are two industry-specific components of the CWA requirements: NPDES permitting and pretreatment programs. Other general CWA requirements, such as those for wetlands and stormwater, may also apply to rubber and plastics products manufacturing facilities and are described in Section VI.A.

In addition to applicable general CWA requirements, rubber product manufacturers are subject to the specific requirements contained in 40 CFR Part 428, "EPA Effluent Guidelines and Standards for Rubber Manufacturing." These regulations contain pretreatment and performance standards and requirements for the application of best practicable control technologies and/or best available technologies. The regulated pollutants include TSS, oil and grease, pH, COD, BOD₅, lead, and chromium. The standards are promulgated under the authority of Sections 301, 304, 306, 307, 308, and 501 of the CWA and in response to the settlement reached in *Natural Resources Defense Council v. Train*.

EPA promulgated regulations contained in the *Federal Register*, Vol. 55 No. 222, "National Pollutants Discharge Elimination System Permit Application Regulations for Storm Water Discharge: Final Rule" on November 16, 1990. These regulations require permit applications for stormwater discharges from selected municipal and industrial point sources. The rubber manufacturing industry is regulated because it is covered by SIC code 30. Only areas where material handling equipment or activities, raw materials, intermediate products, final products, waste materials, by-products, or industrial equipment are exposed to stormwater are covered. The regulations require that a stormwater pollution prevention plan (SWPPP) be developed for each facility covered by this regulation. The regulations require that the SWPPP be prepared in accordance with good engineering practices and in accordance with the factors outlined in 40 CFR Section 125.3(d)(2) or (3) as appropriate.

Plastics products manufacturers are subject to applicable general CWA requirements and to the specific requirements contained in 40 CFR Part 463, "Plastic Molding and Forming Point Source Category Effluent Limitations Guidelines; Pretreatment Standards and New Source Performance Standards." This regulation establishes effluent limitations guidelines and standards that limit the discharge of pollutants into navigable waters by existing and new sources engaged in plastic molding and forming. The regulated pollutants include BOD₅, TSS, oil and grease, and pH.

For facilities that discharge their wastewater to a POTW, pretreatment standards may apply. In addition to general standards established by EPA that address all industries, there are pretreatment standards for new sources and pretreatment standards for existing sources that are specific to the RMPP industry. These standards regulate the biocides trichlorophenol and pentachlorophenol, with limits that are specified for each subcategory of the industry.

Emergency Planning and Community Right-to-Know Act

Three of the components of EPCRA are directly relevant to the rubber and plastics products manufacturing facilities:

- Emergency Planning (Section 302(a)) - Businesses that produce, use or store "hazardous substances" must submit: 1) MSDSs or the equivalent, and 2) Tier I/Tier II annual inventory report forms to the appropriate local emergency planning commission. Those handling "extremely hazardous substances" also are required to submit a one-time notice to the SERC.
- Emergency Notification of Extremely Hazardous Substance Release (Section 304) - A business that unintentionally releases a reportable quantity of an extremely hazardous substance must report that release to the SERC and the LEPC.
- Release Reporting (Section 313) - Manufacturing businesses with 10 or more employees that manufactured, processed, or otherwise used a listed toxic chemical in excess of the "established threshold" must annually file a Toxic Chemical Release form with EPA and the state. Documentation supporting release estimates must be kept for three years.

Resource Conservation and Recovery Act

Facilities engaged in rubber product or rubber tire manufacture use RCRA-regulated commercial chemical products which, if spilled or sent for disposal, are considered hazardous waste. These include ethylene thiourea, phenol, guanidines, and some lead, selenium, and cadmium compounds. Because these are all compounding agents that are added to the rubber mixture in their original form, spills are a reasonable possibility and RCRA requirements are likely to apply. Some waste streams containing solvents such as toluene, MEK, 1,1,1-trichloroethane, acetone, methanol, xylene, methyl isobutyl ketone, trichlorofluoromethane, trichloroethylene, and n-butyl alcohol may be hazardous waste if they are D001 ignitable.

VI.C. Pending and Proposed Regulatory Requirements

The following pending and proposed regulations affect the RMPP industry:

*Clean Water Act*Minimizing Adverse Environmental Impact from Cooling Water Intake Structures at Existing Facilities Under Section 316(b) of the Clean Water Act, Phase III

This rulemaking affects existing facilities that use cooling water intake structures, and whose intake flow levels exceed a minimum threshold EPA will determine. The rule will require that the location, design, construction, and capacity of cooling water intake structures reflect the best technology available for minimizing adverse environmental impact. The final

rule is anticipated before December 2004. (Deborah Nagle, Office of Water, (202) 566-1063 or J.T. Morgan, Office of Water, (202) 564-7684)

Clean Air Act

NESHAP: Industrial/Commercial/Institutional Boilers and Process Heaters

This rule would affect any new or existing boiler or process heater at a major (for HAPs) source facility. The final rule was signed in 2004. A copy of the final signed version and the proposed version are at: <http://www.epa.gov/ttn/atw/boiler/boilerpg.html>.

Resource Conservation and Recovery Act

Universal Waste Regulations

In June 2002, EPA proposed to add mercury-containing equipment to the universal waste list. The Universal Waste Rule allows facilities to streamline the waste management of certain widely generated hazardous wastes. The waste management requirements of universal wastes are less strict than those for other RCRA-listed hazardous wastes. Visit the web site www.epa.gov/epaoswer/hazwaste/id/univwast/regs.htm for more information.

VII. COMPLIANCE AND ENFORCEMENT PROFILE*Background*

Until recently, EPA has focused much of its attention on ensuring compliance with specific environmental statutes. This approach allows the Agency to track compliance with the CAA, the RCRA, the CWA, and other environmental statutes. Within the last several years, the Agency has begun to supplement single-media compliance indicators with facility-specific, multimedia indicators of compliance. In doing so, EPA is in a better position to track compliance with all statutes at the facility level, and within specific industrial sectors.

A major step in building the capacity to compile multimedia data for industrial sectors was EPA's creation of the Integrated Data for Enforcement Analysis (IDEA) system. IDEA has the capacity to "read into" the Agency's single-media databases, extract compliance records, and match the records to individual facilities. The IDEA system can match Air, Water, Waste, Toxics/Pesticides/EPCRA, TRI, and Enforcement Docket records for a given facility, and generate a list of historical permit, inspection, and enforcement activity. IDEA also has the capability to analyze data by geographic area and corporate holder. As the capacity to generate multimedia compliance data improves, EPA will make available more in-depth compliance and enforcement information. Additionally, sector-specific measures of success for compliance assistance efforts are under development.

Compliance and Enforcement Profile Description

This section uses inspection, violation, and enforcement data from the IDEA system to present the historical compliance and enforcement activity of the RMPP sector. Compliance and enforcement records from EPA's data systems are compiled to the facility level using the Facility Registry System's (FRS) Master Source ID, which links records from virtually any of EPA's data systems to a facility record. For each facility (i.e., Master Source ID), the Industry Sector Notebooks analysis uses the facility-level SIC code that is designated by IDEA, which can be described as follows:

1. If the facility reports to TRI, then the designated SIC code is the primary SIC code reported in the most recent TRI reporting year.
2. If the facility does not report to TRI, the first SIC codes from all linked AIRS Facility Subsystem (AFS), Permit Compliance System (PCS), RCRAInfo, and BIS ID/permits are assembled. If more than one permit/ID exists for a particular program, then only one record from that data system is used. The SIC code that occurs most often, if there is one, becomes the designated SIC code.
3. If the facility does not report to TRI and no SIC code occurs more often than others, the designated SIC code is chosen from the linked programs in the following order: AFS, PCS, BIS, RRR, National Compliance Database (NCDB), DCK. If more than one permit/ID exists for a particular program, then only one record from that data system is used.

Note that EPA does not attempt to define the actual number of facilities that fall within each sector. Instead, the information presented in this section reflects the records of a subset of facilities within the sector that are well defined within EPA databases.

As a check on the relative size of the full sector universe, most notebooks contain an estimated number of facilities within the sector according to the Bureau of Census (See Section II). With sectors dominated by small businesses, such as metal finishers and printers, the reporting universe within the EPA databases might be small compared to Census data. However, the facilities selected for inclusion in this data analysis section should be consistent with this sector's general make-up.

Following this introduction is a list defining each data column presented within this section. These values represent a retrospective summary of inspections or enforcement actions, and solely reflect EPA, state, and local compliance assurance activity that have been entered into EPA databases. To identify any changes in trends, EPA ran two data queries, one for the past five calendar years (February 1999 to February 2004) and the other for the most recent 24-month period (February 2002 to February 2004). The five-year analysis gives an average level of activity for that period for comparison to the more recent activity.

Because most inspections focus on single-media requirements, the data queries presented in this section are taken from single media databases. These databases do not provide data on whether inspections are state/local- or EPA-led. However, the table breaking down the universe of violations does provide a general measure of the EPA's and states' efforts within each media program. The presented data illustrate the variations across Regions for certain sectors.² This variation may be attributable to state/local data entry variations, specific geographic concentrations, proximity to population centers, sensitive ecosystems, highly toxic chemicals used in production, or historical noncompliance. Therefore, these data do not rank regional performance or necessarily reflect which regions may have the most compliance problems.

This section contains five tables which summarize enforcement and compliance activities for the RMPP and selected industries. Table 16 looks exclusively at the RMPP industry for the past 5 years. Tables 17 and 18 look at the RMPP and selected industries for the past 5 and 2 year periods respectively. Tables 17 and 18 look at the RMPP and selected industries for the past 5 and 2 year periods respectively based on statutes. Following this introduction is a list defining each column in the tables presented in this section. The data in these tables solely reflect EPA, state, and local compliance assurance activity data that have been entered into EPA databases.

² EPA Regions include the following states: I (CT, MA, ME, RI, NH, VT); II (NJ, NY, PR, VI); III (DC, DE, MD, PA, VA, WV); IV (AL, FL, GA, KY, MS, NC, SC, TN); V (IL, IN, MI, MN, OH, WI); VI (AR, LA, NM, OK, TX); VII (IA, KS, MO, NE); VIII (CO, MT, ND, SD, UT, WY); IX (AZ, CA, HI, NV, Pacific Trust Territories); X (AK, ID, OR, WA).

*Compliance and Enforcement Data Definitions**General Definitions*

Facility Registry System (FRS) -- this system assigns a common Master Source ID to EPA single-media permit records. The Master Source ID allows EPA to compile and review all permit, compliance, enforcement, and pollutant release data for any given regulated facility.

Integrated Data for Enforcement Analysis (IDEA) -- is a data integration system that can retrieve information from the major EPA program office databases. IDEA uses the FRS-maintained Master Source ID identification number to "glue together" separate data records from EPA's databases. This is done to create a "master list" of data records for any given facility. Some of the data systems accessible through IDEA are: Air Facility Indexing and Retrieval System, PCS, RCRAInfo (Resource Conservation and Recovery Information System, Office of Solid Waste), NCDB, CERCLIS (Comprehensive Environmental and Liability Information System, Superfund), and TRIS (Toxic Release Inventory System). IDEA also contains information from outside sources such as Dun and Bradstreet and OSHA. Most data queries displayed in notebook sections IV and VII were conducted using IDEA.

Data Table Column Heading Definitions

Facilities in Search -- based on the number of the FRS-maintained Master Source IDs that were designated to the listed SIC code range. The SIC code range selected for each search is defined by each notebook's selected SIC code coverage described in Section II (Tables 16-20).

Facilities Inspected -- the number of EPA and state agency inspections for the facilities in this data search. These values show what percentage of the facility universe is inspected in a 24- or 60-month period (Table 16-20).

Number of Inspections -- the total number of inspections conducted in this sector. An inspection is counted each time it is entered into a single media database (Tables 16-20).

Average Number of Months Between Inspections -- an average length of time, in months, between compliance inspections at a facility within the defined universe (Tables 16-17).

Facilities with One or More Enforcement Actions -- the number of facilities that were subject to at least one enforcement action within the defined time period. This category is broken down further into federal and state actions. Data are obtained for administrative, civil/judicial, and criminal enforcement actions. Administrative actions include Notices of Violation (NOVs). A facility with multiple enforcement actions is only counted once in this column (facility with three enforcement actions counts as one). All percentages that appear are referenced to the number of facilities inspected (Tables 16-18).

Total Enforcement Actions -- the total number of enforcement actions identified for an industrial sector across all environmental statutes. A facility with multiple enforcement actions is counted multiple times (e.g., a facility with three enforcement actions counts as three) (Tables 16-18).

Percentage of State Led Actions -- percentage of the total enforcement actions taken by state and local environmental agencies. Varying levels state use of EPA data systems may limit the volume of actions accorded state enforcement activity. Some states extensively report enforcement activities to EPA data systems, while other states may use their own data systems (Tables 16-18).

Percentage of Federal Led Actions -- percentage of the total enforcement actions taken by EPA, including referrals from state agencies. Many of these actions result from coordinated or joint state/federal efforts (Table 16-18).

Enforcement-to-Inspection Ratio -- how often enforcement actions result from inspections. This value is a ratio of enforcement actions to inspections, and is presented for comparative purposes only. This measure simply indicates historically how many enforcement actions can be attributed to inspection activity. Reported inspections and enforcement actions under the CWA (PCS), CAA (AFS), and RCRA are included in this ratio. Inspections and actions from the TSCA/FIFRA/EPCRA database are not factored into this ratio because most of the actions taken under these programs are not the result of facility inspections. This ratio does not account for enforcement actions arising from noninspection compliance monitoring activities (e.g., self-reported water discharges) that can result in enforcement action within the CAA, CWA and RCRA (Tables 16-18).

Facilities with One or More Violations Identified -- the percentage of inspected facilities having a violation identified in one of the following data categories: In Violation or Significant Violation Status (CAA); Reportable Noncompliance, Current Year Noncompliance, Significant Noncompliance (CWA); Noncompliance and Significant Noncompliance (FIFRA, TSCA, and EPCRA); and Unresolved Violation and Unresolved High Priority Violation (RCRA). The values presented in this column reflect the extent of noncompliance within the measured time frame, but not the severity of the noncompliance. Percentages within this column can exceed 100 percent because facilities can be in violation status without being inspected. Violation status may be a precursor to an enforcement action, but does not necessarily indicate that an enforcement action will occur (Table 18).

Media Breakdown of Enforcement Actions and Inspections -- four columns identify the proportion of total inspections and enforcement actions within EPA Air, Water, Waste, and TSCA/FIFRA/EPCRA databases. Each column is a percentage of either the "Total Inspections," or the "Total Actions" column (Tables 19-20).

VII.A. The RMPP Industry Compliance History (1999 to 2004)

Table 16 provides a Regional breakdown of the five-year enforcement and compliance activities for the RMPP industry. Regions IV and V conducted approximately 60 percent of the inspections of rubber and miscellaneous plastics products manufacturing facilities

performed in the United States over the past five years. This large percentage is due to the concentration of rubber and miscellaneous plastics products facilities in these areas.

VII.B. Comparison of Enforcement Activity Between Selected Industries (1999 to 2004)

Tables 17 through 20 contain summaries of the two- and five-year enforcement and compliance activities for the RMPP industry, as well as for other selected industries. As indicated in Tables 17 and 18, the RMPP industry has an average enforcement-to-inspection ratio (9 percent) when compared to other industries. Of the 9,231 inspections conducted at 3,821 RMPP manufacturing facilities over a five-year period, 787 (9 percent) resulted in enforcement actions. Approximately 10 percent of inspections in the manufacturing sector as a whole resulted in enforcement actions.

Table 16: Five-Year Enforcement and Compliance Summary for the Rubber and Plastics Industry (1999 - 2004)

A	B	C	D	E	F	G	H	I	J
Rubber and Plastic (SIC Code 30)	Facilities in Search	Facilities Inspected	Number of Inspections	Average Number of Months Between Inspections	Facilities with 1 or More Enforcement Action	Total Enforcement Actions	Percentage of State-Led Actions	Percentage of Federal-Led Actions	Enforcement-to-Inspection Ratio
Region I	214	121	339	38	31	42	76%	24%	0.12
Region II	278	140	366	46	46	84	86%	14%	0.23
Region III	379	271	1533	15	38	61	92%	8%	0.04
Region IV	979	622	3180	18	120	227	94%	6%	0.07
Region V	1,000	570	1688	36	106	145	91%	9%	0.09
Region VI	309	182	667	28	57	93	100%	0%	0.14
Region VII	261	158	609	26	27	49	82%	18%	0.08
Region VIII	64	46	180	21	3	7	100%	0%	0.04
Region IX	219	101	371	35	43	55	69%	31%	0.15
Region X	118	81	298	24	10	24	96%	4%	0.08
Total/Average	3,821	2,292	9,231	287	481	787	90%	10%	0.09

Table 17: Five-Year Enforcement and Compliance Summary for Selected Industries (1999 - 2004)

Sector	Facilities In Search	Facilities Inspected	Number of Inspections	Average Number of Months Between Inspections	Facilities with 1 or More Enforcement Actions	Total Enforcement Actions	Percentage of State-Led Actions	Percentage of Federal-Led Actions	Enforcement-to-Inspection Ratio
Rubber and Plastic	3,823	2,294	9,239	25	481	787	90%	10%	0.09
Aerospace	764	526	2,704	17	246	238	65%	35%	0.09
Ag Chem Pesticide & Fertilizer	585	345	2,123	17	138	107	57%	43%	0.05
Ag Crop Production	131	69	165	48	12	7	86%	14%	0.04
Ag Livestock Production	53	17	58	55	14	28	11%	89%	0.48
Air Transportation	428	211	619	41	80	62	71%	29%	0.1
Dry Cleaning	3,345	1,620	2,944	68	232	178	92%	8%	0.06
Electronics & Computer	1,852	906	2,486	45	286	196	75%	25%	0.08
Fossil Fuel Elec Power Gen	3,520	2,543	18,758	11	1,170	1,582	78%	22%	0.08
Ground Transportation	4,970	3,338	13,612	22	1,084	880	96%	4%	0.06
Healthcare	1,798	1,187	3,953	27	195	343	96%	4%	0.09
Inorganic Chemical	1,007	629	5,291	11	352	414	79%	21%	0.08
Iron and Steel	683	480	6,060	7	312	536	78%	22%	0.09
Lumber & Wood Products	3,038	2,045	10,728	17	872	814	85%	16%	0.08
Metal Casting	1,346	797	3,549	23	348	340	79%	21%	0.1
Metal Fabrication	8,279	5,092	16,568	30	2,138	1,716	76%	24%	0.1
Metal Mining	281	183	980	17	70	71	85%	16%	0.07
Motor Vehicle Assembly	1,886	1,211	5,531	20	500	448	77%	23%	0.08
Non-Fuel, Non-Metal Mining	3,778	2,005	9,291	24	522	524	95%	6%	0.06
Nonferrous Metals	531	327	2,968	11	242	395	88%	12%	0.13
Oil & Gas Extraction	2,783	1,681	6,371	26	1,120	949	96%	4%	0.15
Organic Chemical	1,050	787	8,483	7	558	846	73%	27%	0.1

Table 17: Five-Year Enforcement and Compliance Summary for Selected Industries (1999 - 2004) (Continued)

Sector	Facilities In Search	Facilities Inspected	Number of Inspections	Average Number of Months Between Inspections	Facilities with 1 or More Enforcement Actions	Total Enforcement Actions	Percentage of State-Led Actions	Percentage of Federal-Led Actions	Enforcement-to-Inspection Ratio
Petroleum Refining	438	297	5,405	5	352	1,335	69%	31%	0.25
Pharmaceutical	572	414	2,108	16	174	199	84%	16%	0.09
Plastic Resins & Fibers	709	502	4,637	9	344	444	85%	15%	0.1
Printing	2,384	1,460	4,913	29	476	435	90%	10%	0.09
Pulp and Paper	566	467	5,830	6	336	498	90%	10%	0.09
Shipbuilding & Repair	235	168	870	16	96	83	81%	19%	0.1
Stone Clay Glass&Concrete	3,388	2,013	12,190	17	876	930	89%	11%	0.08
Textiles	1,226	814	3,859	19	304	310	87%	13%	0.08
Water Transportation	269	158	384	42	40	36	89%	11%	0.09
Wood Furniture & Fixtures	1,652	1,047	5,515	18	440	382	89%	12%	0.07

Table 18: Two-Year Enforcement and Compliance Summary for Selected Industries (2002 - 2004)

Sector	Facilities In Search	Facilities Inspected	Number of Inspections	Facilities with 1 or More Violations		Facilities with 1 or More Enforcement Actions		Total Enforcement Actions	Enforcement-to-Inspection- Ratio
				Number	Percentage of Inspected Facilities ¹	Number	Percentage of Inspected Facilities ¹		
Rubber and Plastic	3,823	1,494	3,499	618	41%	241	16%	339	0.1
Aerospace	764	338	974	167	49%	82	24%	70	0.07
Ag Chem Pesticide & Fertilizer	585	192	626	68	35%	62	32%	41	0.07
Ag Crop Production	131	37	64	12	32%	10	27%	6	0.09
Ag Livestock Production	53	4	5	5	125%	10	250%	20	4
Air Transportation	428	118	226	52	44%	28	24%	18	0.08
Dry Cleaning	3,345	687	1,038	269	39%	120	17%	79	0.08
Electronics & Computer	1,852	431	806	279	65%	96	22%	63	0.08
Fossil Fuel Elec Power Gen	3,520	2,021	7,011	492	24%	580	29%	607	0.09
Ground Transportation	4,970	2,195	4,879	452	21%	592	27%	418	0.09
Healthcare	1,798	743	1,561	266	36%	121	16%	200	0.13
Inorganic Chemical	1,007	414	1,651	189	46%	170	41%	168	0.1
Iron and Steel	683	350	1,505	209	60%	146	42%	212	0.14
Lumber & Wood Products	3,038	1,399	3,647	557	40%	404	29%	352	0.1
Metal Casting	1,346	518	1,149	274	53%	160	31%	120	0.1
Metal Fabrication	8,279	2,815	5,884	1599	57%	960	34%	683	0.12
Metal Mining	281	128	320	26	20%	40	31%	33	0.1
Motor Vehicle Assembly	1,886	797	2,026	407	51%	282	35%	207	0.1

Table 18: Two-Year Enforcement and Compliance Summary for Selected Industries (2002 - 2004) (Continued)

Sector	Facilities In Search	Facilities Inspected	Number of Inspections	Facilities with 1 or More Violations		Facilities with 1 or More Enforcement Actions		Total Enforcement Actions	Enforcement-to-Inspection- Ratio
				Number	Percentage of Inspected Facilities ¹	Number	Percentage of Inspected Facilities ¹		
Non-Fuel, Non-Metal Mining	3,778	1,113	2,850	334	30%	220	20%	172	0.06
Nonferrous Metals	531	215	875	132	61%	114	53%	129	0.15
Oil & Gas Extraction	2,783	1,048	2,171	291	28%	556	53%	414	0.19
Organic Chemical	1,050	537	2,729	292	54%	308	57%	359	0.13
Petroleum Refining	438	224	1,409	147	66%	224	100%	502	0.36
Pharmaceutical	572	276	784	118	43%	82	30%	85	0.11
Plastic Resins & Fibers	709	358	1,514	169	47%	176	49%	187	0.12
Printing	2,384	865	1,829	337	39%	262	30%	193	0.11
Pulp and Paper	566	379	1,856	125	33%	166	44%	168	0.09
Shipbuilding & Repair	235	106	275	50	47%	44	42%	31	0.11
Stone Clay Glass&Concrete	3,388	1,390	4,123	473	34%	432	31%	369	0.09
Textiles	1,226	545	1,378	175	32%	156	29%	128	0.09
Water Transportation	269	76	122	16	21%	20	26%	17	0.14
Wood Furniture & Fixtures	1,652	693	1,954	311	45%	198	29%	162	0.08

¹Percentages are based on the number of facilities inspected. Percentages can exceed 100% because violations and enforcement actions can occur without a facility inspection.

Table 19: Five-Year Inspection and Enforcement Summary by Statute for Selected Industries (1999 - 2004)

Sector	Facilities In Search	Facilities Inspected	Number of Total Inspections	Total Enforcement Actions	Clean Air Act		Clean Water Act		RCRA		FIFRA/TSCA/EPCRA/Other	
					% of Total Inspections	% of Total Enforcement Actions	% of Total Inspections	% of Total Enforcement Actions	% of Total Inspections	% of Total Enforcement Actions	% of Total Inspections	% of Total Enforcement Actions
Rubber and Plastic	3,823	2,294	9,239	787	71%	73%	1%	0%	27%	23%	1%	5%
Aerospace	764	526	2,704	238	52%	43%	3%	3%	44%	51%	0%	3%
Ag Chem Pesticide & Fertilizer	585	345	2,123	107	55%	34%	12%	8%	27%	31%	6%	27%
Ag Crop Production	131	69	165	7	50%	71%	0%	0%	46%	29%	4%	0%
Ag Livestock Production	53	17	58	28	53%	89%	0%	7%	47%	0%	0%	4%
Air Transportation	428	211	619	62	38%	23%	1%	2%	61%	74%	0%	2%
Dry Cleaning	3,345	1,620	2,944	178	26%	35%	0%	0%	74%	65%	0%	0%
Electronics & Computer	1,852	906	2,486	196	31%	14%	4%	5%	64%	67%	1%	15%
Fossil Fuel Elec Power Gen	3,520	2,543	18,758	1,582	75%	88%	18%	8%	6%	3%	0%	1%
Ground Transportation	4,970	3,338	13,612	880	78%	76%	0%	1%	21%	23%	0%	1%
Healthcare	1,798	1,187	3,953	343	78%	82%	0%	2%	21%	16%	1%	1%
Inorganic Chemical	1,007	629	5,291	414	48%	54%	13%	10%	37%	31%	1%	6%
Iron and Steel	683	480	6,060	536	61%	67%	13%	10%	26%	20%	0%	3%
Lumber & Wood Products	3,038	2,045	10,728	814	75%	76%	1%	0%	24%	23%	1%	1%
Metal Casting	1,346	797	3,549	340	60%	59%	3%	2%	36%	33%	1%	6%
Metal Fabrication	8,279	5,092	16,568	1,716	45%	46%	2%	1%	52%	46%	1%	7%
Metal Mining	281	183	980	71	56%	52%	28%	39%	15%	7%	1%	1%
Motor Vehicle Assembly	1,886	1,211	5,531	448	60%	56%	1%	1%	38%	40%	0%	3%
Non-Fuel, Non-Metal Mining	3,778	2,005	9,291	524	97%	99%	1%	0%	2%	1%	0%	0%
Nonferrous Metals	531	327	2,968	395	64%	70%	9%	5%	27%	22%	0%	2%
Oil & Gas Extraction	2,783	1,681	6,371	949	97%	98%	0%	1%	3%	2%	0%	0%
Organic Chemical	1,050	787	8,483	846	47%	55%	12%	13%	39%	28%	2%	5%

Table 19: Five-Year Inspection and Enforcement Summary by Statute for Selected Industries (1999 - 2004) (Continued)

Sector	Facilities In Search	Facilities Inspected	Number of Total Inspections	Total Enforcement Actions	Clean Air Act		Clean Water Act		RCRA		FIFRA/TSCA/EPCRA/Other	
					% of Total Inspections	% of Total Enforcement Actions	% of Total Inspections	% of Total Enforcement Actions	% of Total Inspections	% of Total Enforcement Actions	% of Total Inspections	% of Total Enforcement Actions
Petroleum Refining	438	297	5,405	1,335	57%	83%	15%	6%	27%	10%	1%	1%
Pharmaceutical	572	414	2,108	199	40%	49%	7%	8%	52%	37%	1%	6%
Plastic Resins & Fibers	709	502	4,637	444	51%	59%	19%	17%	29%	22%	1%	3%
Printing	2,384	1,460	4,913	435	65%	66%	0%	0%	34%	33%	1%	1%
Pulp and Paper	566	467	5,830	498	67%	75%	26%	18%	7%	4%	0%	3%
Shipbuilding & Repair	235	168	870	83	59%	34%	6%	8%	35%	57%	1%	1%
Stone Clay Glass&Concrete	3,388	2,013	12,190	930	85%	87%	1%	1%	13%	10%	1%	2%
Textiles	1,226	814	3,859	310	76%	59%	12%	23%	12%	14%	1%	3%
Water Transportation	269	158	384	36	42%	50%	1%	0%	56%	50%	1%	0%
Wood Furniture & Fixtures	1,652	1,047	5,515	382	76%	75%	0%	1%	23%	23%	0%	2%

Table 20: Two-Year Inspection and Enforcement Summary by Statute for Selected Industries (2002 - 2004)

Sector	Facilities In Search	Facilities Inspected	Number of Total Inspections	Total Enforcement Actions	Clean Air Act		Clean Water Act		RCRA		FIFRA/TSCA/EPCRA/Other	
					% of Total Inspections	% of Total Actions	% of Total Inspections	% of Total Actions	% of Total Inspections	% of Total Actions	% of Total Inspections	% of Total Actions
Rubber and Plastic	3,823	1,494	3,499	339	73%	78%	1%	0%	26%	18%	0%	4%
Aerospace	764	338	974	70	47%	61%	4%	0%	49%	39%	0%	0%
Ag Chem Pesticide & Fertilizer	585	192	626	41	51%	42%	14%	5%	31%	27%	4%	27%
Ag Crop Production	131	37	64	6	50%	67%	0%	0%	45%	33%	5%	0%
Ag Livestock Production	53	4	5	20	80%	95%	0%	5%	20%	0%	0%	0%
Air Transportation	428	118	226	18	43%	17%	1%	0%	57%	78%	0%	6%
Dry Cleaning	3,345	687	1,038	79	23%	60%	0%	0%	77%	41%	0%	0%
Electronics & Computer	1,852	431	806	63	30%	16%	4%	5%	66%	71%	0%	8%
Fossil Fuel Elec Power Gen	3,520	2,021	7,011	607	75%	93%	18%	4%	7%	2%	0%	1%
Ground Transportation	4,970	2,195	4,879	418	79%	87%	1%	1%	21%	12%	0%	0%
Healthcare	1,798	743	1,561	200	80%	87%	0%	1%	20%	12%	0%	1%
Inorganic Chemical	1,007	414	1,651	168	41%	60%	15%	8%	44%	30%	1%	2%
Iron and Steel	683	350	1,505	212	48%	73%	16%	9%	36%	17%	0%	1%
Lumber & Wood Products	3,038	1,399	3,647	352	71%	78%	1%	0%	28%	22%	0%	0%
Metal Casting	1,346	518	1,149	120	52%	62%	3%	1%	44%	32%	1%	4%
Metal Fabrication	8,279	2,815	5,884	683	45%	51%	2%	0%	52%	45%	0%	4%
Metal Mining	281	128	320	33	52%	67%	30%	24%	18%	9%	0%	0%
Motor Vehicle Assembly	1,886	797	2,026	207	57%	55%	2%	1%	41%	43%	0%	1%
Non-Fuel, Non-Metal Mining	3,778	1,113	2,850	172	96%	99%	2%	0%	2%	1%	0%	0%
Nonferrous Metals	531	215	875	129	59%	74%	10%	5%	31%	19%	0%	2%
Oil & Gas Extraction	2,783	1,048	2,171	414	97%	99%	0%	1%	3%	1%	0%	0%
Organic Chemical	1,050	537	2,729	359	44%	65%	14%	10%	42%	22%	0%	3%

Table 20: Two-Year Inspection and Enforcement Summary by Statute for Selected Industries (2002 - 2004) (Continued)

Sector	Facilities In Search	Facilities Inspected	Number of Total Inspections	Total Enforcement Actions	Clean Air Act		Clean Water Act		RCRA		FIFRA/TSCA/EPCRA/Other	
					% of Total Inspections	% of Total Actions	% of Total Inspections	% of Total Actions	% of Total Inspections	% of Total Actions	% of Total Inspections	% of Total Actions
Petroleum Refining	438	224	1,409	502	40%	86%	23%	6%	38%	8%	0%	1%
Pharmaceutical	572	276	784	85	43%	55%	7%	8%	49%	32%	1%	5%
Plastic Resins & Fibers	709	358	1,514	187	48%	69%	21%	5%	31%	23%	0%	3%
Printing	2,384	865	1,829	193	66%	0%	0%	0%	34%	0%	0%	0%
Pulp and Paper	566	379	1,856	168	62%	86%	31%	9%	7%	3%	0%	2%
Rubber and Plastic	3,823	1,494	3,499	339	73%	78%	1%	0%	26%	18%	0%	4%
Shipbuilding & Repair	235	106	275	31	56%	52%	6%	0%	37%	45%	1%	3%
Stone Clay Glass&Concrete	3,388	1,390	4,123	369	84%	89%	2%	2%	14%	7%	0%	2%
Textiles	1,226	545	1,378	128	76%	66%	11%	21%	13%	12%	0%	1%
Water Transportation	269	76	122	17	34%	65%	2%	0%	64%	35%	0%	0%
Wood Furniture & Fixtures	1,652	693	1,954	162	78%	81%	0%	1%	22%	16%	0%	2%

VII.C. Review of Major Legal Actions

This section discusses major legal cases and pending litigation within the rubber and plastics products industry as well as supplemental environmental projects (SEPs) involving rubber and plastics products facilities. Detailed information regarding major cases or pending litigation is available from the Office of Regulatory Enforcement.

VII.C.1. Review of Major Cases

As indicated in EPA's ICIS EZ Search, several enforcement cases were resolved between 1999 and 2004 for the RMPP manufacturing industry. Of these actions, 23 involved violations of EPCRA; 7 involved violations of CERCLA; 4 involved violations of TSCA, CWA, and FIFRA; 3 involved violations of CAA; and 1 involved violations of RCRA. A majority of the cases were brought against plastics products manufacturers. The cases involving the rubber products manufacturing industry included discharging water without an NPDES permit, failure to file Form R, and failure to register a PCB transformer.

Five of the six enforcement actions resulted in the assessment of a penalty. Penalties ranged from \$100 to \$89,050, and, in several cases, the defendant was ordered to spend additional money to improve the processes or technologies and to increase future compliance. For example, in the matter of Associated Plastics, Inc. (1999), the company paid a \$10,367 penalty and spent approximately \$162,000 on SEPs. The average penalty per case was approximately \$21,000 and SEPs were required in six of the cases. In another case, BP Amoco Chemical Company (2001) was required to provide training for LEPC. Table 21 lists recent SEPs for this industry.

The case of U.S. et al. v. Production Plated Plastic, Inc. et al. (1992) is considered significant by EPA because the court held a corporate officer and the owner of the company personally liable.

VII.C.2. Supplementary Environmental Projects

SEPs are compliance agreements that reduce a facility's stipulated penalty in return for an environmental project that exceeds the value of the reduction. Often, these projects fund pollution prevention activities that can significantly reduce the future pollutant loadings of a facility.

The EPA's ICIS EZ Search provides information on the number and type of SEPs for a sector. Table 21 contains a sample of the SEPs addressing the RMPP industry. The information contained in Table 21 is not comprehensive and provides only a sample of the types of SEPs developed for the RMPP industry.

Table 21: Supplemental Environmental Projects in RMPP Facilities (SIC Code 30)

General Information				Violation Information			Supplemental Environmental Project Information	
FY	Docket #	Company Name	State/Region	Type	Assessed Penalty	SEP Cost to Company	SEP Category	SEP Description
2002	06-2001-3318	BP Amoco Chemical Company	TX	CERCLA 103	\$2,000	\$32,000	Emergency Planning and Preparedness	Sponsorship of training for LEPC.
2000	09-1999-0103	Fiberglass Representatives Inc.	CA	EPCRA 313	\$100	\$400	Environmental Compliance Promotion	Conduct a sector-based compliance outreach program.
1999	09-1999-0024	Associated Plastics Inc.	CA	EPCRA 313	\$10,367	\$162,150		
1999	05-1999-0208	FOAMEX LP	IN	CERCLA 103	\$3,867	\$14,800	Pollution Prevention/ Equipment-Technology Modification	
1999	06-1999-0747	BP Amoco Chemical Company	AK	CERCLA 103	\$2,000	\$12,000	Emergency Planning and Preparedness	Donation of equipment to LEPC and donation to a conference
1998	06-1998-0663	Interplastics Corporation	OK	EPCRA 312	\$1,300	\$6,000	Emergency Planning and Preparedness	Donate equipment and assistance to the LEPC and donation to a conference.
1997	06-1997-0702	Dynagen Inc.	TX	CERCLA 103	\$4,000	\$16,000	Emergency Planning and Preparedness	Donation of equipment to LEPC and donation to a conference. Must provide training and purchase alarms.

VIII. COMPLIANCE ACTIVITIES AND INITIATIVES

This section highlights the activities undertaken by the RMPP sector and public agencies to voluntarily improve the sector's environmental performance. These activities include those independently initiated by industrial trade associations. This section lists and describes national and regional trade associations.

VIII.A. Sector-Related Environmental Programs and Activities*Bridgestone/Firestone Wildlife Habitat Projects*

Bridgestone/Firestone donated a 10,000-acre natural treasure to the state of Tennessee, officially designated the Bridgestone/Firestone Centennial Wilderness. This area includes over 12 miles of the Caney Fork River Gorge in White and Van Buren Counties.

Other projects include partnering with the Wildlife Habitat Council to establish wildlife habitat projects at Bridgestone/Firestone manufacturing plants. These land conservation and grounds management initiatives are currently promoting environmental awareness at the Oklahoma City, OK and Warren County, TN facilities as well as their surrounding communities.

Gillette Environmental Leadership Program (ELP) Project

The objective of the Gillette ELP is to develop and implement a third-party compliance and management systems audit and verification process. The project will involve developing environmental compliance and environmental management systems audit protocol criteria that can be adopted and easily implemented by other facilities to assess compliance with relevant regulations. The three Gillette facilities that are participating are: South Boston Manufacturing Center, blade and razor manufacturing; North Chicago Manufacturing Center, batch chemical manufacturing; and Santa Monica, CA, stationary products manufacturing. (Contact: Scott Throwe, (202) 564-7013.)

VIII.B. EPA Voluntary Programs*Compliance Assistance Clearinghouse*

The National Environmental Compliance Assistance Clearinghouse is a web-based clearinghouse designed to provide quick access to compliance assistance tools, contacts, and planned activities across EPA and other compliance assistance providers. The Clearinghouse also serves as a forum to collaborate and exchange information. The Clearinghouse provides links to compliance assistance activities, tools, or technical assistance that: (1) assist the regulated community in understanding and complying with environmental regulations; or (2) assist compliance assistance providers in helping the regulated community to comply with environmental regulations. The Clearinghouse web site is <http://www.epa.gov/clearinghouse/>.

High Production Volume Challenge

As part of EPA's Chemical Right-to-Know Initiative, chemical producers and importers have been invited to provide basic toxicity information voluntarily on their high production volume (HPV) chemicals. HPV chemicals are those chemicals that are produced in or imported to the United States in amounts over 1 million pounds per year. The information generated through the Voluntary Challenge Program is available to the public through the EPA web site, which is provided below.

Chemical companies that participate in the voluntary program make commitments identifying the chemicals they will adopt and test, and the schedule of which chemicals they will begin to test in each year of the program. Following the guidance established by EPA, participating companies will assess the adequacy of existing data; design and submit test plans; provide test results as they are generated; and prepare summaries of the data characterizing each chemical.

The voluntary program uses the same tests, testing protocols, and basic information summary formats used by the Screening Information Data Set (SIDS) program. SIDS is a cooperative, international effort to secure basic toxicity information on HPV chemicals worldwide. Information prepared for this U.S. domestic program will be acceptable in the international effort as well. As of 2002, the program has been very successful; 403 companies have committed to providing health and environmental data on 2,011 chemicals. For more information, see the web site at <http://www.epa.gov/opptintr/chemrtk/>.

Chem Right to Know - Voluntary Children's Chemical Evaluation Program (VCCEP)

The VCCEP makes information available that helps the public better understand the potential health risks to children associated with certain chemical exposures. VCCEP's goal is to ensure that adequate data are publicly available to assess the special impact that industrial chemicals may have on children.

EPA has identified industrial/commercial chemicals to which children have a high likelihood of exposure based on biomonitoring data, and has designed VCCEP to develop the information needed to assess the impact on children. The hazard, exposure, and risk assessments for four chemicals were submitted to EPA and underwent peer consultations in fiscal year 2003. The outcomes of the peer consultations are expected to conclude whether data are sufficient to adequately characterize the risks to children or whether additional data are necessary. For more information, see the web site at <http://www.epa.gov/chemrtk/vccep/>.

Green Suppliers Network (GSN)

GSN is partnered with the Department of Commerce and the National Institute of Standards and Technology (NIST) Manufacturing Extension Partnership (MEP) to provide direct technical assistance to suppliers. GSN offers a NIST technical assistance package of 'Lean Manufacturing' and 'Pollution Prevention' practices directly to manufacturer's suppliers through on-site engagements with supplier facilities.

GSN has actively engaged other EPA, state and other federal agencies' voluntary programs to provide training for NIST MEP centers and additional implementation resources for suppliers.

GSN looks at identified opportunities such as lowering scrap and rework, changing to a more environmentally benign die lubricant, and reduction in disposal of waste to provide significant environmental impact reductions. Suppliers agree to report back to EPA and their manufacturer on the progress of implementing the opportunities identified through the GSN review. For more information, see the web site at <http://www.epa.gov/p2/programs/gsn.htm>.

Design for the Environment (DfE) Program

EPA's DfE Program works directly with industry sectors to compare human health and environmental risks, taking into consideration traditional business factors of cost and performance. The DfE Program works as a catalyst for lasting change, providing a better understanding of the relative risks of chemicals that allows businesses to move to cleaner technologies and safer chemical alternatives – protecting workers, consumers, and the environment. Rather than rely on end-of-pipe controls, DfE encourages pollution prevention, or front-end innovations, through the redesign of formulations, technologies, and management processes. Current and fiscal year 2005 activities are listed below:

Automotive Refinishing: EPA is conducting best practices site visits and train-the-trainer workshops to reduce toxic paint emissions in 60,000 auto body shops and neighboring communities. Partner shops reduced emissions by as much as 30 percent, while saving roughly \$4,000 per shop.

Electronics: The industry is moving to using lead-free solder, wire, and cable in printed wiring boards (PWBs). Partnership has had substantial impacts on the industry's move toward cleaner technologies for manufacturing PWBs, with significant increase in the use of lead-free surface finishes.

Formulator: Formulators are using safer surfactants, solvents, bleaches, and fragrances in detergents, cleaning, floor care, and other products. One partnership eliminated over 340,000 gallons of toxic chemicals, while saving over 100 million gallons of water along with the energy to heat it.

Industrial Design: DfE is collaborating with the 15,000 industrial designers to drive choices of materials, finishes, colors, and assemblage of products.

Integrated Environmental Management Systems: EPA is developing a template/manual for greening industry.

Flame Retardants: Working with furniture and foam manufacturers, DfE is helping to facilitate the transition to safer alternatives.

Polyurethane Foam: Building on DfE best practices and safer substitutes, EPA is developing an approach to reduce emissions of diisocyanates, the leading cause of occupational asthma.

See <http://www.epa.gov/dfe> for more information and other DfE projects.

Green Chemistry Program

Green chemistry is the design of chemical products and processes that are safer to human health and the environment. The environmentally conscious design of chemical products and processes is the central focus of EPA's Green Chemistry Program, a voluntary partnership program with the chemical industry and scientific community. Key program activities include the following:

Presidential Green Chemistry Challenge: This program recognizes outstanding accomplishments in green chemistry through an annual awards program in order to demonstrate their scientific, economic, and environmental benefits.

Green Chemistry Research: The Green Chemistry Program supports the research, development, and implementation of innovative green chemistry technologies in order to provide industry with scientifically sound and cost-effective alternatives.

Green Chemistry Curriculum Development: The Green Chemistry Program supports a variety of educational activities including the development of materials and courses to assist in the training of professional chemists in industry and education of students in academia.

Scientific Outreach: The Green Chemistry Program supports a number of outreach projects including organizing and participating in prominent scientific meetings and workshops, publishing in scientific journals and books, and developing and disseminating computational tools and databases.

International Activities: While the United States is recognized as the world leader in green chemistry, other countries are becoming increasingly interested and active in the area. The United States continues to coordinate with other countries to promote green chemistry on a global scale.

National Environmental Performance Track

EPA's National Environmental Performance Track Program is designed to motivate and reward top environmental performance. By encouraging a systematic approach to managing environmental responsibilities, taking extra steps to reduce and prevent pollution, and being good corporate neighbors, the program is rewarding companies that strive for environmental excellence. At the same time, many participating companies are finding that they are saving money and improving productivity. (Contact: Performance Track hotline at (888) 339-PTRK or the web site at <http://www.epa.gov/performancetrack/>.)

The rubber industry has 'Charter Members' in Performance Track. Since its inception in June 2000 to the end of December 2003, Performance Track members went beyond legal requirements to reduce:

- Energy use by 3.1 million mmBtus;
- Water use by 775 million gallons;

-
- Hazardous materials use by 17,996 tons;
 - Solid waste by 176,126 tons;
 - Hazardous waste by 6,558 tons;
 - Emissions of greenhouse gases by 40,193 tons;
 - Emissions of nitrogen oxides (NO_x) by 2,152 tons;
 - Emissions of sulfur dioxide (SO₂) by 13,621 tons; and
 - Toxic discharges to water by 6,834 tons.

Members also increased their use of reused and recycled materials by 13,760 tons and preserved or restored 4,485 acres of habitat.

Reference: <http://www.epa.gov/performance/members/PTtemplate/fastfacts.htm>.

WasteWi\$e Program

The WasteWi\$e Program was started in 1994 by EPA's Office of Solid Waste and Emergency Response (OSWER). The program is aimed at reducing municipal solid wastes by promoting waste minimization, recycling collection, and the manufacturing and purchase of recycled products. As of 2001, the program had about 1,175 companies as members, including a number of major corporations. Members agree to identify and implement actions to reduce their solid wastes and must provide EPA with their waste reduction goals along with yearly progress reports. EPA in turn provides technical assistance to member companies and allows the use of the WasteWi\$e logo for promotional purposes. Over 30 chemical companies currently are members of WasteWi\$e. (Contact: Jeff Tumarkin at EPA's OSWER at (703) 308-8686 or Tumarkin.Jeff@epa.gov, or the WasteWi\$e Hotline at (800) EPA-WISE ((800) 372-9473) or <http://www.epa.gov/wastewise>.)

Project XL

Project XL, which stands for "eXcellence and Leadership," is a national pilot program that allows state and local governments, businesses and federal facilities to develop with EPA innovative strategies to test better or more cost-effective ways of achieving environmental and public health protection. In exchange, EPA will issue regulatory, program, policy, or procedural flexibilities to conduct the experiment. Under Project XL, private businesses, federal facilities, business sectors, and state and local governments are conducting experiments that address the following eight Project XL selection criteria:

- Produce superior environmental results beyond those that would have been achieved under current and reasonably anticipated future regulations or policies;
- Produce benefits such as cost savings, paperwork reduction, regulatory flexibility, or other types of flexibility that serve as an incentive to both project sponsors and regulators;
- Provide support by stakeholders;
- Achieve innovation/pollution prevention;

-
- Produce lessons or data that are transferable to other facilities;
 - Demonstrate feasibility;
 - Establish accountability through agreed-upon methods of monitoring, reporting, and evaluations; and
 - Avoid shifting the risk burden (i.e., do not create worker safety or environmental justice problems as a result of the experiment).

By 2001, three chemical companies (Crompton, Eastman Kodak, and PPG) had undertaken projects under Project XL. (For more information, contact Chris Knopes in the Office of Reinvention Programs at (202) 260-9298 or Knopes.Christopher@epa.gov, or the web site at <http://www.epa.gov/projectxl>.)

Energy Star®

In 1991, EPA introduced Green Lights®, a program designed for businesses and organizations to proactively combat pollution by installing energy efficient lighting technologies in their commercial and industrial buildings. In April 1995, Green Lights® expanded into Energy Star® Buildings—a strategy that optimizes whole-building energy-efficiency opportunities. The energy needed to run commercial and industrial buildings in the United States produces 19 percent of U.S. carbon dioxide emissions, 12 percent of NO_x, and 25 percent of SO₂, at a cost of \$110 billion a year. If implemented in every U.S. commercial and industrial building, the Energy Star® Buildings upgrade approach could prevent up to 35 percent of the emissions associated with these buildings and cut the nation's energy bill by up to \$25 billion annually.

The more than 7,000 participants include corporations, small businesses, universities, health care facilities, nonprofit organizations, school districts, and federal and local governments. Energy Star® has successfully delivered energy and cost savings across the country, saving businesses, organizations, and consumers more than \$5 billion a year. Over the past decade, Energy Star® has been a driving force behind the more widespread use of such technological innovations as LED traffic lights, efficient fluorescent lighting, power management systems for office equipment, and low standby energy use.

Manufacturers can become partners in Energy Star® by pledging to undertake the following steps:

- Measure, track, and benchmark their organization's energy performance by using tools such as those offered by Energy Star®;
- Develop and implement a plan to improve energy performance in their facilities and operations by adopting the strategy provided by Energy Star®; and

- Educate their staff and the public about their partnership with Energy Star®, and highlight their achievements with the Energy Star label, where available.

(Contact: Energy Star Hotline, (888) STAR-YES ((888) 782-7937) or visit the web site at <http://www.energystar.gov>.)

National Industrial Competitiveness through Energy, Environment, and Economics (NICE³)

The U.S. Department of Energy administers a grant program called NICE³. By providing grants of up to 50 percent of the total project cost, the program encourages industry to reduce industrial waste at its source and become more energy-efficient and cost-competitive through waste minimization efforts. Industry uses the grants to design, test, demonstrate, and assess the feasibility of new processes and/or equipment with the potential to reduce pollution and increase energy efficiency. The program is open to all industries; however, priority is given to proposals from participants in the chemicals, agriculture, aluminum, pulp and paper, glass, metal casting, mining, petroleum, and steel industries. (Contact: DOE's Golden Field Office at (303) 275-4728, or see the web site at <http://www.oit.doe.gov/nice3>.)

EPA Audit Policy

EPA encourages companies with multiple facilities to take advantage of the Agency's Audit Policy (Incentives for Self-Policing: Discovery, Disclosure, Correction and Prevention of Violations, 65 FR 19618 (April 11, 2000)) to conduct audits and develop environmental compliance systems. The Audit Policy eliminates gravity-based penalties for companies that voluntarily discover, promptly disclose, and expeditiously correct violations of federal environmental law. More information on EPA's Audit Policy can be obtained from the web site at: <http://www.epa.gov/Compliance/resources/policies/incentives/auditing/index-old.html>.

Small Business Compliance Policy

The Small Business Compliance Policy promotes environmental compliance among small businesses (those with 100 or fewer employees) by providing incentives to discover and correct environmental problems. EPA will eliminate or significantly reduce penalties for small businesses that voluntarily discover violations of environmental law and promptly disclose and correct them. A wide range of resources is available to help small businesses learn about environmental compliance and take advantage of the Small Business Compliance Policy. These resources include training, checklists, compliance guides, mentoring programs, and other activities.

Businesses can find more information through links on the web site at: <http://www.epa.gov/smallbusiness/>.

VIII.C. Trade Association-/Industry-Sponsored Activities

To determine the activities the sector is to improve undertaking its environmental performance, EPA contacted major trade associations and corporations. There are a significant number of activities occurring in the RMPP. The Rubber Manufacturers Association (RMA) has projects completed or underway that are looking at issues such as stormwater, emissions factors, scrap tires, and leaching potentials of rubber products. The SPI has started an incentive program called OCS to help plastics products manufacturers comply with the EPA-regulated problem of plastic resin pellet loss.

VIII.C.1. Environmental Programs*Stormwater*

EPA has identified stormwater runoff as one of the leading causes of the deterioration of water quality in rivers, lakes, streams, wetlands, and estuaries. As a result, EPA promulgated regulations on November 16, 1990 that required permit applications for stormwater discharges from selected municipal and industrial point sources. In 1990, the RMA sponsored a group stormwater application project that involved over 275 individual facilities. Stormwater sampling indicated that the rubber products manufacturing facilities have minimal stormwater pollution concerns. The draft NPDES permits published in the *Federal Register* on November 19, 1993 for the rubber industry reflected this "minimal concern" by proposing the following provisions:

- No specific numerical effluent limitations are needed;
- Best management practices (BMP) are effective at reducing pollutants; and
- Quarterly visual observation of stormwater discharges will help minimize pollution.

Many states are not waiting for EPA to finalize the permitting requirements and have requested that plants obtain local permits with reporting and chemical analysis provisions.

Within the miscellaneous plastics products industry, SPI started the incentive program OCS to promote efforts to reduce plastic resin pellet loss. SPI implements the program informally, by requiring all participating facilities to encourage spill minimization, prompt and thorough cleanup of spills, and proper pellet disposal. The participating manufacturers sign a pledge that says they will try to prevent pellet loss.

Air Emissions

In 1994 and 1995, RMA conducted an extensive air emission sampling project on the various manufacturing processes in the rubber industry. The purpose of this project was to develop accurate air emission factors for the rubber products manufacturing industry. Today, up-to-date emission factors are available for this industry. Six processes common to both tire and general rubber products plants (mixing, milling, extruding, calendaring, vulcanizing, and

grinding) were the subjects of this project. Twenty-six rubber compounds/mixtures were studied in this project. For each manufacturing process and compound, emission rates were developed as pounds of pollutant emitted per pound of rubber (or product) processed, except for grinding, which is expressed in terms of pounds of pollutant per pound of rubber ground off.

The RMA initiative resulted in draft emission factors for several rubber processing operations included in the 5th Edition, Volume 1 of the AP-42. Section 4.12 is dedicated to emission factors for the manufacture of rubber products. Many of the processes include:

- Calendering;
- Extrusion;
- Grinding;
- Internal mixing;
- Mixing;
- Autoclave curing;
- Hot air curing; and
- Platen press curing.

Emissions factors are included for this project. This is breaking new ground as this type of testing has never been done on such a scale for the tire and rubber industry. This is the first time that EPA's air program in Research Triangle Park has utilized data from an outside organization like the RMA to compile emissions factor for an industry.

Scrap Tire Disposal

Scrap tire disposal is another issue being addressed by the RMA. The RMA is working to find uses for scrap tires that are both economically and environmentally sound. The three main themes held by the RMA are reuse, recycle, or recovery. To date, improvements in finding uses for scrap tires have been strong. In 2001, approximately 78 percent of the 281 million scrap tires introduced that year were used in some way. This represents a 50-percent increase in the use of scrap tires used in 1994 and a seven-fold increase in scrap tire usage since 1990.

Using scrap tires as a fuel source is the leading method of utilizing of scrap tires. As of 1999, approximately 40 percent of scrap tires were used in this manner. An average tire releases 12,000 to 15,000 Btu/lb of energy. One 20-pound tire is equivalent to about 25 pounds of coal; shredded tire chips are added to coal as a fuel supplement. Whole tires are used at times as fuel in cement kilns.

Approximately 9 percent of scrap tires are used in civil engineering projects while 7 percent are recycled as other rubber products. Recycled ground rubber is incorporated into new tires, although the recycled content is limited so that tire performance is not compromised. In 2003, approximately 9 percent of the 290 million scrap tires were sent to landfills for disposal. Most landfills will not accept whole tires so scrap tires are usually chipped before being deposited in a landfill.

RMA has concluded that leachate issues from scrap rubber do not pose a concern. In 1989, the RMA conducted an assessment using EPA's proposed TCLP, to determine what levels of chemicals, if any, are leached from representative RMA products. The results of the TCLP analysis showed that none of the products tested, cured or uncured, exceeded proposed TCLP regulatory levels. The RMA also compared the effect of a modification to the TCLP proposed by EPA in 1989 that would eliminate grinding prior to leaching, in effect making TCLP tests of rubber products more representative of disposal practices. The results from tests of ground and unground samples were comparable.

VIII.C.2. Summary of Trade Associations

Rubber Manufacturers Association (RMA)

1400 K Street, N.W.	Members: Approximately 100
Washington, D.C. 20005	Staff: 25
Phone: (202) 682-4800	Budget:
Fax: (202) 682-4854	Contact: Tracey J. Norberg

RMA is the national trade association representing the tire and rubber manufacturing industry. Its members include all 7 major tire manufacturers and approximately 100 companies that manufacture other rubber products, including hoses, belts, seals, gaskets, anti-vibration equipment, and other molded rubber products for industrial and automotive applications. RMA represents its members on policy and technical issues, develops industry standards, compiles industry statistics, and provides educational opportunities for its members. RMA members are active in a variety of committees, which address environmental, safety and health, government affairs, communications, technical and standards, and statistical issues. The web site is located at: <http://www.rma.org/>.

Tire Industry Association (TIA)

1532 Pointer Ridge Place	Members: 4,500
Suite E	Staff: 18
Bowie, MD 20716-1883	Budget:
Phone: (800) 876-8372	Contact: Colleen Wood
Fax: (301) 430-7283	

TIA is an international association representing all segments of the tire industry, including those that manufacture, repair, recycle, sell, service, or use new or retreaded tires, and also those suppliers or individuals who furnish equipment, material or services to the industry. TIA was formed by the July 2002 merger of the International Tire & Rubber Association (ITRA) and the Tire Association of North America (TANA).

The TIA produces two publications, *Today's Tire Industry* and *CTS Today*. These are published six times annually. The web site is located at: <http://www.tireindustry.org/about.asp>.

Tire and Rim Association (TRA)

175 Montrose Avenue, West	Members: 40
Copley, OH 44321	Staff: 3
Phone: (216) 666-8121	Budget:
Fax: (216) 666-8340	Contact: J.F. Pacuit

Founded in 1903, TRA includes manufacturers of tires, rims, wheels, and related parts. TRA establishes standards (primarily dimensional) for the interchanging of tires, rim contours, tubes, valves, and flaps for passenger cars, motorcycles, trucks, buses, airplanes, and for earth-moving, road-building, agricultural, and industrial vehicles. TRA includes a Standards and Technical Advisory Committee. Subcommittees include Agricultural Tire and Rim, Aircraft Tire and Rim, Cycle Tire and Rim, Industrial Tire and Rim, Off-the-Road Tire and Rim, Passenger Car Tire and Rim, Truck-Bus Tire and Rim, and Tube and Valve. TRA also publishes *Engineering Design Information for Aircraft Tires and Rims* (periodic), *Engineering Design Information for Ground Vehicles Tires and Rims* (quarterly), *Tire and Rim Association-Aircraft Year Book*, and *Tire and Rim Association Year Book*. The web site is located at: <http://www.us-tra.org/traMain.htm>.

National Tire Dealers and Retreaders Association (NTDRA)

6333 Long Street, Suite 340	Members: 5,000
Shawnee, KS 66216	Staff: 30
Phone: (913) 268-6273	Budget:
Fax: (913) 268-6388	Contact: Don Wilson

Founded in 1920, NTDRA represents independent tire dealers and retreaders. It includes 25 state and 80 local groups. NTDRA publishes *Master Retreader* (bimonthly), *National Tire Dealers and Retreaders Association-Hotline* (bimonthly), *National Tire Dealers and Retreaders Association-Who's Who Membership Directory* (annual), *NTDRA Dealer News* (monthly), and *NTDRA Membergram* (monthly). The web site is located at:

The Society of the Plastics Industry, Inc. (SPI)

1801 K Street, N.W., Suite 600K	Members: 1,000
Washington, D.C. 20006	Staff: 57
Phone: (202) 974-5200	Budget:
Fax: (202) 296-7005	Contact: Bonnie Limbach

Founded in 1937, SPI represents manufacturers and processors of molded, extruded, fabricated, laminated, calendered, and reinforced plastic; manufacturers of raw materials, machinery, tools, dies, and molds; and testing laboratories. SPI supports research, proposes standards for plastics products, compiles statistics, organizes competitions, and bestows awards. SPI also publishes *Financial and Operating Ratios* (annual); *SPI Link* (weekly); *The Society of the Plastics Industry, Inc. - Labor Survey* (annual); and an *Annual Report* to members. The web site is located at: <http://www.plasticsindustry.org>.

Society of Plastic Engineers (SPE)

14 Fairfield Drive
P.O. Box 403
Brookfield, CT 06804-0403
Phone: (203) 775-0471
Fax: (203) 775-8490

Members: 37,000
Staff: 31
Budget: \$5,000,000
Contact: Gail Bristol

Founded in 1942, SPE is a professional society of scientists, engineers, educators, students, and others interested in the design, development, production, and utilization of plastic materials, products, and equipment. The SPE awards graduate and undergraduate scholarships ranging from \$1,000 to \$5,000. SPE awards a plaque, gold medal, and \$5,000 in recognition of fundamental contributions to the technology of polymer science and engineering, plus seven other awards of \$2,500 each for achievements in engineering and technology, education, business management, research, production of unique plastics products for consumer and industrial use, and contribution to mankind in the field of plastic. SPE also conducts seminars. Committees within SPE include Award, Credentials, Education, Education Seminar, International Relations, Management Involvement, New Technology, Plastic Education Foundation, Public Interest, Technical Programs, and Technical Volumes. Divisions include Advanced Polymer Composites, Automotive, Blow Molding, Color and Appearance, Decorating, Electrical and Electronics, Engineering Properties and Structure, Extrusion, Injection Molding, Marketing, Medical Plastic, Mold Making and Mold Design, Plastic Analysis, Plastic Recycling, Polymodifiers and Additives, Thermoforming, Thermoplastic Materials and Foams, Thermosetting Molding, and Vinyl Plastic. SPE also publishes the *Journal of Vinyl Technology* (quarterly), *Plastic Engineering* (monthly), *Polymer Composites* (bimonthly), *Polymer Engineering and Science* (semimonthly), and *Preprint Volumes and the Plastic Engineering Series* (books). The web site is located at: <http://www.4spe.org/>.

Association of Rotational Molders (ARM) International

2000 Spring Road,
Suite 511
Oak Brook, IL 60523
Phone: (630) 571-0611
Fax: (630) 571-0616

Members: 435
Staff: 3
Budget: \$500,000
Contact: Charles D. Fredrick

Founded in 1976, ARM represents plastic processors who use the rotational molding process, their suppliers, and overseas molders. ARM's purposes are to increase awareness of roto-molding, exchange technical information, provide education, and standardize production guidelines. ARM conducts research seminars, educational video, and slide programs, maintains a private library, sponsors a product contest, and bestows awards. ARM also offers a membership database. ARM publishes the *ARM Roster* (annual) and the *Roto-Molder Review* (4-6/year). The web site is located at: <http://www.rotomolding.org/>.

International Association of Plastic Distributors (IAPD)

4707 College Blvd., Suite 105	Members: 450
Leawood, KS 66211-1667	Staff: 6
Phone: (913) 345-1005	Budget: \$825,000
Fax: (913) 345-1006	Contact: Carol K. Wagner

Founded in 1956, IAPD represents distributors of plastic materials, firms that both manufacture and distribute these materials, and manufacturers who sell their products through plastic distributors. The objective of IAPD is to promote proper and efficient distributor involvement in the plastic industry. IAPD maintains liaison with associated organizations, operates a library, bestows awards, and compiles statistics. Publications include the *Membership Directory* (annual), the *IAPD Magazine* (monthly), and computerized data processing manuals, charts, and other materials. The web site is located at: <http://www.iapd.org/>.

Plastic Pipe and Fittings Association (PPFA)

Building C, Suite 20	Members: 73
800 Roosevelt Road	Staff: 4
Glen Ellyn, IL 60137	Budget:
Phone: (708) 858-6540	Contact: Richard W. Church
Fax: (630) 790-3095	

Founded in 1978, PPFA represents raw material suppliers, processors, machinery suppliers, consultants, and testing labs for plastic pipe and fittings. PPFA's objectives are to provide a forum for exchange of information and ideas; to see that existing code approvals for use of plastic pipe and fittings are retained; to obtain additional code approvals and develop new markets for products; to provide leadership and continuity for the industry; and to seek liaison and involvement with other organizations within the industry. The web site is located at: <http://www.ppfahome.org/>.

**IX. CONTACTS/ACKNOWLEDGMENTS/RESOURCE MATERIALS/
BIBLIOGRAPHY****General Profile**

Industry and Trade Summary - Pneumatic Tires and Tubes, U.S. International Trade Commission, Washington, D.C., February 1994.

Natural Rubber, Senior Policy Paper, Theodore J. Goering, The World Bank, Washington, D.C., 1982.

Tire Business - 2001 Annual Report, Tire Business, Akron, OH. <http://www.tirebusiness.com>

Tire Shipments Lose Momentum in 2001, Rubber Manufacturers Association, March 2002. <http://www.rma.org>

Tread Rubber Shipments Will Improve in 2nd Half of 2003, Rubber Manufacturers Association, August 2003. <http://www.rma.org>

2002, 2003, and 2004 Growth in Tire Shipments (annotated), Rubber Manufacturers Association, 2004. <http://www.rma.org>

U.S. Industrial Outlook 1994, Department of Commerce.

Industrial Rubber Products, Freedonia Group, July 2002. <http://www.mindbranch.com>

Plastics End-Market Snapshots, The Society of the Plastics Industry, Inc., 2001. <http://www.plasticsdatasource.org>

Global Business Trends, Partners, Hot Products, The Society of the Plastics Industry, Inc., 2001. <http://www.plasticsdatasource.org>

1997 Economic Census, Bureau of the Census, 1997. <http://www.census.gov/epcd/www/econ97.html>

Process Descriptions

The Chemical Process Industries, First ed., R. Norris Shreve, McGraw-Hill Book Company, Inc., New York, NY, 1945.

EPA Emergency Planning and Community Right-To-Know Act (EPCRA) Section 313 Reporting Guidance for Rubber and Plastics Manufacturing, U.S. EPA, May 2000.

Assessment of Industrial Hazardous Waste Practices - Rubber and Plastic Industry, Foster D. Snell for the U.S. EPA, Cleveland, OH, 1975.

“Foam Processing,” *Modern Plastic*, October 1991.

The Identification of Effluents from Rubber Vulcanization, Stephen M. Rappaport, University of North Carolina, Chapel Hill. Presented at the Conference on Environmental Aspects of Chemical Use in Rubber Processing, Akron, OH, 1975.

McGraw-Hill Encyclopedia of Science & Technology, 6th Edition, McGraw-Hill Book Company, New York, NY, 1992.

“Tire Materials and Construction,” Kevin Jost, *Automotive Engineering*, October 1992.

Regulatory Profile

Federal Register: Standards of Performance for New Stationary Sources; Rubber Tire Manufacturing Industry; Final Rule. 52 FR 34868, September 15, 1987.

Federal Register: Plastic Molding and Forming Point Source Category Effluent Limitations Guidelines; Pretreatment Standards and New Source Performance Standards; Final Regulation. 49 FR 49026, December 17, 1984.

Federal Register: National Emission Standards for Hazardous Air Pollutants: Rubber Tire Manufacturing; Final Rule. 67 FR 45588, July 9, 2002.

The Society of the Plastic Industry Issues, Volume V, No. 1-8, The Society of the Plastics Industry, Inc., Washington, D.C., 1994.

EPA’s Integrated Compliance Information System (ICIS).

http://www.epa.gov/idea/otis/icis_ns.html

EPA’s Air Toxics Web Site, National Emissions Standards for Hazardous Air Pollutants

<http://www.epa.gov/ttn/atw/mactfnlalph.html>

Pollution Prevention

Environmental Fact Sheet - Plastic: The Facts About Production, Use, and Disposal, U.S. EPA, Office of Solid Waste and Emergency Response, February 1990.

Environmental Fact Sheet - Plastic: The Facts on Source Reduction, U.S. EPA, Office of Solid Waste and Emergency Response, February 1990.

Environmental Fact Sheet - The Facts on Degradable Plastic, U.S. EPA, Office of Solid Waste and Emergency Response, February 1990.

Environmental Fact Sheet - The Facts on Recycling Plastic, U.S. EPA, Office of Solid Waste and Emergency Response, February 1990.

Operation Clean Sweep, Only You Can Stop Resin Pellet Loss!, The Society of the Plastics Industry, Inc., Washington, D.C.

Recent Experience in Encouraging the Use of Pollution Prevention in Enforcement Settlements, Monica M Becker and Nicholas A Ashford, Massachusetts Institute of Technology, Center for Technology, Policy, and Industrial Development, Cambridge, MA, May 1992.

Scrap Tires: Alternative and Markets in the United States, Goodyear Tire and Rubber Company, Akron, OH.

Scrap Tires for Fuel, an Energy Alternative, A.L. Eastman, Goodyear Tire and Rubber Company. Presented at the Akron Rubber Fall Technical Symposium, October 1991.

Scrap Tires - Understanding the Challenge, Goodyear Tire and Rubber Company, Akron, OH, 1990.

A Study of the Use of Recycled Paving Material, Report to Congress, U.S. Department of Transportation, Federal Highway Administration and U.S. EPA, June 1993. (FHWA-RD-93-147; EPA 530/R-93/013).

Summary of Markets for Scrap Tires, U.S. EPA, Office of Solid Waste and Emergency Response, October 1991.

Title III Section 313, Release Reporting Guidance, Estimating Chemical Releases From Rubber Production and Compounding, U.S. EPA, Office of Pesticides and Toxic Substances, March 1992. (EPA 560/4-88/004q)

U.S. Scrap Tire Markets 2001, Rubber Manufacturers Association, December 2002.

http://www.rma.org/scrap_tires/scrap_tire_markets/

Waste Minimization Strategies for the Fabricated Rubber Products Industry, Christopher Bozzini, Thomas O'Regan, Patrick Sheehan, and Catherine Walsh, Prepared for the U.S. EPA, August 1992.

1999 National Emissions Inventory, U.S. EPA, December 2003.

<http://www.epa.gov/ttn/chief/net/index.html>

2001 Toxic Release Inventory Data, U.S. EPA, June 2003. <http://www.epa.gov/tri>

Books, Reports, and Documents

Noyes Data Corporation, "Alternative Formulations and Packaging to Reduce Use of Chlorofluorocarbons," 1990, ISBN0-8155-1257-0.

Research Triangle Institute, "Alternatives for Measuring Hazardous Waste Reduction," 1991, PB91-208595.

Noyes Data Corporation, "Aqueous Cleaning as an Alternative to CFC and Chlorinated Solvent-Based Cleaning," 1991, ISBN0-8155-1285-6.

-
- EPA, "Background Document on Clean Products Research and Implementation," 1990, EPA/600/S2-90/048.
- EPA, "Case Studies from the Pollution Prevention Information Clearinghouse: Solvent Recovery," 1989, ISM-4 (PPIC).
- Government Institutes, "Case Studies in Waste Minimization," 1991, ISBN0-86587-267-8.
- United Nations Environmental Programme (UNEP), "Cleaner Production Newsletter," Industry and Environmental Office, ICPIIC-1 (PPIC).
- EPA, "Degreaser System Pollution Prevention Evaluation," 1990, EPA/600/S2-90/052.
- Oregon Department of Environmental Quality, "Guidelines for Waste Reduction and Recycling: Solvents," 1989, ISM-13 (PPIC).
- EPA, "Guides to Pollution Prevention: Research and Educational Institutions," 1990, ISM-19 (PPIC).
- EPA, "Guides to Pollution Prevention: The Fiberglass-Reinforced and Composite Plastics Industry," ISM-19 (PPIC).
- McGraw-Hill, Inc., "Hazardous Waste Minimization," 1990, ISBN0-07-022043-3.
- Lewis Publishers, "Hazardous Waste Minimization Handbook," 1989, ISBN0-87371-176-9.
- ASTM, "Hazardous and Industrial Solid Waste Minimization Practices," 1989, ISBN0-8031-1269-6.
- EPA, "Industrial Pollution Prevention for the 1990s," 1991, EPA/600/S8-91/052.
- EPA, "Pollution Prevention Benefits Manual: Volume 1 (Draft)," 1989, WAM-1 (PPIC).
- EPA, "Pollution Prevention Information Exchange System (PIES) User Guide," Version 1.1, 1989, EPA/600/9-89/086, free.
- CMA, "Pollution Prevention Resource Manual," 1991, \$75.00 (non-members), \$50.00 (members, Order no. 018031).
- EPA, "Prevention Reference Manual: Control Technologies. Volume 2: Post-Release Mitigation Measures for Controlling Accidental Releases of Air Toxics," 1987, EPA/600/S8-87/039b.
- EPA, "Prevention Reference Manual: Control Technologies. Volume 1: Prevention and Protection Technologies for Controlling Accidental Releases of Air Toxics," 1987, EPA/600/S8-87/039a.

-
- EPA, "Prevention Reference Manual: Overviews on Preventing and Controlling Accidental Releases of Selected Toxic Chemicals," 1988, EPA/600/S8-88/074.
- EPA, "Prevention Reference Manual: User's Guide, Overview for Controlling Accidental Releases of Air Toxics," 1987, EPA/600/S8-87/028.
- EPA, "Proceedings of the International Workshop on Research in Pesticide Treatment/Disposal/Waste Minimization," 1991, EPA/600-S9-91/047.
- Alaska Health Project, "Profiting from Waste Reduction in Your Small Business," 1988, free, QAM-2 (PPIC).
- National Academy Press, "Reducing Hazardous Waste Generation: An Evaluation and a Call for Action," 1985, \$9.95, ISBN 0-309-03498-1.
- Noyes, Data Corporation, "Solvent Waste Reduction," 1990, \$45, ISBN 0-8155-1254-6.
- EPA, "Solvent Waste Reduction Alternatives," 1989, EPA/625/4-89/021.
- EPA, "Source Characterization and Control Technology Assessment of Methylene Chloride Emissions from Eastman Kodak Company," Rochester, NY, 1989, EPA/600-S2-043.
- Government Institutes, "The Greening of American Business: Making Bottom-Line Sense of Environmental Responsibility," 1992, \$24.95, ISBN: 0-86587-295-3.
- Van Nostrand Reinhold, "The Recycler's Manual for Business, Government, and the Environmental Community," 1992, \$64.95, ISBN 0-442-01190-3.
- National Academy Press, "Tracking Toxic Substances at Industrial Facilities: Engineering Mass Balance Versus Materials Accounting," 1990, ISBN 0-0309-04086-8.
- EPA, "Waste Exchange Information Package," 1991, free, GEN-13 (PPIC).
- EPA, "Waste Minimization: Environmental Quality with Economic Benefits," 1990, free, EPA/530-SW-87-026 (also GEN-14 (PPIC)).
- Government Institutes, "Waste Minimization Manual," 1987, \$57.00, ISBN: 0-86587-731-9.
- EPA, "Waste Minimization Opportunity Assessment Manual," 1988, EPA/625/7-88/003.
- CMA, "Waste Minimization Workshop Handbook," 1987, \$250.00 (non-members); \$100.00 (members), Order no. 018016.
- API, "Waste Minimization in the Petroleum Industry: A Compendium of Practices," 1991, \$35.00, Order no. 849-30200.
- Lewis Publishers, "Waste Minimization: Implementing an Effective Program," due 1992, \$59.00, ISBN 0-87371-521-7.

Noyes Data Corporation, "Waste Oil: Reclaiming Technology, Utilization, and Disposal," 1989, \$39.00, ISBN 0-8155-1193-0.

California Department of Health Service, "Waste Reduction Fact Sheet: Pesticide Formulating Industry," free, FCAD-7 (PPIC).

Executive Enterprises, "Waste Reduction: Policy and Practice," \$39.95, ISBN 1-55840-272-1.

Contacts

Contacts	Organization	Telephone
Becky MacDicken	International Tire Association	(301) 430-7280
Lynne Harris	The Society of the Plastics Industry, Inc.	(202) 974-5200
Bob Larch	Ohio EPA, Solid Waste	(614) 644-2734
Hope Pillsbury	EPA, OSW, Solid Waste	(703) 308-7258
Roger M. Ferris	Society of Plastics Engineers	(203) 775-0471
J.F. Pacuit	Tire and Rim Association	(330) 666-8121
Tracey Norberg	Rubber Manufacturers Association	(202) 682-4800
Tony Wayne	EPA, Office of Air Quality Planning and Standards	(919) 541-5439
Dave Salman	EPA, Office of Air Quality Planning and Standards	(919) 541-0859



U.S. Environmental Protection Agency
Office of Enforcement and Compliance Assurance
1200 Pennsylvania Avenue, NW (MC 2224-A)
Washington, D.C. 20460

EPA/310-R-05-003
February 2005

www.epa.gov/compliance/sectornotebooks.html