

EPA Office of Compliance Sector Notebook Project

**Profile of the Agricultural Chemical, Pesticide, and Fertilizer
Industry**

September 2000

Office of Compliance
Office of Enforcement and Compliance Assurance
United States Environmental Protection Agency
1200 Pennsylvania Avenue, NW (MC 2221-A)
Washington, DC 20460

This report is one in a series of volumes published by the United States Environmental Protection Agency (EPA) to provide information of general interest regarding environmental issues associated with specific industrial sectors. The documents were developed under contract by Abt Associates (Cambridge, MA), Science Applications International Corporation (McLean, VA), and Booz-Allen & Hamilton, Inc. (McLean, VA). A listing of available Sector Notebooks is included on the following page.

Obtaining copies:

Electronic versions of all sector notebooks are available via Internet on the Enviro\$en\$e World Wide Web at www.epa.gov/oeca/sector. Enviro\$en\$e is a free, public, environmental exchange system operated by EPA's Office of Enforcement and Compliance Assurance and Office of Research and Development. The Network allows regulators, the regulated community, technical experts, and the general public to share information regarding: pollution prevention and innovative technologies; environmental enforcement and compliance assistance; laws, executive orders, regulations, and policies; points of contact for services and equipment; and other related topics. The Network welcomes receipt of environmental messages, information, and data from any public or private person or organization. Direct technical questions to the "Feedback" button on the bottom of the web page.

Purchase printed bound copies from the **Government Printing Office (GPO)** by consulting the order form at the back of this document or order via the Internet by visiting the on-line GPO Sales Product Catalog at https://orders.access.gpo.gov/su_docs/sale/prf/prf.html. Search using the exact title of the document "Profile of the XXXX Industry" or simply "Sector Notebook." When ordering, use the GPO document number found in the order form at the back of this document.

Complimentary volumes are available to certain groups or subscribers, including public and academic libraries; federal, state, tribal, and local governments; and the media from EPA's National Service Center for Environmental Publications at **(800) 490-9198**. When ordering, use the EPA publication number found on the following page.

The Sector Notebooks were developed by the EPA's Office of Compliance. Direct general questions about the Sector Notebook Project to:

Seth Heminway, Coordinator, Sector Notebook Project
US EPA Office of Compliance
1200 Pennsylvania Avenue, NW (2223-A)
Washington, DC 20460
(202) 564-7017

For further information, and for answers to questions pertaining to these documents, please refer to the contact names listed on the following page.

SECTOR NOTEBOOK CONTACTS

Questions and comments regarding the individual documents should be directed to the specialists listed below. See the Notebook web page at: www.epa.gov/oeca/sector for the most recent titles and staff contacts.

EPA Publication

Number	Industry	Contact	Phone (202)
EPA/310-R-95-001.	Profile of the Dry Cleaning Industry	Joyce Chandler	564-7073
EPA/310-R-95-002.	Profile of the Electronics and Computer Industry*	Steve Hoover	564-7007
EPA/310-R-95-003.	Profile of the Wood Furniture and Fixtures Industry	Bob Marshall	564-7021
EPA/310-R-95-004.	Profile of the Inorganic Chemical Industry*	Walter DeRieux	564-7067
EPA/310-R-95-005.	Profile of the Iron and Steel Industry	Maria Malave	564-7027
EPA/310-R-95-006.	Profile of the Lumber and Wood Products Industry	Seth Heminway	564-7017
EPA/310-R-95-007.	Profile of the Fabricated Metal Products Industry*	Scott Throwe	564-7013
EPA/310-R-95-008.	Profile of the Metal Mining Industry	Maria Malave	564-5027
EPA/310-R-95-009.	Profile of the Motor Vehicle Assembly Industry	Anthony Raia	564-6045
EPA/310-R-95-010.	Profile of the Nonferrous Metals Industry	Debbie Thomas	564-5041
EPA/310-R-95-011.	Profile of the Non-Fuel, Non-Metal Mining Industry	Rob Lischinsky	564-2628
EPA/310-R-95-012.	Profile of the Organic Chemical Industry *	Walter DeRieux	564-7067
EPA/310-R-95-013.	Profile of the Petroleum Refining Industry	Tom Ripp	564-7003
EPA/310-R-95-014.	Profile of the Printing Industry	Ginger Gotliffe	564-7072
EPA/310-R-95-015.	Profile of the Pulp and Paper Industry	Seth Heminway	564-7017
EPA/310-R-95-016.	Profile of the Rubber and Plastic Industry		564-2310
EPA/310-R-95-017.	Profile of the Stone, Clay, Glass, and Concrete Ind.	Scott Throwe	564-7013
EPA/310-R-95-018.	Profile of the Transportation Equip. Cleaning Ind.	Virginia Lathrop	564-7057
EPA/310-R-97-001.	Profile of the Air Transportation Industry	Virginia Lathrop	564-7057
EPA/310-R-97-002.	Profile of the Ground Transportation Industry	Virginia Lathrop	564-7057
EPA/310-R-97-003.	Profile of the Water Transportation Industry	Virginia Lathrop	564-7057
EPA/310-R-97-004.	Profile of the Metal Casting Industry	Steve Hoover	564-7007
EPA/310-R-97-005.	Profile of the Pharmaceuticals Industry	Emily Chow	564-7071
EPA/310-R-97-006.	Profile of the Plastic Resin and Man-made Fiber Ind.	Sally Sasnett	564-7074
EPA/310-R-97-007.	Profile of the Fossil Fuel Electric Power Generation Industry	Rafael Sanchez	564-7028
EPA/310-R-97-008.	Profile of the Shipbuilding and Repair Industry	Anthony Raia	564-6045
EPA/310-R-97-009.	Profile of the Textile Industry		564-2310
EPA/310-R-98-001.	Profile of the Aerospace Industry	Anthony Raia	564-6045
EPA/310-R-97-010.	Sector Notebook Data Refresh-1997 **	Seth Heminway	564-7017
EPA/310-R-99-006.	Profile of the Oil and Gas Extraction Industry	Dan Chadwick	564-7054
EPA/310-R-00-003.	Profile of the Agricultural Chemical, Pesticide, and Fertilizer Industry	Michelle Yaras	564-4153
EPA/310-R-00-001	Profile of the Agricultural Crop Production Industry	Ginah Mortensen	913-551-5211
EPA/310-R-00-002	Profile of the Agricultural Livestock Production Industry	Ginah Mortensen	913-551-5211

Government Series

EPA/310-R-99-001.	Profile of Local Government Operations		564-2310
-------------------	--	--	----------

* Spanish translations available.

** This document revises compliance, enforcement, and toxic release inventory data for all profiles published in 1995.

TABLE OF CONTENTS

LIST OF FIGURES	v
LIST OF TABLES	vi
LIST OF ACRONYMS	viii
I. INTRODUCTION TO THE SECTOR NOTEBOOK PROJECT	1
I.A. Summary of the Sector Notebook Project	1
I.B. Additional Information	2
II. INTRODUCTION TO THE AGRICULTURAL CHEMICAL INDUSTRY	3
II.A. Introduction, Background, and Scope of the Notebook	3
II.B. Characterization of the Fertilizer, Pesticide, and Agricultural Chemical Industry ...	4
II.B.1. Product Characterization	5
II.B.2. Industry Size and Geographic Distribution	19
II.B.3. Economic Trends	24
III. INDUSTRIAL PROCESS DESCRIPTION	27
III.A. Nitrogenous Fertilizers	27
III.A.1. Synthetic Ammonia	27
III.A.2. Nitric Acid	32
III.A.3. Ammonium Nitrate and Urea	36
III.B. Phosphatic Fertilizers	40
III.B.1. Phosphoric Acid (Wet Process)	40
III.B.2. Ammonium Phosphate	43
III.B.3. Normal Superphosphate	44
III.B.4. Triple Superphosphate	47
III.C. Fertilizer Mixing	49
III.D. Pesticide Formulating Processes	51
III.D.1. Liquid Formulating and Packaging	53
III.D.2. Dry Formulating and Packaging	54
III.D.3. Aerosol Packaging	56
III.D.4. Pressurized Gas Formulating and Packaging	57
III.D.5. Repackaging	57
III.E. Raw Material Inputs and Pollution Outputs	59
III.E.1. Fertilizers	59
III.E.2. Pesticide Formulating, Packaging, and Repackaging	68
III.F. Management of Chemicals in Wastestream	74
IV. CHEMICAL RELEASE AND TRANSFER PROFILE	78
IV.A. EPA Toxic Release Inventory for the Fertilizer, Pesticide, and Agricultural Chemical Industry	81
IV.B. Summary of Selected Chemicals Released	95
IV.C. Other Data Sources	99
IV.D. Comparison of Toxic Release Inventory Between Selected Industries	101

V. POLLUTION PREVENTION OPPORTUNITIES	104
V.A. Equipment Cleaning	108
V.B. Process Changes	112
V.C. Good Housekeeping	114
VI. Summary of Applicable Federal Statutes and Regulations	120
VI.A. General Description of Major Statutes	120
Imports and Exports	122
VI.B. Industry Specific Requirements	138
VI.C. State Regulation of Pesticides	150
VI.D. Pending and Proposed Regulatory Requirements	152
VII. COMPLIANCE AND ENFORCEMENT HISTORY	155
VII.A. Fertilizer, Pesticide, and Agricultural Chemical Industry Compliance History	159
VII.B. Comparison of Enforcement Activity Between Selected Industries	161
VII.C. Review of Major Legal Actions	166
VII.C.1. Review of Major Cases	166
VII.C.2. Supplementary Environmental Projects (SEPs)	170
VIII. COMPLIANCE ASSURANCE ACTIVITIES AND INITIATIVES	171
VIII.A. Sector-Related Environmental Programs and Activities	171
VIII.B. EPA Voluntary Programs	173
VIII.C. Trade Association/Industry Sponsored Activity	178
VIII.C.1. State Advisory Groups	178
VIII.C.2. Trade Associations	180
IX. CONTACTS/ACKNOWLEDGMENTS/RESOURCE MATERIALS	187

LIST OF FIGURES

Figure 1:	Number of Facilities and Value of Shipments of the Fertilizer, Pesticide, and Agricultural Chemical Manufacturing Industry	6
Figure 2:	Product Distribution for SIC 2873, Nitrogenous Fertilizers	9
Figure 3:	Product Distribution for SIC 2874, Phosphorous Fertilizers	11
Figure 4:	Product Distribution for SIC 2879, Pesticides and Miscellaneous Agricultural Chemicals	16
Figure 5:	Geographic Distribution of the Fertilizer Industry (SIC 2873, 2874, 2875)	20
Figure 6:	Geographic Distribution of the Pesticide Formulating and Miscellaneous Agrichemical Formulating Facilities (SIC 2879)	22
Figure 7:	Typical Process of Ammonia Synthesis	29
Figure 8:	Typical Process of Dual-Stage, Weak Nitric Acid Production	35
Figure 9:	Typical Process Diagram of High Strength Nitric Acid Production	36
Figure 10:	Typical Process for Ammonium Nitrate and Urea Manufacturing	39
Figure 11:	Typical Process of a Wet Process Dihydrate Phosphoric Acid Plant	42
Figure 12:	Typical Vacuum Evaporator Process	42
Figure 13:	Simplified Process Flow Diagram of Diammonium Phosphate Production	44
Figure 14:	Typical Process for Normal Superphosphate Manufacturing	46
Figure 15:	Typical Process for Triple Superphosphate	48
Figure 16:	Typical Process for Liquid Formulating	54
Figure 17:	Typical Process for Dry Formulating	56
Figure 18:	Raw Material Flowchart for Principal Fertilizer Materials	59
Figure 19:	Summary of 1995 TRI Releases and Transfers by Industry	102

LIST OF TABLES

Table 1:	Nitrogenous Fertilizer Products (SIC 2873)	7
Table 2:	Phosphatic Fertilizer Products (SIC 2874)	9
Table 3:	1990 Direct vs Mixed Application of Primary Fertilizer Nutrients	12
Table 4:	SIC 2879 Pesticides and Miscellaneous Agricultural Chemicals, List of Products .	13
Table 5:	Establishment Counts Based on Product Type	18
Table 6:	Facility Size Distribution for the Fertilizer, Pesticide, and Agricultural Chemical Manufacturing Industry	19
Table 7:	States with the Largest Number of Fertilizer Manufacturing Facilities	21
Table 8:	Top United States Agricultural Chemical Companies	23
Table 9:	Fertilizer Materials Used in Bulk Blends	49
Table 10:	Approximate Quantities of Most Commonly Used Conventional Pesticides in United States Agricultural Crop Production	70
Table 11:	Summary of Potential Pollution Outputs for the Agricultural Chemical Industry . . .	73
Table 12:	Source Reduction and Recycling Activity for the Fertilizer Industry as Reported within TRI	75
Table 13:	Source Reduction and Recycling Activity for the Pesticide and Miscellaneous Agricultural Chemicals Industry	76
Table 14:	1996 TRI Releases for Agricultural Chemicals Facilities (SICs 2873,2874,2875) by Number of Facilities Reporting (Releases reported in pounds/year)	84
Table 15:	1996 TRI Transfers for Agricultural Chemicals Facilities (SICs 2873,2874,2875) by Number and Facilities Reporting (Transfers reported in pounds/year)	85
Table 16:	1996 TRI Releases for Agricultural Chemicals Facilities (SIC 2879) by Number of Facilities Reporting (Releases reported in pounds/year)	86
Table 17:	1996 TRI Transfers for Agricultural Chemicals Facilities (SIC 2879) by Number and Facilities Reporting (Transfers reported in pounds/year)	89
Table 18:	Top 10 TRI Releasing Fertilizer Manufacturing and Mixing Facilities (SIC 2873, 2874, 2875)	93
Table 19:	Top 10 TRI Releasing Facilities Reporting Fertilizer Manufacturing and Mixing SIC Codes	93
Table 20:	Top 10 TRI Releasing Pesticide and Miscellaneous Agricultural Chemicals Facilities (SIC 2879)	94
Table 21:	Top 10 TRI Releasing Facilities Reporting Pesticide and Miscellaneous Agricultural Chemicals SIC Codes	94
Table 22:	Air Pollutant Releases by Industry Sector (tons/year)	100
Table 23:	1995 Toxics Release Inventory Data for Selected Industries	102
Table 24:	Waste Minimization Methods for the Fertilizer, Pesticide, and Agricultural Chemical Industry	107
Table 25:	Five-Year Enforcement and Compliance Summary for the Fertilizer, Pesticide, and Agricultural Chemical Industry	160
Table 26:	Five-Year Enforcement and Compliance Summary for Selected Industries	162
Table 27:	One-Year Enforcement and Compliance Summary for Selected Industries	163
Table 28:	Five-Year Inspection and Enforcement Summary by Statute for Selected Industries	164
Table 29:	One-Year Inspection and Enforcement Summary by Statute for Selected Industries	165

Table 30: Fertilizer, Pesticide, and Agricultural Chemical Industry Participation in the
33/50 Program 175

LIST OF ACRONYMS

AAEA	American Agricultural Economics Association
AAPCO	Association of American Pesticide Control Officials
AAPFCO	Association of American Plant Food Control Officials
ACPA	American Crop Protection Association
AFS	AIRS Facility Subsystem (CAA database)
AI	Active Ingredient
AIRS	Aerometric Information Retrieval System (CAA database)
ASA	American Society of Agronomy
BIFs	Boilers and Industrial Furnaces (RCRA)
BOD	Biochemical Oxygen Demand
CAA	Clean Air Act
CAAA	Clean Air Act Amendments of 1990
CERCLA	Comprehensive Environmental Response, Compensation and Liability Act
CERCLIS	CERCLA Information System
CFA	California Fertilizer Association
CFCs	Chlorofluorocarbons
CMA	Chemical Manufacturers Association
CO	Carbon Monoxide
COD	Chemical Oxygen Demand
CSI	Common Sense Initiative
CSMA	Chemical Specialties Manufacturers Association
CWA	Clean Water Act
DAP	Diammonium Phosphate
DOT	Department of Transportation
D&B	Dun and Bradstreet Marketing Index
EPA	United States Environmental Protection Agency
EPCRA	Emergency Planning and Community Right-to-Know Act
FFDCA	Federal Food, Drug, and Cosmetic Act
FIFRA	Federal Insecticide, Fungicide, and Rodenticide Act
FINDS	Facility Indexing System
FIRT	Fertilizer Industry Round Table
FQPA	Food Quality Protection Act
HAPs	Hazardous Air Pollutants (CAA)
HSDB	Hazardous Substances Data Bank
IDEA	Integrated Data for Enforcement Analysis
IFDC	International Fertilizer Development Center
LDR	Land Disposal Restrictions (RCRA)
LEPCs	Local Emergency Planning Committees
MACT	Maximum Achievable Control Technology (CAA)
MAP	Monoammonium Phosphate
MCLGs	Maximum Contaminant Level Goals
MCLs	Maximum Contaminant Levels
MEA	Monoethanolamine
MEK	Methyl Ethyl Ketone
MSDSs	Material Safety Data Sheets

NACD	National Association of Chemical Distributors
NASDA	National Association of State Departments of Agriculture
NASHA	North American Horticultural Supply Association
NCDB	National Compliance Database (for TSCA, FIFRA, EPCRA)
NCP	National Oil and Hazardous Substances Pollution Contingency Plan
NEC	Not Elsewhere Classified
NEIC	National Enforcement Investigation Center
NESHAP	National Emission Standards for Hazardous Air Pollutants
NO ₂	Nitrogen Dioxide
NOV	Notice of Violation
NO _x	Nitrogen Oxide
NPCA	National Pest Control Association
NPDES	National Pollution Discharge Elimination System (CWA)
NPK	Nitrogen-Phosphorous-Potassium
NPL	National Priorities List
NRC	National Response Center
NRDC	National Resources Defense Council
NSP	Normal Superphosphate
NSPS	New Source Performance Standards (CAA)
OECA	Office of Enforcement and Compliance Assurance
OMB	Office of Management and Budget
OPA	Oil Pollution Act
OPPTS	Office of Prevention, Pesticides, and Toxic Substances
OSHA	Occupational Safety and Health Administration
OSW	Office of Solid Waste
OSWER	Office of Solid Waste and Emergency Response
OW	Office of Water
P2	Pollution Prevention
PCS	Permit Compliance System (CWA Database)
PRP	Potentially Responsible Party
POTW	Publicly Owned Treatments Works
PPI	Potash and Phosphate Institute
RCRA	Resource Conservation and Recovery Act
RCRIS	RCRA Information System
SARA	Superfund Amendments and Reauthorization Act
SDWA	Safe Drinking Water Act
SEPs	Supplementary Environmental Projects
SERCs	State Emergency Response Commissions
SFIREG	State FIFRA Issues Research and Evaluation Group
SIC	Standard Industrial Classification
SO ₂	Sulfur Dioxide
SO _x	Sulfur Oxides
TOC	Total Organic Carbon
TFI	The Fertilizer Institute
TRI	Toxic Release Inventory
TRIS	Toxic Release Inventory System
TCRIS	Toxic Chemical Release Inventory System

TSCA	Toxic Substances Control Act
TSP	Triple Superphosphate
TSS	Total Suspended Solids
TVA	Tennessee Valley Authority
UIC	Underground Injection Control (SDWA)
UPFDA	United Products Formulators and Distributors Association
USDA	United States Department of Agriculture
UST	Underground Storage Tanks (RCRA)
VOCs	Volatile Organic Compounds
WCPA	Western Crop Protection Association

I. INTRODUCTION TO THE SECTOR NOTEBOOK PROJECT

I.A. Summary of the Sector Notebook Project

Integrated environmental policies based upon comprehensive analysis of air, water and land pollution are a logical supplement to traditional single-media approaches to environmental protection. Environmental regulatory agencies are beginning to embrace comprehensive, multi-statute solutions to facility permitting, enforcement and compliance assurance, education/outreach, research, and regulatory development issues. The central concepts driving the new policy direction are that pollutant releases to each environmental medium (air, water and land) affect each other, and that environmental strategies must actively identify and address these inter-relationships by designing policies for the “whole” facility. One way to achieve a whole facility focus is to design environmental policies for similar industrial facilities. By doing so, environmental concerns that are common to the manufacturing of similar products can be addressed in a comprehensive manner. Recognition of the need to develop the industrial “sector-based” approach within the EPA Office of Compliance led to the creation of this document.

The Sector Notebook Project was originally initiated by the Office of Compliance within the Office of Enforcement and Compliance Assurance (OECA) to provide its staff and managers with summary information for eighteen specific industrial sectors. As other EPA offices, states, the regulated community, environmental groups, and the public became interested in this project, the scope of the original project was expanded to its current form. The ability to design comprehensive, common sense environmental protection measures for specific industries is dependent on knowledge of several inter-related topics. For the purposes of this project, the key elements chosen for inclusion are: general industry information (economic and geographic); a description of industrial processes; pollution outputs; pollution prevention opportunities; federal statutory and regulatory framework; compliance history; and a description of partnerships that have been formed between regulatory agencies, the regulated community and the public.

For any given industry, each topic listed above could alone be the subject of a lengthy volume. However, in order to produce a manageable document, this project focuses on providing summary information for each topic. This format provides the reader with a synopsis of each issue, and references where more in-depth information is available. Text within each profile was researched from a variety of sources, and was usually condensed from more detailed sources pertaining to specific topics. This approach allows for a wide coverage of activities that can be further explored based upon the citations and references listed at the end of this profile. As a check on the information included, each notebook went through an external review process. The Office of Compliance appreciates the efforts of all those that participated

in this process who enabled us to develop more complete, accurate and up-to-date summaries. Many of those who reviewed this notebook are listed as contacts in Section IX and may be sources of additional information. The individuals and groups on this list do not necessarily concur with all statements within this notebook.

I.B. Additional Information

Providing Comments

OECA's Office of Compliance plans to periodically review and update the notebooks and will make these updates available both in hard copy and electronically. If you have any comments on the existing notebook, or if you would like to provide additional information, please send a hard copy and computer disk to the EPA Office of Compliance, Sector Notebook Project (2223-A), 1200 Pennsylvania Avenue, NW, Washington, DC 20460. Comments can also be uploaded to the Enviro\$en\$e World Wide Web for general access to all users of the system. Follow instructions in Appendix A for accessing this system. Once you have logged in, procedures for uploading text are available from the on-line Enviro\$en\$e Help System.

Adapting Notebooks to Particular Needs

The scope of the industry sector described in this notebook approximates the national occurrence of facility types within the sector. In many instances, industries within specific geographic regions or states may have unique characteristics that are not fully captured in these profiles. The Office of Compliance encourages state and local environmental agencies and other groups to supplement or repackage the information included in this notebook to include more specific industrial and regulatory information that may be available. Additionally, interested states may want to supplement the "Summary of Applicable Federal Statutes and Regulations" section with state and local requirements. Compliance or technical assistance providers may also want to develop the "Pollution Prevention" section in more detail. Please contact the appropriate specialist listed on the opening page of this notebook if your office is interested in assisting us in the further development of the information or policies addressed within this volume. If you are interested in assisting in the development of new notebooks for sectors not covered in the original eighteen, please contact the Office of Compliance at 202-564-2310.

II. INTRODUCTION TO THE AGRICULTURAL CHEMICAL INDUSTRY

This section provides background information on the size, geographic distribution, employment, production, sales, and economic condition of the fertilizer, pesticide, and agricultural chemical industry. Facilities described within this document are described in terms of their Standard Industrial Classification (SIC) codes whenever possible.

II.A. Introduction, Background, and Scope of the Notebook

The scope of this Sector Notebook covers the manufacturing and production of fertilizers, the formulation of pesticide chemicals (both agricultural and non-agricultural) manufactured at separate facilities, and the production of other miscellaneous agricultural chemicals. It does not include the use, sale, distribution, or storage of such chemicals.

The Fertilizer, Pesticide, and Agricultural Chemical Industry is classified by the Office of Management and Budget (OMB) under Standard Industrial Classification (SIC) Industry Group Number 287. This classification corresponds to SIC codes which were established by the OMB to track the flow of goods and services within the economy. Industry Group Number 287 includes SIC codes:

- 2873-- Nitrogenous Fertilizers
- 2874-- Phosphatic Fertilizers
- 2875-- Fertilizers, Mixing Only
- 2879-- Pesticides and Agricultural Chemicals, Not Elsewhere Classified (n.e.c)

This notebook covers both fertilizer manufacturing and formulating operations including ammonia synthesis, nitric and phosphoric acid production, and the mixing, preparing, and packaging of nitrogenous and phosphatic fertilizers. Establishments engaged in manufacturing fertilizer materials or mixing fertilizers produced at the same establishment are classified under SIC codes 2873 and 2874. Mixing of fertilizer materials, such as compost, potting soil, and fertilizers made in plants not manufacturing fertilizer materials, is classified under SIC code 2875. This notebook does not include the mining or grinding of phosphate rock, which is classified under SIC code 1475, and it also does not include the use or application of fertilizers.

SIC code 2879, pesticides and agricultural chemicals not elsewhere classified (n.e.c.), hereafter referred to as pesticides and miscellaneous agricultural chemicals, covers only the formulating, preparing, and packaging of ready-to-use agricultural and household pest control chemicals. This industry code also includes establishments primarily engaged in the manufacturing or formulating of agricultural chemicals, not elsewhere classified, such as minor or trace elements and soil conditioners. This notebook does not discuss the use or

application of pesticide products. Establishments primarily engaged in the manufacturing of basic or technical agricultural pesticides are classified in Industry Group 281 if the chemicals produced are inorganic or Industry Group 286 if the chemicals produced are organic. This notebook also does not cover the agricultural supply sector, SIC 5191, which is engaged in the wholesale and distribution of various agricultural supplies including fertilizers and pesticides. Also, there is little discussion of the potassium fertilizer industry as potash is classified under SIC 2819, Inorganic Chemicals n.e.c.

Federal government agencies, including United States EPA, are beginning to implement an industrial classification system developed by OMB to replace the SIC code system. The new system, which is based on similar production processes, is called the North American Industrial Classification System (NAICS). In the NAIC system, the manufacturing of nitrogenous fertilizers (SIC 2873) is classified as NAIC 325311, phosphatic fertilizers (SIC 2874) as NAIC 325312, and fertilizer mixing only (SIC 2875) as NAIC 325314. Pesticide formulating and agricultural chemicals n.e.c. (SIC 2879) is classified under NAIC 32532. Because EPA databases, and other databases used in this document, are still using the SIC system, the industry sectors described in this Sector Notebook are described in terms of their SIC codes.

II.B. Characterization of the Fertilizer, Pesticide, and Agricultural Chemical Industry

As the world population increases, crop lands are unable to meet the growing demand for food without employing some method of crop enhancement. There are five common practices used to meet the growing demand:

- C increasing tilled acreage
- C improving plant strains
- C introducing or expanding irrigation
- C controlling pest by chemical or biological methods
- C initiating or increasing fertilizer usage

Increased utilization of the last two methods has created a large agrichemical industry which produces a wide variety of products designed to increase crop production and protect crops from disease and pests (Kent, 1992). Together, the production of fertilizers and the formulation of pesticides was a \$18.8 billion industry in 1992, employing over 40,000 people (USDOD, 1995).

Plants require 18 elements to grow, the most important being oxygen, carbon, hydrogen, nitrogen, phosphorous, and potassium. Oxygen, carbon, and hydrogen are obtained from the atmosphere and water, while nitrogen, phosphorous, and potassium are naturally obtained from soil. However, under current high yield production methods, soils are stripped of the essential nutrients, requiring the addition of fertilizers (primarily consisting of nitrogen, phosphorous, and potassium) to resupply the land. The additional 12 essential nutrients are generally maintained in soil at sufficient levels for plant growth,

but they may be added to some fertilizers (Kent, 1992).

Even before the addition of nutrients to farm lands, farmers were forced to protect their crops against pests with chemicals. References to pesticide usage date back to 1000 B.C. Pests are continuously adapting to pesticide chemicals requiring new pesticides and the usage of multiple chemical agents. The industry is rapidly changing due to biological adaptation of pests, laboratory discoveries, and government regulation (Kent, 1992). The pesticide industry is faced with the need for new formulations and the abundance of possible combinations, but restricted by cost factors and a sometimes lengthy registration process.

Pesticides are applied on about three-quarters of United States farms and households. Farmers' expenditures on pesticides were equal to 4.6 percent of total farm production expenditures in 1995, up from 3.9 percent in 1993. About one billion pounds of active ingredient of conventional pesticides are used annually in the United States; this usage involves about 21,000 pesticide products (including non-agricultural products) and 875 active ingredients registered under the Federal Pesticide Law, according to the *1994 and 1995 Market Estimates for Pesticides Industry Sales and Usage* (Aspelin, 1997).

II.B.1. Product Characterization

This notebook covers all aspects of fertilizer production and pesticide formulating and packaging. However, because the industrial processes, pollutant outputs, economics, size, and geographic distribution of the two industries are different, they are dealt with separately throughout the notebook.

Figure 1 compares the number of manufacturing facilities and value of shipments for each of the major sectors within the Fertilizer, Pesticide, and Agricultural Chemical Industry, as reported by the United States Bureau of Census. The figure shows that the fertilizer mixing industry has the largest number of facilities but the smallest value of shipments. This reflects that, compared to other sub-sectors within the Fertilizer, Pesticide and Agricultural Chemical Industry, these facilities produce a relatively small volume of product and sell a relatively low value product. Phosphatic fertilizer producers, on the other hand, comprise the smallest number of facilities but have a relatively large share of the industry's value of shipments, reflecting that individual facilities produce a relatively large volume of product.

Figure 1: Number of Facilities and Value of Shipments of the Fertilizer, Pesticide, and Agricultural Chemical Manufacturing Industry

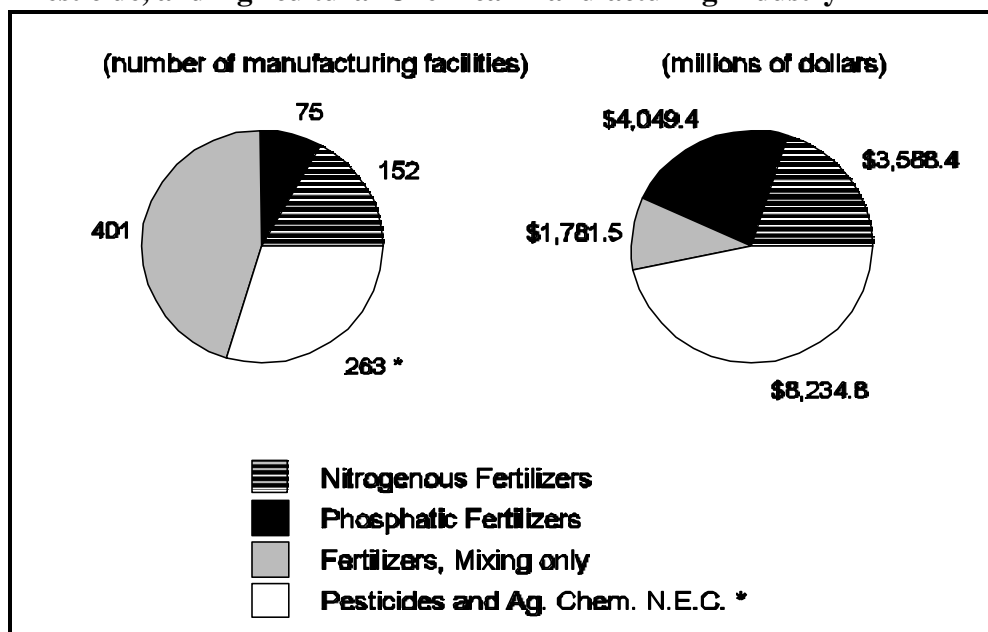

Source: 1992 Census of Manufacturers, Industry Series: Agricultural Chemicals, United States Department of Commerce, Bureau of the Census, May 1995.

* United States EPA has identified over 8,000 establishments that could fall within this SIC code as it is defined by the OMB. See discussion in text below.

The Census of Manufacturers reports 263 establishments that can be defined as producing pesticides and miscellaneous agricultural chemicals. These establishments reportedly account for almost half of the value of shipments for the sector. There are over 8,000 establishments identified by the United States EPA that manufacture, formulate and package pesticides and other agricultural chemicals and that could fall within OMB's SIC code definition for this sector. Many of these are small establishments and establishments that have a primary line of business other than producing pesticides and other miscellaneous agricultural chemicals. The Census only counts those facilities which report an SIC code as their primary line of business, thus the number of facilities shown above is not inclusive of all facilities involved in agricultural chemical production. Under the "Pesticides and Miscellaneous Agricultural Chemicals" heading later in this section, other pesticide producing establishment counts are presented based on EPA estimates and reporting under section 7 of the Federal Insecticide, Fungicide, and Rodenticide Act.

Nitrogenous Fertilizers

The nitrogenous fertilizer industry includes the production of synthetic ammonia, nitric acid, ammonium nitrate, and urea. Synthetic ammonia and nitric acid, however, are used primarily as intermediates in the production of ammonium nitrate and urea fertilizers. Table 1 lists specific products classified as nitrogenous fertilizers by OMB.

**Table 1: Nitrogenous Fertilizer Products
(SIC 2873)**

Ammonia liquor
Ammonium nitrate
Ammonium sulfate
Anhydrous ammonia
Aqua ammonia
Fertilizers, mixed, produced in nitrogenous fertilizer plants
Fertilizers, natural
Nitric acid
Nitrogen fertilizer solutions
Plant foods, mixed in nitrogenous fertilizer plants
Urea

Source: Standard Industrial Classification Manual, Office of Management and Budget, 1987.

Synthetic Ammonia

Synthetic ammonia refers to ammonia that has been synthesized from natural gas. In this process, natural gas molecules are reduced to carbon and hydrogen. The hydrogen is then purified and reacted with nitrogen to produce ammonia. Approximately 75 percent of the synthetic ammonia produced in the United States is used as fertilizer, either directly as ammonia or indirectly after fertilizer synthesis into urea, ammonium nitrate, and monoammonium or diammonium phosphates. One-third of the fertilizer nitrogen is applied directly to the land as anhydrous ammonia. The remaining 25 percent of ammonia produced in the United States is used as raw material in the manufacture of polymeric resins, explosives, nitric acid, and other products (USEPA, 1993a).

Nitric Acid

Nitric acid is formed by concentration, absorption, and oxidation of anhydrous ammonia. About 70 percent of the nitric acid produced is consumed as an intermediate in the manufacture of ammonium nitrate (NH_4NO_3), which is primarily used in fertilizers. Another 5 to 10 percent of the nitric acid produced is used in adipic acid manufacturing, an intermediate in nylon production. Explosive manufacturing utilizes nitric acid for organic nitrations to produce nitrobenzene, dinitrotoluenes, and other chemical intermediates. Other end uses of nitric acid are gold and silver separation, military munitions,

steel and brass pickling, photoengraving, and acidulation of phosphate rock (USEPA, 1993a).

Ammonium Nitrate

Ammonium nitrate is produced by neutralizing nitric acid with ammonia. Approximately 15 to 20 percent of ammonium nitrate is used for explosives and the balance for fertilizer. Ammonium nitrate is marketed in several forms, depending upon its use. Liquid ammonium nitrate may be sold as a fertilizer, generally in combination with urea. Liquid ammonium nitrate may also be concentrated to form an ammonium nitrate "melt" for use in solids formation processes. Solid ammonium nitrate may be produced in the form of prills, grains, granules or crystals. Prills, round or needle-shaped aggregates, can be produced in either high or low density form, depending on the concentration of the melt. High density prills, granules and crystals are used as fertilizer, grains are used solely in explosives, and low density prills can be used as either fertilizer or explosives (USEPA, 1993a).

Urea

Urea, also known as carbamide or carbonyl diamide, is produced by reacting ammonia with carbon dioxide. Eighty-five percent of urea solution produced is used in fertilizer mixtures, with three percent going to animal feed supplements and 12 percent is used for plastics and other uses. Urea is marketed as a solution or in solid form. Most solids are produced as prills or granules for use as fertilizer or protein supplement in animal feed, and in plastics manufacturing (USEPA, 1993a).

Ammonium sulfate

It is not economically feasible to produce ammonium sulfate for use as a fertilizer. However, ammonium sulfate is formed as a by-product of other process such as acid scrubbing of coke oven gas, synthetic fiber production, and the ammoniation of process sulfuric acid (Hoffmeister, 1993). Therefore, the production of ammonium sulfate is not described in this notebook.

Figure 2: Product Distribution for SIC 2873, Nitrogenous Fertilizers

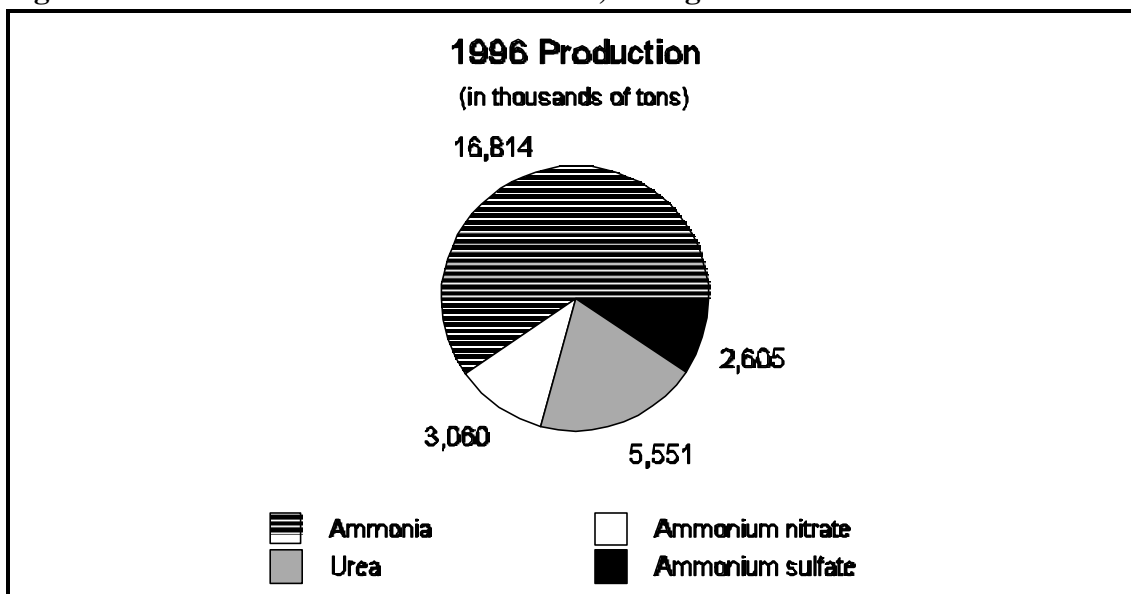

Source: Fertilizer Institute data as reported in *Chemical and Engineering News*, June 23, 1998. Figures are based on Fertilizer Institute surveys and may not represent the entire industry.

Phosphatic Fertilizers

The phosphatic fertilizer industry can be divided into three major segments: phosphoric acid, granular ammonium phosphate, and normal and triple superphosphate. Table 2 lists these, and a few additional, less common products classified as phosphatic fertilizers by OMB.

Table 2: Phosphatic Fertilizer Products (SIC 2874)

- Ammonium phosphates
- Calcium meta-phosphates
- Defluorinated phosphates
- Diammonium phosphates
- Fertilizers, mixed, produced in phosphatic fertilizer plants
- Phosphoric acid
- Plant foods, mixed in phosphatic fertilizer plants
- Superphosphates, ammoniated and not ammoniated

Source: *Standard Industrial Classification Manual, Office of Management and Budget, 1987.*

Phosphoric Acid

Phosphoric acid (H_3PO_4) can be manufactured using either a wet or a thermal process to react phosphate rock with sulfuric acid. Approximately 96 percent of the phosphoric acid produced in the United States is produced using the wet process. Wet process phosphoric acid has a phosphorous concentration typically ranging from 26-30% as phosphorous pentoxide (P_2O_5) and is used in the production of ammonium phosphates and triple superphosphates. Thermal process phosphoric acid is commonly used in the manufacture of high grade chemicals requiring a much higher purity.

Ammonium Phosphates

Ammonium phosphate ($\text{NH}_4\text{H}_2\text{PO}_4$) is produced by reacting phosphoric acid with anhydrous ammonia. Both solid and liquid ammonium phosphatic fertilizers are produced in the United States. The most common ammonium phosphatic fertilizer grades are monoammonium phosphate (MAP) and diammonium phosphate (DAP). DAP has become one of the most commonly used fertilizers because it provides a large quantity of plant food, is compatible with most mix fertilizer ingredients, and is nonexplosive. It may be directly applied or used in irrigation systems as it is completely soluble in water. DAP is also preferred over MAP because it is capable of fixing twice as much ammonia per phosphorous pentoxide in solid form (Nielson, 1987.) MAP contains a higher concentration of phosphorous pentoxide than DAP. It is favored for use with alkaline soils and may be applied either directly or in a dry blend.

Normal Superphosphates

Like phosphoric acid, normal, or "ordinary," superphosphate fertilizers are produced by reacting phosphate rock with sulfuric acid. However, normal superphosphate (NSP) retains calcium sulfate which forms by the reaction between phosphate rock and sulfuric acid. For this reason NSP retains its importance wherever sulphur deficiency limits crop yields (UNEP, 1996). NSP refers to fertilizer material containing 15 to 21 percent phosphorous as phosphorous pentoxide (P_2O_5). As defined by the Census Bureau, NSP contains not more than 22 percent of available P_2O_5 (USEPA, 1993a). Production of NSP has given way to the higher-yielding triple superphosphates and ammonium phosphates. In 1990, production of NSP accounted for only one percent by weight of the phosphorous fertilizer industry. Because of its low P_2O_5 concentration, shipping can be prohibitively expensive due to the large volumes required. NSP is favored in low cost Nitrogen-Phosphorous-Potassium (NPK) mixes because it is a less expensive form of phosphorous, however, it is unacceptable for higher-grade mixes (Kent, 1992).

Triple Superphosphates

Triple superphosphates (TSP) are produced by reacting ground phosphate rock with phosphoric acid. Triple superphosphate is also known as double, treble, or concentrated superphosphate. The phosphorus content of triple superphosphates is over 40 percent, measured as phosphorus pentoxide (P_2O_5),

which is its main advantage over other phosphatic fertilizers (USEPA, 1993a). TSP began to be produced in large quantities when wet process phosphoric acid production became available commercially. It is commonly produced along with phosphoric acid near phosphate rock supplies. TSP may be applied directly or as a bulk blend (Kent, 1992).

Figure 3: Product Distribution for SIC 2874, Phosphorous Fertilizers

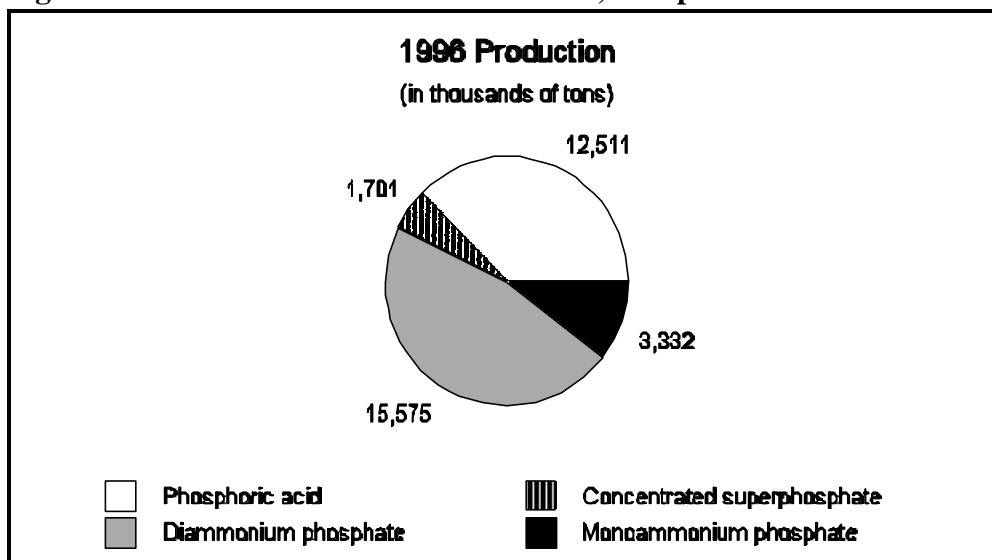

Source: Chemical and Engineering News, June 23, 1998. Figures are based on Fertilizer Institute surveys and may not represent the entire industry.

Fertilizers, Mixing Only

A significant part of the fertilizer industry only purchases fertilizer materials in bulk from fertilizer manufacturing facilities and mixes them to sell as a fertilizer formulation.

Phosphorous is the single nutrient most likely to be applied in a fertilizer mixture, as seen in Table 3.

Table 3: 1990 Direct vs Mixed Application of Primary Fertilizer Nutrients

Nutrient	Method, % applied	
	Direct	Mixtures
Nitrogen	80	20
Phosphorous	8	92
Potassium	65	35
TOTAL	61	39

Source: Hoffmeister, G., "Fertilizers," Kirk-Othmer Encyclopedia of Chemical Technology, V. 10, 1993.

Although the Bureau of the Census only counts 401 facilities reporting the SIC code for fertilizer mixing (2875) in 1992, other sources estimated the true number of fertilizer mixing facilities to be closer to five or six thousand in 1984 (Adrienas and Vroomen, 1990). About half of applied fertilizers are bulk blends. Fertilizer mixing facilities generally serve a small area such as farms within a ten to fifty mile radius. The processes involved are simple and relatively little value is added to the raw materials purchased by mixing facilities. Nevertheless, there are many of these facilities and volume of production results in a \$1.8 billion industry (value of annual shipments). The industrial process is simple and resembles that of the pesticide formulating sector. A brief discussion of fertilizer mixing processes is included in this notebook.

Pesticides and Miscellaneous Agricultural Chemicals

The pesticides and agricultural chemicals n.e.c. (referred to here as pesticides and miscellaneous agricultural chemicals) industry group (SIC 2879) formulates and prepares ready to use agricultural and household pesticides and other agricultural chemicals. The manufacture of pesticide active ingredients is classified under either Industry Group 281 for inorganic chemicals or 286 for organics which are not covered by this notebook. (*See Profile of the Inorganic Chemicals Industry and Profile of the Organic Chemicals Industry Sector Notebooks.*) In the United States, over 850 different pesticide formulations and preparations are produced. In 1995, 31 new active ingredients were registered in the United States (Aspelin, 1997). Most of these pesticides can be classified as either insecticides, herbicides, or fungicides, although many other minor classifications exist. Also included in this category are blends of fertilizers and pesticides produced at pesticide formulating and

mixing facilities. Table 4 lists the pesticides and other products included in SIC 2879.

Table 4: SIC 2879 Pesticides and Miscellaneous Agricultural Chemicals, List of Products

Agricultural disinfectants	Insecticides, agricultural and household	Poison, household
Agricultural pesticides	Lime-sulfur, dry and solution	Pyrethrin
Arsenates and arsenites	Lindane, formulated	Rodenticides
Bordeaux mixture	Moth repellants	Rotenone
Cattle dips and sheep dips	Nicotine and salts	Soil conditioners
DDT	Paris green	Sulfur dust
Defoliants	Pesticides, household	Thiocyanates
Fly sprays	Phytoactin	Trace elements (agricultural)
Fungicides	Plant hormones	Xanthone
Growth regulants		
Herbicides		

Source: Standard Industrial Classification Manual, Office of Management and Budget, 1987.

In 1995, 77 percent (by volume) of all pesticides were used for agriculture, 12 percent for industrial, commercial, or governmental lands or facilities, and 11 percent for homes and gardens (Aspelin, 1997). Non-agricultural pesticides and miscellaneous agricultural chemicals are included in the data presented for sales, production, waste management, and enforcement and compliance. However, since they represent a relatively small part of the industry and cover a wide range of chemicals and production processes, these products are not covered in the Industrial Processes and Pollutant Outputs sections of this document.

Herbicides

Herbicides (in both value and quantity) are the largest class of pesticides used in the United States, as well as in the world. This class of pesticides, which accounts for approximately fifty percent of the value of aggregate world pesticide usage, is used to destroy or control a wide variety of weeds and other unwanted plants. Because of its demonstrated farm labor savings, nearly all the agricultural land in the United States is currently being treated with some type of herbicide. In recent years, approximately fifty percent of total United States pesticide consumption (by value) was herbicides (USITC, 1994).

Insecticides

Insecticides are the second largest pesticide category (by value) used in the United States and in the world. In the early 1990s, insecticides accounted for approximately twenty-nine percent of the total value of United States pesticide consumption. Historically, the category of synthetic organic insecticides has been divided into one of four major chemical groups:

- C organochlorines (e.g., DDT and chlordane)

- C organophosphates (e.g., parathion and diazinon)
- C carbamates (e.g., carbaryl)
- C pyrethroids (e.g., natural and synthetic)

Several compounds, discovered during the 1950s, found widespread use in agriculture because of their high toxicity to a variety of insects. However, the qualities that made these chemicals so desirable also led to their eventual removal from the market, as these products also proved harmful to humans and to the environment. Spurred in part by increased environmental concern, researchers developed a new series of less toxic synthetic compounds called pyrethroids. These compounds are based on the natural pyrethroids, which are found in such plants as the chrysanthemum (USITC, 1994).

Fungicides

In recent years, fungicides accounted for approximately ten percent of the value of total United States pesticide consumption. Fungicides are used today primarily to protect agricultural crops and seeds from various fungi; farmers previously used inorganic products, such as elemental sulfur and copper sulfate. Initially, synthetic products were commercially unsuccessful, because of their high manufacturing costs. By the 1940s, however, newer, less expensive products became commercially successful. Today, fungicides are manufactured from a variety of chemical classes. Commercially, the most important fungicides are halogenated compounds, the carbamates and dithiocarbamates, and organophosphates (USITC, 1994).

Other Pesticides

Although small in total quantity consumed, a number of other classes of pesticide products are on the market. Some of these pesticides are not covered by this Notebook.

- C **Biological pesticides**, also known as biopesticides, include true biological agents, living or reproduced biological entities such as viruses or bacteria, and naturally occurring biochemicals such as plant growth regulators, hormones, and insect sexual attractants (pheromones) that function by modes of action other than innate toxicity. At the end of 1998, there were approximately 175 registered biopesticide active ingredients and 700 products. Generally, biological pesticides pose little or no risk to human health or the environment. Accordingly EPA generally requires much less data to register a biopesticide than to register a conventional pesticide (USEPA, 1999). To further facilitate the registration of biopesticides, in 1994, EPA established the Biopesticides and Pollution Prevention Division in the Office of Pesticide Programs.
- C **Plant growth regulators** have been developed by many companies to improve crop production. Plant growth regulators are produced for a variety of purposes, including loosening ripened fruits for faster harvest; controlling the size and firmness of fruits; and regulating the size of a plant

to increase branching. These products account for a small portion of world and United States usage. Future development will probably be directed toward selected crops for which the application of these specialty products is found to be the most cost effective (USITC, 1994).

- C **Sex attractants** may be used to attract insects to traps or to confuse specific male insects, making it difficult to locate females for mating. Commercially available sexual attractants are synthetically produced compounds. Insect growth regulators, such as juvenile growth hormones, are synthetic compounds similar to the natural chemicals that regulate insect growth.
- C **Genetically modified plants** are plants developed through the use of biotechnology. There are three types of plants that are relevant to pest control: herbicide-tolerant plants (which can tolerate certain types of herbicides), insect-resistant plants (which can withstand attacks by certain insects), and virus- and other pest-resistant plants (which are immune to some types of plant viruses and other plant pests). As of September 1994, several genetically modified plants had been commercialized and had elicited optimism that genetically modified plants would become an important new approach to controlling pests (USDA, 1995).

The environmental benefits of reduced use of chemical pesticides are also significant. Environmental side effects of traditional pesticides include the cost of providing alternative sources of drinking water, increased treatment costs for public and private water systems, lost boating and swimming opportunities, worker safety concerns, exposure to nearby residents, increased exposures for farm children, possible loss of biodiversity, pressure on threatened and endangered species, and damage to recreational and fishery resources (USDA, 1995).

Pesticide Formulations

Pesticide formulations may exist in any of the three following physical states: liquid, dry, and pressurized gas. The liquid formulation may be applied directly in liquid form or propelled as an aerosol. Some common dry-based formulations are dusts, wettable powders, granules, treated seed, bait pellets, encapsulated, and cubes. Pressurized gas formulations are used primarily for soil fumigation (USEPA, 1996). Gaseous pesticides can be subjected to high pressures which often convert the formulation to a liquid which can be stored, transported and applied from gas cylinders.

Repackaging of pesticide formulations is common when materials are to be transferred from bulk storage to a smaller scale of packaging for use by a consumer. Products are typically repackaged in smaller containers and consumer-specific labeling is added (USEPA, 1996).

In 1995, roughly 79 percent of all pesticides were used on agricultural

cropland. The remainder were used in private homes and gardens and on commercial and industrial property (Aspelin, 1997). Therefore, although non-agricultural pesticides are included in SIC code 2879 and thus the notebook, the specific packaging or formulating requirements of those products are not included. However, the sales, production, pollutant releases, and enforcement and compliance data reflect non-agricultural pesticides as well as agricultural pesticides.

The majority of pesticides were used on only a few major crops: cotton, corn, soybeans, and apples. The major pesticide chemicals used in United States agricultural crop production are atrazine, metolachlor, metamsodium, methyl bromide¹, and dichloropropene (Aspelin, 1997).

Figure 4: Product Distribution for SIC 2879, Pesticides and Miscellaneous Agricultural Chemicals

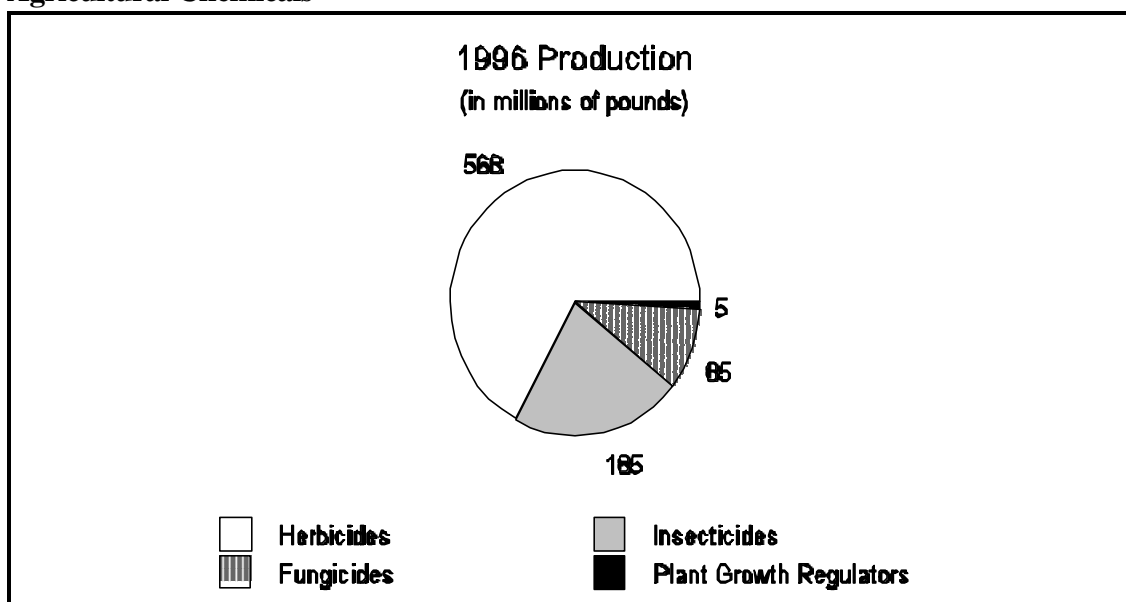

Source: American Crop Protection Association, as reported in *Chemical and Engineering News*, June 23, 1998.

Establishment Reporting Under FIFRA Section 7

Information reported under section 7 of the Federal Insecticide, Fungicide, and Rodenticide Act (FIFRA) is another source of facility level data for the pesticides

¹ Production and importation of methyl bromide is currently being phased out. It will be reduced from 1991 levels and will be completely phased out in 2005.

industry. All establishments that produce pesticides in the United States or that import pesticides into the United States are required to register and report their production volume to the EPA. These data differ from the Census of Manufacturers data presented above for the agricultural chemical industry as a whole. The Census of Manufacturers data only covers facilities that are manufacturing these products, while the FIFRA data system more broadly includes establishments that “produce” these products. The term, “produce” has been defined under FIFRA and 40 CFR Part 167 to mean “to manufacture, prepare, propagate, compound, or process any pesticide, including any pesticide produced pursuant to section 5 of FIFRA, any active ingredient, or device, or to package, repackage, label, relabel, or otherwise change the container of any pesticide or device.” Repackaging or otherwise changing the container of any pesticide or device in bulk amounts constitutes pesticide production. Under FIFRA section 7, products are reported under one of four product types:

- 1) Technical material or active ingredient
- 2) End-use blend, formulation, or concentrate
- 3) Repackaged or relabeled product
- 4) Device

The total number of establishments, domestic and foreign, that reported to EPA under FIFRA section 7 are presented in Table 5. Although there are approximately twelve to thirteen thousand Active Registered Pesticide-Producing Establishments, table 5 below only lists establishments that reported actual production for the calendar year 1996. The establishments that reported either zero production or who were non-reporters for calendar year 1996 are not included in the establishment number totals in the table. The significant difference between the pesticide producing establishment counts as reported under section 7 (8,612) and the pesticide and agricultural chemical manufacturers n.e.c. reported by the Census (263) can be attributed to the section 7 broad inclusion of producers vs. the relatively narrow, Census inclusion of manufacturers. In addition, the Census of Manufacturers uses SIC code definitions which lump many pesticide active ingredient manufacturers into SIC codes that represent organic or inorganic chemicals. Establishments classified under the first product type, as well as some of the second, may include facilities classified under the chemical manufacturing SIC codes 286 or 281. Also, the Census only counts a facility in an SIC code if they report a product in that SIC code as their primary line of business. Therefore, facilities producing a variety of products might not be classified under all applicable SIC codes. For example, a facility which produces many different types of fertilizers as well as some pesticides might only be counted under the fertilizer SIC codes by the Census Bureau to avoid double counting of facilities.

Type	Product	Total	Domestic	Foreign
1	Technical Material, Active Ingredient	555	410	145
2	End-Use Blend, Formulation, Concentrate	2,590	2,454	136
3	Repackaged or Relabeled Goods	5,267	5,243	24
4	Devices	200	166	34
Total		8,612	8,273	339

Source: U.S.EPA, Enforcement, Planning, Targeting & Data Division,, FIFRA, section 7 Data System, United States EPA. 1996.

II.B.2. Industry Size and Geographic Distribution

Table 6 lists the facility size distribution within the nitrogenous fertilizer, phosphatic fertilizer, fertilizer mixing, and pesticide and agricultural chemical formulating industries. For each industry code, the majority of facilities employ less than 50 people.

Table 6: Facility Size Distribution for the Fertilizer, Pesticide, and Agricultural Chemical Manufacturing Industry								
Employees per Facility	FERTILIZERS						PESTICIDES	
	Nitrogenous Fertilizers (SIC 2873)		Phosphatic Fertilizers (SIC 2874)		Fertilizers, Mixing only (SIC 2875)		Pesticides and other Agrichemicals (SIC 2879)*	
	Number of Facilities	Percentage of Facilities	Number of Facilities	Percentage of Facilities	Number of Facilities	Percentage of Facilities	Number of Facilities	Percentage of Facilities
1-9	60	39%	27	36%	205	51%	108	41%
10-49	47	31%	22	29%	166	41%	95	36%
50-249	43	28%	15	20%	30	8%	45	17%
250-499	1	1%	6	8%	0	0%	7	3%
500-2499	1	1%	5	7%	0	0%	8	3%
Total	152	100%	75	100%	401	100%	263*	100%

Source: 1992 Census of Manufacturers, Industry Series: Agricultural Chemicals, US Department of Commerce, Bureau of the Census, May 1995.

Note: 1992 Census of Manufacturers data are the most recent available. Changes in the number of facilities, location, and employment figures since 1992 are not reflected in these data.

* United States EPA has identified over 8,600 registered pesticide producing establishments. The SIC code as it is defined by the OMB only includes 263 of those establishments.

Figure 5 shows the United States distribution of fertilizer manufacturing and mixing facilities. The geographic distribution of nitrogenous and phosphatic fertilizer manufacturers is determined by natural resources and demand. Seventy percent of synthetic ammonia plants in the United States are concentrated in Louisiana, Texas, Oklahoma, Iowa, and Nebraska due to abundant natural gas supplies. The majority of nitric acid plants are located in agricultural regions such as the Midwest, South Central, and Gulf States in order to accommodate the high volume of fertilizer usage. Florida has the largest phosphate rock supply in the United States, thus phosphoric acid manufacturing is concentrated primarily in Florida and spreads into the Southeast.

Figure 5: Geographic Distribution of the Fertilizer Industry (SIC 2873, 2874, 2875)

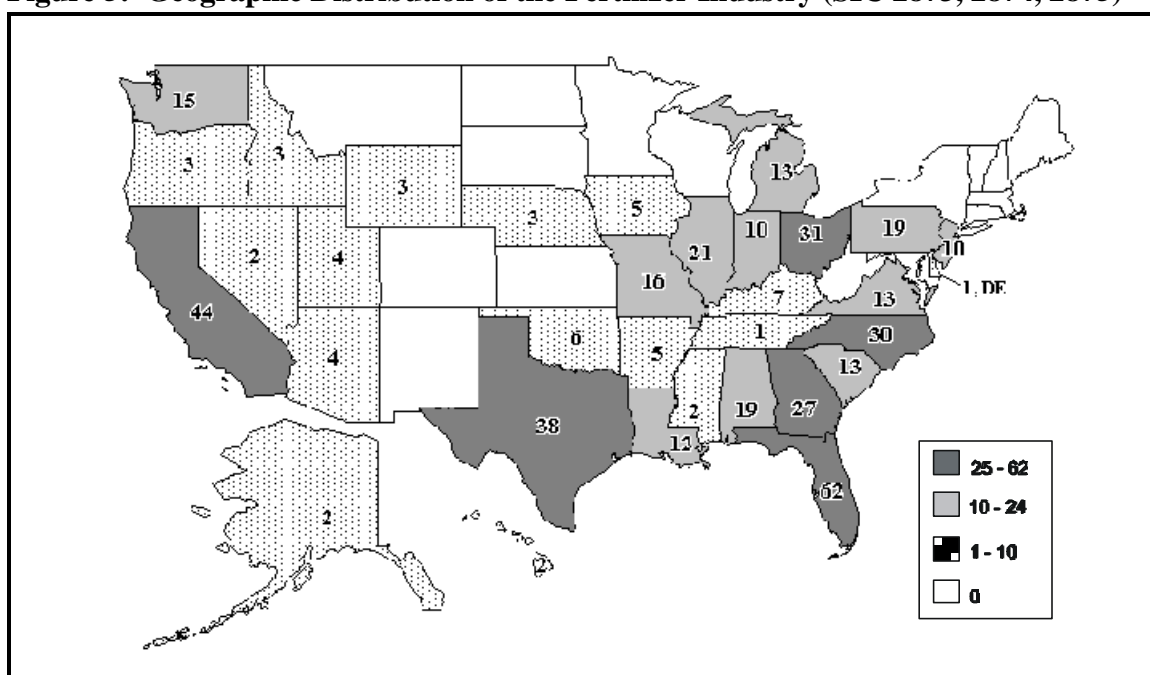

Source: 1992 Census of Manufacturers, Industry Series: Agricultural Chemicals, United States Department of Commerce, Bureau of the Census, May 1995.

Table 7 further divides the geographic distribution of fertilizer manufacturing and mixing facilities. The top states in which the nitrogenous fertilizer, phosphatic fertilizer, and fertilizer mixing industries are concentrated are given along with their respective number of establishments. Florida's supply of phosphate rock causes a concentration of phosphatic and mixed fertilizer facilities, while nitrogenous fertilizer plants are often located near sources of raw materials.

States in which industry is concentrated, based on number of establishments	Nitrogenous Fertilizers (SIC 2873)		Phosphatic Fertilizers (SIC 2874)		Fertilizers, Mixing only (SIC 2875)	
	Top States	Establishments	Top States	Establishments	Top States	Establishments
	California	17	Florida	15	Florida	42
Texas	12	North Carolina	9	Ohio	31	
Louisiana	8			Texas	26	
% of total	24%		32%		25%	

Source: 1992 Census of Manufacturers, Industry Series: Agricultural Chemicals, US Department of Commerce, Bureau of the Census, May 1995.

Note: 1992 Census of Manufacturers data are the most recent available. Changes in the number of facilities, location, and employment figures since 1992 are not reflected in these data.

Figure 6 shows the United States distribution of pesticide formulating and miscellaneous agrichemical formulating facilities. The distribution follows the general distribution of the petrochemical industry (coasts and Great Lakes) which the industry relies on for its raw materials, and the distribution of agricultural production in the United States (Midwest and Great Plains states).

Figure 6: Geographic Distribution of the Pesticide Formulating and Miscellaneous Agrichemical Formulating Facilities (SIC 2879)*

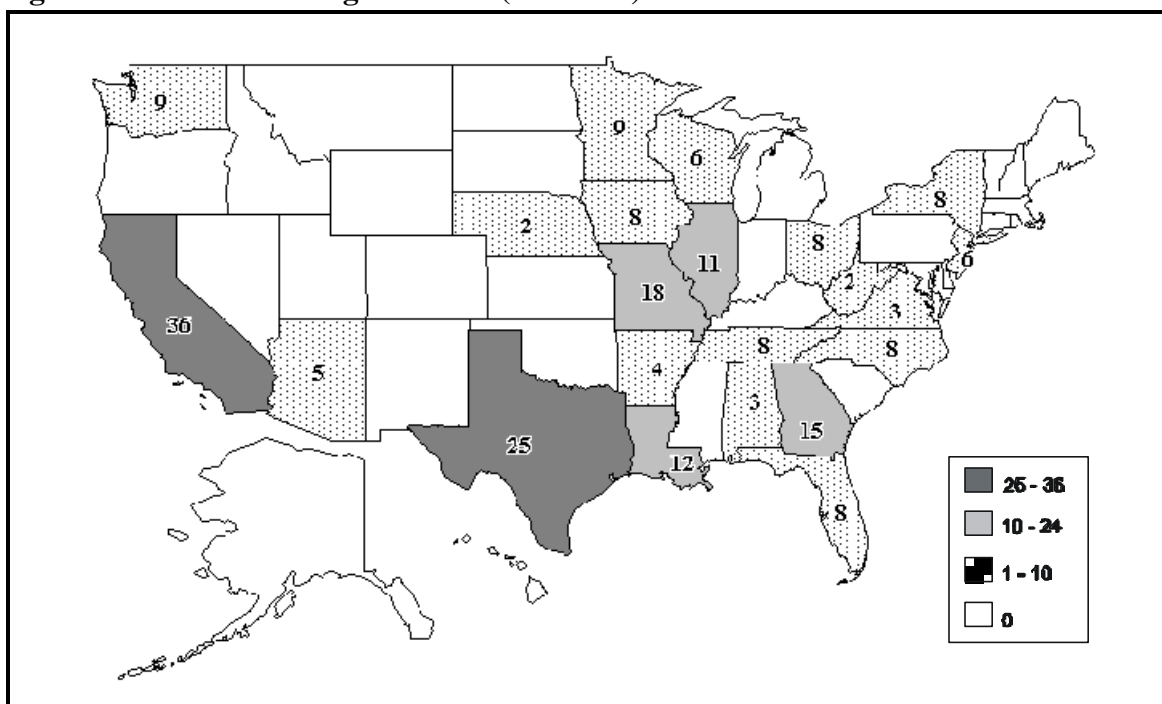

Source: 1992 Census of Manufacturers, Industry Series: Agricultural Chemicals, United States Department of Commerce, Bureau of the Census, May 1995.

* United States EPA has identified over 8,000 establishments that could fall within this SIC code as it is defined by the OMB.

Table 8: Top United States Agricultural Chemical Companies			
Rank	Company	1997 Sales (millions of dollars)	SIC Code(s) Reported
1	IMC Global - Northbrook, IL	2,981	2874, 2875, 2819, 1474, 1475
2	Zeneca Inc. - Wilmington, DE	2,822	2879, 2834, 2899
3	Agrium United States Inc. - Spokane, WA	1,814	2873
4	CF Industries, Inc. - Lake Zurich, IL	1,383	2873, 2874
5	PCS Nitrogen Inc. - Memphis, TN	1,310	2873, 2874
6	Dowelanco (now named Dow AgriSciences) - Indianapolis, IN	1,288	2879
7	The Scotts Company - Marysville, OH	752	2873, 2874, 2879, 0139, 2499, 3524
8	Cargill Fertilizer - Riverview, FL	600	2874
9	ChemFirst Inc. - Jackson, MS	595	2873, 2865, 3567, 3312
10	La Roche Industries Inc. - Atlanta, GA	449	2873, 5191, 2812, 2869, 3291, 3569
<i>Source: Dun & Bradstreet's Million Dollar Directory, 1997</i>			
Note: Not all sales can be attributed to the companies agricultural chemical operations.			

Dun & Bradstreet's *Million Dollar Directory*, compiles financial data on United States companies including those operating within the Fertilizer, Pesticide, and Agricultural Chemical Industry. Dun & Bradstreet ranks United States companies, whether they are a parent company, subsidiary or division, by sales volume within their assigned 4-digit SIC code. Readers should note that: (1) companies are assigned a 4-digit SIC code that resembles their principal industry most closely; and (2) sales figures include total company sales, including subsidiaries and operations (possibly not related to agricultural chemicals). Additional sources of company specific financial information include Standard & Poor's *Stock Report Service*, Ward's *Business Directory of United States Public and Private Companies*, Moody's Manuals, and annual reports.

The Bureau of the Census publishes concentration ratios, which measure the degree of competition in a market. They compute the value of shipments percentage controlled by the top 4, 8, 20, and 50 companies in a given industry. Within the agricultural chemical industry, the phosphatic fertilizer

industry had the highest concentration ratio for the top four companies in 1992, 62 percent. The pesticide and other agricultural chemicals, nitrogenous fertilizers, and fertilizer mixing industries' concentration ratios were 53, 48, and 19 percent respectively.

II.B.3. Economic Trends

The United States is a major producer and exporter of agricultural chemicals. It is the largest producer of phosphatic fertilizers and pesticides and the second largest producer of nitrogenous fertilizers in the world (USDOC, 1998).

Domestic Market Trends

The majority of important crops, such as corn and soybeans, are grown using fertilizers and pesticides. As a result, year-to-year changes in the domestic demand for agrichemicals reflect the level of planted acreage, which in turn is affected by grain prices and weather conditions. Increases in planted acreage of corn, feedgrains and other crops in recent years have resulted in increased demand and production of agrichemicals in the United States. Industry shipments of agricultural chemicals should show modest annual growth through the end of the decade (USDOC, 1998).

The Federal Agricultural Improvement and Reform Act of 1996 could have a major long-term impact on the agricultural chemical industry. This law gives farmers greater flexibility in making planting decisions and allows them to rely more on the marketplace as a guide for crop plantings. The bill eliminates the annual acreage set-aside program, thus potentially boosting the levels of crop acreage (USDOC, 1998).

Agricultural chemical production showed little change between 1995 and 1996. Total production was approximately 103 million pounds each year. However, experts claim that due to lower dosage requirements for pesticides, agrichemical demand is actually higher than it would appear. Pesticides saw a six percent rise in production from 1995 to 1996. Nitrogenous fertilizer production was up approximately seven percent, and phosphate production increased slightly except for its major product, diammonium phosphate. Prices for agricultural chemicals rose three percent from 1995 to 1996, while the number of production workers fell two percent (USDOC, 1998).

International Market Trends

The United States accounts for more than 50 percent of world trade in phosphatic fertilizers, with a two-thirds share of total trade in DAP (diammonium phosphate), the principal phosphatic fertilizer product. Exports generally account for about half of total shipments for the United States phosphatic fertilizer industry, with about half of all exports going to China.

International markets, especially less developed nations in Asia and Latin America, hold greater market potential for the agrichemicals industry as population levels grow, income levels rise, and demands for better standards of living and diets increase the need for grain production. From the current level of about 5.8 billion, the world population is expected to increase by about 80 million each year between 1996 and 2000. Developing nations are becoming more sophisticated in agricultural practices, thus increasing their usage of fertilizers and pesticides to improve production (USDOC, 1998).

The United States has been a net exporter of pesticide chemicals, and this is expected to continue through the turn of the century. Exports of pesticides accounted for about 25 percent of United States pesticide production in 1994, according to The American Crop Protection Association. United States pesticide producers benefit from a highly developed chemical sector and strong demand from developing regions of the world. Nevertheless, export opportunities are being restrained by industry-wide globalization as producers are choosing to site facilities closer to end-use markets. In addition, regulatory reforms in Western Europe, such as the competitive access provider plan, are expected to limit prospects in that region, currently the largest destination for United States produced pesticides (USDOC, 1998).

International competition for the United States phosphatic fertilizer industry generally comes from countries with phosphate rock reserves and capacity to convert rock into phosphate chemicals. Diammonium phosphate imports are expected to account for most of the growth in world trade, thus giving the United States a promising outlook for this product. Morocco possesses at least 50 percent of the world's rock reserves and is the largest phosphate rock exporter. China and Russia are also major phosphate rock and fertilizer producers, with Russia also a leading exporter of phosphate chemicals. In the world pesticide markets, major competitors are companies based in Germany, France, and Switzerland.

The United States is a net importer of nitrogenous fertilizers. Trinidad and Tobago and Canada are the leading United States suppliers of nitrogen due to their low-cost supplies of natural gas.

Agricultural biotechnology is beginning to play a major role in agricultural pest control, spurred on by government pesticide restrictions, increased insect resistance to pesticides, and farmers' demand for productivity gains. Genetically engineered plants will be higher yielding, more resistant to disease and insects, and tolerant to herbicides. A number of companies have received approvals for the use of genetically engineered seeds, including corn and cotton, that are resistant to insects and herbicide tolerant. Commercial usage should increase rapidly over the next few years (USDOC, 1998).

This page left intentionally blank.

III. INDUSTRIAL PROCESS DESCRIPTION

This section describes the major industrial processes within the Fertilizer, Pesticide, and Agricultural Chemical Industry, including the materials and equipment used, and the processes employed. The section is designed for those interested in gaining a general understanding of the industry, and for those interested in the inter-relationship between the industrial process and the topics described in subsequent sections of this profile -- pollutant outputs, pollution prevention opportunities, and federal regulations. This section does not attempt to replicate published engineering information that is available for this industry. Refer to Section IX for a list of resource materials and contacts that are available.

This section specifically contains a description of commonly used production processes, associated raw materials, the by-products produced or released, and the materials either recycled or transferred off-site. This discussion, coupled with schematic drawings of the identified processes, provide a concise description of where wastes may be produced in the process. This section also describes the potential fate (via air, water, and soil pathways) of these waste products.

The three most important nutrients for plant growth are nitrogen, phosphorous, and potassium. However, the production of the major potassium fertilizer salts, or potash as they are commonly known, is typically considered an inorganic chemical process (SIC 2819). Therefore, the discussion of fertilizer production in this notebook is restricted to nitrogenous and phosphatic mixtures. The fertilizer, pesticide, and agricultural chemical industry can be divided into Nitrogenous Fertilizers, Phosphatic Fertilizers, Fertilizers (Mixing-only), and the formulating and preparing of pesticides and other agricultural chemicals. A detailed description of the production processes for nitrogenous and phosphatic fertilizers is presented here, along with brief descriptions of the fertilizer mixing and pesticide formulating and preparing industry.

III.A. Nitrogenous Fertilizers

The major nitrogenous fertilizers include synthetic ammonia, ammonium nitrate, and urea. The various industrial processes used to manufacture these products are described, as well as the production process for nitric acid, an important intermediate in nitrogenous fertilizer production.

III.A.1. Synthetic Ammonia

Synthetic ammonia (NH_3) is produced by reacting hydrogen with nitrogen at a molar ratio of three to one. Nitrogen is obtained from the air, which is primarily comprised of nitrogen (78 percent) and oxygen (21 percent) (Lewis, 1993). Hydrogen is obtained from either the catalytic steam reforming of

natural gas (methane) or naphtha, or as the byproduct from the electrolysis of brine at chlorine plants. In the United States, about 98 percent of the hydrogen used to synthesize ammonia is produced by catalytic steam reforming of natural gas, and only 2 percent is obtained from chlorine plants (USEPA, 1993a).

Six process steps are required to produce synthetic ammonia using the catalytic steam reforming method:

- 1) natural gas desulfurization
- 2) catalytic steam reforming
- 3) carbon monoxide shift
- 4) carbon dioxide removal
- 5) methanation
- 6) ammonia synthesis.

The first, third, fourth, and fifth steps remove impurities such as sulfur, CO, CO₂ and water from the feedstock, hydrogen and synthesis gas streams. In the second step, hydrogen is manufactured and mixed with air (nitrogen). The sixth step produces anhydrous ammonia from the synthetic gas. An anhydrous compound is inorganic and does not contain water either adsorbed on its surface or combined as water of crystallization. While almost all ammonia plants use these basic process steps, details such as operating pressures, temperatures, and quantities of feedstock vary from plant to plant. Figure 7 shows a simplified process flow diagram of a typical ammonia plant (USEPA, 1993a).

Natural gas desulfurization

In the natural gas desulfurization step, the sulfur content (primarily as H₂S) in natural gas feedstock is reduced to below 280 micrograms per cubic meter to prevent poisoning of the catalyst used in the catalytic steam reforming step. Desulfurization can be accomplished by passing the natural gas through a bed of either activated carbon or zinc oxide. In both systems, the hydrogen sulfide in the gas adsorbs to the surface of the activated carbon or zinc oxide medium and the desulfurized natural gas passes through.

Over 95 percent of the ammonia plants in the United States use activated carbon fortified with metallic oxide additives for feedstock desulfurization. After a certain amount of impurities adsorb to the activated carbon, its effectiveness is reduced and it must be regenerated by passing superheated steam through the carbon bed. The superheated steam strips out the sulfur impurities, is condensed, and sent to the wastewater treatment plant. One disadvantage of the activated carbon system is that some of the heavy hydrocarbons in the natural gas adsorb to the carbon, decreasing its effectiveness and lowering the heating value of the desulfurized gas.

The remaining five percent of plants use zinc oxide for desulfurization. The zinc oxide system is capable of absorbing up to 20 percent sulfur by weight

Figure 7: Typical Process of Ammonia Synthesis

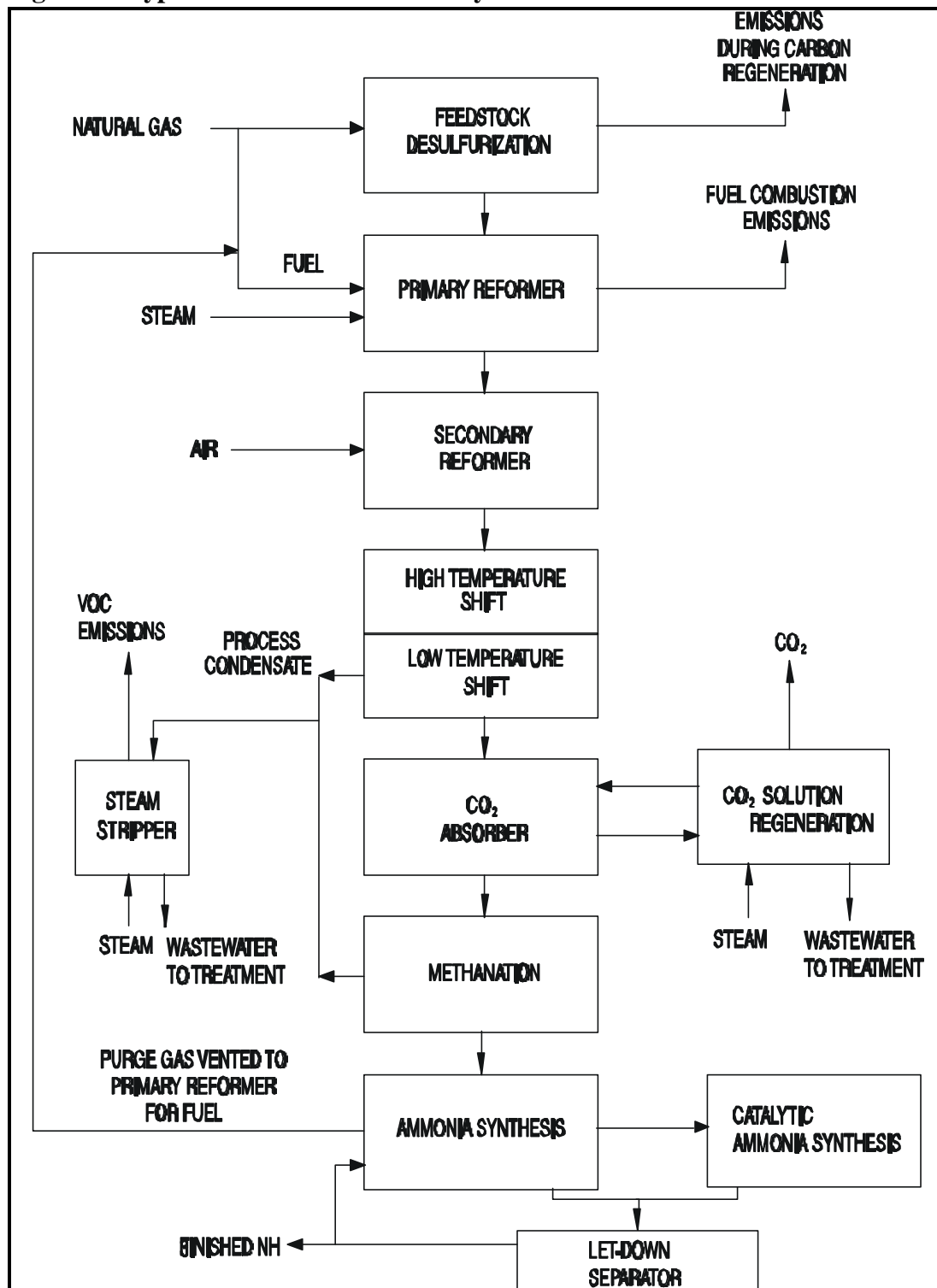

Source: United States EPA, 1993a.

(Hodge, 1994). Zinc oxide is replaced rather than regenerated, which lowers

energy consumption and minimizes impact to the atmosphere. The higher molecular weight hydrocarbons are not removed; therefore, the heating value of the natural gas is not reduced. However, it is impractical and uneconomical to replace the zinc oxide beds so few plants use it (USEPA, 1993a).

Catalytic steam reforming

Next, the desulfurized natural gas is preheated by mixing with superheated steam. The mixture of steam and gas enters the primary reformer tubes which are filled with a nickel-based reforming catalyst, and the tubes are heated by natural gas or oil-fired burners. Approximately 70 percent of the methane (CH₄) is converted to hydrogen (H₂) and carbon dioxide (CO₂), according to the following reaction:

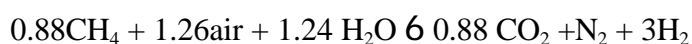

The remainder of the CH₄ is converted to H₂ and CO. This process gas is then sent to the secondary reformer, where it is mixed with compressed hot air at 540°C (1004°F). Sufficient air is added to produce a final synthesis gas having a hydrogen-to-nitrogen mole ratio of three to one. The gas leaving the secondary reformer (primarily hydrogen, nitrogen, CO, CO₂, and H₂O) is then cooled to 360°C (680°F) in a waste heat boiler before being sent to the carbon monoxide shift (USEPA, 1993a).

Carbon monoxide shift

After cooling, the secondary reformer effluent gas enters a high temperature (350-400°C) CO shift converter which converts the CO to CO₂, followed by a low temperature (200-250°C) shift converter which continues to convert CO to CO₂ (Kroschwitz and Howe-Grant, 1992). The high temperature CO shift converter is filled with chromium oxide initiator and iron oxide catalyst. The following reaction takes place (USEPA, 1993a):



The exit gas is then cooled in a heat exchanger before being sent to a low temperature shift converter for ammonia, amines, and methanol where CO continues to be converted to CO₂ by a copper oxide/zinc oxide catalyst (Kent, 1992). In some plants, the gas is first passed through a bed of zinc oxide to remove any residual sulfur contaminants that would poison the low temperature shift catalyst. In other plants, excess low temperature shift catalyst is added to ensure that the unit will operate as expected. Final shift gas from this converter is cooled from 210 to 110°C (410 to 230°F) and unreacted steam is condensed and separated from the gas in a knockout drum. The final shift gas then enters the bottom of the carbon dioxide absorption system. The condensed steam (process condensate) contains ammonium carbonate ((NH₄)₂CO₃ • H₂O) from the high temperature shift converter, methanol (CH₃OH) from the low temperature shift converter, and small amounts of sodium, iron, copper, zinc, aluminum and calcium. Process condensate is sent to the stripper

to remove volatile gases such as ammonia, methanol, and carbon dioxide. Trace metals remaining in the process condensate are typically removed in an ion exchange unit (USEPA, 1993a).

Carbon dioxide removal

In this step, CO₂ in the final shift gas is removed. CO₂ removal can be done by using one of two methods: monoethanolamine (C₂H₄NH₂OH) scrubbing or hot potassium scrubbing. Approximately 80 percent of the ammonia plants use monoethanolamine (MEA) for removing CO₂. In this process, the CO₂ gas is passed upward through an adsorption tower countercurrent to a 15 percent to 30 percent solution of MEA in water fortified with corrosion inhibitors. After absorbing the CO₂, the amine-CO₂ solution is preheated and regenerated in a reactivating tower. The reacting tower removes CO₂ by steam stripping and then by heating. The CO₂ gas (98.5 percent CO₂) is either vented to the atmosphere or used for chemical feedstock in other parts of the plant complex. The regenerated MEA is pumped back to the absorber tower after being cooled in a heat exchanger and solution cooler (USEPA, 1993a).

Methanation

Carbon dioxide absorption is not 100 percent effective in removing CO₂ from the gas stream, and CO₂ can poison the synthesis converter. Therefore, residual CO₂ in the synthesis gas must be removed by catalytic methanation. In a reactor containing a nickel catalyst and at temperatures of 400 to 600°C (752 to 1112°F) and pressures up to 3,000 kPa (435 psia) methanation follows the following reaction steps:

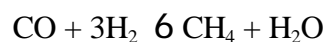

Exit gas from the methanator is almost a pure three to one mole ratio of hydrogen to nitrogen (USEPA, 1993a).

Ammonia Synthesis

In the synthesis step, the hydrogen and nitrogen synthesis gas from the methanator is converted to ammonia.

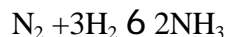

First, the gas is compressed to pressures ranging from 13,800 to 34,500 kPa (2000 to 5000 psia), mixed with recycled synthesis gas, and cooled to 0°C (32°F). This results in a portion of the gas being converted to ammonia which is condensed and separated from the unconverted synthesis gas in a liquid-vapor separator and sent to a let-down separator. The unconverted synthesis gas is further compressed and heated to 180°C (356°F) before entering a synthesis converter containing an iron oxide catalyst. Ammonia gas exiting the

synthesis converter is condensed and separated, then sent to the let-down separator. A small portion of the overhead gas is purged to prevent the buildup of inert gases such as argon in the circulating gas system. Ammonia in the let-down separator is flashed to atmospheric pressure (100 kPa (14.5 psia)) at -33°C (-27°F) to remove impurities from the make-up gas. The flash vapor is condensed in a let-down chiller where anhydrous ammonia is drawn off and stored at low temperature (USEPA, 1993a).

Storage and Transport

Ammonia is typically stored at ambient pressure and -33°C (-28°F) in large 20,000 ton tanks. Some tanks are built with a double wall to minimize leakage and insulate. If heat leaks into the tank and ammonia is vaporized, the vapors are typically captured, condensed, and returned to the tank. Ammonia is mostly transported by barge to key agricultural areas, but there is also a small system of interstate ammonia pipelines (Kent, 1992).

III.A.2. Nitric Acid

Nitric acid (HNO₃) is produced by two methods. The first method utilizes oxidation, condensation, and absorption of ammonia to produce a “weak” nitric acid. Weak nitric acid has a concentration ranging from 30 to 70 percent nitric acid. The second method combines dehydrating, bleaching, condensing, and absorption to produce “high strength” nitric acid from weak nitric acid. High strength nitric acid generally contains more than 90 percent nitric acid (USEPA, 1993a). The following text discusses each of these processes.

Weak Nitric Acid Production

Nearly all the weak nitric acid produced in the United States is manufactured by the high temperature catalytic oxidation of ammonia as shown schematically in Figure 8. This process typically consists of three steps:

- 1) ammonia oxidation
- 2) nitric oxide oxidation
- 3) absorption.

Each step corresponds to a distinct chemical reaction.

Ammonia Oxidation

During ammonia oxidation, a one to nine ammonia to air mixture is oxidized at a temperature of 750 to 800°C (1380 to 1470°F) as it passes through a catalytic converter, according to the following reaction:



The most commonly used catalyst is made of gauze squares of fine wire constructed of 90 percent platinum and 10 percent rhodium. Under these

conditions the oxidation of ammonia to nitric oxide (NO) proceeds in an exothermic reaction with 93 to 98 percent yield. Higher catalyst temperatures increase reaction selectivity toward nitric oxide (NO) production. Lower catalyst temperatures tend to be more selective toward nitrogen (N₂) and nitrous oxide (N₂O) (USEPA, 1993a). The nitric oxide then passes through a waste heat boiler and a platinum filter in order to recover the precious metal platinum (Kent, 1992).

Nitric Oxide Oxidation

The nitric oxide formed during the ammonia oxidation is further oxidized in another process step. The nitric oxide process stream is passed through a cooler/condenser and cooled to 38°C (100°F) or less at pressures up to 800 kPa (116 psia). The nitric oxide reacts noncatalytically with residual oxygen to form nitrogen dioxide and its liquid dimer, dinitrogen tetroxide:

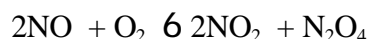

(A dimer is a small polymer whose molecule is composed of two molecules of the same composition (Lewis, 1993).) This slow, homogeneous reaction is temperature and pressure dependent. Operating at low temperatures and high pressures promotes maximum production of NO₂ within a minimum reaction time (USEPA, 1993a).

Nitrogen dioxide absorption

The final step introduces the gaseous nitrogen dioxide/dimer mixture into an absorption process after being cooled. The mixture is pumped into the bottom of an absorption tower with trays, while liquid dinitrogen tetroxide (N₂O₄) is added at a higher point. Deionized water enters the top of the column. Both liquids flow countercurrent to the dioxide/dimer gas mixture. The exothermic reaction occurs as follows (USEPA, 1993a):



A secondary air stream is introduced into the column to re-oxidize the NO that is formed. This secondary air also removes NO₂ from the product acid. Oxidation of NO to NO₂ takes place in the free space between the trays, while absorption of NO₂ into the water occurs on the trays. An aqueous solution of 55 to 65 percent (typically) nitric acid is withdrawn from the bottom of the tower. The acid concentration can vary from 30 to 70 percent nitric acid depending upon the temperature, pressure, number of absorption stages, and concentration of nitrogen oxides entering the absorber (USEPA, 1993a).

There are two variations of the process described above to produce weak nitric acid: single-stage pressure process and dual-stage pressure process. In the past, nitric acid plants have been operated at a single pressure, ranging from atmospheric pressure to 1400 kPa (14.7 to 203 psia). However, since the oxidation of ammonia is favored by low pressures and the oxidation of

nitric oxide and the absorption of nitrogen dioxide are favored by higher pressures, newer plants tend to operate a dual-stage pressure system, incorporating a compressor between the ammonia oxidizer and the condenser. The oxidation reaction is carried out at pressures from slightly negative to about 400 kPa (58 psia), and the absorption reactions are carried out at 800 to 1,400 kPa (116 to 203 psia) (USEPA, 1993a).

In the dual-stage pressure system, the nitric acid formed in the absorber (bottoms) is usually sent to an external bleacher where air is used to remove (bleach) any dissolved oxides of nitrogen (NO, NO₂, etc.). The bleacher gases are then compressed and again passed through the absorber. The absorber tail gas (distillate) is sent to an entrainment separator for acid mist removal. Next, the tail gas is reheated in the ammonia oxidation heat exchanger to approximately 200°C (392°F). The gas is then passed through catalytic reduction units for NO_x emissions control. The final step expands the gas in the power-recovery turbine. The thermal energy produced in this turbine can be used to drive the compressor.

Figure 8: Typical Process of Dual-Stage, Weak Nitric Acid Production

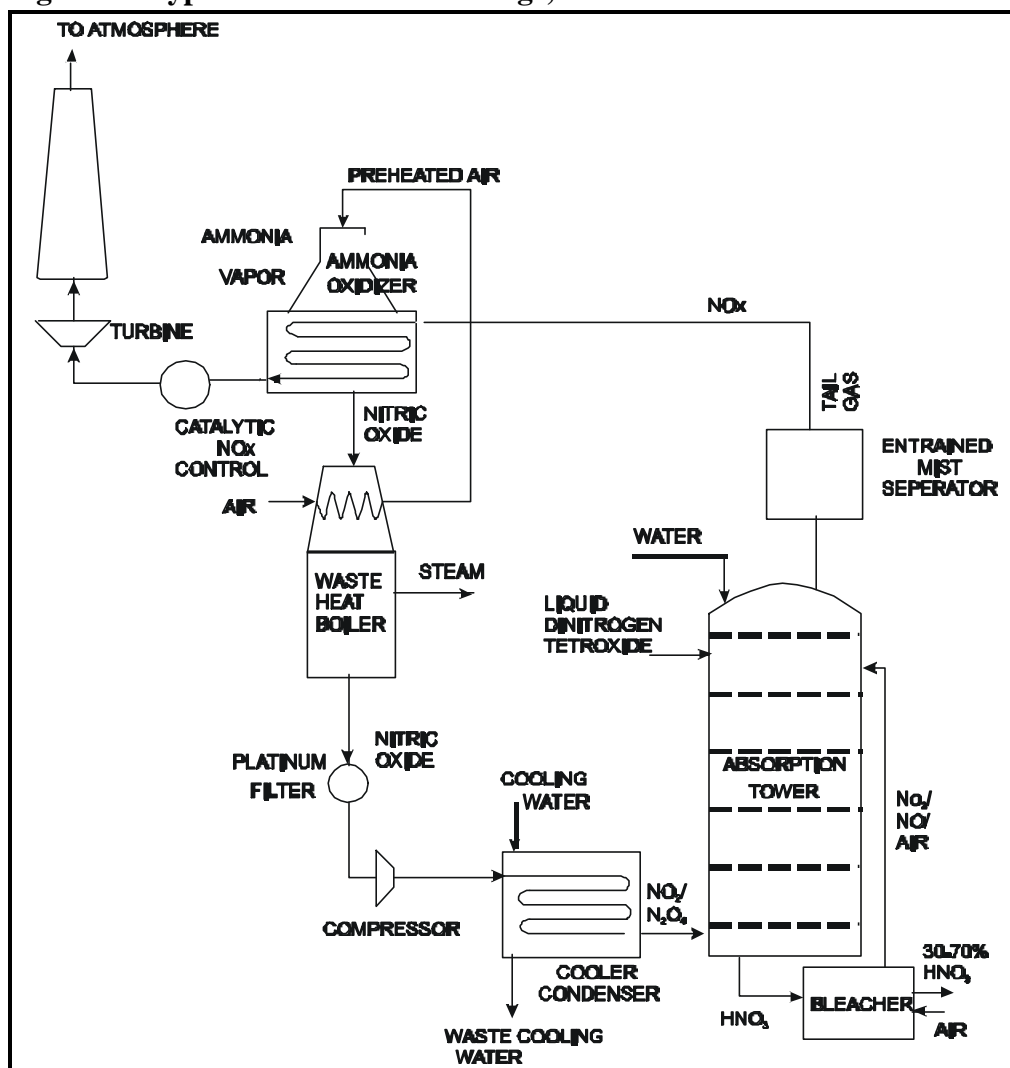

Source: United States EPA, 1993a.

High Strength Nitric Acid

High strength nitric acid (98 to 99 percent concentration) can be obtained by concentrating weak nitric acid (30 to 70 percent concentration) using extractive distillation. Extractive distillation is distillation carried out in the presence of a dehydrating agent. Concentrated sulfuric acid (typically 60 percent sulfuric acid) is most commonly used for this purpose. The weak nitric acid cannot be concentrated by simple fractional distillation, in which the acid is concentrated by removing water vapor in a column with trays or plates.

The nitric acid concentration process consists of feeding strong sulfuric acid and 55 to 65 percent nitric acid into the top of a packed dehydrating column at approximately atmospheric pressure. The acid mixture flows downward and concentrated nitric acid leaves the top of the column as 99 percent vapor, containing a small amount of NO_2 and O_2 resulting from dissociation of nitric acid. The concentrated acid vapor then goes to a bleacher and a countercurrent condenser system to condense strong nitric acid and separate out the oxygen and nitrogen oxide by-products. The bleacher uses air to strip nitrogen oxides out of the nitric acid and the countercurrent condenser system cools the vapor by flowing air through the vapor causing droplets to separate out.

These nitrogen oxide by-products then flow to an absorption column where the nitric oxide mixes with auxiliary air to form NO_2 , which is recovered as weak nitric acid. Inert and unreacted gases are vented to the atmosphere from the top of the absorption column. Emissions from this process are relatively small compared to weak acid production (USEPA, 1993a). Figure 9 illustrates a typical high strength nitric acid production process.

Figure 9: Typical Process Diagram of High Strength Nitric Acid Production

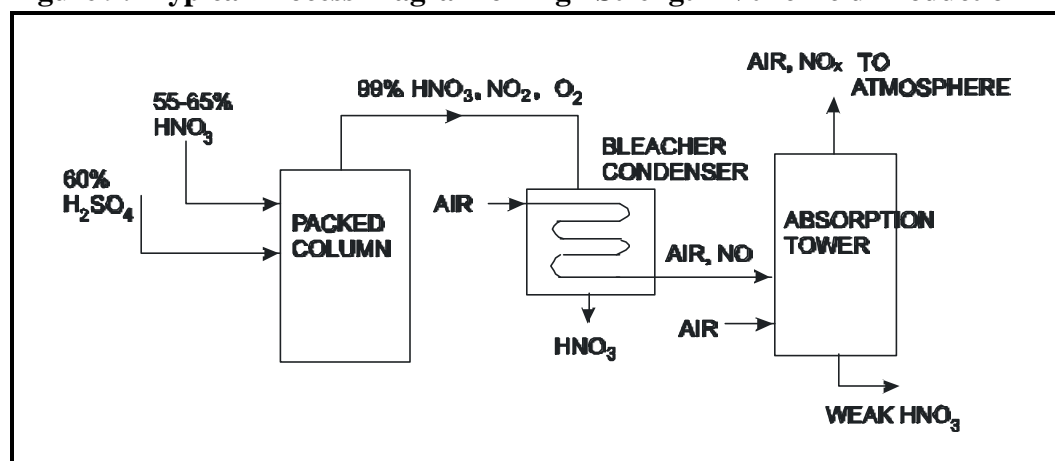

Source: Adapted from United States EPA, 1993a.

III.A.3. Ammonium Nitrate and Urea

The manufacture steps for ammonium nitrate (NH_4NO_2) and urea ($\text{CO}(\text{NH}_2)_2$) are similar. In both cases, several major unit operations are involved, including:

- 1) solution formation
- 2) concentration
- 3) solids formation
- 4) finishing
- 5) screening

- 6) coating
- 7) product bagging and/or bulk shipping.

These operations are shown schematically in Figure 10. Not all steps are always necessary depending on the end product desired. For example, plants producing ammonium nitrate or urea liquid solutions alone use only the solution formation, solution blending and bulk shipping operations. Plants producing a solid product may employ all of the operations.

Solution synthesis

Ammonium nitrate.

Ammonium nitrate plants produce an aqueous ammonium nitrate solution through the reaction of ammonia and nitric acid in a neutralizer where water is evaporated by the heat of the reaction as follows:



The temperature, pressure, and final concentration of the ammonium nitrate are interdependent. Higher temperatures and pressures can be used to produce a higher concentration of ammonium nitrate (Hodge, 1994); however, the temperature of the operation should be below 120°C (250°F) in order to prevent explosions. Up to 99.5 percent of the ammonia and nitric acid is typically converted to ammonium nitrate (Kent, 1992). Ammonium nitrate solution can then be used as an ingredient for nitrogen solution fertilizers or concentrated to a solid form.

Urea.

In the urea solution synthesis operation, ammonia (NH₃) and carbon dioxide (CO₂) are reacted to form ammonium carbamate (NH₂CO₂NH₄) as follows:

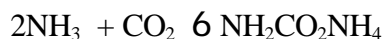

Typical operating conditions include temperatures from 180 to 200°C (356 to 392°F), pressures from 14,000 to 25,000 kPa (140 to 250 psia), molar ratios of NH₃ to CO₂ from 3:1 to 4:1, and a retention time of twenty to thirty minutes. The ammonium carbamate is then dehydrated to yield 70 to 77 percent aqueous urea solution. This reaction follows: (USEPA, 1993a)



Urea solution can be used as an ingredient of nitrogen solution fertilizers, or it can be concentrated further to produce solid urea.

Solids Concentration

Ammonium nitrate.

To produce a solid product, the aqueous ammonium nitrate solution is concentrated in an evaporator or concentrator. The resulting liquid “melt” contains about 95 to 99.8 percent ammonium nitrate at approximately 149°C (300°F). This melt is then used to make solid ammonium nitrate products (USEPA, 1993a).

Urea.

The three methods of concentrating the urea solution are vacuum concentration, crystallization, and atmospheric evaporation. The method chosen depends upon the level of biuret ($\text{NH}_2\text{CONHCONH}_2$) impurity allowable in the end product. Biuret can cause mottling in urea solutions, reducing the fertilizers effectiveness in foliar applications (Kent, 1992). Aqueous urea solution decomposes with heat to biuret and ammonia. Therefore, if only a low level of biuret impurity is allowed in the end product, the method with the least heat requirement will be chosen, such as crystallization and vacuum concentration (Kent, 1992). However, the simplest and most common method of solution concentration is atmospheric evaporation.

Solids Formation

Prilling and granulation are the most common processes used to produce solid ammonium nitrate and urea. Prills are round or needle-shaped artificially prepared aggregates of a material. To produce prills, concentrated melt is sprayed into the top of a prill tower. In the tower, melt droplets fall countercurrent to a rising air stream that cools and solidifies the falling droplets into prills. Prill density can be varied by using different concentrations of ammonium nitrate melt. Low density prills, in the range of 1.29 specific gravity, are formed from a 95 to 97.5 percent ammonium nitrate melt, and high density prills, in the range of 1.65 specific gravity, are formed from a 99.5 to 99.8 percent melt. Low density ammonium nitrate prills are used for making blasting agents because they are more porous than high density prills and will absorb oil. Most high density prills are used as fertilizers (USEPA, 1993a).

Granulated ammonium nitrate and urea are produced by spraying a concentrated melt (99.0 to 99.8 percent) onto small seed particles of ammonium nitrate or urea in a long rotating cylindrical drum. As the seed particles rotate in the drum, successive layers of the nitrogenous chemical are added to the particles, forming granules. Pan granulators operate on the same principle as drum granulators, except the solids are formed in a large, rotating circular pan. Pan granulators produce a solid product with physical characteristics similar to those of drum granules (USEPA, 1993a).

Although not widely used, additives such as magnesium nitrate or magnesium oxide may be injected directly into the melt stream. Additives can serve three

purposes: to raise the crystalline transition temperature of the final solid product in order to retain its strength and density; to act as a desiccant, drawing water into the final product to reduce caking; and to allow solidification to occur at a low temperature by reducing the freezing point of molten ammonium nitrate. (Kent, 1992)

Solids Cooling

The temperature of the nitrogenous product exiting the solids formation process is approximately 66 to 124°C (150 to 255°F). To prevent deterioration and agglomeration, the product must be cooled before storage and shipping. Typically, rotary drums or fluidized beds are used to cool granules and prills leaving the solids formation process. Because low density prills have a high moisture content, they require drying in rotary drums or fluidized beds before cooling (USEPA, 1993a).

Solids Screening

Since the solids are produced in a wide variety of sizes, they must be screened for consistently sized prills or granules. After cooling, off size prills are dissolved and recycled back to the solution concentration process. Granules are screened before cooling. Undersize particles are returned directly to the granulator and oversize granules may be either crushed and returned to the granulator or sent to the solution concentration process (USEPA, 1993a).

Solids Coating

Following screening, products can be coated in a rotary drum to prevent agglomeration during storage and shipment. The most common coating materials are clays and diatomaceous earth. However, the use of additives in the melt before solidification may preclude the use of coatings.

The solid product is stored and shipped in either bulk or bags. The majority of solid product is bulk shipped in trucks, enclosed railroad cars, or barges, and approximately ten percent of solid ammonium nitrate and urea produced in the United States is bagged (USEPA, 1993a).

Figure 10: Typical Process for Ammonium Nitrate and Urea Manufacturing

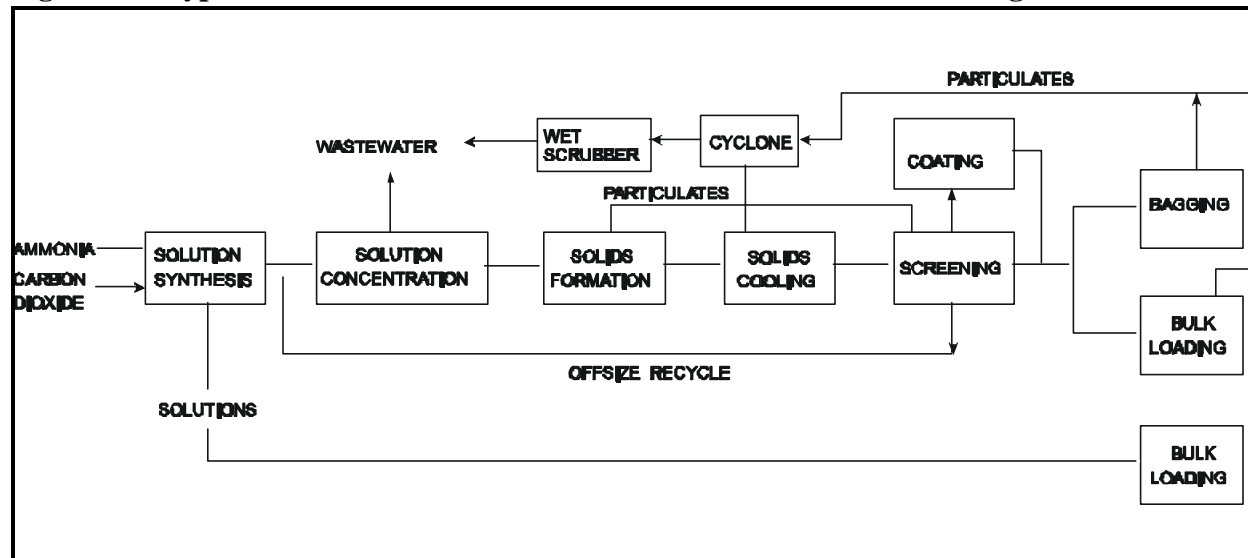

Source: United States EPA, 1993a.

III.B. Phosphatic Fertilizers

The primary products of the phosphatic fertilizers industry are phosphoric acid, ammonium phosphate, normal superphosphate, and triple superphosphate. Phosphoric acid is sold as is or is used as an intermediate in producing other phosphatic fertilizers. Monoammonium phosphate is favored for its high phosphorous content, while diammonium phosphate is favored for its high nitrogen content. Normal superphosphate has a relatively low concentration of phosphorous, however it is used in mixtures because of its low cost. Triple superphosphate provides a high concentration of phosphorous, more than 40% phosphorous pentoxide. The industrial processes for each of these products are described below.

III.B.1. Phosphoric Acid (Wet Process)

In a wet process phosphoric acid facility (shown schematically in Figure 11), phosphoric acid is produced by reacting sulfuric acid (H_2SO_4) with naturally occurring phosphate rock. The phosphate rock is mined, dried, crushed until 60 to 70 percent of the rock is less than 150 μm in diameter, and then continuously fed into the reactor along with sulfuric acid (UNEP, 1996). The reaction also combines calcium from the phosphate rock with sulfate, forming calcium sulfate ($CaSO_4$), commonly referred to as gypsum. Gypsum is separated from the reaction solution by filtration.

Facilities in the United States generally use a dihydrate process that produces gypsum in the form of calcium sulfate with two molecules of water ($CaSO_4 \cdot 2H_2O$ or calcium sulfate dihydrate). Japanese phosphoric acid facilities use

a hemihydrate process which produces calcium sulfate with a half molecule of water ($\text{CaSO}_4 \cdot \frac{1}{2} \text{H}_2\text{O}$). This one-step hemihydrate process has the advantage of producing wet process phosphoric acid with a higher phosphate pentoxide (P_2O_5) concentration and less impurities than the dihydrate process. Due to these advantages, some United States companies have recently converted to the hemihydrate process. However, since most wet process phosphoric acid is still produced by the dihydrate process, the hemihydrate process will not be discussed in detail here.

A simplified reaction for the dihydrate process is as follows:



To make the strongest phosphoric acid possible and to decrease evaporation costs, a highly concentrated 93 percent sulfuric acid is normally used. Because the proper ratio of acid to rock in the reactor is critical, precise automatic process control equipment is employed in the regulation of these two feed streams (USEPA, 1993a).

During the reaction, gypsum crystals are precipitated and separated from the acid by filtration. The separated crystals must be washed thoroughly to yield at least a 99 percent recovery of the filtered phosphoric acid. After washing, the slurried gypsum is pumped into a gypsum settling pond for storage. Water is siphoned off and recycled through a surge cooling pond to the phosphoric acid process. Depending on a variety of factors, such as average ambient temperature and annual rainfall, settling and cooling ponds may require between 0.25 and 1.0 acre for each ton of daily P_2O_5 capacity (TFI, 1999).

Considerable heat is generated in the reactor when the sulfuric acid and phosphate rock react. In older plants, this heat was removed by blowing air over the hot slurry surface. Modern plants vacuum flash cool a portion of the slurry, and then recycle it back into the reactor.

Wet process phosphoric acid normally contains 26 to 30 percent P_2O_5 . In most cases, the acid must be further concentrated to meet phosphate feed material specifications for fertilizer production. Depending on the types of fertilizer to be produced, phosphoric acid is usually concentrated to 40 to 55 percent P_2O_5 by using two or three vacuum evaporators (USEPA, 1993a). These evaporators operate with a forced circulation and generate a vacuum through vacuum pumps, steam ejectors, or an entraining condenser downstream of the evaporator. Figure 12 illustrates a vacuum evaporator.

Figure 11: Typical Process of a Wet Process Dihydrate Phosphoric Acid Plant

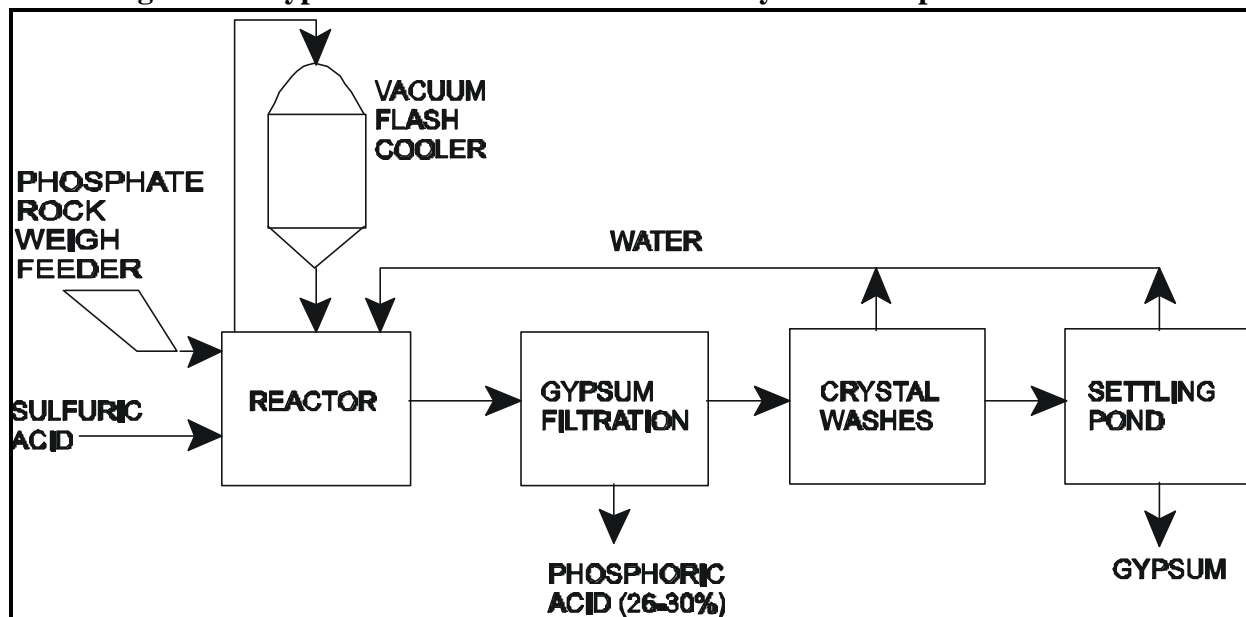

Source: Adapted from United States EPA, 1993a.

Figure 12: Typical Vacuum Evaporator Process

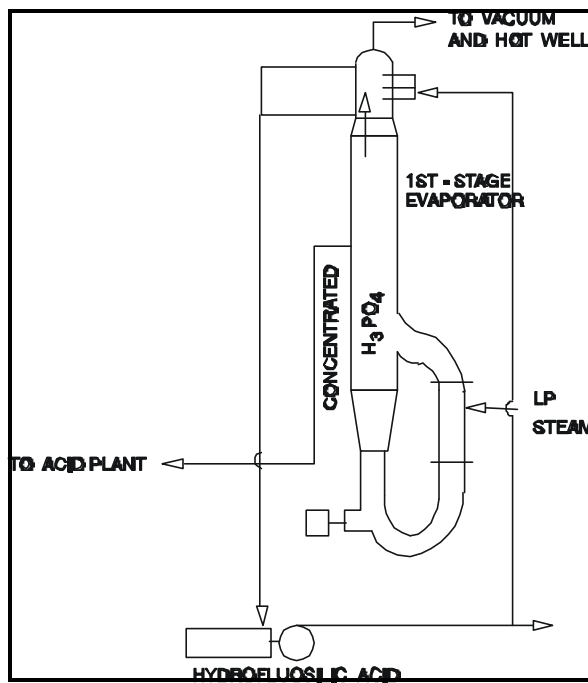

Source: United States EPA, 1993a

III.B.2. Ammonium Phosphate

Diammonium phosphate (DAP) and monoammonium phosphate are the major types of ammonium phosphatic fertilizer. Ammonium phosphates are produced by reacting phosphoric acid with ammonia. The ammonium phosphate liquid slurry produced is then converted to solid granules. Approximately 95 percent of ammoniation-granulation plants in the United States use a rotary drum mixer developed and patented by the Tennessee Valley Authority (TVA).

In the TVA DAP process, phosphoric acid is mixed in an acid surge tank with 93 percent sulfuric acid (H_2SO_4) and recycled acid from wet scrubbers. The mixed acids are then partially neutralized with liquid or gaseous anhydrous ammonia in a brick-lined acid reactor. All of the phosphoric acid and approximately 70 percent of the ammonia needed to complete the reaction are introduced into this vessel. A slurry of ammonium phosphate and 22 percent water are produced and sent through steam-traced lines to the ammoniator-granulator.

Slurry from the reactor is distributed in the rotary drum granulator, and the remaining ammonia (approximately 30 percent) is sparged under the slurry. The basic rotary drum granulator consists of an open-ended, slightly inclined rotary cylinder, with retaining rings at each end and a scraper or cutter mounted inside the drum shell. A rolling bed of dry material is maintained in the unit while the slurry is introduced through distributor pipes set lengthwise in the drum. Gravity forces the slurry to travel through the turning granulator to the lower end. Moist DAP granules are then discharged into a rotary dryer, where excess water is evaporated and the chemical reaction is accelerated to completion by the dryer heat. Dried granules are cooled and then sized on vibrating screens. The product ranges in granule diameter from one to four millimeters (mm). The oversized granules are crushed, mixed with the undersized, and recycled back to the ammoniator-granulator. Product-size DAP granules are allowed to cool, screened, bagged, and shipped. Before being exhausted to the atmosphere, particulate and ammonia rich off-gases from the granulator, cooler, and screening operations pass through cyclones and wet scrubbers (USEPA, 1993a).

TVA developed two minor modifications in their DAP process to produce Monoammonium Phosphate (MAP). In one, the phosphoric acid is ammoniated to an ammonia to phosphoric acid ratio of only 0.6 in the preneutralizer and then 1.0 in the granulator. This compares to a ratio of about 1.4 for DAP. With the second modification, the ammonium to phosphoric acid ratio is brought to 1.4 in the preneutralizer, then additional phosphoric acid is added in the granulator to bring the ratio back to 1.0. The second method is preferred by industry because higher temperatures may be used to dry the MAP, increasing production rates (Kent, 1992).

A schematic diagram of the ammonium phosphate process flow diagram is

shown in Figure 13.

Source: U.S.EPA, 1993a and TFI, 1999

Figure 13: Simplified Process Flow Diagram of Diammonium Phosphate Production

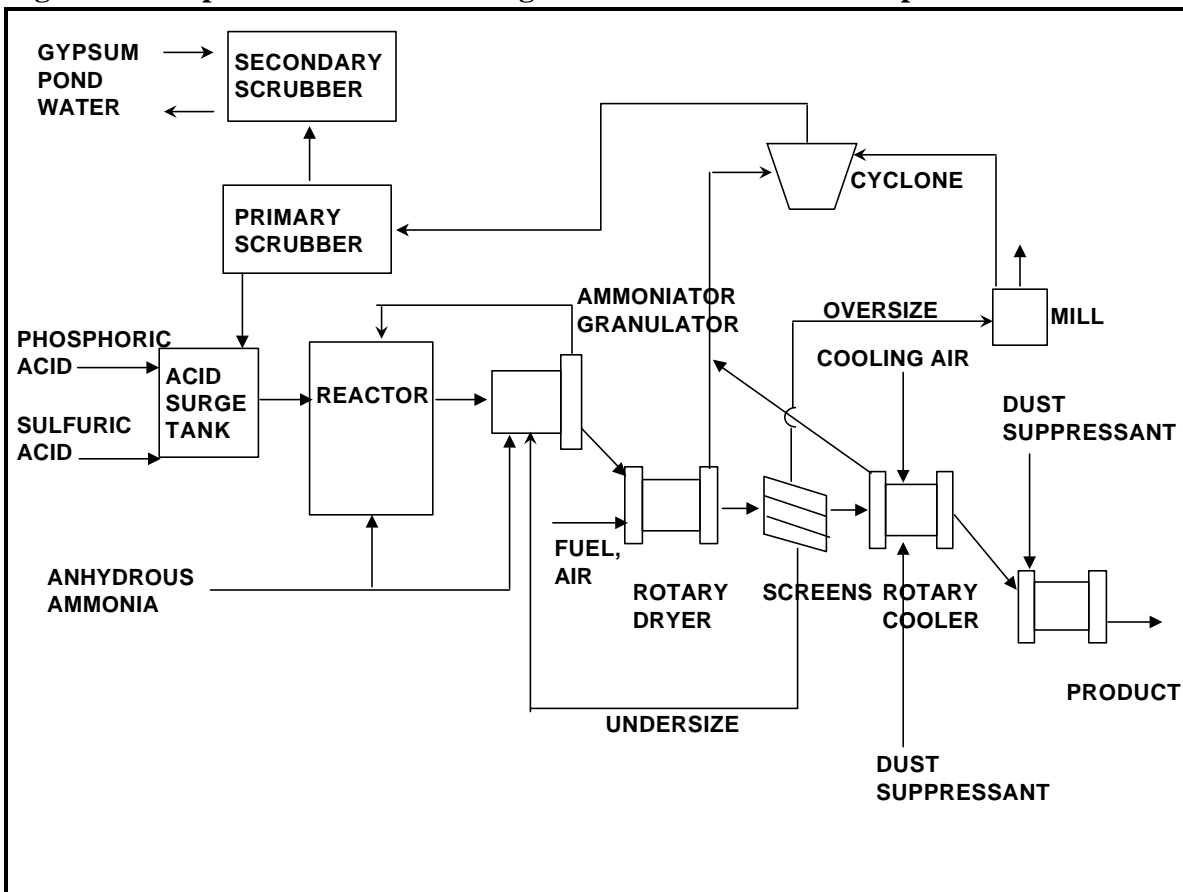

III.B.3. Normal Superphosphate

Normal superphosphates (NSP) are prepared by reacting ground phosphate rock with 65 to 75 percent sulfuric acid to produce a solid fertilizer material. NSP is most often used as a high-phosphate additive in the production of granular fertilizers. It can also be granulated for sale as granulated superphosphate or granular mixed fertilizer.

There are two primary types of sulfuric acid used in superphosphate manufacture: virgin and spent acid. Virgin acid is produced from elemental sulfur, pyrites, and industrial gases and is relatively pure. Spent acid is a recycled waste product from various industries that use large quantities of sulfuric acid. Problems encountered with using spent acid include unusual

color, unfamiliar odor, and toxicity. An important factor in the production of normal superphosphates is the amount of iron and aluminum in the phosphate rock. Aluminum (as Al_2O_3) and iron (as Fe_2O_3) above five percent imparts an extreme stickiness to the superphosphate and makes it difficult to handle (USEPA, 1993a).

A generalized process diagram of normal superphosphate production is shown in Figure 14. Ground phosphate rock is weighed and mixed with sulfuric acid (H_2SO_4) and held in an enclosed area for about 30 minutes until the reaction is partially completed. The mixing may be done in a cone mixer, which relies on an inputted swirling motion of the acid to mix the rock and acid, a pug mill, which operates with one or two mixing shafts, or a pan mixer, which agitates the solution. The reaction is (AWMA, 1992):

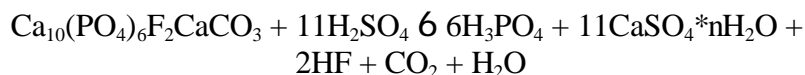

The mixture is then transferred, using an enclosed conveyer known as the den, through the cutter which breaks up clumps, and finally to a storage pile for curing. Off-gases from the reactor are typically treated in a wet scrubber. Particulates throughout the process are controlled with cyclones and baghouses (USEPA, 1993a).

To produce granulated normal superphosphate, cured superphosphate is fed through a clod breaker and sent to a rotary drum granulator where steam, water, and acid may be added to aid in granulation. Material is processed through a rotary drum granulator, a rotary dryer, and a rotary cooler, and is then screened to specification similar to the process used for ammonium nitrate and urea. Finally, it is stored in bagged or bulk form prior to being sold (USEPA, 1993a).

Figure 14: Typical Process for Normal Superphosphate Manufacturing

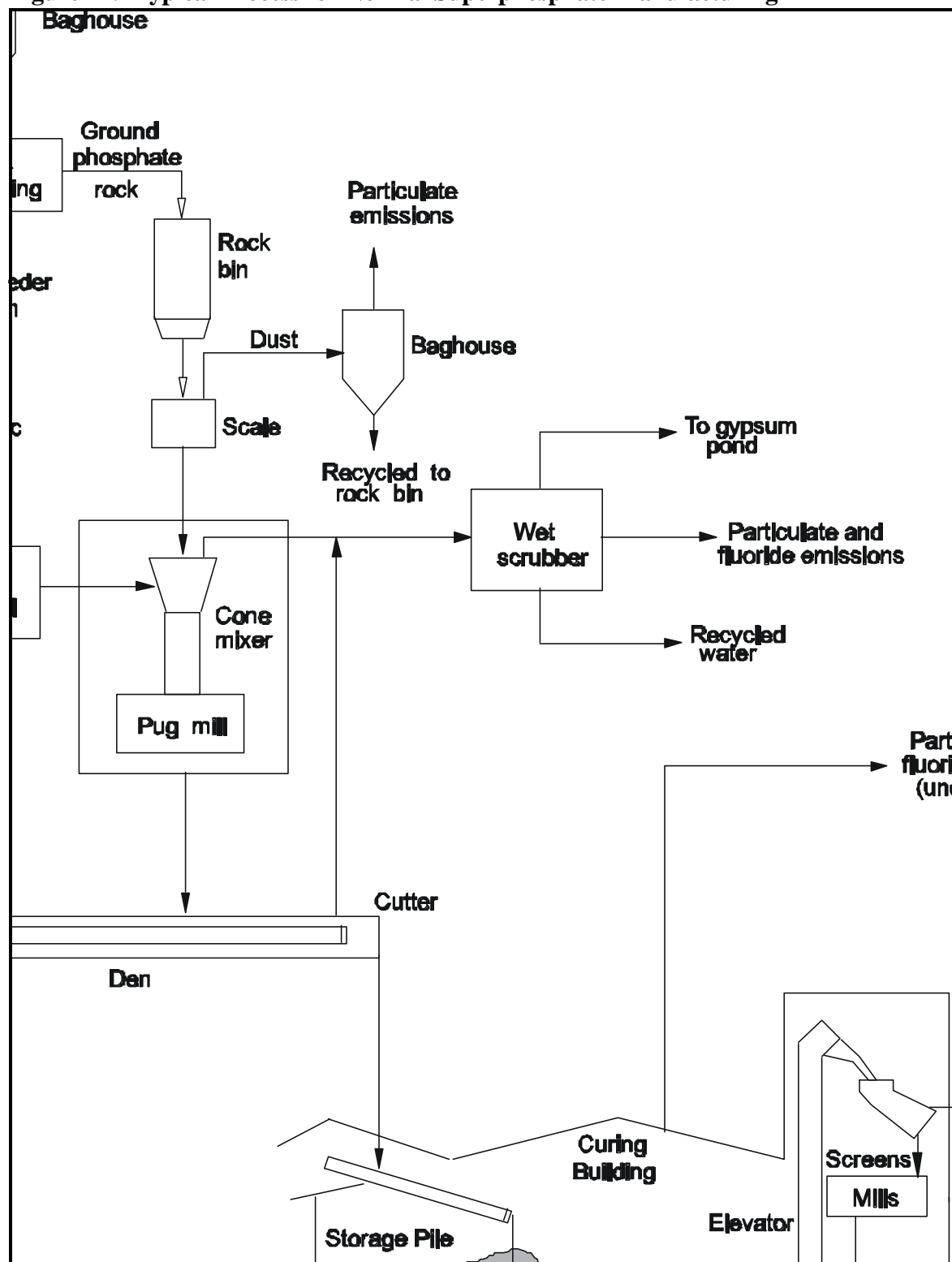

Source: United States EPA, 1993a.

III.B.4. Triple Superphosphate

Triple superphosphate provides a high concentration of phosphorous. Two processes have been used to produce triple superphosphate: run-of-the-pile (ROP-TSP) and granular (GTSP). GTSP yields larger, more uniform particles with improved storage and handling properties than ROP-TSP. At this time, no facilities in the United States are producing ROP-TSP, so only the GTSP process is described here.

Most GTSP material is made with the Dorr-Oliver slurry granulation process, illustrated in Figure 15. This process is similar to that for normal superphosphates with the major exception being that phosphoric acid is used instead of sulfuric acid. In this process, ground phosphate rock or limestone is reacted with phosphoric acid in one or two reactors in series (USEPA, 1993a). The reaction is:



(Hodge, 1994) The phosphoric acid used in this process has a relatively low concentration (40 percent P_2O_5). The lower strength acid maintains the slurry in a fluid state during a mixing period of one to two hours. A small sidestream of slurry is continuously removed and distributed onto dried, recycled fines in a granulator, where it coats the granule surfaces and builds up its size.

Granules are then dried in a rotary dryer, elevated and passed through screens to eliminate oversize and undersize granules. Oversize granules are crushed and sent back to the first screen, while undersize ones are sent into the emission control systems. The granules within the size range of the product are then cooled and stored in a curing pile where the reaction is completed. Particulates from the rock handling, drying, screening, cooling, and storing processes are typically controlled with cyclones and baghouses and off-gases from the reactor, granulator, and cyclones and baghouses are typically treated with wet scrubbers (USEPA, 1993a).

Figure 15: Typical Process for Triple Superphosphate

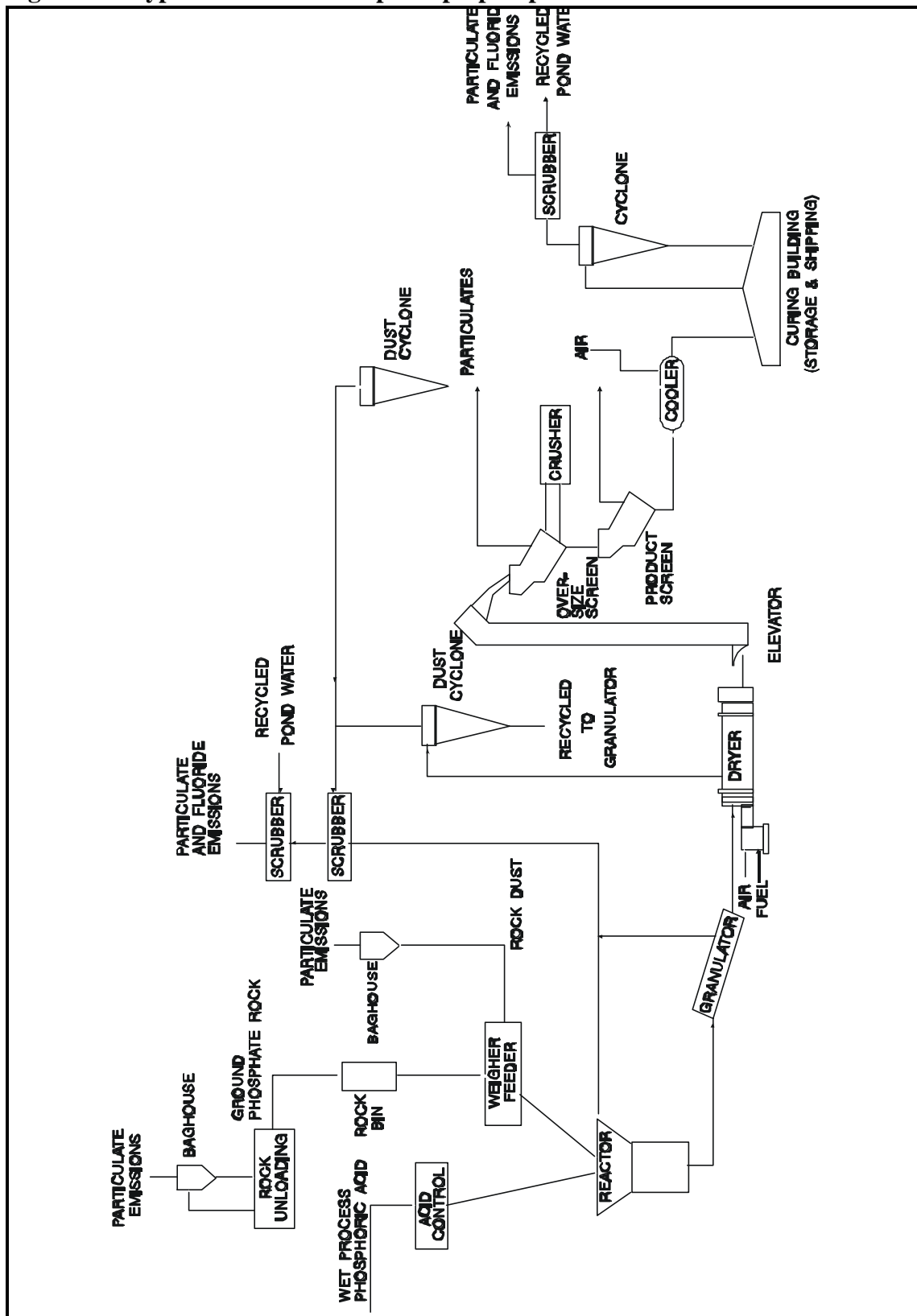

Source: United States EPA, 1993a

III.C. Fertilizer Mixing

A significant part of the fertilizer industry only purchases fertilizer materials in bulk from fertilizer manufacturing facilities and mixes them to sell as a fertilizer formulation. Fertilizer mixing facilities use many different materials in their blends. The most common granular fertilizer materials are listed in Table 9.

Table 9: Fertilizer Materials Used in Bulk Blends		
	Typical Grade N-P ₂ O ₅ -K ₂ O	Percent of fertilizer plants using this material
Ammonium nitrate	31-0-0	41%
Urea	46-0-0	66%
Ammonium sulfate	21-0-0	22%
Diammonium phosphate (DAP)	18-46-0	95%
Monoammonium phosphate (MAP)	11-52-0	11%
Triple Superphosphate	0-46-0	78%
Normal superphosphate	0-20-0	4%
Potassium chloride	0-0-60	94%

Source: "Retail Marketing of Fertilizers in the United States," by Hargett, Norman and Ralph Pay, 1980.

DAP is favored for fertilizer mixing because of its ease in storage and handling, convenient low nitrogen and high phosphorous content, and compatibility with almost any other material. Granular triple superphosphate is also very popular, but is incompatible with urea, a common nitrogen source. Therefore, TSP is commonly used in no-nitrogen blends necessary for legumes. Ammonium sulfate has the lowest nitrogen content of the major nitrogen sources, however its production cost is quite low. Potassium chloride is the only major potassium source used in fertilizer blending. Additional materials may also be added to the blends, such as micronutrients and pesticides (Nielson, 1987).

Inert ingredients may also be added to fertilizer mixtures to improve the consistency or ease of application. Inert ingredients include sands, clays, and water.

Fertilizer mixing plants consist of five primary phases:

1. mixing and storing
2. moving materials to mixers
3. proportioning of materials
4. mixing, and
5. moving the finished blend to holding bins or transport containers

Fertilizer materials may be mixed as bulk blends or formed into granulations by a variety of processes. Bulk blending is a dry process, where different fertilizers are combined. Materials are typically received by rail cars and transferred through elevators to storage areas. Front-end loaders then carry the materials to weighing hoppers which feed into the mixers. There are two types of mixers most commonly used: the horizontal axis rotary drum mixer and the inclined axis rotary drum mixer. The inclined axis mixer is similar to a cement mixer in design and appearance. Ribbon-type bulk-blend mixers are also used in some plants. A ribbon-type mixer has an axial shaft with mixing spokes radiating out of the shaft in a configuration which forces the blend to flow in a ribbon-like pattern through the mixture (Nielson, 1987).

After preparation and initial bulk blending of materials, granulation may be employed in order to form larger fertilizer particles with multi-nutrient compositions. Granulation of mixed fertilizers may be accomplished by steam granulation, slurry granulation, melt, or compaction granulation.

Steam granulation is primarily used in Europe and Australia. The process results in little chemical reaction in order to maintain the P_2O_5 content of the fertilizer. Plasticity and agglomeration of the fertilizer materials is promoted by the injection of steam into rotating pans, rotary drums, or pug mills. The particles are then dried with heated air in a rotary drum dryer and cooled in a rotary drum cooler. In some cases, particles may be coated with chalk or clay to prevent caking (Hoffmeister, 1993).

Slurry granulation is more commonly used in the United States. The process involves a chemical reaction of the feed ingredients. In slurry granulation, one of the feed ingredients is prepared as a slurry and reacted with the others in a preneutralizer. The slurry is then fed to a granulator such as the ammoniator-granulator developed by the TVA. Fertilizer producers in the United States found that higher concentrations of acid could be fed to this preneutralizer-granulator process than to a granulator alone, thus increasing the grades of fertilizers and making the TVA process popular in the United States (Hoffmeister, 1993).

Another granulation process similar to slurry granulation is melt granulation. The slurry feed is replaced by a hot, concentrated, almost anhydrous melt of feed fertilizer, typically ammonium phosphate, prepared in a pipe reactor. The hot melt provides the plasticity necessary for granulation. The granules cool first in the granulator and then in the cooler, eliminating the need for a dryer.

Compaction granulation is based on the fact that most materials are semiplastic and when subjected to high pressures, the materials will compact, deform, and it is possible to roll them out into flat, stable sheets. These sheets are then cracked, forming granule-size chips which are most stable and less prone to caking than other granulations. This process has been successful for many fertilizer mixtures, particularly those including potassium chloride and ammonium phosphates and superphosphates. Ammonium sulfate, however, has limited crystal plasticity, making it unsuitable for compaction granulation (Hoffmeister, 1993).

The mixtures are then typically bagged in woven polypropylene bags for strength and resistance, with liner bags to prevent leaks. The bags are either clamped, tied, heat sealed, or sewn, sewing being the cheapest and most common method (Nielson, 1987).

III.D. Pesticide Formulating Processes

Pesticide formulation involves the process of mixing, blending, or diluting one or more pesticide active ingredients (AIs) and inert ingredients to obtain a product used for additional processing or an end-use (retail) product. Formulation does not involve an intended chemical reaction (i.e., chemical synthesis). AIs are produced at separate facilities not included in this notebook. Pesticide formulations take many forms: water-based liquid; organic solvent-based liquid; dry products in granular, powder, and solid forms; pressurized gases; and aerosols. The formulations can be in a concentrated form requiring dilution before application, or they can be ready to apply. The packaging of the formulated pesticide product depends on the type of formulation. Liquids generally are packaged into jugs, cans, or drums; dry formulations generally are packaged into bags, boxes, drums, or jugs; pressurized gases are packaged into cylinders; and aerosols are packaged into aerosol cans.

Formulating, packaging, and repackaging is performed in a variety of ways, ranging from very sophisticated and automated formulating and packaging lines to completely manual lines. Descriptions of liquid formulating and packaging, dry formulating and packaging, aerosol packaging, pressurized gas formulating and packaging, and repackaging operations are provided below.

III.D.1. Liquid Formulating and Packaging

Liquid formulations contain mixtures of several raw materials, including AIs, inert ingredients such as base solvents, emulsifiers, or surfactants. The solvent must be able to dissolve the AIs and other ingredients. It may be water or an organic chemical, such as isopropyl alcohol or petroleum distillate. In some cases, the formulation is an emulsion and contains both water and an organic solvent. Solid materials, such as powders or granules, may also be used as part of a liquid formulation by dissolving or emulsifying the dry materials to form a liquid or suspension. The formulated product may be in a concentrated form requiring dilution before application, or may be ready to apply.

Typical liquid formulating lines consist of storage tanks or containers to hold active and inert raw materials and a mixing tank for formulating the pesticide product. A storage tank may also be used on the formulating line to hold the formulated pesticide product, prior to a packaging step. Facilities may receive their raw materials in bulk and store them in bulk storage tanks, or they may receive the raw materials in smaller quantities, such as 55-gallon drums, 50-pound bags, or 250-gallon minibulk refillable containers or “totes.” These raw materials are either piped to the formulation vessel from bulk storage tanks or added directly to the vessel from drums, bags, or minibulks. Typically, water or the base solvent is added to the formulation vessel in bulk quantities (USEPA, 1996). A typical liquid formulating line is shown in Figure 16.

The formulating line may also include piping and pumps for moving the raw material from the storage tanks to the mixing tank, and for moving formulated pesticide product to the packaging line. Other items that may be part of the line are premixing tanks, stirrers, heaters, bottle washers, and air pollution control equipment. Some lines may also have refrigeration units for formulation and storage equipment, scales, and other equipment.

Many liquid formulations are packaged by simply transferring the final product into containers. Small quantities of product are often manually packaged by gravity feeding the product directly from the formulation tank into the product container. For larger quantities, the process is often automated. Formulated product is transferred to the packaging line through pipes or hoses, or is received from a separate formulating facility and placed in a filler tank. A conveyor belt is used to carry product containers, such as jugs, bottles, cans, or drums, through the filling unit, where nozzles dispense the appropriate volume of product. The belt then carries the containers to a capper, which may be automated or manual, and to a labeling unit. Finally, the containers are packed into shipping cases (USEPA, 1996).

Figure 16: Typical Process for Liquid Formulating

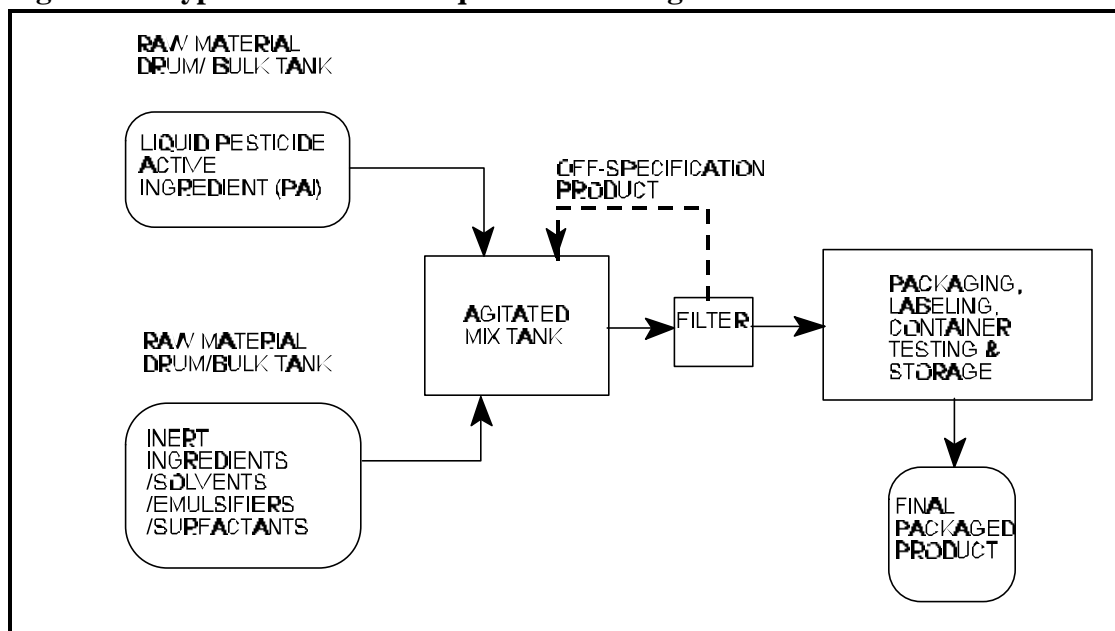

Source: United States EPA, 1996

III.D.2. Dry Formulating and Packaging

Dry formulations also contain active and inert ingredients. The final product may be in many different forms, such as powders, dusts, granules, blocks, solid objects impregnated with pesticide (e.g., flea collars), pesticides formed into a solid shape (e.g., pressed tablets), microencapsulated dusts or granules (AI coated with a polymeric membrane to prevent premature degradation), or encapsulated water soluble packaging. They are formulated in various ways, including:

- C mixing powdered or granular AIs with dry inert carriers;
- C spraying or mixing a liquid active ingredient onto a dry carrier;
- C soaking or using pressure and heat to force active ingredients into a solid matrix;
- C mixing active ingredients with a monomer and allowing the mixture to polymerize into a solid; and
- C drying or hardening an active ingredient solution into a solid form.

These dry pesticide products may be designed to be applied in solid form or dissolved or emulsified in water or solvent prior to application (USEPA, 1996).

Because there are many types of dry pesticide products, dry pesticide formulating lines can vary considerably. In general, though, dry formulating

lines have tanks or containers to hold the active ingredients and inert raw materials, and may include mixing tanks, ribbon blenders, extruding equipment, high pressure and temperature tanks for impregnating solids with active ingredient, vacuums or other types of drying equipment, tanks or bins for storage of the formulated pesticide product, pelletizers, presses, milling equipment, sieves, and sifters (USEPA, 1996).

Raw materials for dry pesticide products may be liquid or solid. Liquid raw materials may be stored in rail tank cars, tank trucks, minibulks, drums, or bottles. Dry raw materials may be stored in silos, rail cars, tank trucks, minibulks, metal drums, fiber drums, bags, or boxes. Liquid raw materials may be pumped, poured or sprayed into formulation vessels, while dry raw materials are frequently transferred to formulation equipment by screw conveyors (consisting of a helix mounted on a shaft and turning in a trough), elevators, or by pouring.

Dry formulating lines may also include piping and pumps to move raw materials from storage tanks to the formulation equipment, and to move formulated pesticide product to the packaging equipment. Other items that may be included in the dry pesticide product line are premixing tanks, tanks for storing formulated product prior to packaging, stirrers, heaters, refrigeration units on formulation and storage equipment, scales, and air pollution control equipment (e.g., cyclones, filters, or baghouses) (USEPA, 1996).

Dry pesticide products may be packaged into rail tank cars, tank trucks, totes, and minibulks, but are typically packaged into bags, boxes, and drums. As with many liquid formulations, dry formulations are packaged by simply transferring the final product into boxes, drums, jugs, or bags. Small quantities or bags are typically packaged manually using a gravity feed from the formulating unit into the containers or bags. Larger quantities may be packaged on an automated line, similar to liquid packaging lines.

Figure 17 illustrates a dry pesticide formulation line.

Figure 17: Typical Process for Dry Formulating

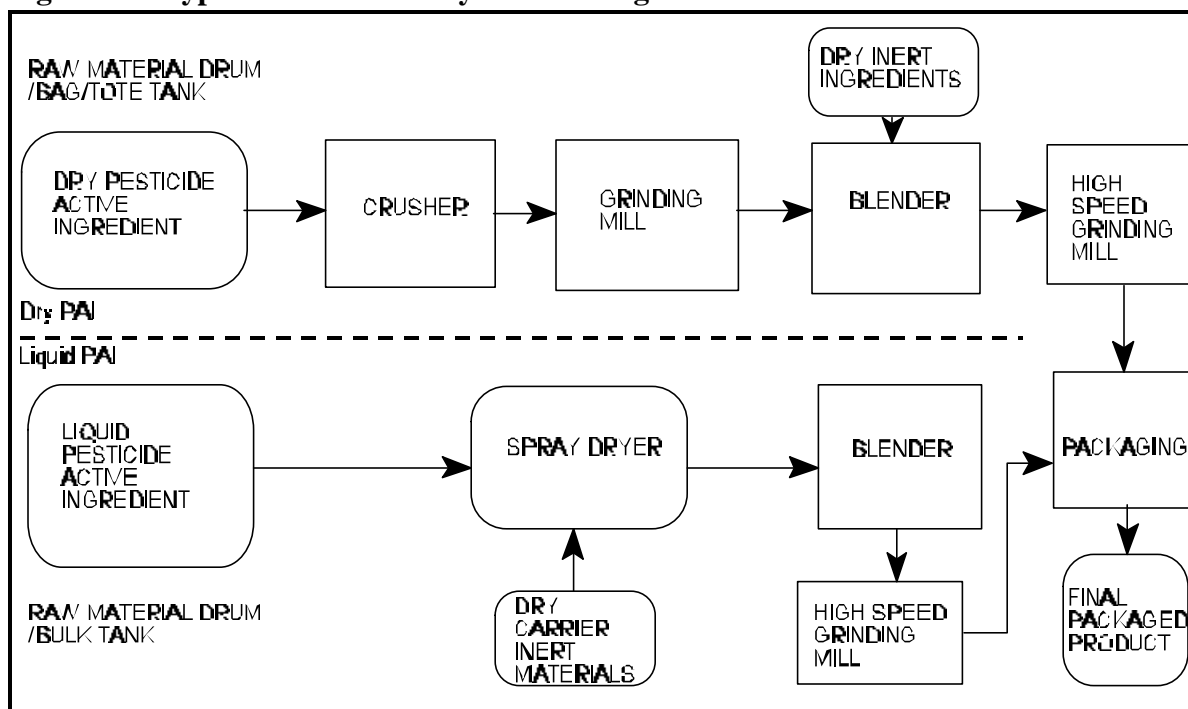

Source: United States EPA, 1996

III.D.3. Aerosol Packaging

Some pesticide products (typically water-based or solvent-based liquids) are packaged as aerosols, which can be applied to surfaces or dispersed in the air. The product is placed in spray cans that are put under pressure and a propellant is added, which forces the product out of the can in an aerosol spray. An aerosol packaging line typically includes a filler, a capper, a propellant injector, and a United States Department of Transportation (DOT) test bath. In the filler, formulated pesticide product is dispensed into empty aerosol cans, in much the same way as the liquid packaging lines fill containers. The cans are then sent to the capper, where a cap with a nozzle is placed on the can. The can enters a separate room, where the propellant is injected into the can, a vacuum is pulled, and the cap is crimped to make the can airtight. In order to comply with DOT regulations on the transport of pressurized containers, each can must then be tested for leaks and rupturing in a DOT test bath. Test baths indicate leaks by the appearance of bubbles at the point of leakage on the cylinder. The aerosol packaging line may also include a can washer to remove residue from can exteriors prior to entering the test bath (to reduce contaminant buildup in the bath), a dryer to dry can exteriors, and machinery to package aerosol cans into boxes for shipment (USEPA, 1996).

III.D.4. Pressurized Gas Formulating and Packaging

Some pesticide products are formulated and packaged as pressurized gases, primarily for the purpose of soil fumigation. Soil fumigation is used where the nematodic and fungal populations in soil prohibit successful seed planting. Volatile general toxicants, such as low molecular weight halogenated compounds, are typically injected into the soil before planting, but are also occasionally used once plants have reached maturity (Kent, 1992).

The active and inert ingredients are received as liquid, pressurized liquids, or gases, and are stored in tanks, tank trucks, rail cars, or minibulk storage containers. Liquid ingredients are placed in a holding tank prior to formulation. Formulating and packaging operations for these products usually occurs in one step in a closed-loop system. The ingredients are metered by weight through pressurized transfer lines into DOT-approved steel application cylinders. Other equipment that may be included in a pressurized gas line include pump and piping, and heating and refrigerating units to maintain gas pressures and temperatures in storage (USEPA, 1996).

The cylinders may be refilled at a later date, after they have been tested to ensure that they are still capable of containing pressurized fluids. DOT requires hydrostatic pressure testing, as well as visual examination of the cylinder (USEPA, 1996).

III.D.5. Repackaging

Repackaging operations are similar to packaging operations, except the “raw material” is an already formulated product that has been packaged for sale. Repackagers often purchase formulated pesticide products, transfer the product to new containers with customer-specific labeling, and sell them to distributors (USEPA, 1996).

A separate type of repackaging, called refilling, is usually performed by agrichemical facilities that transfer pesticide products from bulk storage tanks into minibulks. These refillable containers are typically constructed of plastic and typically have capacities ranging from 100 to 500 gallons. Minibulks may be owned by the refilling establishment, the pesticide registrant, or by the end user. Production lines usually consist of a bulk storage tank, a minibulk tank into which the product is repackaged, and any interconnecting hoses or piping. The bulk storage tanks may be dedicated by product and clustered together in a diked area. The products are dispensed to the minibulks by the use of manual system or a computer-regulated system of pumps and meters (USEPA, 1996).

III.E. Raw Material Inputs and Pollution Outputs

Raw material inputs and pollution outputs of fertilizer products and pesticide products differ considerably, and, therefore, are discussed separately below. The pollution outputs are discussed both specifically by product as well as generally by process since there are some similarities in the fertilizer and pesticide production processes and pollutant outputs.

III.E.1. Fertilizers

The primary raw materials for fertilizer manufacturing are phosphate rock, natural gas, sulfuric acid, and carbon dioxide. These materials are combined by several methods and in different proportions to produce a variety of fertilizer products, as described in section III.

Figure 18 summarizes the fertilizer material inputs for the principal fertilizer products.

Figure 18: Raw Material Flowchart for Principal Fertilizer Materials

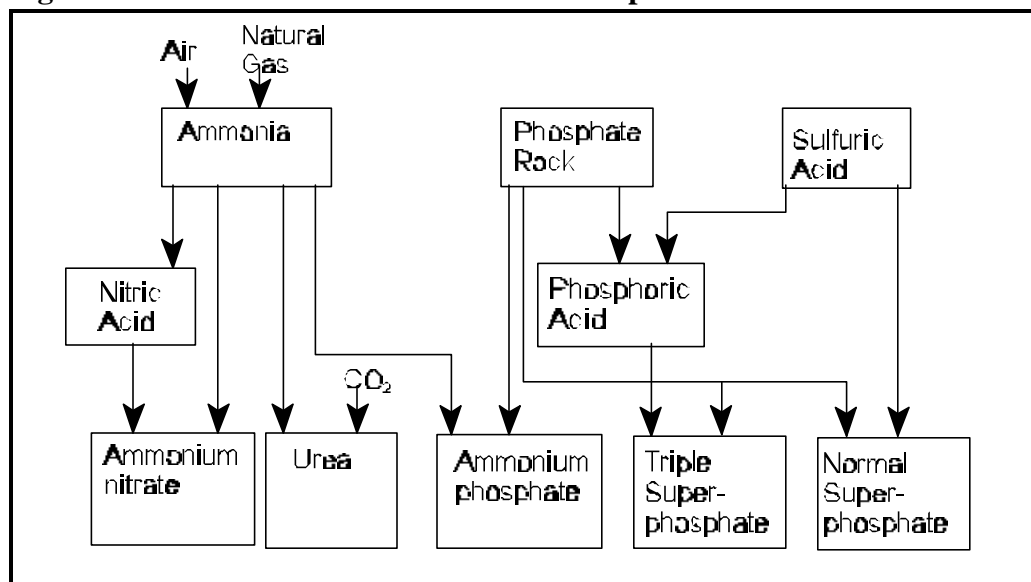

Source: Adapted from Manual on Fertilizer Statistics, Food and Agriculture Organization of the United Nations, Rome 1991.

Because the basic fertilizer nutrients are found in many natural and manmade materials, raw materials for fertilizers can also be derived from sources other than the virgin materials described above. Common sources of fertilizer ingredients are sewerage treatment sludges and certain industrial wastes. Although these waste-derived fertilizers may contain essentially the same

nutrients as fertilizers derived from virgin materials, they also may contain additional constituents that were present in the waste material and which may not be beneficial, or are potentially harmful to crops, human health, or the environment. Such constituents may enter the food chain or groundwater and could become concentrated in the soil after repeated use. Lead, cadmium and arsenic are some of the more common fertilizer ingredients that could be harmful if sufficient quantities are present. It should be noted, however, that fertilizers derived from virgin materials also have the potential to contain harmful levels of these constituents if significant quantities are naturally present in the raw materials.

One waste material input which has received some attention recently is cement kiln dust (CKD). Although there has been a considerable amount of research conducted on CKD use as a fertilizer, existing applications of CKD for this purpose have been mostly anecdotal, and there is only limited evidence that commercial CKD use as a fertilizer is growing significantly (USEPA, 1993b).

Like agricultural lime, CKD is alkaline and contains a number of essential plant nutrients. Because of these parallel characteristics, CKD has been used as an agricultural soil amendment. CKD possesses significant fertilizer potential, particularly because of its high potassium content. Soil scientists have also suggested that other key plant nutrients contained in CKD, such as calcium, phosphorous, and zinc, might be beneficial in some fertilizer applications. However, some concern has been raised over hazardous wastes in CKD (USEPA, 1993b).

Coal combustion by-products are also receiving attention for their potential agricultural benefits, including alleviating soil trace elemental deficiencies, modifying soil pH, and increasing levels of Ca and S, infiltration rates, depth of rooting, and drought tolerance. Flue gas desulfurization residues, which contain gypsum, have the potential to improve water use efficiency, product quality, and productivity of soil-crop systems. The short term benefits of coal combustion by-products usage has been demonstrated, however, long term effects have not been documented. Future hazards and benefits are yet to be determined (Korcak, 1995). Electric-arc furnace dust is also used as a fertilizer ingredient since it contains a number of trace elements required by plants, including zinc.

Pollution outputs are summarized in terms of air emission, wastewater, and residual wastes.

Air Emissions

Synthetic Ammonia

Air pollutants from the manufacture of synthetic anhydrous ammonia are emitted primarily from four process steps:

- C regeneration of the desulfurization bed,
- C heating of the catalytic steam,
- C regeneration of carbon dioxide scrubbing solution,
- C steam stripping of process condensate.

More than 95 percent of the ammonia plants in the United States use activated carbon fortified with metallic oxide additives for feedstock desulfurization. Vented regeneration steam contains sulfur oxides (SO_x) and hydrogen sulfide (H_2S), depending on the amount of oxygen in the steam. Regeneration may also emit hydrocarbons and carbon monoxide (CO). The reformer, heated with natural gas or fuel oil, may emit combustion products such as NO_x , CO , SO_x , hydrocarbons, and particulates (USEPA, 1993a).

Carbon dioxide (CO_2) is removed from the synthesis gas by scrubbing with monoethanolamine ($\text{C}_2\text{H}_4\text{NH}_2\text{OH}$) or hot potassium carbonate solution. Regeneration of this CO_2 scrubbing solution with steam produces emissions of water, NH_3 , CO , CO_2 and monoethanolamine (USEPA, 1993a).

Cooling the synthesis gas after low temperature shift conversion forms a condensate containing NH_3 , CO_2 , methanol (CH_3OH), and trace metals. Condensate steam strippers are used to remove NH_3 and methanol from the water, and steam from this may be vented to the atmosphere, emitting NH_3 , CO_2 , and methanol (USEPA, 1993a).

Nitric Acid

Emissions from nitric acid manufacturing consist primarily of NO and NO_2 (which account for visible emissions), and trace amounts of HNO_3 mist and NH_3 . The major source of nitrogen oxides is the tail gas from the acid absorption tower. In general, the quantity of nitrogen oxides (NO_x) emissions is directly related to the kinetics of the nitric acid formation reaction and absorption tower design. NO_x emissions can increase when there is:

- C insufficient air supply to the oxidizer and absorber,
- C low pressure, especially in the absorber,
- C high temperatures in the cooler/condenser and absorber,
- C production of an excessively high-strength product acid,
- C operation at high throughput rates,
- C faulty equipment such as compressors or pumps which lead to lower pressures, leaks, and reduced plant efficiency (USEPA, 1993a).

Comparatively small amounts of nitrogen oxides are also lost from acid concentrating plants. These losses (mostly NO_2) are from the condenser system, but the emissions are small enough to be controlled easily by absorbers.

Acid mist emissions do not occur from the tail gas of a properly operated

plant. The small amounts that may be present in the absorber exit gas streams are typically removed by a separator or collector prior to entering the catalytic reduction unit or expander.

The acid production system and storage tanks can be a significant source of visible NO_x emissions at nitric acid plants. Emissions from acid storage tanks are most likely to occur during tank filling (USEPA, 1993a).

Ammonium Nitrate

The primary air emissions from ammonium nitrate production plants are particulate matter (ammonium nitrate and coating materials), ammonia and nitric acid. Ammonia and nitric acid are emitted primarily from solution formation and granulators. Particulate matter (largely as ammonium nitrate) can be emitted from most of the process operations (USEPA, 1993a).

The emission sources in solution formation and concentration processes are neutralizers and evaporators, emitting nitric acid and ammonia. The vapor stream off the top of the neutralization reactor is primarily steam with some ammonia and NH₄NO₃ particulates present. Specific plant operating characteristics, however, make these emissions vary depending upon use of excess ammonia or acid in the neutralizer. Particulate emissions from these operations tend to be smaller in size than those from solids production and handling processes and generally are recycled back to the process (USEPA, 1993a).

Emissions from solids formation processes are ammonium nitrate particulate matter and ammonia. The sources of primary importance are prill towers (for high density and low density prills) and granulators (rotary drum and pan). Emissions from prill towers result from carryover of fine particles and fume by the prill cooling air flowing through the tower. These fine particles are from microprill formation, attrition of prills colliding with the tower or one another, and rapid transition of the ammonia nitrate between crystal states (USEPA, 1993a).

Microprill formation resulting from partially plugged orifices of melt spray devices can increase fine dust loading and emissions. Certain designs (spinning buckets) and practices (vibration of spray plates) help reduce plugged orifices and thus microprill formation. High ambient air temperatures can cause increased emissions because of entrainment as a result of higher air flow required to cool prills and because of increased fume formation at the higher temperatures (USEPA, 1993a).

Emissions from screening operations are generated by the attrition of the ammonium nitrate solids against the screens and against one another. Almost all screening operations used in the ammonium nitrate manufacturing industry are enclosed or have a cover over the uppermost screen. Emissions are ducted from the process for recovery or reuse (USEPA, 1993a).

Bagging and bulk loading operations are also a source of particulate emissions. Dust is emitted from each type of bagging process during final filling when dust laden air is displaced from the bag by the ammonium nitrate. The potential for emissions during bagging is greater for coated than for uncoated material. It is expected that emissions from bagging operations are primarily the kaolin, talc or diatomaceous earth coating matter. About 90 percent of solid ammonium nitrate produced domestically is bulk loaded. While particulate emissions from bulk loading are not generally controlled, visible emissions are within typical state regulatory requirements (below 20 percent opacity) (USEPA, 1993a).

Urea

Emissions from urea manufacture are mainly ammonia and particulate matter. Formaldehyde and methanol, hazardous air pollutants, may be emitted if additives are used. Formalin™, used as a formaldehyde additive, may contain up to 15 percent methanol. Ammonia is emitted during the solution synthesis and solids production processes. Particulate matter is emitted during all urea processes (USEPA, 1993a).

In the synthesis process, some emission control is inherent in the recycle process where carbamate gases and/or liquids are recovered and recycled. Typical emission sources from the solution synthesis process are noncondensable vent streams from ammonium carbamate decomposers and separators. Emissions from synthesis processes are generally combined with emissions from the solution concentration process and are vented through a common stack. Combined particulate emissions from urea synthesis and concentration operations are small compared to particulate emissions from a typical solids-producing urea plant. The synthesis and concentration operations are usually uncontrolled except for recycle provisions to recover ammonia (USEPA, 1993a).

Uncontrolled emission rates from prill towers may be affected by the following factors:

- C product grade being produced
- C air flow rate through the tower
- C type of tower bed
- C ambient temperature and humidity (USEPA, 1993a)

The total of mass emissions per unit is usually lower for feed grade prill production than for agricultural grade prills, due to lower airflows. Uncontrolled particulate emission rates for fluidized bed prill towers are higher than those for nonfluidized bed prill towers making agricultural grade prills, and are approximately equal to those for nonfluidized bed feed grade prills (USEPA, 1993a).

Ambient air conditions can affect prill tower emissions. Available data indicate that colder temperatures promote the formation of smaller particles

in the prill tower exhaust. Since smaller particles are more difficult to remove, the efficiency of prill tower control devices tends to decrease with ambient temperatures. This can lead to higher emission levels for prill towers operated during cold weather. Ambient humidity can also affect prill tower emissions. Air flow rates must be increased with high humidity, and higher air flow rates usually cause higher emissions (USEPA, 1993a).

In the solids screening process, dust is generated by abrasion of urea particles and the vibration of the screening mechanisms. Therefore, almost all screening operations used in the urea manufacturing industry are enclosed or are covered over the uppermost screen. Emissions attributable to coating include entrained clay dust from loading, inplant transfer, and leaks from the seals of the coater (USEPA, 1993a).

Phosphoric Acid

Gaseous fluorides such as silicon tetrafluoride (SiF_4) and hydrogen fluoride (HF) can be major emissions from wet process acid production. Phosphate rock contains 3.5 to 4.0 percent fluorine. Part of the fluorine from the rock is precipitated with the gypsum, another part is leached out with the phosphoric acid product, and the remaining portion is vaporized in the reactor or evaporator. The relative quantities of fluorides in the filter acid and gypsum depend on the type of rock and the operating conditions. Final disposition of the volatilized fluoride depends on the design and operation of the plant (USEPA, 1993a).

The reactor in which phosphate rock is reacted with sulfuric acid is the main source of emissions. Fluoride emissions accompany the air used to cool the reactor slurry. Vacuum flash cooling has replaced the air cooling method to a large extent, since emissions are minimized in the closed system.

Acid concentration by evaporation is another source of fluoride emissions. Approximately 20 to 40 percent of the fluorine originally present in the rock vaporizes in this operation. Particulate matter containing fluorides can be emitted directly from process equipment. About three to six percent of the particulates can be fluorides, as measured at one facility (USEPA, 1993a).

Ammonium Phosphates

The major sources of air emissions from the production of ammonium phosphatic fertilizers include the reactor, the ammoniator-granulator, the dryer and cooler, product sizing and material transfer, and the gypsum pond. The reactor and ammoniator-granulator produce emissions of gaseous ammonia, gaseous fluorides such as hydrogen fluoride (HF) and silicon tetrafluoride (SiF_4), and particulate ammonium phosphates. These two exhaust streams are generally combined and passed through primary and secondary scrubbers (USEPA, 1993a).

Exhaust gases from the dryer and cooler also contain ammonia, fluorides and

particulates, and these streams are commonly combined and passed through cyclones and primary and secondary scrubbers. Particulate emissions and low levels of ammonia and fluorides from product sizing and material transfer operations are controlled the same way (USEPA, 1993a).

Normal Superphosphates

Sources of emissions at a normal superphosphate plant include rock unloading and feeding, mixing operations (in the reactor), storage (in the curing building), and fertilizer handling operations. Rock unloading, handling and feeding generate particulate emissions of phosphate rock dust. The mixer, den and curing building emit gases in the form of silicon tetrafluoride (SiF_4), hydrogen fluoride (HF) and particulates composed of fluoride and phosphate material (USEPA, 1993a).

Triple Superphosphates

Emissions of fluorine compounds and dust particles occur during the production of granulated triple superphosphate. Silicon tetrafluoride (SiF_4) and hydrogen fluoride (HF) are released by the acidulation reaction and they evolve from the reactors, den, granulator, and dryer. Evolution of fluoride is essentially finished in the dryer and there is little fluoride evolved from the storage pile in the curing building (USEPA, 1993a).

Sources of particulate emissions include the reactor, granulator, dryer, screens, cooler, mills, and transfer conveyors. Additional emissions of particulate result from the unloading, grinding, storage, and transfer of ground phosphate rock. Facilities may also use limestone, which is received in granulated form and does not require additional milling (USEPA, 1993a).

Wastewater

Wastewater from the fertilizer industry can be classified into four groups:

- C process effluents resulting from contact with gas, liquids, or solids
- C dedicated effluents which may be separated for use in one process or for recycling at a controlled rate
- C effluents from general services such as cleaning or pretreatment
- C occasional effluents such as leaks or spills

A number of process wastewater streams from the nitrogenous fertilizer industry have been identified. Frequently these wastewaters contain high levels of nitrogenous compounds such as ammonia, nitrates, and organic nitrogen. In ammonia production, wastewater is generated from process condensate stripping. Ammonium nitrate manufacturing produces process wastewater in the neutralization process, the evaporation unit, and air cooling equipment. The vacuum condenser in urea plants is a source of wastewater. Most scrubbing operations are also a source of wastewater. Nitric acid

production generates relatively little wastewater since there is no process wastewater source. Steam generated in nitrogenous fertilizer processing may contain dissolved and suspended solids, alkalinity, and hardness (USEPA, 1974).

The most common methods for removing nitrogenous compounds include:

- C Biological nitrification/denitrification
- C Air or steam stripping
- C Ion exchange
- C Breakpoint chlorination (Water Environment Federation, 1994).

The major source of wastewater from any phosphatic fertilizer manufacturing process is referred to as “pond water.” Phosphoric acid production creates large quantities of pond water for cooling of the process, concentration of the product and for processing and storage of the gypsum byproduct. Gypsum slurry water is decanted from the top of the gypsum stacks and sent to the cooling pond through collection ditches (USEPA, 1993a). Through evaporation and recycling, contaminant concentrations in pond water can reach several grams per liter of phosphates and fluoride. Additional elemental contaminants in pond water which originate in phosphate rock are arsenic, cadmium, uranium, vanadium, and radium (USEPA, 1974).

The most common industry treatment for removing phosphorous is lime neutralization and settling.

Occasional wastewater is generated in any fertilizer production facility by leaks, spills, cleaning, maintenance, and laboratory tests. Cleaning of cooling and pollution control systems also produces process wastewater. Cooling water may contain ammonia, sulfate, chloride, phosphate, chromate, and dissolved solids which become concentrated through evaporation (USEPA, 1974). The laundry of workers' clothing is another source of wastewater originating outside the actual process.

Solid/Hazardous/Residual Wastes

One of the largest solid wastes in the fertilizer industry is phosphogypsum which is produced during phosphoric acid production. Approximately 1.5 tons of phosphogypsum is produced per ton of phosphate rock fed, or 5 tons per ton of phosphoric acid produced (expressed as P_2O_5). Gypsum (calcium sulphate dihydrate) is a mineral which also occurs in nature. Phosphogypsum is produced by the reaction of phosphate rock with sulphuric acid during the process of producing phosphoric acid. The term “phosphogypsum” is used to specify the particular gypsum arising from the acidulation of phosphate rock, because it contains trace amounts of many of the mineral impurities that accompany phosphate rock. One of these impurities is radium, the parent of radon. Other trace impurities found in phosphogypsum include arsenic, nickel, cadmium, lead, aluminum, fluoride, and phosphoric acid. Mainly because of

the radium content, the EPA restricts use of phosphogypsum and stipulates that no phosphogypsum with radium over ten pCi/g can be removed from the stacks adjacent to the agricultural chemical plants (UNEP, 1996).

The use of waste phosphogypsum for other purposes has been widely encouraged, but economic and/or quality problems and/or the demand for the resulting products frequently inhibit or prevent this. These problems relate not only to the impurities in the gypsum, but also to its relatively high moisture content. Plasterboard, plaster, and cement are the main possibilities. It is also possible to recycle phosphogypsum in sulphuric acid production. The ready availability of natural gypsum and the high cost of gypsum-based sulphuric acid, as well as the presence of trace contaminants, are the main obstacles to its use (Miller, 1995). However, in countries where gypsum and other sulphurous raw materials are scarce, phosphogypsum has been successfully used for these purposes (UNEP, 1996).

Dumping gypsum on land is not possible everywhere because the material settles and dries slowly and requires an adequate land area and certain climatic and soil conditions where the stack is situated. Gypsum stacks are being increasingly regulated in terms of lining and cap systems to prevent contaminated leaching or runoff (UNEP, 1996).

All phosphate ores contain traces of radioactive elements and a number of metals. During processing, these are partitioned between beneficiation process wastes, the waste from the further processing into intermediate and finished fertilizer production, and some end up in the final product (UNEP, 1996).

Cadmium is a heavy metal which accumulates in living systems and can become toxic above certain limits. The quantity of cadmium contained in a phosphatic fertilizer depends on the source of the rock or waste material from which it was made. The cadmium content of phosphate rocks varies from almost zero to over 300 mg/kg P₂O₅. The acidulation of phosphate rock partitions the cadmium between the fertilizer product and the by-products, mainly the phosphogypsum arising from phosphoric acid production (UNEP, 1996).

The fertilizer industry has for some decades tried to develop cadmium separation processes. Processes studied so far have shown serious limitations and problems, with regard to safety, cost, energy consumption or environmental concerns. Currently available processes are expensive and are not economically viable except for phosphates destined for human or animal consumption, which have a greater added value. A process developed for removing cadmium from phosphoric acid, which is used in the production of many phosphatic fertilizers (except normal superphosphate), has shown promise on a laboratory scale, but needs further testing before being used on an industrial scale (UNEP, 1996).

Off-specification product, spills, and dusts collected in emission control systems are potential sources of residual wastes. Products are occasionally suspended or canceled, leaving stockpiles of residual product. Other possible sources of solid wastes are spent catalysts, spent containers, wastewater treatment sludges, and spent filters. Many of these wastes are transported off-site for disposal. However, with good housekeeping techniques and dedicated systems, some of these wastes may be recycled back into the process instead of being wasted.

Catalysts used in the steam reforming process need to be replaced every two to six years. Spent catalysts contain oxides of hexavalent chromium, zinc, iron, and nickel. They are typically returned to the manufacturer or other metal recovery companies for recycling and reclamation of valuable materials (UNEP, 1996).

III.E.2. Pesticide Formulating, Packaging, and Repackaging

As listed below, input raw materials include the pesticide concentrates from pesticide manufacturing plants as well as diluents and other chemical additives used in the formulating process:

C Active Ingredients

Organic/inorganic pesticides: insecticides, herbicides, fungicides, and others. (See Table 10.)

C Formulation and preparation materials

Dry formulations:

organic flours, sulfur, silicon oxide, lime, gypsum, talc, pyrophyllite, bentonites, kaolins, attapulgate, and volcanic ash.

Liquid formulations:

Solvents: xylenes, kerosenes, methyl isobutyl ketone, amyl acetate, and chlorinated solvents.

Propellants: carbon dioxide and nitrogen.

Others: wetting and dispersing agents, masking agents, deodorants, and emulsifiers (USEPA, 1990).

In addition to pesticide materials, some facilities listed under SIC code 2879 produce fertilizer/pesticide blends. A variety of nitrogenous, phosphatic, and mixed fertilizers may be inputted into bulk blending tanks to produce these combinations.

Table 10: Approximate Quantities of Most Commonly Used Conventional Pesticides in United States Agricultural Crop Production

Chemical	1995 Consumption (Million pounds active ingredient)	Chemical	1995 Consumption (Million pounds active ingredient)
Atrazine	68-73	Chlorpyrifos	9-13
Metolachlor	59-64	Chlorothalonil	8-12
Metam Sodium	449-54	Copper Hydroxide	7-11
Methyl Bromide	39-46	Propanil	6-10
Dichloropropene	38-43	Dicamba	6-10
2,4-D	31-36	Terbufos	6-9
Glyphosate	25-30	Mancozeb	6-9
Cyanazine	24-29	Fluometuron	5-9
Pendimethalin	23-28	MSMA	4-8
Trifluralin	23-28	Bentazone	4-8
Acetochlor	22-27	Parathion	4-7
Alachlor	19-24	Sodium Chlorate	4-6
EPTC	9-13		

Source: Pesticide Industry Sales and Usage, 1994 and 1995 Market Estimates, EPA, August 1997.

Air Emissions

Air emissions can be generated throughout the pesticide formulating and packaging processes, mostly when fine particulates of pesticide dust become suspended in air while the materials are being moved, processed, or stored. Most dust or granule blending mills are equipped with vacuum systems, cyclones, and wet scrubbers to collect fugitive dust. Some vacuum systems are dedicated to certain processes to facilitate reuse of the dust. Other systems are used to collect dust from a number of areas (USEPA, 1990). Dust generated by pesticide formulation processes contain AIs which may be toxic to humans and the environment. Thus, they are important to contain.

Volatile organic compound (VOC) emissions such as xylene may also arise when solvent-based liquid formulations are produced. VOC emissions may also be generated during equipment cleaning with solvents.

Wastewater

Process wastewater is defined in 40 CFR 122.2 as “any water which, during manufacturing or processing, comes into direct contact with or results from the production or use of any raw material, byproduct, intermediate product, finished product, or waste product.” Wastewater from the pesticide formulating industry is typically due to cleaning of equipment and related process areas and not the actual formulating processes (USEPA, 1996).

Cleaning and decontaminating blending and liquid pesticide mixing and storage equipment generates pesticide-contaminated wastewater or solvent, depending upon whether the equipment is used to formulate water or solvent-based pesticides. Decontamination is performed between batches of different types of formulations to prevent cross contamination of the subsequent batch. Decontamination is also performed prior to taking the equipment out of service for maintenance. The decontamination is commonly performed using high pressure water hoses equipped with spray nozzles, portable steam generators, or by running a batch of solvent through the formulating equipment (USEPA, 1990).

Active ingredient containers, such as 55-gallon drums, are often decontaminated by triple rinsing. The decontamination is usually performed using a high pressure water hose equipped with a spray nozzle or a portable steam jenny. The containers can then be sold or given to commercial recycling firms, depending on label directions (USEPA, 1990).

Floor, wall, and equipment exterior washing is typically performed using water hoses equipped with spray nozzles. It may also involve the use of mops and squeegees. Wastewater is also generated by clean-up of spills and leaks.

Wastewater from these operations typically contains AIs, solvents, and wetting agents (USEPA, 1990). Other sources of wastewater include:

- C Pollution control scrubber water
- C Department of Transportation leak test water
- C Safety equipment wash water
- C Laboratory equipment wash water
- C Shower water
- C Laundry water
- C Fire protection test water
- C Contaminated precipitation runoff (USEPA, 1996)

Solid/Hazardous/Residual Wastes

Residual wastes include containers and container liners potentially contaminated with pesticides, as well as off-spec product, dust collected from

emission control equipment, and product spills. Contaminated laboratory equipment and protective workers clothing are other potential solid waste sources (USEPA, 1990).

Decontamination of the solid-based pesticide blending mills may generate solid diluent contaminated with pesticides. The diluent typically consists of clay for dust mills and sand for granule mills (USEPA, 1990).

In case of pesticide products which have been suspended or canceled, there may be existing stocks of these products remaining. EPA may allow the use of existing stocks or prohibit such use. State environmental agencies occasionally collect unusable pesticides.

Procedures for pesticide management have been proposed by EPA, as authorized under section 19 of the Federal Insecticide, Fungicide, and Rodenticide Act (FIFRA). For more details, refer to section VI.C on pending and proposed regulatory requirements.

Table 11: Summary of Potential Pollution Outputs for the Agricultural Chemical Industry			
Process	Air Emissions	Process Wastewater	Residual Waste
Nitric Acid Absorption Tower	NO, NO ₂ , HNO ₃ in tailgas	NA	Spent tower materials, trays
Solution Formulation and Granulation	NH ₃ , HNO ₃ particulates	Condensed steam with NH ₄ NO ₃ and NH ₃	NA
Solids Formation	Particulates, NO _x , SiF ₄ , HF	NA	Dusts
Regeneration of Desulfurization and Filter Beds	Hydrocarbons, CO, NH ₃ , CO ₂	Condensed steam, NH ₃ , CO ₂	Spent bed material
Screening	Dust	NA	Mixed undersized captured dusts, used screens
Wet Process Phosphoric Acid Production	SiF ₄ , HF	Pond water	Gypsum
Unloading of materials into blending tanks	Dust/particulates released in transfer	NA	Leftover raw material containers
Open processing and storage equipment	VOC's	NA	NA
Equipment and facility cleaning	NA	Washwater, waste solvent	Waste sands and clays, used mops/squeegees/etc.
Laboratory procedures	VOC's and dusts released	Washwater, lab testing water	Off-spec product used for testing/analysis
Spills and runoff	Dust/particulates released by spill	Contaminated rainfall/runoff	Contaminated solid product
Pollution control systems	NA	Contaminated scrubber water	Spent filter material

Source: Guide to Pollution Prevention, The Pesticide Formulating Industry, Center for Environmental Research Information, United States EPA, Washington D.C., 1990.

III.F. Management of Chemicals in Wastestream

The Pollution Prevention Act of 1990 (PPA) requires facilities to report information about the management of Toxic Release Inventory (TRI) chemicals in waste and efforts made to eliminate or reduce those quantities. These data have been collected annually in section 8 of the TRI reporting Form R beginning with the 1991 reporting year. The data summarized below cover the years 1995-1998 and are meant to provide a basic understanding of the quantities of waste handled by the industry, the methods typically used to manage this waste, and recent trends in these methods. TRI waste management data can be used to assess trends in source reduction within individual industries and facilities, and for specific TRI chemicals. This information could then be used as a tool in identifying opportunities for pollution prevention or compliance assistance activities.

While the quantities reported for 1995 and 1996 are estimates of quantities already managed, the quantities listed by facilities for 1997 and 1998 are projections only. The PPA requires these projections to encourage facilities to consider future source reduction, not to establish any mandatory limits. Future-year estimates are not commitments that facilities reporting under TRI are required to meet.

Fertilizers

Table 12 shows that the TRI reporting fertilizer manufacturing and mixing facilities managed about 566 million pounds of production related wastes (total quantity of TRI chemicals in the waste from routine production operations in column B) in 1996. From the yearly data presented in column B, the total quantity of production related TRI wastes decreased between 1995 and 1996. Production related wastes are projected to increase in 1997 and 1998. Note that the affects of production increases and decreases on the quantities of wastes generated are not evaluated here.

In 1996, about 84 percent of the industry's TRI wastes were managed on-site through recycling, energy recovery, or treatment as shown in columns C, D, and E, respectively. Most of these on-site managed wastes were recycled on-site. There is a negligible amount (<1%) of wastes being transferred off-site for recycling, energy recovery, or treatment. The remaining portion of the production related wastes (12 percent in 1995 and 16 percent in 1996), shown in column I, is either released to the environment through direct discharges to air, land, water, and underground injection, or is transferred off-site for disposal.

Table 12: Source Reduction and Recycling Activity for the Fertilizer Industry as Reported within TRI								
A	B	On-Site			Off-Site			I
Year	Quantity of Production-Related Waste (10 ⁶ lbs.) ^a	C	D	E	F	G	H	% Released and Disposed ^c Off-site
		% Recycled	% Energy Recovery	% Treated	% Recycled	% Energy Recovery	% Treated	
1995	719	76%	8%	4%	0%	0%	0%	12%
1996	566	77%	1%	6%	0%	0%	0%	16%
1997	606	77%	1%	7%	0%	0%	0%	15%
1998	617	78%	1%	7%	0%	0%	0%	14%

Source: 1996 Toxics Release Inventory Database.

^a Within this industry sector, non-production related waste < 1% of production related wastes for 1996.

^b Total TRI transfers and releases as reported in section 5 and 6 of Form R as a percentage of production related wastes.

^c Percentage of production related waste released to the environment and transferred off-site for disposal.

Pesticides and Miscellaneous Agricultural Chemicals

Table 13 shows that the TRI reporting pesticide and miscellaneous agricultural chemicals facilities managed about 252 million pounds of production related wastes (total quantity of TRI chemicals in the waste from routine production operations in column B) in 1996. From the yearly data presented in column B, the total quantity of production related TRI wastes increased between 1995 and 1996. Production related wastes were projected to continue to increase in 1997 and 1998. Note that the affects of production increases and decreases on the quantities of wastes generated are not evaluated here.

In 1996, about 95 percent of the industry's TRI wastes were managed on-site through recycling, energy recovery, or treatment as shown in columns C, D, and E, respectively. Most of these on-site managed wastes were recycled on-site. A small portion of the remaining wastes (4% in 1996) are transferred off-site for recycling, energy recovery, or treatment. The remaining one percent of the production related wastes, shown in column I, is either released to the environment through direct discharges to air, land, water, and underground injection, or is transferred off-site for disposal.

Table 13: Source Reduction and Recycling Activity for the Pesticide and Miscellaneous Agricultural Chemicals Industry as Reported within TRI								
A	B	On-Site			Off-Site			I
Year	Quantity of Production-Related Waste (10 ⁶ lbs.) ^a	C	D	E	F	G	H	% Released and Disposed ^c Off-site
		% Recycled	% Energy Recovery	% Treated	% Recycled	% Energy Recovery	% Treated	
1995	245	85%	0%	10%	2%	1%	1%	2%
1996	252	84%	0%	11%	2%	1%	1%	1%
1997	266	84%	0%	11%	1%	1%	2%	1%
1998	279	85%	0%	11%	1%	1%	1%	1%

Source: 1996 Toxics Release Inventory Database.

^a Within this industry sector, non-production related waste < 1% of production related wastes for 1996.

^b Total TRI transfers and releases as reported in section 5 and 6 of Form R as a percentage of production related wastes.

^c Percentage of production related waste released to the environment and transferred off-site for disposal.

THIS PAGE WAS INTENTIONALLY LEFT BLANK

IV. CHEMICAL RELEASE AND TRANSFER PROFILE

This section is designed to provide background information on the pollutant releases that are reported by this industry in correlation with other industries. The best source of comparative pollutant release information is the Toxic Release Inventory (TRI). Pursuant to the Emergency Planning and Community Right-to-Know Act, TRI includes self-reported facility release and transfer data for over 600 toxic chemicals. Facilities within SIC Codes 20 through 39 (manufacturing industries) that have more than 10 employees, and that are above weight-based reporting thresholds are required to report TRI on-site releases and off-site transfers. The information presented within the sector notebooks is derived from the most recently available (1996) TRI reporting year (which includes over 600 chemicals), and focuses primarily on the on-site releases reported by each sector. Because TRI requires consistent reporting regardless of sector, it is an excellent tool for drawing comparisons across industries. TRI data provide the type, amount and media receptor of each chemical released or transferred.

Although this sector notebook does not present historical information regarding TRI chemical releases over time, please note that in general, toxic chemical releases have been declining. In fact, according to the 1996 Toxic Release Inventory Public Data Release, reported onsite releases of toxic chemicals to the environment decreased by 5 percent (111.6 million pounds) between 1995 and 1996 (not including chemicals added and removed from the TRI chemical list during this period). Reported releases dropped by 48 percent between 1988 and 1996. Reported transfers of TRI chemicals to off-site locations increased by 5 percent (14.3 million pounds) between 1995 and 1996. More detailed information can be obtained from EPA's annual Toxics Release Inventory Public Data Release book (which is available through the EPCRA Hotline at 800-535-0202), or directly from the Toxic Release Inventory System database (for user support call 202-260-1531).

Wherever possible, the sector notebooks present TRI data as the primary indicator of chemical release within each industrial category. TRI data provide the type, amount and media receptor of each chemical released or transferred. When other sources of pollutant release data have been obtained, these data have been included to augment the TRI information.

TRI Data Limitations

Certain limitations exist regarding TRI data. Within some sectors, (e.g. dry cleaning, printing and transportation equipment cleaning) the majority of facilities are not subject to TRI reporting because they are not considered manufacturing industries, or because they are below TRI reporting thresholds. For these sectors, release information from other sources has been included. In addition, many facilities report TRI more under than one SIC code reflecting the multiple operations carried out onsite whether or not the operation is the

facilities primary area of business as reported to the U.S. Census Bureau. Reported chemicals are limited to the approximately 600 TRI chemicals. A portion of the emissions from agricultural chemical facilities, therefore, are not captured by TRI. Also, reported releases and transfers may or may not all be associated with the industrial operations described in this notebook.

The reader should also be aware that TRI “pounds released” data presented within the notebooks is not equivalent to a “risk” ranking for each industry. Weighting each pound of release equally does not factor in the relative toxicity of each chemical that is released. The Agency is in the process of developing an approach to assign toxicological weightings to each chemical released so that one can differentiate between pollutants with significant differences in toxicity. As a preliminary indicator of the environmental impact of the industry’s most commonly released chemicals, the notebook briefly summarizes the toxicological properties of the top five chemicals (by weight) reported by each industry.

Definitions Associated With Section IV Data Tables

General Definitions

SIC Code -- is the Standard Industrial Classification (SIC) code, a statistical classification standard used for all establishment-based federal economic statistics. The SIC codes facilitate comparisons between facility and industry data.

TRI Facilities -- are manufacturing facilities that have 10 or more full-time employees and are above established chemical throughput thresholds. Manufacturing facilities are defined as facilities in Standard Industrial Classification primary codes 20-39. Facilities must submit estimates for all chemicals that are on the EPA’s defined list and are above throughput thresholds.

Data Table Column Heading Definitions

The following definitions are based upon standard definitions developed by EPA’s Toxic Release Inventory Program. The categories below represent the possible pollutant destinations that can be reported.

RELEASES -- are on-site discharges of a toxic chemical to the environment. This includes emissions to the air, discharges to bodies of water, releases at the facility to land, as well as contained disposal into underground injection wells.

Releases to Air (Point and Fugitive Air Emissions) -- include all air emissions from industry activity. Point emissions occur through confined air streams as found in stacks, vents, ducts, or pipes. Fugitive emissions include

equipment leaks, evaporative losses from surface impoundments and spills, and releases from building ventilation systems.

Releases to Water (Surface Water Discharges) -- encompass any releases going directly to streams, rivers, lakes, oceans, or other bodies of water. Releases due to runoff, including storm water runoff, are also reportable to TRI.

Releases to Land -- occur within the boundaries of the reporting facility. Releases to land include disposal of toxic chemicals in landfills, land treatment/application farming, surface impoundments, and other disposal on land (such as spills, leaks, or waste piles).

Underground Injection -- is a contained release of a fluid into a subsurface well for the purpose of waste disposal. Wastes containing TRI chemicals are injected into either Class I wells or Class V wells. Class I wells are used to inject liquid hazardous wastes or dispose of industrial and municipal wastewaters beneath the lowermost underground source of drinking water. Class V wells are generally used to inject non-hazardous fluid into or above an underground source of drinking water. TRI reporting does not currently distinguish between these two types of wells, although there are important differences in environmental impact between these two methods of injection.

TRANSFERS -- are transfers of toxic chemicals in wastes to a facility that is geographically or physically separate from the facility reporting under TRI. Chemicals reported to TRI as transferred are sent to off-site facilities for the purpose of recycling, energy recovery, treatment, or disposal. The quantities reported represent a movement of the chemical away from the reporting facility. Except for off-site transfers for disposal, the reported quantities do not necessarily represent entry of the chemical into the environment.

Transfers to POTWs -- are wastewater transferred through pipes or sewers to a publicly owned treatments works (POTW). Treatment or removal of a chemical from the wastewater depends on the nature of the chemical, as well as the treatment methods present at the POTW. Not all TRI chemicals can be treated or removed by a POTW. Some chemicals, such as metals, may be removed but not destroyed and may be disposed of in landfills or discharged to receiving waters.

Transfers to Recycling -- are wastes sent off-site for the purposes of regenerating or recovery by a variety of recycling methods, including solvent recovery, metals recovery, and acid regeneration. Once these chemicals have been recycled, they may be returned to the originating facility or sold commercially.

Transfers to Energy Recovery -- are wastes combusted off-site in industrial

furnaces for energy recovery. Treatment of a chemical by incineration is not considered to be energy recovery.

Transfers to Treatment -- are wastes moved off-site to be treated through a variety of methods, including neutralization, incineration, biological destruction, or physical separation. In some cases, the chemicals are not destroyed but prepared for further waste management.

Transfers to Disposal -- are wastes taken to another facility for disposal, generally as a release to land or as an injection underground.

IV.A. EPA Toxic Release Inventory for the Fertilizer, Pesticide, and Agricultural Chemical Industry

This section summarizes the TRI data of fertilizer manufacturing and mixing facilities reporting SIC codes 2873, 2874, or 2875 as their primary SIC code and of pesticide and miscellaneous agricultural chemicals formulating facilities reporting SIC code 2879 as their primary SIC code.

According to the 1995 Toxics Release Inventory (TRI) data, 190 fertilizer and pesticide facilities reporting SIC 2873, 2874, 2875, or 2879 released (to the air, water, or land) and transferred (shipped off-site or discharged to sewers) a total of 106 million pounds of toxic chemicals during calendar year 1996. This represents approximately 2 percent of the 5.6 billion pounds of releases and transfers from all manufacturers (SICs 20-39) reporting to TRI that year. The top two chemicals released by weight are ammonia and phosphoric acid (both from fertilizer manufacturing). These two account for about 89 percent (82 million pounds) of the industry's total releases. Xylene, methanol, and ethylbenzene are the three top chemicals transferred by weight (all from pesticide formulating). These three account for about 71 percent (9 million pounds) of the total TRI chemicals transferred by the industries. The variability in facilities' TRI chemical profiles may be attributed to the variety of processes and products in the industries. Eighty-seven percent of the 243 different chemicals reported were reported by fewer than 10 facilities.

Fertilizers (SIC 2873, 2874, 2875)

According to 1996 TRI data, fertilizer manufacturing and mixing facilities released and transferred approximately 93 million pounds of pollutants during calendar year 1996. One hundred and ninety facilities reported TRI emissions for 46 chemicals. Only 13 of the 46 chemicals (28 percent) were reported (as releases and/or transfers) by ten or more facilities, evidence of the diversity of the industry. Fertilizer facilities released an average of 481,000 pounds per facility and transferred an average of 8,000 pounds per facility. The high release per facility values are, in a large part, a result of significant releases for ammonia and phosphoric acid from seventy or more facilities.

Releases

Table 14 presents the number and weights of chemicals released by fertilizer manufacturing and mixing facilities reporting SIC 2873, 2874, and 2875 in 1996. The total quantity of releases was 91.3 million pounds or 98 percent of the total weight of chemicals reported to TRI by the fertilizer industry (i.e., releases and transfers). The top chemical released by this industry is ammonia, accounting for 54 percent of the total releases. Phosphoric acid is the next largest release at 35 percent of the total. Fifty-eight percent of all TRI releases in the fertilizer industry were air emissions, 53 percent as point source and 5 percent as fugitive. Ammonia accounts for 91 percent of air releases. The majority of the other releases were land disposed (32 percent) with phosphoric acid accounting for 99 percent of land disposals. The remaining nine percent was released as water discharges or underground injections.

Transfers

Table 15 presents the number and weights of chemicals transferred off-site by fertilizer manufacturing and mixing facilities reporting SIC 2873, 2874, or 2875 in 1996. The total amount of transfers was about 1.5 million pounds or only two percent of the total amount of chemicals reported to TRI by the fertilizer industry (i.e., releases and transfers). Transfers to recycling facilities accounted for the largest amount, 51 percent of the total transfers. The next greatest percentage went for disposal and the rest to treatment facilities. No energy recovery transfers were reported for this industry. Copper compounds, phosphoric acid, and zinc compounds represented the largest transfers (primarily to recycling), as 60 percent of the total transfers. Ammonia only accounted for 4 percent of the transfers compared to 54 percent of releases.

Pesticides and Miscellaneous Agricultural Chemicals (SIC 2879)

According to 1996 TRI data, pesticide formulating facilities released and transferred approximately 13 million pounds of pollutants during calendar year 1996. One hundred and ninety-three facilities reported TRI emissions for 197 chemicals in 1996. Only 18 (9 percent) of these chemicals were reported by ten or more facilities, evidence of the particularly diverse nature of the industry. Pesticide formulating facilities released an average of 10,000 pounds of pollutants per facility and transferred an average of 59,000 pounds per facility. The high average transfer per facility is due mostly to high average xylene, ethylbenzene, and methanol transfers.

Releases

Table 16 presents the number and weights of chemicals released by pesticide and miscellaneous agricultural chemicals formulating facilities reporting SIC

2879 in 1996. The total amount of releases was 2.0 million pounds or 15 percent of the total quantity of TRI chemicals reported by the pesticide and miscellaneous agricultural chemicals industry (i.e., releases and transfers). This is substantially less than the 98 percent of reported chemicals released by the fertilizer industry. The top two chemicals released by this industry are methanol (23 percent of releases) and dichloromethane (13 percent of releases).

About 69 percent (1.4 million pounds) of all the chemicals released by the pesticide industry were released to air in the form of point source emissions (50 percent) and fugitive air releases (19 percent). Air releases were primarily comprised of dichloromethane, carbon disulfide, and methyl isobutyl ketone. Approximately 29 percent of the releases were by underground injection, and the remaining releases were to water (2 percent) and land disposal (1 percent). The relatively large number of chemicals reported to TRI under SIC 2879 compared to the fertilizer industry illustrates the variety of chemical formulations produced by the pesticide industry.

Transfers

Table 17 presents the number and weights of chemical transfers by the pesticide and miscellaneous agricultural chemicals formulating facilities reporting SIC 2879 in 1996. The total amount of transfers off-site was 11.3 million pounds or 85 percent of the total amount of chemicals reported to TRI by the pesticide industry (i.e., releases and transfers). Xylene, methanol, and ethylbenzene accounted for 58, 12, and 10 percent, respectively, of the chemical TRI transfers. Transfers to recycling facilities accounted for the largest quantity (51 percent) although only eight facilities reported recycling transfers. Xylene accounted for 84 percent of all recycling transfers. Energy recovery and treatment accounted for 23 and 31 percent respectively. The remainder of transfers consisted of off-site disposals.

Table 14: 1996 TRI Releases for Agricultural Chemicals Facilities (SICs 2873,2874,2875) by Number of Facilities Reporting (Releases reported in pounds/year)

Chemical Name	# Reporting Chemical	Fugitive Air	Point Air	Water Discharges	Underground Injection	Land Disposal	Total Releases	Avg. Releases Per Facility
Ammonia	106	4,590,371	43,967,432	427,065	539,900	78,814	49,603,582	467,958
Phosphoric Acid	72	1,452	8,631	2,939,394	0	29,071,310	32,020,787	444,733
Zinc Compounds	56	3,946	2,969	7,817	65	4,023	18,820	336
Manganese Compounds	43	5,292	1,696	1,500	0	500	8,988	209
Nitrate Compounds	42	1,529	261,250	3,108,211	971,850	125,960	4,468,800	106,400
Copper Compounds	37	1,477	525	1,443	60	528	4,033	109
Sulfuric Acid (1994 and after "Acid Aerosols" Only)	32	3,237	1,435,613	5	15,000	25,587	1,479,442	46,233
Nitric Acid	30	22,388	17,418	10	0	7,655	47,471	1,582
Chlorine	30	5,345	25,787	7,818	0	0	38,950	1,298
Methanol	20	38,447	3,068,775	63,362	20	185	3,170,789	158,539
Formaldehyde	13	730	20,874	10	220	5	21,839	1,680
Chromium Compounds	11	251	0	536	90	1,430	2,307	210
Nickel Compounds	10	255	250	795	270	565	2,135	214
Copper	8	5	10	0	0	0	15	2
Zinc (Fume or Dust)	8	5	8	0	0	0	13	2
Lead Compounds	7	17	270	510	0	0	797	114
Hydrogen Fluoride	7	15,325	13,820	15	0	3,309	32,469	4,638
Diethanolamine	6	5	7,907	31,470	0	0	39,382	6,564
2,4-D	5	21	251	0	0	0	272	54
Manganese	5	5	10	0	0	0	15	3
Diazinon	4	0	2	0	0	0	2	1
Benfluralin	4	445	258	0	0	0	703	176
Atrazine	3	140	0	0	0	0	140	47
Trifluralin	2	239	0	0	0	0	239	120
Chromium	2	400	0	0	0	0	400	200
Cadmium Compounds	1
Cobalt Compounds	1
Diisocyanates	1	10	70	0	0	0	80	80
Certain Glycol Ethers	1	0	0	0	0	0	0	0
Carbaryl	1	5	5	0	0	0	10	10
N-butyl Alcohol	1	5	0	0	0	0	5	5
Quintozene	1	0	0	0	0	0	0	0
Mecoprop	1	10	250	0	0	0	260	260
Methoxone	1	5	250	0	0	0	255	255
Ethylene Glycol	1	750	0	13,000	0	250	14,000	14,000
Methyl Isobutyl Ketone	1	73,325	16,241	0	0	0	89,566	89,566
Dicofol	1	250	0	.	0	0	250	250
2,4-DP	1	7	250	0	0	0	257	257
Asbestos (Friable)	1	0	0	0	0	0	0	0
Dicamba	1	12	250	0	0	0	262	262
Nickel	1	400	0	0	0	0	400	400
Vanadium (Fume or Dust)	1
Hydrochloric Acid (1995 and after "Acid Aerosols" Only)	1	0	0	0	260,000	0	260,000	260,000
Thiophanate-methyl	1	0	0	0	0	0	0	0
Pendimethalin	1	0	0	0	0	0	0	0
Oxyfluorfen	1	0	0	0	0	0	0	0
	190**	4,766,111	48,851,072	6,603,991	1,787,475	29,320,121	91,327,740	480,672

** Total number of facilities (not chemical reports) reporting to TRI in this industry sector.

Table 15: 1996 TRI Transfers for Agricultural Chemicals Facilities (SICs 2873,2874,2875) by Number and Facilities Reporting (Transfers reported in pounds/year)

Chemical Name	# Reporting Chemical	Potw Transfers	Disposal Transfers	Recycling Transfers	Treatment Transfers	Energy Recovery Transfers	Total Transfers	Avg Transfer Per Facility
Ammonia	106	51600	.	.	11477	.	63077	595
Phosphoric Acid	72	0	289528	.	418	.	289946	4,027
Zinc Compounds	56	5	1060	179327	45834	.	226226	4,040
Manganese Compounds	43	0	1000	.	3834	.	4834	112
Nitrate Compounds	42	95000	.	14657	750	.	110407	2,629
Copper Compounds	37	0	11861	384419	11000	.	407280	11,008
Sulfuric Acid (1994 and after "Acid Aerosols" Only)	32	0	0	0
Nitric Acid	30	0	250	.	.	.	250	8
Chlorine	30	25	25	1
Methanol	20	1542	1542	77
Formaldehyde	13	250	250	19
Chromium Compounds	11	0	14207	63230	.	.	77437	7,040
Nickel Compounds	10	0	.	81600	20000	.	101600	10,160
Copper	8	0	.	14657	.	.	14657	1,832
Zinc (Fume or Dust)	8	0	505	14657	5	.	15167	1,896
Lead Compounds	7	0	10	.	.	.	10	1
Hydrogen Fluoride	7	0	0	0
Diethanolamine	6	19940	.	.	20000	.	39940	6,657
2,4-D	5	0	.	.	4613	.	4613	923
Manganese	5	0	0	0
Diazinon	4	0	.	.	4608	.	4608	1,152
Benfluralin	4	0	.	.	1250	.	1250	313
Atrazine	3	0	.	.	107880	.	107880	35,960
Trifluralin	2	0	0	0
Chromium	2	0	.	14657	.	.	14657	7,329
Cadmium Compounds	1
Cobalt Compounds	1
Diisocyanates	1	0	0	0
Certain Glycol Ethers	1	0	0	0
Carbaryl	1	0	.	.	591	.	591	591
N-butyl Alcohol	1	0	0	0
Quintozene	1	0	.	.	4358	.	4358	4,358
Mecoprop	1	0	.	.	250	.	250	250
Methoxone	1	0	.	.	250	.	250	250
Ethylene Glycol	1	0	.	185	.	.	185	185
Methyl Isobutyl Ketone	1	0	0	0
Dicofol	1	0	250	.	.	.	250	250
2,4-DP	1	0	.	.	250	.	250	250
Asbestos (Friable)	1	0	19300	.	.	.	19300	19,300
Dicamba	1	0	.	.	250	.	250	250
Nickel	1	0	.	14657	.	.	14657	14,657
Vanadium (Fume or Dust)	1
Hydrochloric Acid (1995 and after "Acid Aerosols" Only)	1	0	0	0
Thiophanate-methyl	1	0	.	.	4358	.	4358	4,358
Pendimethalin	1	0	.	.	4358	.	4358	4,358
Oxyfluorfen	1	0	.	.	4358	.	4358	4,358
	190**	168,362	337,971	782,046	250,692	0	1,539,071	8,100

** Total number of facilities (not chemical reports) reporting to TRI in this industry sector.

Table 16: 1996 TRI Releases for Agricultural Chemicals Facilities (SIC 2879) by Number of Facilities Reporting (Releases reported in pounds/year)

Chemical Name	# Reporting Chemical	Fugitive Air	Point Air	Water Discharges	Underground Injection	Land Disposal	Total Releases	Avg. Releases Per Facility
1,2,4-trimethylbenzene	24	5310	3185	0	0	0	8495	354
Xylene (Mixed Isomers)	24	24494	16327	0	17760	0	58581	2,441
Ethylene Glycol	22	7856	819	2521	2290	7922	21408	973
Naphthalene	21	4536	3402	17	0	20	7975	380
Malathion	17	571	280	10	0	0	861	51
Diazinon	17	21	227	10	0	0	258	15
Ammonia	14	20529	36889	4908	2300	360	64986	4,642
2,4-D	13	1926	1535	5	0	255	3721	286
Carbaryl	12	1005	9005	10	0	2500	12520	1,043
Methanol	12	12434	35850	8217	400300	51	456852	38,071
N-butyl Alcohol	12	1498	1668	0	0	0	3166	264
Captan	12	519	12106	5	5	0	12635	1,053
Quintozene	11	1050	561	0	0	0	1611	146
Trifluralin	11	1304	2578	87	0	0	3969	361
Chlorothalonil	11	622	1005	0	0	1670	3297	300
2,4-d 2-ethylhexyl Ester	11	2160	1065	5	0	0	3230	294
Ethylbenzene	10	1065	421	0	0	0	1486	149
Atrazine	10	4000	2430	5	1	0	6436	644
Copper Compounds	9	547	188	11	0	5	751	83
Zinc Compounds	9	2299	2307	0	0	0	4606	512
Dimethylamine	9	3547	7560	0	250	0	11357	1,262
Arsenic Compounds	8	267	1089	14	0	0	1370	171
Certain Glycol Ethers	8	10501	250	0	0	0	10751	1,344
Lindane	8	255	255	5	0	250	765	96
Bromomethane	8	9398	63421	0	0	0	72819	9,102
Chloropicrin	8	2240	5835	0	0	0	8075	1,009
Cumene	8	108	78	0	0	0	186	23
Permethrin	8	976	509	0	0	0	1485	186
Dicamba	7	348	324	132	59200	0	60004	8,572
Piperonyl Butoxide	6	35	6	0	0	0	41	7
Dimethoate	6	225	260	10	0	0	495	83
Mecoprop	6	510	920	0	0	255	1685	281
Toluene	6	11676	27350	39	536	71	39672	6,612
Thiram	6	510	1000	0	0	0	1510	252
Methyl Parathion	6	716	312	0	0	0	1028	171
Diuron	6	261	1250	8	0	0	1519	253
Prometryn	6	250	268	0	0	0	518	86
Chlorine	6	6020	2455	0	5	0	8480	1,413
Manganese Compounds	5	6657	75	0	0	0	6732	1,346
Nitrate Compounds	5	5	6	22000	0	0	22011	4,402
1,1,1-trichloroethane	5	1729	7400	0	0	0	9129	1,826
Carbon Disulfide	5	6817	112994	0	5	0	119816	23,963
Methoxone	5	265	510	250	0	250	1275	255
Metham Sodium	5	1266	258	1	0	2	1527	305
N-methyl-2-pyrrolidone	5	310	10	5	750	5	1080	216
Carbofuran	5	22	274	1	0	0	297	59
Bromoxynil Octanoate	5	270	251	0	0	0	521	104
Maneb	5	0	0	0	0	0	0	0
Cyanazine	5	285	1625	0	0	0	1910	382
Formaldehyde	4	3020	8018	1083	0	5	12126	3,032
Chloromethane	4	7434	82165	0	0	9	89608	22,402
Dichloromethane	4	12585	256135	100	0	23	268843	67,211
O-xylene	4	5602	35250	5	0	5	40862	10,216
Methyl Isobutyl Ketone	4	105310	58755	5	0	5	164075	41,019
Simazine	4	1005	1005	5	0	0	2015	504
Hydrochloric Acid (1995 and after "Acid Aerosols" Only)	4	3698	48257	0	0	56	52011	13,003
Phosphoric Acid	4	438	0	0	0	0	438	110
Sulfuric Acid (1994 and after "Acid Aerosols" Only)	4	1009	1	0	0	15	1025	256
Metribuzin	4	2	1010	5	0	0	1017	254
Acephate	4	255	1250	0	0	0	1505	376
Chromium Compounds	3	250	88	3	0	0	341	114
Chlorodifluoromethane	3	11406	2441	0	0	0	13847	4,616
Maleic Anhydride	3	1079	2385	5	0	0	3469	1,156
M-xylene	3	508	250	0	0	0	758	253
Dicofol	3	210	0	0	0	0	210	70
Aldicarb	3	21	1205	0	0	5	1231	410
Linuron	3	5	5	5	0	0	15	5
Ethyl Dipropylthiocarbamate	3	6706	619	2	29	0	7356	2,452
Paraquat Dichloride	3	500	500	0	0	0	1000	333

Table 16: 1996 TRI Releases for Agricultural Chemicals Facilities (SIC 2879) by Number of Facilities Reporting (Releases reported in pounds/year)

Chemical Name	# Reporting Chemical	Fugitive Air	Point Air	Water Discharges	Underground Injection	Land Disposal	Total Releases	Avg. Releases Per Facility
Propachlor	3	0	0	0	0	0	0	0
Fluometuron	3	260	512	0	0	0	772	257
Dimethylamine Dicamba	3	580	5	0	0	5	590	197
Carboxin	3	8	0	0	0	0	8	3
Copper	3	0	5	0	0	0	5	2
Ethoprop	3	250	615	0	0	0	865	288
Thiophanate-methyl	3	70	9	0	0	0	79	26
Pendimethalin	3	970	260	22	0	140	1392	464
Hexazinone	3	17	283	0	0	0	300	100
Ethylenebisdithiocarbamic Acid, Salts and Esters	2	1057	57	0	0	0	1114	557
Trichlorfon	2
Parathion	2
Dichlorvos	2	0	0	0	0	0	0	0
S,s,s-tributyltrithiophosphate	2	1325	473	2	0	8	1808	904
2,4-db	2	470	250	0	0	0	720	360
1,4-dichlorobenzene	2	340	1371	0	0	0	1711	856
1,2-dichloroethane	2	6300	57000	33	0	250	63583	31,792
Chlorobenzene	2	320	0	0	0	0	320	160
Phenol	2	533	0	1	0	0	534	267
Diethanolamine	2	255	255	0	0	0	510	255
2,4-dp	2	250	5	0	0	5	260	130
Naled	2	0	50	0	0	0	50	25
Hydrazine	2	201	12	0	0	0	213	107
1,3-dichloropropylene	2	2301	120	0	0	0	2421	1,211
Propanil	2	250	2627	0	0	0	2877	1,439
Ametryn	2	255	298	5	0	0	558	279
Cycloate	2	0	49	1	2	0	52	26
Bromoxynil	2	5	10	0	0	0	15	8
2,4-d Butoxyethyl Ester	2	262	401	0	0	0	663	332
Sodium Dicamba	2	5	750	0	0	0	755	378
Dipotassium Endothall	2	39	4	0	0	0	43	22
Molinate	2	315	271	1	0	0	587	294
Chlorpyrifos Methyl	2	5	5	0	0	0	10	5
Zinc (Fume or Dust)	2	250	0	0	0	0	250	125
Nitric Acid	2	4000	398	5	0	280	4683	2,342
Resmethrin	2	1	0	0	0	0	1	1
Desmedipham	2	15	0	0	0	0	15	8
Thiophanate Ethyl	2
Thiobencarb	2	530	281	0	0	0	811	406
Thiodicarb	2	250	1000	0	0	250	1500	750
Propiconazole	2	5	5	0	0	0	10	5
Cyfluthrin	2	3	13	0	0	350	366	183
Fomesafen	2	255	250	0	0	0	505	253
Quizalofop-ethyl	2	1	0	0	0	0	1	1
Lactofen	2	847	29	0	0	0	876	438
Bifenthrin	2	6	1	0	0	0	7	4
Myclobutanil	2
Antimony Compounds	1	0	2	0	0	0	2	2
Chlorophenols	1	250	250	0	73400	0	73900	73,900
Cyanide Compounds	1	15	41	5	0	5	66	66
Diisocyanates	1
Lead Compounds	1	130	139	0	0	0	269	269
Carbon Tetrachloride	1	66	41000	0	5	0	41071	41,071
Formic Acid	1	810	700	29	0	0	1539	1,539
Isopropyl Alcohol (Manufacturing, Strong-acid Process Only, No Supplies)	1	0	15	0	0	0	15	15
N,n-dimethylformamide	1	1	38	0	0	0	39	39
Methoxychlor	1	5	5	0	0	0	10	10
Vinyl Chloride	1	552	644	0	0	0	1196	1,196
Tert-butyl Alcohol	1	20	121	0	0	0	141	141
2-methylacetonitrile	1	0	180	0	0	0	180	180
Triphenyltin Hydroxide	1
Hexachlorocyclopentadiene	1	5	5	0	250	0	260	260
Dicyclopentadiene	1	141	562	0	0	0	703	703
Dimethyl Sulfate	1
Methyl Ethyl Ketone	1	32	240	0	0	0	272	272
Dichloran	1
P-xylene	1	5	5	0	0	0	10	10
1,3-butadiene	1	77	1200	0	0	0	1277	1,277
Cyclohexanol	1	0	18	0	0	0	18	18

Table 16: 1996 TRI Releases for Agricultural Chemicals Facilities (SIC 2879) by Number of Facilities Reporting (Releases reported in pounds/year)

Chemical Name	# Reporting Chemical	Fugitive Air	Point Air	Water Discharges	Underground Injection	Land Disposal	Total Releases	Avg. Releases Per Facility
N-hexane	1	2910	5560	0	0	0	8470	8,470
Pyridine	1	4836	5617	0	0	0	10453	10,453
Propoxur	1
Di(2-ethylhexyl) Phthalate	1	10	25	0	0	0	35	35
Hexachlorobenzene	1	5	0	0	0	0	5	5
1,2,4-trichlorobenzene	1	8000	750	0	750	0	9500	9,500
2,4-dichlorophenol	1	2630	250	0	15390	0	18270	18,270
Triethylamine	1	3298	101	0	0	0	3399	3,399
Hydroquinone	1	250	5	0	0	0	255	255
Folpet	1	0	5	0	0	0	5	5
Merphos	1	200	0	0	0	0	200	200
Oxydemeton Methyl	1
Bromacil	1	6	0	0	0	0	6	6
Methyl Isothiocyanate	1	0	0	0	0	0	0	0
Perchloromethyl Mercaptan	1	0	510	0	0	0	510	510
Methyl Isocyanate	1	0	0	0	0	0	0	0
Pebulate	1	250	250	0	.	0	500	500
Benfluralin	1
Nitrapyrin	1
Triallate	1	250	250	0	0	0	500	500
Dodine	1	5	5	0	0	0	10	10
Dimethyl Chlorothiophosphate	1	0	0	0	0	0	0	0
Temephos	1
Terbacil	1
Hydrogen Fluoride	1	0	0	0	0	0	0	0
Bromine	1	0	0	0	0	0	0	0
Mevinphos	1	0	0	0	0	0	0	0
Phosphine	1	0	1076	0	0	0	1076	1,076
Creosote	1	15	25	0	0	0	40	40
Zineb	1
Fenbutatin Oxide	1
Alachlor	1	2100	0	0	0	0	2100	2,100
Benomyl	1
Oryzalin	1
Oxydiazon	1	5	250	0	0	0	255	255
Aluminum Phosphide	1
Bendiocarb	1
Pronamide	1	5	250	0	0	0	255	255
Toluene Diisocyanate (Mixed Isomers)	1
Propetamphos	1	5	5	0	0	250	260	260
Amitraz	1
Tebuthiuron	1	0	5	0	0	0	5	5
Diflubenzuron	1
Sulprofos	1
Dinocap	1
Fenpropathrin	1
Profenofos	1
Oxyfluorfen	1
Triadimefon	1
Vinclozolin	1
Fenvalerate	1	1	0	0	0	0	1	1
Dimethipin	1
Triclopyr Triethylammonium Salt	1	0	6	0	0	0	6	6
Fenarimol	1
Acifluorfen, Sodium Salt	1	0	0	2	0	5	7	7
Chlorsulfuron	1	0	1	.	0	0	1	1
Fluvalinate	1
Chlorimuron Ethyl	1	0	1	.	0	0	1	1
Tribenuron Methyl	1	0	1	.	0	0	1	1
	193**	369,954	995,519	39,600	573,228	15,287	1,993,588	10,329

** Total number of facilities (not chemical reports) reporting to TRI in this industry sector.

**Table 17: 1996 TRI Transfers for Agricultural Chemicals Facilities (SIC 2879)
by Number and Facilities Reporting (Transfers reported in pounds/year)**

Chemical Name	# Reporting Chemical	Potw Transfers	Disposal Transfers	Recycling Transfers	Treatment Transfers	Energy Recovery Transfers	Total Transfers	Avg Transfer Per Facility
1,2,4-trimethylbenzene	24	5	475	.	43314	.	43794	1,825
Xylene (Mixed Isomers)	24	9	2599	4851510	731777	1020414	6606309	275,263
Ethylene Glycol	22	463	3600	16070	11478	.	31611	1,437
Naphthalene	21	0	823	.	6962	45	7830	373
Malathion	17	0	.	.	1207	.	1207	71
Diazinon	17	0	.	.	3370	.	3370	198
Ammonia	14	25397	.	.	47248	.	72645	5,189
2,4-d	13	263	6017	.	8700	.	14980	1,152
Carbaryl	12	5	2750	.	61666	.	64421	5,368
Methanol	12	4367	5	.	126038	1186991	1317401	109,783
N-butyl Alcohol	12	5	584	.	4150	.	4739	395
Captan	12	0	2191	.	2081	.	4272	356
Quintozene	11	4	.	.	392714	221410	614128	55,830
Trifluralin	11	5	2278	.	9772	.	12055	1,096
Chlorothalonil	11	255	2005	.	1518	.	3778	343
2,4-d 2-ethylhexyl Ester	11	5	2077	.	23721	.	25803	2,346
Ethylbenzene	10	0	231	807182	150224	214836	1172473	117,247
Atrazine	10	73	5673	.	28161	.	33907	3,391
Copper Compounds	9	0	9267	754	1500	.	11521	1,280
Zinc Compounds	9	5	260	2730	.	.	2995	333
Dimethylamine	9	5	.	.	520	.	525	58
Arsenic Compounds	8	10	100655	.	231855	.	332520	41,565
Certain Glycol Ethers	8	57107	.	.	1132	.	58239	7,280
Lindane	8	0	276	.	1388	.	1664	208
Bromomethane	8	0	0	0
Chloropicrin	8	0	0	0
Cumene	8	0	5	.	1453	.	1458	182
Permethrin	8	0	1250	.	1617	.	2867	358
Dicamba	7	5	.	.	125	.	130	19
Piperonyl Butoxide	6	0	.	.	2082	.	2082	347
Dimethoate	6	0	.	.	3091	.	3091	515
Mecoprop	6	5	3896	.	2497	.	6398	1,066
Toluene	6	0	.	.	2171	.	2171	362
Thiram	6	2	533	.	38081	.	38616	6,436
Methyl Parathion	6	0	360	.	2120	.	2480	413
Diuron	6	250	.	.	380	.	630	105
Prometryn	6	12	250	.	6580	.	6842	1,140
Chlorine	6	6319	6319	1,053
Manganese Compounds	5	5	5	21	6309	.	6340	1,268
Nitrate Compounds	5	5	5	.	.	.	10	2
1,1,1-trichloroethane	5	0	.	.	22147	.	22147	4,429
Carbon Disulfide	5	0	0	0
Methoxone	5	5	4778	.	941	.	5724	1,145
Metham Sodium	5	1	15862	.	4603	557	21023	4,205
N-methyl-2-pyrrolidone	5	0	1770	.	8041	.	9811	1,962
Carbofuran	5	0	.	.	17525	.	17525	3,505
Bromoxynil Octanoate	5	0	16605	.	1448	.	18053	3,611
Maneb	5	0	250	.	1108	.	1358	272
Cyanazine	5	62	755	.	13905	.	14722	2,944
Formaldehyde	4	0	1200	.	29000	.	30200	7,550
Chloromethane	4	0	26	.	.	.	26	7
Dichloromethane	4	0	.	19277	3555	.	22832	5,708
O-xylene	4	0	.	.	1310	.	1310	328
Methyl Isobutyl Ketone	4	940	.	.	1630	.	2570	643
Simazine	4	5	1255	.	250	.	1510	378
Hydrochloric Acid (1995 and after "Acid Aerosols" Only)	4	0	0	0
Phosphoric Acid	4	0	25549	.	.	.	25549	6,387
Sulfuric Acid (1994 and after "Acid Aerosols" Only)	4	0	0	0
Metribuzin	4	0	.	.	13213	.	13213	3,303
Acephate	4	250	.	.	15800	.	16050	4,013
Chromium Compounds	3	1	11257	.	155	.	11413	3,804
Chlorodifluoromethane	3	0	0	0
Maleic Anhydride	3	0	0	0
M-xylene	3	0	.	.	410	.	410	137
Dicofol	3	0	.	.	250	.	250	83
Aldicarb	3	0	.	.	32289	.	32289	10,763
Linuron	3	0	0	0
Ethyl Dipropylthiocarbamate	3	5	590	.	9610	.	10205	3,402

**Table 17: 1996 TRI Transfers for Agricultural Chemicals Facilities (SIC 2879)
by Number and Facilities Reporting (Transfers reported in pounds/year)**

Chemical Name	# Reporting Chemical	Potw Transfers	Disposal Transfers	Recycling Transfers	Treatment Transfers	Energy Recovery Transfers	Total Transfers	Avg Transfer Per Facility
Paraquat Dichloride	3	32	5	.	250	.	287	96
Propachlor	3	15	.	.	6490	.	6505	2,168
Fluometuron	3	235	1505	.	13785	.	15525	5,175
Dimethylamine Dicamba	3	0	255	.	.	.	255	85
Carboxin	3	2	384	.	390	.	776	259
Copper	3	0	0	0
Ethoprop	3	0	250	.	1105	.	1355	452
Thiophanate-methyl	3	0	1167	.	.	.	1167	389
Pendimethalin	3	0	0	0
Hexazinone	3	250	250	.	250	.	750	250
Ethylenebisdithiocarbamic Acid, Salts and Esters	2	0	.	.	12830	.	12830	6,415
Trichlorfon	2	0	0	0
Parathion	2
Dichlorvos	2	0	.	.	145	104	249	125
S,s,s-tributyltrithiophosphate	2	0	.	.	116	.	116	58
2,4-db	2	0	.	.	792	.	792	396
1,4-dichlorobenzene	2	0	.	.	1365	.	1365	683
1,2-dichloroethane	2	0	0	0
Chlorobenzene	2	0	.	.	1700	.	1700	850
Phenol	2	0	0	0
Diethanolamine	2	5	51	.	5	.	61	31
2,4-dp	2	0	39	.	3	.	42	21
Naled	2	5	.	.	3176	.	3181	1,591
Hydrazine	2	0	0	0
1,3-dichloropropylene	2	0	.	.	51325	.	51325	25,663
Propanil	2	0	.	.	1744	.	1744	872
Ametryn	2	0	.	.	9700	.	9700	4,850
Cycloate	2	0	28	.	1006	.	1034	517
Bromoxynil	2	0	1388	.	8	.	1396	698
2,4-d Butoxyethyl Ester	2	0	.	.	3256	.	3256	1,628
Sodium Dicamba	2	750	750	375
Dipotassium Endothall	2	0	.	.	250	.	250	125
Molinate	2	0	4405	.	1256	21	5682	2,841
Chlorpyrifos Methyl	2	0	.	.	500	.	500	250
Zinc (Fume or Dust)	2	0	0	0
Nitric Acid	2	0	0	0
Resmethrin	2	0	.	.	600	.	600	300
Desmedipham	2	0	.	.	492	.	492	246
Thiophanate Ethyl	2
Thiobencarb	2	0	4930	.	.	.	4930	2,465
Thiodicarb	2	5	250	.	18411	.	18666	9,333
Propiconazole	2	0	1332	.	.	.	1332	666
Cyfluthrin	2	0	.	.	1019	.	1019	510
Fomesafen	2	0	2501	.	5	.	2506	1,253
Quizalofop-ethyl	2	0	0	0
Lactofen	2	0	250	.	3069	.	3319	1,660
Bifenthrin	2	0	.	.	48	.	48	24
Myclobutanil	2
Antimony Compounds	1	0	132	.	.	.	132	132
Chlorophenols	1	0	2290	.	1198	670	4158	4,158
Cyanide Compounds	1	0	.	.	4	.	4	4
Diisocyanates	1
Lead Compounds	1	0	.	65000	.	.	65000	65,000
Carbon Tetrachloride	1	0	0	0
Formic Acid	1	0	830	.	2800	.	3630	3,630
Isopropyl Alcohol (Manufacturing, Strong-acid Process Only, No Supplies)	1	0	.	.	.	529	529	529
N,n-dimethylformamide	1	250	54765	.	4055	2331	61401	61,401
Methoxychlor	1	.	.	.	500	.	500	500
Vinyl Chloride	1	0	0	0
Tert-butyl Alcohol	1	0	.	.	416	.	416	416
2-methylacetonitrile	1	0	0	0
Triphenyltin Hydroxide	1
Hexachlorocyclopentadiene	1	0	.	.	3735	800	4535	4,535
Dicyclopentadiene	1	0	0	0
Dimethyl Sulfate	1	0	0	0
Methyl Ethyl Ketone	1	0	.	.	814	.	814	814
Dichloran	1
p-xylene	1	0	.	.	250	.	250	250
1,3-butadiene	1	0	0	0

**Table 17: 1996 TRI Transfers for Agricultural Chemicals Facilities (SIC 2879)
by Number and Facilities Reporting (Transfers reported in pounds/year)**

Chemical Name	# Reporting Chemical	Potw Transfers	Disposal Transfers	Recycling Transfers	Treatment Transfers	Energy Recovery Transfers	Total Transfers	Avg Transfer Per Facility
Cyclohexanol	1	0	.	.	35289	.	35289	35,289
N-hexane	1	0	.	.	20740	56	20796	20,796
Pyridine	1	8506	8506	8,506
Propoxur	1
Di(2-ethylhexyl) Phthalate	1	2	.	.	1033	.	1035	1,035
Hexachlorobenzene	1	0	.	.	3849	2215	6064	6,064
1,2,4-trichlorobenzene	1	0	.	.	7920	890	8810	8,810
2,4-dichlorophenol	1	0	0	0
Triethylamine	1	0	.	.	61668	2568	64236	64,236
Hydroquinone	1	250	250	250
Folpet	1	0	0	0
Merphos	1	0	0	0
Oxydemeton Methyl	1
Bromacil	1	0	.	.	868	.	868	868
Methyl Isothiocyanate	1	0	0	0
Perchloromethyl Mercaptan	1	0	0	0
Methyl Isocyanate	1	0	0	0
Pebulate	1	0	500	.	250	.	750	750
Benfluralin	1
Nitrapyrin	1
Triallate	1	0	509	.	676	.	1185	1,185
Dodine	1	0	.	.	500	.	500	500
Dimethyl Chlorothiophosphate	1	0	0	0
Temephos	1
Terbacil	1
Hydrogen Fluoride	1	0	0	0
Bromine	1	750	750	750
Mevinphos	1	0	0	0
Phosphine	1	0	0	0
Creosote	1	5	.	.	602	.	607	607
Zineb	1
Fenbutatin Oxide	1
Alachlor	1	0	.	.	8600	.	8600	8,600
Benomyl	1
Oryzalin	1
Oxydiazon	1	0	.	.	250	.	250	250
Aluminum Phosphide	1
Bendiocarb	1
Pronamide	1	0	.	.	500	.	500	500
Toluene Diisocyanate (Mixed Isomers)	1
Propetamphos	1	0	1000	.	.	.	1000	1,000
Amitraz	1
Tebuthiuron	1	0	.	.	937	.	937	937
Diflubenzuron	1
Sulprofos	1	0	0	0
Dinocap	1
Fenpropathrin	1
Profenofos	1
Oxyfluorfen	1
Triadimefon	1	0	0	0
Vinclozolin	1
Fenvalerate	1	0	.	.	3994	.	3994	3,994
Dimethipin	1
Triclopyr Triethylammonium Salt	1	0	.	.	82	.	82	82
Fenarimol	1
Acifluorfen, Sodium Salt	1	0	0	0
Chlorsulfuron	1	0	.	.	9807	.	9807	9,807
Fluvalinate	1
Chlorimuron Ethyl	1	0	.	.	36604	.	36604	36,604
Tribenuron Methyl	1	0	.	.	17387	.	17387	17,387
	193**	106,917	306,983	5,762,544	2,494,611	2,654,437	11,325,492	58,681

** Total number of facilities (not chemical reports) reporting to TRI in this industry sector.

Top 10 TRI Releasing Agricultural Chemical Companies

The TRI database contains a detailed compilation of self-reported, facility-specific chemical releases. The top reporting facilities for the agricultural chemical industries are listed below in Tables 18,19, 20, and 21. Facilities that have reported the primary SIC codes covered under this notebook appear on Table 18 for fertilizers and Table 20 for pesticides and miscellaneous agricultural chemicals. Tables 19 and 21 contain additional facilities that have reported the SIC codes covered within this report, and one or more SIC codes that are not within the scope of this notebook. Therefore, the second list includes facilities that conduct multiple operations -- some that are under the scope of this notebook, and some that are not. Currently, the facility-level data do not allow pollutant releases to be broken apart by industrial process.

Table 18: Top 10 TRI Releasing Fertilizer Manufacturing and Mixing Facilities (SIC 2873, 2874, 2875)*		
Rank	Facility	Total TRI Releases in Pounds
1	PCS Phosphate Co., Inc. - Aurora, NC	13,202,617
2	CF Ind. Inc. - Donaldsonville, LA	5,823,740
3	Unocal Agricultural Products - Kenai, AK	4,715,420
4	Terra Nitrogen - Catoosa, OK	4,147,000
5	PCS Nitrogen Fertilizer LP - Millington, TN	3,957,624
6	IMC Nitrogen Co. - East Dubuque, IL	3,954,025
7	IMC-Agrico - Uncle Sam, LA	3,570,548
8	Triad Chemical - Donaldsonville, LA	3,478,835
9	IMC-Agrico - Mulberry, FL	3,161,160
10	Farmland Ind. Inc. - Enid, OK	2,804,790
	Total	45,615,759

Source: *US Toxics Release Inventory Database, 1996.*
 *Being included on this list does not mean that the release is associated with non-compliance with environmental laws.

Table 19: Top 10 TRI Releasing Facilities Reporting Fertilizer Manufacturing and Mixing SIC Codes *			
Rank	Facility	SIC Codes Reported in TRI	Total TRI Releases in Pounds
1	PCS Phosphate Co. Inc. - Geismar, LA	2873, 2874, 2819	23,192,580
2	PCS Phosphate Co. Inc. - Aurora, NC	2874	13,202,617
3	IMC Agrico Co. - St. James, LA	2873, 2874, 2819	12,794,917
4	Du Pont - Beaumont, TX	2822, 2865, 2869, 2873	10,880,836
5	Rubicon Inc. - Geismar, LA	2865, 2869, 2873	8,327,597
6	Monsanto Co. - Luling, LA	2879, 2834, 2873, 2869, 2819	7,742,540
7	Coastal Chemical Co. - Cheyenne, WY	2813, 2819, 2869, 2873, 2899	7,674,410
8	PCS Phosphate - White Springs, FL	2874, 2819	6,961,770
9	Vicksburg Chemical Co. - Vicksburg, MS	2819, 2873, 2812	6,139,460
10	CF Ind. Inc. - Donaldsonville, LA	2873	5,823,740
	Total		102,740,467

Source: *US Toxics Release Inventory Database, 1996.*
 * Being included on this list does not mean that the release is associated with non-compliance with environmental laws.

Table 20: Top 10 TRI Releasing Pesticide and Miscellaneous Agricultural Chemicals Facilities (SIC 2879)*

Rank	Facility	Total TRI Releases in Pounds
1	BASF Corp. - Beaumont, TX	649,472
2	Rhone-Poulenc Ag. Co. - Woodbine, GA	242,293
3	American Cyanamid Co. - Palmyra, MO	227,942
4	Zeneca Inc. - Perry, OH	178,291
5	Farmland Ind. Inc. - Saint Joseph, MO	162,037
6	Zeneca Inc. - Pasadena, TX	149,968
7	Bayer Corp. - Kansas City, MO	45,881
8	Trical Inc. - Hollister, CA	32,447
9	FMC Corp. - Institute, WV	22,195
10	McLaughlin Gormley King Co. - Chaska, MN	21,611
	Total	1,732,137

Source: *US Toxics Release Inventory Database, 1996.*

* Being included on this list does not mean that the release is associated with non-compliance with environmental laws.

Table 21: Top 10 TRI Releasing Facilities Reporting Pesticide and Miscellaneous Agricultural Chemicals SIC Codes *

Rank	Facility	SIC Codes Reported in TRI	Total TRI Releases in Pounds
1	Monsanto Co. - Luling, LA	2879, 2834, 2873, 2869, 2819	7,742,540
2	Monsanto - Alvin, TX	2869, 2819, 2841, 2879	7,718,029
3	Uniroyal Chemical Co. - Geismar, LA	2822, 2869, 2879	2,936,127
4	Du Pont - La Porte, TX	2819, 2869, 2879	2,633,242
5	Dow Chemical USA - Midland, MI	2800, 2819, 2821, 2834, 2869, 2879	1,523,414
6	Novartis Crop Protection Inc. - St. Gabriel, LA	2819, 2865, 2869, 2879	1,488,589
7	Tippecanoe Laboratories - Shadeland, IN	2834, 2879	1,206,435
8	Clinton Laboratories - Clinton, IN	2833, 2879	1,158,105
9	Ciba Specialty Chemicals Corp. - McIntosh, AL	2879, 2821, 2865, 3069	1,067,347
10	Du Pont - Belle, WV	2821, 2869, 2879	795,378
	Total		28,269,206

Source: *US Toxics Release Inventory Database, 1996.*

* Being included on this list does not mean that the release is associated with non-compliance with environmental laws.

IV.B. Summary of Selected Chemicals Released

The following is a synopsis of current scientific toxicity and fate information for the top chemicals (by weight) that facilities within this sector self-reported as released to the environment based upon 1995 TRI data. Because this section is based upon self-reported release data, it does not attempt to provide information on management practices employed by the sector to reduce the release of these chemicals. Information regarding pollutant release reduction over time may be available from EPA's TRI and 33/50 programs, or directly from the industrial trade associations that are listed in Section IX of this document. Since these descriptions are cursory, please consult these sources for a more detailed description of both the chemicals described in this section, and the chemicals that appear on the full list of TRI chemicals appearing in Section IV.A.

The brief descriptions provided below were taken from the Hazardous Substances Data Bank (HSDB) and the Integrated Risk Information System (IRIS), both accessed via TOXNET.² The discussions of toxicity describe the range of possible adverse health effects that have been found to be associated with exposure to these chemicals. These adverse effects may or may not occur at the levels released to the environment. Individuals interested in a more detailed picture of the chemical concentrations associated with these adverse effects should consult a toxicologist or the toxicity literature for the chemical to obtain more information. The effects listed below must be taken in context of these exposure assumptions that are explained more fully within the full chemical profiles in HSDB. For more information on TOXNET, contact the TOXNET help line at 1-800-231-3766.

² TOXNET is a computer system run by the National Library of Medicine that includes a number of toxicological databases managed by EPA, National Cancer Institute, and the National Institute for Occupational Safety and Health. For more information on TOXNET, contact the TOXNET help line at 800-231-3766. Databases included in TOXNET are: CCRIS (Chemical Carcinogenesis Research Information System), DART (Developmental and Reproductive Toxicity Database), DBIR (Directory of Biotechnology Information Resources), EMICBACK (Environmental Mutagen Information Center Backfile), GENE-TOX (Genetic Toxicology), HSDB (Hazardous Substances Data Bank), IRIS (Integrated Risk Information System), RTECS (Registry of Toxic Effects of Chemical Substances), and TRI (Toxic Chemical Release Inventory). HSDB contains chemical-specific information on manufacturing and usage, chemical and physical properties, safety and handling, toxicity and biomedical effects, pharmacology, environmental fate and exposure potential, exposure standards and regulations, monitoring and analysis methods, and additional references.

Ammonia³ (CAS: 7664-41-7)

Sources. Ammonia is the primary nitrogen source for all nitrogenous fertilizers and ammonium phosphatic fertilizers.

Toxicity. Anhydrous ammonia is irritating to the skin, eyes, nose, throat, and upper respiratory system.

Ecologically, ammonia is a source of nitrogen (an essential element for aquatic plant growth), and may therefore contribute to eutrophication of standing or slow-moving surface water, particularly in nitrogen-limited waters such as the Chesapeake Bay. In addition, aqueous ammonia is moderately toxic to aquatic organisms.

Carcinogenicity. There is currently no evidence to suggest that ammonia is carcinogenic.

Environmental Fate. Ammonia combines with sulfate ions in the atmosphere and is washed out by rainfall, resulting in rapid return of ammonia to the soil and surface waters.

Ammonia is a central compound in the environmental cycling of nitrogen. Ammonia in lakes, rivers, and streams is converted to nitrate.

Physical Properties. Ammonia is a colorless gas at atmospheric pressure, but is shipped as a liquefied compressed gas. It is soluble to about 34 percent in water and has a boiling point of -28 degrees F. Ammonia is corrosive and has a pungent odor.

Phosphoric Acid (CAS: 7664-38-2)

Sources. Phosphoric acid is the primary phosphorous source used for phosphatic fertilizers.

Toxicity. Phosphoric acid is toxic by ingestion and inhalation, and is an irritant to skin and eyes. The toxicity of phosphoric acid is related to its corrosivity as an acid, with ulceration of membranes and tissues with which it comes in contact. Because it is a source of phosphorous, an essential element for aquatic plant growth, phosphoric acid may contribute to eutrophication of standing or slow-moving surface water, particularly in phosphorous-limited waters such as the Great Lakes.

³ The reporting standards for ammonia were changed in 1995. Ammonium sulfate is deleted from the list and threshold and release determinations for aqueous ammonia are limited to 10 percent of the total ammonia present in solution. This change will reduce the amount of ammonia reported to TRI. Complete details of the revisions can be found in 40 CFR Part 372.

Carcinogenicity. There is currently no evidence to suggest that phosphoric acid is carcinogenic.

Environmental Fate. The acidity of phosphoric acid may be reduced readily by natural water hardness minerals. The phosphate will persist until used by plants as a nutrient.

Physical Properties. Phosphoric acid is a thick, colorless, and odorless crystalline solid, often used in an aqueous solution. Its boiling point is 415° F and it is soluble in water.

Nitrate compounds

Sources. Many different nitrate compounds are formed during nitrogenous fertilizer production.

Toxicity. Nitrate compounds that are soluble in water release nitrate ions which can cause both human health and environmental effects. Human infants exposed to aqueous solutions of nitrate ion can develop a condition in which the blood's ability to carry oxygen is reduced. This reduced supply of oxygen can lead to damaged organs and death. Because it is a source of nitrogen, an essential element for aquatic plant growth, nitrate ion may contribute to eutrophication of standing or slow-moving surface water, particularly in nitrogen-limited waters, such as the Chesapeake Bay.

Carcinogenicity. There is currently no evidence to suggest that nitrate compounds are carcinogenic.

Environmental Fate. Nitrogen in nitrate is the form of nitrogen most available to plants. In the environment, nitrate ion is taken up by plants and becomes part of the natural nitrogen cycle. Excess nitrate can stimulate primary production in plants and can produce changes in the dominant species of plants, leading to cultural eutrophication and ultimately to deterioration of water quality.

Methanol (CAS: 67-56-1)

Sources. Methanol is generated in ammonia production. It is also used as a solvent and for equipment cleaning in pesticide formulations.

Toxicity. Methanol is readily absorbed from the gastrointestinal tract and the respiratory tract and is toxic to humans in moderate to high doses. In the body, methanol is converted into formaldehyde and formic acid. Methanol is excreted as formic acid. Observed toxic effects at high dose levels generally include central nervous system damage and blindness. Long-term

exposure to high levels of methanol via inhalation cause liver and blood damage in animals.

Ecologically, methanol is expected to have low toxicity to aquatic organisms. Concentrations lethal to half the organisms of a test population are expected to exceed one mg methanol per liter water. Methanol is not likely to persist in water or to bioaccumulate in aquatic organisms.

Carcinogenicity. There is currently no evidence to suggest that methanol is carcinogenic.

Environmental Fate. Methanol is highly volatile and flammable. Liquid methanol is likely to evaporate when left exposed. Methanol reacts in air to produce formaldehyde which contributes to the formation of air pollutants. In the atmosphere it can react with other atmospheric chemicals or be washed out by rain. Methanol is readily degraded by microorganisms in soils and surface waters.

Physical Properties. Methanol is a colorless liquid with a characteristic pungent odor. It is miscible with water, and its boiling point is 147°F.

Sulfuric Acid (CAS: 7664-93-9)

Sources. Sulfuric acid is a raw material of most fertilizer products.

Toxicity. Concentrated sulfuric acid is corrosive. In its aerosol form, sulfuric acid has been implicated in causing and exacerbating a variety of respiratory ailments.

Ecologically, accidental releases of solution forms of sulfuric acid may adversely affect aquatic life by inducing a transient lowering of the pH (i.e., increasing the acidity) of surface waters. In addition, sulfuric acid in its aerosol form is also a component of acid rain. Acid rain can cause serious damage to crops and forests.

Carcinogenicity. There is currently no evidence to suggest that sulfuric acid is carcinogenic.

Environmental Fate. Releases of sulfuric acid to surface waters and soils will be neutralized to an extent due to the buffering capacities of both systems. The extent of these reactions will depend on the characteristics of the specific environment.

Physical Properties. Sulfuric acid is an oily, odorless liquid which can be colorless to dark-brown. It is miscible, and its boiling point is 554°F.

Sulfuric acid reacts violently with water with evolution of heat and is corrosive to metals. Pure sulfuric acid is a solid below 51°F.

IV.C. Other Data Sources

The toxic chemical release data obtained from TRI captures only about 236 of the facilities in the Fertilizer, Pesticide, and Agricultural Chemical Industry. However, it allows for a comparison across years and industry sectors. Reported chemicals are limited to the approximately 600 TRI chemicals. A portion of the emissions from agricultural chemical facilities, therefore, are not captured by TRI. The EPA Office of Air Quality Planning and Standards has compiled air pollutant emission factors for determining the total air emissions of priority pollutants (e.g., total hydrocarbons, SO_x, NO_x, CO, particulates, etc.) from many chemical manufacturing and formulating sources.

The Aerometric Information Retrieval System (AIRS) contains a wide range of information related to stationary sources of air pollution, including the emissions of a number of air pollutants which may be of concern within a particular industry. With the exception of volatile organic compounds (VOCs), there is little overlap with the TRI chemicals reported above. Table 22 summarizes annual releases (from the industries for which a Sector Notebook Profile was prepared) of carbon monoxide (CO), nitrogen dioxide (NO₂), particulate matter of 10 microns or less (PM₁₀), sulfur dioxide (SO₂), and volatile organic compounds (VOCs).

Table 22: Air Pollutant Releases by Industry Sector (tons/year)

Industry Sector	CO	NO₂	PM10	PT	SO₂	VOC
Metal Mining	4,951	49,252	21,732	9,478	1,202	119,761
Non-Fuel, Non-Metal Mining	31,008	21,660	44,305	16,433	9,183	138,684
Textiles	8,164	33,053	1,819	38,505	26,326	7,113
Lumber and Wood Products	139,175	45,533	30,818	18,461	95,228	74,028
Wood Furniture and Fixtures	3,659	3,267	2,950	3,042	84,036	5,895
Pulp and Paper	584,817	365,901	37,869	535,712	177,937	107,676
Printing	8,847	3,629	539	1,772	88,788	1,291
Inorganic Chemicals	242,834	93,763	6,984	150,971	52,973	34,885
Plastic Resins and Man-made Fibers	15,022	36,424	2,027	65,875	71,416	7,580
Pharmaceuticals	6,389	17,091	1,623	24,506	31,645	4,733
Organic Chemicals	112,999	177,094	13,245	129,144	162,488	17,765
Agricultural Chemicals	12,906	38,102	4,733	14,426	62,848	8,312
Petroleum Refining	299,546	334,795	25,271	592,117	292,167	36,421
Rubber and Plastic	2,463	10,977	3,391	24,366	110,739	6,302
Stone, Clay, Glass and Concrete	92,463	335,290	58,398	290,017	21,092	198,404
Iron and Steel	982,410	158,020	36,973	241,436	67,682	85,608
Metal Castings	115,269	10,435	14,667	4,881	17,301	21,554
Nonferrous Metals	311,733	31,121	12,545	303,599	7,882	23,811
Fabricated Metal Products	7,135	11,729	2,811	17,535	108,228	5,043
Electronics and Computers	27,702	7,223	1,230	8,568	46,444	3,464
Motor Vehicle Assembly	19,700	31,127	3,900	29,766	125,755	6,212
Aerospace	4,261	5,705	890	757	3,705	10,804
Shipbuilding and Repair	109	866	762	2,862	4,345	707
Ground Transportation	153,631	594,672	2,338	9,555	101,775	5,542
Water Transportation	179	476	676	712	3,514	3,775
Air Transportation	1,244	960	133	147	1,815	144
Fossil Fuel Electric Power	399,585	5,661,468	221,787	13,477,367	42,726	719,644
Dry Cleaning	145	781	10	725	7,920	40

Source: United States EPA Office of Air and Radiation, AIRS Database, 1997.

IV.D. Comparison of Toxic Release Inventory Between Selected Industries

The following information is presented as a comparison of pollutant release and transfer data across industrial categories. It is provided to give a general sense as to the relative scale of TRI releases and transfers within each sector profiled under this project. Please note that the following figure and table do not contain releases and transfers for industrial categories that are not included in this project, and thus cannot be used to draw conclusions regarding the total release and transfer amounts that are reported to TRI. Similar information is available within the annual TRI Public Data Release Book.

Figure 19 is a graphical representation of a summary of the TRI data for the Fertilizer, Pesticide, and Agricultural Chemical Industry and the other sectors profiled in separate notebooks. The bar graph presents the total TRI releases and total transfers on the vertical axis. Industry sectors are presented in the order of increasing SIC code. The graph is based on the data shown in Table 23 and is meant to facilitate comparisons between the relative amounts of releases and transfers both within and between these sectors. Table 23 also presents the average releases per facility in each industry. The reader should note that differences in the proportion of facilities captured by TRI exist between industry sectors. This can be a factor of poor SIC matching and relative differences in the number of facilities reporting to TRI from the various sectors. In the case of the Fertilizer, Pesticide, and Agricultural Chemical Industry, the 1995 TRI data presented here covers 236 facilities. These facilities listed SIC 2873, 2874, 2875, or 2879 as a primary SIC code.

Figure 19: Summary of 1995 TRI Releases and Transfers by Industry

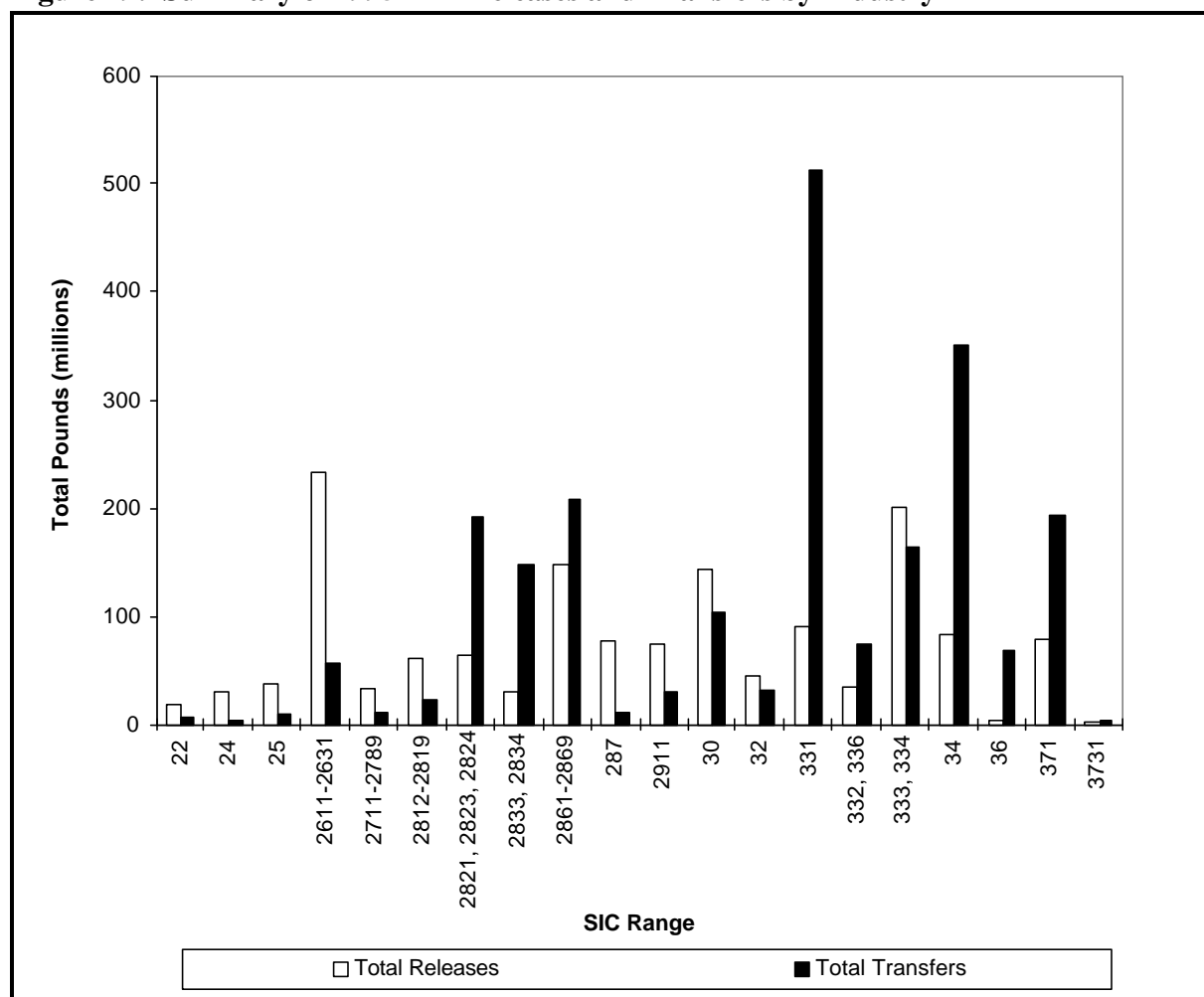

Source: US EPA 1995 Toxics Release Inventory Database.

SIC Range	Industry Sector	SIC Range	Industry Sector	SIC Range	Industry Sector
22	Textiles	2833, 2834	Pharmaceuticals	332, 336	Metal Casting
24	Lumber and Wood Products	2861-2869	Organic Chem. Mfg.	333, 334	Nonferrous Metals
25	Furniture and Fixtures	287	Agricultural Chemicals	34	Fabricated Metals
2611-2631	Pulp and Paper	2911	Petroleum Refining	36	Electronic Equip. and Comp.
2711-2789	Printing	30	Rubber and Misc. Plastics	371	Motor Vehicles, Bodies, Parts, and Accessories
2812-2819	Inorganic Chemical Manufacturing	32	Stone, Clay, and Concrete	3731	Shipbuilding
2821, 2823, 2824	Resins and Plastics	331	Iron and Steel		

Table 23: 1995 Toxics Release Inventory Data for Selected Industries

Industry Sector	SIC Range	# TRI Facilities	TRI Releases		TRI Transfers		Total Releases + Transfers (million lbs.)	Average Releases + Transfers per Facility (pounds)
			Total Releases (million lbs.)	Ave. Releases per Facility (pounds)	Total Transfers (million lbs.)	Ave. Trans. per Facility (pounds)		
Textiles	22	339	17.8	53,000	7.0	21,000	24.8	74,000
Lumber and Wood Products	24	397	30.0	76,000	4.1	10,000	34.1	86,000
Furniture and Fixtures	25	336	37.6	112,000	9.9	29,000	47.5	141,000
Pulp and Paper	2611-2631	305	232.6	763,000	56.5	185,000	289.1	948,000
Printing	2711-2789	262	33.9	129,000	10.4	40,000	44.3	169,000
Inorganic Chem. Mfg.	2812-2819	413	60.7	468,000	21.7	191,000	438.5	659,000
Resins and Plastics	2821,2823,2824	410	64.1	156,000	192.4	469,000	256.5	625,000
Pharmaceuticals	2833, 2834	200	29.9	150,000	147.2	736,000	177.1	886,000
Organic Chemical Mfg.	2861-2869	402	148.3	598,000	208.6	631,000	946.8	1,229,000
Agricultural Chemicals	287	236	77.1	326,788	11.4	48,461	88.5	375,000
Petroleum Refining	2911	180	73.8	410,000	29.2	162,000	103.0	572,000
Rubber and Misc. Plastics	30	1,947	143.1	73,000	102.6	53,000	245.7	126,000
Stone, Clay, and Concrete	32	623	43.9	70,000	31.8	51,000	75.7	121,000
Iron and Steel	331	423	90.7	214,000	513.9	1,215,000	604.6	1,429,000
Metal Casting	332, 336	654	36.0	55,000	73.9	113,000	109.9	168,000
Nonferrous Metals	333, 334	282	201.7	715,000	164	582,000	365.7	1,297,000
Fabricated Metals	34	2,676	83.5	31,000	350.5	131,000	434.0	162,000
Electronic Equip. and Comp.	36	407	4.3	11,000	68.8	169,000	73.1	180,000
Motor Vehicles, Bodies, Parts, and Accessories	371	754	79.3	105,000	194	257,000	273.3	362,000
Shipbuilding	3731	43	2.4	56,000	4.1	95,000	6.5	151,000

Source: US EPA Toxics Release Inventory Database, 1995.

V. POLLUTION PREVENTION OPPORTUNITIES

The best way to reduce pollution is to prevent it in the first place. Some companies have creatively implemented pollution prevention techniques that improve efficiency and increase profits while at the same time minimizing environmental impacts. This can be done in many ways such as reducing material inputs, re-engineering processes to reuse by-products, improving management practices, and substituting toxic chemicals with those less toxic. Some smaller facilities are able to actually get below regulatory thresholds just by reducing pollutant releases through aggressive pollution prevention policies.

The Pollution Prevention Act of 1990 established a national policy of managing waste through source reduction, which means preventing the generation of waste. The Pollution Prevention Act also established as national policy a hierarchy of waste management options for situations in which source reduction cannot be feasibly implemented. In the waste management hierarchy, if source reduction is not feasible the next alternative is recycling of wastes, followed by energy recovery, and waste treatment as a last alternative.

In order to encourage these approaches, this section provides both general and company-specific descriptions of some pollution prevention advances that have been implemented within the Fertilizer, Pesticide, and Agricultural Chemical Industry. While the list is not exhaustive, it does provide core information that can be used as the starting point for facilities interested in beginning their own pollution prevention projects. This section provides summary information from activities that maybe, or are being implemented by this sector. When possible, information is provided that gives the context in which the technique can be used effectively. Please note that the activities described in this section do not necessarily apply to all facilities that fall within this sector. Facility-specific conditions must be carefully considered when pollution prevention options are evaluated, and the full impacts of the change must examine how each option affects air, land and water pollutant releases.

The Fertilizer, Pesticide, and Agricultural Chemical Industry uses many pollution prevention (P2), recycle and reuse, and water conservation practices. Wastewaters are primarily generated not by the production or formulating processes themselves but by cleaning operations of the process areas and associated equipment. Because the wastewaters are mostly cleaning rinsates and not waters of reaction, the pollution prevention practices are not process-specific. There are many P2, recycle and reuse, and water conservation practices that are widely accepted and practiced by the Fertilizer, Pesticide, and Agricultural Chemical Industry today.

These pollution prevention, recycle and reuse, and water conservation practices fall into three groups: production practices, housekeeping practices, and practices that use equipment that, by design, promote pollution prevention. Some of these practices and equipment conserve water, others reduce the amount of fertilizer or pesticide product in the wastewater, and still others may prevent the generation of a wastewater altogether (USEPA, 1996). A number of common P2 practices are listed below.

Production practices include:

- C triple-rinsing raw material shipping containers directly into the formulation
- C scheduling production to minimize cleanouts
- C segregating processing/formulating/packaging equipment by:
 - individual product
 - solvent-based versus water-based formulations
 - products that contain similar active ingredients in different concentrations
- C storing interior equipment rinse waters for use in formulating the same product
- C packaging products directly from formulation vessels
- C using raw material drums for packaging final products
- C dedicating equipment (possibly only mix tank or agitator) for "hard-to-clean" formulations

Housekeeping practices include:

- C performing preventive maintenance on all valves, fittings, and pumps
- C placing drip pans under leaky valves and fittings or under any valves or fittings where hoses or lines are routinely connected and disconnected
- C cleaning up spills or leaks in outdoor bulk containment areas to prevent contamination of storm water

Equipment that promotes pollution prevention by reducing or eliminating wastewater generation includes:

- C low-volume/high-pressure hoses
- C spray nozzle attachments for hoses
- C squeegees and mops
- C low-volume/recirculating floor scrubbing machines
- C portable steam cleaners
- C drum triple rinsing stations
- C roofs over outdoor tank farms (USEPA, 1996)

Table 24: Waste Minimization Methods for the Fertilizer, Pesticide, and Agricultural Chemical Industry	
Waste Stream	Waste Minimization Methods
Equipment Cleaning Wastes	<p>Maximize production runs.</p> <p>Store and reuse cleaning wastes.</p> <p>Use of wiper blades and squeegees.</p> <p>Use of low-volume, high-efficiency cleaning.</p> <p>Use of plastic or foam “pigs.”</p>
Spills and Area Washdowns	<p>Use of dedicated vacuum system.</p> <p>Use of dry cleaning methods.</p> <p>Use of recycled water for initial cleanup.</p> <p>Actively involved supervision.</p>
Off-Specification Products	<p>Strict quality control and automation.</p> <p>Reformulating off-spec batches.</p>
Containers	<p>Return containers to supplier and or reuse as directed.</p> <p>Triple rinse containers.</p> <p>Drums with liners versus plastic drums or bags.</p> <p>Segregating solid waste.</p>
Air Emissions	<p>Control bulk storage air emissions.</p> <p>Dedicate dust collection systems.</p> <p>Use automatic enclosed cut-in hoppers.</p> <p>Eliminate emissions of ammonia from reaction of anhydrous ammonia and phosphoric acid.</p>
Miscellaneous Wastewater Streams	<p>Pave high spillage areas.</p>
<p><i>Source: Guides to Pollution Prevention, The Pesticide Formulating Industry, Center for Environmental Research Information, United States EPA, Cincinnati, Ohio, 1990.</i></p>	

V.A. Equipment Cleaning**Shipping Container/Drum Cleaning Operations**

Fertilizer and pesticide facilities frequently receive raw materials in containers such as 55-gallon plastic or steel drums or 30-gallon fiber drums. In some cases, the empty drums are returned to the supplier, but usually the facility is responsible for disposal of the drums. The simplest, most cost-effective, and best approach to prevent pollution associated with cleaning drums and shipping containers is to rinse empty drums prior to disposal to capture the raw material residue for direct reuse in future formulations of the same product. In this way, the facility not only eliminates a potential highly contaminated wastewater source, but is also able to recover the product value of the raw material and avoids costs associated with storage of the wastewater (USEPA, 1996). However, pesticide chemicals formulating and packaging facilities and pesticide repackaging and refilling facilities should consult the List of Pollution Prevention Alternative Practices and ensure compliance with the effluent guidelines and standards found in 40 CFR 455 Subparts C and E before implementing pollution prevention techniques listed in this section.

Rinsing procedures for pesticide drums are provided in 40 CFR Part 165. The most common method of drum rinsing in the agrichemical industry is triple rinsing. After a drum containing AIs or pesticide products is emptied, it should be triple rinsed with the solvent that will be used in the formulation. This method prevents the creation of a rinsate that cannot be added directly to the formulation (e.g., a facility will not create a water-based rinsate when producing a solvent-based product). Note in some cases the label may specify how to rinse.

Some facilities use a high-pressure, low-volume wash system equipped with a hose and a spray nozzle to triple rinse drums; volumes of five to fifteen gallons of water per drum have been reported. EPA has identified many facilities that reuse these rinsates directly in product formulations. Other facilities treat drum rinsate and reuse the effluent for further drum or equipment rinsing. If the rinsate cannot be reused directly in product formulations, another effective method to reduce wastewater generation during shipping container/drum cleaning processes is the use of drum rinsing stations (USEPA, 1996).

One facility uses a three-cell station for triple-rinsing drums. The water in the first cell is used for the first rinse, the water in the second cell is used for the second rinse, and the water in the third cell is used for the final rinse. The rinse water in the first cell is reused until it is visually too contaminated to effectively clean the drums. At that time, it is removed from the cell (for treatment) and the rinse water from the second cell is transferred into the first cell. The rinse water from the third cell is transferred into the second cell, and the third cell is refilled with treated effluent from their treatment system. Each

cell contains approximately 100 gallons of water; approximately 70 drums can be rinsed before the first cell requires water changing (USEPA, 1996).

Another site uses a unique, closed-loop set-up for emptying and triple rinsing raw material drums. The system was designed by the facility for several purposes: to aid it in emptying and cleaning drums and performing the triple rinse, to eliminate the need for storage of the water (or solvent) for reuse, and to prevent mathematical errors by the operators during the weighing out of raw materials and water (or solvent). The system consists of two 55-gallon drums, a formulation tank, and connecting hoses. One of the drums is permanently fixed on top of the formulation tank. The formulation tank and drum are situated on a load cell (used for weighing). The second drum, which is full of raw material, is placed on the ground next to the formulation tank. One hose is used to vacuum out the raw material and transfer it to the drum on the formulations tank/load cell. The other hose is equipped with a doughnut-shaped nozzle that provides the triple rinse by spraying the interior of the now empty raw material drum. The rinsate that is created by the triple rinse procedure is automatically removed by the vacuum line and is transferred to the drum on the formulation tank/load cell.

The load cell can be used to weigh the amount of raw material and/or rinsate that is added to the formulation by zeroing out the weight of the tank and drum. This allows the volume of both raw material and rinse water (or solvent) to be factored into the total volume of water (or solvent) required in the formulation. The drum on top of the formulation tank is equipped with a spring-loaded valve that enables the operator to take weight measurements prior to emptying the contents of the drum into the mix tank. This set-up has almost completely eliminated operator math errors and related formulation specification problems.

Bulk Tank and Equipment Cleaning

Pesticide formulating and fertilizer mixing facilities sometimes produce large quantities of formulated pesticide and fertilizer products and receive large quantities of raw materials used to produce those products. Those products and raw materials are stored on site in bulk tanks. The tanks are typically rinsed only when it becomes necessary to use the tank to store a different material. Each time the facility switches the product stored in a bulk tank, the tank is rinsed. Bulk tanks are sometimes also rinsed at the end of a season as a part of general maintenance (USEPA, 1996). Pesticide formulating and fertilizer mixing facilities should consult the List of Pollution Prevention Alternative Practices and ensure compliance with the effluent guidelines and standards found in 40 CFR Part 455 Subparts C and E before implementing pollution prevention techniques involving bulk tank and other equipment cleaning.

Product changeover cleanings can be eliminated or greatly reduced by

dedicating equipment to specific products or groups of products. Although entire lines are not generally dedicated, there are many facilities that dedicate tanks to formulation mixing only, thereby eliminating one of the most highly contaminated wastewater streams generated at pesticide formulating and packaging facilities. Facilities also dedicate lines to the production of a specific product type, such as water-based versus solvent-based products, thereby reducing the number of cleanings required, and allowing greater reuse of the cleaning water or solvent.

Another effective pollution prevention technique is to schedule production to reduce the number of product changeovers, which reduces the number of equipment interior cleanings required. Facilities may also reduce the number of changeover cleanings required or the quantity of water or solvent used for cleaning by scheduling products in groups. Products may lend themselves to a particular production sequence if they have common active ingredients, assuming the products also have the same solvent base (including water). Where other raw material cross-contamination problems are not a concern, no cleaning would be required between changeover. Facilities that have implemented this technique have conducted testing to ensure that product quality is not adversely affected (USEPA, 1996).

Scheduling production according to packaging type can reduce changeover cleanings of packaging equipment. Packaging lines are often able to handle containers of different sizes; a slight adjustment to one packaging line, such as adding a short length of hose, may prevent the use of an entirely different set of packaging equipment that would also require cleaning. Packaging can also be performed directly out of the formulation vessels to avoid using and subsequently cleaning interim storage tanks and transfer hoses.

Another effective pollution prevention and water conservation technique to minimize the quantity of rinse water generated by equipment interior cleaning is the use of water hoses equipped with hand-control devices (for example, spray-gun nozzles such as those used on garden hoses). This practice prevents the free flow of water from unattended hoses. Another technique to conserve water is the use of high-pressure, low-volume washers instead of ordinary hoses. One of the facilities visited indicated that, by using high-pressure washers, they reduced typical equipment interior rinse volumes from twenty gallons per rinse to ten gallons per rinse (USEPA, 1996).

Steam cleaning can also be a particularly effective method to clean viscous products that otherwise require considerable volumes of water and/or the addition of a detergent to remove. Many facilities have access to steam from boilers on site; however, if there is no existing source of steam, steam cleaning equipment can be purchased. Although steam generation can increase energy consumption and add NO_x and SO_x pollutants to the atmosphere, there are benefits to be gained. Facilities may end up creating a much smaller volume of wastewater and may potentially avoid the need to use detergents or other

cleaning agents that could prevent product recovery. However, steam would be a poor choice for cleaning applications where volatile organic solvents or inerts are part of the product, as the steam would accelerate the volatilization of the organic compounds.

Facilities also clean equipment interiors by using squeegees to remove the product from the formulation vessel and by using absorbent “pigs” to clean products out of the transfer lines before equipment rinsing. These techniques minimize the quantity of cleaning water required, although they generate a solid waste stream requiring disposal. Regardless of whether or not residual product is removed from equipment interiors before rinsing, if certain conditions are met, equipment interior rinsate can typically be reused as make-up water the next time that a water-based product is being formulated with the same chemical (USEPA, 1996). Pesticide chemicals formulating and packaging facilities and pesticide repackaging and refilling facilities should consult the List of Pollution Prevention Alternative Practices and ensure compliance with the effluent guidelines and standards found in 40 CFR Part 455 Subparts C and E before implementing pollution prevention techniques involving bulk tank and other equipment cleaning.

One facility uses a unique method of cleaning to reduce the volume of water needed to clean equipment interiors. At this facility, the production lines are hooked to dedicated product storage tanks. Prior to rinsing these production lines, the facility uses air to “blow” the residual product in the line back to product storage. Not only will these lines require less water to clean, but the residual product that is blown back to storage is not diluted and should not affect the product specifications in any way.

Another facility drastically reduced dichloromethane usage at several plants by switching to soap and water for cleaning. This change enabled the facility to cut its target chemicals by two-thirds. The facility also reduced the release of carbon tetrachloride, and installed a closed-loop recycling system, to reduce water usage (CMA, 1993).

Aerosol Container Leak Testing

No method of eliminating wastewater from test baths has been identified. However, the volume of water used may be minimized by using a contained (or batch) water bath as opposed to a continuous overflow water bath. A contained water bath is completely emptied and refilled with water when required, based upon visual inspection by the operator. Therefore, the quantity of wastewater generated depends on the frequency of refilling and the volume of the bath (200 gallons is a typical volume of the contained water baths). One facility uses a contained water bath and heats the bath with steam to ensure that the temperature of the cans reaches 130°F. This facility indicated that steam condensation causes some overflow that exits the bath via a standpipe. A continuous overflow bath would probably generate more wastewater per

production unit than a batch water bath (USEPA, 1996).

One facility has installed a diatomaceous earth filter on one DOT test bath. The facility recirculates the bath water through the filter to remove contaminants such as oil and grease and suspended solids. The filtered water is then reused in the bath, thereby extending the usefulness of the bath water. The facility anticipates they will dispose of the filter as nonhazardous waste.

Another facility uses a can-washing step prior to the DOT test bath, presenting an additional source of wastewater. This can washing is performed at the operator's discretion to reduce the quantity of contaminants entering the bath water. The effectiveness of this step has not been quantitatively determined (USEPA, 1996).

Laboratory Equipment Cleaning

Many pesticide formulating and packaging facilities operate on-site laboratories for conducting quality control tests of raw materials and formulated products. Wastewater is generated from these tests and from cleaning glassware used in the tests. One effective pollution prevention/reuse technique during laboratory equipment cleaning operations is to dedicate laboratory sinks to certain products, and collect any wastewater generated from the testing of those products either for reuse in the same product or for transfer back to the AI manufacturer or product registrant. In the cases where the facility uses solvents in conjunction with the quality control tests performed in the laboratory, the solvent-contaminated water may not be able to be reused in the process (USEPA, 1996).

V.B. Process Changes

Storage Tanks

One method to reduce the amount of wastewater from ammonium nitrate production is to incorporate a wastewater evaporator system which reduces the amount of contaminated cooling water discharge. The wastewater passes through a series of evaporation steps whereby the vapors are used as wash water in the calcium carbonate filters and the concentrated solution is pumped to the neutralizers where it is mixed with the acidic nitrogen-phosphate solution and used to regulate the nitrogen-phosphate nutrient ratio of the fertilizer. Through this modified technology, steam and electric energy consumption increases somewhat, but such increases are balanced by the more effective utilization of nitrogen and the reduction of wastewater. More information on this method can be found in "Waste Water Evaporation Process for Fertilizer Production Technology," *Compendium on Low and Non-waste Technology*, United Nations Economic and Social Counsel. (<http://es.inel.gov/studies/cs244.html>)

Many methods are available for reducing the amount of emissions resulting from fixed roof storage tanks. Some of these methods include use of conservation vents, conversion to floating roof tanks, use of nitrogen blanketing to suppress emissions and reduce material oxidation, use of refrigerated condensers, use of lean-oil or carbon absorbers, or use of vapor equilibration lines. When dealing with volatile materials, employment of one or more of these methods can result in cost savings to the facility by reducing raw material losses and improving compliance with local air quality requirements (USEPA, 1996).

Air Emission Control Systems

Agricultural chemical facilities often produce large quantities of dust which are collected from numerous sources. The chemical composition of the various dust sources can vary widely. Opportunities often exist to reduce waste generation through segregation of these waste dusts and particulates.

At Daly-Herring Co., in Kingston, NC, dust streams from several different production areas were handled by a single baghouse. Since all of the streams were mixed, none of the waste could be recycled to the process that generated them. By installing separate dedicated baghouses for each production line, all of the collected pesticide dust could be recycled. The initial investment for the equipment was \$9,600. The payback period was only ten months. Daly-Herring saved over \$9,000 per year in disposal costs and \$2,000 per year in raw material costs (Hunt, 1989).

At FMC Corp. in Fresno, CA, common dust collectors were used by multiple production systems. Due to the cross contamination of materials, recycling was impossible. To promote recycling, the company compartmentalized the dust collectors with each compartment serving a single source. All collected materials are analyzed for cross contamination and if none exists, they are reused in the succeeding product batch. Other work involved the installation of self-contained dust collectors at each inlet hopper dump station so that captured dust can be returned to the system (USEPA, 1996).

Facilities may also use wet scrubbers to control air emissions. Some facilities may only need a wet scrubber on one particular process (i.e., a dedicated scrubber). These facilities have been able to reuse the scrubber blowdown or changed-out scrubber water as make-up water in the formulation of that particular product. Some facilities with nondedicated scrubbers have been

able to use the scrubber blowdown or changed-out scrubber water for floor or equipment exterior cleaning (USEPA, 1996).

Microprill Formation

Microprill formation resulting from partially plugged orifices of melt spray devices can increase fine dust loading and emissions. Certain designs (spinning buckets) and practices (vibration of spray plates) help reduce microprill formation. Reducing the ambient air temperature reduces emissions because the air flow required to cool prills and the formation of fumes are decreased at lower temperatures.

V.C. Good Housekeeping

Floor/Wall/Equipment Exterior Cleaning

During processing, formulating, and packaging operations, the exteriors of equipment may become soiled from drips, spills, and dust (especially equipment located near dry lines). The floors in the area become dirty in the same manner and also from normal traffic. Facility workers clean the equipment exteriors and floors for general housekeeping purposes, and to keep sources of product contamination to a minimum. When water is used, these cleaning procedures become a source of wastewater.

Wastewater can again be minimized through the use of high-pressure, low-volume washers rather than ordinary water hoses. Additionally, some facilities practice steam cleaning rather than water cleaning of equipment exteriors to reduce the amount of wastewater generated (USEPA, 1996).

Instead of hosing down the exterior of a piece of equipment, some facilities wipe equipment exteriors with rags or use a solvent cleaner, such as a commercially available stainless steel cleaner. This practice avoids generating a wastewater stream, but does create a solid waste that, depending on the solvent used, could be considered a hazardous waste. Squeegees are also used to clean equipment exteriors and floors, and are not disposed of after single uses. It may be possible to dedicate squeegees to a certain line or piece of equipment, but using squeegees may still require using some water (USEPA, 1996).

Some facilities use automated floor scrubbers, which replace the practice of hosing down floors. Floor scrubbers are mechanical devices that continually recirculate cleaning water to clean flat, smooth surfaces with circulating brushes. During operation, the scrubber collects the cleaning water in a small tank that is easily emptied after the cleaning process, or at a later date. Using a floor scrubbing machine can require as little as five to fifteen gallons of cleaning solution (typically water) per use. A mop and a single bucket of

water can also be used in place of a hose. Floor mopping can generate as little as ten gallons of water per cleaning depending on the size of the surface to be cleaned (USEPA, 1996).

A number of facilities reuse their floor wash water with and without filtering. One facility has set up its production equipment on a steel-grated platform directly above a collection sump. Following production, the equipment and the floor of the platform, on which the operator stands when formulating product, are rinsed and the water is allowed to flow into the sump. A pump and a filter have been installed in the sump area to enable the operator to transfer this rinsate back into the formulation tank for the next formulation. This sump is also connected to floor trenches in the packaging area for the same product. When the exterior of the packaging equipment and the floors in this area are rinsed, this water is directed to the trenches and eventually ends up in the collection sump for reuse (USEPA, 1996).

Leaks and Spills Clean-Up

Dry products that have leaked or spilled can be vacuumed or swept without generating any wastewater. Liquid leaks and spills can be collected into a trench or sump (for reuse, discharge, or disposal) with a squeegee, leaving only a residue to be mopped up or hosed down if further water cleanup is required. Liquid leaks and spills can also be cleaned up using absorbent material, such as absorbent pads or soda ash. For an acidic product, soda ash or a similar base material will also serve to neutralize the spill. If a residue remains, some water may be used for mopping up or hosing the area down, but methods to reduce floor wash should be implemented whenever possible. Many facilities clean up leaks and spills from water-based products with water and then solvent-based products with absorbent materials. Using an absorbent material may be the best practice for cleaning up small scale solvent-based leaks and spills; however, EPA does recognize that this material then needs to be disposed of (cross-media transfer). Therefore, good housekeeping practices may be even more important in the case of organic solvent-based product spills and leaks because, if not prevented, these spills and leaks may have to be cleaned up with absorbent material and disposed of (USEPA, 1996).

Direct reuse of products which have leaked or spilled is another possible pollution prevention technique. If drip pans or other containers are used to catch leaks and spills, the material (either water-based or solvent-based) can be immediately reused in the product being processed, formulated, or packaged, or stored for use in the next product batch. Collection hoppers or rubs can be installed beneath packaging fillers to capture spills and immediately direct the spills back to the fillers. Leaks or spills around bulk

storage tanks can be contained by dikes, which, in fact, are often required by state regulations (USEPA, 1996).

Precipitation Runoff

Precipitation runoff includes all precipitation that falls on facility surfaces that are believed to be contaminated. Contaminated precipitation runoff can be prevented by bringing all operations indoors, as many facilities have done, or by covering outdoor storage tanks and dikes with roofs, which has also been done at many facilities. The roofs would ideally extend low enough to prevent crosswinds from blowing rain into spill-containment dikes. To prevent rainwater contamination, the drain spouts and gutters should conduct roof runoff to areas away from process operations, and the roofs should be kept in good repair (USEPA, 1996).

If operations remain outdoors, a transfer, or containment pad should be installed with a sump or other means of collecting rinse water. The pad should be constructed of asphalt or concrete and maintained with crack sealer and a top coat sealer to control infiltration. The pad should also be large enough to contain wind-blown particulates from dry materials. If pads are cleaned before a rainfall, then uncontaminated precipitation runoff may be directly discharged to surface drains (CFA, 1996). Facilities can also monitor the water in a containment system by periodically testing for a variety of contaminants.

It may be difficult for facilities that do not require large volumes of water to reuse all the precipitation collected in the containment system. These facilities could keep the containment system free of any spilled pesticides through good housekeeping practices so that precipitation falling into the containment system does not become contaminated. Some facilities house their pesticide bulk storage area inside a building or under a covered area to eliminate precipitation from collecting in the containment system, as well as to protect the area from vandalism and severe weather (USEPA, 1996).

Containment Pad in the Loading/Unloading Area

Agrichemical dealers sometimes install loading/containment pads in the operation area to contain and collect any product spills that may occur during pesticide loading operations. The pad is usually installed contiguous to the bulk storage tanks and the repackaging of products into smaller containers. Facilities may also conduct all their portable cleaning operations, such as rinsing minibulk containers, directly on the pad in order to contain and collect the rinsates.

The pad is normally constructed of concrete and is sloped to a sump area. Some facilities divide the sump area into individual collection basins so that the facilities can segregate wastewaters contaminated by different products

and reuse these wastewaters for applications. For instance, facilities in the Midwest frequently have two collection basins; one basin collects wastewaters contaminated with corn herbicides and the other collects wastewaters contaminated with soybean herbicides. As part of this collection system, some facilities install one or more tanks to store wastewater until it can be applied to land, while other facilities use portable minibulk tanks to store the wastewater. When facilities collect wastewaters that must be segregated by different types of products, multiple storage tanks are used to avoid contamination (USEPA, 1996).

V. D. Energy Efficiency

Installation of a Feed-Gas Saturator

A mixture of steam and natural gas with a volumetric ratio of steam to carbon of about 3.5:1 is reacted in the primary reformer of reforming ammonia plants. Most of the steam is generated from heat sources within the plant, but the balance of the steam has to be produced in auxiliary boilers. This retrofit permits the use of low-level heat from the flue gases, which would otherwise be lost, to be used in saturating the feed natural gas with water. This generates extra steam which replaces some of the steam generated in the boiler (UNEP, 1996).

Modification of Convection Coils

As a result of other modifications, the temperature profile of the flue gases may change considerably in the cold-leg section of the primary reformer. This change can be compensated for by replacing the low steam superheat coil with a new one with additional rows of tubes and heavier fins on all tubes (UNEP, 1996).

Low-heat Removal of Carbon Dioxide

The traditional systems used for removal of carbon dioxide from the process steam uses hot potassium carbonate which requires heat for regeneration. This heat comes from process heat but needs to be supplemented with external steam. A new low-heat removal system is now available, which uses flashing for part of the regeneration process, and requires less external heat (UNEP, 1996).

Ammonia Synthesis Modifications

Ammonia Converter Retrofit

The vertical quench-type converters are changed from axial flow to radial flow, greatly decreasing the pressure drop across the converter which in turn allows the use of smaller size catalyst with a larger surface area. This improved catalyst yields a higher conversion per pass, generating a lower

recycle volume. The lower recycle volume and the lower pressure drop result in reduced energy requirements. This modification yields an increase effective capacity of the ammonia converter of about 35 percent (UNEP, 1996).

Addition of Process Computer

A dedicated process computer can be installed along with other on-line analysis and control systems to monitor and control key variables. With this system, continuous set point changes are possible to optimize the operation of several plant areas such as hydrogen/nitrogen ratio, steam/carbon ratio, synthesis loop purge, methane leakage, converter control, and refrigeration purge (UNEP, 1996).

Hydrogen Recovery from the Purge Gas

Inert gases must be pumped from the plant to avoid their buildup in the system. This purge is carried out by removing a side stream of synthesis gas after recovering the ammonia. By installing the proper recovery system, the hydrogen in this gas mixture can be recovered decreasing the energy requirements of the process by about five percent or permitting an increase of about five percent in production capacity (UNEP, 1996).

THIS PAGE WAS INTENTIONALLY LEFT BLANK

VI. SUMMARY OF APPLICABLE FEDERAL STATUTES AND REGULATIONS

This section discusses the federal regulations that may apply to this sector. The purpose of this section is to highlight and briefly describe the applicable federal requirements, and to provide citations for more detailed information. The three following sections are included:

- C Section VI.A contains a general overview of major statutes
- C Section VI.B contains a list of regulations specific to this industry
- C Section VI.C contains a general discussion on State regulation of pesticides
- C Section VI.D contains a list of pending and proposed regulatory requirements

The descriptions within Section VI are intended solely for general information. Depending upon the nature or scope of the activities at a particular facility, these summaries may or may not necessarily describe all applicable environmental requirements. Moreover, they do not constitute formal interpretations or clarifications of the statutes and regulations. For further information, readers should consult the Code of Federal Regulations (CFR) and other state or local regulatory agencies. EPA Hotline contacts are also provided for each major statute.

VI.A. General Description of Major Statutes

Federal Insecticide, Fungicide, and Rodenticide Act

The Federal Insecticide, Fungicide, and Rodenticide Act (FIFRA) was first passed in 1947, and amended numerous times, most recently by the Food Quality Protection Act (FQPA) of 1996. FIFRA provides EPA with the authority to oversee, among other things, the registration, distribution, sale and use of pesticides. The Act applies to all types of pesticides, including insecticides, herbicides, fungicides, rodenticides, and antimicrobials. FIFRA covers both intrastate and interstate commerce.

Establishment Registration

Section 7 of FIFRA requires that establishments producing pesticides, or active ingredients used in producing a pesticide subject to FIFRA, register with EPA. Registered establishments must report the types and amounts of pesticides and active ingredients they produce. The Act also provides EPA inspection authority and enforcement authority for facilities/persons that are not in compliance with FIFRA.

Product Registration

Under section 3 of FIFRA, all pesticides (with few exceptions) sold or distributed in the United States must be registered by EPA. Pesticide registration is very specific and generally allows use of the product only as

specified on the label. Each registration specifies the use site, i.e., where the product may be used, and amount that may be applied. The person who seeks to register the pesticide must file an application for registration. The application process often requires either the citation or submission of extensive environmental, health, and safety data.

To register a pesticide, the EPA Administrator must make a number of findings, one of which is that the pesticide, when used in accordance with widespread and commonly recognized practice, will not generally cause unreasonable adverse effects on the environment.

FIFRA defines “unreasonable adverse effects on the environment” as “(1) any unreasonable risk to man or the environment, taking into account the economic, social, and environmental costs and benefits of the use of the pesticide, or (2) a human dietary risk from residues that result from a use of a pesticide in or on any food inconsistent with the standard under section 408 of the Federal Food, Drug, and Cosmetic Act (21 U.S.C. 346a).”

Under FIFRA section 6(a)(2), after a pesticide is registered, the registrant must also notify EPA of any additional facts and information concerning unreasonable adverse environmental effects of the pesticide. Also, if EPA determines that additional data are needed to support a registered pesticide, registrants may be required to provide additional data. If EPA determines that the registrant(s) did not comply with their request for more information, the registration can be suspended under FIFRA section 3(c)(2)(B) and section 4.

Use Restrictions

As a part of the pesticide registration, EPA must classify the product for general use, restricted use, or general for some uses and restricted for others (Miller, 1993). For pesticides that may cause unreasonable adverse effects on the environment, including injury to the applicator, EPA may require that the pesticide be applied either by or under the direct supervision of a certified applicator.

Reregistration

Due to concerns that much of the safety data underlying pesticide registrations becomes outdated and inadequate, in addition to providing that registrations be reviewed every 15 years, FIFRA requires EPA to reregister all pesticides that were registered prior to 1984 (section 4). After reviewing existing data, EPA may approve the reregistration, request additional data to support the registration, cancel, or suspend the pesticide.

Tolerances and Exemptions

A tolerance is the maximum amount of pesticide residue that can be on a raw product and still be considered safe. Before EPA can register a pesticide that is used on raw agricultural products, it must grant a tolerance or exemption from a tolerance (40 CFR sections 163.10 through 163.12). Under the Federal Food, Drug, and Cosmetic Act (FFDCA), a raw agricultural product is deemed unsafe if it contains a pesticide residue, unless the residue is within the limits of a tolerance established by EPA or is exempt from the requirement.

Cancellation and Suspension

EPA can cancel a registration if it is determined that the pesticide or its labeling does not comply with the requirements of FIFRA or causes unreasonable adverse effects on the environment (Haugrud, 1993).

In cases where EPA believes that an “imminent hazard” would exist if a pesticide were to continue to be used through the cancellation proceedings, EPA may suspend the pesticide registration through an order and thereby halt the sale, distribution, and usage of the pesticide. An “imminent hazard” is defined as an unreasonable adverse effect on the environment or an unreasonable hazard to the survival of a threatened or endangered species that would be the likely result of allowing continued use of a pesticide during a cancellation process.

When EPA believes an emergency exists that does not permit a hearing to be held prior to suspending, EPA can issue an emergency order which makes the suspension immediately effective.

Imports and Exports

Under FIFRA section 17(a), pesticides not registered in the United States and intended solely for export are not required to be registered provided that the exporter obtains and submits to EPA, prior to export, a statement from the foreign purchaser acknowledging that the purchaser is aware that the product is not registered in the United States and cannot be sold for use there. EPA sends these statements to the government of the importing country. FIFRA sets forth additional requirements that must be met by pesticides intended solely for export. The enforcement policy for exports is codified in sections 40 CFR sections 168.65, 168.75, and 168.85.

Under FIFRA section 17(c), imported pesticides and devices must comply with United States pesticide law. Except where exempted by regulation or statute, imported pesticides must be registered. FIFRA section 17(c) requires that EPA be notified of the arrival of imported pesticides and devices. This is accomplished through the Notice of Arrival (NOA) (EPA Form 3540-1), which is filled out by the importer prior to importation and submitted to the EPA regional office applicable to the intended port of entry. United States Customs regulations prohibit the importation of pesticides without a completed NOA. The EPA-reviewed and signed form is returned to the importer for

presentation to United States Customs when the shipment arrives in the United States. NOA forms can be obtained from contacts in the EPA Regional Offices or www.epa.gov/oppfead1/international/noalist.htm.

Additional information on FIFRA and the regulation of pesticides can be obtained from a variety of sources, including EPA's Office of Pesticide Programs' homepage at www.epa.gov/pesticides, EPA's Office of Compliance, Agriculture and Ecosystem Division at <http://es.epa.gov/oeca/agecodiv.htm>, or The National Agriculture Compliance Assistance Center toll-free at 888-663-2155 or <http://es.epa.gov/oeca/ag>. Other sources include the National Pesticide Telecommunications Network toll-free at 800-858-7378 and the National Antimicrobial Information Network toll-free at 800-447-6349.

Clean Water Act

The primary objective of the Federal Water Pollution Control Act, commonly referred to as the Clean Water Act (CWA), is to restore and maintain the chemical, physical, and biological integrity of the nation's surface waters. Pollutants regulated under the CWA are classified as either "toxic" pollutants; "conventional" pollutants, such as biochemical oxygen demand (BOD), total suspended solids (TSS), fecal coliform, oil and grease, and pH; or "non-conventional" pollutants, including any pollutant not identified as either conventional or priority.

The CWA regulates both direct and "indirect" dischargers (those who discharge to publicly owned treatment works). The National Pollutant Discharge Elimination System (NPDES) permitting program (CWA section 402) controls direct discharges into navigable waters. Direct discharges or "point source" discharges are from sources such as pipes and sewers. NPDES permits, issued by either EPA or an authorized state (EPA has authorized 43 states and 1 territory to administer the NPDES program), contain industry-specific, technology-based and water quality-based limits and establish pollutant monitoring and reporting requirements. A facility that proposes to discharge into the nation's waters must obtain a permit prior to initiating a discharge. A permit applicant must provide quantitative analytical data identifying the types of pollutants present in the facility's effluent. The permit will then set forth the conditions and effluent limitations under which a facility may make a discharge.

Water quality-based discharge limits are based on federal or state water quality criteria or standards, that were designed to protect designated uses of surface waters, such as supporting aquatic life or recreation. These standards, unlike the technology-based standards, generally do not take into account technological feasibility or costs. Water quality criteria and standards vary from state to state, and site to site, depending on the use classification of the receiving body of water. Most states follow EPA guidelines which propose

aquatic life and human health criteria for many of the 126 priority pollutants.

Storm Water Discharges

In 1987 the CWA was amended to require EPA to establish a program to address storm water discharges. In response, EPA promulgated NPDES permitting regulations for storm water discharges. These regulations require that facilities with the following types of storm water discharges, among others, apply for an NPDES permit: (1) a discharge associated with industrial activity; (2) a discharge from a large or medium municipal storm sewer system; or (3) a discharge which EPA or the state determines to contribute to a violation of a water quality standard or is a significant contributor of pollutants to waters of the United States.

The term “storm water discharge associated with industrial activity” means a storm water discharge from one of 11 categories of industrial activity defined at 40 CFR section 122.26. Six of the categories are defined by SIC codes while the other five are identified through narrative descriptions of the regulated industrial activity. If the primary SIC code of the facility is one of those identified in the regulations, the facility is subject to the storm water permit application requirements. If any activity at a facility is covered by one of the five narrative categories, storm water discharges from those areas where the activities occur are subject to storm water discharge permit application requirements.

Those facilities/activities that are subject to storm water discharge permit application requirements are identified below. To determine whether a particular facility falls within one of these categories, the regulation should be consulted.

Category i: Facilities subject to storm water effluent guidelines, new source performance standards, or toxic pollutant effluent standards.

Category ii: Facilities classified as SIC 24-lumber and wood products (except wood kitchen cabinets); SIC 26-paper and allied products (except paperboard containers and products); SIC 28-chemicals and allied products (except drugs and paints); SIC 29-petroleum refining; SIC 311-leather tanning and finishing; SIC 32 (except 323)-stone, clay, glass, and concrete; SIC 33-primary metals; SIC 3441-fabricated structural metal; and SIC 373-ship and boat building and repairing.

Category iii: Facilities classified as SIC 10-metal mining; SIC 12-coal mining; SIC 13-oil and gas extraction; and SIC 14-nonmetallic mineral mining.

Category iv: Hazardous waste treatment, storage, or disposal facilities.

Category v: Landfills, land application sites, and open dumps that receive or have received industrial wastes.

Category vi: Facilities classified as SIC 5015-used motor vehicle parts; and SIC 5093-automotive scrap and waste material recycling facilities.

Category vii: Steam electric power generating facilities.

Category viii: Facilities classified as SIC 40-railroad transportation; SIC 41-local passenger transportation; SIC 42-trucking and warehousing (except public warehousing and storage); SIC 43-U.S. Postal Service; SIC 44-water transportation; SIC 45-transportation by air; and SIC 5171-petroleum bulk storage stations and terminals.

Category ix: Sewage treatment works.

Category x: Construction activities except operations that result in the disturbance of less than five acres of total land area.

Category xi: Facilities classified as SIC 20-food and kindred products; SIC 21-tobacco products; SIC 22-textile mill products; SIC 23-apparel related products; SIC 2434-wood kitchen cabinets manufacturing; SIC 25-furniture and fixtures; SIC 265-paperboard containers and boxes; SIC 267-converted paper and paperboard products; SIC 27-printing, publishing, and allied industries; SIC 283-drugs; SIC 285-paints, varnishes, lacquer, enamels, and allied products; SIC 30-rubber and plastics; SIC 31-leather and leather products (except leather and tanning and finishing); SIC 323-glass products; SIC 34-fabricated metal products (except fabricated structural metal); SIC 35-industrial and commercial machinery and computer equipment; SIC 36-electronic and other electrical equipment and components; SIC 37-transportation equipment (except ship and boat building and repairing); SIC 38-measuring, analyzing, and controlling instruments; SIC 39-miscellaneous manufacturing industries; and SIC 4221-4225-public warehousing and storage.

Pretreatment Program

Another type of discharge that is regulated by the CWA is one that goes to a publicly owned treatment works (POTW). The national pretreatment program (CWA section 307(b)) controls the indirect discharge of pollutants to POTWs by “industrial users.” Facilities regulated under section 307(b) must meet certain pretreatment standards. The goal of the pretreatment program is to protect municipal wastewater treatment plants from damage that may occur when hazardous, toxic, or other wastes are discharged into a sewer system and to protect the quality of sludge generated by these plants.

EPA has developed technology-based standards for industrial users of POTWs. Different standards apply to existing and new sources within each category. “Categorical” pretreatment standards applicable to an industry on a nationwide basis are developed by EPA. In addition, another kind of pretreatment standard, “local limits,” are developed by the POTW in order to

assist the POTW in achieving the effluent limitations in its NPDES permit.

Regardless of whether a state is authorized to implement either the NPDES or the pretreatment program, if it develops its own program, it may enforce requirements more stringent than federal standards.

Wetlands

Wetlands, commonly called swamps, marshes, fens, bogs, vernal pools, playas, and prairie potholes, are a subset of “waters of the United States,” as defined in section 404 of the CWA. The placement of dredge and fill material into wetlands and other water bodies (i.e., waters of the United States) is regulated by the United States Army Corps of Engineers (Corps) under 33 CFR Part 328. The Corps regulates wetlands by administering the CWA section 404 permit program for activities that impact wetlands. EPA’s authority under section 404 includes veto power of Corps permits, authority to interpret statutory exemptions and jurisdiction, enforcement actions, and delegating the section 404 program to the states.

EPA’s Office of Water, at (202) 260-5700, will direct callers with questions about the CWA to the appropriate EPA office. EPA also maintains a bibliographic database of Office of Water publications which can be accessed through the Ground Water and Drinking Water Resource Center at (202) 260-7786.

Oil Pollution Prevention Regulation

Section 311(b) of the CWA prohibits the discharge of oil, in such quantities as may be harmful, into the navigable waters of the United States and adjoining shorelines. The EPA Discharge of Oil regulation, 40 CFR Part 110, provides information regarding these discharges. The Oil Pollution Prevention regulation, 40 CFR Part 112, under the authority of section 311(j) of the CWA, requires regulated facilities to prepare and implement Spill Prevention Control and Countermeasure (SPCC) plans. The intent of a SPCC plan is to prevent the discharge of oil from onshore and offshore non-transportation-related facilities. In 1990, Congress passed the Oil Pollution Act which amended section 311(j) of the CWA to require facilities that because of their location could reasonably be expected to cause “substantial harm” to the environment by a discharge of oil to develop and implement Facility Response Plans (FRP). The intent of a FRP is to provide for planned responses to discharges of oil.

A facility is SPCC-regulated if the facility, due to its location, could reasonably be expected to discharge oil into or upon the navigable waters of the United States or adjoining shorelines, and the facility meets one of the following criteria regarding oil storage: (1) the capacity of any aboveground storage tank exceeds 660 gallons, or (2) the total aboveground storage capacity exceeds 1,320 gallons, or (3) the underground storage capacity exceeds 42,000 gallons. The 40 CFR section 112.7 contains the format and content

requirements for a SPCC plan. In New Jersey, SPCC plans can be combined with DPCC plans required by the state provided there is an appropriate cross-reference index to the requirements of both regulations at the front of the plan.

According to the FRP regulation, a facility can cause “substantial harm” if it meets one of the following criteria: (1) the facility has a total oil storage capacity greater than or equal to 42,000 gallons and transfers oil over water to or from vessels; or (2) the facility has a total oil storage capacity greater than or equal to 1 million gallons and meets any one of the following conditions: (i) does not have adequate secondary containment, (ii) a discharge could cause “injury” to fish and wildlife and sensitive environments, (iii) shut down a public drinking water intake, or (iv) has had a reportable oil spill greater than or equal to 10,000 gallons in the past 5 years. Appendix F of 40 CFR Part 112 contains the format and content requirements for a FRP. The FRPs that meet EPA’s requirements can be combined with United States Coast Guard FRPs or other contingency plans, provided there is an appropriate cross-reference index to the requirements of all applicable regulations at the front of the plan.

For additional information regarding SPCC plans, contact EPA’s RCRA, Superfund, and EPCRA Hotline, at (800) 424-9346. Additional documents and resources can be obtained from the hotline’s homepage at www.epa.gov/epaoswer/hotline. The hotline operates weekdays from 9:00 a.m. to 6:00 p.m., EST, excluding federal holidays.

Safe Drinking Water Act

The Safe Drinking Water Act (SDWA) mandates that EPA establish regulations to protect human health from contaminants in drinking water. The law authorizes EPA to develop national drinking water standards and to create a joint federal-state system to ensure compliance with these standards. The SDWA also directs EPA to protect underground sources of drinking water through the control of underground injection of fluid wastes.

EPA has developed primary and secondary drinking water standards under its SDWA authority. EPA and authorized states enforce the primary drinking water standards that are contaminant-specific concentration limits that apply to certain public drinking water supplies. Primary drinking water standards consist of maximum contaminant level goals (MCLGs), which are non-enforceable health-based goals, and maximum contaminant levels (MCLs), which are enforceable limits set generally as close to MCLGs as possible, considering cost and feasibility of attainment.

The SDWA Underground Injection Control (UIC) program (40 CFR Parts 144-148) is a permit program which protects underground sources of drinking water by regulating five classes of injection wells. The UIC permits include design, operating, inspection, and monitoring requirements. Wells used to

inject hazardous wastes must also comply with RCRA corrective action standards in order to be granted a RCRA permit, and must meet applicable RCRA land disposal restrictions standards. The UIC permit program is often state/tribe-enforced, since EPA has authorized many states/tribes to administer the program. Currently, EPA shares the UIC permit program responsibility in seven states and runs the program in 10 states and on all tribal lands.

The SDWA also provides for a federally-implemented Sole Source Aquifer program, which prohibits federal funds from being expended on projects that may contaminate the sole or principal source of drinking water for a given area, and for a state-implemented Wellhead Protection program, designed to protect drinking water wells and drinking water recharge areas.

The SDWA Amendments of 1996 require states to develop and implement source water assessment programs (SWAPs) to analyze existing and potential threats to the quality of the public drinking water throughout the state. Every state is required to submit a program to EPA and to complete all assessments within 3 ½ years of EPA approval of the program. SWAPs include: (1) delineating the source water protection area; (2) conducting a contaminant source inventory; (3) determining the susceptibility of the public water supply to contamination from the inventories sources; and (4) releasing the results of the assessments to the public.

EPA's Safe Drinking Water Hotline, at (800) 426-4791, answers questions and distributes guidance pertaining to SDWA standards. The Hotline operates from 9:00 a.m. through 5:30 p.m., EST, excluding federal holidays. Visit the website at <http://www.epa.gov/ogwdw> for additional material.

Resource Conservation and Recovery Act

The Solid Waste Disposal Act (SWDA), as amended by the Resource Conservation and Recovery Act (RCRA) of 1976, addresses solid and hazardous waste management activities. The Act is commonly referred to as RCRA. The Hazardous and Solid Waste Amendments (HSWA) of 1984 strengthened RCRA's waste management provisions and added Subtitle I, which governs underground storage tanks (USTs).

Regulations promulgated pursuant to Subtitle C of RCRA (40 CFR Parts 260-299) establish a "cradle-to-grave" system governing hazardous waste from the point of generation to disposal. RCRA hazardous wastes include the specific materials listed in the regulations (discarded commercial chemical products, designated with the code "P" or "U"; hazardous wastes from specific industries/sources, designated with the code "K"; or hazardous wastes from non-specific sources, designated with the code "F") or materials which exhibit a hazardous waste characteristic (ignitability, corrosivity, reactivity, or toxicity and designated with the code "D").

Entities that generate hazardous waste are subject to waste accumulation, manifesting, and recordkeeping standards. A hazardous waste facility may accumulate hazardous waste for up to 90 days (or 180 days depending on the amount generated per month) without a permit or interim status. Generators may also treat hazardous waste in accumulation tanks or containers (in accordance with the requirements of 40 CFR section 262.34) without a permit or interim status.

Facilities that treat, store, or dispose of hazardous waste are generally required to obtain a RCRA permit. Subtitle C permits for treatment, storage, or disposal facilities contain general facility standards such as contingency plans, emergency procedures, recordkeeping and reporting requirements, financial assurance mechanisms, and unit-specific standards. RCRA also contains provisions (40 CFR Part 264 Subparts I and S) for conducting corrective actions which govern the cleanup of releases of hazardous waste or constituents from solid waste management units at RCRA treatment, storage, or disposal facilities.

Although RCRA is a federal statute, many states implement the RCRA program. Currently, EPA has delegated its authority to implement various provisions of RCRA to 47 of the 50 states and two United States territories. Delegation has not been given to Alaska, Hawaii, or Iowa.

Most RCRA requirements are not industry specific but apply to any company that generates, transports, treats, stores, or disposes of hazardous waste. Here are some important RCRA regulatory requirements:

- C **Criteria for Classification of Solid Waste Disposal Facilities and Practices** (40 CFR Part 257) establishes the criteria for determining which solid waste disposal facilities and practices pose a reasonable probability of adverse effects on health or the environment. The criteria were adopted to ensure non-municipal, non-hazardous waste disposal units that receive conditionally exempt small quantity generator waste do not present risks to human health and environment.
- C **Criteria for Municipal Solid Waste Landfills** (40 CFR Part 258) establishes minimum national criteria for all municipal solid waste landfill units, including those that are used to dispose of sewage sludge.
- **Identification of Solid and Hazardous Wastes** (40 CFR Part 261) establishes the standard to determine whether the material in question is considered a solid waste and, if so, whether it is a hazardous waste or is exempted from regulation.
- **Standards for Generators of Hazardous Waste** (40 CFR Part 262) establishes the responsibilities of hazardous waste generators including obtaining an EPA ID number, preparing a manifest, ensuring proper packaging

and labeling, meeting standards for waste accumulation units, and recordkeeping and reporting requirements. Generators can accumulate hazardous waste on-site for up to 90 days (or 180 days depending on the amount of waste generated) without obtaining a permit.

- **Land Disposal Restrictions (LDRs)** (40 CFR Part 268) are regulations prohibiting the disposal of hazardous waste on land without prior treatment. Under the LDRs program, materials must meet treatment standards prior to placement in a RCRA land disposal unit (landfill, land treatment unit, waste pile, or surface impoundment). Generators of waste subject to the LDRs must provide notification of such to the designated TSD facility to ensure proper treatment prior to disposal.
- **Used Oil Management Standards** (40 CFR Part 279) impose management requirements affecting the storage, transportation, burning, processing, and re-refining of the used oil. For parties that merely generate used oil, regulations establish storage standards. For a party considered a used oil processor, re-refiner, burner, or marketer (one who generates and sells off-specification used oil directly to a used oil burner), additional tracking and paperwork requirements must be satisfied.
- **Tanks and Containers Standards** (40 CFR Part 264-265, Subpart CC) contains unit-specific standards for all units used to store, treat, or dispose of hazardous waste. Tanks and containers used to store hazardous waste with a high volatile organic concentration must meet emission standards under RCRA. Regulations require generators to test the waste to determine the concentration of the waste, to satisfy tank and container emissions standards, and to inspect and monitor regulated units. These regulations apply to all facilities who store such waste, including large quantity generators accumulating waste prior to shipment offsite.
- **Underground Storage Tanks (USTs)** containing petroleum and hazardous substances are regulated under Subtitle I of RCRA. Subtitle I regulations (40 CFR Part 280) contain tank design and release detection requirements, as well as financial responsibility and corrective action standards for USTs. The UST program also includes upgrade requirements for existing tanks that were to be met by December 22, 1998.
- **Boilers and Industrial Furnaces (BIFs)** that use or burn fuel containing hazardous waste must comply with design and operating standards. BIF regulations (40 CFR Part 266, Subpart H) address unit design, provide performance standards, require emissions monitoring, and, in some cases, restrict the type of waste that may be burned.

EPA's RCRA, Superfund, and EPCRA Hotline, at (800) 424-9346, responds to questions and distributes guidance regarding all RCRA regulations. Additional documents and resources can be obtained from the hotline's

homepage at <http://www.epa.gov/epaoswer/hotline>. The RCRA Hotline operates weekdays from 9:00 a.m. to 6:00 p.m., EST, excluding federal holidays.

Comprehensive Environmental Response, Compensation, and Liability Act

The Comprehensive Environmental Response, Compensation, and Liability Act (CERCLA), a 1980 law commonly known as Superfund, authorizes EPA to respond to releases, or threatened releases, of hazardous substances that may endanger public health, welfare, or the environment. The CERCLA also enables EPA to force parties responsible for environmental contamination to clean it up or to reimburse the Superfund for response or remediation costs incurred by EPA. The Superfund Amendments and Reauthorization Act (SARA) of 1986 revised various sections of CERCLA, extended the taxing authority for the Superfund, and created a free-standing law, SARA Title III, also known as the Emergency Planning and Community Right-to-Know Act (EPCRA).

The CERCLA hazardous substance release reporting regulations (40 CFR Part 302) direct the person in charge of a facility to report to the National Response Center (NRC) any environmental release of a hazardous substance which equals or exceeds a reportable quantity. Reportable quantities are listed in 40 CFR section 302.4. A release report may trigger a response by EPA or by one or more federal or state emergency response authorities.

EPA implements hazardous substance responses according to procedures outlined in the National Oil and Hazardous Substances Pollution Contingency Plan (NCP) (40 CFR Part 300). The NCP includes provisions for cleanups. The National Priorities List (NPL) currently includes approximately 1,300 sites. Both EPA and states can act at other sites; however, EPA provides responsible parties the opportunity to conduct cleanups and encourages community involvement throughout the Superfund response process.

EPA's RCRA, Superfund and EPCRA Hotline, at (800) 424-9346, answers questions and references guidance pertaining to the Superfund program. Documents and resources can be obtained from the hotline's homepage at <http://www.epa.gov/epaoswer/hotline>. The Superfund Hotline operates weekdays from 9:00 a.m. to 6:00 p.m., EST, excluding federal holidays.

Emergency Planning and Community Right-To-Know Act

The Superfund Amendments and Reauthorization Act (SARA) of 1986 created the Emergency Planning and Community Right-to-Know Act (EPCRA, also known as SARA Title III), a statute designed to improve community access to information about chemical hazards and to facilitate the development of chemical emergency response plans by state and local governments. Under EPCRA, states establish State Emergency Response Commissions (SERCs),

responsible for coordinating certain emergency response activities and for appointing Local Emergency Planning Committees (LEPCs). EPCRA and the EPCRA regulations (40 CFR Parts 350-372) establish four types of reporting obligations for facilities which store or manage specified chemicals:

- **EPCRA section 302** requires facilities to notify the SERC and LEPC of the presence of any extremely hazardous substance at the facility in an amount in excess of the established threshold planning quantity. The list of extremely hazardous substances and their threshold planning quantities is found at 40 CFR Part 355, Appendices A and B.
- **EPCRA section 303** requires that each LEPC develop an emergency plan. The plan must contain (but is not limited to) the identification of facilities within the planning district, likely routes for transporting extremely hazardous substances, a description of the methods and procedures to be followed by facility owners and operators, and the designation of community and facility emergency response coordinators.
- **EPCRA section 304** requires the facility to notify the SERC and the LEPC in the event of a release exceeding the reportable quantity of a CERCLA hazardous substance (defined at 40 CFR Part 302) or an EPCRA extremely hazardous substance.
- **EPCRA sections 311 and 312** require a facility at which a hazardous chemical, as defined by the Occupational Safety and Health Act, is present in an amount exceeding a specified threshold to submit to the SERC, LEPC and local fire department material safety data sheets (MSDSs) or lists of MSDSs and hazardous chemical inventory forms (also known as Tier I and II forms). This information helps the local government respond in the event of a spill or release of the chemical.
- **EPCRA section 313** requires certain covered facilities, including SIC codes 20 through 39 and others, which have ten or more employees, and which manufacture, process, or use specified chemicals in amounts greater than threshold quantities, to submit an annual toxic chemical release report. This report, commonly known as the Form R, covers releases and transfers of toxic chemicals to various facilities and environmental media. EPA maintains the data reported in a publically accessible database known as the Toxics Release Inventory (TRI).

All information submitted pursuant to EPCRA regulations is publicly accessible, unless protected by a trade secret claim.

EPA's RCRA, Superfund, and EPCRA Hotline, at (800) 535-0202, answers questions and distributes guidance regarding the emergency planning and community right-to-know regulations. Documents and resources can be

obtained from the hotline's homepage at <http://www.epa.gov/epaoswer/hotline>. The EPCRA Hotline operates weekdays from 9:00 a.m. to 6:00 p.m., EST, excluding federal holidays.

Clean Air Act

The Clean Air Act (CAA) and its amendments are designed to “protect and enhance the nation's air resources so as to promote the public health and welfare and the productive capacity of the population.” The CAA consists of six sections, known as Titles, which direct EPA to establish national standards for ambient air quality and for EPA and the states to implement, maintain, and enforce these standards through a variety of mechanisms. Under the CAA, many facilities are required to obtain operating permits that consolidate their air emission requirements. State and local governments oversee, manage, and enforce many of the requirements of the CAA. CAA regulations appear at 40 CFR Parts 50-99.

Pursuant to Title I of the CAA, EPA has established national ambient air quality standards (NAAQSs) to limit levels of “criteria pollutants,” including carbon monoxide, lead, nitrogen dioxide, particulate matter, ozone, and sulfur dioxide. Geographic areas that meet NAAQSs for a given pollutant are designated as attainment areas; those that do not meet NAAQSs are designated as non-attainment areas. Under section 110 and other provisions of the CAA, each state must develop a State Implementation Plan (SIP) to identify sources of air pollution and to determine what reductions are required to meet federal air quality standards. Revised NAAQSs for particulates and ozone were finalized in 1997. However, these revised NAAQSs are currently being challenged before the U.S. Supreme Court.

Title I also authorizes EPA to establish New Source Performance Standards (NSPS), which are nationally uniform emission standards for new and modified stationary sources falling within particular industrial categories. The NSPSs are based on the pollution control technology available to that category of industrial source (*see* 40 CFR Part 60).

Under Title I, EPA establishes and enforces National Emission Standards for Hazardous Air Pollutants (NESHAPs), nationally uniform standards oriented toward controlling specific hazardous air pollutants (HAPs). Section 112(c) of the CAA further directs EPA to develop a list of sources that emit any of 188 HAPs and to develop regulations for these categories of sources. To date EPA has listed 185 source categories and developed a schedule for the establishment of emission standards. The emission standards are being developed for both new and existing sources based on “maximum achievable control technology” (MACT). The MACT is defined as the control technology achieving the maximum degree of reduction in the emission of the HAPs, taking into account cost and other factors.

Title II of the CAA pertains to mobile sources, such as cars, trucks, buses, and planes. Reformulated gasoline, automobile pollution control devices, and vapor recovery nozzles on gas pumps are a few of the mechanisms EPA uses to regulate mobile air emission sources.

Title IV-A establishes a sulfur dioxide and nitrogen oxides emissions program designed to reduce the formation of acid rain. Reduction of sulfur dioxide releases will be obtained by granting to certain sources limited emissions allowances that are set below previous levels of sulfur dioxide releases.

Title V of the CAA establishes an operating permit program for all “major sources” (and certain other sources) regulated under the CAA. One purpose of the operating permit is to include in a single document all air emissions requirements that apply to a given facility. States have developed the permit programs in accordance with guidance and regulations from EPA. Once a state program is approved by EPA, permits are issued and monitored by that state.

Title VI of the CAA is intended to protect stratospheric ozone by phasing out the manufacture of ozone-depleting chemicals and restrict their usage and distribution. Production of Class I substances, including 15 kinds of chlorofluorocarbons (CFCs), were phased out (except for essential uses) in 1996. Methyl bromide, a common pesticide, has been identified as a significant stratospheric ozone depleting chemical. The production and importation of methyl bromide, therefore, is currently being phased out in the United States and internationally. As specified in the Federal Register of June 1, 1999 (Volume 64, Number 104) and in 40 CFR Part 82, methyl bromide production and importation will be reduced from 1991 levels by 25% in 1999, by 50% in 2001, by 70% in 2003, and completely phased out by 2005. Some uses of methyl bromide, such the production, importation, and consumption of methyl bromide to fumigate commodities entering or leaving the United States or any state (or political subdivision thereof) for purposes of compliance with Animal and Plant Health Inspection Service requirements or with any international, federal, state, or local sanitation or food protection standard, will be exempt from this rule. After 2005, exceptions may also be made for critical agricultural uses. The United States EPA and the United Nations Environment Programme have identified alternatives to using methyl bromide in agriculture. Information on the methyl bromide phase-out, including alternatives, can be found at the EPA Methyl Bromide Phase-Out Web Site: (<http://www.epa.gov/docs/ozone/mbr/mbrqa.html>).

EPA's Clean Air Technology Center, at (919) 541-0800 and at the Center's homepage at <http://www.epa.gov/ttn/catc>, provides general assistance and information on CAA standards. The Stratospheric Ozone Information Hotline, at (800) 296-1996 and at <http://www.epa.gov/ozone>, provides general information about regulations promulgated under Title VI of the CAA; EPA's EPCRA Hotline, at (800) 535-0202 and at

http://www.epa.gov/epaoswer/hotline, answers questions about accidental release prevention under CAA section 112(r); and information on air toxics can be accessed through the Unified Air Toxics website at http://www.epa.gov/ttn/uatw. In addition, the Clean Air Technology Center's website includes recent CAA rules, EPA guidance documents, and updates of EPA activities.

Toxic Substances Control Act

The Toxic Substances Control Act (TSCA) granted EPA authority to create a regulatory framework to collect data on chemicals in order to evaluate, assess, mitigate, and control risks which may be posed by their manufacture, processing, and use. TSCA provides a variety of control methods to prevent chemicals from posing unreasonable risk. It is important to note that pesticides as defined in FIFRA are not included in the definition of a "chemical substance" when manufactured, processed, or distributed in commerce for use as a pesticide.

TSCA standards may apply at any point during a chemical's life cycle. Under TSCA section 5, EPA established an inventory of chemical substances. If a chemical substance is not already on the inventory, and has not been excluded by TSCA, a premanufacture notice (PMN) must be submitted to EPA prior to manufacture or import. The PMN must identify the chemical and provide available information on health and environmental effects. If available data are not sufficient to evaluate the chemical's effects, EPA can impose restrictions pending the development of information on its health and environmental effects. EPA can also restrict significant new uses of chemicals based upon factors such as the projected volume and use of the chemical.

Under TSCA section 6, EPA can ban the manufacture or distribution in commerce, limit the use, require labeling, or place other restrictions on chemicals that pose unreasonable risks. Among the chemicals EPA regulates under section 6 authority are asbestos, chlorofluorocarbons (CFCs), lead, and polychlorinated biphenyls (PCBs).

Under TSCA section 8(e), EPA requires the producers and importers (and others) of chemicals to report information on a chemical's production, use, exposure, and risks. Companies producing and importing chemicals can be required to report unpublished health and safety studies on listed chemicals and to collect and record any allegations of adverse reactions or any information indicating that a substance may pose a substantial risk to humans or the environment.

EPA's TSCA Assistance Information Service, at 202 554-1404, answers questions and distributes guidance pertaining to Toxic Substances Control Act standards. The Service operates from 8:30 a.m. through 4:30 p.m., EST, excluding federal holidays.

Coastal Zone Management Act

The Coastal Zone Management Act (CZMA) encourages states/tribes to preserve, protect, develop, and where possible, restore or enhance valuable natural coastal resources such as wetlands, floodplains, estuaries, beaches, dunes, barrier islands, and coral reefs, as well as the fish and wildlife using those habitats. It includes areas bordering the Atlantic, Pacific, and Arctic Oceans, Gulf of Mexico, Long Island Sound, and Great Lakes. A unique feature of this law is that participation by states/tribes is voluntary.

In the Coastal Zone Management Act Reauthorization Amendments (CZARA) of 1990, Congress identified nonpoint source pollution as a major factor in the continuing degradation of coastal waters. Congress also recognized that effective solutions to nonpoint source pollution could be implemented at the state/tribe and local levels. In CZARA, Congress added section 6217 (16 U.S.C. section 1455b), which calls upon states/tribes with federally-approved coastal zone management programs to develop and implement coastal nonpoint pollution control programs. The section 6217 program is administered at the federal level jointly by EPA and the National Oceanic and Atmospheric Agency (NOAA).

Section 6217(g) called for EPA, in consultation with other agencies, to develop guidance on “management measures” for sources of nonpoint source pollution in coastal waters. Under section 6217, EPA is responsible for developing technical guidance to assist states/tribes in designing coastal nonpoint pollution control programs. On January 19, 1993, EPA issued its *Guidance Specifying Management Measures For Sources of Nonpoint Pollution in Coastal Waters*, which addresses five major source categories of nonpoint pollution: (1) urban runoff, (2) agriculture runoff, (3) forestry runoff, (4) marinas and recreational boating, and (5) hydromodification.

Additional information on coastal zone management may be obtained from EPA's Office of Wetlands, Oceans, and Watersheds at <http://www.epa.gov/owow> or from the Watershed Information Network at <http://www.epa.gov/win>. The NOAA website at <http://www.nos.noaa.gov/ocrm/czm/> also contains additional information on coastal zone management.

VI.B. Industry Specific Requirements

The agricultural chemical industry is affected by several major federal environmental statutes. In addition, the industry is subject to numerous laws and regulations from state and local governments designed to protect health, safety, and the environment. A summary of the major federal regulations affecting the agricultural chemical industry follows.

Federal Insecticide, Fungicide, and Rodenticide Act (FIFRA)

Every regulation promulgated under FIFRA affects the agricultural chemical industry in some way. The FIFRA regulations are found in 40 CFR Parts 152 through 186. Each part and its title are listed below.

- Part 152 - Pesticide Registration and Classification Procedures
- Part 153 - Registration Policies and Interpretations
- Part 154 - Special Review Procedures
- Part 155 - Registration Standards
- Part 156 - Labeling Requirements for Pesticides and Devices
- Part 157 - Packaging Requirements for Pesticides and Devices
- Part 158 - Data Requirements for Registration
- Part 160 - Good Laboratory Practice Standards
- Part 162 - State Registration of Pesticide Products
- Part 163 - Certification of Usefulness of Pesticide Chemicals
- Part 164 - Rules of Practice Governing Hearings, Under FIFRA, Arising from Refusals to Register, Cancellations of Registrations, Changes of Classifications, Suspensions of Registrations and Other Hearings Called Pursuant to section 6 of the Act
- Part 166 - Exemption of Federal and State Agencies for Use of Pesticides Under Emergency Conditions
- Part 167 - Registration of Pesticide and Active Ingredient Producing Establishments, Submission of Pesticide Reports
- Part 168 - Statements of Enforcement Policies and Interpretations
- Part 169 - Books and Records of Pesticide Production and Distribution
- Part 170 - Worker Protection Standards
- Part 171 - Certification of Pesticide Applicators
- Part 172 - Experimental Use Permits
- Part 173 - Procedures Governing the Rescission of State Primary Enforcement Responsibility for Pesticide Use Violations
- Part 177 - Issuance of Food Additive Regulations

- Part 178 - Objections and Requests for Hearings
- Part 179 - Formal Evidentiary Public Hearing
- Part 180 - Tolerances and Exemptions from Tolerances for Pesticide Chemicals in or on Raw Agricultural Commodities
- Part 185 - Tolerances for Pesticides in Food
- Part 186 - Pesticides in Animal Feed

Please refer to the general discussion of FIFRA in Section VI.A for additional requirements not discussed below.

Product Registration Data Requirements

EPA requires the citation or submission of extensive environmental, health, and/or safety data during the registration application process. The categories of data required include the product's chemistry; environmental fate; residue chemistry, hazards to humans, domestic animals, and nontarget organisms; spray drift characteristics; reentry protection requirements; and performance (40 CFR Part 158). Under the "product chemistry" category, applicants must supply technical information describing the product's active and inert ingredients, manufacturing or formulating processes and physical and chemical characteristics. Data from "environmental fate" studies are used to assess the effects of pesticide residues on the environment, including its toxicity to people through consumption or exposure to applied areas and its effect on nontarget organisms and their habitat. Residue chemistry information includes the expected frequency, amounts, and time of application, and test results of residue remaining on treated food or feed. Information under "hazards to humans, domestic animals, and non-target organisms" includes specific test data assessing acute, subchronic, and chronic toxicity. All studies required to be submitted must satisfy Good Laboratory Practice (GLP) regulations (40 CFR Part 160). Guidelines for studies of product chemistry, residue chemistry, environmental chemistry, hazard evaluation and occupational and residential exposure can be found in 40 CFR Part 158.

Registration of Establishments

Any person producing a pesticide or device, except a custom blender,⁴ is subject to section 7 and 40 CFR. Part 167; and is required to register his establishment with EPA prior to beginning production. Foreign establishments also must register with EPA if they produce a pesticidal product for import to

⁴ A *custom blender* means any establishment which provides the service of mixing pesticides to a customer's specifications, usually a pesticide(s)-fertilizer(s), pesticide-pesticide, or a pesticide animal feed mixture, when: (1) The blend is prepared to the order of the customer and is not held in inventory by the blender; (2) the blend is to be used on the customer's property (including leased or rented property); (3) the pesticide(s) used in the blend bears end-use labeling directions which do not prohibit use of the product in such a blend; (4) the blend is prepared from registered pesticides; (b) the blend is delivered to the end-user along with a copy of the end-use labeling of each pesticide used in the blend and a statement specifying the composition of mixture; and (6) no other pesticide production activity is performed at the establishment.

the United States. Establishments must be registered with EPA if they intend that a substance produced will be used as an active ingredient of a pesticide or if they have actual or constructive notice that the substance will be used as an active ingredient. If a pesticide is produced for export, whether registered or unregistered, or is produced under an experimental use permit, the producing establishment must be registered.

In order to register an establishment with EPA, contact the EPA Regional office where the establishment is located, or for a foreign establishment, the Washington, DC EPA office. The following information must be submitted on EPA Form 3540-1 when registering an establishment: (1) the name and address of the company; (2) the type of ownership; and (3) the name and address of each producing establishment for which registration is sought. Any changes to the information provided must be submitted to EPA within thirty days after such changes occur. Upon receiving a complete application, EPA will assign a registration number for each listed establishment. This number must appear on the label.

Establishment Reporting Requirements

Under section 7(c) and 40 CFR. section 167.85, each registered pesticide producing establishment must submit an annual production report to EPA by March 1 of each year. Domestic establishments submit their report to the EPA regional office where the company headquarters is located. Foreign establishment production reports are submitted to the Washington, DC EPA office. Custom blenders are exempt from this requirement.

The report must cover any pesticide, active ingredient, or device produced. The report, to be submitted on specific EPA forms, includes the following information: (1) the name and address of the establishment; (2) the amount of each pesticide produced, repackaged, or relabeled in the past year; (3) the amount of each pesticide sold, distributed, or exported in the past year; and (4) the amount of the pesticide estimated to be produced, repackaged, or relabeled in the current year. Foreign establishments only are required to submit a report on pesticides imported into the United States.

Maintenance of Records

All producers of pesticides, devices, or active ingredients used in producing any pesticide must maintain records concerning the production and shipment of each pesticide under 40 CFR Part 169. These records are independent of other required records, including in-plant maintenance, extermination, or sanitation programs. Each establishment must maintain these records for two years. In addition, records on disposal methods must be maintained for 20 years, as well as authorized human trials. Records containing research data must be maintained as long as the registration is valid and the producer is in business. All required records must be available if requested by an inspector.

Prior Informed Consent

As part of its participation in a voluntary international program known as the Prior Informed Consent procedure, EPA prepares the following lists of pesticides that are suspended, canceled or severely restricted. These lists were last updated by EPA in August of 1997.

A "Suspended or Canceled" pesticide is defined as a pesticide for which all registered uses have been prohibited by final government action, or for which all requests for registration or equivalent action for all uses have, for health or environmental reasons, not been granted.

C Suspended or Canceled

1. aldrin
2. benzene hexachloride [BHC] (voluntary cancellation)
3. 2,3,4,5-Bis(2-butylene)tetrahydro-2-furaldehyde [Repellent-11]
4. bromoxynil butyrate (voluntary cancellation)
5. cadmium compounds (voluntary cancellation)
6. calcium arsenate (voluntary cancellation)
7. captafol (voluntary cancellation)
8. carbon tetrachloride
9. chloranil (voluntary cancellation)
10. chlordane
11. chlordimeform (voluntary cancellation)
12. chlorinated camphene [Toxaphene] (voluntary cancellation)
13. chlorobenzilate (voluntary cancellation)
14. chloromethoxypropylmercuric acetate [CPMA]
15. copper arsenate (voluntary cancellation)
16. cyhexatin (voluntary cancellation)
17. DBCP
18. decachlorooctahydro-1,3,4-metheno-2H-cyclobuta(cd) pentalen-2-one[chlordecone]
19. DDT
20. dieldrin
21. dinoseb and salts
22. Di(phenylmercury)dodeceny succinate [PMDS] (voluntary cancellation)
23. EDB
24. endrin (voluntary cancellation)
25. EPN (voluntary cancellation)
26. ethyl hexyleneglycol [6-12] (voluntary cancellation)
27. hexachlorobenzene [HCB] (voluntary cancellation)
28. lead arsenate (voluntary cancellation)
29. leptophos (Never received initial registration)
30. mercurous chloride
31. mercuric chloride

32. mevinphos
33. mirex (voluntary cancellation)
34. monocrotophos (voluntary cancellation)
35. nitrofen (TOK) (voluntary cancellation)
36. OMPA (octamethylpyrophosphoramidate)
37. phenylmercury acetate [PMA]
38. phenylmercuric oleate [PMO] (voluntary cancellation)
39. potassium 2,4,5-trichlorophenate [2,4,5-TCP]
40. pyriminil [Vacor] (voluntary cancellation)
41. safrole (voluntary cancellation)
42. silvex
43. sodium arsenite
44. TDE (voluntary cancellation)
45. Terpene polychlorinates [Strobane] (voluntary cancellation)
46. thallium sulfate
47. 2,4,5-Trichlorophenoxyacetic acid [2,4,5-T]
48. vinyl chloride

A “Severely Restricted” pesticide means a pesticide for which virtually all registered uses have been prohibited by final government regulatory action, but for which certain specific registered use or uses remain authorized.

C Severely Restricted

1. arsenic trioxide
2. azinphos methyl
3. carbofuran (voluntary cancellation)
4. daminozide (voluntary cancellation)
5. heptachlor
6. methyl parathion
7. sodium arsenate
8. tributyltin compounds

Federal Food, Drug, and Cosmetics Act

Under the Federal Food, Drug, and Cosmetics Act (FFDCA), EPA sets tolerances for pesticide residues in food. This authority originally belonged to the Food and Drug Administration (FDA), but was transferred when EPA was formed in 1970. FDA still has responsibility for enforcing compliance with the tolerances. An agricultural product is deemed unsafe under the FFDCA if it contains pesticide residues above the tolerance level established by EPA or if there is no tolerance, unless it is exempt from the requirement for tolerances.

The FFDCA also contains the Delaney Clause that bars the establishment of food additive regulations covering substances that induce cancer in humans or animals. Prior to the Food Quality Protection Act of 1996, this provision

applied to certain pesticide residues in processed food. With the 1996 amendments, pesticide residues are now governed by a single safety clause set forth in section 408.

Toxic Substances Control Act (TSCA)

TSCA gives EPA comprehensive authority to regulate any chemical substance whose manufacture, processing, distribution in commerce, use, or disposal may present an unreasonable risk of injury to health or the environment. EPA keeps an inventory of existing chemicals regulated under TSCA (TSCA section 8(b)). Certain chemicals are specifically excluded from the TSCA inventory, such as pesticides, as defined when manufactured, processed, or distributed in commerce for use as a pesticide under FIFRA (40 CFR section 710.2(h)(2)). However, if a chemical has multiple uses, those uses not subject to FIFRA are regulated by TSCA. In addition, certain mixtures of chemicals are exempt from TSCA (40 CFR section 710.2(h)(1)) (Landfair, 1993).

Four sections are of primary importance to the remainder of the agricultural chemical industry. Section 5 mandates that chemical companies submit to EPA pre-manufacture notices that provide information on health and environmental effects for each new product and test existing products for these effects (40 CFR Part 720). Over 20,000 premanufacture notices have been filed. Section 4 authorizes EPA to require testing of certain substances (40 CFR Part 790). Section 6 gives EPA the authority to prohibit, limit, or ban the manufacture, process, and usage of chemicals (40 CFR Part 750). Among the chemicals EPA regulates under section 6 are asbestos, chlorofluorocarbons (CFCs), and polychlorinated biphenyls (PCBs). For certain chemicals, TSCA section 8 also imposes record-keeping and reporting requirements including substantial risk notification; record-keeping for data relative to adverse reactions; and periodic updates to the TSCA Inventory.

Resource Conservation and Recovery Act (RCRA)

The Resource Conservation and Recovery Act (RCRA) was enacted in 1976 to address problems related to hazardous and solid waste management. RCRA gives EPA the authority to establish a list of solid and hazardous wastes and to establish standards and regulations for the treatment, storage, and disposal of these wastes. Regulations in Subtitle C of RCRA address the identification, generation, transportation, treatment, storage, and disposal of hazardous wastes. These regulations are found in 40 CFR Part 124 and CFR Parts 260-279. Under RCRA, persons who generate waste must determine whether the waste is defined as solid waste or hazardous waste. Solid wastes are considered hazardous wastes if they are listed by EPA as hazardous or if they exhibit characteristics of a hazardous waste: toxicity, ignitability, corrosivity, or reactivity.

Products, intermediates, and off-specification products potentially generated at agricultural chemical facilities that are considered hazardous wastes are listed in 40 CFR Part 261. Some of the handling and treatment requirements for RCRA hazardous waste generators are covered under 40 CFR Part 262 and include the following: determining what constitutes a RCRA hazardous waste (Subpart A); manifesting (Subpart B); packaging, labeling, and accumulation time limits (Subpart C); and record keeping and reporting (Subpart D).

Many agricultural chemical facilities store some hazardous wastes at the facility beyond the accumulation time limits available to generators (e.g., 90 or 180 days). Such facilities are required to have a RCRA treatment, storage, and disposal facility (TSDF) permit (40 CFR Part 262.34). Some agricultural chemical facilities are considered TSDF facilities and are subject to a number of regulations, including but not limited to those covered under 40 CFR Part 264: contingency plans and emergency procedures (40 CFR Part 264 Subpart D); manifesting, record keeping, and reporting (40 CFR Part 264 Subpart E); use and management of containers (40 CFR Part 264 Subpart I); tank systems (40 CFR Part 264 Subpart J); surface impoundments (40 CFR Part 264 Subpart K); land treatment (40 CFR Part 264 Subpart M); corrective action of hazardous waste releases (40 CFR Part 264 Subpart S); air emissions standards for process vents of processes that process or generate hazardous wastes (40 CFR Part 264 Subpart AA); emissions standards for leaks in hazardous waste handling equipment (40 CFR Part 264 Subpart BB); and emissions standards for containers, tanks, and surface impoundments that contain hazardous wastes (40 CFR Part 264 Subpart CC).

Many agricultural chemical facilities are also subject to the underground storage tank (UST) program (40 CFR Part 280). The UST regulations apply to facilities that store either petroleum products or hazardous substances (except hazardous waste) identified under the Comprehensive Environmental Response, Compensation, and Liability Act. UST regulations address design standards, leak detection, operating practices, response to releases, financial responsibility for releases, and closure standards.

A number of RCRA wastes have been prohibited from land disposal unless treated to meet specific standards under the RCRA Land Disposal Restriction (LDR) program. The wastes covered by the RCRA LDRs are listed in 40 CFR Part 268 Subpart C and include a number of wastes that could potentially be generated at agricultural chemical facilities. Standards for the treatment and storage of restricted wastes are described in Subparts D and E, respectively.

The LDRs also apply to the use of fertilizers containing hazardous wastes. Therefore, fertilizers containing hazardous wastes that do not meet the applicable land disposal treatment standards cannot be spread on the land, with some exceptions. Specific exemptions to the use of certain recycled materials and hazardous wastes in fertilizers have been provided in 40 CFR Part 266, Subpart C - Recycled Materials Used in a Manner Constituting

Disposal. Subpart C states that products containing recyclable materials are not subject to regulation under RCRA if the recyclables are physically inseparable from the product or if they meet the standards of 40 CFR Part 268, Subpart D “for each recyclable material (i.e., hazardous waste) that they contain.” These standards include limits on heavy metals. Subpart C also states that zinc-containing fertilizers using hazardous waste K061 (emission control dust/sludge from the primary production of steel in electric furnaces) which is listed as hazardous due to its hexavalent chromium, lead, and cadmium content, are not subject to the land disposal requirements.

Comprehensive Environmental Response, Compensation, and Liability Act (CERCLA)

The Comprehensive Environmental Response, Compensation, and Liability Act of 1980 (CERCLA) and the Superfund Amendments and Reauthorization Act of 1986 (SARA) provide the basic legal framework for the federal “Superfund” program to clean up abandoned hazardous waste sites (40 CFR Part 300 et seq.). The 1986 SARA legislation extended CERCLA taxes for five years and adopted a new broad-based corporate environmental tax, applicable to the allied chemicals (SIC 28) industry, which includes the agricultural chemical industry. In 1990, Congress passed a simple reauthorization that did not substantially change the law but extended the program authority until 1994 and the taxing authority until the end of 1995. A comprehensive reauthorization was considered in 1994, but not passed. Since the expiration of the taxing authority on December 31, 1995, taxes for Superfund have been temporarily suspended. The taxes can only be reinstated by reauthorization of Superfund or an omnibus reconciliation act which could specifically reauthorize taxing authority. The allied chemical industry paid about \$300 million a year in Superfund chemical feedstock taxes. Joint and several liability generally requires Potentially Responsible Parties (PRPs) to perform or pay for their fair share of cleanup costs.

Title III of the 1986 SARA amendments (also known as Emergency Response and Community Right-to-Know Act, EPCRA) requires all manufacturing facilities, including agricultural chemical facilities, to report annual information about stored toxic substances, as well as release of these substances into the environment, to local and state governments and to the public. This is known as the Toxic Release Inventory (TRI). EPCRA also establishes requirements for federal, state, and local governments regarding emergency planning. In 1994, over 300 more chemicals were added to the list of chemicals for which reporting is required.

Clean Air Act (CAA)

The original CAA authorized EPA to set limits on agricultural chemical facility emissions. The new source performance standards (NSPS) for fertilizer manufacturers can be found in 40 CFR Part 60:

- Subpart G - Standards of Performance for Nitric Acid Plants
(40 CFR section 60.70 - 60.74)
- Subpart T - Standards of Performance for the Phosphate Fertilizer Industry: Wet Process Phosphoric Acid Plants
(40 CFR section 60.200 - 60.204)
- Subpart U - Standards of Performance for the Phosphate Fertilizer Industry: Superphosphoric Acid Plants
(40 CFR section 60.210 - 60.214)
- Subpart V - Standards of Performance for the Phosphate Fertilizer Industry: Diammonium Phosphate Plants
(40 CFR section 60.220 - 60.224)
- Subpart W - Standards of Performance for the Phosphate Fertilizer Industry: Triple Superphosphate Plants
(40 CFR section 60.230 - 60.234)
- Subpart X - Standards of Performance for the Phosphate Fertilizer Industry: Granular Triple Superphosphate Storage Facilities (40 CFR section 60.240 - 60.244)

These standards primarily consist of emission and monitoring standards for nitrogen oxides (Nitric Acid Plants) and fluorides (Phosphatic Fertilizer Industry) .

The Clean Air Act Amendments of 1990 set National Emission Standards for Hazardous Air Pollutants (NESHAP) from industrial sources for 41 hazardous air pollutants to be met by 1995 and for 148 other hazardous air pollutants to be reached by 2003. National emission standards for new and existing major sources in phosphoric acid manufacturing, phosphate fertilizers production and pesticide active ingredient production are listed in 40 CFR Parts 9 and 63. 40 CFR Parts 61 and 63 contains several provisions dealing with emissions sources potentially found at an agricultural chemical facility (e.g. equipment leaks, tanks, surface impoundments, separators, and waste treatment operations) may affect the agricultural chemical industry. A number of the chemicals used and produced at agricultural chemical manufacturing and formulating facilities are hazardous air pollutants under CAA.

Under section 112(r) of CAA, owners and operators of stationary sources who produce, process, handle, or store substances listed under CAA section 112(r)(3) or any other extremely hazardous substance have a “general duty” to initiate specific activities to prevent and mitigate accidental releases. Since the general duty requirements apply to stationary sources regardless of the quantity of substances managed at the facility, many agricultural chemical manufacturing and formulating facilities are subject. Activities such as identifying hazards which may result from accidental releases using

appropriate hazard assessment techniques; designing, maintaining and operating a safe facility; and minimizing the consequences of accidental releases if they occur are considered essential activities to satisfy the general duty requirements. These statutory requirements have been in affect since the passage of the Clean Air Act in 1990. Although there is no list of “extremely hazardous substances,” EPA’s Chemical Emergency Preparedness and Prevention Office provides some guidance at its website: <http://www.epa.gov/swercepp.html>.

Also under section 112(r), EPA was required to develop a list of at least 100 substances that, in the event of an accidental release, could cause death, injury, or serious adverse effects to human health or the environment. The list promulgated by EPA is contained in 40 CFR section 68.130 and includes acutely toxic chemicals, flammable gases and volatile flammable liquids. Under section 112(r)(7), facilities handling more than a threshold quantity (ranging from 500 to 20,000 pounds) of these substances are subject to chemical accident prevention provisions including the development and implementation of a risk management program (40 CFR sections 68.150-68.220). The requirements in 40 CFR Part 68 begin to go into effect in June 1999. Many of the chemicals on the 112(r) list are commonly handled by agricultural chemical manufacturers and formulators in quantities greater than the threshold values. Ammonia held by farmers for use as an agricultural nutrient is exempt from the chemical accident prevention provisions.

Standards in 40 CFR Part 61 Subpart R - National Emission Standards for Radon Emissions from Phosphogypsum Stacks (40 CFR sections 61.200 - 61.210) deal specifically with the phosphatic fertilizer industry. The standards require monitoring and reporting of radon-222 emissions from the stacks and sets limits on the amounts of radon-222 that can be emitted into the air. EPA has also set standards for the maximum concentration of radium-226 allowed in phosphogypsum removed from stacks for use in agriculture.

Clean Water Act (CWA)

The Clean Water Act, first passed in 1972 and amended in 1977 and 1987, gives EPA the authority to regulate effluents from sewage treatment works, chemical plants, and other industrial sources into waters. The act sets standards for treatment of wastes for both direct and indirect (to a Publicly Owned Treatment Works (POTW)) discharges. EPA has set effluent guidelines for both the fertilizer manufacturing and formulating, and pesticide formulating, packaging and repackaging point source categories. The implementation of the guidelines is left primarily to the states who issue National Pollutant Discharge Elimination System (NPDES) permits for each facility (EPA has authorized 43 states to operate the NPDES program).

Effluent guidelines specific to the fertilizer manufacturing and formulating point source category are contained in 40 CFR Part 418 and are divided into

product specific effluent guidelines as follows:

- Subpart A - Phosphates (40 CFR section 418.10 - 418.17)
- Subpart B - Ammonia (40 CFR section 418.20 - 418.27)
- Subpart C - Urea (40 CFR section 418.30 - 418.36)
- Subpart D - Ammonium Nitrate (40 CFR section 418.40 - 418.46)
- Subpart E - Nitric Acid (40 CFR section 418.50 - 418.56)
- Subpart F - Ammonium Sulfate (40 CFR section 418.60 - 418.67)
- Subpart G - Mixed and Blend Fertilizer Production
(40 CFR section 418.70 - 418.77)

In 1997, revised effluent guidelines were finalized for the Pesticide Formulating, Packaging and Repackaging Subcategory. These regulations replace the effluent guidelines established in 1978 for the Pesticide Formulating and Packaging Subcategory. The revised guidelines are contained in 40 CFR Part 455 and are divided into the following subcategories:

- Subpart C - Pesticide Chemicals Formulating and Packaging Subcategory
- Subpart E - Repackaging of Agricultural Pesticides Performed at Refilling Establishments

Each Subpart consists of effluent standards representing the amount of effluent reduction possible by using either best practicable control technologies (BPT), best conventional pollution technologies (BCT), or best available technologies (BAT). The states and EPA give effect to these standards through NPDES permits that they issue to direct dischargers. BCT standards limit the discharge of conventional pollutants, while BPT and BAT standards represent successive levels of control of priority pollutants and non-conventional pollutants.

For Subcategory C, EPA established effluent limitations and pretreatment standards which allow each facility a choice of meeting a zero discharge limitation or to comply with a pollution prevention alternative that authorizes the discharge of some pesticide active ingredients (AIs) and priority pollutants after various pollution prevention practices are followed and treatment is conducted as needed. For Subcategory E, EPA has established a zero discharge limitation and pretreatment standard.

The Storm Water Rule (40 CFR section 122.26) requires fertilizer manufacturing and formulating and pesticide formulating facilities discharging storm water associated with industrial activities (40 CFR section 122.26 (b)(14)(ii)) to apply for NPDES permits for those discharges.

Under 40 CFR 503 Subpart B - Land Application, EPA regulates the land application of sewerage treatment sludge, which includes fertilizers derived from sewerage treatment sludge. Subpart B regulations include specific limitations on heavy metal content, as well as general operational and management standards.

VI.C. State Regulation of Pesticides

All states have their own pesticide laws and many states have their own pesticide registration requirements. States have primary use enforcement authority if EPA has determined that the state has adequate pesticide use laws and has adopted adequate procedures to enforce those laws. The EPA may enter into a cooperative agreement with a state to carry out enforcement of state laws and train and certify applicators. The FIFRA allows states to administer their own EPA-approved applicator certifications program. Also, each state is allowed to regulate the sale and use of pesticides as long as the regulations are at least as stringent as EPA's and the regulations do not conflict or differ from EPA's labeling and packaging restrictions.

States typically require that fertilizer products be registered with the state and that claims made on fertilizer labels can be substantiated. States also regulate the efficacy of fertilizers through labeling requirements. State fertilizer labeling requirements typically require that the label indicate the product name, the brand and grade, the percentage of each nutrient (nitrogen, available phosphate, potassium, etc.), and the name and address of the registrant. Some states also require that the label indicate materials from which the nutrients are derived.

Additional information on specific state requirements can be obtained from the Association of American Pesticide Control Officials, Inc. (AAPCO) at: <http://aapco.ceris.purdue.edu/index.html>. This website contains a list of state pesticide control officials that includes contact information.

VI.D. Pending and Proposed Regulatory Requirements

FIFRA

Registration

- In order to reduce the potential for groundwater contamination from certain pesticides, EPA proposed the Ground Water Pesticide Management Plan Rule in June of 1996 (61 FR 33259). EPA is proposing to restrict the use of certain pesticides by providing states and tribes with the flexibility to protect the ground water in the most appropriate way for local conditions, through the development and use of Pesticide Management Plans (PMPs). When finalized, the regulations will likely give states and tribes the authority to develop management plans that specify risk reduction measures for the following four pesticides: atrazine, alachlor, simazine, and metolachlor. Without EPA-approved plans, use of these chemicals would be prohibited. A final rule is expected to be published in late 2000. (Contact: Arty Williams, United States EPA Office of Prevention, Pesticides and Toxic Substances, 703-305-5239)
- In response to the Food Quality Protection Act of 1996, EPA is planning to propose revisions to antimicrobial registration and classification procedures (40 CFR Part 152) that will reduce to the extent possible the review time for antimicrobial pesticides. Revisions to labeling requirements (40 CFR Part 156) and data requirements for antimicrobial registration (40 CFR Part 158) are also being proposed. The revisions are expected to be released in early 2001. This regulation would also implement some general provisions of FIFRA that pertain to all pesticides, including labeling requirements and notification procedures. (Contact: Jean Frane, United States EPA Office of Prevention, Pesticides, and Toxic Substances, 703-305-5944 and Paul Parsons, United States EPA Office of Prevention, Pesticides, and Toxic Substances, 703-308-9073)
- In order to evaluate the registrability of pesticide products, EPA is expected to propose revisions to the data requirements for FIFRA registration (40 CFR Part 158). These revisions would clarify all data requirements to reflect current practice and are expected to be published in 2001. (Contact: Jean Frane, United States EPA Office of Prevention, Pesticides, and Toxic Substances, 703-305-5944)

Use Restrictions

- In May of 1991, EPA proposed amendments to the existing Restricted Use Classification (RUC) regulations (40 CFR Part 152, Subpart I) to add criteria pertaining to the groundwater contamination potential of pesticides (56 FR 22076). The criteria would be used to determine

which pesticides should be considered for restricted use classifications to protect groundwater. A policy statement is expected to be issued in late 2000. (Contact: Joseph Hogue, United States EPA Office of Prevention, Pesticides, and Toxic Substances, 703-308-9072)

Tolerances and Exemptions

- EPA expects to reassess pesticide tolerances and exemptions for raw and processed foods established prior to August 3, 1996 (40 CFR Part 180, 40 CFR Part 185, 40 CFR Part 186), to determine whether they meet the standard of the Federal Food, Drug and Cosmetic Act (FFDCA). FFDCA section 408 (q), as amended by the Food Quality Protection Act, requires that EPA conduct this reassessment on a phased 10-year schedule. For the current phased schedule, EPA is required to complete reassessments as follows: 33% by August 3, 1999, 66% by August 3, 2002, and 100% by August 3, 2006. Based on its reassessment, EPA will likely propose a series of regulatory actions to modify or revoke tolerances. (Contacts: Robert McNally, United States EPA, Office of Prevention, Pesticides and Toxic Substances, 703-308-8085 and Joseph Nevola, United States EPA Office of Prevention Pesticides and Toxic Substances, 703-308-8037)
- Regulations specifying policies and procedures under which the EPA can establish food tolerances associated with the use of pesticides under emergency exemptions (40 CFR Part 176) are expected to be finalized in late 2000. The EPA issues emergency exemptions for temporary use of pesticides where emergency conditions exist. Under FFDCA, as amended by the Food Quality Protection Act, EPA must establish time-limited tolerances for such pesticides if the use is likely to result in residues in food. (Contact: Joseph Hogue, United States EPA Office of Prevention, Pesticides, and Toxic Substances, 703-308-9072)
- EPA proposed a rule to adjust and update the fee structure and fee amounts for tolerance actions, which are required under FFDCA (40 CFR section 180.33). The rule is expected to be finalized in late 2000. (Contact: Carol Peterson, United States EPA, Office of Prevention, Pesticides, and Toxic Substances, 703-305-6598)
- Revisions to regulations on emergency exemptions under section 18 of FIFRA, are expected to be issued in late 2001 (40 CFR Part 166). EPA is considering revisions in four areas: 1) Options for increased authority for states to administer certain aspects of the exemption process, and/or increased use by the EPA of multi-year exemptions; 2) the use of emergency exemptions to address pesticide resistance; 3) the

possibility of granting exemptions based upon reduced risk considerations; and 4) definitions of emergency situation and significant economic loss, which would affect whether or not an exemption may be granted. (Contact: Joseph Hogue, United States EPA Office of Prevention, Pesticides, and Toxic Substances, 703-308-9072)

Pesticide Storage and Disposal

- In 1994, EPA proposed a rule, authorized under section 19 of FIFRA, to establish standards for pesticide containers and secondary containment relating to the distribution and sale of pesticides (59 FR 6712). Standards are expected to be developed for the removal of pesticides from containers, rinsing containers, container design, container labeling, container refilling, the containment of stationary bulk containers and for the containment of pesticide dispensing areas (40 CFR Part 165, 40 CFR Part 156). A final rule is expected to be published in late 2000. (Contact: Nancy Fitz, United States EPA, Office of Prevention, Pesticides and Toxic Substances, 703-305-7385)

Exports

- The Rotterdam Agreement, signed in 1998, requires that certain banned or severely restricted hazardous chemicals are subject to intensive information exchange procedures, and if an importing country decides against import, exporting countries are obligated to prohibit export to that country. Twenty-four pesticides are currently covered by the treaty. As a result of the United States signing of this treaty, EPA has drafted legislation that allows it in the future to propose revisions to its pesticide export policy. (Contact: Cathleen Barnes, United States EPA Office of Prevention, Pesticides and Toxic Substances, 703-305-7101)

Worker Protection

- EPA has proposed a change to the Worker Protection Standards (WPS) of FIFRA (40 CFR Part 170). Specifically, the glove requirements may be modified to allow glove liners to be worn inside chemically resistant gloves. The proposed rule will be finalized in 2001. (Contact: Kevin Keaney, United States EPA Office of Prevention, Pesticides and Toxic Substances, 703-305-5557)

VII. COMPLIANCE AND ENFORCEMENT HISTORY

Background

Until recently, EPA has focused much of its attention on measuring compliance with specific environmental statutes. This approach allows the Agency to track compliance with the Federal Insecticide, Fungicide, and Rodenticide Act, the Clean Air Act, the Resource Conservation and Recovery Act, the Clean Water Act, and other environmental statutes. Within the last several years, the Agency has begun to supplement single-media compliance indicators with facility-specific, multimedia indicators of compliance. In doing so, EPA is in a better position to track compliance with all statutes at the facility level, and within specific industrial sectors.

A major step in building the capacity to compile multimedia data for industrial sectors was the creation of EPA's Integrated Data for Enforcement Analysis (IDEA) system. IDEA has the capacity to "read into" the Agency's single-media databases, extract compliance records, and match the records to individual facilities. The IDEA system can match Air, Water, Waste, Toxics/Pesticides/EPCRA, TRI, and Enforcement Docket records for a given facility, and generate a list of historical permit, inspection, and enforcement activity. IDEA also has the capability to analyze data by geographic area and corporate holder. As the capacity to generate multimedia compliance data improves, EPA will make available more in-depth compliance and enforcement information. Additionally, sector-specific measures of success for compliance assistance efforts are under development.

Compliance and Enforcement Profile Description

Using inspection, violation and enforcement data from the IDEA system, this section provides information regarding the historical compliance and enforcement activity of this sector. In order to mirror the facility universe reported in the Toxic Chemical Profile, the data reported within this section consists of records only from the TRI reporting universe. With this decision, the selection criteria are consistent across sectors with certain exceptions. For the sectors that do not normally report to the TRI program, data have been provided from EPA's Facility Indexing System (FINDS) which tracks facilities in all media databases. Please note, in this section, EPA does not attempt to define the actual number of facilities that fall within each sector. Instead, the section portrays the records of a subset of facilities within the sector that are well defined within EPA databases.

As a check on the relative size of the full sector universe, most notebooks contain an estimated number of facilities within the sector according to the Bureau of Census (*See* Section II). With sectors dominated by small businesses, such as metal finishers and printers, the reporting universe within

the EPA databases may be small in comparison to Census data. However, the group selected for inclusion in this data analysis section should be consistent with this sector's general make-up.

Following this introduction is a list defining each data column presented within this section. These values represent a retrospective summary of inspections and enforcement actions, and reflect solely EPA, state, and local compliance assurance activities that have been entered into EPA databases. To identify any changes in trends, the EPA ran two data queries, one for the past five calendar years (April 1, 1992 to March 31, 1997) and the other for the most recent twelve-month period (April 1, 1996 to March 31, 1997). The five-year analysis gives an average level of activity for that period for comparison to the more recent activity.

Because most inspections focus on single-media requirements, the data queries presented in this section are taken from single media databases. These databases do not provide data on whether inspections are state/local or EPA-led. However, the table breaking down the universe of violations does give the reader a crude measurement of the EPA's and states' efforts within each media program. The presented data illustrate the variations across EPA regions for certain sectors.⁵ This variation may be attributable to state/local data entry variations, specific geographic concentrations, proximity to population centers, sensitive ecosystems, highly toxic chemicals used in production, or historical noncompliance. Hence, the exhibited data do not rank regional performance or necessarily reflect which regions may have the most compliance problems.

Compliance and Enforcement Data Definitions

General Definitions

Facility Indexing System (FINDS) -- assigns a common facility number to EPA single-media permit records. The FINDS identification number allows EPA to compile and review all permit, compliance, enforcement, and pollutant release data for any given regulated facility.

Integrated Data for Enforcement Analysis (IDEA) -- is a data integration system that can retrieve information from the major EPA program office databases. IDEA uses the FINDS identification number to link separate data records from EPA's databases. This allows retrieval of records from across

⁵ EPA Regions include the following states: I (CT, MA, ME, RI, NH, VT); II (NJ, NY, PR, VI); III (DC, DE, MD, PA, VA, WV); IV (AL, FL, GA, KY, MS, NC, SC, TN); V (IL, IN, MI, MN, OH, WI); VI (AR, LA, NM, OK, TX); VII (IA, KS, MO, NE); VIII (CO, MT, ND, SD, UT, WY); IX (AZ, CA, HI, NV, Pacific Trust Territories); X (AK, ID, OR, WA).

media or statutes for any given facility, thus creating a “master list” of records for that facility. Some of the data systems accessible through IDEA are: AFS (Air Facility Indexing and Retrieval System, Office of Air and Radiation), PCS (Permit Compliance System, Office of Water), RCRIS (Resource Conservation and Recovery Information System, Office of Solid Waste), NCDB (National Compliance Data Base, Office of Prevention, Pesticides, and Toxic Substances), CERCLIS (Comprehensive Environmental and Liability Information System, Superfund), and TRIS (Toxic Release Inventory System). IDEA also contains information from outside sources such as Dun and Bradstreet and the Occupational Safety and Health Administration (OSHA). Most data queries displayed in notebook sections IV and VII were conducted using IDEA.

Data Table Column Heading Definitions

Facilities in Search -- are based on the universe of TRI reporters within the listed SIC code range. For industries not covered under TRI reporting requirements (metal mining, nonmetallic mineral mining, electric power generation, ground transportation, water transportation, and dry cleaning), or industries in which only a very small fraction of facilities report to TRI (e.g., printing), the notebook uses the FINDS universe for executing data queries. The SIC code range selected for each search is defined by each notebook's selected SIC code coverage described in section II.

Facilities Inspected --- indicates the level of EPA and state agency inspections for the facilities in this data search. These values show what percentage of the facility universe is inspected in a one-year or five-year period.

Number of Inspections -- measures the total number of inspections conducted in this sector. An inspection event is counted each time it is entered into a single media database.

Average Time Between Inspections -- provides an average length of time, expressed in months, between compliance inspections at a facility within the defined universe.

Facilities with One or More Enforcement Actions -- expresses the number of facilities that were the subject of at least one enforcement action within the defined time period. This category is broken down further into federal and state actions. Data are obtained for administrative, civil/judicial, and criminal enforcement actions. Administrative actions include Notices of Violation (NOVs). A facility with multiple enforcement actions is only counted once in this column, e.g., a facility with 3 enforcement actions counts as 1 facility.

Total Enforcement Actions -- describes the total number of enforcement actions identified for an industrial sector across all environmental statutes. A facility with multiple enforcement actions is counted multiple times, e.g., a facility with 3 enforcement actions counts as 3.

State Lead Actions -- shows what percentage of the total enforcement actions are taken by state and local environmental agencies. Varying levels of usage by states of EPA data systems may limit the volume of actions recorded as state enforcement activity. Some states extensively report enforcement activities into EPA data systems, while other states may use their own data systems.

Federal Lead Actions -- shows what percentage of the total enforcement actions are taken by the United States Environmental Protection Agency. This value includes referrals from state agencies. Many of these actions result from coordinated or joint state/federal efforts.

Enforcement to Inspection Rate -- is a ratio of enforcement actions to inspections, and is presented for comparative purposes only. This ratio is a rough indicator of the relationship between inspections and enforcement. It relates the number of enforcement actions and the number of inspections that occurred within the one-year or five-year period. This ratio includes the inspections and enforcement actions reported under the Clean Water Act (CWA), the Clean Air Act (CAA) and the Resource Conservation and Recovery Act (RCRA). Inspections and actions from the TSCA/FIFRA/EPCRA database are not factored into this ratio because most of the actions taken under these programs are not the result of facility inspections. Also, this ratio does not account for enforcement actions arising from non-inspection compliance monitoring activities (e.g., self-reported water discharges) that can result in enforcement action within the CAA, CWA, and RCRA.

Facilities with One or More Violations Identified -- indicates the percentage of inspected facilities having a violation identified in one of the following data categories: In Violation or Significant Violation Status (CAA); Reportable Noncompliance, Current Year Noncompliance, Significant Noncompliance (CWA); Noncompliance and Significant Noncompliance (FIFRA, TSCA, and EPCRA); Unresolved Violation and Unresolved High Priority Violation (RCRA). The values presented for this column reflect the extent of noncompliance within the measured time frame, but do not distinguish between the severity of the noncompliance. Violation status may be a precursor to an enforcement action, but does not necessarily indicate that an enforcement action will occur.

Media Breakdown of Enforcement Actions and Inspections -- four columns identify the proportion of total inspections and enforcement actions within

EPA Air, Water, Waste, and TSCA/FIFRA/EPCRA databases. Each column is a percentage of either the “Total Inspections,” or the “Total Actions” column.

VII.A. Fertilizer, Pesticide, and Agricultural Chemical Industry Compliance History

Table 25 provides an overview of the reported compliance and enforcement data for the Fertilizer, Pesticide, and Agricultural Chemical Industry over five years from April 1992 to April 1997. These data are also broken out by EPA Regions thereby permitting geographical comparisons. A few points evident from the data are listed below.

- C About 75 percent of agricultural chemical facility inspections and 73 percent of enforcement actions occurred in EPA Regions IV, V, VI, and VII.
- C Region IX had the highest ratio of enforcement actions to inspections (0.13) and the longest average time between inspections (21 months). This indicates that fewer inspections were conducted in relation to the number of facilities in the Region, but that these inspections were more likely to result in an enforcement action than inspections conducted in other Regions.
- C With the exception of Region I, in which no inspections or enforcement actions were carried out in between 1992 and 1997, Region VIII had the lowest enforcement to inspection rate (0.03).

A	B	C	D	E	F	G	H	I	J
Region	Facilities in Search	Facilities Inspected	Number of Inspections	Average Months Between Inspections	Facilities with 1 or More Enforcement Actions	Total Enforcement Actions	Percent State Lead Actions	Percent Federal Lead Actions	Enforcement to Inspection Rate
I	3	0	0	--	0	0	0%	0%	--
II	11	8	50	13	3	4	75%	25%	0.08
III	18	16	123	9	2	10	80%	20%	0.08
IV	77	44	449	10	15	41	83%	17%	0.09
V	35	23	128	16	4	7	57%	43%	0.05
VI	34	21	167	12	5	9	56%	44%	0.05
VII	43	31	225	11	8	17	71%	29%	0.08
VIII	9	5	33	16	1	1	100%	0%	0.03
IX	25	10	72	21	5	9	78%	22%	0.13
X	8	6	46	10	4	4	25%	75%	0.09
TOTAL	263	164	1,293	12	47	102	74%	26%	0.08

Source: Data obtained from EPA's Integrated Data for Enforcement Analysis (IDEA) system in 1997.

VII.B. Comparison of Enforcement Activity Between Selected Industries

Tables 26 and 27 allow the compliance history of the agricultural chemical sector to be compared to the other industries covered by the industry sector notebooks. Comparisons between Tables 26 and 27 permit the identification of trends in compliance and enforcement records of the various industries by comparing data covering five years (April 1992 to April 1997) to that of the last year for which data were available (April 1996 to April 1997). Some points evident from the data are listed below.

- C The agricultural chemical sector was inspected more frequently than most of the sectors shown (12 months on average between inspections).
- C Between 1992 and 1997, the industry had a higher enforcement to inspection rate than most sectors (0.08); however, in 1997 the ratio decreased to 0.05 which is lower than most sectors.
- C The agricultural chemical sector had one of the highest percentages of facilities inspected with one or more violations (97 percent) in 1997, but one of the lowest percentages of facilities with one or more enforcement actions (5 percent).

Tables 28 and 29 provide a more in-depth comparison between the Fertilizer, Pesticide, and Agricultural Chemical Industry and other sectors by breaking out the compliance and enforcement data by environmental statute. As in the previous Tables (Tables 26 and 27), the data cover the years 1992 to 1997 (Table 28) and 1997 (Table 29) to facilitate the identification of recent trends. A few points evident from the data are listed below.

- C The percent of inspections carried out under each environmental statute has changed only slightly between the average of the years 1992 to 1997 and that of the past year. The Clean Air Act accounted for the most inspections (43 percent) during this period. This increased to almost half of all agricultural chemical facility inspections (49 percent) in 1997.
- C The percent of enforcement actions taken under each environmental statute changed significantly from the 1992 to 1997 period to the past year. Enforcement actions taken under the Clean Air Act increased from 39 percent to 55 percent and enforcement actions taken under RCRA increased from 30 percent to 36 percent. At the same time, the enforcement actions taken under the Clean Water Act went from 20 percent in 1992 to 1995 to no actions in 1997.

Table 26: Five-Year Enforcement and Compliance Summary for Selected Industries

A	B	C	D	E	F	G	H	I	J
Industry Sector	Facilities in Search	Facilities Inspected	Number of Inspections	Average Months Between Inspections	Facilities with 1 or More Enforcement Actions	Total Enforcement Actions	Percent State Lead Actions	Percent Federal Lead Actions	Enforcement to Inspection Rate
Metal Mining	1,232	378	1,600	46	63	111	53%	47%	0.07
Coal Mining	3,256	741	3,748	52	88	132	89%	11%	0.04
Oil and Gas Extraction	4,676	1,902	6,071	46	149	309	79%	21%	0.05
Non-Metallic Mineral Mining	5,256	2,803	12,826	25	385	622	77%	23%	0.05
Textiles	355	267	1,465	15	53	83	90%	10%	0.06
Lumber and Wood	712	473	2,767	15	134	265	70%	30%	0.10
Furniture	499	386	2,379	13	65	91	81%	19%	0.04
Pulp and Paper	484	430	4,630	6	150	478	80%	20%	0.10
Printing	5,862	2,092	7,691	46	238	428	88%	12%	0.06
Inorganic Chemicals	441	286	3,087	9	89	235	74%	26%	0.08
Resins and Manmade Fibers	329	263	2,430	8	93	219	76%	24%	0.09
Pharmaceuticals	164	129	1,201	8	35	122	80%	20%	0.10
Organic Chemicals	425	355	4,294	6	153	468	65%	35%	0.11
Agricultural Chemicals	263	164	1,293	12	47	102	74%	26%	0.08
Petroleum Refining	156	148	3,081	3	124	763	68%	32%	0.25
Rubber and Plastic	1,818	981	4,383	25	178	276	82%	18%	0.06
Stone, Clay, Glass and Concrete	615	388	3,474	11	97	277	75%	25%	0.08
Iron and Steel	349	275	4,476	5	121	305	71%	29%	0.07
Metal Castings	669	424	2,535	16	113	191	71%	29%	0.08
Nonferrous Metals	203	161	1,640	7	68	174	78%	22%	0.11
Fabricated Metal Products	2,906	1,858	7,914	22	365	600	75%	25%	0.08
Electronics	1,250	863	4,500	17	150	251	80%	20%	0.06
Automobile Assembly	1,260	927	5,912	13	253	413	82%	18%	0.07
Shipbuilding and Repair	44	37	243	9	20	32	84%	16%	0.13
Ground Transportation	7,786	3,263	12,904	36	375	774	84%	16%	0.06
Water Transportation	514	192	816	38	36	70	61%	39%	0.09
Air Transportation	444	231	973	27	48	97	88%	12%	0.10
Fossil Fuel Electric Power	3,270	2,166	14,210	14	403	789	76%	24%	0.06

Table 27: One-Year Enforcement and Compliance Summary for Selected Industries

A Industry Sector	B Facilities in Search	C Facilities Inspected	D Number of Inspections	E Facilities with 1 or More Violations		F Facilities with 1 or more Enforcement Actions		G Total Enforcement Actions	H Enforcement to Inspection Rate
				Number	Percent*	Number	Percent*		
Metal Mining	1,232	142	211	102	72%	9	6%	10	0.05
Coal Mining	3,256	362	765	90	25%	20	6%	22	0.03
Oil and Gas Extraction	4,676	874	1,173	127	15%	26	3%	34	0.03
Non-Metallic Mineral Mining	5,256	1,481	2,451	384	26%	73	5%	91	0.04
Textiles	355	172	295	96	56%	10	6%	12	0.04
Lumber and Wood	712	279	507	192	69%	44	16%	52	0.10
Furniture	499	254	459	136	54%	9	4%	11	0.02
Pulp and Paper	484	317	788	248	78%	43	14%	74	0.09
Printing	5,862	892	1,363	577	65%	28	3%	53	0.04
Inorganic Chemicals	441	200	548	155	78%	19	10%	31	0.06
Resins and Manmade Fibers	329	173	419	152	88%	26	15%	36	0.09
Pharmaceuticals	164	80	209	84	105%	8	10%	14	0.07
Organic Chemicals	425	259	837	243	94%	42	16%	56	0.07
Agricultural Chemicals	263	105	206	102	97%	5	5%	11	0.05
Petroleum Refining	156	132	565	129	98%	58	44%	132	0.23
Rubber and Plastic	1,818	466	791	389	83%	33	7%	41	0.05
Stone, Clay, Glass and Concrete	615	255	678	151	59%	19	7%	27	0.04
Iron and Steel	349	197	866	174	88%	22	11%	34	0.04
Metal Castings	669	234	433	240	103%	24	10%	26	0.06
Nonferrous Metals	203	108	310	98	91%	17	16%	28	0.09
Fabricated Metal	2,906	849	1,377	796	94%	63	7%	83	0.06
Electronics	1,250	420	780	402	96%	27	6%	43	0.06
Automobile Assembly	1,260	507	1,058	431	85%	35	7%	47	0.04
Shipbuilding and Repair	44	22	51	19	86%	3	14%	4	0.08
Ground Transportation	7,786	1,585	2,499	681	43%	85	5%	103	0.04
Water Transportation	514	84	141	53	63%	10	12%	11	0.08
Air Transportation	444	96	151	69	72%	8	8%	12	0.08

Table 28: Five-Year Inspection and Enforcement Summary by Statute for Selected Industries

Industry Sector	Facilities Inspected	Total Inspections	Total Enforcement Actions	Clean Air Act		Clean Water Act		RCRA		FIFRA/TSCA/EPCRA/Other	
				% of Total Inspections	% of Total Actions	% of Total Inspections	% of Total Actions	% of Total Inspections	% of Total Actions	% of Total Inspections	% of Total Actions
Metal Mining	378	1,600	111	39%	19%	52%	52%	8%	12%	1%	17%
Coal Mining	741	3,748	132	57%	64%	38%	28%	4%	8%	1%	1%
Oil and Gas Extraction	1,902	6,071	309	75%	65%	16%	14%	8%	18%	0%	3%
Non-Metallic Mineral Mining	2,803	12,826	622	83%	81%	14%	13%	3%	4%	0%	3%
Textiles	267	1,465	83	58%	54%	22%	25%	18%	14%	2%	6%
Lumber and Wood	473	2,767	265	49%	47%	6%	6%	44%	31%	1%	16%
Furniture	386	2,379	91	62%	42%	3%	0%	34%	43%	1%	14%
Pulp and Paper	430	4,630	478	51%	59%	32%	28%	15%	10%	2%	4%
Printing	2,092	7,691	428	60%	64%	5%	3%	35%	29%	1%	4%
Inorganic Chemicals	286	3,087	235	38%	44%	27%	21%	34%	30%	1%	5%
Resins and Manmade Fibers	263	2,430	219	35%	43%	23%	28%	38%	23%	4%	6%
Pharmaceuticals	129	1,201	122	35%	49%	15%	25%	45%	20%	5%	5%
Organic Chemicals	355	4,294	468	37%	42%	16%	25%	44%	28%	4%	6%
Agricultural Chemicals	164	1,293	102	43%	39%	24%	20%	28%	30%	5%	11%
Petroleum Refining	148	3,081	763	42%	59%	20%	13%	36%	21%	2%	7%
Rubber and Plastic	981	4,383	276	51%	44%	12%	11%	35%	34%	2%	11%
Stone, Clay, Glass and Concrete	388	3,474	277	56%	57%	13%	9%	31%	30%	1%	4%
Iron and Steel	275	4,476	305	45%	35%	26%	26%	28%	31%	1%	8%
Metal Castings	424	2,535	191	55%	44%	11%	10%	32%	31%	2%	14%
Nonferrous Metals	161	1,640	174	48%	43%	18%	17%	33%	31%	1%	10%
Fabricated Metal	1,858	7,914	600	40%	33%	12%	11%	45%	43%	2%	13%
Electronics	863	4,500	251	38%	32%	13%	11%	47%	50%	2%	7%
Automobile Assembly	927	5,912	413	47%	39%	8%	9%	43%	43%	2%	9%
Shipbuilding and Repair	37	243	32	39%	25%	14%	25%	42%	47%	5%	3%
Ground Transportation	3,263	12,904	774	59%	41%	12%	11%	29%	45%	1%	3%
Water Transportation	192	816	70	39%	29%	23%	34%	37%	33%	1%	4%
Air Transportation	231	973	97	25%	32%	27%	20%	48%	48%	0%	0%
Fossil Fuel Electric Power	2,166	14,210	789	57%	59%	32%	26%	11%	10%	1%	5%
Dry Cleaning	2,360	3,813	66	56%	23%	3%	6%	41%	71%	0%	0%

Table 29: One-Year Inspection and Enforcement Summary by Statute for Selected Industries

Industry Sector	Facilities Inspected	Total Inspections	Total Enforcement Actions	Clean Air Act		Clean Water Act		RCRA		FIFRA/TSCA/EPCRA/Other	
				% of Total Inspections	% of Total Actions	% of Total Inspections	% of Total Actions	% of Total Inspections	% of Total Actions	% of Total Inspections	% of Total Actions
Metal Mining	142	211	10	52%	0%	40%	40%	8%	30%	0%	30%
Coal Mining	362	765	22	56%	82%	40%	14%	4%	5%	0%	0%
Oil and Gas Extraction	874	1,173	34	82%	68%	10%	9%	9%	24%	0%	0%
Non-Metallic Mineral Mining	1,481	2,451	91	87%	89%	10%	9%	3%	2%	0%	0%
Textiles	172	295	12	66%	75%	17%	17%	17%	8%	0%	0%
Lumber and Wood	279	507	52	51%	30%	6%	5%	44%	25%	0%	40%
Furniture	254	459	11	66%	45%	2%	0%	32%	45%	0%	9%
Pulp and Paper	317	788	74	54%	73%	32%	19%	14%	7%	0%	1%
Printing	892	1,363	53	63%	77%	4%	0%	33%	23%	0%	0%
Inorganic Chemicals	200	548	31	35%	59%	26%	9%	39%	25%	0%	6%
Resins and Manmade Fibers	173	419	36	38%	51%	24%	38%	38%	5%	0%	5%
Pharmaceuticals	80	209	14	43%	71%	11%	14%	45%	14%	0%	0%
Organic Chemicals	259	837	56	40%	54%	13%	13%	47%	34%	0%	0%
Agricultural Chemicals	105	206	11	48%	55%	22%	0%	30%	36%	0%	9%
Petroleum Refining	132	565	132	49%	67%	17%	8%	34%	15%	0%	10%
Rubber and Plastic	466	791	41	55%	64%	10%	13%	35%	23%	0%	0%
Stone, Clay, Glass and Concrete	255	678	27	62%	63%	10%	7%	28%	30%	0%	0%
Iron and Steel	197	866	34	52%	47%	23%	29%	26%	24%	0%	0%
Metal Castings	234	433	26	60%	58%	10%	8%	30%	35%	0%	0%
Nonferrous Metals	108	310	28	44%	43%	15%	20%	41%	30%	0%	7%
Fabricated Metal	849	1,377	83	46%	41%	11%	2%	43%	57%	0%	0%
Electronics	420	780	43	44%	37%	14%	5%	43%	53%	0%	5%
Automobile Assembly	507	1,058	47	53%	47%	7%	6%	41%	47%	0%	0%
Shipbuilding and Repair	22	51	4	54%	0%	11%	50%	35%	50%	0%	0%
Ground Transportation	1,585	2,499	103	64%	46%	11%	10%	26%	44%	0%	1%
Water Transportation	84	141	11	38%	9%	24%	36%	38%	45%	0%	9%
Air Transportation	96	151	12	28%	33%	15%	42%	57%	25%	0%	0%
Fossil Fuel Electric Power	1,318	2,430	135	59%	73%	32%	21%	9%	5%	0%	0%
Dry Cleaning	1,234	1,436	16	69%	56%	1%	6%	30%	38%	0%	0%

VII.C. Review of Major Legal Actions

Major Cases/Supplemental Environmental Projects

This section provides summary information about major cases that have affected this sector, and a list of Supplemental Environmental Projects (SEPs).

VII.C.1. Review of Major Cases

As indicated in EPA's *Enforcement Accomplishments Report, FY1995 and FY1996* publications, about 17 significant enforcement actions were resolved between 1995 and 1996 for the Fertilizer, Pesticide, and Agricultural Chemical Industry.

American Cyanamid Company On June 28, 1995, Region II issued an administrative complaint against American Cyanamid Company for violations at its Lederle Laboratories facility located in Pearl River, New York. The complaint proposed assessment of a \$272,424 fine for the company's failure to submit timely TRI Form Rs for 1,1,1-trichloroethane, naphthalene, phosphoric acid, toluene, manganese compounds and zinc compounds for the reporting years 1990, 1991, 1992, and 1993.

Precision Generators, Inc. The Regional Administrator signed a consent order in the *Precision Generators, Inc.*, a FIFRA case, in which the respondent agreed to pay the proposed penalty of \$4,000. The administrative complaint cited the respondent's sale and misbranding of its unregistered pesticide product ethylene fluid used to accelerate the ripening of fruits and vegetables. Such a product is a "plant regulator" falling within the definition of "pesticide" in FIFRA.

E.C. Geiger, Inc. On August 18, 1995, the Regional Administrator signed a consent agreement and consent order finalizing settlement of the administrative proceeding against E.C. Geiger, Inc. of Harleysville, Pennsylvania, for violations of sections 12(a)(1)(A) and (B) of FIFRA, 7 U.S.C. section 136j(a)(1)(A) and (B). The complaint alleged that during 1992, Geiger sold or distributed an unregistered and misbranded pesticide product, a rooting hormone called "Indole-3-butyric Acid-Horticultural Grade." For these violations the complaint sought a \$14,000 penalty. Geiger has agreed to pay a penalty of \$8,900.

Rhone-Poulenc, Inc. Region III reached a settlement with Rhone-Poulenc, Inc., in a Part II administrative action brought for violations of RCRA boiler and industrial furnace (BIF) regulations at Rhone-Poulenc's Institute, West Virginia plant. The settlement calls for Rhone-Poulenc to pay a penalty of over \$244,000 and to undertake numerous compliance tasks.

IMC-Agrico Company On November 8, 1994, the Regional Administrator ratified a consent decree between the United States and IMC-Agrico Company

concerning IMC's violations of section 301(a) of the CWA. IMC owns and operates phosphate rock mines and associated processing facilities in Florida and Louisiana. Eight of its mineral extraction operations located throughout Florida and its Port Sutton Phosphate Terminal located in Tampa, Florida, were the subject of this referral. The action arose out of IMC's violation of its permit effluent limits for a variety of parameters including dissolved oxygen, suspended solids, ammonia, and phosphorous, as well as non-reporting and stormwater violations at the various facilities-over 1,500 permit violations total. The case was initiated following review of the facility discharge monitoring reports and EPA and state inspections of the sites. The consent decree settlement involved an up-front payment of \$835,000 and a \$265,000 Supplemental Environmental Project (SEP). The pollution prevention SEP involved converting IMC's scrubber discharge and intake water systems into a closed loop system, greatly reducing pollution loading at the Port Sutton facility, by April 1995.

J.T. Eaton & Company, Inc. J.T. Eaton & Company, Inc. distributed and sold at least 13 unregistered pesticides (mostly rodenticides). These unregistered pesticides resulted from varying the form of the rodent bait and the packaging of several of Eaton's registered products (e.g., registered as a bulk product) but sold in ready-to-use place packs. The company also distributed and sold a misbranded pesticide product and made inaccurate claims in advertising for another product. A stop sale, use, or removal order and an administrative complaint were issued simultaneously on March 23, 1995. The penalty assessed in the complaint was \$67,500. The complaint was settled on August 25, 1995, for \$40,000.

Citizens Elevator Co., Inc. Citizens Elevator Co. repackaged and distributed and sold the pesticide "Preview" in five gallon buckets, many bearing pie filling labels, to at least 24 customers, constituting the distribution and sale of an unregistered pesticide. The complaint, issued June 30, 1994, assessed a penalty of \$108,000. In supplemental environmental projects for the prevention of spills of pesticides and fertilizers and the safer, more efficient storage and application of pesticides and fertilizer. The respondent spent \$184,771. A consent agreement signed June 30, 1995, settled the case for \$8,400.

Nitrogen Products, Inc. On September 25, 1995, a joint stipulation and order of dismissal was filed in the United States District Court for the Eastern District of Arkansas. Nitrogen Products, Inc. (NPI), agreed to pay a civil penalty of \$243,600 to the United States for violations of the Clean Air Act, and Subparts A and R of 40 CFR Part 61. The foreign parent corporation, Internationale Nederlanden Bank, N.V., acquired the facility through

foreclosure and expended over \$2 million to cover the phosphogypsum stack and regrade.

Micro Chemical, Inc. The illegal transportation of hazardous waste by a Louisiana pesticide formulation company, Micro Chemical, Inc., to an unpermitted disposal facility in violation of RCRA resulted in a \$500,000 fine, five years of probation, and compliance with corrective action measures contained in a corrective action administrative order on consent. In March 1990, Micro Chemical transported 100 cubic yards of hazardous waste from its facility to a field in Baskin, Louisiana—a location that did not have a RCRA permit. After its discovery, it was removed under the Louisiana Department of Agriculture's guidance. Micro Chemical has taken measures to stabilize and prevent the spread of pesticide contamination from the Micro Chemical facility site, as required by a RCRA 3008(h) corrective action administrative order on consent. The order will result in the removal of all contaminated soil at the site, and the remediation of all off-site contamination that has migrated into a drainage basin located adjacent to the site.

Chempace Corporation On September 26, 1996, Region V PTES filed a civil administrative complaint against Chempace corporation of Toledo, Ohio alleging 99 counts for the distribution or sale of unregistered and misbranded pesticides, and pesticide production in unregistered establishments. The total proposed penalty in the complaint is \$200,000. The case is significant in that Chempace had, previous to the complaint, canceled all of the company's pesticide product registrations pursuant to section 4 of FIFRA, as well as their establishment registration pursuant to section 7. However, the company continued to produce and sell those canceled pesticides in a facility that was not registered.

Northrup King Co. On September 30, 1996, as a result of a FIFRA inspection conducted by Region V on March 27-28, 1996, Region V issued a FIFRA civil complaint to Northrup King Co. of Golden Valley, Minnesota. The pesticide involved in the case is a genetically engineered corn seed that protects against the corn borer. Because this case is the first FIFRA complaint involving a genetically engineered pesticide, the case is nationally significant. The complaint alleged 21 counts of sale and distribution of an unregistered pesticide, 21 counts for failure to file a Notice of Arrival for pesticide imports, and 8 counts of pesticide production in unregistered establishments, for a total proposed penalty of \$206,500. A consent agreement and consent order was filed simultaneously with, and in resolution of the complaint. The respondent agreed to pay \$165,200, which is the largest penalty collected by Region V under FIFRA.

Micro Chemical. Micro Chemical is a pesticide formulating, mixing, and packaging facility 3,000 feet up gradient of the Winnsboro's groundwater well complex. In March 1990, a release from the facility was reported by a citizen. Investigations revealed that the company had attempted to dump 100 cubic yards of pesticide contaminated soil offsite. People living near the dump site

became ill from the fumes and the state ordered the soil to be returned to Micro Chemical. Ultimately a criminal case was initiated for the midnight dumping. Other storage violations detected were the subject of an administrative complaint issued in September 1992. A RCRA 3008(h) order on consent was entered into on September 1994 to remediate the site. In resolving the September 1992 complaint, a final order was issued on March 28, 1996. Micro Chemical agreed to pay a penalty of \$25,000 and agreed to fund a SEP valued at \$25,000. The SEP established collection events for household waste and waste pesticides in the Franklin Parish area. During FY96, the SEP enabled about 100 tons of waste to be collected and properly disposed.

Terra Industries, Inc. At the request of the Chemical Emergency Prevention and Preparedness Office (CEPPO), and in accordance with section 112(r) of the CAA, EPA released the results of its investigation into the cause of an explosion of the ammonium nitrate plant at this nitrogen fertilizer manufacturing facility. The report released in January 1996 identifies numerous unsafe operating procedures at the plant as contributing factors to the explosion, and recommends certain standard operating procedures which would help prevent similar occurrences at ammonium nitrate production facilities.

The Terra explosion occurred on December 13, 1994, killing four individuals and injuring 18 others. It also resulted in the release of approximately 5,700 tons of anhydrous ammonia to the air and approximately 25,000 gallons of nitric acid to the ground and required evacuation over a two-state area of over 2,500 persons from their homes.

In a subsequent action, an administrative civil complaint alleging violations of EPCRA sections 213 and 313, and section 8(a) of TSCA, was filed citing that Terra International failed to submit Toxic Release Inventory (TRI) information to EPA in a timely manner, and data submitted to EPA by Terra failed to include releases of more than 17 million pounds of toxic chemicals to the environment on-site.

Pfizer/AgrEvo Reporting of unreasonable adverse effects information is required under FIFRA section 6(a)(2), and failure to submit such reports has resulted in a \$192,000 settlement involving AgrEvo Environmental Health, Inc. and Pfizer, Inc. The case arose in early 1994 after an individual reported disabling neurological symptoms and chemical sensitivity after using RID products to kill lice. The ensuing EPA investigation revealed numerous additional unreported incidents involving RID which is manufactured by AgrEvo and distributed by Pfizer. EPA amended the complaint charging 24 counts against each company. FIFRA 6(a)(2) requires pesticide registrants to submit to EPA any additional information (beyond that submitted in the pesticide registration process) that they have regarding unreasonable adverse effects of their pesticides on human health or the environment. The information is used by the Agency in the determination of risks associated with pesticides.

Rohm and Haas Company This complaint cited Rohm and Haas for 66 violations under FIFRA section 12(a)(1)(c), for the distribution or sale of a registered pesticide the composition of which differed from the composition as described in its registration under FIFRA section 3. EPA registers pesticides based upon the accurate assessment of components used in the manufacture of the product. Use of an unapproved formula can lead to production of a pesticide for which no assessment of risk has been determined or result in unknown synergistic effects. Following settlement negotiations, and in accordance with the FIFRA Enforcement Response Policy, the original penalty of \$330,000 was reduced to \$118,800, based on a 20% reduction to the gravity level, a 40% reduction for immediate self-disclosure, mitigation, and corrective actions, and a 15% reduction for good attitude, cooperation, and efforts to comply with FIFRA.

VII.C.2. Supplementary Environmental Projects (SEPs)

SEPs are compliance agreements that reduce a facility's non-compliance penalty in return for an environmental project that exceeds the value of the reduction. Often, these projects fund pollution prevention activities that can reduce the future pollutant loadings of a facility. Information on SEP cases can be accessed via the Internet at <http://es.epa.gov/oeca/sep>.

VIII. COMPLIANCE ASSURANCE ACTIVITIES AND INITIATIVES

This section highlights the activities undertaken by this industry sector and public agencies to voluntarily improve the sector's environmental performance. These activities include those initiated independently by industrial trade associations. In this section, the notebook also contains a listing and description of national and regional trade associations.

VIII.A. Sector-Related Environmental Programs and Activities

National Agricultural Compliance Assistance Center (Ag Center)

EPA's Office of Compliance, with the support from the United States Department of Agriculture (USDA), developed EPA's National Agriculture Compliance Assistance Center (Ag Center). The Ag Center offers comprehensive, easy-to-understand information about approaches to compliance that are both environmentally protective and agriculturally sound.

The Ag Center focuses on providing information about EPA's own requirements. In doing so, the center relies heavily on existing sources of agricultural information and established distribution channels. Educational and technical information on agricultural production is provided by the USDA and other agencies, but assistance in complying with environmental requirements has not traditionally been as readily available. The Ag Center is currently working with USDA and other federal and state agencies to provide the agricultural community, including regional and state regulatory agencies, with a definitive source for federal environmental compliance information. The Ag Center offers information on a variety of topics, including the following:

- Pesticides
- Animal waste management
- Emergency planning and response
- Groundwater and surface water
- Tanks / containment
- Solid / hazardous waste

Through a toll-free telephone number and a website that is regularly updated and expanded, the Ag Center offers a variety of resources including:

- current news, compliance policies and guidelines, pollution prevention information, sources of additional information and expertise, and summaries of regulatory initiatives and requirements
- user-friendly materials that consolidate information about compliance requirements, pollution prevention, and technical assistance resources for use by regional and state assistance and educational programs, trade associations, businesses, citizens, and local governments

- agriculture-related information on reducing pollution and using the latest pollution prevention methods and technologies
- information on ways to reduce the costs of meeting environmental requirements, including identification of barriers to compliance

The Ag Center's toll-free number is 1-888-663-2155 and the website address is: <http://es.epa.gov/oeca/ag/>

National Pesticide Information Retrieval System (NPIRS)

Purdue University has developed a collection of databases through their Center for Environmental and Regulatory Information Systems, one of which is the National Pesticide Information Retrieval System. NPIRS is a collection of six databases related to pesticides, including product registration document information, data submitter information, residue tolerances, fact sheets, material safety data sheets, and the daily federal register. Full search access to the NPIRS databases is by annual subscription.

Association of American Plant Food Control Officials (AAPFCO) Label Recommendations

The AAPFCO is considering a set of recommendations issued by a task force of fertilizer producers and state officials. These recommendations call for labeling and standards for non-nutrient constituents in fertilizer and directions that will allow users to apply fertilizers at a rate that will not exceed these standards. One proposed addition to labels is to list all raw materials, including recycled wastes; however, the concentration of these materials will not be required (ARA, 1997).

Agricultural Research Institute

ARI was founded in 1951 as a part of the National Academy of Sciences, then incorporated separately in 1973. ARI analyzes agricultural problems and promotes research by its members to solve them. ARI publishes annual meeting minutes, a directory, books, pamphlets, and newsletters.

National Association of State Departments of Agriculture (NASDA)

NASDA was founded in 1916 by directors of state and territorial departments of agriculture to coordinate policies, procedures, laws, and activities between the states and federal agencies and Congress. NASDA conducts research, holds a trade show, and distributes several bulletins, newsletters, and directories.

ChemAlliance

EPA's Office of Compliance developed ChemAlliance, a new Compliance Assistance Center for the chemical industry. Among its features is an exciting "expert help," which offers an interactive guide to finding compliance

resources specific to a user's needs. Take a "virtual plant tour" to find out which regulations apply to your company's operations by clicking on a detailed chemical plant illustration. ChemAlliance can be reached at 1-800-672-6048; its web site is located at . <http://www.chemalliance.org>,

VIII.B. EPA Voluntary Programs

Pesticide Environmental Stewardship Program (PESP)

The Pesticide Environmental Stewardship Program (PESP) is a broad effort by EPA, USDA, and the FDA to reduce pesticide use and risk in both agriculture and nonagricultural settings. In September 1993, the three agencies announced a federal commitment to two major goals: 1) developing specific use/risk reduction strategies that include reliance on biological pesticides and other approaches to pest control that are thought to be safer than traditional chemical methods, and 2) by the year 2000, having 75 percent of United States agricultural acreage adopt integrated pest management programs.

A key part of the PESP is the public/private partnership which began when EPA, USDA, and FDA announced the partnership and more than 20 private organizations signed on as charter members. All organizations with a commitment to pesticide use/risk reduction are eligible to join the PESP, either as Partners or Supporters. The PESP program has 35 partners. Together, these partners represent at least 45,000 pesticide users. The program has a goal of adding 35 new partners per year.

33/50 Program

The 33/50 Program is a ground breaking program that has focused on reducing pollution from seventeen high-priority chemicals through voluntary partnerships with industry. The program's name stems from its goals: a 33% reduction in toxic releases by 1992, and a 50% reduction by 1995, against a baseline of 1.5 billion pounds of releases and transfers in 1988. The results have been impressive: 1,300 companies have joined the 33/50 Program (representing over 6,000 facilities) and have reached the national targets a year ahead of schedule. The 33% goal was reached in 1991, and the 50% goal -- a reduction of 745 million pounds of toxic wastes -- was reached in 1994. The 33/50 Program can provide case studies on many of the corporate accomplishments in reducing waste (Contact 33/50 Program Director David Sarokin -- 202-260-6396).

Table 30 lists those companies participating in the 33/50 program that reported the SIC codes 2873, 2874, 2875, and 2879 to TRI. Some of the companies shown also listed facilities that are not producing agricultural chemicals. The number of facilities within each company that are participating in the 33/50 program and that report SIC codes 2873, 2874, 2875, and 2879 is shown. Where available and quantifiable against 1988 releases and transfers, each company's 33/50 goals for 1995 and the actual total releases and transfers and percent reduction between 1988 and 1995 are presented. Eleven of the seventeen target chemicals were reported to TRI by agricultural chemical facilities in 1995.

Table 30 shows that 24 companies comprised of 78 facilities reporting SIC 287 participated in the 33/50 program. For those companies shown with more than one agricultural chemical facility, all facilities may not have participated in 33/50. The 33/50 goals shown for companies with multiple facilities, however, were company-wide, potentially aggregating more than one facility and facilities not carrying out agricultural chemical operations. In addition to company-wide goals, individual facilities within a company may have had their own 33/50 goals or may have been specifically listed as not participating in the 33/50 program. Since the actual percent reductions shown in the last column apply to only the companies' agricultural chemical facilities, direct comparisons to those company goals incorporating non-agricultural chemical facilities or excluding certain facilities may not be possible. For information on specific facilities participating in 33/50, contact David Sarokin (202-260-6907) at the 33/50 Program Office.

Table 30: Fertilizer, Pesticide, and Agricultural Chemical Industry Participation in the 33/50 Program

Parent Company (Headquarters Location)	Company-Owned Facilities Reporting 33/50 Chemicals	Company- Wide % Reduction Goal ¹ (1988 to 1995)	1988 TRI Releases and Transfers of 33/50 Chemicals (pounds) ²	1995 TRI Releases and Transfers of 33/50 Chemicals (pounds) ²	% of Change per Facility (1988-1995)
AMERICAN HOME PRODUCTS CORP. MADISON, NJ	2	49	47,950	73,876	-54
ARCADIAN CORP. MEMPHIS, TN	6	0	4,340	10,127	-133
BAY ZINC CO. INC. MOXEE CITY, WA	1	50	77,250	252	100
CHEM-TECH LTD. DES MOINES, IA	1	90	800	0	100
CHEVRON CORP. SAN FRANCISCO, CA	3	50	8,746	0	100
CONAGRA INC. OMAHA, NE	6	8	17,086	5,238	69
E.I. DU PONT DE NEMOURS & CO WILMINGTON, DE	2	50	144,412	440,370	-205
ELF AQUITAINE INC. NEW YORK, NY	1	49	3,068	0	100
FIRST MISSISSIPPI CORP. JACKSON, MS	7	0	701,144	214,334	69
FMC CORPORATION CHICAGO, IL	5	50	6,190	2,339	62
GLAXO WELLCOME INC. RESEARCH TRIANGLE PARK, NC	1	37	1,125	0	100
GOWAN COMPANY YUMA, AZ	1	0	0	2,207	---
IMC FERTILIZER GROUP INC. NORTHBROOK, IL	7	0	56,350	51,548	9
ISK AMERICAS INC. ATLANTA, GA	2	50	884,412	726,713	18
LAROCHE HOLDINGS INC. ATLANTA, GA	1	0	17,590	0	100
MALLINCKRODT GROUP INC. SAINT LOUIS, MO	1	44	0	0	---
MILES INC. PITTSBURGH, PA	1	38	39,822	6,650	83
MONSANTO COMPANY SAINT LOUIS, MO	1	23	0	1,260	---
RHONE-POULENC INC. MONMOUTH JUNCTION, NJ	21	50	3,128,263	1,392,117	55
SC JOHNSON & SON INC. RACINE, WI	1	50	19,086	20,096	-5
SANDOZ CORPORATION NEW YORK, NY	3	50	207,086	87,000	58
TALLEY INDUSTRIES PHOENIX, AZ	1	0	8,243	2,289	72
UNIVERSAL COOPERATIVES INC. MINNEAPOLIS, MN	1	70	17,750	1,265	93
UNOCAL CORPORATION LOS ANGELES, CA	2	50	0	9	---
Total	78	---	5,390,713	3,037,690	44

Source: United States EPA 33/50 Program Office, 1997.

¹ Company-Wide Reduction Goals aggregate all company-owned facilities which may include facilities not producing agricultural chemicals.

² Releases and Transfers are from facilities only. 1995 33/50 TRI data were not available at time of publication.

* = Reduction goal not quantifiable against 1988 TRI data. ** = Use reduction goal only. *** = No numeric reduction goal.

Project XL

Project XL was initiated in March 1995 as a part of President Clinton's *Reinventing Environmental Regulation* initiative. The projects seek to achieve cost effective environmental benefits by providing participants regulatory flexibility on the condition that they produce greater environmental benefits. EPA and program participants will negotiate and sign a Final Project Agreement, detailing specific environmental objectives that the regulated entity shall satisfy. EPA will provide regulatory flexibility as an incentive for the participants' superior environmental performance. Participants are encouraged to seek stakeholder support from local governments, businesses, and environmental groups.

There have been at least two Project XL proposals relating to fertilizer production, however both of these have been either rejected or withdrawn. PCS Nitrogen (formerly Arcadian Fertilizer) had proposed to reuse stockpiled phosphogypsum as an ingredient in a soil enhancer. Another proposal by Dow Chemical Company in Louisiana was to trade off equipment leak reductions for relief from some emissions control, monitoring, reporting and record-keeping requirements.

EPA hopes to implement fifty pilot projects in four categories, including industrial facilities, communities, and government facilities regulated by EPA. Applications will be accepted on a rolling basis. For additional information regarding XL projects, including application procedures and criteria, see the May 23, 1995 Federal Register Notice. (Contact: Fax-on-Demand Hotline 202-260-8590, Web: <http://www.epa.gov/ProjectXL>, or Christopher Knopes at EPA's Office of Policy, Planning and Evaluation 202-260-9298)

Climate Wise Program

EPA's ENERGY STAR Buildings Program is a voluntary, profit-based program designed to improve the energy-efficiency in commercial and industrial buildings. Expanding the successful Green Lights Program, ENERGY STAR Buildings was launched in 1995. This program relies on a 5-stage strategy designed to maximize energy savings thereby lowering energy bills, improving occupant comfort, and preventing pollution -- all at the same time. If implemented in every commercial and industrial building in the United States, ENERGY STAR Buildings could cut the nation's energy bill by up to \$25 billion and prevent up to 35% of carbon dioxide emissions. (This is equivalent to taking 60 million cars off the road). ENERGY STAR Buildings participants include corporations; small and medium sized businesses; local, federal and state governments; non-profit groups; schools; universities; and health care facilities. EPA provides technical and non-technical support including software, workshops, manuals, communication tools, and an information hotline. EPA's Office of Air and Radiation manages the operation of the ENERGY STAR Buildings Program. (Contact: Green Light/Energy Star Hotline at 1-888-STAR-YES or Maria Tikoff Vargas, EPA Program

Director at 202-233-9178 or visit the ENERGY STAR Buildings Program website at <http://www.epa.gov/appdstar/buildings/>)

Green Lights Program

EPA's Green Lights program was initiated in 1991 and has the goal of preventing pollution by encouraging United States institutions to use energy-efficient lighting technologies. The program saves money for businesses and organizations and creates a cleaner environment by reducing pollutants released into the atmosphere. The program has over 2,345 participants which include major corporations, small and medium sized businesses, federal, state and local governments, non-profit groups, schools, universities, and health care facilities. Each participant is required to survey their facilities and upgrade lighting wherever it is profitable. As of March 1997, participants had lowered their electric bills by \$289 million annually. EPA provides technical assistance to the participants through a decision support software package, workshops and manuals, and an information hotline. EPA's Office of Air and Radiation is responsible for operating the Green Lights Program. (Contact: Green Light/Energy Star Hotline at 1-888-STARYES or Maria Tikoff Vargar, EPA Program Director, at 202-233-9178)

WasteWi\$e Program

The WasteWi\$e Program was started in 1994 by EPA's Office of Solid Waste and Emergency Response. The program is aimed at reducing municipal solid wastes by promoting waste prevention, recycling collection and the manufacturing and purchase of recycled products. As of 1997, the program had about 500 companies as members, one third of whom are Fortune 1000 corporations. Members agree to identify and implement actions to reduce their solid wastes setting waste reduction goals and providing EPA with yearly progress reports. To member companies, EPA, in turn, provides technical assistance, publications, networking opportunities, and national and regional recognition. (Contact: WasteWi\$e Hotline at 1-800-372-9473 or Joanne Oxley, EPA Program Manager, 703-308-0199)

NICE³

The United States Department of Energy is administering a grant program called The National Industrial Competitiveness through Energy, Environment, and Economics (NICE³). By providing grants of up to 45 percent of the total project cost, the program encourages industry to reduce industrial waste at its source and become more energy-efficient and cost-competitive through waste minimization efforts. Grants are used by industry to design, test, and demonstrate new processes and/or equipment with the potential to reduce pollution and increase energy efficiency. The program is open to all industries; however, priority is given to proposals from participants in the forest products, chemicals, petroleum refining, steel, aluminum, metal casting and glass manufacturing sectors. (Contact: <http://www.oit.doe.gov/access/nice3>, Chris Sifri, DOE, 303-275-4723 or Eric Hass, DOE, 303-275-4728)

Design for the Environment (DfE)

DfE is working with several industries to identify cost-effective pollution prevention strategies that reduce risks to workers and the environment. DfE helps businesses compare and evaluate the performance, cost, pollution prevention benefits, and human health and environmental risks associated with existing and alternative technologies. The goal of these projects is to encourage businesses to consider and use cleaner products, processes, and technologies. For more information about the DfE Program, call (202) 260-1678. To obtain copies of DfE materials or for general information about DfE, contact EPA's Pollution Prevention Information Clearinghouse at (202) 260-1023 or visit the DfE Website at <http://es.inel.gov/dfe>.

VIII.C. Trade Association/Industry Sponsored Activity**VIII.C.1. State Advisory Groups**

Association of American Pesticide Control Officials (AAPCO)
P.O. Box 1249
Hardwick, VT 05843
Phone: 802-472-6956
Fax: 802-472-6957
E-mail: aapco@plainfield.bypass.com
Members: 55
Staff: 1

Formed in 1947, the Association of American Pesticide Control Officials (AAPCO) consists of state and federal pesticide regulatory officials. All federal and provincial Canadian officials, officials of all North American countries involved with the regulation of pesticides may be members of AAPCO as well. AAPCO holds meetings twice a year and publishes an annual handbook that contains uniform policies and model pesticide legislation that the association has adopted.

AAPCO aims to promote uniform and effective state legislation and pesticide regulatory programs. Its other objectives are to develop inspection procedures, to promote labeling and safe use of pesticides, to provide opportunities for members to exchange information, and to work with industry to promote the usefulness and effectiveness of pesticide products.

State FIFRA Issues Research and Evaluation Group (SFIREG)
P.O. Box 1249
Hardwick, VT 05843
Phone: 802-472-6956
Fax: 802-472-6957
E-mail: aapco@plainfield.bypass.com
Members:
10 state representatives

The State FIFRA Issues Research and Evaluation Group evolved in 1978 out

of a cooperative agreement between the EPA's Office of Pesticide Programs (OPP) and the Association of American Pesticide Control Officials (AAPCO). SFIREG is an independent but related body of AAPCO that provides state comments to the Office of Pesticide Programs on issues relating to the manufacture, use and disposal of pesticides. Its membership is comprised of ten state representatives, who represent and are selected by the states in each of the ten EPA Regions.

The Fertilizer Institute (TFI)
501 2nd St., NE
Washington, DC 20002
Phone: 202-675-8250
Fax: 202-544-8123

Members: 300
Staff: 22

The Fertilizer Institute was founded in 1970 and now has 48 affiliated groups. Members include producers, manufacturers, retailers, trading firms, and equipment manufacturers. TFI represents members in various legislative, educational, and technical areas, and provides information and public relations programs. Publications include: *Directory of Fertilizer References*, annual; *Fertilizer Facts and Figures*, annual; *Fertilizer Institute--Action Letter*, monthly; *Fertilizer Record*, periodic.

Chemical Manufacturers Association (CMA)
1300 Wilson Blvd.
Arlington, VA 22209
Phone: 703-741-5000
Fax: 703-741-6000

Members: 185
Staff: 280

The Chemical Manufacturers Association was founded in 1872 and now has a budget of \$36 million. CMA conducts advocacy and administers research areas of broad import to chemical manufacturing, such as pollution prevention and other special research programs. CMA also conducts committee studies, operates the Chemical Emergency Center (CHEMTREC) for guidance to emergency service on handling emergencies involving chemicals and the Chemical Reference Center which offers health and safety information about chemicals to the public. Publications include semi-monthly newsletters, *ChemEcology* and *CMA News*, and the *CMA Directory and User's Guide*.

Chemical Specialties Manufacturers Association (CSMA)
1913 Eye St., NW
Washington, DC 20006
Phone: 202-872-8110
Fax: 202-872-8114

Members: 425
Staff: 31

The Chemical Specialties Manufacturers Association was founded in 1914 and is made up of manufacturers, marketers, formulators, and suppliers of household, industrial, and personal care chemical specialty products such as pesticides, cleaning products, disinfectants, sanitizers, and polishes. CSMA serves as a liaison to federal and state agencies and public representatives, provides information and sponsors seminars on governmental activities and scientific developments.

American Crop Protection Association (ACPA)
1156 15th St., NW, Ste. 400 Members: 82
Washington, DC 20005 Staff: 29
Phone: 202-296-1585
Fax: 202-463-0474

The American Crop Protection Association was founded in 1933 and now has a budget of \$7 million. Members include companies involved in producing or formulating agricultural chemical products including agricultural fumigants, agricultural scalicides, chemical plant sprays and dusts, defoliants, soil disinfectants, weed killers, and others. It is comprised of legislative, regulatory and science departments and publishes a periodic bulletin, manuals, *Growing Possibilities*, quarterly, and *This Week and Next*, weekly.

Western Crop Protection Association (WCPA)
3835 N. Freeway Blvd. Ste. 140 Members: 170
Sacramento, CA 95834 Staff: 6
Phone: 916-568-3660
Fax: 916-565-0113

The WCPA is a regional organization of manufacturers, formulators, distributors, and dealers of basic pesticide chemicals and suppliers of solvents, diluents, emulsifiers, and containers. They are affiliated with the American Crop Protection Association. They publish several bulletins and periodicals.

National Pest Control Association (NPCA)
8100 Oak St. Members: 2,300
Dunn Loring, VA 22027 Staff: 21
Phone: 703-573-8330
Fax: 703-573-4116

The National Pest Control Association was founded in 1933 and now has a budget of \$2.8 million. Members include companies engaged in control of insects, rodents, birds, and other pests. NPCA provides advisory services on control procedures, new products, and safety and business administration practices. NPCA sponsors research at several universities, furnishes, technical information and advice to standards and code writing groups, and maintains an extensive library on pests. NPCA publishes many titles including manuals, newsletters, membership guides, technical releases, and reports.

International Fertilizer Development Center (IFDC)
PO Box 2040

Muscle Shoals,

AL 35662
Phone: 205-381-6600
Fax: 205-381-7408

Nonmembership
Staff: 180

The International Fertilizer Development Center was founded in 1974 and includes participants such as scientists, engineers, economists and specialists in market research and development and communications. IFDC uses a \$13.5 million budget to try to alleviate world hunger by increasing agricultural production in the tropics and subtropics through development of improved fertilizers. IFDC sponsors and conducts studies in fertilizer efficiencies and offers courses on fertilizer production, environmental issues, and crop sustainability. They maintain greenhouses and laboratories, and publish several periodicals and manuals.

United Products Formulators and Distributors Association (UPFDA)
1 Executive Concourse No. 103
Duluth, GA 30136
Phone: 404-623-8721
Fax: 404-623-1714

Members: 102
Staff: 1

The United Products Formulators and Distributors Association was founded in 1968 and is made up of companies engaged in formulating and distributing pesticide products. The UPFDA works to solve problems of member companies and promote sound and beneficial legislation and to cooperate with allied industries.

North American Horticultural Supply Association (NAHSA)
1790 Arch St.
Philadelphia, PA 19103
Phone: 215-564-3484
Fax: 215-564-2175

Members: 135
Staff: 3

The North American Horticultural Supply Association was founded in 1988 and represents horticultural supplies such as greenhouse building materials and supplies, pesticides, and fertilizers. The NAHSA works to strengthen and enhance the relationship between manufacturers and distributors and promotes distribution in the market. They publish a quarterly newsletter, *NAHSA News*, and an annual *Industry Calendar*.

American Agricultural Economics Association (AAEA)
1110 Buckeye Ave.
Ames, IA 50010-8063
Phone: 515-233-3202
Fax: 515-233-3101

Members: 4,500
Staff: 6

The American Agricultural Economics Association, founded in 1910, is a professional society of state, federal, and industrial agricultural economists, teachers, and extension workers. The AAEA works to further knowledge of agricultural economics through scientific research, instruction, publications, meetings, and other activities. They publish a bimonthly newsletter, a semi-bimonthly *American Journal of Agricultural Economics*, a quarterly magazine *Choices*, and a biennial *Handbook Directory*.

Institute for Agriculture and Trade Policy (IATP)
1313 5th St., SE, No. 303
Minneapolis, MN 55414
Phone: 612-379-5980
Fax: 612-379-5982

The IATP was founded in 1986 and has an annual budget of \$1.15 million. They maintain a speakers bureau and conduct research programs on trade agriculture, global institutions, North-South relations, and the Third World. They publish several periodical bulletins.

California Fertilizers Association (CFA)
1700 I St., Ste. 130
Sacramento, CA 95814
Phone: 916-441-1584
Fax: 916-441-2569

The CFA represents fertilizer manufacturers, distributors, wholesalers, and retail dealers that sell products within California. They maintain a legislative hotline and publish studies and handbooks on issues pertaining to fertilizers.

THIS PAGE WAS INTENTIONALLY LEFT BLANK

IX. CONTACTS/ACKNOWLEDGMENTS/RESOURCE MATERIALS

For further information on selected topics within the Fertilizer, Pesticide, and Agricultural Chemical Industry, a list of contacts and publications are provided below.

Contacts⁶

Name	Organization	Telephone	Subject
Michelle C. Yaras	EPA, Office of Enforcement and Compliance Assurance (OECA), Agriculture and Ecosystems Division, Agriculture Branch	202 564-4153	Notebook Contact
Arty Williams	EPA, Office of Prevention, Pesticides and Toxic Substances (OPPT)	703 305-5239	Ground Water Pesticide Management Plan Rule
Jean Frane	EPA, OPPT	703 305-5944	Food Quality Protection Act
Paul Parsons	EPA, OPPT	703 308-9073	FIFRA Data Requirements
David Stangel	EPA, OECA	202 564-4162	Stored or Suspended Pesticides; Good Laboratory Practice Standards; Pesticide Management and Disposal
Joseph Hogue	EPA, OPPT	703 308-9072	FIFRA Restricted Use Classifications
Robert McNally	EPA, OPPT	703 308-8085	FIFRA Pesticide Tolerances
Joseph Nevola	EPA, OPPT	703 308-8037	FIFRA Pesticide Tolerances
Ellen Kramer	EPA, OPPT	703 305-6475	FIFRA Pesticide Tolerances
Carol Peterson	EPA, OPPT	703 305-6598	FIFRA Tolerance Fee Structure
Robert A. Forrest	EPA, OPPT	703 308-9376	FIFRA Exemptions
Nancy Fitz	EPA, OPPT	703 305-7385	FIFRA Pesticide Management and Disposal
Cathleen Barnes	EPA, OPPT	703 305-7101	FIFRA Prior Informed Consent
John MacDonald	EPA, OPPT	703 305-7370	Certification and Training
Kevin Keaney	EPA, OPPT	703 305-5557	FIFRA Worker Protection Standards

⁶ Many of the contacts listed above have provided valuable information and comments during the development of this document. EPA appreciates this support and acknowledges that the individuals listed do not necessarily endorse all statements made within this notebook.

The following people received a draft copy of this Sector Notebook and may have provided comments.

Name	Organization	Telephone
Paul Bangser	EPA, Office of General Counsel, Water Division	202 260-7630
Philip J. Ross	EPA, Office of General Counsel, Pesticides and Toxic Substances Division	202 260-0779
Don Olson, Chief	EPA, Industrial Branch, OECA, Office of Regulatory Enforcement, Water Enforcement Division	202 564-5558
Jon Jacobs	EPA, OECA, Office of Regulatory Enforcement, Case Development, Policy and Enforcement Branch -Eastern Regions, Toxics and Pesticides Enforcement Division	202 564-4037
Jerry Stubbs	EPA, Case Development, Policy and Enforcement Branch-Western Regions, Toxics and Pesticides Enforcement Division, Office of Regulatory Enforcement	202 564-4178
Anne E. Lindsay, Director	EPA, Field and External Affairs Division Office of Pesticide Programs	703 305-5265
Marcia E. Mulkey, Director	EPA, Office of Pesticide Programs	703 305-7090
Artie Williams, Chief	EPA, Environmental Field Branch, Field and External Affairs Division, Office of Pesticide Programs	703 305-5239
Seth Heminway	EPA, OC Sector Notebook Coordinator	202 564-7017
Sam Silverman	EPA, Enforcement Coordinator Region 1	617 565-3443
Laura Livingston	EPA, Enforcement Coordinator Region 2	212 637-4059
Samantha Fairchild	EPA, Enforcement Coordinator Region 3	215 814-5710
Sherri Fields	EPA, Enforcement Coordinator Region 4	404 562-9684
Tinka Hyde	EPA, EPA, Enforcement Coordinator Region 5	312 886-9296
Robert Lawrence	EPA, Enforcement Coordinator Region 6	214 665-6580
Diane Callier	EPA, Enforcement Coordinator Region 7	913 551-7459
Mike Gaydosh	EPA, Enforcement Coordinator Region 8	303 312-6773
Jo-Ann Semones	EPA, Enforcement Coordinator Region 9	415 744-1547
Ron Kreizenbeck	EPA, Enforcement Coordinator Region 10	206 553-1265
Edward M. White	Assistant Pesticide Administrator, Indiana State Chemist Office, Purdue University	765 494-1587

Dale Dubberly, Chief	Bureau of Compliance Monitoring Florida Department of Agriculture & Consumer Services	850 488-8731
Robin Rosenbaum	Pesticide Registration Manager, Pesticide & Plant Pest Management Division, Michigan Department of Agriculture	517 335-6542
Buzz Vance	Nebraska Department of Agriculture	402 471-6853
Donnie Dippel	Assistant Commissioner, Pesticide Programs, Texas Department of Agriculture	512 463-7476
Paul Kindinger	Agricultural Retailers Association (ARA)	314 567-6655
Joel Padmore	Association of American Plant Food Control Officials (AAPFCO), Food & Drug Protection Division North Carolina Department of Agriculture	919 733-7366
Renee Pinel	California Fertilizers Association	916 441-1584
Mark Muller	Institute for Agriculture and Trade Policy	612 870-3420
Rick Kirchhoff	National Association of State Departments of Agriculture (NASDA)	202 296-9680
Robert Rosenberg	National Pest Control Association	703 573-8330
Robert E. Roberts	Executive Director Environmental Council of States (ECOS)	202 624-3660
Diane Bateman	The Fertilizer Institute (TFI)	202 675-8250
Jay Vroom	American Crop Protection Association	202 296-1585

Section II: Introduction to the Fertilizer, Pesticide, and Agricultural Chemical Industry

1992 Census of Manufacturers Industry Series: Agricultural Chemicals, United States Department of Commerce, Bureau of Census, Economics and Statistics Administration, Washington, DC, May 1995.

1987 Standard Industrial Classification Manual, Office of Management and Budget, 1987.

Aspelin, Arnold, *Pesticide Industry Sales and Usage, 1994 and 1995 Market Estimates*, Office of Prevention, Pesticides and Toxic Substances, USEPA, August 1997.

“Facts and Figures for the Chemical Industry,” *Chemical and Engineering News*, June 23, 1998.

Hodge, Charles A. and Popovici, Neculai N., ed., *Pollution Control in Fertilizer Production*, Marcel Dekker, Inc., 1994.

Hoffmeister, George. “Fertilizers”, *Kirk-Othmer Encyclopedia of Chemical Technology*, 4th ed. New York: John Wiley & Sons. 1993.

Kent, James A., ed., *Riegel’s Handbook of Industrial Chemistry*, Ninth edition, Van Nostrand Reinhold, New York, 1992.

Ollinger, Michael, and Fernandez-Cornejo, Jorge. *Regulation, Innovation, and Market Structure in the United States Pesticide Industry*, Economic Research Service, USDA, June 1995.

Andrilenas, Paul, and Vroomen, Harry. United States Department of Agriculture, *Seven Farm Input Industries, Fertilizer*, Economic Research Service, U.S.D.A., September 1990.

Dun & Bradstreet’s Million Dollar Directory, 1997.

United Nations Environment Programme and United Nations Industrial Development Organization, *Mineral Fertilizer Production and the Environment*, UNEP, Paris, 1996.

United States Environmental Protection Agency, Enforcement, Planning, Targeting & Data Division,, *FIFRA, section 7 Data System*, United States EPA. 1996.

United States Environmental Protection Agency, *Development Document for Best Available Technology, Pretreatment Technology, and New Source Performance Technology for the Pesticide Formulating, Packaging, and Repackaging Industry- Final*, EPA, Office of Water, Washington, DC, September 1996.

United States Environmental Protection Agency, *Biopesticides Web Site*, Office of Pesticide Programs, <<http://www.epa.gov/oppbpd1/biopesticides/>>, August 1999.

United States Environmental Protection Agency, *Compilation of Air Pollutant Emission Factors (AP-42)*, Fifth edition, EPA, Office of Air Quality Planning and Standards, Research Triangle Park, NC, July 1993.

United States Environmental Protection Agency, *Guides to Pollution Prevention, The Pesticide Formulating Industry*, EPA, Center for Environmental Research Information, Cincinnati, February 1990.

United States Industry & Trade Outlook '98, United States Department of Commerce, International Trade Administration, Washington, DC, 1998.

United States International Trade Commission, *Industry & Trade Summary, Pesticide Products and Formulations*, USITC Publication 2750, Office of Industries, March 1994.

Section III: Industrial Process Description

Air and Waste Management Association, Buonicore, Anthony J. and Davis, Wayne T., ed., *Air Pollution Engineering Manual*, Van Nostrand Reinhold, New York, 1992.

Cremlyn, R., *Pesticides*, John Wiley & Sons, New York, 1978.

Hargett, Norman and Pay, Ralph, "Retail Marketing of Fertilizers in the United States" Presented at the Fertilizer Industry Round Table, Atlanta, Georgia, 1980.

Hoffmeister, George. "Fertilizers", *Kirk-Othmer Encyclopedia of Chemical Technology*, 4th ed. Volume 10, New York: John Wiley & Sons. 1993.

Kroschwitz, Jacqueline, and Howe-Grant, Mary (eds.). "Ammonia", *Kirk-Othmer Encyclopedia of Chemical Technology*, 4th ed. Volume 2, New York: John Wiley & Sons. 1992.

Hodge, Charles A. and Popovici, Neculai N., ed., *Pollution Control in Fertilizer Production*, Marcel Dekker, Inc., 1994.

Kent, James A., ed., *Riegel's Handbook of Industrial Chemistry*, Ninth edition, Van Nostrand Reinhold, New York, 1992.

Korcak, R.F. "Utilization of Coal Combustion By-Products in Agriculture and Horticulture," *Agricultural Utilization of Urban and Industrial By-Products*, American Society of Agronomy, Madison, WI, 1995.

Lewis, Richard J., Sr., ed., *Hawley's Condensed Chemical Dictionary*, Twelfth edition, Van Nostrand Reinhold, New York, 1993.

Manual on Fertilizer Statistics, Food and Agriculture Organization of the United Nations, Rome, 1991.

Miller, W.P. "Environmental Considerations in Land Application of By-Product Gypsum," *Agricultural Utilization of Urban and Industrial By-Products*, American Society of Agronomy, Madison, WI, 1995.

Nielson, Francis T., *Manual of Fertilizer Processing*, Marcel Dekker, Inc., New York, 1987.

The Fertilizer Institute (TFI), comments submitted by Jim Skillen on a draft of this Sector Notebook, September 1999.

United Nations Environment Programme, *Mineral Fertilizer Production and the Environment*, Technical Report N.26, United Nations Industrial Development Organization, 1996.

United States Environmental Protection Agency, *Compilation of Air Pollutant Emission Factors (AP-42)*, Fifth edition, EPA, Office of Air Quality Planning and Standards, Research Triangle Park, NC, July 1993a.

United States Environmental Protection Agency, *Development Document for Best Available Technology, Pretreatment Technology, and New Source Performance Technology for the Pesticide Formulating, Packaging, and Repackaging Industry-Final*, EPA, Office of Water, Washington, DC, September 1996.

United States Environmental Protection Agency, *Development Document for Effluent Limitations Guidelines and New Source Performance Standards for the Basic Fertilizer Chemicals Segment of the Fertilizer Manufacturing Point Source Category*, EPA, Office of Air and Water Programs, Washington, DC, March 1974.

United States Environmental Protection Agency, *Guides to Pollution Prevention, The Pesticide Formulating Industry*, Risk Reduction Engineering Laboratory and Center for Environmental Research Information, Office of Research and Development, February 1990.

United States Environmental Protection Agency, *Pesticide Industry Sales and Usage, 1994 and 1995 Market Estimates*, Office of Prevention, Pesticides and Toxic Substances, August 1997.

United States Environmental Protection Agency, *Report to Congress for Cement Kiln Dust*. Volume II: Methods and Findings. Springfield, VA: United States Department of Commerce, December 1993b.

United States Environmental Protection Agency, *1996 Toxics Release Inventory Database*.

Water Environment Federation, *Pretreatment of Industrial Wastes*, Manual of Practice FD-3, Alexandria, VA, 1994.

Section IV: Chemical Release and Transfer Profile

United States Environmental Protection Agency, *1996 Toxics Release Inventory Database*.

United States Environmental Protection Agency, *1995 Toxics Release Inventory Database*.

United States EPA Office of Air and Radiation, AIRS Database, 1997.

United States Environmental Protection Agency, *1995 Toxics Release Inventory Public Data Release*, United States EPA Office of Pollution Prevention and Toxics, April 1997. (EPA 745-R-97-005)

Section V: Pollution Prevention Opportunities

California Fertilizer Association, *Dry and Liquid Fertilizer Handling Guidelines for Retail Fertilizer Facilities*, CFA, <http://www.calfertilizer.org/fertguide.html>, November 1996.

Hunt, Gary, et. al., eds. *Case Summaries of Waste Reduction by Industries in the Southeast*. Waste Reduction Resource Center for the Southeast, North Carolina department of Natural Resources and Community Development, Raleigh, NC, July 1989.

Preventing Pollution in the Chemical Industry, Five Years of Progress, Chemical Manufacturers Association, 1993.

United Nations Environment Programme, *Mineral Fertilizer Production and the Environment*, Technical Report N.26, United Nations Industrial Development Organization, 1996.

United States Environmental Protection Agency, *Development Document for Best Available Technology, Pretreatment Technology, and New Source Performance Technology for the Pesticide Formulating, Packaging, and Repackaging Industry- Final*, EPA, Office of Water, Washington, DC, September 1996.

United States Environmental Protection Agency, *Guides to Pollution Prevention, The Pesticide Formulating Industry*, EPA, Center for Environmental Research Information, Cincinnati, February 1990.

Section VI: Summary of Applicable Federal Statutes and Regulations

Haugrud, K. Jack. "Agriculture," Chapter 8 in *Sustainable Environmental Law, Integrating Natural Resource and Pollution Abatement Law from Resources to Recovery*, Environmental Law Institute, St. Paul, 1993.

Landfair, Stanley W. "Toxic Substances Control Act," Chapter 11 in *Environmental Law Handbook*, 12th ed., Government Institutes, Inc., Rockville, MD, 1993.

Miller, Marshall E. "Federal Regulation of Pesticides," Chapter 13 in *Environmental Law Handbook*, 12th ed., Government Institutes, Inc., Rockville, MD, 1993.

Section VII: Compliance and Enforcement History

United States Environmental Protection Agency, Data obtained from EPA's *Integrated Data for Enforcement Analysis (IDEA)* system in 1997.

Section VIII: Compliance Activities and Initiatives

Agricultural Retailers Association, *Retailer Facts by FAX*, ARA Weekly, November 7, 1997.

Center for Environmental and Regulatory Information Services. <<http://www.ceris.purdue.edu>>

Jaszczak, Sandra, ed. *Gale Encyclopedia of Associations*. 31st ed., International Thomson Publishing Co., 1996.

United States Environmental Protection Agency, 33/50 Program Office, 1997.