

**COMPUTER TESTING SUPPLEMENT
FOR
FLIGHT AND GROUND INSTRUCTOR**

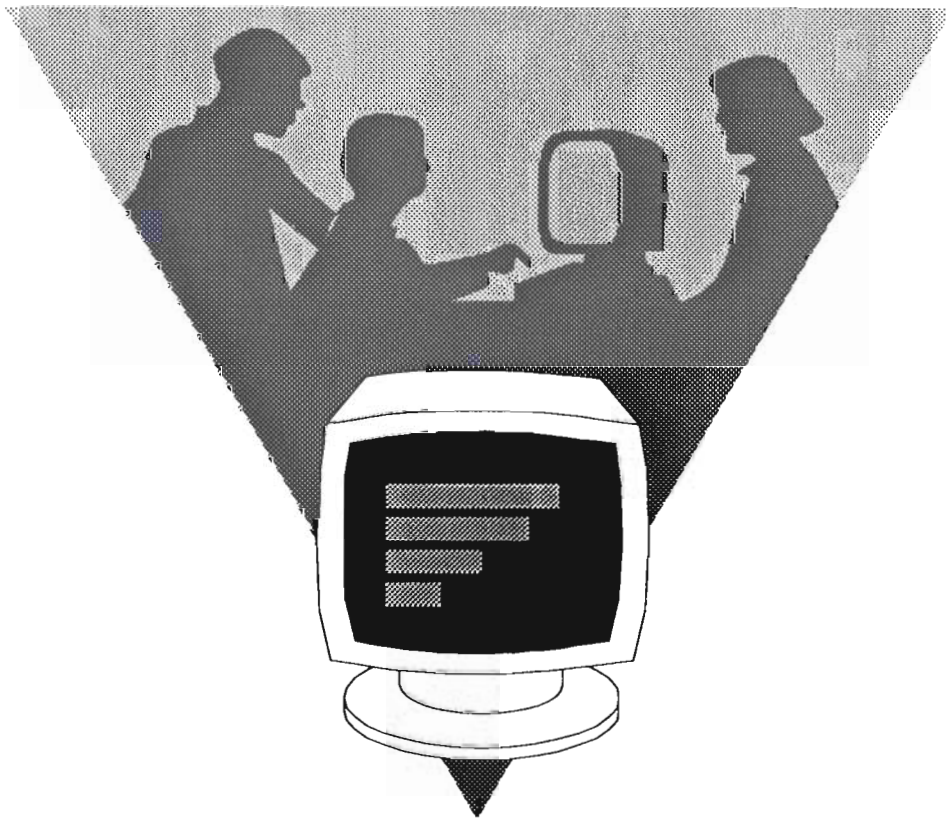

DO NOT MARK IN THIS BOOK



**COMPUTER TESTING SUPPLEMENT
FOR
FLIGHT AND GROUND INSTRUCTOR**

2001

**U.S. DEPARTMENT OF TRANSPORTATION
FEDERAL AVIATION ADMINISTRATION**
Flight Standards Service

PREFACE

This computer testing supplement is designed by the Flight Standards Service of the Federal Aviation Administration (FAA) for use by computer testing designees (CTD's) in the administration of airman knowledge tests in the following knowledge areas.

Fundamentals of Instructing

Ground Instructor—Basic

Ground Instructor—Advanced

Flight Instructor—Airplane

Flight Instructor—Helicopter

Flight Instructor—Gyroplane

Flight Instructor—Glider

Flight Instructor—Airplane (Added Rating)

Flight Instructor—Helicopter (Added Rating)

Flight Instructor—Gyroplane (Added Rating)

Flight Instructor—Glider (Added Rating)

FAA-CT-8080-5E supersedes FAA-CT-8080-5D, Computer Testing Supplement for Flight and Ground Instructor, dated 2000.

Comments regarding this supplement should be sent to:

U.S. Department of Transportation

Federal Aviation Administration

Flight Standards Service

Airman Testing Standards Branch, AFS-630

P.O. Box 25082

Oklahoma City, OK 73125

CONTENTS

Preface	iii
Contents	v
FIGURE 1.—Lesson Plan	1
FIGURE 1A.—Lesson Plan	2
FIGURE 2.—Pseudo-Adiabatic Chart	3
FIGURE 3.—Aviation Routine Weather Reports (METAR)	4
FIGURE 4.—Pilot Weather Report	4
FIGURE 5.—Terminal Aerodrome Forecasts (TAF)	4
FIGURE 6.—Aviation Area Forecast (FA)	5
FIGURE 7.—Winds and Temperatures Aloft Forecast (FD)	6
FIGURE 8.—Surface Analysis Chart Symbol	6
FIGURE 9.—Surface Analysis Chart Symbols	6
FIGURE 10.—Weather Depiction Chart Symbol	6
FIGURE 11.—Weather Depiction Chart Symbol	6
FIGURE 12.—Weather Depiction Chart	7
FIGURE 13.—Radar Summary Chart	8
FIGURE 14.—Significant Weather Prognostic Chart	9
FIGURE 15.—Severe Weather Outlook Chart	10
FIGURE 16.—Stability Chart	11
FIGURE 17.—Velocity/Load Factor Chart	11
FIGURE 18.—Load Factor/Stall Speed Chart	12
FIGURE 19.—Angle-of-Attack Chart	12
FIGURE 20.—Drag Chart	13
FIGURE 21.—Aspect Ratio	13
FIGURE 22.—Force Vectors	13
FIGURE 23.—Wing Flap Diagrams	14
FIGURE 24.—Density Altitude Chart	14
FIGURE 25.—Airspeed Calibration/Stall Speeds Chart	15
FIGURE 26.—Takeoff Data Chart	15
FIGURE 27.—Maximum Climb Chart	16
FIGURE 28.—Short-Field Takeoff Distance Chart	17
FIGURE 29.—Glide Distance Chart	18
FIGURE 30.—Wind Component Chart	19
FIGURE 31.—Landing Distance Chart	20
FIGURE 32.—Weight and Balance Diagram	21
FIGURE 33.—Weight and Balance Diagram	21
FIGURE 34.—Weight and Balance Diagram	21
FIGURE 35.—Weight and Balance Diagram	21
FIGURE 36.—Weight and Balance Chart	22
FIGURE 37.—Rotor Blade Positions	23
FIGURE 37A.—Rotor Blade	23
FIGURE 38.—Glider Cross-Country	23
FIGURE 39.—Balloon Performance Graph	23
FIGURE 40.—Wind Triangle	24
FIGURE 41.—ADF Indicators (Fixed-Dial)	24
FIGURE 42.—VOR Indications	25
FIGURE 43.—RMI Indicators	26
FIGURE 44.—Sectional Chart Excerpt	27
FIGURE 45.—Sectional Chart Excerpt	28

FIGURE 46.—Sectional Chart Excerpt	29
FIGURE 47.—Class C Airspace Diagram	30
FIGURE 48.—Rectangular Course	30
FIGURE 49.—Ground Track Diagram	31
FIGURE 50.—S-Turn Diagram	31
FIGURE 51.—S-Turn Diagram	31
FIGURE 52.—Turn-and-Slip Indicators	31
FIGURE 53.—Helipport Markings	31
FIGURE 54.—Traffic Pattern Indicator	31
FIGURE 55.—Airport/Facility Directory	32

LESSON	GROUND REFERENCE MANEUVERS	STUDENT	DATE
A		TO DEVELOP THE STUDENT'S SKILL IN PLANNING AND FOLLOWING A PATTERN OVER THE GROUND COMPENSATING FOR WIND DRIFT AT VARYING ANGLES.	
B		USE OF GROUND REFERENCES TO CONTROL PATH. OBSERVATION AND CONTROL OF WIND EFFECT. CONTROL OF AIRPLANE ATTITUDE, ALTITUDE, AND HEADING.	
C		PREFLIGHT DISCUSSION. : 10 INSTRUCTOR DEMONSTRATIONS. : 25 STUDENT PRACTICE. : 45 POSTFLIGHT CRITIQUE. : 10	
D		CHALKBOARD FOR PREFLIGHT DISCUSSION. IFR VISOR FOR MANEUVERS REVIEWED.	
E		PREFLIGHT – DISCUSS LESSON OBJECTIVE. DIAGRAM "S" TURNS, EIGHTS ALONG A ROAD, AND RECTANGULAR COURSE ON A CHALKBOARD. INFLIGHT – DEMONSTRATE ELEMENTS. DEMONSTRATE FOLLOWING A ROAD, "S" TURNS, EIGHTS ALONG A ROAD, AND RECTANGULAR COURSE. COACH STUDENT PRACTICE. POSTFLIGHT – CRITIQUE STUDENT PERFORMANCE AND MAKE STUDY ASSIGNMENT.	
F		PREFLIGHT – DISCUSS LESSON OBJECTIVE AND RESOLVE QUESTIONS. INFLIGHT – REVIEW PREVIOUS MANEUVERS INCLUDING POWER-OFF STALLS AND FLIGHT AT MINIMUM CONTROLLABLE AIRSPEED. PERFORM EACH NEW MANEUVER AS DIRECTED. POSTFLIGHT – ASK PERTINENT QUESTIONS.	
G		STUDENT SHOULD DEMONSTRATE COMPETENCY IN MAINTAINING ORIENTATION, AIRSPEED WITHIN 10 KNOTS, ALTITUDE WITHIN 100 FEET, AND HEADINGS WITHIN 10 DEGREES, AND IN MAKING PROPER CORRECTION FOR WIND DRIFT.	

FIGURE 1.—Lesson Plan.

LESSON PLAN

Introduction (3 minutes)

- A _____ Relates aircraft accident in which a multi-engine airplane ran off the end of the runway. This could have been avoided by correctly computing the landing distance. Relate similar personal experience of the same type of mishap.
- B _____ Tell students how landing distance can affect them (any aircraft, plus future application).
- C _____ Explain what will be learned. Explain how the lesson will proceed. Define landing distance and explain the normal landing distance chart. Then, demonstrate how to solve for landing distance. The students will practice the procedure: at least once with supervision and at least once with as little help as possible. Next, the students will be evaluated according to the standards. Finally, the lesson will conclude with questions and answers, followed by a brief summary.

Body (29 minutes)

- D _____ Define landing distance. Explain the normal landing distance chart to include the scale and interpolation. Ensure students can see demonstration and encourage questions. Demonstrate the procedure using °C with a headwind and °F with a tailwind. Show the normal landing distance chart with given data in the following order:
1. temperature
 2. pressure altitude
 3. gross weight
 4. headwind-tailwind component
 5. read ground roll distance from graph
- E _____ Review standards. Hand out chart and practice problems. Remind students to use a pencil, to make small tick marks, and to work as accurately as possible. Explain that they should follow the procedure on the chart to work the practice problems. Encourage students to ask questions. Check progress of each student continually so they develop skill proficiency within acceptable standards. Reteach any area(s) of difficulty to the class as they go along.
- F _____ Review procedure again from the chart. Reemphasize standards of acceptable performance including time available. Prepare area for evaluation by removing the task step chart and practice problem sheets, and by handing out the evaluation problems. Ask students to work the three problems according to conditions and standards specified. Terminate evaluation after 6 minutes. Evaluate each student's performance and tactfully reveal results. Record results for use in reteaching any area(s) of difficulty in the summary.

Conclusion (3 minutes)

- G _____ Review lessons with emphasis on any weak areas(s).
- H _____ Remind students that landing distance will be an important consideration in any aircraft they fly.
- I _____ Advise students that this lesson will be used as a starting point for the next lesson. Assign study materials for the next lesson.

FIGURE 1A.—Lesson Plan.

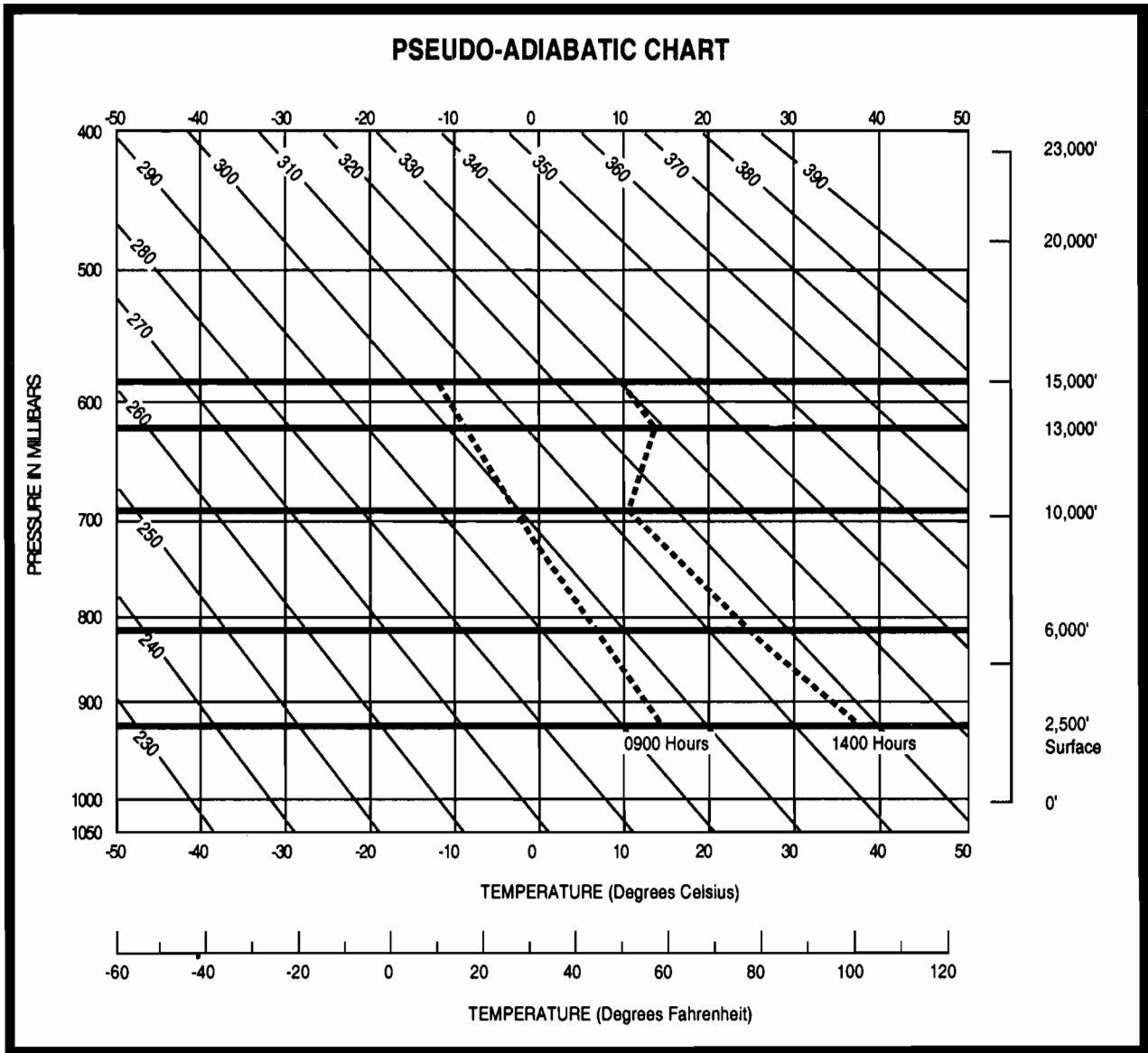

FIGURE 2.—Pseudo-Adiabatic Chart.

METAR KAMA 301651Z 05016KT 5/8SM R04/3000FT BR OVC007 11/9 A3013
 RMK DZB26DZE40

METAR KAUS 301651Z 12008KT 4SM -RAHZ BKN010 BKN023 OVC160 21/17
 A3005 RMK RAB25

METAR KBRO 301655Z 15015G20KT 7SM SCT020 SCT130 TCU OVC250 29/19
 A2997 RMK RAB19RAE25

METAR KDAL 301649Z 00000KT 3SM BRHZ OVC009 22/17 A3010

METAR KFTW 301654Z 09004KT 1/2SM HZFU VV006 21/17 A3010

METAR KTYR 301650Z AUTO 08004KT 3SM BR SCT015 24/19 A2999

FIGURE 3.—Aviation Routine Weather Reports (METAR).

UA/OV KOKC-KTUL/TM 1800/FL120/TP BE90//SK BKN018-TOP055/OVC072-
 TOP089/CLR ABV/TA M7/WV 08021/TB LGT 055-072/IC LGT-MOD RIME 072-089

FIGURE 4.—Pilot Weather Report.

TAF

KMEM 121720Z 121818 20012KT 5SM HZ BKN030 PROB40 2022 1SM TSRA OVC008CB
 FM2200 33015G20KT P6SM BKN015 OVC025 PROB40 2202 3SM SHRA
 FM0200 35012KT OVC008 PROB40 0205 2SM -RASN BECMG 0608 02008KT BKN012
 BECMG 1012 00000KT 3SM BR SKC TEMPO 1214 1/2SM FG
 FM1600 VRB06KT P6SM SKC=

KOKC 051130Z 051212 14008KT 5SM BR BKN030 TEMPO 1316 1 1/2SM BR
 FM1600 18010KT P6SM SKC BECMG 2224 20013G20KT 4SM SHRA OVC020
 PROB40 0006 2SM TSRA OVC008CB BECMG 0608 21015KT P6SM SCT040=

FIGURE 5.—Terminal Aerodrome Forecasts (TAF).

BOSC FA 241845
SYNOPSIS AND VFR CLDS/WX
SYNOPSIS VALID UNTIL 251300
CLDS/WX VALID UNTIL 250700...OTLK VALID 250700-251300
ME NH VT MA RI CT NY LO NJ PA OH LE WV MD DC DE VA AND CSTL WTRS

SEE AIRMET SIERRA FOR IFR CONDS AND MTN OBSCN.
TS IMPLY SEV OR GTR TURB SEV ICE LLWS AND IFR CONDS.
NON MSL HGTS DENOTED BY AGL OR CIG.

SYNOPSIS...19Z CDFNT ALG A 160NE ACK-ENE LN...CONTG AS A QSTNRY
FNT ALG AN END-50SW MSS LN. BY 13Z...CDFNT ALG A 140ESE ACK-HTO
LN...CONTG AS A QSTNRY FNT ALG A HTO-SYR-YYZ LN. TROF ACRS CNTRL
PA INTO NRN VA. ...REYNOLDS...

OH LE
NRN HLF OH LE...SCT-BKN025 OVC045. CLDS LYRD 150. SCT SHRA. WDLY
SCT TSRA. CB TOPS FL350. 23-01Z OVC020-030. VIS 3SM BR. OCNL -
RA. OTLK...IFR CIG BR FG.
SWRN QTR OH...BKN050-060 TOPS 100. OTLK...MVFR BR.
SERN QTR OH...SCT-BKN040 BKN070 TOPS 120. WDLY SCT -TSRA. 00Z
SCT-BKN030 OVC050. WDLY SCT -TSRA. CB TOPS FL350. OTLK...VFR
SHRA.

CHIC FA 241945
SYNOPSIS AND VFR CLDS/WX
SYNOPSIS VALID UNTIL 251400
CLDS/WX VALID UNTIL 250800...OTLK VALID 250800-251400
ND SD NE KS MN IA MO WI LM LS MI LH IL IN KY

SEE AIRMET SIERRA FOR IFR CONDS AND MTN OBSCN.
TS IMPLY SEV OR GTR TURB SEV ICE LLWS AND IFR CONDS.
NON MSL HGTS DENOTED BY AGL OR CIG.

SYNOPSIS.:LOW PRES AREA 20Z CNTRD OVR SERN WI FCST MOV NEWD INTO
LH BY 12Z AND WKN. LOW PRES FCST DEEPEN OVR ERN CO DURG PD AND
MOV NR WRN KS BORDER BY 14Z. DVLPG CDFNT WL MOV EWD INTO S CNTRL
NE-CNTRL KS BY 14Z. ..SMITH..

UPR MI LS
WRN PTNS...AGL SCT030 SCT-BKN050. TOPS 080. 02-05Z BECMG CIG
OVC010 VIS 3-5SM BR. OTLK...IFR CIG BR.
ERN PTNS...CIG BKN020 OVC040. OCNL VIS 3-5SM -RA BR. TOPS FL200.
23Z CIG OVC010 VIS 3-5SM -RA BR. OTLK...IFR CIG BR.

LWR MI LM LH
CNTRL/NRN PTNS...CIG OVC010 VIS 3-5SM -RA BR. TOPS FL200.
OTLK...IFR CIG BR.

SRN THIRD...CIG OVC015-025. SCT -SHRA. TOPS 150. 00-02Z BECMG CIG
OVC010 VIS 3-5SM BR. TOPS 060. OTLK...IFR CIG BR.

IN
NRN HALF...CIG BKN035 BKN080. TOPS FL200. SCT -SHRA. 00Z CIG
BKN-SCT040 BKN-SCT080. TOPS 120. 06Z AGL SCT-BKN030. TOPS 080.
OCNL VIS 3-5SM BR. OTLK...MVFR CIG BR.
SRN HALF...AGL SCT050 SCT-BKN100. TOPS 120. 07Z AGL SCT 030
SCT100. OTLK...VFR.

FIGURE 6.—Aviation Area Forecast (FA).

FD WBC 151745
 DATA BASED ON 151200Z
 VALID 1600Z FOR USE 1800-0300Z. TEMPS NEG ABV 24000

FT	3000	6000	9000	12000	18000	24000	30000	34000	39000
ALS			2420	2635-08	2535-18	2444-30	245945	246755	246862
AMA		2714	2725+00	2625-04	2531-15	2542-27	265842	256352	256762
DEN			2321-04	2532-08	2434-19	2441-31	235347	236056	236262
HLC		1707-01	2113-03	2219-07	2330-17	2435-30	244145	244854	245561
MKC	0507	2006+03	2215-01	2322-06	2338-17	2348-29	236143	237252	238160
STL	2113	2325+07	2332+02	2339-04	2356-16	2373-27	239440	730649	731960

FIGURE 7.—Winds and Temperatures Aloft Forecast (FD).



FIGURE 8.—Surface Analysis Chart Symbol.

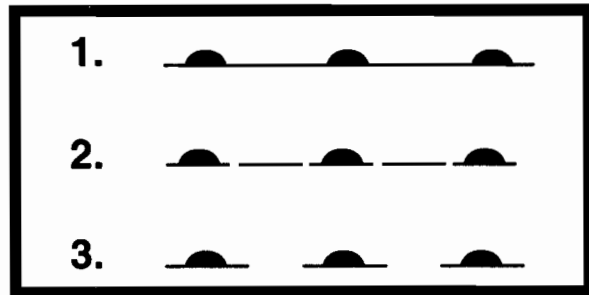

FIGURE 9.—Surface Analysis Chart Symbols.

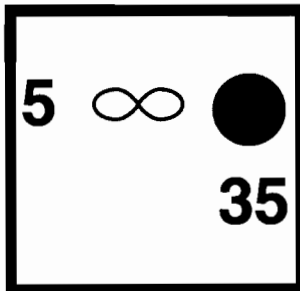

FIGURE 10.—Weather Depiction Chart Symbol.

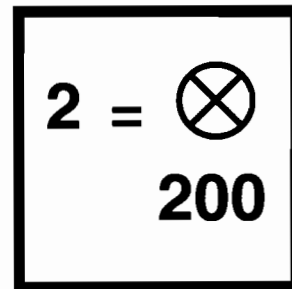

FIGURE 11.—Weather Depiction Chart Symbol.

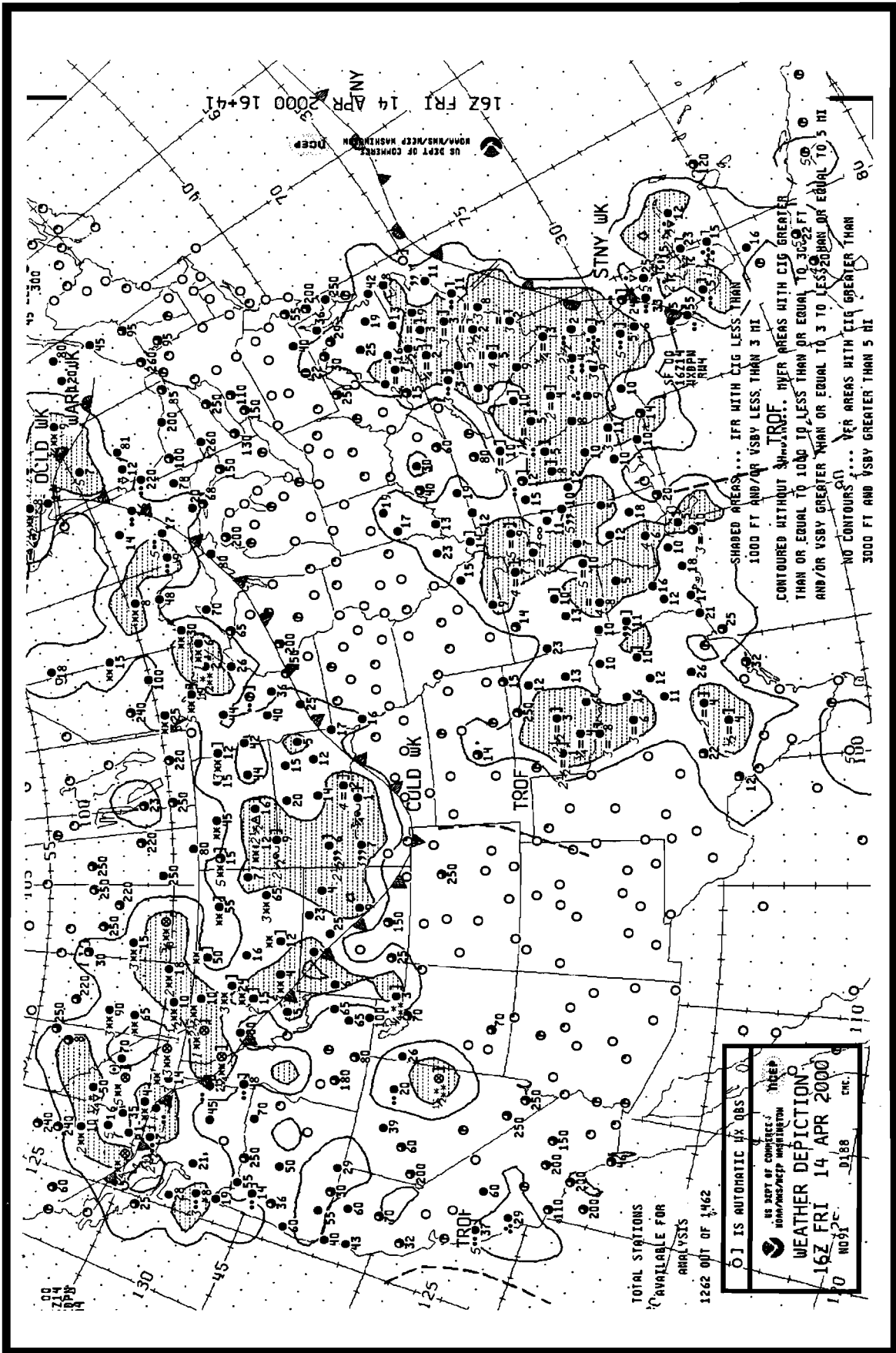

FIGURE 12.—Weather Depiction Chart.

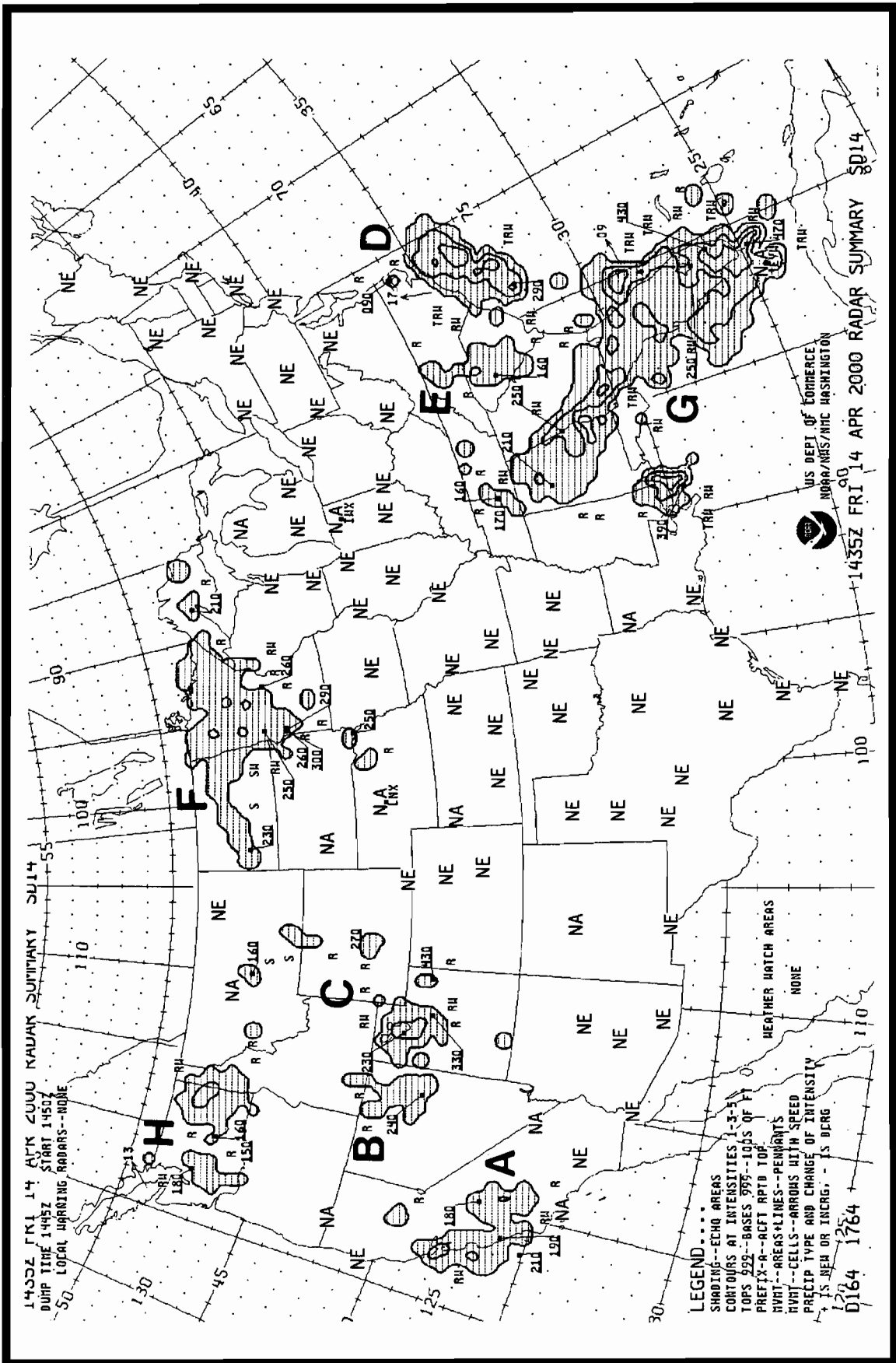

FIGURE 13.—Radar Summary Chart.

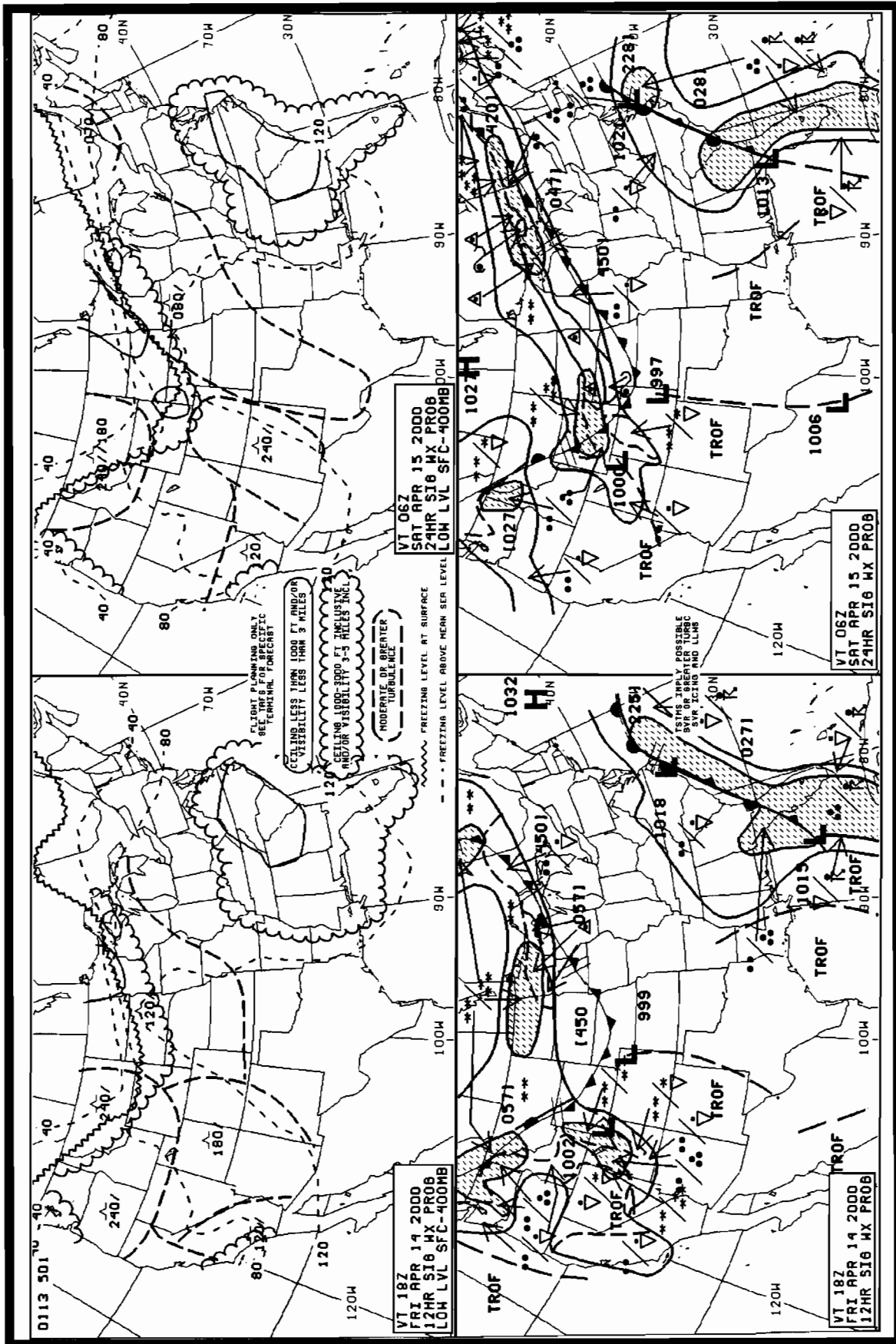

FIGURE 14.—Significant Weather Prognostic Chart.

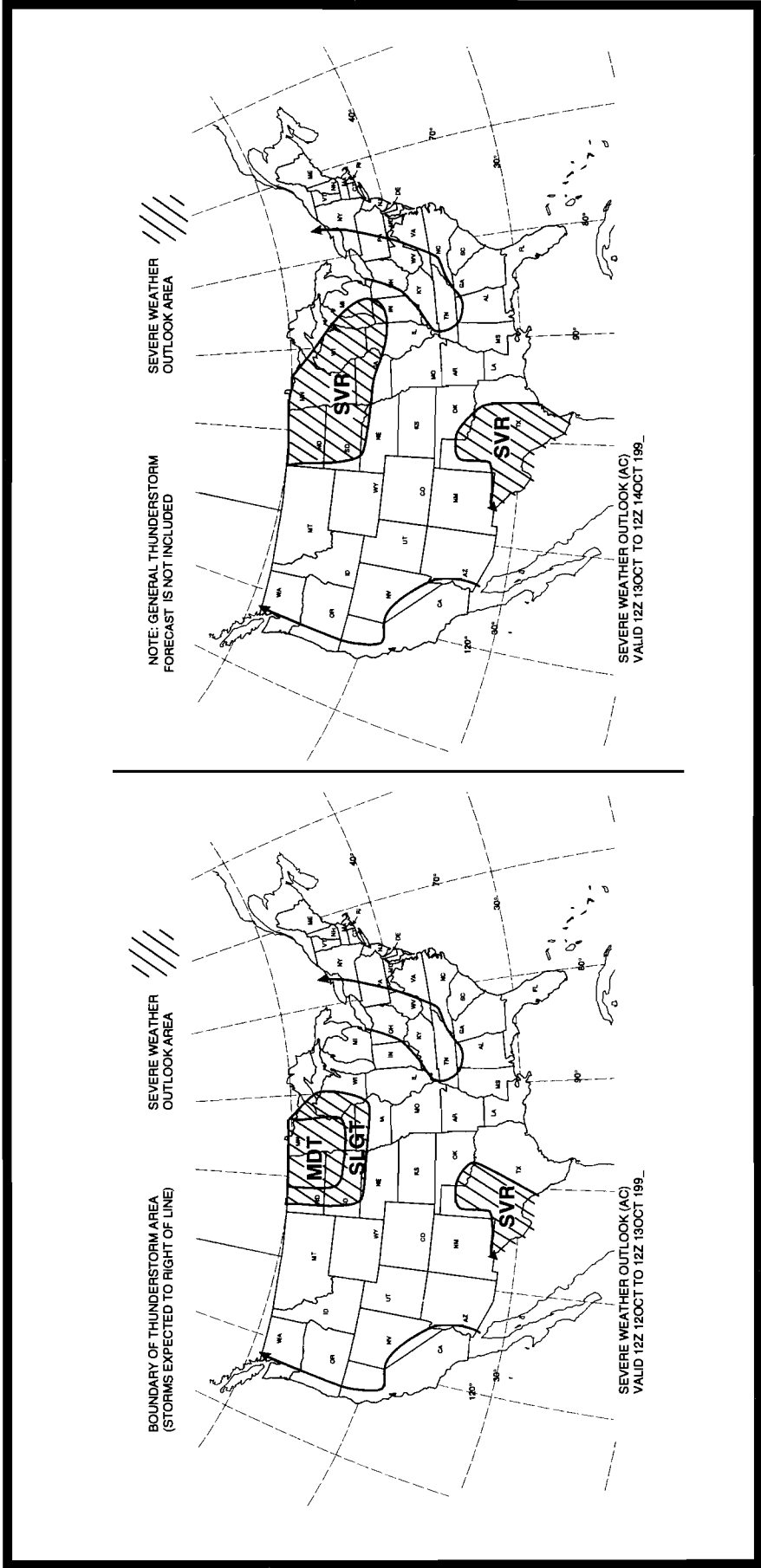

FIGURE 15.—Severe Weather Outlook Chart.

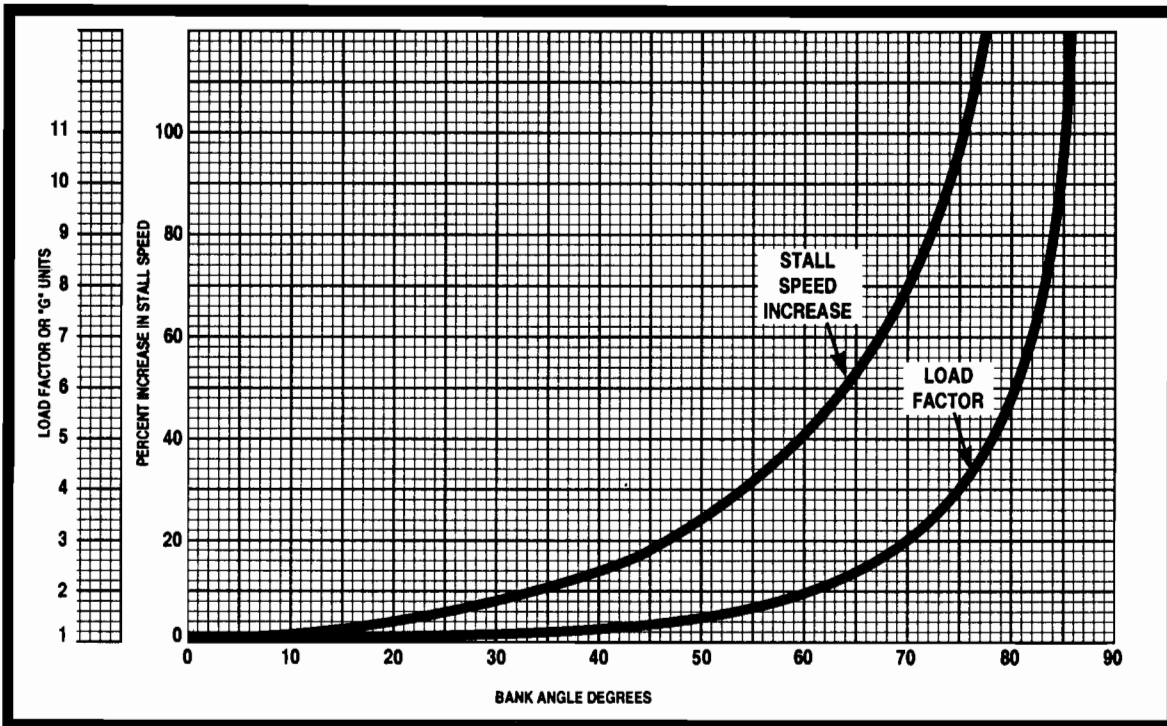

FIGURE 18.—Load Factor/Stall Speed Chart.

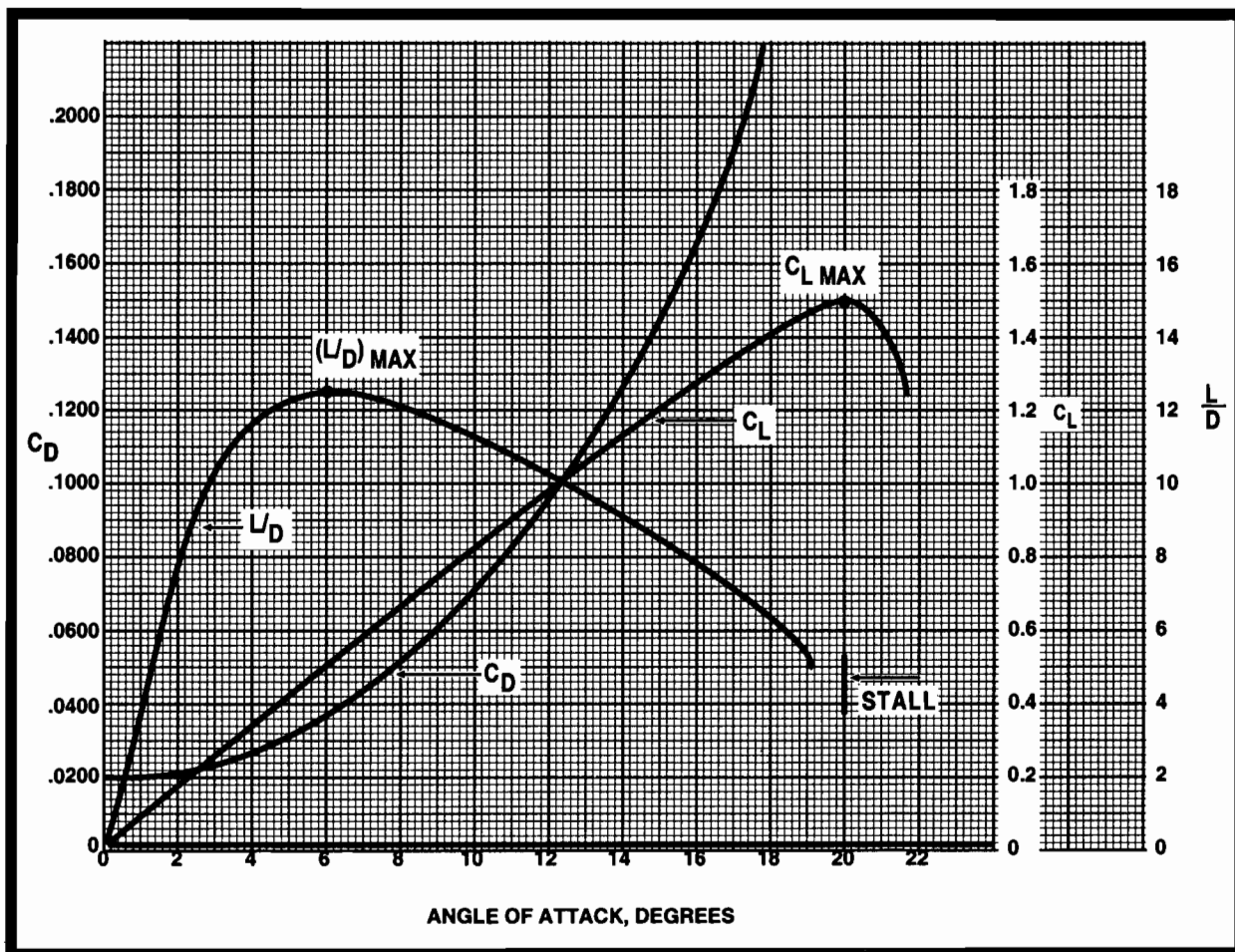

FIGURE 19.—Angle-of-Attack Chart.

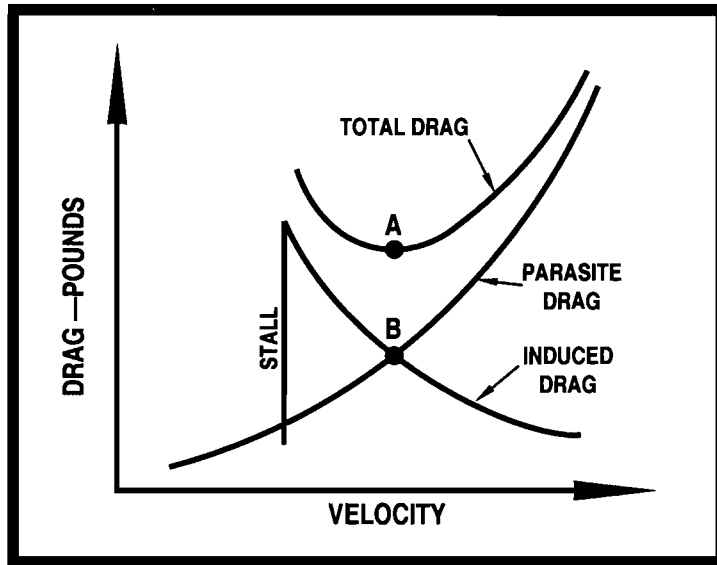

FIGURE 20.—Drag Chart.

AIRCRAFT	1	2	3	4
WING SPAN	40'	35'	48'	30'
AVERAGE WING CHORD	6'	5'	6'	6'

FIGURE 21.—Aspect Ratio.

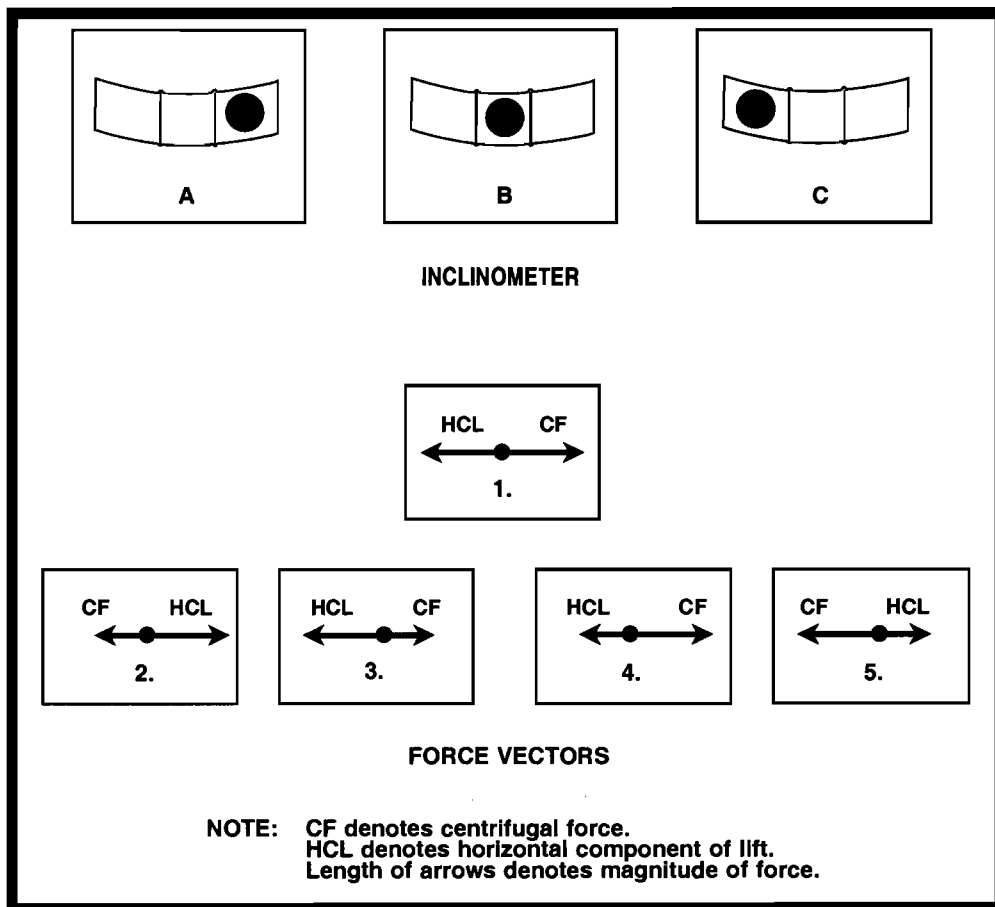

FIGURE 22.—Force Vectors.

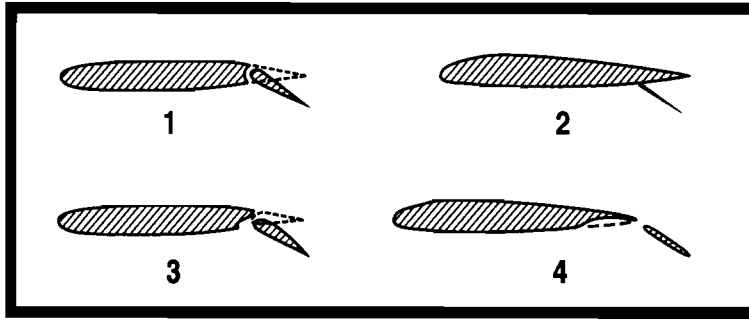

FIGURE 23.—Wing Flap Diagrams.

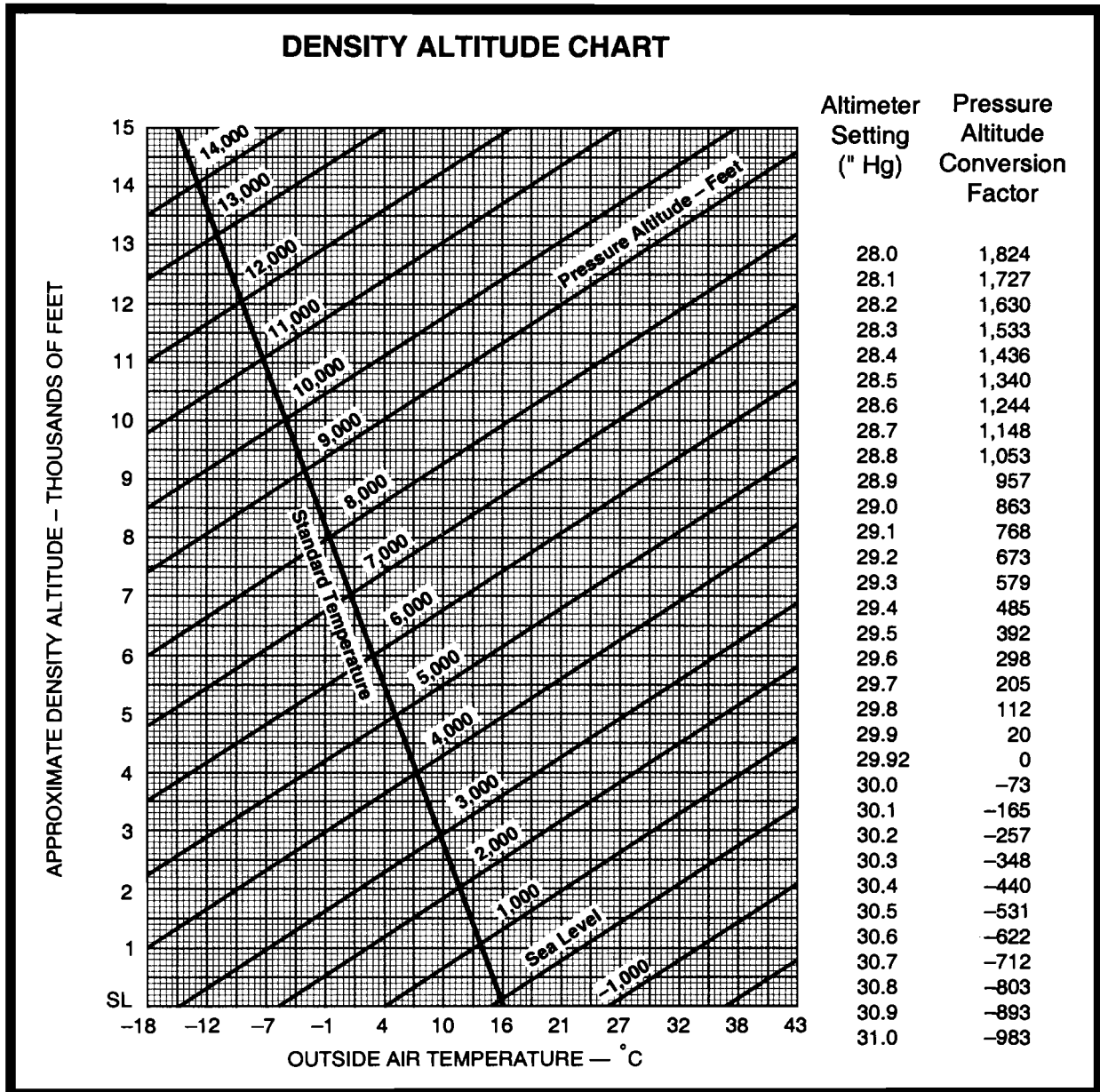

FIGURE 24.—Density Altitude Chart.

AIRSPED CALIBRATION — NORMAL SYSTEM					
Flaps 0°		Flaps 15°		Flaps 45°	
CIAS	KCAS	CIAS	KCAS	CIAS	KCAS
80	84	70	79	70	76
100	102	80	86	80	84
120	122	90	94	90	93
140	141	100	103	100	102
160	161	110	112	110	111
180	181	120	121	120	120
200	201	130	131	130	129
220	221	140	141	140	138
240	242	150	151		

KIAS — INDICATED AIRSPEED IN KNOTS
 KCAS — CALIBRATED AIRSPEED IN KNOTS

STALL SPEEDS — KCAS				
4600 LB GROSS WEIGHT				
CONFIGURATION	ANGLE OF BANK			
	0°	20°	40°	60°
Gear and Flaps Up	84	87	97	119
Gear Down and Flaps 15°	80	83	92	113
Gear Down and Flaps 45°	76	79	87	108

FIGURE 25.—Airspeed Calibration/Stall Speeds Chart.

TAKEOFF DATA											
TAKEOFF DISTANCE WITH 10° FLAPS FROM HARD-SURFACED RUNWAY											
GROSS WEIGHT LB	CIAS AT 50 FT	HEAD WIND KTS	AT SEA LEVEL & 15° C		AT 2500 FT & 10° C		AT 5000 FT & 5° C		AT 7500 FT & 0° C		
			GROUND ROLL	TOTAL TO CLEAR 50' OBS	GROUND ROLL	TOTAL TO CLEAR 50' OBS	GROUND ROLL	TOTAL TO CLEAR 50' OBS	GROUND ROLL	TOTAL TO CLEAR 50' OBS	
2200	55	0	345	680	405	770	480	885	580	1040	
		15	205	460	245	525	295	615	365	725	
		30	100	275	120	320	155	380	195	460	
2600	60	0	500	915	585	1045	705	1230	855	1470	
		15	310	635	370	735	455	870	560	1055	
		30	165	395	200	465	255	565	325	695	
3000	64	0	695	1210	820	1405	990	1675	1205	2045	
		15	450	855	535	1005	660	1215	815	1505	
		30	250	555	310	665	390	820	500	1030	

NOTE: INCREASE DISTANCES 10% FOR EACH 14° C ABOVE STANDARD TEMPERATURE FOR PARTICULAR ALTITUDE.

FIGURE 26.—Takeoff Data Chart.

MAXIMUM CLIMB (CLIMB SPEED)

CONDITIONS:

MAXIMUM CONTINUOUS POWER
3400 POUNDS
GEAR UP
FLAPS UP

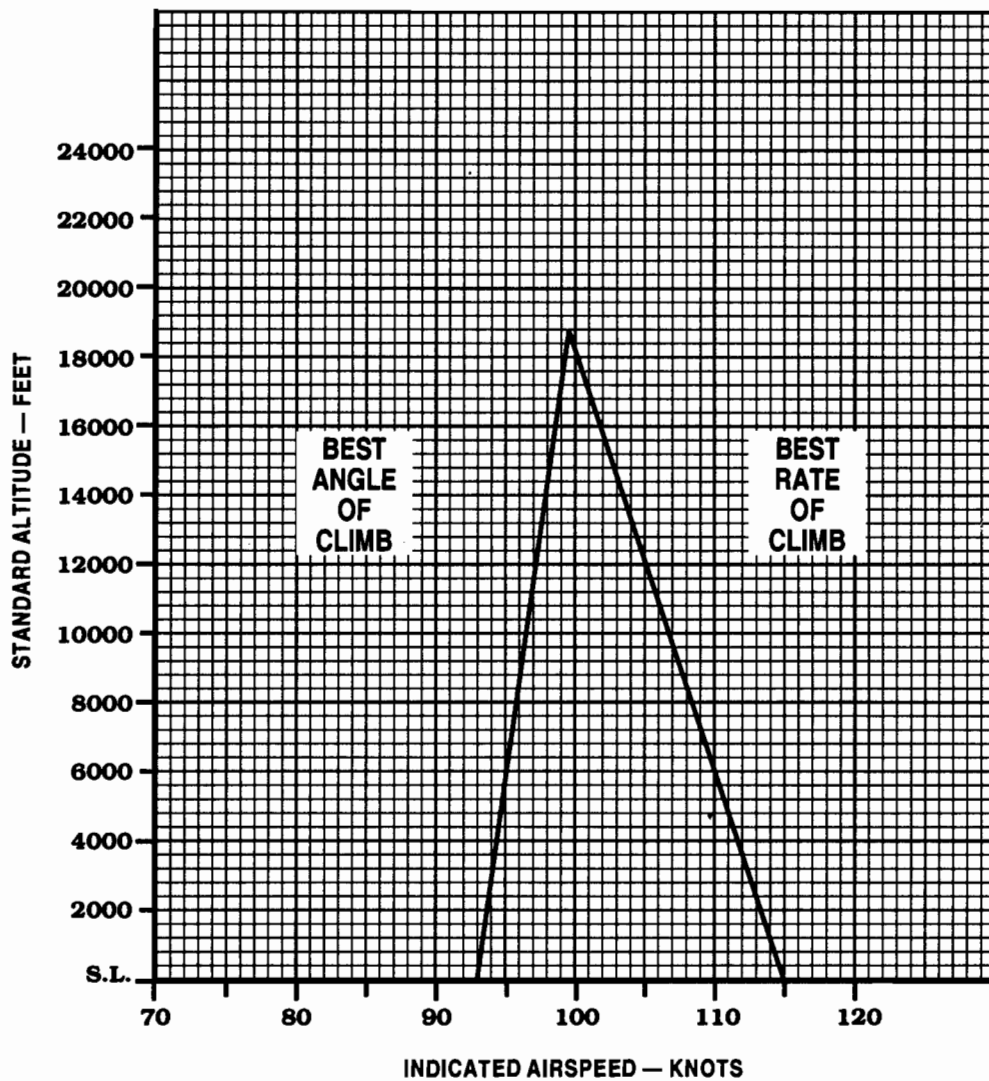

FIGURE 27.—Maximum Climb Chart.

SHORT-FIELD TAKEOFF DISTANCE

CONDITIONS:

1. Power – FULL THROTTLE and 2700 RPM before releasing brakes.
2. Mixtures — LEAN for field elevation.
3. Cowl flaps — OPEN.
4. Wing flaps — UP.
5. Level, dry, hard-surface runway.

NOTE:

1. Increase total distance 8 percent for operation on dry, sod runway.
2. Decrease total distance 7 percent for each 10 knots of headwind.
3. Increase total distance 5 percent for each 2 knots of tailwind.

WEIGHT- POUNDS	TAKEOFF TO 50- FOOT OBSTACLE SPEED- KIAS	PRESSURE ALTITUDE- FEET	20 C		30 C		40 C	
			GROUND ROLL - FEET	TOTAL DISTANCE TO CLEAR 50' OBS	GROUND ROLL - FEET	TOTAL DISTANCE TO CLEAR 50' OBS	GROUND ROLL - FEET	TOTAL DISTANCE TO CLEAR 50' OBS
5500	82	Sea Level	1390	1760	1490	1890	1590	2020
		1000	1530	1950	1640	2080	1760	2230
		2000	1680	2150	1810	2300	1940	2470
		3000	1860	2380	2000	2550	2150	2750
		4000	2060	2650	2220	2850	2380	3070
		5000	2280	2950	2460	3190	2640	3450
		6000	2530	3310	2730	3590	2950	3900
		7000	2830	3750	3160	4190	3410	4570
		8000	3280	4420	3540	4840	3830	5330
		9000	3690	5170	4000	5730	4330	6420
10,000	4150	6140	4500	6980	4880	8130		
5100	78	Sea Level	1160	1470	1240	1570	1330	1680
		1000	1280	1620	1370	1730	1470	1850
		2000	1400	1780	1500	1910	1610	2040
		3000	1550	1960	1660	2100	1780	2260
		4000	1710	2180	1840	2340	1970	2510
		5000	1890	2410	2030	2590	2180	2790
		6000	2090	2690	2250	2890	2420	3120
		7000	2330	3010	2510	3250	2700	3520
		8000	2600	3400	2800	3680	3030	4010
		9000	2920	3890	3270	4360	3530	4760
10,000	3390	4580	3660	5030	3960	5560		
4700	75	Sea Level	960	1220	1020	1300	1090	1380
		1000	1050	1340	1120	1430	1200	1520
		2000	1150	1460	1230	1560	1320	1670
		3000	1270	1610	1360	1720	1460	1840
		4000	1400	1770	1500	1900	1610	2030
		5000	1540	1960	1650	2100	1780	2250
		6000	1700	2170	1830	2330	1970	2500
		7000	1890	2410	2030	2590	2190	2790
		8000	2100	2700	2260	2910	2440	3140
		9000	2350	3040	2540	3290	2730	3570
10,000	2620	3430	2830	3730	3060	4060		

FIGURE 28.—Short-Field Takeoff Distance Chart.

GLIDE DISTANCE

CONDITIONS:

GEAR	UP
FLAPS	UP
COWL FLAPS	CLOSED
PROPELLER	FULL HIGH PITCH (LOW RPM)
GLIDE SPEED	122 KIAS

- NOTES: 1. INCREASE GLIDE DISTANCE APPROXIMATELY 10% FOR EACH 10 KNOTS OF TAILWIND.
2. DECREASE GLIDE DISTANCE APPROXIMATELY 10% FOR EACH 10 KNOTS OF HEADWIND.

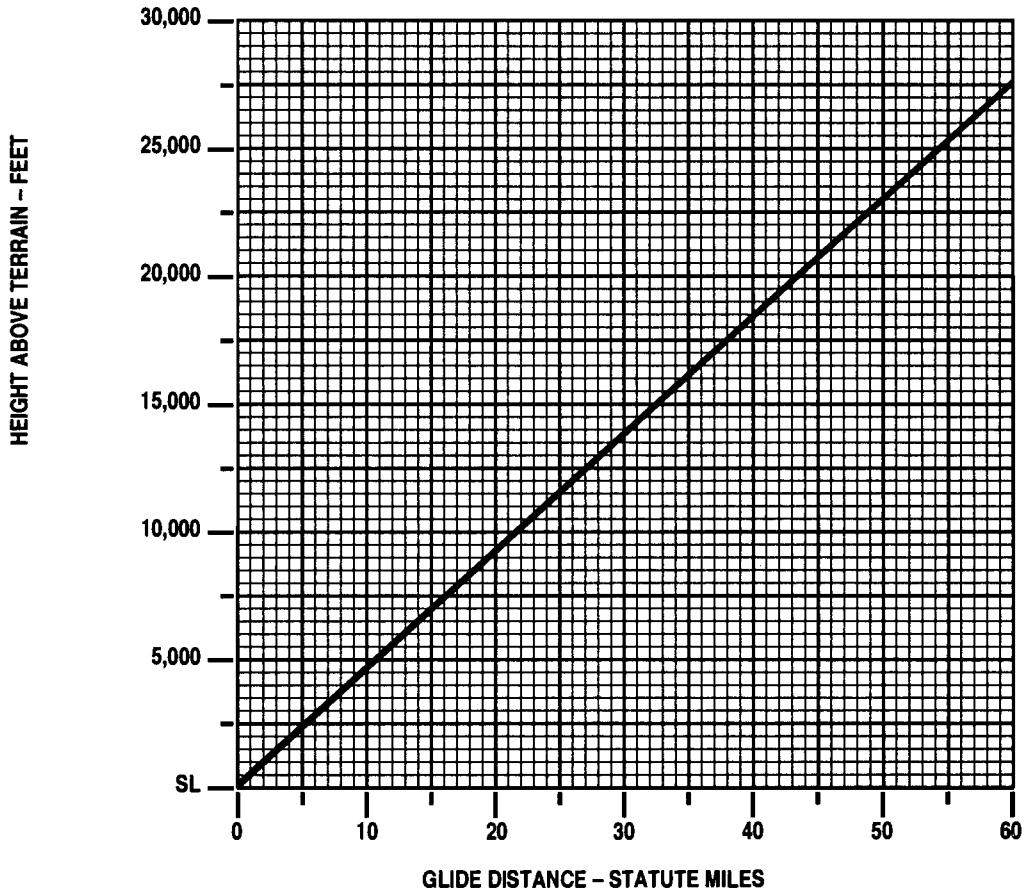

FIGURE 29.—Glide Distance Chart.

WIND COMPONENT

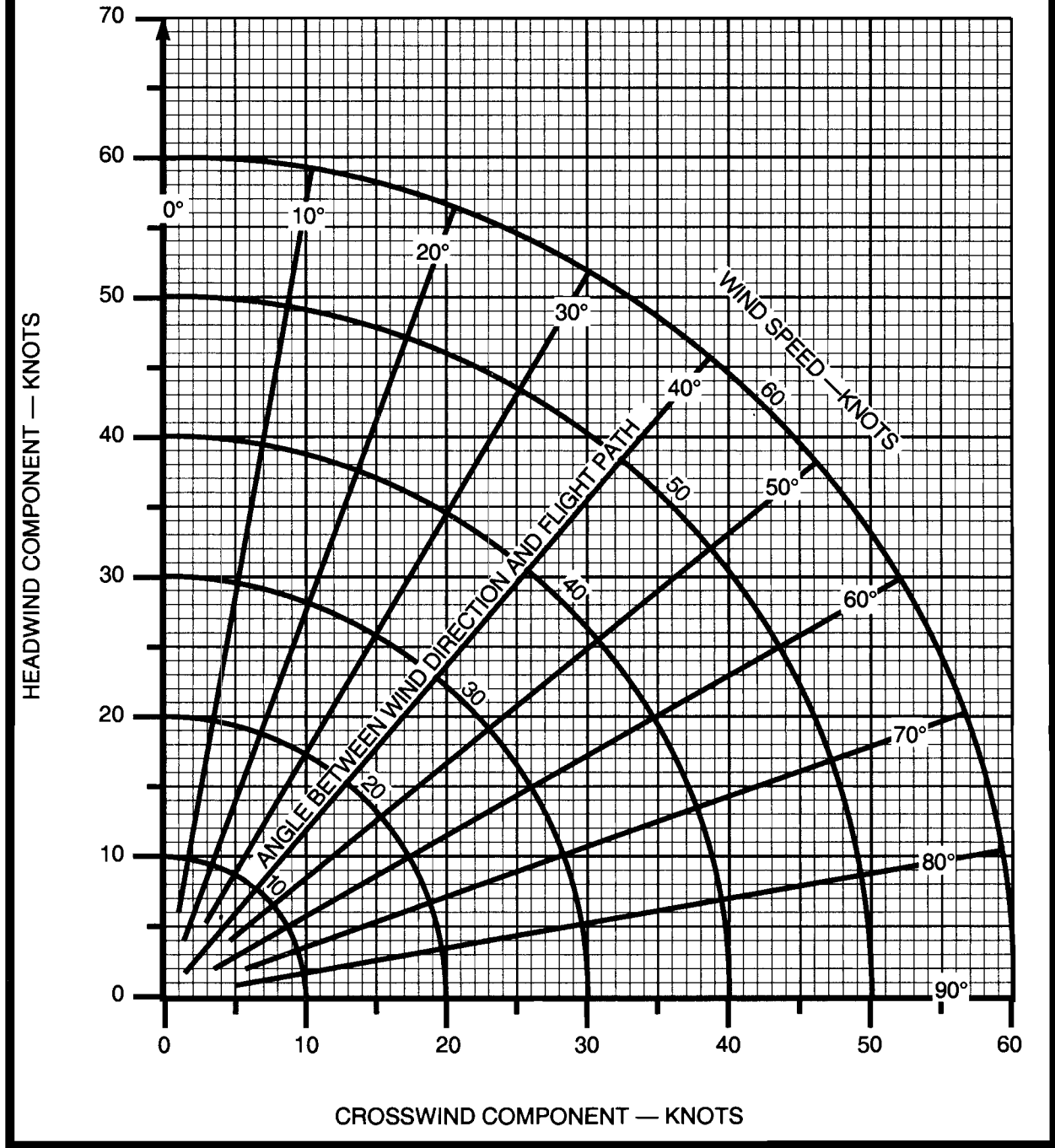

FIGURE 30.—Wind Component Chart.

LANDING DISTANCE

CONDITIONS:

POWER AS REQUIRED TO MAINTAIN 800 FT/MIN DESCENT ON APPROACH

FLAPS DOWN

RUNWAY PAVED, LEVEL, DRY SURFACE

APPROACH SPEED IAS AS TABULATED

EXAMPLE:

OAT 27 °C

PRESSURE ALTITUDE 4000 FT

LANDING WEIGHT 3200 LB

HEADWIND 10 KTS

TOTAL LANDING DISTANCE OVER A 50 FT OBSTACLE 1475 FT

GROUND ROLL (53% OF 1475) 782 FT

IAS APPROACH SPEED 87 MPH IAS

NOTE: GROUND ROLL IS APPROX. 53% OF TOTAL LANDING DISTANCE OVER A 50 FT OBSTACLE.

WEIGHT POUNDS	IAS APPROACH SPEED (ASSUMES ZERO INSTR. ERROR)	
	MPH	KNOTS
3400	90	78
3200	87	76
3000	84	73
2800	81	70
2600	78	68
2400	75	65

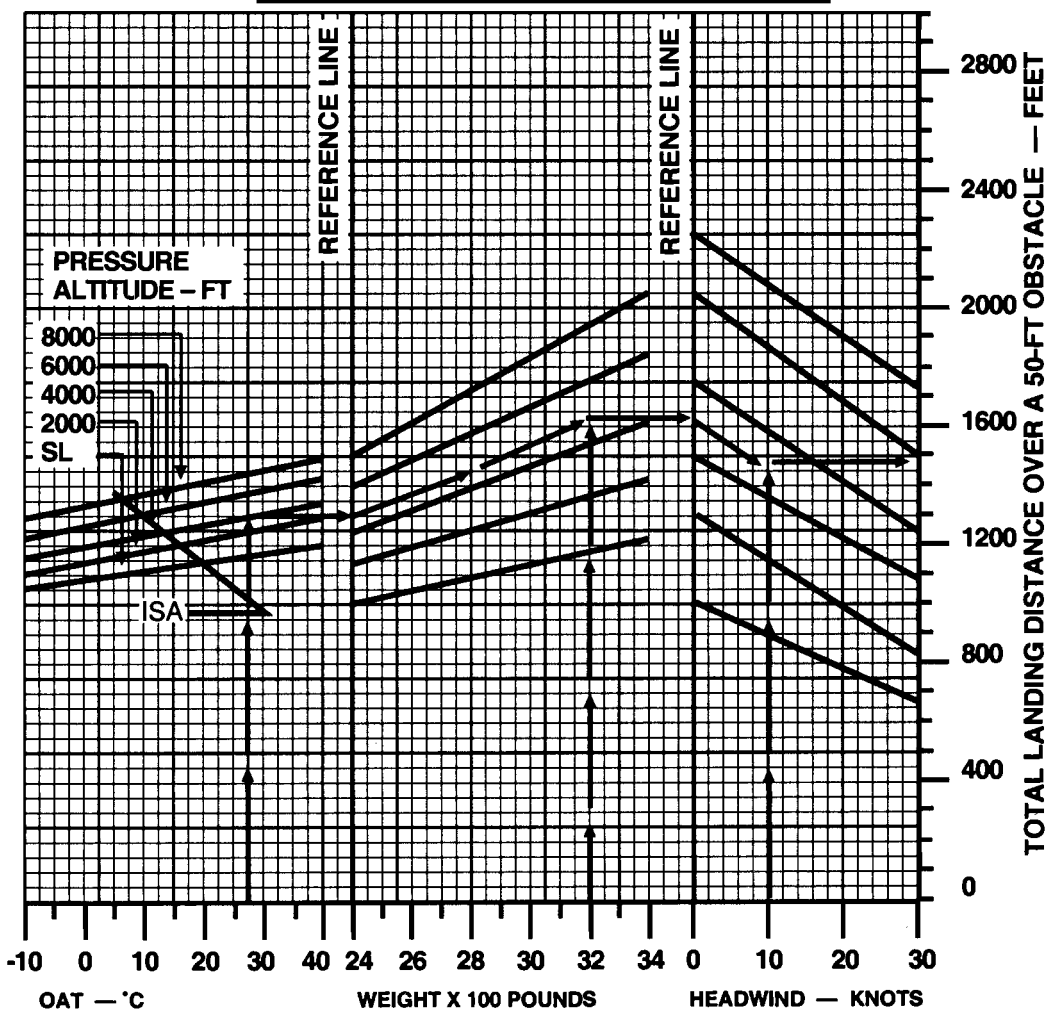

FIGURE 31.—Landing Distance Chart.

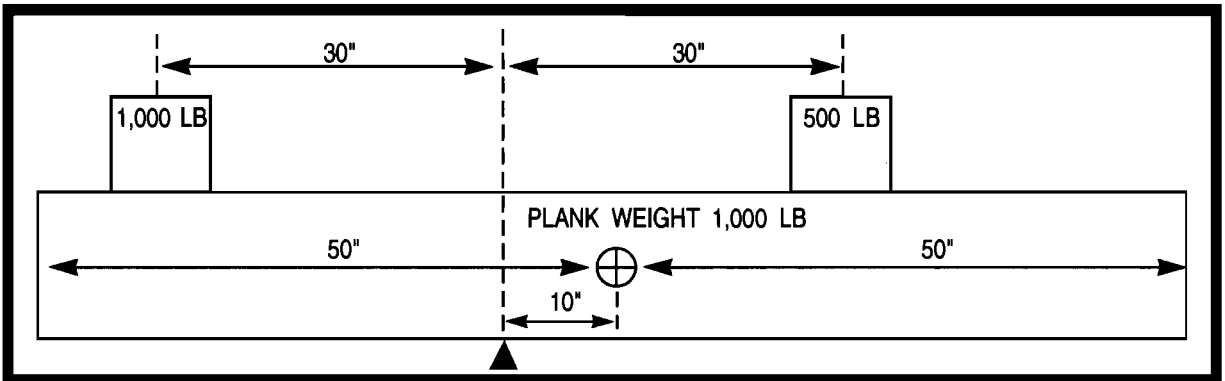

FIGURE 32.—Weight and Balance Diagram.

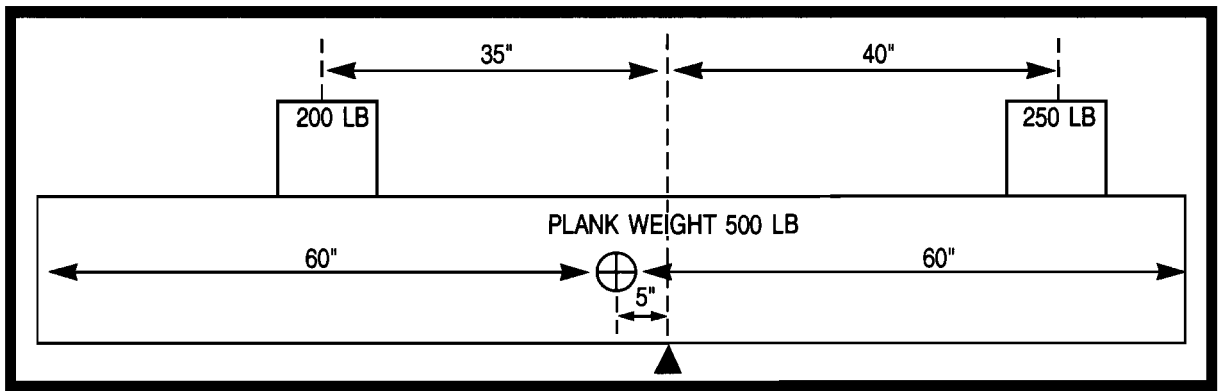

FIGURE 33.—Weight and Balance Diagram.

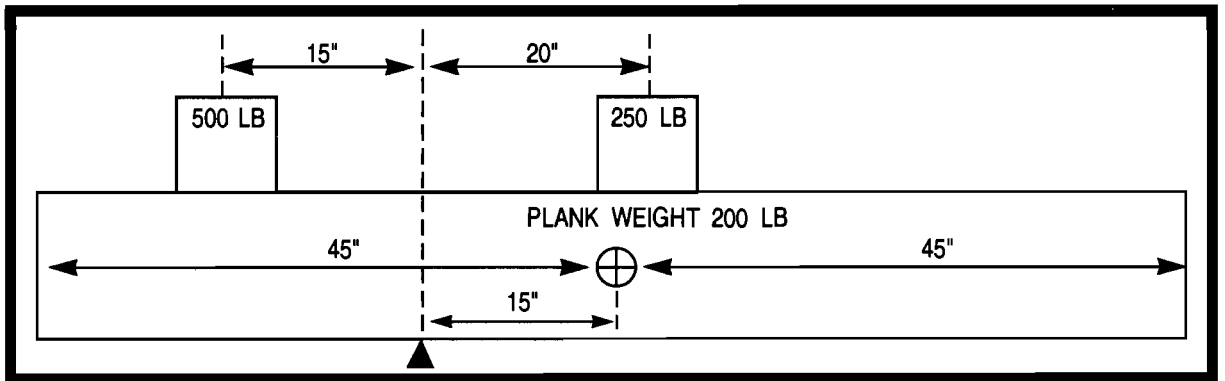

FIGURE 34.—Weight and Balance Diagram.

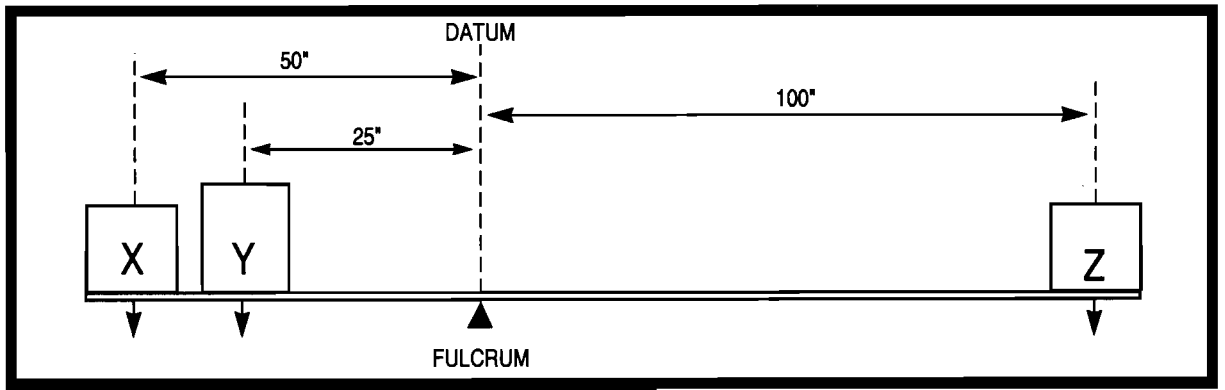

FIGURE 35.—Weight and Balance Diagram.

USEFUL LOAD WEIGHTS AND MOMENTS

EMPTY WEIGHT DATA		
*Oil is included in empty weight	Empty Weight (Lb.)	Empty Weight Moment (/100)
	Certificated Weight	2110 1652

OCCUPANTS				
Front Seats		Rear Seats		
ARM 85			Fwd Position ARM 111	Aft Position ARM 136
Weight	Moment	Weight	Moment	Moment
120	102	120	145	163
130	111	130	157	177
140	119	140	169	190
150	128	150	182	204
160	136	160	194	218
170	145	170	206	231
180	153	180	218	245
190	162	190	230	258
200	170	200	242	273

FUEL					
ARM 75					
Gallons	Weight	Moment	Gallons	Weight	Moment
5	30	23	45	270	203
10	60	45	49	294	221
15	90	68	55	330	248
20	120	90	60	360	270
25	150	113	65	390	293
30	180	135	70	420	315
35	210	158	75	450	338
40	240	180	80	480	360

BAGGAGE	
ARM 150	
Weight	Moment
10	15
20	30
30	45
40	60
50	75
60	90
70	105
80	120
90	135
100	150
110	165
120	180
130	195
140	210
150	225
160	240
170	255
180	270
190	285
200	300
210	315
220	330
230	345
240	360
250	375
260	390
270	405

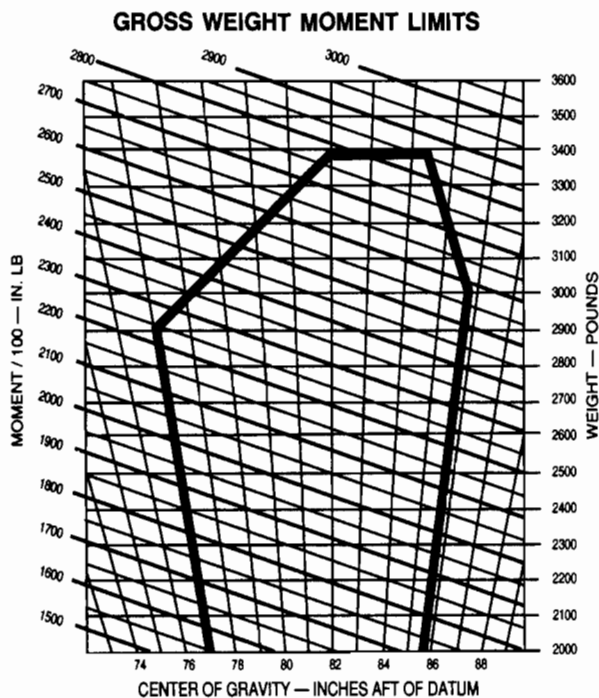

NOTE: All moments are equal to

$$\frac{\text{weight X arm}}{100}$$

FIGURE 36.—Weight and Balance Chart.

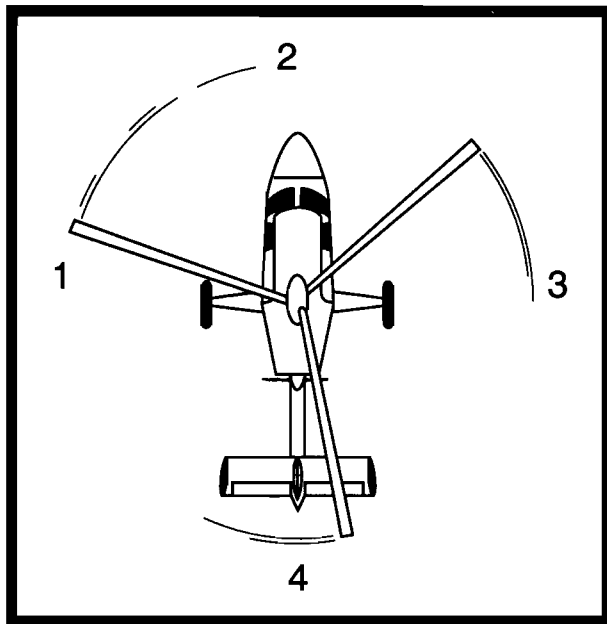

FIGURE 37.—Rotor Blade Positions.

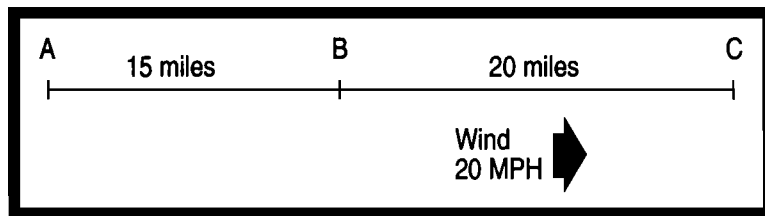

FIGURE 38.—Glider Cross-Country.

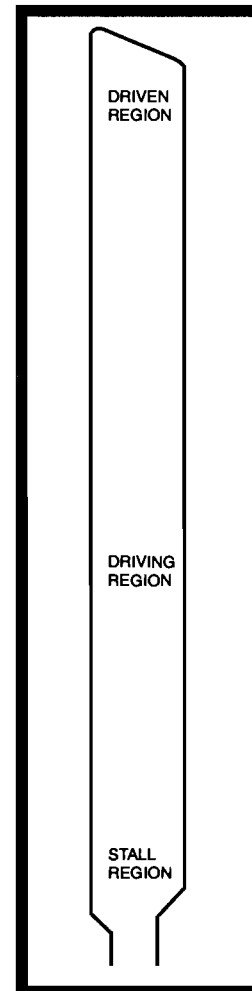

FIGURE 37A.—Rotor Blade.

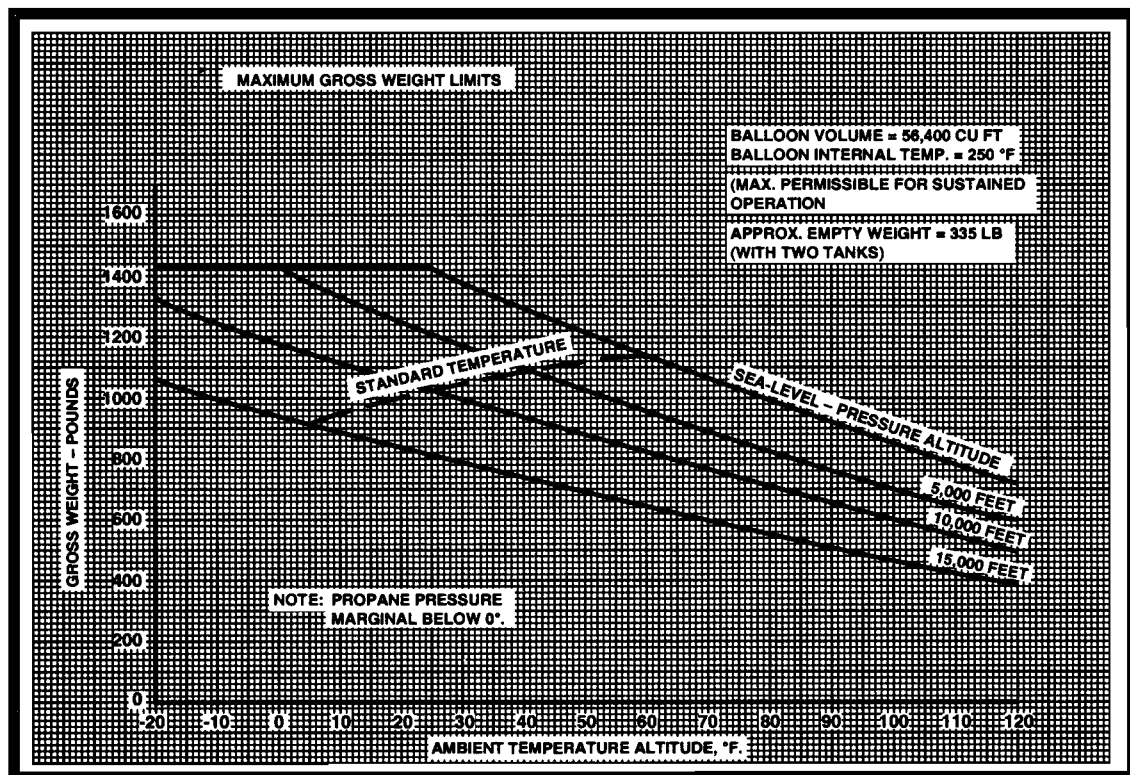

FIGURE 39.—Balloon Performance Graph.

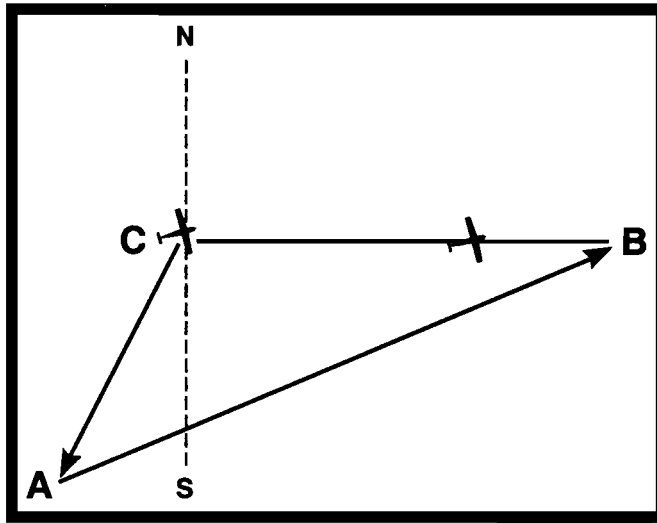

FIGURE 40.—Wind Triangle.

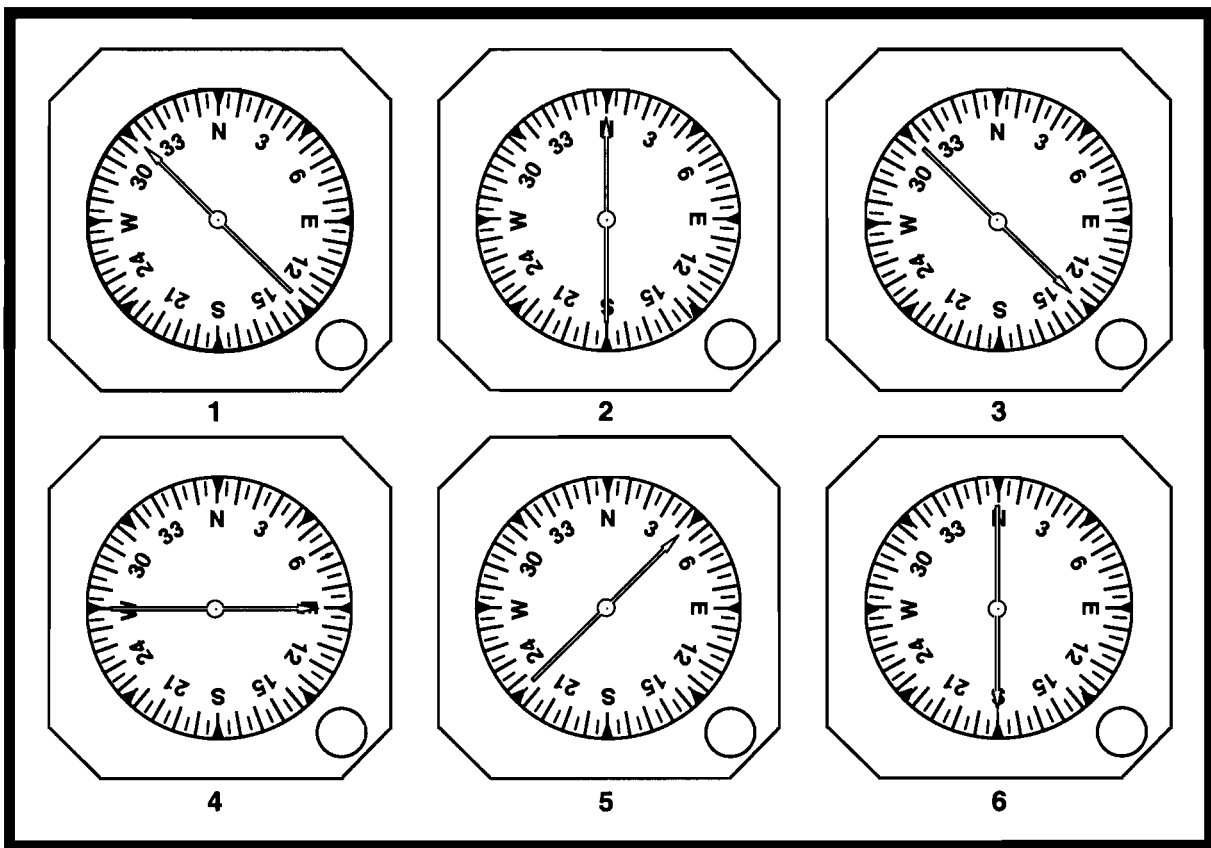

FIGURE 41.—ADF Indicators (Fixed-Dial).

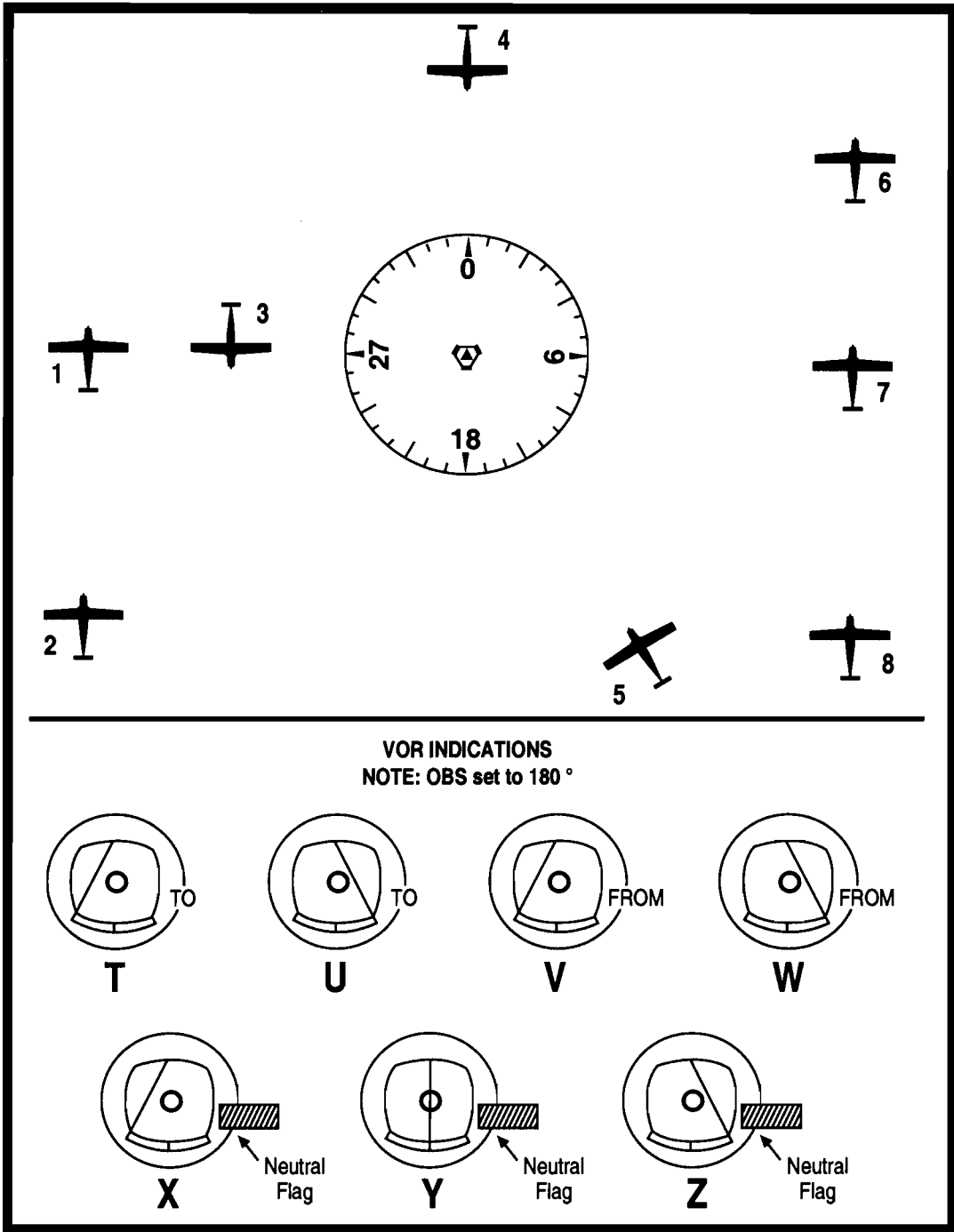

FIGURE 42.—VOR Indications.

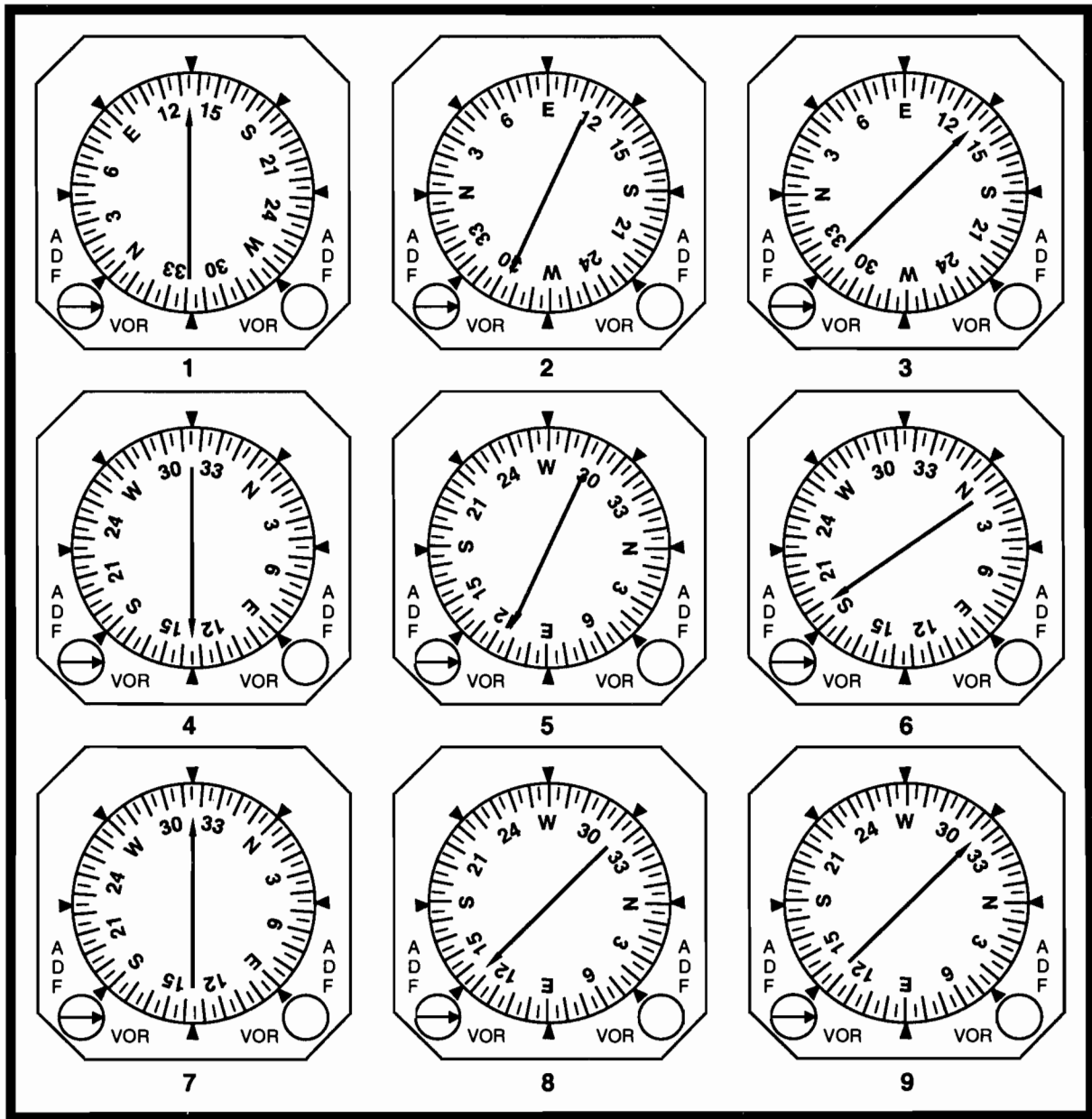

FIGURE 43.—RMI Indicators.



FIGURE 44.—Sectional Chart Excerpt.

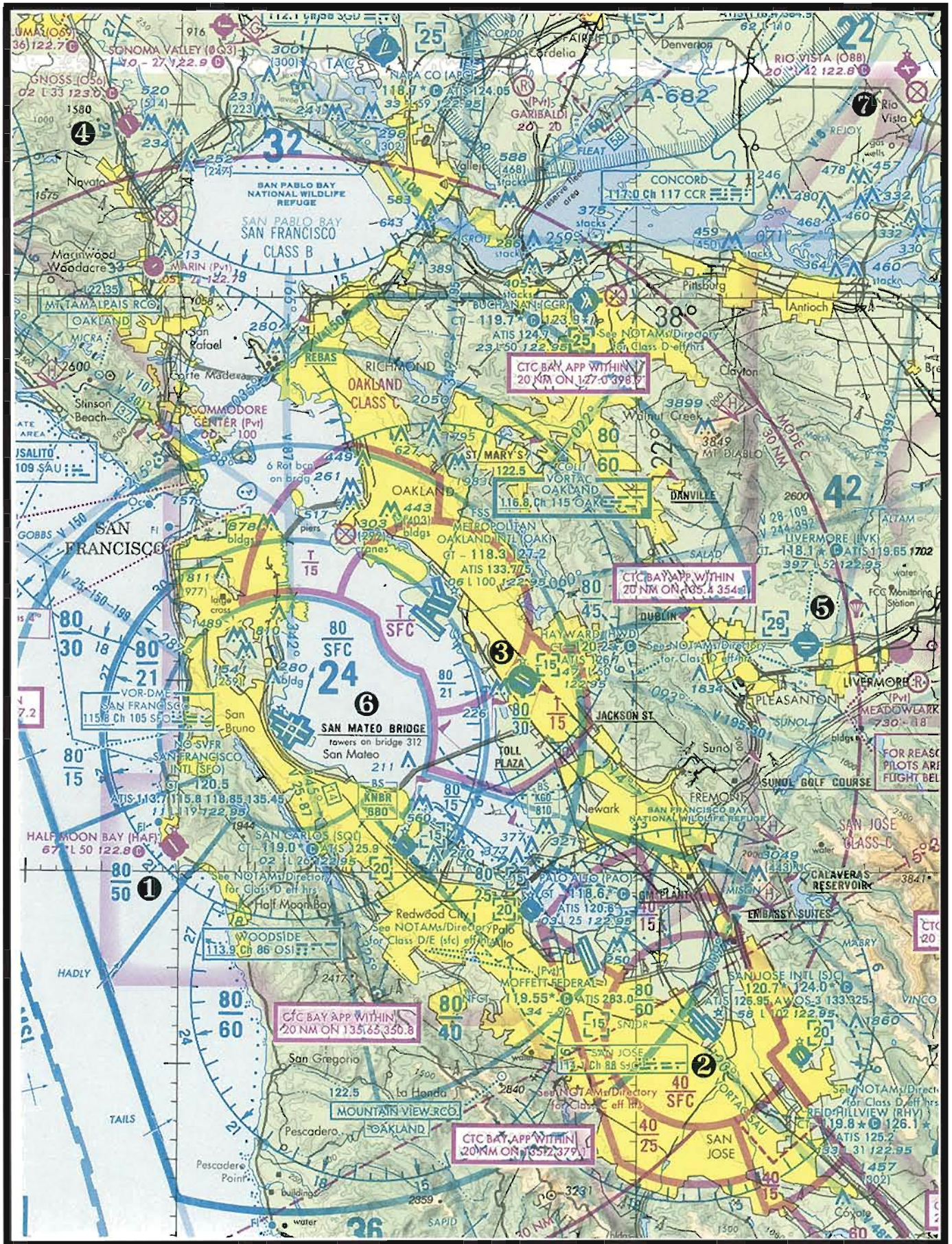
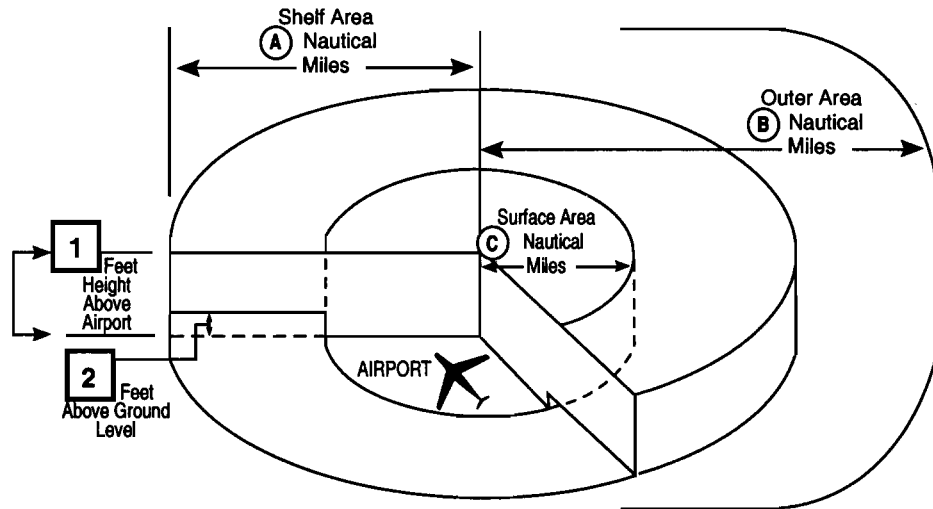

FIGURE 46.—Sectional Chart Excerpt.

Class C Airspace



Services upon establishing two-way radio communication and radar contact:

- Sequencing Arrivals
- IFR/VFR Standard Separation
- IFR/VFR Traffic Advisories and Conflict Resolution
- VFR/VFR Traffic Advisories

IFR: Instrument Flight Rules
VFR: Visual Flight Rules

FIGURE 47.—Class C Airspace Diagram.

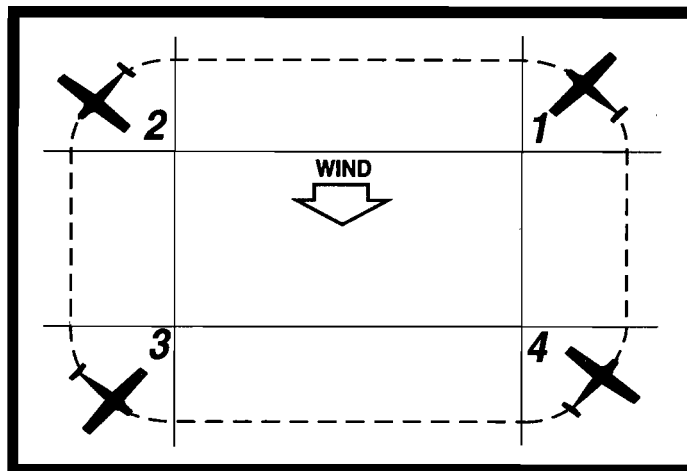

FIGURE 48.—Rectangular Course.

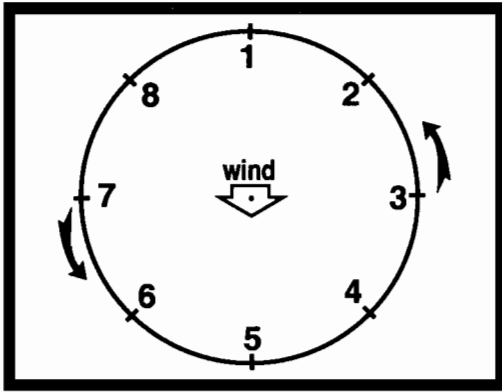

FIGURE 49.—Ground Track Diagram.

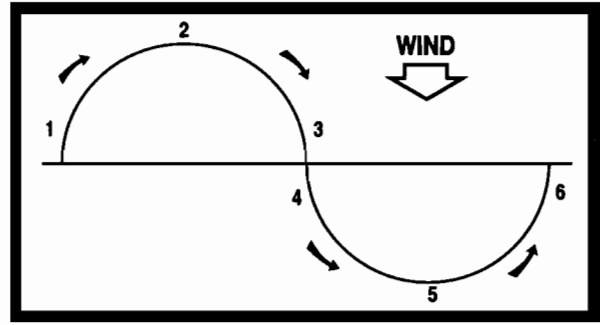

FIGURE 50.—S-Turn Diagram.

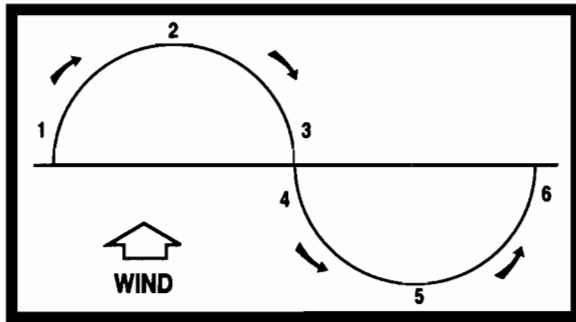

FIGURE 51.—S-Turn Diagram.

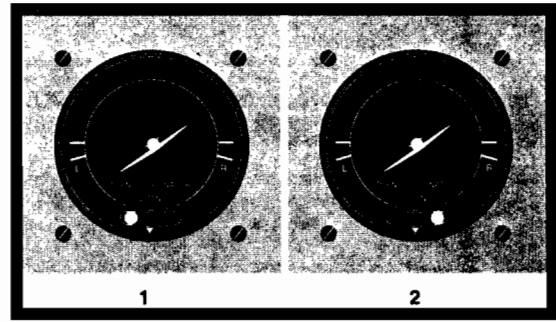

FIGURE 52.—Turn-and-Slip Indicators.

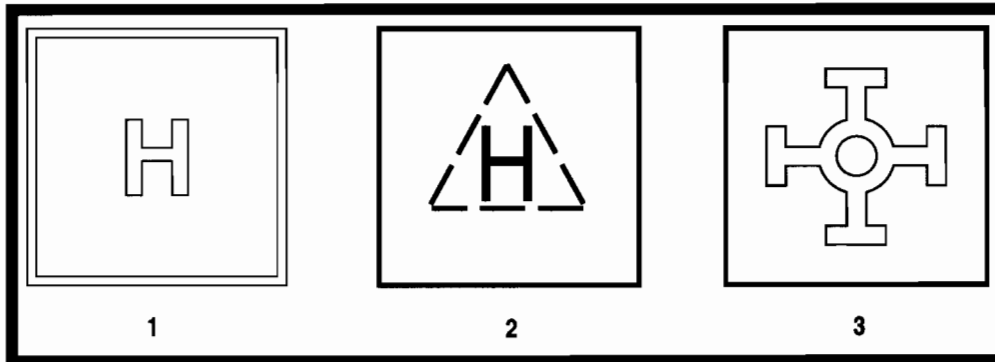

FIGURE 53.—Heliport Markings.

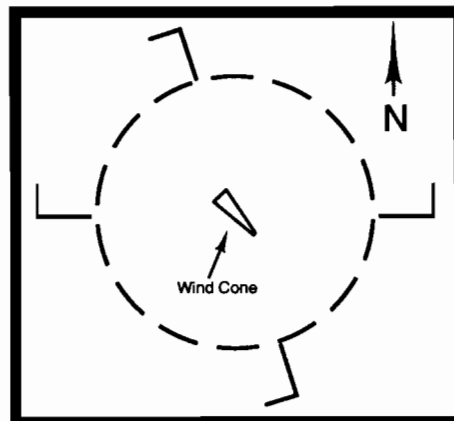

FIGURE 54.—Traffic Pattern Indicator.

DALLAS LOVE FLD (DAL) 5 NW UTC-6(-5DT) N32°50.83' W96°51.11' **DALLAS-FT. WORTH**
 487 B S4 FUEL 100LL, JET A OX 1, 2, 3, 4 LRA ARFF Index B **H-2E, 4F, 5B, L-13C, A**
 RWY 13R-31L: H8800X150 (CONC) S-100, D-200, DT-350 HIRL,CL **IAP**
 RWY 13R: VASI(V4L)—GA 3.0' TCH 53'. Thld displcd 490'. Tree. Rgt tfc.

RWY 31L: MALSR. TDZ. Building.
 RWY 13L-31R: H7753X150 (CONC-GRVD) S-100, D-200, DT-350 HIRL, CL
 RWY 13L: MALSR. TDZ. Tree. RWY 31R: MALSR. VASI(V4L)—GA 3.0' TCH 38'. Pole. Rgt tfc.

RWY 18-36: H6149X150 (ASPH) S-50, D-74, DT-138 HIRL
 RWY 18: VASI(V4L)—GA 3.0' TCH 52'. Rgt tfc. RWY 36: VASI(V4L)—GA 3.0' TCH 52'. REIL. Tree. Rgt tfc.

RUNWAY DECLARED DISTANCE INFORMATION

RWY 13L: TORA-7753 TORA-7753 ASDA-7753 LDA-7753
 RWY 31R: TORA-7753 TORA-7753 ASDA-7753 LDA-7753
 RWY 13R: TORA-8800 TORA-8800 ASDA-8800 LDA-8310
 RWY 31L: TORA-8800 TORA-8800 ASDA-8800 LDA-8800
 RWY 18: TORA-6149 TORA-6149 ASDA-6149 LDA-6149
 RWY 36: TORA-6149 TORA-6149 ASDA-6149 LDA-6149

AIRPORT REMARKS: Attended continuously. Birds on and in/ovt arpt. 260' AGL crane 1 mile south AER 3 1L SR-SS. 160' marked crane 4000' south AER 31L daigt hours. Ldg Rwy 18 & takeoff Rwy 38 not authorized to aircraft over 60,000 lbs gross weight unless crosswind NW-SE rwys exceed acft safe operating capability. Noise sensitive areas all quadrants, noise abatement procedures in effect for fixed and rotary wing tfc, for information call arpt ops 214-870-8810. Private pilot certificate or better required to takeoff or land, no student solo flights permitted. Rwy 36 VASI OTS Indef. Rwy 31R VASI OTS Indef. Twy B7 clsd indef. Twy A has a 500' lgtd barricade 3600' apch end Rwy 13L. Twy M edge lgts out of svc between Twy B and Rwy 18, reflectors in place. Twy K clsd thru traffic. Flight Notification Service (ADCUS) available. NOTE: See Land and Hold Short Operations Section.

COMMUNICATIONS: ATIS 120.15 UNICOM 122.95
 FORT WORTH FSS (FTW) TF 1-800-WX-BRIEF. NOTAM FILE DAL.
 DALLAS RCO 122.3 (FORT WORTH FSS)

Ⓞ REGIONAL APP CON 125.2 (South) 124.3 (North)
 LOVE TOWER 118.7 GND CON 121.75 CLNC DEL 127.9

Ⓞ REGIONAL DEP CON 118.55

RADIO AIDS TO NAVIGATION: NOTAM FILE DAL.

DALLAS - FT WORTH (H) VORTACW 117.0 DFW Chan 117 N32°51.96' W97°01.68'
 089° 9.0 NM to fld. 560/8E

CONIS NDB (LOM) 275 LV N32°46.48' W96°46.51' 311° 5.8 NM to fld.

ILS/DME 111.5 I-DAL Chan 52 Rwy 13L.

ILS/DME 111.1 I-DPX Chan 48 Rwy 13R. LOC unusable beyond 25' right side of course.

ILS/DME 111.1 I-LVF Chan 48 Rwy 31L. LOM CONIS NDB. BC unusable.

ILS/DME 111.5 I-OVW Chan 52 Rwy 31R.

ASR

REDBIRD (RBD) 6 SW UTC-6(-5DT) N32°40.85' W96°52.09' **DALLAS-FT. WORTH**
 660 B S4 FUEL 100LL, JET A OX 1, 2 **COPTER**
 RWY 13-31: H6451X150 (CONC) S-35, D-60, DT-110 MIRL 0.3% up NW **H-2E, 4F, 5B, L-13C, 17A, A**
 RWY 13: REIL. VASI(V4L)—GA 3.0' TCH 50'. Trees. **IAP**
 RWY 31: LDIN. VASI(V4L)—GA 3.0' TCH 47'. Road.

RWY 17-35: H3801X150 (CONC) S-35, D-60, DT-110 MIRL
 RWY 17: REIL. PAPI (P4R)—GA 3.0' TCH 43'. RWY 35: REIL.

AIRPORT REMARKS: Attended 1400-0300Z. Birds on and in vicinity of arpt. When twr closed ACTIVATE LDIN Rwy 31 VASI Rwy 13 and PAPI RWY 17—120.3. NOTE: See Land and Hold Short Operations Section.

WEATHER DATA SOURCES: ASOS 126.925 (214) 330-5317. LAWRS.

COMMUNICATIONS: CTAF 120.3 ATIS 126.35 UNICOM 122.95

FORT WORTH FSS (FTW) TF 1-800-WX-BRIEF. NOTAM FILE RBD.

Ⓞ REGIONAL APP/DEP CON 125.2

TOWER 120.3 (1400-0300z) GND CON 121.7 CLNC DEL 125.45

AIRSPACE: CLASS D svc effective 1400-0300Z other times CLASS G.

RADIO AIDS TO NAVIGATION: NOTAM FILE DFW.

DALLAS-FT WORTH (H) VORTACW 117.0 DFW Chan 117 N32°51.96' W97°01.68'
 136°13.7 NM to fld. 560/06E.

NDB (HW) 287 RBD N32°40.62' W96°52.27' at fld. NOTAM FILE RBD.

ILS 108.5 I-RBD Rwy 31. Unmonitored when tower closed.

DAN E. RICHARDS MUNI (See PADUCAH)

DAVID HOOKS N30°07.53' W95°33.96' NOTAM FILE DWH. **HOUSTON**
 NDB (MHW) 521 DWH 164° 3.9 NM to David Wayne Hooks Mem. Unmonitored. **L-17B**

DAVID WAYNE HOOKS MEM (See HOUSTON)

FIGURE 55.—Airport/Facility Directory.