

Addendum B

FAA-CT-8080-7C

May 2012

**COMPUTER TESTING
SUPPLEMENT
FOR
AIRLINE TRANSPORT PILOT
AND
AIRCRAFT DISPATCHER**



DO NOT MARK IN THIS BOOK



U.S. Department of Transportation
Federal Aviation Administration

LDA X RWY 8 JUNEAU INTL (JNU) (PAJN)

LOC/DME I-JDL 109.9 Chan 36	APP CRS 068°	Rwy Idg TDZE 21 Apt Elev 21	8457
---	------------------------	---	-------------

▼ Circling NA north of Rwy 8/26. **CAUTION:** Any go-around after passing MAP will not provide standard obstruction clearance. For night circling, if runway lights not visible over MAP, execute missed approach.

MALS
MISSED APPROACH: Immediate climbing right turn via heading 280° and I-JDL west course to cross BARLO Int/I-JDL 8 DME at or above 3000. Continue climb to 5400 direct SSR VORTAC or EEF NDB and hold.

ATIS 135.2	ANCHORAGE CENTER 133.9	JUNEAU TOWER* 118.7 (CTAF) 278.3	GND CON 121.9	JUNEAU RADIO 122.2
----------------------	----------------------------------	--	-------------------------	------------------------------

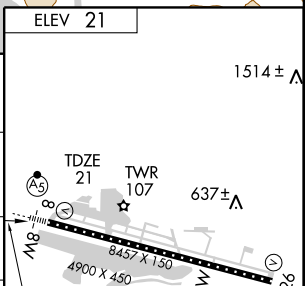
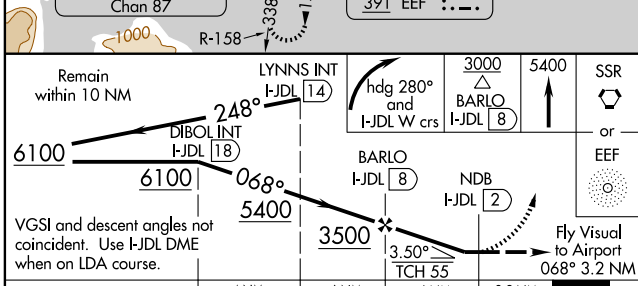
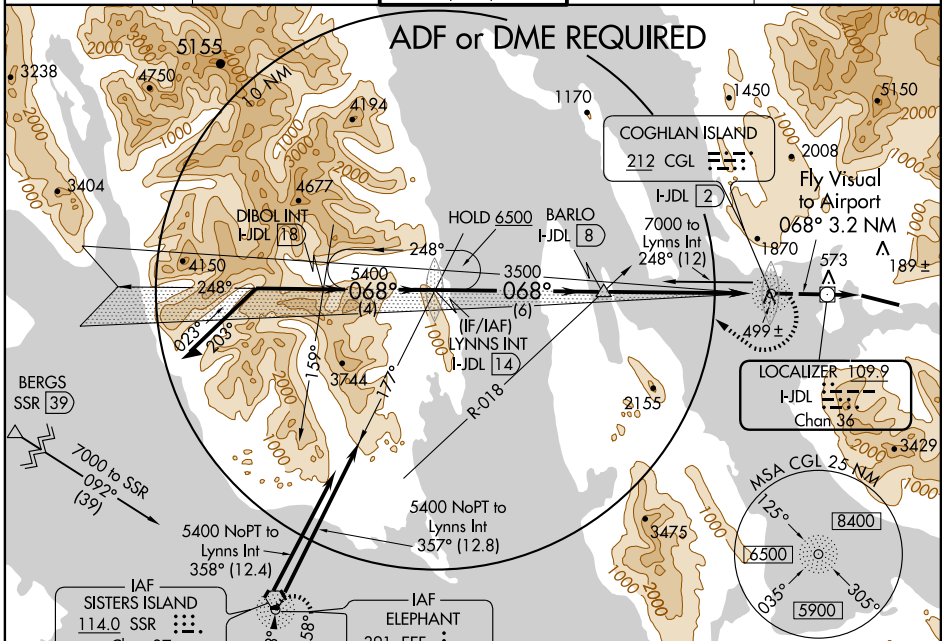

CATEGORY	A	B	C	D
S-8	2120-4 2099 (2100-4)	2700-4 2679 (2700-4)	3200-4 3179 (3200-4)	3440-4 3419 (3500-4)
CIRCLING	2120-4 2099 (2100-4)	2700-4 2679 (2700-4)	3200-4 3179 (3200-4)	3440-4 3419 (3500-4)
NIGHT MINIMUMS				
S-8	2120-4 2099 (2100-4)	2700-4 2679 (2700-4)	3200-4 3179 (3200-4)	3440-4 3419 (3500-4)
CIRCLING	3000-5 2979 (3000-5)	3000-10 2979 (3000-10)	3200-10 3179 (3200-10)	3440-10 3419 (3500-10)

REIL Rwy 26
HIRL Rwy 8-26

AK, 05 APR 2012 to 31 MAY 2012

AK, 05 APR 2012 to 31 MAY 2012

AIRPORT DIAGRAM

AL-237 (FAA)

LOS ANGELES INTL (LAX)
LOS ANGELES, CALIFORNIA

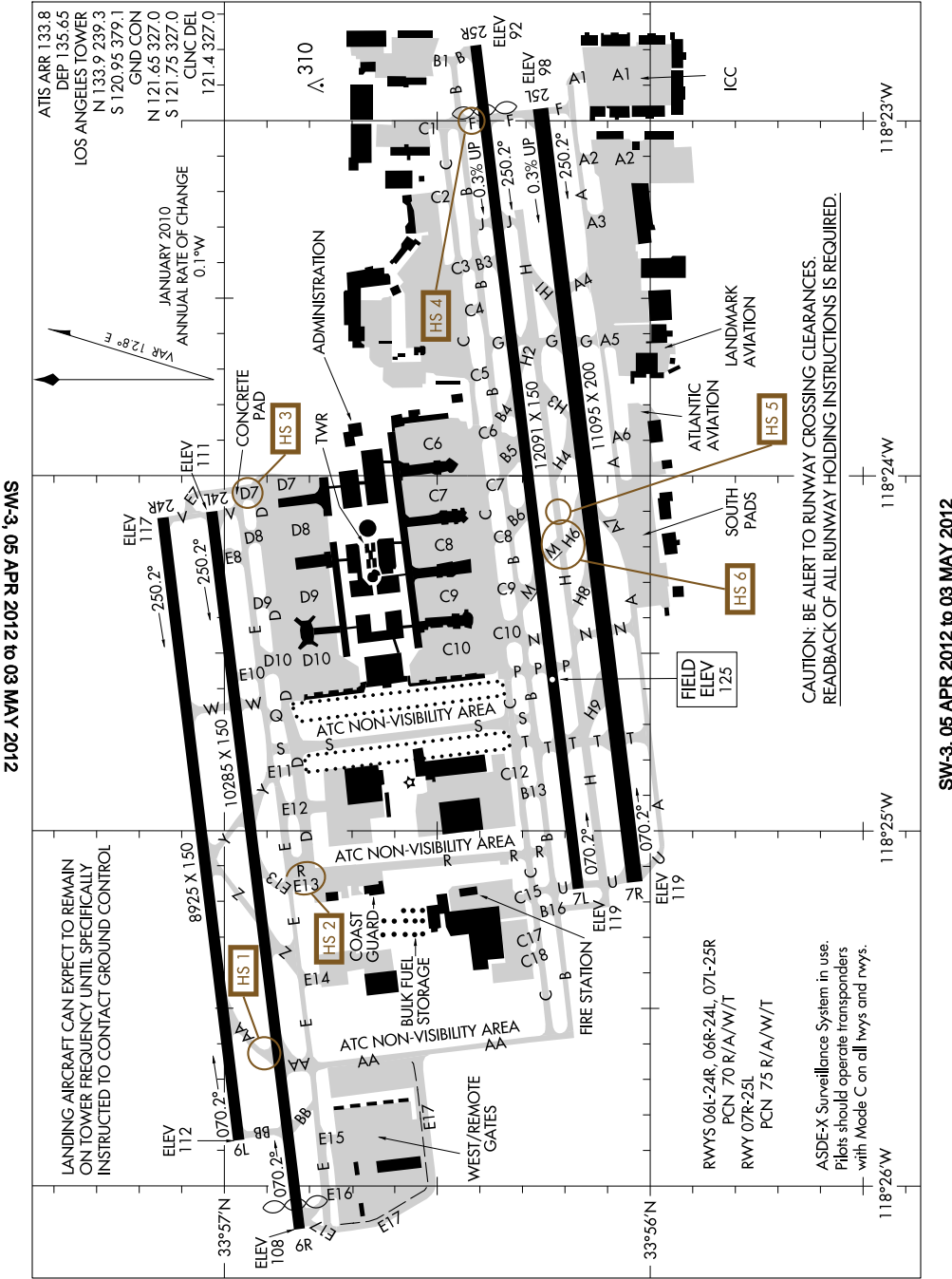

SW-3, 05 APR 2012 to 03 MAY 2012

CAUTION: BE ALERT TO RUNWAY CROSSING CLEARANCES.
REARBACK OF ALL RUNWAY HOLDING INSTRUCTIONS IS REQUIRED.

LANDING AIRCRAFT CAN EXPECT TO REMAIN ON TOWER FREQUENCY UNTIL SPECIFICALLY INSTRUCTED TO CONTACT GROUND CONTROL

RWYS 06L-24R, 06R-24L, 07L-25R
PCN 70 R/A/W/T
RWY 07R-25L
PCN 75 R/A/W/T

ASDE-X Surveillance System in use.
Pilots should operate transponders with Mode C on all twys and rwys.

SW-3, 05 APR 2012 to 03 MAY 2012

AIRPORT DIAGRAM

LOS ANGELES, CALIFORNIA
LOS ANGELES INTL (LAX)

Figure 255

DOWNE FOUR ARRIVAL

ST-237 (FAA)

LOS ANGELES INTL
LOS ANGELES, CALIFORNIA

SW-3, 08 MAR 2012 TO 05 APR 2012

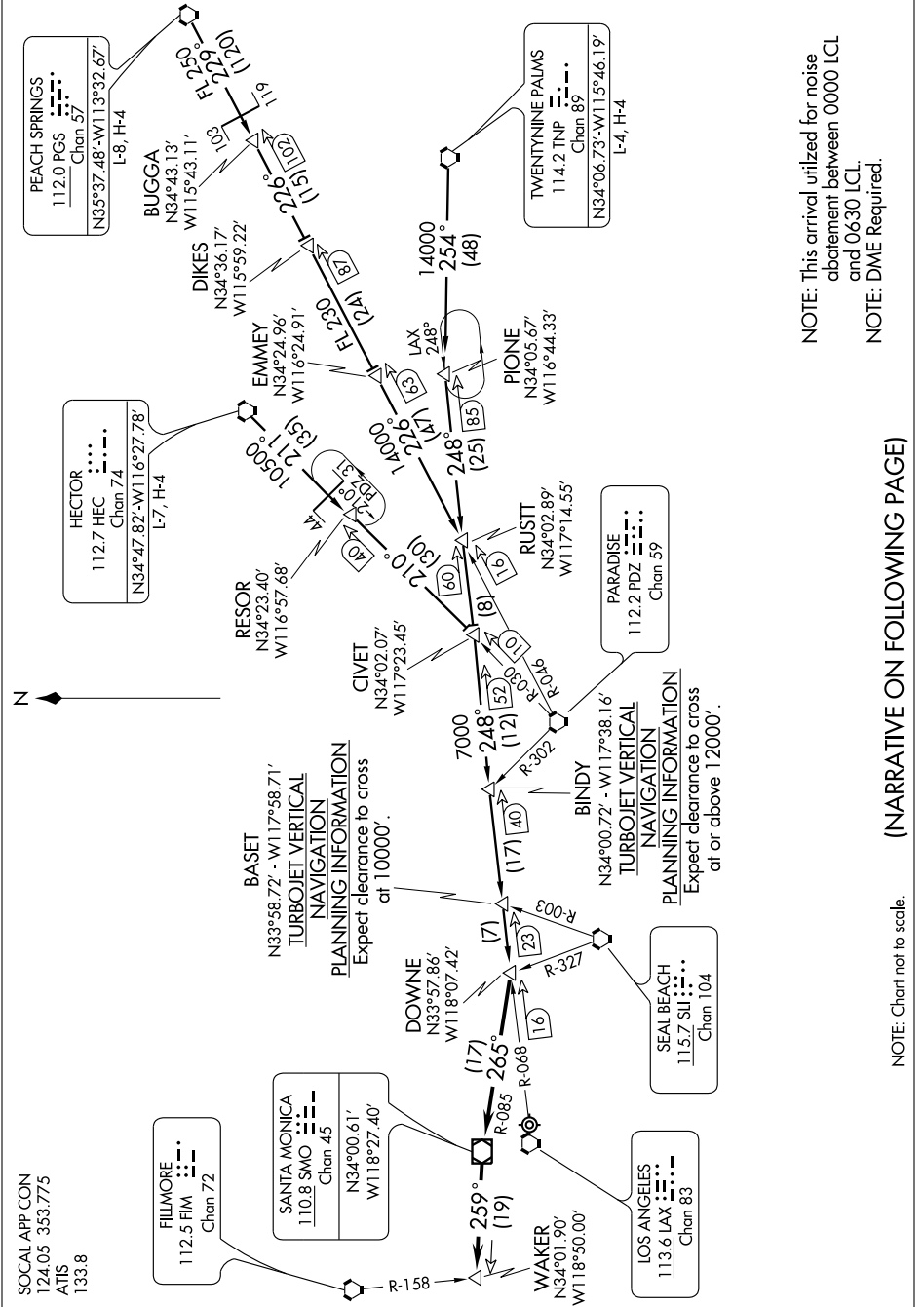

(NARRATIVE ON FOLLOWING PAGE)

NOTE: Chart not to scale.

SW-3, 08 MAR 2012 TO 05 APR 2012

Figure 255A

ARRIVAL DESCRIPTION

HECTOR TRANSITION (HEC.DOWNE4): From over HEC VORTAC via HEC R-211 and PDZ R-030 to CIVET INT, then LAX R-068 to DOWNE INT. Thence....

PEACH SPRINGS TRANSITION (PGS.DOWNE4): From over PGS VORTAC via PGS R-229 and PDZ R-046 to RUSTT INT, then LAX R-068 to DOWNE INT. Thence....

TWENTYNINE PALMS TRANSITION (TNP.DOWNE4): From over TNP VORTAC via TNP R-254 to PIONE DME, then LAX R-068 to DOWNE INT. Thence....

....From DOWNE INT via SMO R-085 to SMO VOR/DME, then via SMO R-259 to WAKER INT, expect vector to final approach course for runways 6 and 7.

SW-3, 08 MAR 2012 to 05 APR 2012

SW-3, 08 MAR 2012 to 05 APR 2012

CONTINUED FROM PRECEDING PAGE

ILS/DME 108.5 I-UWU Chan 22 Rwy 06L. Class IE. DME also serves Rwy 24R.
 ILS/DME 111.7 I-GPE Chan 54 Rwy 06R. Class IE. MM OTS indef. DME also serves Rwy 24L.
 ILS/DME 111.1 I-IAS Chan 48 Rwy 07L. Class ID. MM OTS indef. Glideslope unusable byd 5° right of localizer course. DME also serves Rwy 25R.
 ILS/DME 109.9 I-MKZ Chan 36 Rwy 07R. Class IT. GS unusable 5° left and 4° right of course. Coupled approaches not applicable below 264' MSL. DME also serves Rwy 25L.
 ILS/DME 111.7 I-HQB Chan 54 Rwy 24L. Class IE. DME also serves Rwy 06R.
 ILS/DME 108.5 I-OSS Chan 22 Rwy 24R. Class IIIE. DME also serves Rwy 06L
 ILS/DME 109.9 I-LAX Chan 36 Rwy 25L. Class IIIE.
 ILS/DME 111.1 I-CFN Chan 48 Rwy 25R. Class IE. DME also serves Rwy 07L.

WHITEMAN (WHP) 1 E UTC-8(-7DT) N34°15.56' W118°24.81'
 1003 B S4 FUEL 100LL, JET A OX 1, 3 TPA—2003(1000) NOTAM FILE WHP

RWY 12-30: H4120X75 (ASPH) S-12.5 MIRL 1.0% up NW
 RWY 12: REIL. PAPI(P2R)—GA 3.8° TCH 40'. Thld dsplcd 729'. P-line.
 RWY 30: REIL. PAPI(P2L)—GA 3.8° TCH 40'. Thld dsplcd 478'. P-line.
 Rgt tfc.

RUNWAY DECLARED DISTANCE INFORMATION

RWY 12: TORA-3442 TODA-4120 ASDA-3910 LDA-3181
 RWY 30: TORA-3191 TODA-4120 ASDA-3940 LDA-3462

AIRPORT REMARKS: Attended continuously. Birds on and invof arpt.
 Helicopter ops 2500' MSL (1500' AGL) and below. Arpt CLOSED to helicopter training/pattern opr 0400-1600Z†. Dirt infield areas.
 Helicopters advised to use care to prevent blasting dirt and debris onto movement areas.

WEATHER DATA SOURCES: AWOS-3PT 132.1 (818) 899-9820.

COMMUNICATIONS: CTAF 135.0 ATIS 132.1 818-899-9820

UNICOM 122.95

Ⓡ **SOCAL APP/DEP CON** 120.4 134.2 (VNY 280°-BUR 050°) 134.2 (VNY 160°-VNY 280°)

TOWER 135.0 (1600-0400Z†) **GND CON** 125.0

CLNC DEL For clnc del when ATCT clsd call Socal App 800-448-3724.

AIRSPACE: CLASS D svc 1600-0400Z† other times CLASS G

RADIO AIDS TO NAVIGATION: NOTAM FILE VNY.

VAN NUYS (L) VOR/DME 113.1 VNY Chan 78 N34°13.41' W118°29.50' 046° 4.4 NM to fld. 812/15E.

VOR/DME unusable:

010°-030° byd 20 NM blo 6,700'

030°-050° byd 25 NM blo 8,600'

330°-350° byd 25 NM blo 5,500'

350°-010° byd 15 NM blo 6,100'

DME unusable:

094°-096° byd 35 NM blo 5,000'

PACOIMA NDB (MHW) 370 PAL N34°15.58' W118°24.80' at fld. NOTAM FILE HHR. VFR only.

COMM/NAV/WEATHER REMARKS: Whiteman arpt altimeter setting not avbl.

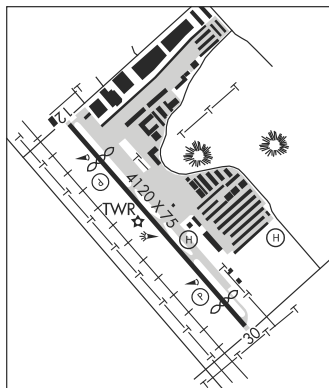

**LOS ANGELES
 COPTER
 L-3E, 4G, 7B, A
 IAP, AD**

LOS BANOS

LOS BANOS MUNI (LSN) 1 W UTC-8(-7DT) N37°03.83' W120°52.19'

121 B S2 FUEL 100LL, JET A TPA—921(800) NOTAM FILE RIU

RWY 14-32: H3801X75 (ASPH) S-23 MIRL

RWY 14: REIL. PAPI(P2L)—GA 3.0° TCH 30'. Tree. Rgt tfc.

RWY 32: REIL. PAPI(P2L)—GA 3.0° TCH 38'. Tree.

AIRPORT REMARKS: Unattended. For cash fuel after hours call 209-827-7070. 24 hour automated fuel avbl with major credit card. Avoid overflight of houses south of arpt. No departures over housing areas to east of arpt. MIRL Rwy 14-32 preset low intensity until 0800Z†. To increase intensity and ACTIVATE MIRL Rwy 14-32, REIL Rwy 14 and Rwy 32, and PAPI Rwy 14 and Rwy 32—CTAF.

WEATHER DATA SOURCES: AWOS-3 118.675 (209) 827-7084.

COMMUNICATIONS: CTAF/UNICOM 122.8

PANOCHÉ RCO 122.1R 112.6T (FRESNO RADIO)

Ⓡ **NORCAL APP/DEP CON** 120.95

RADIO AIDS TO NAVIGATION: NOTAM FILE RIU.

PANOCHÉ (L) VORTAC 112.6 PXN Chan 73 N36°42.93' W120°46.72' 332° 21.3 NM to fld. 2060/16E.

VOR unusable:

230°-280° byd 7NM blo 9,000'

**SAN FRANCISCO
 L-3B
 IAP**

LOC/DME I-LAX	APP CRS	Rwy Idg	25L	25R
109.9	249°	THRE	11095	11134
Chan 36		Apt Elev	126	126

ILS or LOC RWY 25L

LOS ANGELES INTL (LAX)

⚠ Inoperative table does not apply to Sidestep Rwy 25R Cats A and B.
 Simultaneous approach authorized with Rwy 24L/R.
 LOC procedure NA during simultaneous operations.

ALSIF-2 Rwy 25L
 MALSR Rwy 25R

MISSED APPROACH: Climb to 800 then climbing left turn to 2000 on heading 190° and LAX VORTAC R-210 to CATLY INT/LAX 12.8 DME and hold.

ATIS	124.3 363.2	SOCAL APP CON	124.9 269.0	LOS ANGELES TOWER	GND CON	CLNC DEL
ARR 133.8	(APCH FM WEST)		(090°-224°)	N 133.9 239.3	N 121.65 327.0	
DEP 135.65	124.5 235.975		128.5 360.7	S 120.95 379.1	S 121.75 327.0	121.4 327.0
	(225°-044°)		(045°-089°)			

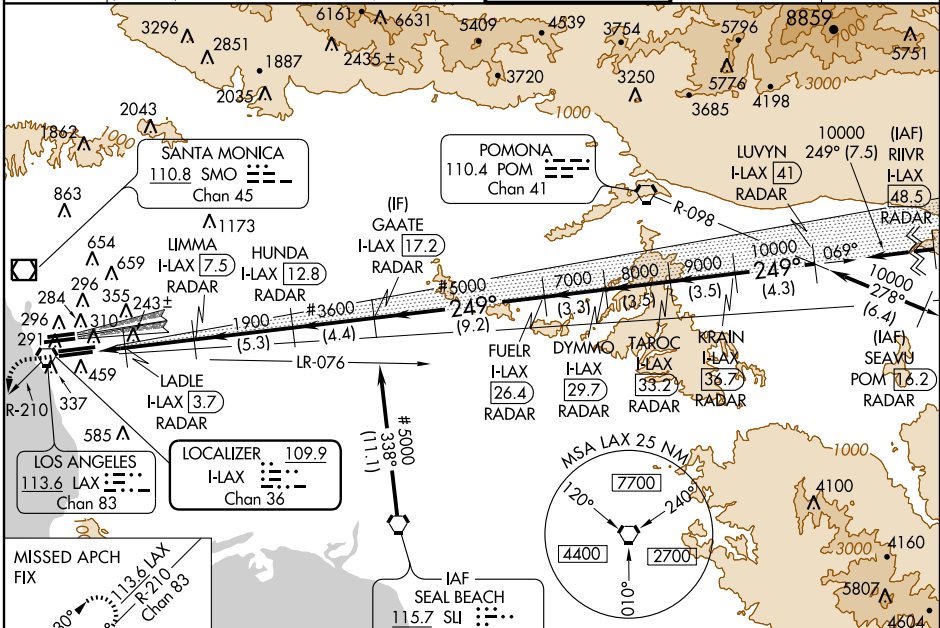

SW-3, 08 MAR 2012 to 05 APR 2012

SW-3, 08 MAR 2012 to 05 APR 2012

DME or RADAR REQUIRED

Procedure NA for arrivals at SU VORTAC on V459-597 southbound.

800	2000	LAX	CATLY INT	# When assigned by ATC, intercept glidepath at 3600 or 5000.					
hdg 190°	R-210			*LOC only					
		LIMMA	HUNDA	GAATE	FUELR	DYMMO	TAROC	KRAIN	LUVYN
		I-LAX	I-LAX	I-LAX	I-LAX	I-LAX	I-LAX	I-LAX	I-LAX
		7.5	12.8	17.2	26.4	29.7	33.2	36.7	41
		RADAR	RADAR	RADAR	RADAR	RADAR	RADAR	RADAR	RADAR
		3.7							
		RADAR							
		1900	3600#	5000#	7000	8000	9000	10000	10000
		700*	1900						
		1.7 NM	3.8 NM	-5.3 NM	4.4 NM	9.2 NM	3.3 NM	3.5 NM	4.3 NM
		A			B		C		D
		S-ILS 25L		298/18		200 (200-½)			
		S-LOC 25L		540/24		442 (500-½)		540/45 442 (500-¾)	
		SIDESTEP 25R		700/50		606 (600-1)		700/60 606 (600-1¼) 700-1½ 606 (600-1½)	

ELEV 126	THRE 25L 98	THRE 25R 94			
249° 5.5 NM from FAF					
TDZ/CL Rwsy 6R, 7L, 24R, and 25L					
HIRL all Rwsy					
FAF to MAP 5.5 NM					
Knots	60	90	120	150	180
Min:Sec	5:30	3:40	2:45	2:12	1:50

ILS RWY 24R (CAT II)

LOS ANGELES INTL (LAX)

LOC/DME I-OSS 108.5 Chan 22	APP CRS 249°	Rwy Idg TDZE Apt Elev	8925 120 126
--	------------------------	-----------------------------	---

Simultaneous approach authorized with Rwy 25L/R. ALSF-2

MISSED APPROACH: Climb to 2000 via heading 249° and LAX R-260 to RAFFS INT/LAX 15.1 DME and hold.

ATIS ARR 133.8 DEP 135.65	124.3 363.2 [APCH FM WEST] 124.5 235.975 (225°-044°)	SOCAL APP CON 124.9 269.0 (090°-224°) 128.5 360.7 (045°-089°)	LOS ANGELES TOWER N 133.9 239.3 S 120.95 379.1	GND CON N 121.65 327.0 S 121.75 327.0	CLNC DEL 121.4 327.0
---	---	---	--	---	--------------------------------

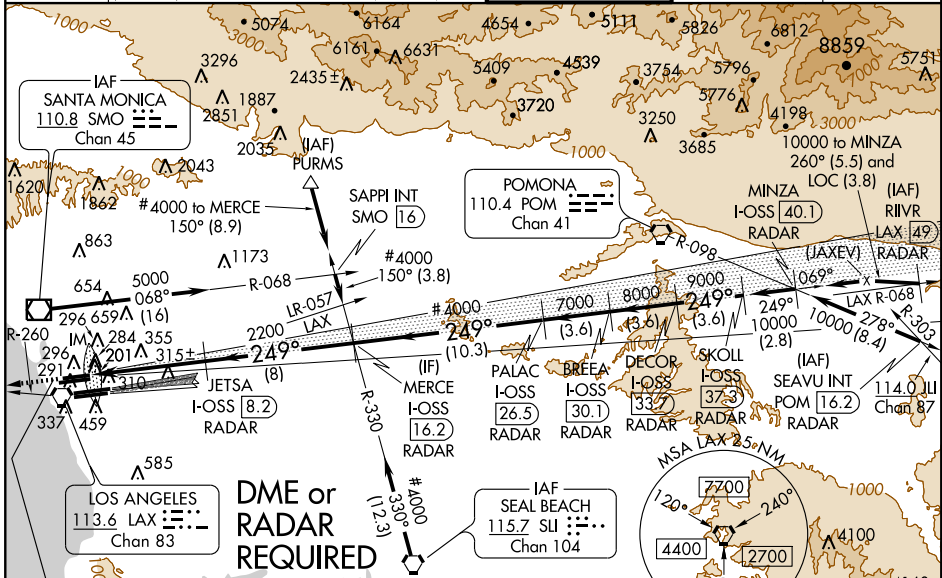

SW-3, 05 APR 2012 to 03 MAY 2012

SW-3, 05 APR 2012 to 03 MAY 2012

LOCALIZER 108.5
I-OSS
Chan 22

ELEV 126 **TDZE 120**

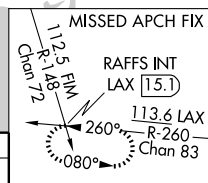

Procedure NA for arrivals at PURMS via V186 northwest bound.

Procedure NA for arrival on SLI VORTAC airway radials 272 CW 319.

Procedure NA for arrivals at SMO VOR/DME via V107 westbound.

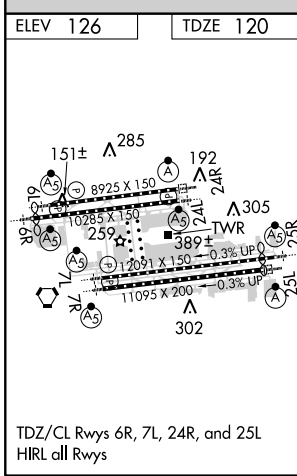

2000	hdg 249°	LAX R-260	RAFFS INT LAX 15.1	# When assigned by ATC, intercept glidepath at 4000.
		JETSAs I-OSS 8.2 RADAR	MERCE I-OSS 16.2 RADAR	PALAC I-OSS 26.5 RADAR
		BREEA I-OSS 30.1 RADAR	DECOR I-OSS 33.7 RADAR	SKOLL I-OSS 37.3 RADAR
				Procedure Turn NA
				GS 3.00°
				TCH 59

CATEGORY	A	B	C	D
S-ILS 24R	RA 115/12 100 DA 220			

CATEGORY II ILS - SPECIAL AIRCREW & AIRCRAFT CERTIFICATION REQUIRED

Figure 257B

WAAS CH 81811 W32A	APP CRS 316°	Rwy Idg TDZE Apt Elev	6121 714 728
--	------------------------	-----------------------------	---

RNAV (GPS) RWY 32

BUFFALO NIAGARA INTL (BUF)

<p>▼ DME/DME RNP-0.3 NA. Baro-VNAV NA below -16°C (4°F). For inoperative MALSRS increase LPV all Cats visibility to 1 mile.</p>		<p>MALSRS AS</p>	<p>MISSED APPROACH: Climb to 3000 direct TOMDE and via 239° track to SUSKE and hold.</p>	
ATIS 135.35	BUFFALO APP CON 126.15 263.125	BUFFALO TOWER 120.5 257.8	GND CON 133.2 257.8	CLNC DEL 124.7 257.8

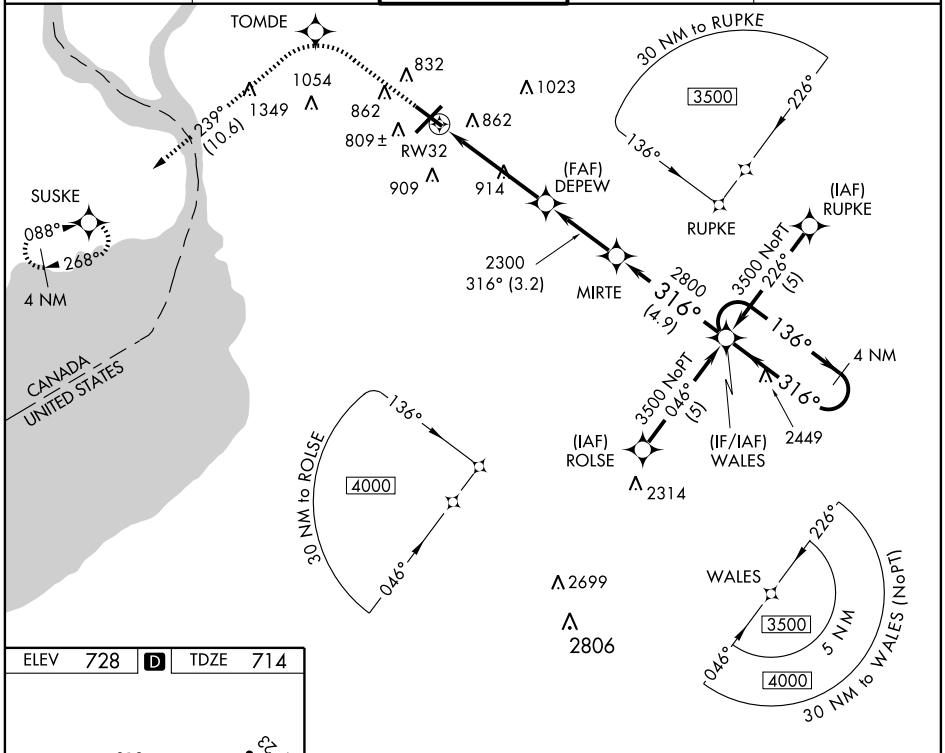

NE-2, 05 APR 2012 to 03 MAY 2012

NE-2, 05 APR 2012 to 03 MAY 2012

ELEV 728	D	TDZE 714
----------	----------	----------

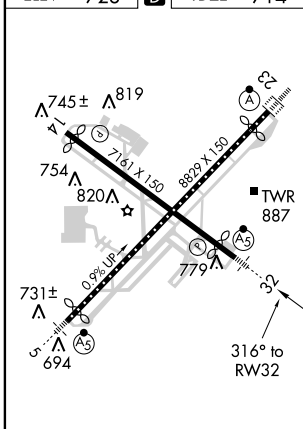

REIL Rwy 14
TDZ/CL Rwy 5 and 23
HIRL Rwy 5-23 and 14-32

3000	TOMDE	tr 239°	SUSKE	WALEs 4 NM Holding Pattern
* LNAV only.				
<p>MIRTE DEPEW WALES 316° 136° 3500</p> <p>RW32 2300 2800 316° 3500</p> <p>1.4 3.3 3.2 4.9 NM</p> <p>GS 3.00° TCH 54</p>				
CATEGORY	B			C
LPV DA	1003-½ 289 (300-½)			D
LNAV/VNAV	1146-1 432 (500-1)			
LNAV MDA	1220-½ 506 (500-½)		1220-1 506 (500-1)	
CIRCLING	1220-1½ 492 (500-1½)		1280-2 552 (600-2)	

HOUSTON, TEXAS

AL-5461 (FAA)

ILS or LOC RWY 33R

LOC I-CDG 111.9	APP CRS 327°	Rwy 33R Idg 12001 TDZE 89 Apt Elev 97	Rwy 33L Idg 9999 TDZE 91 Apt Elev 97
---------------------------	------------------------	--	---

HOUSTON/ GEORGE BUSH
INTERCONTINENTAL/HOUSTON (IAH)

▼ DME from IAH VORTAC. Simultaneous reception of I-CDG and IAH DME required. DME or RADAR REQUIRED. For inoperative MALSR, increase S-ILS 33R Cat E visibility to RVR 4000 and S-LOC 33R Cat E visibility to 1½. #RVR 1800 authorized with the use of FD or AP or HUD to DA.

MALSR

MISSED APPROACH: Climb to 2000 via IAH R-330 to GOMER INT / IAH 24.9 DME and hold.

ATIS 124.05	HOUSTON APP CON 120.05 379.1 EAST	HOUSTON TOWER 8L/26R 120.725 290.2 8R/26L 125.35 290.2	HOUSTON TOWER 9/27 135.15 290.2 15L/R 33L/R 127.3 288.25	GND CON 8L/R 26L/R, 9/27 121.7 15L/R 33L/R 118.575	CLNC DEL 128.1
-----------------------	---	--	--	--	--------------------------

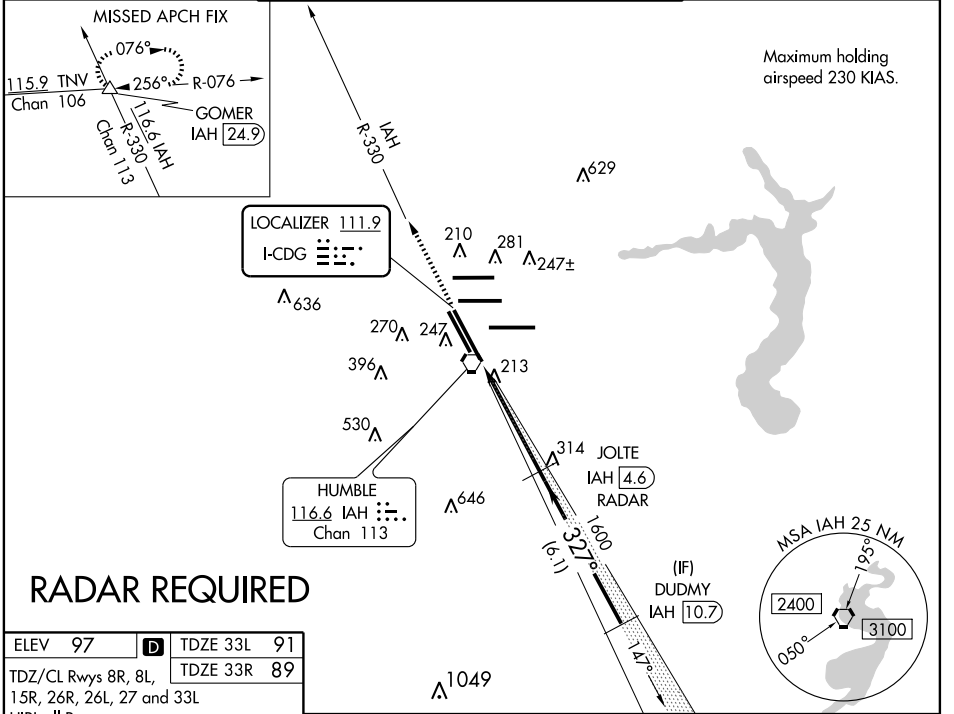

RADAR REQUIRED

ELEV 97	D	TDZE 33L 91
TDZ/CL Rwys 8R, 8L, 15R, 26R, 26L, 27 and 33L		TDZE 33R 89
HIRL all Rwys		

9000 X 150

9402 X 150

10000 X 150

327° 4.5 NM from FAF

FAF to MAP 4.5 NM

Knots	60	90	120	150	180
Min:Sec	4:30	3:00	2:15	1:48	1:30

2000	GOMER IAH R-330	JOLTE IAH 4.6 RADAR	DUDMY IAH 10.7
1600		327°	2000
4.5 NM		6.1 NM	GS 3.00° TCH 48

CATEGORY	A	B	C	D	E
S-ILS 33R	#289/24 200 (200-½)				289/24 200 (200-½)
S-LOC 33R	540/24		451 (500-½)	540/50 451 (500-1)	
SIDESTEP Rwy 33L	540-1 449 (500-1)	540-1½ 449 (500-1½)	540-2 449 (500-2)	NA	
CIRCLING	NA				

HOUSTON, TEXAS
Amdt 12A 12040

HOUSTON/ GEORGE BUSH INTERCONTINENTAL/HOUSTON (IAH)
29° 59' N-95° 20' W

ILS or LOC RWY 33R

Figure 259

SC-5, 05 APR 2012 to 03 MAY 2012

SC-5, 05 APR 2012 to 03 MAY 2012

TAKE-OFF MINIMUMS AND (OBSTACLE) DEPARTURE PROCEDURES

11349

CROCKETT, TX

HOUSTON COUNTY (DKR)

ORIG 11349 (FAA)

TAKE-OFF MINIMUMS: **Rwy 2**, 400-2 or std. w/min. climb of 280' per NM to 800. **Rwy 20**, 300-1½ or std. w/min. climb of 459' per NM to 700.

NOTE: **Rwy 2**, multiple trees beginning 57' from DER, 61' right of centerline, up to 50' AGL/399' MSL. Multiple trees and terrain beginning 27' from DER, 109' left of centerline, up to 50' AGL/409' MSL. Tower 1.5 NM from DER, 2864' left of centerline 233' AGL/623' MSL. **Rwy 20**, multiple towers beginning 4567' from DER, 1025' right of centerline, up to 200' AGL/529' MSL.

EAGLE LAKE, TX

EAGLE LAKE

TAKE-OFF MINIMUMS: **Rwy 17**, 200-1, or std. with a min. climb of 420' per NM to 500.

NOTE: **Rwy 17**, tower 3068' from departure end of runway, 793' left of centerline, 192' AGL/317' MSL.

GALVESTON, TX

SCHOLTES INTL AT GALVESTON (GLS)

AMDT 4 08157 (FAA)

TAKE-OFF MINIMUMS: **Rwy 17**, 300-1 or std. w/min. climb of 502' per NM to 300.

NOTE: **Rwy 13**, bush 381' from departure end of runway, 533' left of centerline, 15' AGL/20' MSL. Fence 201' from departure end of runway, 490' left of centerline, 6' AGL/11' MSL. Tree 343' from departure end of runway, 468' right of centerline, 12' AGL/17' MSL. **Rwy 17**, building 3057' from departure end of runway, 339' left of centerline, 123' AGL/130' MSL. Multiple poles beginning 2034' from departure end of runway, 87' right of centerline, up to 60' AGL/70' MSL. Multiple transmission towers beginning 636' from departure end of runway, 551' right of centerline, up to 55' AGL/60' MSL. Tree 460' from departure end of runway, 316' right of centerline, 22' AGL/29' MSL. **Rwy 31**, multiple cranes beginning 4341' from departure end of runway, 1017' left of centerline, up to 131' AGL/131' MSL. **Rwy 35**, tree 730' from departure end of runway, 501' right of centerline, 27' AGL/32' MSL.

GIDDINGS, TX

GIDDINGS-LEE COUNTY (GYB)

ORIG 10210 (FAA)

NOTE: **Rwy 17**, numerous trees beginning 720' from DER, 58' right of centerline, up to 50' AGL/479' MSL. Numerous trees beginning 754' from DER, 340' left of centerline, up to 50' AGL/479' MSL. **Rwy 35**, numerous trees beginning 613' from DER, 272' right of centerline, up to 50' AGL/539' MSL. Numerous trees beginning 558' from DER, 265' left of centerline, up to 50' AGL/559' MSL. Vehicle on road 516' from DER, 246' left of centerline, 15' AGL/514' MSL.

HOUSTON, TX

DAN JONES INTL (T51)

ORIG 11321 (FAA)

TAKE-OFF MINIMUMS: **Rwy 17**, NA - numerous trees. **Rwy 35**, NA - numerous trees.

HOUSTON, TX (CON'T)

DAVID WAYNE HOOKS MEMORIAL (DWH)

AMDT 3 08157 (FAA)

TAKE-OFF MINIMUMS: **Rwys 17L, 35R**, NA - Environmental. **Waterways 17, 35**, NA - air traffic.

NOTE: **Rwy 17R**, multiple trees beginning 708' from departure end of runway, 68' left of centerline, up to 71' AGL/220' MSL. Multiple hangars beginning 433' from departure end of runway, 515' left of centerline, up to 37' AGL/182' MSL. DME antenna 653' from departure end of runway, 256' left of centerline, 13' AGL/162' MSL. Multiple trees and pole beginning 85' from departure end of runway, 294' right of centerline, up to 45' AGL/189' MSL. **Rwy 35L**, multiple trees and poles beginning 144' from departure end of runway, 32' left of centerline, up to 79' AGL/238' MSL. Multiple hangars and buildings beginning 85' from departure end of runway, 9' left of centerline, up to 53' AGL/202' MSL. Multiple trees, towers and pole beginning 100' from departure end of runway, 124' right of centerline, up to 93' AGL/247' MSL. Vehicle and road 315' from departure end of runway, on centerline 15' AGL/166' MSL. Building 894' from departure end of runway, 231' right of centerline, 23' AGL/173' MSL.

ELLINGTON FIELD (EFD)

AMDT 2 08157 (FAA)

NOTE: **Rwy 17R**, pole 1489' from departure end of runway, 817' right of centerline, 40' AGL/74' MSL.

Rwy 22, antenna on building 1998' from departure end of runway, 598' right of centerline, 54' AGL/83' MSL. Obstruction light on glide slope 327' from departure end of runway, 543' left of centerline, 39' AGL/68' MSL. **Rwy 35R**, tree 1597' from departure end of runway, 32' left of centerline, 33' AGL/80' MSL. **Rwy 35L**, multiple trees beginning 1118' from departure end of runway, 679' right of centerline, up to 37' AGL/77' MSL. Crane 2352' from departure end of runway, 1024' left of centerline, 37' AGL/97' MSL.

GEORGE BUSH INTERCONTINENTAL/ HOUSTON (IAH)

AMDT 2 08157 (FAA)

NOTE: **Rwy 8L**, tree 2866' from departure end of runway, 921' left of centerline, 107' AGL/201' MSL. Multiple trees beginning 2750' from departure end of runway, 106' right of centerline, up to 80' AGL/174' MSL. **Rwy 15L**, multiple trees 2638' from departure end of runway, 758' right of centerline, up to 76' AGL/160' MSL. **Rwy 15R**, tower 1431' from departure end of runway, 591' left of centerline, 48' AGL/133' MSL. Antenna on glideslope 1469' from departure end of runway, 621' left of centerline, 49' AGL/133' MSL. **Rwy 26R**, pole 950' from departure end of runway, 660' right of centerline, 40' AGL/129' MSL. **Rwy 33R**, tree 2868' from departure end of runway, 1027' right of centerline, 73' AGL/172' MSL.

HOUSTON EXECUTIVE (TME)

DEPARTURE PROCEDURE: **Rwy 36**, Climb heading 355° to 700 before turning east.

NOTE: **Rwy 36**, power poles from left to right beginning 703' from departure end of runway, 623' left to 685' right of centerline, up to 32' AGL/196' MSL.

05 APR 2012 to 03 MAY 2012

05 APR 2012 to 03 MAY 2012

11349

TAKE-OFF MINIMUMS AND (OBSTACLE) DEPARTURE PROCEDURES

SC-5

TAKE-OFF MINIMUMS AND (OBSTACLE) DEPARTURE PROCEDURES

11349

HOUSTON, TX (CON'T)

HOUSTON-SOUTHWEST (AXH)

AMDT 5 08157 (FAA)

DEPARTURE PROCEDURE: **Rwy 9**, climb heading 089° to 2000 before turning left. **Rwy 27**, climb heading 269° to 2200 before turning right.

NOTE: **Rwy 9**, multiple hangars beginning 239' from departure end of runway, 360' right of centerline, up to 42' AGL/106' MSL. Multiple trees beginning 501' from departure end of runway, 355' right of centerline, up to 43' AGL/111' MSL. Multiple hangars beginning 119' from departure end of runway, 498' left of centerline, up to 41' AGL/105' MSL. Pole 332' from departure end of runway, 299' left of centerline, 43' AGL/97' MSL. Antenna 1172' from departure end of runway, 658' left of centerline, 51' AGL/115' MSL. Multiple trees beginning 558' from departure end of runway, 68' left of centerline, up to 58' AGL/122' MSL. **Rwy 27**, multiple trees beginning 1050' from departure end of runway, 40' left of centerline, up to 71' AGL/140' MSL. Vehicle and road 99' from departure end of runway, 291' right of centerline, 15' AGL/83' MSL. Multiple trees beginning 873' from departure end of runway, 514' right of centerline, up to 59' AGL/130' MSL. Multiple transmission poles beginning 1304' from departure end of runway, 131' right of centerline, up to 41' AGL/110' MSL.

LONE STAR EXECUTIVE (CXO)

AMDT 3 10266 (FAA)

NOTE: **Rwy 1**, trees beginning 194' from DER, 130' right of centerline, up to 100' AGL/374' MSL. Trees beginning 817' from DER, 15' left of centerline, up to 100' AGL/359' MSL. **Rwy 14**, trees and obstruction light on DME beginning 399' from DER, 80' right of centerline, up to 100' AGL/329' MSL. Trees beginning 640' from DER, 408' left of centerline, up to 100' AGL/329' MSL. **Rwy 19**, trees beginning 68' from DER, 64' right of centerline, up to 100' AGL/344' MSL. Trees beginning 1' from DER, 159' left of centerline, up to 100' AGL/339' MSL. **Rwy 32**, trees beginning 1785' from DER, 973' right of centerline, up to 100' AGL/339' MSL. Trees and vehicles on road beginning 603' from DER, 458' left of centerline, up to 100' AGL/354' MSL.

PEARLAND RGNL

DEPARTURE PROCEDURE: **Rwy 14**, climb heading 139° to 1600 before proceeding south through southwest. **Rwy 32**, climb heading 319° to 900 before proceeding on course.

NOTE: **Rwy 14**, multiple trees beginning 199' from departure end of runway, 226' right of centerline, up to 66' AGL/100' MSL. Vehicle on road 398' from departure end of runway, 405' left of centerline, 9' AGL/55' MSL. Trees 1287' from departure end of runway, 453' left of centerline, up to 56' AGL/90' MSL. **Rwy 32**, multiple trees beginning 690' from departure end of runway, 81' left of centerline, up to 79' AGL/128' MSL. Multiple poles beginning 745' from departure end of runway, 24' left of centerline, up to 40' AGL/80' MSL. Multiple trees and poles beginning 29' from departure end of runway, 11' right of centerline, up to 64' AGL/104' MSL. Building 237' from departure end of runway, 520' right of centerline, 32' AGL/72' MSL.

HOUSTON, TX (CON'T)

SUGAR LAND RGNL (SGR)

AMDT 7 08157 (FAA)

DEPARTURE PROCEDURE: **Rwy 17**, climb heading 170° to 1500 before turning eastbound. **Rwy 35**, climb heading 350° to 1100 before turning southbound.

NOTE: **Rwy 17**, multiple poles beginning 436' from departure end of runway, 172' right of centerline, up to 44' AGL/124' MSL. Railroad 110' from departure end of runway, 10' left of centerline, 23' AGL/104' MSL. Multiple poles beginning 135' from departure end of runway, 270' left of centerline, up to 44' AGL/111' MSL. **Rwy 35**, vehicle and road 65' from departure end of runway, 2' right of centerline, 15' AGL/96' MSL. Multiple trees beginning 37' from departure end of runway, 275' right of centerline, up to 81' AGL/164' MSL. DME antenna 380' from departure end of runway, 253' right of centerline, 24' AGL/100' MSL. Multiple trees beginning 83' from departure end of runway, 65' left of centerline, up to 81' AGL/155' MSL.

WEISER AIR PARK (EYQ)

AMDT 2 08157 (FAA)

TAKE-OFF MINIMUMS: **Rwy 9**, 200-1 or std. w/min. climb of 399' per NM to 400.

NOTE: **Rwy 9**, tank 4127' from departure end of runway, 1455' left of centerline, 147' AGL/282' MSL. **Rwy 27**, railroad 462' from departure end of runway, 555' left of centerline, 23' AGL/165' MSL. Vehicle and road 650' from departure end of runway, 7' left of centerline, 17' AGL/159' MSL.

WEST HOUSTON (IWS)

AMDT 3 09295 (FAA)

NOTE: **Rwy 15**, vehicles on roadway beginning abeam DER, left and right of centerline, up to 15' AGL/124' MSL. Building 177' from DER, 398' left of centerline, 18' AGL/126' MSL. Trees beginning 178' from DER, 289' right of centerline, up to 100' AGL/209' MSL. **Rwy 33**, building 265' from DER, 364' left of centerline, 33' AGL/143' MSL. Trees beginning 2706' from DER, 700' left of centerline, up to 100' AGL/214' MSL. Trees beginning 3159' from DER, 747' right of centerline, up to 100' AGL/216' MSL.

05 APR 2012 to 03 MAY 2012

05 APR 2012 to 03 MAY 2012

11349

TAKE-OFF MINIMUMS AND (OBSTACLE) DEPARTURE PROCEDURES

RIICE THREE ARRIVAL Transition Routes

HOUSTON, TEXAS

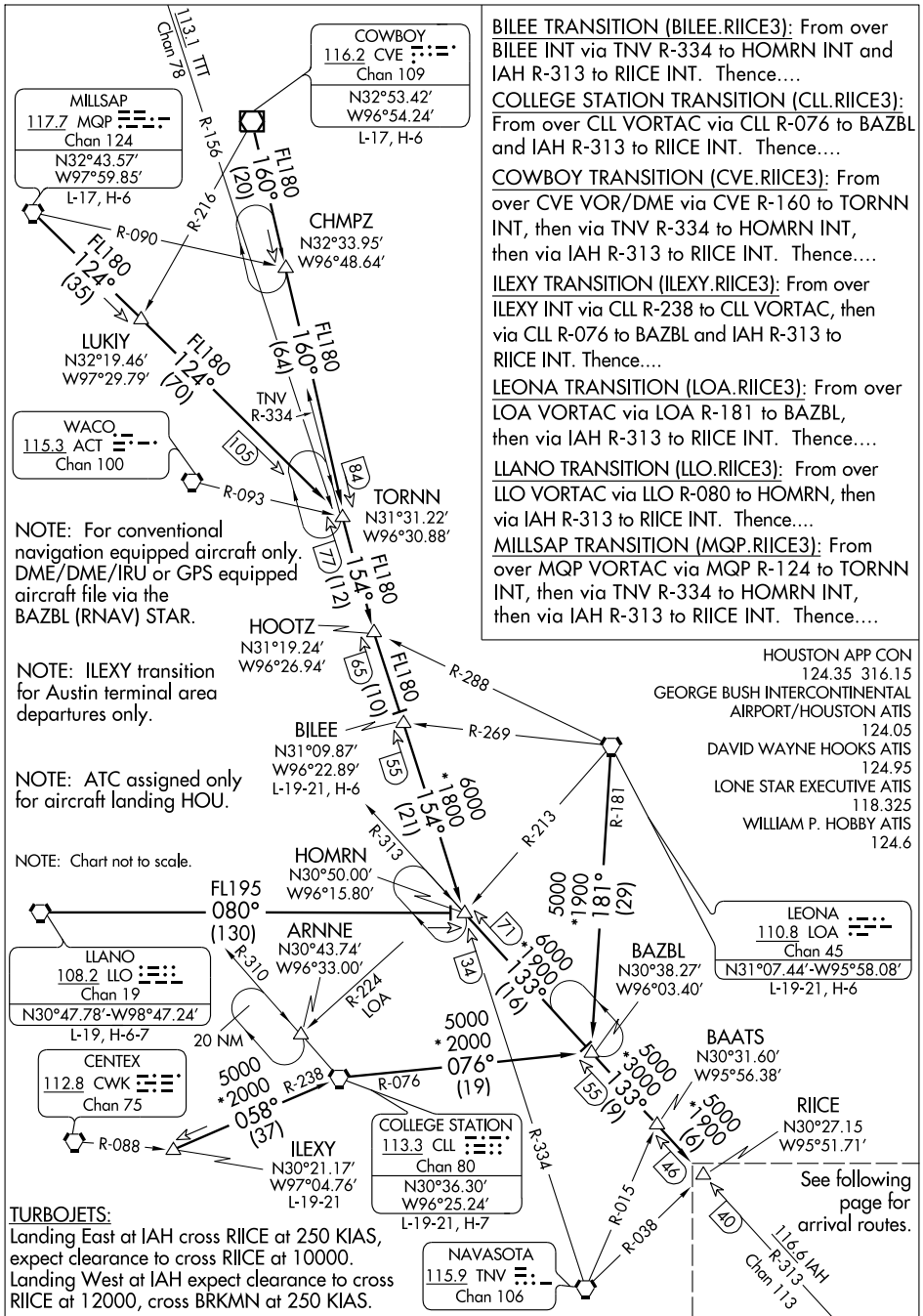

SC-5, 05 APR 2012 to 03 MAY 2012

SC-5, 05 APR 2012 to 03 MAY 2012

RIICE THREE ARRIVAL Transition Routes

HOUSTON, TEXAS

(RIICE.RIICE3) 10210

ST-5461 (FAA)

RIICE THREE ARRIVAL Arrival Routes

HOUSTON, TEXAS

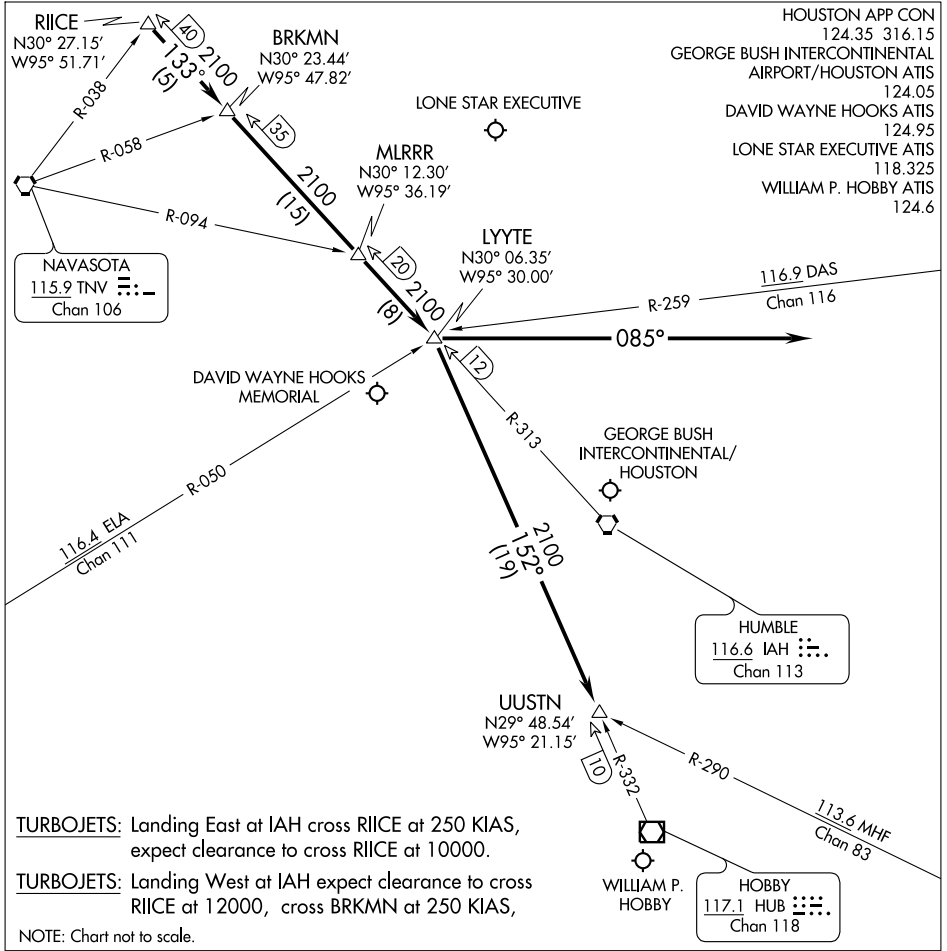

HOUSTON APP CON
124.35 316.15
GEORGE BUSH INTERCONTINENTAL
AIRPORT/HOUSTON ATIS
124.05
DAVID WAYNE HOOKS ATIS
124.95
LONE STAR EXECUTIVE ATIS
118.325
WILLIAM P. HOBBY ATIS
124.6

SC-5, 05 APR 2012 to 03 MAY 2012

SC-5, 05 APR 2012 to 03 MAY 2012

TURBOJETS: Landing East at IAH cross RIICE at 250 KIAS, expect clearance to cross RIICE at 10000.

TURBOJETS: Landing West at IAH expect clearance to cross RIICE at 12000, cross BRKMN at 250 KIAS,

NOTE: Chart not to scale.

ARRIVAL ROUTE DESCRIPTION

GEORGE BUSH INTERCONTINENTAL/HOUSTON (IAH):

....From over RIICE INT via IAH R-313 to LYTE INT.
LANDING RUNWAYS 26L/26R, 27: Fly heading 085° for vectors to final approach course.
LANDING ALL OTHER RUNWAYS: Expect vectors to final approach course at or prior to LYTE INT.

WILLIAM P. HOBBY (HOU) (ATC ASSIGNED):

....From over RIICE INT via IAH R-313 to LYTE INT, then via HUB R-332 to UUSTN INT, expect vectors to final approach course at or prior to UUSTN INT.

DAVID WAYNE HOOKS MEMORIAL (DWH) and LONE STAR EXECUTIVE (CXO):

....From over RIICE INT via IAH R-313 to LYTE INT, expect vectors to final approach course at or prior to LYTE INT.

RIICE THREE ARRIVAL Arrival Routes

HOUSTON, TEXAS

(RIICE.RIICE3) 10210

Figure 263

LOC/DME I-BZU 111.55 Chan 52 (Y)	APP CRS 087°	Rwy Idg TDZE Apt Elev	9000 96 97
---	------------------------	-----------------------------	---------------------------------------

ILS or LOC RWY 8L

HOUSTON/GEORGE BUSH INTERCONTINENTAL/HOUSTON (IAH)

▼ For inoperative ALSF increase S-ILS 8L Cat E visibility to RVR 4000, and S-LOC 8L Cat E visibility to 1/4. Simultaneous approach authorized with Rwy 8R and Rwy 9. LOC procedure NA during simultaneous operations.

ALSF-2

MISSED APPROACH: Climb to 600 then climbing left turn to 4000 via IAH VORTAC R-019 to CLEEP INT/IAH 22.1 DME and hold.

ATIS 124.05	HOUSTON APP CON 120.05 379.1 EAST 124.35 316.15 WEST	HOUSTON TOWER 9/27 135.15 290.2 8L/26R 120.725 290.2 8R/26L 125.35 290.2 15L/R 33L/R 127.3 288.25	GND CON 26L/R, 9/27 121.7 15L/R 33L/R 118.575	CINC DEL 128.1
-----------------------	--	---	---	--------------------------

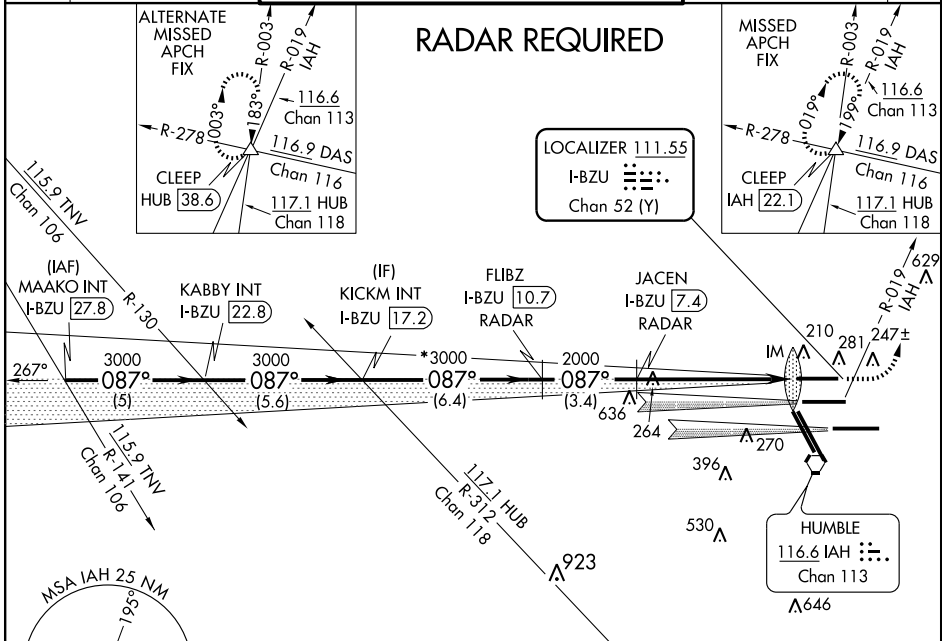

SC-5, 05 APR 2012 to 03 MAY 2012

SC-5, 05 APR 2012 to 03 MAY 2012

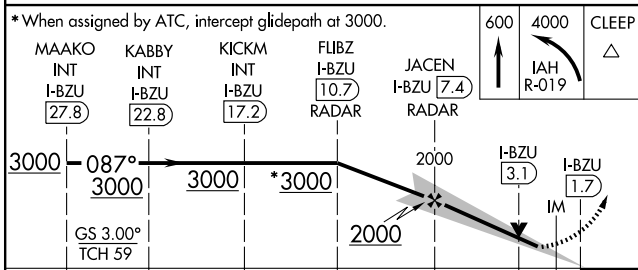
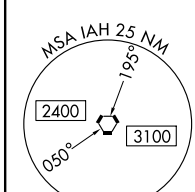

CATEGORY	A	B	C	D	E
S-ILS 8L	296/18 200 (200-½)				
S-LOC 8L	600/24	504 (600-½)	600/50	504 (600-1)	600/60 504 (600-1¼)

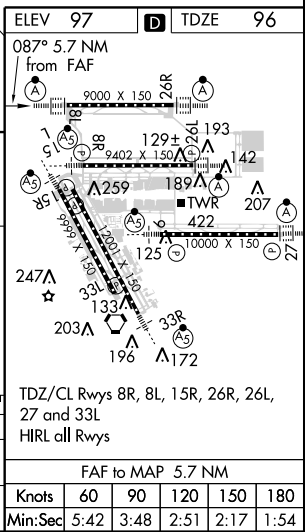

Figure 264

ILS or LOC RWY 8L

WAAS CH 97726 W26A	APP CRS 265°	Rwy Idg THRE 95 Apt Elev 97	9000
--	------------------------	--	-------------

RNAV (GPS) Z RWY 26R

HOUSTON/GEORGE BUSH INTERCONTINENTAL/HOUSTON (IAH)

▼ For uncompensated Baro-VNAV systems, LNAV/VNAV NA below -2°C (29°F) or above 39°C (101°F). For inoperative ALSF, increase LPV Cat E visibility to RVR 4000. LNAV/VNAV all Cats visibility to 1¼, and LNAV Cat C/D/E visibility to 1¾. DME/DME RNP-0.3 NA. Simultaneous approach authorized with Rwy 26L and Rwy 27. LNAV procedure NA during simultaneous operations. Use of FD or AP providing RNAV track guidance required during simultaneous operations.

ALSF-2 	MISSED APPROACH: Climb to 600 then climbing right turn to 3000 direct PEPBI and hold.
------------	---

ATIS 124.05	HOUSTON APP CON 120.05 379.1 EAST	HOUSTON TOWER 8L/26R 120.725 290.2 9/27 135.15 290.2	GND CON 8L/R 26L/R, 9/27 121.7	CLNC DEL 128.1
	124.35 316.15 WEST	8R/26L 125.35 290.2 15L/R 33L/R 127.3 288.25	15L/R 33L/R 118.575	

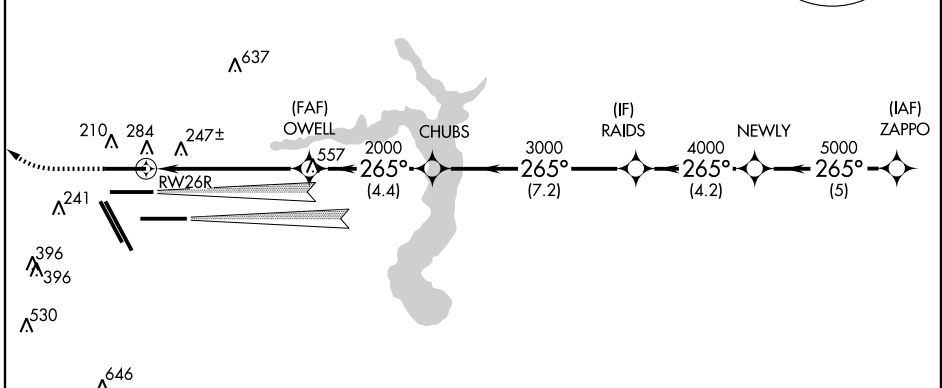
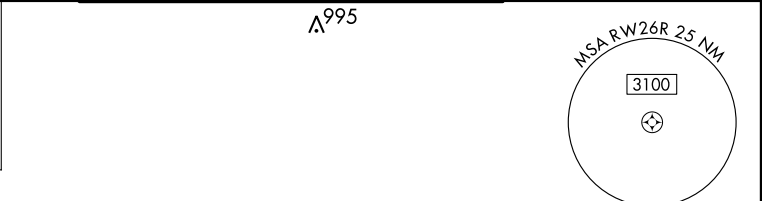
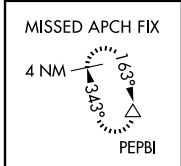

ELEV 97	D	THRE 95
---------	----------	---------

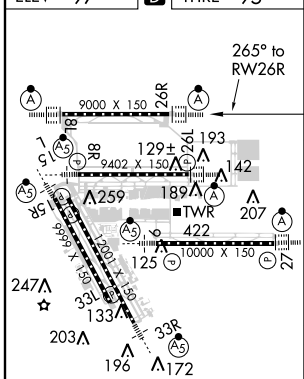

TDZ/CL Rws 8R, 8L, 15R, 26R, 26L, 27 and 33L
HIRL all Rws

RADAR REQUIRED

	600	3000	PEPBI	NEWLY	ZAPPO
*LNAV only				RAIDS	5000
				CHUBS	5000
				OWELL	2000
				RAIDS	4000
				NEWLY	5000
				ZAPPO	5000
					GS 3.00°
					TCH 59
	1.4	4.4 NM	4.4 NM	7.2 NM	4.2 NM
	5 NM				
CATEGORY	A	B	C	D	E
LPV DA		295/24	200 (200-½)		
LNAV/VNAV DA		492/45	397 (400-¾)		
LNAV MDA	600/24	505 (600-½)		600/55	505 (600-1¼)



DEPARTURE ROUTE DESCRIPTION

HECTOR or LAKE HUGHES TRANSITION: Climb runway heading to 800' then fly assigned heading for radar vectors to SLI VORTAC. Thence. . . .

VENTURA TRANSITION: Climb runway heading to 800' then fly assigned heading for radar vectors to LAX VORTAC. Thence. . . .

. . . .via (transition) or (assigned route). Maintain assigned altitude. Expect clearance to filed altitude 10 minutes after departure.

HECTOR TRANSITION (ANAHM3.HEC): From over SLI VORTAC via SLI R-058 and PDZ R-238 to PDZ VORTAC, then via PDZ R-012 and HEC R-232 to HEC VORTAC.

LAKE HUGHES TRANSITION (ANAHM3.LHS): From over SLI VORTAC via SLI R-058 and PDZ R-238 to POXKU INT, then via POM R-164 to BAYJY INT, then via VNY R-095 to DARTS INT. Thence via SLI R-319 and LHS R-139 to LHS VORTAC.

VENTURA TRANSITION (ANAHM3.VTU): From over SLI VORTAC via SLI R-251 to WILMA INT, then via LAX R-123 to LAX VORTAC, then via LAX R-276 and VTU R-093 to VTU VOR/DME.

SW-3, 05 APR 2012 to 03 MAY 2012

SW-3, 05 APR 2012 to 03 MAY 2012

SENIC ONE DEPARTURE (RNAV)

SW-3, 05 APR 2012 to 03 MAY 2012

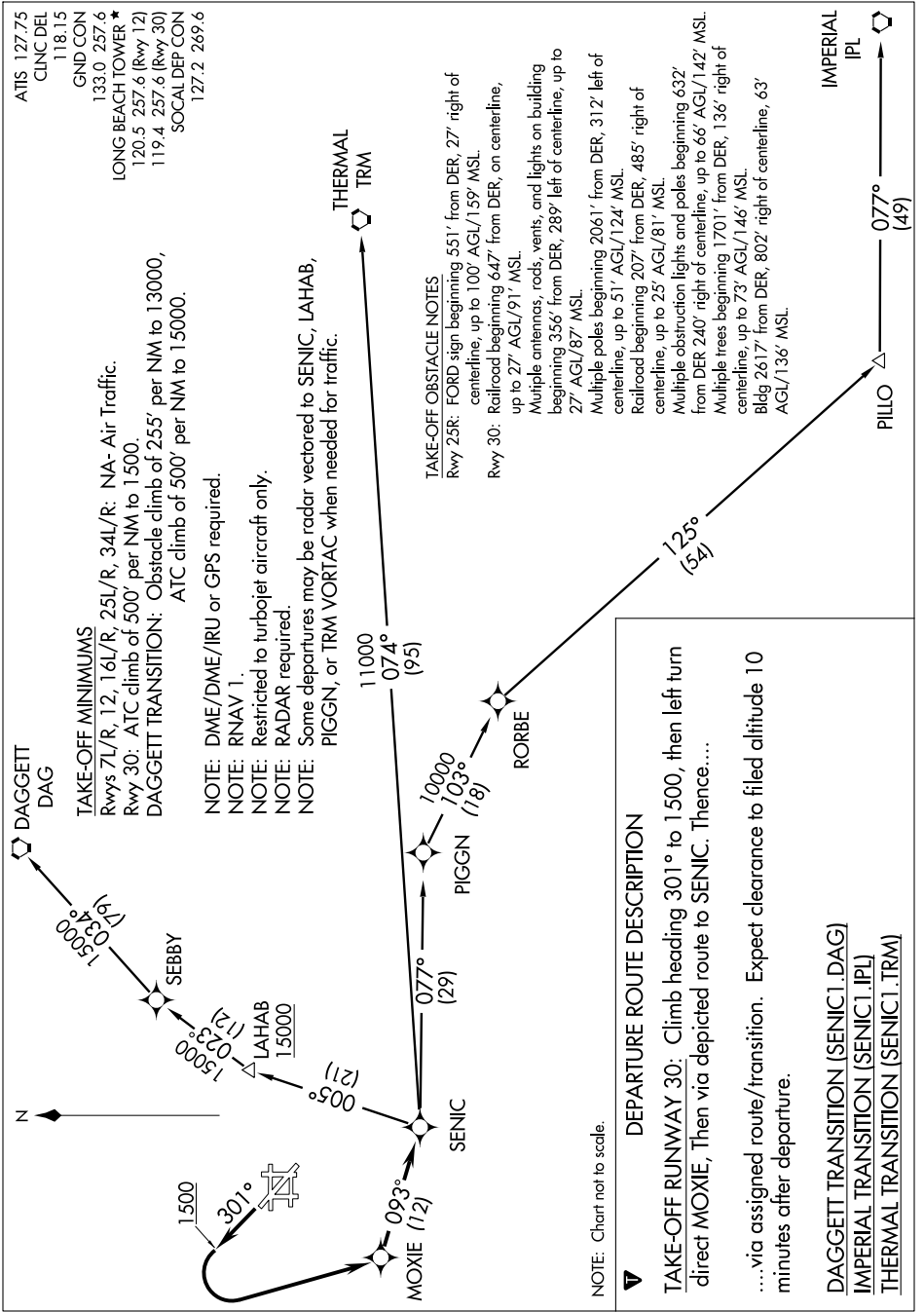

SW-3, 05 APR 2012 to 03 MAY 2012

SENIC ONE DEPARTURE (RNAV)

Figure 269

VORTAC SLI 115.7 Chan 104	APP CRS 275°	Rwy ldg TDZE Apt Elev	8000 38 60
---	------------------------	-----------------------------	---------------------------------------

VOR or TACAN RWY 30

LONG BEACH (DAUGHERTY FIELD) (LGB)

<p>Inoperative table does not apply. Visibility reduction by helicopters NA.</p>	<p>MALSR</p>	<p>MISSED APPROACH: Climbing left turn to 2500 via heading 200° and LAX R-145 to PADDR Int/LAX 22 DME and hold.</p>			
			<p>ATIS 127.75</p>	<p>SOCAL APP CON 124.65 316.125</p>	<p>LONG BEACH TOWER* 120.5 257.6 (Rwy 12) 119.4 (CTAF) 0 257.6 (Rwy 30)</p>

ATIS 127.75	SOCAL APP CON 124.65 316.125	LONG BEACH TOWER* 120.5 257.6 (Rwy 12) 119.4 (CTAF) 0 257.6 (Rwy 30)	GND CON 133.0 257.6	CLNC DEL 118.15	UNICOM 122.95
-----------------------	--	---	-------------------------------	---------------------------	-------------------------

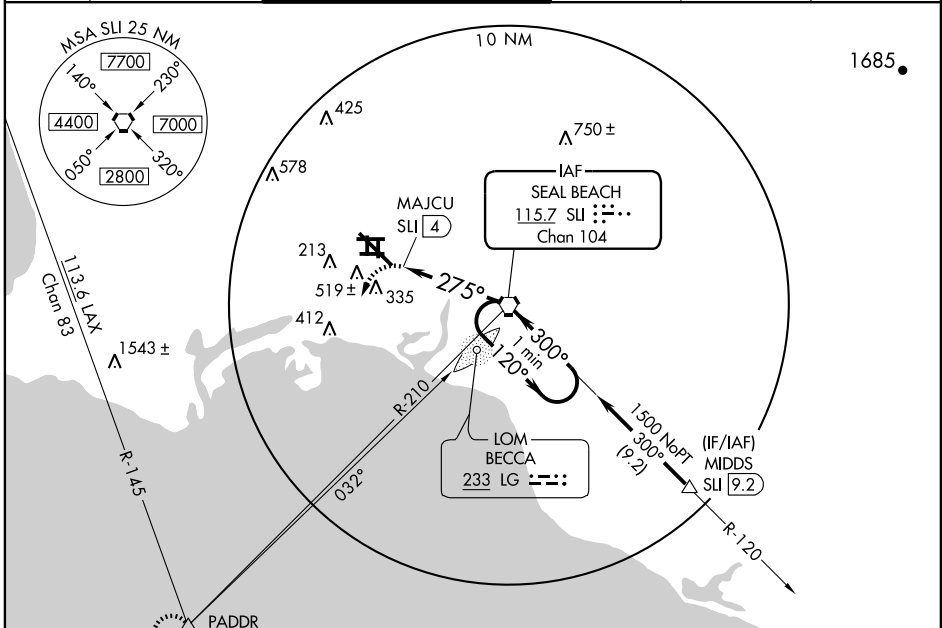

SW-3, 05 APR 2012 to 03 MAY 2012

SW-3, 05 APR 2012 to 03 MAY 2012

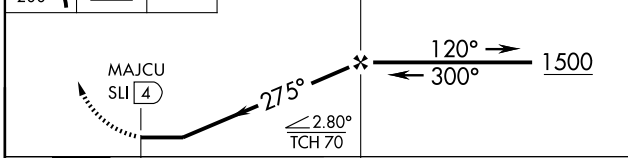

ELEV 60	D
---------	---

TDZ/CL Rwy 30
MIRL Rwys 7L-25R
REIL Rwys 12, 25L, and 25R
HIRL Rwys 7R-25L and 12-30

FAF to MAP 4 NM

Knots	60	90	120	150	180
Min:Sec	4:00	2:40	2:00	1:36	1:20

CATEGORY	A	B	C	D
S-30	640/50	602 (600-1)	640-1¾ 602 (600-1¾)	640-2 602 (600-2)
CIRCLING	880-1 820 (900-1)	880-1¼ 820 (900-1¼)	880-2½ 820 (900-2½)	880-2¾ 820 (900-2¾)

Figure 270

(IMPER1.IMPER) 11125

IMPER ONE DEPARTURE

SL-237 (FAA)

LOS ANGELES INTL (LAX)
LOS ANGELES, CALIFORNIA

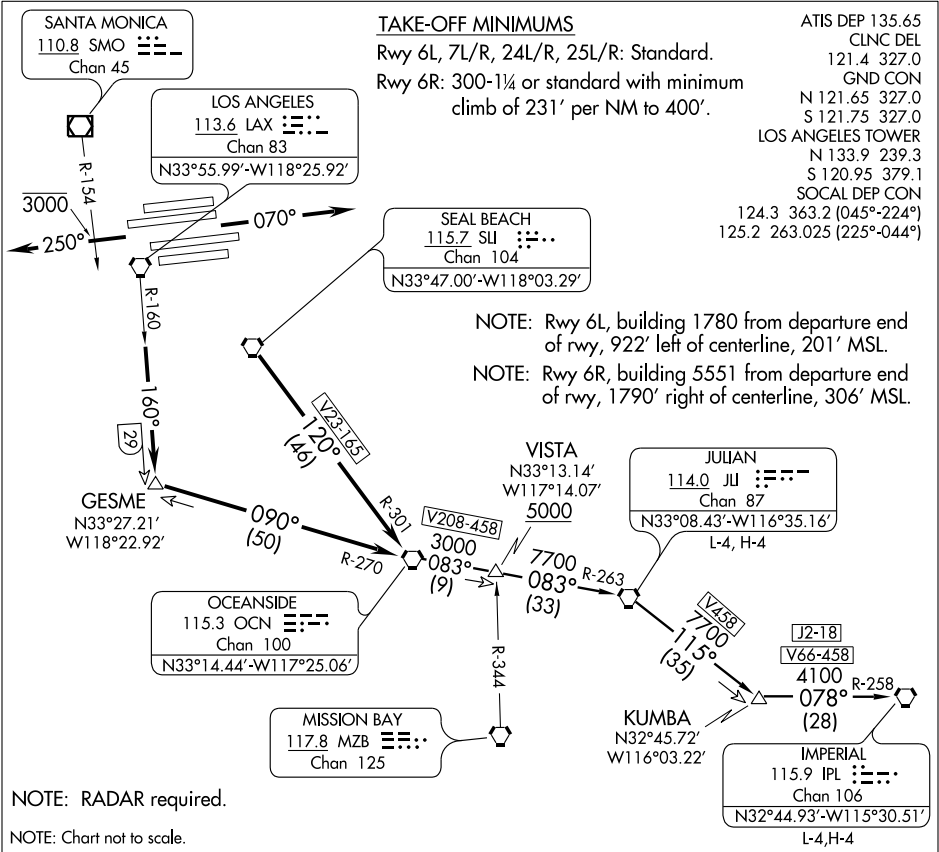

SW-3, 05 APR 2012 to 03 MAY 2012

SW-3, 05 APR 2012 to 03 MAY 2012

DEPARTURE ROUTE DESCRIPTION

TAKE-OFF RUNWAYS 6L/R, 7L/R: Climb via heading 070° for vector to SLI VORTAC, then via SLI R-120 and OCN R-301 to OCN VORTAC. Thence. . .

TAKE-OFF RUNWAYS 24L/R, 25L/R: Climb via heading 250° to cross SMO R-154 at or below 3000. Then via radar vectors to join LAX R-160 to GESME INT. Then via OCN R-270 to OCN VORTAC. Thence. . .

. . . via (assigned transition) or (assigned route). All aircraft expect further clearance to filed flight level three minutes after departure.

LOST COMMUNICATIONS: If not in contact with Departure Control within five minutes after departure, climb to FL230 or filed altitude whichever is lower. Aircraft filing FL240 or above climb to filed altitude ten minutes after departure.

IMPERIAL TRANSITION (IMPER1.IPL): From over OCN VORTAC via OCN R-083 and JLI R-263 to JLI VORTAC. Then via JLI R-115 and IPL R-258 to IPL VORTAC.

JULIAN TRANSITION (IMPER1.JLI): From over OCN VORTAC via OCN R-083 and JLI R-263 to JLI VORTAC.

IMPER ONE DEPARTURE
(IMPER1.IMPER) 11125

LOS ANGELES, CALIFORNIA
LOS ANGELES INTL (LAX)

Figure 271

ARLIN THREE ARRIVAL

ST-322 (FAA)

PHOENIX, ARIZONA

SW-4, 05 APR 2012 to 03 MAY 2012

BLYTE TRANSITION (BLH.ARLIN3): From over BLH VORTAC via BLH R-089 and IWA R-256 to ARLIN INT. Thence....

MOHAK TRANSITION (MOHAK.ARLIN3): From over MOHAK INT via GBN R-247 and BXK R-215 to HYDRR INT, then via IWA R-256 to ARLIN INT. Thence....

.... From over ARLIN INT:

PHOENIX SKY HARBOR INTL: Rwy 7L/R or 8: Expect vectors after ARLIN INT to final approach course; Rwy 25L/R or 26: via IWA R-256 to TUKEE INT. Expect vectors prior to TUKEE INT to final approach course.

SATELLITE AIRPORTS: Expect vectors after passing TUKEE INT.

LOST COMMUNICATIONS: After ARLIN INT, via IWA R-256 and PXR R-143 to PXR VORTAC.

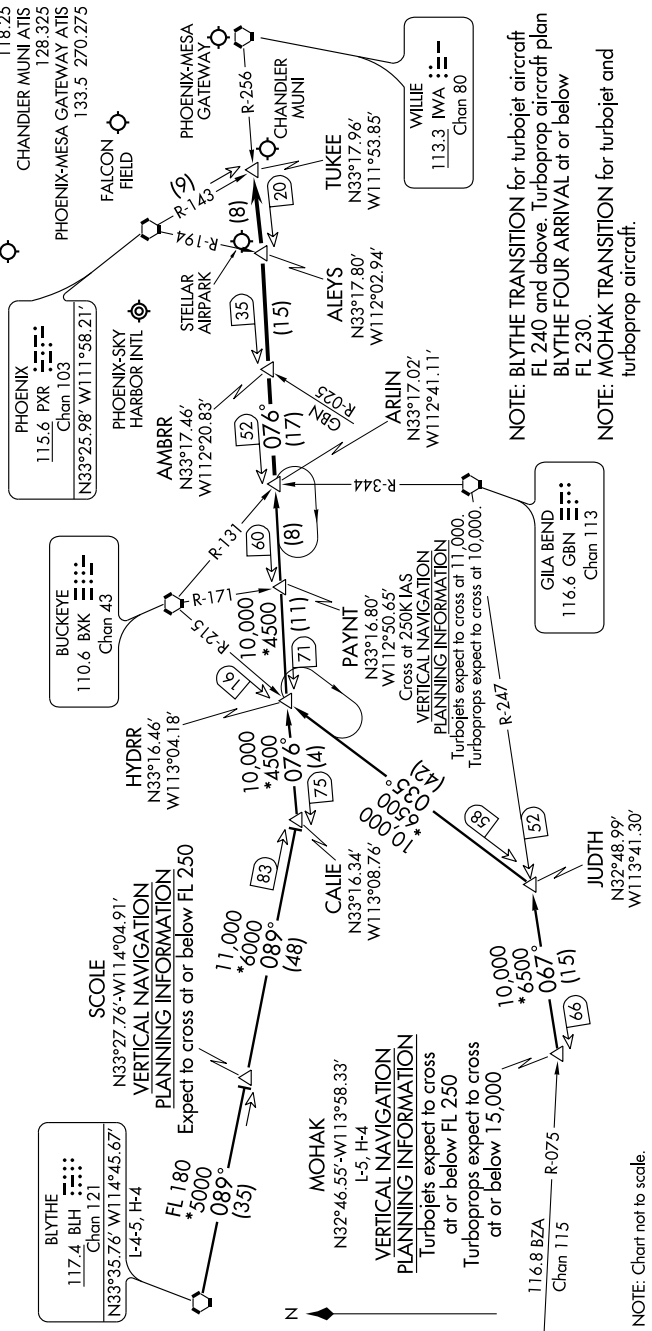

NOTE: BLYTHE TRANSITION for turbojet aircraft FL 240 and above. Turbojet aircraft plan BLYTHE FOUR ARRIVAL at or below FL 230.

NOTE: MOHAK TRANSITION for turbojet and turbojet aircraft.

ARLIN THREE ARRIVAL

PHOENIX, ARIZONA

Figure 272

SW-4, 05 APR 2012 to 03 MAY 2012

NOTE: Chart not to scale.

LOC/DME I-RJG 110.75 Chan 44 (Y)	APP CRS 258°	Rwy Idg TDZE Apt Elev	7800 1126 1135
---	------------------------	-----------------------------	---

ILS or LOC RWY 25L

PHOENIX SKY HARBOR INTL (PHX)

Autopilot coupled approach NA below 1925.
Simultaneous approach authorized with Rwy 26.

MALS

MISSED APPROACH: Climb to 3000 then climbing left turn to 5000 on heading 130° and PXR R-163 to POPKE 15 DME and hold.

ATIS 127.575	PHOENIX APP CON 128.65 353.8	PHOENIX TOWER 118.7 278.8 (Rwy 8-26) 120.9 254.3 (Rwy 7L-25R, 7R-25L)	GND CON 119.75 269.2 (N) 132.55 269.2 (S)	CLNC DEL 118.1 269.2
------------------------	--	---	---	--------------------------------

△ 2362

DME or RADAR REQUIRED

LOCALIZER **110.75**
I-RJG
Chan 44 (Y)

PHOENIX
115.6 PXR
Chan 103

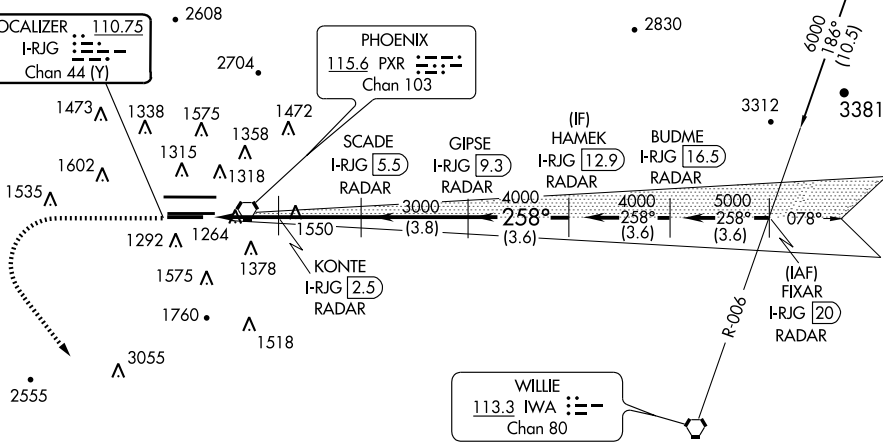

SW-4, 05 APR 2012 to 03 MAY 2012

SW-4, 05 APR 2012 to 03 MAY 2012

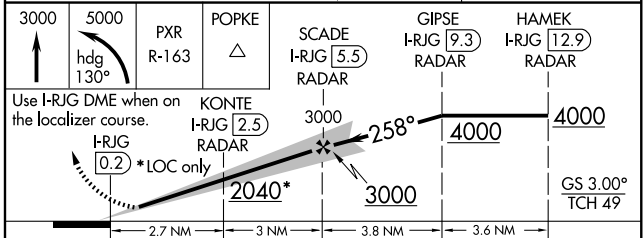
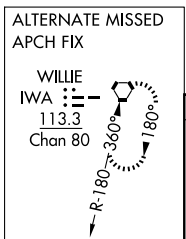
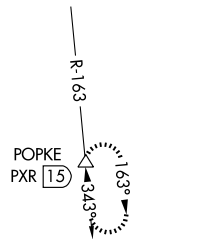
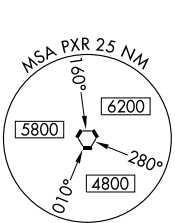

ELEV 1135	D	TDZE 1126
-----------	---	-----------

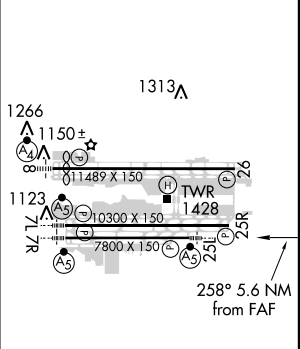

CATEGORY	A	B	C	D
S-ILS 25L	1326-1/2 200 (200-1/2)			
S-LOC 25L	1520-1/2 394 (400-1/2)		1520-3/4 394 (400-3/4)	
CIRCLING	1740-1 605 (700-1)	1740-1 3/4 605 (700-1 3/4)	1920-2 785 (800-2)	

FAF to MAP 5.6 NM					
Knots	60	90	120	150	180
Min:Sec	5:36	3:44	2:48	2:14	1:52

Figure 273

WAAS CH 82211 W25B	APP CRS 258°	Rwy Idg TDZE Apt Elev	7800 1126 1135
--	------------------------	-----------------------------	---

RNAV (GPS) Y RWY 25L

PHOENIX SKY HARBOR INTL (PHX)

⚠ For inoperative MALSR, increase LPV all Cats visibility to 1 ¼ For uncompensated Baro-VNAV systems, LNAV/VNAV NA below -17°C (2°F) or above 46°C (114°F). DME/DME RNP-0.3 NA. Simultaneous approach authorized with ILS or LOC Rwy 26. Use of FD or AP providing RNAV track guidance required during simultaneous operations. LNAV procedure NA during simultaneous operations.

MALSR

MISSED APPROACH: Climb to 5000 direct OVNUY and via 261° track to BXX VORTAC and hold.

ATIS 127.575	PHOENIX APP CON 128.65 353.8	PHOENIX TOWER 118.7 278.8 (Rwy 8-26) 120.9 254.3 (Rwy 7L-25R, 7R-25L)	GND CON 119.75 269.2 (N) 132.55 269.2 (S)	CLNC DEL 118.1 269.2
------------------------	--	---	---	--------------------------------

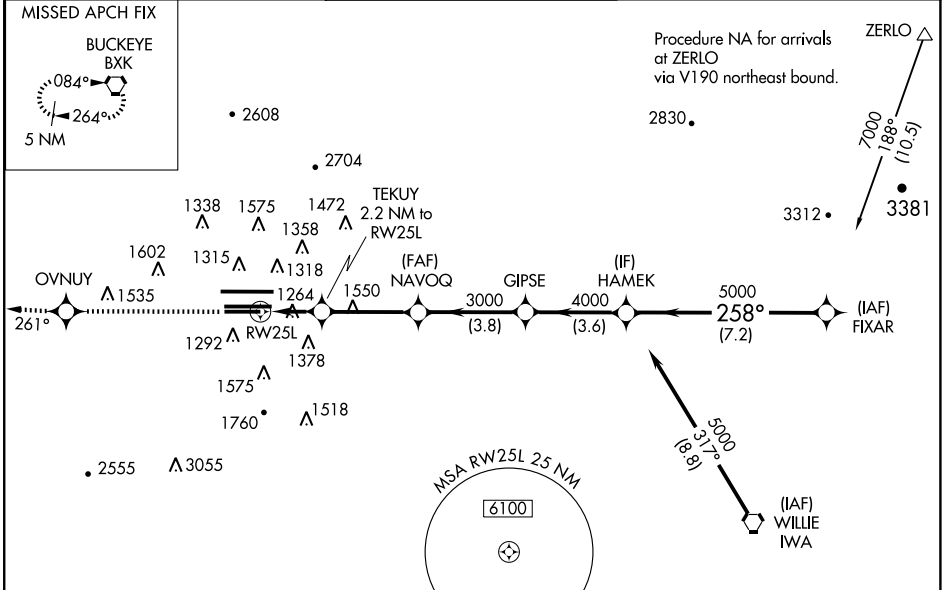

SW-4, 05 APR 2012 to 03 MAY 2012

SW-4, 05 APR 2012 to 03 MAY 2012

ELEV 1135	D	TDZE 1126
-----------	----------	-----------

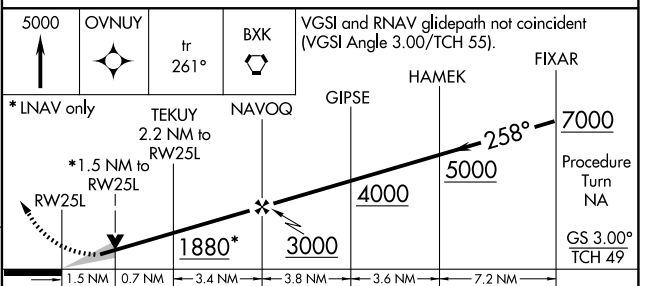
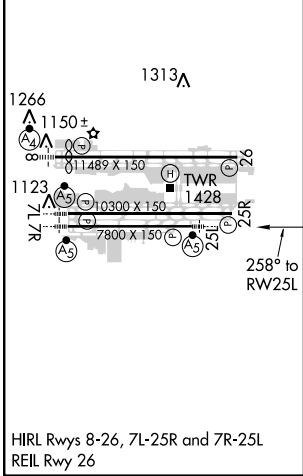

CATEGORY	A	B	C	D
LPV DA		1482-¾	356 (400-¾)	
LNAV/VNAV DA		1613-1¼	487 (500-1¼)	
LNAV MDA	1680-½	554 (600-½)	1680-1 554 (600-1)	1680-1¼ 554 (600-1¼)
CIRCLING	1740-1	605 (700-1)	1740-1¾ 605 (700-1¾)	1920-2 ½ 785 (800-2½)

Figure 274

POWER PLANT VISUAL RWY 25R

PHOENIX APP CON
 126.8 256.9
 128.65 353.8
 PHOENIX TOWER
 120.9 254.3 (Rwy 7L-25R, 7R-25L)
 118.7 278.8 (Rwy 8-26)
 GND CON
 119.75 269.2 (NORTH)
 132.55 269.2 (SOUTH)
 CLNC DEL
 118.1 269.2
 ATIS 127.575

SW-4, 05 APR 2012 to 03 MAY 2012

SW-4, 05 APR 2012 to 03 MAY 2012

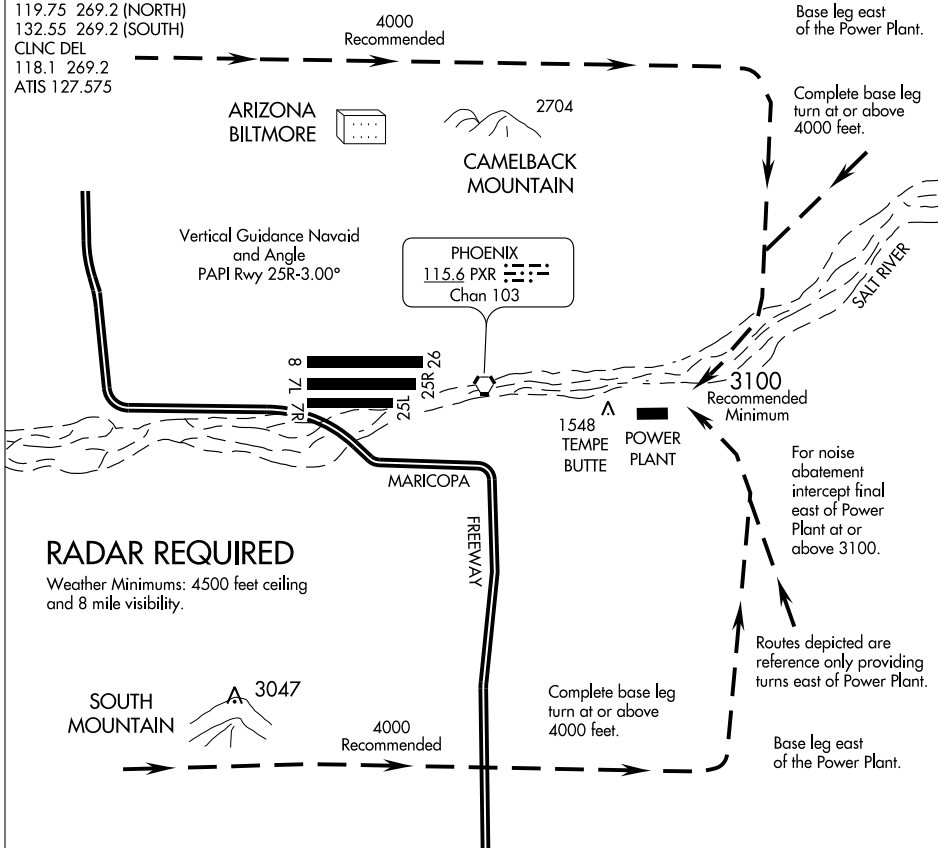

RADAR REQUIRED
 Weather Minimums: 4500 foot ceiling and 8 mile visibility.

1 NM	2	3	4	5	6	7	8	9	10	11	12	13	14	15	16
------	---	---	---	---	---	---	---	---	----	----	----	----	----	----	----

POWER PLANT VISUAL RWY 25R

When visual approaches to Runway 25R are in progress, clearances will be given utilizing in part the following phraseology:

"(IDENT) CLEARED FOR A POWER PLANT VISUAL RUNWAY 25R APPROACH"

POWER PLANT VISUAL RWY 25R

Figure 275

CHILY ONE DEPARTURE

SL-322 (FAA)

PHOENIX SKY HARBOR INTL (PHX)

PHOENIX, ARIZONA

SW-4, 05 APR 2012 to 03 MAY 2012

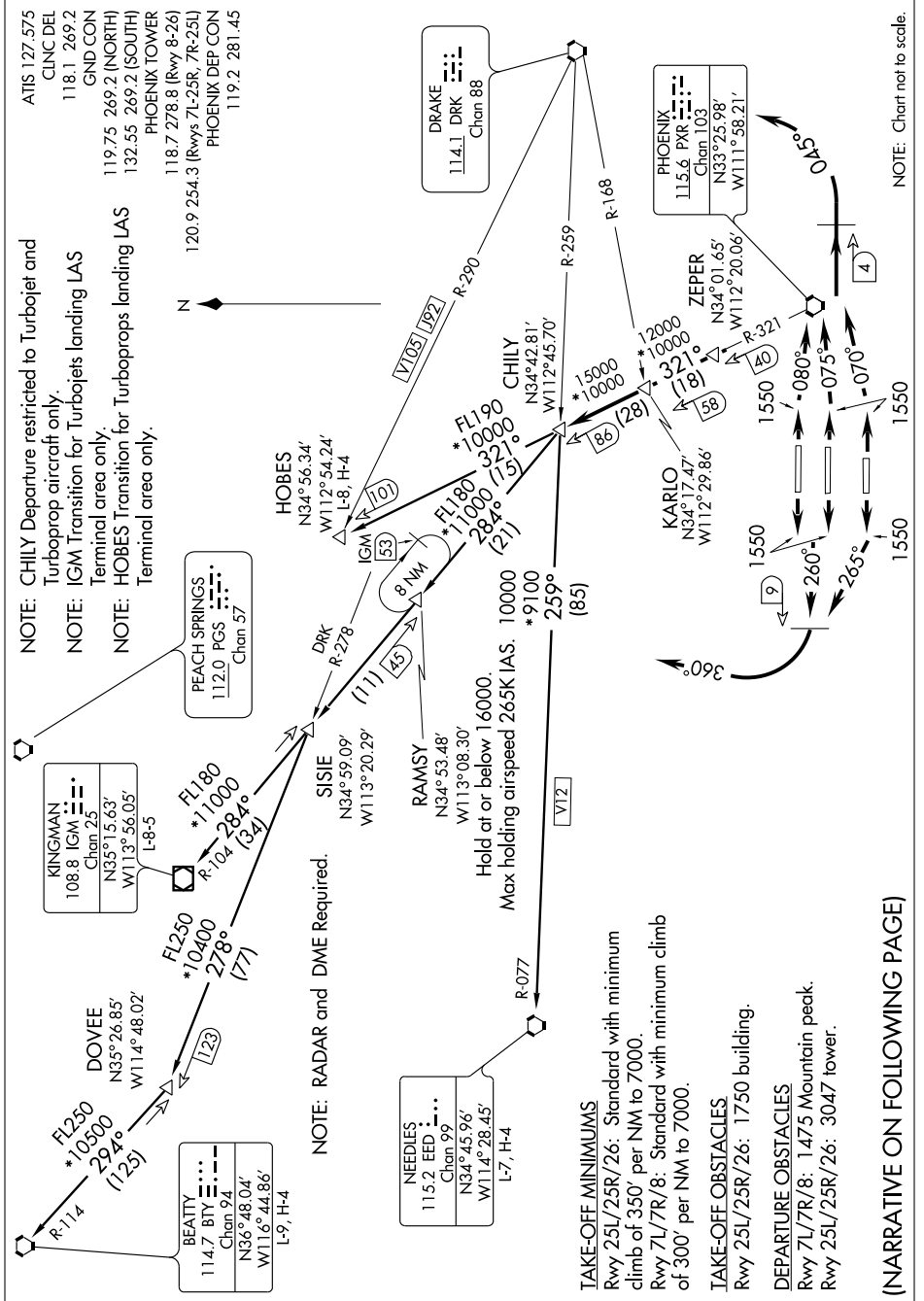

CHILY ONE DEPARTURE

PHOENIX, ARIZONA

PHOENIX SKY HARBOR INTL (PHX)

SW-4, 05 APR 2012 to 03 MAY 2012

Figure 276



DEPARTURE ROUTE DESCRIPTION

TAKE-OFF RUNWAY 7L: Climb runway heading to 1550, then climbing left turn heading 075°, at 4 DME east of PXR VORTAC, climbing left turn heading 045°.

Thence....

TAKE-OFF RUNWAY 7R: Climb runway heading to 1550, then climbing left turn heading 070°, at 4 DME east of PXR VORTAC, climbing left turn heading 045°.

Thence....

TAKE-OFF RUNWAY 8: Climb runway heading to 1550, then climbing right turn heading 080°, at 4 DME east of PXR VORTAC, climbing left turn heading 045°.

Thence....

TAKE-OFF RUNWAY 25L: Climb runway heading to 1550, then climbing right turn heading 265°, at 9 DME west of PXR VORTAC, climbing right turn heading 360°.

Thence....

TAKE-OFF RUNWAY 25R: Climb runway heading to 1550, then climbing right turn heading 260°, at 9 DME west of PXR VORTAC, climbing right turn heading 360°.

Thence....

TAKE-OFF RUNWAY 26: Climb runway heading to 1550, then climbing right turn heading 260°, at 9 DME west of PXR VORTAC, climbing right turn heading 360°.

Thence....

....maintain 7000. Expect radar vectors to PXR R-321 to ZEPER INT then CHILY INT. Then via (transition). Expect filed altitude 3 minutes after departure.

BEATTY TRANSITION (CHILY1.BTY): From over CHILY INT via IGM R-104 to SISIE INT, then via DRK R-278 to DOVEE INT, then via BTY R-114 to BTY VORTAC.

HOBES TRANSITION (CHILY1.HOBES): From over CHILY INT via PXR R-321 to HOBES INT.

KINGMAN TRANSITION (CHILY1.IGM): From over CHILY INT via IGM R-104 to IGM VOR/DME.

NEEDLES TRANSITION (CHILY1.EED): From over CHILY INT via DRK R-259 and EED R-077 to EED VORTAC.

SW-4, 05 APR 2012 to 03 MAY 2012

SW-4, 05 APR 2012 to 03 MAY 2012

Figure 277

(BUF3.BUF) 09127

BUFFALO THREE DEPARTURE

SL-65 (FAA)

BUFFALO NIAGARA INTL (BUF)
BUFFALO, NEW YORK

ATIS 135.35
CLNC DEL
124.7
GND CON
133.2 257.8
BUFFALO TOWER
120.5 257.8

BUFFALO
116.4 BUF
Chan 111
N42°55.74'
W78°38.78'
L-31, H-10-11

TAKEOFF MINIMUMS:
All Rwys, STANDARD.

LONDON
117.2 YXU
Chan 119
N43°02.29'
W81°08.91'
L-30-31, H-10-11

ROCHESTER
110.0 ROC
Chan 37
N43°07.08'
W77°40.37'
L-31-32, H-10-11-12

SYRACUSE
117.0 SYR
Chan 117
N43°09.63'
W76°12.27'
L-32, H-11-12

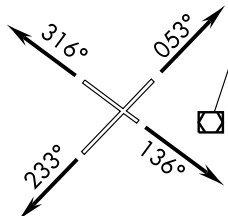

AYLMER
114.2 YQO
Chan 89
N42°42.40'
W80°53.27'
L-30, H-10-11

DUNKIRK
116.2 DKK
Chan 109
N42°29.43'
W79°16.45'
L-30, H-10

GENESEEO
108.2 GEE
Chan 19
N42°50.06'
W77°43.97'
L-31-32, H-10-11-12

WELLSVILLE
111.4 ELZ
Chan 51
N42°05.38'
W77°59.97'
L-30-32, H-10-12

JAMESTOWN
114.7 JHW
Chan 94
N42°11.32'
W79°07.28'
L-30, H-10

STONYFORK
108.6 SFK
Chan 23
N41°41.72'
W77°25.19'
L-30, H-10-12

DRYER
113.6 DJB
Chan 83
N41°21.48'
W82°09.72'
L-30, H-10

BRADFORD
116.6 BFD
Chan 113
N41°47.18'
W78°37.16'
L-30

SLATE RUN
113.9 SLT
Chan 86
N41°30.77'
W77°58.21'
L-30, H-10-12

NOTE: RADAR Required.

NOTE: Chart not to scale.

(Continued on next page)

DEPARTURE ROUTE DESCRIPTION

TURBOJET AIRCRAFT:

TAKE-OFF RUNWAY 5: Climb via heading 053° until leaving 3000, thence. . .

TAKE-OFF RUNWAY 14: Climb via heading 136° until leaving 3000, thence. . .

TAKE-OFF RUNWAY 23: Climb via heading 233° until leaving 3000, thence. . .

TAKE-OFF RUNWAY 32: Climb via heading 316° until leaving 2000, thence. . .

NON-TURBOJET AIRCRAFT ONLY: Climb on assigned heading, thence. . .

. . . Expect vectors to filed route or depicted fix. Maintain 10,000' or assigned lower altitude.
Expect further clearance to requested altitude/flight level ten minutes after departure.

BUFFALO THREE DEPARTURE

(BUF3.BUF) 09127

BUFFALO, NEW YORK
BUFFALO NIAGARA INTL (BUF)

NE-2, 05 APR 2012 to 03 MAY 2012

NE-2, 05 APR 2012 to 03 MAY 2012

LOC I- HDN 110.75	APP CRS 323°	Rwy ldg TDZE Apt Elev	10003 653 672
------------------------------------	------------------------	-----------------------------	--

ILS or LOC RWY 32R

CHICAGO-O'HARE INTL (ORD)

▼ DME from ORD VOR/DME.	MALSR 	MISSED APPROACH: Climb to 1100, then climbing right turn to 4000 via ORD R-089 to LAIRD INT/ORD 13.9 DME and hold.
-------------------------	-----------	--

ATIS 282.225	CHICAGO APP CON 119.0 393.1	O'HARE TOWERS (Rwy 9L/27R) 128.15 126.9 132.7 348.0 (CENTER)	(TWR NORTH) GND CON (TWR CENTER) 124.125 121.75 (OBND) 121.9 (IBND) 226.675	CLNC DEL 121.6
------------------------	---------------------------------------	---	---	--------------------------

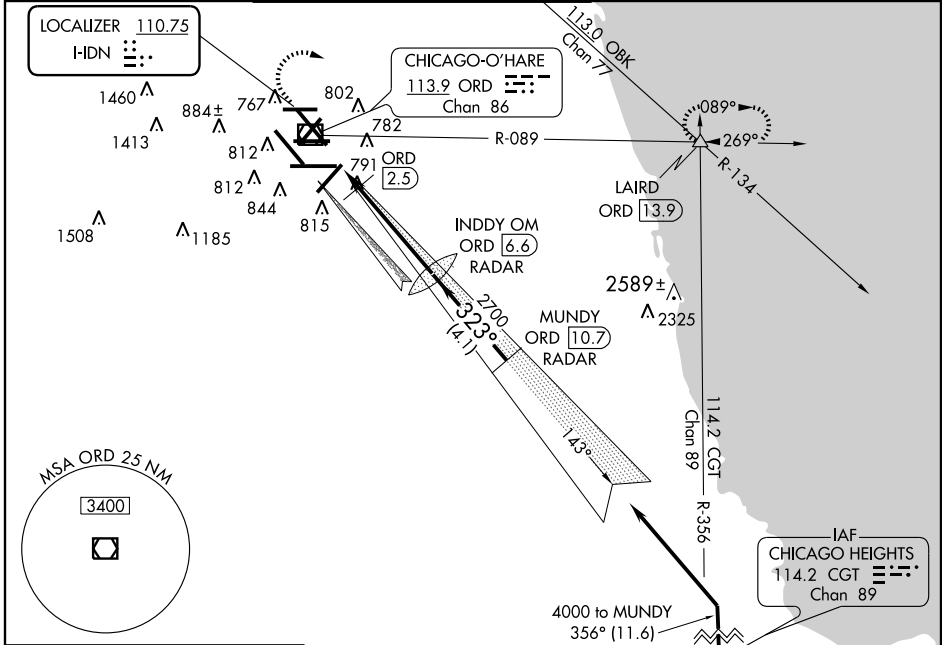

EC-3, 05 APR 2012 to 03 MAY 2012

EC-3, 05 APR 2012 to 03 MAY 2012

ELEV 672	D	TDZE 653
----------	----------	----------

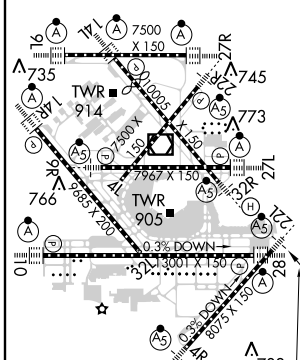

HIRL all Rwys
TDZ/CL all Rwys except 4L and 32L

323° 6 NM from FAF

FAF to MAP 6 NM

Knots	60	90	120	150	180
Min:Sec	6:00	4:00	3:00	2:24	2:00

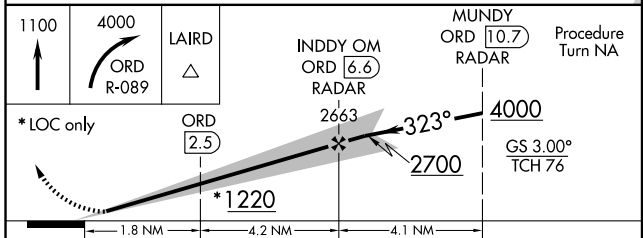

CATEGORY	A	B	C	D
S-ILS 32R	853/18		200 (200-½)	
S-LOC 32R	1220/24	567 (600-½)	1220/50 567 (600-1)	1220/60 567 (600-1½)
CIRCLING	1220-1	548 (600-1)	1220-1½ 548 (600-1½)	1240-2 568 (600-2)
DME MINIMUMS				
S-LOC 32R	1100/24	447 (500-½)	1100/40 447 (500-¾)	1100/50 447 (500-1)
CIRCLING	1220-1	548 (600-1)	1220-1½ 548 (600-1½)	1240-2 568 (600-2)

Figure 279

LOC/DME I-SAJ 111.75 Chan 54 (Y)	APP CRS 093°	Rwy Idg TDZE Apt Elev	7500 668 672
---	------------------------	-----------------------------	---

ILS or LOC RWY 9L
CHICAGO-O'HARE INTL (ORD)

Simultaneous approach authorized with Rwy 9R and 10.

ALSF-2

MISSED APPROACH: Climb to 1100 then climbing left turn to 4000 via OBK VOR/DME R-166 to OBK VOR/DME and hold.

ATIS 135.4 282.225	CHICAGO APP CON 119.0 393.1	O'HARE TOWERS (Rwy 9L/27R) 128.15 120.75 126.9 132.7 348.0 (CENTER)	(TWR NORTH) GND CON (TWR CENTER) 124.125 121.75 (OBND) 121.9 (IBND) 226.675	CLNC DEL 121.6
--	---------------------------------------	--	---	--------------------------

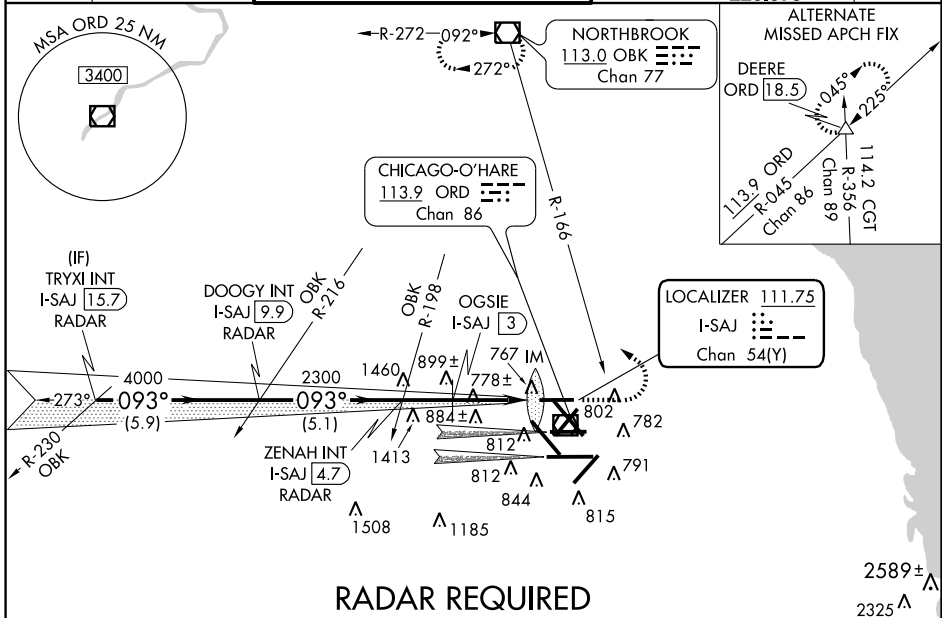

EC-3, 05 APR 2012 to 03 MAY 2012

EC-3, 05 APR 2012 to 03 MAY 2012

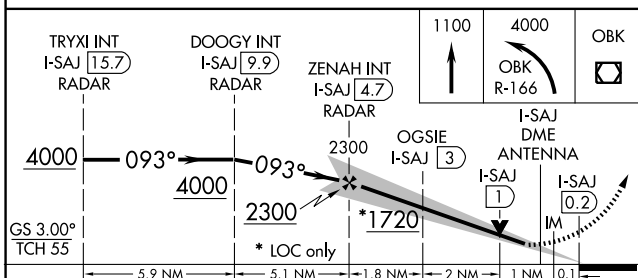

CATEGORY	A	B	C	D
S-ILS 9L	868/18 200 (200-½)			
S-LOC 9L	1720/40 1052 (1100-¾)	1720/50 1052 (1100-1)	1720-2½	1052 (1100-2½)
CIRCLING	1720-1¼ 1048 (1100-1½)	1720-1½	1720-3	1048 (1100-3)
OGSIE FIX MINIMUMS				
S-LOC 9L	1080/24	412 (500-½)	1080/40	412 (500-¾)
CIRCLING	1220-1	548 (600-1)	1220-1½	1240-2 568 (600-2)

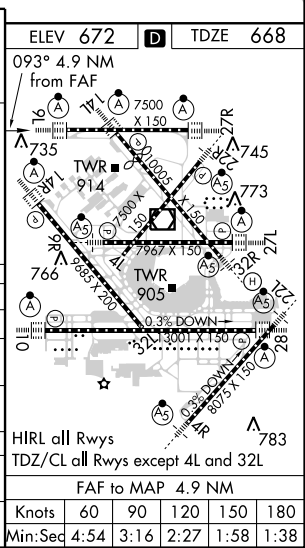
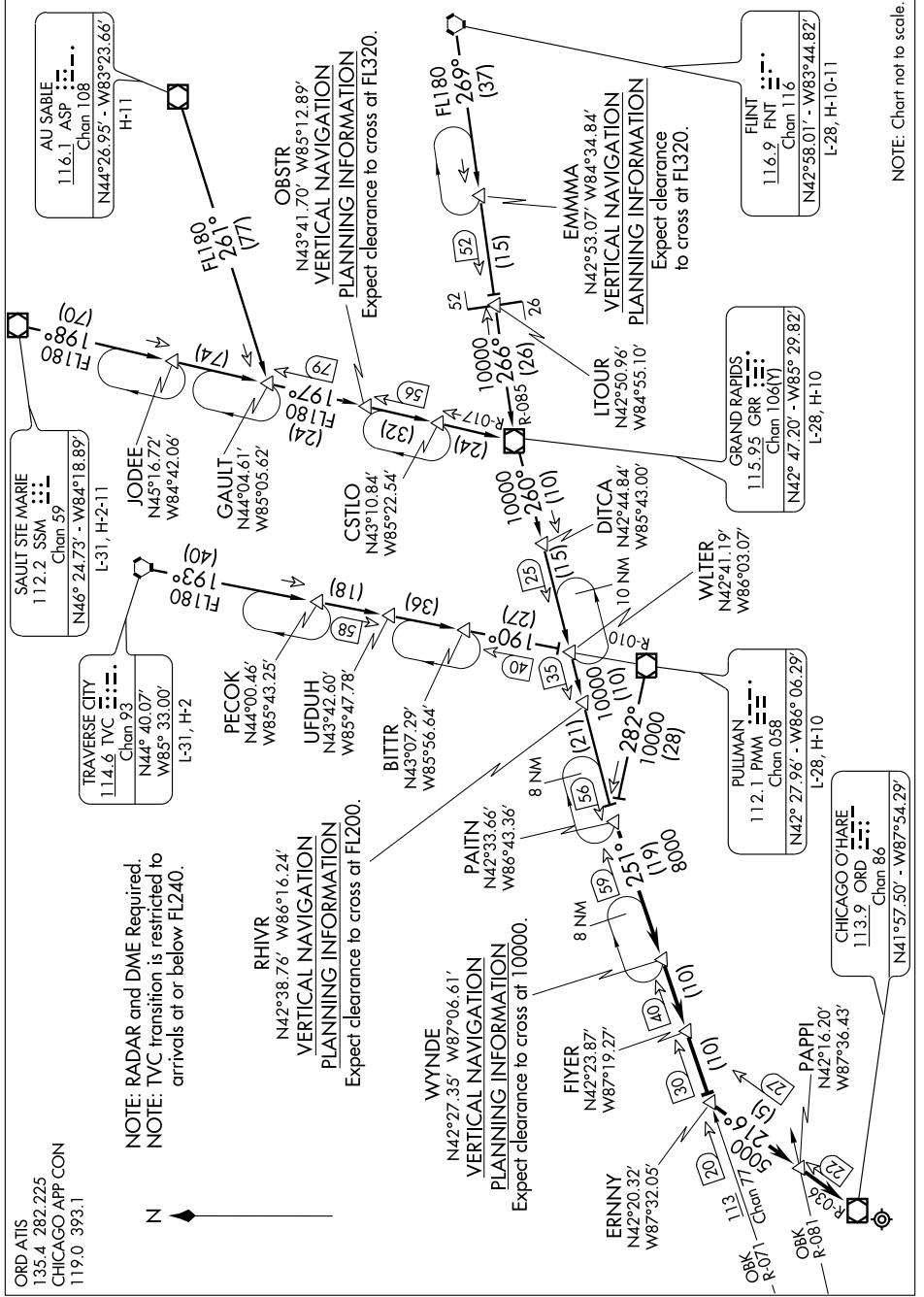

Figure 280

EC-3, 05 APR 2012 to 03 MAY 2012



NOTE: RADAR and DME Required.
 NOTE: TVC transition is restricted to arrivals at or below FL240.

RHVR
 N42°38.76' W86°16.24'
 VERTICAL NAVIGATION
 PLANNING INFORMATION
 Expect clearance to cross at FL200.

WYNDY
 N42°27.35' W87°06.61'
 VERTICAL NAVIGATION
 PLANNING INFORMATION
 Expect clearance to cross at 10000.

PAITN
 N42°33.66' W86°43.36'
 VERTICAL NAVIGATION
 PLANNING INFORMATION
 Expect clearance to cross at 10000.

FLYER
 N42°23.87' W87°19.27'
 VERTICAL NAVIGATION
 PLANNING INFORMATION
 Expect clearance to cross at 10000.

WYNER
 N42°33.66' W86°43.36'
 VERTICAL NAVIGATION
 PLANNING INFORMATION
 Expect clearance to cross at 10000.

PULLMAN
 N42°27.95' W86°06.29'
 VERTICAL NAVIGATION
 PLANNING INFORMATION
 Expect clearance to cross at 10000.

GRAND RAPIDS
 N42°47.20' W85°29.82'
 VERTICAL NAVIGATION
 PLANNING INFORMATION
 Expect clearance to cross at 10000.

FLINT
 N42°58.01' W83°44.82'
 VERTICAL NAVIGATION
 PLANNING INFORMATION
 Expect clearance to cross at 10000.

CHICAGO O'HARE
 N41°57.50' W87°54.29'
 VERTICAL NAVIGATION
 PLANNING INFORMATION
 Expect clearance to cross at 10000.

NOTE: Chart not to scale.

Figure 281

EC-3, 05 APR 2012 to 03 MAY 2012

ARRIVAL ROUTE DESCRIPTION

AU SABLE TRANSITION (ASP.PAITN2): From over ASP VOR/DME via ASP R-261 to GAULT then via GRR R-017 to GRR VOR/DME then via GRR R-260 to PAITN. Thence....

FLINT TRANSITION (FNT.PAITN2): From over FNT VORTAC via FNT R-269 to LTOUR and GRR R-085 to GRR VOR/DME then via GRR R-260 to PAITN. Thence....

GRAND RAPIDS TRANSITION (GRR.PAITN2): From over GRR VOR/DME via GRR R-260 to PAITN. Thence....

PULLMAN TRANSITION (PMM.PAITN2): From over PMM VOR/DME via PMM R-282 to PAITN. Thence....

SAULT STE MARIE TRANSITION (SSM.PAITN2): From over SSM VOR/DME via SSM R-198 to GAULT then via GRR R-017 to GRR VOR/DME then via GRR R-260 to PAITN. Thence....

TRAVERSE CITY TRANSITION (TVC.PAITN2): From over TVC VORTAC via TVC R-193 to BITTR then via PMM R-010 to WLTER then via GRR R-260 to PAITN. Thence....

....From over PAITN via OBK VOR/DME R-071 to WYNDE/OBK 40 DME, then via OBK VOR/DME R-071 to FIYER/OBK 30 DME, then via OBK VOR/DME R-071 to ERNNY/OBK 20 DME, then via ORD VOR/DME R-036 to PAPPI/ORD 22 DME, then via ORD VOR/DME R-036 to ORD VOR/DME. Expect radar vectors to final approach course.

EC-3, 05 APR 2012 to 03 MAY 2012

EC-3, 05 APR 2012 to 03 MAY 2012

WAAS CH 40004 W10A	APP CRS 099°	Rwy Idg TDZE 24 Apt Elev 31
---------------------------------	------------------------	---

RNAV (GPS) RWY 10R

PORTLAND INTL (PDX)

⚠ For uncompensated Baro-VNAV systems, LNAV/VNAV NA below -15°C (5°F) or above 49°C (120°F). DME/DME RNP-0.3 NA. Simultaneous approach authorized with ILS or LOC RWY 10L. Use of FD or AP providing RNAV track guidance required during simultaneous operations. LNAV procedure NA during simultaneous operations.

ALSF-2
MISSED APPROACH: Climb to 3400 direct LEZLI and hold.

ATIS 128.35 269.9	PORTLAND APP CON 124.35 299.2	PORTLAND TOWER Rwy 10L-28R 118.7 257.8 Rwys 3-21, 10R-28L 123.775 251.125	GND CON 121.9 348.6	CLNC DEL 120.125 318.1
-----------------------------	---	---	-------------------------------	----------------------------------

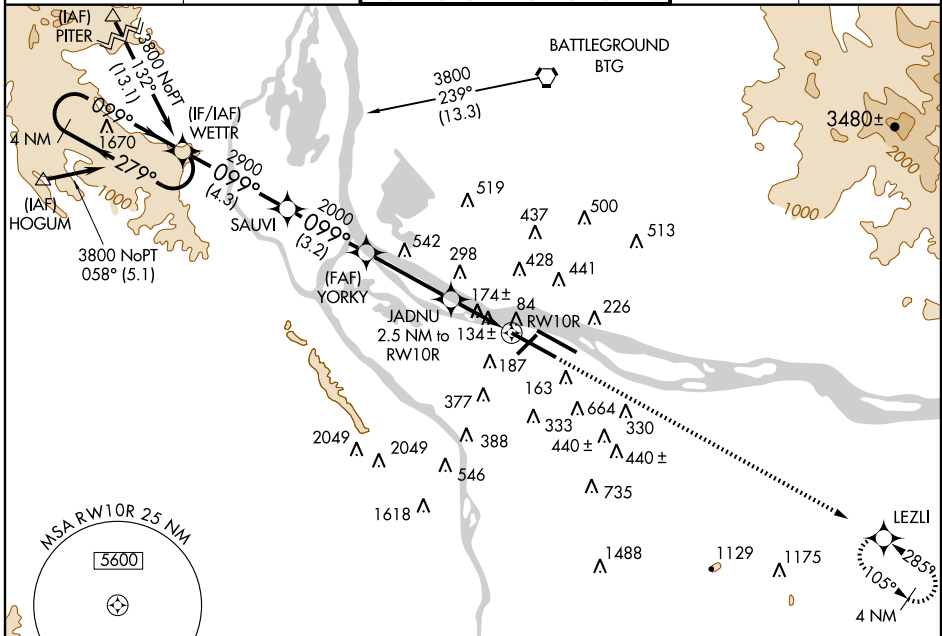

NW-1, 05 APR 2012 to 03 MAY 2012

NW-1, 05 APR 2012 to 03 MAY 2012

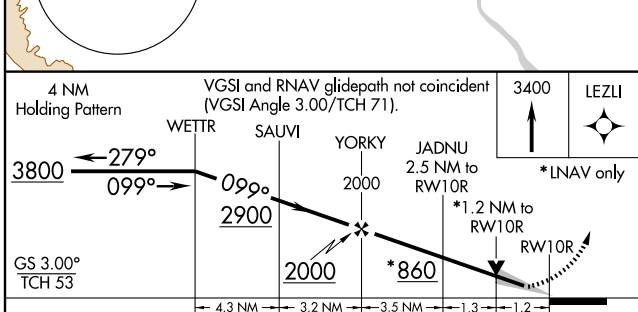

ELEV 31	D TDZE 24
---------	------------------

CATEGORY	A	B	C	D
LPV DA	224/24 200 (200-½)			
LNAV/VNAV DA	663-1¾ 639 (700-1¾)			
LNAV MDA	460/24 436 (500-½)		460/40 436 (500-¾)	460/50 436 (500-1)
CIRCLING	720-1 689 (700-1)	740-1 709 (800-1)	760-2 729 (800-2)	1000-3 969 (1000-3)

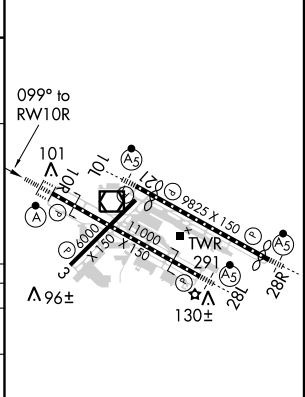

REIL Rwys 3 and 21
TDZ or CL Rwy 10L-28R and 10R-28L
MIRL Rwy 3-21
HIRL Rwys 10L-28R and 10R-28L

LOC/DME I-GPO 108.9 Chan 26	APP CRS 205°	Rwy Idg TDZE Apt Elev	6000 23 31
--	------------------------	-----------------------------	---------------------------------------

LOC/DME RWY 21

PORTLAND INTL (PDX)

<p>V Visibility reduction by helicopters NA.</p> <p>A</p>	<p>MISSED APPROACH: Climbing right turn to 4200 via BTG VORTAC R-160 to BTG VORTAC and hold, continue climb-in-hold to 4200.</p>
---	--

<p>ATIS 128.35 269.9</p>	<p>PORTLAND APP CON 124.35 299.2</p>	<p>PORTLAND TOWER Rwys 10L-28R 118.7 257.8</p>	<p>Rwys 3-21, 10R-28L 123.775 251.125</p>	<p>GND CON 121.9 348.6</p>	<p>CLNC DEL 120.125 318.1</p>
-------------------------------------	---	---	--	---------------------------------------	--

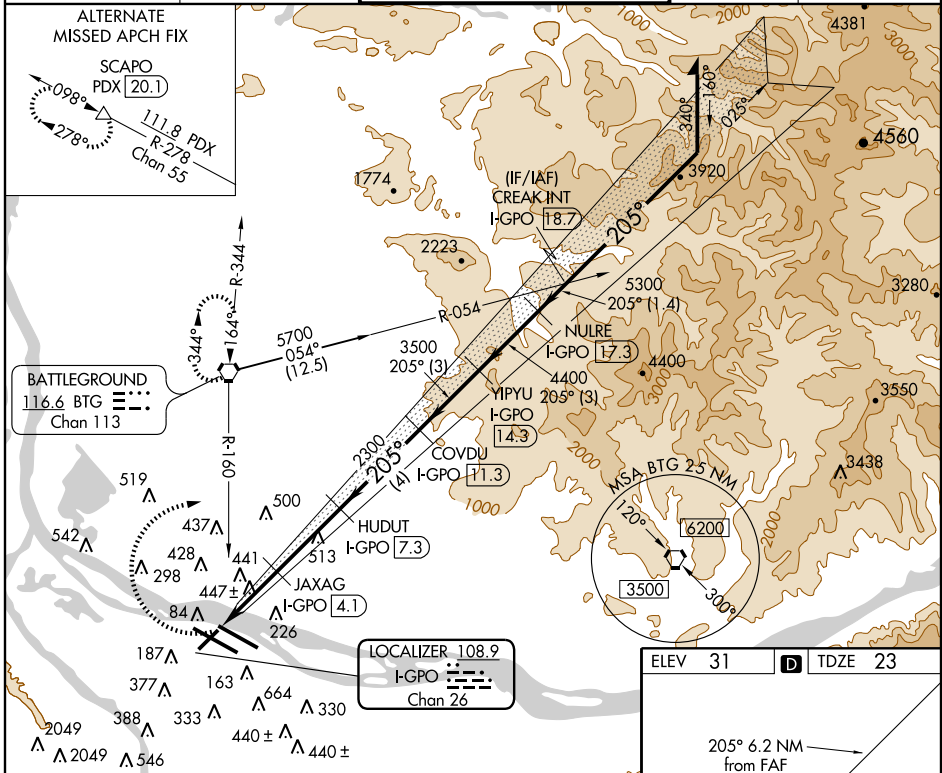

NW-1, 05 APR 2012 to 03 MAY 2012

NW-1, 05 APR 2012 to 03 MAY 2012

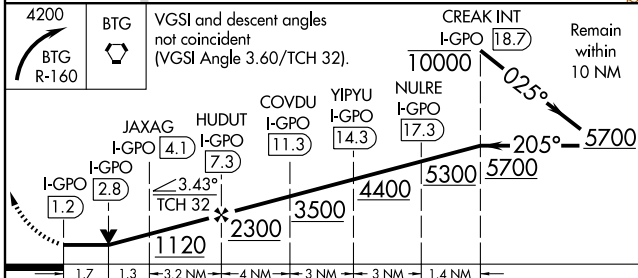

ELEV 31	D	TDZE 23
---------	----------	---------

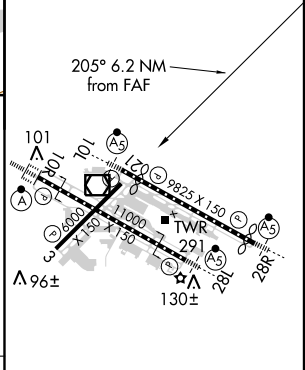

CATEGORY	A	B	C	D
S-21	700-1 677 (700-1)		700-2 677 (700-2)	700-2 1/4 677 (700-2 1/4)
CIRCLING	720-1 689 (700-1)	740-1 709 (800-1)	760-2 729 (800-2)	1000-3 969 (1000-3)

REIL Rwys 3 and 21
TDZ or CL Rwy 10L-28R and 10R-28L
MIRL Rwy 3-21
HIRL Rwys 10L-28R and 10R-28L

RNAV (GPS) Y RWY 15

BURLINGTON INTL (BTV)

APP CRS	Rwy Idg	7820
146°	TDZE	326
	Apt Elev	335

NA For inoperative MALSRS, increase LNAV Cat A and B visibility to RVR 5000 and Cat E visibility to 1½. When YGSI inoperative, Circling Rwy 1 NA at night. DME/DME RNP-0.3 NA.



MISSED APPROACH: Climb to 1000 then climbing right turn to 4500 direct NARUE WP and hold.

ATIS 123.8 269.9	BURLINGTON APP CON * 121.1 278.8	BURLINGTON TOWER * 118.3 (CTAF) 257.8	BURLINGTON RADIO 122.6 255.4	GND CON 119.15 348.6
----------------------------	--	--	--	--------------------------------

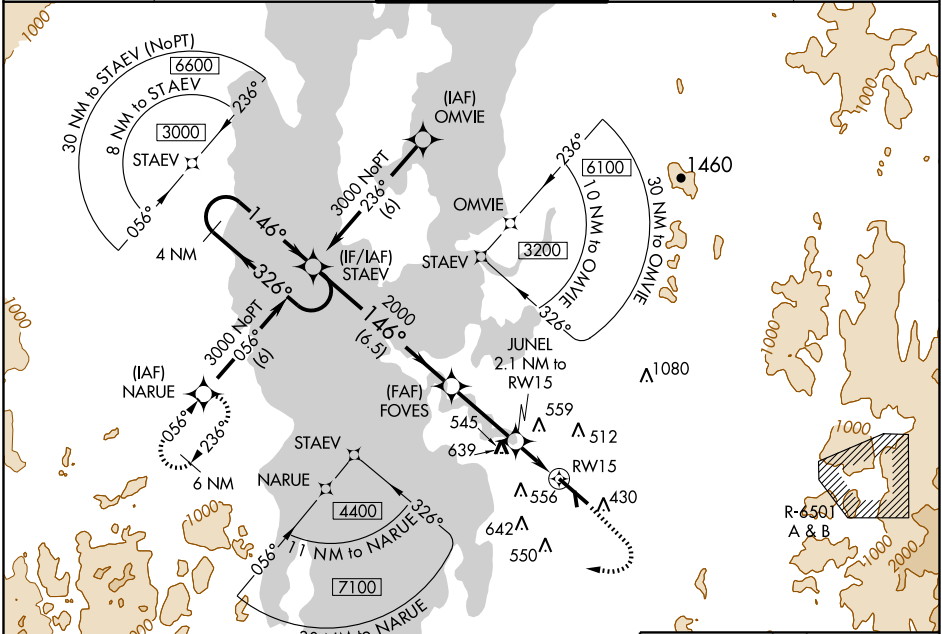

NE-1, 05 APR 2012 to 03 MAY 2012

NE-1, 05 APR 2012 to 03 MAY 2012

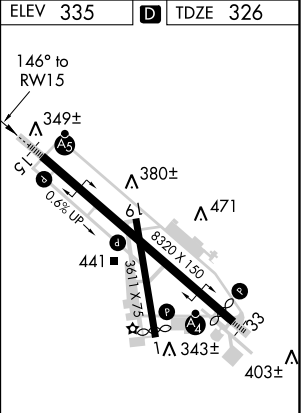
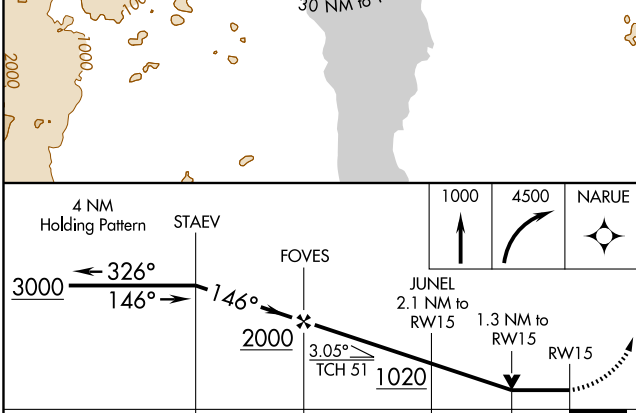

	4 NM Holding Pattern		STAEV	FOVES	JUNEL 2.1 NM to RW15	1.3 NM to RW15	RW15
CATEGORY	A	B	C	D	E		
LNAV MDA	760/40	434 (500-¾)	760/50	434 (500-1)			
CIRCLING	840-1 505 (600-1)	860-1 525 (600-1)	860-1½ 525 (600-1½)	1000-2 665 (700-2)	1280-3 945 (1000-3)		

MIRL Rwy 1-19
HIRL Rwy 15-33

LOC/DME I-VOE 110.3 Chan 40	APP CRS 326°	Rwy Idg TDZE Apt Elev 7820 335 335
--	------------------------	--

ILS or LOC/DME RWY 33

BURLINGTON INTL (BTV)

▼ Inoperative table does not apply to S-LOC 33 Cats C, D, and E. Inoperative table does not apply to S-ILS all Cats. **MALSF** MISSED APPROACH: Climb to 1200 then climbing left turn to 2800 direct BTV VOR/DME and hold, continue climb-in-hold to 2800.

ATIS 123.8 269.9	BURLINGTON APP CON * 121.1 278.8	BURLINGTON TOWER * 118.3 (CTAF) 257.8	BURLINGTON RADIO 122.6 255.4	GND CON 119.15 348.6
----------------------------	--	---	--	--------------------------------

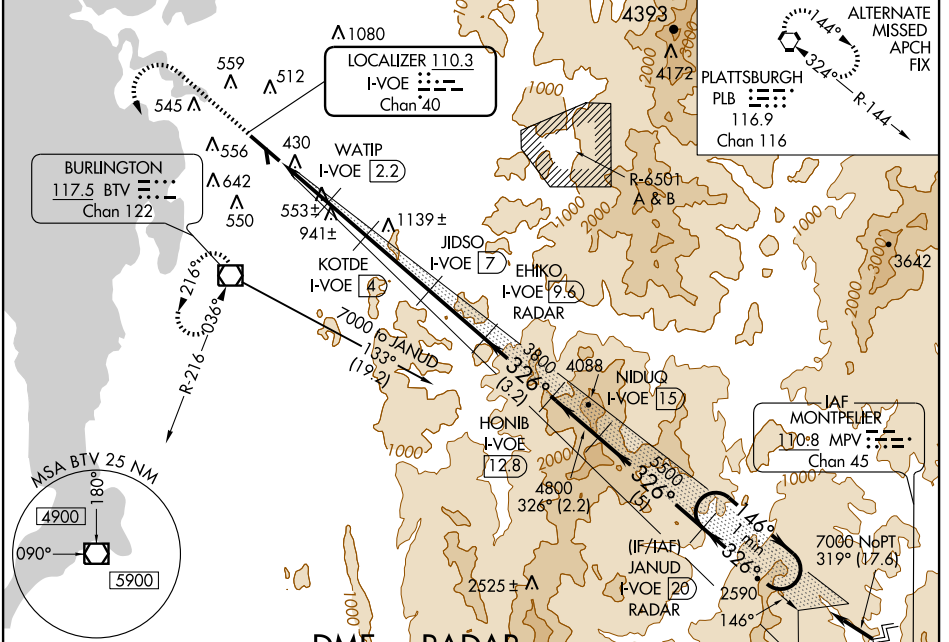

ELEV 335	TDZE 335
----------	----------

DME or RADAR REQUIRED

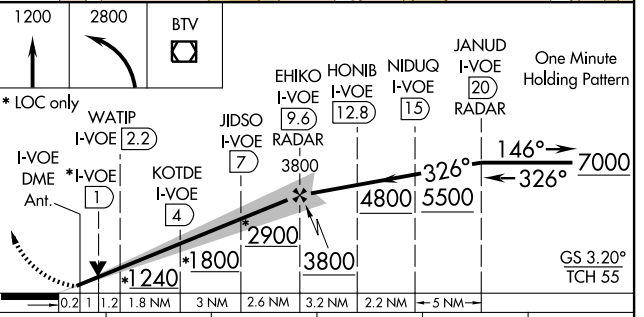
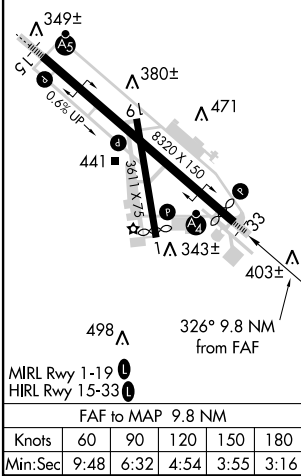

CATEGORY	A	B	C	D	E
S-ILS 33	535/40 200 (200-¾)		585/50 250 (300-1)		NA
S-LOC 33	820/40 485 (500-¾)		820/60 485 (500-1¼)	820-1½ 485 (500-1½)	820-1¾ 485 (500-1¾)
CIRCLING	840-1 505 (600-1)	860-1 525 (600-1)	860-1½ 525 (600-1½)	1000-2 665 (700-2)	1280-3 945 (1000-3)

NE-1, 05 APR 2012 to 03 MAY 2012

NE-1, 05 APR 2012 to 03 MAY 2012

APP CRS 311°	Rwy Idg TDZE Apt Elev	7820 335 335
------------------------	-----------------------------	---

RNAV (GPS) Y RWY 33

BURLINGTON INTL (BTV)

<p>When VGSI inop, circling to Rwy 1 NA at night. DME/DME RNP- 0.3 NA. Visibility reduction by helicopters NA.</p>	<p>MALS F</p>	<p>MISSED APPROACH: Climb to 3000 direct MANIF and via track 329° to STAEV and hold.</p>

ATIS 123.8 269.9	BURLINGTON APP CON * 121.1 278.8	BURLINGTON TOWER * 118.3 (CTAF) 0 257.8	BURLINGTON RADIO 122.6 255.4	GND CON 119.15 348.6
----------------------------	--	---	--	--------------------------------

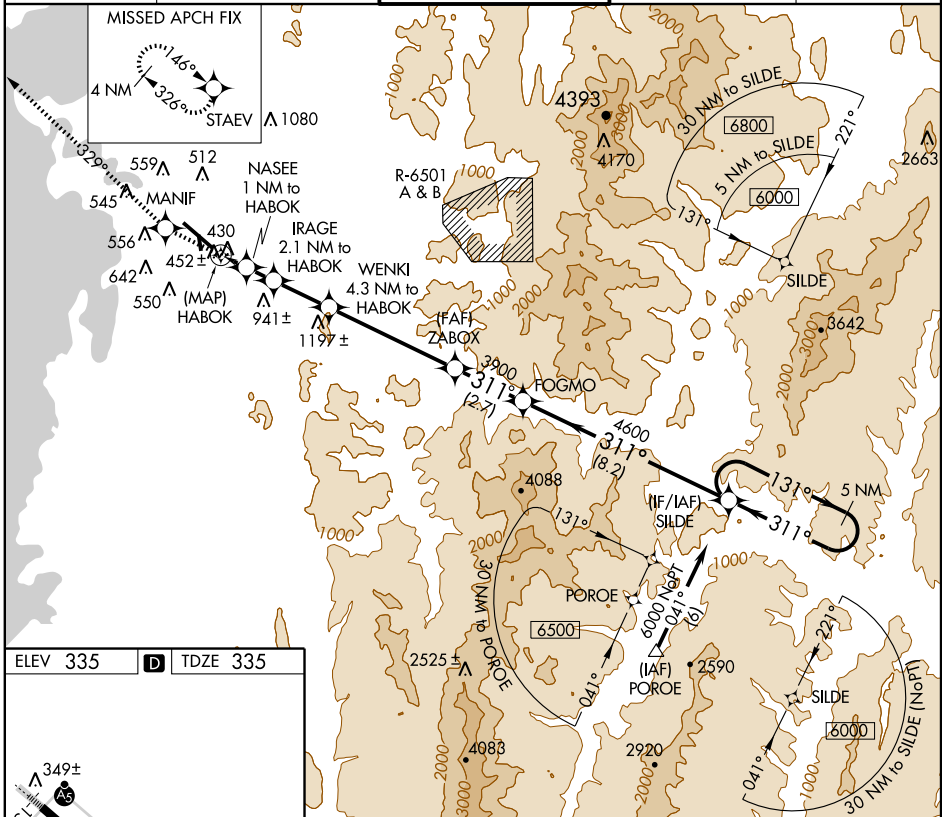

NE-1, 05 APR 2012 to 03 MAY 2012

NE-1, 05 APR 2012 to 03 MAY 2012

ELEV 335	D	TDZE 335
----------	----------	----------

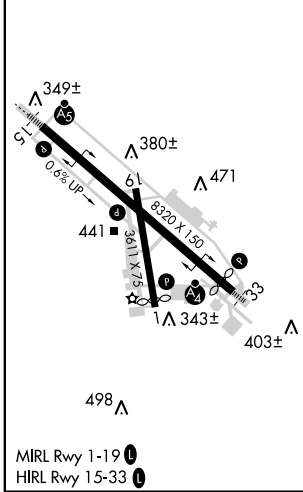

3000	MANIF	tr 329°	STAEV	WENKI 4.3 NM to HABOK	ZABOX	FOGMO	SILDE	5 NM Holding Pattern
				IRAGE 2.1 NM to HABOK				
				NASEE 1 NM to HABOK				
				HABOK HABOK				
				TCH 53	940	1320	2120	3900
								4600
								311°
								131°
								6000
								VGSI and descent angles not coincident. (VGSI Angle 3.20/TCH 53).
								0.5 1 NM 1.1 NM 2.2 NM 5 NM 2.7 NM 8.2 NM
CATEGORY	A	B	C	D	E			
LNAV MDA	720/40	385 (400-¾)	720/60	385 (400-1½)				
CIRCLING	840-1 505 (600-1)	860-1 525 (600-1)	860-1½ 525 (600-1½)	1000-2 665 (700-2)	1280-3 945 (1000-3)			

Figure 287

BURLINGTON SIX DEPARTURE

ATIS
123.8 269.9
BURLINGTON GND CON
119.15 348.6
BURLINGTON TOWER ★
118.3 257.8
BURLINGTON DEP CON
121.1 278.8
BURLINGTON RADIO
122.6 255.4

ST JEAN
115.8 YJN
Chan 105
N45°15.35'-W73°19.28'
L-32, H-11-12

SHERBROOKE
113.2 YSC
Chan 79
N45°18.99'-W71°47.29'
L-32, H-11

BANGOR
114.8 BGR
Chan 95
N44°50.51'
W68°52.44'
L-32, H-11

BERLIN
110.4 BML
Chan 41
N44°38.00'
W71°11.17'
L-32

PLATTSBURGH
116.9 PLB
Chan 116
N44°41.10'-W73°31.36'
L-32, H-11-12

MASSENA
114.1 MSS
Chan 88
N44°54.86'
W74°43.36'
L-32, H-11-12

SARANAC LAKE
109.2 SLK
Chan 29
N44°23.07'
W74°12.27'
L-32

BURLINGTON
117.5 BTV
Chan 122
N44°23.83'
W73°10.95'
L-32, H-11-12

MONTPELIER
110.8 MPV
Chan 45
N44°05.13'-W72°26.96'
L-32

LEBANON
113.7 LEB
Chan 84
N43°40.73'
W72°12.96'
L-32

WATERTOWN
109.8 ART
Chan 35
N43°57.13'
W76°03.88'
L-32, H-11-12

GLENS FALLS
110.2 GFL
Chan 39
N43°20.50'
W73°36.71'
L-32

KEENE
109.4 EEN
Chan 31
N42°47.66'
W72°17.51'
L-32-33,
H-11-12

SYRACUSE
117.0 SYR
Chan 117
N43°09.63'
W76°12.27'
L-32, H-11-12

CAMBRIDGE
115.0 CAM
Chan 97
N42°59.66'
W73°20.64'
L-32-34, H-11-12

ALBANY
115.3 ALB
Chan 100
N42°44.84'-W73°48.19'
L-32-33-34, H-10-11-12

TAKEOFF MINIMUMS:

- Rwy 1: Standard with minimum climb of 360' per NM to 6000.
- Rwy 15: Standard with minimum climb of 375' per NM to 5900.
- Rwy 19: Standard with minimum climb of 345' per NM to 5900.
- Rwy 33: Standard with minimum climb of 340' per NM to 5900.

NOTE: Radar required.

NOTE: Chart not to scale

(NARRATIVE ON FOLLOWING PAGE)

NE-1, 05 APR 2012 to 03 MAY 2012

NE-1, 05 APR 2012 to 03 MAY 2012

BURLINGTON SIX DEPARTURE



DEPARTURE ROUTE DESCRIPTION

TAKEOFF RUNWAYS 1, 15, 19, 33: Climb on assigned heading for vectors to filed navaid, fix, or airway to 10000 or assigned lower altitude. Expect filed altitude ten minutes after departure.

TAKEOFF OBSTACLE NOTES:

- Rwy 1: Trees beginning 1396' from DER, 216' right of centerline, up to 64' AGL/384' MSL.
Trees 1694' from DER, 200' left of centerline, up to 80' AGL/380' MSL.
- Rwy 15: Bush 318' from DER, 292' left of centerline, up to 23' AGL/343' MSL.
Trees beginning 1418' from DER, 358' right of centerline, up to 27' AGL/387' MSL.
Hopper and trees beginning 1801' from DER, 377' left of centerline, up to 63' AGL/403' MSL.
Building 3453' from DER, 1145' left of centerline, 110' AGL/430' MSL.
- Rwy 19: Trees beginning 168' from DER, 24' right of centerline, up to 56' AGL/436' MSL.
Trees beginning 172' from DER, 184' left of centerline, up to 93' AGL/413' MSL.
- Rwy 33: Pole and trees beginning 971' from DER, 755' left of centerline, up to 97' AGL/357' MSL.
Trees beginning 1091' from DER, 590' right of centerline, up to 34' AGL/334' MSL.

NE-1, 05 APR 2012 to 03 MAY 2012

NE-1, 05 APR 2012 to 03 MAY 2012

PHILADELPHIA, PENNSYLVANIA

AL-320 (FAA)

ILS PRM RWY 26 (SIMULTANEOUS CLOSE PARALLEL)

PHILADELPHIA INTL (PHL)

LOC/DME I-LLH 111.55	APP CRS 263°	Rwy Idg 5000
Chan 52(Y)		THRE 36
		Apt Elev 36

Simultaneous Close Parallel approach authorized with ILS PRM Rwy 27L. Procedure NA when glideslope not available. Dual VHF Comm Required. See additional requirements on AAUP. Visibility reduction by helicopters NA.



MISSED APPROACH: Climb to 800 then climbing right turn to 3000 on heading 310° and OOD VORTAC R-353 to FROSE INT/ MXE VORTAC 12.6 DME and hold.

ATIS ARR 133.4 DEP 135.925	PHILADELPHIA APP CON 124.35 319.15	PHILADELPHIA TOWER 118.5 327.05 (Rwys 9L/27R, 8/26 and 17/35) 135.1 327.05 (Rwy 9R/27L) PRM 123.6	GND CON 121.9 348.6	CLNC DEL 118.85 348.6
--	--	---	-------------------------------	---------------------------------

RADAR REQUIRED

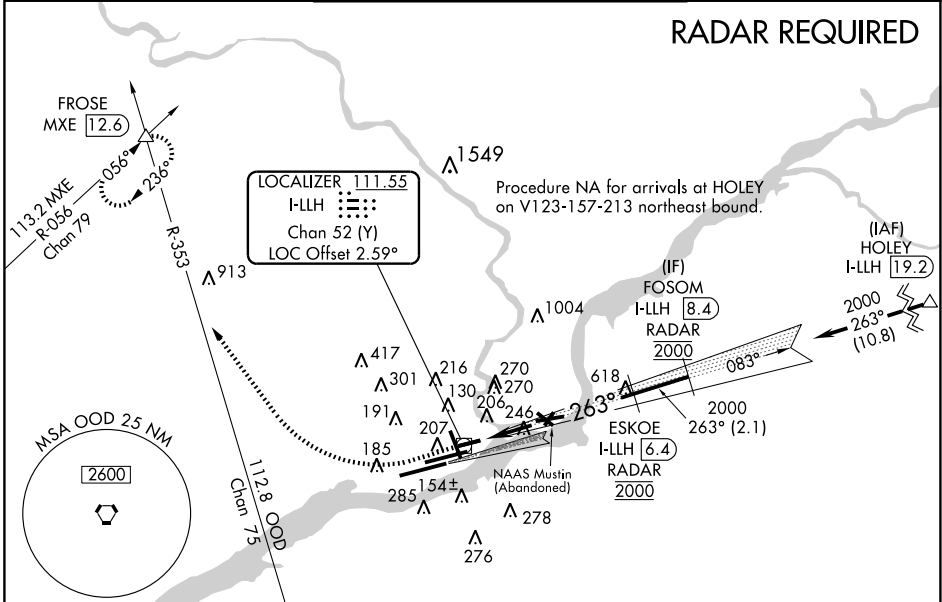

NE-4, 05 APR 2012 to 03 MAY 2012

NE-4, 05 APR 2012 to 03 MAY 2012

ELEV 36	D	THRE 36
---------	----------	---------

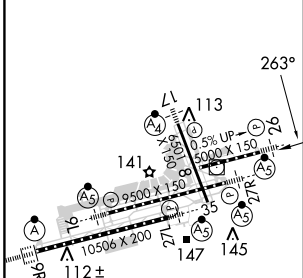

ALTERNATE MISSED APCH FIX

POTTSTOWN
PTW ILLH 116.5
Chan 112 R-152

800	3000	OOD R-353	FROSE	ESKOE I-LLH 6.4 RADAR	FOSOM I-LLH 8.4 RADAR
-----	------	-----------	-------	-----------------------	-----------------------

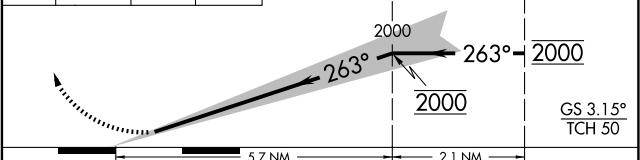

REIL Rwys 9L and 35
TDZ/CL Rwy 9R
HIRL all Rwys

CATEGORY	A	B	C	D
S-ILS 26	299/40	263 (300-34)		NA

PHILADELPHIA, PENNSYLVANIA

39°52'N - 75°14'W

PHILADELPHIA INTL (PHL)

Amdt 4 25AUG11

ILS PRM RWY 26 (SIMULTANEOUS CLOSE PARALLEL) Figure 290

ATTENTION ALL USERS OF ILS PRECISION RUNWAY MONITOR (PRM)

Condensed Briefing Point:

*When instructed, immediately switch to the tower frequency and select the monitor frequency audio.

1. **ATIS.** When the ATIS broadcast advises that simultaneous ILS/PRM and LDA/PRM approaches are in progress, pilots should brief to fly the ILS/PRM 26 approach. If later advised to expect an ILS 26 approach, the ILS/PRM 26 chart may be used after completing the following briefing items:

- (a) Minimums and missed approach procedures are unchanged.
- (b) Monitor frequency no longer required.

2. **Dual VHF Communication required.** To avoid blocked transmissions, each runway will have two frequencies, a primary and a monitor frequency. The tower controller will transmit on both frequencies. The monitor controller's transmissions, if needed, will override both frequencies. Pilots will **ONLY** transmit on the tower controller's frequency, but will listen to both frequencies. Select the monitor frequency audio only when instructed by ATC to contact the tower. The volume levels should be set about the same on both radios so that the pilots will be able to hear transmissions on at least one frequency if the other is blocked.

3. **ALL "Breakouts"** are to be hand flown to assure that the maneuver is accomplished in the shortest amount of time. Pilots, when directed by ATC to break off an approach, must assume that an aircraft is blundering toward their course and a breakout must be initiated immediately.

(a) ATC Directed "Breakouts": ATC directed breakouts will consist of a turn and a climb or descent. Pilots must always initiate the breakout in response to an air traffic controller instruction. Controllers will give a descending breakout only when there are no other reasonable options available, but in no case will the descent be below minimum vectoring altitude (MVA) which provides at least 1000 feet required obstruction clearance. The MVA in the final approach segment is 1800 feet at Philadelphia Intl Airport.

(b) Phraseology - "TRAFFIC ALERT": If an aircraft enters the "NO TRANSGRESSION ZONE" (NTZ), the controller will breakout the threatened aircraft on the adjacent approach. The phraseology for the breakout will be:

"TRAFFIC ALERT, (aircraft call sign) TURN (left/right) IMMEDIATELY, HEADING (degrees), CLIMB/DESCEND AND MAINTAIN (altitude)".

4. **ILS Navigation** Descending on ILS glideslope ensures complying with any charted crossing restrictions.

Special pilot training required. Pilots who are unable to participate will be afforded appropriate arrival services as operational conditions permit and must notify the controlling ARTCC as soon as practical, but at least 100 miles from destination.

NE-4, 05 APR 2012 to 03 MAY 2012

NE-4, 05 APR 2012 to 03 MAY 2012

LOC/DME I-GDI 108.5 Chan 22	APP CRS 134°	Rwy Idg TDZE 12 Apt Elev 21	7003
---	------------------------	---	-------------

ILS or LOC RWY 13

NEW YORK/LA GUARDIA (LGA)

⚠ When VGSI inoperative, Circling Rwy 31 NA at night. DME or RADAR required.
**** RVR 1800 authorized with use of FD or AP or HUD to DA.**

MALS  MISSED APPROACH: Climb to 800 then climbing left turn to 2000 via LGA VOR/DME R-043 to GREKO INT/ LGA 5.7 DME and hold, continue climb-in-hold to 2000.

ATIS ARR 125.95	NEW YORK APP CON 120.8 263.0	LA GUARDIA TOWER 118.7 263.0	GND CON 121.7 263.0	CLNC DEL 135.2
ATIS DEP 127.05				

RADAR REQUIRED

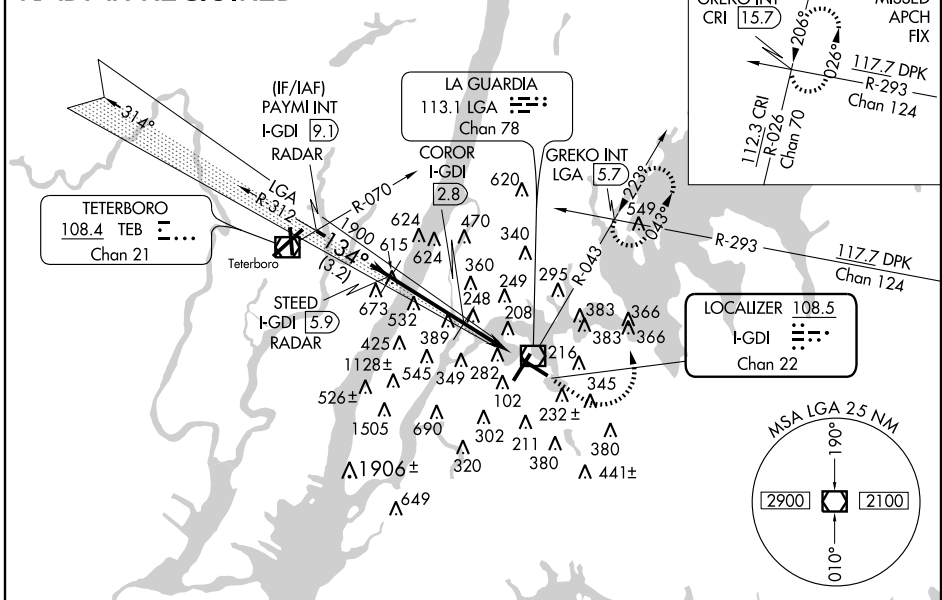

NE-2, 05 APR 2012 to 03 MAY 2012

NE-2, 05 APR 2012 to 03 MAY 2012

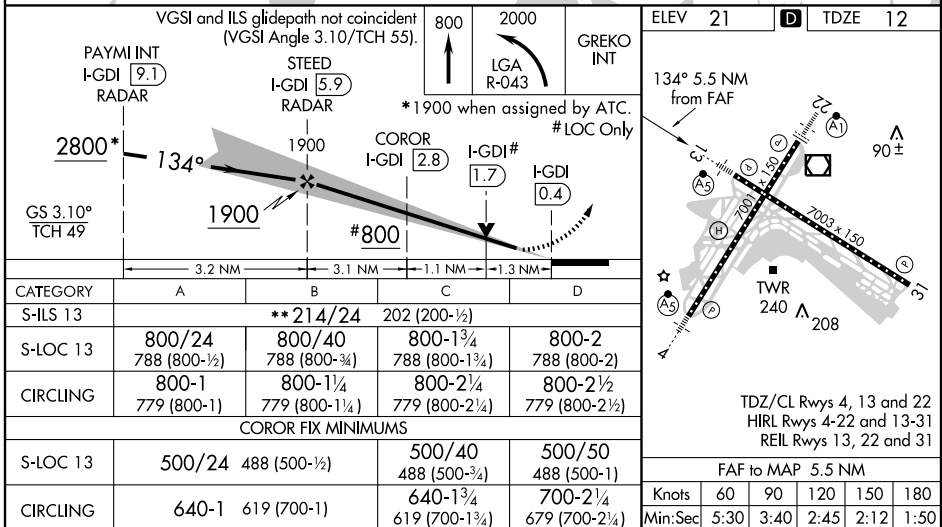

VOR or GPS RWY 13L/13R

NEW YORK / JOHN F. KENNEDY INTL (JFK)

VOR/DME CRI 112.3 Chan 70	APP CRS 041°	Rwy Idg 13R 12468 13L 9095 TDZE 13 Apt Elev 13
--	------------------------	---

<p>For inoperative LDIN, procedure not authorized.</p>	<p>Rwy 13L ALSF-2</p>	<p>MISSED APPROACH: At or beyond MAP, climbing right turn to 4000 via heading 100° and V-16 to DPK VOR/DME and hold.</p>
--	-----------------------	--

ATIS (ARR-NE) (ARR-SW) 128.725 117.7 115.4	NEW YORK APP CON 127.4 269.0	KENNEDY TOWER Rwys 4R/22L and 13L/31R 119.1 281.55 Rwys 4L/22R and 13R/31L 123.9 281.55	GND CON 121.9 348.6	CLNC DEL 135.05 348.6
--	--	---	-------------------------------	---------------------------------

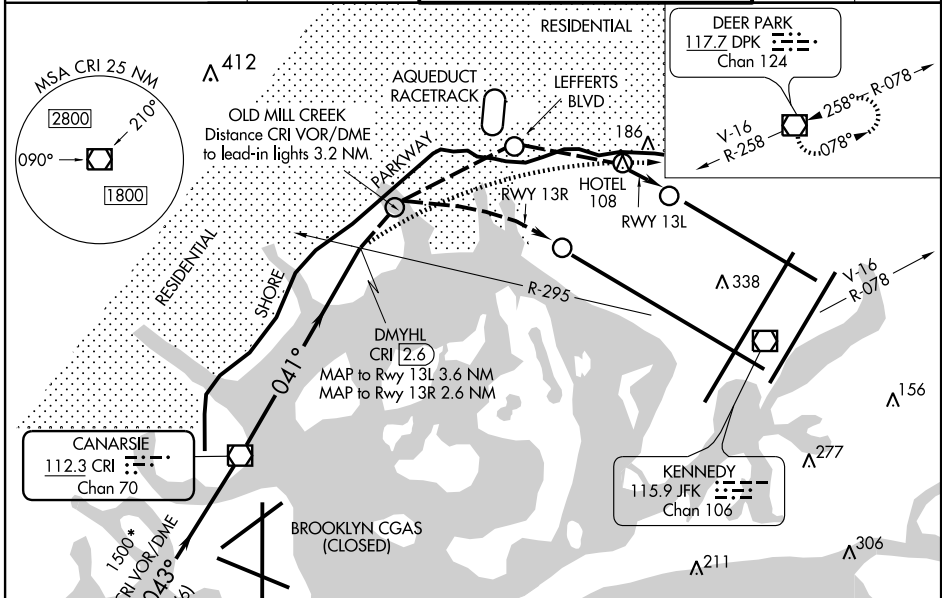

DME or RADAR REQUIRED

○ Lead-in light clusters

When visual reference established, fly visual to airport via lead-in lights to Rwy 13L or 13R. Close adherence to flight track required for noise abatement.

*1000 minimum when authorized by ATC.

† 2000 minimum when authorized by ATC.

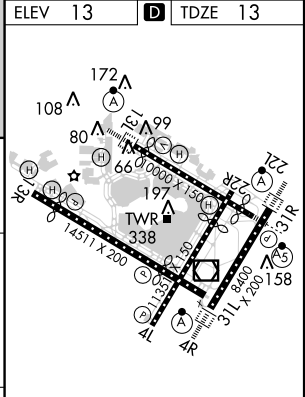
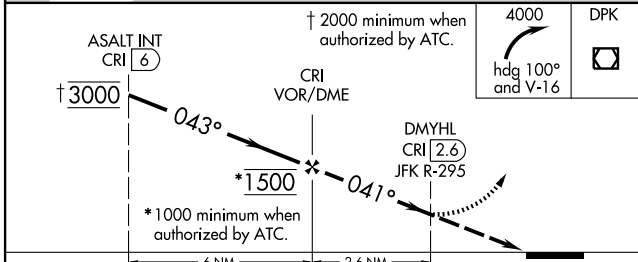

CATEGORY	A	B	C	D
LDIN-13L	800-2 787 (800-2)	800-2 1/4 787 (800-2 1/4)	800-2 1/4 787 (800-2 1/4)	800-2 1/2 787 (800-2 1/2)
LDIN-13R	800-2 787 (800-2)	800-2 1/4 787 (800-2 1/4)	800-2 1/2 787 (800-2 1/2)	800-2 1/2 787 (800-2 1/2)

HIRL all Rwys

TDZ/CL Rws 4R, 13L, 31R and 22L

FAF to MAP 2.6 NM

Knots	60	90	120	150	180
Min:Sec	2:36	1:44	1:18	1:02	0:52

VOR or GPS RWY 13L/13R

Figure 293

NE-2, 05 APR 2012 to 03 MAY 2012

NE-2, 05 APR 2012 to 03 MAY 2012

COPTER RNAV (GPS) 028°

NEW YORK/ JOHN F. KENNEDY INTL (JFK)

APP CRS 028°	Rwy Idg TDZE Apt Elev	N/A N/A N/A
------------------------	-----------------------------	-------------------

▲ NA Proceed VFR from HELOG WP or conduct the specified missed approach. Limit final and missed approach airspeed to 70 KIAS. Use John F. Kennedy Intl altimeter setting.

MISSED APPROACH: Climbing left turn to 1800 direct COVER WP and hold.

ATIS ARR-NE 128.725	ARR-SW 115.4	NEW YORK APP CON 127.4 269.0
----------------------------------	------------------------	--

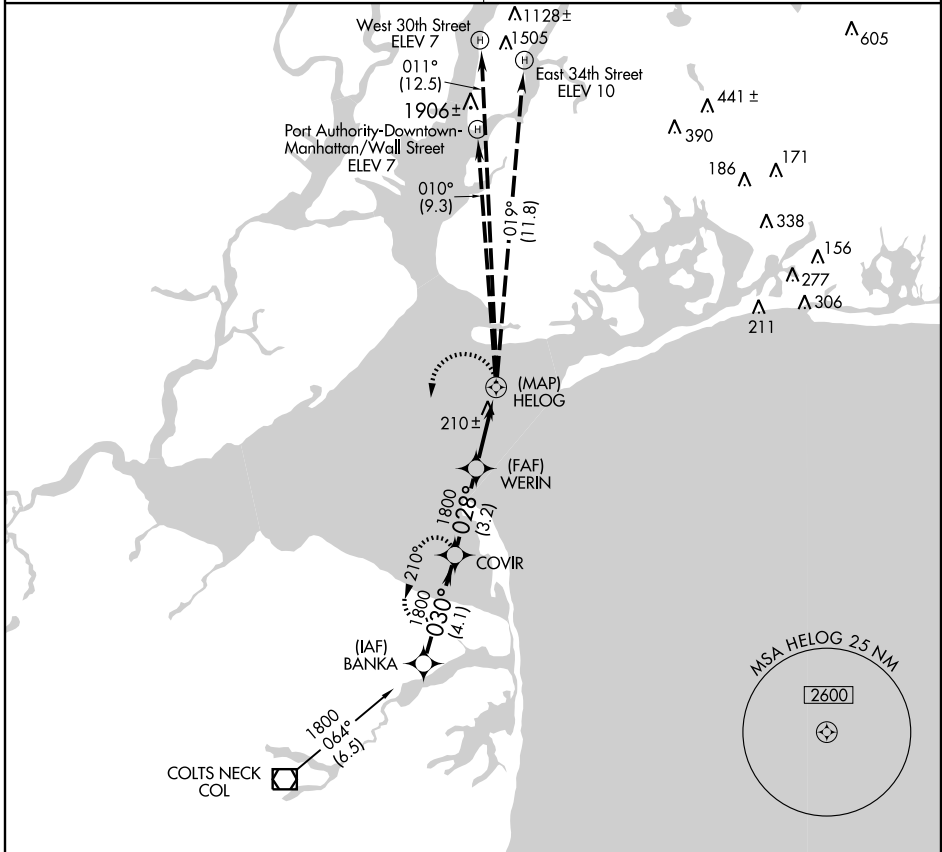

NE-2, 05 APR 2012 to 03 MAY 2012

NE-2, 05 APR 2012 to 03 MAY 2012

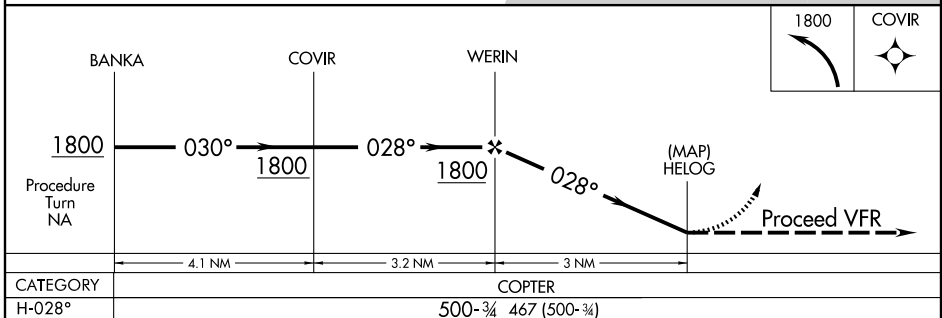

CATEGORY	COPTER	
H-028°	500-¾ 467 (500-¾)	

Figure 294

LOC I-IVI 111.1	APP CRS 058°	Rwy Idg TDZE Apt Elev	5500 2402 2417
---------------------------	------------------------	-----------------------------	---

ILS or LOC RWY 6R

TUCSON/RYAN FIELD (RYN)

<p>▼ ▲ NA</p>	<p>MISSED APPROACH: Climb to 3000, then climbing right turn to 5000 via direct RBJ NDB and 305° bearing RBJ to DRIBB Int and hold.</p>		
<p>AWOS-3 133.35</p>	<p>TUCSON APP CON 128.5 395.9</p>	<p>RYAN TOWER★ 125.8 (CTAF) 0</p>	<p>GND CON 118.2</p>

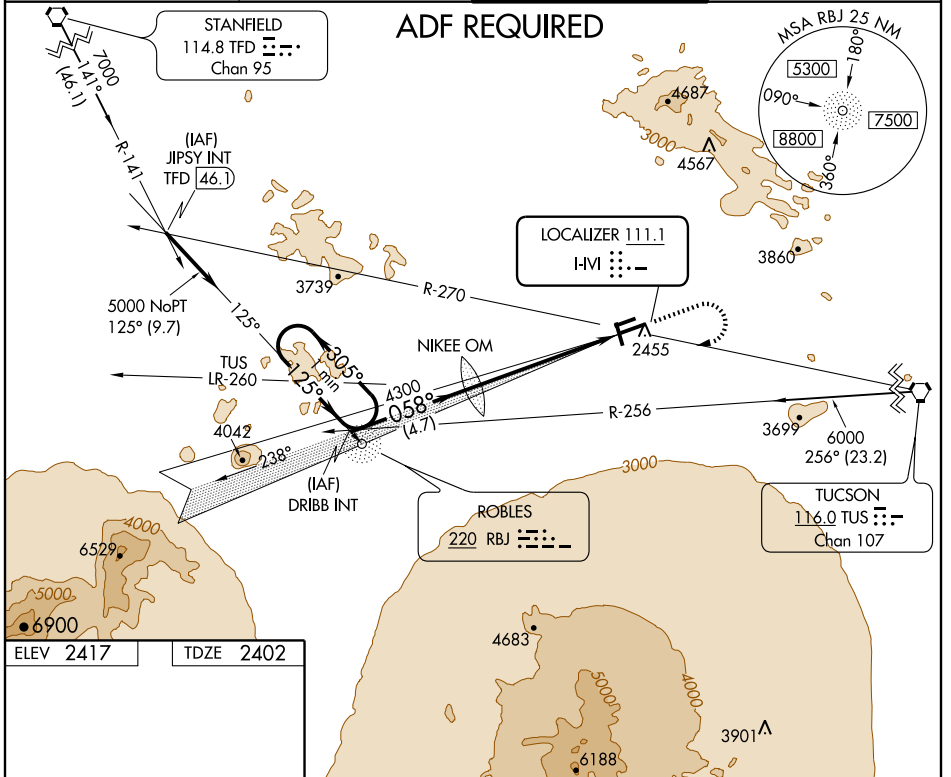

SW-4, 05 APR 2012 to 03 MAY 2012

SW-4, 05 APR 2012 to 03 MAY 2012

ELEV 2417	TDZE 2402
-----------	-----------

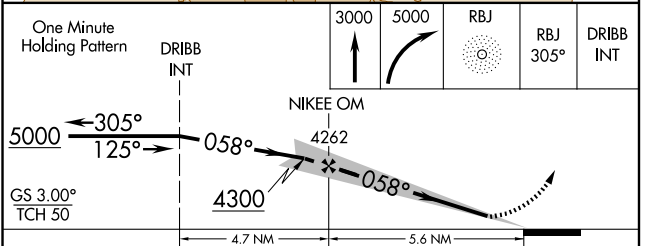
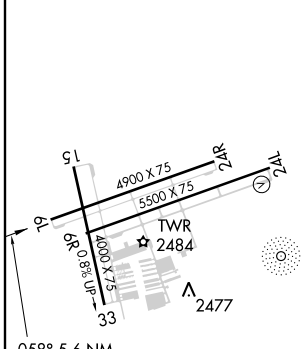

FAF to MAP 5.1 NM	REIL Rwy 6R	MIRL Rwy 6R-24L			
Knots	60	90	120	150	180
Min:Sec	5:06	3:24	2:33	2:02	1:42
CATEGORY	A	B	C	D	
S-ILS 6R	2652-1				250 (300-1)
S-LOC 6R	2900-1	498 (500-1)	2900-1¼ 498 (500-1¼)	2900-1½ 498 (500-1½)	
CIRCLING	2900-1	483 (500-1)	2900-1½ 483 (500-1½)	2980-2 563 (600-2)	

Figure 295

NDB/DME or GPS RWY 6R

TUCSON/ RYAN FIELD (RYN)

NDB RYN 338	APP CRS 074°	Rwy Idg TDZE Apt Elev	5500 2400 2415
-----------------------	------------------------	-----------------------------	---

NA DME from TUS VORTAC. Simultaneous reception of RYN NDB and TUS DME required.

MISSED APPROACH: Climb to 5000 direct RYN NDB and hold.

AWOS-3 133.35	TUCSON APP CON 128.5 395.9	RYAN TOWER ★ 125.8 (CTAF) 0	GND CON 118.2
-------------------------	--------------------------------------	---------------------------------------	-------------------------

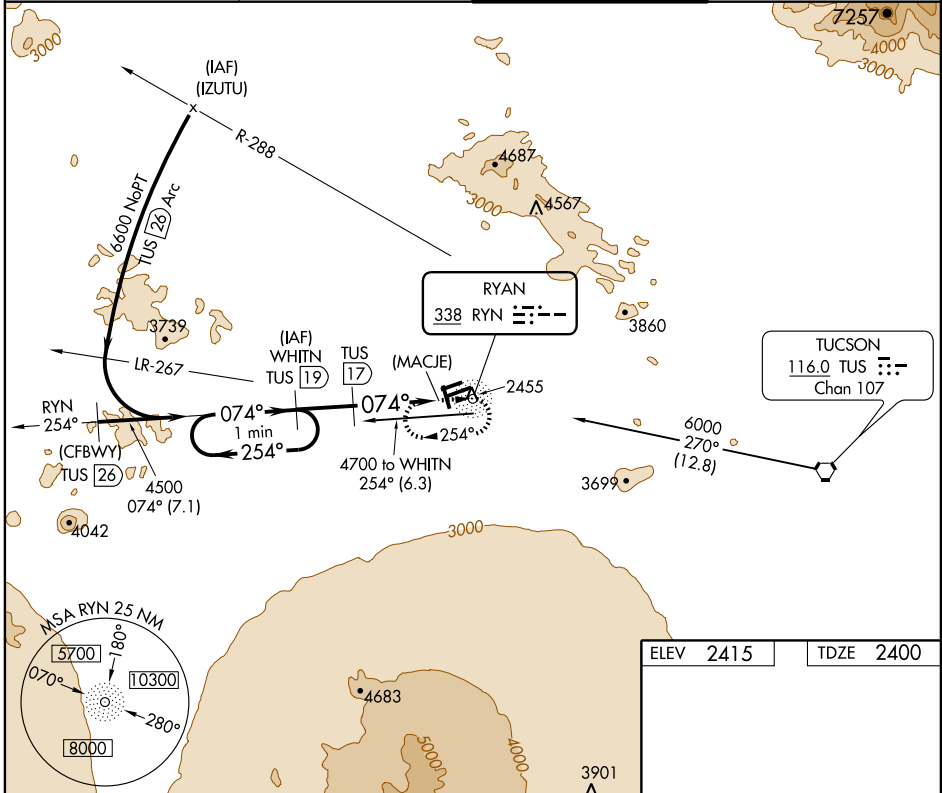

SW-4, 05 APR 2012 to 03 MAY 2012

SW-4, 05 APR 2012 to 03 MAY 2012

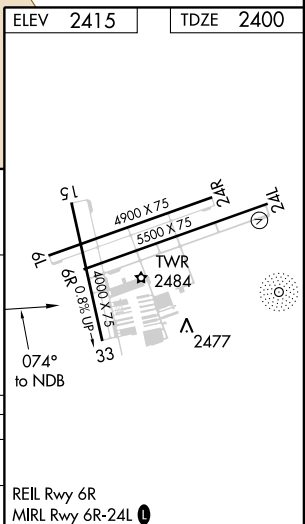
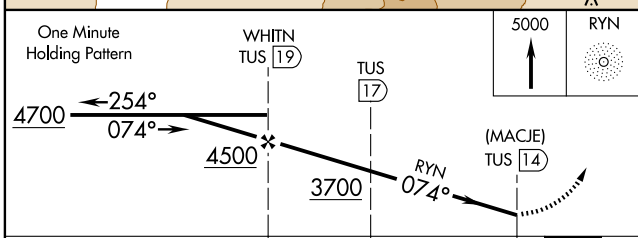

CATEGORY	A	B	C	D
S-6R	3300-1¼ 900 (900-1¼)		3300-2¾ 900 (900-2¾)	3300-3 900 (900-3)
CIRCLING	3300-1¼ 885 (900-1¼)		3300-2¾ 885 (900-2¾)	3300-3 885 (900-3)

LOC/DME I-SPT 111.9 Chan 56	APP CRS 079°	Rwy Idg 12793 TDZE 5320 Apt Elev 5355
---	------------------------	--

ILS or LOC RWY 8

ALBUQUERQUE INTL SUNPORT (ABQ)

ASR	MALSR	MISSED APPROACH: Climb to 5800 then climbing right turn to 8000 direct ABQ VORTAC and hold.
-----	-------	---

ATIS 118.0 257.7	ALBUQUERQUE APP CON 123.9 354.1	ALBUQUERQUE TOWER 120.3 351.9	GND CON 121.9 348.6	CLNC DEL 119.2 259.3
----------------------------	---	---	-------------------------------	--------------------------------

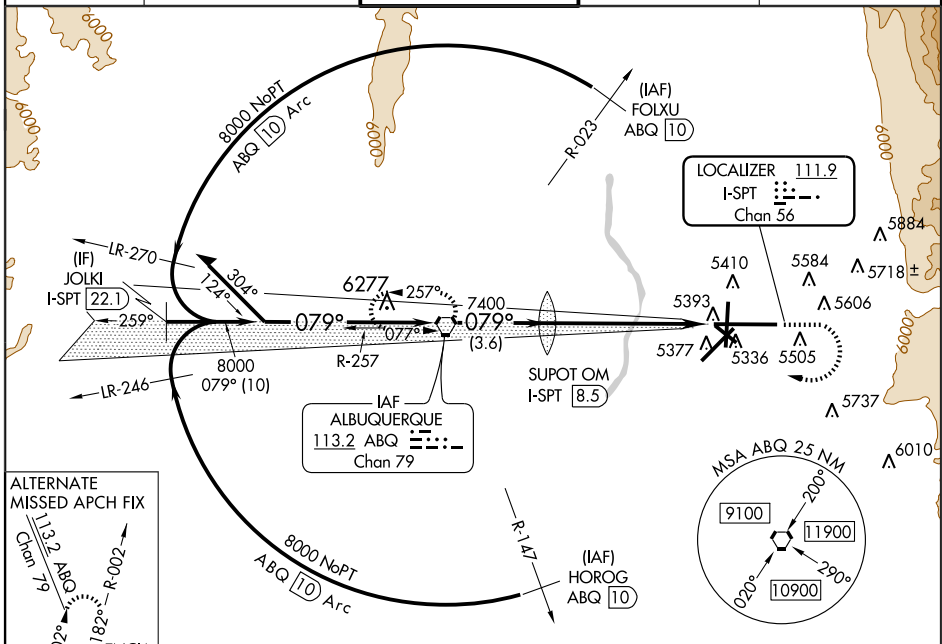

SW-1, 05 APR 2012 to 03 MAY 2012

SW-1, 05 APR 2012 to 03 MAY 2012

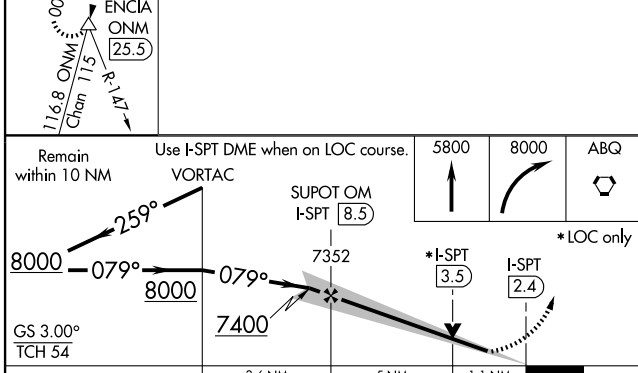

ELEV 5355		TDZE 5320
-----------	--	-----------

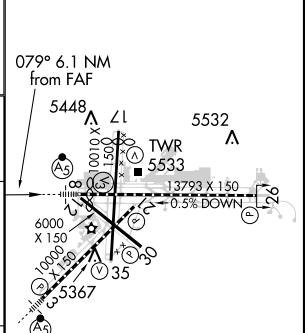

CATEGORY	A	B	C	D		
S-ILS 8	5522/18 202 (200-½)					
S-LOC 8	5720/24	400 (400-½)	5720/40 400 (400-¾)			
CIRCLING	5840-1 485 (500-1)	5900-1½ 545 (600-1½)	5920-2 565 (600-2)			
	TDZ/CL Rwys 3 and 8 HIRL Rwys 3-21 and 8-26 MIRL Rwys 12-30 and 17-35 REIL Rwys 3, 17, 21, 26, 30 and 35 FAF to MAP 6.1 NM					
	Knots	60	90	120	150	180
	Min:Sec	6:06	4:04	3:03	2:26	2:02

Figure 297

ILS RWY 22

ALBUQUERQUE/ DOUBLE EAGLE II (A/E/G)

LOC I-AEG 110.1	APP CRS 215°	Rwy Idg TDZE Apt Elev 7398 5817 5837
---------------------------	------------------------	--

<p>NA Autopilot coupled approaches not authorized. For inoperative MALSRL, increase S-LOC 22 Cat D visibility to 1.</p>	<p>MALSRL</p>	<p>MISSED APPROACH: Climb to 6500 then climbing right turn to 8000 direct Duddle LOM and hold.</p>
--	---------------	--

AWOS-3 119.025	ALBUQUERQUE APP CON 127.4 253.5	DOUBLE EAGLE II TOWER * 120.15 (CTAF) 0	GND CON 121.625	ALBUQUERQUE CLNC DEL 124.8 (When tower closed)
--------------------------	---	---	---------------------------	--

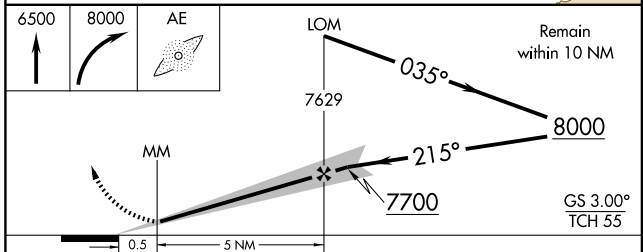
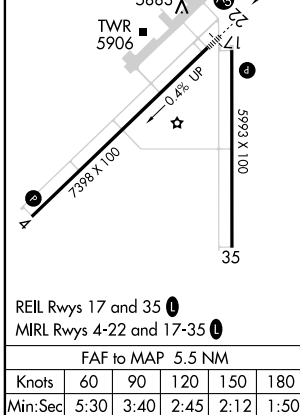
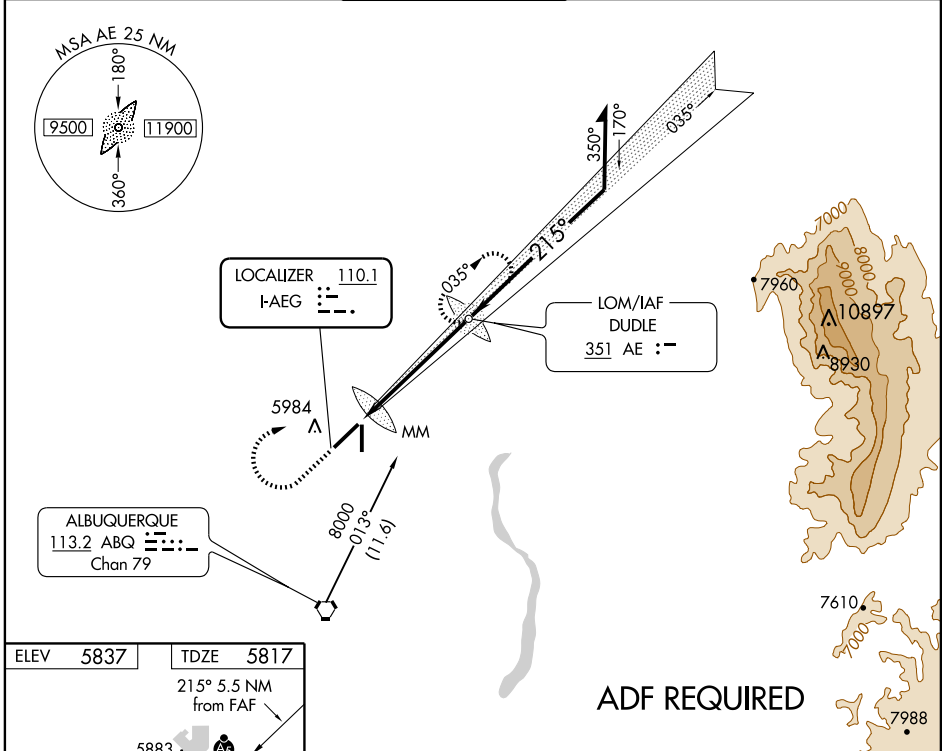

CATEGORY	A	B	C	D
S-ILS 22	6017-½ 200 (200-½)			
S-LOC 22	6140-½ 323 (400-½)		6140-¾ 323 (400-¾)	
CIRCLING	6400-1 563 (600-1)		6400-1½ 563 (600-1½)	

SW-1, 05 APR 2012 to 03 MAY 2012

SW-1, 05 APR 2012 to 03 MAY 2012

ILS or LOC RWY 16

CHICAGO EXECUTIVE (PWK)

LOC I-PWK 111.9	APP CRS 161°	Rwy Idg 5001
		TDZE 643
		Apt Elev 647

⚠ If local altimeter setting not received, use Chicago-O'Hare Intl altimeter setting and increase all DAs 22 feet, and all visibilities 1/4 mile; increase all MDAs 40 feet, and S-LOC Cat C and D visibilities 1/4 mile. Visibility reduction by helicopters NA.

MISSED APPROACH: Climb to 1400 then climbing left turn to 2700 direct OBK VOR/DME and hold.

ATIS 124.2	CHICAGO APP CON 120.55 290.2	EXECUTIVE TOWER * 119.9 (CTAF) 0	GND CON 121.7	CLNC DEL 124.7	UNICOM 122.95
----------------------	--	--	-------------------------	--------------------------	-------------------------

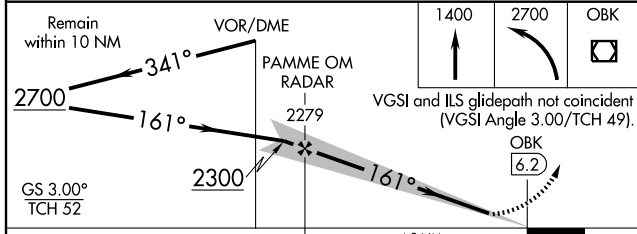
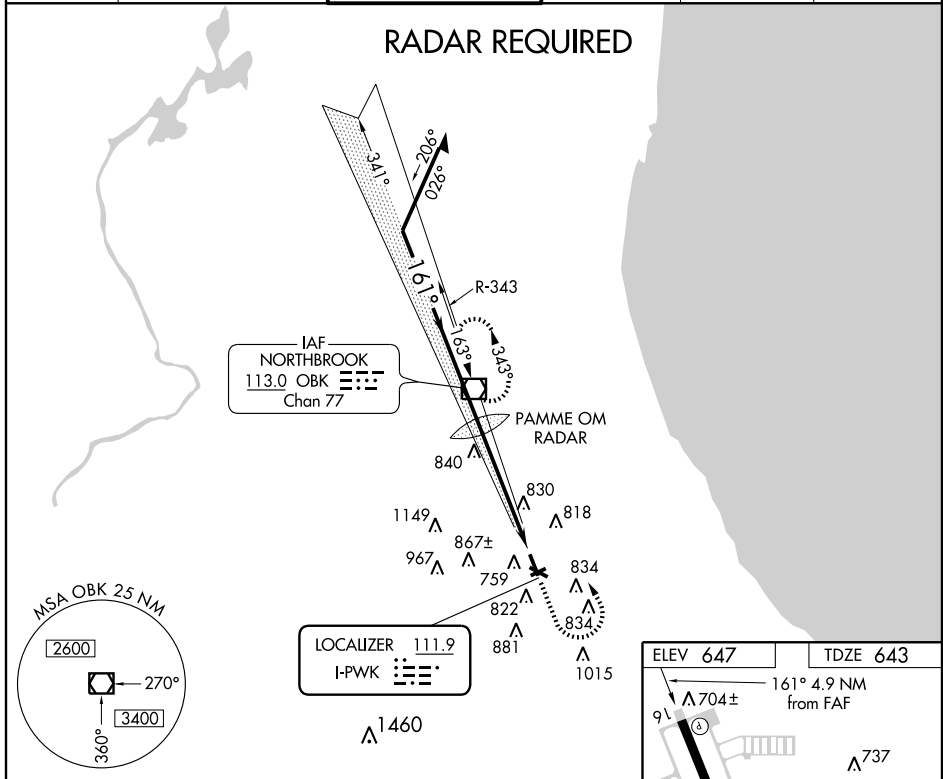

CATEGORY	A	B	C	D
S-ILS 16	893-3/4 250 (300-3/4)			
S-LOC 16	1140-1 497 (500-1)	1140-1 497 (500-1/4)	1140-1 497 (500-1/2)	1140-1 497 (500-1)
CIRCLING	1140-1 493 (500-1)	1140-1 493 (500-1/2)	1140-1 553 (600-2)	1200-2

Knots	60	90	120	150	180
Min:Sec	4:54	3:16	2:27	1:58	1:38

FAF to MAP 4.9 NM

HIRL all Rwy's 1

REIL Rwy's 16 and 34 1

LDIN Rwy 16 1

701±

EC-3, 05 APR 2012 to 03 MAY 2012

EC-3, 05 APR 2012 to 03 MAY 2012

LOC/DME I-BNQ 109.95 Chan 36 (Y)	APP CRS 316°	Rwy Idg TDZE Apt Elev 6121 714 728
--	------------------------	--

ILS or LOC/DME RWY 32

BUFFALO NIAGARA INTL (BUF)

ATIS 135.35		BUFFALO APP CON 126.15 263.125	BUFFALO TOWER 120.5 257.8	GND CON 133.2 257.8	CLNC DEL 124.7 257.8
------------------------------	--	---	--	--------------------------------------	---------------------------------------

MALSRL 		MISSED APPROACH: Climb to 1200 then climbing left turn to 3000 via heading 245° and BUF R-267 to WELLA INT/BUF 23.1 DME and hold.			
--	--	--	--	--	--

DME REQUIRED

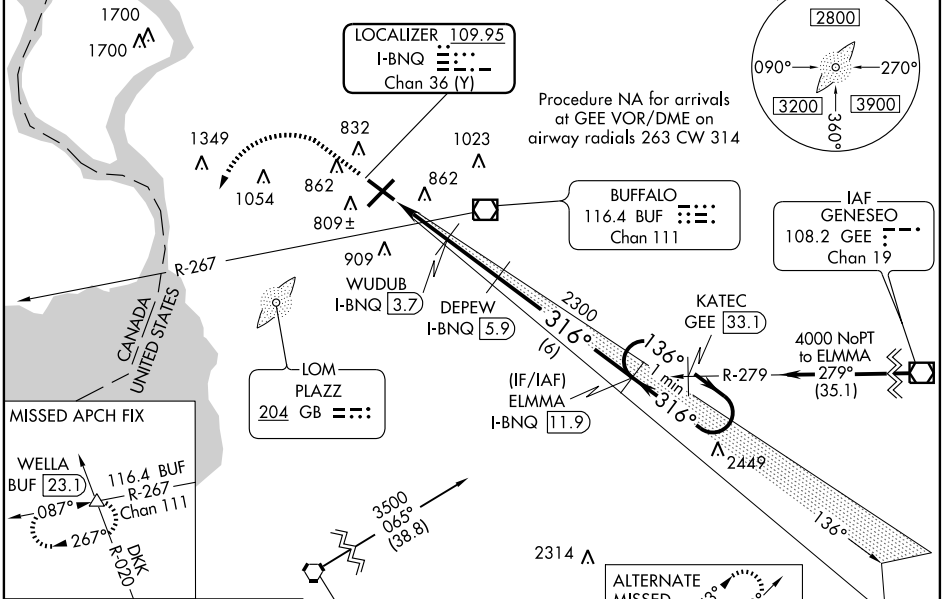

NE-2, 05 APR 2012 to 03 MAY 2012

NE-2, 05 APR 2012 to 03 MAY 2012

ELEV 728	D	TDZE 714
----------	----------	----------

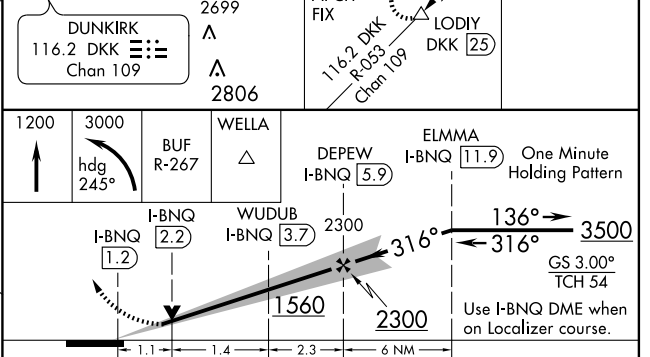
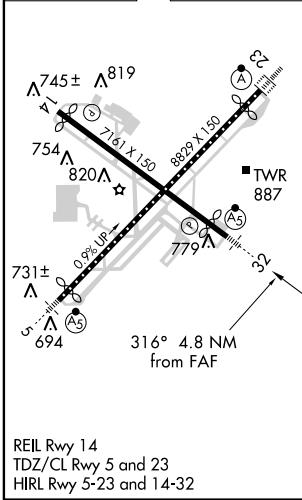

CATEGORY	A	B	C	D
S-ILS 32	938-1/2		224 (300-1/2)	
S-LOC 32	1100- 1/2 386 (400-1/2)		1100-3/4 386 (400-3/4)	
CIRCLING	1200-1 472 (500-1)		1200-1 1/2 472 (500-1 1/2)	
	1280-2 552 (600-2)			

LOC/DME I-MRZ 109.9 Chan 36	APP CRS 100°	Rwy Idg THRE Apt Elev 9003 419 421
--	------------------------	--

ILS or LOC RWY 10

SYRACUSE HANCOCK INTL (SYR)

V **RVR 1800 authorized with the use of FD or AP or HUD to DA.
For inoperative MALSR, increase S-LOC 10 Cats A and B visibility to RVR 5500 and Cats C and D visibility to 1/4. TANUE fix minimums, for inoperative MALSR, increase S-LOC 10 all Cats visibility to RVR 5500.



MISSED APPROACH: Climb to 3000 via SYR VORTAC R-111 to STODA Int/SYR 15.5 DME and hold.

ATIS 124.225	SYRACUSE APP CON 134.275 279.6	SYRACUSE TOWER 120.3 239.0	GND CON 121.7 348.6	CLNC DEL 125.05 257.775
------------------------	--	--------------------------------------	-------------------------------	-----------------------------------

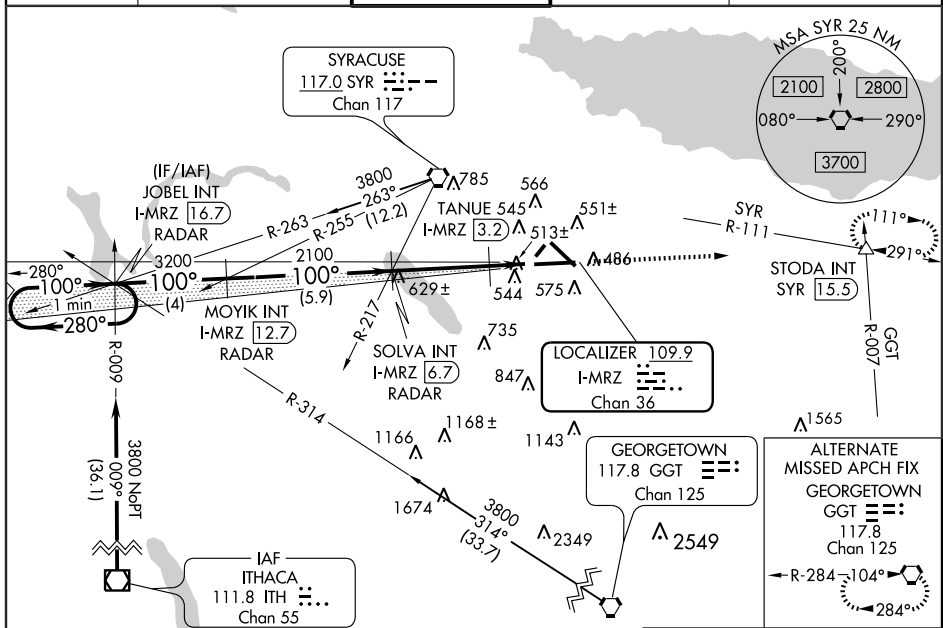

NE-2, 05 APR 2012 to 03 MAY 2012

NE-2, 05 APR 2012 to 03 MAY 2012

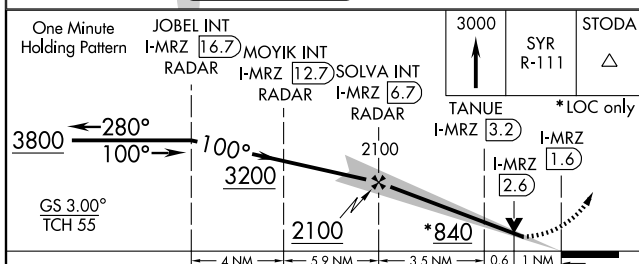

ELEV 421	THRE 419
----------	----------

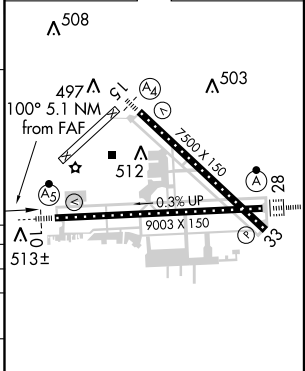

CATEGORY	A	B	C	D
S-ILS 10	**619/24		200 (200-1/2)	
S-LOC 10	840/24	421 (500-1/2)	840/40	421 (500-3/4)
CIRCLING	880-1	459 (500-1)	900-1 1/2 479 (500-1 1/2)	980-2 559 (600-2)
TANUE FIX MINIMUMS				
S-LOC 10	780/24	361 (400-1/2)	780/35	361 (400-3/4)
CIRCLING	880-1	459 (500-1)	900-1 1/2 479 (500-1 1/2)	980-2 559 (600-2)

TDZ/CL Rwy 28					
HIRL Rwy 10-28 and 15-33					
FAF to MAP 5.1 NM					
Knots	60	90	120	150	180
Min:Sec	5:06	3:24	2:33	2:02	1:42

Figure 301

GND CON
121.9
CTAF 119.4
ASOS 135.575

PULLMAN
109.0 PUV
Chan 27
N46°40.46-W117°13.41'
L-13

NEZ PERCE
108.2 MQG
Chan 19

POTOR
N46°21.61'
W117°17.72'
4700

CLOVA
N46°17.55'
W117°18.65'
L-13

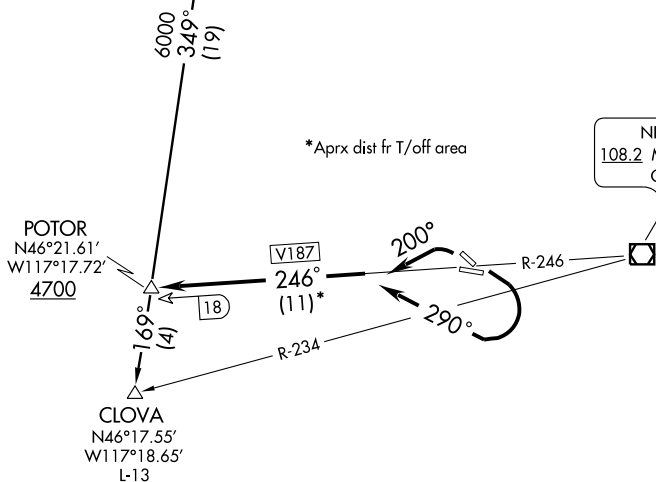

NOTE: Departures may be restricted to cross POTOR INT at 5000.

NOTE: Minimum climb required- Rws 26 and 30-300'/NM to 4700' (750 FPM/150K IAS, 1000 FPM/200K IAS).
Rws 8 and 12-270'/NM to 4700' (675 FPM/150K IAS, 900 FPM/200K IAS) or 4600' ceiling and three miles visibility.

NOTE: Chart not to scale.



DEPARTURE ROUTE DESCRIPTION

TAKE-OFF RUNWAYS 8, 12: Turn right heading 290°. Thence....

TAKE-OFF RUNWAYS 26, 30: Turn left heading 200°. Thence....

....Intercept and proceed via MQG R-246 (V187) to POTOR INT. Thence via (assigned route) or (transition).

CLOVA TRANSITION (POTOR2.CLOVA): From over POTOR INT via PUV R-169 to CLOVA INT.

PULLMAN TRANSITION (POTOR2.PUW): From over POTOR INT via PUV R-169 to PUV VOR/DME.

ILS RWY 26

LEWISTON-NEZ PERCE COUNTY (LWS)

LOC I-LWS 109.7	APP CRS 264°	Rwy Idg TDZE 1442 Apt Elev 1442
---------------------------	------------------------	---

▼ When local altimeter setting not received, procedure NA. Autopilot coupled approach NA below 2500.

MALS 

MISSED APPROACH: Climb to 3000 then climbing left turn to 5300 direct MQG VOR/DME and hold, continue climb-in-hold to 5300.

ASOS 135.575	SEATTLE CENTER 123.95 290.55	LEWISTON TOWER ★ 119.4 (CTAF) 318.8	GND CON 121.9	UNICOM 122.95
------------------------	--	---	-------------------------	-------------------------

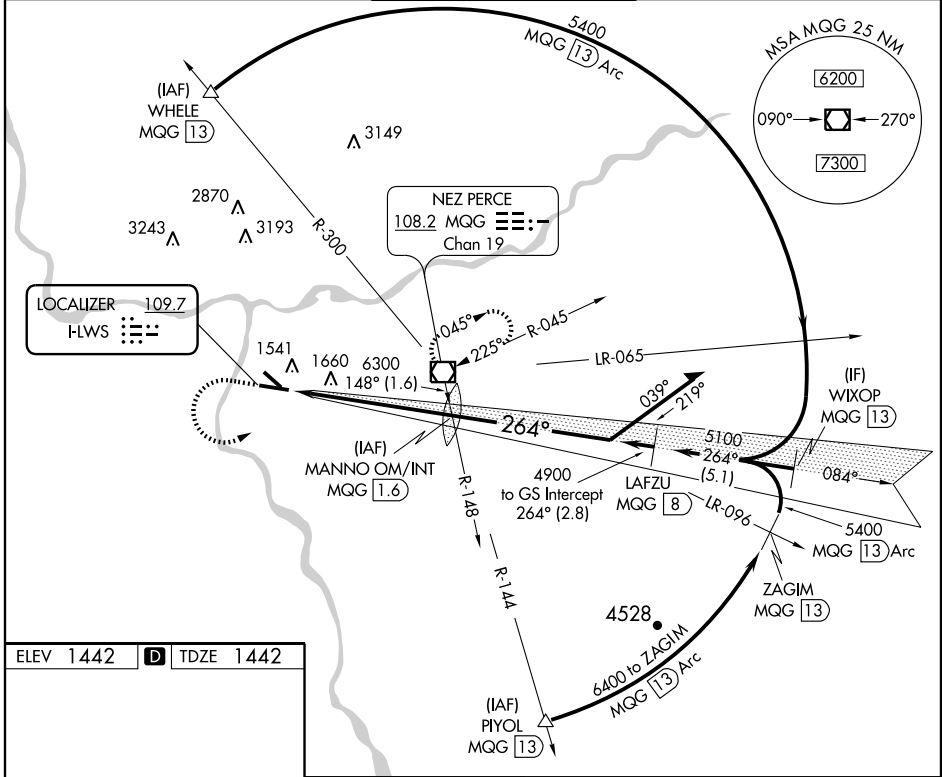

NW-1, 05 APR 2012 to 03 MAY 2012

NW-1, 05 APR 2012 to 03 MAY 2012

ELEV 1442	D	TDZE 1442
------------------	----------	------------------

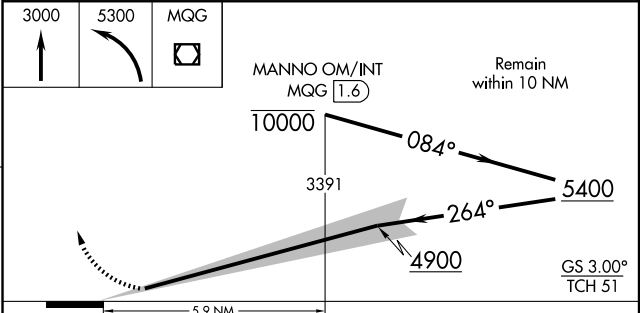
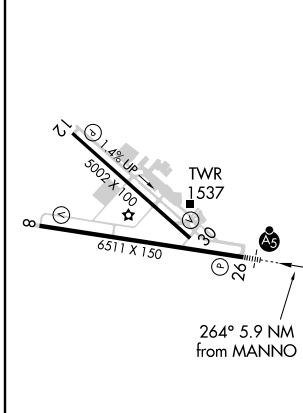

CATEGORY	A	B	C	D
S-ILS 26	1642-½ 200 (200-½)			

ILS RWY 26

Figure 303

LOC/DME I-HQM 108.7 Chan 24	APP CRS 241°	Rwy Idg 5000 THRE 15 Apt Elev 18
--	------------------------	---

ILS or LOC/DME RWY 24

HOQUIAM/BOWERMAN (HQM)

⚠ When local altimeter setting not received, procedure NA. For inop MALSRL, increase S-ILS Cat C visibility to 7/8 mile and S-LOC Cat C visibility to 1 1/8 mile. Circling NA northwest of Rwy 6-24.



MISSED APPROACH: Climb to 2500 direct HQM VORTAC and hold.

ASOS 135.775	SEATTLE CENTER 128.3 269.0	UNICOM 122.7 (CTAF)
------------------------	--------------------------------------	-------------------------------

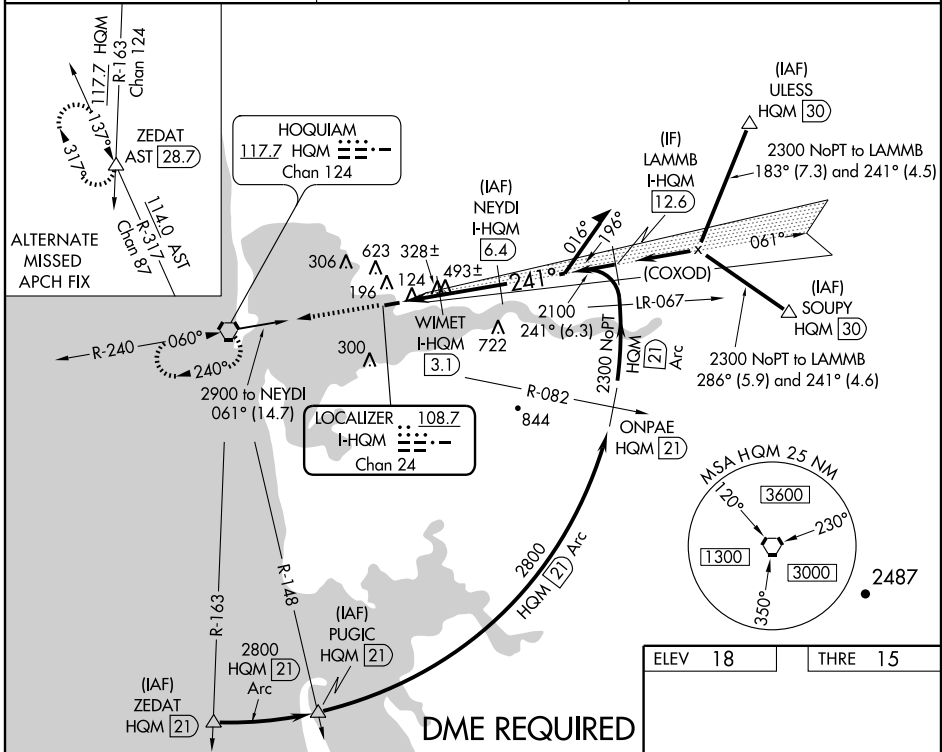

NW-1, 05 APR 2012 to 03 MAY 2012

NW-1, 05 APR 2012 to 03 MAY 2012

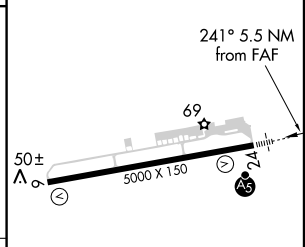
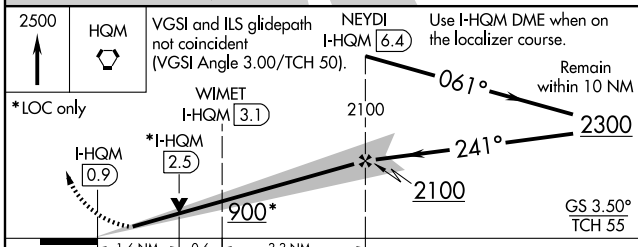

CATEGORY	A	B	C	D
S-ILS 24	215-1/2	200 (200-1/2)	285-1/2 270 (300-1/2)	NA
S-LOC 24	580-1/2	565 (600-1/2)	580-1 1/4 565 (600-1 1/4)	NA
CIRCLING	580-1	562 (600-1)	580-1 5/8 562 (600-1 5/8)	NA

REIL Rwy 6 **Ⓛ**
HIRL Rwy 6-24 **Ⓛ**

Figure 304

LOC I-OLM 111.9	APP CRS 172°	Rwy Idg 5501
		TDZE 207
		Apt Elev 209

ILS or LOC RWY 17

OLYMPIA RGNL (OLM)

▽ DME or RADAR required. When local altimeter setting not received, use Sanderson Field altimeter setting and increase all DA 53 feet and all MDA 60 feet, and increase circling Cats C and D visibility ¼ mile. For inoperative MALSR, when using Sanderson Field altimeter setting, increase S-ILS 17 all Cats visibility to 1 mile.

▲ MALSR

MISSED APPROACH: Climb to 1400, then continue climb to 5500 via OLM VORTAC R-176 to CETRA INT/OLM VORTAC 15 DME and hold, continue climb-in-hold to 5500.

ATIS 135.725	SEATTLE APP CON 121.1 290.9	OLYMPIA TOWER* 124.4 (CTAF) 254.25	GND CON 121.6	UNICOM 122.95
------------------------	---------------------------------------	--	-------------------------	-------------------------

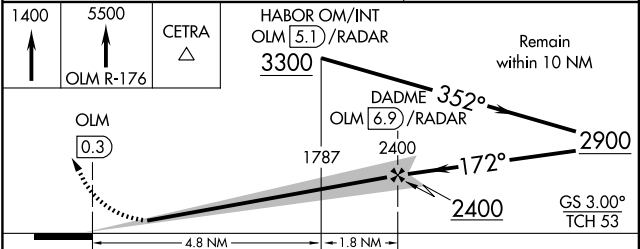
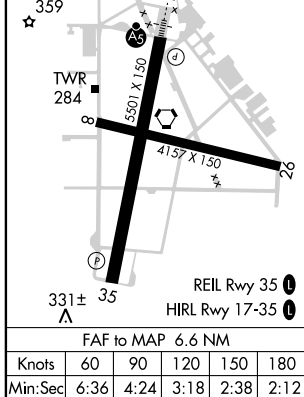
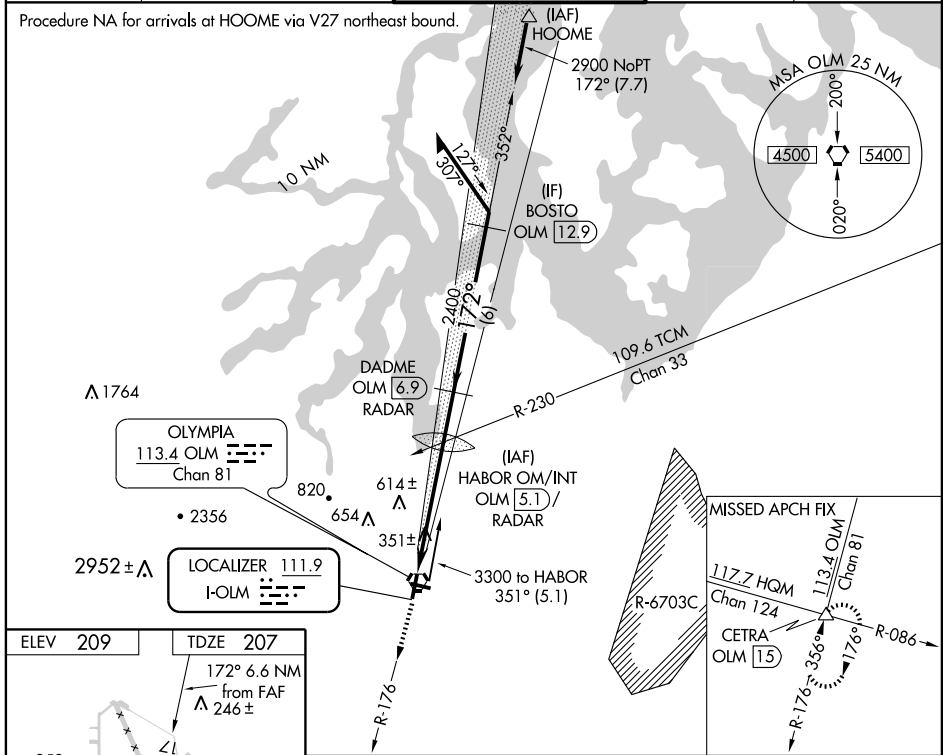

CATEGORY	A	B	C	D
S-ILS 17	414-½ 207 (300-½)			
S-LOC 17	640-½	433 (500-½)	640-¾ 433 (500-¾)	640-1 433 (500-1)
CIRCLING	720-1	511 (600-1)	820-1¾ 611 (700-1¾)	860-2 651 (700-2)

NW-1, 05 APR 2012 to 03 MAY 2012

NW-1, 05 APR 2012 to 03 MAY 2012

LOC/DME I-PHF 110.1 Chan 38	APP CRS 067°	Rwy Idg 8003 TDZE 39 Apt Elev 42
--	------------------------	---

ILS or LOC RWY 7

NEWPORT NEWS/ WILLIAMSBURG INTL (PHF)

<p>V VDP NA with Norfolk Intl altimeter setting. When local altimeter not received, use Norfolk Intl altimeter setting and increase all DA 49 feet and all MDA 60 feet; increase S-LOC 7 Cat C visibility to RVR 5000. **RVR 1800 authorized with the use of FD or AP or HUD to DA.</p>	<p>MALS </p>	<p>MISSED APPROACH: Climb to 2500 on heading 067° and on CCV VORTAC R-253 to RIPPS INT/ CCV 17.5 DME and hold.</p>
--	---	---

ATIS 128.65	NORFOLK APP CON 125.7	NEWPORT NEWS TOWER* 118.7 (CTAF) 0 257.9	GND CON 121.9 348.6	CLNC DEL 121.65 225.4	UNICOM 122.95
-----------------------	---------------------------------	--	-------------------------------	---------------------------------	-------------------------

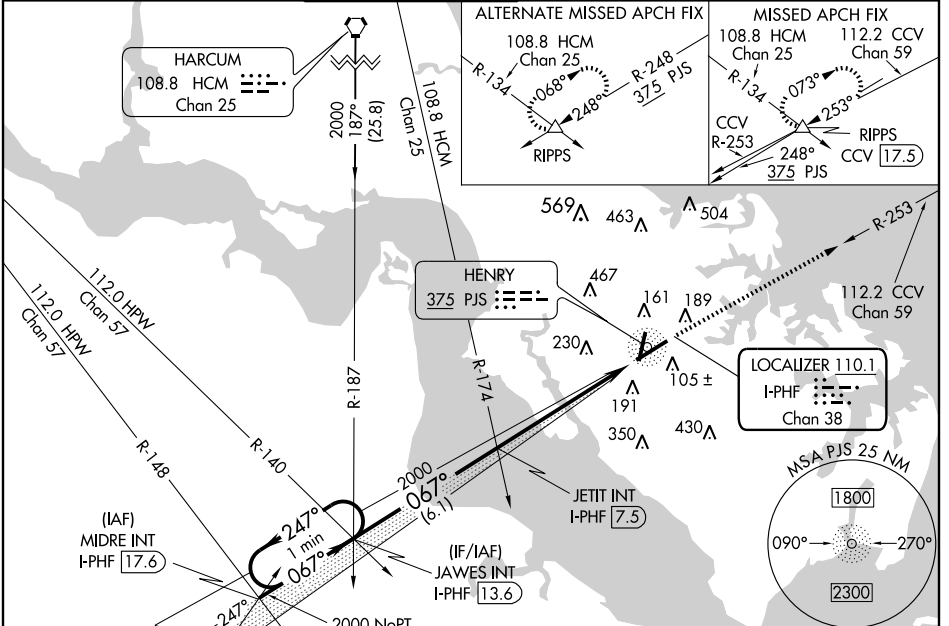

One Minute Holding Pattern	JAWES INT I-PHF 13.6	JETIT INT I-PHF 7.5	2500	CCV R-253	RIPPS
2000	2000	2000	hdg 067°		
2000	2000	2000		*I-PHF 2.8	I-PHF 1.6
				*LOC only	
CATEGORY	A	B	C	D	
S-ILS 7	**239/24 200 (200-½)				
S-LOC 7	480/24	441 (500-½)	480/40 441 (500-¾)	480/50 441 (500-1)	
CIRCLING	520-1	478 (500-1)	520-1½ 478 (500-1½)	600-2 558 (600-2)	

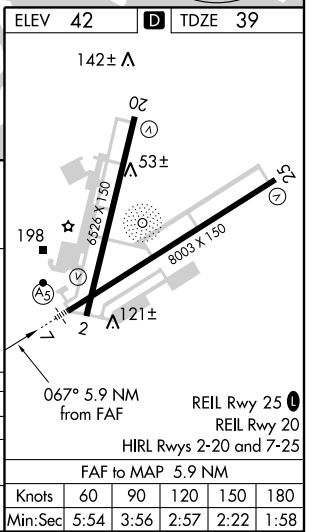

NE-3, 05 APR 2012 to 03 MAY 2012

NE-3, 05 APR 2012 to 03 MAY 2012

Figure 306

HENRY TWO DEPARTURE

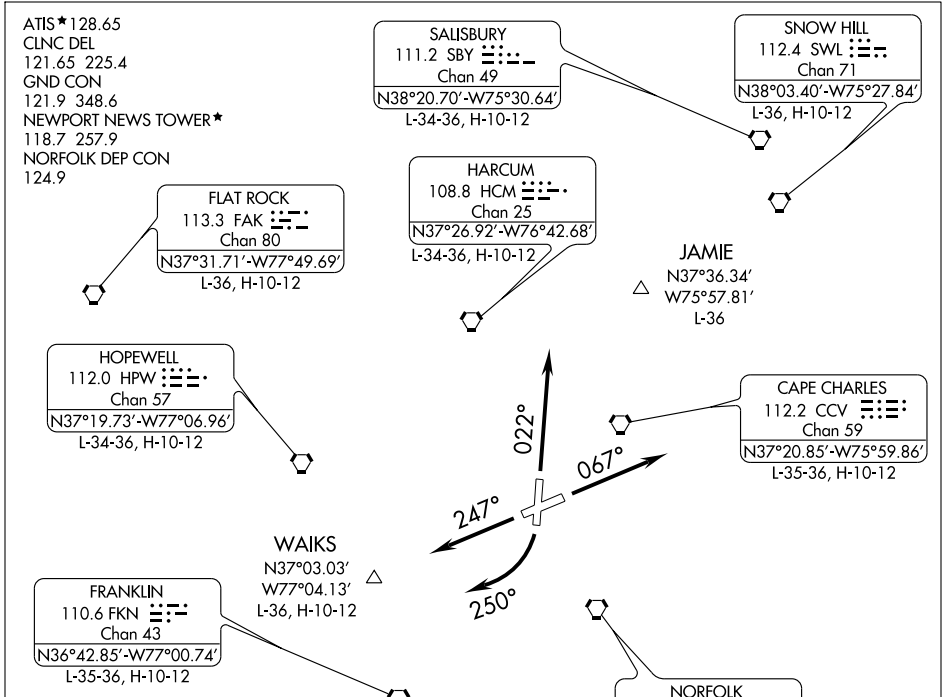

NE-3, 05 APR 2012 to 03 MAY 2012

NE-3, 05 APR 2012 to 03 MAY 2012

TAKE-OFF OBSTACLES

- Rwy 2: Bush, 295' from DER, 291' right of centerline, 22' AGL/62' MSL.
Tree, 937' from DER, 603' left of centerline, 81' AGL/131' MSL.
Pole, 1221' from DER, 487' right of centerline, 31' AGL/81' MSL.
Tree, 1275' from DER, 517' left of centerline, 79' AGL/132' MSL.
Multiple Trees beginning 1554' from DER, 298' left of centerline, up to 88' AGL/141' MSL.
Tree, 1686' from DER, 428' right of centerline, 61' AGL/114' MSL.
Tree, 1849' from DER, 598' right of centerline, 72' AGL/125' MSL.
T-L Tower, 3351' from DER, 1008' left of centerline, 109' AGL/161' MSL.
- Rwy 7: Tree, 371' from DER, 588' left of centerline, 36' AGL/73' MSL.
T-L Tower, 4120' from DER, 1324' right of centerline, 93' AGL/116' MSL.
T-L Tower, 5625' from DER, 1345' left of centerline, 133' AGL/191' MSL.
- Rwy 20: Bush, 96' from DER, 293' left of centerline, 22' AGL/52' MSL.
Stack, 5977' from DER, 598' left of centerline, 186' AGL/227' MSL.
- Rwy 25: Tree, 694' from DER, 549' right of centerline, 42' AGL/65' MSL.
Tree, 1020' from DER, 703' right of centerline, 23' AGL/97' MSL.
Tree, 1622' from DER, 529' left of centerline, 59' AGL/79' MSL.
Tree 2654' from DER, 335' right of centerline, 86' AGL/106' MSL.
Tree. 3435' from DER, 1125' right of centerline, 116' AGL/139' MSL.

TAKE-OFF MINIMUMS
Rwys 2, 7, 25: STANDARD
Rwy 20: 300-1¼ or STANDARD with a minimum climb of 255 feet per NM to 300.

NOTE: RADAR required.
NOTE: Chart not to scale.

DEPARTURE ROUTE DESCRIPTION

- TAKE-OFF RUNWAY 2:** Climb heading 022° to 2000, thence
- TAKE-OFF RUNWAY 7:** Climb heading 067° to 2000, thence
- TAKE-OFF RUNWAY 20:** Climbing right turn to 2000 via heading 250°, thence
- TAKE-OFF RUNWAY 25:** Climb heading 247° to 2000, thence
- via vectors to assigned route/fix. Expect clearance to requested altitude 10 minutes after departure.

Figure 307

CEDAR LAKE EIGHT ARRIVAL

PHILADELPHIA, PENNSYLVANIA

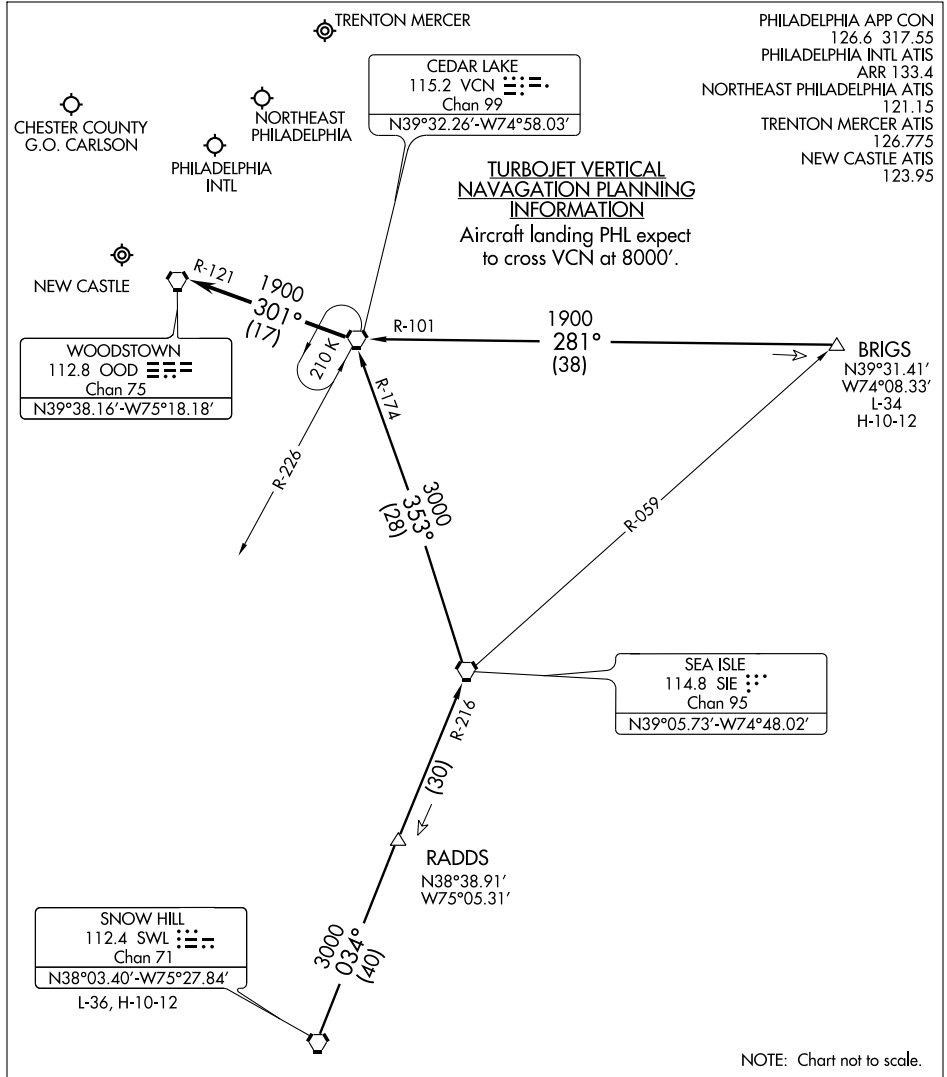

NE-4, 05 APR 2012 to 03 MAY 2012

NE-4, 05 APR 2012 to 03 MAY 2012

BRIGS TRANSITION (BRIGS.VCN8): From over BRIGS INT via VCN R-101 to VCN VORTAC. Thence. . . .

SNOW HILL TRANSITION (SWL.VCN8): From over SWL VORTAC via SWL R-034 and SIE R-216 to SIE VORTAC, then via the SIE R-353 and VCN R-174 to VCN VORTAC. Thence. . . .

. . . .From over VCN VORTAC: Turbojets expect radar vectors to final approach course. Non-Turbojets continue via the VCN R-301 and the OOD R-121 to OOD VORTAC; expect radar vectors to final approach course.

CEDAR LAKE EIGHT ARRIVAL

PHILADELPHIA, PENNSYLVANIA

ILS or LOC RWY 9R

PHILADELPHIA INTL (PHL)

LOC/DME I- PHL	APP CRS	Rwy Idg	10506
109.3	087°	TDZE	21
Chan 30		Apt Elev	36

▽	ALSIF-2	MISSED APPROACH: Climb to 1500, then climbing right turn to 3000 direct OOD VORTAC and hold.
----------	----------------	--

ATIS	PHILADELPHIA APP CON	PHILADELPHIA TOWER	GND CON	CLNC DEL
ARR 133.4	124.35 319.15	118.5 327.05 (Rwys 9L/27R, 8/26 and 17/35)	121.9 348.6	118.85 348.6
DEP 135.925		135.1 327.05 (Rwy 9R/27L)		

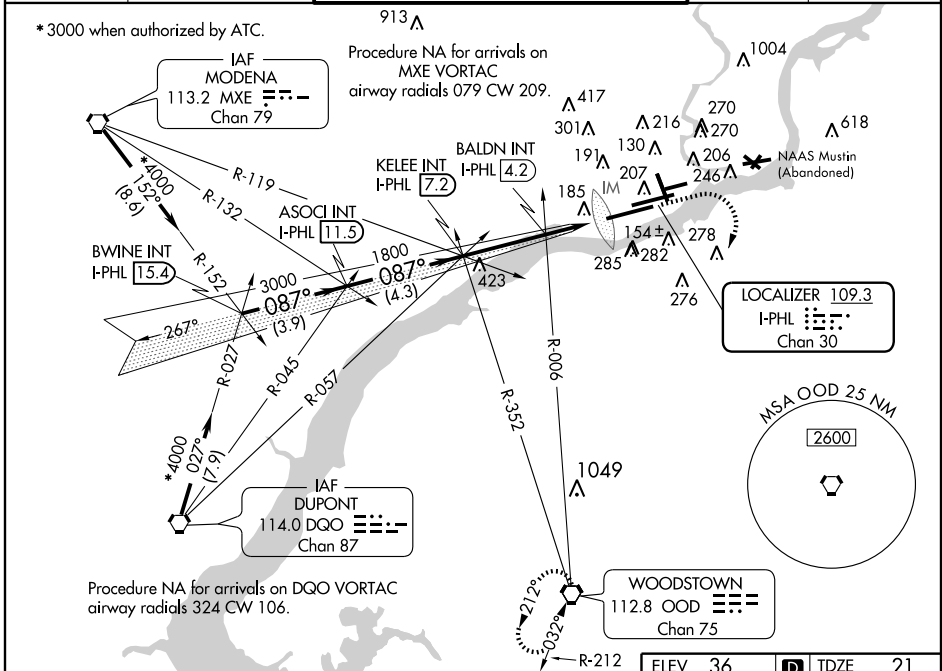

	* 3000 when authorized by ATC.				ELEV 36	TDZE 21
	BWINE INT I- PHL (15.4)	ASOCI INT I- PHL (11.5)	KELEE INT I- PHL (7.2)	BALDN INT I- PHL (4.2)	I- PHL (1.9)	OOD
* 4000	Procedure Turn NA				↑ LOC Only	
GS 3.00°	TCH 58					
	3.9 NM	4.3 NM	3 NM	2.2 NM	0.1	
CATEGORY	A	B	C	D		
S-ILS 9R	221/18					200 (200-½)
S-LOC 9R	740/24	719 (800-½)	740-1½	740-1¾	719 (800-1¾)	
CIRCLING	740-1	704 (800-1)	740-2	740-2¼	704 (800-2¼)	
BALDN FIX MINIMUMS						
S-LOC 9R	580/24	559 (600-½)	580/50	580/60	559 (600-1¼)	
CIRCLING	580-1	640-1	640-1¾	640-2	604 (700-2)	

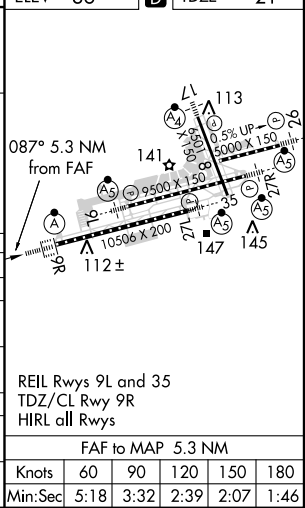

NE-4, 05 APR 2012 to 03 MAY 2012

NE-4, 05 APR 2012 to 03 MAY 2012

ILS or LOC RWY 9L

PHILADELPHIA INTL (PHL)

LOC/DME I-VII 108.95	APP CRS 085°	Rwy Idg TDZE Apt Elev 9500 13 36
Chan 26 (Y)		

<p>▽ ** RVR 1800 authorized with use of FD or AP or HUD to DA.</p> <p>▲ MALSR</p> 	<p>MISSED APPROACH: Climb to 1500, then climbing right turn to 3000 direct OOD VORTAC and hold.</p>			
<p>ATIS ARR 133.4 DEP 135.925</p>	<p>PHILADELPHIA APP CON 124.35 319.15</p>	<p>PHILADELPHIA TOWER 118.5 327.05 (Rwys 9L/27R, 8/26 and 17/35) 135.1 327.05 (Rwy 9R/27L)</p>	<p>GND CON 121.9 348.6</p>	<p>CLNC DEL 118.85 348.6</p>

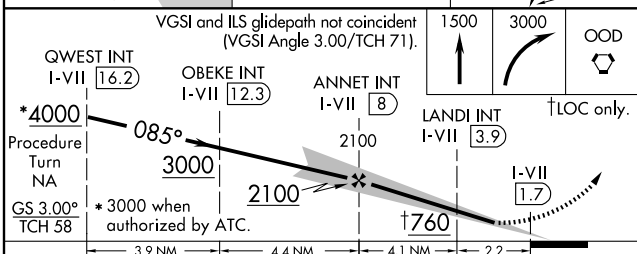
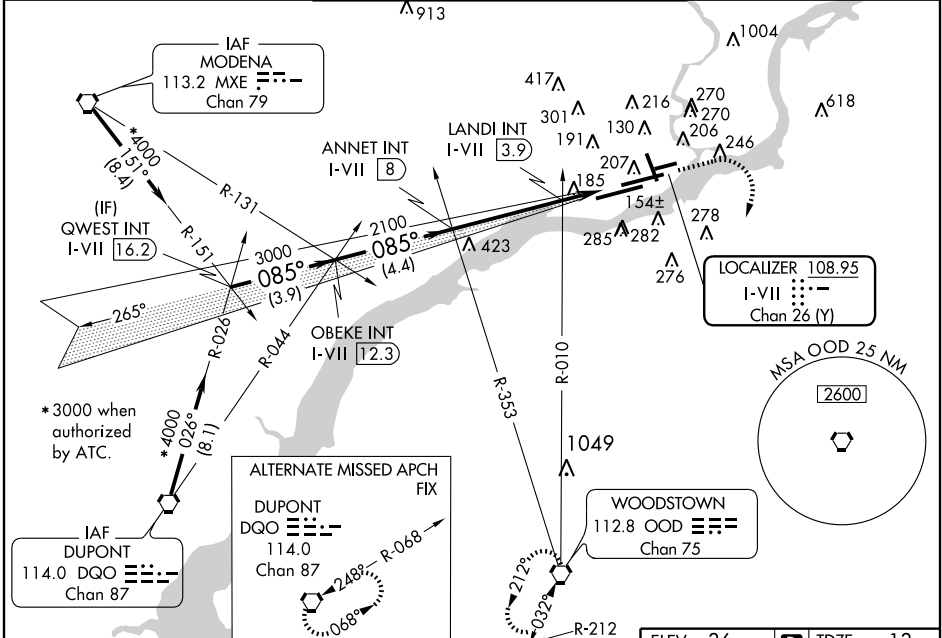

ELEV 36	D	TDZE 13
---------	----------	---------

Procedure Turn NA	GS 3.00°	TCH 58
-------------------	----------	--------

REIL Rwys 9L and 35	TDZ/CL Rwy 9R	HIRL all Rwys			
FAF to MAP 6.3 NM					
Knots	60	90	120	150	180
Min:Sec	6:18	4:12	3:09	2:31	2:06

CATEGORY	A	B	C	D
S-ILS 9L	** 213/24 200 (200-½)			
S-LOC 9L	760/24 747 (800-½)	760/40 747 (800-¾)	760-1¾ 747 (800-1¾)	760-2 747 (800-2)
CIRCLING	760-1 724 (800-1)	760-1¼ 724 (800-1¼)	760-2¼ 724 (800-2¼)	760-2½ 724 (800-2½)
LANDI FIX MINIMUMS				
S-LOC 9L	440/24	427 (500-½)	440/40 427 (500-¾)	440/50 427 (500-1)
CIRCLING	540-1 504 (600-1)	640-1 604 (700-1)	640-1¾ 604 (700-1¾)	640-2 604 (700-2)

Figure 310

NE-4, 05 APR 2012 to 03 MAY 2012

NE-4, 05 APR 2012 to 03 MAY 2012

ILS or LOC RWY 13

ATLANTIC CITY INTL (ACY)

LOC/DME I-PVO 109.1 Chan 28	APP CRS 128°	Rwy ldg 10000 TDZE 75 Apt Elev 75
--	------------------------	--

▲ For inoperative MALSRS, increase S-ILS 13 Cat E visibility to RVR 4000, increase S-LOC 13 Cat D visibility to RVR 5000, and Cat E to RVR 6000.

MALSRS MISSED APPROACH: Climb to 600 then climbing left turn to 2000 via ACY R-090 to SMITS INT/ACY 11 DME and hold.

ATIS 108.6 316.15	ATLANTIC CITY APP CON 124.6 327.125	ATLANTIC CITY TOWER 120.3 239.0	GND CON 121.9 284.6	CLNC DEL 127.85 353.775
-----------------------------	---	---	-------------------------------	-----------------------------------

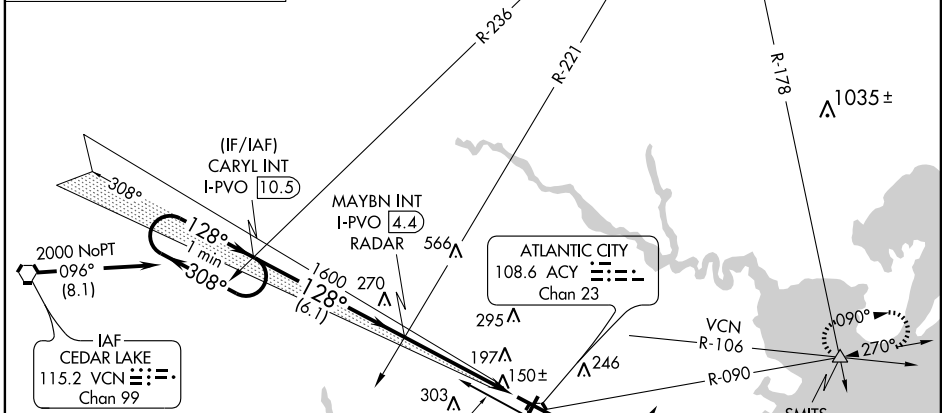
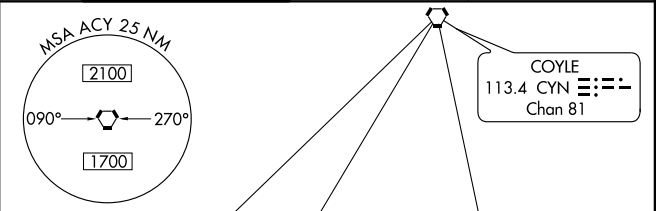
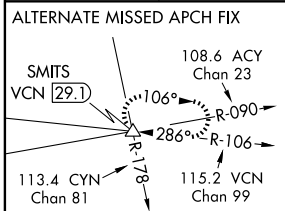

ELEV 75	D	TDZE 75
---------	----------	---------

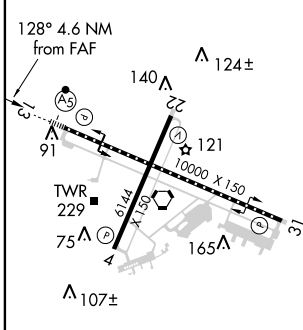

TDZ/CL Rwy 13
HIRL Rwys 4-22 and 13-31
REIL Rwy 31

FAF to MAP 4.6 NM

Knots	60	90	120	150	180
Min:Sec	4:36	3:04	2:18	1:50	1:32

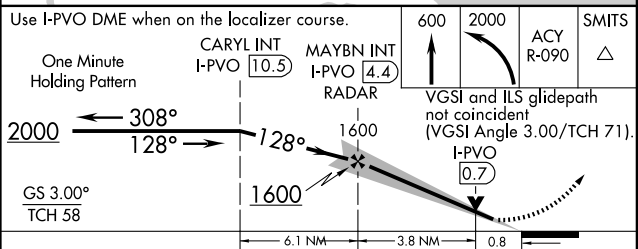

CATEGORY	A	B	C	D	E
S-ILS 13	275/18 200 (200-½)				275/24 200 (200-½)
S-LOC 13	400/24 325 (400-½)		400/40 325 (400-¾)		
CIRCLING	540-1 465 (500-1)		540-1½ 465 (500-1½)		640-2 565 (600-2) 760-2½ 685 (700-2½)

NE-2, 05 APR 2012 to 03 MAY 2012

NE-2, 05 APR 2012 to 03 MAY 2012

GRAHAM, TEXAS

AL-5535 (FAA)

RNAV (GPS) RWY 3

GRAHAM MUNI (RPH)

APP CRS 033°	Rwy Idg 5000
	TDZE 1116
	Apt Elev 1123

▼ When local altimeter setting not received, use Mineral Wells altimeter setting and increase all MDAs 100 feet and increase LNAV and circling CAT B visibility ¼ mile.
 ▲ Visibility reduction by helicopters NA. DME/DME RNP-0.3 NA.

MISSED APPROACH: Climb to 3900 direct IROTE and left turn via 273° track to VAYTU and hold.

AWOS-3 118.025	FORT WORTH CENTER 127.0 360.6	UNICOM 122.975 (CTAF)
--------------------------	---	---------------------------------

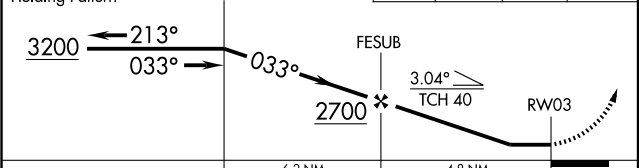
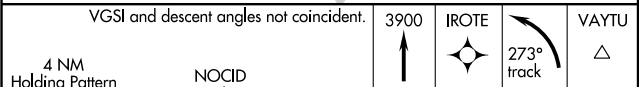
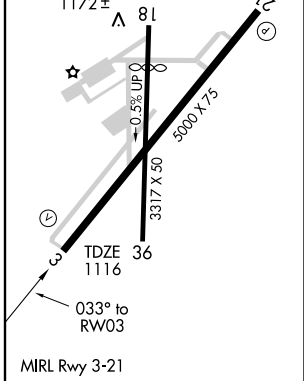
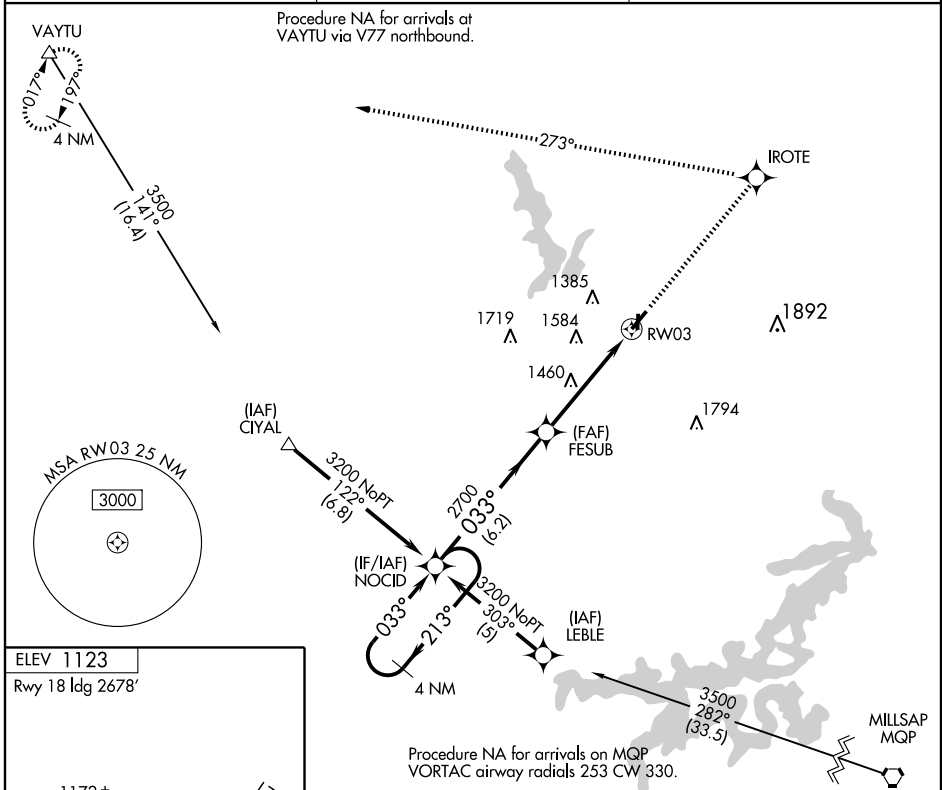

CATEGORY	A	B	C	D
LNAV MDA	1760-1	644 (700-1)	NA	
CIRCLING	1760-1	637 (700-1)	NA	

GRAHAM, TEXAS
Orig 10042

33°07'N-98°33'W

GRAHAM MUNI (RPH)

RNAV (GPS) RWY 3

Figure 312

SC-2, 05 APR 2012 to 03 MAY 2012

SC-2, 05 APR 2012 to 03 MAY 2012

GRAHAM, TEXAS

AL-5535 (FAA)

RNAV (GPS) RWY 21

GRAHAM MUNI (RPH)

APP CRS	Rwy Idg	5000
213°	TDZE	1114
	Apt Elev	1123

▼ When local altimeter setting not received, use Mineral Wells altimeter setting and increase all MDAs 100 feet.
▲ Visibility reduction by helicopters NA. DME/DME RNP-0.3 NA.

MISSED APPROACH: Climb to 3900 direct FESUB and via 300° track to VAYTU and hold.

AWOS-3 118.025	FORT WORTH CENTER 127.0 360.6	UNICOM 122.975 (CTAF)
--------------------------	---	---------------------------------

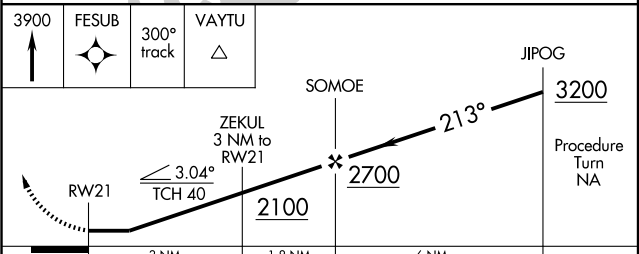
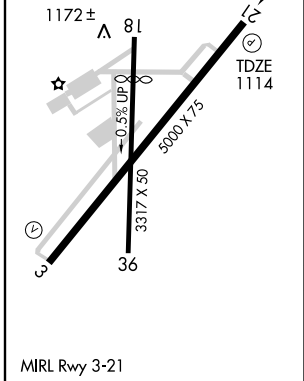
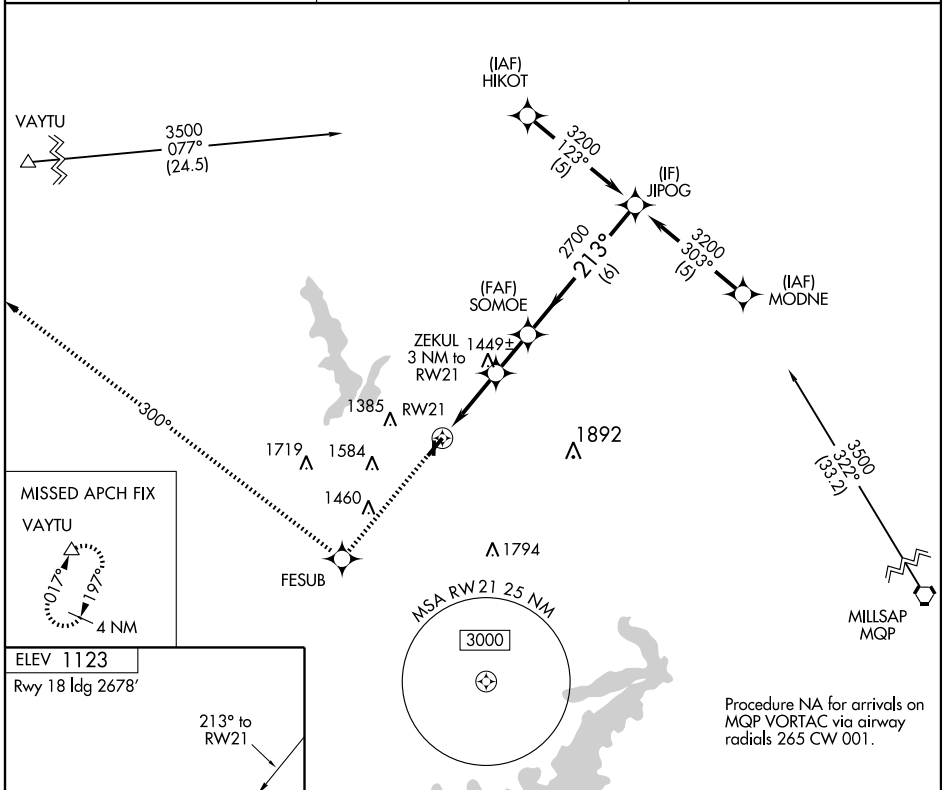

CATEGORY	A	B	C	D
LNAV MDA	1700-1	586 (600-1)	NA	
CIRCLING	1700-1	577 (600-1)	NA	

GRAHAM, TEXAS
Orig 10042

33°07'N-98°33'W

GRAHAM MUNI (RPH)

RNAV (GPS) RWY 21

Figure 313

SC-2, 05 APR 2012 to 03 MAY 2012

SC-2, 05 APR 2012 to 03 MAY 2012



TAKE-OFF MINIMUMS AND (OBSTACLE) DEPARTURE PROCEDURES



12096

FORT WORTH, TX (CON'T)

FORT WORTH SPINKS

TAKE-OFF MINIMUMS: **Rwys 17L, 35R**, NA.
(Environmental)

DEPARTURE PROCEDURE: **Rwy 17R** climb heading 173° to 1200 before turning right.

NOTE: **Rwy 17R**, tree 4909' from departure end of runway, 1556' left of centerline, 60' AGL/830' MSL.

FORT WORTH NAS JRB (CARSWELL
FLD)(KNFW)

FORT WORTH, TX 10014

Rwy 17, Cross DER at or above 6' AGL/656' MSL.

TAKE-OFF OBSTACLES: **Rwy 17**, rising terrain up to 670' MSL, 200'-600' from DER, 500'-560' right of centerline.

GAINESVILLE, TX

GAINESVILLE MUNI (GLE)

ORIG 09127 (FAA)

NOTE: **Rwy 17**, trees and poles beginning 1' from DER, 472' right and left of centerline, up to 25' AGL/819' MSL.

Rwy 30, taxiways beginning 651' from DER, crossing centerline left to right 859' MSL. Trees and terrain beginning 2' from DER, 14' left and right of centerline, up to 64' AGL/890' MSL. **Rwy 35**, terrain, trees, poles, road, and vehicle beginning 149' from DER, 51' left of centerline, up to 95' AGL/940' MSL. Terrain and poles beginning 13' from DER, 85' right of centerline, up to 37' AGL/882' MSL.

GILMER, TX

FOX STEPHENS FIELD-GILMER MUNI (JXI)

ORIG 11293 (FAA)

DEPARTURE PROCEDURE: **Rwy 18**, climb heading 177° to 1000 before turning left.

NOTE: **Rwy 18**, trees beginning abeam the DER left and right of centerline, up to 100' AGL/500' MSL. **Rwy 36**, trees beginning abeam the DER left and right of centerline, up to 50' AGL/505' MSL.

GLADEWATER, TX

GLADEWATER MUNI (07F)

AMDT 1 11153 (FAA)

TAKE-OFF MINIMUMS: **Rwy 17**, 300-1¼ or std. w/min. climb of 285' per NM to 600. **Rwy 32**, 300-1. **Rwy 35**, Std. w/min. climb of 280' per NM to 1300 or 1100-2½ for climb in visual conditions.

DEPARTURE PROCEDURE: **Rwy 32**, climb heading 320° to 1100 before turning right. **Rwy 35**, for climb in visual conditions cross Gladewater Municipal Airport at or above 1200 before proceeding on course.

NOTE: **Rwy 14**, vehicles on roadway beginning 450' from DER, left and right of centerline, up to 17' AGL/311' MSL. Trees beginning 770' from DER, left and right of centerline, up to 100' AGL/394' MSL. Power lines 3524' from DER, left to right of centerline, 150' AGL/420' MSL. **Rwy 17**, vehicles on roadway beginning 212' from DER, left and right of centerline, up to 17' AGL/311' MSL. Trees beginning 624' from DER, left and right of centerline, up to 100' AGL/509' MSL. Power lines 1807' from DER, left to right of centerline, 150' AGL/439' MSL. **Rwy 32**, trees beginning 12' from DER, left and right of centerline, up to 100' AGL/429' MSL. **Rwy 35**, trees beginning 47' from DER, left and right of centerline, up to 100' AGL/429' MSL. Power lines 1.4 NM from DER, 844' right of centerline, 75' AGL/520' MSL.

12096



TAKE-OFF MINIMUMS AND (OBSTACLE) DEPARTURE PROCEDURES



GRAFORD, TX

POSSUM KINGDOM (F35)

ORIG-A 10154 (FAA)

TAKE-OFF MINIMUMS: **Rwy 20**, 400-2½ or std. w/a min. climb of 212' per NM to 1500 or alternatively, with standard takeoff minimums and a normal 200' per NM climb gradient, takeoff must occur no later than 1600' prior to DER.

DEPARTURE PROCEDURE: **Rwy 20**, climb heading 204° to 1500 before turning left.

NOTE: **Rwy 2**, trees beginning 31' from DER, 22' left of centerline, up to 100' AGL/1099' MSL. Trees beginning 1023' from DER, 114' right of centerline, up to 100' AGL/1129' MSL. **Rwy 20**, vehicle on roadway 116' from DER, 498' right of centerline, 15' AGL/1024' MSL. Trees beginning 494' from DER, 126' right of centerline, up to 100' AGL/1109' MSL. Trees beginning 977' from DER, 115' left of centerline, up to 100' AGL/1109' MSL. Trees beginning 2.29 miles from DER, 1679' left of centerline, up to 100' AGL/1329' MSL.

GRAHAM, TX

GRAHAM MUNI

DEPARTURE PROCEDURE: **Rwys 17, 21**, climb runway heading to 2000 before proceeding on course.

NOTE: **Rwy 17**, light pole 21' from departure end of runway, 195' left of centerline, 30' AGL/1141' MSL. Light pole 86' from departure end of runway, 381' left of centerline, 50' AGL/1168' MSL.

GRANBURY, TX

GRANBURY RGNL (GDJ)

AMDT 2 11125 (FAA)

TAKE-OFF MINIMUMS: **Rwy 14**, 300-1.

DEPARTURE PROCEDURE: **Rwy 14**, climb heading 144° to 1700 before turning right.

NOTE: **Rwy 14**, vehicles on road beginning 1020' from DER, on centerline, 15' AGL/814' MSL. Trees and power poles beginning at DER, 75' right of centerline, up to 100' AGL/879' MSL. Trees, power poles, light poles and vehicles on road beginning at DER, 251' left of centerline, up to 100' AGL/899' MSL. **Rwy 32**, train on railroad tracks, transmission poles and tree beginning 339' from DER, 107' right of centerline, 76' AGL/845' MSL. Trees, vehicles on road and bush beginning 14' from DER, 198' left of centerline, up to 46' AGL/815' MSL.

GRAND PRAIRIE, TX

GRAND PRAIRIE MUNI (GPM)

AMDT 4 09295 (FAA)

DEPARTURE PROCEDURE: **Rwy 17**, climbing right turn to 2000 via heading 200° and TTT R-180 to NINAE/TTT 24 DME before proceeding on course. DME Required. **Rwy 35**, climb heading 356° to 1400 before turning south.

NOTE: **Rwy 17**, antenna 190' from DER, 456' right of centerline, 26' AGL/615' MSL. Road, multiple poles and signs beginning 570' from DER, 410' right of centerline, up to 31' AGL/620' MSL. Tree 1506' from DER, 517' right of centerline, 37' AGL/617' MSL.

Rwy 35, tree 837' from DER, 204' left of centerline, up to 100' AGL/665' MSL. Pole 2687' from DER, 122' left of centerline, up to 75' AGL/653' MSL.

AIRPORT DIAGRAM

AL-662 (FAA)

LAS VEGAS/McCARRAN INTL (LAS)
 LAS VEGAS, NEVADA

SW-4, 05 APR 2012 to 03 MAY 2012

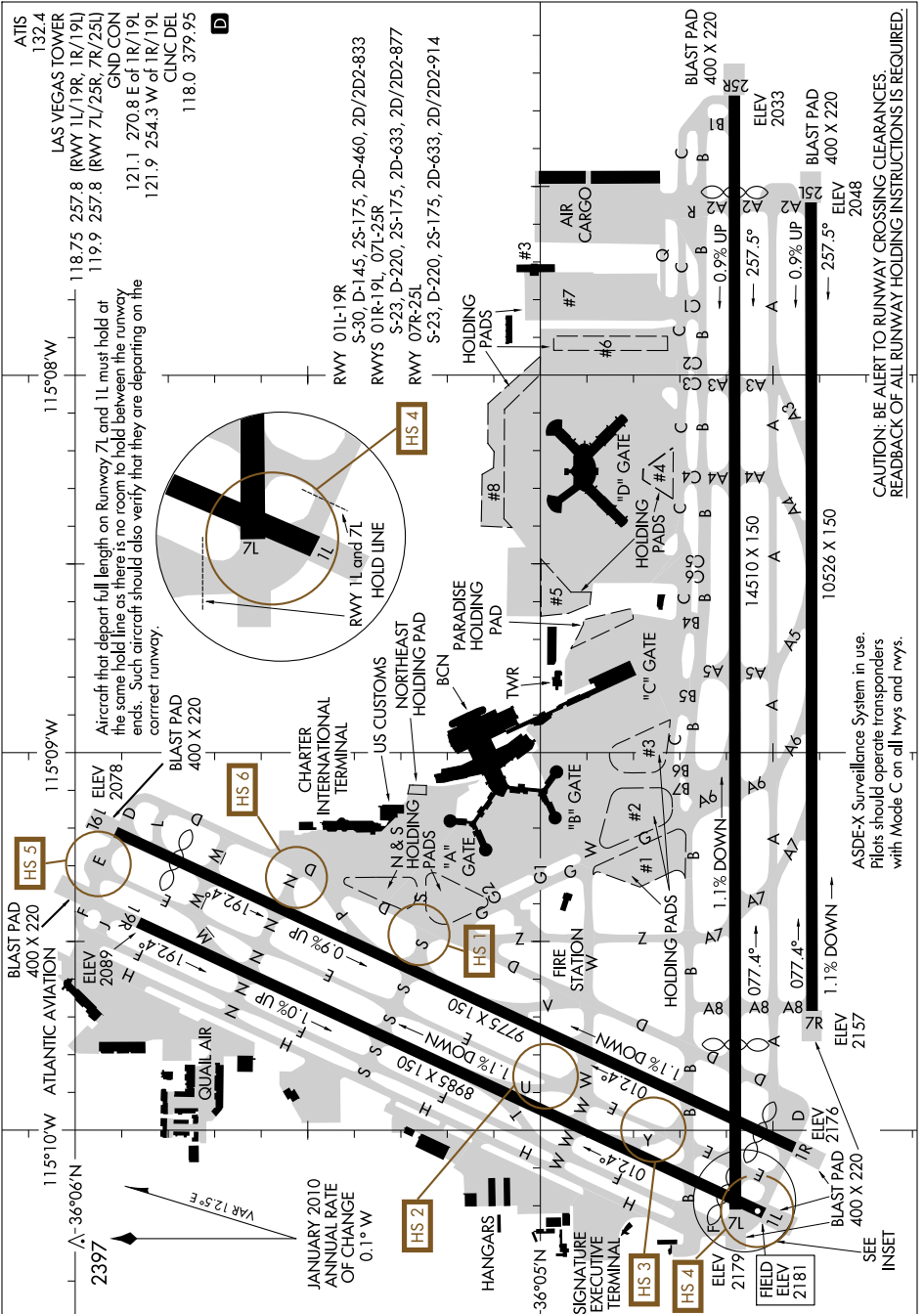

SW-4, 05 APR 2012 to 03 MAY 2012

AIRPORT DIAGRAM

LAS VEGAS, NEVADA
 LAS VEGAS/McCARRAN INTL (LAS)

Figure 315

LOC/DME I-PVU 110.3 Chan 40	APP CRS 134°	Rwy Idg THRE Apt Elev	8599 4497 4497
--	------------------------	-----------------------------	---

ILS or LOC/DME RWY 13

PROVO MUNI (PVU)

⚠ Circling NA east of Rwy 18 and 31.
⚠ MISSED APPROACH: Climb to 9000 on heading 134° to intercept PVU VOR/DME R-130 to ZIPUT/PVU 5.9 DME then climbing right turn on heading 330° and on FFU VORTAC R-110 to FFU VORTAC and hold.

ATIS 135.175	SALT LAKE CITY APP CON 124.3 322.3	PROVO TOWER 125.3 (CTAF)	GND CON 119.4
------------------------	--	------------------------------------	-------------------------

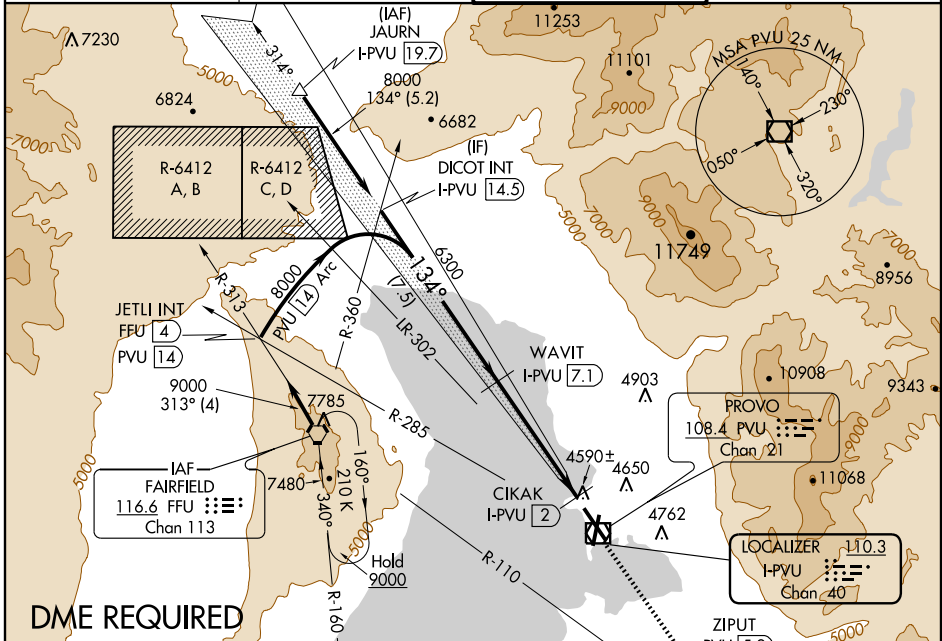

SW-4, 05 APR 2012 to 03 MAY 2012

SW-4, 05 APR 2012 to 03 MAY 2012

ELEV 4497	D	THRE 4497
-----------	----------	-----------

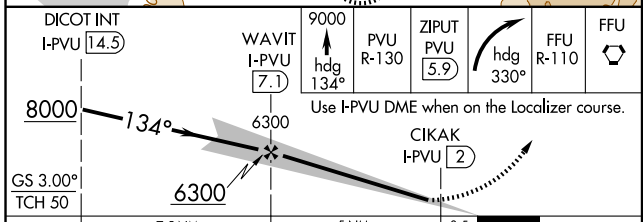
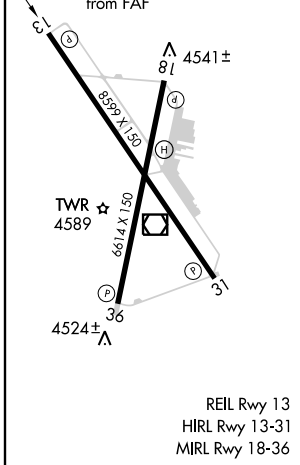

CATEGORY	A	B	C	D
S-ILS 13*		4697- ³ / ₄	200 (200- ³ / ₄)	
S-LOC 13*		4820-1	323 (400-1)	
CIRCLING*	4940-1 443 (500-1)	4960-1 463 (500-1)	4980-1 ¹ / ₂ 483 (500-1 ¹ / ₂)	5060-2 563 (600-2)
S-ILS 13		4947-1 ¹ / ₂	450 (500-1 ¹ / ₂)	
S-LOC 13	5100-1	603 (700-1)	5100-1 ³ / ₄	603 (700-1 ³ / ₄)
CIRCLING	5100-1	603 (700-1)	5100-1 ³ / ₄ 603 (700-1 ³ / ₄)	5100-2 603 (700-2)

Figure 316

PROVO FOUR DEPARTURE (OBSTACLE)

ATIS 135.175
GND CON 119.4
PROVO TOWER *
125.3 (CTAF)
SALT LAKE CITY DEP CON
118.85

TAKE-OFF MINIMUMS

- Rwy 13: Standard with a minimum climb of 400' per NM to 9000, or 3100-3 for climb in visual conditions.
- Rwy 18: Standard with a minimum climb of 350' per NM to 9000, or 3100-3 for climb in visual conditions.
- Rwy 31: Standard with a minimum climb of 380' per NM to 9000, or 3100-3 for climb in visual conditions.
- Rwy 36: Standard with a minimum climb of 365' per NM to 9000, or 3100-3 for climb in visual conditions.

NOTE: Climb in visual conditions NA at night.

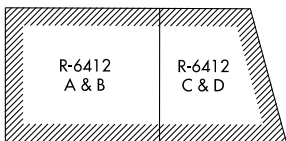

TAKE-OFF OBSTACLE NOTES

- Rwy 18: Multiple trees beginning 429' from DER, 288' left of centerline, up to 57' AGL/4533' MSL. Multiple trees beginning 852' from DER, 202' right of centerline, up to 57' AGL/4533' MSL. Road 775' from DER, on centerline, 15' AGL/4518' MSL.
- Rwy 31: Multiple trees beginning 1954' from DER, 743' right of centerline, up to 72' AGL/4561' MSL.
- Rwy 36: Multiple trees beginning 978' from DER, 18' right of centerline, up to 46' AGL/4541' MSL. Road 210' from DER, on centerline, 15' AGL/4516' MSL.

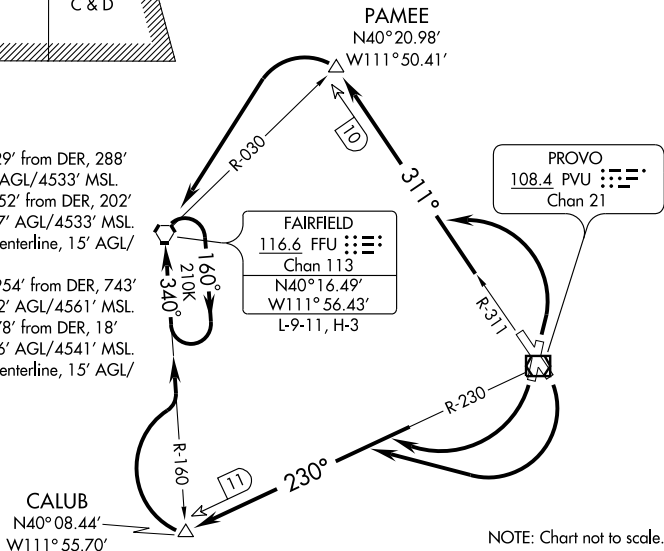

NOTE: Chart not to scale.

DEPARTURE ROUTE DESCRIPTION

TAKE-OFF RUNWAYS 13, 18: Climbing right turn to 9000 via PVU VOR/DME R-230 to CALUB INT/PVU 11 DME and a right turn via FFU VORTAC R-160 to FFU VORTAC and hold. Thence... or climb in visual conditions to cross Provo Muni Airport southwest bound at or above 7400, climb to 9000 via PVU R-230 to CALUB INT/PVU 11 DME and right turn via FFU R-160 to FFU VORTAC and hold. Thence...

TAKE-OFF RUNWAY 31: Climb to 9000 via PVU VOR/DME R-311 to PAMEE INT/PVU 10 DME and left turn direct FFU VORTAC and hold. Thence... or climb in visual conditions to cross Provo Muni Airport northwest bound at or above 7400, climb to 9000 via PVU R-311 to PAMEE INT/PVU 10 DME and left turn direct FFU VORTAC and hold. Thence...

TAKE-OFF RUNWAY 36: Climbing left turn to 9000 via PVU VOR/DME R-311 to PAMEE INT/PVU 10 DME and left turn direct FFU VORTAC and hold. Thence... or climb in visual conditions to cross Provo Muni Airport northwest bound at or above 7400, climb to 9000 via PVU R-311 to PAMEE INT/PVU 10 DME, and left turn direct FFU VORTAC and hold. Thence...

....Expect clearance for filed route and altitude within 10 minutes after departure.

PROVO FOUR DEPARTURE (OBSTACLE)

Figure 317

SW-4, 05 APR 2012 to 03 MAY 2012

SW-4, 05 APR 2012 to 03 MAY 2012

LOC/DME I-UUH 111.9 Chan 56	APP CRS 343°	Rwy Idg TDZE Apt Elev	12000 4226 4227
--	------------------------	-----------------------------	--

ILS or LOC RWY 34L

SALT LAKE CITY INTL (SLC)

▼ DME or RADAR required.
Simultaneous approach authorized with Rwy 34R and Rwy 35.

ALSF-2

MISSED APPROACH: Climb to 4800, then climbing left turn to 8100 via TCH VORTAC R-249 to STACO INT/ TCH VORTAC 20 DME and hold.

ATIS 124.75 125.625	SALT LAKE CITY APP CON 124.3 322.3	SALT LAKE CITY TOWER 119.05 257.8 (Rwy 16L-34R)	118.3 257.8 (Rwys 14-32, 17-35)	132.65 336.4 (Rwy 16R-34L)	GND CON 121.9 348.6 (Rwys 14-32, 17-35)	133.65 348.6 (Rwys 16L-34R, 16R-34L)
---	--	--	---	--------------------------------------	--	--

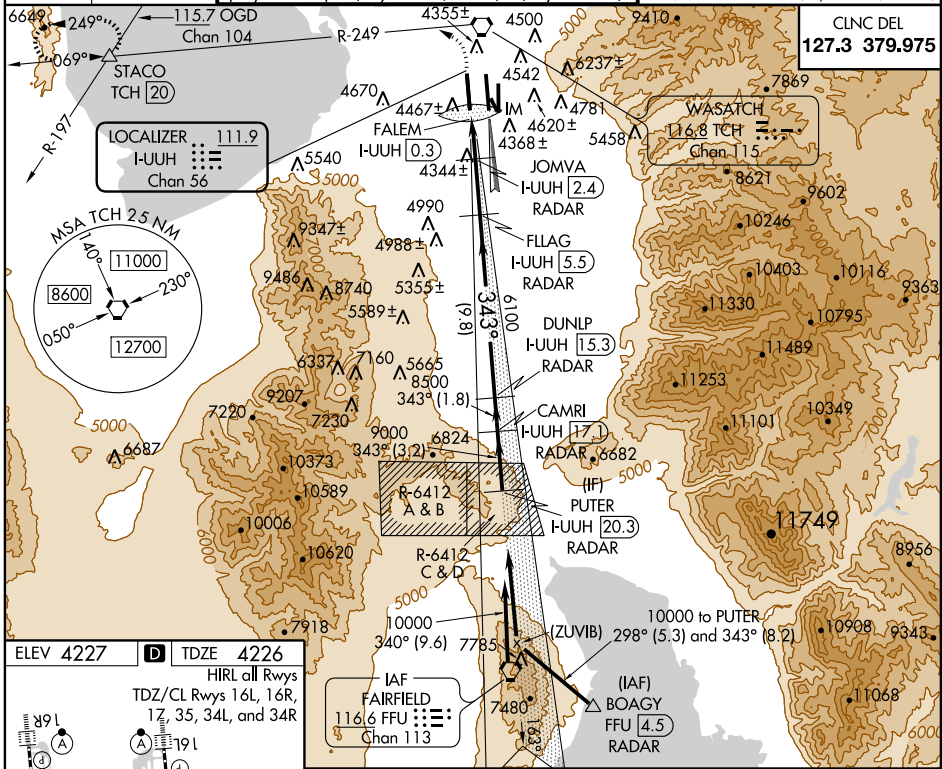

SW-4, 05 APR 2012 to 03 MAY 2012

SW-4, 05 APR 2012 to 03 MAY 2012

ELEV 4227	TDZE 4226
HIRL all Rwys TDZ/CL Rwys 16L, 16R, 17, 35, 34L, and 34R	

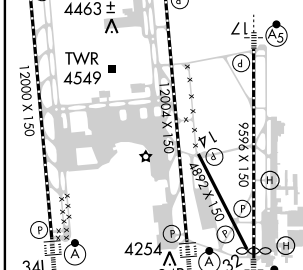

4800 8100
TCH R-249

STACO

VGSI and ILS glidepath not coincident (VGSI Angle 3.00/TCH 73).

FLAG
I-UUH 5.5
RADAR

DUNLIP
I-UUH 15.3
RADAR

CAMRI
I-UUH 17.1
RADAR

PUTER
I-UUH 20.3
RADAR

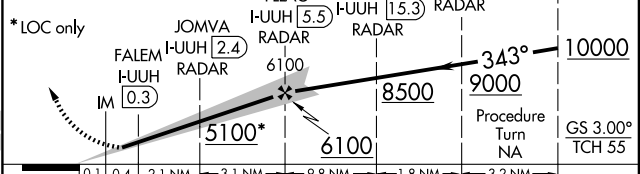

CATEGORY	A	B	C	D
S-ILS 34L	4426/18 200 (200-½)			
S-LOC 34L	4600/24 374 (400-½)			4600/40 374 (400-¾)

Figure 318

SAYGE SEVEN ARRIVAL

ST-9077 (FAA)

DENVER, COLORADO

SW-1, 05 APR 2012 to 03 MAY 2012

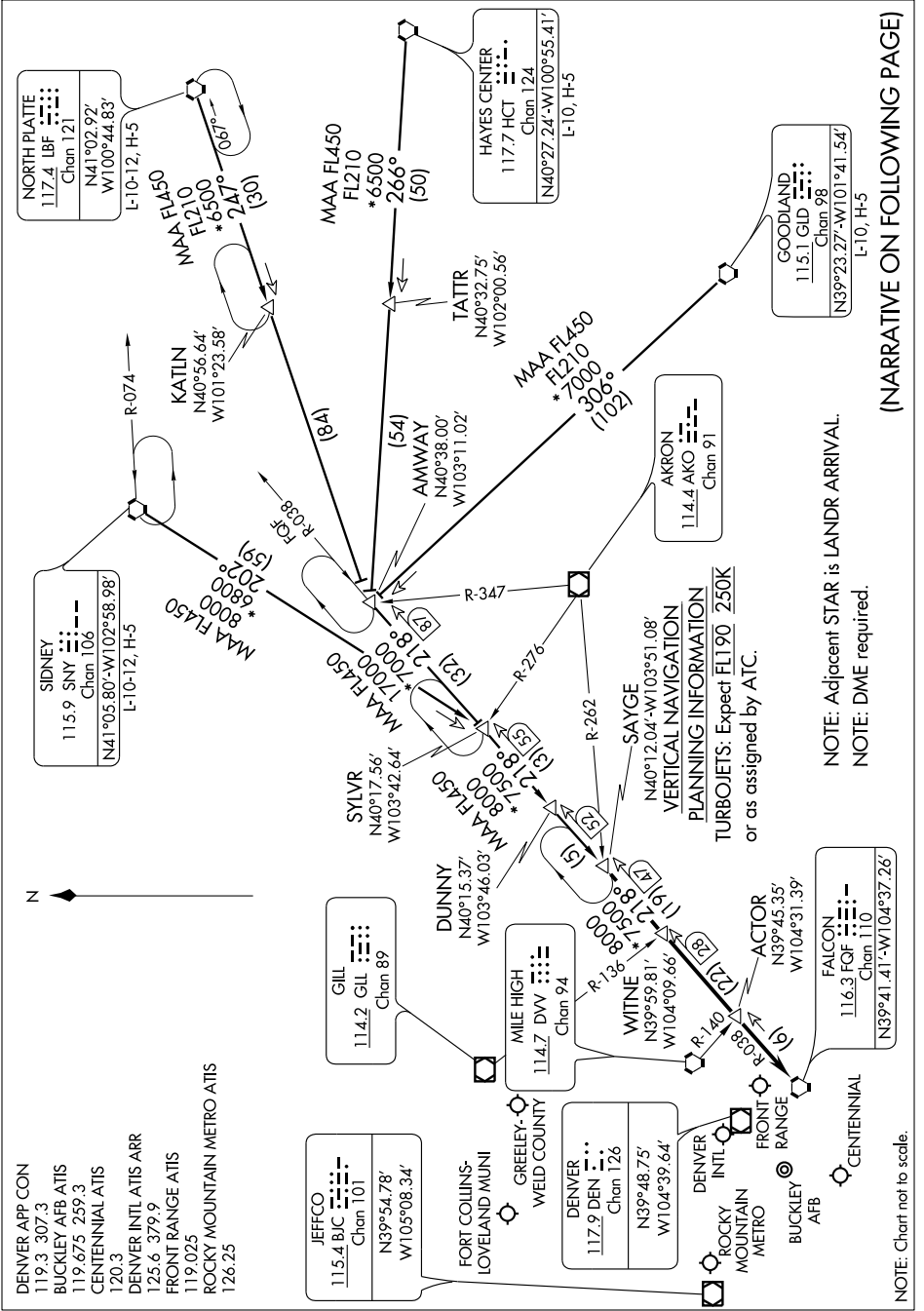

(NARRATIVE ON FOLLOWING PAGE)

SW-1, 05 APR 2012 to 03 MAY 2012

SAYGE SEVEN ARRIVAL

DENVER, COLORADO

Figure 319

ARRIVAL ROUTE DESCRIPTION

GOODLAND TRANSITION (GLD.SAYGE7): From over GLD VORTAC via GLD R-306 and FQF R-038 to SAYGE INT. Thence....

HAYES CENTER TRANSITION (HCT.SAYGE7): From over HCT VORTAC via HCT R-266 and FQF R-038 to SAYGE INT. Thence....

NORTH PLATTE TRANSITION (LBF.SAYGE7): From over LBF VORTAC via LBF R-247 and FQF R-038 to SAYGE INT. Thence....

SIDNEY TRANSITION (SNY.SAYGE7): From over SNY VORTAC via SNY R-202 and FQF R-038 to SAYGE INT. Thence....

....From over SAYGE INT via FQF R-038 to FQF VORTAC. Expect RADAR vectors to the final approach course at or before FQF VORTAC.

SW-1, 05 APR 2012 to 03 MAY 2012

SW-1, 05 APR 2012 to 03 MAY 2012

RNAV (GPS) -D
EAGLE COUNTY RGNL (EGE)

APP CRS 247°	Rwy Idg TDZE Apt Elev N/A N/A 6535
------------------------	--

NA GPS or RNP-0.3 required. DME/DME RNP-0.3 NA. Circling south of Rwy 7-25 not authorized for Cat. C and D at night.

MISSED APPROACH: Climb to 14500 via 247° course to ZODSY WP, then via 006° course to JESIE WP and hold.

ATIS 135.575	DENVER CENTER 128.65 282.2	EAGLE TOWER ★ 119.8 (CTAF) D	GND CON 121.8	CLNC DEL 124.75	DENVER CLNC DEL 124.75 (When tower closed)
------------------------	--------------------------------------	---	-------------------------	---------------------------	---

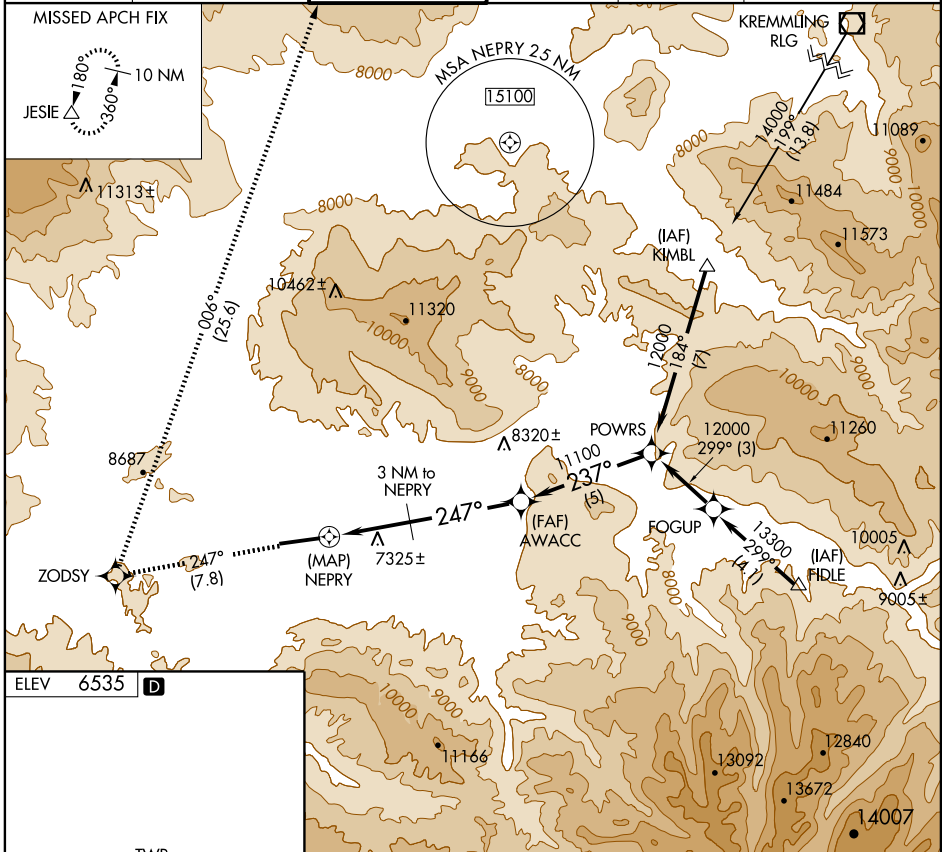

SW-1, 05 APR 2012 to 03 MAY 2012

SW-1, 05 APR 2012 to 03 MAY 2012

ELEV **6535** **D**

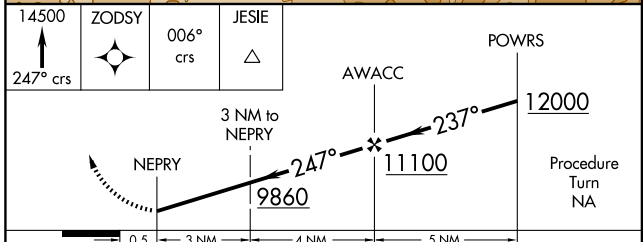
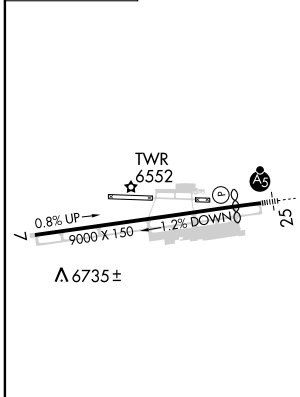

CATEGORY	A	B	C	D
CIRCLING	8900-1¼ 2365 (2400-1¼)	8900-1½ 2365 (2400-1½)	8900-3	2365 (2400-3)

Figure 321

LDA/DME RWY 25

EAGLE COUNTY RGNL (EGE)

LOC/DME I-ESJ 109.75 Chan 34(Y)	APP CRS 246°	Rwy Idg 8000 TDZE 6540 Apt Elev 6540
---	------------------------	--

▼ Inoperative table does not apply.
▲ At night increase LDA/GS visibility to 5 miles.
 * Fly visual to airport authorized during day only.

MALS R
MISSED APPROACH: Climb to 14500 direct SWX VOR/DME and climbing right turn via SWX R-001 to JESIE INT/SWX 24.2 DME and hold.

ATIS 135.575	DENVER CENTER 128.65 282.2	EAGLE TOWER * 119.8 (CTAF)	GND CON 121.8	CLNC DEL 124.75	DENVER CLNC DEL 124.75 (When tower closed)
------------------------	--------------------------------------	--------------------------------------	-------------------------	---------------------------	---

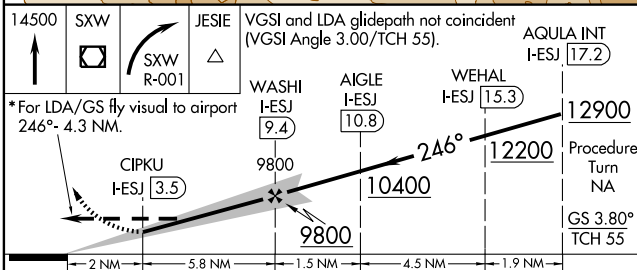
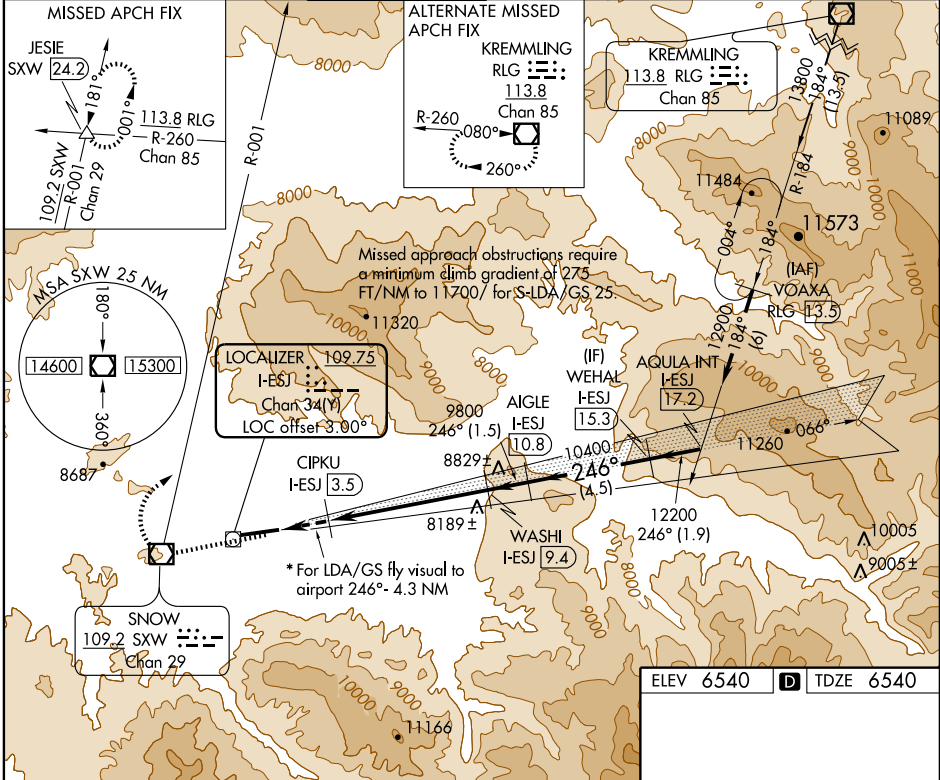

ELEV 6540	D TDZE 6540
-----------	--------------------

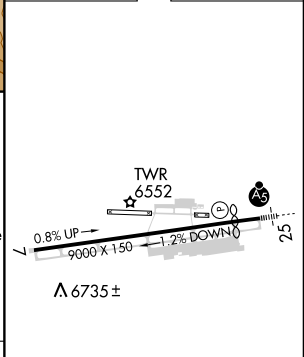

CATEGORY	A	B	C	D
S-LDA/GS 25	8330-3	1790 (1800-3)		NA
S-LDA 25	8620-2½	2080 (2100-2½)	8620-3 2080 (2100-3)	NA

HIRL Rwy 7-25 **0**
 REIL Rwy 7 **0**

SW-1, 05 APR 2012 TO 03 MAY 2012

SW-1, 05 APR 2012 TO 03 MAY 2012

GYPSUM FOUR DEPARTURE (OBSTACLE)

ATIS 135.575
 CLNC DEL
 124.75
 GND CON
 121.8
 EAGLE TOWER ★
 119.8
 DENVER CENTER
 128.65 282.2
 DENVER CLNC DEL
 124.75 (When tower closed)

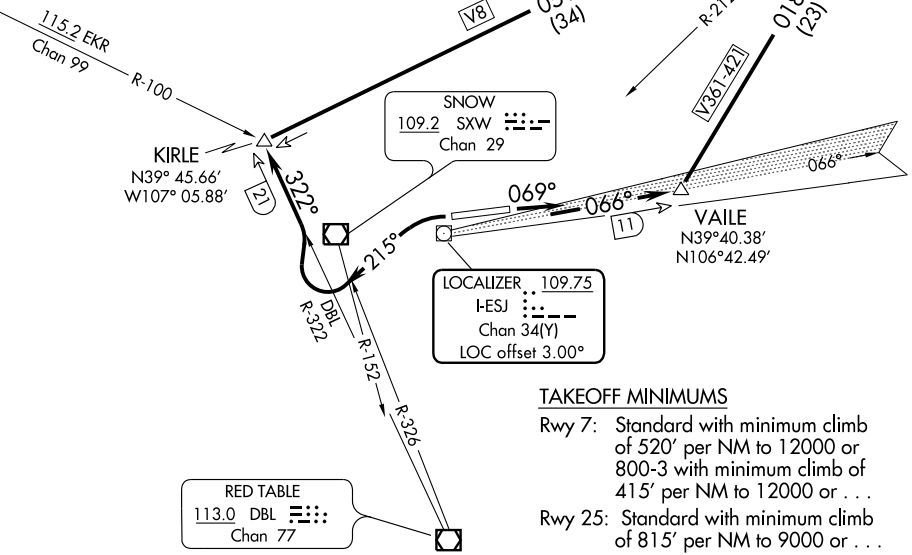

TAKEOFF MINIMUMS

Rwy 7: Standard with minimum climb of 520' per NM to 12000 or 800-3 with minimum climb of 415' per NM to 12000 or ...
 Rwy 25: Standard with minimum climb of 815' per NM to 9000 or ...
 ... 4100-3 for climb in visual conditions

TAKEOFF OBSTACLE NOTES

Rwy 7: Windsock 99' from DER, 352' left of centerline, 12' AGL/6552' MSL.
 OL on tower 2.2 NM from DER, 1688' right of centerline, 57' AGL/7057' MSL.
 Trees beginning 1.1 NM from DER, 1945' right of centerline, up to 18' AGL/7017' MSL.
 Tree 2.2 NM from DER, 3227' right of centerline, 27' AGL/7252' MSL.
 Rwy 25: Multiple trees beginning 1.6 NM from DER, 233' left of centerline, up to 15' AGL/7694' MSL.
 Pole 2 NM from DER, 111' left of centerline, 14' AGL/7333' MSL.
 Multiple trees beginning 1.4 NM from DER, 795' right of centerline, up to 16' AGL/7615' MSL.
 Multiple poles, tank, and OL on tower beginning 1.4 NM from DER, 77' right of centerline, up to 37' AGL/7716' MSL.

NOTE: Chart not to scale.

DEPARTURE ROUTE DESCRIPTION

TAKEOFF RUNWAY 7: Climb heading 069° and I-ESJ northeast course to VAILE INT/I-ESJ 11 DME then turn left via RLG R-198 to RLG VOR/DME or ...

TAKEOFF RUNWAY 25: Climbing left turn heading 215°, upon crossing SXW R-152 or DBL R-326 turn right via DBL R-322 to KIRLE INT/DBL 21 DME then turn right via RLG R-231 to RLG VOR/DME or ...

... Climb in visual conditions to cross Eagle County Rgnl Airport northeast bound at or above 10500, then via RLG R-212 to RLG VOR/DME.

GYPSUM FOUR DEPARTURE (OBSTACLE)

Figure 323

SW-1, 05 APR 2012 to 03 MAY 2012

SW-1, 05 APR 2012 to 03 MAY 2012

MEEKER ONE DEPARTURE

- ATIS 135.575
- CLNC DEL 124.75
- GND CON 121.8
- EAGLE TOWER * 119.8
- DENVER CENTER 128.65 282.2
- DENVER CLNC DEL 124.75 (When tower closed)

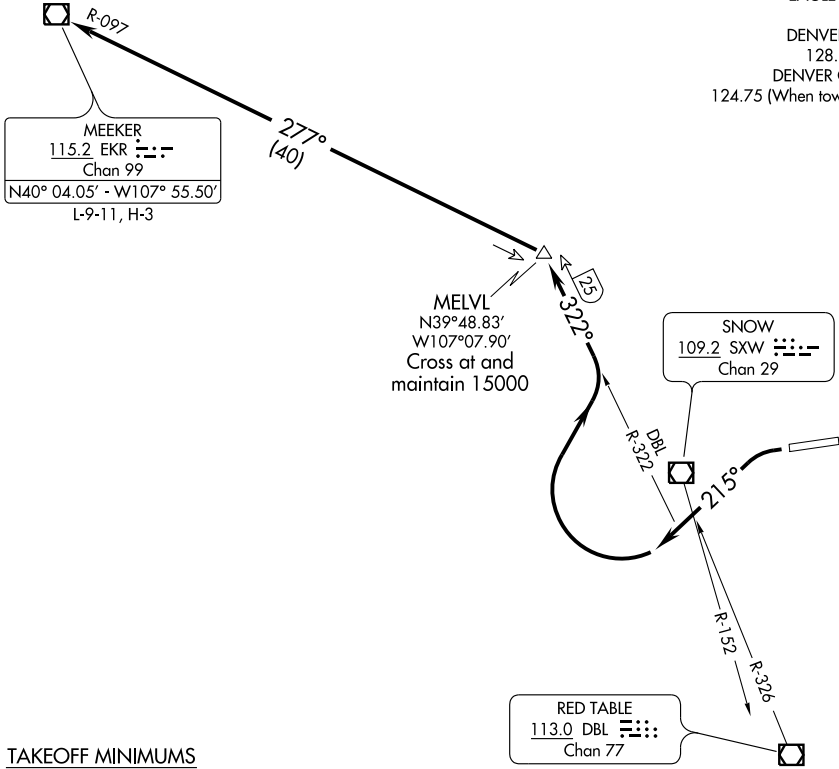

SW-1, 05 APR 2012 to 03 MAY 2012

SW-1, 05 APR 2012 to 03 MAY 2012

TAKEOFF MINIMUMS

Rwy 7: NA - ATC

Rwy 25: Standard with minimum climb of 815' per NM to 15000.

TAKEOFF OBSTACLE NOTES

- Rwy 25: Multiple trees beginning 1.6 NM from DER, 233' left of centerline, up to 15' AGL/7694' MSL.
- Pole 2 NM from DER, 111' left of centerline, 14' AGL/7333' MSL.
- Multiple trees beginning 1.4 NM from DER, 795' right of centerline, up to 16' AGL/7615' MSL.
- Multiple poles, tank and OL on tower beginning 1.4 NM from DER, 77' right of centerline, up to 37' AGL/7716' MSL.

NOTE: Chart not to scale.



DEPARTURE ROUTE DESCRIPTION

TAKEOFF RUNWAY 25: Climbing left turn heading 215°, upon crossing SXW R-152 or DBL R-326 turn right via DBL R-322 to MELVL INT/DBL 25 DME then turn left via EKR R-097 to EKR VOR/DME. Cross MELVL at and maintain 15000, expect filed altitude 10 minutes after departure.

MEEKER ONE DEPARTURE

Figure 324

AIRPORT DIAGRAM

EAGLE COUNTY RGNL (E.G.E)
EAGLE, COLORADO

AL-6403 (FAA)

SW-1, 05 APR 2012 to 03 MAY 2012

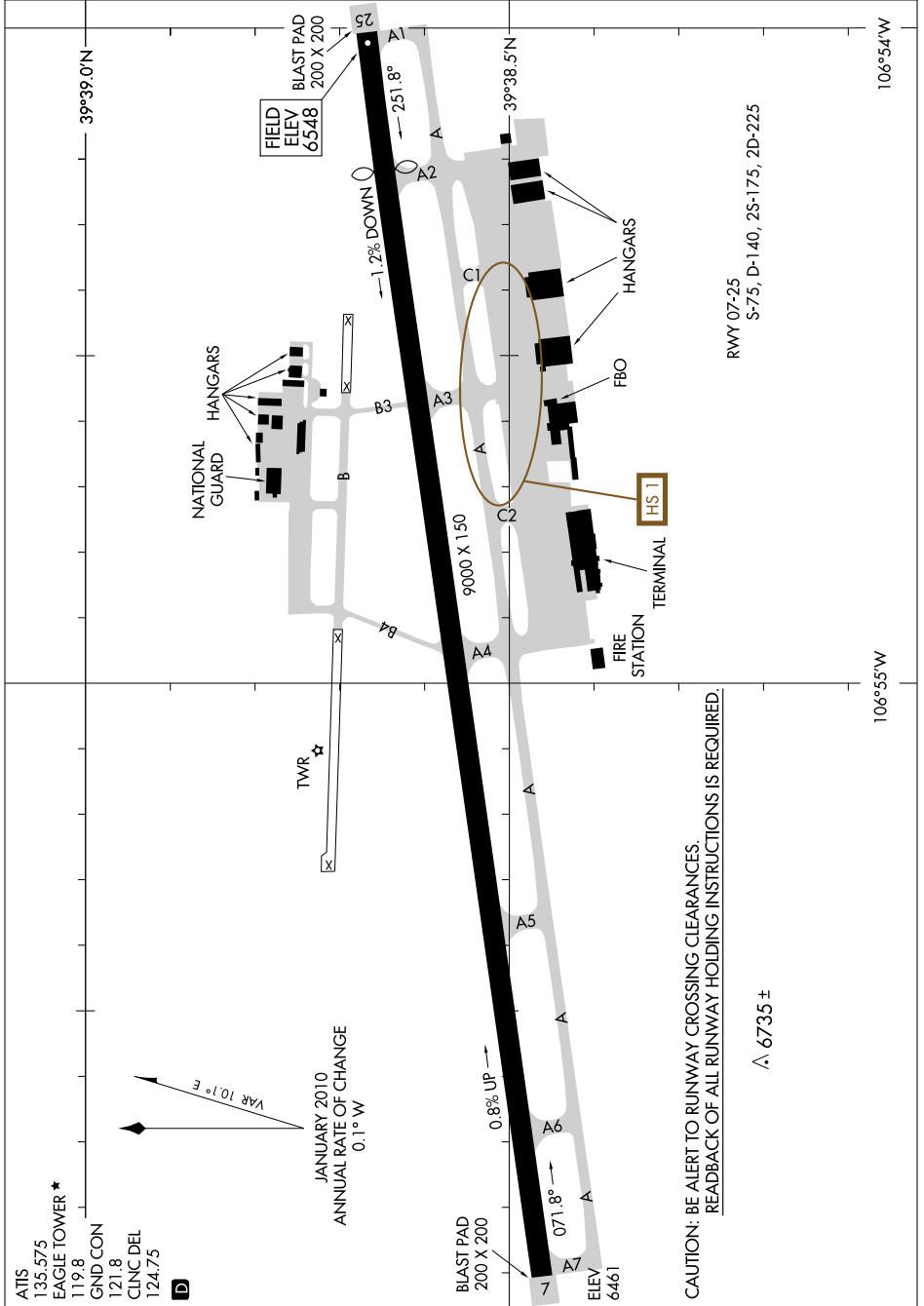

AIRPORT DIAGRAM

EAGLE, COLORADO
EAGLE COUNTY RGNL (E.G.E)

SW-1, 05 APR 2012 to 03 MAY 2012

Figure 325



ALTERNATE MINS

M2



NAME ALTERNATE MINIMUMS

DENVER, CO

CENTENNIAL (APA) ILS or LOC Rwy 35R¹
NDB Rwy 35R²
RNAV (GPS) Rwy 28^{3,4}
RNAV (GPS) Rwy 35R¹⁴

¹Categories A,B, 900-2; Category C, 900-2½, Category D, 900-2¾.

²Categories A,B, 1000-2; Categories C,D, 1000-3.

³Category D, 800-2¼.

⁴NA when local weather not available.

ROCKY MOUNTAIN METROPOLITAN

(BJC) ILS or LOC Y Rwy 29R^{1,2,3}
ILS or LOC Z Rwy 29R^{2,3}
RNAV (GPS) Rwy 29L³
RNAV (GPS) Rwy 29R³
VOR/DME Rwy 29L/R²

¹ILS, Categories A, B, C, D, 700-2.

²NA when control tower closed.

³NA when local weather not available.

EAGLE, CO

EAGLE COUNTY

RGNL (EGE) LDA/DME Rwy 25
Categories A,B, 2100-2; Category C, 2100-3.
NA when control tower closed.
NA when local weather not available.

FARMINGTON, NM

FOUR CORNERS

RGNL (FMN) ILS or LOC Rwy 25^{1,2}
RNAV (GPS) Rwy 5³
RNAV (GPS) Rwy 7³
RNAV (GPS) Rwy 23⁴
RNAV (GPS) Rwy 25³

¹NA when control tower closed.

²ILS, Categories B,C,D, 700-2.

³NA when local weather not available.

⁴Category D, 800-2¼.

FORT COLLINS/LOVELAND, CO

FORT COLLINS-LOVELAND

MUNI (FNL) RNAV (GPS) Rwy 15
RNAV (GPS) Rwy 33
VOR/DME-A

NA when local weather not available.

GALLUP, NM

GALLUP MUNI (GUP) RNAV (GPS) Rwy 6^{1,2}
RNAV (GPS) Rwy 24³
VOR Rwy 6⁴

¹Categories A, B, 900-2; Category C, 900-2½; Category D, 900-3.

²NA when local weather not available.

³Category D, 900-3.

⁴Category C, 800-2¼; Category D, 900-3.

NAME ALTERNATE MINIMUMS

GRAND JUNCTION, CO

GRAND JUNCTION

RGNL (GJT) ILS or LOC Rwy 11^{1,2}
LDA/DME Rwy 29³
RNAV (GPS) Y Rwy 11³

¹ILS, Category D, 700-2¼.

²NA when local weather not available.

³Category D, 800-2¼.

GREELEY, CO

GREELEY-WELD

COUNTY (GXY) ILS or LOC Rwy 34
RNAV (GPS) Rwy 16
RNAV (GPS) Rwy 27
RNAV (GPS) Rwy 34
VOR-A

NA when local weather not available.

GUNNISON, CO

GUNNISON-CRESTED

BUTTE RGNL (GUC) ILS or LOC Rwy 6¹
RNAV (RNP) Rwy 6, 800-2¼
VOR or GPS-A^{2,3}

¹ILS, LOC, Categories A, B, C, 1600-3.

²Categories A,B,C, 1700-3; Cat D, 2300-3.

³NA when local altimeter setting not available except for operators with approved weather reporting service.

HAYDEN, CO

YAMPA

VALLEY (HDN) ILS or LOC/DME Y Rwy 10^{1,2}
RNAV (GPS) Y Rwy 10^{1,2}
RNAV (RNP) Z Rwy 10, 800-2¼¹
VOR/DME-B³

¹NA when local weather not available.

²Categories A, B, 1200-2; Categories C, D, 1200-3.

³Categories A, B, 1300-2; Categories C, D, 1300-3.

HOBBS, NM

LEA COUNTY

RGNL (HOB) ILS or LOC Rwy 3¹
LOC/DME BC Rwy 21²
RNAV (GPS) Rwy 3³
RNAV (GPS) Rwy 21²
RNAV (GPS) Rwy 30²
VOR/DME or TACAN Rwy 21²
VOR or TACAN Rwy 3²

¹NA when control tower closed.

²NA when control tower closed, except standard for operators with approved weather reporting service.

³NA when local weather not available.



ALTERNATE MINS

M2

SW-1



LOC/DME I-GUC 110.5 Chan 42	APP CRS 062°	Rwy Idg TDZE Apt Elev 9400 7667 7680
---	------------------------	--

ILS or LOC RWY 6

GUNNISON-CRESTED BUTTE RGNL (GUC)

⚠ Circling NA at night. Inoperative table does not apply.
⚠ When local altimeter setting not received, procedure NA.
 DME required. Visibility reduction by helicopters NA.
 Procedure NA when airport closed except by prior arrangement.



MISSED APPROACH: Climb to 10000 then climbing right turn to 12000 via heading 180° and HBU VOR/DME R-050 to WIDIG/HBU 4. DME continue via HBU VOR/DME R-050 to HBU VOR/DME and hold.

AWOS-3
135.075

DENVER CENTER
125.35 354.05

UNICOM
122.7 (CTAF)

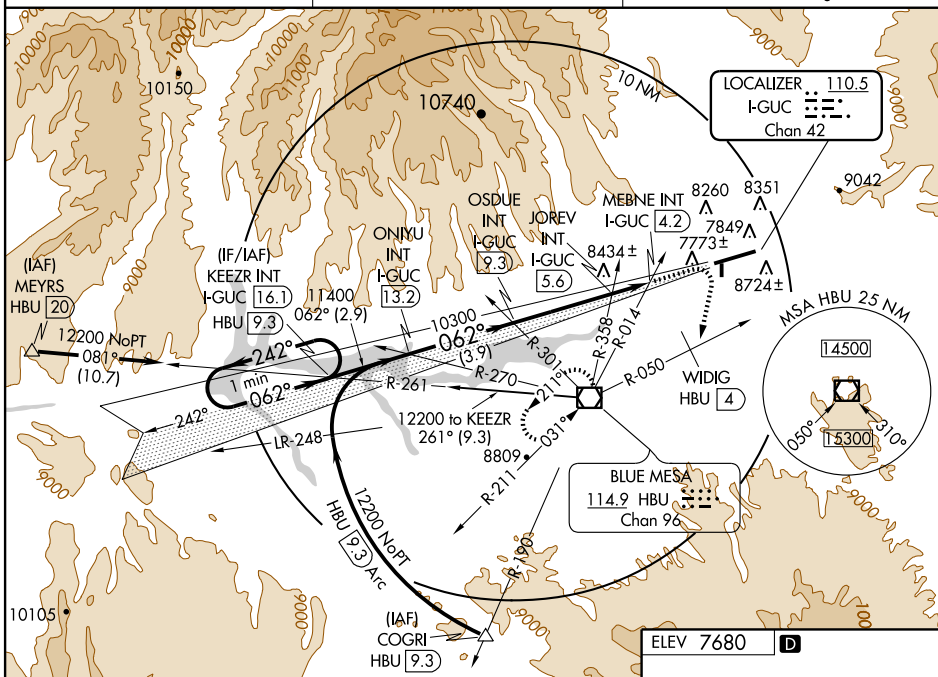

SW-1, 05 APR 2012 to 03 MAY 2012

SW-1, 05 APR 2012 to 03 MAY 2012

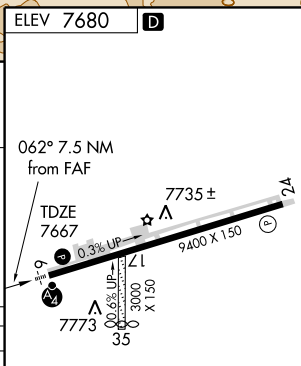
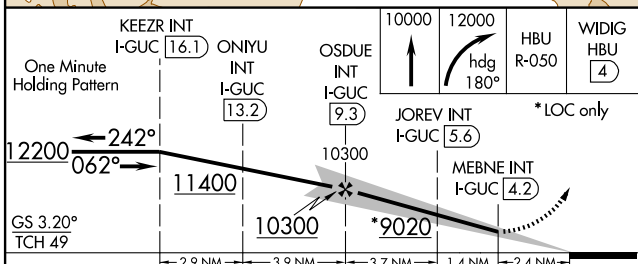

CATEGORY	A	B	C	D
S-ILS 6	8590-3 923 (1000-3)			NA
S-LOC 6	9020-3 1353 (1400-3)			
CIRCLING	9260-3 1580 (1600-3)			
	JOREV FIX MINIMUMS			
S-LOC 6	8640-3 973 (1000-3)			
CIRCLING	9260-3 1580 (1600-3)			

HIRL Rwy 6-24
REIL Rwy 24

FAF to MAP 5.1 NM

Knots	60	90	120	150	180
Min:Sec	5:06	3:24	2:33	2:02	1:42

Figure 327

APP CRS	Rwy Idg	9400
242°	TDZE	7680
	Apt Elev	7680

RNAV (RNP) RWY 24

GUNNISON-CRESTED BUTTE RGNL (GUC)

RF and GPS required.
 When local altimeter setting not received, procedure NA.
 Procedure NA for aircraft with wingspan greater than 136 feet.
 For uncompensated Baro-VNAV systems, procedure NA below -29°C (-20°F) or above 24°C (75°F).
 When VGSI inoperative, procedure NA at night.
 Missed approach requires minimum climb of 425 feet per NM to 9000.

MISSED APPROACH: Climb to 14000 on track 242° to KEEZR, and left turn to NUWZO, and on track 330° to HBU VOR/DME and hold.

AWOS-3
135.075

DENVER CENTER
125.35 354.05

UNICOM
122.7 (CTAF)

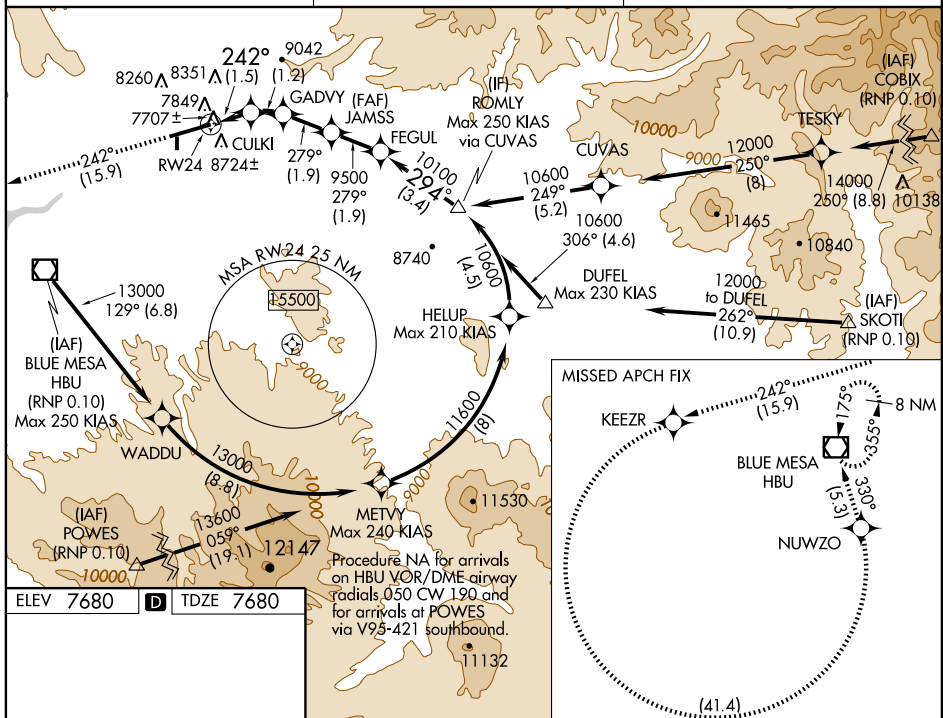

SW-1, 05 APR 2012 to 03 MAY 2012

SW-1, 05 APR 2012 to 03 MAY 2012

ELEV 7680	D	TDZE 7680
------------------	----------	------------------

Procedure NA for arrivals on HBU VOR/DME airway radials, 050 CW 190 and for arrivals at POWES via V95-421 southbound.

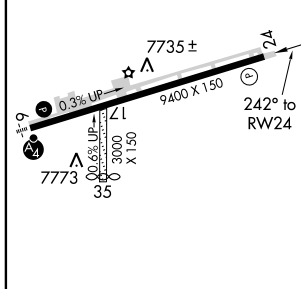

14000	KEEZR	NUWZO	VGSI and RNAV glidepath not coincident (VGSI Angle 3.10/TCH 50).
tr 242°			

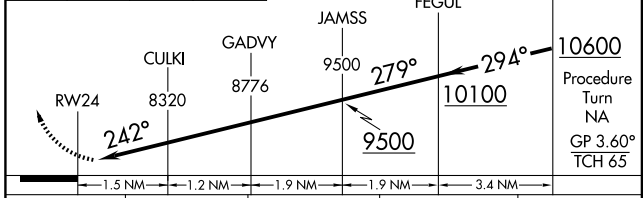

CATEGORY	A	B	C	D
RNP 0.10 DA	7989-1 309 (400-1)			NA

AUTHORIZATION REQUIRED

LOC/DME I-OGD 111.7 Chan 54	APP CRS 031°	Rwy Idg TDZE Apt Elev	7252 4473 4473
---	------------------------	-----------------------------	---

ILS or LOC RWY 3

OGDEN-HINCKLEY (OGD)

<p>▽ When local altimeter setting not received, use Hill AFB altimeter setting. ▲ When VGSi inoperative, circling Rwy 7 and 16 NA at night. Inoperative table does not apply to S-LOC 3 and Cat C. DME or RADAR required.</p>	<p>MALS (A) </p>	<p>MISSED APPROACH: Climb to 4900, then climbing left turn to 6000 direct OGD VORTAC, then climb to 13000 on OGD R-263 to MOINT INT/OGD 15.1 DME and hold, continue climb-in-hold to 13000.</p>
--	---------------------------------------	---

ATIS 125.55	SALT LAKE CITY APP CON 121.1 319.25	OGDEN TOWER* 118.7 (CTAF) 253.5	GND CON 121.7	UNICOM 122.95
-----------------------	---	---	-------------------------	-------------------------

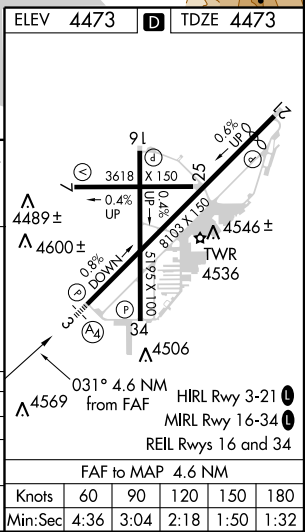
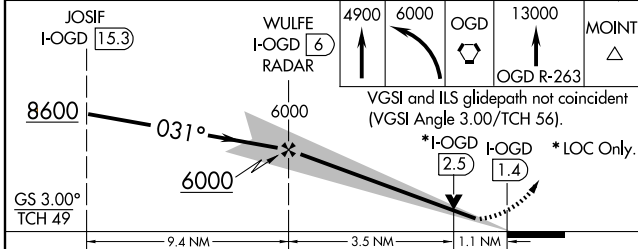
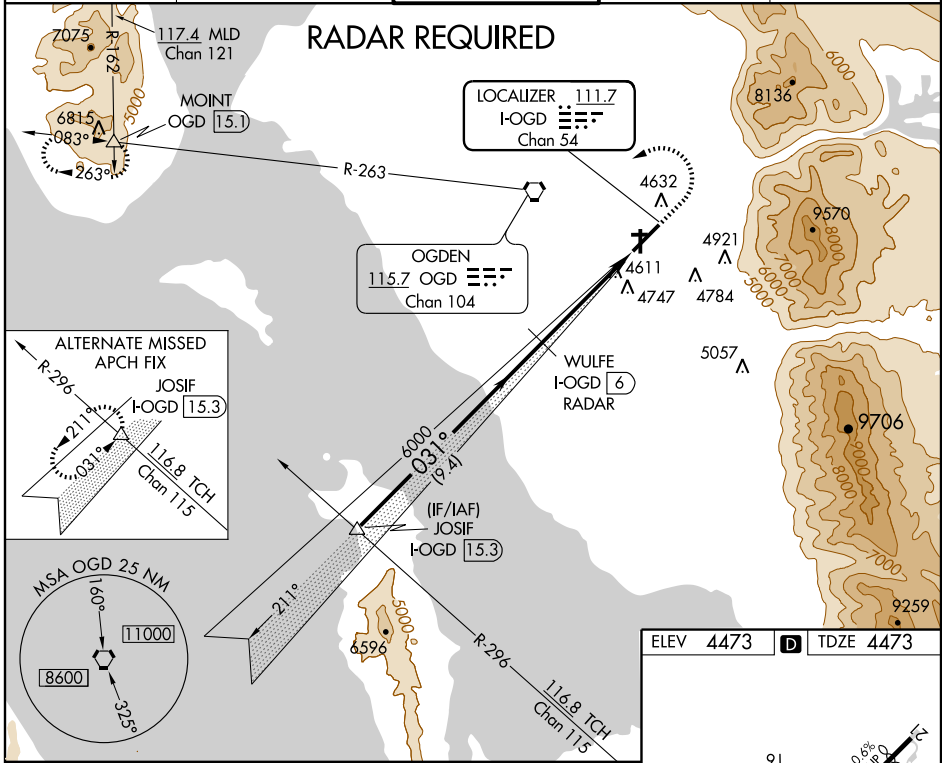

CATEGORY	A	B	C	D
S-ILS 3	4673-1/2 200 (200-1/2)			
S-LOC 3	4880-3/4 407 (500-3/4)	4880-1/4 407 (500-1/4)		
CIRCLING	4980-1 507 (600-1)	5060-1 587 (600-1)	5060-1/2 587 (600-1/2)	5100-2 627 (700-2)

ILS or LOC RWY 19L SAN FRANCISCO INTL (SFO)

LOC/DME I-SIA 108.9 Chan 26	APP CRS 191°	Rwy 19L Idg 8648 TDZE 11 Apt Elev 13	Rwy 19R Idg 7500 TDZE 10 Apt Elev 13
--	------------------------	---	---

⚠ Inoperative table does not apply.

⚠ MALS Fwy 19L $\frac{1}{2}$ -

MISSED APPROACH: Climb to 420 then climbing left turn to 4000 via SFO VOR/DME R-101 to DUMBA INT and hold.

ATIS 113.7 115.8 118.85 135.45	NORCAL APP CON 134.5 338.2	SAN FRANCISCO TOWER 120.5 269.1	GND CON 121.8	CLNC DEL 118.2
--	--------------------------------------	---	-------------------------	--------------------------

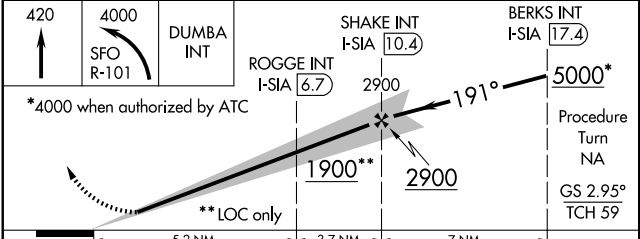
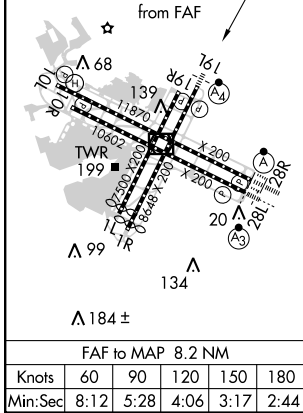
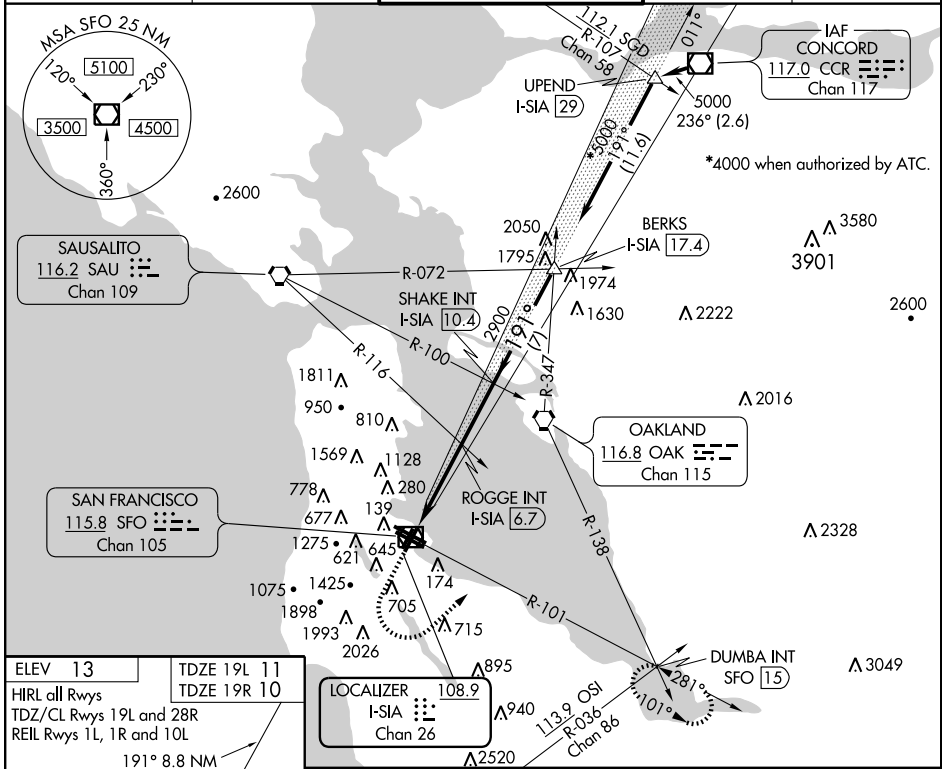

CATEGORY	A	B	C	D
S-ILS 19L		211/40	200 (200-¾)	
S-LOC 19L		340/50	329 (400-1)	
SIDESTEP RWY 19R	340/50	330 (400-1)	340-1½ 330 (400-1½)	340-2 330 (400-2)
CIRCLING	760-1¼ 747 (800-1¼)	940-1½ 927 (1000-1½)	1040-3 1027 (1100-3)	1160-3 1147 (1200-3)

ILS or LOC RWY 28L SAN FRANCISCO INTL (SFO)

LOC/DME I-SFO 109.55 Chan 32 (Y)	APP CRS 281°	Rwy 28L Idg 10602 TDZE 13 Apt Elev 13	Rwy 28R Idg 11870 TDZE 13 Apt Elev 13
---	------------------------	--	--

⚠ Inoperative table does not apply to sidestep 28R Cat A and B. Disregard IM and MM indications. #RVR 1800 authorized with the use of FD or AP or HUD to DA.

MISSED APPROACH: Climb to 600 then climbing right turn to 3000 via heading 285° and SFO VOR/DME R-280 to OLYMM INT 15 DME and hold.

ATIS 113.7 115.8 118.85 135.45	NORCAL APP CON 134.5 338.2	SAN FRANCISCO TOWER 120.5 269.1	GND CON 121.8	CLNC DEL 118.2
--	--------------------------------------	---	-------------------------	--------------------------

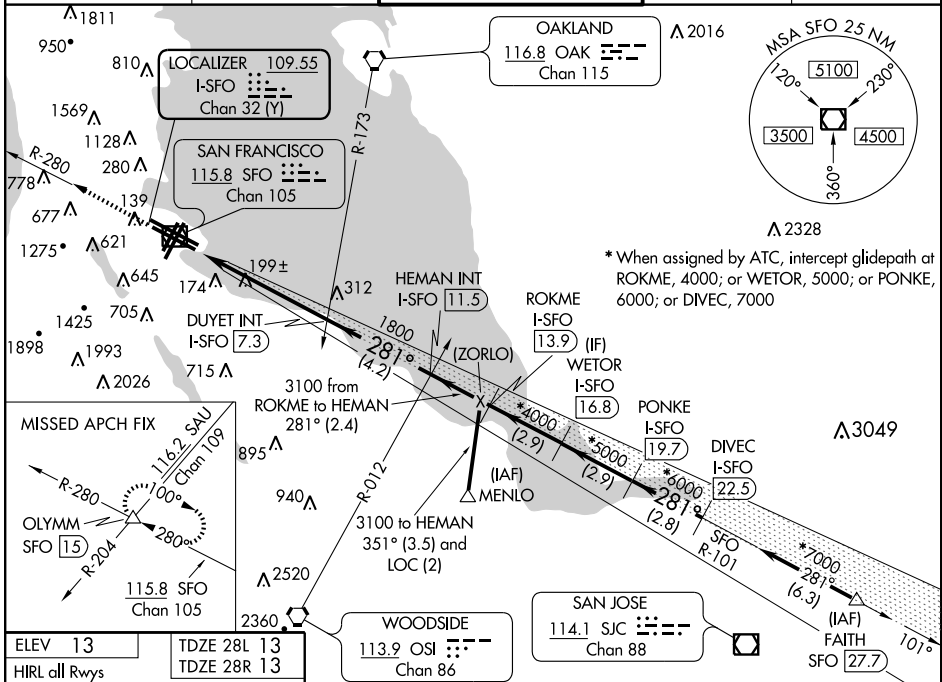

SW-2, 05 APR 2012 to 03 MAY 2012

SW-2, 05 APR 2012 to 03 MAY 2012

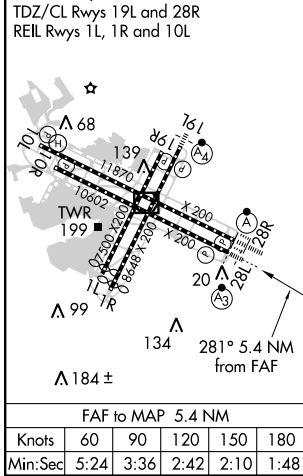

600	3000	SFO	OLYMM	* When assigned by ATC, intercept glidepath at ROKME, 4000; or WETOR, 5000; or PONKE, 6000; or DIVEC, 7000.
↑	hdg 285°	R-280	△	Procedure Turn NA
Use I-SFO DME when on the LOC course.	DUYET INT I-SFO 7.3	HEMAN INT I-SFO 11.5	ROKME I-SFO 13.9	WETOR I-SFO 16.8
GS 3.00° TCH 57	I-SFO 1.9	1800	3100	4000* 5000* 6000*
	I-SFO 1.9	1800	3100	4000* 5000* 6000*
	1.2	4.2 NM	4.2 NM	2.4 NM
			2.9 NM	2.9 NM
				2.8 NM
CATEGORY	A	B	C	D
S-ILS 28L	# 213/24 200 (200-½)			
S-LOC 28L	460/24	447 (500-½)	460/40 447 (500-¾)	460/50 447 (500-1)
SIDESTEP RWY 28R	460/50 447 (500-1)			460-1½ 447 (500-1½)
CIRCLING	760-1 747 (800-1)	940-1¼ 927 (1000-1¼)	1040-3 1027 (1100-3)	1160-3 1147 (1200-3)

VGSI and ILS glidepath not coincident (VGSI Angle 3.00/TCH 75).

Figure 331

ILS PRM RWY 28L (SIMULTANEOUS CLOSE PARALLEL) SAN FRANCISCO INTL (SFO)

LOC/DME I-SFO 109.55 Chan 32 (Y)	APP CRS 281°	Rwy Idg TDZE Apt Elev	10602 13 13
---	------------------------	-----------------------------	--

NA Simultaneous close parallel approach authorized with LDA PRM Rwy 28R. Localizer only not authorized during close-parallel operations. Dual VHF comm required. Disregard IM and MM indications. See additional requirements on AAUP. Runway 28L and 28R separated by 750' centerline to centerline.

SSALR
MISSED APPROACH: Climb to 600 then climbing right turn to 3000 via heading 285° and SFO VOR/DME R-280 to OLYMM INT/SFO VOR/DME 1.5 DME and hold.

ATIS 113.7 115.8 118.85 135.45	NORCAL APP CON 134.5 338.2	SAN FRANCISCO TOWER 120.5 269.1 PRM 125.15	GND CON 121.8	CLNC DEL 118.2
--	--------------------------------------	--	-------------------------	--------------------------

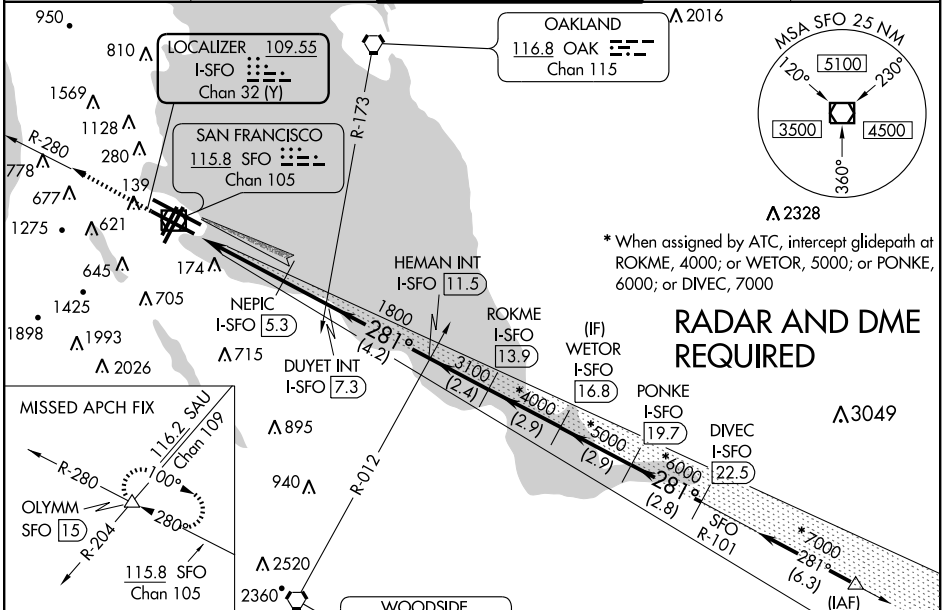

ELEV 13	TDZE 13
---------	---------

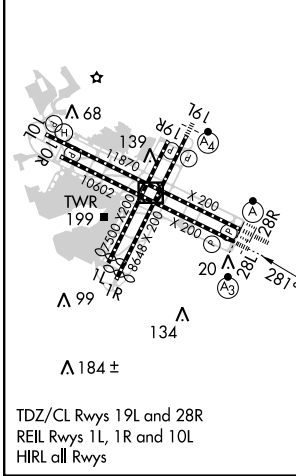

WOODSIDE 113.9 OSI Chan 86	2572 2840 1960	SAN JOSE 114.1 SJC Chan 88
----------------------------------	-------------------	----------------------------------

600	3000	SFO	OLYMM	* When assigned by ATC, intercept glidepath at ROKME, 4000; or WETOR, 5000; or PONKE, 6000; or DIVEC, 7000.			
↑	hdg 285°	R-280	△	Procedure Turn NA			
Use I-SFO DME when on the LOC course.		DUYET INT	HEMAN INT	ROKME	WETOR	PONKE	DIVEC
		I-SFO 7.3	I-SFO 11.5	I-SFO 13.9	I-SFO 16.8	I-SFO 19.7	I-SFO 22.5
GS 3.00°		NEPIC					
TCH 57		I-SFO 5.3					
		1800	3203	4000*	5000*	6000*	7000*
		VGSi and ILS glidepath not coincident (VGSi Angle 3.00/TCH 75).					
		3.4 NM	2 NM	4.2 NM	2.4 NM	2.9 NM	2.9 NM
		CATEGORY A B C D					
S-ILS 28L		213/24 200 (200-½)					

SW-2, 05 APR 2012 to 03 MAY 2012

SW-2, 05 APR 2012 to 03 MAY 2012

Figure 332

ATTENTION ALL USERS PAGE (AAUP)

Condensed Briefing Points:

- Listen to the PRM monitor frequency when communicating with NORCAL approach control (135.65), no later than LOC intercept.
- Expect to be switched to SFO Tower (120.5) at NEPIC (I-SFO 5.3 DME).
- PRM monitor frequency may be de-selected after determining that the aircraft is on the tower frequency.

1. **ATIS.** When the ATIS broadcast advises that simultaneous ILS/PRM and LDA/PRM approaches are in progress, pilots should brief to fly the ILS/PRM 28L approach. If later advised to expect an ILS 28L approach, the ILS/PRM 28L chart may be used after completing the following briefing items:

- (a) Minimums and missed approach procedures are unchanged.
- (b) Monitor frequency no longer required.
- (c) A different glideslope intercept altitude may be assigned when advised to expect the ILS 28L approach.

Simultaneous parallel approaches will only be offered/conducted when the weather is at least 2100 feet (ceiling) and 4 miles (visibility).

2. **Dual VHF Communication required.** To avoid blocked transmissions, each runway will have two frequencies, a primary and a PRM monitor frequency. The NORCAL approach controller will transmit on both frequencies. The PRM Monitor controller's transmissions, if needed, will override both frequencies. Pilots will ONLY transmit on the approach controller's frequency (135.65), but will listen to both frequencies. Select the PRM monitor frequency audio only when in contact with NORCAL approach control (135.65). The volume levels should be set about the same on both radios so that the pilots will be able to hear transmissions on at least one frequency if the other is blocked. The PRM monitor frequency may be de-selected passing NEPIC.

3. **ALL "Breakouts"** are to be hand flown to assure that the maneuver is accomplished in the shortest amount of time. Pilots, when directed by ATC to break off an approach, must assume that an aircraft is blundering toward their course and a breakout must be initiated immediately.

- (a) ATC Directed "Breakouts:" ATC directed breakouts will consist of a turn and a climb or descent. Pilots must always initiate the breakout in response to an air traffic controller instruction. Controllers will give a descending breakout only when there are no other reasonable options available, but in no case will the descent be below minimum vectoring altitude (MVA) which provides at least 1000 feet required obstruction clearance. The MVA in the final approach segment is 1600 feet at San Francisco International Airport.
- (b) Phraseology - "TRAFFIC ALERT:" If an aircraft enters the "NO TRANSGRESSION ZONE" (NTZ), the controller will breakout the threatened aircraft on the adjacent approach. The phraseology for the breakout will be:

"TRAFFIC ALERT, (aircraft call sign) TURN (left/right) IMMEDIATELY, HEADING (degrees), CLIMB/DESCEND AND MAINTAIN (altitude)".

4. Descending on (not above) the ILS glideslope ensures complying with any charted crossing restrictions and assists traffic on the LDA PRM 28R approach to mitigate possible wake turbulence encounters without destabilizing the LDA approach and creating a go-around.

5. **LDA Traffic:** While conducting this ILS/PRM approach to Runway 28L, other aircraft may be conducting the offset LDA/PRM approach to Runway 28R. These aircraft will approach from the right-rear and will re-align with 28R after making visual contact with the ILS traffic.

Special pilot training required. Pilots who are unable to participate will be afforded appropriate arrival services as operational conditions permit and must notify the controlling ARTCC as soon as practical, but at least 100 miles from destination.

SW-2, 05 APR 2012 to 03 MAY 2012

SW-2, 05 APR 2012 to 03 MAY 2012

LOC/DME I-FNP 110.75 Chan 44(Y)	APP CRS 278°	Rwy Idg TDZE 11870 13	Apt Elev 13
--	------------------------	---	-----------------------

LDA/DME RWY 28R

SAN FRANCISCO INTL (SFO)

NA Runway 28L and 28R separated by 750 feet centerline to centerline.
 Procedure NA when glideslope is not available.
 Localizer course 1199° right of Rwy 28R threshold.
 Inoperative table does not apply.

ALS-F-2



MISSED APPROACH: Climbing right turn to 6000 via heading 030° and SFO VOR/DME R-035 and OAK VORTAC R-060 to SALAD INT and hold, continue climb in hold to 6000.

ATIS 113.7 115.8 118.85 135.45	NORCAL APP CON 134.5 338.2	SAN FRANCISCO TOWER 120.5 269.1	GND CON 121.8	CLNC DEL 118.2
--	--------------------------------------	---	-------------------------	--------------------------

RADAR AND DME REQUIRED LDA/GLIDESLOPE

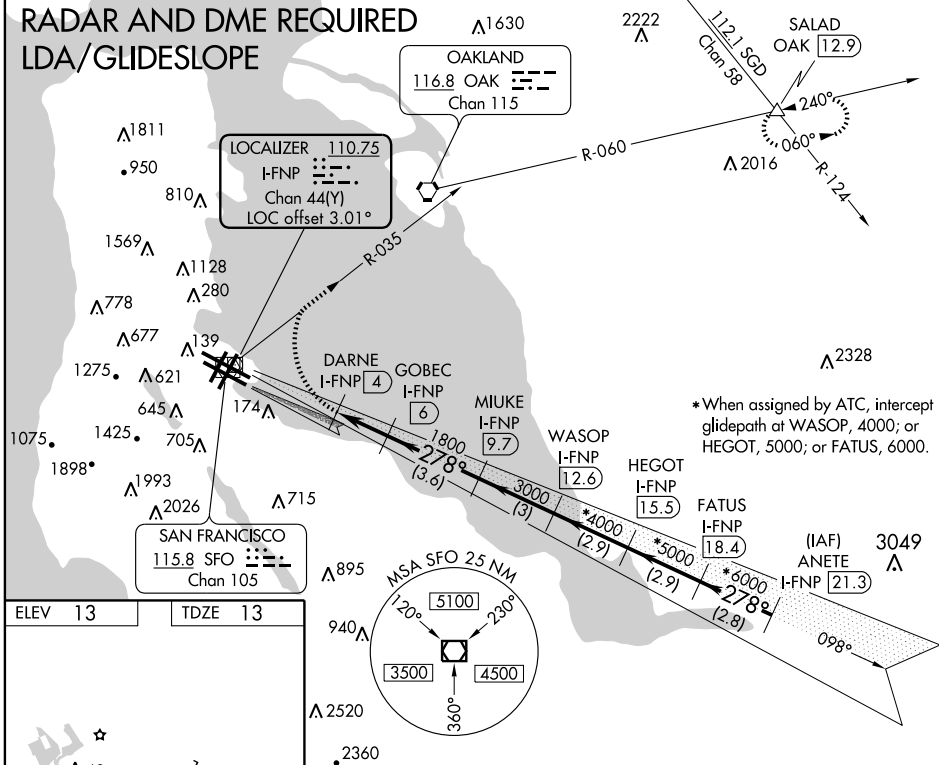

ELEV 13	TDZE 13
---------	---------

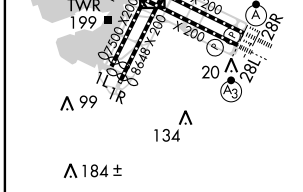

TDZ/CL Rws 19L and 28R
 REIL Rws 1L, 1R, and 10L
 HIRL all Rws

6000	SFO R-035	OAK R-060	SALAD	*When assigned by ATC, intercept glidepath at WASOP, 4000; or HEGOT, 5000; or FATUS, 6000.	ANETE I-FNP 21.3
------	-----------	-----------	-------	--	------------------

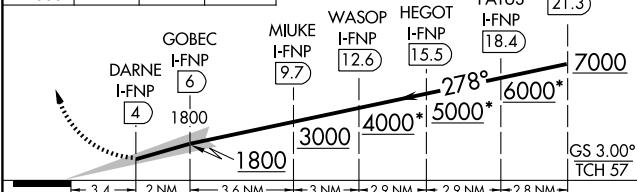

CATEGORY	A	B	C	D
S-LDA/GS 28R	1140-4 1127 (1200-4)			

Figure 334

SW-2, 05 APR 2012 to 03 MAY 2012

SW-2, 05 APR 2012 to 03 MAY 2012

AIRPORT DIAGRAM

AL-375 (FAA)

SAN FRANCISCO INTL (SFO)
SAN FRANCISCO, CALIFORNIA

SW-2, 05 APR 2012 to 03 MAY 2012

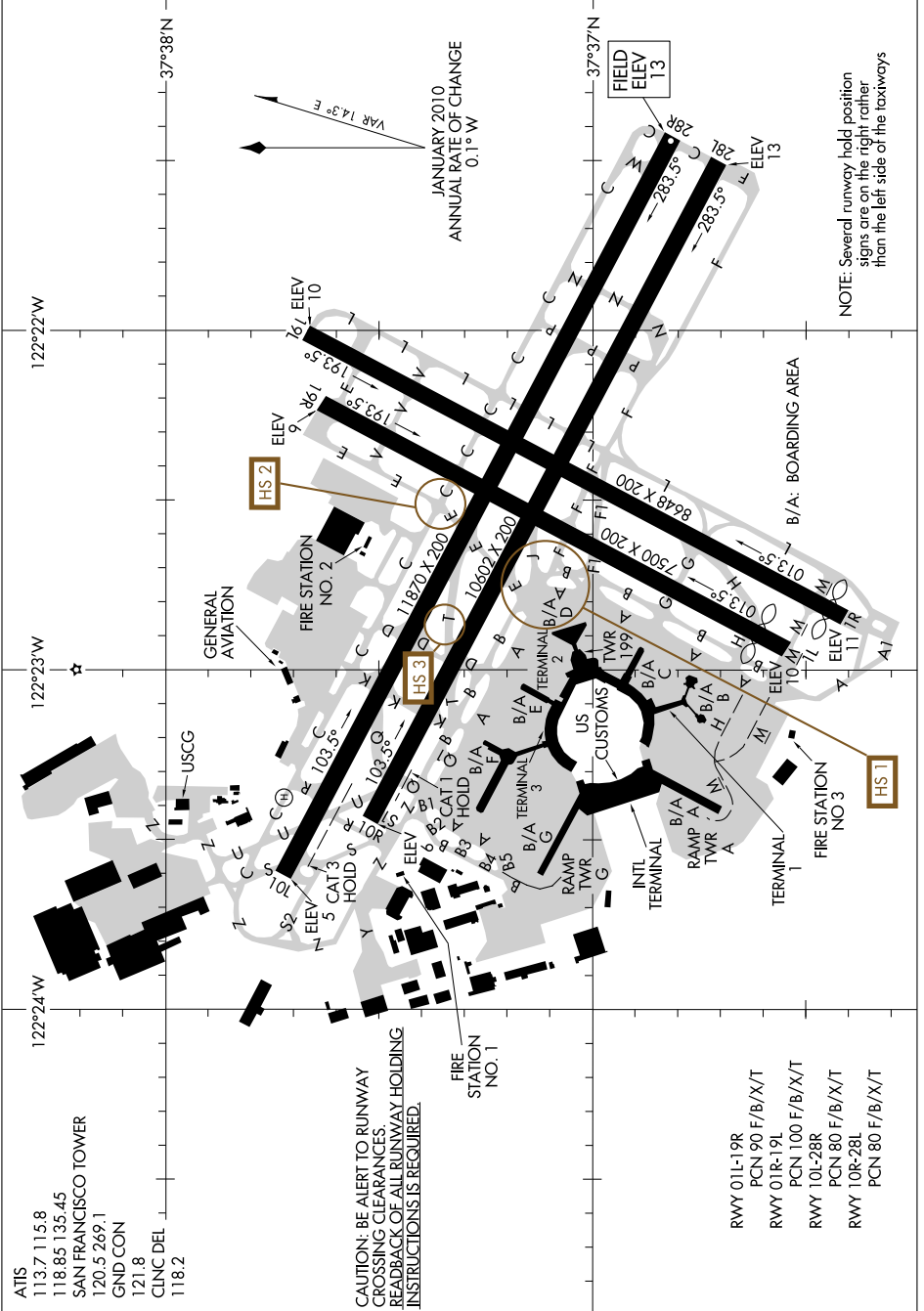

SW-2, 05 APR 2012 to 03 MAY 2012

AIRPORT DIAGRAM

SAN FRANCISCO, CALIFORNIA
SAN FRANCISCO INTL (SFO)

Figure 335

LOC I-OAK 109.9	APP CRS 276°	Rwy Idg TDZE Apt Elev	27R 5454 7 9	27L 6213 9 9
---------------------------	------------------------	-----------------------------	--	--

ILS or LOC/DME RWY 27R

OAKLAND/METROPOLITAN OAKLAND INTL (OAK)

<p>▼ *RVR 1800 authorized with the use of FD or AP or HUD to DA.</p>	<p>MALSR Rwy 27R AS</p>	<p>MISSED APPROACH: Climb to 3000 via OAK R-285 to intercept SGD R-165 to REBAS INT/SGD 14.3 and hold.</p>
--	-----------------------------	--

<p>ATIS 133.775</p>	<p>NORCAL APP CON 125.35 310.8 354.1</p>	<p>OAKLAND TOWER (Rwys 9-27, 15-33) (Rwy 11-29) 118.3 291.65 127.2 256.9</p>	<p>GND CON (Rwys 9-27, 15-33) (Rwy 11-29) 121.9 121.75</p>	<p>CLNC DEL 121.1</p>
--------------------------------	---	---	---	----------------------------------

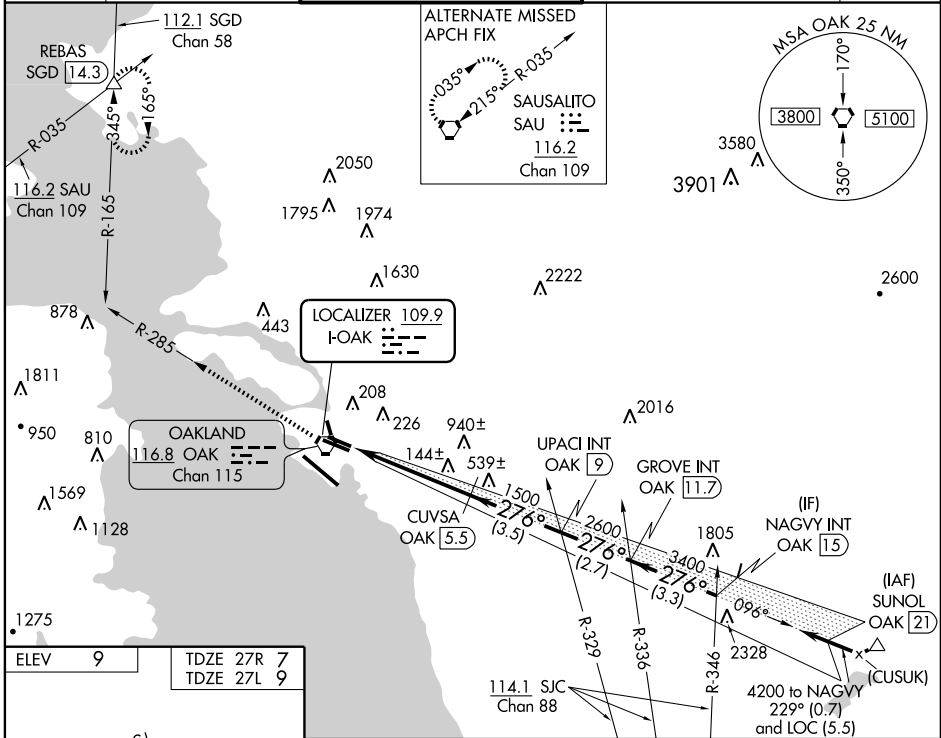

ELEV 9	TDZE 27R 7
	TDZE 27L 9

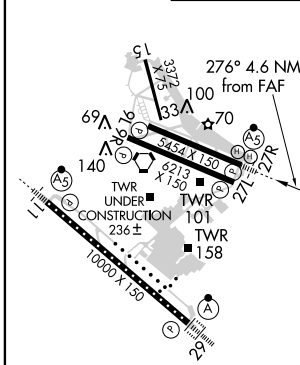

TDZ/CL Rwy 29
MIRL Rwy 15-33
REIL Rwy 9R
HIRL Rwys 11-29, 9L-27R, and 9R-27L

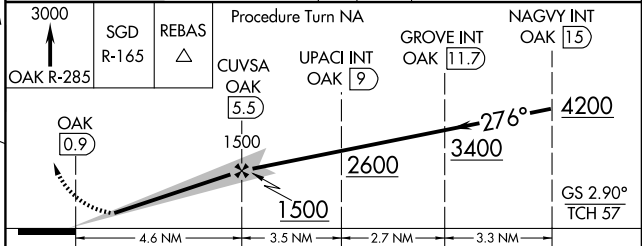

CATEGORY	A	B	C	D
S-ILS 27R	*207/24 200 (200-½)			
S-LOC 27R	400/24 393 (400-½)			400/40 393 (400-¾)
SIDESTEP RWY 27L	420-1/2 411 (500-1)		420-2 411 (500-2)	
CIRCLING	520-1 511 (600-1)	540-1 531 (600-1)	540-1/2 531 (600-1/2)	560-2 551 (600-2)

Figure 336

SW-2, 05 APR 2012 to 03 MAY 2012

SW-2, 05 APR 2012 to 03 MAY 2012

NDB FIS 332	APP CRS 071°	Rwy ldg TDZE Apt Elev	N/A N/A 3
-----------------------	------------------------	--------------------------	--------------------------------------

NDB or GPS-A
KEY WEST INTL (EYW)

ASR	MISSED APPROACH: Climbing left turn to 1500 via heading 360°, then left turn direct FIS NDB and hold.				
------------	---	--	--	--	--

ATIS 119.675	NAVY KEY WEST APP CON * 124.025 313.7	KEY WEST TOWER * 118.2 (CTAF) 0 257.8	GND CON 121.9	CLNC DEL 121.9	UNICOM 122.95
------------------------	---	---	-------------------------	--------------------------	-------------------------

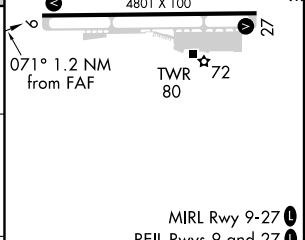
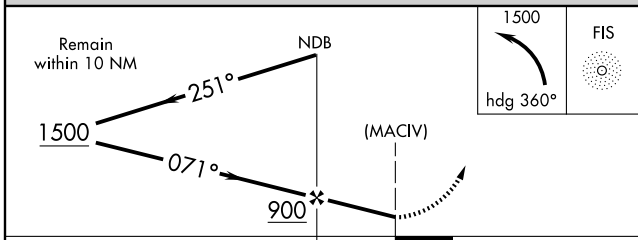
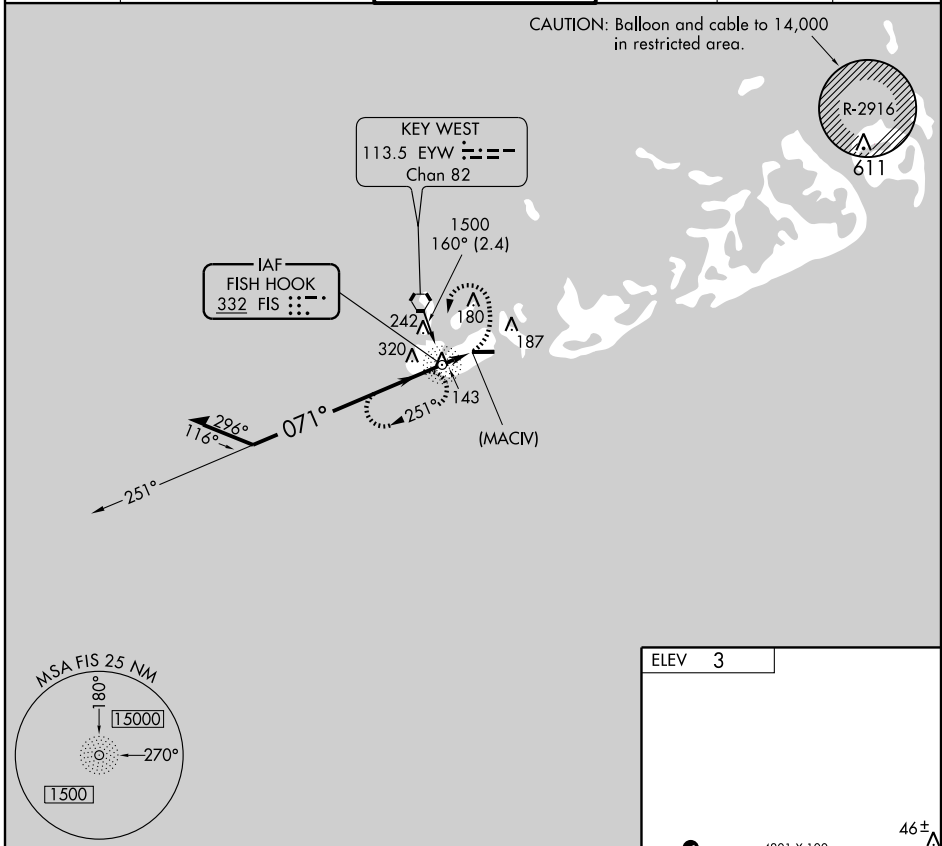

CATEGORY	A	B	C	D	FAF to MAP 1.2 NM					
CIRCLING	500-1	497 (500-1)	500-1½ 497 (500-1½)	620-2 617 (700-2)	Knots	60	90	120	150	180
					Min:Sec	1:12	0:48	0:36	0:29	0:24

Figure 337

SE-3, 05 APR 2012 to 03 MAY 2012

SE-3, 05 APR 2012 to 03 MAY 2012

RNAV (GPS) RWY 27

KEY WEST INTL (EYW)

WAAS CH 82100 W27A	APP CRS 273°	Rwy Idg 4801 TDZE 3 Apt Elev 3
--	------------------------	---

W DME/DME RNP-0.3 NA. If local altimeter setting not received, use Key West NAS/Boca Chica Fld altimeter setting.
ASR

MISSED APPROACH: Climb to 2400 direct ATNAW and via 003° track to CHETS and hold.

ATIS 119.675	NAVY KEY WEST APP CON * 124.025 313.7	KEY WEST TOWER * 118.2 (CTAF) 257.8	GND CON 121.9	CLNC DEL 121.9	UNICOM 122.95
------------------------	---	---	-------------------------	--------------------------	-------------------------

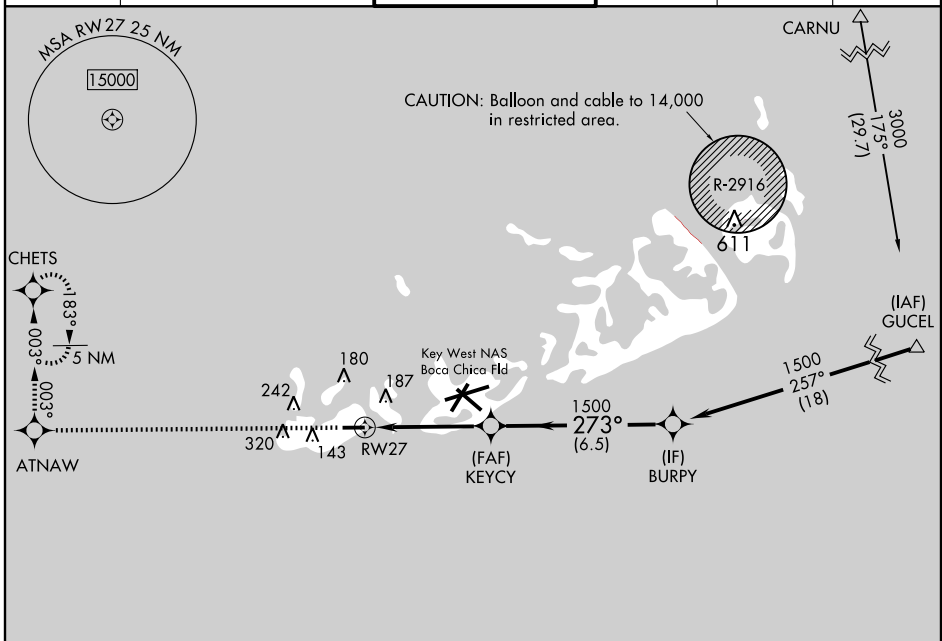

SE-3, 05 APR 2012 to 03 MAY 2012

SE-3, 05 APR 2012 to 03 MAY 2012

ELEV 3	TDZE 3
--------	--------

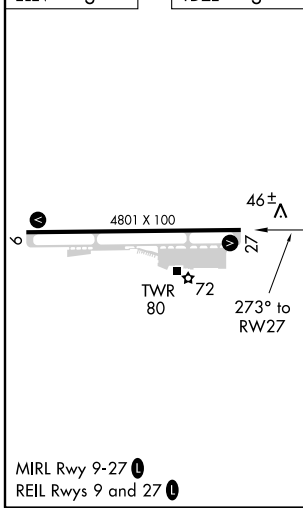

2400	ATNAW	CHETS	VGSI and RNAV glidepath not coincident (VGSI Angle 3.00/TCH 34).	
↑	☉	☉	KEYCY	BURPY
	003° tr		Procedure Turn NA	
			273°	1500
			1500	
			4.5 NM	6.5 NM
CATEGORY	A	B	C	D
LPV DA	253-1 250 (300-1)			
LNAV MDA	420-1	417 (500-1)	420-1¼	417 (500-1¼)
CIRCLING	500-1	497 (500-1)	500-1½	620-2
			497 (500-1½)	617 (700-2)

KEY WEST, FLORIDA
Orig 12096

24°33'N-81°46'W

KEY WEST INTL (EYW)

RNAV (GPS) RWY 27

Figure 338

LOC I-SJU 110.3	APP CRS 078°	Rwy Idg 9783
		TDZE 9
		Apt Elev 9

ILS or LOC RWY 8

SAN JUAN/LUIS MUNOZ MARIN INTL (SJU)(TJSJ)

	MISSED APPROACH: Climb to 2000 then climbing left turn to 3000 on heading 320° and SJU VORTAC R-004 to DEEDY Int/SJU 15 DME and hold.

ATIS 125.8	SAN JUAN APP CON 119.4 269.2 (WEST & SW) 120.9 290.2 (NORTH & EAST)	SAN JUAN TOWER 132.05 257.8	GND CON 121.9 348.6	CLNC DEL 126.4 284.6
----------------------	---	---------------------------------------	-------------------------------	--------------------------------

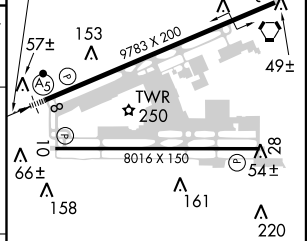
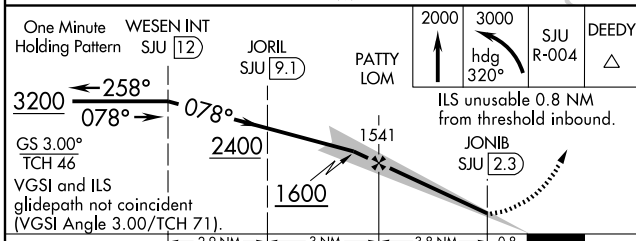
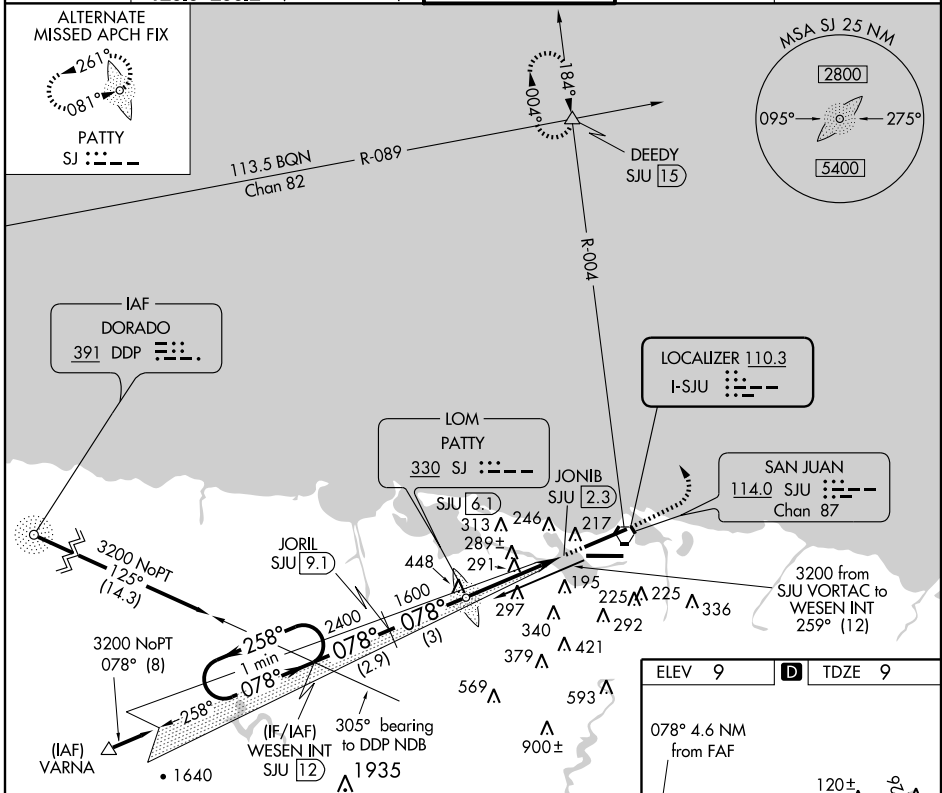

CATEGORY	A	B	C	D
S- ILS-8		311-½	302 (400-½)	
S- LOC-8	560-½	551 (600-½)	560-1 551 (600-1)	560-1½ 551 (600-1¼)
CIRCLING	600-1	591 (600-1)	600-1½ 591 (600-1½)	600-2 591 (600-2)

REIL Rwy 26
 HIRL Rwy 8-26 and 10-28

FAF to MAP 3.8 NM

Knots	60	90	120	150	180
Min:Sec	3:48	2:32	1:54	1:31	1:16

Figure 339

ILS or LOC RWY 8

SE-3, 05 APR 2012 to 03 MAY 2012

SE-3, 05 APR 2012 to 03 MAY 2012

ILS RWY 10

CHARLOTTE AMALIE/ CYRIL E KING (STT)(TIST)

LOC/DME I-TMN 110.1 Chan 38	APP CRS 100°	Rwy Idg 7000 TDZE 23 Apt Elev 23
---	------------------------	---

Procedure not authorized when control tower closed.
Procedure not authorized north of Runway 10-28.
Procedure not authorized at night.

MISSED APPROACH: Climb to 500 then climbing right turn to 2800 via heading 180° then right turn direct STT VOR/DME and hold.

ATIS 124.0	SAN JUAN CENTER 128.65 279.6	ST. THOMAS TOWER * 118.8 (CTAF) 0 257.6 118.1 (NORTH OF ISLAND)	GND CON 121.9	UNICOM 122.95
----------------------	--	--	-------------------------	-------------------------

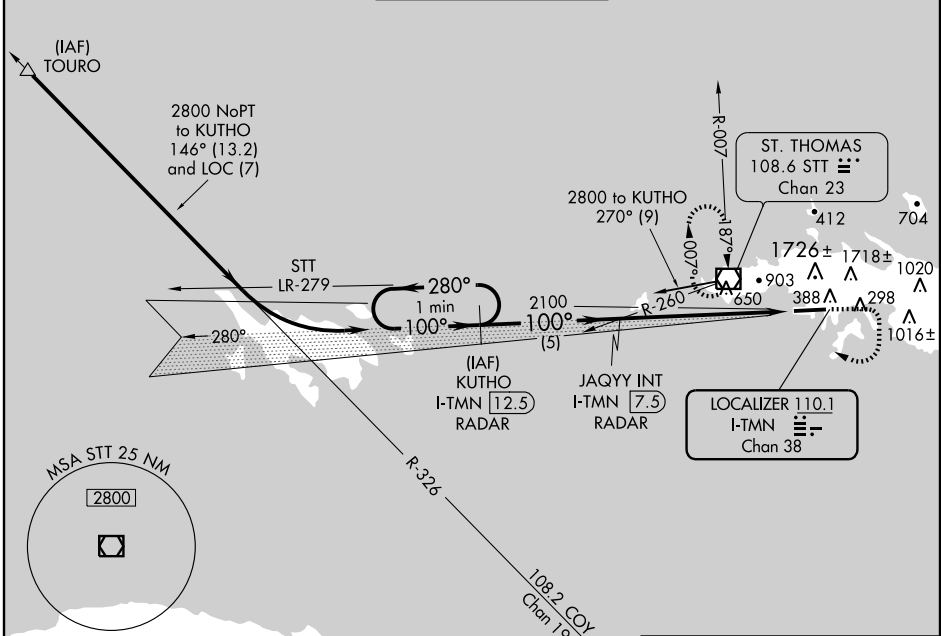

SE-3, 05 APR 2012 to 03 MAY 2012

SE-3, 05 APR 2012 to 03 MAY 2012

CAUTION: Pilots may encounter false illusory indications during night approaches to Runway 10 when using outside visual cues for vertical guidance.

ELEV 23	D TDZE 23
---------	------------------

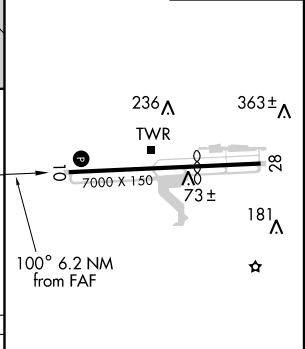
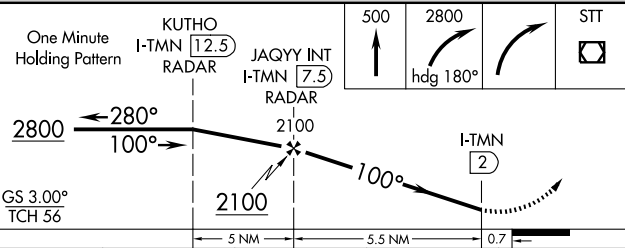

CATEGORY	A	B	C	D
S-ILS 10	372-1¼		349 (400-1¼)	
S-LOC 10	620-1	597 (600-1)	620-1½ 597 (600-1½)	620-1¾ 597 (600-1¾)
CIRCLING	660-1¼	637 (700-1¼)	660-1¾ 637 (700-1¾)	660-2 637 (700-2)

REIL Rwy 10					
MIRL Rwy 10-28					
FAF to MAP 5.5 NM					
Knots	60	90	120	150	180
Min:Sec	5:30	3:40	2:45	2:12	1:50

ILS RWY 10

Figure 340

VOR RWY 13

ST. AUGUSTINE / NORTHEAST FLORIDA RGNL (SGJ)

VOR/DME SGJ	APP CRS	Rwy Idg	6144
109.4	128°	TDZE	10
Chan 31		Apt Elev	10

⚠ Circling NA at night to Rwy 2,6,20,24.
⚠ Visibility reduction by helicopters NA.

MISSED APPROACH: Climb to 1000 then climbing left turn to 2000 direct SGJ VOR/DME and hold.

ATIS 119.625	JACKSONVILLE APP CON 120.75 308.4	ST AUGUSTINE TOWER * 127.625 (CTAF) 269.475	GND CON 121.175 251.125	UNICOM 122.95
------------------------	---	--	-----------------------------------	-------------------------

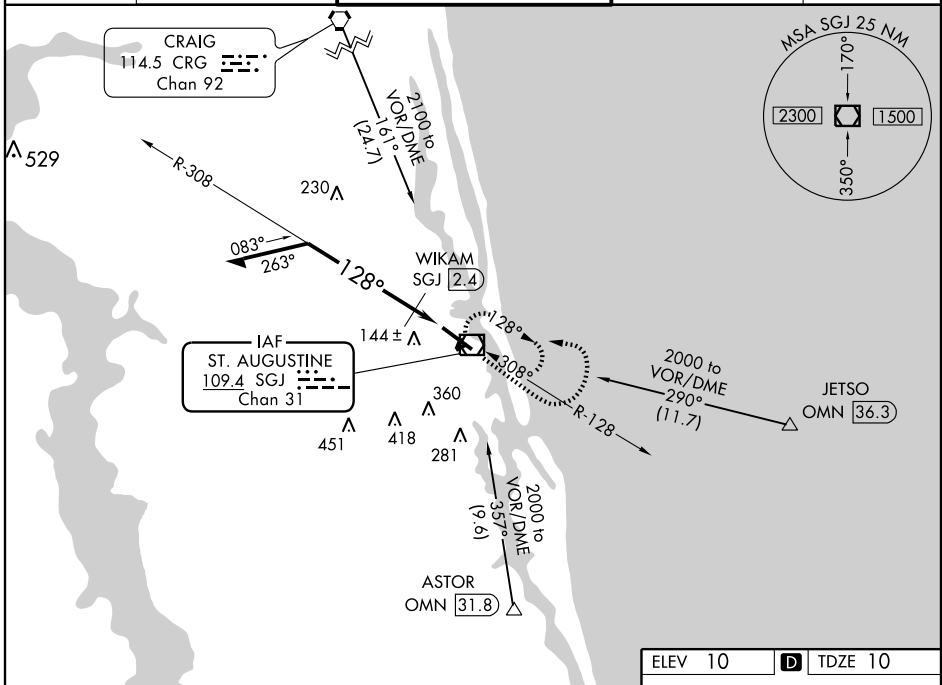

SE-3, 05 APR 2012 to 03 MAY 2012

SE-3, 05 APR 2012 to 03 MAY 2012

ELEV 10	D TDZE 10
---------	------------------

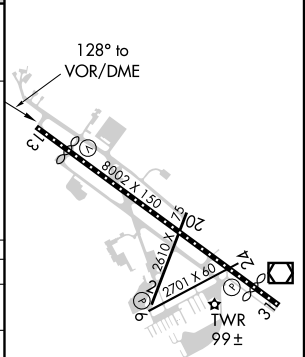
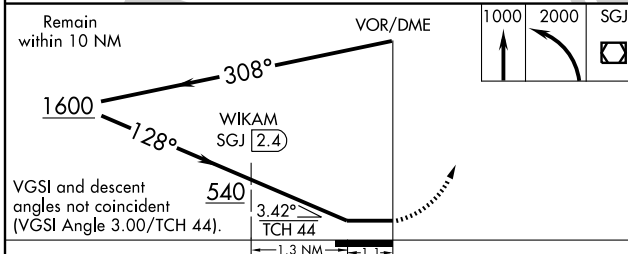

CATEGORY	A	B	C	D
S-13	540-1	530 (600-1)	540-1½ 530 (600-1½)	540-1¾ 530 (600-1¾)
CIRCLING	540-1	530 (600-1)	540-1½ 530 (600-1½)	560-2 550 (600-2)
WIKAM FIX MINIMUMS				
S-13	400-1 390 (400-1)		400-1¼ 390 (400-1¼)	
CIRCLING	460-1	450 (500-1)	460-1½ 450 (500-1½)	560-2 550 (600-2)

MIRL Rwy 2-20 and 6-24
 HIRL Rwy 13-31

VOR RWY 13

Figure 341

RNAV (GPS) RWY 13

ST. AUGUSTINE / NORTHEAST FLORIDA RGNL (SGJ)

WAAS CH 77711	APP CRS 130°	Rwy Idg TDZE Apt Elev	6144 10 10
W13A			

▼ Baro-VNAV NA when using Jacksonville NAS/Towers Field altimeter setting. For uncompensated Baro-VNAV systems, LNAV/VNAV NA below -15°C (5°F) or above 48°C (118°F). DME/DME RNP-0.3 NA. Visibility reduction by helicopters NA. When local altimeter setting not received, use Jacksonville NAS/Towers Field altimeter setting and increase all DA 57 feet and all MDA 60 feet, increase LPV and LNAV/VNAV all Cats. visibility ¼ mile.

MISSED APPROACH:
Climb to 2000 direct YUTKA and hold.

ATIS 119.625	JACKSONVILLE APP CON 120.75 308.4	ST AUGUSTINE TOWER ★ 127.625 (CTAF) 269.475	GND CON 121.175 251.125	UNICOM 122.95
------------------------	---	---	-----------------------------------	-------------------------

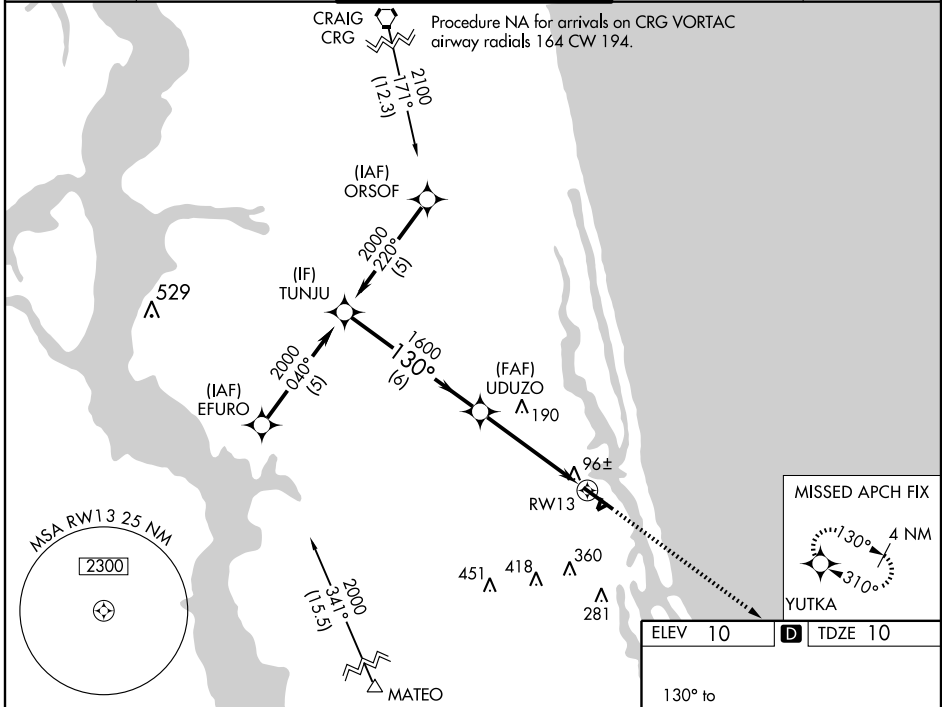

SE-3, 05 APR 2012 to 03 MAY 2012

SE-3, 05 APR 2012 to 03 MAY 2012

Procedure Turn NA	TUNJU	VGSI and RNAV glidepath not coincident (VGSI Angle 3.00/TCH 44).		2000	YUTKA
GS 3.00° TCH 58					
CATEGORY	A	B	C	D	
LPV DA		357-1¼	347 (400-1¼)		
LNAV/ VNAV DA		391-1¼	381 (400-1¼)		
LNAV MDA	440-1	430 (500-1)	440-1¼ 430 (500-1¼)	440-1½ 430 (500-1½)	
CIRCLING	460-1	450 (500-1)	460-1½ 450 (500-1½)	580-2 570 (600-2)	

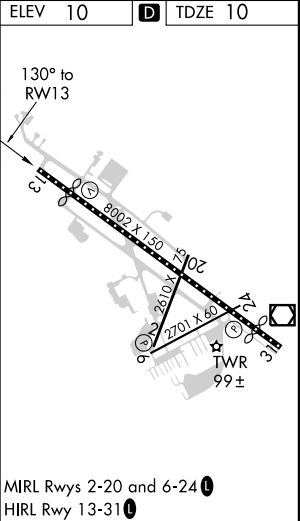

RNAV (GPS) RWY 13

Figure 342

AIRPORT DIAGRAM

WINDSOR LOCKS / BRADLEY INTL (BDL)
WINDSOR LOCKS, CONNECTICUT

AL-460 (FAA)

ATIS
118.15
BRADLEY TOWER
120.3 351.8
GND CON
121.9 348.6
CLNC DEL
121.75 322.3

D

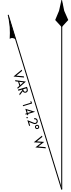

JANUARY 2010
ANNUAL RATE OF CHANGE
0.0°E

NE-1, 05 APR 2012 to 03 MAY 2012

NE-1, 05 APR 2012 to 03 MAY 2012

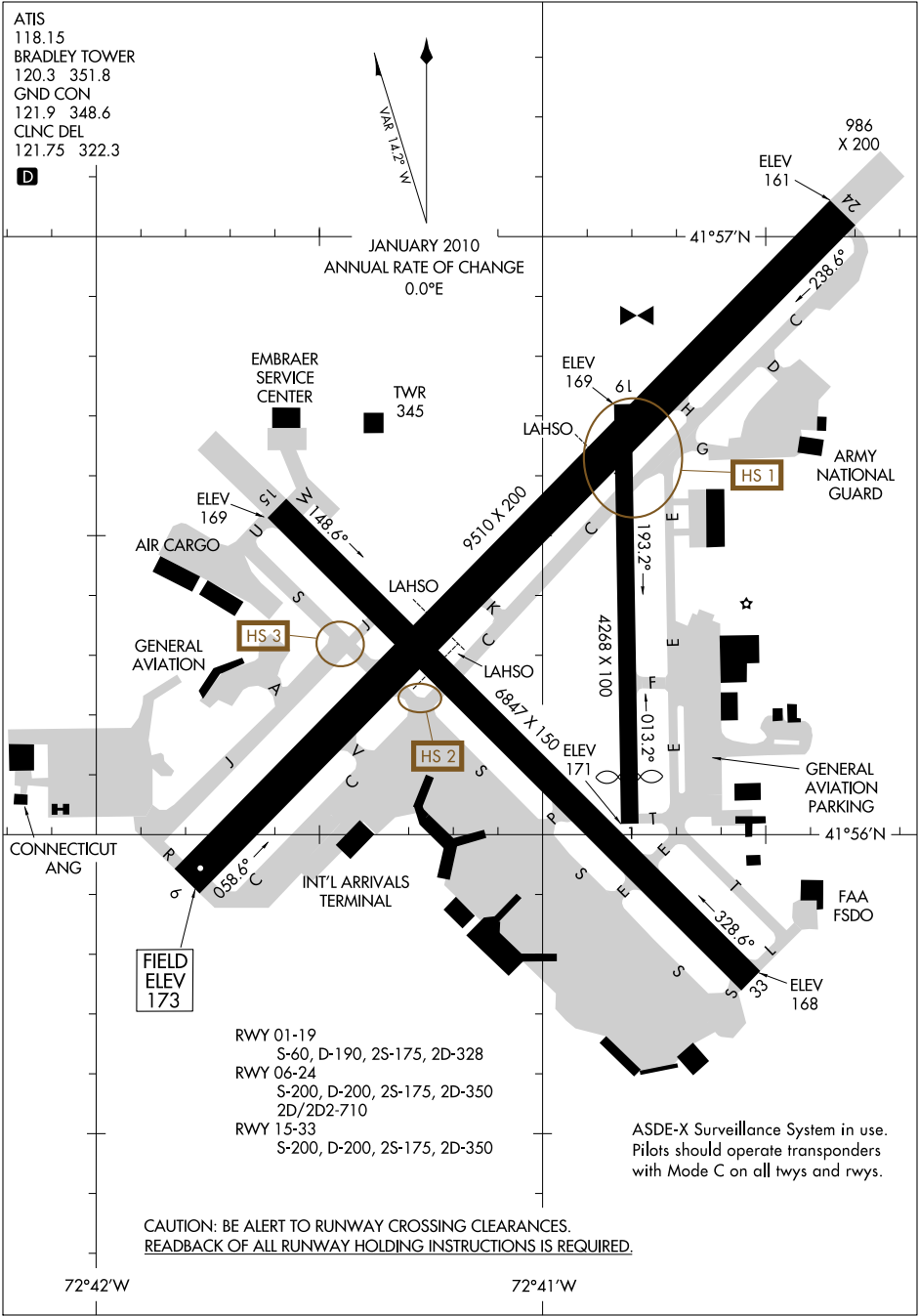

FIELD
ELEV
173

RWY 01-19
S-60, D-190, 2S-175, 2D-328
RWY 06-24
S-200, D-200, 2S-175, 2D-350
2D/2D2-710
RWY 15-33
S-200, D-200, 2S-175, 2D-350

ASDE-X Surveillance System in use.
Pilots should operate transponders
with Mode C on all twys and rwys.

CAUTION: BE ALERT TO RUNWAY CROSSING CLEARANCES.
READBACK OF ALL RUNWAY HOLDING INSTRUCTIONS IS REQUIRED.

72°42'W

72°41'W

AIRPORT DIAGRAM

WINDSOR LOCKS, CONNECTICUT
WINDSOR LOCKS / BRADLEY INTL (BDL)

Figure 343

LOC/DME I-BDL	APP CRS	Rwy Idg	9509
111.1	058°	THRE	173
Chan 48		Apt Elev	173

COPTER ILS or LOC RWY 6

WINDSOR LOCKS / BRADLEY INTL (BDL)

ALSF-2 For inoperative ALSF-2, increase H-ILS 6 visibility to RVR 2400 and H-LOC 6 visibility to RVR 4000.

MISSED APPROACH: Climb to 4000 then left turn direct BAF VORTAC and hold.

ATIS 118.15	BRADLEY APP CON 127.225 323.2	BRADLEY TOWER 120.3 351.8	GND CON 121.9 348.6	CLNC DEL 121.75 322.3
-----------------------	---	-------------------------------------	-------------------------------	---------------------------------

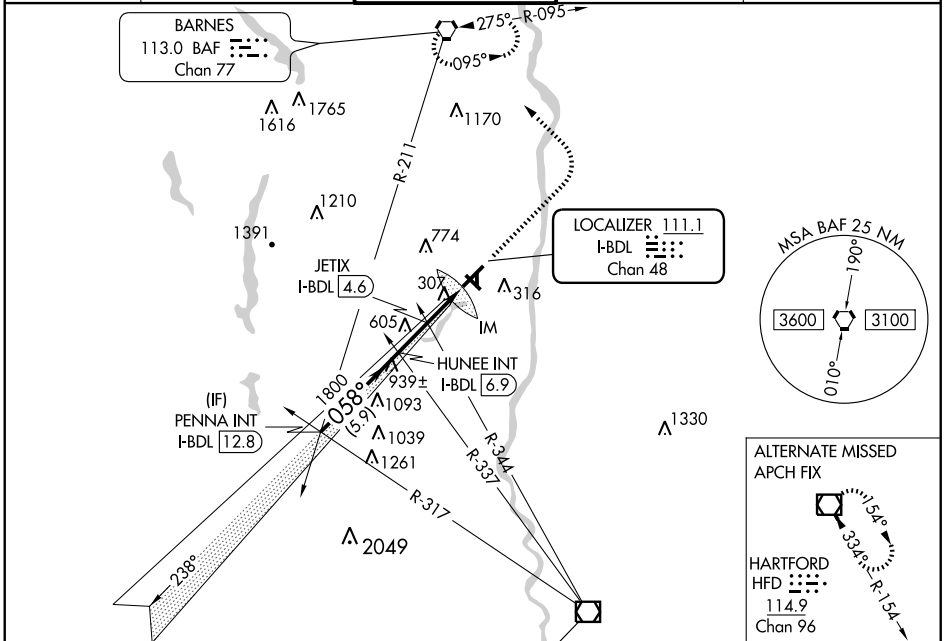

NE-1, 05 APR 2012 to 03 MAY 2012

NE-1, 05 APR 2012 to 03 MAY 2012

RADAR REQUIRED

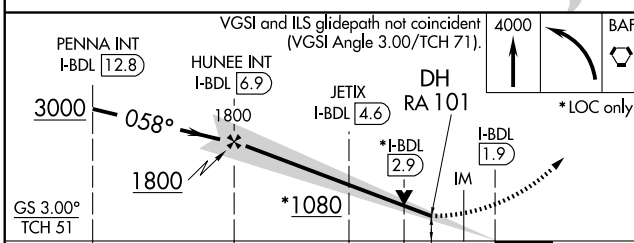

CATEGORY	COPTER	
H-ILS 6	273/12	100 (100-¼)
H-LOC 6	1080/24	907 (1000-½)
JETIX FIX MINIMUMS		
H-LOC 6	560/24	387 (400-½)

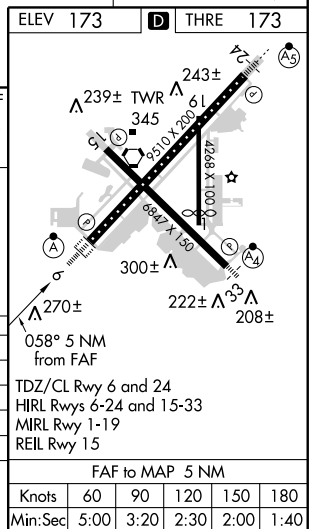

COPTER ILS CATEGORY II - SPECIAL AIRCREW & AIRCRAFT CERTIFICATION REQUIRED

Figure 344

LOC/DME I-BDL 111.1 Chan 48	APP CRS 058°	Rwy Idg 9509 THRE 173 Apt Elev 173
---	------------------------	--

ILS or LOC RWY 6

WINDSOR LOCKS / BRADLEY INTL (BDL)

<p>▼ For inoperative ALSF-2, increase S-ILS 6 all Cats visibility to RVR 4000. ▲ JETIX Fix Minimums: For inoperative ALSF-2, increase S-LOC 6 Cat C, D visibility to RVR 6000.</p>	<p>ALSF-2</p>	<p>MISSED APPROACH: Climb to 4000 then left turn direct BAF VORTAC and hold.</p>
--	---------------	--

<p>ATIS 118.15</p>	<p>BRADLEY APP CON 127.225 323.2</p>	<p>BRADLEY TOWER 120.3 351.8</p>	<p>GND CON 121.9 348.6</p>	<p>CLNC DEL 121.75 322.3</p>
-------------------------------	---	---	---------------------------------------	---

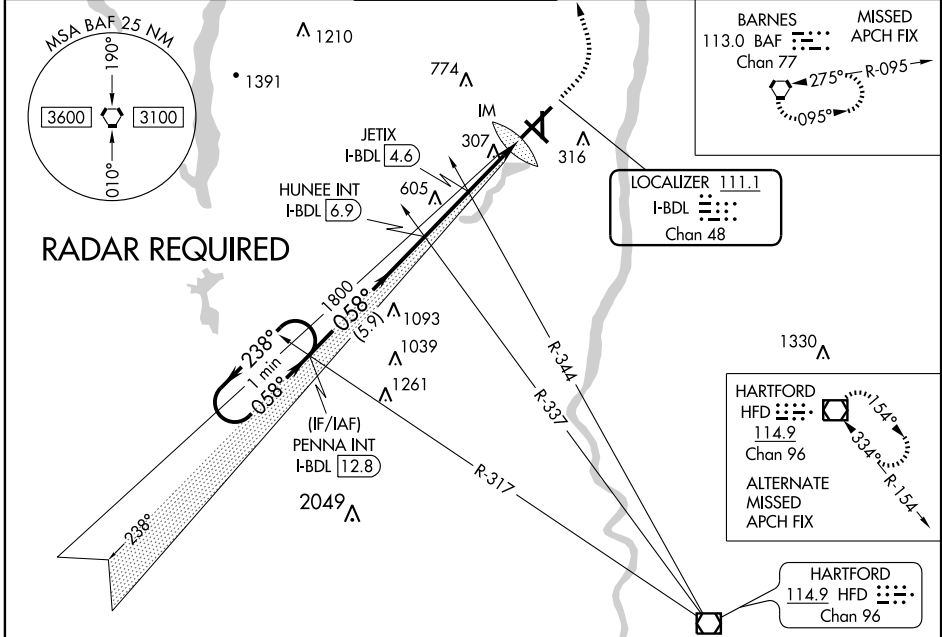

NE-1, 05 APR 2012 to 03 MAY 2012

NE-1, 05 APR 2012 to 03 MAY 2012

ILS or LOC RWY 6

Figure 345

ATIS 118.15
CLNC DEL
121.75 322.3
GND CON
121.9 348.6
TOWER
120.3 351.8

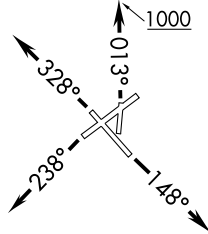

HARTFORD
114.9 HFD
Chan 96
N41°38.47'-W72°32.85'

THUMB
N41°31.40'
W72°21.53'

YODER
N41°17.38'
W72°20.55'

CALVERTON
117.2 CCC
Chan 119
N40°55.78'-W72°47.93'

KENNEDY
115.9 JFK
Chan 106

HAMPTON
113.6 HTO
Chan 83

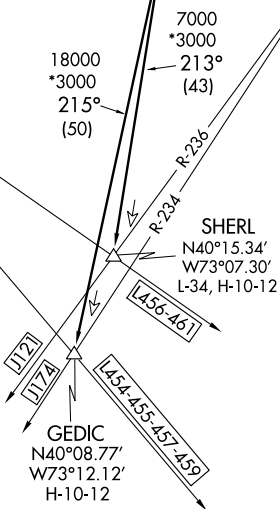

NOTE: RADAR REQUIRED.

TAKE-OFF MINIMUMS:

- Rwy 19 NA.
- Rwy 01, 06, 15, 24 STANDARD.
- Rwy 33 STANDARD with minimum climb of 326 feet per NM to 1000.

NOTE: Chart not to scale.
(NARRATIVE ON FOLLOWING PAGE)

Figure 346

NE-1, 05 APR 2012 to 03 MAY 2012

NE-1, 05 APR 2012 to 03 MAY 2012

COASTAL THREE DEPARTURE

DEPARTURE ROUTE DESCRIPTION

NOTE: INITIAL DEPARTURE HEADINGS ARE PREDICATED ON AVOIDING NOISE SENSITIVE AREAS. FLIGHT CREW AWARENESS AND COMPLIANCE IS IMPORTANT IN MINIMIZING NOISE IMPACTS ON SURROUNDING COMMUNITIES.

NOTE: APPROPRIATE DEPARTURE CONTROL FREQUENCY TO BE ASSIGNED BY ATC.

TAKE-OFF RWY 1: Climb heading 013° to 1000 or as assigned for radar vectors to HFD VOR/DME, thence . . .

TAKE-OFF RWY 6: Fly assigned heading for radar vectors to HFD VOR/DME, thence . . .

TAKE-OFF RWY 15: Climb heading 148° or as assigned for radar vectors to HFD VOR/DME, thence . . .

TAKE-OFF RWY 24: Climb heading 238° or as assigned for radar vectors to HFD VOR/DME, thence . . .

TAKE-OFF RWY 33: Climb heading 328° or as assigned for radar vectors to HFD VOR/DME, thence . . .

. . . . From over HFD VOR/DME proceed via HFD R-143 to THUMB INT, then proceed via HTO R-010 to YODER INT, then proceed via CCC R-057 to CCC VOR/DME. Then via (transition) or (assigned route). Maintain 4000 or assigned altitude. Expect clearance to requested flight level ten minutes after departure.

GEDIC TRANSITION (CSTL3.GEDIC): From over CCC VOR/DME via CCC R-215 to GEDIC.

SHERL TRANSITION (CSTL3.SHERL): From over CCC VOR/DME via CCC R-213 to SHERL.

TAKE-OFF OBSTACLE NOTES:

Rwy 1: Vehicle on road 342' from DER, 564' left of centerline, 15' AGL/184' MSL. Trees beginning 441' from DER, 493' left of centerline, up to 100' AGL/269' MSL. Trees beginning 1884' from DER, 45' right of centerline, up to 100' AGL/299' MSL.

Rwy 6: Trees beginning 21' from DER, 464' left of centerline, up to 100' AGL/249' MSL. Trees beginning 1956' from DER, 921' right of centerline, up to 100' AGL/239' MSL.

Rwy 15: Vehicle on roadway 531' from DER, 606' left of centerline, up to 15' AGL/186' MSL. Trees beginning 2341' from DER, 767' left of centerline, up to 100' AGL/244' MSL. Vehicle on roadway 429' from DER, 572' right of centerline, up to 15' AGL/186' MSL. Tree 1520' from DER, 786' right of centerline, up to 100' AGL/259' MSL.

Rwy 24: Trees beginning 3066' from DER, 599' left of centerline, up to 100' AGL/269' MSL. OL on fence 1239' DER, 784' left of centerline, up to 45' AGL/215' MSL. Trees beginning 2345' from DER, 489' right of centerline, up to 100' AGL/299' MSL.

Rwy 33: Trees beginning 1590' from DER, 275' left of centerline, up to 100' AGL/256' MSL. Tower 2.4 NM from DER, 3534' left of centerline, 104' AGL/774' MSL. Trees beginning 1618' from DER, 264' right of centerline, up to 100' AGL/263' MSL.

NE-1, 05 APR 2012 to 03 MAY 2012

NE-1, 05 APR 2012 to 03 MAY 2012

COASTAL THREE DEPARTURE

Figure 347

TUCSON INTL (TUS) 6 S UTC-7 N32°06.97' W110°56.46'

2643 B S4 **FUEL** 100LL, JET A OX 1, 2, 3, 4 TPA—See Remarks AOE Class I, ARFF Index C

NOTAM FILE TUS

RWY 11L-29R: H10996X150 (ASPH-GRVD) S-160, D-200, 2S-175, 2D-350, 2D/2D2-585 HIRL

RWY 11L: MALS R. PAPI(P4L)—GA 3.0° TCH 55'. 0.7% up..

RWY 29R: REIL. PAPI(P4L)—GA 3.0° TCH 76'. Ground. 0.5% down..

RWY 11R-29L: H8408X75 (ASPH) S-120, D-140, 2S-175, 2D-220 MIRL

RWY 11R: PAPI(P4L)—GA 3.0° Thld dsplcd 1410'. Rgt tfc. 0.7% up..

RWY 29L: REIL. Pole. 0.6% down..

RWY 03-21: H7000X150 (ASPH-GRVD) S-105, D-137, 2S-174, 2D-230, 2D/2D2-500 MIRL

RWY 03: Thld dsplcd 841'. Railroad.

RWY 21: REIL. PAPI(P4L)—GA 3.0° TCH 55'. Rgt tfc.

RUNWAY DECLARED DISTANCE INFORMATION

RWY 03: TORA-7000 TODA-7000 ASDA-7000 LDA-6160

RWY 21: TORA-6000 TODA-7000 ASDA-6000 LDA-6000

ARRESTING GEAR/SYSTEM

RWY 03 ← HOOK E5 (403')

RWY 11L HOOK BAK-12B(B) (1220' OVRN) BAK-14 BAK-12B(B) (1000')

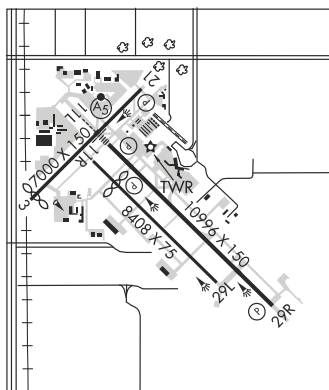

BAK-14 BAK-12B(B) (1215') HOOK BAK-12B(B) (128' OVRN) **RWY 29L**

AIRPORT REMARKS: Attended continuously. Air carriers use Rwy 11L-29R. Rwy 11R-29L rstd to acct with wing span less than 73' and ldg speed less than 120 kt. Acft dep Rwy 11R required to attain at least 400' AGL prior to starting turn. No B-747 training except PPR; no flight training 0500-1300Z except PPR, call Flightline Office 520-573-8128. Rwy 11L-29R gross weight limit: DC-10-10 315,000 lbs, DC-10-30/40 400,000 lbs, L-1011-1 325,000 lbs, L-1011-100/200 340,000 lbs. Rwy 03-21 gross weight limit: DC-10-10 300,000 lbs DC-10-30/40 375,000 lbs, L-1011-01 310,000 lbs, L-1011-100/200 315,000 lbs. Helicopter ops located south of Rwy 11R-29L and west of Twy A13. TPA-3443 (800) small acft, 4043 (1400) large/heavy turbojet acft. B-747 acft taxi with inboard engines only. Rwy 11L touchdown runway visual range avbl. Twy T-general aviation twy 30,000 lbs. or less. Portions of Twy D not visible from twr due to hangars. Twy A5 limited to 70,000 lbs or less. REIL Rwy 29L and Rwy 29R dalgt hrs only. Ldg fee. Flight Notification Service (ADCUS) avbl. NOTE: See Special Notices—Glider Operations Northwest of Tucson, Arizona, U.S. Special Customs Requirement.

WEATHER DATA SOURCES: ASOS (520) 889-7236. **HIWAS** 116.0 TUS.LLWAS.

COMMUNICATIONS: ATIS 123.8 520-741-1177 **UNICOM** 122.95

TUCSON RCO 122.2 (PRESCOTT RADIO)

MOUNT LEMMON RCO 122.4 (PRESCOTT RADIO)

Ⓡ **APP/DEP CON** 125.1 (Rwy 11 090°-285°) 119.4 (Rwy 29 275°-065°) 119.4 (Rwy 11 286°-089°) (Rwy 29 066°-274°)

TOWER 118.3 119.0 **GND CON** 124.4 **CLNC DEL** 126.65

AIRSPACE: CLASS C svc ctc **APP CON**

RADIO AIDS TO NAVIGATION: NOTAM FILE TUS.

(H) **VORTACW** 116.0 TUS Chan 107 N32°05.71' W110°54.89' 301° 1.8 NM to fld. 2672/12E. **HIWAS.**

VORTAC unusable:

050°-080° byd 30 NM blo 13,000'

350°-020° byd 30 NM blo 13,000'

DME unusable:

155°-165° byd 35 NM blo 13,000'

ILS/DME 111.7 I-TUS Chan 54 Rwy 11L. Localizer backcourse unusable byd 15 NM blo 7,200'. Backcourse unusable byd 10° right of course.

VALLE (See GRAND CANYON on page 39)

ILS or LOC RWY 11L

TUCSON INTL (TUS)

LOC/DME I-TUS 111.7 Chan 54	APP CRS 123°	Rwy Idg 10996 TDZE 2599 Apt Elev 2643
---	------------------------	--

▼ For inoperative MALSR, increase S-ILS 11L Cat E visibility to RVR 5000, S-LOC 11L Cat D and Cat E visibility to RVR 5000. ADF or DME required.

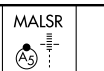

MISSED APPROACH: Climb to 4000 then climbing right turn to 6000 via heading 300° and TUS R-270 to RYN NDB/TUS 12.8 DME and hold.

ATIS 123.8 279.65	TUCSON APP CON 119.4 318.1	TUCSON TOWER 118.3 257.8	GND CON 124.4 348.6	CLINC DEL 126.65 326.2
-----------------------------	--------------------------------------	------------------------------------	-------------------------------	----------------------------------

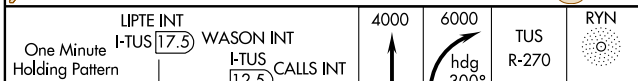
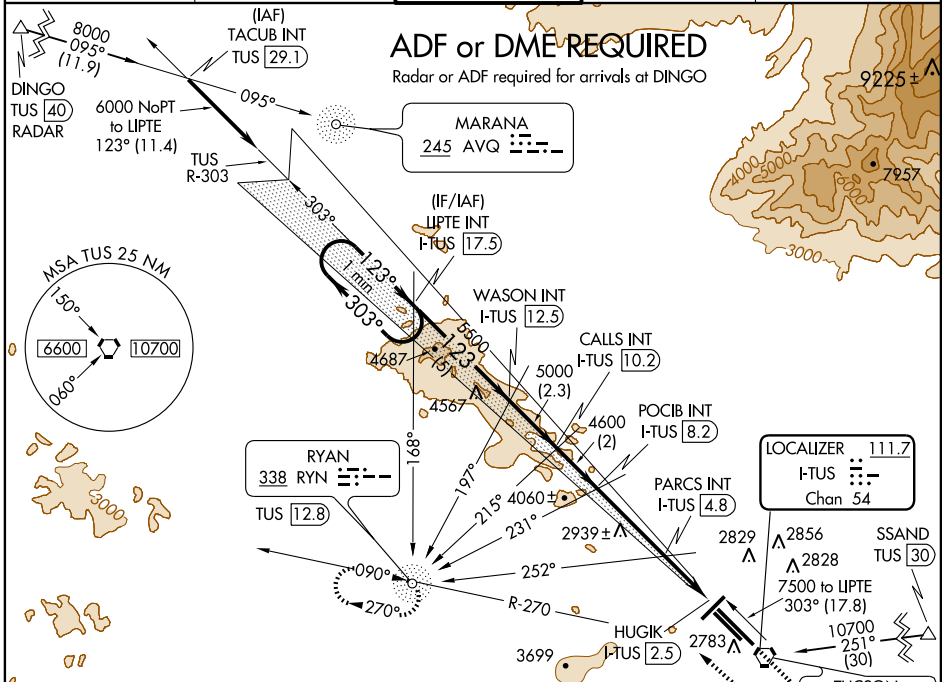

	A	B	C	D	E
S-ILS 11L	2800/24 201 (200-½)				
S-LOC 11L	3480-1 ¼	881 (900-1 ¼)	3480-2 ¾ 881 (900-2 ¾)	3480-3	881 (900-3)
CIRCLING	3480-1 ¼	837 (900-1 ¼)	3480-2 ¾ 837 (900-2 ¾)	3480-3	3740-3
PARCS FIX MINIMUMS					
S-LOC 11L	2900/24	301 (300-½)	2900/40	301 (300-¾)	
CIRCLING	3100-1 457 (500-1)	3220-1 577 (600-1)	3220-1 ½ 577 (600-1 ½)	3220-2 577 (600-2)	3740-3 1097(1100-3)

ELEV 2643	D	TDZE 2599
-----------	----------	-----------

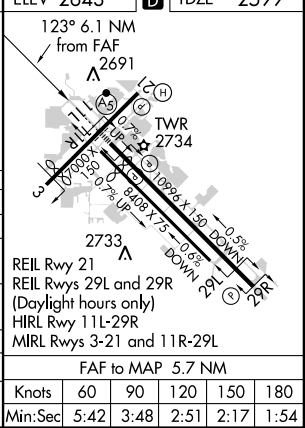

SW-4, 05 APR 2012 to 03 MAY 2012

SW-4, 05 APR 2012 to 03 MAY 2012

VOR or TACAN RWY 11L

TUCSON INTL (TUS)

VORTAC TUS 116.0 Chan 107	APP CRS 123°	Rwy Idg TDZE 2599 Apt Elev 2643
--	------------------------	---

<p>▽ For inoperative MALS, increase S-11L Cats. D and E visibility to RVR 6000.</p> <p>▲ ADF or DME required.</p>	<p>MALS</p>	<p>MISSED APPROACH: Climb to 4000 then climbing right turn to 6000 (Cat. E 8000) via heading 300° and TUS R-270 to RYN NDB/TUS 12.8 DME and hold.</p>
---	-------------	---

<p>ATIS 123.8 279.65</p>	<p>TUCSON APP CON 119.4 318.1</p>	<p>TUCSON TOWER 118.3 257.8</p>	<p>GND CON 124.4 348.6</p>	<p>CLNC DEL 126.65 326.2</p>
-------------------------------------	--	--	---------------------------------------	---

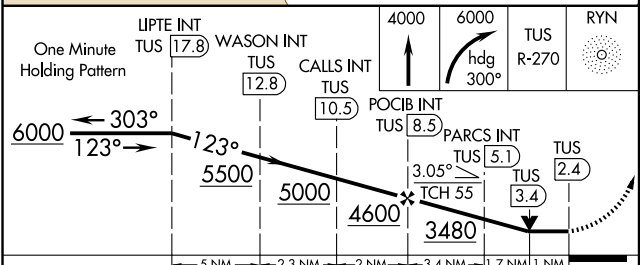
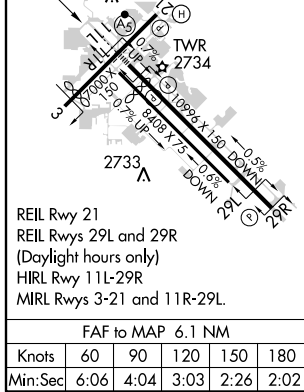
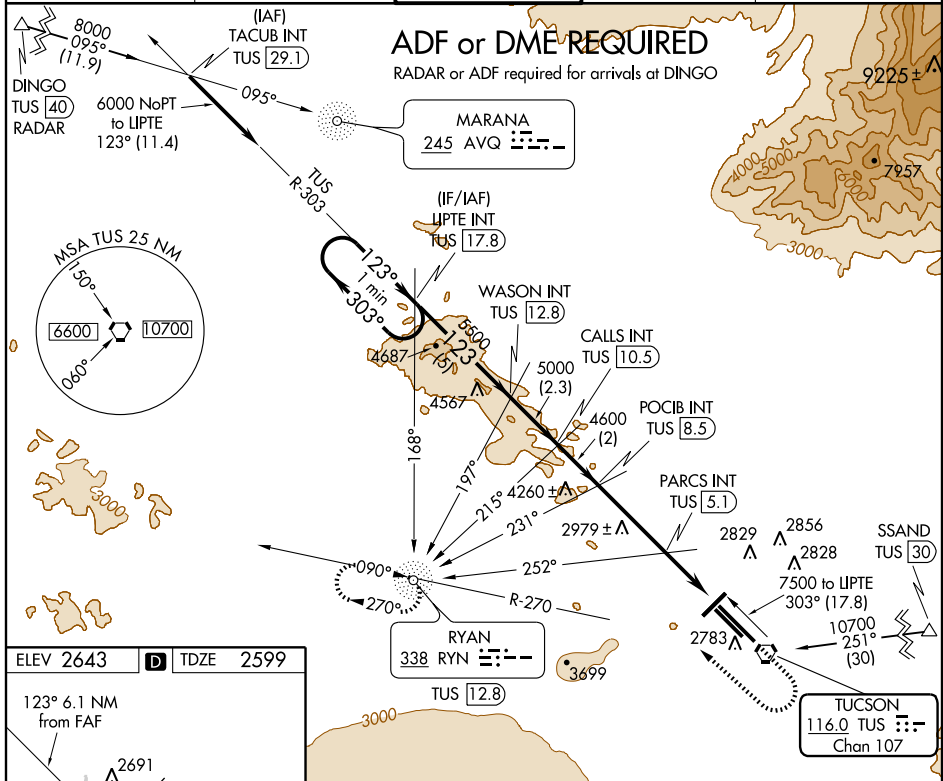

CATEGORY	A	B	C	D	E
S-11L	2960/24	361 (400-½)		2960/50	361 (400-1)
CIRCLING	3100-1 457 (500-1)	3220-1 577 (600-1)	3220-1½ 577 (600-1½)	3220-2 577 (600-2)	3740-3 1097 (1100-3)

TUCSON, ARIZONA
Amdt 1A 11237

32°07'N-110°56'W

VOR or TACAN RWY 11L

Figure 350

SW-4, 05 APR 2012 to 03 MAY 2012

SW-4, 05 APR 2012 to 03 MAY 2012

GATEWAY FOUR DEPARTURE

NC-3, 05 APR 2012 to 03 MAY 2012

DEPARTURE ROUTE DESCRIPTION

Fly assigned heading for vector to appropriate route. From over CSX VOR/DME via CSX R-087 or over TOY VORTAC via TOY R-076 or over STL VORTAC via STL R-094 to TWILA INT. Departures climb and maintain 5000 feet or assigned altitude. Expect clearance to filed altitude 10 minutes after departure.

BIBLE GROVE TRANSITION (GATWY4.BIB): From over TWILA INT via TOY R-076 and BIB R-258 to BIB VORTAC.

BRICKYARD TRANSITION (GATWY4.VHP): From over TWILA INT via TOY R-076 and BIB R-258 to BIB VORTAC, then via BIB R-067 and SHB R-251 to KELLY INT, then via VHP R-209 to VHP VORTAC.

CREEP TRANSITION (GATWY4.CREEP): From over TWILA INT via TOY R-076 and BIB R-258 to BIB VORTAC, then via BIB R-067 and SHB R-251 to SHB VORTAC, then via SHB R-075 to CREEP INT.

JIGSY TRANSITION (GATWY4.JIGSY): From over TWILA INT via TOY R-076 to JIGSY INT.

ROSEWOOD TRANSITION (GATWY4.ROD): From over TWILA INT via TOY R-076 and BIB R-258 to BIB VORTAC, then via BIB R-067 and SHB R-251 to SHB VORTAC, then via SHB R-063 and BIB R-258 to R-250 to ROD VORTAC.

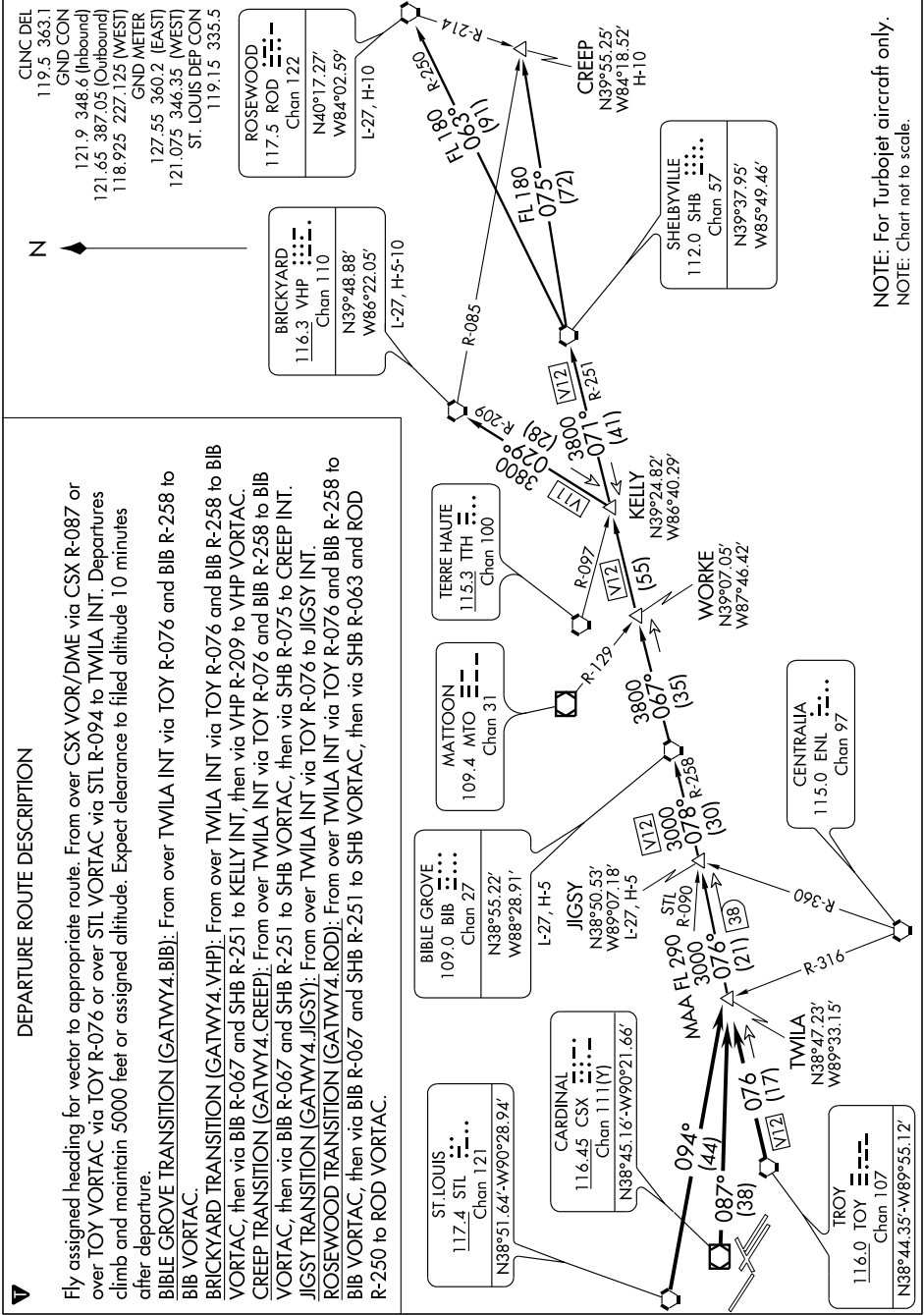

NOTE: For Turbojet aircraft only.
NOTE: Chart not to scale.

Figure 351

NC-3, 05 APR 2012 to 03 MAY 2012

MILTON FOUR ARRIVAL

NE-2, 05 APR 2012 to 03 MAY 2012

KEATING TRANSITION (ETG.MIP4):
PHILPSBURG TRANSITION (PSB.MIP4):
STONYFORK TRANSITION (SEK.MIP4):

From over MIP VORTAC on MIP R-117 and FJC R-298 to FJC VORTAC, then on SBJ R-295 to LIZZI INT, then on RBV VORTAC R-323 to BEUTY INT, then on COL VOR/DME R-303 to HARLM INT and DREMS INT, then on JFK VOR/DME R-263 to APPLE INT, then on LGA VOR/DME R-225 to PROUD INT.
Expect radar vectors to final approach course.

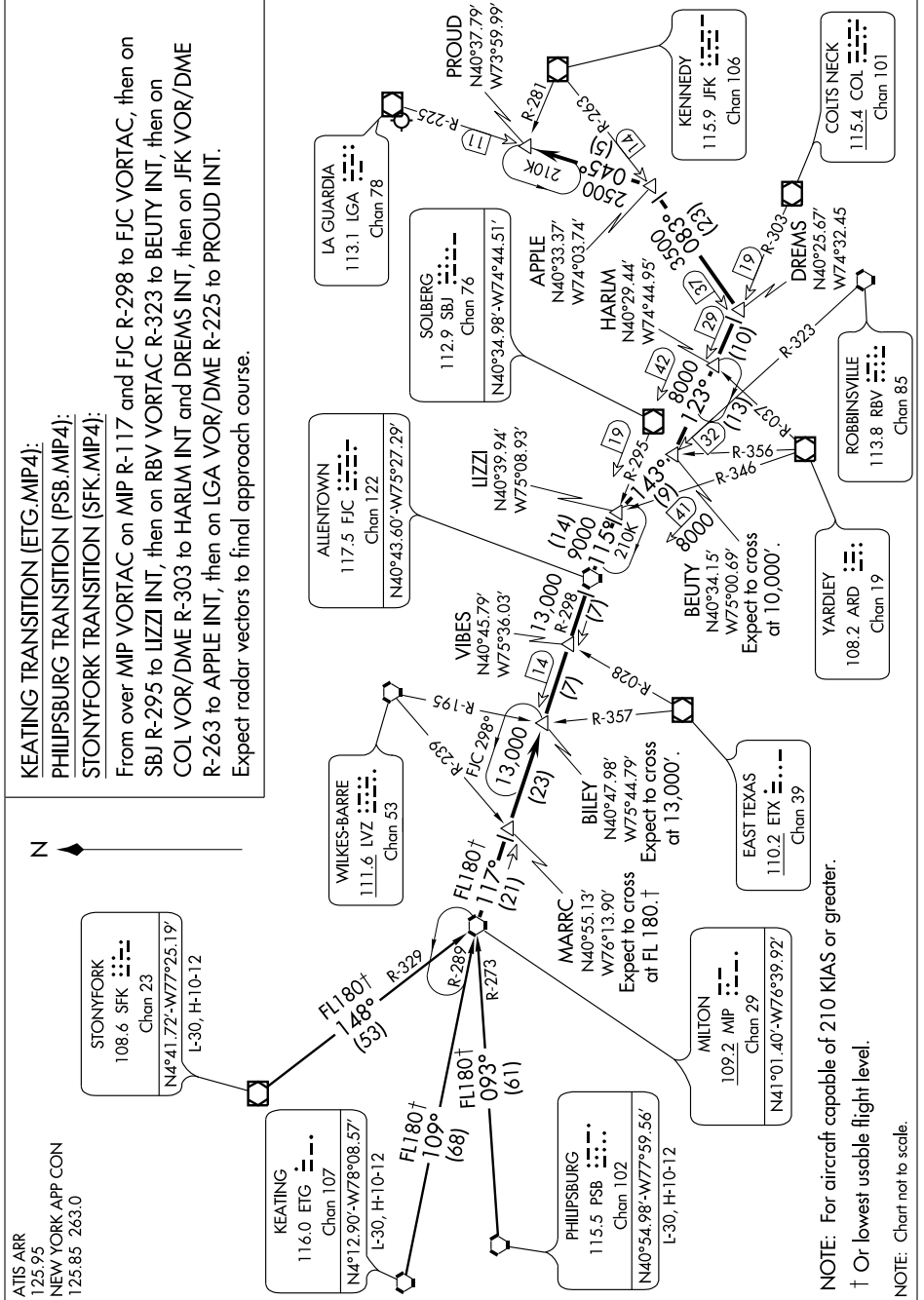

NOTE: For aircraft capable of 210 KIAS or greater.
† Or lowest usable flight level.

NOTE: Chart not to scale.

NE-2, 05 APR 2012 to 03 MAY 2012

MILTON FOUR ARRIVAL

Figure 352

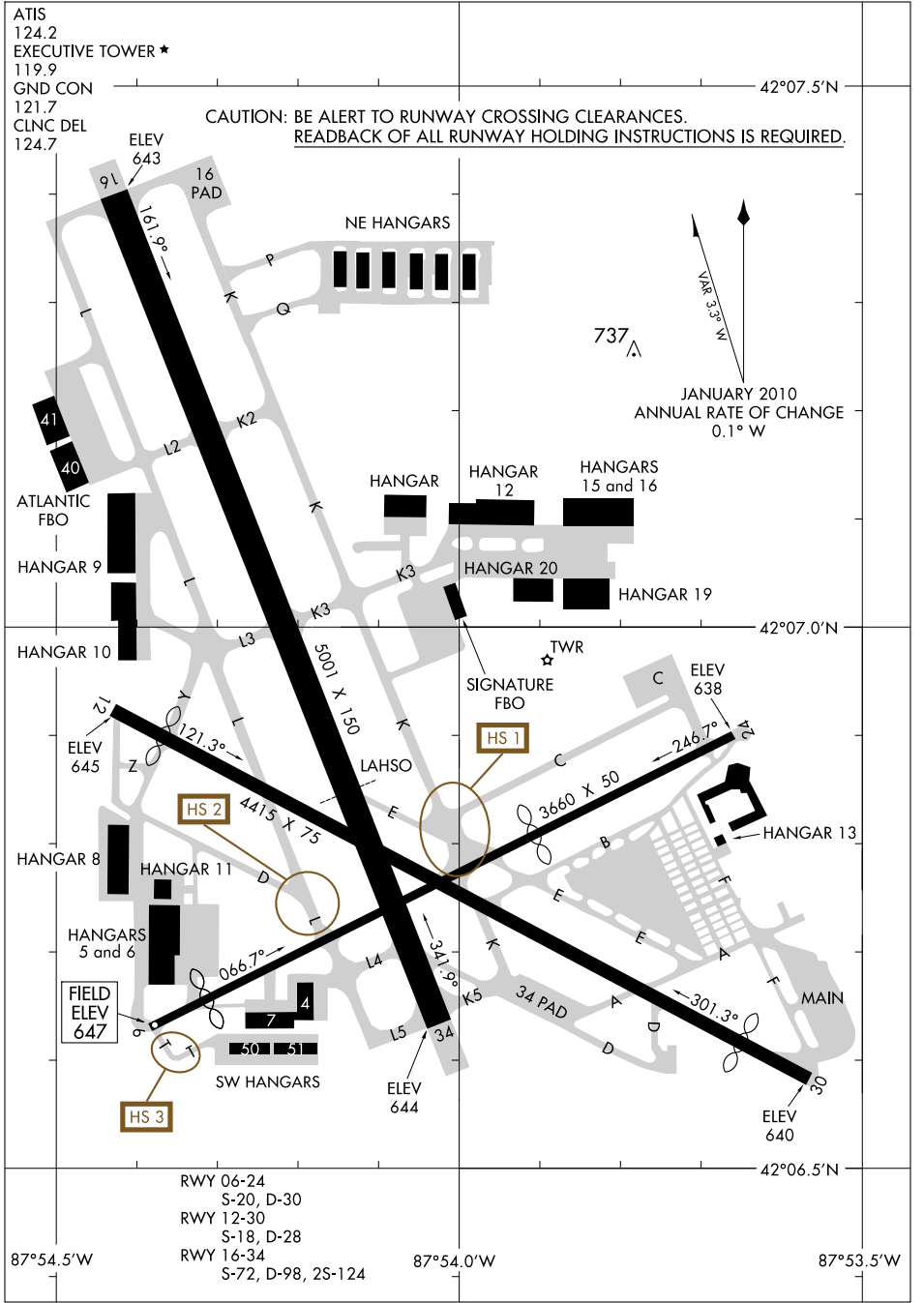

EC-3, 05 APR 2012 to 03 MAY 2012

EC-3, 05 APR 2012 to 03 MAY 2012

Figure 353

PAL-WAUKEE TWO DEPARTURE

CHICAGO/PROSPECT HEIGHTS/WHEELING, ILLINOIS

ATIS★ 124.2
 CLNC DEL
 124.7
 GND CON
 121.7
 EXECUTIVE TOWER★
 119.9 (CTAF)
 CHICAGO DEP CON
 120.55 290.2

NO WIND						
BANK ANGLE	5°	10°	15°	20°	25°	30°
MAXIMUM TAS	70 kts	99 kts	122 kts	143 kts	162 kts	180 kts

DUBUQUE
 115.8 DBQ
 Chan 105
 N42°24.09'
 W90°42.54'
 L-28, H-5

BADGER
 116.4 BAE
 Chan 111
 N43°07.01'-W88°17.06'
 L-28, H-5

PETTY
 N42°49.64'
 W87°38.04'
 L-28

KEELER
 116.6 ELX
 Chan 113
 N42°08.66'
 W86°07.36'
 L-28, H-5-10

POLO
 111.2 PLL
 Chan 49
 N41°57.94'
 W89°31.45'
 L-28

SIMMN
 N41°58.84'
 W88°52.71'
 L-28

MUSKY
 N42°09.20'
 W86°56.23'
 L-28

UNBAR
 N42°02.90'
 W85°12.79'
 H-5-10

IOWA CITY
 116.2 IOW
 Chan 109
 N41°31.14'
 W91°36.80'
 L-28, H-5

HINCK
 N41°49.48'
 W88°40.56'
 L-28

CHICAGO O'HARE
 113.9 ORD
 Chan 86
 N41°57.50'-W87°54.29'
 H-5

GIPPER
 115.4 GIJ
 Chan 101
 N41°46.12'
 W86°19.10'
 L-28, H-5-10

BRADFORD
 114.7 BDF
 Chan 94
 N41°09.58'
 W89°35.27'
 L-27, H-5

NEWT
 N41°03.54'
 W88°04.60'
 L-27

WORDY
 N40°40.54'
 W87°38.00'
 H-5

PEOTON
 113.2 EON
 Chan 79
 N41°16.18'
 W87°47.46'
 L-28

WHEAT
 N41°09.61'
 W86°35.05'
 H-5-10

ROBERTS
 116.8 RBS
 Chan 115
 N40°34.90'-W88°09.86'
 L-27, H-5

NOTE: A turn radius of less than 5,000' is required.

NOTE: Chart not to scale

DEPARTURE ROUTE DESCRIPTION

All aircraft expect radar vectors to appropriate navaid/fix; maintain 3000 feet or assigned altitude. Expect clearance to requested altitude/flight level (three minutes for jet/turbo engine or five minutes for piston engines) after departure.

TAKE-OFF RUNWAY 16: Start right turn within 1 NM of departure end of runway and complete turn to assigned heading east of R-345 of the ORD VOR/DME. This will insure separation from the runway 14R final approach course at O'Hare Intl. If unable to comply, advise Executive Tower prior to take-off.

PAL-WAUKEE TWO DEPARTURE

CHICAGO/PROSPECT HEIGHTS/WHEELING, ILLINOIS
CHICAGO EXECUTIVE (PWK)

EC-3, 05 APR 2012 to 03 MAY 2012

EC-3, 05 APR 2012 to 03 MAY 2012

11293

AIRPORT DIAGRAM

BUFFALO NIAGARA INTL (BUF)
BUFFALO, NEW YORK

AL-65 (FAA)

ATIS
135.35
BUFFALO TOWER
120.5 257.8
GND CON
133.2 257.8
CLNC DEL
124.7 257.8

D



JANUARY 2010
ANNUAL RATE OF CHANGE
0.0° W

NE-2, 05 APR 2012 to 03 MAY 2012

NE-2, 05 APR 2012 to 03 MAY 2012

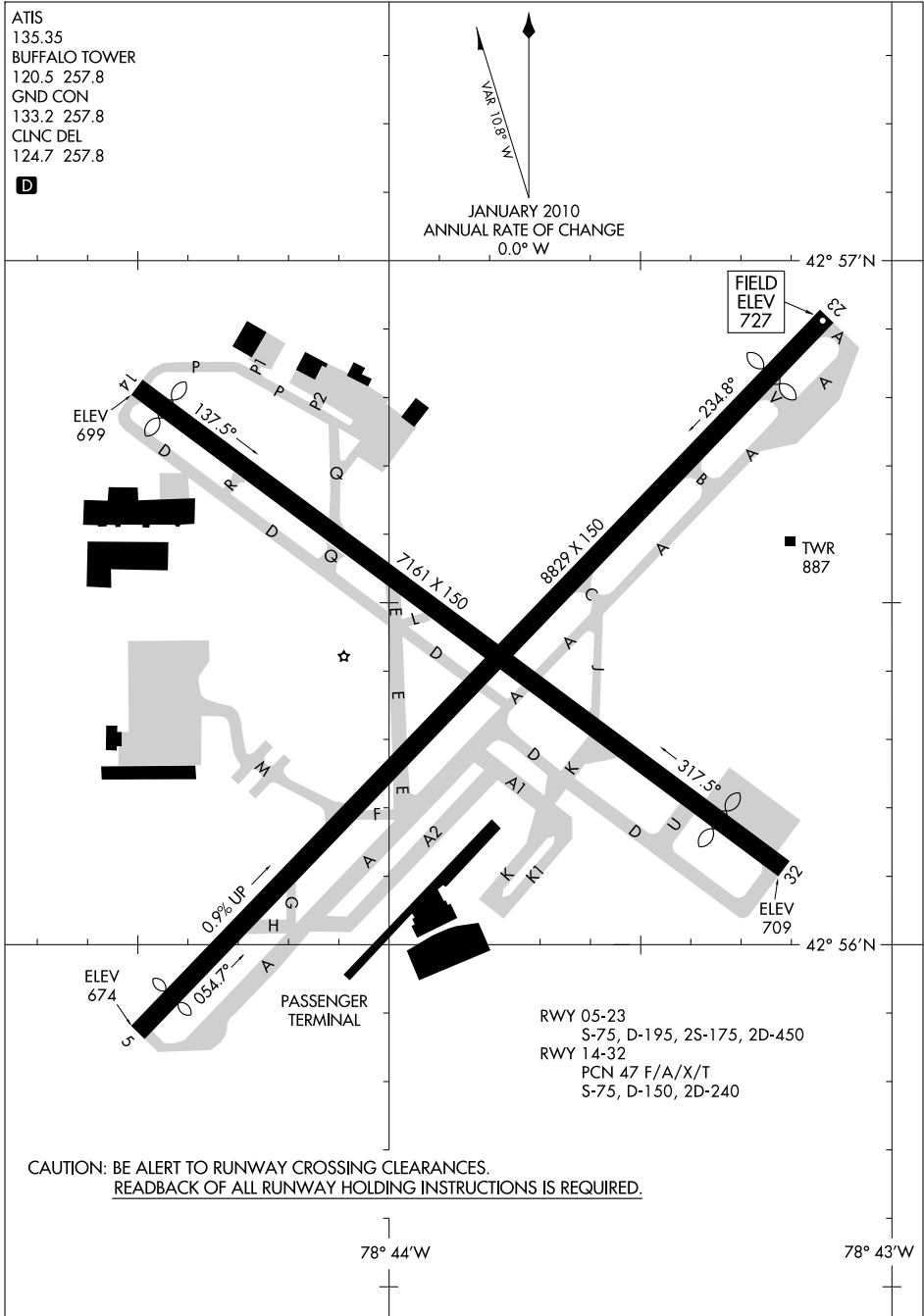

CAUTION: BE ALERT TO RUNWAY CROSSING CLEARANCES.
READBACK OF ALL RUNWAY HOLDING INSTRUCTIONS IS REQUIRED.

78° 44'W

78° 43'W

AIRPORT DIAGRAM

11293

BUFFALO, NEW YORK
BUFFALO NIAGARA INTL (BUF)

Figure 355

BUFFALO NIAGARA INTL (BUF) 5 E UTC-5(-4DT) N42°56.43' W78°43.84'
 727 B S4 FUEL 100LL, JET A OX 1, 2, 3, 4 LRA Class I, ARFF Index D
 NOTAM FILE BUF

DETROIT
 H-10H, 11B, L-31E
 IAP, AD

RWY 05-23: H8829X150 (ASPH-GRVD) S-75, D-195, 2S-175,
 2D-450 HIRL CL
RWY 05: MALSRR. TDZL. Thld dspcd 535'. Bldg. 0.9% up.
RWY 23: ALSF2. TDZL. Thld dspcd 725'. Tree.
RWY 14-32: H7161X150 (ASPH-GRVD) S-75, D-150, 2D-240
 PCN 47 F/A/X/T HIRL
RWY 14: REIL. PAPI(P4L)—GA 3.0° TCH 45'. Thld dspcd 320'. Tree.
RWY 32: MALSRR. REIL. PAPI(P4L)—GA 3.0° TCH 54'. Thld dspcd
 720'. Sign.

RUNWAY DECLARED DISTANCE INFORMATION

RWY 05: TORA-8827 TODA-8827 ASDA-8292 LDA-7757
RWY 14: TORA-7161 TODA-7161 ASDA-6441 LDA-6121
RWY 23: TORA-8827 TODA-8827 ASDA-8292 LDA-7567
RWY 32: TORA-7161 TODA-7161 ASDA-6841 LDA-6121

AIRPORT REMARKS: Attended continuously. Heavy concentration of gulls, blackbirds, and starlings up to 5000 ft on and in/ov arpt. Deer on and in/ov arpt. Twy K1 clsd 0200-1300Z† daily. Twy A SW runup area/holding bay marked design group 3 acft (generally B727 or smaller), unavbl design group 4 (includes but not limited to B757, DC8). For fixed-base operator svcs ctc 131.75; for cargo svcs ctc 122.95. Rwy 23 ALSF2 unmonitored. Ldg fee. Flight Notification Service (ADCUS) available.

WEATHER DATA SOURCES: ASOS (716) 635-0532. WSP.

COMMUNICATIONS: D-ATIS 135.35

RCO 122.6 122.2 122.1R (BUFFALO RADIO)

Ⓡ APP DEP/CON 126.15 (053°-233°) 126.5 (234°-052°)

TOWER 120.5 GND CON 133.2 CLNC DEL 124.7 PRE-TAXI CLNC 124.7

AIRSPACE: CLASS C svc continuous, ctc APP CON

RADIO AIDS TO NAVIGATION: NOTAM FILE BUF.

(H) VOR/DME 116.4 BUF Chan 111 N42°55.74' W78°38.78' 288° 3.8 NM to fld. 730/08W.

VOR/DME unusable:

036°-261° blo 11,000'

276°-305° blo 6000'

262°-275° blo 2300'

KLUMP NDB (LOM) 231 BU N43°00.02' W78°39.05' 233° 5.0 NM to fld.

PLAZZ NDB (LOM) 204 GB N42°52.43' W78°48.99' 053° 5.5 NM to fld.

ILS 111.3 I-BUF Rwy 23. Class IE. LOM KLUMP NDB. Glideslope unusable byd 5° rgt of course.

ILS 108.5 I-GBI Rwy 05. Class IA. LOM PLAZZ NDB.

ILS/DME 109.95 I-BNQ Chan 36(Y) Rwy 32.

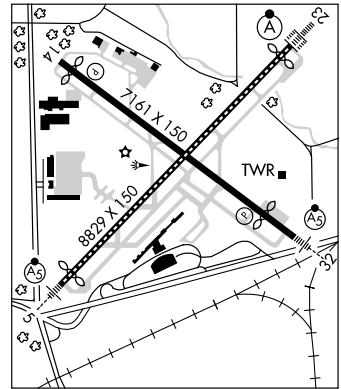

CLARENCE AERODROME (D51) 5 NE UTC-5(-4DT) N43°04.00' W78°40.99'

DETROIT

589 NOTAM FILE BUF

RWY 10-28: 2500X67 (TURF) LIRL

RWY 10: Fence. **RWY 28:** Trees.

AIRPORT REMARKS: Unattended. Ultralights on and in/ov arpt. Rwy 10-28 outlined with cones. ACTIVATE LIRL Rwy 10-28-122.7.

COMMUNICATIONS: CTAF/UNICOM 122.7

BUFFALO-LANCASTER RGNL (See LANCASTER)

BURRELLO-MECHANICVILLE (See MECHANICVILLE)

CALVERTON N40°55.78' W72°47.93' NOTAM FILE ISP.

NEW YORK

(L) VORW/DME 117.2 CCC Chan 119 219° 7.2 NM to Brookhaven. 85/13W.

COPTER

VOR portion unusable 280°-290° byd 25 NM.

H-10I, L-33B, 34I

CAMBRIDGE N42°59.66' W73°20.64' NOTAM FILE BTV.

NEW YORK

(L) VORW/DME 115.0 CAM Chan 97 159° 7.5 NM to Bennington State, Vt. 1490/14W.

H-11C, 12I, L-326, 34J

HIWAS.

DME unusable 050°-130° beyond 20 NM below 9000'.

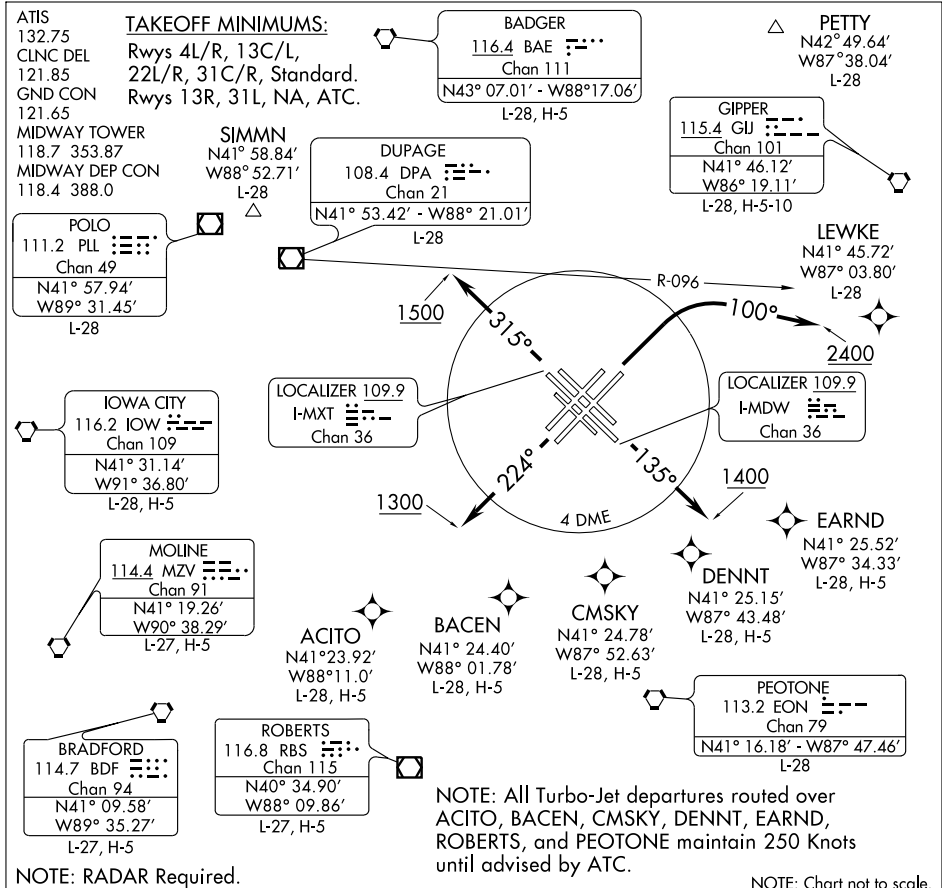

EC-3, 05 APR 2012 to 03 MAY 2012

EC-3, 05 APR 2012 to 03 MAY 2012

DEPARTURE ROUTE DESCRIPTION

ALL AIRCRAFT:
TAKE-OFF RWYS 4L/R: Northbound departures assigned headings 360° (CW) thru 080°, climbing right turn to 2400 heading 100° before proceeding on course, thence. . . .
TAKE-OFF RWY 13C: Climb heading 135° to 1400 before turning, thence. . . .
TAKE-OFF RWY 13L: Climb heading 135° to 1400 before turning, thence. . . .
TAKE-OFF RWY 22L: Climb heading 224° to 1300 before turning, thence. . . .
TAKE-OFF RWY 22R: Climb heading 224° to 1300 before turning, thence. . . .
TAKE-OFF RWY 31C: Climb heading 315° to 1500 before turning, thence. . . .
TAKE-OFF RWY 31R: Climb heading 315° to 1500 before turning, thence. . . .

DME EQUIPPED AIRCRAFT: Complete initially assigned turn within 4 DME of Midway. Maintain 3000 feet or assigned lower altitude, thence. . . .

NON-DME EQUIPPED AIRCRAFT: Complete initially assigned turn south of DPA R-096, maintain 3000 feet or assigned lower altitude, thence. . . .

....expect radar vectors to first enroute fix. Expect clearance to requested altitude/flight level 10 (ten) minutes after departure.

Figure 358

TAKEOFF OBSTACLE NOTES:

NOTE: RWY 4L, Fence 18 feet from DER, 257 feet left of centerline, 12 feet AGL/616 feet MSL. Vehicle plus road 143 feet from DER, 163 feet left of centerline, 16 feet AGL/620 feet MSL. Bldg 251 feet from DER, 217 feet left of centerline, 26 feet AGL/630 feet MSL. Sign 1,912 feet from DER, 330 feet left of centerline, 88 feet AGL/692 feet MSL. Multiple lt poles and trees beginning 375 feet from DER, 98 feet right of centerline, up to 75 feet AGL/679 feet MSL.

NOTE: RWY 4R, LOC 300 feet from DER, on centerline, 10 feet AGL/614 feet MSL. Lt pole and multiple trees beginning 40 feet from DER, 369 feet left of centerline, up to 75 feet AGL/679 feet MSL. Blast fence 277 feet from DER, 45 feet left of centerline, 9 feet AGL/613 feet MSL. Tower 3,983 feet from DER, 1,142 feet left of centerline, 109 feet AGL/708 feet MSL. Multiple lt poles and trees beginning 96 feet from DER, 21 feet right of centerline, up to 53 feet AGL/657 feet MSL. Train beginning 1,483 feet from DER, 570 feet right of centerline, 48 feet AGL/654 feet MSL.

NOTE: RWY 13C, LOC 248 feet from DER, on centerline, 8 feet AGL/619 feet MSL. Bldg 101 feet from DER, 254 feet left of centerline, 14 feet AGL/625 feet MSL. Trees beginning 288 feet from DER, 459 feet left of centerline, up to 76 feet AGL/680 feet MSL. Trees beginning 109 feet from DER, 402 feet right of centerline, up to 86 feet AGL/700 feet MSL.

NOTE: RWY 13L, Multiple poles and trees beginning 362 feet from DER, 215 feet left of centerline, up to 71 feet AGL/675 feet MSL. Trees beginning 1,136 feet from DER, 54 feet right of centerline, up to 76 feet AGL/680 feet MSL.

NOTE: RWY 22L, Multiple poles and trees beginning 74 feet from DER, 375 feet left of centerline, up to 70 feet AGL/689 feet MSL. Multiple poles and trees beginning 465 feet from DER, 49 feet right of centerline, up to 60 feet AGL/679 feet MSL. Tank 4,100 feet from DER, 161 feet right of centerline, 109 feet AGL/728 feet MSL.

NOTE: RWY 22R, Multiple poles and trees beginning 575 feet from DER, 168 feet left of centerline, up to 58 feet AGL/677 feet MSL. Tank 4,100 feet from DER, 161 feet left of centerline, 109 feet AGL/728 feet MSL. Fence 198 feet from DER, 3 feet right of centerline, 12 feet AGL/630 feet MSL. Trees beginning 183 feet from DER, 65 feet right of centerline, up to 72 feet AGL/686 feet MSL.

NOTE: RWY 31C, LOC 239 feet from DER, on centerline, 10 feet AGL/617 feet MSL. Trees beginning 452 feet from DER, 454 feet left of centerline, up to 63 feet AGL/667 feet MSL. Spire 2,207 feet from DER, 699 feet left of centerline, 78 feet AGL/684 feet MSL. Multiple poles and trees beginning 142 feet from DER, 28 feet right of centerline, up to 73 feet AGL/672 feet MSL. DME 183 feet from DER, 309 feet right of centerline, 17 feet AGL/624 feet MSL. Sign 1,528 feet from DER, 270 feet right of centerline, 52 feet AGL/652 feet MSL. Tank 5,576 feet from DER, 1,430 feet right of centerline, 162 feet AGL/756 feet MSL.

NOTE: RWY 31R, Multiple poles and trees beginning 379 feet from DER, 49 feet left of centerline, up to 65 feet AGL/664 feet MSL. Pole and trees beginning 70 feet from DER, 50 feet right of centerline, up to 68 feet AGL/667 feet MSL.

ILS or LOC RWY 28

ROCHESTER / GREATER ROCHESTER INTL (ROC)

LOC I-ROC 109.5	APP CRS 278°	Rwy ldg 5801
		TDZE 548
		Apt Elev 559

⚠ Inoperative table does not apply to S-ILS 28 all Cats and S-LOC 28 Cats A and B.
⚠ Visibility reduction by helicopters NA.
Multiple unshielded lights in final approach area.



MISSED APPROACH: Climb to 2000 then dimming left turn to 3000 via heading 230° and ROC VOR/DME R-268 to MONCK INT/ROC 10 DME and hold.

ATIS 124.825	ROCHESTER APP CON 119.55 269.6	ROCHESTER TOWER 118.3 254.3	GND CON 121.7	CLNC DEL 118.8 387.0
------------------------	--	---------------------------------------	-------------------------	--------------------------------

ALTERNATE MISSED APCH FIX
GENESEEO
GENE :
108.2
Chan 19

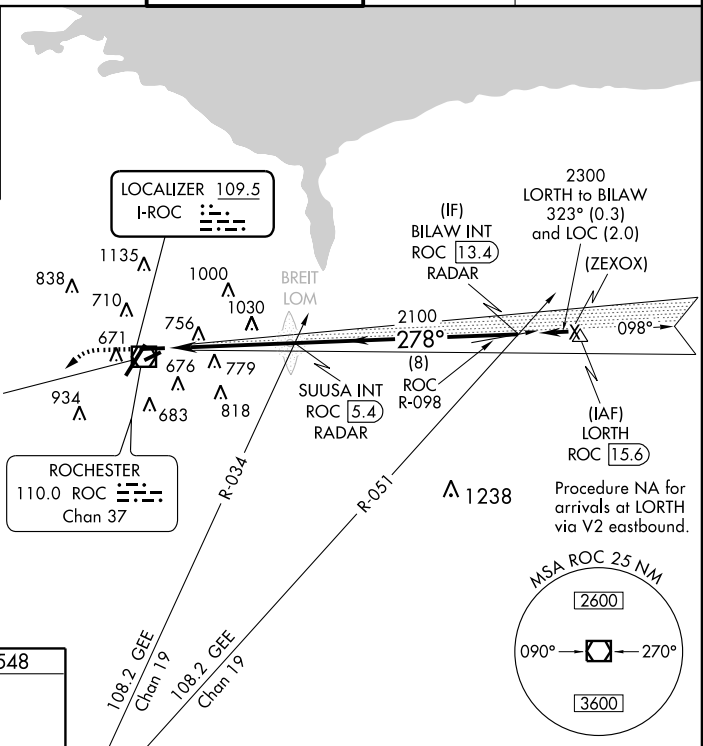

ELEV 559	D TDZE 548
----------	-------------------

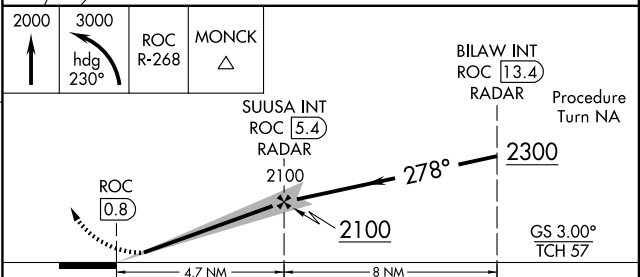
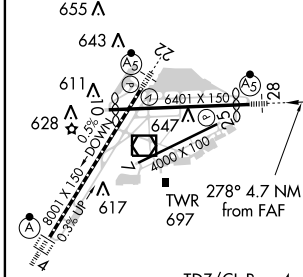

CATEGORY	A	B	C	D
S-ILS 28	798/50 250 (300-1)			
S-LOC 28	1280/50	732 (800-1)	1280-1½ 732 (800-1½)	1280-1¾ 732 (800-1¾)
CIRCLING	1280-1	721 (800-1)	1280-2 721 (800-2)	1280-2¼ 721 (800-2¼)

ILS or LOC RWY 28

Figure 360

NE-2, 05 APR 2012 to 03 MAY 2012

NE-2, 05 APR 2012 to 03 MAY 2012

TUCSON SEVEN DEPARTURE

SL-430 (FAA)

TUCSON INTL (TUS)
TUCSON, ARIZONA

TAKE-OFF OBSTACLE NOTES

- RWY 3: Multiple trees and a sign beginning 1385' from DER, 322' left of centerline to 333' right of centerline, up to 45' AGL/2626' MSL.
- RWY 11L: Multiple bushes and vents beginning 115' from DER, 606' left of centerline to 383' right of centerline, up to 24' AGL/2674' MSL.
- RWY 11R: Tree 584' from DER, 176' right of centerline, 25' AGL/2645' MSL.
- RWY 21: Multiple bushes, poles, lights, railroad cars, and trees beginning 104' from DER, 594' left of centerline to 330' right of centerline, up to 48' AGL/2616' MSL.

- ATIS 123.8 279.65
- CLNC DEL 126.65 326.2
- GND CON 124.4 348.6
- TUCSON TOWER 118.3 257.8
- TUCSON DEP CON 125.1 269.55

BUCKEYE
110.6 BXX
Chan 43
N33°27.21'-W112°49.48'

PHOENIX
115.6 PXR
Chan 103
N33°25.98'-W111°58.21'
L-5, H-4

STANFIELD
114.8 TFD
Chan 95
N32°53.15'
W111°54.52'

GILA BEND
116.6 GBN
Chan 113
N32°57.38'-W112°40.46'
L-5, H-4

ROSKR
N32°16.90'
W111°27.70'

TUCSON
116.0 TUS
Chan 107
N32°05.71'-W110°54.89'

SAN SIMON
115.4 SSO
Chan 101
N32°16.16'-W109°15.78'
L-5, H-4

MESCA
N31°53.64'
W110°29.13'

COCHISE
115.8 CIE
Chan 105
N32°02.00'-W109°45.49'
L-5, H-4

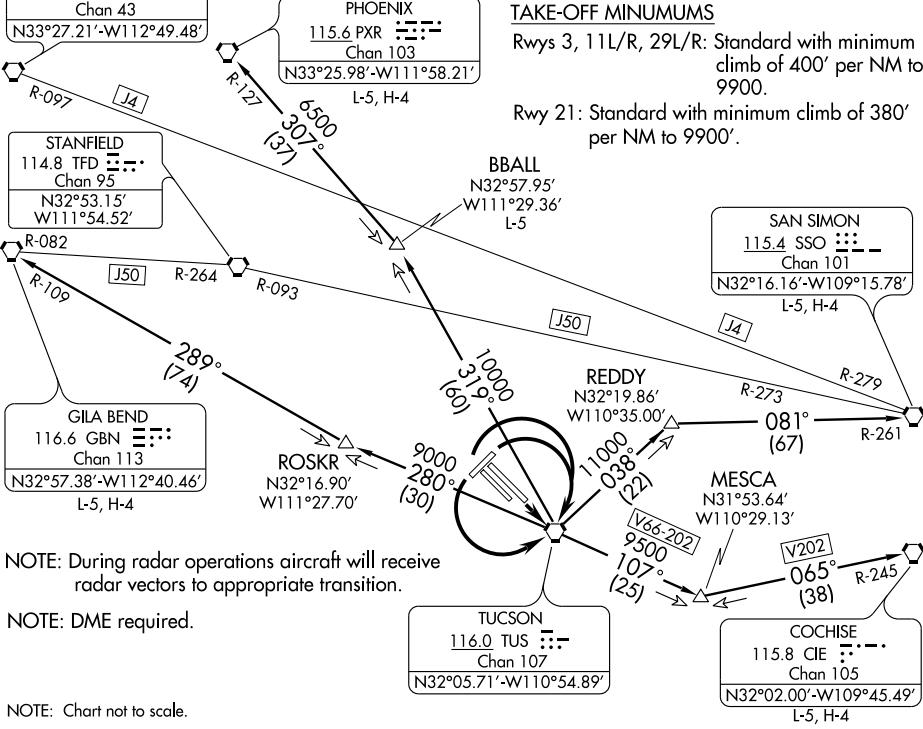

- NOTE: During radar operations aircraft will receive radar vectors to appropriate transition.
- NOTE: DME required.
- NOTE: Chart not to scale.

DEPARTURE ROUTE DESCRIPTION

- TAKE-OFF RUNWAYS 11L/R:** Climb direct TUS VORTAC. Thence. . .
- TAKE-OFF RUNWAYS 3, 29L/R:** Climbing right turn direct TUS VORTAC. Thence. . .
- TAKE-OFF RUNWAY 21:** Climbing left turn direct TUS VORTAC. Thence. . .
- . . . via assigned transition. Maintain 17000, expect clearance to filed altitude 10 minutes after departure.
- BBALL TRANSITION (TUS7.BBALL):** From over TUS VORTAC via TUS R-319 to BBALL INT.
- COCHISE TRANSITION (TUS7.CIE):** From over TUS VORTAC via TUS R-107 and CIE R-245 to CIE VORTAC.
- GILA BEND TRANSITION (TUS7.GBN):** From over TUS VORTAC via TUS R-280 and GBN R-109 to GBN VORTAC.
- PHOENIX TRANSITION (TUS7.PXR):** From over TUS VORTAC via TUS R-319 and PXR R-127 to PXR VORTAC.
- SAN SIMON TRANSITION (TUS7.SSO):** From over TUS VORTAC via TUS R-038 and SSO R-261 to SSO VORTAC.

TUCSON SEVEN DEPARTURE

TUCSON, ARIZONA
TUCSON INTL (TUS)

SW-4, 05 APR 2012 to 03 MAY 2012

SW-4, 05 APR 2012 to 03 MAY 2012

TAKE-OFF MINIMUMS AND (OBSTACLE) DEPARTURE PROCEDURES

12096

TONOPAH TEST RANGE (KTNX)

TONOPAH, NV. AMDT 1 12096

DEPARTURE PROCEDURE: **Rwy 14:** 1000-3 with minimum climb of 320 ft/NM to 10,700 or 2700-3 for Climb in Visual Conditions. Climb on a heading between 325° CW to 155° from departure end of runway or Climb in Visual Conditions to cross KZ-KTNX airport at or above 8100 MSL before proceeding on course. **Rwy 32:** 1000-3 with minimum climb of 260 ft/NM to 5900 or 2700-3 for Climb in Visual Conditions. Climb on a heading between 295° CW to 005° from departure end of runway or Climb in Visual Conditions to cross KZ-KTNX airport at or above 8100 MSL before proceeding on course.

TAKE-OFF OBSTACLES: **Rwy 14,** Terrain, 5582' MSL, 1204' from DER, 823' right of centerline. Terrain, 5565' MSL, 63' from DER, 517' right of centerline. Terrain, 5564' MSL, 46' from DER, 480' right of centerline. Terrain, 5561' MSL, 0' from DER, 353' right of centerline. Terrain, 5558' MSL, 62' from DER, 200' right of centerline. Terrain, 5561' MSL, 14' from DER, 292' right of centerline. Terrain, 5561' MSL, 0' from DER, 287' right of centerline. Terrain, 5559' MSL, 0' from DER, 222' right of centerline. Surveyed terrain, 5560' MSL, 215' from DER, 427' right of centerline. **Rwy 32,** Terrain, 5476' MSL, 0' from DER, 500' left of centerline. Terrain, 5476' MSL, 19' from DER, 465' left of centerline. Terrain, 5476' MSL, 110' from DER, 529' left of centerline.

TOOELE, UT

BOLINDER FIELD-TOOELE VALLEY

TAKE-OFF MINIMUMS: **Rwy 17,** std. with a min. climb of 490' per NM to 11000. **Rwy 35,** std. with a min. climb of 360' per NM to 9000.

DEPARTURE PROCEDURE: Use STACO DEPARTURE.

NOTE: **Rwy 17,** tree 794' from departure end of runway, 277' right of centerline, 35' AGL/4380' MSL. Tree 967' from departure end of runway, 432' right of centerline, 35' AGL/4394' MSL. Tree 1023' from departure end of runway, 313' right of centerline, 35' AGL/4395' MSL.

TUCSON, AZ

MARANA RGNL

TAKE-OFF MINIMUMS: **Rwys 3, 12,** N/A-Obstacles DEPARTURE PROCEDURE: **Rwy 21,** climb to 6500 via heading 360° and TUS R-308 to TOTEC Int/TUS 57 DME, then as filed. **Rwy 30,** climb to 6500 via heading 303° intercept TUS R-308 above 3500, to TOTEC INT/TUS 57 DME, then as filed.

NOTE: **Rwy 21,** road 192' from departure end of runway, 527' left of centerline 15' AGL/2034' MSL.

RYAN FIELD (RYN)

AMDT 3 10210 (FAA)

TAKE-OFF MINIMUMS: **Rwys 6L, 15, 24R, 33, NA,** ATC.

DEPARTURE PROCEDURE: **Rwys 6R, 24L,** use ALMON DEPARTURE.

TUCSON, AZ (CON'T)

TUCSON INTL (TUS)

AMDT 4A 08241 (FAA)

TAKE-OFF MINIMUMS: **Rwy 3,** 300-1¼ or std. w/min. climb of 228' per NM to 3000.

DEPARTURE PROCEDURE: **Rwys 3, 29L, 29R,** climbing right turn direct to TUS VORTAC. **Rwys 11L, 11R** climb via runway heading to 4000 then climbing left turn direct TUS VORTAC. **Rwy 21,** climbing left turn direct to TUS VORTAC. **All aircraft** continue climbing in holding pattern (NW, right turns, 128° inbound) to depart TUS VORTAC at or above 9000.

NOTE: **Rwy 3,** tower 9215' from departure end of runway, 1689' left of centerline, 246' AGL/2831' MSL.

VERNAL, UT

VERNAL RGNL

TAKE-OFF MINIMUMS: **Rwy 16,** 1500-2 or std with a min. climb of 250' per NM to 7000'. **Rwy 25,** 1500-2 or std. with a min. climb of 390' per NM to 7000. **Rwy 34,** 1600-2 prstd. with a min. climb of 330' per NM to 7000'.

DEPARTURE PROCEDURE: **Rwys 7, 34,** turn right.

Rwys 16, 25, turn left. **All aircraft** climb direct VEL. Aircraft departing V391 S-bound climb on course. All others climb in holding pattern (SE, right turns, 322° inbound). Aircraft SW-bound V208 depart VEL at or above 8400'. All others depart VEL at or above 9500'. Continue climb on course to MEA or assigned altitude.

WENDOVER, UT

WENDOVER

TAKE-OFF MINIMUMS: **Rwy 26,** standard with a min. climb of 300' per NM to 7000. **Rwy 30, NA.**

DEPARTURE PROCEDURE: **Rwys 8, 12, 26,** climbing left turn direct BVL VORTAC. Aircraft departing BVL VORTAC R-330 CW R-150 climb on course. All others continue climb in BVL VORTAC holding pattern (Hold NE right turns, 247° inbound) to cross at or above 7400, then climb on course.

WILLCOX, AZ

COCHISE COUNTY

DEPARTURE PROCEDURE: **Rwy 3,** turn right. **Rwy 21,** turn left. **All aircraft** climb direct CIE VORTAC.

WINDOW ROCK, AZ

WINDOW ROCK

TAKE-OFF MINIMUMS: **Rwy 2,** 700-2 or std. with a min. climb of 500' per NM to 8000. **Rwy 20,** 600-2 or std. with a min. climb of 260' per NM to 8200.

DEPARTURE PROCEDURE: **Rwy 2,** turn right.

Rwy 20, turn left direct to GUP VORTAC before proceeding on course.

NOTE: **Rwy 2,** terrain 3832' from departure end of runway, 1025' right of centerline, 6926' MSL. Poles 5220' from departure end of runway, 245' right of centerline, 180' AGL/6922' MSL. Tower 7067' from departure end of runway, 3072' left of centerline, 71' AGL/7316' MSL. Terrain 7449' from departure end of runway, 1612' left of centerline, 6991' MSL. Terrain 8776' from departure end of runway, 1851' left of centerline, 7109' MSL. Tree 9665' from departure end of runway, 1326' right of centerline, 7340' MSL. Tree 11326' from departure end of runway, 355' left of centerline, 7351' MSL. **Rwy 20,** trees 1018' from departure end of runway, 620' left of centerline, 30' AGL/6768' MSL.

12096

TAKE-OFF MINIMUMS AND (OBSTACLE) DEPARTURE PROCEDURES

ILS or LOC Y RWY 27

HELENA RGNL (HLN)

LOC I-HLN 110.1	APP CRS 267°	Rwy Idg TDZE Apt Elev 9000 3852 3877
---------------------------	------------------------	--

⚠ Circling NA for Cats. D and E south of Rwy 9-27. Inoperative table does not apply to S-LOC 27 Cats. A-B. For inoperative MALSR, increase S-ILS 27 all Cats. visibility to 2 miles, S-LOC 27 Cat. E visibility to 3 miles, FERRI fix minimums: S-LOC 27 Cat E visibility to 2½ miles. DME arc to final approach required for turbojet aircraft. Holding at HAU NDB authorized for Category A and B aircraft only.



MISSED APPROACH: Climb to 4700 then climbing right turn to 9000 via heading 021° and HLN VORTAC R-336 to WOKEN INT and hold.

ATIS 120.4	HELENA APP CON * 119.5 229.4	HELENA TOWER * 118.3 (CTAF) 0 257.8	GND CON 121.9	UNICOM 122.95
----------------------	--	---	-------------------------	-------------------------

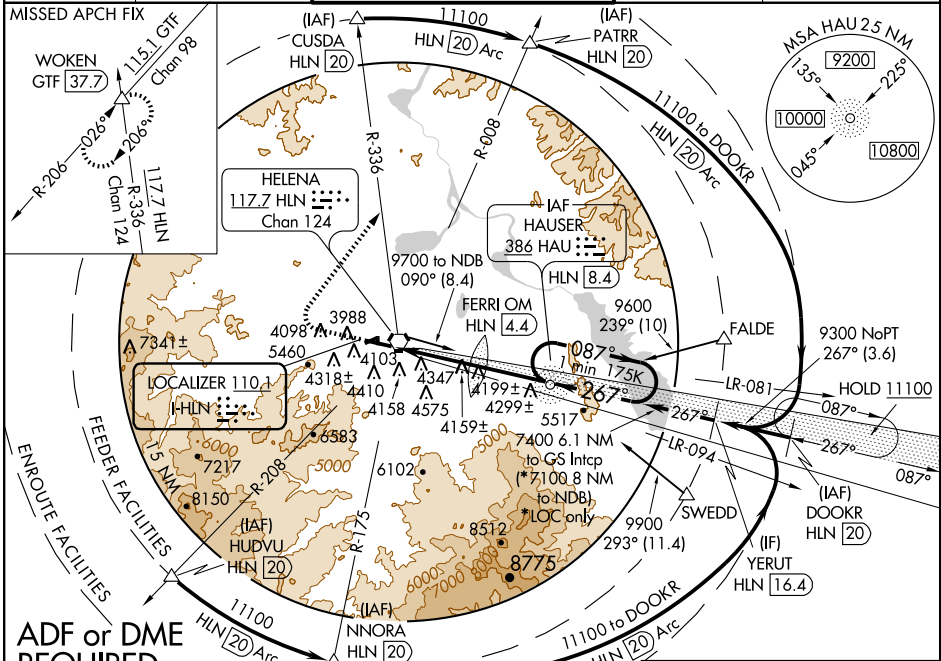

NW-1, 05 APR 2012 to 03 MAY 2012

NW-1, 05 APR 2012 to 03 MAY 2012

ADF or DME REQUIRED

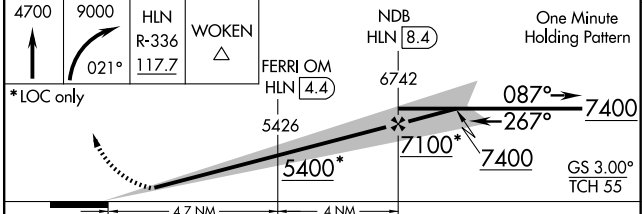

ELEV 3877

CATEGORY	A	B	C	D	E
S-ILS 27	4402-1½ 550 (600-1½)				
S-LOC 27	5400-1¼ 1548 (1600-1¼)	5400-1½ 1548 (1600-1½)	5400-2½	1548 (1600-2½)	
CIRCLING	5400-1¼ 1523 (1600-1¼)	5400-1½ 1523 (1600-1½)	5400-3	1523 (1600-3)	
FERRI FIX MINIMUMS *					
S-LOC 27	4560-½ 708 (700-½)	4560-1½ 708 (700-1½)	4560-1¾ 708 (700-1¾)	4560-2 708 (700-2)	
CIRCLING	4640-1 763 (800-1)	4740-2½ 863 (900-2½)	4740-2¾ 863 (900-2¾)	4840-3 963 (1000-3)	

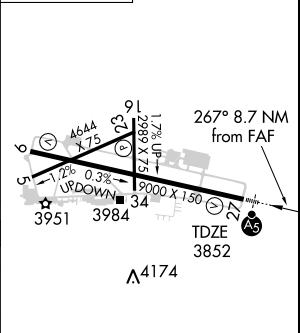

REIL Rwy 9	
MIRL Rwys 5-23 and 16-34	
HRL Rwy 9-27	
FAF to MAP 8.7 NM	
Knots	60 90 120 150 180
Min:Sec	8:42 5:48 4:21 3:29 2:54

Figure 363

COPTER VOR 251°

VORTAC HLN 117.7 Chan 124	APCH CRS 251°	Rwy Idg TDZE Arpt Elev N/A N/A 3877	AL-192 [USA]	HELENA RGNL (KHLN)
---	-------------------------	---	--------------	--------------------

▽ MISSED APPROACH: Climbing right turn to 8000 direct HLN VORTAC and hold.
▲ NA when tower clsd.

ATIS 120.4	HELENA APP CON 119.5 229.4	HELENA TOWER ★ 118.3 (CTAF) 0 257.8	GND CON 121.9	UNICOM 122.95
----------------------	--------------------------------------	---	-------------------------	-------------------------

Final approach from holding pattern at HLN VORTAC not authorized. Procedure turn required.

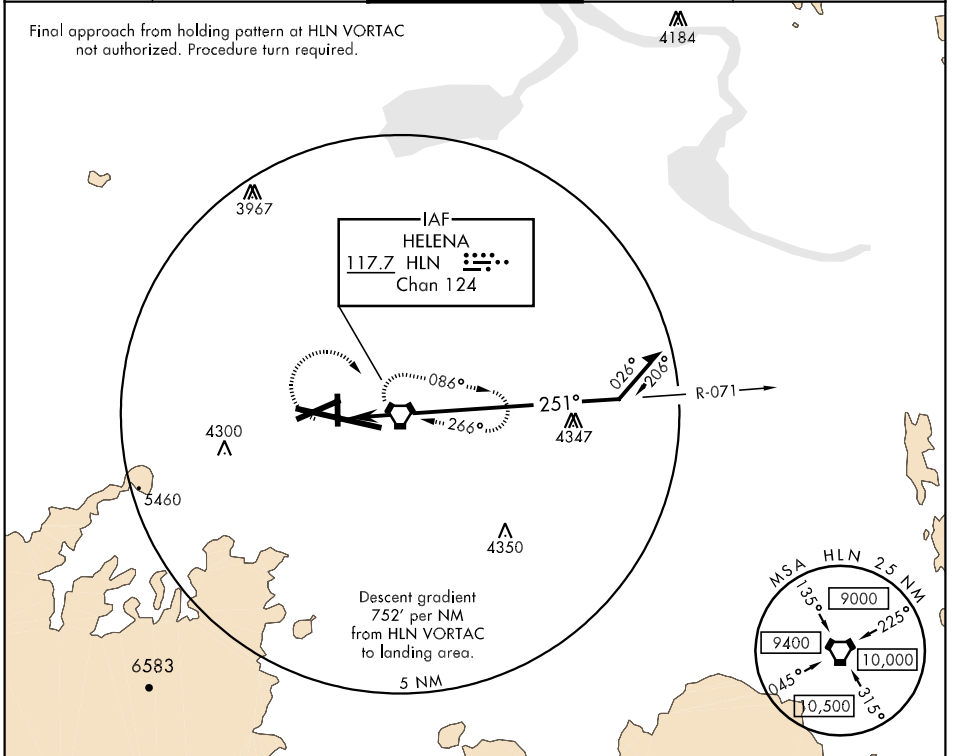

NW-1, 05 APR 2012 to 03 MAY 2012

NW-1, 05 APR 2012 to 03 MAY 2012

COPTER ONLY

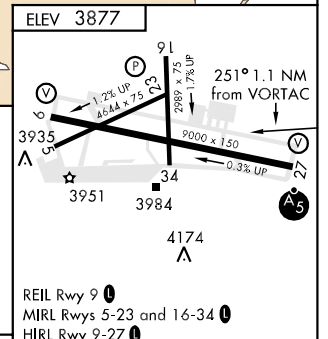
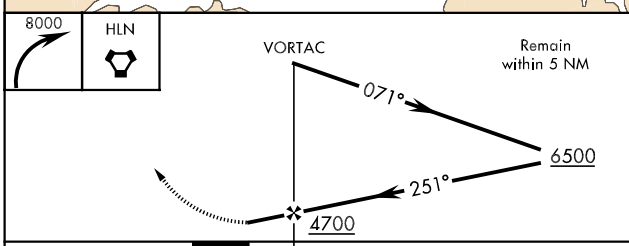

CATEGORY	COPTER					FAF to MAP 1.1 NM									
H-251°	4260-½	412	(400-½)	Knots	45	60	75	90	105	Min:Sec	1:28	1:06	0:53	0:44	0:37

COPTER VOR 251°

Figure 364

NDB CVP 335	APP CRS 242°	Rwy Idg TDZE Apt Elev	N/A N/A 3877
-----------------------	------------------------	-----------------------------	---------------------------

⚠ MISSED APPROACH: Climb to 5200, then climbing right turn to 6400 direct CVP NDB and hold.

ATIS 120.4	HELENA APP CON * 119.5 229.4	HELENA TOWER * 118.3 (CTAF) 257.8	GND CON 121.9	UNICOM 122.95
----------------------	--	---	-------------------------	-------------------------

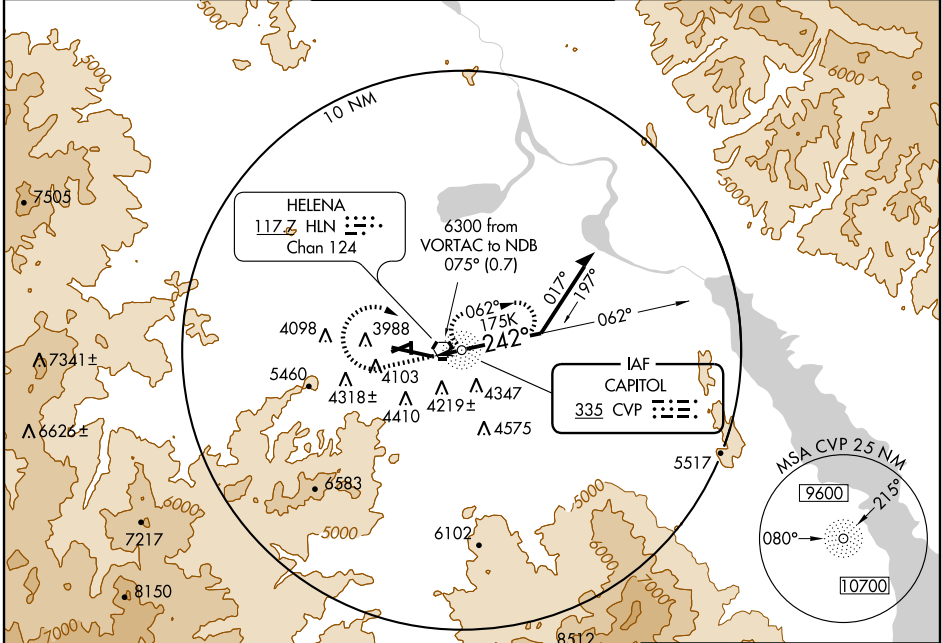

NW-1, 05 APR 2012 to 03 MAY 2012

NW-1, 05 APR 2012 to 03 MAY 2012

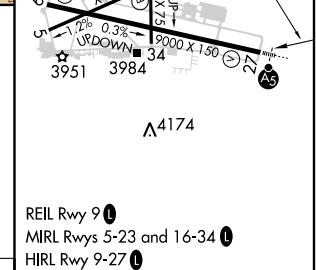
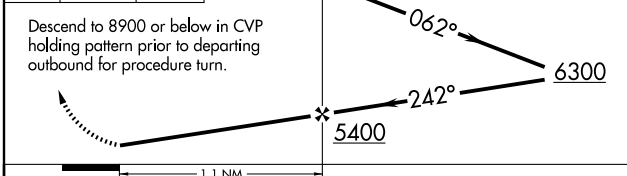

CATEGORY	A	B	C	D	FAF to MAP 1.1 NM
CIRCLING	4980-1¼ 1103 (1200-1¼)		NA		
					Knots 60 90 120 150 180 Min:Sec 1:06 0:44 0:33 0:26 0:22

LOC I-HLN 110.1	APP CRS 087°	Rwy ldg TDZE N/A	Apt Elev N/A
			3877

LOC/DME BC-C

HELENA RGNL (HLN)

⚠ Circling to Rwy 5, 34 NA, at night. When local altimeter setting not received, procedure NA.
⚠ Visibility reduction by helicopters NA. DME from HLN VORTAC simultaneous reception of I-HLN and HLN DME required. When VGSI inop, circling to Rwy 9, 23 NA at night.

MISSED APPROACH: Climbing left turn to 9300 on HLN VORTAC R-336 to WOKEN INT and hold.

ATIS 120.4	HELENA APP CON* 119.5 229.4	HELENA TOWER* 118.3 (CTAF) 257.8	GND CON 121.9	UNICOM 122.95
----------------------	---------------------------------------	--	-------------------------	-------------------------

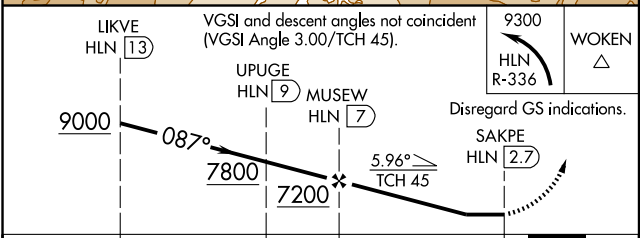
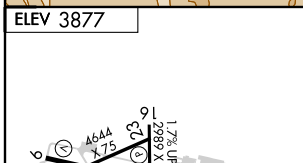
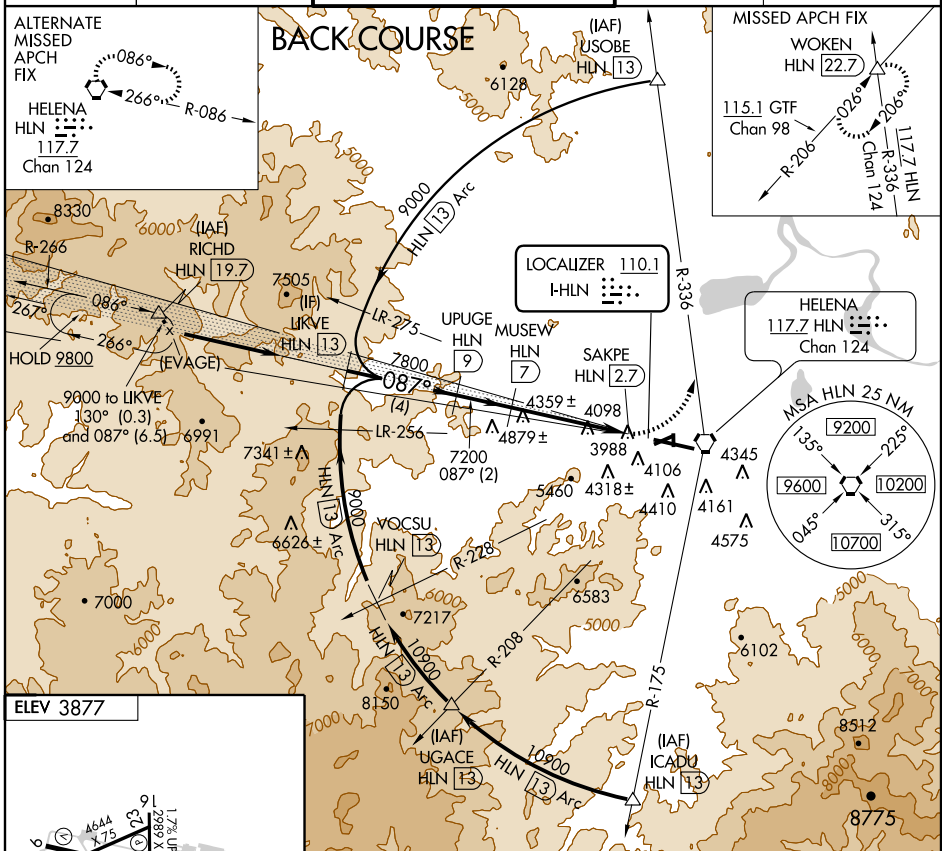

REIL Rwy 9
 MIRL Rwy 5-23 and 16-34
 HIRL Rwy 9-27

CATEGORY	A	B	C	D
CIRCLING	5140-1¼ 1263 (1300-1¼)	5140-1½ 1263 (1300-1½)	5140-3 1263 (1300-3)	NA

NW-1, 05 APR 2012 to 03 MAY 2012

NW-1, 05 APR 2012 to 03 MAY 2012

MINNEAPOLIS FIVE DEPARTURE

SL-264 (FAA)

MINNEAPOLIS, MINNESOTA

ATIS DEP 120.8
 CLNC DEL
 133.2
 MINNEAPOLIS DEP CON
 SOUTH or EAST 124.7 357.4
 NORTH or WEST 125.75 357.4
 MINNEAPOLIS TOWER
 123.95 273.55 (12L-30R)
 126.7 273.55 (12R-30L, 4-22)
 123.675 273.55 (17-35)

FARGO
 116.2 FAR
 Chan 109
 N46°45.20'-W96°51.13'
 L-14, H-2

DULUTH
 112.6 DLH
 Chan 73
 N46°48.13'-W92°12.17'
 L-14, H-2

ABERDEEN
 113.0 ABR
 Chan 77
 N45°25.04'-W98°22.12'
 L-12-14, H-2

FLYING CLOUD
 117.7 FCM
 Chan 124

Rwy 17
 (For assigned 230° CW 285°)
 3500

BRAINERD
 116.9 BRD
 Chan 116
 N46°20.89'-W94°01.55'
 L-14, H-2

GREEN BAY
 115.5 GRB
 Chan 102
 N44°33.31'-W88°11.69'
 L-28-31, H-2

RAPID CITY
 112.3 RAP
 Chan 70
 N43°58.56'-W103°00.74'
 L-12, H-2

MINNEAPOLIS
 115.3 MSP
 Chan 100

DME aircraft Rwy 12L/12R
 (For assigned 060° CW 100°)
 3500

NODINE
 117.9 ODI
 Chan 126
 N43°54.74'-W91°28.05'
 L-28, H-2

FARMINGTON
 115.7 FGT
 Chan 104

Rwy 30L/30R
 (For assigned 220° CW 360°)
 3500

Non DME Aircraft
 Rwy 12L/12R
 (For assigned 060° CW 100°)
 3500

SIoux FALLS
 115.0 FSD
 Chan 97
 N43°38.97'-W96°46.87'
 L-12, H-2-5

FORT DODGE
 113.5 FOD
 Chan 82
 N42°36.67'-W94°17.69'
 L-12, H-5

ROCHESTER
 112.0 RST
 Chan 57
 N43°46.98'-W92°35.80'
 L-12-28, H-2

DELLS
 117.0 DLL
 Chan 117
 N43°33.05'-W89°45.82'
 L-28, H-2-5

O'NEILL
 113.9 ONL
 Chan 86
 N42°28.23'-W98°41.22'
 L-12, H-5

OMAHA
 116.3 OVR
 Chan 110
 N41°10.03'-W95°44.21'
 L-10-12, H-5

DES MOINES
 117.5 DSM
 Chan 122
 N41°26.26'-W93°38.91'
 L-12-27, H-5

ST JOSEPH
 115.5 STJ
 Chan 102
 N39°57.63'-W94°55.51'
 L-10, H-5

KANSAS CITY
 113.25 MCI
 Chan 79 (Y)
 N39°17.12'-W94°44.22'
 L-10-27, H-5

NOTE: RADAR Required.

TAKE-OFF MINIMUMS:

Rwy 4, 12L/R, 17, 22: Standard.

Rwy 30L: Standard with minimum climb of 210' per NM to 2100.

Rwy 30R: Standard with minimum climb of 220' per NM to 2100.

Rwy 35: Standard with minimum climb of 219' per NM to 2100.

DEPARTURE CROSSING RESTRICTIONS:

Runway 12L/R DME aircraft requires an ATC climb gradient of 546' per NM to 3500.

Runway 12L/R Non-DME aircraft requires an ATC climb gradient of 594' per NM to 3500.

Runway 17 requires an ATC climb gradient of 465' per NM to 3500.

Runway 30L/R requires an ATC climb gradient of 380' per NM to 3500.

(NARRATIVE ON FOLLOWING PAGE)

NOTE: Chart not to scale.

MINNEAPOLIS FIVE DEPARTURE

MINNEAPOLIS, MINNESOTA

NC-1, 05 APR 2012 to 03 MAY 2012

NC-1, 05 APR 2012 to 03 MAY 2012



DEPARTURE ROUTE DESCRIPTION

ALL RUNWAYS: Fly assigned heading for radar vectors to join filed/assigned route. Turbojet aircraft maintain 7000 or lower assigned altitude, all other aircraft maintain 5000 or lower assigned altitude. Expect clearance to assigned altitude/flight level 10 (ten) minutes after departure.

DME EQUIPPED AIRCRAFT RWY 12L/12R DEPARTURES: For assigned heading from 060° clockwise to 100°, cross MSP 7 DME at or above 3500, maintain assigned altitude. If unable to comply advise ATC as soon as possible prior to departure.

NON-DME EQUIPPED AIRCRAFT RWY 12L/12R DEPARTURES: For assigned headings from 060° clockwise to 100°, cross FGT R-010 at or above 3500, maintain assigned altitude. If unable to comply, advise ATC as soon as possible prior to departure.

TAKE-OFF RWY 17 DEPARTURES: For assigned headings from 230° clockwise to 285° cross MSP 7 DME at or above 3500, maintain assigned altitude. If unable to comply, advise ATC as soon as possible prior to departure.

TAKE-OFF RWYS 30L/30R DEPARTURES: For assigned headings from 220° clockwise to 360° cross MSP 7 DME at or above 3500, maintain assigned altitude. If unable to comply, advise ATC as soon as possible prior to departure.

TAKE-OFF OBSTACLE NOTES:

RWY 04: Multiple trees beginning 800' from DER, 264' left of centerline, up to 75' AGL/921' MSL.
Rod on building 2528' from DER, 1175' left of centerline, 78' AGL/922' MSL.
Fence 803' from DER, 585' left of centerline, 15' AGL/860' MSL.
Ant on OL building 456' from DER, 319' left of centerline, 13' AGL/850' MSL.
LT poles 1932' from DER, 718' left of centerline, 45' AGL/885' MSL.
Stack 4535' from DER, 481' left of centerline, 139' AGL/949' MSL.

RWY 12R: Multiple trees beginning 1477' from DER, 407' left of centerline, up to 86' AGL/851' MSL.
Multiple trees beginning 1426' from DER, 124' right of centerline, up to 111' AGL/847' MSL.
LT pole 1408' from DER, 746' right of centerline, 85' AGL/843' MSL.
Radar reflector 983' from DER, 32' left of centerline, 15' AGL/829' MSL.
Pipe on bldg, 826' from DER, 576' left of centerline, 10' AGL/825' MSL.
OL on LOC 766' from DER, on centerline, 7' AGL/821' MSL.

RWY 17: Antenna 1272' from DER, 562' right of centerline, 57' AGL/891' MSL.
Pole 409' from DER, 530' right of centerline, 29' AGL/866' MSL.
Wind direction indicator on bldg 2619' from DER, 881' left of centerline, 97' AGL/918' MSL.
Bldg 2619' from DER, 859' left of centerline, 84' AGL/905' MSL.
LT 1176' from DER, 291' right of centerline, 11' AGL/875' MSL.
Tree 2619' from DER, on centerline, 79' AGL/900' MSL.

RWY 22: Tree 2906' from DER, 833' right of centerline, 94' AGL/934' MSL.
Hopper 1717' from DER, 456' left of centerline, 48' AGL/888' MSL.

RWY 30L: Multiple trees beginning 1113' from DER, 701' left of centerline, up to 80' AGL/919' MSL.
Tree 1230' from DER, 633' right of centerline, 30' AGL/877' MSL.
Ground 28' from DER, 490' right of centerline, 0' AGL/844' MSL.

RWY 30R: Bldg 1056' from DER, 198' left of centerline, 13' AGL/853' MSL.
Multiple trees beginning 3010' from DER, 334' left of centerline, up to 94' AGL/940' MSL.
LT pole 1849' from DER, 698' right of centerline, 17' AGL/871' MSL.
Fence 1327' from DER, 667' right of centerline, 8' AGL/857' MSL.
Tree 3703' from DER, 350' right of centerline, 67' AGL/914' MSL.
Rod on pole 3143' from DER, 47' right of centerline, 38' AGL/898' MSL.

RWY 35: Tree 175' from DER, 398' right of centerline, 73' AGL/883' MSL.
Multiple trees beginning 1989' from DER, 351' left of centerline, up to 65' AGL/902' MSL.
Multiple buildings beginning 5.5 NM from DER, 1787' left of centerline, up to 811' AGL/1743' MSL.

NC-1, 05 APR 2012 to 03 MAY 2012

NC-1, 05 APR 2012 to 03 MAY 2012

LOC/DME I-PJL 110.7 Chan 44	APP CRS 120°	Rwy Idg TDZE 7620 839 Apt Elev 841
--	------------------------	---

ILS or LOC RWY 12L
MINNEAPOLIS-ST PAUL INTL/WOLD-CHAMBERLAIN (MSP)

⚠ For inop ALSF, increase S-ILS 12L Cat E visibility to RVR 4000 and S-LOC 12L Cat E visibility to 2½ mile. For inop ALSF when using AASUN fix minimums, increase S-LOC Cat E visibility to 1½ mile. Simultaneous approach authorized with Rwy 12R.

ⓘ **ALSF-2** MISSED APPROACH: Climb to 1500, then climbing left turn to 4000 via heading 350° and FCM VOR/DME R-046 to WHISK INT/ GEP 17.5 DME and hold.

ATIS ARR 135.35 239.275 DEP 120.8	MINNEAPOLIS APP CON 119.3 335.5	MINNEAPOLIS TOWER 123.95 273.55 (12L-30R) 126.7 273.55 (12R-30L, 4-22) 123.675 273.55 (17-35)	GND CON N 121.8 348.6 S 121.9 348.6 W 127.925	CLNC DEL 133.2
---	---	---	---	--------------------------

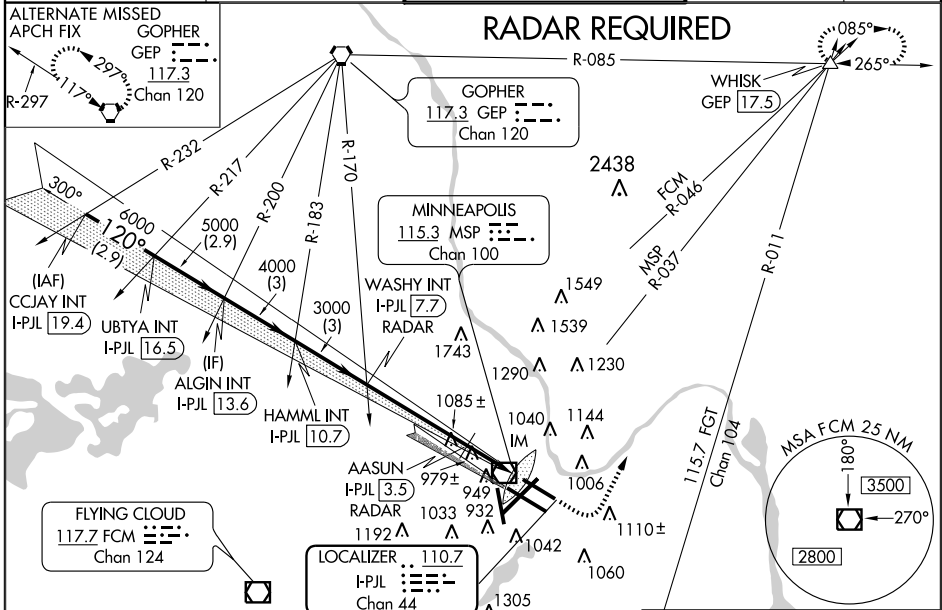

NC-1, 05 APR 2012 to 03 MAY 2012

NC-1, 05 APR 2012 to 03 MAY 2012

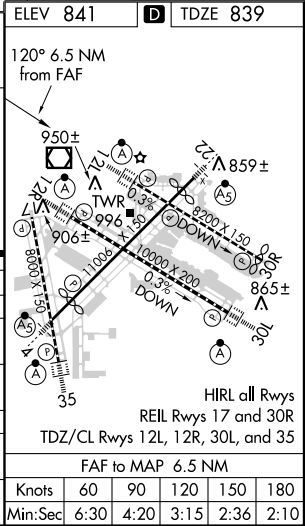
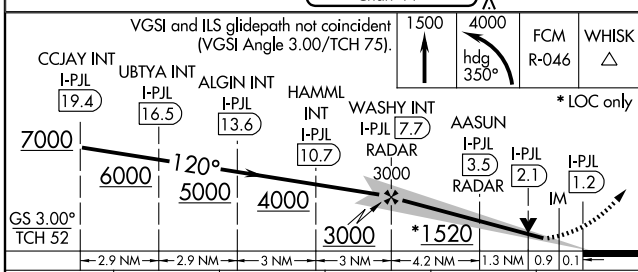

CATEGORY	A	B	C	D	E
S-ILS 12L	1039/18 200 (200-½)				
S-LOC 12L	1520/24	681 (700-½)	1520-1½ 681 (700-1½)	1520-1¾ 681 (700-1¾)	1520-2 681 (700-2)
CIRCLING	1520-1	679 (700-1)	1520-2 679 (700-2)	1520-2¼ 679 (700-2¼)	1660-3 819 (900-3)
AASUN FIX MINIMUMS					
S-LOC 12L	1240/24	401 (400-½)	1240/40	401 (400-¾)	1240/50 401 (400-1)
CIRCLING	1360-1	519 (600-1)	1360-1½ 519 (600-1½)	1460-2 619 (700-2)	1660-3 819 (900-3)

HIRL all Rwys
REIL Rwy 17 and 30R
TDZ/CL Rwy 12L, 12R, 30L, and 35

FAF to MAP 6.5 NM

Knots	60	90	120	150	180
Min:Sec	6:30	4:20	3:15	2:36	2:10

Figure 369

ILS or LOC RWY 12L

LOC/DME I-BMA 110.95 Chan 46(Y)	APP CRS 349°	Rwy Idg TDZE Apt Elev	8000 834 841
---	------------------------	-----------------------------	---

ILS or LOC RWY 35

MINNEAPOLIS-ST PAUL INTL/WOLD-CHAMBERLAIN (MSP)

⚠ For inoperative ALSF, increase S-ILS 35 Cat E visibility to RVR 4000, increase all S-LOC 35 Cat E visibilities to ½ mile.	ALSF-2 	MISSED APPROACH: Climb to 1600 then climbing left turn to 5000 via heading 240° and GEP R-182 to LYDIA INT/ GEP 32.6 DME and hold.
--	------------	--

ATIS ARR 135.35 239.275 DEP 120.8	MINNEAPOLIS APP CON 119.3 335.5	MINNEAPOLIS TOWER 123.95 273.55 (12L-30R) 126.7 273.55 (12R-30L, 4-22) 123.675 273.55 (17-35)	GND CON N 121.8 348.6 S 121.9 348.6 W 127.925	CLNC DEL 133.2
---	---	---	---	--------------------------

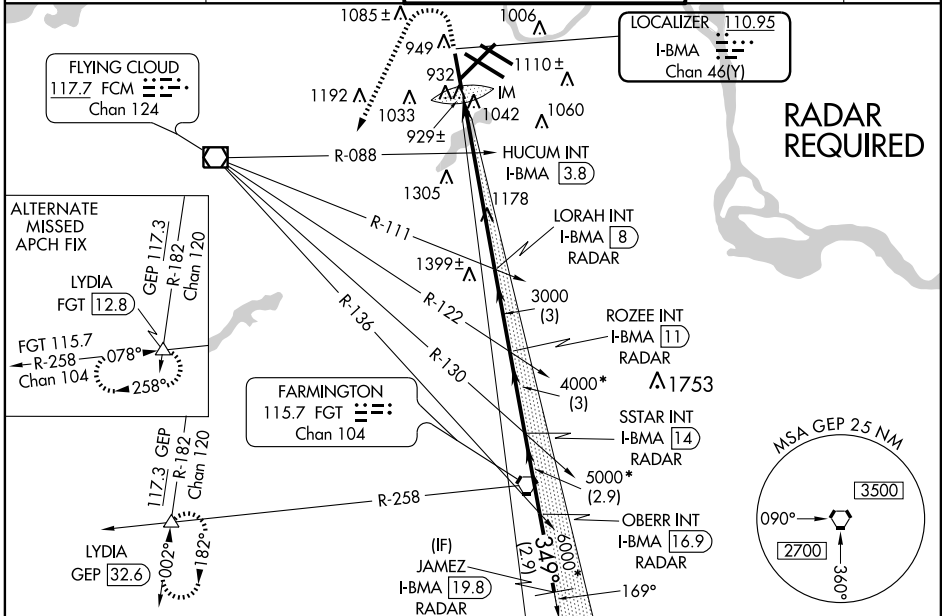

NC-1, 03 MAY 2012 to 31 MAY 2012

NC-1, 03 MAY 2012 to 31 MAY 2012

ELEV 841	D	TDZE 834	1600	5000	GEP R-182	LYDIA	*When assigned by ATC, intercept glidepath at 4000 or 5000 or 6000 or 7000.
----------	----------	----------	------	------	-----------	-------	---

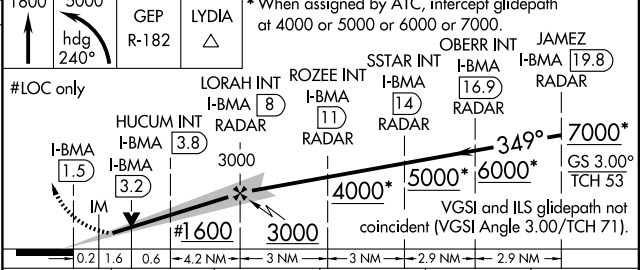
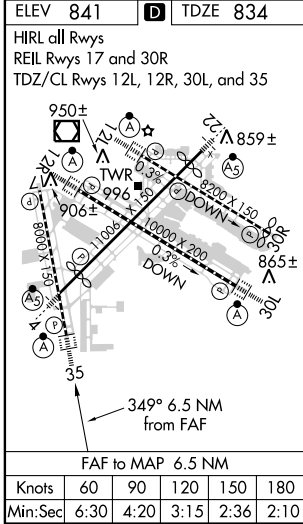

CATEGORY	A	B	C	D	E
S-ILS 35	1034/18 200 (200-½)				
S-LOC 35	1600/24 766 (800-½)	1600/40 766 (800-¾)	1600-1¾ 766 (800-1¼)	1600-2 766 (800-2)	1600-2¼ 766 (800-2¼)
CIRCLING	1600-1 759 (800-1)	1600-1¼ 759 (800-1¼)	1600-2¼ 759 (800-2¼)	1600-2½ 759 (800-2½)	1660-3 819 (900-3)
HUCUM FIX MINIMUMS					
S-LOC 35	1460/24 626 (700-½)	626 (700-½)	1460/60 626 (700-1¼)	1460-1½ 626 (700-1½)	1460-1¾ 626 (700-1¾)
CIRCLING	1460-1 619 (700-1)	619 (700-1)	1460-1¾ 619 (700-1¾)	1460-2 619 (700-2)	1660-3 819 (900-3)

Figure 370

LANDR SIX ARRIVAL

ST-9077 (FAA)

DENVER, COLORADO

SW-1, 05 APR 2012 to 03 MAY 2012

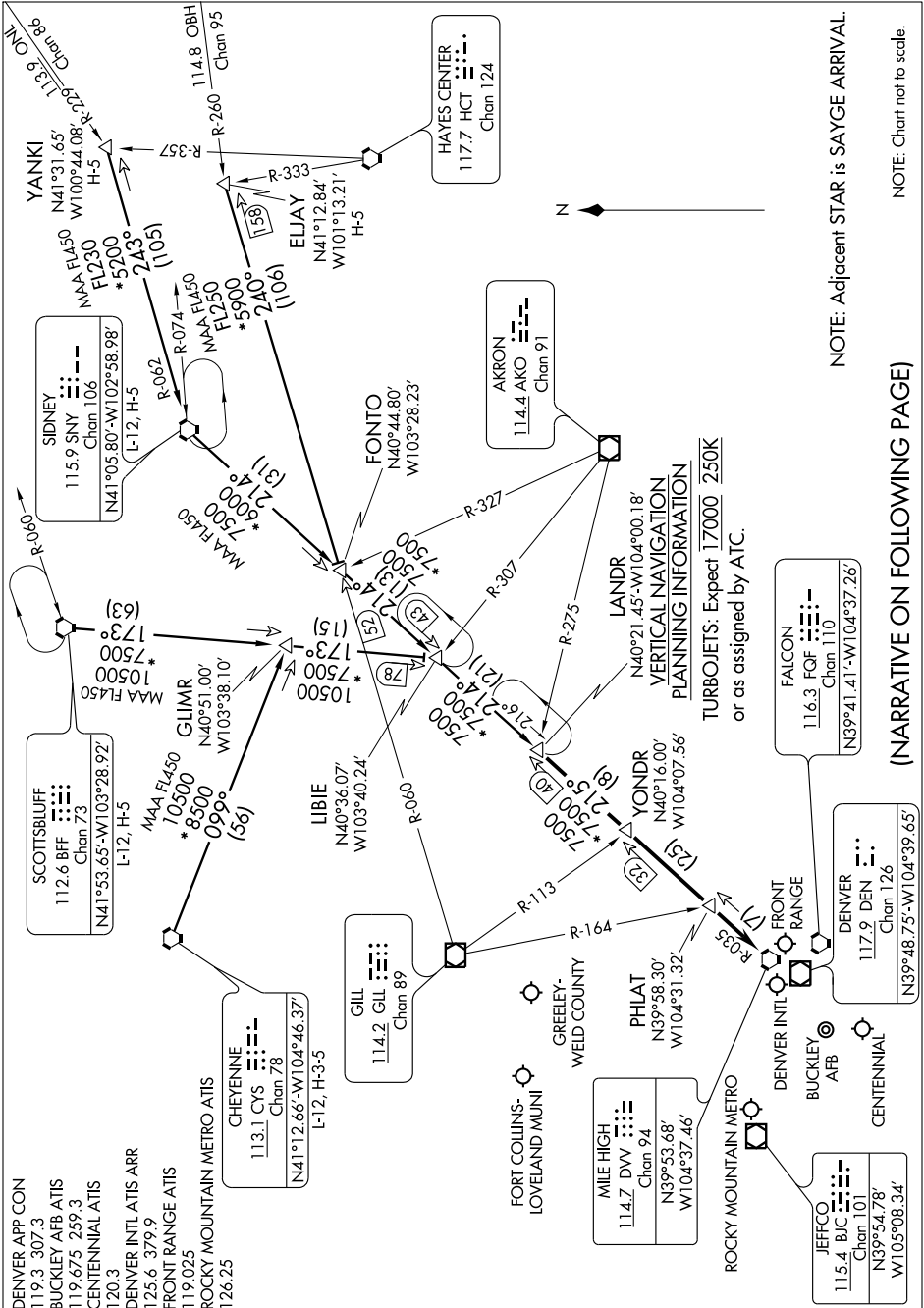

(NARRATIVE ON FOLLOWING PAGE)

SW-1, 05 APR 2012 to 03 MAY 2012

LANDR SIX ARRIVAL

(LANDR.LANDR6) 12096

DENVER, COLORADO

Figure 371

ARRIVAL ROUTE DESCRIPTION

CHEYENNE TRANSITION (CYS.LANDR6): From over CYS VORTAC via CYS R-099 and BFF R-173 to LIBIE INT; then via SNY R-214 and DVV R-035 to LANDR INT. Thence

ELJAY TRANSITION (ELJAY.LANDR6): From over ELJAY INT via GLL R-060 to FONTO INT, then via SNY R-214 and DVV R-035 to LANDR INT. Thence

SCOTTSBLUFF TRANSITION (BFF.LANDR6): From over BFF VORTAC via BFF R-173 to LIBIE INT; then via SNY R-214 and DVV R-035 to LANDR INT. Thence

SIDNEY TRANSITION (SNY.LANDR6): From over SNY VORTAC via SNY R-214 to FONTO INT, then via SNY R-214 and DVV R-035 to LANDR INT. Thence

YANKI TRANSITION (YANKI.LANDR6): From over YANKI INT via SNY R-062 to SNY VORTAC; then via SNY R-214 and DVV R-035 to LANDR INT. Thence

. . . . From over LANDR INT via DVV R-035 to DVV VORTAC. Expect RADAR vectors to the final approach course at or before DVV VORTAC.

SW-1, 05 APR 2012 to 03 MAY 2012

SW-1, 05 APR 2012 to 03 MAY 2012

Figure 372

DENVER, COLORADO

AL-9077 (FAA)

ILS or LOC RWY 25

DENVER INTL (DEN)

LOC/DME I-ERP 111.55 Chan 52 (Y)	APP CRS 260°	Rwy Idg TDZE Apt Elev	12000 5352 5431
---	------------------------	-----------------------------	--

▼ Simultaneous approach authorized with Rwy 26.
 S-LOC minimums not authorized during simultaneous operations.
 # RVR 1800 authorized with the use of FD or AP or HUD to DA.

MALS R
AS

MISSED APPROACH: Climb to 12000 via 260° heading and FQF VORTAC R-306 to HYGEN INT/FQF 37.9 DME and hold.

ATIS ARR 125.6 379.9 DEP 134.025	DENVER APP CON 119.3 307.3 (NORTH) 120.35 379.3 (SOUTH)	DENVER TOWER 132.35 273.55	GND CON 127.5 379.175	CLNC DEL 118.75
--	---	--------------------------------------	---------------------------------	---------------------------

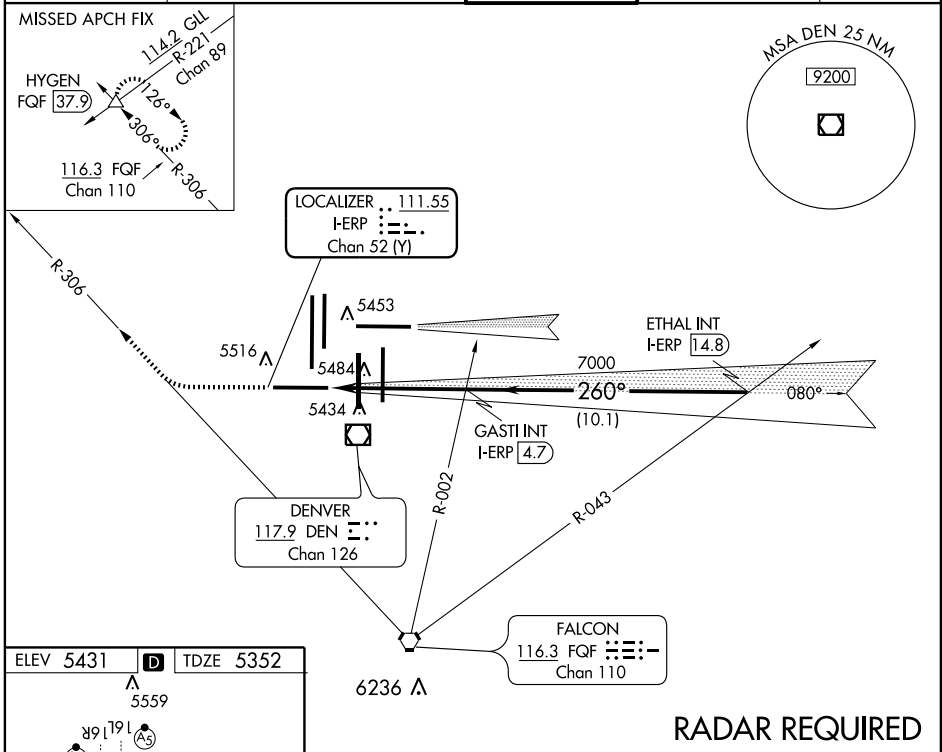

SW-1, 05 APR 2012 to 03 MAY 2012

SW-1, 05 APR 2012 to 03 MAY 2012

ELEV 5431	D	TDZE 5352
-----------	----------	-----------

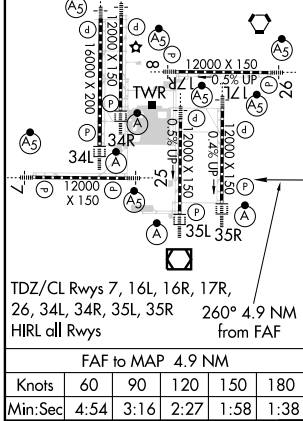

RADAR REQUIRED

12000 260° hdg	FQF R-306	HYGEN △	*or as assigned by ATC ↑7000 when assigned by ATC	ETHAL INT I-ERP 14.8
GASTI INT I-ERP 4.7		7000		10000*
7000		8000†		GS 3.00° TCH 59
4.9 NM		10.1 NM		
CATEGORY	A	B	C	D
S-ILS 25	# 5552/24 200 (200-½)			
S-LOC 25	5720/24 368 (300-½)		5720/40 368 (300-¾)	
CIRCLING	NA			

DENVER, COLORADO
Amdt 2B 12096

39°52'N-104°40'W

ILS or LOC RWY 25

Figure 373

DENVER, COLORADO

AL-9077 (FAA)

ILS or LOC RWY 8 DENVER INTL (DEN)

LOC/DME I-FUI 108.9 Chan 26	APP CRS 080°	Rwy Idg TDZE 5351 Apt Elev 5431
---	------------------------	---

Simultaneous approaches authorized with Rwy 7.
 S-LOC minima not authorized during simultaneous operations.
 ** RVR 1800 authorized with the use of FD or AP or HUD to DA.

MALS
 MISSED APPROACH: Climb to 10000 via 080° heading and FQG VORTAC R-038 to WITNE INT/FQG 28.1 DME and hold.

ATIS ARR 125.6 379.9 DEP 134.025	DENVER APP CON 119.3 307.3 (NORTH) 120.35 379.3 (SOUTH)	DENVER TOWER 124.3 239.275	GND CON 121.85 377.1	CLNC DEL 118.75
--	---	--------------------------------------	--------------------------------	---------------------------

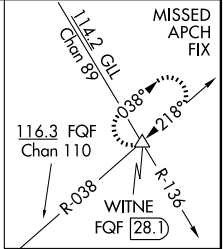
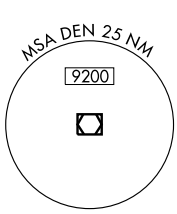

LOCALIZER 108.9
 I-FUI [---]
 Chan 26

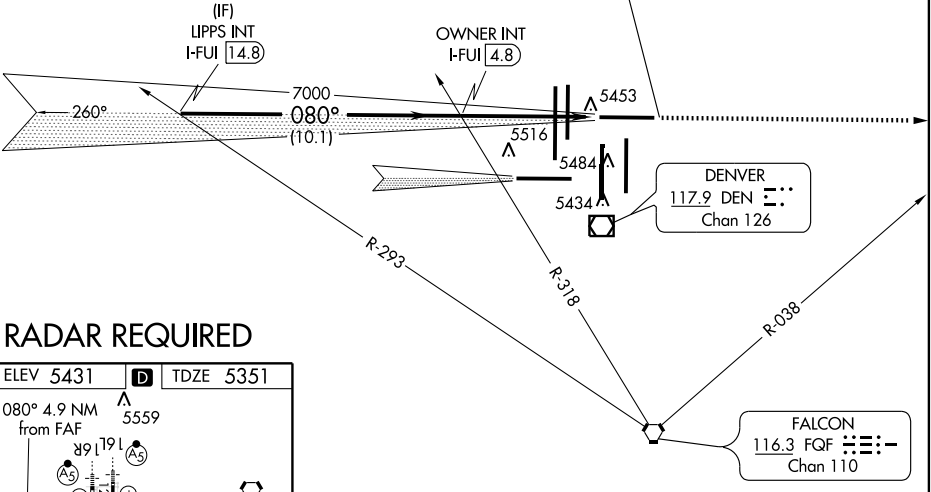

SW-1, 05 APR 2012 to 03 MAY 2012

SW-1, 05 APR 2012 to 03 MAY 2012

RADAR REQUIRED

ELEV 5431	D	TDZE 5351
-----------	----------	-----------

080° 4.9 NM from FAF

TDZ/CL Rwy 7, 16L, 16R, 17R, 26, 34L, 34R, 35L, 35R
 HIRL all Rwy

FAF to MAP 4.9 NM					
Knots	60	90	120	150	180
Min:Sec	4:54	3:16	2:27	1:58	1:38

LIPPS INT I-FUI [14.8]	# 7000 when assigned by ATC * or as assigned by ATC.	10000 ↑ 080° hdg	FQG R-038	WITNE △
------------------------	---	------------------------	-----------	---------

CATEGORY	A	B	C	D
S-ILS 8	** 551/24 200 (200-1/2)			
S-LOC 8	5700/24 349 (300-1/2)			5700/40 349 (300-3/4)
CIRCLING	NA			

DENVER, COLORADO
Amdt 4A 12096

39°52'N-104°40'W

DENVER INTL (DEN) ILS or LOC RWY 8

Figure 374

AIRPORT DIAGRAM

AL-9077 (FAA)

DENVER INTL (DEN)
DENVER, COLORADO

SW-1, 05 APR 2012 to 03 MAY 2012

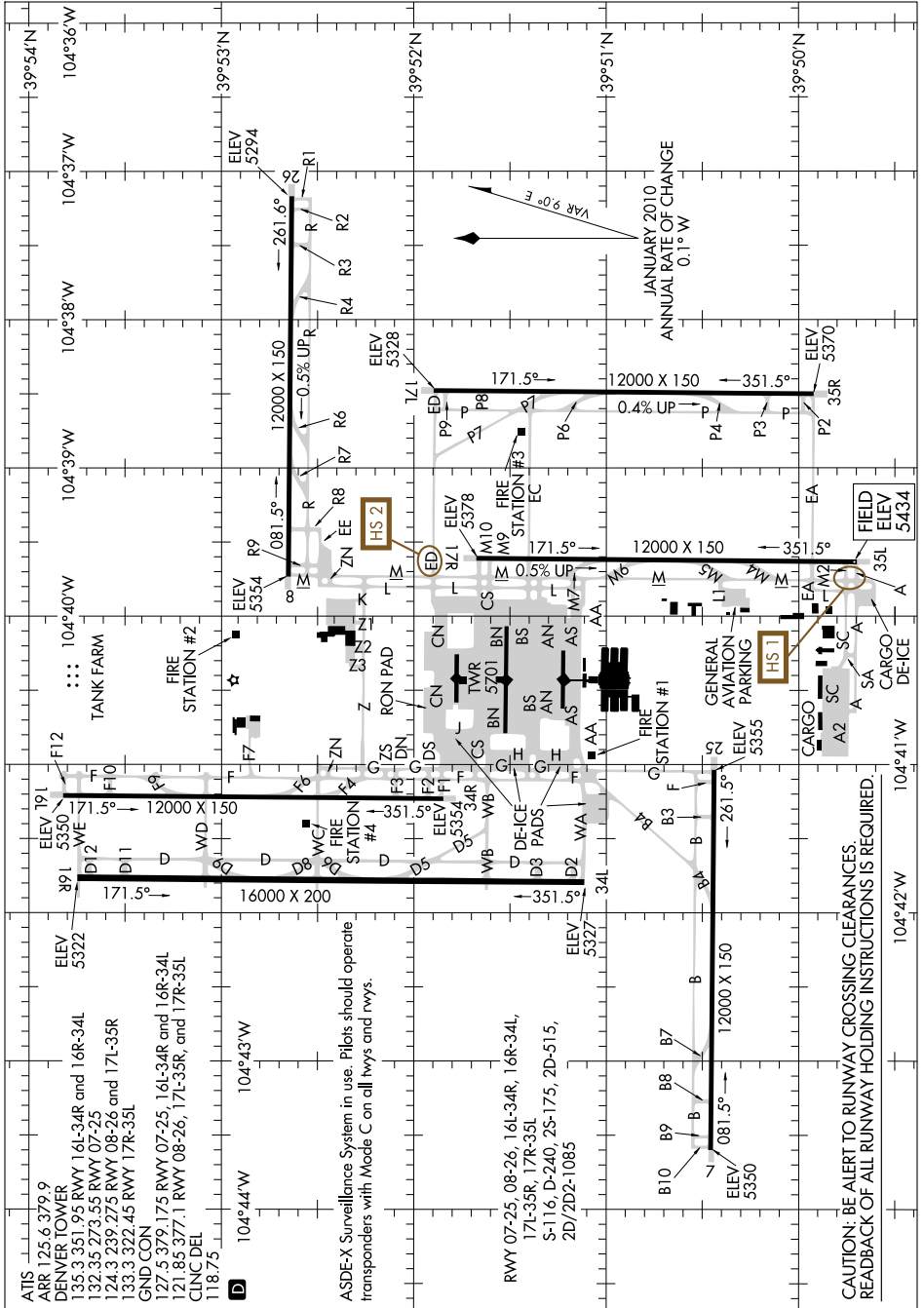

SW-1, 05 APR 2012 to 03 MAY 2012

AIRPORT DIAGRAM

DENVER, COLORADO
DENVER INTL (DEN)

Figure 375

DENVER INTL (DEN) 16 NE UTC-7(-6DT) N39°51.70' W104°40.39'
 5434 B S4 FUEL 100, 100LL, JET A, MOGAS OX 1, 3 Class I, ARFF Index E
 NOTAM FILE DEN

DENVER
 H-3F, 5A, L-10F, A
 IAP, AD

RWY 16R-34L: H16000X200 (CONC-GRVD) S-116, D-240, 2S-175, 2D-515, 2D/2D2-1085 PCN 92 R/B/W/T HIRL CL
RWY 16R: MALSR. TDZL. PAPI(P4R)—GA 3.0° TCH 55'.
RWY 34L: ALSF2. TDZL. PAPI(P4L)—GA 3.0° TCH 50'.
RWY 07-25: H12000X150 (CONC-GRVD) S-116, D-240, 2S-175, 2D-515, 2D/2D2-1085 PCN 92 R/B/W/T HIRL CL
RWY 07: MALSR. TDZL. PAPI(P4R)—GA 3.0° TCH 55'.
RWY 25: MALSR. PAPI(P4L)—GA 3.0° TCH 59'.
RWY 08-26: H12000X150 (CONC-GRVD) S-116, D-240, 2S-175, 2D-515, 2D/2D2-1085 PCN 92 R/B/W/T HIRL CL
RWY 08: MALSR. PAPI(P4L)—GA 3.0° TCH 52'.
RWY 26: MALSR. TDZL. PAPI(P4L)—GA 3.0° TCH 55'. 0.5% up.
RWY 16L-34R: H12000X150 (CONC-GRVD) S-116, D-240, 2S-175, 2D-515, 2D/2D2-1085 PCN 92 R/B/W/T HIRL CL
RWY 16L: MALSR. TDZL. PAPI(P4L)—GA 3.0° TCH 60'.
RWY 34R: ALSF2. TDZL. PAPI(P4L)—GA 3.0° TCH 59'.
RWY 17L-35R: H12000X150 (CONC-GRVD) S-116, D-240, 2S-175, 2D-515, 2D/2D2-1085 PCN 92 R/B/W/T HIRL CL
RWY 17L: MALSR. PAPI(P4L)—GA 3.0° TCH 55'. 0.4% up.
RWY 35R: ALSF2. TDZL. PAPI(P4R)—GA 3.0° TCH 59'.
RWY 17R-35L: H12000X150 (CONC-GRVD) S-116, D-240, 2S-175, 2D-515, 2D/2D2-1085 PCN 92 R/B/W/T HIRL CL
RWY 17R: MALSR. TDZL. PAPI(P4L)—GA 3.0° TCH 60'. 0.5% up.
RWY 35L: ALSF2. TDZL. PAPI(P4R)—GA 3.0° TCH 57'.

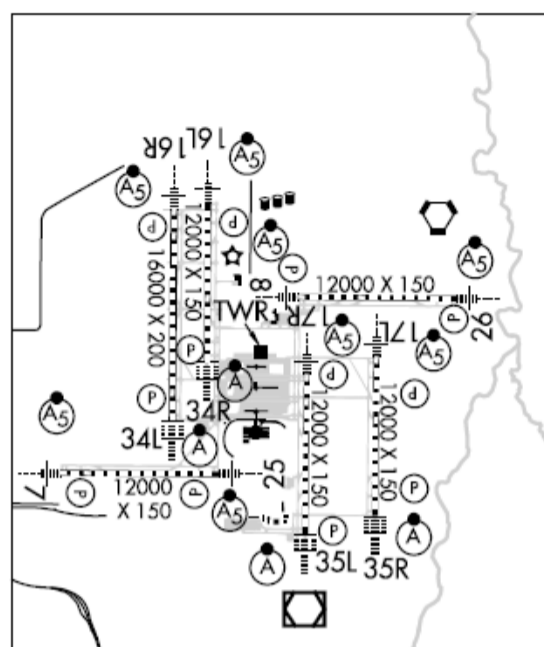

RUNWAY DECLARED DISTANCE INFORMATION

RWY 07: TORA-12000 TODA-12000 ASDA-12000 LDA-12000
RWY 08: TORA-12000 TODA-13000 ASDA-12000 LDA-12000
RWY 16L: TORA-12000 TODA-12000 ASDA-12000 LDA-12000
RWY 16R: TORA-16000 TODA-16000 ASDA-16000 LDA-16000
RWY 17L: TORA-12000 TODA-12000 ASDA-12000 LDA-12000
RWY 17R: TORA-12000 TODA-12000 ASDA-12000 LDA-12000
RWY 25: TORA-12000 TODA-13000 ASDA-12000 LDA-12000
RWY 26: TORA-12000 TODA-12000 ASDA-12000 LDA-12000
RWY 34L: TORA-16000 TODA-16000 ASDA-16000 LDA-16000
RWY 34R: TORA-12000 TODA-13000 ASDA-12000 LDA-12000
RWY 35L: TORA-12000 TODA-12000 ASDA-12000 LDA-12000
RWY 35R: TORA-12000 TODA-12000 ASDA-12000 LDA-12000

AIRPORT REMARKS: Attended continuously. Waterfowl and migratory bird activity in vo of arpt year round. ASDE-X Surveillance System in use: Pilots should opr transponders with Mode C on all twys and rwys. Arpt maintains clearways (500' X 1000'). 1.25% slope) on departure Rwy 08, Rwy 26, and Rwy 34R. RVR Rwy 07 touchdown, rollout, RVR Rwy 25 touchdown, rollout, RVR Rwy 08 touchdown, rollout, RVR Rwy 26 touchdown, rollout, RVR Rwy 16L touchdown, midfield, rollout, RVR Rwy 34R touchdown, midfield, rollout, RVR Rwy 17L touchdown, midfield, rollout, RVR Rwy 35R touchdown, midfield, rollout, RVR Rwy 17R touchdown, midfield, rollout, RVR Rwy 35L touchdown, midfield, rollout. RVR Rwy 16R touchdown, midfield, rollout, RVR Rwy 34L touchdown, midfield, rollout. Overhead passenger bridge on South side of concourse `A` provides 42 ft tail and 118 ft wingspan clearance when on twy centerline. Insufficient twy corner fillet pavement in the SE corner of the Twy M/M2 intersection for acft with wingspan over 107 ft. Informal rwy use program is in effect 24 hours a day. For additional noise abatement information contact airport management at 303-342-4200. Customs avbl with prior permission. Ldg fee. Flight Notification Service (ADCUS) avbl. NOTE: See Special Notices—Continuous Power Facilities.

WEATHER DATA SOURCES: ASOS (303) 342-0838 LLWAS-NE. TDWR.

COMMUNICATIONS: D-ATIS ARR 125.6 303-342-0819 D-ATIS DEP 134.025 303-342-0820 UNICOM 122.95

RCO 122.2 122.35 (DENVER RADIO)

RCO 123.65 (DENVER RADIO)

Ⓡ APP CON 119.3 124.95 (North) 120.35 126.55 (South) FINAL CON 120.8

TOWER 132.35 (Rwy 07-25) 135.3 (Rwy 16L-34R, Rwy 16R-34L) 133.3 (Rwy 17R-35L) 124.3 (Rwy 08-26 and 17L-35R)

GND CON 127.5 (Rwy 07-25, Rwy 16L-34R and Rwy 16R-34L) 121.85 (Rwys 08-26, 17L-35R and 17R-35L)

CLNC DEL 118.75

Ⓡ DEP CON 128.25 (East) 127.05 (North) 126.1 (West) 128.45 (South)

AIRSPACE: CLASS B See VFR Terminal Area Chart

RADIO AIDS TO NAVIGATION: NOTAM FILE DEN.

CONTINUED ON NEXT PAGE

CONTINUED FROM PRECEDING PAGE

(H) VORW/DME 117.9 DEN Chan 126 N39°48.75' W104°39.64' 338° 3.0 NM to fld. 5452/11E.

ILS/DME 111.55 I-DZG Chan 52(Y) Rwy 07. Class IE.

ILS/DME 108.9 I-FUI Chan 26 Rwy 08.

ILS/DME 111.1 I-LTT Chan 48 Rwy 16L. Class IE.

ILS/DME 111.9 I-DQQ Chan 56 Rwy 16R.

ILS/DME 110.15 I-BXP Chan 38(Y) Rwy 17L. Class IE.

ILS/DME 108.5 I-ACX Chan 22 Rwy 17R. Class IE.

ILS/DME 111.55 I-ERP Chan 52(Y) Rwy 25. Class IE.

ILS/DME 108.9 I-JOY Chan 26 Rwy 26. Class IE.

ILS/DME 111.9 I-DXU Chan 56 Rwy 34L. Class IIIE.

ILS/DME 111.1 I-OUF Chan 48 Rwy 34R. Class IIIE.

ILS/DME 108.5 I-AQD Chan 22 Rwy 35L.

ILS/DME 110.15 I-DPP Chan 38(Y) Rwy 35R. Class IIIE.

COMM/NAV/WEATHER REMARKS: Emerg frequency 121.5 not avbl at twr.

FRONT RANGE (FTG) 19 E UTC-7(-6DT) N39°47.12' W104°32.59'
5512 B S4 FUEL 100LL, JET A OX 1, 2 TPA-6500(988) NOTAM FILE FTG

DENVER
H-5A, L-10F, A
IAP, AD

RWY 08-26: H8000X100 (ASPH) S-28, D-40 HIRL

RWY 08: REIL. PAPI(P2L)—GA 3.0° TCH 50'. Rgt tfc. 0.5% up.

RWY 26: MALSR. PAPI(P2L)—GA 3.0° TCH 50'. 0.4% down.

RWY 17-35: H8000X100 (ASPH) S-34, D-75 MIRL

RWY 17: REIL. PAPI(P4L)—GA 3.0° TCH 50'. 0.5% up.

RWY 35: MALSR. PAPI(P4L)—GA 3.0° TCH 50'. Rgt tfc.

AIRPORT REMARKS: Attended 1400-0400Z†. For svc after hrs call 303-208-8536. 24 hr credit card 100LL self fueling station. Be alert, intensive USAF student training invof Colorado Springs and Pueblo Colorado. Noise sensitive areas SE, S and SW of arpt. Avoid flights blo 1,000 ft over populated areas. Blue and yellow reflectors along Twy A, B, C, E edges. ACTIVATE MIRL Rwy 17-35, HIRL Rwy 08-26, PAPI Rwy 08, Rwy 26, Rwy 17 and Rwy 35 and REIL Rwy 08 and Rwy 17, MALSR Rwy 26 and Rwy 35—CTAF. See Special Notices—USAF 306 FTG Flight Training Areas, Vicinity of Colorado Springs and Pueblo Colorado.

WEATHER DATA SOURCES: AWOS-3 119.025 (303) 261-9104.

COMMUNICATIONS: CTAF 120.2 ATIS 119.025 UNICOM 122.95

DENVER APP/DEP CON 128.2

TOWER 120.2 (1400-0400Z†) GND CON 124.7 CLNC DEL 124.7

DENVER CLNC DEL 121.75 (0400-1400Z†)

AIRSPACE: CLASS D svc 1400-0400Z† other times CLASS G

RADIO AIDS TO NAVIGATION: NOTAM FILE DEN.

DENVER (H) VORW/DME 117.9 DEN Chan 126 N39°48.75' W104°39.64' 096° 5.7 NM to fld. 5452/11E.

SKIPI NDB (LOM) 321 FT N39°47.51' W104°26.05' 255° 5.1 NM to fld. Unmonitored.

ILS/DME 110.9 I-FZR Chan 46 Rwy 17.

ILS/DME 109.3 I-FTG Chan 30 Rwy 26. LOM SKIPI NDB. Unmonitored.

ILS/DME 110.9 I-VWT Chan 46 Rwy 35.

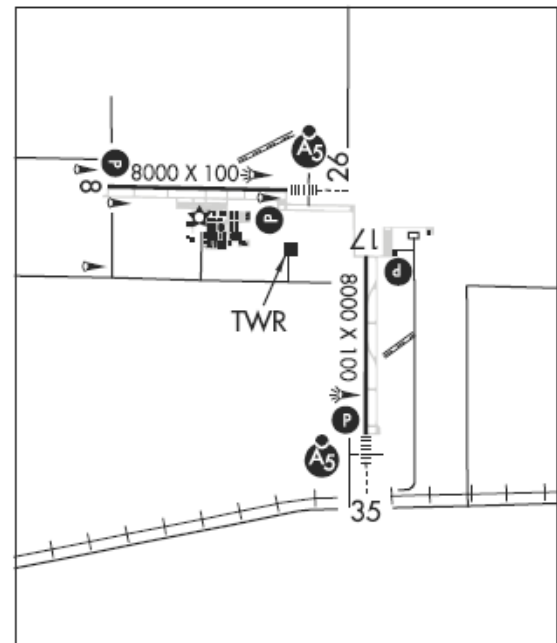

MCCARRAN THREE DEPARTURE

ATIS 132.4
 CLNC DEL
 118.0 379.95
 GND CON
 121.1 270.8 E of 1R/19L
 121.9 254.3 W of 1R/19L
 LAS VEGAS TOWER
 118.75 257.8 (Rwy 1L/19R, 1R/19L)
 119.9 257.8 (Rwy 7L/25R, 7R/25L)
 LAS VEGAS DEP CON
 125.9 307.25

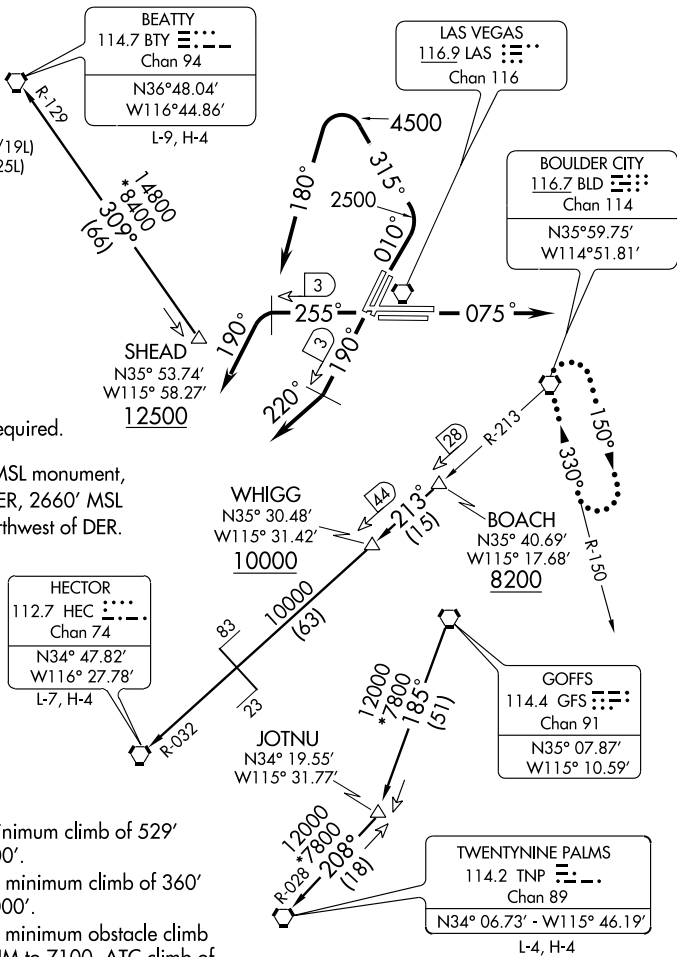

NOTE: RADAR and DME required.

NOTE: Rwys 1L/R 3189' MSL monument, 2.7 NM north of DER, 2660' MSL building, 1 NM northwest of DER.

TAKE-OFF MINIMUMS

- Rwys 1L/R: 1100-3 with minimum climb of 529' per NM to 7000'.
- Rwys 19L/R: Standard with minimum climb of 360' per NM to 7000'.
- Rwys 25L/R: Standard with minimum obstacle climb of 324' per NM to 7100, ATC climb of 360' per NM to 7000.
- Rwys 7L/R: Standard with minimum ATC climb of 440' per NM to 7000'.

TAKE-OFF OBSTACLE NOTES

- RWY 1L: Pole 450' from DER, 283' left of centerline, 38' AGL/2118' MSL.
Obstacle light on wind sock 248' from DER, 224' right of centerline, 50' AGL/2104' MSL.
Pole 1029' from DER, 715' left of centerline, 85' AGL/2124' MSL.
Tree 1536' from DER, 502' left of centerline, 100' AGL/2132' MSL.
- RWY 1R: Sign 1331' from DER, 448' right of centerline, 60' AGL/2120' MSL
Building 599' from DER, 541' right of centerline, 70' AGL/2096' MSL

(NOTES CONTINUED ON FOLLOWING PAGE)

(NARRATIVE ON FOLLOWING PAGE)

NOTE: Chart not to scale.

Figure 378

SW-4, 05 APR 2012 to 03 MAY 2012

SW-4, 05 APR 2012 to 03 MAY 2012

MCCARRAN THREE DEPARTURE



DEPARTURE ROUTE DESCRIPTION

TAKE-OFF RUNWAYS 1L/R: Climb via heading 010° to 2500', then climbing left turn via heading 315° to 4500', then climbing left turn heading 180°, thence

TAKE-OFF RUNWAYS 7L/R: Climb via heading 075°, thence

TAKE-OFF RUNWAYS 19L/R: Climb via heading 190° until LAS VORTAC 3 DME, then right turn via heading 220°, thence

TAKE-OFF RUNWAYS 25L/R: Climb via heading 255° until LAS VORTAC 3 DME, then left turn via heading 190°, thence

....via radar vectors to transition or assigned route, maintain 7000', expect clearance to filed altitude 2 minutes after departure.

LOST COMMUNICATIONS: If no contact with ATC upon reaching 7000', proceed direct BLD VORTAC, then climb in BLD VORTAC holding pattern to the appropriate MEA for route of flight.

BEATTY TRANSITION (MCCRN3.BTY): From over SHEAD INT via BTY R-129 to BTY VORTAC.

HECTOR TRANSITION (MCCRN3.HEC): From over BOACH INT via BLD R-213 and HEC R-032 to HEC VORTAC.

TWENTY NINE PALMS TRANSITION (MCCRN3.TNP): From over GFS VORTAC via GFS R-185 to JOTNU INT, then via TNP R-028 to TNP VORTAC.

TAKE-OFF OBSTACLE NOTES (CONTINUED)

RWY 25R: Light pole 3115' from DER, 1033' right of centerline, 109' AGL/2301' MSL.
Light on pole 1.5 NM from DER, 2836' left of centerline, 124' AGL/2457' MSL.
Light pole 1.7 NM from DER, 2965' left of centerline, 139' AGL/2469' MSL.
Light on pole 1100' from DER, 508' left of centerline, 47' AGL/2226' MSL.
Building 1822' from DER, 652' left of centerline, 46' AGL/2238' MSL.
Building 2202' from DER, 596' left of centerline, 44' AGL/2246' MSL.
Rod on building 534' from DER, 369' left of centerline, 33' AGL/2202' MSL.
Road 678' from DER, 16' right of centerline, 35' AGL/2201' MSL.
Light on localizer antenna 533' from DER, 32' AGL/2195' MSL.

RWY 25L: Pole 2860' from DER, 813' left of centerline, 57' AGL/2236' MSL.
Sign 3672' from DER, 1302' left of centerline, 57' AGL/2256' MSL.
Antenna on building 1002' from DER, 251' left of centerline, 34' AGL/2183' MSL.
Pole 3677' from DER, 145' left of centerline, 67' AGL/2249' MSL.

RWY 7L: Tree 1257' from DER, 789' left of centerline, 85' AGL/2077' MSL.
Light pole 747' from DER, 441' right of centerline, 62' AGL/2057' MSL.
Tree 1007' from DER, 557' right of centerline, 70' AGL/2062' MSL.

RWY 7R: Light on wind sock 102' from DER, 300' right of centerline, 30' AGL/2051' MSL.

RWY 19L: Pole 1394' from DER, 533' right of centerline, 36' AGL/2236' MSL.
Sign 2181' from DER, 1062' right of centerline, 50' AGL/2256' MSL.
Rod on building 2921' from DER, 581' right of centerline, 50' AGL/2262' MSL.
Pole 2633' from DER, 319' right of centerline, 40' AGL/2246' MSL.

RWY 19R: Pole 1135' from DER, 619' right of centerline, 65' AGL/2249' MSL.
Pole 756' from DER, 618' right of centerline, 50' AGL/2231' MSL.
Sign 2182' from DER, 125' right of centerline, 50' AGL/2256' MSL.
Pole 1396' from DER, 403' left of centerline, 55' AGL/2236' MSL.
Rod on building 197' from DER, 441' right of centerline, 30' AGL/2202' MSL.
Rod on building 2922' from DER, 356' left of centerline, 50' AGL/2262' MSL.

SW-4, 05 APR 2012 to 03 MAY 2012

SW-4, 05 APR 2012 to 03 MAY 2012

SAN FRANCISCO INTL (SFO) 8 SE UTC-8(-7DT) N37°37.14' W122°22.49'
 13 B S4 FUEL 100, 100LL, JET A OX 1, 2, 3, 4 LRA Class I, ARFF Index E
 NOTAM FILE SFO

SAN FRANCISCO
H-3B, L-2F, 3B, A
IAF, AD

RWY 10L-28R: H11870X200 (ASPH-GRVD) PCN 80 F/B/X/T HIRL CL

RWY 10L: REIL. PAPI(P4L)—GA 3.0° TCH 80'. Tower.

RWY 28R: ALSF2. TDZL. PAPI(P4L)—GA 3.0° TCH 70'. Rgt tfc.

RWY 10R-28L: H10602X200 (ASPH-GRVD) PCN 80 F/B/X/T HIRL CL

RWY 10R: PAPI(P4L)—GA 3.0° TCH 75'. Tower. Rgt tfc.

RWY 28L: SSALR. PAPI(P4L)—GA 3.0° TCH 75'.

RWY 01R-19L: H8648X200 (ASPH-GRVD) PCN 100F/B/X/T HIRL CL

RWY 01R: REIL. Thld dspldc 238'. Tree.

RWY 19L: MALSF. TDZL. PAPI(P4L)—GA 3.0° TCH 75'.

RWY 01L-19R: H7500X200 (ASPH-CONC-GRVD) PCN 90 F/B/X/T HIRL CL

RWY 01L: REIL. Thld dspldc 491'.

RWY 19R: PAPI(P4L)—GA 3.0° TCH 73'.

AIRPORT REMARKS: Attended continuously. PAEW AER 28L, Rwy 28R and Rwy 19L indef. Flocks of birds feeding along shoreline adjacent to arpt, on occasions fly across various parts of arpt. Due to obstructed vision, SFO twr is able to provide only limited arpt tfc control svc on Twy A between gates 88 and 89. Twr personnel are unable to determine whether this area is clear of traffic or obstructions. Rwy 10 preferred rwy between 0900-1400Z† weather and flight conditions permitting. Simultaneous ops in effect all rwys. Helicopter ldg area marked on Twy (C) west of Twy (R) opr for civil and military use. Noise sensitive arpt. For noise abatement procedures ctc arpt noise office Monday-Friday 1600-0100Z† by calling 650-821-5100. Airline pilots shall strictly follow the painted nose gear lines and no oversteering adjustment is permitted. No grooving exists at arpt rwy intersections. Rwy 01L-19R, 01R-19L, Rwy 10R-28L, Rwy 10L-28R grooved full length except at rwy intersections.

B747, B777, A330, A340 or larger acft are restricted from using Twy A1 when B747-400, A340-600 or larger acft are holding short of Rwy 01R on Twy A. 747-400's shall taxi at a speed of less than 10 miles per hour on all non-restricted taxiways on the terminal side of the intersecting rwys. All outbound Twy Y heavy aircraft with a wingspan of 171' or greater under power prohibited from entering westbound Twy Z. Ramp clsd to acft with wingspan over 117' at Terminal 1, gate C41 indef. Movement speed of not more than 5 miles per hour is required when two 747-400's pass or overtake each other on parallel taxiways A and B. Rwy 19L MALSF has a NSTD length of 1115' with 3 sequenced flashers. Ldg fee. Flight Notification Service (ADCUS) available. NOTE: See Special Notices—Intersection Departures During Period of Darkness, Expanded Charted Visual Flight Procedures. Continuous Power Facilities, Special Noise Abatement Procedures, Special Noise Abatement Procedures—Preferential Runways.

WEATHER DATA SOURCES: ASOS (650) 872-0246 LLWAS.

COMMUNICATIONS: D-ATIS 135.45 118.85 115.8 113.7 650-877-3585/8422 UNICOM 122.95

① NORCAL APP CON 135.65 (S) 133.95

TOWER 120.5 GND CON 121.8 CLNC DEL 118.2 PRE TAXI CLNC 118.2

① NORCAL DEP CON 135.1 (SE-W) 120.9 (NW-E)

AIRSPACE: CLASS B See VFR Terminal Area Chart

RADIO AIDS TO NAVIGATION: NOTAM FILE SFO.

(L) VOR/DME 115.8 SFO Chan 105 N37°37.17' W122°22.43' at fld. 13/17E.

VOR DME unusable:

025°-065° byd 30 NM blo 18,000'

035°-055° byd 12 NM blo 6,500'

150°-190° byd 25 NM blo 4,500'

190°-260° byd 10 NM blo 4,500'

260°-295° byd 35 NM blo 3,000'

295°-330° byd 20 NM blo 8,000'

BRIJ NDB (LOM) 379 GW N37°34.33' W122°15.59' 282° 6.2 NM to fld. LOM unusable 160°-195° byd 6 NM.

ILS/DME 108.9 I-SIA Chan 26 Rwy 19L. Class IE. Ry 19L glideslope deviations are possible when critical areas are not required to be protected. Acft operating invof glideslope transmitter. Pilots should be alert for momentary localizer course excursions due to large aircraft operating in vicinity of localizer antenna.

ILS/DME 109.55 I-SFO Chan 32(Y) Rwy 28L. Class IE.

ILS/DME 111.7 I-GWQ Chan 54 Rwy 28R. Class IIIE. LOM BRIJ NDB. LOM unusable 160°-195° byd 6 NM.

LDA/DME 110.75 I-FNP Chan 44(Y) Rwy 28R.

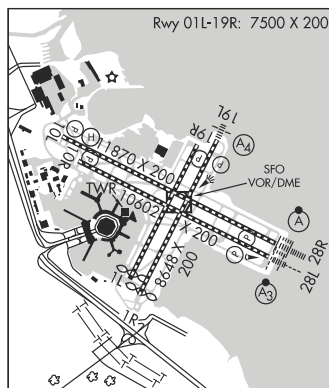

LOCKE ONE ARRIVAL

ST-375 (FAA)

SAN FRANCISCO, CALIFORNIA

SW-2, 05 APR 2012 to 03 MAY 2012

CLOVIS TRANSITION (CZQ.LOCKE1): From over CZQ VORTAC via CZQ R-305 and MOD R-093 to MOD VOR/DME. Thence....
COALDALE TRANSITION (OAL.LOCKE1): From over OAL VORTAC via OAL R-246 and MOD R-064 to MOD VOR/DME. Thence....
MINA TRANSITION (MVA.LOCKE1): From over MVA VORTAC via MVA R-204, OAL R-246 and MOD R-064 to MOD VOR/DME. Thence....
MUSTANG TRANSITION (FMG.LOCKE1): From over FMG VORTAC via FMG R-182 and MOD R-064 to MOD VOR/DME. Thence....
From over MOD VOR/DME via MOD R-245 to GROAN INT, then via SGD VORTAC R-107 to UPEND INT. Expect vectors to final approach course.
LOST COMMUNICATIONS METRO OAKLAND INTL ONLY: Depart UPEND INT via SGD R-107 to intercept and proceed via SAU R-035 to COMMO INT.

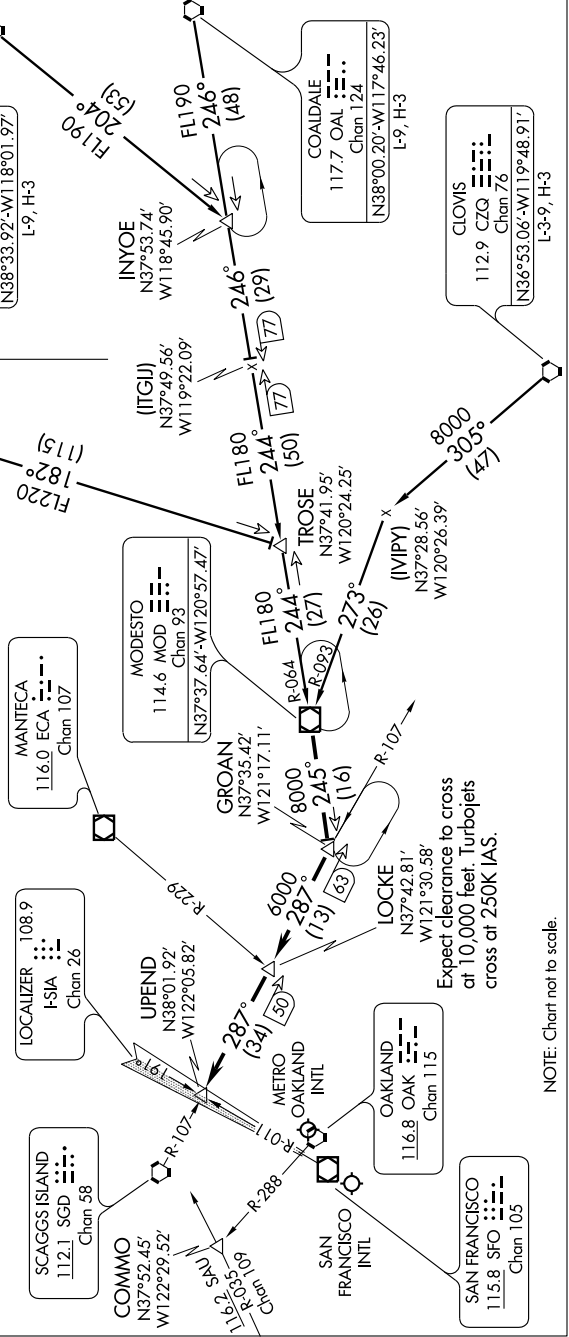

LOCKE ONE ARRIVAL

SAN FRANCISCO, CALIFORNIA

SW-2, 05 APR 2012 to 03 MAY 2012

Figure 381

OAKLAND

METROPOLITAN OAKLAND INTL (OAK) 4 S UTC-8(-7DT) N37°43.28' W122°13.24'
 9 B S4 FUEL 100LL, JET A OX 1, 2, 3, 4 TPA—See Remarks LRA Class I, ARFF Index D
 NOTAM FILE OAK

SAN FRANCISCO
 H-3B, L-2F, 3B, A
 IAP, AD

RWY 11-29: H10000X150 (ASPH-GRVD) PCN 71 F/A/W/T HIRL CL

RWY 11: MALSR. PAPI(P4L)—GA 2.75° TCH 65'. Rgt tfc.

RWY 29: ALSF2. TDZL. PAPI(P4L)—GA 3.0° TCH 71'.

RWY 09R-27L: H6213X150 (ASPH-GRVD) PCN 97 F/B/W/T HIRL

RWY 09R: REIL. PAPI(P4R)—GA 3.0° TCH 50'.

RWY 27L: PAPI(P4L)—GA 3.0° TCH 71'.

RWY 09L-27R: H5454X150 (ASPH-GRVD) PCN 69 F/C/W/T HIRL

RWY 09L: PAPI(P4R)—GA 3.0° TCH 49'.

RWY 27R: MALSR. PAPI(P4L)—GA 2.9° TCH 57'. Bldg. Rgt tfc.

RWY 15-33: H3372X75 (ASPH) S-12.5 MIRL

RWY 33: Rgt tfc.

AIRPORT REMARKS: Attended continuously. Rwy 15-33 CLOSED to air carrier acft. Birds on and invof arpt. Acft with experimental or limited certification having over 1,000 horsepower or 4,000 pounds are restricted to Rwy 11-29. 24 hr Noise abatement procedure—turbojet and turboprop powered acft, turboprops over 17,000 lbs, four engine reciprocating powered acft, and surplus Military acft over 12,500 lbs should not depart Rwy 27L and Rwy 27R or land on Rwy 09L and Rwy 09R. For noise abatement information ctc noise abatement office at 510-563-6463. Intersection of Twy B, Twy W and Twy V not visible from twr. Twy K between Rwy 33 and Twy D and portions of Twy D not visible from twr. Twy A, Twy E, Twy G, Twy H between Rwy 27R and Twy C max acft weight 150,000 lbs. Twy G and Twy H between Rwy 27L and Rwy 27R, max acft weight 12,500 lbs. Twy P max acft weight 24,000 lbs single, 40,000 lbs dual. Twy C between Rwy 27R and Twy G and Twy B, Twy J, and Twy D max acft weight 9,000,000 lbs. Twy C between Twy G and Twy J max acft weight 25,000 lbs single, 175,000 lbs dual, 4,000,000 lbs tandem. Twy C between Twy J and Twy F max acft weight 25,000 lbs single, 150,000 lbs dual. 155,000 lbs tandem (dual tandem not authorized). Twy K between Twy D and intersection Twy F, Twy L, Twy K max acft weight 25,000 lbs single, 115,000 lbs dual, 140,000 lbs tandem. Twy K between Rwy 9R and intersection Twy F, Twy L, Twy K max acft weight 25,000 lbs single, 115,000 lbs dual, 140,000 lbs tandem. Twy K between Rwy 9R and intersection Twy F, Twy L, Twy K max acft weight 25,000 lbs single, 45,000 lbs dual, tandem not authorized. Preferential rwy use program in effect 0600-1400Z±. North fld preferred arrival Rwy 27L, north fld preferred departure Rwy 09R or 27R. If these Rwy's unacceptable for safety or twr instruction then Rwy 11-29 must be used. Noise prohibitions not applicable in emerg or whenever Rwy 11-29 is closed due to maintenance, safety, winds or weather. 400' blast pad Rwy 29 and 500' blast pad Rwy 11. Rwy 29, 27R and 27L distance remaining signs left side. TPA—Rwy 27L 606(597), TPA—Rwy 27R 1006(997). Ldg fee may apply for Rwy 11-29, rwy commercial ops and tiedown, ctc afd ops 510-563-3361. Flight Notification Service (ADCUS) avbl.

WEATHER DATA SOURCES: ASOS (510) 383-9514 HIWAS 116.8 OAK.

COMMUNICATIONS: D-ATIS 133.775 (510) 635-5850 (N and S Complex) UNICOM 122.95

OAKLAND RCO 122.2 122.5 (OAKLAND RADIO)

Ⓡ **NORCAL APP CON** 125.35 (East) 135.65 (South) 135.1 (West) 134.5 120.9

Ⓡ **NORCAL DEP CON** 135.1 (West) 120.9 (Northwest)

OAKLAND TOWER 118.3 (N Complex) 127.2 (S Complex) 124.9

GND CON 121.75 (S Complex) 121.9 (N Complex) **CLNC DEL** 121.1

AIRSPACE: CLASS C svc ctc **APP CON**

RADIO AIDS TO NAVIGATION: NOTAM FILE OAK.

OAKLAND (H) VORTACW 116.8 OAK Chan 115 N37°43.56' W122°13.42' at fld. 10/17E. **HIWAS.**

DME unusable:

335°-065° byd 30 NM blo 8,000'

ILS 111.9 I-AAZ Rwy 11. Class IE. Glideslope deviations are possible when critical areas are not required to be protected. Acft operating invof glideslope transmitter.

ILS 109.9 I-OAK Rwy 27R. Class IE.

ILS 108.7 I-INB Rwy 29. Class IIIE.

COMM/NAV/WEATHER REMARKS: Emerg frequency 121.5 not avbl at twr.

OAKLAND N37°43.56' W122°13.42' NOTAM FILE OAK.

SAN FRANCISCO
 H-3A, L-2F, 3B, A

(H) VORTACW 116.8 OAK Chan 115 at Metropolitan Oakland Intl. 10/17E. **HIWAS.**

DME unusable:

335°-065° byd 30 NM blo 8,000'

RCO 122.2 122.5 (OAKLAND RADIO)

ASOS OAK N37°43.28' W122°13.24'. (510) 383-9514.

OCEAN RIDGE (See GUALALA on page 113)

KEY WEST INTL (EYW) 2 E UTC-5(-4DT) N24°33.37' W81°45.57'

MIAMI

3 B S4 FUEL 100, JET A AOE Class I, ARFF Index IB NOTAM FILE EYW

L-21D, 23C

RWY 09-27: H4801X100 (ASPH-GRVD) S-75, D-125, 2D-195 MIRL

IAP, AD

RWY 09: REIL. VASI(V4L)—GA 3.0° TCH 34'. Rgt tfc.

RWY 27: REIL. VASI(V4L)—GA 3.0° TCH 34'.

ARRESTING GEAR/SYSTEM

RWY 09: EMAS

AIRPORT REMARKS: Attended 1200-0400Z†. Parachute Jumping.

Numerous flocks of birds on and in the vicinity of airport.

Departing VFR acft requested to maintain rwy heading until reaching fld boundary, then execute turns for N or S dep.

Restricted area R-2916 located 14 NM NE of arpt has strobe-lgtld

and marked balloon and cable to 14,000 ft. Extremely noise sensitive area. Urge no ops 0400-1200Z†. Use NBAA close in

noise abatement procedures other times. Local ordinance rqr engine runups in designated area on N side commercial ramp

from 0400-1200Z† and fines. PPR for unscheduled air carrier operations with more than 30 passenger seats 0430-1045Z†;

Call arpt manager 305-809-5200. PPR for acft exceeding rwy weight bearing capacity; call arpt manager 305-809-5200.

Intensive military jet tfc S and E of arpt; acft entering arpt tfc area

from SE through W. Enter arpt tfc area blo 2000'; refer to MIAMI

VFR Terminal Area Chart for suggested VFR flyway routes. Twy A5 and Twy A6 not visible from twr. **ACTIVATE**

MIRL Rwy 09-27, VASI/REIL Rwsy 09-27—CTAF. Flight Notification Service (ADCUS) available. **NOTE:** See

Special Notices—U.S. Special Customs Requirement.

WEATHER DATA SOURCES: ASOS 119.65 (305) 292-4046. HIWAS 113.5 EYW.

COMMUNICATIONS: CTAF 118.2 ATIS 119.675 UNICOM 122.95

RCD 122.1R 113.5T (MIAMI RADIO)

RCD 123.65 122.2 (MIAMI RADIO)

® **NAVY KEY WEST APP/DEP CON** 124.025 126.575 (1200-0300Z†)

® **MIAMI CENTER APP/DEP CON** 133.5

(0300-1200Z†)

TOWER 118.2 (1200-0200Z†) **GND CON** 121.9 **CLNC DEL** 121.9

AIRSPACE: CLASS D svc 1200-0200Z† other times CLASS G.

RADIO AIDS TO NAVIGATION: NOTAM FILE EYW.

(H) **VORTAC** 113.5 EYW Chan 82 N24°35.15' W81°48.03' 127° 2.9 NM to fld. 10/01E.

HIWAS. VOR unusable 040°-050°, 210°-240°.

FISH HOOK NDB (HW) 332 FIS N24°32.90' W81°47.18' 076° 1.5 NM to fld.

ASR (1100-0300Z†)

COMM/NAV/WEATHER REMARKS: FSS freqs 123.65 and 122.2 unusable 330°-015° beyond 20 NM below 1500'. VORTAC unusable 121°-139°. Acft overflying SIMPL, ACRUZ, CANOA, and MAXIM shall ctc Miami Center 10 minutes prior to crossing the Miami flight information region 132.2.

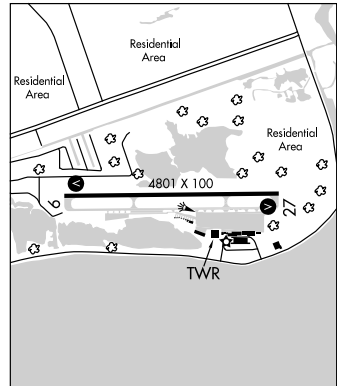

Figure 383

SE, 05 APR 2012 to 31 MAY 2012

RNAV (GPS) RWY 4

VERO BEACH MUNI (VRB)

WAAS CH 61311 W04A	APP CRS 040°	Rwy ldg TDZE Apt Elev	4974 24 24
--	------------------------	-----------------------------	---------------------------------------

Baro-VNAV NA when using Fort Pierce altimeter setting. For uncompensated Baro-VNAV systems, LNAV/VNAV NA below -15° C (5° F) or above 48° C (118° F). DME/DME RNP-0.3 NA.
 Procedure NA at night. Visibility reduction by helicopters NA. When local altimeter setting not received, use Fort Pierce altimeter setting and increase all DA 23 feet and all MDA 40 feet, increase LPV and LNAV/VNAV all Cats and Circling Cat D visibilities ¼ mile.

MISSED APPROACH:
Climb to 2700 direct OJEMY and hold.

ATIS 132.5	MIAMI CENTER 132.25 370.9	VERO BEACH TOWER * 126.3 (CTAF) 0	GND CON 127.45	CLNC DEL 134.975	UNICOM 122.95
----------------------	-------------------------------------	---	--------------------------	----------------------------	-------------------------

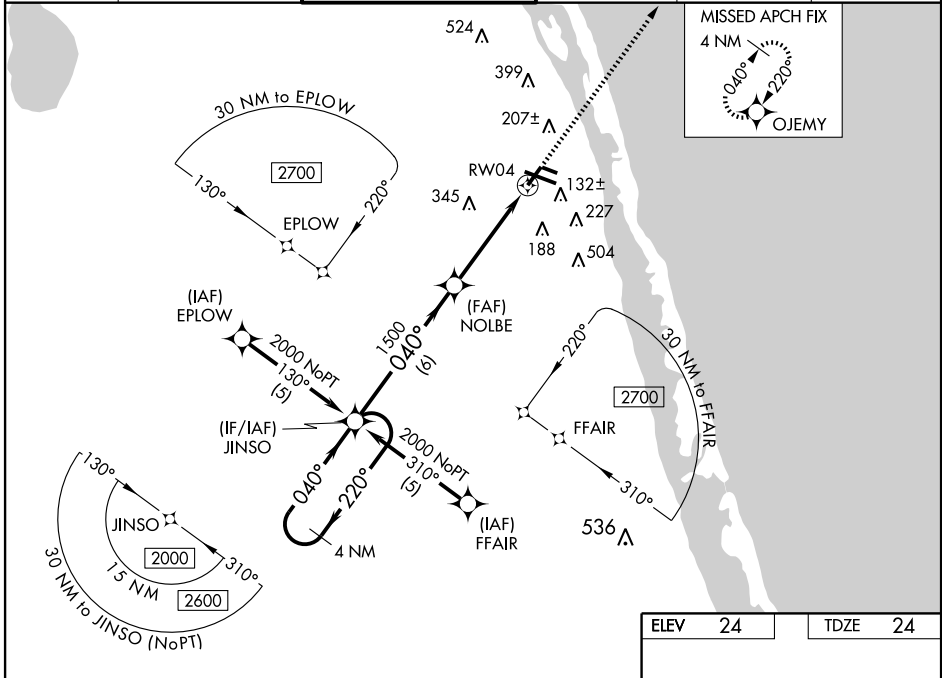

SE-3, 05 APR 2012 to 03 MAY 2012

SE-3, 05 APR 2012 to 03 MAY 2012

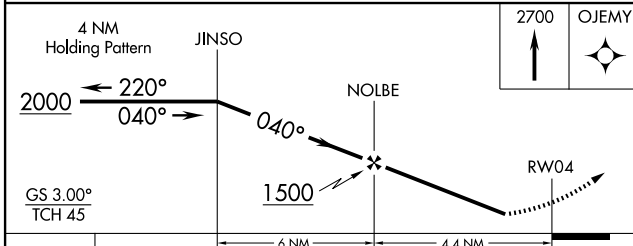

ELEV 24	TDZE 24
---------	---------

Obstacles shown in the diagram: 100±, 57±, 3504 X 75, 29R, 7314 X 100, 125±, 11R, 29L, 75, TWR 143±.

040° to RWY 4

MIRL Rwy 4-22 and 11L-29R
 REIL Rwy 11R and 29L
 MIRL Rwy 11R-29L
 REIL Rwy 4 and 22

CATEGORY	A	B	C	D
LPV DA	323-1 299 (300-1)			
LNAV/VNAV DA	395-1¼ 371 (400-1¼)			
LNAV MDA	460-1	436 (500-1)	460-1¼ 436 (500-1¼)	460-1½ 436 (500-1½)
CIRCLING	560-1	536 (600-1)	560-1½ 536 (600-1½)	660-2 636 (700-2)

VERO BEACH MUNI (VRB) 1 NW UTC-5(-4DT) N27°39.33' W80°25.08'

MIAMI

24 B S4 FUEL 100, JET A OX 1, 2 TPA—See Remarks Class IV, ARFF Index A
 NOTAM FILE VRB

H-81, L-24F
 IAP, AD

RWY 11R-29L: H7314X100 (ASPH-GRVD)
 S-85, D-115, 2S-146, 2D-220 MIRL
RWY 11R: REIL. PAPI (P4L)—GA 3.0° TCH 41'. Trees.
RWY 29L: REIL. PAPI(P4L) TCH 58'.
RWY 04-22: H4974X100 (ASPH-GRVD) S-30, D-115, 2S-146,
 2D-220 MIRL
RWY 04: REIL. VASI(V4L)—GA 3.0° TCH 45'. Trees.
RWY 22: REIL. PAPI(P4L)—GA 3.0° TCH 42'. Trees.
RWY 11L-29R: H3504X75 (ASPH) S-12.5 MIRL
RWY 11L: PAPI(P2L)—GA 3.0° TCH 37'. Tree.
RWY 29R: PAPI(P2L)—GA 3.5° TCH 35'. Poles.

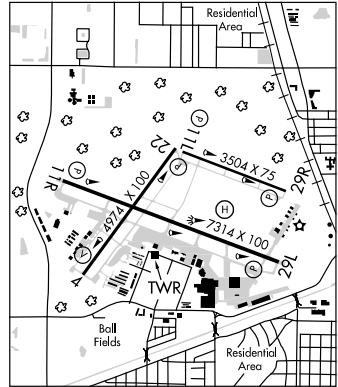

LAND AND HOLD SHORT OPERATIONS

LANDING	HOLD SHORT POINT	DIST AVBL
RWY 29L	04/22	4700

AIRPORT REMARKS: Attended 1200-0200Z†. Rwy 04-22 CLOSED when twr clsd. TPA 1024(1000) large acft 1524(1500). Rwy 11L-29R CLOSED when twr clsd. CLOSED to air carrier ops with more than 30 passenger seats except 24 hrs PPR, call arpt manager 772-978-4930. No intersection departures except by ATC req. Noise sensitive arpt. Jet acft use NBAA noise abatement procedures. Voluntary local noise abatement procedures in effect call 772-978-4930. No touch and go ops 0300-1200Z† except PPR. Extensive flight training. ACTIVATE MIRL Rwy 11R-29L and REIL Rwy 11R and Rwy 29L—CTAF.

WEATHER DATA SOURCES: ASOS (772) 978-9535. HIWAS 117.3 VRB.

COMMUNICATIONS: CTAF 126.3 ATIS 132.5 UNICOM 122.95

RCO 122.1R 117.3T (ST PETERSBURG RADIO)

RCO 122.5 122.2 (ST PETERSBURG RADIO)

Ⓜ MIAMI CENTER APP/DEP CON 132.25

TOWER 126.3 133.15 (1200-0200Z†) GND CON 127.45 CLNC DEL 134.975

AIRSPACE: CLASS D svc 1200-0200Z† other times CLASS E.

RADIO AIDS TO NAVIGATION: NOTAM FILE VRB.

(H) VORTAC 117.3 VRB Chan 120 N27°40.71' W80°29.38' 114° 4.1 NM to fld. 11/04W. HIWAS.

VIRGINIA KEY N25°45.11' W80°09.27' NOTAM FILE MIA.

MIAMI

(H) VOR/DME 117.1 VKZ Chan 118 293° 7.8 NM to Miami Intl. 12/04W.

H-81, L-23C, A

VOR portion unusable 020°-064° byd 20 NM blo 4500', 091°-104° byd 30 NM blo 3000', 279°-284° byd 25 NM blo 7500', 285°-319° byd 15 NM blo 7500', 320°-335° byd 25 NM blo 3000'.

RCO 122.1R 117.1T (MIAMI RADIO)

WAKUL N30°19.57' W84°21.50' NOTAM FILE TLH.

JACKSONVILLE

NDB (HW/LOM) 379 TL 007° 4.2 NM to Tallahassee Rgnl.

H-8G, L-21D, 22I

WAKULLA CO (See PANACEA)

WARRINGTON N30°28.69' W86°31.25' NOTAM FILE CEW.

NEW ORLEANS

(T) TACAN Chan 2 DWG (134.5) at Eglin AFB 118/00°E.

L-21C, 22H

Figure 385

SE, 05 APR 2012 to 31 MAY 2012

WINDSOR LOCKS

BRADLEY INTL (BDL) 3 W UTC-5(-4DT) N41°56.35' W72°41.00'
 173 B S4 FUEL 100LL, JET A OX 1, 2, 3, 4 TPA—See Remarks
 LRA Class I, ARFF Index D NOTAM FILE BDL

NEW YORK
 H-101, 11D, 12K, L-33C, 34I
 IAP, AD

RWY 06-24: H9510X200 (ASPH-GRVD) S-200, D-200, 2S-175, 2D-350, 2D/2D2-710 HIRL CL
RWY 06: ALSF2. TDZL. PAPI(P4L)—GA 3.0° TCH 71'. Trees.
RWY 24: MALS R. TDZL. PAPI(P4L)—GA 3.0° TCH 71'. Trees.
RWY 15-33: H6847X150 (ASPH-GRVD) S-200, D-200, 2S-175, 2D-350 HIRL
RWY 15: REIL. PAPI(P4L)—GA 3.5° TCH 61'. Trees.
RWY 33: MALS F. PAPI(P4R)—GA 3.0° TCH 72'. Trees.
RWY 01-19: H4268X100 (ASPH) S-60, D-190, 2S-175, 2D-328 MIRL
RWY 01: Thld dsplcd 475'. Acft. **RWY 19:** Trees.

LAND AND HOLD SHORT OPERATIONS

LANDING	HOLD SHORT POINT	DIST AVBL
RWY 06	01-19	6000
RWY 24	15-33	5850
RWY 33	06-24	4550

RUNWAY DECLARED DISTANCE INFORMATION

RWY 01: TORA-4268	TODA-4268	ASDA-4268	
RWY 06: TORA-9509	TODA-9509	ASDA-9509	LDA-9509
RWY 15: TORA-6847	TODA-6847	ASDA-6847	LDA-6847
RWY 19:			LDA-4268
RWY 24: TORA-9509	TODA-9509	ASDA-9509	LDA-9509
RWY 33: TORA-6847	TODA-6847	ASDA-6847	LDA-6847

AIRPORT REMARKS: Attended continuously. Numerous birds frequently on or in/ov arpt. No training flights; no practice apchs; no touch and go ldgs between: Mon-Sat 0400-1200Z† and Sun 0400-1700Z†. Rwy 01-19 open for acft with wingspan less than 79'. Rwy 01 CLOSED for arrivals to all fixed wing acft. Rwy 19 CLOSED for departures to all fixed wing acft. Twy J clsd between S and R to acft with wing spans in excess of 171 ft. Air National Guard ramp PAEW barricaded adjacent northeast side. ASDE-X Surveillance System in Use. Pilots should operate transponders with Mode C on all twys and rwys. Rwy 33 touchdown RVR avbl. TPA-1873(1700) heavy acft. Rwy 06 visual glideslope indicator and glidepath not coincident. Rwy 24 visual glideslope indicator and glidepath not coincident. Rwy 33 visual glideslope indicator and glidepath not coincident. Ldg fee for business, corporate and revenue producing acft. Flight Notification Service (ADCUS) available. NOTE: See Special Notices-Land and Hold Short Lights.

WEATHER DATA SOURCES: ASOS (860) 627-9732. WSP.

COMMUNICATIONS: D-ATIS 118.15 (860-386-3570) UNICOM 122.95

WINDSOR LOCKS RCO 122.3 (BRIDGEPORT RADIO)

Ⓡ **BRADLEY APP CON** 123.95 (176°-240°) 125.35 (241°-060°) 127.8 (061°-175° and HFD area)

Ⓡ **BRADLEY DEP CON** 123.95 (176°-240°) 125.35 (241°-060°) 127.8 (061°-175° and HFD area)

TOWER 120.3 GND CON 121.9 CLNC DEL 121.75

AIRSPACE: CLASS C svc continuous ctc APP CON

RADIO AIDS TO NAVIGATION: NOTAM FILE BDL.

(T) **VORTACW** 109.0 BDL Chan 27 N41°56.46' W72°41.32' at fld. 160/14W.

ILS/DME 111.1 I-BDL Chan 48 Rwy 06. Class IIIE.

ILS/DME 108.55 I-IKX Chan 22(Y) Rwy 33. Class IE.

ILS/DME 111.1 I-MYQ Chan 48 Rwy 24. Class IT. DME unusable from .4 NM inbound to Rwy 24.

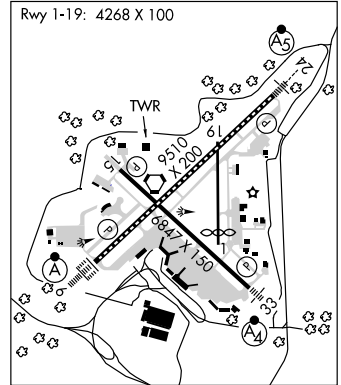

YALESVILLE HELIPORT (4C3) 2 N UTC-5(-4DT) N41°29.51' W72°48.67'

65 B FUEL 100LL, JET A NOTAM FILE BDR

HELIPAD H1: H65X65 (CONC)

HELIPORT REMARKS: Attended 1400-2300Z†. Pilots unfamiliar with heliport ctc 203-294-8800 prior to arrival for a briefing on current procedures. ACTIVATE rotating bcn-123.5

COMMUNICATIONS: CTAF/UNICOM 123.05

Figure 386

NE, 05 APR 2012 to 31 MAY 2012

AIRPORT DIAGRAM

AL-437 (FAA)

VERO BEACH MUNI (VRB)

VERO BEACH, FLORIDA

SE-3, 05 APR 2012 to 03 MAY 2012

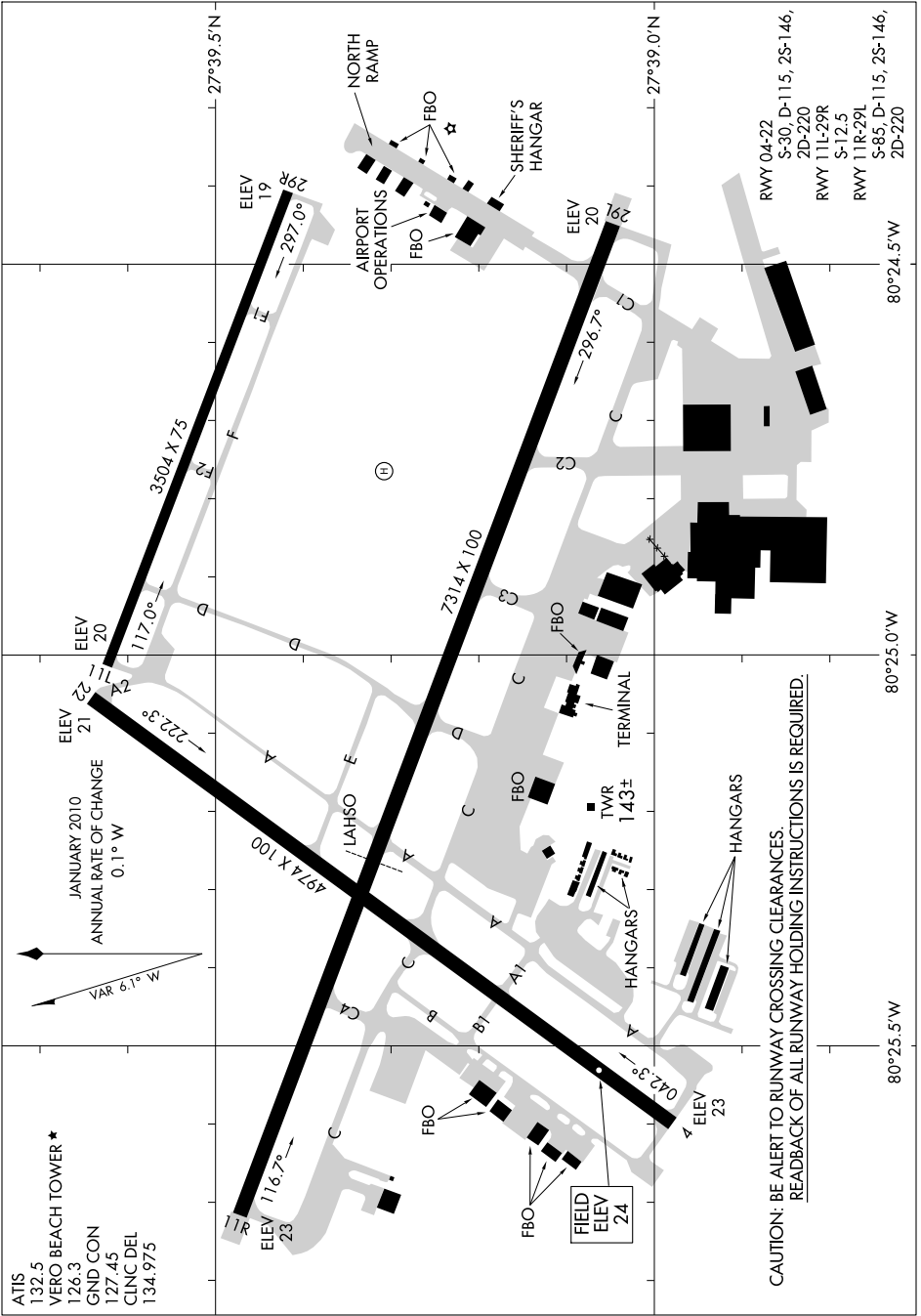

CAUTION: BE ALERT TO RUNWAY CROSSING CLEARANCES.
READBACK OF ALL RUNWAY HOLDING INSTRUCTIONS IS REQUIRED.

SE-3, 05 APR 2012 to 03 MAY 2012

AIRPORT DIAGRAM

VERO BEACH, FLORIDA
VERO BEACH MUNI (VRB)

Figure 387



ALTERNATE MINS

M4



NAME ALTERNATE MINIMUMS

ROCHESTER, NY
 GREATER ROCHESTER
 INTL (ROC) **ILS or LOC Rwy 4¹**
 ILS or LOC Rwy 22¹
 ILS or LOC Rwy 28²
 RNAV (GPS) Rwy 4³
 RNAV (GPS) Rwy 22³
 RNAV (GPS) Rwy 25³
 RNAV (GPS) Rwy 28⁴
 VOR Rwy 4³
 VOR/DME Rwy 4³

¹ILS, Category D, 700-2¼. LOC, Category D, 800-2¼.

²ILS, Categories A,B,C, 800-2; Category D, 800-2¼. LOC, Category D, 800-2¼.

³Category D, 800-2¼.

⁴Category C, 800-2¼; Category D, 800-2¼.

ROME, NY

GRIFFISS INTL (RME) **ILS or LOC Rwy 33¹²**
 RNAV (GPS) Rwy 15³
 RNAV (GPS) Rwy 33³

NA when local weather not available.

¹NA when control tower closed.

²ILS, Categories A, B, 700-2; Category C, 800-2; Category D, 800-2½. LOC, Category D, 800-2½.

³Category D, 800-2½.

SARANAC LAKE, NY

ADIRONDACK
 RGNL (SLK) **VOR/DME Rwy 5¹**
 VOR or GPS Rwy 9²

¹Category A, 1100-2; Category B, 1200-2; Categories C,D, 1200-3.

²Categories A,B, 1400-2; Categories C,D, 1400-3.

SHIRLEY, NY

BROOKHAVEN (HWV) **RNAV (GPS) Rwy 6**
 RNAV (GPS) Rwy 15
 RNAV (GPS) Y Rwy 24
 RNAV (GPS) Z Rwy 24
 RNAV (GPS) Rwy 33
 VOR Rwy 6

NA when local weather not available.

SUSSEX, NJ

SUSSEX (FWN) **RNAV (GPS) Rwy 3¹**
 VOR-A²

NA when local weather not available.

¹Categories A, B, 900-2; Category C, 900-2¼.

²Categories A, B, 1400-2; Category C, 1400-3.

NAME ALTERNATE MINIMUMS

TETERBORO, NJ
 TETERBORO (TEB) **ILS or LOC Rwy 6¹**
 ILS RWY 19¹
 RNAV (GPS) Y Rwy 6³
RNAV (RNP) Z Rwy 6, 800-2¼
 VOR/DME-A²
 VOR/DME-B²
 VOR/DME Rwy 6³
 VOR Rwy 24⁴

¹ILS, Categories A,B, 800-2; Category C, 800-2¼; Category D, 900-2¼. LOC, Category C, 800-2¼; Category D, 900-2¼.

²Categories A,B, 1000-2; Categories C,D, 1000-3.

³Category C, 800-2¼; Category D, 900-2¼.

⁴Categories B,C,D, 1000-3.

TRENTON, NJ

TRENTON MERCER (TTN) **ILS Rwy 6**
 NDB or GPS Rwy 6
 VOR or GPS-A
 VOR or GPS Rwy 24

NA when control tower closed.

WATERTOWN, NY

WATERTOWN
 INTL (ART) **ILS or LOC Rwy 7¹**
 RNAV (GPS) Rwy 7²
 RNAV (GPS) Rwy 10³
 RNAV (GPS) Rwy 28³
 VOR Rwy 7²

¹ILS, Categories A, B, C, 700-2; Category D 700-2¼. LOC, Category D, 800-2¼.

²Category D, 800-2¼.

³NA when local weather not available.

WELLSVILLE, NY

WELLSVILLE MUNI ARPT, TARANTINE
 FIELD (ELZ) **RNAV (GPS) Rwy 10**
 RNAV (GPS) Rwy 28
 VOR-A¹

NA when local weather not available.

¹Categories A,B, 1100-2; Categories C,D, 1100-3.

WESTHAMPTON BEACH, NY

FRANCIS S.
 GABRESKI (FOK) **ILS or LOC Rwy 24¹**
 RNAV (GPS) Rwy 24

NA when local weather not available.

¹NA when control tower closed.

²NA when control tower closed.

³Category D, 800-2¼.



ALTERNATE MINS

M4

NE-2

