

# 3Rs Explosives Safety Guide

## Maritime Industry

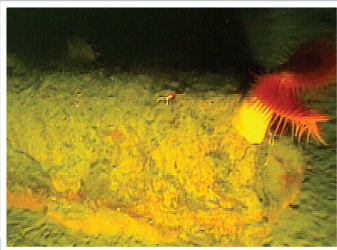

**DURING COMMERCIAL OPERATIONS SUCH AS FISHING, CLAMMING OR DREDGING; NETS; BOTTOM TENDING GEAR; AND DREDGES MAY CATCH OR DREDGE UP MUNITIONS FROM THE OCEAN. THESE MUNITIONS SHOULD BE CONSIDERED A SERIOUS DANGER TO A VESSEL AND ITS CREW.**

Many vessel crews tell sea stories about catching suspicious items in their nets or dredging gear. The lucky crews live to spin their own tales, while others become the subject of tragic sea stories.

In July 1965, such a tragedy took place aboard the fishing vessel (*FV Snoopy*). The *FV Snoopy* was trawling for scallops off the coast of North Carolina when it caught a large cylinder in its net. A witness said he could clearly see a long round object swaying in the net amidships, over the deck.

What happened next is unclear; but an explosion caused the loss of the *FV Snoopy* and eight members of her crew.

What went wrong? Was it preventable? Could something have been done to save the crew? While all these questions were asked, no one but the *FV Snoopy's* crew knows what actually happened that day. However, the tale of the *FV Snoopy* is meaningful if others learn from this tragedy.

(Note: Both commercial and sport divers should also be aware of the hazards munitions present).

To protect your crew and vessel if you encounter or suspect you have encountered a munition at sea, follow the 3Rs of explosives safety: Recognize, Retreat, Report.



*Unexploded Ordnance Recovered During Dredging*

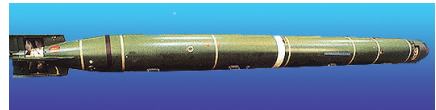

*A Clean Torpedo (top) and a Heavily Corroded Torpedo on the Seafloor (bottom)*



# Recognize

The military has conducted training and combat operations at sea for centuries. Prior to 1970, the U.S. military as well as the militaries of other nations also sea-disposed of excess, obsolete and unserviceable munitions either en route to port or as part of planned disposals. In the 1970s, the U.S. military stopped the practice, now only allowing it in an emergency. Mariners are cautioned they could encounter munitions during commercial operations, such as fishing or dredging. Using common sense and basic knowledge, Mariners can spin their own story rather than becoming a character in a tragic sea tale.

Munitions can be encountered anywhere at sea, not just in charted hazard areas. Munitions that may be encountered include mines, torpedoes, depth charges, artillery shells, bombs and missiles. These munitions, which can contain high explosives or chemical agents, can present a serious danger to a vessel and its crew.

- Munitions, to include those that have been lying dormant in sea or fresh water for many years, should be considered extremely dangerous.
- In some cases, munitions that have been in water for a long period may become more sensitive.
- Regardless of whether encountered on land or recovered from the sea, munitions can explode when handled.
- Munitions submerged in sea or fresh water for any length of time may be:
  - Like new and easy to identify;
  - Heavily encrusted with sea growth and difficult to identify.



*Various Recovered Projectiles*

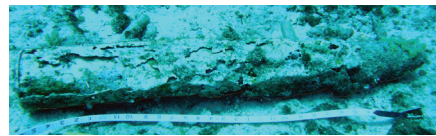

*Projectile and Cartridge Case on Seafloor*

This guide includes drawings representative of munitions that may be encountered at sea. Drawings may help in recognizing suspect munitions.

## MUNITIONS ARE DESIGNED TO BE DANGEROUS

Munitions are designed to injure, maim, or kill people, or to destroy equipment (e.g., vessels). The best protection from the potential hazards associated with munitions is to heed the warnings on nautical charts, avoid known disposal areas, and follow the 3Rs (Recognize, Retreat, Report).

## CHEMICAL MUNITIONS AND CHEMICAL AGENTS

Beginning in World War I, the Department of Defense (then, the Department of War) designed toxic chemical agents to kill, seriously injure, or incapacitate an enemy. In the past, the United States and other countries sea-disposed chemical munitions and chemical agents in bulk containers, such as 55-gallon drums. As a result, some munitions or containers recovered from the sea may contain toxic chemical agents.

Vessel crews should be alert for conditions or signs that could indicate the presence of toxic chemical agents:

- Unusual odor from equipment or fish;
- A stinging sensation in the eyes, or burning or irritated skin;
- Corroded containers or suspicious clay-like lumps.



*Recovered Chemical Filled Projectile*



*Chemical Filled Projectile Recovered from Clam Bed*

## IF CHEMICAL AGENTS ARE SUSPECTED, IMMEDIATE ACTION IS NECESSARY TO PROTECT THE CREW AND VESSEL.

### If You Suspect You Have Encountered a Chemical Munition:

- Move all crew members up wind;
- Close all doors and hatches;
- Shut down all ventilation systems;
- Steam into the wind to carry contaminants away from the crew;
- Contact the U.S. Coast Guard for assistance



*Munitions on the Seafloor*

In case of physical contact with toxic chemical agents, immediately rinse the contaminated area with large amounts of water (if possible, use warm soapy water), even if no effects are felt.

Crewmembers should not work in a contaminated area and every effort should be made to prevent the spread of contaminants. Fishing vessels that have come into contact with toxic chemical agents must not bring their catch ashore until it has been checked and released by the appropriate state's Department of Environmental Health. Sea life contaminated by chemical agents is unsuitable for human or animal consumption.



*A Clean Aerial Bomb Prepared for Shipping (above) and an Aerial Bomb on the Seafloor (below).*



## Retreat

Because munitions present a potential explosive hazard, they should never be touched, moved or disturbed (handled); however, at sea, the specific action required will depend on the circumstances.

- If possible, crews should avoid bringing munitions (or suspect munitions) onboard. If a munition is ensnared or fouled in gear, retreat by carefully jettisoning the munition, or by cutting away the gear. If this is not possible, carefully secure the munition onboard and move and keep the crew as far away from the munition as possible.
- Great care should be taken to avoid bumping the munition; each action carries risk.

## **NEVER BRING A MUNITION OR SUSPECT MUNITION INTO PORT**

### **Munitions Not On Board**

If an actual or suspect munition is recovered:

- Immediately stop all operations;
- Do not bring the munition or gear containing it onboard, if possible;
- Do not allow the munition to come or remain along side the vessel where wave action may cause contact with the hull;



*A Clean 5-inch Caliber Projectile (above) and Recovered 5-inch 38 Caliber Projectiles (below)*



- If a munition is in the gear and has not been brought onboard, try to safely lower it back into the water and, as indicated below, note the position and report it to the U.S. Coast Guard.
- If in shallow water (less than 130 feet), lower the munition to the bottom, buoy off the net or dredge recovery lines (remain in the immediate area).
- If in deep water, stream the munition as far aft as possible and maintain steerageway as necessary.
- Remain in the area while awaiting assistance.



A Clean Rifle Grenade (above) and a Recovered Grenade. Item is about four inches long.



### Munitions Onboard

- If the gear is brought over the deck with an actual or suspected munition, but remains suspended and can continue to be safely suspended in place or nearby, immediately:
  - Secure the munition with guy lines to prevent further movement;
  - Keep the crew away from that area.

If a suspect munition is brought onboard:

- Keep unneeded crew members as far away as possible.
- Decide whether to do one of the following:
  - Carefully jettison it, or
  - Retain it onboard.
- If jettisoned, note and report position.
- If retained onboard:
  - Limit handling and avoid hitting or bending any part of the munition;
  - Stow the munition on deck as far away as possible from heat sources, vibration and the crew, but limit handling;
  - Firmly chock and lash the munition to prevent movement;
  - Cover and/or wet to minimize the potential for:
    - Deterioration of metal parts and release of any fill;
    - Explosives to dry out and become sensitive to shock.
  - Keep crew away from item.
  - Request assistance (Channel 16--156.800 MHz).
- If within 2 or 3 hours of land, the safest measure is to notify the U.S. Coast Guard and move to a rendezvous area offshore.

# Report

Careful observation is necessary prior to reporting, so that proper instructions and assistance can be provided. The information you provide may be combined with other reports to produce new warnings to mariners and update nautical charts.

When actual or suspect munitions are encountered at sea, the vessel's captain should notify the U.S. Coast Guard and provide the below information, as soon as possible. (Note: If a munition is encountered while in port [e.g., during off loading or processing] call 911.)



Floating Mine Washed Up on Beach

- The vessel's position (use World Geodetic System 1984 [WGS-84] for reporting).
- If the exact position is unknown, give approximate coordinates, or a range and bearing from a charted feature.
- The activity being conducted when the munition was encountered (e.g., fishing, dredging).
- A general description of the munition's key features (size, shape, fins, props, markings) and condition. (Never attempt to clean, open, or tamper with a munition in any way).
- The action taken (e.g. stowed or jettisoned).
- If jettisoned, also provide:
  - The position of the release, water depth, and buoys or markings used;
  - A description of any entanglement (e.g., net, dredge) or other details.
- Any unusual odors, if noticed.
- Whether the munition was jettisoned:
  - In or near a charted munitions dump;
  - Near (within 1,000 yards of) any surface or sub-surface structures.

**THE US COAST GUARD WILL NOTIFY THE APPROPRIATE MILITARY EXPLOSIVE ORDNANCE DISPOSAL UNIT TO ARRANGE FOR REQUIRED SUPPORT.**

---

## DEPTH CHARGES

Length 28" / Diameter 18" to 25"

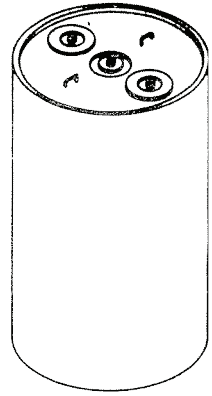
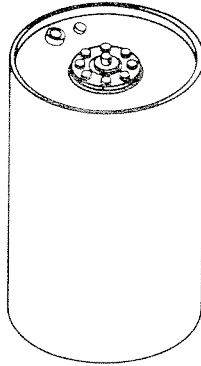
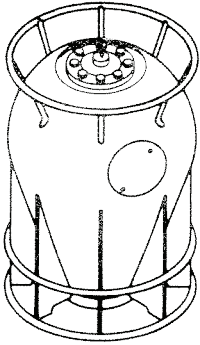

---

## DEPTH BOMB

Length 50" to 59" / Diameter 15" to 18"

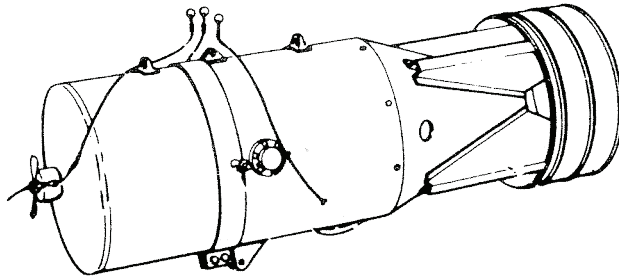

---

## PRACTICE DEPTH CHARGES

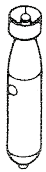



---

**PROJECTED ANTI-SUBMARINE-WARFARE WEAPONS**

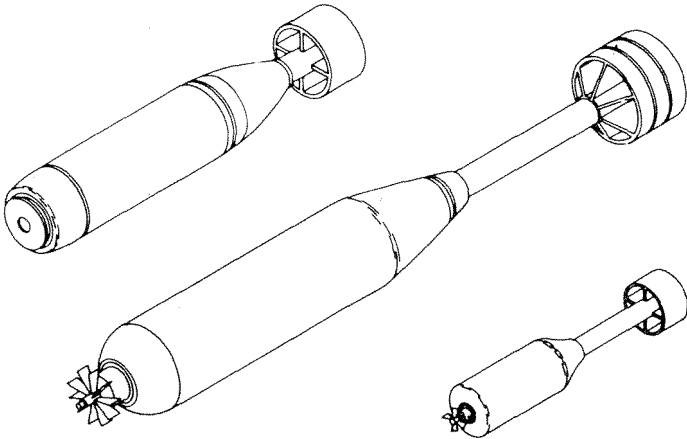

---

**REPRESENTATIVE TORPEDOES**

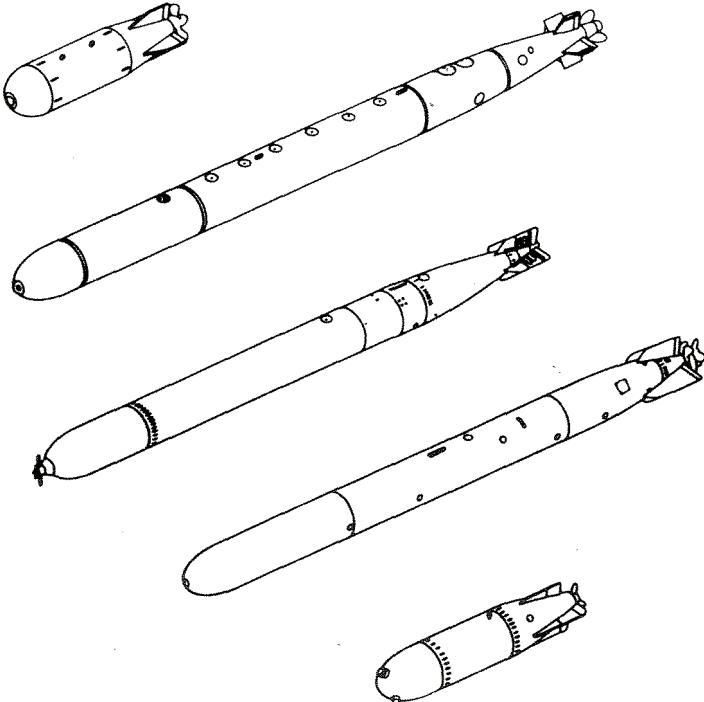

---

## MISCELLANEOUS MINE FLOATS

Length 10" to 24"

Diameter 12" to 18"

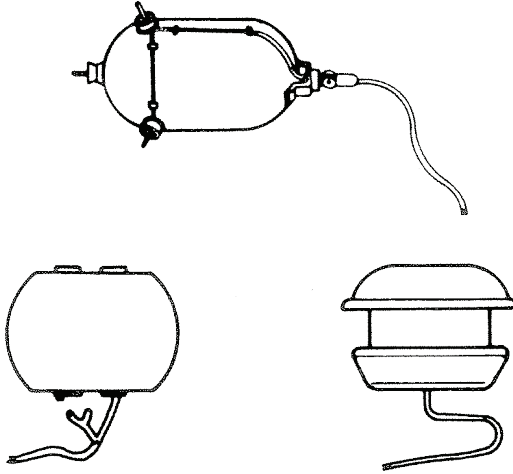

---

## PROJECTILES

Lengths 20 mm to 16"

3" to 5" in Diameter (Typically)

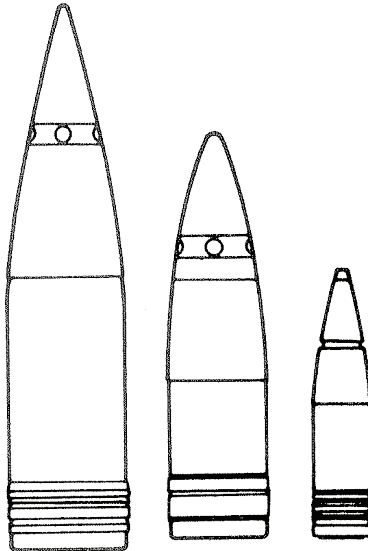

---

## AERIAL BOMBS

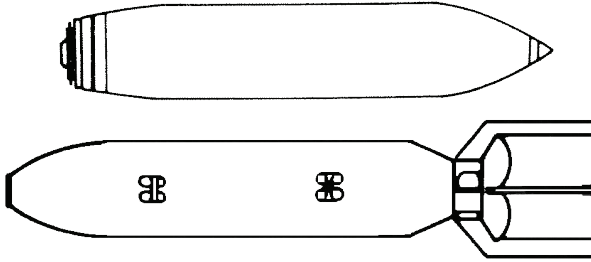

Bomb Body Lengths 39" to 97"

Diameter 7" to 19"

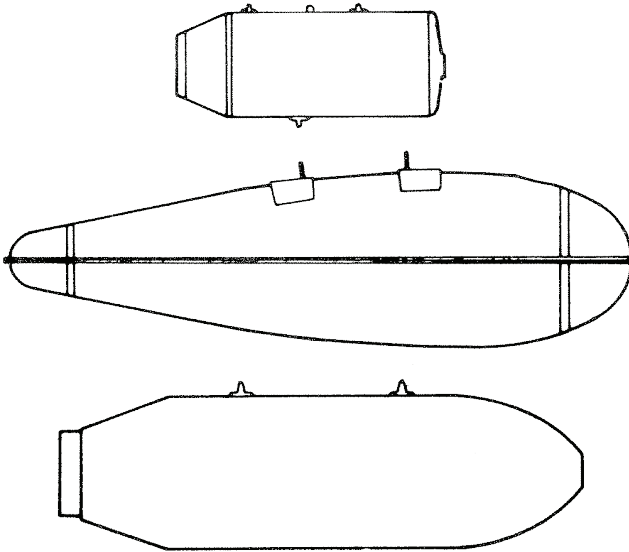

---

## MARKERS AND SIGNALS



Lengths 10" to 18" (Approximately)

Diameter 2" to 5" (Approximately)

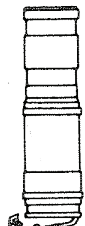

# Don't Forget

- Munitions are dangerous and may not be easily recognizable!
- Avoid military and former military ranges and disposal areas!
- Do not bring munitions on-board!
- Never bring a munition into port, unless directed to do so by USCG!

## Follow the 3Rs

### Recognize

When you may have encountered a munition.

### Retreat

If you know or suspect you have encountered a munition, jettison it or secure it and keep the crew from the immediate area.

### Report

Immediately notify the US Coast Guard of the vessel's or munitions' location and provide a description of the munition.

#### Emergency contacts:

- In Port: Call 911
- At sea: Use Channel 16 (156.800 MHz)



For additional information call  
U.S. Army Technical Center for Explosives Safety  
at (918) 420-8919  
or see

the US Army's UXO Safety Education website  
<https://www.denix.osd.mil/uxosafety>