

# Staff Operations:

---

## The X Corps in Korea, December 1950

by  
Richard W. Stewart



## FOREWORD

"Corps are the Army's largest tactical units, the instruments with which higher echelons of command conduct maneuver at the operational level" (FM 100-5, *Operations*, May 1986). The corps staff is the principal planning and coordinating agency upon which the corps commander relies for the detailed preparation and oversight of his operations. It is the collective brain of the corps. It is useful to examine the performance of a corps staff required by fortune to respond to rapidly shifting circumstances of combat. During the Korean War in 1950, the Army's X Corps was faced with such circumstances, including the necessity to retreat and conduct a forced evacuation by sea, surely one of war's most difficult situations.

Led by Major General Edward M. Almond, X Corps consisted of the 1st Marine Division and two Army divisions. After the Inchon landing and the capture of Seoul, X Corps landed on Korea's northeast coast and moved inland, where it was forced to retreat by attacking Chinese troops. X Corps, nonetheless, fought its way back to the coast and was evacuated by ship at the port of Hungnam.

This Combat Studies Institute Special Study focuses on the withdrawal of X Corps and its evacuation, emphasizing how the corps' staff operated under adversity. Using original corps reports and documents, Dr. Richard W. Stewart provides a penetrating and critical analysis of the X Corps' staff as it faced the demands of retreat. His study reveals significant insights into the complex nature of corps operations with obvious relevance to today's Army.

April 1991



ROGER J. SPILLER, PH.D.  
Director, Combat Studies Institute



CSI publications cover a variety of military history topics. The views expressed in this CSI publication are those of the author and not necessarily those of the Department of the Army or the Department of Defense.

# **Staff Operations:**

---

**The X Corps in Korea,  
December 1950**

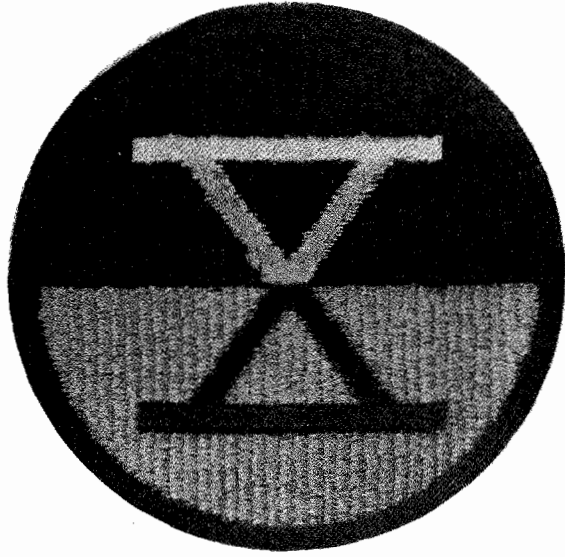

# Staff Operations:

---

## The X Corps in Korea, December 1950

by  
Richard W. Stewart

U.S. Army Command and General Staff College  
Fort Leavenworth, Kansas 66027-6900

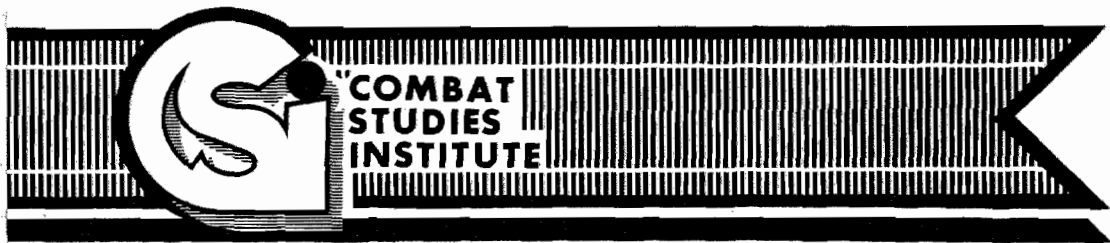

**Library of Congress Cataloging-in-Publication Data**

Stewart, Richard W. (Richard Winship), 1951-  
Staff operations : the X Corps in Korea, December 1950 /  
by Richard W. Stewart.  
p. cm.

Includes bibliographical references.

1. Korean War, 1950-1953—Campaigns—Korea (North)—Changjin Reservoir. 2. Korean War, 1950-1953—Regimental histories—United States. 3. United States. Army. Corps, 10th—History I. Title.

DS912.2.S74 1991  
951.904'2—dc20

90-27286  
CIP

---

## CONTENTS

I. The X Corps: Inchon to the Yalu .....	1
II. The X Corps at Hungnam: The Staff .....	11
III. Managing the Withdrawal .....	21
IV. Conclusions .....	49
Appendix 1. The X Corps' Major Subordinate Units .....	53
Appendix 2. Demolition Table, Hamhung-Hungnam Operation .....	55
Appendix 3. The X Corps' Operating Instructions No. 27 .....	57
Appendix 4. The X Corps' Operations Order No. 10 .....	61
Notes .....	69
Bibliography .....	75

---

# ILLUSTRATIONS

## Figures

1. The X Corps' Hungnam Evacuation Control Group .....19

## Maps

1. The Eighth Army and X Corps' invasion of North Korea .....3
  2. The retreat of X Corps .....15
  3. Phase I: Hungnam evacuation .....22
  4. Phase II: Hungnam evacuation .....31
  5. Phase III: Hungnam evacuation .....33
  6. End of Phase II (modified): Hungnam evacuation .....35
-



# I

## THE X CORPS: INCHON TO THE YALU

The staff becomes an all-controlling bureaucracy, a paper octopus squirting ink and wriggling its tentacles into every corner. Unless pruned with an axe it will grow like a fakir's mango tree, and the more it grows the more it overshadows the general. It creates work, it creates officers, and, above all, it creates the rear-spirit.<sup>1</sup>

— J. F. C. Fuller

A mind that adheres rigidly and unalterably to original plans will never succeed in war, for success goes only to the flexible mind which can conform at the proper moment to a changing situation.<sup>2</sup>

— Hugo von Freytag-Loringhaven

The X Corps in Korea was an unusual, one of a kind, organization. All corps are uniquely configured for their missions and thus tend to break many organizational rules, but the X Corps was unusual even by usual corps standards. The corps was activated on 26 August, barely in time for the Inchon landings it was supposedly responsible for planning. Its commanding general, Major General Edward M. ("Ned") Almond, retained his position as General Douglas MacArthur's chief of staff of the Far Eastern Command (FEC). This was to lead to some ill will between the X Corps' and Eighth Army's logistics personnel. According to some sources, the X Corps used the dual-hatted position of their boss to ensure priority for supplies and personnel for the X Corps at the expense of Eighth Army.<sup>3</sup> This exacerbated Almond's already tense relationship with Lieutenant General Walton H. Walker, Eighth Army commander.<sup>4</sup> In addition, upon assumption of his new command, Almond almost instantly quarreled with Major General Oliver Smith, the commander of the 1st Marine Division which, along with the anemic 7th Infantry Division, comprised his corps. According to one contemporary observer, X Corps was a "hasty throwing together of a provisional Corps headquarters" and was "at best only a half-baked affair."<sup>5</sup> The 1st Marine Division did most of the planning for and execution of the Inchon landings since X Corps was neither fully formed nor experienced enough in amphibious operations to operate as a functional headquarters.<sup>6</sup>

The confusion and coordination problems within X Corps lasted beyond the Inchon landings on 15 September. The capture of Seoul proceeded slowly, and Almond did not endear himself to his units with his excessive prodding for them to move faster

and his meddling that occurred down to regimental and battalion level. Only the overwhelming power of UN forces prevented serious consequences from these problems in coordination and personality at the corps level.<sup>7</sup>

After its capture of Seoul and its linkup with Eighth Army, X Corps was withdrawn through the Inchon beachhead and landed on the eastern coast of Korea at Wonsan and Iwon.<sup>8</sup> Thus, instead of being sent north with Eighth Army, the withdrawing X Corps caused massive confusion and supply bottlenecks. It did not help when advancing Republic of Korea (ROK) forces took Wonsan before the Marine spearheads of the X Corps could make it ashore through the minefields that filled the harbor.<sup>9</sup> The X Corps landings from 25 through 29 October established the U.S. and ROK forces in northeast Korea, but at the same time, the X Corps was virtually isolated from the remainder of the UN forces.<sup>10</sup> Consequently, General Almond drew supplies directly from Japan, bypassing Eighth Army, to rapidly build up his forces. The X Corps, which included the newly arrived 3d Infantry Division, was set for a "race to the Yalu" against crumbling North Korean opposition. It seemed as if the war was winding to a successful close (see map 1).

The heady optimism of October and November 1950 (the "home for Christmas" offensive) soon disappeared as the Siberian winds intruded and a massive Chinese force threw back and crippled X Corps units. The units near the Yalu hurriedly retreated, but the major Marine Corps and Army formations near the Chosin Reservoir were cut off. General Almond and his staff had blindly followed the guidance of the supremely optimistic Far Eastern Command, which seemed to ignore or discount sign after sign of a possible massive Chinese intervention. Almond directed his units to race to the Yalu without regard to their flanks or to the location of any enemy forces. Afterwards, some officers blamed Almond for this apparently reckless behavior. An equal number of officers understood that Almond was only following orders from MacArthur. Nonetheless, Almond almost certainly followed MacArthur blindly and tended to ignore or downplay the warning signs. As a commander of an independent corps, Almond should have been more vigilant and cautious.<sup>11</sup>

Almond pushed his units hard, especially the more conservative 1st Marine Division. General Smith, the Marine commander, was leery of an operation in such mountainous terrain so far from the sea and was cautious—at the cost of numerous prodding visits from Almond. Other division staffs that attempted

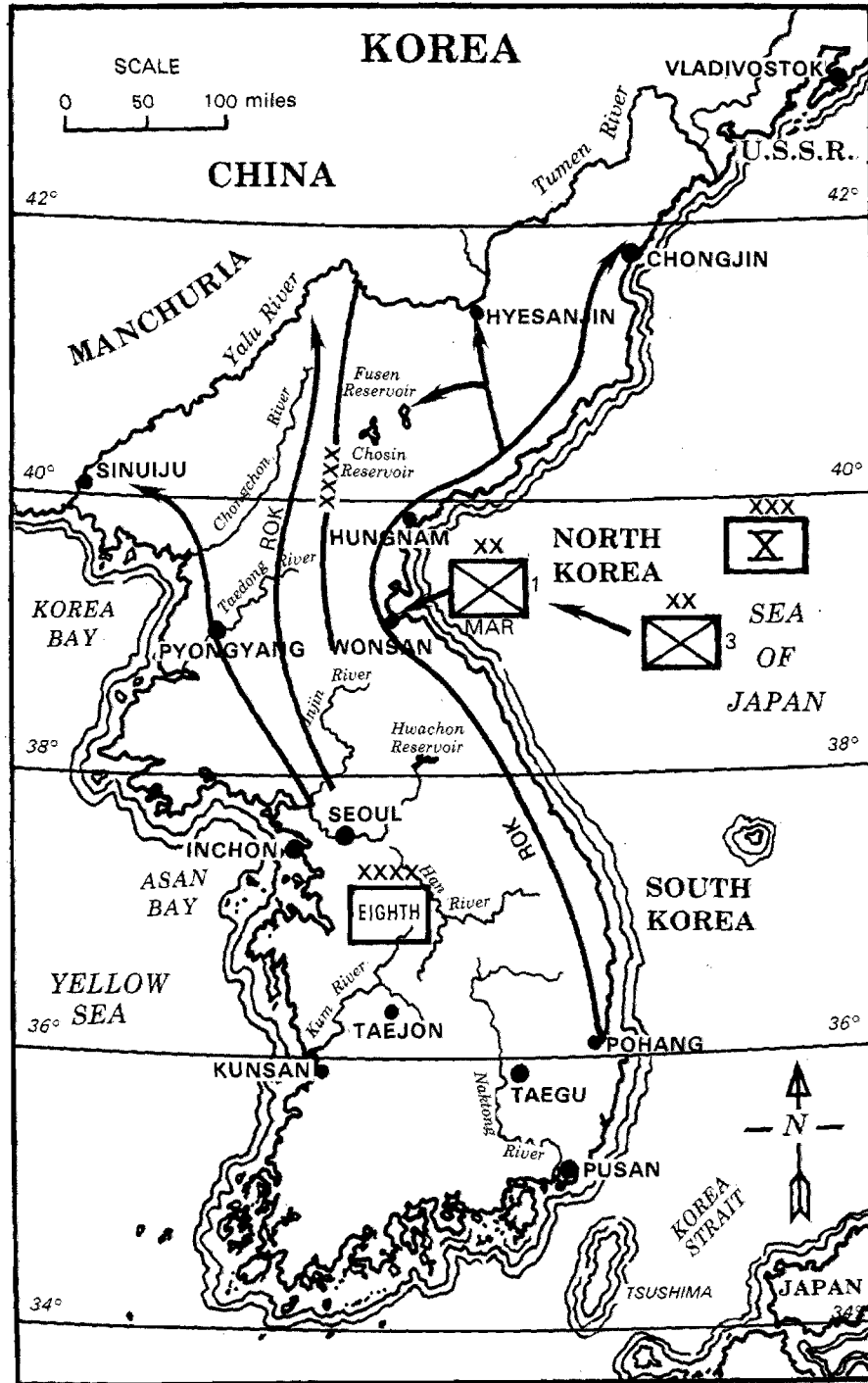

Map 1. The Eighth Army and X Corps' invasion of North Korea

to plan careful, conservative troop advances sometimes lost their subordinate units to the X Corps in Almond's headlong rush to be the first to reach the Yalu. As the G3 of the ill-fated 7th Infantry Division stated:

We planned an orderly concentration and movement to Chosin, by first concentrating the regiments and moving them one by one . . . [but] this plan was never carried out. Before we knew it, Almond ordered our closest battalions and smaller units to Chosin, individually, and as fast as they could get there.<sup>12</sup>

As a result, as one modern author on the Korean War has stated: "The underestimation of CCF strength and the rush to launch the X Corps offensive per schedule on November 27 had led to an ill-advised thinning out of American forces on the east side of the Chosin Reservoir."<sup>13</sup>

So sure were Almond and his staff of the enemy's weakness that they thinned forces across the entire front. The prejudicial intelligence of MacArthur's Far Eastern Command—in particular the intelligence estimates of the FEC's G2, General Willoughby—asserted that a Chinese intervention was highly unlikely but that if it occurred the Chinese would suffer massive casualties to UN air power. This optimism colored the plans and ideas of all subordinate commands. Almond himself, shortly after the start of the Chinese offensive, visited an isolated regimental combat team (Task Force [TF] MacLean) that only a few days later was to be overwhelmed and destroyed while it attempted to break out of an encirclement by a Chinese division. He told the officers of the task force: "The enemy who is delaying you for the moment is nothing more than remnants of Chinese divisions fleeing north . . . We're still attacking and we're going all the way to the Yalu. Don't let a bunch of Chinese laundrymen stop you."<sup>14</sup>

When asked about his perceptions and decisions twenty years later, General Almond stated quite clearly that he had received his marching orders from General MacArthur to determine enemy strength in the area from Hungnam to the Yalu. He was determined to perform that mission until given other orders by MacArthur. Almond stated: "I was concerned with the immediate operations and operated under the orders that were at hand."<sup>15</sup> Nevertheless, this explanation overlooks a commander's responsibility to remain independent in attitude and to rely on his own perceptions of the situation and the ground under his direct observation. Obviously, this was not the creed of Ned Almond.<sup>16</sup>



National Archives

Maj. Gen. Edward M. Almond, commanding general of U.S. X Corps, studying a map in northeast Korea

At the start of the massive Chinese intervention, the X Corps staff at first tried to ignore it or downplay its effect on the corps' offensive plans. Almond himself, seeking guidance from MacArthur, flew to Tokyo and conferred with MacArthur on 28 November. Even while X Corps units were being attacked and cut off by thousands of Chinese, Almond waited until MacArthur made a decision to "readjust his front by withdrawing from the contact with the enemy until it was clearer to all concerned the extent of the invasion."<sup>17</sup>

Almond returned to Korea on the morning of 29 November and only then proceeded to direct the G3 and other staff officers to begin planning for "the discontinuance of the X Corps attack to the northwest and the withdrawal of the Corps forces as a whole to allow for our redeployment in action against the enemy to be decided later by General MacArthur." Whether that redeployment was to be south to Pusan or west to link up with

Eighth Army was not yet clear. Early on the morning of the 30th, Almond assembled his entire staff and the commanders of his divisions, explained to them the new concentration of the corps, and ordered Generals Smith and Barr to "submit a plan for the withdrawal of the 31st and the 32d Regiments from the positions east of the lake into Hagaru-ri and the evacuation of the wounded."<sup>18</sup> (Here Almond was referring to Task Force Faith, previously called Task Force MacLean until Colonel MacLean became missing in action.) However, the plans were not prepared in time, and the task force was virtually destroyed during its retreat to the Marine positions at Hagaru-ri.<sup>19</sup>

The crisis that now faced the X Corps immediately affected the staff. In response to the new guidance and in an attempt to react to the rapidly changing situation for which they had no contingency plans, the X Corps staff prepared a succession of orders, each outlining vastly different types of operations. It then proceeded to publish these orders in rapid order, changing its plans each time before the subordinate divisions could do more than begin to react to the preceding order. As at Inchon, the corps specified missions for regiments and even battalions without coordinating the changes with their respective divisions. The 65th Regimental Combat Team (RCT) of the newly arrived 3d Infantry Division reeled from the confusion emanating from X Corps headquarters. The divisional history of the 3d Division during this period adequately sums up the situation: "During the 1st of December to the 3d of December 1950 three different plans of operations were either initiated or considered and later abolished following changes in orders and missions from higher headquarters . . . [due to the] rapidly changing requirements of Corps."<sup>20</sup> The result was chaos. As another critic of the X Corps staff noted:

For several days the harassed and overburdened X Corps staff, in response to Almond's directives, had been issuing a Niagara of orders to his far-flung units. These orders came down to the divisions, and then to the regiments, in a steady stream. The recipients remembered them as a series of conflicting "march and countermarch" orders that were consistently overtaken by events and that seemed to make little sense and gave the impression that X Corps had lost all control of the situation.<sup>21</sup>

The X Corps staff was doing what corps do worst—reacting to rapidly changing tactical environments. Planning, coordination, and shaping the battlefield are not possible if a corps

staff does not anticipate and foresee battlefield developments forty-eight to seventy-two hours in advance. A corps that is trying to catch up with a bold and unexpected enemy is often a hindrance to its subordinate units. It sends out orders that are old or wrong and do not reflect the current tactical situation. The X Corps staff in Korea in late November and early December 1950 was groping in the dark for solutions to the Chinese attacks and was always too late with its prescriptions.<sup>22</sup>



National Archives

Lt. Gen. Ned Almond of X Corps and his chief of staff, Brig. Gen. John S. Guthrie

MacArthur and his staff's incorrect understanding of the situation was only redeemed, in part, by the heroism and sacrifice of the men of the 1st Marine Division and 7th Infantry Division. Their story—the narrative of the destruction of Task Force Faith and the Marine retreat from Chosin Reservoir—has been told before.<sup>23</sup> What has not been described, or has at best been evaluated superficially, is the way in which the staff of the X Corps recovered from the disasters of the last days of November and early December 1950. In the face of possible destruction, the corps planners managed to arrange, supervise, and execute a series of complex operations beginning in early December. These operations included the successful withdrawal of the 1st Marine Division from the Chosin Reservoir (a “break-out to the coast”), the consolidation of the corps in the Hungnam port area, and then the execution of the deliberate, progressive withdrawal of men and supplies out of Hungnam by 23 December. While not a flawless operation, the withdrawal of 105,000 men, 17,500 vehicles, and 350,000 tons of supplies in 3 weeks

under enemy pressure was an outstanding operation. In an exemplary operation, the X Corps planned and executed those plans, foreseeing developments, preparing contingency plans, and monitoring the daily tactical situation without undue interference. The staff specified missions and boundaries and coordinated only what it needed to as a corps. In other words, it acted as the staff of a corps headquarters and not as a tactical headquarters or a "super division."

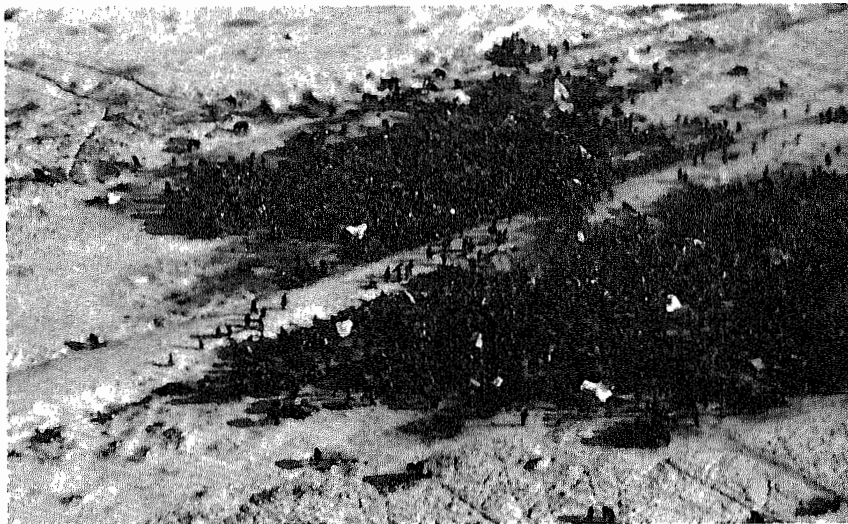

Marine Corps

Marines assembling for their withdrawal from the Chosin Reservoir area

This paper will focus on the withdrawal of X Corps from northeastern Korea and its evacuation through the port of Hungnam. In the process, it will examine how the corps' staff functioned in this critical withdrawal and reconstruct the organization and implementation of the withdrawal and port destruction plans. How the corps' staff actually functioned during this complex operation will be delineated. While much has been written about how great commanders and their troops respond to war, comparatively little work has been done on how a modern staff plans, coordinates, and conducts operations.<sup>24</sup> By examining the command reports, staff journals, and reports of X Corps and its subordinate divisions, this work will reconstruct the flow of information, commands, and guidance from lower to higher headquarters and back again that occurred during this operation. In corps and higher staff operations, this information flow, far from



being a mere bureaucratic exercise, is an essential element in successful staff performance. Critical information must move quickly and accurately along channels if staff decisions are to be correct and timely. Timely information allows the commanders to monitor the tactical situation and to predict with some accuracy operational developments two to three days in the future. Armed with the proper information, a corps can demonstrate initiative rather than merely react. The evacuation of the UN forces from the port of Hungnam was a severe test of the staff and men of X Corps. An examination of the evacuation may reveal how a staff can be trained today to cope with such a complex and fast-moving battlefield.

---

## II

### THE X CORPS AT HUNGNAM: THE STAFF

Command groups and staffs are not just faceless automata, mindlessly and heartlessly concocting grandiose schemes to inflict on the poor combat soldier at the front. They often consist of former commanders who are attempting as best they can to make order out of the chaos of information reaching them. Commanders and their staffs also have distinct styles and personalities that affect their decisions and how they are transmitted to the implementing forces. We have already seen how the X Corps staff coordination at Inchon and Seoul was not what it should have been. The new staff needed time to become a team and resolve the inevitable personality conflicts between staff members and commanders at all echelons. Unfortunately, events moved too swiftly to afford the opportunity for adequate coordination, either in the attack or the withdrawal.

The commander of the X Corps, Major General Edward ("Ned") Almond, has been called "the most controversial senior commander in Korea."<sup>25</sup> General Almond was aggressive, uncompromising, argumentative, unforgiving, and personally brave to the point of recklessness. Even though he had served in the Italian theater in World War II rather than in the Pacific, he was one of MacArthur's most loyal disciples. Once given orders by MacArthur, as we have seen, he would drive his staff, his men, and himself to the utmost to accomplish them. This mission-oriented ferocity made him a terror to his staff and, during his regular flying trips to frontline units, a driver of his men. In one incident late in the Korean War, Almond, unsatisfied with the pace of an advancing reconnaissance column, literally descended upon the unit in his L-5 reconnaissance plane and aggressively chewed it out for sloth. Later, when that same column received a report of 4,000 Chinese just ahead, the commander of the point reportedly declared, "We're going to attack the Chinks. If we turn back, we'll run into General Almond!"<sup>26</sup>

Almond was just as hard on his staff. His G3 after the Hungnam evacuation, Colonel Frank Mildren, admitted that his job was "the first job I'd had in the Army that I thought I couldn't handle." Late hours, high tension, and Almond's perfectionism were almost too much for Mildren and for others of the

staff. In one instance, Mildren recounted Almond's sometimes maddening attention to detail:

Almond loved to draw arrows on maps. One time I brought him a map depicting a ROK operation, but I only had two arrows: one for the main effort; one for a secondary effort. Almond got up and drew in a lot more arrows—seven or eight. I thought he was wrong; it was too great a dispersion of the available forces. So I went back to my office and took off most of the arrows. Later Almond demanded to know, "where are my arrows?" Instead of telling him forthrightly that he was overdispersing the forces, I said, "If you'd presented that solution at Leavenworth [at the Command and General Staff School], they'd have given you a fuzzy U [unsatisfactory]." God, the air turned blue . . . I said, "General Almond, you don't need a G-three." He said, "You're right, I don't." So I left and the next morning I let my assistant give the briefing. Almond demanded, "Where's the G-three? The G-three is supposed to give the briefing." So I got up and gave the briefing, and he never said a word about it.<sup>27</sup>

Almond's leadership style was aggressive to a fault. He liked bold and flashy maneuvers with scant regard for caution or flanks. He liked to create special task forces and had a tendency to tell regiments and even battalions how to fight their battles. He often showed up in person near the point of an attack to spur the "lagging" unit commanders to greater speed, often regardless of the situation. This style spoke well of Almond's personal bravery, but bypassing normal command channels while conducting fast and fragmented attacks set dangerous precedents—precedents that helped cause the heavy loss of life in the "Race to the Yalu" campaign. It also kept Almond's staff in a permanent state of crisis management.

Almond's X Corps staff consisted of a number of highly talented individuals, most of whom went on to higher rank. His chief of staff was Major General Clark L. ("Nick") Ruffner, later to rise to four stars. One of his aides (who flew with Almond to the Chosin perimeter of the doomed Task Force Faith) was Lieutenant Alexander M. Haig, Jr., also to reach four stars, who served as chief of staff in Nixon's White House and secretary of state under President Reagan. Almond's G2 (intelligence) during the evacuation was Lieutenant Colonel William W. ("Bill") Quinn, later to command the 17th Infantry of the 7th Infantry Division and who rose to three stars.<sup>28</sup> One of Almond's assistant chiefs of staff and closest confidants was Lieutenant Colonel William J. MacCaffrey, who retired as a lieutenant general.<sup>29</sup> The corps' G3 (operations and plans) was Lieutenant Colonel Jack Chiles, who felt the constant pressure of Almond's



National Archives

Lieutenant General Almond's G3, Lt. Col. John H. ("Jack") Chiles

leadership style.<sup>30</sup> The G1 (personnel) was Colonel Richard H. Harrison and the G4 (logistics) was Lieutenant Colonel Aubrey Smith.<sup>31</sup> Rounding out this picture of talent was Lieutenant Colonel Edward L. Rowny, the corps engineer, who became a three-star general before retiring and then went on to become President Reagan's chief strategic arms negotiator. Rowny, like McCaffrey, had served in Italy with the 92d Division as Almond's G3. His role in planning the evacuation from Hungnam and the destruction of the port was to be critical to its success.

Another key player in the evacuation was a Marine Corps officer who, while not on the corps staff per se, was attached by the Marines at Inchon and at Hungnam and supervised much of the amphibious operations. This was Colonel E. H. Forney, who was given the position of deputy chief of staff for ship movements and who supervised much of the actual loading of troops and equipment at Hungnam.<sup>32</sup> He worked closely with Colonel Twitty, commander of the 2d Engineer Special Brigade. Colonel Twitty was the base and port commander who, with Colonel Forney, arranged the details of the evacuation from Hungnam. Handling the daunting problem of controlling the flow of refugees was the corps' provost marshal, Lieutenant Colonel William Campbell. The flood of refugees that followed the withdrawing X Corps threatened at times to clog up the vital movement of soldiers and materiel to the south.<sup>33</sup> All of these staff officers had their role to play in X Corps' operations, and none could do it in isolation; to ensure the corps' successful withdrawal under Chinese pressure, staff synchronization and coordination were vital.<sup>34</sup>

The staff actions that resulted in the evacuation of X Corps from northeast Korea began with the 8 December planning conference at X Corps headquarters in Hamhung, just north of Hungnam (see map 2). However, the corps' staff had obviously been thinking about evacuation problems before this time, since they outlined an initial plan for the sealift of the corps out of the port at this meeting. This was an example of diligence and foresight on the staff's part, since the delicate withdrawal of the Marine and Army units from the Chosin Reservoir area was also still under way and needed constant supervision. At this point, at least two major subdivisions in the corps staff existed. One section of the staff was busily planning for the evacuation from the port. The other section was coping with the hourly strains of coordinating the actual withdrawal of forces in the face of the enemy. On 8 December, Marine breakout and linkup forces were still positioned 2,000 yards apart along the narrow road between Koto-ri and Hungnam. (The 1st Battalion of the 1st Marines, backed up by Task Force Dog of the 3d Infantry Division, was pushing north, while the 7th Marines was pushing south.) Only the X Corps staff could orchestrate the fire support, communications, personnel, and materiel necessary to manage that complex operation. The corps staff, however, was already turning at least part of its efforts to the next challenge. Obviously, the corps had already learned one of the most important lessons of staff work: to anticipate developments and begin

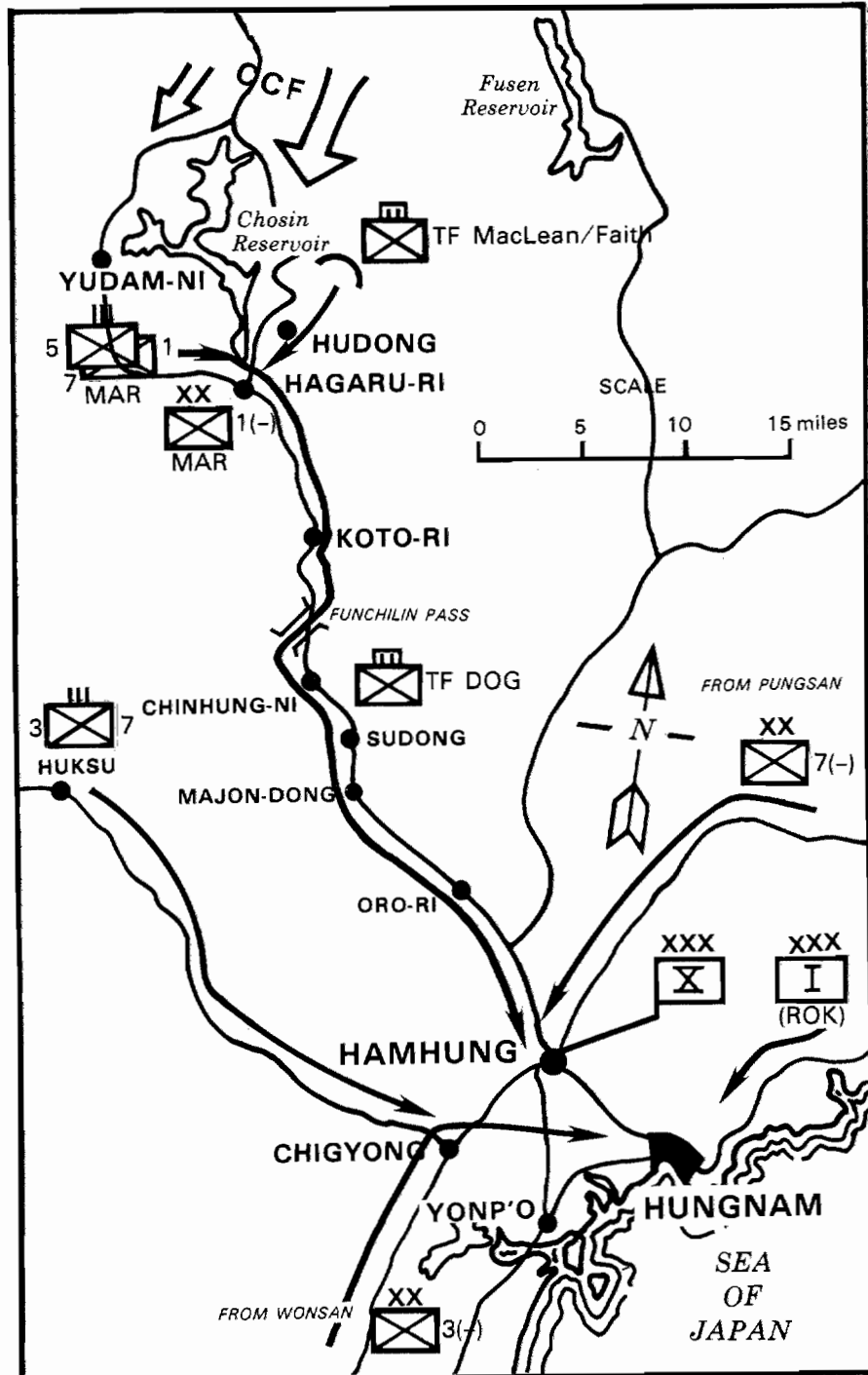

Map 2. The retreat of X Corps

simultaneous contingency planning to meet those developments. As time went on, the corps staff further subdivided as it sent an advance element to Pusan to coordinate the arrival of the evacuated forces, their resupply, and their redeployment as a part of the Eighth Army.<sup>35</sup>

The X Corps staff meeting with Major General Almond at 1030 on 8 December was the first official attempt to deal with the problem of orchestrating and synchronizing the withdrawal. Even so, General Almond was not pleased. He berated his staff for having prepared a plan that used only sealift and ordered them to try again with a plan that utilized *all* possible means of evacuation, including airlift capacity.<sup>36</sup> The staff, in its haste, had violated one of the first rules of staff operations: any plan, even an outline, must address, even if briefly, *all* angles of a problem. In its extreme form, this rule can become almost a "Murphy's Law" of staff work: whatever small aspect of a problem has been overlooked or considered unimportant will be seized on by the commander and used as proof that the staff has not done its work. The X Corps staff immediately began creating a new plan.

Right from the start, the corps staff faced the problems of balancing evacuation means (sea, air, land) and evacuation times (which units, of what type, and when) to ensure that just enough combat power was on hand with enough supplies to defend an ever-shrinking perimeter surrounded by enemy forces. This involved a certain amount of intelligence forecasting, care in framing assumptions, and just plain wild guessing. The staff erred on the side of caution more often than not, in part as a response to the shock of the massive Chinese attacks that drove the corps south along its main supply routes (MSRs).

While planning continued on a more comprehensive withdrawal operation, the land evacuation option rapidly disappeared as Chinese units quickly cut off all roads to the south. An overland convoy would have involved running continual risks of ambush and destruction while necessarily abandoning large quantities of supplies at the Hungnam base. All the available trucks could not have carried more than a small portion of the huge supply dumps at Hungnam. With news just coming in of the frightful destruction of Eighth Army units during the retreat from the Chongchon River (especially the 2d Infantry Division's running of the "gauntlet" at Kunu-ri), the land retreat option grew less and less feasible and was finally completely abandoned.<sup>37</sup> As for air evacuation, that was only possible as

long as the Yonp'o airfield south of Hungnam was retained. In addition, the corps planners realized that airlift was incapable of meeting more than a small fraction of the corps' needs. Yet even though planes were not able to lift tremendous amounts of supplies, air evacuation was especially useful in moving the wounded south to Pusan. Air evacuation was exploited so well that from 10 to 15 December, 3,600 men, 1,300 tons of cargo, 196 vehicles, and even a few refugees were airlifted successfully out of Hungnam.<sup>38</sup>

The corps planners quickly recognized that the most important means for evacuating the X Corps and its equipment was by sealift. There were over 100,000 troops converging on the Hungnam area and around 350,000 tons of military supplies, including 8,635 tons of ammunition, 29,400 fifty-five-gallon drums of fuel and 1,850 tons of food. The number of personnel to be evacuated was increased as well by Almond's courageous decision to evacuate all civil government officials and their families "together with as many other loyal and non-communist citizens as shipping space would allow." When asked later about his decision, Almond explained that while his initial impulse was humanitarian, "I had decided that this humanitarian attitude towards the evacuation of the refugees would in no way interfere with the operations plans of X Corps troop movements."<sup>39</sup> Nevertheless, to accommodate such tremendous numbers of military personnel and civilian refugees—with the addition of the huge volume of equipment and supplies—could only be effected by sea evacuation.

Almond specifically ruled out talk of a Dunkirk-type evacuation, since he wanted to remove all usable supplies and vehicles. At Dunkirk, most of the heavy equipment and supplies were abandoned in order to save the men. That was never an option for General Almond. Despite the gathering of unknown numbers of Chinese divisions to his north, General Almond declared his intent to withdraw deliberately in order to provide the time necessary to allow all equipment and supplies to be withdrawn. Operating Instructions No. 27 (see appendix 3), published on 9 December, explicitly stated that *all* supplies would be moved or, if necessary, destroyed: "Personnel, equipment and supplies ashore not needed in defense of HUNGNAM will be outloaded and shipped to PUSAN-POHANG-DONG area. Supply stocks, while in last priority for outloading, will be out-loaded to the maximum degree possible. Those which cannot will be finally destroyed."<sup>40</sup> Operating Instructions No. 27 also ordered X Corps





National Archives

Part of the 15,000 U.S. troops that retreated from Chosin Reservoir as they rest momentarily on the narrow, frigid road leading to Hungnam

to evacuate by phases to Pusan-Pohang-Dong on the southern tip of Korea. There, the men and equipment would be matched up again, and the corps would move into line as part of Eighth Army. The desperate situation of Eighth Army was recognized by Almond and MacArthur, and this situation required that X Corps preserve as much combat power as possible so that the corps could reconstitute as quickly as possible and join Eighth Army on line.

The importance of logistics in this evacuation was further highlighted by the fact that the logistics annex dealing with the flow of men and supplies was issued as a complete annex A to the operations instruction. The detailed operations order for the defense and withdrawal operation was not issued until 11 December (see appendix 4). Those in charge of the cumbersome logistics system needed even more advance warning of a major shift in operations than did the tacticians.

The operating instructions also established a special "Corps Control Group" under the command of Colonel E. H. Forney (see figure 1). This control group established cells to coordinate the movement of supplies and troop units. During this complicated "amphibious landing in reverse," it was apparent that an experienced Marine Corps officer could best coordinate between the land forces and the Navy. The control group maintained

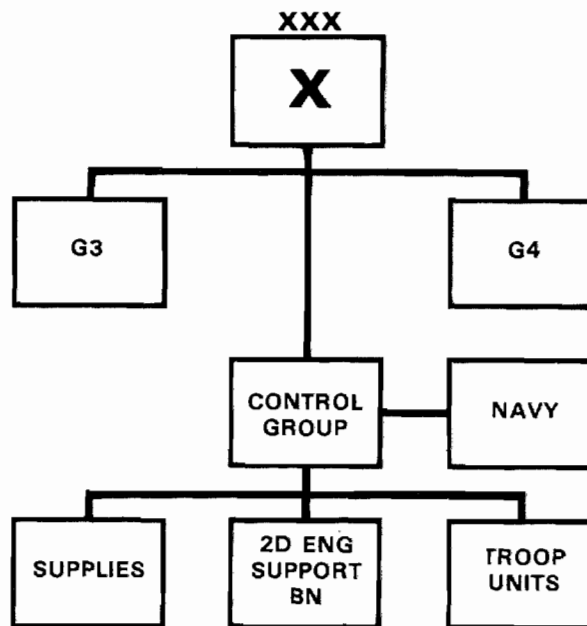

Figure 1. The X Corps' Hungnam Evacuation Control Group

Source: X Corps Special Report, Hungnam Evacuation

constant communications with the Navy, the loading units, the corps headquarters, and the commander of the 2d Engineer Special Brigade, who was responsible for the final staging area.

Another ad hoc control group was established under the command of Lieutenant Colonel Arthur M. Murray. This group went to Pusan to receive the troops and equipment as efficiently as possible in order to send the ships back for another load.<sup>41</sup> This group coordinated the unloading of supplies and expedited the entire process. The unloading of the ships was reduced from the normal three days to one day. This was due in no small measure to the efforts of this control group.

### III

## MANAGING THE WITHDRAWAL

### The Evacuation

The actual evacuation of the port of Hungnam and north-east Korea began as elements of the 1st Marine Division withdrew along the Koto-ri—Hamhung—Hungnam axis (see map 2). Upon reaching the port, the division was immediately loaded on the ships. The Marines had been through an extended ordeal and were loaded as quickly as possible without having them take up a position in the newly established perimeter defenses. However, the attached army elements of the 7th Infantry Division (ID), many of which had been in fighting as severe as that of the Marines, rejoined their parent division without a break and assumed a role in the defense of the X Corps perimeter. It was just as well that the Chinese did not immediately attack the defensive perimeter in force.

The withdrawal of X Corps' units was in the following order: 1st Marine Division, ROK I Corps (3d Division and Capitol Division), U.S. 7th Infantry Division, and U.S. 3d Infantry Division. The Marines were loaded from 9 to 14 December, the ROK I Corps from 15 to 17 December, the U.S. 7th Infantry Division from 18 to 21 December, and U.S. 3d Infantry Division from 21 to 24 December (see map 3). For political and publicity reasons, the Marines, who had just finished a highly publicized and almost disastrous withdrawal from the Chosin Reservoir, were loaded onto ships first. The ROK troops—whose condition was quite poor even though most of their withdrawal was unopposed—came next. Since the 3d Infantry Division was the freshest unit of all—only a few of its battalions had seen combat up to this point—it was the logical choice to stay behind as the rear guard until the last. It covered the withdrawal of the mangled 7th Infantry Division. The 7th, after the destruction of Task Force Faith at Chosin, was virtually a two-regiment division.<sup>42</sup>

During the final stages of the withdrawal, conventional artillery, naval gunfire, and close air support effectively prevented any major enemy forces from endangering the beachhead. The Hungnam perimeter contracted gradually according to the plan outlined in Operations Order No. 10 (see appendix 4). But the Chinese and North Korean forces were kept off-balance and thus were not able to exploit the opportunity. What

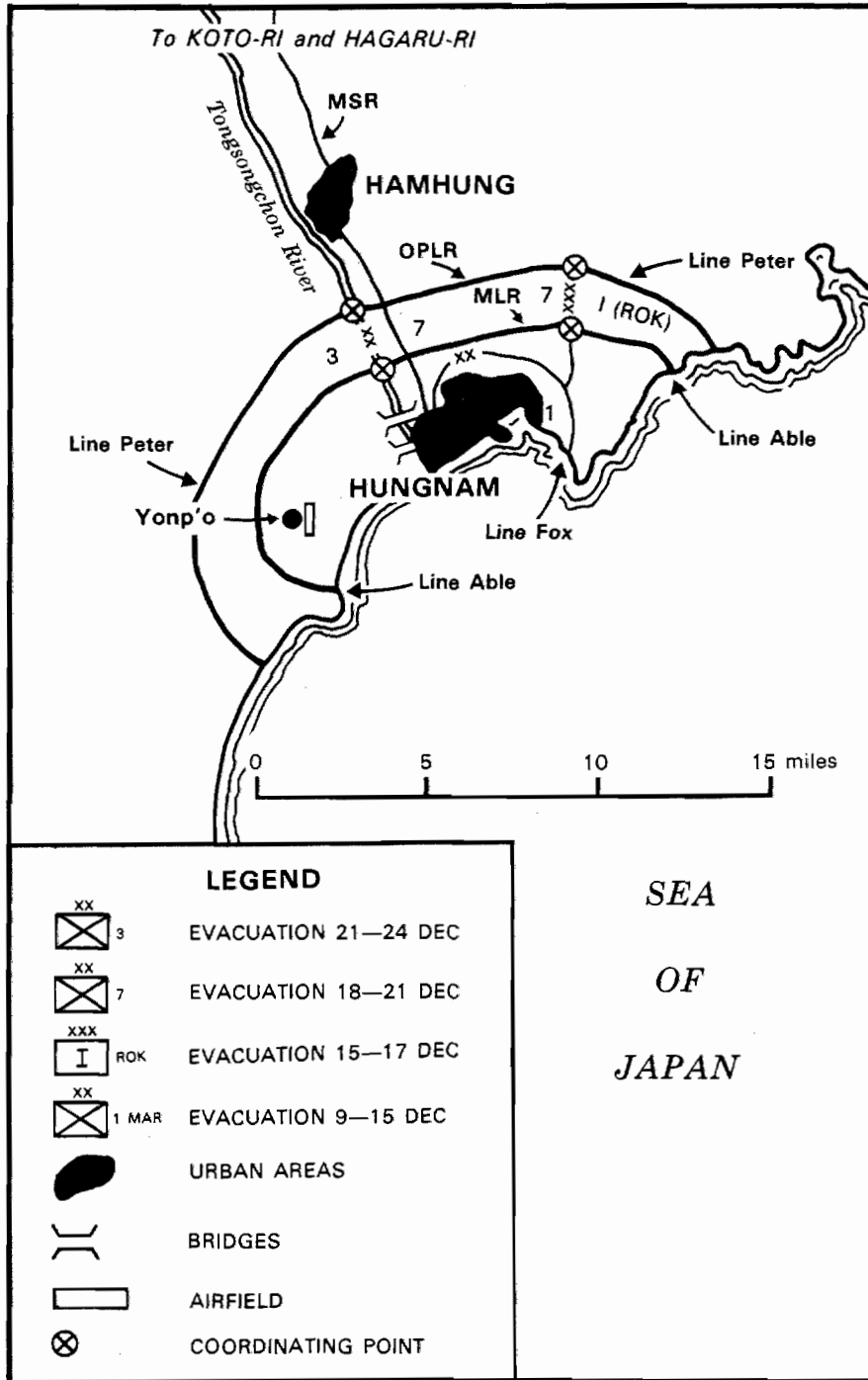

Map 3. Phase I: Hungnam evacuation

few attacks there were occurred on 16, 18, and 19 December, but nowhere did the enemy units penetrate the main line of resistance (MLR). These probing attacks did generate intelligence for the Chinese Communist Forces (CCF), but before that intelligence could be exploited, U.S. forces conducted a series of deliberate withdrawals to new defensive positions. The CCF would thus have to locate and attack new positions all over again in the face of withering air and naval gunfire.

Finally, on 24 December, the last three battalions (one from each regiment) of the 3d ID, which had been covering the removal of its regiments from the perimeter, abandoned their final strongpoints and loaded onto landing craft. Planned demolitions of bridges and rail lines were carried out as these units retreated under close air and naval gunfire support. Finally, the few military supplies left (mostly unserviceable or, in the case of some frozen dynamite, too dangerous to move) were detonated as the convoy sailed for Pusan.<sup>43</sup> Some of the dynamite that was usable was apparently set as booby traps for the Chinese to discover. Lieutenant Colonel Mildren, acting G3, said he had the engineers from the 3d Division "mine all of the toilets. They had pull type chains. We put I forget how many tons of dynamite underneath so that the first person who pulled the chain on a toilet was going to get the shock of his life."<sup>44</sup> The results of these booby traps are not known. The evacuation from Hungnam was no Dunkirk, but it was still a retreat and a demoralizing defeat after the high hopes of November.

### **Simultaneous Planning**

The complexities of the massive withdrawal operation from Hungnam must have seemed overwhelming to the staff of X Corps. Virtually no doctrine guided them, and precious few examples existed of successful withdrawals of such huge quantities of men and equipment in the face of an enemy. When asked later about his lack of guidance, Almond replied: "To be perfectly frank, this operation, practically in its entirety, was entirely new to me and to my staff. I would say that the success of it was due 98% to common sense and judgment and that this common sense and judgment [was] being practiced by all concerned."<sup>45</sup> Without any blueprint, the corps staff had to piece together a plan to synchronize the movement of units, supplies, and equipment into a single port; coordinate for the defensive battle, while slowly loading a mixture of tactical and support units and equipment; juggle the arrival and departure times of ships and planes with the Navy and Air Force; and ensure that



An infantryman guarding a pass twelve miles north of Hamhung during the evacuation

the off-loaded units and equipment were battle ready as quickly as possible after their arrival at Pusan.

The first staff action during the withdrawal of X Corps was to ensure the successful retreat of the 1st Marine Division and their attached Army elements from their positions around Hagaru-ri and Koto-ri to Hungnam. The Marines had managed to concentrate two of their three regiments at Hagaru-ri, while a third was isolated to their south at Koto-ri. Even though the fighting had to be handled by the forces in contact, most of the planning fell on the shoulders of the X Corps.

General Almond was personally involved in the planned withdrawal and reconcentration of forces right from the start. He ordered his staff to begin initial planning on 29 November for the concentration of the corps at Hungnam. He then flew to Hagaru-ri and met with General Smith (1st Marine Division commander), Major General Barr (7th Infantry Division commander), and Brigadier General Hank Hodes (deputy commander, 7th Infantry Division). At this meeting, still surrounded in controversy because of the destruction the following day of Task Force Faith, Almond explained his concept of the withdrawal of the corps. He also ordered Smith and Barr to "submit a plan for the withdrawal of the 31st and 32d Regiments from the positions east of the lake [Chosin Reservoir] into Hagaru-ri and the evacuation of the wounded."<sup>46</sup> He fully expected Smith and Barr to save the cutoff Army forces, but their lack of action doomed Task Force Faith to destruction. After the meeting, Almond returned to his headquarters at Hamhung and ordered his staff to work on the larger plan. Shortly after the Marine units and their attached Army forces gathered at Hagaru-ri on 1 and 2 December, Almond and his staff began orchestrating their breakout attempt.<sup>47</sup> Many of the troops were wounded and exhausted after fighting their way back from Yudam-ni and from the east side of the reservoir. This made the planning for the breakout attempt critical to its ultimate success or failure.

### **Task Force Dog: Holding Open the Door**

For the breakout to be successful, it was essential that the MSR from Hagaru-ri to Hungnam be kept open for the retreating Army and Marine units. The use of Task Force Dog of the 3d Infantry Division was an essential element of the plan to accomplish that mission. Given the state of the 7th Infantry Division, Almond naturally turned to his freshest combat force, the 3d Infantry Division, to provide security to the Hungnam base and the MSR.



Commanders in Korea (left to right): 7th Division artillery commander, Homer W. Kiefer; 7th Infantry Division deputy commander, Brig. Gen. Hank Hodes; X Corps commander, Lieut. Gen. Ned Almond; 7th Infantry Division commander, Maj. Gen. Dave Barr; and Robert B. Powell, commander of the 17th Infantry Division's 17th Infantry. This picture was taken along the banks of the Yalu at Hyesanjin.

The 3d Division was fresh, partly because it had never had a chance to implement most of the orders that reached it from 30 November to 3 December. It had received a series of orders, each of which sent the division in different directions and each of which was superseded before it could be implemented. On 3 December alone, X Corps published Operating Instructions Nos. 23 and 24, each of which caused major reorganizations, reorientations, and boundary changes for the 3d Division.<sup>48</sup> The final order, Operating Instructions No. 24, called upon the division to concentrate in the Hamhung area. This time, the order remained in force. The 3d Infantry Division closed on the Hamhung-Hungnam area from 4 through 7 December, withdrawing from the Wonsan area by road and by sea.

General Almond discussed the need for a special force to hold open the MSR with the 3d Infantry Division commander, Major General Robert Soule, on 5 December.<sup>49</sup> Orders were issued later that day, and TF Dog was formed at 0930 on 6 December at Hamhung. It was placed under the command of an assistant 3d Infantry Division commander, Brigadier General Armistead D. Mead.<sup>50</sup> It consisted of the 3d Battalion, 7th Infantry; the 82d Armored Field Artillery Battalion (Self-



propelled [SP] 155-mm howitzers); the 3d Platoon, 3d Reconnaissance Company; Detachment Headquarters (HQ), 3d Infantry Division (and a detachment from the tactical command post); HQ Detachment, 3d Antiaircraft Artillery (AAA), Automatic Weapons (AW) Battalion (SP); Company A, 73d Engineers (Combat); a detachment of the Ordnance Bomb Disposal Unit; a detachment of the 3d Signal Company; and the 52d Truck Transportation Battalion.<sup>51</sup> TF Dog was further assisted by the 65th RCT and the 999th Field Artillery Battalion, the latter of which was given the mission of general support reinforcing (GSR) of the artillery units assigned to TF Dog.

No time was wasted in getting TF Dog on the road. Established at 0930 on 6 December, it was ordered at 1130 to go to an assembly area at Oro-ri as soon as possible. By 1200, all the newly assembled staff sections had been alerted, and the first unit was on the road north by 1500.<sup>52</sup> By 1530, the entire task force was in convoy, and the advanced command post reached Oro-ri by 1645. It moved quickly up the MSR towards Koto-ri, reaching Majon-dong at 1430 on 7 December. It then pushed on through Sudong to Chinhung-ni (see map 2). This movement enabled the 1st Battalion, 1st Marines, at Chinhung-ni to push north to Funchilin Pass to assist in the critical bridging operations. The X Corps coordinated the dropping of bridging material at Funchilin Pass (the only bridge over a wide



National Archives

The commander of the 3d Infantry Division, Maj. Gen. Robert H. "Shorty" Soule (left), with the commander of the 65th Puerto Rican Regiment, William H. Harris. Soule reinforced X Corps in northeast Korea.

chasm had been destroyed), and by late afternoon of 9 December, the way to the south was clear.<sup>53</sup>

With Navy and Marine air flying close air support and TF Dog providing fire support—aided by the 999th and 58th Field Artillery Battalions and F Battery of the 1st Marine Regiment—the road was kept open. TF Dog coordinated carefully both with air and artillery support and set up blocking positions to ensure control of the MSR. They also filled in holes in the road and controlled the high ground.<sup>54</sup>

The actual meeting of the retreating Marine elements and the northernmost troops of TF Dog occurred near Chinhung-ni at 0240 on 10 December. Marine and Army troops doubtless breathed a sigh of relief as they passed through TF Dog and the rest of the 3d Infantry Division, knowing that the end of their ordeal was in sight.<sup>55</sup> Despite some scattered attacks by small elements of Chinese, the stream of men and vehicles poured south. By 0500, over ninety-four vehicles had passed through TF Dog and double that number by 1000.<sup>56</sup> The Chinese did manage to cut the road at one point near Sudong late on 10 December in the 65th RCT area. A composite Marine force led by two Army officers (one of whom, Lieutenant Colonel John U. D. Page, was killed in action and received the Medal of Honor posthumously) beat back the attack, and the withdrawal continued. By late evening of the 11th, the commander of the 65th RCT was able to report that TF Dog was itself able to retreat and that his G Company arrived at Majon-dong at 1955. "The Gate," he reported, "is closed, the door locked."<sup>57</sup>

The initial phase of the withdrawal of X Corps from northeastern Korea was completed. Staff coordination of all available assets had paid off. However, the hurried nature of the withdrawal, essential under the circumstances, had severely pressed the subordinate staffs. The staff of TF Dog, for example, afterwards complained about the shortness of time allowed them for planning. The new staff needed time to make complete plans and issue detailed orders to units unfamiliar to them. The situation was only overcome by the concerted efforts of the task force commander and his staff, through their "being constantly available for consultation and actively supervising all planning and troop movements." The other complaint, common to any "pick-up" or ad hoc task force, was that "the Task Force Commander did not intimately know the capabilities and personality of subordinate commanders." The TF staff had never worked together

U.S. Marine Corps



An aerial view of the road through the Funchilin Pass south of Koto-ri, December 1950

as a team. The result was that each staff member encountered new command systems and methods that initially caused "a lack of harmony, certain disunity of effort and duplication of work." This disorientation included an unsettling lack of certainty over who would furnish enlisted personnel and even office supplies for the command post (CP)! The TF staff had to operate on a shoestring, and this inhibited the efficient operation and movement of the CP. The unit that provided most of the enlisted personnel and the equipment for the CP apparently was not "habitually required to make rapid and frequent CP displacement. Therefore, there was considerable confusion and delay in breaking down one CP and establishing another." All of these problems were overcome by conscientious staff officers, but such difficulties should be remembered by any commanders when they get the urge to task organize without restraint.<sup>58</sup>

### Port Operations

Once the corps was concentrated in the Hungnam area, the actual withdrawal from the port could begin. The corps had been working on that plan even while managing the withdrawal of the Marine and Army column from Hagaru-ri to the coast. The first and most critical need during the evacuation from Hungnam was a carefully orchestrated defensive plan. This plan was outlined in X Corps Operations Order No. 10. In this plan, the initial defense of the Hamhung-Hungnam area was divided

up among the remaining divisions of X Corps and the retreating elements of ROK I Corps, which was under temporary X Corps control. The 3d Infantry Division was generally responsible for blocking the enemy threats on the western side of the perimeter. The 7th Infantry Division was placed in the northeast sector, and the ROK I Corps—retreating from the far north-east—took up positions along the eastern side of the perimeter (see map 3).

Despite the presence of elements of five Chinese divisions, enemy activity throughout the period of the withdrawal and establishment of the defensive area was minimal. In fact, after it was all over, one infantry regimental commander was puzzled that the CCF “hadn’t really hit us.”<sup>59</sup> After the hammer blows of the last few days of November, it seemed as if the Chinese forces were content with merely forcing X Corps to withdraw. Most enemy actions were restricted to small ambushes, probing attacks, and attempts to infiltrate into the port of Hungnam hidden in the crowds of refugees. This lull was probably the result of the Chinese’ lack of mobility and their rudimentary logistics infrastructure. It also was due to the fact that their attacks on the Marine division and Army regimental combat team were very costly to them.

The initial plan for the phased withdrawal of forces from Hungnam was as follows:

#### **Phase I**

*9–15 December.* A perimeter was to be established including Yonp’o airfield, and the 1st Marine Division was to be withdrawn (see map 3).

#### **Phase II**

*15–18 December.* The corps was to be withdrawn to line Nan. The 3d Infantry Division would then begin to retreat through the 7th Infantry Division’s positions to establish another perimeter along line Fox, close to Hungnam. ROK I Corps was to begin to withdraw to lines Nan and Dog while out-loading one regiment of Marines then attached to the 3d Infantry Division (see map 4).

*18–19 December.* The 3d Infantry Division was then to establish a perimeter along line Fox, while the 7th Infantry Division was to withdraw completely behind the Tongsongchon River defenses along line Dog.

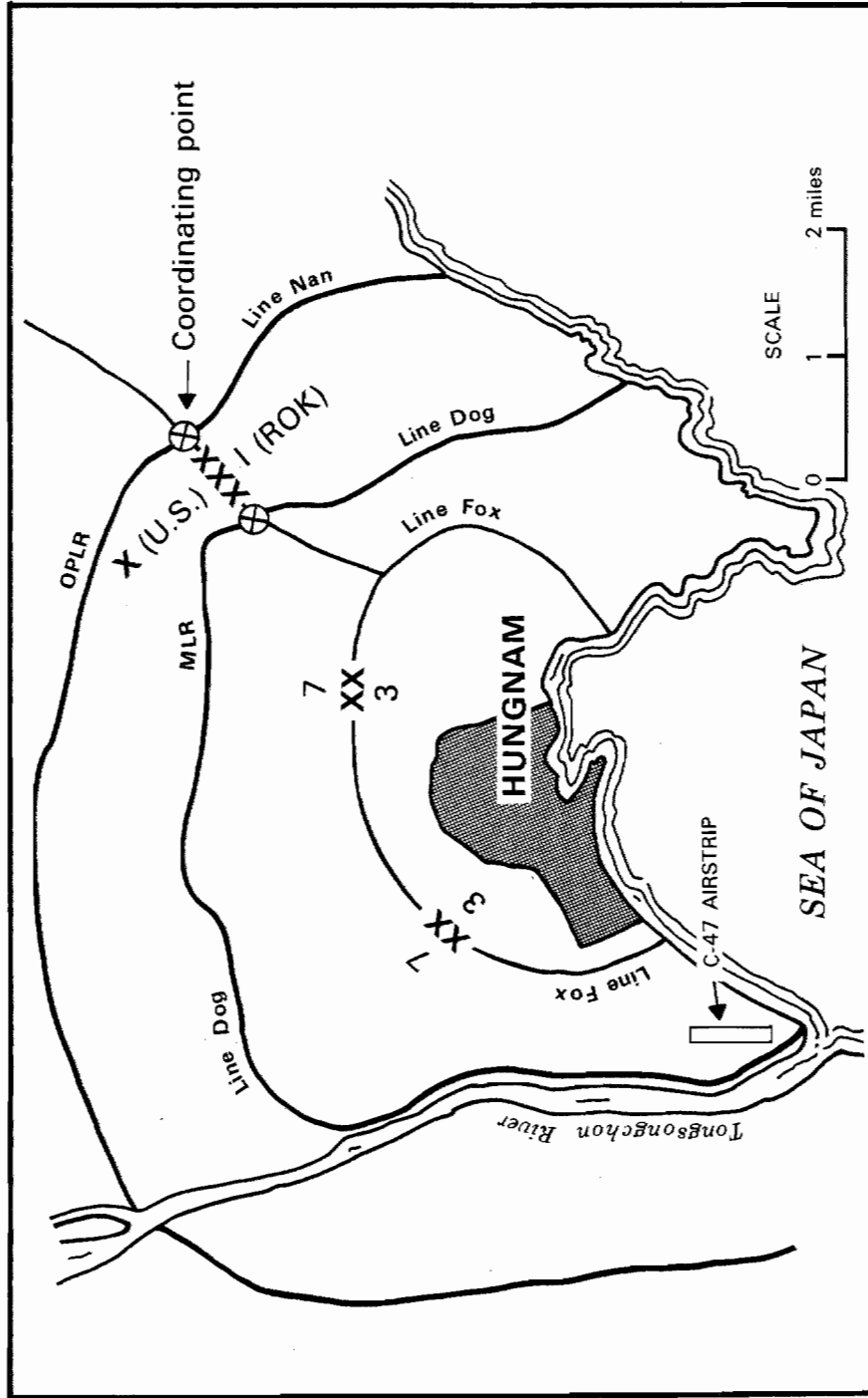

Map 4. Phase II: Hungnam evacuation

Approved for Release by NSA on 05-08-2014 pursuant to E.O. 13526

### Phase III

*19–24 December.* The 7th Infantry Division and the remainder of ROK I Corps were to out-load completely, while the 3d Infantry Division assumed control of the entire shrunken perimeter along line Fox (see map 5). The 3d Infantry Division was then to load its trains while the last of the bulk supplies were taken aboard ships. Gradually the 3d Division was to withdraw its battalions leaving only strongpoints behind until the last minute. Then, the last battalions, one per regiment, were to withdraw completely and move into waiting landing craft for what was in essence a reverse amphibious landing. The demolitions that had been prepared beforehand by the engineers were then to be set off.

Even the best of plans must often be changed, however, and the withdrawal from Hungnam was no exception. The plan had to be modified at the last minute. Phase I went as scheduled, but a meeting of the G3s of the divisions at corps headquarters on the 15th saw a problem developing. The 3d Infantry Division's G3 was worried that if his division withdrew rapidly to line Fox as Phase II planned, it would both overstretch the frontage of the 7th Infantry Division and would prematurely restrict the 3d Infantry Division's maneuvering space. The danger was also that as the 7th Infantry Division pulled back during Phase III, the Chinese could move rapidly on the beachhead. This could expose the final stages of the withdrawal to enemy artillery barrages.

A modified plan was subsequently proposed and accepted that had the 3d Division retain battalion-strength outposts along line Nan in conjunction with the 7th Infantry Division while a portion of the 3d Division was establishing the final defensive perimeter along a modified line Fox. The remainder of the division was to establish strongpoints along the main line of resistance on line Dog. The 3d Infantry Division's 15th Infantry was also given to the 7th Infantry Division, initially to cover the far right of the line after the withdrawal of ROK I Corps. At the end of this modified Phase II, the 7th Infantry Division would withdraw directly to the loading docks, while the outposts on line Nan (now manned by all three regiments of the 3d Infantry Division) held up any enemy attacks (see map 6).

This modified plan was approved, and overlays were distributed in lieu of an operations order. By 1500 on 16 December, the 7th, 65th, and 15th Infantries of the 3d Infantry Division

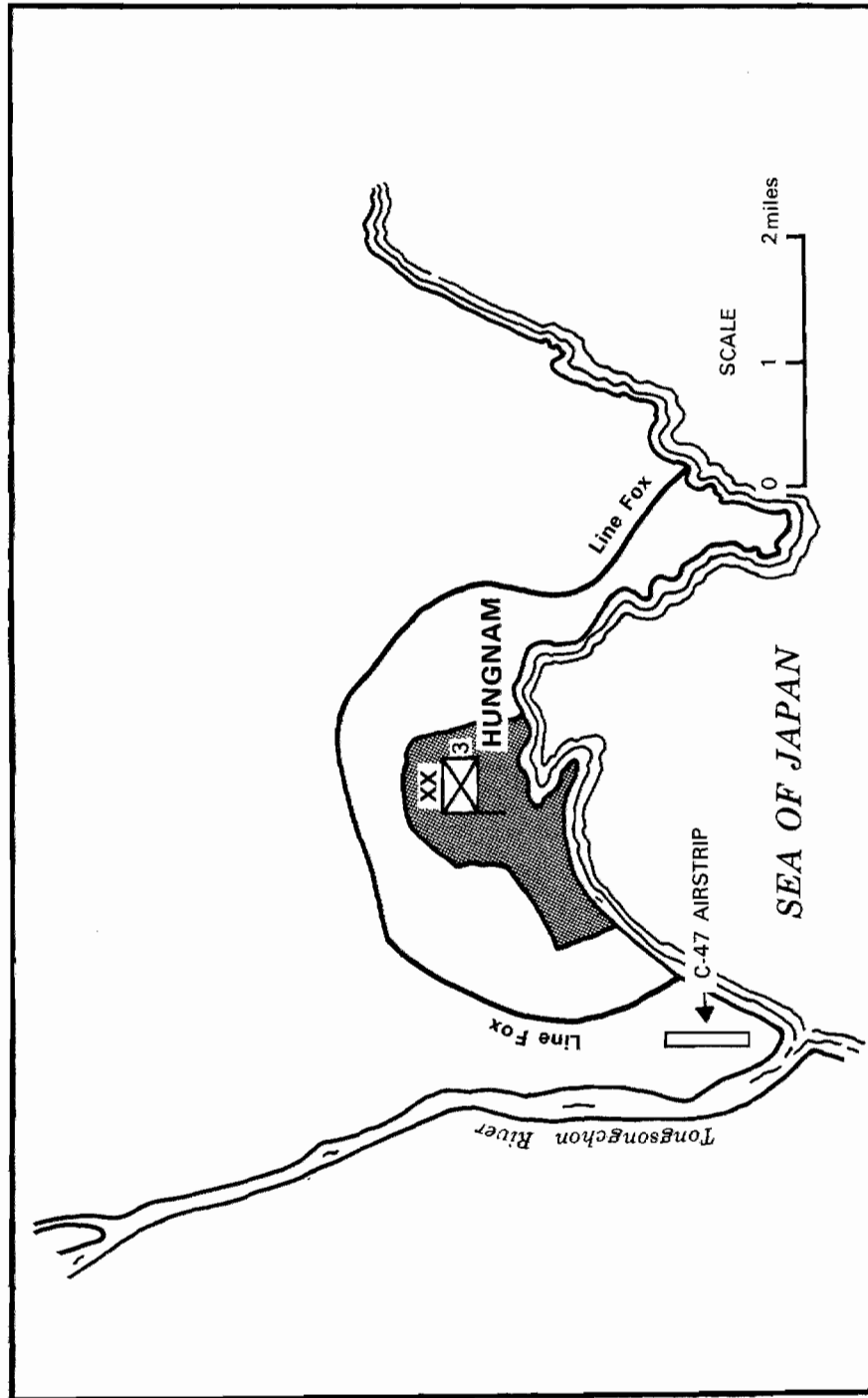

Map 5. Phase III: Hungnam evacuation

had established themselves along line Dog in force, and the 7th Infantry Division created outposts on line Nan. Then, in a further modification, General Almond directed on 17 December that the 7th Infantry Division retain its positions along line Nan until the last minute. Enemy pressure was unexpectedly light, and Almond eagerly sought to buy as much time as possible to load supplies. The 3d Division was temporarily given the 17th Infantry of the 7th Division and then took over complete control, first of line Nan on the 20th and then line Dog on the 21st. The 3d Division retained line Dog until the 23d, when it withdrew again to line Fox. Gradually reducing their frontline strength, selected 3d Division units out-loaded all day on the 23d. Finally, on 24 December, the last battalions of the 3d Infantry Division pulled back to their landing crafts, and the port of Hungnam went up in smoke as the last supplies and buildings were destroyed.<sup>60</sup>

Working together with each other and with the other services and allies, the division and corps staffs were able to improvise successfully to pull off this increasingly complicated withdrawal. Careful planning, the ability to make last-minute changes, and generally successful staff communications were among the keys to the success of this operation. All of these elements had been lacking in earlier X Corps operations. Either the corps staff had gained a certain measure of confidence from months of experience, or else, as seems more likely, their realization that defeat was a real possibility generated a greater attention on their part to detail than they previously had exhibited.

### **Staff Coordination**

Obviously one of the keys to managing the phased withdrawal of UN forces from Hungnam was the establishment of the Evacuation Control Group. This organization ensured that there was a point of contact for staff communications and coordination. The control group managed and controlled both the supply-loading problems and the tasks of supplying the remaining troops with food and ammunition. It also served as the controlling headquarters that would orchestrate the movement of units from the front lines to their designated holding areas and then load them swiftly onto ships. All of these activities had to be carefully coordinated with the tactical staffs so as not to weaken the forces on the observation post line of resistance (OPLR) and the main lines of resistance.



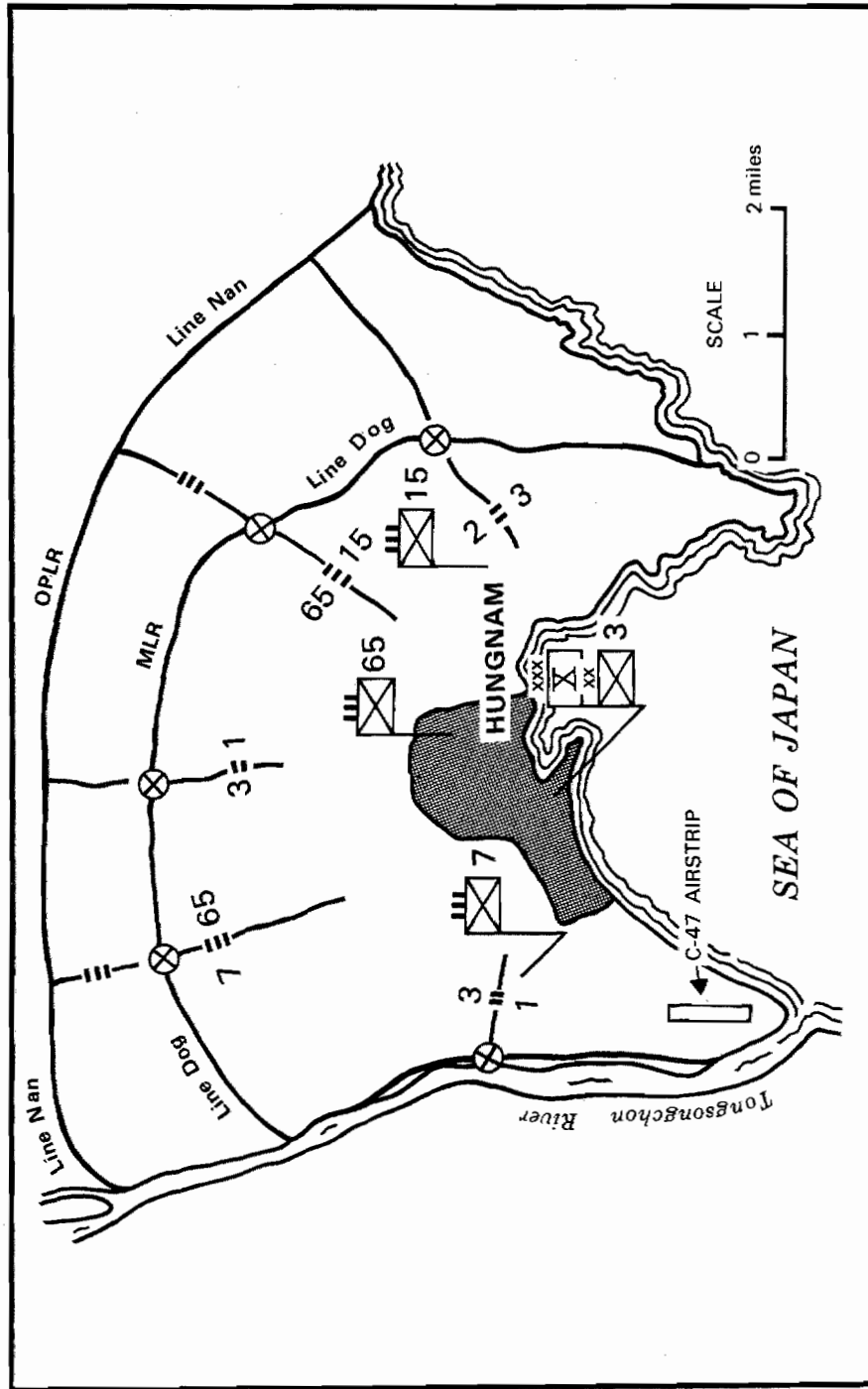

Map 6. End of Phase II (modified): Hungnam evacuation

The use of a control group was an ad hoc method of ensuring that all concerned staff elements had a single point of contact to coordinate all tactical and logistical moves. The control group did not replace the traditional corps staff but rather provided them with a communications node that ensured that each member of the staff knew what the other staff elements were doing. This information flow was then coordinated with the naval personnel and the port facilities operators. The G3 and G4 of the corps remained in primary control of tactical and logistical matters, respectively. However, as soon as the G3 and G4 had agreed on the timing for pulling a unit out of the line, they notified the control group, who then worked out the fine tuning and details of the moving and loading process.

Within the control group, the operating agency was the 2d Engineer Special Brigade. This was the unit that actually supervised the military and civilian personnel (5,000 in number at one point) in the port area and coordinated the loading of the ships. The brigade further supervised a quartermaster battalion, a tank company (security), and an ordnance ammunition company.<sup>61</sup>

The process worked as follows. The tactical unit that was notified through its chain of command of its pullback was required immediately to send back a liaison officer to the control group headquarters. Upon the arrival of this liaison officer, all future operations of that unit were controlled by the control group. The control group managed the road and rail network, the holding areas, and the warehouses and ensured that shipping was available at precisely the moment of the unit's arrival. The designated unit moved back to an assembly area with its equipment (including basic loads of ammunition in case of an unexpected enemy attack). The unit's vehicles were loaded first, followed by the men. The heavier equipment (tanks and artillery pieces) had been loaded before the unit's arrival. The control group directly supervised the loading process and eventually developed its collective skills so that it knew just how long it would take for loading each type of unit. The group then prepared the holding area facilities to accommodate the next arrivals, who were on their way even before the last soldier of the latest increment was loaded.

The establishment and successful operation of the Hungnam Evacuation Control Group was essential to the orderly withdrawal of X Corps. In any corps or higher headquarters, there is no greater problem than communication and coordination.



As the evacuation of Hungnam nears completion, explosives are placed on a pier



National Archives

The docks at Hungnam, as they are blown up on 24 December 1950. Retiring landing craft are shown in the foreground.

Staff elements are always unsure of exactly who has a need to know certain elements of their plans. The control group cut this Gordian knot of confusion by establishing one special working group for this unusual problem with one mission to accomplish: to coordinate an evacuation. All staff elements—especially the G3 and G4—knew exactly what to provide to this central control point and when to provide it. The Evacuation Control Group helped turn a confused, bumbling, half-defeated corps into a successful corps. It turned the corps staff into a model of successful coordination.

The Evacuation Control Group was the critical element that helped ensure that the G2, G3, and G4 staff elements coordinated their actions. As a result, cooperation between all staff elements during the evacuation was apparently superb. However, if the journal entries of the G2 and G3 are any indication of the general flow of communications within the corps, this was not the usual state of affairs in X Corps outside of the control group.

The two critical staff elements for the tactical phases of this operation, as indeed in any military operation, were the G2 and G3. Since the lines of communication and responsibility between these two staff elements were not as clear in the 1950s as they are today, it is important that we clarify the G2 and G3 functional areas of concern at the time and describe briefly how they conducted their daily activities.

The X Corps' G2 prepared and distributed the daily PERINTREPS (periodic intelligence reports) that discussed the enemy situation, possible enemy intentions, recent enemy contacts, summaries of patrol findings, and the status of how the counterintelligence corps (CIC) was handling their portion of the rear battle. This latter problem was a particular concern in this operation because of the number and location of refugees and infiltrators. The G2 had the key staff role in controlling (though not necessarily fighting) the rear battle. In terms of the close battle, the G2 did little more than note instances of enemy activity and then try to match the attacks up with known enemy units. His more critical role was in providing intelligence for use by the few deep battle assets available to the corps commander: mainly Marine, Navy, and Air Force bombing support.

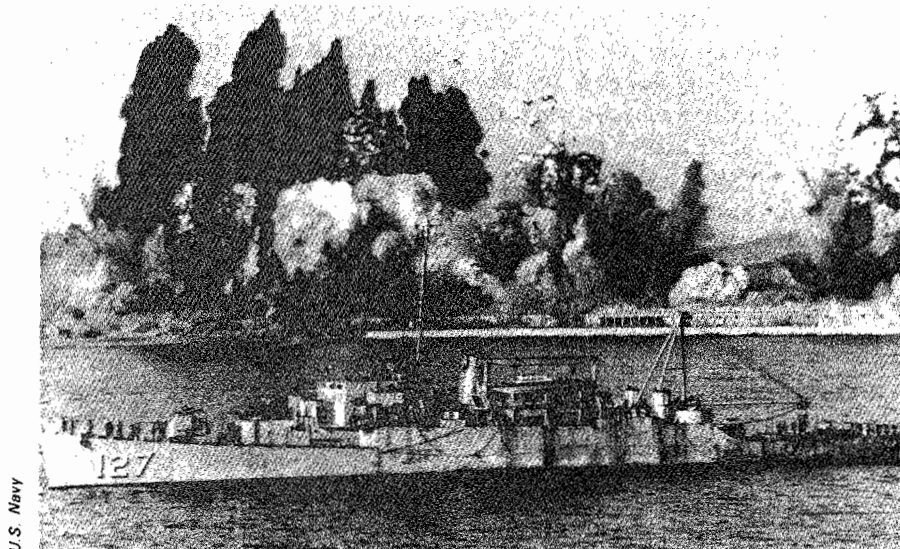

U.S. Navy

As the USS *Begor*, a high-speed transport, rests at anchor in preparation for loading the last UN landing craft, a huge explosion destroys the harbor installations at Hungnam

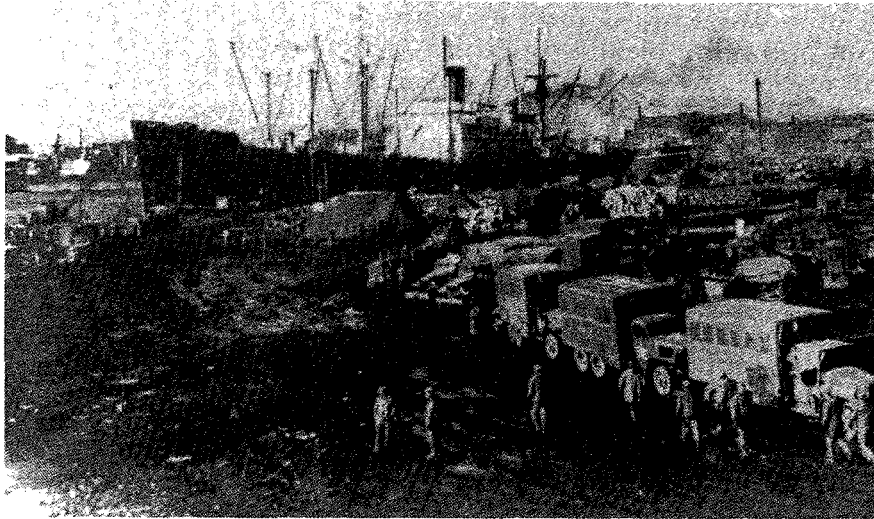

As enemy forces strike the X Corps, the evacuation proceeds

The larger role for fighting the deep battle fell within the purview of the corps' G3. The G3 coordinated the air support missions, the deep artillery strikes, and the naval gunfire. The corps' G3 also was responsible for submitting the daily situation report. This was the PEROPREP (periodic operations report). This report covered the friendly situation, fire support coordination problems, air support, engineering activities, bomblines reports (the line beyond which friendly bombers ran no risk of hitting friendly troops), patrolling-route overlays, and the status of demolition plans. The G3 thus controlled much of the deep battle intelligence collection capabilities and was responsible for acting on many of the results of that collection. Thus, the G3 probably had more knowledge of what was happening deep in the battle zone than did the G2. This was not all bad, since the G3 had the responsibility to fight the deep battle, but there were numerous instances of confusion and duplication of reports that resulted from this partial overlap of duties with the G2. Much of this confusedness can be appreciated by reading the X Corps' staff journals.

While staff journals for any organization are seldom flawless, those of the X Corps during the evacuation show several instances of critical events being reported only to the G2 and not to the G3—and also the other way around. Even a cursory examination of the journals, preserved in the command reports

for the corps, show numerous discrepancies between the journals of the two staff elements. Since the PERINTREPS and PEROPREPS were based on these journals, errors can be tracked as they worked their way into the official summaries for higher and lower distribution. Mistakes resulting from the lack of congruity between these journals, and reports emanating from them, had an impact on corps operations.

An example of how one event was handled highlights this problem. At 0130 on 14 December, Bravo Company, 1st Battalion, 65th Infantry (1-65), 3d Division, was attacked by between 200 and 300 Chinese in the Oro-ri area. (This occurred before the company's withdrawal closer to Hungnam.) The company was forced to withdraw across the river west of the town. Only by daybreak, supported by two other companies and a tank platoon, were they able to restore their positions.

The first report sent to X Corps about this breach in the defensive perimeter was sent to the G2, not the G3, at 0300, one and a half hours after the attack began. An hour and a half time lag cannot be considered unusual, especially since the corps' G2 was probably interested in the event for no other reason than to maintain his order of battle and as an aid to analyzing enemy intentions. However, the G2 journal went on to note at 0400 that the attack ended as of 0350. The G2 summary of the event was a quick statement: "Events of the



U.S. and South Korean infantrymen loading aboard an LCVP at Hungnam



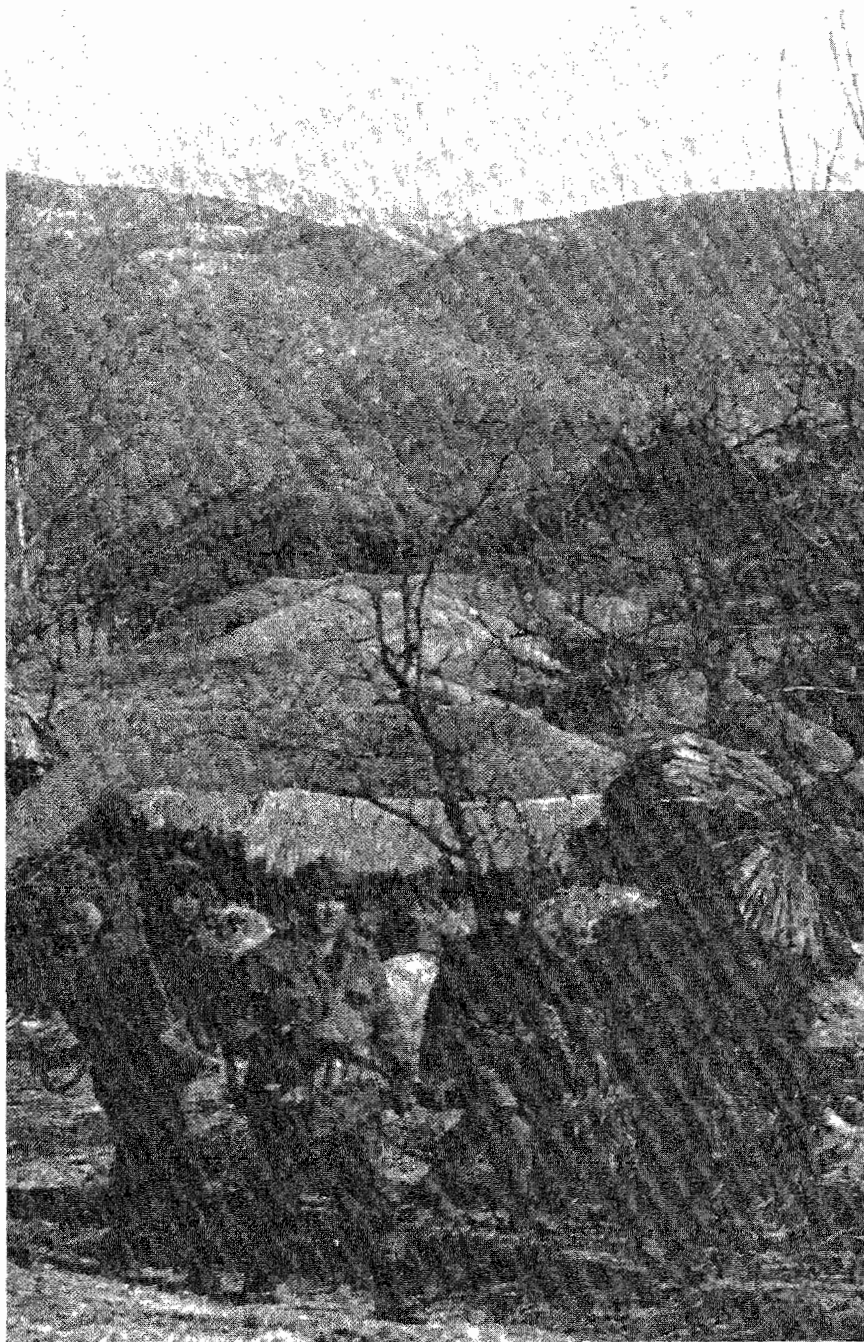

National Archives

Riflemen from the U.S. 65th Infantry, 3d Infantry Division, as they move toward the Hungnam defense perimeter to relieve U.S. forces



past few days emphasize the steady closing in of enemy forces around the X Corps beachhead."<sup>62</sup>

The G3 journal, however, tells a slightly different story of the same event, and it is evident that the two staff elements received their information through different channels at different times and did not share that information. The first report of the attack was sent to the G3, X Corps, by the G3, 3d Infantry Division, at 0320, twenty minutes *after* the X Corps' G2 had been notified. The initial report stated that the enemy had attacked but that the 3d Infantry Division forces had counter-attacked and the situation was "well in hand." This confident report was contradicted at 0445, when it was reported that an estimated 300—400 enemy were still attacking and that artillery was firing on the B/1-65's former positions. Then, at 0840, the division reported that a large counterattack force had been formed and was moving out at 0830 to retake the lost positions. The situation was not as "well in hand" as had been reported earlier. Finally, at 0945, the G3 of the 3d Infantry Division reported that his men were back in Oro-ri and were "mopping up." However, a later report at 1350 indicated that the positions were not actually retaken from the enemy until 1130, so the earlier report of the "mopping up" at 0945 was optimistic to say the least. (The G2 journal does not even list any report after 0400 despite the obvious interest in the details shown by the G3.) This action cost Company B almost one-third of its strength killed, wounded, or missing in action.<sup>63</sup>

This small skirmish (small for the corps, a major attack for B Company) highlights several issues of interest to students of staff coordination. First, it takes time, in this case between one and a half to two hours, for reports—even of major events—to reach a corps headquarters. This, if nothing else, must point out the corps' earlier folly (at the Inchon landings and the race to the Yalu) of trying to control individual battalions or regiments from the corps level. Second, in the example above, the corps' G2 received a battle report twenty minutes before the corps' G3. This points out either a lack of any standard operating procedures (SOP) for reporting combat events (surely the G3 needs to know about the loss of a major frontline position before the G2) or poor reaction on the part of the 3d Infantry Division's G3 personnel. While the battalion and regiment may have been too busy fighting off an attack to report back in great detail, this excuse does not hold for the division. In the press of battle, reports are not the highest priority for the

fighters. However, a division fulfills its role best when, physically removed from the chaos of battle, it reports occurrences clearly and accurately to its higher headquarters. Then it can better arrange for support from air and artillery assets best accessed through corps. This incident also points out what is apparent to anyone reading such staff journals: the G2 and G3 staff elements evidently did not talk to each other as much as they should have, nor did they exchange information regularly. There is no indication that the G2 passed on any of his information to the G3 or that the G3 reciprocated when he began receiving more detailed and regular reports of the action after 0400. Both staff elements had a vested interest in keeping each other informed of the many enemy moves and friendly countermoves. Yet both were guilty of failing to keep the other informed.

Possibly some communications occurred between staff members that were not registered in the staff journals. The staff journals of military organizations, even of a corps headquarters that has the time for more thorough and complete record-keeping procedures than most headquarters, often provide only a listing of receipts of messages from higher and lower headquarters rather than a comprehensive record of information flow and decisions. Thus, staff journals are less than ideal historical sources for determining why specific military decisions are made. Nevertheless, they are often the only reliable sources we have.

Despite these coordination problems between the G2 and G3 at Hungnam, the evacuation went smoothly. The Chinese pressure was not too strong and, with few exceptions, the naval gunfire and air support were excellent. Such fire support was critical to the long-term survival of the evacuation perimeter. In the area of naval gunfire, it was not always easy to coordinate the required support. On at least one occasion, Army and Navy personnel quarreled because of their inability to understand each other's capabilities and planning constraints. On 15 December, the 7th Infantry Division arranged with the Navy for a series of "harassing fire" missions against possible enemy concentrations to its north. The 7th Infantry Division's naval contact at the fire support coordination center (FSCC), a Lieutenant Sheltron, informed the 7th at 2045 that the fire mission was all set and that the Air Force, the ROKs, and the 3d Infantry Division all had been notified. However, at 2140, a Lieutenant Colonel Tabor, also at the FSCC, reported that the fires had been suspended until a friendly patrol cleared the

designated fire area. Only twenty minutes later, Colonel Franson aboard the command ship *Mt. McKinley*, called the 3d Infantry Division's G3 and stated that "Naval personnel went to quite a bit of trouble to clear the fire mission and notify AF [Air Force] opns." He was upset that just prior to the mission going off, it was canceled and the Navy put on standby alert until the patrol could be located. The G3 hastened to inform the colonel that the 7th Infantry Division had been called and "corrective action" was being taken.<sup>64</sup> Just what that corrective action was was not made clear.

It is apparent that 7th Infantry Division personnel did not fully understand, even at this late date, the complex procedure for clearing naval gunfire and how difficult it was to modify a fire plan at the last minute. On the other hand, the Navy apparently did not understand the inexact nature of land warfare—where anything can (and does) happen to delay patrols or cause them to lose communications with small units. All Army units make due allowance for "friction" in the course of every operation, but such inexactness apparently was not understood by the Navy in this instance. Even so, there were hundreds of other successful naval fire missions during the course of the evacuation, including the delivery of 3,000 eight-inch shells; 18,600 five-inch shells; and 162 sixteen-inch shells from the battleship *Missouri*.<sup>65</sup> When this naval artillery support is added to the hundreds of air sorties per day (including "Night Stalker" B-26 flights) and the thousands of rounds of conventional artillery shells fired during the course of the evacuation, it is apparent that the X Corps perimeter was well supported by fire.

## The Refugees

Providing security to the Hungnam perimeter area during X Corps' withdrawal was only one U.S. concern; the refugee problem added an additional concern. As the special report on the Hungnam evacuation states: "The extent of the mass exodus of civilians from their homes as a result of the United Nations' withdrawals in the X Corps zone had not been anticipated."<sup>66</sup> The mass movement of refugees really began when thousands of Koreans followed the columns of Marines as they retreated from Koto-ri. The X Corps' fear of a large-scale infiltration of the Hungnam perimeter prompted it initially to turn away all refugees from the port. As the withdrawal began, the numbers of refugees increased. A rumor apparently began to spread that the UN forces would furnish ships to all who wanted to leave.

The result was a flood of humanity that converged on the port. Over 50,000 refugees from Hamhung tried to board the last refugee train from that city to Hungnam as the UN forces pulled out. The refugees clogged the MSRs, railways, and roads. At Hungnam and Hamhung, even the city officials quit their posts and joined the flood of refugees. Consequently, all civil government and police control broke down.

The X Corps staff attempted to cope with the refugee problem as best it could. The provost marshal, assisted by numerous military police and Counterintelligence Corps (CIC) agents, collected all the refugees and moved them to the nearby village of Soho-jin. The X Corps' civil affairs section chief, Lieutenant Colonel Moore, coordinated with the provost marshal and nearby tactical units to ensure that the refugees were safe, fed, and controlled.<sup>67</sup> He also tried to coordinate with the U.S. advisers of the KMAG (Korean military advisory group) attached to ROK I Corps. However, the ROK commanders seemed mostly concerned with evacuating their own troops.

The refugees, once controlled, were quickly screened by the CIC and military police. Enemy agents were—as far as possible, given the numbers involved—identified and removed for intensive interrogation. Some intelligence information was also gleaned from the remaining refugees.

Following General Almond's policy of evacuating as many refugees as possible, the U.S. and Korean Navies cooperated in making as many cargo ships available as possible. Initially, the loading process was under the control of Lieutenant Colonel Raemon and Lieutenant Dodge of the Hungnam civil affairs team. However, on 19 December, these men were evacuated, and from 20 to 23 December, the 3d Infantry Division had to cope with the problem with only a little assistance from X Corps' provost marshal section. Working in less than ideal circumstances, the division coped as best it could. Tactical commanders at all levels from platoon to division were involved in the refugee problem—either in guarding them, feeding them, moving them, or planning for their evacuation. Authorities loaded a total of 98,100 refugees and evacuated them to the south. Unfortunately, they had to leave almost an equal number behind to attempt to evacuate on foot or else stay to face the consequences.

How the X Corps dealt with the refugee problem at Hungnam points out several interesting lessons. First, since no

U.S. Army

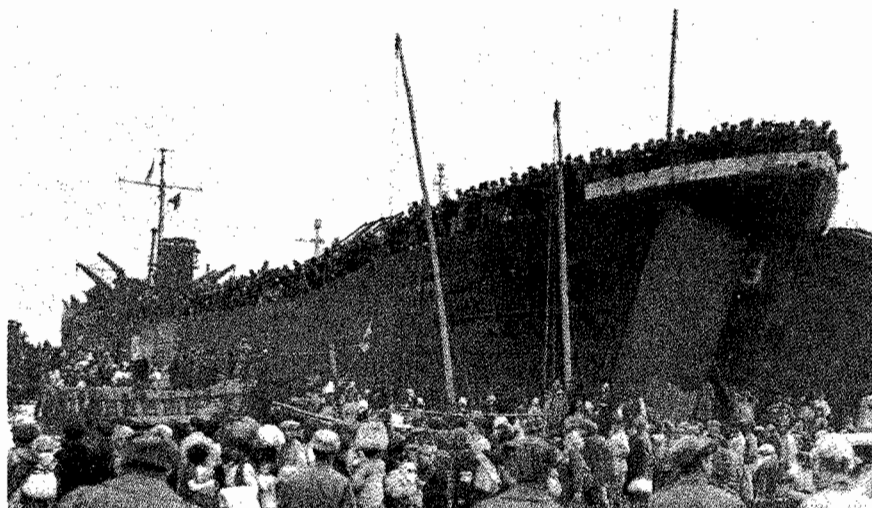

Refugees being evacuated on an LST during the evacuation of Hungnam

one had expected such a large number of refugees, no plans or coordination had been prepared ahead of time. Apparently, it was assumed that the Koreans would handle the problem. When this assumption proved false, the X Corps' staff had to react and throw together a team and plan at the same time a delicate withdrawal operation was under way. The initially uncontrolled flow of refugees compromised the security of the corps and inhibited the smooth functioning of the logistical flow along the MSR. The collapse of all civil government—for which the civil affairs team was an inadequate substitute—compounded the refugee problem. Tactical commanders and military policemen found themselves performing unfamiliar duties. While the X Corps staff reacted well to the problem, clever improvisation was no substitute for carefully thought-out plans. Doubtless, the corps staff did not expect the refugee problem any more than they expected the massive intervention of the Chinese. However, a corps staff—even more than a division staff—must be judged on its ability to prepare for all possible contingencies and to plan accordingly.

Another lesson which can be learned from the Hungnam refugee problem is that even though the problem was handled for the most part by corps resources, the tactical units were not unaffected by the problem. The tactical units had to deal with the refugees in their areas and contend with the threat to their

own movement and security. Tactical commanders, such as the 3d Infantry Division commander who was left virtually on his own with the refugees at the very end, cannot afford to assume that refugees will not be a problem. Refugees posed a problem for all units in the area as they attempted to move, screen, feed, and evacuate them. A staff problem in this instance had a way of becoming a tactical problem as well.

---

## IV CONCLUSIONS

A number of conclusions and lessons can be drawn from X Corps' experience in its evacuation from Hungnam:

### **Communications**

The establishment of a centralized control group was a critical element in ensuring the timely flow of information on coordination measures in the evacuation from Hungnam. Through the use of a centralized control group, X Corps continued its normal staff operations of coordinating tactical moves, fire support, close air support, reconnaissance, and movement plans while managing the evacuation. From X Corps' experience, we can assume that extensive coordination is needed to perform even the simplest of manipulations of a corps.

### **Vision**

X Corps should have anticipated the nature of its developing battlefield further in advance and with greater clarity. A corps, with all of its logistical and support activities, is cumbersome to move and needs all the warning that farsighted staff officers can provide. In regard to tactical operations, a corps' ability to understand the full range of battlefield possibilities (encompassing the deep, close, and rear battles) is of vital importance to its subordinate divisions. Corps can warn their subordinate units of impending attacks, prepare contingency plans, wargame courses of action, and do in-depth analysis of possible courses of action. Few of these activities are possible in anywhere near the same degree of detail at a division headquarters (as opposed to a corps headquarters).

### **Joint and Combined Operations**

Any corps can expect to be involved in joint or combined operations. Naval gunfire, Marine or Air Force air support, allied forces, refugees, host government programs, and a multitude of other coordination opportunities could present themselves to a corps. Although most corps may not be separate corps, these eventualities cannot be ruled out. Corps must learn to function at an operational level in political and military affairs and not focus on what is perhaps most familiar to most officers—tactics at the brigade or battalion level. Major political concerns, civil problems, joint and combined military operations, and even strategic plans must become the stock-in-trade of the corps' staff

officers. Current military training barely touches the surface on most of these issues.

### Focus

In general, a corps headquarters, such as that of the X Corps in Korea in November and December 1950, is successful and useful if it focuses on what it does best: long-term planning, coordinating movements of subordinate units, and coping with the logistical situation while fighting the deep and rear battles. It is least successful when it tries to micromanage the battlefield and move battalions around in a vain attempt to react quickly enough to outperform a rapidly developing threat. This is as true in the defense as it is in the offense. As the doctrine of the time stated: "The Corps issues the necessary instructions to assure coordination between adjacent divisions. As a rule, the detailed execution of defensive measures will be left to the division."<sup>68</sup> Corps must analyze and control the full range of operations (especially deep and rear operations) while allowing divisions to fight their own portion of the battle.

### Doctrine

The doctrine for large units in 1950 consisted of general statements in Field Manual 100-15, *Field Service Regulations for Larger Units*.<sup>69</sup> The need for a corps to focus on the deep battle comes through unmistakably in this manual as does the concern that corps obtain accurate and timely intelligence about enemy long-range intentions:

The Corps plan must be projected well into the future; they must envisage action days in advance. . . . Adequate and timely information of the enemy must be assured if the commander is to make the maximum use of his own forces and employ them decisively. . . . Plans for the employment of the corps cannot be improvised. From the initiation of operations until their conclusion the corps commander and his staff must be planning far in advance of the current situation. . . . Failure of large units to prepare suitable plans for future action may so delay the execution of suitable measures as to jeopardize the operations of the corps and higher units.<sup>70</sup>

All of these points reinforce what corps must understand as a matter of course: they cannot be taken for granted.

The race to the Yalu and the Chosin Reservoir campaign were painful defeats because, to a great extent, X Corps did not follow its own doctrine of foreseeing events and planning for all contingencies. The corps jeopardized its own operations and almost presented the Eighth Army and the U.S. government



with a catastrophic defeat due to its lack of vision. The Far Eastern Command and General MacArthur must share in this blame, but the X Corps was the controlling headquarters and could have done more to analyze and plan for different contingencies. The recovery of the situation after the disastrous defeats of late November and early December were partly a result of X Corps' remembering how a corps should act. The evacuation of Hungnam was a considerable triumph because X Corps recalled its proper role and coordinated as a corps should.

---

# APPENDIX 1

## The X Corps' Major Subordinate Units

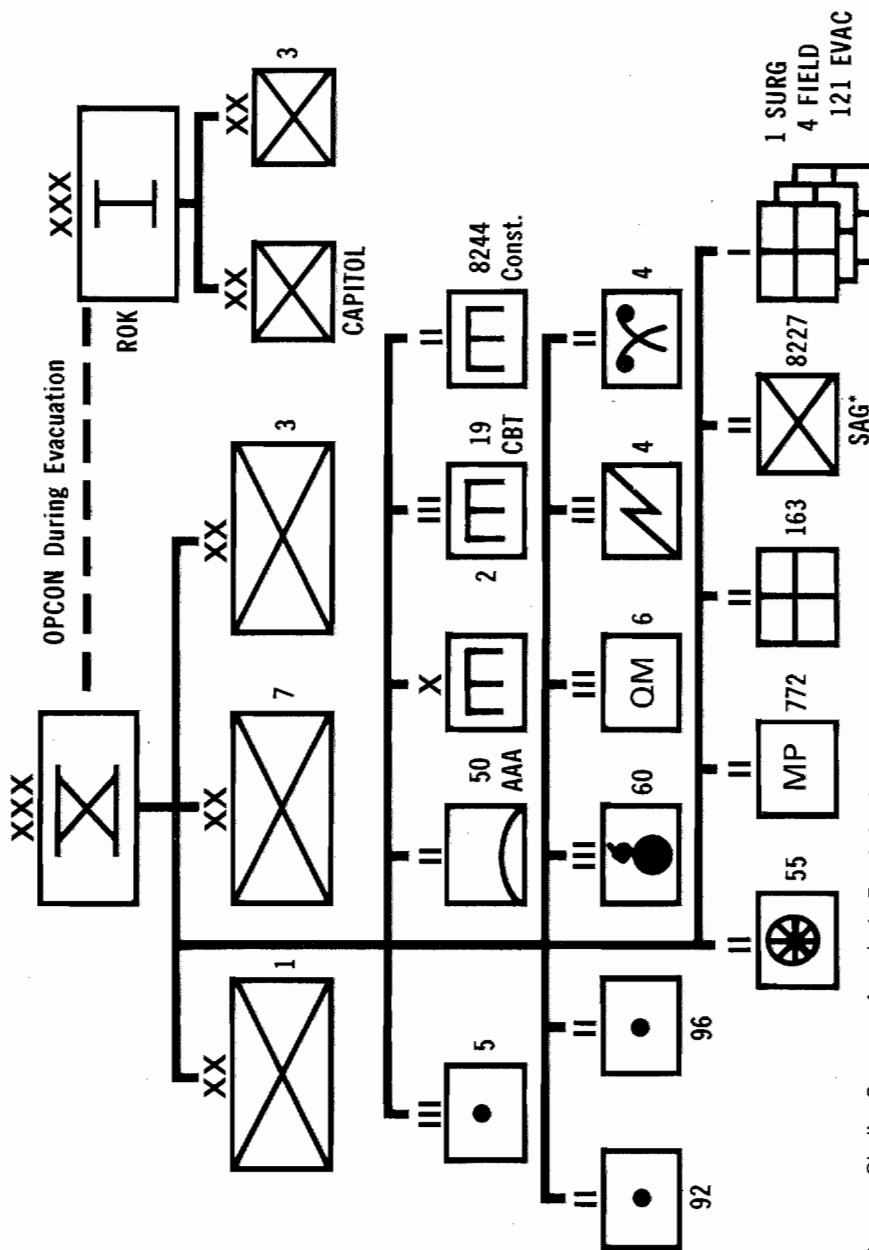

Source: Shelby Stanton, *America's Tenth Legion*, 331-32.

## APPENDIX 2

### Demolition Table, Hamhung-Hungnam Operation

NO	FACILITY OR INSTALLATION	COORDINATES	DESTROYED BY	DATE	REMARKS
1	Bay Bridge	CV 5171	1st Mar Div	10 Dec 50	Blown
2	Bay Bridge	CV 5660	1st Mar Div	14 Dec 50	Blown under fire
3	Bay Bridge	CV 5654	1st Mar Div	15 Dec 50	Steel treadway blown under fire
4	Defile	CV 4723	3d Inf Div	Approx 7 Dec 50	Road crater
5	Defile	CV 4726	3d Inf Div	Approx 7 Dec 50	Road crater
6	Bay Bridge	CV 6831	3d Inf Div	16 Dec 50	Blown
7	Low-Level Wooden Bridge	CV 7221	3d Inf Div	18 Dec 50	Blown and burned
8	Bay Bridge	CV 7820	7th Inf Div	18 Dec 50	Blown
9	RR Rolling Stock RR Turntable	CV 7719	X Corps Engr	18 Dec 50	Blown and burned
10	RR Bridge	CV 7718	7th Inf Div	18 Dec 50	Blown
11	Bay Bridge	CV 7418	3d Inf Div	18 Dec 50	Blown
12	Bay Bridge	CV 7318	3d Inf Div	18 Dec 50	Blown
13	RR Bridge	CV 7417	X Corps Engr	17-18 Dec 50	300 Pr cars engines blown and burned
14	RR Overpass	CV 7517	3d Inf Div	18 Dec 50	Blown
15	Bay Bridge RR Bridge	CV 7716	7th Inf Div	18 Dec 50	Blown
16	Bay Bridge	CV 6612	3d Inf Div	16 Dec 50	Blown
17	Low-Level Wooden Bridge	CV 7712	3d Inf Div	21 Dec 50	Blown and burned
18	Bay Bridge	CV 7810	3d Inf Div	21 Dec 50	Blown
19	Pier #1 and cranes	CV 8209	Navy UDT	24 Dec 50	Blown plus NGT
20	RR Tunnel	CV 8508	Cap Div (ROK)	Approx 18 Dec 50	Blown
21	RR Tunnel	CV 8913	Cap Div (ROK)	Approx 18 Dec 50	Blown
22	RR Tunnel	CV 9213	Cap Div (ROK)	Approx 18 Dec 50	Blown
23	RR Tunnel	CV 9615	Cap Div (ROK)	Approx 15 Dec 50	Blown
24	RR Tunnel	CV 9616	Cap Div (ROK)	Approx 15 Dec 50	Blown
25	RR Tunnel	CV 9817	Cap Div (ROK)	Approx 15 Dec 50	Blown

<i>NO</i>	<i>FACILITY OR INSTALLATION</i>	<i>COORDINATES</i>	<i>DESTROYED BY</i>	<i>DATE</i>	<i>REMARKS</i>
26	Defile	CV 6904	3d Inf Div	Approx 10 Dec 50	Road crater
27	Bay Bridge	CV 7203	3d Inf Div	Approx 10 Dec 50	Blown
28	Defile	CV 9504	Cap Div (ROK)	Approx 15 Dec 50	Road crater
29	Defile	CV 9704	Cap Div (ROK)	Approx 15 Dec 50	Road crater

---

## APPENDIX 3

### The X Corps' Operating Instructions No. 27

X Corps  
APT 909  
9 Dec 50

OI 27

Task Organ: N/C

1. X Corps initiates withdrawal by water and air without delay from HUNGNAM area to PUSAN - POHANG-DONG area.
2. Opns O to be issued separately.
3. Logistical Instructions for Embarkation, Annex A.

ALMOND  
Maj Gen

Annex "A": Logistical Instructions for Embarkation

Distr: C, Plus  
I ROK Corps  
Com 7th Flt  
CTF 77

OFFICIAL:

Chiles

G-3

Annex A to OI 27

***Logistical Instructions for Embarkation***

1. Personnel, equipment and supplies ashore not needed in defense of HUNGNAM will be outloaded and shipped to PUSAN - POHANG-DONG area. Supply stocks while in last priority for outloading, will be outloaded to the maximum degree possible. Those which cannot will be finally destroyed.
2. Equipment and supplies afloat, except that urgently needed ashore, will be diverted to target area.
3. X Corps Control Group, Col E. H. Forney, in charge, is responsible for maintaining a continuous flow of personnel and equipment out of HUNGNAM area. Designated representatives of major units will report to the X Corps Control Officer with descriptive list of personnel and equipment to be outloaded. The Commanding General, 1st Mar Div will furnish TQM assistance as requested by Col Forney.
4. The CO 2d ESB, with 1st Shore Party Bn FMF and 58th MP Co attached, will be responsible for loading, for operation of port facilities, and for stocking ships, when needed, with B rations for consumption during voyage. Troop assistance will be made available by debarking units as required.
5. The 2d ESB, with 79th Engr C Bn attached, will be responsible for operation of final staging areas. Units reporting to this area will be fed and sheltered by 2d Engr Spec Brigade. Troop assistance will be made available by embarking units as required.
6. Units are responsible for initial assembly of personnel and equipment.
7. Movement from initial areas will be directed by the X Corps Control Officer.
8. Personnel will report to final staging areas with hand carried baggage and equipment only. Remainder of personal equipment and clothing will be carried on organic vehicles.

Vehicles will be stowed no higher than cab height and with nothing protruding beyond the sides and rear of the truck.

9. Units moved to the final staging area will remain there until called to the loading point.

10. When called to the final loading point, each vehicle will be manned by one driver who accompanies the vehicle until debarked at destination.

11. Operational rations are in short supply and must be conserved for units in contact.

12. Units will carry basic load of ammunition on transport.

13. Units of Bn or larger sizes will send advance detachments to PUSAN. Arrangement for such parties will be made through G-4, X Corps.

ALMOND  
Maj Gen

OFFICIAL:

Smith

G-4

---

## APPENDIX 4

### The X Corps' Operations Order No. 10

X Corps  
APO 909  
11 Dec 50

Opn O 10  
Map: KOREA, 1:50,000

Task Orgn, Annex A.

1. a. Annex B, Intel.  
b. FEAF and NAVFE Spt X Corps Opns. Eighth Army delays on successive Psns to the South.
2. X Corps withdraws to the HUNGNAM base, thence by sea and air lift to the PUSAN - POHANG-DONG area. Annexes C, D and E: (Phases 1, 2 and 3 respectively, Opn Overlays).
3. a. I ROK Corps (-): Defend Asgd sector (Phases 1 and 2), embark on X Corps O (Phase 3).  
b. 1st Mar Div: Embark as directed.  
c. 3d US Inf Div: 1st KMC Regt Atchd; withdraw deliberately from present psns, effect maximum delay of En, defend assigned sector, (Phase 1), cover withdrawal and embarkation of X Corps Elms (Phases 2 and 3), embark on X Corps O. One Regt (Annex C) Corps Res.  
d. 7th US Inf Div: Withdraw deliberately from present Psns, effect maximum delay of En, defend assigned sector (Phases 1 and 2), embark on Corps O.  
e. Sp Act Gp: X Corps Res, HUNGNAM.  
f. X Corps Arty: Annex F, Arty.  
g. Engrs: Annex G, Engrs.  
h. X Corps Res One Regt, 3d US Inf Div, Vic HUNGNAM; SP Act Gp, Vic HUNGNAM.  
x. (1) All units carry one basic load Ammo upon embarkation.  
(2) Expedite Mvmt all tactically non-essential Pers, Veh, Equip and Sup to embarkation points.



(3) Exert maximum effort to prevent abandonment or destruction Equip or Sup.

(4) Exert maximum effort to locate En Trip Conc prior to En atks and to bring Air Strikes and Arty Conc thereon promptly.

(5) Employ demolitions, obstacles and mines to the maximum to block En Adv.

(6) No mvmt of civilians into or out of X Corps Def areas. Permit no refugees to enter outpost area.

(7) Unit Def areas to be abandoned only on authority next higher cmd.

(8) Organize Psns with maximum depth and all-round Scty.

(9) Stock adequate Ammo on Psns. Avoid overstocking in Fwd areas.

(10) Bn and larger units, maintain approximately one-third combat Str as Res. Prep for C/Atk to restore original Psns.

(11) Improve Defensive Psns continually.

(12) Organize Alt and supplementary Psns within sectors as appropriate.

(13) Prep C/Atk plans concurrent with organization of Psns.

(14) Hold MLR at all costs.

(15) Destroy all bridges, Afld, port facilities and other installations of Mil value; destroy Sup on X Corps O only.

4. a. Adm O: N/C

b. Embarkation instructions - See Annex A, OI 27.

5. a. Current SOI in Eff.

b. CP's: X Corps HUNGNAM; others Rept Locs:

ALMOND  
Maj Gen

Annexes: A - Task Orgn

B - Intel (issued separately)

C - Opn Overlay, Phase 1

D - Opn Overlay, Phase 2

E - Opn Overlay, Phase 3

- F - Artillery
- G - Engineer
- H - NGF Spt (issues separately)

DISTR: C, Plus: I ROK Corps, COM 7th FLT, CTF 77

OFFICIAL:

/s/ CHILES

G-3

X Corps  
APO 909  
11 Dec 50

Annex A, Task Orgn, to Opn O 10

Command Group \_\_\_\_\_ Maj Gen E M Almond

Hq & Hq Co, X Corps  
8222nd Defense Plat  
521st Mil Intel Svc Det (w/2 Interpreters)  
522nd Mil Intel Svc Det  
210th CIC Det  
Two (2) Civil Asst Teams  
X Corps MP Co (Prov)  
772nd MP Bn  
88th MP Co  
One (1) MP Co, ROK  
3d Hcptr Det  
106th Fin Disb Sect  
1st BPQ  
4th Sig Bn (-)  
Attached Units:  
GHQ RTT & Photo Teams  
272nd Sig Const Co  
581st Sig Relay Co (-)  
226th Sig Svc Co (-)  
2nd Sig Intel Unit  
X Corps, Sig Depot (Prov)  
S & I Sect, 226th Sig Svc Co  
S & I Sect, 65th Sig Depot Co  
Sig Repair Sect, 4th Sig Bn  
205th Sig Repair Det  
19th CID  
Honor Guard Co  
ROK Honor Guard Co  
52nd Repl Co  
369th Repl Co  
1st KMC Bn  
3d KMC Bn

a. I ROK Corps \_\_\_\_\_ Maj Gen KIM, Pac II  
One (1) TACP, 5th USAF  
3d ROK Div \_\_\_\_\_ Brig Gen RHEE, Chong Chan  
Two (2) TACP's, 5th USAF  
ROK Capital Div \_\_\_\_\_ Brig Gen SONG, Yo Chan

SFCP Det, ANGLICO, 1st Sig Bn, 1st Mar Div  
 Two (2) TACP's, 5th USAF  
 One (1) TACP, 1st Mar Div

- b. 1st Marine Division, FMF, (Reinf)  
 1st Marine Division, FMF  
 1st Amph Trac Bn, FMF  
 Co B, 1st Armd Amph Bn, FMF  
 Btry C, 1st 4.5 Rkt Bn, FMF  
 VMO 6 FMF  
 Radio Relay Plat, 1st Sig Opns Co, FMF  
 One (1) Civil Asst Team, USA  
 163d Mil Intel Svc Det, USA  
 181st CIC Det, USA  
 41st Royal Marine Commandos, BC
- c. 3rd Inf Div (-one (1) Regt) \_\_\_\_\_ Maj Gen R. H. Soule  
 1st KMC Regt (-1st and 3d Bns)  
 One (1) TACP, 5th USAF  
 Five (5) SFCP Dets, ANGLICO, 1st Sig Bn, 1st Mar Div  
 Five (5) TACP's, 5th USAF  
 59th MP Co
- d. 7th Inf Div \_\_\_\_\_ Maj Gen D. B. Barr  
 7th CIC Team  
 One (1) Civil Asst Team  
 One (1) ANGLICO Det, FMF/LANT  
 Eight (8) TACP's, 5th USAF  
 Three (3) TACP's, 1st Mar Div
- e. Corps Reserve  
 One (1) Regt, 3d US Inf Div  
 Hq & Hq Svc Co, 8227th Special Activities GP  
 Prov Raider Co  
 ROK Special Attack Bn
- f. Artillery With the Corps \_\_\_\_\_ Col W. P. Ennis  
 Hq & Hq Btry, 5th FA Gp \_\_\_\_\_ Col J. K. Wilson  
 8221st FA Topo and Met Det  
 96th FA Bn  
 92nd AFA Bn  
 50th AAA AW Bn
- g. 2nd Engr Spec Brig (-) \_\_\_\_\_ Col J. J. Twitty  
 Co A., 56th Amph Tk and Trac Bn (-)  
 1st Shore Party Bn, FMF  
 58th MP Co  
 79th Engr Const Bn (-)

- h. 1st Combat Service Group, FMF \_\_\_\_\_ Col Cook  
 7th MT Bn (-two (2) Co's) FMF  
 1st Air Del Plat, FMF  
 Co A, 1st Amph Trk Bn, FMF
- i. Corps Chemical Units \_\_\_\_\_ Lt Col W. T. Dozier  
 Hq & Hq Det, 4th Cml Smk Gen Bn  
 69th Cml Smk Gen Co
- j. Corps Engr Units \_\_\_\_\_ Lt Col L. C. Fairbank  
 8224th Hq & Hq Co, Engr Const Gp  
 Attached Units:  
 44th Engr Const Bn  
 Det, 79th Engr Const Bn  
 73d Engr (C) Bn  
 185th Engr (C) Bn  
 512th Engr Dump Trk Co  
 91st Engr Water Sup Co, Plat  
 Engr Maint Co  
 630th Engr Lt Equip Co  
 58th Engr Trdwy Br Co  
 1st Engr Depot Plat (Prov) (Opn Control, X Corps)  
 8223d Engr Map Distr Det (Opn Control, X Corps)  
 8128th Engr Repro Det (Opn Control, X Corps)  
 543d Engr Base Depot Co
- k. Corps Ord Units \_\_\_\_\_ Maj R. E. Harper  
 Hq & Hq Det, 328th Ord Bn  
 Attached Units:  
 1st Ord Maint Co  
 14th Ex Ord Disp Squad  
 17th Ex Ord Disp Squad  
 330th Ord Depot Co  
 58th Ord Ammo Co  
 69th Ord Ammo Co  
 508th Ord Tech Intel Team  
 504th Cml Svc Co, Det  
 Attached Units:  
 21st Cml Decon Co (Cadre)  
 2nd Ord Med Maint Co  
 Det, 47th Ord Lt Acft Maint Co
- l. Corps Quartermaster Units \_\_\_\_\_ Lt Col B. B. Baber  
 Hq & Hq Det, 142d QM Bn  
 Attached Units:  
 58th QM Salv Co

1st Plat, 565th QM GR Co (-)  
821st QM Bath Co  
1st Plat, 20th QM Subs Sup Co  
1st Plat, 529th QM Petr'l Distr Co  
580th QM Svc Co

m. Corps Medical Units \_\_\_\_\_ Col A. G. Gorby

121st Evac Hospital

Attached Units:

8216th Med Lab (Mbl)

1st Surg Hosp (Mbl)

Hq & Hq Det 163d Med Bn

Attached Units:

Two (2) Plats, 421st Med Coll Co

618th Med Clr Co (Sep)

559th Med Amb Co (-) (Sep)

560th Med Amb Co (Sep)

Avd Plat, 6th Med Sup Depot

n. Corps Transportation Units \_\_\_\_\_ Col L. L. Ayers

Hq & Hq Co 52nd Trans Trk Bn

Attached Units:

377th Trans Trk Co

513th Trans Trk Co

515th Trans Trk Co

Hq & Hq Co, 21st Trans Med Port Bn

301st Railroad Opn Bn, ROK

ALMOND  
Maj Gen

OFFICIAL:

/s/CHILES

G-3

---

## NOTES

1. J. F. C. Fuller, *Generalship: Its Diseases and Their Cure* (Harrisburg, PA: Military Service Publishing Co., 1936).
2. Freiherr Hugo Friedrich Philipp Johann von Freytag-Loringhoven, *The Power of Personality in War* (Harrisburg, PA: Military Service Publishing Co., 1955).
3. United States Army, 8th Army Korea, "Special Problems in the Korean Conflict" (Seoul, 1952), 43—47, 51.
4. Clay Blair, *The Forgotten War: America in Korea, 1950—53* (New York: Time Books, 1987), 36, 229, 295, 416—17.
5. Robert Heintz, *Victory at High Tide* (Annapolis, MD: Nautical and Aviation Publishing Co., 1979), 53—54. Comments of Major General Hickey, Deputy Chief of Staff of the Far Eastern Command (FEC). General Wright, G3 of FEC, also agreed that the Marines should have handled the planning for Inchon.
6. However, X Corps apparently did an outstanding job coordinating the complex movement of forces from all over Japan to their ports of embarkation and their subsequent loading. The invasion was launched a mere thirty days after the creation of the corps planning cell (X Force) even though the Navy insisted that sixty days was the absolute minimum time necessary to plan and conduct the operation. See Shelby Stanton, *America's Tenth Legion: X Corps in Korea, 1950* (Novato, CA: Presidio Press, 1989), 39—93.
7. For a detailed account of the 1st Marine Division and 7th Infantry Division coordination problems with X Corps during the capture of Seoul, see Roy Appleman, *South to the Naktong, North to the Yalu. (June—November 1950)*, United States Army in the Korean War (Washington, DC: Office of the Chief of Military History, Department of the Army, 1961), 515—41.
8. 8th Army Korea, "Special Problems," 38.
9. Blair, *The Forgotten War*, 345—46, 354, 365—66.
10. There were attempts to link up with Eighth Army, but they were feeble at best. On 12 November, the 65th Regimental Combat Team of the 3d Infantry Division made contact with a friendly unit of Eighth Army to the east by "message drop." Then, on the 14th, "One patrol from Co. C. made contact with the 10th ROK Regiment [of Eighth Army] on our west boundary." United States Army, 65th Regimental Combat Team, Command Report, November 1950, Box 2886, Record Group 407, National Archives Federal Records Center, Suitland, MD. The Records Center is hereafter cited as NAFRC.
11. Oddly enough, although men at the front tended to blame Almond and his headquarters, Almond's staff saw the intelligence failure and the staff inflexibility originating at MacArthur's Far Eastern Command. Years after the event, one of Almond's key staffers, Deputy Chief of Staff William McCaffrey, stated clearly in his interview that "It really wasn't Almond, it was MacArthur. Almond was doing the best he could with the missions X

Corps had." Lieutenant General William McCaffrey, U.S. Army (ret.), interview, Box 52, Clay Blair Papers, United States Army Military History Institute, Carlisle Barracks, PA, hereafter cited as McCaffrey interview. The institute is hereafter cited as USAMHI.

12. Blair, *The Forgotten War*, 420.
13. *Ibid.*, 457.
14. *Ibid.*, 462.
15. Lieutenant General Edward Almond, U.S. Army (ret.), interview with Captain Thomas G. Fergusson, 1975, sect. V, p. 9, in the Almond Papers, USAMHI, hereafter cited as the Almond interview.
16. As one of his own staff officers later stated in his own interview, Almond was "highly intelligent, opinionated, and completely devoted to General MacArthur. General MacArthur didn't have anybody that was more of a disciple than Ned Almond." Major General John H. Chiles, U.S. Army (ret.), "Oral Reminiscences of Major General John H. Chiles" [interview with D. Clayton James], July 1977, Box 50, Blair Papers, USAMHI.
17. Almond interview, sect. V, pp. 12–13.
18. *Ibid.*
19. For the most complete reconstruction of the critical events of 28–30 November, see Roy Appleman's harrowing study of the destruction of Task Force Faith in his *East of Chosin: Entrapment and Breakout in Korea, 1950* (College Station: Texas A & M University Press, 1987). Almond, surprisingly, at the 28th of November meeting in Tokyo wanted to continue the attack to the northwest and the west. He still did not appreciate the size of the danger. See also Appleman's newest study of this operation from the X Corps perspective. Roy E. Appleman, *Escaping the Trap: The US Army X Corps in Northeast Korea, 1950* (College Station: Texas A & M University Press, 1990).
20. Max Dolcater, ed., *3d Infantry Division in Korea* (Tokyo: Toppan Printing Co., 1953), 88–89.
21. Blair, *The Forgotten War*, 509.
22. McCaffrey interview.
23. Especially by Roy Appleman, *East of Chosin*; and United States Marine Corps, *U.S. Marine Operations in Korea, 1950–53*, vol. 3, *The Chosin Reservoir Campaign*, written by Lynn Montross and Nicholas A. Canzona (1957; reprint, St. Clair Shores, MI: Scholarly Press, 1976).
24. On this "gap" in military historiography, see Roger Beaumont, "Command Method: A Gap in Military Historiography," *Naval War College Review* 31 (Winter 1979):63–72.
25. Blair, *The Forgotten War*, caption under photograph of Almond, photograph no. 6 between pp. 144–45.
26. Russell A. Gugeler, "Task Force Gerhardt," in *Combat Actions in Korea*, rev. ed., Army Historical Series (Washington, DC: Office of the Chief of Military History, United States Army, 1987, 1970), 190.



27. Quoted in Blair, *The Forgotten War*, 722—23.
28. Apparently, few blamed Lieutenant Colonel Quinn for the intelligence failures of December. See *ibid.*, 616. In Quinn's oral history, he recounts the story of how he and Almond berated General Willoughby (MacArthur's thoroughly disliked intelligence chief) about the Chinese prisoners they captured. Apparently Almond told Willoughby, "You said they weren't coming. They are here!" When Willoughby didn't believe him, Almond invited him over to see for himself. He refused, contending that it was only a "token force." Lieutenant General William Quinn, U.S. Army (ret.), Oral history interview, 1981, pp. 72—74, Quinn Papers, USAMHI.
29. McCaffrey, while admitting that Almond had his faults, still referred to him as "a great soldier." He had served as Almond's chief of staff in the 92d Division in Italy in World War II. "I got hired on because we'd been through the mill together. We had some bad times in Italy." McCaffrey interview.
30. Chiles summed up Almond in his interview as follows: "Very proud, very intolerant, but very fundamental along with it." Chiles, "Oral Reminiscences." Almond considered Chiles, along with Ruffner, to be among his best staff officers. Almond interview, sect. VI, pp. 17—18.
31. Blair, *The Forgotten War*, 289. Aubrey Smith was later murdered by his wife in Japan while she was apparently under the influence of drugs. See *ibid.*, 408—9 and 409n.
32. Colonel Forney was decorated with the "Medal of Merit for his efficient action which involved Inchon first and Hungnam second." Almond even referred to him at one point in his interview as "General Forney, who organized the activities in fine form. I mean Colonel Forney, he should have been a General!" Almond interview, sect. V, pp. 22—23, 26—27.
33. Campbell had also been provost marshal of the 92d Division under Almond in Italy. *Ibid.*, pp. 23—24.
34. For a complete listing of all X Corps staff officers and the principal officers of the subordinate units, see Shelby Stanton, *America's Tenth Legion*, 323—28.
35. For a comparative study of the withdrawal of large forces in the face of the enemy in modern warfare and the problems of planning such operations, see Major Michael Burke's "Extracting the Beaten Expeditionary Force: The Margin Between Defeat and Catastrophe," School of Advanced Military Studies, United States Army Command and General Staff College, Fort Leavenworth, KS, 1989.
36. United States Army, X Corps, Command Report, 18 December 1950, Box 1985, Record Group 407, NAFRC.
37. United States Army, X Corps, "X Corps Special Report, Hungnam Evacuation," p. 3, Box 1983, Record Group 407, NAFRC, hereafter cited as "Special Report Hungnam." For the story of the 2d Infantry Division's ordeal running the "gauntlet," see S. L. A. Marshall's *The River and the Gauntlet: November 1950, the Defeat of Eighth Army* (Nashville, TN: Battery Press, 1987).
38. "Special Report Hungnam," 3.

39. Almond interview, sect. V, pp. 23—24. Almond stated that "As Commanding General, my policy was to evacuate all civil government officials and their families together with as many other loyal and non-Communist citizens as shipping space would allow. This was extremely successful because as we loaded our ships with equipment and materials, particularly the LSTs in loading tanks out, there was a lot of vacant space between tanks and on deck." Almond was highly praised for his decision both by Korean officials and by public opinion in general.
40. "Special Report Hungnam," 3.
41. Annex A (Logistics) to Operating Instructions 27. Although initially the Navy indicated that turn-around shipping would not be required, the size of the evacuation mandated that ships off-load in Pusan quickly and return for two and sometimes three additional loads.
42. "Special Report Hungnam," 5.
43. According to Lieutenant Colonel Frank Mildren, acting G3 at the close of the operation, "The only thing we left there was all of this frozen fruit juice. We blew up what ammunition we couldn't take out but left all these big cases of frozen juice that we couldn't use. You know, they sent us all this fancy orange juice, pineapple juice, and all kinds of other juices. Well in 40 degrees below zero temperature you can't drink it. It's all frozen." Colonel Frank Mildren, U.S. Army (ret.), Oral history interview with Lieutenant Colonel James T. Scott, 1980, USAMHI, pp. 131—32.
44. Ibid.
45. Almond interview, sect. V, pp. 26—27.
46. Ibid., pp. 12—13. At least one of Almond's staff officers, Lieutenant Colonel McCaffrey, felt that Brigadier General Hodes was deficient in his duty in that he was tasked, presumably at this meeting, to rescue TF Faith but failed to do so. He stated in his oral history interview: "There was this Ass't Division Commander [Hodes] who was supposed to break in with another battalion. The 3d [2d] Bn of the 31st and the Tank Co. of the 7th Div. was supposed to break in. They got to a road block and lost 8 tanks out of 24 and the ADC turned them around and said they couldn't break through. He came back and told Dave Barr they couldn't break through. The Maj. Gen. [Barr] was in Hungnam, the ADC was in Hungnam [Hagaru-ri] and there were 2,600 men dying up there, and I haven't forgotten that one either. Those two G. D. General officers could have been up there. That's where the Marines were." McCaffrey interview. However, at the time that Hodes did try to break through, he had only the RCT HQ and a tank company; the 2-31st Infantry was stuck at Koto-ri. See Appleman, *Escaping the Trap*, 85.
47. The Marine forces at Hagaru-ri and Koto-ri were joined by the survivors of TF Faith at Chosin but only made it to Koto-ri before the Chinese cut the roads.
48. Dolcater, *3d Infantry Division*, 88—89.
49. Appleman, *Escaping the Trap*, 282.
50. Brigadier General Mead had just wound up a similar mission as commanding general of Task Force C protecting the withdrawal from Wonsan by

elements of the 3d ID. His new staff of TF Dog (and their normal units/sections) were Major Burdell, S3, HQ 3d ID; Captain Motta, S2, HQ 3d ID; Lieutenant Colonel Newbury, XO, 3d AAA Bn; Major Hay, S4, 3d AAA Bn; Major Steward, Asst. XO, 3d AAA Bn; Captain Patterson, Asst S3, 3d AAA Bn; Captain Javins, Commo, HQ 3d ID; and Captain Roth, Asst S4, HQ 3d ID. United States Army, 3d Infantry Division, Command Report, December 1950, Box 2881, Record Group 407, NAFRC, hereafter cited as 3d ID, CR, December 1950.

51. Dolcater, *3d Infantry Division*, 92; and Blair, *The Forgotten War*, 538—39. Clay Blair mistakenly adds in the entire 65th RCT and a battalion of the 15th Infantry (3/15) to TF Dog and states "Task Force Dog . . . consisted of five of the division's nine infantry battalions, powerfully supported by tanks and 3rd Division and X Corps artillery." Those other units were in the area and played a key role in the rescue of the Marine division, but they remained under their own chain of command and were not part of Task Force Dog.
52. The first unit on the road was the HQ section of 3d AAA AW BN (SP).
53. Blair, *The Forgotten War*, 538—41. Almond later objected when Ridgway in his memoirs implied that the Marines had organized the bridge drop. Ridgway claimed, according to Almond, that Smith had "foreseen this danger and had a Treadway bridge air-dropped in sections in time to get his forces across." In reality, Almond stated that the operation was "planned by the X Corps Commander who beforehand had arranged for a rehearsal at YONPO airfield for the air-drop of the bridge sections. I saw the test-drop made before the bridge was ever dropped at the proper place south of Koto-ri." Almond, *Personal Notes and War Diary*, Almond Papers.
54. 3d ID, CR, December 1950, incl. 8, TF Dog Data.
55. There were, after all, 2,300 Army personnel in the retreating column, although to read the news reports, one would think it composed solely of Marines.
56. Message from TF Dog S3 to CG 3d ID in 3d ID, CR, December 1950, incl. 8, TF Dog Data.
57. United States Army, 65th Regimental Combat Team, S3 Journal, Command Report, December 1950, Box 2888, Record Group 407, NAFRC.
58. 3d ID, CR, December 1950, incl. 8, TF Dog Data. Comments by Major Burdell, TF S3.
59. Blair, *The Forgotten War*, 544.
60. Dolcater, *3d Infantry Division*, 102—4.
61. "Special Report Hungnam," 5.
62. United States Army, X Corps, G2 Journal, Command Report, 14—15 December 1950, Box 1986, Record Group 407, NAFRC.
63. United States Army, X Corps, G3 Journal, Command Report, 14—15 December 1950, Box 1986, Record Group 407, NAFRC.
64. *Ibid.*

65. Blair, *The Forgotten War*, 544.
  66. "Special Report Hungnam," 23.
  67. United States Army, X Corps, Civil Affairs Journal, Command Report, 12 December 1950, Box 1885, Record Group 407, NAFRC.
  68. United States War Department, FM 100-15, *Field Service Regulations: Larger Units* (Washington, DC: United States Government Printing Office, June 1942), 70.
  69. United States Department of the Army, FM 100-15, *Larger Units* (Washington, DC, June 1950). The updated version of this regulation probably did not reach the field for many months after its publication. Corps staff officers probably drew largely upon their experiences in World War II, however, and what they knew about doctrine (impossible to assess) probably was drawn from the 1942 rather than the 1950 version of the FM. The sections dealing with the corps in the offense or defense were, moreover, almost word for word in the two versions.
  70. *Ibid.*, 62–63, 67.
-

## BIBLIOGRAPHY

### PRIMARY SOURCES

#### *National Archives Federal Records Center, Suitland, MD*

United States Army. 65th Regimental Combat Team. Command Report. November 1950. Box 2886, Record Group 407.

\_\_\_\_\_. S3 Journal, Command Report. December 1950. Box 2888, Record Group 407.

United States Army. X Corps. Civil Affairs Journal, Command Report. 12 December 1950. Box 1885, Record Group 407.

\_\_\_\_\_. Command Report. 18 December 1950. Box 1985, Record Group 407.

\_\_\_\_\_. G2 Journal and G3 Journal, Command Report. 14–15 December 1950. Box 1986, Record Group 407.

\_\_\_\_\_. "X Corps Special Report, Hungnam Evacuation." N.d. Box 1983, Record Group 407.

United States Army. 3d Infantry Division. Command Report. December 1950. Box 2881, Record Group 407.

#### *United States Army Military History Institute, Carlisle Barracks, PA*

Almond, Edward, Lieutenant General, U.S. Army (ret.). Interview with Captain Thomas G. Fergusson, 1975. Almond Papers.

Chiles, John H., Major General, U.S. Army (ret.). "Oral Reminiscences of Major General John H. Chiles" [interview with D. Clayton James], July 1977. Box 50, Clay Blair Papers.

McCaffrey, William, Lieutenant General, U.S. Army (ret.). Interview. Box 52, Clay Blair Papers.

Mildren, Frank, Lieutenant Colonel, U.S. Army (ret.). Oral history interview with Lieutenant Colonel James T. Scott, 1980.

Quinn, William, Lieutenant General, U.S. Army (ret.). Oral history interview, 1981. Quinn Papers.

### OTHER WORKS

Appleman, Roy. *East of Chosin: Entrapment and Breakout in Korea, 1950*. College Station: Texas A & M University Press, 1987.

\_\_\_\_\_. *Escaping the Trap: The US Army X Corps in Northeast Korea, 1950*. College Station: Texas A & M University Press, 1990.

\_\_\_\_\_. *South to the Naktong, North to the Yalu (June–November 1950)*. United States Army in the Korean War. Washington, DC: Office of the Chief of Military History, Department of the Army, 1961.

Beaumont, Roger. "Command Method: A Gap in Military Historiography." *Naval War College Review* 31 (Winter 1979):61–74.

- Blair, Clay. *The Forgotten War: America in Korea, 1950—53*. New York: Time Books, 1987.
- Burke, Michael, Major. "Extracting the Beaten Expeditionary Force: The Margin Between Defeat and Catastrophe." School of Advanced Military Studies, United States Army Command and General Staff College, Fort Leavenworth, KS, 1989.
- Dolcater, Max, ed. *3d Infantry Division in Korea*. Tokyo: Toppan Printing Co., 1953.
- Freytag-Loringhoven, Hugo Friedrich Philipp Johann, Freiherr von. *The Power of Personality in War*. Harrisburg, PA: Military Service Publishing Co., 1955.
- Fuller, J. F. C. *Generalship: Its Diseases and Their Cure*. Harrisburg, PA: Military Service Publishing Co., 1936.
- Gugeler, Russell A. "Task Force Gerhardt." In *Combat Actions in Korea*, rev. ed., 183—92. Army Historical Series. Washington, DC: Office of the Chief of Military History, United States Army, 1987, 1970.
- Heinl, Robert. *Victory at High Tide*. Annapolis, MD: Nautical and Aviation Publishing Co., 1979.
- Marshall, S. L. A. *The River and the Gauntlet: November 1950, the Defeat of Eighth Army*. Nashville, TN: Battery Press, 1987.
- Stanton, Shelby. *America's Tenth Legion: X Corps in Korea, 1950*. Novato, CA: Presidio Press, 1989.
- United States Army. 8th Army Korea. "Special Problems in the Korean Conflict." Seoul, 1950.
- United States Department of the Army. FM 100-15. *Larger Units*. Washington, DC, June 1950.
- United States Marine Corps. *U.S. Marine Operations in Korea*. Vol. 3. *The Chosin Reservoir Campaign*. Written by Lynn Montross and Nicholas A. Canzona. 1957. Reprint. St. Clair Shores, MI: Scholarly Press, 1976.
- United States War Department. FM 100-15. *Field Service Regulations: Larger Units*. Washington, DC: U.S. Government Printing Office, June 1942.
-



Richard W. Stewart, Ph.D.

Dr. Richard W. Stewart is the command historian at the U.S. Army Special Operations Command, Fort Bragg, North Carolina. While researching and writing this study, he was the research historian at the Center for Army Lessons Learned, Fort Leavenworth, Kansas. A graduate of Stetson University in Florida, he received his master's degree in history from the University of Florida and his doctorate in history from Yale University. While completing his doctoral dissertation, Dr. Stewart was a Fulbright fellow at University College, London, and a lecturer in Yale College, Yale University. He is also a U.S. Army Reserve major in Military Intelligence and a graduate of the U.S. Army Command and General Staff College, Fort Leavenworth.

## COMBAT STUDIES INSTITUTE

### *Missions*

The Combat Studies Institute was established on 18 June 1979 as a department-level activity within the U.S. Army Command and General Staff College, Fort Leavenworth, Kansas. CSI has the following missions:

1. Prepare and present instruction in military history at USACGSC and assist other USACGSC departments in integrating military history into their instruction.
2. Serve as the U.S. Army Training and Doctrine Command's executive agent for the development and coordination of an integrated, progressive program of military history instruction in the TRADOC service school system.
3. Conduct research on historical topics pertinent to the doctrinal concerns of the Army and publish the results in a variety of formats for the Active Army and Reserve Components.

U.S. Army Command and General Staff College  
Fort Leavenworth, Kansas

