

Leavenworth Papers

No. 4



*The Dynamics of Doctrine:
The Changes in German
Tactical Doctrine During the
First World War*

by Timothy T. Lupfer

Combat Studies Institute

U.S. Army Command and General Staff College
Fort Leavenworth, Kansas

JULY 1981

FOREWORD

This latest *Leavenworth Paper* is a case study in the wartime evolution of tactical doctrine. Previous publications of the Combat Studies Institute have examined the peacetime development of doctrine and have increased our knowledge of how doctrine has been applied. With the publication of Captain Lupfer's study, "The Dynamics of Doctrine," the Combat Studies Institute adds another dimension to the history of the processes of doctrinal change.

Besides providing a summary of German Infantry tactics of the First World War, this study offers insights into the crucial role of leadership in facilitating doctrinal change during battle. It once again reminds us that success in war demands extensive and vigorous training calculated to insure that field commanders understand and apply sound tactical principles as guidelines for action and not as a substitute for good judgment. It points out the need for a timely effort in collecting and evaluating doctrinal lessons from battlefield experience.

Finally, this study reminds us of yet another fundamental lesson from the past—that tendencies toward accepting the battlefield as a routine can be a deadly error. Altering previously accepted tactics in the middle of a struggle, as the author points out, is a very urgent and serious matter. As members of the Profession of Arms, we must be sensitive to the demands of change, visionary in our examination of their implications, and creative in our adaptation of combat organizations, tactics, and techniques.



WILLIAM R. RICHARDSON
Lieutenant General, USA
Commandant

Director

Colonel William A. Stofft
John F. Morrison Professor of Military History
Dr. David Syrett

Combined Arms Center Historian
Dr. Roger J. Spiller

Chief, Research Committee
Lieutenant Colonel Kenneth A. Steadman

Research Fellows
Major Charles E. Heller

Dr. Edward J. Drea
Dr. William G. Robertson

Chief, Teaching Committee
Lieutenant Colonel David M. Glantz

Teaching Fellows
Major Thomas W. Sweeney
Major Phillip W. Childress
Captain Patricia B. Genung
Captain Jonathan M. House

Sergeant First Class Robert R. Cordell
Chief, Historical Services Committee

Dr. Lawrence A. Yates
Research Librarian

Elizabeth R. Snoke

Editor
Alice M. McCart
Staff

Major Richard H. Barnes
Sergeant First Class Nelson C. Rogers
Mrs. Peggy K. Barrett
Mrs. Debra M. Henderson
Miss Tracy Searles



The *Leavenworth Papers* are issued by the Combat Studies Institute, an element of the U.S. Army Command and General Staff College, Fort Leavenworth, Kansas 66027. The views expressed in this publication are those of the author and not necessarily those of the Department of Defense or any elements thereof. Requests for additional copies or for permission to reprint *Leavenworth Papers* in whole or part should be addressed to the Director, Combat Studies Institute, U.S. Army Command and General Staff College, Fort Leavenworth, Kansas 66027.

Leavenworth Papers US ISSN 0195-3451

Leavenworth Papers

No. 4



*The Dynamics of Doctrine:
The Changes in German
Tactical Doctrine During the
First World War*

by Timothy T. Lupfer

Combat Studies Institute

U.S. Army Command and General Staff College
Fort Leavenworth, Kansas

JULY 1981

Library of Congress Cataloging in Publication Data

Lupfer, Timothy T.

The dynamics of doctrine : the changes in German tactical doctrine during the First World War / by Timothy T. Lupfer.—Fort Leavenworth, Kan. : Combat Studies Institute, U.S. Army Command and General Staff College, 1981.

ix, 73 p. : ill., maps ; 25 cm. — (Leavenworth papers ; no. 4)

"July 1981."

Bibliography: p. 71-73.

S/N 008-020-00890-7

Item 359-C

Supt. of Docs. no.: D 110.9:4

\$4.75

1. Tactics—History—20th century. 2. World War, 1914-1918—Campaigns. 3. World War, 1914-1918—Germany. I. U.S. Army Command and General Staff College. Combat Studies Institute. II. Title. III. Series.

U738.L86 1981

355.4'8—dc19

82-601219

AACR 2 MARC

Library of Congress

[r84]rev

Contents



Illustrations	v
Introduction	vii
Chapter 1. The Elastic Defense-in-Depth	1
Chapter 2. The Offensive Tactics of 1918	37
Chapter 3. Tentative Generalizations	55
Appendixes	59
Notes	63
Bibliography	71

Illustrations



MAPS

1. The Stabilized Front, 1915—16	5
2. Western Front, 1917	25
3. Reims and Arras, 1917	31
4. Western Front, 1918	51

FIGURES

1. German zones in elastic defense-in-depth	14
2. German division organization	17
3. Infantry division in German elastic defense-in-depth	18

Introduction



Bullets quickly write new tactics.
—Wilhelm Balck¹

Although the immediate events of the summer of 1914 which led to the First World War surprised Europe, the possibility of a general European conflict had been anticipated by governments and the military. Despite this anticipation, confusion characterized the conduct of the war, from beginning to end. No belligerent had prepared adequately for the actual conditions and demands of this long war. The confusion was particularly apparent in the realm of tactics on the western front. Prewar tactical doctrine had become inappropriate by December 1914. On all sides expedient modifications soon competed with the prewar doctrine.

Military doctrine is guidance for conduct of battle approved by the highest military authority. In the Imperial German Army on the western front, the Army High Command (*die Oberste Heeresleitung*, hereafter called OHL) changed tactical doctrine significantly on two occasions. In the winter of 1916–17 OHL adopted a new defensive doctrine which described an elastic defense-in-depth in response to the Allied offensive tactics during 1916 (especially those the British employed at the Somme) and in anticipation of the continuation of similar attacks in the spring of 1917. This change is the subject of chapter 1. In the winter of 1917–18, OHL developed a new offensive tactical doctrine in hopes of achieving a decisive victory on the western front with their offensives planned for the spring of 1918. This change is the subject of chapter 2.

As the famous tactician, Wilhelm Balck,* noted, altering tactical procedures in the middle of such a desperate struggle was a very serious undertaking, especially for the German Army.² To alter the deeply ingrained habits in an army famous for its thorough peacetime training was difficult, especially when the confusion of the war made the accuracy of any change uncertain.

*Wilhelm Balck had written extensively on tactics before the war. During the war he served as a division commander. His son, Hermann Balck, was a company-grade officer in the First World War, and became an outstanding field commander in the Second World War.

The Germans did not win the First World War and their *strategic* conduct of the war was often flawed. Yet, much value can be derived from their development of *tactical* doctrine, for the Germans developed and applied new tactical doctrine impressively in 1917 and 1918. Their tactical changes were systematic and thorough, for these changes in doctrine directly effected subsequent battlefield success. The analysis of the doctrinal changes cannot be restricted to examining changes to regulations because doctrine that influences nothing beyond the printing press is stillborn.

German successes in World War I demonstrated a thorough process:

- Perception of a need for change
- Solicitation of ideas, especially from the battlefield units
- Definition of the change
- Dissemination of the change
- Enforcement throughout the army
- Modification of organization and equipment to accommodate the change
- Thorough training
- Evaluation of effectiveness
- Subsequent refinement

This outline describes the manner by which the German Army succeeded in changing and implementing tactical doctrine during war. The process is not rigidly sequential; it is a dynamic process that requires great intellectual ability and strong character from tacticians who desire to make successful changes.

Many characteristics ascribed to the German military have too often sufficed for explanations of German military success. Glib expressions such as "great organization" or "a knack for war" do little justice to the men who brought success to German arms and, more importantly, offer little guidance for anyone who desires to achieve similar success.

In the examination of the German process of tactical change, several important personalities emerge. Their memoirs certainly must be used with caution, but I have quoted extensively from participants in this paper, in part to convey the essential interest in tactics among the participants. Their interest in tactics is instructive, for not all military leaders possess a continuing interest in tactics.

I do not intend to portray all German tactical efforts as inherently brilliant. The Germans usually achieved a *relative* advantage over the Allies with respect to tactical change. Tentative generalizations about the reasons for this German success and about the limitations of doctrine itself in wartime are described in chapter 3. These conclusions can only be tentative, for the uncertainties of war extend to its analysis.

Timothy T. Luper
Department of History
United States Military Academy
West Point, New York

The Elastic Defense-in-Depth

1



Prelude: The German Defense, 1914–16

The German Army of 1914 was not well disposed to the defensive form of war. The most recent major European conflict, the Franco-Prussian War of 1870–71, had demonstrated the importance of thorough prewar organization, rapid mobilization, and aggressive strategic movement. In tactics, the German Army of 1914 strongly emphasized the attack. Crown Prince Wilhelm, the Kaiser's eldest son and an army group commander in the First World War, described in his memoirs the attitude manifested toward defense in prewar training:

The underlying cause of this dull-wittedness in becoming adapted to the forms of tactics [during the First World War] must have lain in the very thorough and somewhat one-sided methods of training in peacetime, in which defense, as a method of warfare utterly foreign to the German spirit, was treated in a somewhat step-motherly fashion.¹

Ludwig Renn,* who served as an infantry company commander during the war, wrote that the prewar training on defense was contradictory:

We young officers had the odd experience of hearing exactly the opposite taught in the lectures on tactics as to what was taught on the art of fortification.²

Renn writes, however, that this did not cause great alarm among the students, for "most of us were utterly disinterested in military theory."³

The German emphasis on aggressive offensive movement influenced their attitudes toward weapons. Because of its consumption of ammunition and its tendency to jam, the machine gun was not expected to be the mainstay of a protracted firefight during the anticipated war of movement.⁴ The coordination of weapons in battle had often been overlooked in peacetime training. In the early battles of 1914 some German commanders, disregarding any need for

*Ludwig Renn is a pseudonym for Arnold Friedrich Vieth von Golssenau, who was trained in the prewar German Army, served in the trenches during the war, and became a communist after the war. He fought on the Republican side during the Spanish Civil War. His writing shows little affection for the German General Staff, and his statements represent a cynical view from the trenches.

artillery superiority, ordered attack. The results were disastrous.⁵ The French shared this aggressive attitude. Their engineer manual contained the only prewar detailed defense regulations of the French Army.⁶

A stabilization of positions running from Switzerland to the Channel followed the failure of the German envelopment in August and September of 1914. The western front became a war of position. The lethality of artillery compelled the infantry to dig. The soldiers, whether German or Allied, did not like the spade,⁷ but the compelling sight of the effect of artillery led to an immediate appreciation of digging.⁸

As the trench system developed along the western front, OHL contemplated an offensive in the west in 1915. The Chief of the General Staff, known in wartime as Chief of Staff of the Army in the Field, directed OHL in the name of the Kaiser, who exercised little direct influence. In preparation for the possible offensive in the west in 1915, General* Erich von Falkenhayn (who had replaced the ineffective Col. Gen. Helmuth von Moltke as Chief of the General Staff in late 1914) solicited comments from subordinate units. However, the demands of the eastern front in 1915 denied the western front any additional German forces for an offensive, so the Germans were compelled to remain on the defense in the west during that year.⁹ The French and the British launched major offensives throughout 1915 and tested the German defenses severely.

The conduct of operations on the western front revealed the tactical dilemmas of the war of position. Whereas in the American Civil War and the Franco-Prussian War the greatest source of battle casualties had been the rifled bullet, the artillery caused the greatest number of casualties over the total duration of the First World War. Technological innovations such as recoil systems, improved propellants and explosives, optical sights, and improved communication made indirect fire unexpectedly effective. Although artillery support of the attack was generally not well developed in anyone's prewar tactical doctrine, the experiences of the first months of the war indicated that artillery fire was essential in support of an infantry assault. The destruction of enemy machine guns, enemy batteries, and dug-in enemy positions, in turn, required vast quantities of munitions. Heavy guns became particularly useful to accomplish this. Unfortunately, to sustain the infantry advance beyond the initial range of the guns was extremely difficult, because such heavy guns could not displace quickly. Artillery communications, almost completely dependent upon field telephones connected by wire, were cumbersome to install and vulnerable to enemy artillery fire if not buried underground for protection. Neither could the vast quantities of artillery munitions be transported quickly. The terrain conditions after intense bombardment made all movement, including that of infantry and horse-drawn artillery, very difficult.

*A table of equivalent ranks is contained in appendix 1.

Conversely, the defense acquired several advantages. Even though the artillery barrage in support of an attack might destroy hundreds of men, if a few defending machine gun nests survived, the attackers could be stopped. The defending artillery, firing upon the slowly advancing infantry and the subsequent waves gathered in the assault trenches, inflicted severe casualties on the massed attackers. Given a transportation network and communications network still relatively intact (because of its distance from enemy artillery and dug-in wire) the defenders could move reserves to critical areas more rapidly than the attackers could reinforce their assault units. The conduct of the attack became more confused and uncertain as it progressed, for the attackers' communications deteriorated and their primary source of firepower, artillery, could not move forward to keep pace with the attack. Time, then, favored the defense.

However, life for the defender was not serene, and the Germans were faced with serious problems in the defense. While the French, fighting on their own soil, were reluctant to yield any ground,¹⁰ the Germans were equally opposed to giving up any hard-won ground. In the war of position, nations magnified any loss of terrain for propaganda purposes,¹¹ and at the soldiers' level the loss of hard-won terrain could create serious morale problems.¹² The Germans defended according to the principle, "*Halten, was zu halten ist,*" meaning "Hold on to whatever can be held,"¹³ a principle that made commanders extremely reluctant to yield ground. The Imperial German Army was well known for its discipline and commanders were very hesitant to do anything which might dilute this fierce fighting spirit, especially in the defense.

The experiences against the Allied offensives of 1915 showed the Germans that some modifications of the tactical defense were necessary. The various field armies published summaries of their experiences on the western front and OHL published selections of these—*Experiences in the War Concerning Field Fortification*—in June 1915.¹⁴ This publication expressed the principle that the first defense line must be held, but it advised building a second line as insurance against a major breakthrough. The German Army was learning several other tactical lessons in the defense, such as the value of the counterattack (which had been demonstrated in the Champagne battles against the French of 1915¹⁵) and the value of reverse slope positions to protect units from enemy observation and indirect fire.¹⁶

The Germans had also been keen observers of their enemies. They consistently complimented the French for their use of terrain,¹⁷ and Ludwig Renn, that bitter observer from the trenches, credits the French with the initial concept of defense-in-depth.¹⁸ Wilhelm Balck confirms Renn's observations that the French were quick to realize the need for greater depth on the defense. Balck records that General Joseph Joffre, the French Commander in Chief,

had cautioned the French against crowding the forward line as early as 5 January 1915, but commanders were reluctant to weaken their forward positions for fear of losing ground:

Numerous captured documents showed that the French were very slow to accept the very correct views of Joffre. Similar views . . . encountered stubborn resistance in the German Army.¹⁹

The Allied offensives of 1915 utilized techniques of attack which the Allies would use for most of the war. Envelopments were impossible because of the extended front. A penetration was the only alternative, and the Allies relied increasingly on massive artillery bombardments to achieve the penetration of the dug-in enemy positions. After the British attack at Neuve-Chapelle in March 1915, the British concluded that heavier artillery preparations would give a higher chance of success.²⁰ Similarly, in the French Army, the dominant maxim became "the artillery conquers and the infantry occupies (*l'artillerie conquiert, l'infanterie occupe*)." Massive artillery firepower became the dominant factor in Allied offensive tactics.

Artillery support dictated the direction and the plan of movement of the attacking infantry. This emphasis not only relegated maneuver to a secondary role, it also created conditions that made maneuver extremely difficult. In addition to tearing up the ground, the massive artillery preparations denied the attacker the benefits of surprise. Before the preparatory artillery fires commenced, the positioning of guns and vast quantities of ammunition, both easily detected by air (unless strict camouflage were enforced) revealed the Allied intentions. The long preparation itself showed generally where the attacks were planned, and allowed the Germans time to shift reserves. This dependence on massive artillery fire also denied the Allied infantry any sense of self-reliance, for, despite efforts to give infantry units their organic indirect fire (mortars and light artillery), infantry units could not conduct operations without the considerable help of the senior partner, artillery. Conduct of Allied operations reflected the rigidly scheduled, inflexible use of firepower. Maneuver could not complement firepower, for infantry could not move without the rigid curtain of fire, and the guns could not move.²¹

Although on the defensive in the west in 1915, in 1916 the Germans conducted a limited offensive at Verdun: the objective was attrition of the enemy rather than the classic German objective of rapid destruction of the enemy force. (See map 1.) To relieve the pressure on the French at Verdun, the British and French units near the Somme conducted an offensive in the summer of 1916. Their tactical techniques confirmed the dominance of firepower over maneuver.

The six-day preparation and the assault barrage consumed 1,628,000 shells in the British sector.²² The British had hoped to destroy all German resistance within range of their artillery. The British failed. Sufficient numbers of Germans survived to inflict grievous casualties on the advancing British.

Map 1. The Stabilized Front, 1915-16.

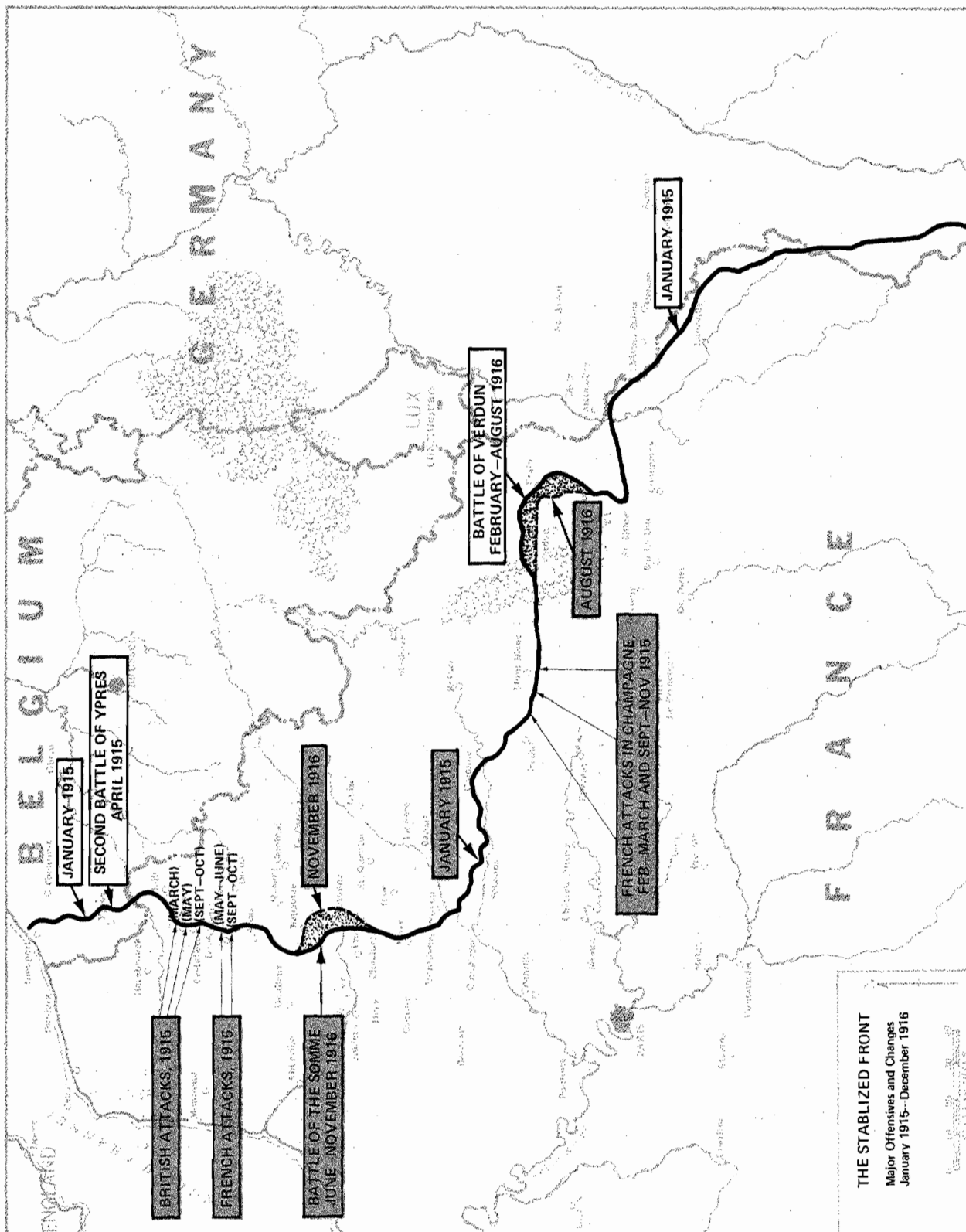

Many of the British soldiers were hurriedly trained volunteers who advanced in linear formations. Hindsight makes these tactics appear absurd, but the immediate conditions provided two justifications for the tactics.

First, the British commanders expected artillery to demolish any resistance, and second, the soldiers had only been trained briefly. Training these volunteers to advance in line had an ironic twist, for it probably required more discipline to stay in line than to trust good sense and use the ground. The French had quickly adopted fire and maneuver techniques at the small unit level, and the Germans, despite intensive prewar training in linear formation, had used rushes by squad and section as early as 1914.²³ Yet at the Somme, the British command thought that the new soldiers could not accomplish such complicated techniques.²⁴

Perhaps the British infantry tactics at the Somme on the first day reflect a failure to recognize that tactical techniques and lessons do not originate exclusively at higher levels and descend to the units. A greater service can be rendered by the higher headquarters that earnestly solicits opinions and experiences from units in the field, evaluates and distills the information, and disseminates the findings back to the field units. The Germans would demonstrate this process after their Somme experience.

German Response to the Somme

While the British have justifiably lamented the slaughter of their soldiers during the Somme campaign, and the picture of British suffering remains vivid today, it is too often overlooked that the Germans also suffered severely during that campaign, principally from British artillery fire.

Despite the mutual suffering, the Germans responded more quickly and more decisively than the British with respect to tactical changes based on the Somme experience. The problem of taking heavy casualties from the massive Allied artillery bombardments had to be solved.

The Germans were amazed at the great amount of ordnance that the British had hurled at them. "We had to adapt ourselves to an entirely new phase of war," wrote Ernst Jünger, a well-decorated frontline officer.²⁵ The Germans called the phenomenon the battle of materiel (*die Materialschlacht*). Throughout the Somme battles, von Falkenhayn, the German Chief of Staff, insisted on holding the forward defense line. His persistence led to a crowding of men in the front lines and reinforcement of the front line during battle. This part of the German defense was well within range of Allied artillery, so the German units suffered accordingly. The density of Germans packed into the front line contributed further to the already heavy German casualties. OHL provided incentive for holding the front line by relieving some German commanders who had failed to retake a front line captured by the Allies.²⁶ Since the Allies clearly had the greater supply of men and materiel, the Germans

could not continue to fight a battle of attrition in the west unless they could defend with greater conservation of their fighting strength. The Germans had to become more effective.

Although the Somme battles continued until 19 November 1916, as early as August 1916 the German situation at the Somme, Verdun, and in the east appeared sufficiently grim to necessitate a change of chief of staff. On 20 August, Field Marshal Paul von Hindenburg, formerly the commander in chief of the German forces on the eastern front, replaced von Falkenhayn. More importantly, his principal assistant, Lt. Gen. Erich Ludendorff, came to OHL with von Hindenburg. The field marshal was the figure of authority but Ludendorff exercised the dominant influence. Ludendorff's position was first quartermaster general,* but his dominance of the conduct of the war made him the de facto successor of von Falkenhayn.

The complementary relationship between von Hindenburg, who provided the authority and steadiness, and Ludendorff, who provided the intellectual brilliance and drive, is difficult to comprehend by one raised in a tradition of dominant *single* personalities (which perhaps characterizes American military experience). The German tactical success was not the product of a single personality, but a *corporate* effort. This is not to say that personalities were not influential in the development of German tactical doctrine. The importance of Ludendorff's personality, however, was that it fostered the corporate spirit, encouraging several German officers to participate in the collective effort and not allowing his own ego to interfere. His personality did *not* monopolize the effort. As events will demonstrate, the Allies, not understanding that this German effort was corporate, often tried to identify one mastermind responsible for the tactical concepts.

A new spirit of resolve and determination developed at OHL. One staff officer later wrote that von Falkenhayn had lacked decisiveness and foresight in the matters of organization and tactics,²⁷ and another staff officer recalled that with Ludendorff "an iron will and firm determination took hold of the German High Command."²⁸

Ludendorff now directed the corporate effort toward the problems of tactical change. The idea of greater depth for the defense had been developing in some units on the western front and in the OHL operations sections at the western front, but von Falkenhayn had neither understood nor encouraged this.²⁹ Ludendorff recognized the tactical ideas, adopted them, and gave them an aggressive character. Col. Max Bauer, a heretofore frustrated member of the OHL staff at the western front, wrote that the change in leadership made the members of his section feel as if a great weight had been lifted from them.³⁰

*In the German Army the term "quartermaster" did not have an exclusive connotation of supply; it indicated a senior staff officer.

Ludendorff had a variety of other concerns, because OHL direction extended to all fronts (western, eastern, Macedonian, Italian, and Middle East), although the western front was considered the most significant front. Ludendorff also became increasingly involved in industrial war production. Despite these competing demands, Ludendorff evaluated conditions on the western front and personally directed changes in German tactics. Throughout his career he had always possessed a genuine interest in tactics and armament.³¹ Although he had arrived on the western front from the eastern front where he had enjoyed spectacular tactical successes, Ludendorff did not try to apply a formula derived from his victories against the Russians:

On the Eastern Front we had for the most part adhered to the old tactical methods and old training which we had learned in the days of peace. Here [in the west] we met with new conditions and it was *my duty to adapt myself* [my italics] to them.³²

Ludendorff was extremely flexible and willing to change—despite his great success in the east.

Ludendorff began his assessment by travelling to as many frontline units as possible. By 1916 the German Army on the western front organized itself into army groups (OHL had begun the war trying to control field armies directly). The two principal army groups were those of Crown Prince Rupprecht of Bavaria in the north and of Crown Prince Wilhelm of Germany in the center. Ludendorff placed great importance on these visits to units; when he visited a unit, he asked for a report from that unit's chief of staff, and he demanded accurate information, "not a favorable report made to order."³³

Soliciting information from the units was a habit acquired not only by Ludendorff. Lt. Gen. Hermann von Kuhl, who served as chief of staff of Rupprecht's Army Group, aggressively sought accurate information. He attempted to take into his staff only those officers who had already served with frontline units and who had demonstrated good tactical judgment. When a battle began, von Kuhl immediately sent selected staff officers to evaluate the action, and he required his staff officers to answer questionnaires after their return to headquarters.³⁴ His network extended beyond his staff. After battles, he had frontline officers meet at his headquarters to tell him about their experiences and their opinions. Von Kuhl recalled that these officers were at first reluctant to talk to him, but in time they would "express the burdens of their hearts."³⁵

The border between interest and interference is imprecise, and OHL and the general staff system were not without critics. Besides personal visits, the telephone was another major means of communication with the front line during the First World War. Ludendorff used it extensively and thought that it was good to use when personal visits could not be conducted. He also felt that the telephone had some value as a counter to the drawbacks of personal visits, such as false personal impressions.³⁶ General von Kuhl, often complimentary

of Ludendorff, admitted that this use of the telephone by OHL sometimes led to interference.³⁷ General Otto von Moser, a division commander, was less kind and complained of the "cantankerous harm of the General Staff institution, reaching out even more powerfully, that is, with the misuse of the telephone behind the backs of the commanders."³⁸

Despite these inevitable conflicts between staff and units in the field, the officers in OHL who were "reaching out" were a very superb group. Only about one dozen staff officers formed the OHL operations section that was responsible for the western front.³⁹ Their wartime performance remains an excellent advertisement for a small, effective staff. During most of Ludendorff's service as first quartermaster general, the chief of OHL operations for the western front was Maj. Georg Wetzell, an extremely capable officer. Another highly influential staff officer was Col. Max Bauer, who devoted his efforts under Ludendorff to problems of industrial war production, although he also helped write the defense regulations in late 1916. Staff members exercised influence irrespective of their rank. One of the most important members of the OHL operations section in the west was Capt. Hermann Geyer, who contributed to the writing of the regulations on both defense and offense.*

This operation section did not invent tactical concepts. More accurately, it solicited ideas and opinions from units in the field, examined as much empirical evidence as possible, defined and developed tactical principles, and articulated these final decisions for distribution to the army. Geyer later wrote that the most important and most difficult exercise of a staff was to review specific war experiences in order to help maintain the excellence of combat units.⁴⁰

One of the most respected officers who provided to OHL ideas based upon recent combat experiences was Col. Fritz von Lossberg. Having served on the western front in 1914 as a corps chief of staff, Colonel von Lossberg became deputy chief of operations at OHL for most of 1915. He then became chief of staff of the Third Army. For the rest of the war von Lossberg was legendary as the fireman of the western front, always being sent by OHL to the area of crisis. While at the Third Army he organized the defense to counter the French in Champagne. When the British attacked along the Somme in July 1916, von Lossberg became chief of staff to Second Army in order to supervise the defense in that sector.** In August 1917 when the British attacked at Arras, von Lossberg went to Sixth Army as chief of staff. Having successfully stopped that British effort, he went to Fourth Army as chief of staff and organized the defense at Passchendaele.⁴¹ Needless to say, von Lossberg was a

*One important characteristic of the Imperial German Army was its extreme stinginess in promotions during the war. This army could not be accused of inflation of rank, unlike its World War II counterpart, the Wehrmacht.

**The German Second Army headquarters was reorganized in a unit redesignation in July 1916 and von Lossberg became chief of staff to First Army, in the same sector.

remarkable man and an expert tactician. General von Kuhl admired von Lossberg's "iron nerves."⁴² Ludendorff praised him highly and referred to von Lossberg's great contributions to German tactical success. Ludendorff also wrote that von Lossberg's confidence in *him* was a great source of satisfaction,⁴³ a sentiment that illustrates the corporate spirit and the mutual confidence which transcend rank.

In addition to examining German unit experiences, the OHL operations section carefully screened captured enemy documents. In 1915 a captured French document described a defensive system consisting of successive echelons: a front line of thinly held outposts, a scattering of strongpoints, and shelters for reserves. Certain members of the OHL operations section viewed this French concept as a practical alternative to the densely occupied German front line.⁴⁴ Influential foreign ideas were not limited to the defense: a captured French document on attack greatly influenced the new German offensive doctrine developed in late 1917.

The desire to change defensive tactics had been building at OHL and unit staffs before Ludendorff's arrival. Several members of OHL had developed new concepts and some field armies had developed techniques locally. OHL had published reports of unit experiences, had translated and published captured documents, and had begun publishing a series of regulations on the employment of weapons in position warfare. But there had been no official change in doctrine for the entire western front.⁴⁵ Ludendorff brought these efforts together to transform the entire effort in the west.

Genesis of the Elastic Defense-in-Depth

Assuming his duties as first quartermaster general in August 1916, Ludendorff quickly visited the area of the Somme fighting (Rupprecht's Army Group).⁴⁶ He was convinced that the German Army must alter its defensive tactics or it would not be able to win the war, for the Allied artillery was wearing down the German forces.⁴⁷ A meeting of OHL in Cambrai on 8 September 1916 began the process of developing the new defensive doctrine. By the end of the winter lull in action, on 9 April 1917, when Allied soldiers went over the top in the first Allied major offensives of 1917, they faced a German Army that in only seven months, despite severe economic and manpower constraints, was organized, trained, equipped, and led according to new defensive principles. Perhaps only the preparation of the German Army for the offensives in spring 1918, which was accomplished in four months, was more impressive.

The change in defensive doctrine occurred in the following way: the operations section sifted through numerous reports from the units and considered the various opinions in developing the new defensive doctrine in fall 1916. On 25 September OHL published what it considered to be the key lessons of recent

fighting. However, opinions and experiences from the different units were often contradictory, and the process of deciding the precise content of the general doctrine was difficult, continuing until December.⁴⁸

The key regulation was *The Principles of Command in the Defensive Battle in Position Warfare* (hereafter called *Principles*), published on 1 December 1916. Ludendorff praised the two men whom he credited with the authorship, Colonel Bauer and Captain Geyer, "who had a well developed sense of tactics and a clear mode of expression."⁴⁹

This document provided general guidance for the conduct of the defense and, with subsequent editions, became the German doctrine of defense for the rest of the war. OHL officially rejected the principle of holding the forward line at all cost. The regulations now stated that the objective of defense was to force the attacker to frustrate and expend himself, while the defender preserved his strength. The *Principles* related the purpose of the defense entirely to the enemy and did not mention retention of terrain as the basic objective. The principles for achieving the objective were:

- The defender must not surrender the initiative to the attacker.
- The defense must rely on firepower, not large numbers of troops.
- The defender must not hold ground at all costs (a controversial principle).
- The defender must consider depth for all construction and positions.⁵⁰

Previous concern with the inviolability of the front line had caused the Germans to strengthen that part of the battlefield within range of Allied artillery and where the Allies applied their maximum power to achieve a penetration, that is, on the forward edge. The range of artillery and the fields of artillery observation favored the Allied concentration of artillery on the German forward edge. With the new German doctrine, the Allied concentration of firepower was on a forward edge held by relatively few German troops. German strength no longer directly confronted Allied strength. As the Allied attack advanced, its relative power would deteriorate as the distance from its artillery support increased because the attack outran its inflexible communications system and eventually exceeded the range of its supporting artillery. As the Allied advance became more confused and weak as it progressed, German power increased, for the Germans positioned their forces in tiers or echelons which became stronger as the distance from the front line increased.

Ideally from the German point of view, the Allies would also cross terrain not easily observed from the Allied front lines, for wherever possible the Germans had placed their defensive positions in depth behind terrain which blocked Allied ground observation. By further concealing their positions from aerial observation, the Germans insured that no Allied plan could anticipate all the surprises that the Germans had hidden in that masked area. German counterattack units were layered in increasing degrees of strength, from the

Ludendorff to problems of industrial war production, although he also helped write the defense regulations in late 1916. Staff members exercised influence irrespective of their rank. One of the most important members of the OHL operations section in the west was Capt. Hermann Geyer, who contributed to the writing of the regulations on both defense and offense.*

This operation section did not invent tactical concepts. More accurately, it solicited ideas and opinions from units in the front. It then synthesized these ideas and opinions.

outposts to deep in the rear. German knowledge of terrain, well-planned and rehearsed reserve movements, and a better-protected communication network gave increasing strength to the German defense.

The *Principles* provided the basic tactical concepts for defense. *The Principles of Field Construction* (hereafter called *Construction*) provided specific regulations for construction of positions. Regulations describing positions had been published earlier in the war, but this edition dated 13 November 1916 specified techniques to apply to the new defense regulations.* The defense now consisted of three successive zones: the outpost zone, the battle zone, and the rearward zone. (See figure 1.) Although the regulation did recommend tactical dimensions, it emphasized adapting the defense to the specific terrain in order to accomplish the mission.

The outpost zone served a purpose similar to outposts in open warfare: to contain enemy raids and patrols, to provide warning of major attacks, and to disrupt those attacks. Behind the outpost zone was the front trench system, usually three successive trench lines, called the main line of resistance (MLR). This main line of resistance was the forward edge of the battle zone. The battle zone extended back, depending on terrain, fifteen hundred to three thousand meters, with a second trench line, the artillery protective line, as its rear boundary. Behind this trench system was the rearward zone, although the Germans later extended the battle zone to create even more depth. The artillery was organized in great depth behind its protective line.⁵¹

If terrain permitted, the main line of resistance was on a reverse slope. The machine gun was the crucial infantry weapon. Although placing the machine gun on the reverse slope did not utilize the weapon's maximum range, combat experience had shown that sudden surprise fire, rather than prolonged long-range engagements, defeated attacks. The reverse slope position also preserved the defender's advantage of surprise, kept his position concealed from enemy ground observation, and offered protection against enemy artillery fire.

The major defensive battle would occur in the battle zone. The new regulations recognized that a massive enemy attack could overrun the MLR, but the regulations also stated that a counterattack in the battle zone would recover the MLR. Several factors favored the defender in this critical struggle. In keeping with the philosophy of using firepower to inflict maximum enemy casualties, the Germans fully integrated artillery into the defense. The *Principles* (1 March 1917 edition) devoted more pages to artillery than to any other combat arm. The tactical considerations for selecting defensive positions were not placement of infantry units, but "observation and positions for artillery, and

*The German regulations did not give a specific name to this defense, but the term elastic defense-in-depth is probably the best brief description. The echeloning of forces provided the depth, the reliance on counterattack (instead of fixed positions) provided the elasticity. The general summary of German defense doctrine described above includes some refinements which were made during the battles of 1917.

Figure 1. German Zones in Elastic Defense-in-Depth

(NOT TO SCALE)

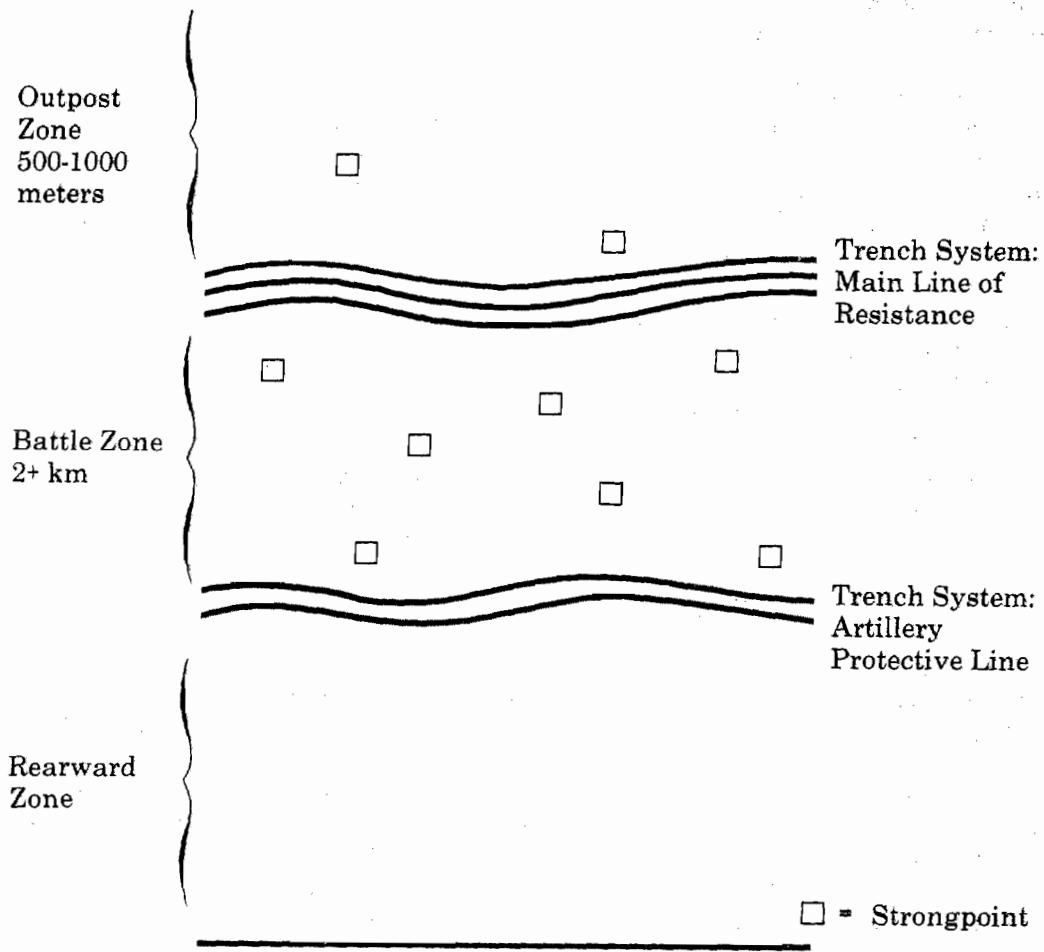

IDEAL CROSS SECTION:

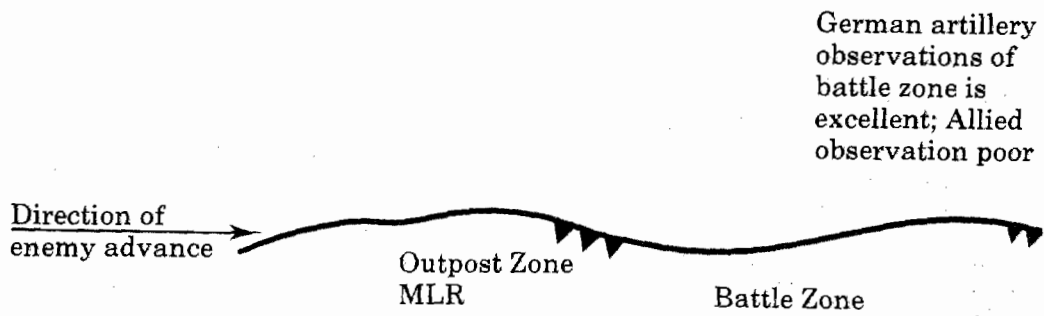

Sources: *Construction*, Wynne, Balck.

communications with the rear,"⁵² which clearly established the role of artillery as crucial in the defense. German artillery observers would have the battle zone under observation, but Allied artillery observers would be unable to direct their own artillery fire because of the masking terrain concealing the German MLR. As the Allies advanced beyond the range of their own artillery support, the Germans responded with carefully planned, timely artillery fire.

The German soldiers in the outposts and the main line of resistance, however, were not simply given carte blanche to evacuate their positions and head for the rear at the first opportunity. The defense was aptly called elastic, for it was to resist, bend, and snap back. The *Principles* stressed tenacity of defense, for "stout hearted men with iron nerves form the real backbone of defense."⁵³ The flexibility given to soldiers in the forward areas was practical: they were to shift to escape the artillery fire, and survive in order to inflict casualties on the subsequent enemy infantry assault. This shifting to escape Allied artillery could be to the flanks, to the rear, or to the front,⁵⁴ and it usually occurred in the numerous shell holes. The Somme experience had shown that large elaborate positions had disadvantages under heavy artillery fire. The trenches were necessary for daily living, but once detected they were lathered with preparatory fire and barrages. Deep dugouts in forward areas were also impractical, for soldiers remained in them too long after the enemy barrage lifted and were often captured. Therefore, under heavy fire, the forward German soldiers evacuated their trenches and shifted from shell hole to shell hole, avoiding concentrations of fire and escaping the detection of aerial artillery spotters.

The Allied advance would first encounter resistance from pockets of German survivors in shell holes. Having been concealed from aerial observation, units positioned on the reverse slope would then open fire unexpectedly.⁵⁵ The Allies would also encounter fortified strongpoints (*Widerstandsnester*). These strongpoints were not deep dugouts as before, but less elaborate fortified positions (of earth, wood, old buildings, or anything else available) for squads or machine gun sections, carefully sited to avoid Allied observation. Placed mostly in the battle zone, they were built to provide for all-around defense and they engaged the attackers, whenever possible, with devastating enfilade fire.⁵⁶ The strongpoints would remain fighting even if cut off by the enemy advance.

The ideal scenario was:

A fragmented, exhausted Allied attack force reaches the battle zone. They hope that their thorough artillery preparation has killed all the Germans, but they encounter several Germans firing at them from shell holes in the torn ground. Sudden fire from the German main line of resistance has slowed the Allies and their scheduled artillery barrage has crept forward without them, according to a timed sequence of fire they cannot modify. They feel helpless without artillery support. The Allies finally have taken the main line of resistance at great cost, but now they are in unfamiliar ground, under fire from concealed enemy machine gunners and riflemen. German artillery, which the Allies expected to destroy in the preparatory fires, now appears very active. The Germans concentrate their artillery fire behind the Allied advanced units,

cutting them off from reinforcements and supplies. For the next few minutes, the Allies have a tenuous hold on a few acres of ground, but by advancing into the battle zone, the Allies are most vulnerable, and have exposed themselves to the counterattack, the soul of the German defense. The immediate counterattack, well coordinated with accurate artillery fire, destroys, captures, or ejects the Allied unit before it can consolidate its gains. The coherence of the German defense is restored.

The German counterattack concept must be examined with respect to the German Army organization.* The Germans began the war with an infantry division that had two infantry brigades of two infantry regiments each. A reorganization begun in 1916 on the western front eliminated the brigade structure and created a division with three infantry regiments. The regiment consisted of three battalions and each battalion had four infantry companies and one machine gun company. The reduced number of units facilitated easier control, and the increased number of divisions provided more opportunity for division rotation, an important practice in German operations.

OHL did not specify to divisions exact frontages or precise defense organizations of subordinate units, but the following description illustrates how a frontline division often organized its defense. (See figure 3.) The three regiments were abreast in the sector. The regiments positioned their battalions in depth: the first battalion in the outpost zone and main line of resistance; the second, in the remainder of the battle zone; and the third, in reserve, ready to occupy the artillery protective line, a trench system in front of the heavy artillery and the reserve units of higher headquarters. The forward division deployed in an area where a major Allied attack was expected would often have an entire counterattack division positioned behind it in the rearward zone.

In its most developed form, the defense had designated counterattack forces throughout the zones. In the outpost zone local commanders designated counterattack squads. In the battle zone commanders designated counterattack companies. These counterattack forces came from the two battalions already occupying the zones. The regiment's reserve battalion was part of the division reserve, in which each remaining battalion from each frontline regiment served as a counterattack battalion, striking from the rear of the battle zone. Behind these counterattack battalions were the reserves of the field army (entire counterattack divisions), and OHL itself retained control of additional counterattack divisions.

The defense thus assumed a very aggressive and potentially offensive character. The best time for counterattack was the period of confusion when the attacker had not yet consolidated his position or reorganized his forces. Timing was critical. The Germans layered or echeloned the counterattack

*The following description refers only to changes in infantry units. It does not describe the changes to the other arms in the German infantry divisions. (See figure 2.)

Figure 2. German Division Organization

German Infantry Division, 1914

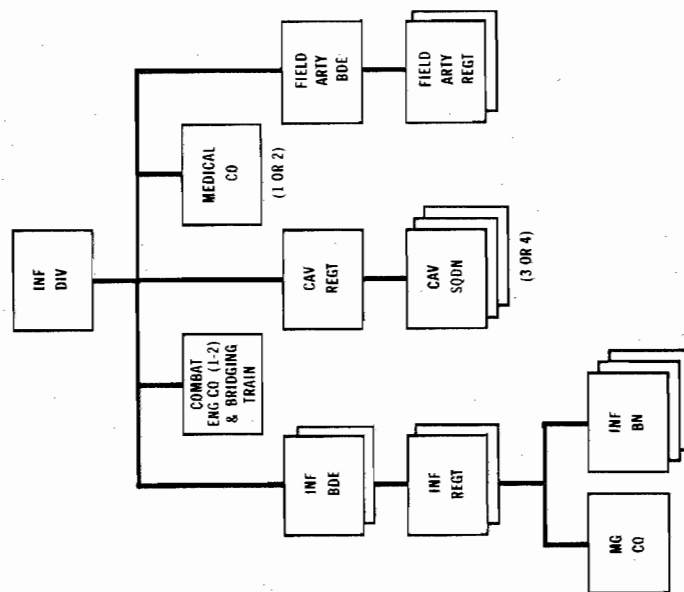

NOTE: Each field artillery regiment comprised six batteries of light artillery (77-mm and 105-mm).

Sources: Nash, Cron, Ludendorff.

German Infantry Division, early 1918

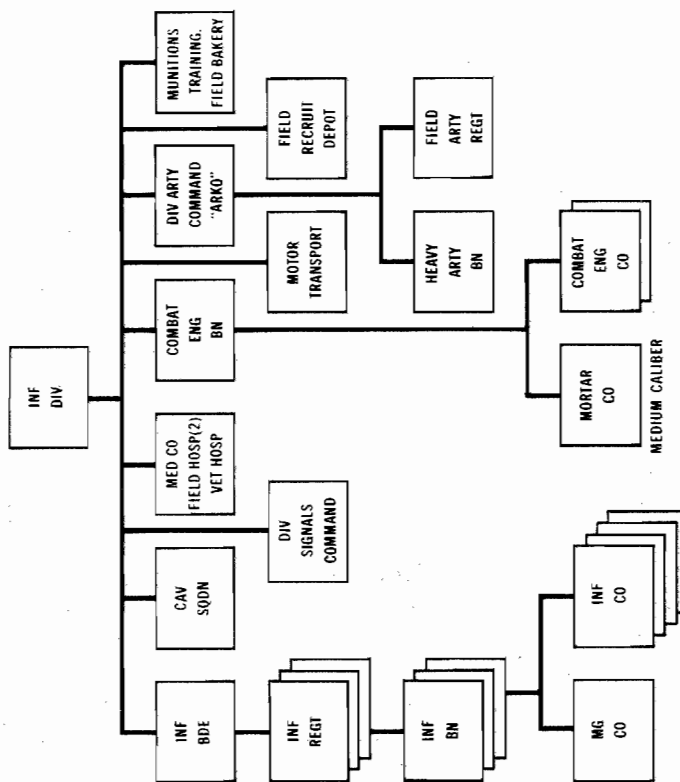

NOTES: 1. Infantry brigade was not a tactical formation.

2. The field artillery regiment contained 9 batteries and 18 machine guns.

3. The heavy artillery battalion contained 2 batteries of heavy howitzers, one battery of 100-mm cannon, and 6 machine guns.

Figure 3. Infantry Division in German Elastic Defense-in-depth

In a portion of the Front where an Allied attack was expected, the German infantry division occupied a three-to-four-kilometer sector. The division usually positioned its three infantry regiments abreast. Within its sector (about 1 km) each regiment positioned its three battalions in column, as shown:

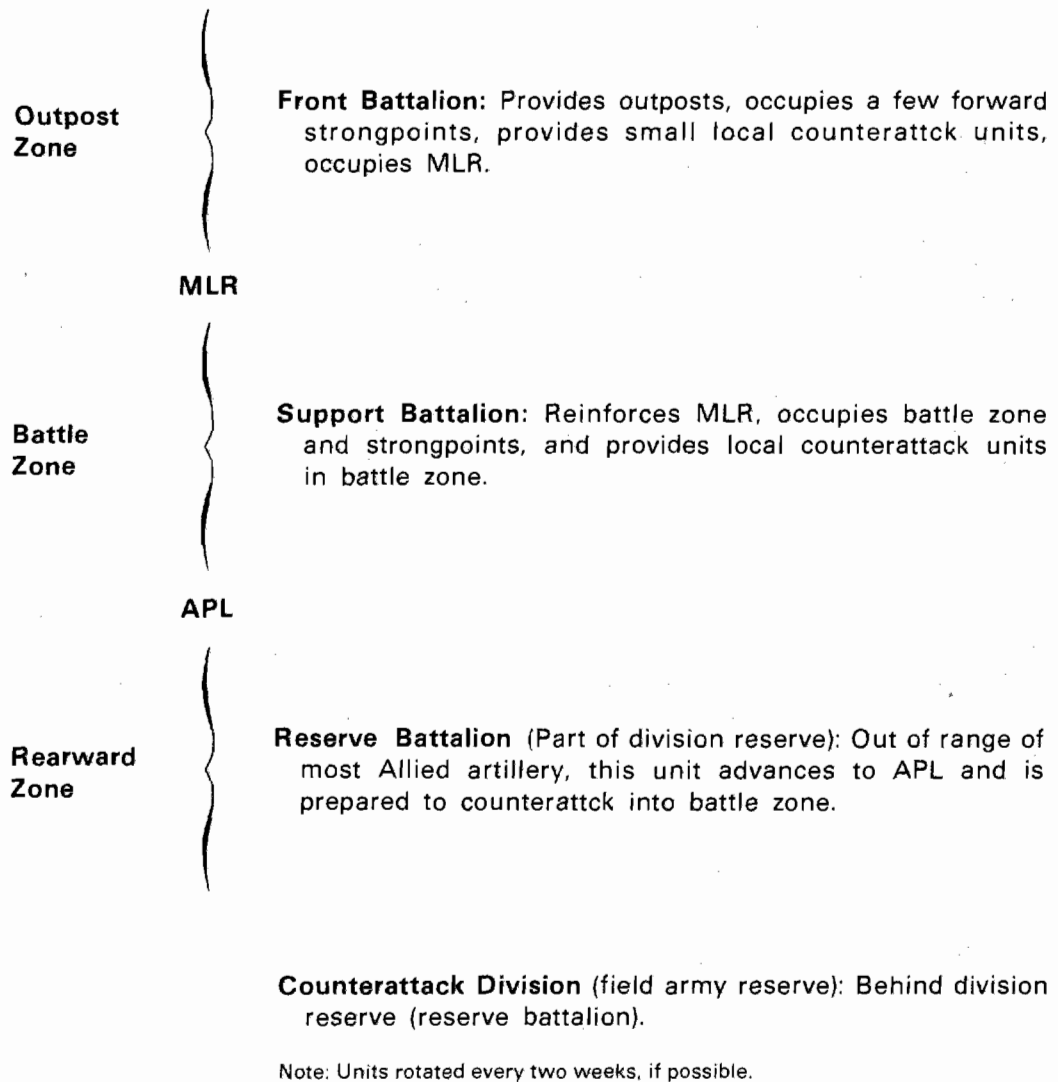

Sources: Balck, Wynne.

units so that they could deliver immediate counterattacks (*der Gegenstoss*) when the situation demanded. If the immediate counterattack failed, the Germans would shell the new Allied position and deliver a deliberate counterattack (*der Gegenangriff*) after a few days of meticulous planning.

All along a threatened sector, units would respond independently according to the demands of the immediate fighting. The necessity for speed and independent action imposed two demands on the German Army: the chain of command had to be streamlined for quick reaction and the quality and initiative of small unit leaders had to be high to apply the new tactics.

In order to streamline the chain of command, OHL made several modifications, based primarily on Colonel von Lossberg's experiences at the Somme. Since the army reforms after 1806, the Prussian Army, and its successor, the German Army, had a tradition of giving wide latitude to the commander at the scene of battle, and these First World War defense modifications reinforced this practice. The commander of the forward battalion possessed complete control over the forces in his sector, *including* units sent to his sector during battle as reinforcements. If the counterattack battalion was sent into his sector, the forward commander exercised final control over *both* units, irrespective of rank. The regimental commander's role was to insure the success of his battalions by organizing their assets. During battle his duty was solely administrative and logistical; he had to get the critical supplies, especially ammunition, forward and to insure that the counterattack battalion (his third battalion) was ready for employment. Eventually, the German system evolved to allow the battalion commanders to bypass regimental headquarters during battle and report directly to division.⁵⁷ Thus the tactical control of units was streamlined. The division commander had the same tactical responsibility as the battalion commander. The *Principles* (1 March 1917 edition) stated, "In the defensive battle the infantry division is the battle unit; it is responsible for the actual conduct of the fight."⁵⁸ The frontline division commander possessed the same authority over counterattack units moving into his sector as the frontline battalion commander had in his sector. According to the *Principles* (September 1917 edition):

Prior to the battle, the counterattack divisions will be under the orders of Corps or Army Headquarters. If engaged as a whole or, as will generally be the case, in small bodies, they will be placed under the orders of the commander of the battle sector. . . . Control of the fighting in his sector will generally be retained by the commander of the division in line regardless of any questions of seniority, and both the division in line and the counterattack division will, consequently, be under his undivided command.⁵⁹

OHL also increased the artillery of the division. In contrast to the earlier German organization and the French organization, in which the corps headquarters exercised the dominant control over artillery, the new German organization placed all artillery except the heaviest under the division commander. Before the war cooperation between artillery and infantry had been neglected in training, but in the new defense, reflecting the necessity for coordination,

artillery headquarters were as close as possible to the respective division headquarters.⁶⁰

As frontline divisions employed their organic counterattack units, the counterattack divisions behind them moved up to fill the recently vacated positions. For faster employment, however, the leading counterattack division sent liaison officers forward to the frontline division headquarters to coordinate movement. If the counterattack unit was directly behind only one frontline division, both division headquarters could be collocated to reduce possible friction when committing the counterattack division.⁶¹

The corps headquarters had a battlefield role similar to that of the regiment, to organize and to sustain the subordinate units, but not to direct the units during battle. The entire German Army organization gave support and authority to the commander of the engaged forces and thus reduced the number of headquarters controlling the tactical situation.

The immediate counterattack itself had to be delivered at the correct time, for German experience had shown that opportunities to crush the attacker were short-lived, and too often, late counterattacks had been unsuccessful. The new defensive tactical doctrine emphasized the immediate counterattack and forbade wasting time by waiting for permission from higher headquarters.⁶² The layered organization of counterattack units allowed even the smallest unit to react aggressively to the attack, and such aggressiveness was encouraged, for if the attack could be repulsed by the lowest level, men and munitions were conserved. Such actions at the small unit level required high standards of small unit leadership. But this devolution of responsibility necessary to apply the new tactical doctrine caused serious misgivings among many German officers. The German Army of December 1916 was not the army of August 1914. Losses had been severe, especially among small unit leaders. The rigorous peacetime training program had been replaced with expedient wartime training programs, in order to fill depleted units with new soldiers. Many German commanders feared that the hasty training made the soldiers less reliable. Ludendorff recognized the dangers of the new tactical doctrine, for tactics had become more individualized (the group, *die Gruppe*, consisting of one noncommissioned officer and eight to eleven men, was becoming the key element in small unit tactics) while the quality of training was deteriorating. He knew that many German officers were skeptical about the ability of the army to apply the new defensive doctrine.⁶³

Nevertheless, the German Army cautiously adopted a doctrine that demanded greater initiative in small units. In direct contrast, the Allied reliance on the brute force of firepower had the opposite effect, that of stifling initiative.

Writing after the war, Lt. Col. Pascal Lucas of the French Army described the lack of initiative in Allied operations:

. . . The [higher] command, which could quickly get information on everything which was going on, tended toward excessive centralization; nothing could be done except upon its orders; it took over all initiative and responsibility. . . . Our corps of officers and noncommissioned officers lost in that school the taste for initiative and responsibility, a grave disadvantage, the results of which were to make themselves cruelly felt later.⁶⁴

Enforcement and Application

Publication of the *Principles* by OHL was the result of a great effort by its highly trained staff. Yet, the publication was meaningless by itself, for doctrine published is not always doctrine applied. There were many impediments to the acceptance of the new doctrine, arising from both the virtues and the vices of the German Army. Despite popular caricatures of Germans as authoritarian and inflexible, the German Army fostered independent thinking among its officers. Because commanders were expected to think for themselves, the *Principles* had a tough, critical audience. Besides valuing independent judgment, the German officer corps was pragmatic and considered concepts situationally, not in theoretical isolation. A concept was not accepted on the basis of a catch-phrase or theoretical neatness. The German officer corps judged concepts according to the specific battlefield conditions in which such concepts would be applied. The new defensive doctrine faced the problem of any new doctrine, for it had to be sufficiently general to apply to the varied conditions along the western front, but sufficiently specific to insure unity of effort and efficiency among German forces. The doctrine then had to pass the most difficult test, that of battle.

There were other obstacles. Despite the high reputation of the German general staff, there was still a universal distrust of higher headquarters and, in particular, of staff members, by German frontline officers and men. The physical organization of static positions, with higher headquarters in safe, comfortable locations well to the rear, magnified this sentiment in all armies during the First World War.⁶⁵ OHL could not rely solely on the strength of its own authority to guarantee compliance with the new doctrine overnight.

Ludendorff's role in overcoming these problems is instructive, for he did not treat the doctrine as Holy Writ, yet he firmly directed and reorganized the German Army so that it would fight in 1917 according to the new doctrine. Ludendorff knew the effort required to transform published doctrine into applied doctrine, for he recognized that "orders on paper were of themselves useless, they had to be ground into the flesh and blood of officers and men."⁶⁶

Ludendorff put his full authority behind the new doctrine. "The controversy raged furiously on my staff; I myself had to take part and I advocated the new

tactics."⁶⁷ Shortly after the publication of the first edition of the *Principles* the French counterattacked in the Verdun sector.* Contrary to the *Principles*, issued two weeks earlier, the German commanders had not moved up their reserves behind the battle zone for quick employment in counterattack. They employed the reserves too late and the French were able to consolidate and hold gains of their limited attack. The two German commanders responsible, General von Lochow, Fifth Army, and General von Zwehl, XIV Reserve Corps, were subsequently relieved.⁶⁸

Ludendorff's other actions, however, showed that he could be tolerant when he detected a disagreement based on reflections and experience, not careless neglect. Ludendorff did not treat such constructive criticism as a personal attack. This tolerance appears in his reaction to the criticism of Colonel von Lossberg. This expert tactician believed that the *Principles* were too liberal in allowing troops in forward trenches to move to the rear if necessary. He also feared that the movements of so many small units would become too chaotic. Ludendorff's reaction was gracious. He published von Lossberg's ideas, as expressed in the paper, "Experiences of the First Army in the Somme Battles," as part of an official training directive rather than stifling all criticism.⁶⁹ He had confidence in the *Principles* but he also realized that effective doctrine could not be dogma. Refinements would be necessary when the battles resumed, so he did not discourage independent thought. Colonel von Lossberg, for his part, later demonstrated great flexibility during the battles of 1917 and he became the supreme practitioner of the elastic defense-in-depth.

Neither was Ludendorff jealous of the ownership of the new doctrine. He never called it "mine," only "ours," and he gave credit to the colonel and captain who had written it. The development of the doctrine required deliberate solicitation of ideas and experiences and gave the final product wide ownership, facilitating its acceptance by subordinate units who felt they had contributed to it and had a stake in its success. Colonel von Lossberg was an important contributor to the concepts, but not the only one. Crown Prince Wilhelm's reaction to the defensive doctrine conveyed this feeling of ownership, for in the new doctrine he recognized ideas that had been forwarded to OHL from his army group, which "was the cause of great satisfaction to my Chief of Staff and myself."⁷⁰

Even the bitter comments of Renn were back-handedly complimentary; although he complained that the defensive changes were overdue, he did not complain that they were incorrect.⁷¹

OHL also published several other documents. Eight weeks after the *Principles* appeared, OHL published the *Manual of Infantry Training for War*. This description of a training program came from a field army training

*Upon assuming duties as first quartermaster general, Ludendorff had stopped the German attacks on Verdun, but the French continued to counterattack to regain lost ground throughout the remainder of 1916.

program and it contained von Lossberg's account of the Somme. The director of artillery at OHL distributed special monthly periodicals on gunnery to units.⁷² Several other OHL regulations described the use of specific weapons, such as trench mortars and machine guns.

This enormous publishing effort was not wholly beneficial, because the constant recording of experiences and publications of directives constituted a paperwork nightmare. There was no relief and von Kuhl recalled that no efforts to alleviate paperwork demands succeeded.⁷³

Despite the inevitable problems with paperwork, the *Principles* and *Construction* were very timely for some concrete reasons. The Germans were constructing new positions behind certain sectors on the western front. (See map 2.) Since September 1916 Ludendorff had contemplated voluntary withdrawal from certain German salients in order to shorten the length of the western front, to occupy more favorable ground for defense, and to release some units to become counterattack units. Besides these benefits, however, these withdrawals also provided the Allies propaganda to create the appearance of German failure. The German selection of favorable defensive terrain for these new positions began in fall 1916 and was based upon the Somme experiences and the subsequently published *Construction*. Throughout the rest of the war, continuous improvements were made to these defensive areas. The Allied press often referred to the system imprecisely as the Hindenburg line, but that name only correctly applied to one specific sector out of five. The use of the word "line" was also misleading because the construction program created deep zones; it was not devoted to making one continuous line invincible.⁷⁴

Amid the construction efforts and the normal demands of the front in the winter of 1916—17, the German Army trained and reorganized according to the elastic defense-in-depth. Doctrine alone was useless unless training could instill the necessary standards of performance. As the *Principles* (1 March 1917 edition) stated succinctly, "The value of troops depends on their standard of training."⁷⁵

Ludendorff supervised the efforts to establish schools to prepare the German Army for the anticipated Allied offensive of 1917, "to get rid of any ignorance as to the nature of defensive fighting."⁷⁶ Schools behind the lines were not new. All adversaries on the western front had established elaborate training schools behind their respective lines, for the static front made establishing and maintaining such institutions possible. As early as 1915 the Germans had established recruit depots in rear areas where divisions trained their combat replacements.⁷⁷ The bulk of recruit training for replacements was therefore already being conducted near the front, not in Germany.⁷⁸ Ludendorff firmly supported additional tactical schools to train the army in the new tactics during the winter lull.⁷⁹

High ranking commanders and staff officers attended the schools at Solesmes (later moved to Valenciennes) and Sedan. The school at Solesmes began classes in February 1917; the Sedan course began in March. Local infantry and artillery units tested ideas (including coordination of the two arms), and student comments received serious consideration.⁸⁰ Field armies established their own schools to train junior officers and noncommissioned officers in the new methods. OHL established additional training areas for those weapons which were particularly useful in the defense: artillery, trench mortars, and machine guns. Despite the considerable strain on German war production, OHL made ample supplies of ammunition available for live-fire training. Training emphasized integration of all combat arms, and officers received cross-training in various weapons when time and other demands allowed.⁸¹ Divisions trained special sharpshooter machine gun units.* Units unable to rotate to the rear for training because of demands of the front conducted training in their sectors. The entire training effort by the German Army was considerable.

The demand for training competed with other considerations. Troops, for example, constantly dug new positions and improved old ones. Despite the German use of labor units composed of prisoners of war and civilians, the demand for manpower for construction was so great that it required additional soldier labor. The Germans also had a requirement for resting units. The German Army was exhausted by the end of 1916, and its leaders recognized the need to include rest periods into the training rotation.

The leaders also soberly recognized the need for soldiers who could apply the new tactical methods. Crown Prince Wilhelm wrote that the elastic defense-in-depth needed well-disciplined, well-trained, and well-led troops which were becoming more difficult to find because of the strain of war.⁸² The German leaders admitted that all these demands necessitated compromise.⁸³

The winter of 1916—17 was also a period of reorganization and standardization for the German Army. The reduction of the infantry division's maneuver units to three infantry regiments continued throughout the army. Battalion strength was also reduced, creating enough surplus soldiers to form thirteen new divisions for the spring. Cavalry units continued to be disbanded, freeing the horses for the urgent demands of transport and freeing the men for services as infantry.⁸⁴

This reorganization and standardization placed great demands for new equipment. The army needed artillery tubes, not only to replace those destroyed, but also to replace tubes worn by the excessive firing.⁸⁵ The famous German steel helmet, having proven its value at the Somme in limited issue, now became standard issue in the German Army.⁸⁶ The army developed the light machine gun during this period, and each infantry company received four, and

*These units were called SS machine gun units, SS meaning *Scharfschützen* (sharpshooter). This designation was not related in any way to the SS (*Schutzstaffel*) of World War II.

later six, of these new weapons.⁸⁷ With the light machine gun placed forward, the heavy machine gun could now be placed in the intermediate area of the battle zone. The machine gun was the most important infantry defense weapon, as Balck recalled:

The unexpected opening of fire of a single machinegun under the efficient leadership, even if served by only a few cool men, has several times been the decisive factor in victory and defeat. Good training must overcome malfunctioning of the gun.⁸⁸

The dominance of the light machine gun caused a gradual reorganization of infantry units. At the smallest unit level, the section (*Gruppe*) was organized into two complementary squads (*Trupps*). One squad consisted of one light machine gun, two gunners, and two ammunition bearers. The second squad consisted of seven riflemen and the leader. Since the machine gun became the dominant weapon, the primary purpose of the rifle squad had become the protection of the machine gun.⁸⁹

German industry had been unable to meet many of the demands of war, and the army had suffered equipment and munition shortages in 1915 and 1916.⁹⁰ To insure that adequate amounts of equipment and munitions would be available in 1917, Ludendorff implemented a national production plan, the Hindenburg Program, in August 1916. Several members of the OHL staff participated in this effort, including Colonel Bauer and Major von Harbou, who calculated the anticipated demand for raw materials for the army. The Hindenburg Program's effects remain controversial, but the program did result in peak production of German war industry in 1917 and enabled Ludendorff to supply the German Army with new weapons and munitions.⁹¹

One final aspect of the extensive preparation of the German Army for the offensive struggle of 1917 was the nurturing of an aggressive spirit in the defense. The previous defense of the forward line cultivated steadfastness, but not aggressiveness. In the new doctrine, however, the counterattack was essential to the elastic defense-in-depth, and an aggressive spirit had to be instilled in soldiers who had grown accustomed to fighting a position defense for two years. Upon arriving in the west, Ludendorff saw a means to foster such an aggressive spirit, not only for counterattacks, but also for future offensives. Visiting Crown Prince Wilhelm's Army Group in September 1916, Ludendorff was greeted by a unique honor guard, the storm troopers of the Rohr Storm Battalion, and for the first time saw "a single detachment in full storming rig-out."⁹²

The concept of storm troopers, like the doctrine of the elastic defense-in-depth, was not invented by OHL or Ludendorff. These concepts were discovered, encouraged, codified, and disseminated. Although the precise origin of the storm troopers is unclear, the use of select infantry soldiers for special missions has been a common development in most protracted wars. As early as August 1914 German units used special assault troops in the Argonne,⁹³ and in 1915 a Bavarian division employed specially trained assault infantry in an attack.⁹⁴ The famous unit that comprised the honor guard observed by

Ludendorff began in March 1915 as an experimental unit of combat engineers. Their first assault against the French in a small unit action was a failure. However, Capt. Willy Rohr assumed control of the unit on 8 August 1915 and under his direction the storm battalion (*Sturmbataillon*) became famous.

Rohr was an innovative officer and he combined a good sense of tactics with experiments with new equipment. His unit, which eventually became known as *Sturmbataillon Rohr*, soon achieved success in small unit operations against the French. What distinguished Rohr's techniques from the prewar German tactical doctrine was the organization of attack forces in small groups deployed in depth, instead of advancing in a broad firing line, and the arming of individual infantry soldiers with various types of weapons, instead of the standard issue rifle. Rohr's storm battalion used grenades, rifles, machine guns, trench mortars, flamethrowers, and light artillery pieces. His battalion practiced extensively with supporting artillery units in order to coordinate unit movement with supporting fire. Live-fire training in these new techniques, which caused some casualties, was extensive. The basic unit of the storm battalion was the assault squad (*Stosstrupp* or *Sturmtrupp*); the originator of the word *Stosstrupp* was Maj. Hermann Reddemann, who developed tactics for the flamethrower, and who was, ironically, a former chief of the Leipzig fire brigade.⁹⁵

The success of Rohr's unit did not go unnoticed. Officers and men from units serving in the front near Rohr's unit were very impressed; at their request, Rohr established a one-week training course in December 1915 to pass on his techniques to other units. After the initial German attacks on Verdun in February 1916, the German Fifth Army, to which Rohr's unit was attached, directed Rohr's unit to serve during lulls in the action as a training cadre for other infantry units, in addition to their combat mission of conducting difficult assaults. This dual mission of storm units, both training cadre and elite assault units, continued throughout the war.

Col. Max Bauer of OHL had also been monitoring Rohr's progress and in May 1916 General von Falkenhayn directed the field armies on the western front to send selected small unit leaders to train with Rohr for fourteen days. These small unit leaders returned to their units and established storm units in their own divisions. There were limitations, however, for necessary equipment was often unavailable, time was scarce, and training, especially in the coordination of artillery fire by assault units, was difficult to organize. The change of German chief of staff in August 1916 from von Falkenhayn to Hindenburg and Ludendorff was decisive in the further development of storm unit techniques. After viewing Rohr's storm battalion during his visit, Ludendorff directed that storm battalions serve as cadre to teach storm unit techniques to the rest of the German Army. With OHL's backing, the training commenced on a large scale. The official encouragement of storm unit techniques helped foster an aggressive spirit in the German Army during the defensive battles of 1917, and carried over to the German offensives of 1918. Crown Prince Wilhelm wrote that this

strong encouragement of storm unit techniques was one of Ludendorff's greatest services rendered during the war.⁹⁶

The Battles of 1917

On 21 March 1917 the German Army awaited the anticipated Allied offensives. Despite severe materiel shortages and extensive demands on several fronts, the German Army, through considerable effort, had prepared well. The new defensive doctrine was not a panacea, however. The Allies would press the Germans hard in 1917, and the Germans would modify their doctrine accordingly. Also, despite OHL's and Ludendorff's efforts, some German units did not resolutely apply the new doctrine, a fact that became painfully apparent with the first Allied attack.

The British began their 1917 offensives near Arras, attacking Crown Prince Rupprecht's Army Group. The preparatory bombardment, beginning on 21 March 1917, saturated an eleven-mile front with 2,687,000 shells. On 9 April the British and Empire forces went over the top. Although the German organization in depth had prevented a repetition of the slaughter of the Somme, things still did not go very well for the Germans on 9 April. They had difficulty in coordinating their defense efforts: artillery did not provide timely support of counterattacks, and division commanders had not positioned counterattack units sufficiently forward for timely insertion.⁹⁷ Ludendorff was distraught and feared that the efforts of seven months had been futile.⁹⁸ Ludendorff talked to frontline participants by telephone and quickly concluded that the principles were sound but had not been applied correctly.⁹⁹ The worst reverses had occurred in the sector of the German Sixth Army, where the well planned and executed British attacks had secured their initial objectives. The German Sixth Army commander, seventy-three-year old Colonel General von Falkenhausen,* was half-hearted in applying the new defensive doctrine.¹⁰¹ To correct this, Ludendorff appointed Col. Fritz von Lossberg, the fireman of the western front, as chief of staff to Sixth Army. Von Lossberg immediately changed the incomplete efforts of the Sixth Army into a coherent system using the newly developed defensive principles. With his characteristic energy, he established methods for coordinating artillery fire for timely response, repositioned forward units, and moved reserves closer to the front lines. Although von Lossberg, it should be remembered, had been a critic of the fluid nature of the elastic defense-in-depth, Ludendorff called upon von Lossberg to rectify the situation at Arras and showed that disagreement did not destroy mutual confidence. For his part, von Lossberg *did* apply the elastic principles wher-

*It is difficult to determine where the greatest responsibility for the failure of the Sixth Army lay. Von Falkenhausen's superior, Crown Prince Rupprecht of Bavaria, wrote that he should have pressed von Falkenhausen more vigorously to move reserve units closer. Von Lossberg also tended to blame Rupprecht's Army Group headquarters. Divisional histories of units in Sixth Army, however, recorded that Sixth Army instructions to counterattack units were not in compliance with the new defensive doctrine from OHL. Interestingly, on 22 April, von Falkenhausen was named Governor-General of Belgium and relinquished command of the Sixth Army.¹⁰⁰

ever local terrain allowed, despite his earlier skepticism of the "elastic" aspects of the doctrine.¹⁰² The enlightened tacticians of the German Army tolerated compromise when it was inspired by good judgment.

On 14 April the British launched attacks with limited objectives to expand the salients created by their initial assault of 9 April. Von Lossberg had prepared the Germans and this time the battles resembled the ideal scenario for the German defense. For example, in the VII Corps (British) sector, British battalions attacked at 0530 behind a creeping artillery barrage. German artillery hit the British infantry, slowing its advance and separating the British infantry from the protective creeping barrage. The British infantry also encountered unexpected small arms fire from German reverse slope positions. Local German counterattack units closed in on the now confused remnants of the British advance. By 0800, having lost two-thirds of the strength from their lead units, the British were back at their original line. Another grim example came from the British VI Corps sector where two British battalions gained nothing, and lost all their forces except those in battalion headquarters. German casualties were much less.¹⁰³

Throughout April and May the British continued to attack in the German Sixth Army sector in a series of battles called the Battles of the Scarpe. The British did not achieve a breakthrough, although on some occasions the Germans became quite alarmed. The German defense worked best where the terrain favored German artillery observation. Not surprisingly, British attacks succeeded best where terrain favored their artillery observation. The essential difference was that the Germans recognized this, and gave up ground where terrain did not offer the good observation necessary for effective artillery support of counterattacks. Much to the relief of the Germans, the British did not appear to understand that observation provided by key terrain greatly affected their operations. The British continued to press on in a wide effort, and did not seize fleeting opportunities to use specific areas with favorable observation to press the advantage. The Germans yielded some ground, but they prevented a breakthrough and preserved their fighting strength.¹⁰⁴ It is significant that the purpose of the elastic defense-in-depth was to restore the cohesion of the German defense, which did *not* always include the recovery of every bit of territory.

The British efforts in April, however, were only part of a larger Allied strategic plan, which did not direct the British to make the major effort. The purpose of the British attacks was to attract the German strategic reserves to the British sector, in order to enhance the chances of success of the major Allied effort by the French (see map 3) led by a newly appointed commander in chief, the tragic Robert Nivelle.

Robert Nivelle, named French commander in chief in December 1916, had risen very quickly to high command during the war.¹⁰⁵ Beginning the war as an artillery colonel, Nivelle demonstrated bravery and competence, and by May 1916 he commanded the Army of Verdun under General Petain and

Map 3. Reims and Arras, 1917.

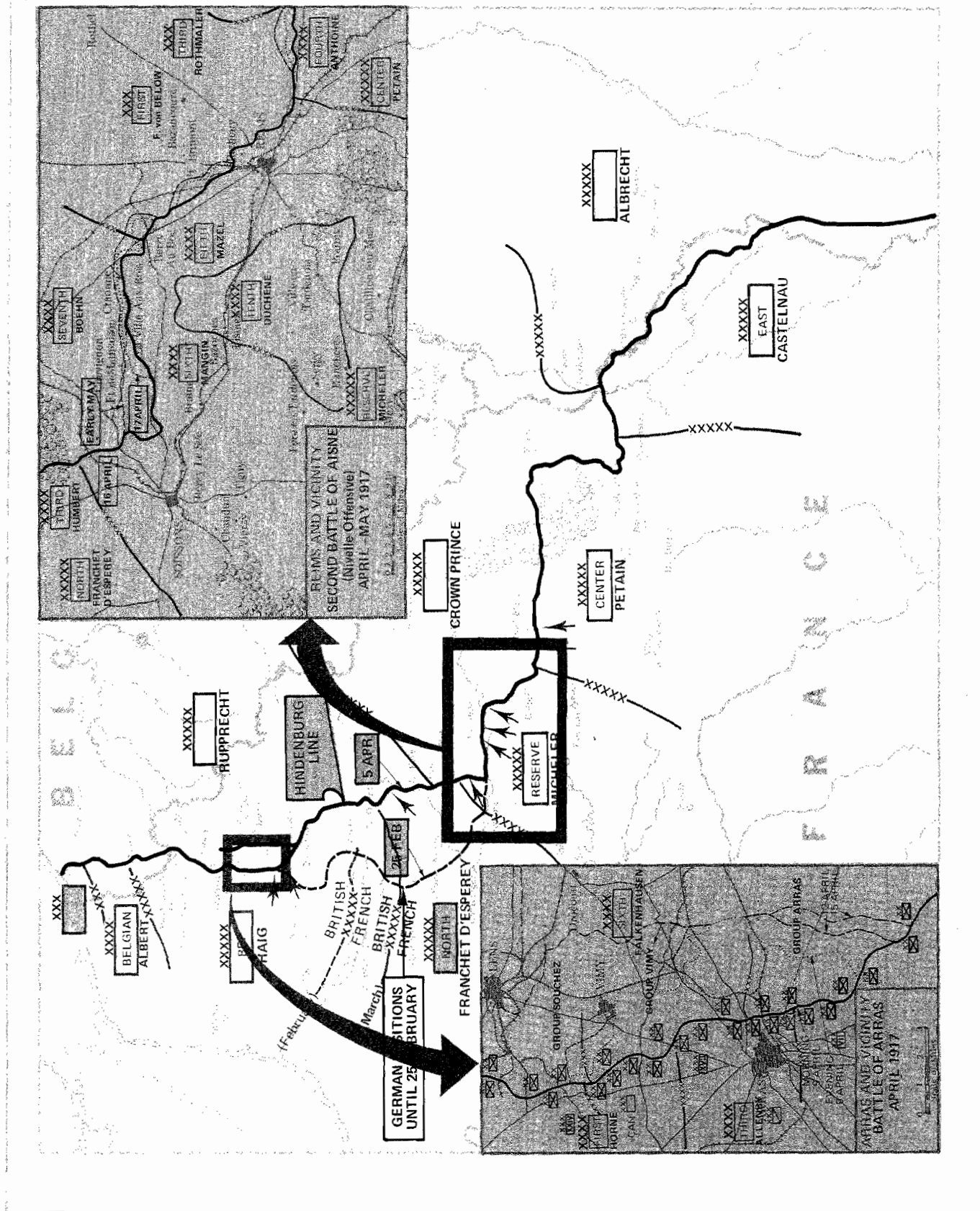

received national attention. He directed the counterattacks which successfully recovered ground previously lost to the German attacks at Verdun. These counterattacks relied upon artillery preparation and a rolling barrage, behind which infantry advanced. The infantry advanced in small groups, pressing home with speed and violence, bypassing centers of resistance.* Nivelle's method gave impressive results at Verdun, for he secured limited objectives at an acceptable cost in lives. Now this man was selected to command all forces in France. As Edward L. Spears, British liaison officer to the French High Command, recalled:

What remained to be seen was whether the glorified raids of Verdun were applicable on a large scale . . . above all whether he [Nivelle] was strong enough to keep his head in the lonely and dizzy height of supreme command.¹⁰⁶

The great tragedy was that Nivelle, upon assuming supreme command, was *not* strong enough to keep his head. His tragic flaw was his insistence, as an article of faith, that his method was inherently irresistible. Uttering, "We have the formula,"¹⁰⁷ Nivelle, with a very confident demeanor, seemed to believe that his methods would succeed of their own merits; he treated the Germans as if they were a terrain obstacle instead of an active, intelligent enemy.

Nivelle's tactical method, instead of a means to an end, became an end in itself. The extensive preparations for the offensive became increasingly unrealistic. For example, French commanders tried to outdo each other in establishing the fastest rolling barrage during training. This would lead to disaster in combat, when the infantry could not keep up with the rapid artillery fire.¹⁰⁸ Spears observed that the more optimistic a prediction by a subordinate headquarters, the more approving was the French high command.¹⁰⁹

In this atmosphere of unrealistic optimism, French High Command also tolerated no criticism or skepticism. Reports of a new German defense technique were ignored. The deliberate German withdrawal to a new defensive zone did not cause significant changes to the French plan. The Germans were particularly well prepared, for they captured a set of orders that described Nivelle's plan (for Nivelle had confidently distributed his orders throughout the army), a document that contained, in the words of Crown Prince Wilhelm, "matter of extraordinary value."¹¹⁰ Displaying an extreme disregard for reality, Nivelle insisted on adhering to his plan *after* he had been informed that it had been compromised. As Nivelle's personal stake in the success of his methods grew, the more unrealistic he became.

The French infantry assaulted on 16 April 1917 with disastrous results. The French infantry was unable to keep up with the "insane pace of the barrage."¹¹¹ Well-concealed German machine gun strongpoints engaged the

*Despite the ultimate failure, Nivelle's methods should not be dismissed as worthless. The German offensive tactics (see chapter 2) had several similarities to Nivelle's concepts, but, as will be shown, the German Army and its leaders were more successful at executing the concepts.

French from all directions, including from the rear, as the French entered the battle zones.¹¹²

The German artillery was as well prepared as the German infantry. Knowing the French preparatory fire plans, German gunners did not fire during the French artillery preparation. The French erroneously concluded that their artillery had silenced the German guns, and French assault units, assembled for attack, often did not take the precaution of digging in. The German artillery suddenly fired on the French assault forces.¹¹³

German defense positions had been chosen for good German artillery observation, and the German counterattacks against the French lead units were well coordinated with German artillery, as Spears observed:

The scenario of these minor battles [the immediate German counterattacks] was practically always the same. They were heralded by very accurate German artillery fire concentrated on the point of attack. The ground the Germans intended recapturing would be turned into a field of smoke and flame under a roaring, screeching sky that seemed about to collapse, forcing down the heads of the [French] defenders; trenches would rock and cave in under the violence of the explosions, then the air would buzz as the steel wasps of the German machine gun bullets came over in their scores of thousands. Suddenly the range would lengthen and, looming out of the smoke of the last explosions, shadowy forms would rush forward, gesticulating wildly, enemy soldiers [German] throwing grenades.¹¹⁴

The problems with the Nivelle offensive went beyond the battlefield. The movement of supplies, especially artillery munitions, created severe problems, caused monumental traffic problems, and left some artillery units without adequate stocks of munitions.¹¹⁵ Nivelle was incorrect: his Verdun method could not simply be expanded administratively and logistically to a larger scale.

Before his offensive, Nivelle had promised success with glowing Napoleonic phrases. The obvious failure of the Nivelle offensive caused a collapse of French morale that led to widespread disobedience in the ranks. Nivelle was relieved; Petain became commander in chief of the French Army and began to solve the crisis of the mutiny. In order to divert the attention of the Germans, who remained unaware of the gravity of the French crisis, the British continued the offensive operations in their sector for the remainder of 1917.

Although the British continued to employ the familiar massive use of artillery to clear the way for their infantry, they also occasionally employed other tactics. One spectacular method was the detonation of 500 tons of explosives that had been placed in tunnels underneath a German position at Messines on 7 June 1917.

The British also used the tank, their attempt to solve the tactical dilemma with a technological innovation. First used in 1916, tanks were employed increasingly by the Allies in 1917, including in the initial successes at Cambrai in November 1917 (see chapter 2).

The major British campaign after the Nivelle failure, the Passchendaele (or Third Ypres) Campaign in Flanders, lasted from 18 July to 16 November. Predictably, Colonel von Lossberg went as chief of staff to the Fourth Army, against whom the British directed their main effort. Also predictably, the German defense held well.

Throughout this period, the Germans constantly reexamined their doctrine, revised it, and adapted it to local conditions. For example, in October 1917 the British conducted shallow, methodical attacks for limited objectives. The Germans attempted to frustrate these attacks, which were not deep enough to trigger the Germans' larger counterattack forces, by placing greater numbers of troops in the forward lines, but the result was a longer casualty list.¹¹⁶ The Germans reverted to the sparsely occupied forward line. Ludendorff constantly discussed the tactical situation with commanders and with chiefs of staff like von Lossberg and von Kuhl. Often, new refinements in the defense were tested.¹¹⁷

This flexibility was a strength in the German attitude toward doctrine. There was no dogmatic formula that became an article of faith, as had occurred with Nivelle. To the best German tacticians, doctrine was a means to an end, not an end in itself.

When the Allies assumed a defensive posture for the winter of 1917—18, they had gained very little ground but had expended much blood and materiel, while the Germans had conserved enough strength to continue the war into 1918, despite the terrible effects of the war and the economic blockade of Germany. The German elastic defense-in-depth had succeeded. Crown Prince Wilhelm wrote that he was firmly convinced that had the German Army not changed its defensive doctrine, it "should not have come victoriously through the great defensive battles of 1917."¹¹⁸

The British grudgingly complimented the Germans that winter by adopting a defensive system based upon captured German documents.¹¹⁹ Unfortunately for the British, they did not completely grasp the spirit of the German doctrine (especially the emphasis on counterattack units) and the British Army did not apply the principles thoroughly during the winter. This shortcoming would be evident when the Germans unleashed their offensive in 1918.

The Offensive Tactics of 1918

2



In the second half of 1917, strategic conditions were developing that would offer the Germans an opportunity to concentrate their military power on the western front in 1918. Russia, suffering from internal convulsions as well as the extreme demands of the war, could not sustain the war effort. As peace negotiations with Russia began, German units traveled from east to west. The number of German divisions in the west went from 150 in October 1917 to 192 in March 1918.¹ The opportunity for force concentration in the west had to be seized quickly, for the United States had declared war on Germany in April 1917. The Germans calculated that it would require one year for the United States to exert any decisive influence on operations in the west. Therefore, the changing strategic situation and deteriorating economic and political conditions in Germany (due to the effects of the Allied blockade of Germany) only permitted the Germans one final attempt at victory in the west.

On 11 November 1917 OHL decided that the great offensive would begin in the spring of 1918. Between this decision and the initiation of the offensive on 21 March 1918, the German Army developed the appropriate doctrine and prepared as many units as possible for the attack. In order to destroy the Allied forces, the Germans attempted to solve the tactical dilemma which had frustrated the Allies for more than three years. The preferred German maneuver in prewar doctrine, the envelopment, was impossible to achieve in the west. Therefore, a successful penetration was required, to be followed up by force sufficient to achieve a strategic breakthrough.

Although in two and one-half years the Germans had conducted only one major offensive on the western front (Verdun), the German Army still had considerable experience from which to draw. Units in the east had been participating in several major offensives throughout the war. More recently, in October 1917, a German field army (Fourteenth Army under General Otto von Below), having been formed with units from the western, eastern, and Rumanian fronts, was sent by OHL to northern Italy to cooperate with the Austrians in an offensive against the Italians. General von Below's order to his forces before battle stated:

Every column on the heights must move forward without hesitation; by doing so opportunities will be created for helping neighbors who cannot make progress, by swinging round in the rear of the enemy opposing him.²

At the Battle of Caporetto the Germans and Austrians smashed through the Italian forces, achieving a strategic penetration, and drove the Italians back to the Piave River. The other Allied powers responded, sending French and British units to Italy to strengthen the front. Italy, although badly shaken, remained in the war. The Germans and Austrians had not eliminated Italy from the war, but the Central Powers success had been most impressive. Italy lost 305,000 soldiers, including 275,000 prisoners.³

The offensive successes in the east and in Italy had occurred within the unique conditions of each theater. OHL, in considering the peculiar nature of the western front, did not blindly adopt techniques derived outside the west and try to apply them immediately to the western front. Instead, OHL examined each combat experience with respect to the particular conditions in which it had occurred.

Also, the German forces on the western front were better prepared for offensive operations than their record of recent experiences in major offensives indicated. Although Verdun had been an offensive with a limited objective and the 1918 offensive plan sought a strategic breakthrough, the Verdun battles had demonstrated several useful points: the value of sudden concentrated artillery fire in depth before the assault, the need for centralized control of artillery, the value of surprise, and the need for greater combined arms cooperation. The Germans had tried several tactical techniques, such as attaching a horse-drawn artillery battery to an infantry regiment in the attack, in order to provide the infantry better fire support.⁴

The German Army's defensive experiences in 1917 provided another very important source of offensive expertise. The aggressive tenor of the elastic defense-in-depth, especially the counterattack, nurtured offensive excellence. To train the army for this defense, units acquired the spirit of the counterattack, and OHL had codified storm trooper techniques to assist this training. Having accumulated considerable counterattack experience in 1917, the German Army in the west already had a deceptively solid base of doctrine and experience for offensive operations.

The Germans had another source of experience on the conduct of the offense. They had defended against the Allied attacks for three years, and recognized that the Allies had been showing them what *not* to do.⁵ Reliance on massive firepower to destroy the enemy was clearly not the solution. In any event, the Germans could not match the Allied expenditure of munitions, so a different offensive technique was required. A French captain inadvertently provided one important source of inspiration for developing such new techniques.

On 9 May 1915 Capt. Andre Laffargue led an attack on a German position. Afterwards, Laffargue reflected upon the problems of the attack and expressed his ideas in a pamphlet, "The Attack in Trench Warfare." The French Army published the pamphlet, but distributed it for information only; it did not

become French doctrine. The British did not translate it.⁶ Early in the summer of 1916 the Germans captured a copy of the pamphlet, translated it at once, and issued it to units. Ludwig Renn wrote that Laffargue's ideas had immediate use as a tactical manual for German infantry.⁷

Laffargue personified that resource of talent which exists at the small unit level and develops in combat; he was a part of the "human canister" of combat who did not want to die, but to succeed.⁸ Exclaiming, "Let us prepare our business down to the slightest detail in order to conquer and live," he set out to record his experiences and ideas.⁹

Laffargue advocated a sudden attack to achieve a deep penetration. His attack resembled a gulp, not a nibble.* The momentum of the in-depth attack would disrupt the enemy, keep him off balance, and prevent him from organizing an effective response. To capitalize on disruption, the assault had to advance as far as possible. The first wave would identify—not reduce—defensive strongpoints and subsequent attack waves would destroy them. An artillery bombardment applied suddenly in depth throughout the enemy area would precede the infantry assault. Disruption of enemy artillery batteries was particularly important to protect the infantry advance.

Laffargue stated that all troops were not assault troops; special training and care were necessary to develop the aggressiveness and skill for the assault. Ironically, the German storm units best epitomized this idea of elite assault units. In his pamphlet, Laffargue also expressed the need for an automatic rifle for firepower in advance positions, a need later met in all armies during the war by the light machine gun.¹¹

Although they did not adopt all of Laffargue's ideas (for example, he was very insistent on some rather cumbersome formations), the Germans derived greater benefit from his ideas and put more of his ideas into practice than the French did. German units became well acquainted with his concepts and the operations section of OHL was impressed with the practical combination of surprise, firepower, and maneuver to break the tactical stalemate.¹²

While the Allies had not pursued Laffargue's concept of sudden attack as vigorously as their enemies, they had pursued a technological solution to the tactical dilemma. During the Somme battle in September 1916 the British introduced tanks. The initial use of tanks failed to capitalize on the tactical and strategic potential of the weapon, to the chagrin of the early tank enthusiasts, whose highly original tactical ideas had been rejected by British High Command. In their first battle, tanks were dispersed as infantry supporting weapons and followed the characteristically heavy and long artillery

*The metaphor likening attacks to consumption of food was popular in the First World War. Joffre described his 1915 strategy of numerous attacks with limited objectives by stating, "I am nibbling at them."¹⁰ The German attack regulations of 1918 used the same metaphor and described "devouring" the enemy position.

preparation. The Germans quickly developed antitank tactics,¹³ but they did not attempt to imitate the Allies in the use of the tank.

On 20 November 1917 at Cambrai the British conducted a surprise limited attack. The attack caught the Germans off-guard, because it had none of the familiar signs that forewarned of Allied attacks. Instead of the long relentless artillery preparation, there was a very brief but concentrated artillery barrage, fired without previous registration in order to insure surprise. Immediately thereafter a large concentration of tanks attacked, followed by infantry.

The results of this attack were as unexpected as the tactical procedures. The attack stunned the Germans. The British penetrated the German defensive zones, suffering few Allied casualties. Then, however, supply and reinforcement difficulties stalled further British progress. Their impressive gains formed a large, inviting salient. The Germans moved reinforcements to the area and ten days later eleven divisions of Crown Prince Rupprecht's Army Group launched a deliberate counterattack.

This large-scale counterattack was the first major German offensive action against the British since 1915. The attack began with a bombardment that lasted only a few hours but gradually intensified. German gunners fired large quantities of gas shells along with high explosive rounds. The German infantry quickly advanced, following the rolling barrage. The *British Official History* provided a description of this infantry assault, which clearly showed storm unit methods, integration of different arms, and methods of bypassing resistance:

Preceded by patrols the Germans had advanced at 7 a.m. in small columns bearing many light machineguns, and, in some cases, flamethrowers. From overhead low flying airplanes, in greater numbers than had hitherto been seen, bombed and machinegunned the British defenders, causing further casualties and, especially, distraction at the critical moment. Nevertheless few posts appear to have been attacked from the front, the assault sweeping in between to envelop them from flanks and rear.¹⁴

The Germans pushed deeply into the British positions, so quickly that the British general commanding the 29th Division barely avoided capture, escaping in his pajamas.¹⁵ In time, confusion abated and British resistance intensified. The campaign ended with lines drawn almost where they had been before the initial tank assault of 20 November.

Ludendorff had expected greater success, but he was still pleased with the results of the counterattack because it had been achieved by troops who had not been specially trained for an offensive.¹⁶ Analyzing the recent experiences almost immediately, Crown Prince Rupprecht's Army Group staff quickly circulated to its units a memorandum that stressed the importance of surprise as demonstrated at Cambrai.¹⁷ This analysis of recent tactical experience was a characteristic German Army method. British General Headquarters also circulated to its units a pamphlet describing a successful action of three British

divisions in the defense against the German counterattack. The *British Official History* noted that this effort by British GHQ was "unusual."¹⁸

The Offensive Doctrine

On 1 January 1918 OHL published *The Attack in Position Warfare* (hereafter referred to as *Attack*), which became the basic document for the German offensives of 1918. Just as *Principles* had described a defense that incorporated the entire battlefield in depth instead of emphasizing only the front line, *Attack* described an attack-in-depth, a devouring* of the entire enemy position instead of nibbling away at the enemy front line. Once again that "mere captain," Hermann Geyer, was instrumental in writing the text.¹⁹

The objective of the major German offensive was to achieve a breakthrough after penetrating the Allied line. In their efforts to penetrate the German defenses, the Allies had relied upon massive artillery fire. The tank was another possible solution, but appropriate tank tactics did not emerge until Cambrai. The Germans could not rely on a long destructive artillery bombardment to give them their penetration, for they lacked the huge quantities of ammunition (their industrial production did not match that of the Allies), and more importantly, they knew such tactics had not worked. The Germans did not seek a solution through technological innovation. For example, they did not attempt to develop the tank on a large scale, but chose to accomplish the attack-in-depth with existing combat means in a carefully coordinated attack relying on surprise.

The doctrine in *Attack* was as applicable to the deliberate counterattacks of the defense as it was to the main attack of an offense to achieve a breakthrough. The introduction to *Attack* clearly stated this and it demonstrated the close tactical connection between the counterattack and the offensive. *Attack* noted that the strategic breakthrough was the ultimate goal of the penetration. In order to achieve that goal the attack had to strike deeply into the enemy position. Acknowledging the impossibility of destroying all enemy forces in such a deep penetration, the German tactical doctrine did not require complete destruction. Instead, disruption of enemy units and communications was essential. Throughout the doctrine, keeping the enemy off balance, pressing the attack continuously, and retaining the initiative received great emphasis.

The authors of *Attack* described all artillery missions (preparatory fire, creeping barrage, isolating the objective) with the acknowledgment that total destruction of enemy forces could not be achieved. For instance, artillery would neutralize, not necessarily destroy, enemy artillery batteries; the *Attack* strongly recommended gas shells because of their disruptive characteristics. The *Attack* clearly identified the need to move artillery and ammunition forward to

*The German text of this regulation, *Der Angriff im Stellungskrieg*, used the word *fressen*, meaning to devour or to consume.

maintain the attack. Also, the authors devoted 21 of the 113 paragraphs of *Attack* to air forces, which received an increased role in strafing enemy positions.

Attack stressed infantry-artillery cooperation and recommended pyrotechnics to control creeping barrages. Special horse-drawn artillery batteries provided mobile artillery to infantry regiments, a technique used at Verdun and in some storm battalion organizations. The doctrine encouraged any techniques that could assist the artillery in keeping up with the infantry, for in the German attack the infantry, *not* the artillery, determined the speed of the attack:

The momentum of the infantry must not be dependent on the barrage, but vice versa, otherwise the dash of the infantry will be checked in the rigid curtain of fire.²⁰

While the *Attack* urged German infantrymen to exploit the effects of artillery, it also reminded them that success depended on their own skill. No amount of munitions could relieve the infantryman from his responsibility to close with the enemy.²¹

To conduct the attack, the German infantry organized in depth. Speed and depth were the means of securing their flanks and rear: speed to keep the enemy from reacting in time to the attack, and depth to provide the follow-up units which would isolate the bypassed pockets of resistance and prevent these remnants from interfering with the continuation of the attack.²²

There has been some confusion about the name of these new German offensive tactics. After the German offensive of 1918, the French called the tactics "Hutier tactics," attributing them to General Oskar von Hutier. After serving on the eastern front, von Hutier was transferred to the west for the 1918 offensives, during which his Eighteenth Army achieved the greatest successes against the enemy. The French credited him with the invention of the offensive tactics, and perhaps this erroneous conjecture provides another example of the personality-dominant thinking of the Allies. The first Allied reaction to the new German tactics was to attempt to identify an individual inventor. The Germans themselves never used the term "Hutier tactics," and recent research has established clearly that von Hutier did not invent these tactics.²³ The tactics were the product of an effective corporate effort.

A better term is "infiltration tactics." While the German text does not use the equivalent German word, "infiltration" is a satisfactory description of the infantry technique of bypassing resistance and pushing forward as far as possible. However, "infiltration" connotes individual movement, whereas the German movement was in small units, and the word is too exclusively infantry oriented. The German effort emphasized the coordination (*das Zusammenwirken*) of all arms, especially infantry and artillery: just as no one personality was the source of tactical wisdom, there was no one weapon or technique that exclusively carried the German attacks. Like the efforts of the officers in

developing doctrine, the efforts of the various arms blended in a complementary fashion.

The Attack Organization

In *Attack* as in *Principles*, the Germans considered the division the basic unit capable of conducting independent battlefield operations. The offensive doctrine, however, established one relationship that differed greatly from the elastic defense-in-depth. Whereas in the defense the forward division commander had the authority to order counterattack units outside his own division organization to deliver an immediate counterattack, in the offensive the higher headquarters retained control of the follow-up units.²⁴ The reinforcements were kept well forward, but under the direction of higher headquarters they would reinforce success.²⁵

To maintain the momentum of an attack, the belligerents had tried several different methods for relieving the leading units in the attack during the war. The French had tried successive waves (the first wave taking one objective, the second wave passing through to take the next one) and the British had used a similar leapfrog technique in 1917.²⁶ But in *Attack* lead units were instructed to continue without relief, for the doctrine considered it preferable to maintain the attack and exhaust the lead unit, rather than attempt a succession which would lose time and impetus.²⁷ Unfortunately, this method resulted in severe losses for the lead units, which would have an adverse effect on the 1918 German offensive.

Maintaining the initiative in the offense demanded the same high standard of small unit leadership which the elastic defense-in-depth required. The fluid tactics required independent action by the assault detachments and groups (*Stosstrupps* and *Gruppen*).²⁸

The group (*Gruppe*) or section of the light machine gun and riflemen was the basic infantry small unit, as it had been in executing the elastic defense-in-depth. This tactical organization represented a significant change from the prewar technique of an advancing line of similarly equipped infantrymen. Ludendorff remarked that the new role of the light machine gun as the dominant weapon and the subordinate role of the riflemen (to protect the machine gun), as shown during the defensive battles, was a difficult change for many German soldiers, previously trained in infantry units where the rifleman had the dominant role, to understand.²⁹

An important aspect of the application of the new offensive doctrine was the role of the storm battalions in teaching the new small unit techniques to the other German infantry units. Each German field army had a storm battalion that acted as a teaching cadre during periods of training. This instruction was so highly regarded that German units on the eastern front began sending officers and noncommissioned officers to the western front to

attend storm unit training courses in late 1916. Field armies on the eastern front then imitated their counterparts in the west by establishing their own storm battalions, based on Rohr's unit.³⁰

The composition of storm units varied within these possibilities:

- 1 to 5 storm companies (infantry assault units)
- 1 to 2 machine gun companies (heavy machine guns)
- 1 flamethrower section
- 1 infantry gun battery (light mountain howitzers
or captured Russian guns)
- 1 *Minenwerfer* company (trench mortars)³¹

Besides the established storm battalions for each field army, ad hoc storm units were often formed within infantry divisions and were usually led by a cadre trained by the field army's organized storm battalion.

Established storm battalions assaulted with additional infantry from an accompanying division. The first wave was an infantry probe (from the accompanying division) whose purpose was to identify enemy positions for the next wave, about 250 meters behind. The second wave consisted of the elite storm companies and the flamethrower section, with additional infantry support from the division. This second wave attempted to penetrate the enemy zones by pushing through weak areas to envelop enemy positions. Supporting these efforts was the third wave, about 150 meters behind, which contained the storm battalion's heavy weapons and similar additional support from the division. This third wave provided fire to support the forward movement of the storm companies and to protect the flanks of the penetrations. Behind these three waves followed the remainder of the accompanying division, which reduced pockets of resistance bypassed by the storm units, provided reinforcements, and maintained the momentum of the attack.³² In sectors where established storm units were not available, infantry divisions used their own ad hoc storm units and imitated storm unit techniques.

The storm unit techniques and the new offensive doctrine emphasized a constant drive forward. Speed and timing were essential for rapid advance, and small unit initiative was crucial to seize the unpredictable and fleeting opportunities of the battlefield. There was no "secret formula" in these techniques. Enemy positions were reduced in a practical fashion: the physical and psychological effects of the advance reinforced each other.

Artillery support was carefully integrated into the assault plan. Although the infantry missions necessitated decentralization of control, the artillery missions in support of the attack required greater centralization of control over artillery. The Germans wanted to avoid any prolonged artillery fire, for surprise would be lost and an artillery duel would develop in which the Allies, with greater amounts of munitions, would eventually prevail.³³ Therefore, German fire had to be fast and accurate, and its mission was neutralization, rather than elusive and costly destruction.

The techniques used to deliver fast and accurate neutralization fire in 1918 were greatly influenced by one very remarkable man, Georg Bruchmüller, the most significant "import" from the eastern front to the western front. He had been on the retired list at the outbreak of the war because of a riding accident.³⁴ Recalled to active duty during the war, he served on the eastern front. Bruchmüller developed techniques to support attacks with a sudden concentration of accurate fire instead of prolonged preparatory bombardments. In the spring of 1916 he convinced the chief of staff of the Tenth Army to adopt this method of concentration for a major attack at Tarnopol, and the effect in supporting the rapid advance of the infantry was impressive.

Bruchmüller's technique emphasized fire in depth throughout the enemy positions.³⁵ His support included an accurate creeping barrage, the *Feuerwalze*, for the advancing infantry.

Bruchmüller knew how to derive the greatest benefits from limited means. Attacks received support based upon the estimated *minimum* number of batteries needed to achieve success. Bruchmüller did not attempt to flatten every enemy position, for this was unnecessary:

In a fire action of a few hours only, the complete destruction of enemy trenches, a complete harassing of rear areas, etc., could naturally not be achieved. This was not at all contemplated. We desired only to break the morale of the enemy, pin him to his position, and then overcome him with an overwhelming assault.³⁶

Bruchmüller developed several techniques to achieve this disruption, which required strict control of all artillery assets. Each battery of each type of weapon received specific fire missions with specific timetables. He organized the stages of delivery of fire in this way:

First Stage: Surprise concentration, hitting headquarters, phone links, command posts, enemy batteries, and infantry positions. Fire is sudden, concentrated, and makes extensive use of gas.

Second Stage: Most batteries reinforce those batteries already firing on enemy batteries.

Third Stage: Fire for effect on designated targets according to range. Some batteries continue to shell infantry positions, and heavy pieces engage long range targets.³⁷

Surprise was essential to achieve maximum disruptive effect on the enemy. Therefore, the Germans had to conceal their attack preparations very carefully and their initial target data had to be very accurate.

The relationship between infantry and artillery in all armies often became strained during the war. In 1915, for example, French infantry in one sector wore conspicuous linen cloth on their backs in a vain attempt to avoid being

shelled by their own artillery.³⁸ To develop mutual confidence between infantry and artillery, Bruchmüller began conducting lectures with the infantry unit before an operation. Bruchmüller took great pride in gaining the confidence of the infantry: "The thanks of the infantry, in my opinion, must be treasured more by every artilleryman than all orders and citations."³⁹ He discussed his targets in detail, describing the timing of the preparation, the conduct of the rolling barrage, and any other matter of mutual concern. At the end of his lectures he would entertain questions, including those from the lowest ranking soldiers.⁴⁰

Bruchmüller soon earned a great reputation as a superb artilleryman. He rose in position in the east, commanding the artillery of von Hutier's Eighth Army at Riga in September 1917. When his unit was transferred to the west in late 1917, Bruchmüller arrived in time to participate in the Cambrai counterattack. Ludendorff knew of Bruchmüller's great skill, and by the beginning of the offensive in March 1918, he had disseminated Bruchmüller's methods to the units in the west. Ludendorff called Bruchmüller "one of the most prominent soldiers of this war."⁴¹

The skills of Bruchmüller, Rohr, and others were brought together by OHL in the training effort to prepare for the great offensive of 1918.

Preparation for the Offensive

Major Wetzell, OHL's chief of operations for the western front, wrote a memorandum about the coming offensive in which he listed three conditions necessary for success in the west in 1918: surprising the enemy, hitting him at a weak point, and training the army "down to the smallest details in accordance with military principles."⁴²

Again, the winter became a period of intense activity for the German Army on the western front. Ludendorff knew that the training efforts of the previous winter had to be imitated, only now in preparation for the offensive.⁴³

German training programs throughout the war strongly emphasized individual training.⁴⁴ Recruit training behind the front, which stressed this individual training, quickly incorporated the new offensive doctrine. OHL revised the courses of instruction at the officer schools at Sedan and Valenciennes. Each field army established a special instructional center behind the lines where newly arrived units from the east trained in accordance with the new doctrine.⁴⁵

When possible, units withdrew from the front and went to the rear to conduct training exercises. In accordance with OHL training outlines, companies, battalions, and regiments conducted exercises emphasizing assault tactics and coordination of different weapons. The scope of the exercises expanded; complete divisions were able to conduct practice assaults. Pyrotechnic devices were

employed in training to develop methods of controlling creeping barrages. Despite a shortage of munitions, the Germans used live ammunition in training to achieve realism. Ernst Jünger's unit trained according to "Ludendorff's marvelously clear scheme of training,"⁴⁶ and Jünger recalled the dangers of training with live ammunition:

Sometimes I made practice attacks with the company on complicated trench systems, with live bombs [grenades], in order to turn to account the lessons of the Cambrai battle [German counterattack of November 1917]. . . . we had some casualties. . . . A machine gunner of my company shot the commanding officer of another unit off his horse while he was reviewing some troops. Fortunately the wound was not fatal.⁴⁷

The artillery units also trained very extensively. Because surprise was essential in the German concept of the attack, the Germans sought methods to develop accurate artillery fire on a first round basis, that is, accuracy without firing registration rounds on the potential target. This was a technique the British had used with success at Cambrai. An artilleryman, Captain Pulkowsky, developed the following method for the German artillery:

- Test fire each artillery piece to determine the peculiar characteristic of the individual gun, called the "special influences."
- Carefully record and tabulate this data for each gun.
- Record the ballistic effects of external factors (wind, atmospheric pressure, precipitation, powder temperature and condition) in tables, under the heading "daily influences."
- Plot initial target data using precise map locations.
- Apply the daily influences and special influences to obtain firing data sufficiently accurate for firing without registration.

Pulkowsky's method met considerable resistance. Von Kuhl, the chief of staff for Crown Prince Rupprecht's Army Group, recalled that several of the subordinate headquarters insisted that no accurate firing could be done without registration. The new method was tested extensively at the artillery school at Maubeuge and finally adopted.⁴⁸

Ludendorff also noticed the objections, but supported the adoption of the method. Captain Pulkowsky became the instructor of the technique and he "carried out his duties with great energy and skill."⁴⁹ Pulkowsky instructed about six thousand officers and noncommissioned officers in this technique before the March 1918 offensive.⁵⁰ A company grade artillery officer's diary provided evidence of the initial resistance to the new instruction. Upon receiving orders to be trained for the offensive, he was disappointed, for he did not want to attend the school.⁵¹ However, once he began the hard training, which included extensive use of live ammunition, his initial skepticism gave way to

acclaim. He described the value of the Pulkowsky method during an attack on 27 May 1918:

Not a single battery had done any range firing, but our shooting was a masterpiece of accuracy, all worked out and plotted according to the latest principles of ballistics.⁵²

In all the extensive preparation for the offensives, OHL did not ignore the continuing refinement of defensive tactics. Of particular importance in light of the Cambrai experience was defense against tanks. The appearance of tanks had often caused German soldiers to panic; OHL reacted to stop this. The artillery units were trained to engage tanks with direct fire. For the infantry, a 13-mm rifle was quickly manufactured, whose bullets could penetrate the armor of Allied tanks. Tank obstacles became part of defense preparation. The initial panic over tanks was overcome.⁵³

This activity contrasted with the reluctance of OHL to begin a major effort in German use of tanks. German units had recommended the German use of tanks from the beginning of Allied employment of tanks, and, for example, a report of 2 October 1916 from the German First Army on the Somme recommended that Germany produce its own tanks.⁵⁴ Ludendorff, however, was not enthusiastic. He thought that the limited resources of Germany were better directed to manufacture more motor transport for greater strategic and operational mobility.⁵⁵ Therefore for the offensive of 1918, the Germans employed only a few German tanks and a limited number of captured ones. This small effort had a negligible effect on the campaign, and Ludendorff's failure to encourage German tank development has been severely criticized.⁵⁶

Although he probably underestimated the value of tanks, Ludendorff neglected no other aspects of the preparation for the offensive. As early as July 1917 Ludendorff had outlined a comprehensive program of patriotic training for the army. Germany was bearing the burden of the effort for the Central Powers, and the length of the struggle and the economic stagnation were seriously affecting German morale at home and in the army. Ludendorff began the patriotic training to reverse this decline of morale in the army, for the effects of the blockade and the frustration of the war threatened the ability of the German Army to perform according to the high standards demanded by their tactics.⁵⁷ Leadership was an important ingredient in improving morale, and OHL published principles of leadership to guide the offensive training, to encourage small unit initiative, and to remind all levels of command that leaders, including commanding generals and their staffs, belonged on the battlefield.⁵⁸

The German Army, however, could not train or equip every division for the offensive. Lack of time, talent, and equipment created an unsatisfactory situation in which 56 divisions out of 192 were designated attack divisions,* while the remaining divisions were called trench divisions (*Stellungsdivisionen*).

*The Germans used the terms *Angriffsdivisionen*, *Stosdivisionen*, or *Mobilmachungsdivisionen* to describe attack divisions.

This distinction was unfortunate but unavoidable for economic reasons. The attack divisions received extra care, better rations, and more equipment, creating resentment among soldiers in the trench divisions.⁵⁹

Another example of a serious manpower shortage that forced the Germans to adopt a grim expedient was their creating a leader reserve, usually in lead units. Heavy casualties had occurred in the officer and noncommissioned officer ranks throughout the war, and in anticipation of such heavy losses in the spring offensive, the German Army identified officers who would be kept out of the fighting intentionally in order to be available to fill the anticipated vacancies caused by casualties.⁶⁰

Despite such difficult conditions, the German Army prepared well for the offensive. Three field armies (Second, Seventeenth, and Eighteenth), designated to conduct the attack on 21 March 1918, contained attack divisions and were ready. Von Kuhl credited this success to Ludendorff's personal efforts,⁶¹ but Ludendorff's greatest contribution was his ability to harness the talents of so many to achieve such unity of effort.

The Offensive

The German offensive began on 21 March 1918. Although the Allies had been expecting a German attack, the extremely rigorous security precautions of the Germans had confused the Allies about the exact location of the main effort. Elaborate German deception measures had convinced the French that the main attack would be delivered in their sector.

The major German attack was directed instead against the British positions east of Amiens. (See map 4.) At 0440 on 21 March 1918 the artillery preparation began. Nearly six thousand guns commenced firing in a seven-phase bombardment plan designed by Colonel Bruchmüller. The elaborately planned bombardment lasted only five hours, and then the infantry assaulted. The concentration of fire in those five hours was terrific. One German artillery observer recalled that, whereas the French and British had pounded the Germans for days during Allied offensives, the Germans had only five hours to return the favor. The fumes from the guns were so intense that many German artillery crews donned their protective masks.⁶²

On the receiving side, a British soldier remembered his experience:

I was impressed by the way it came down with one big crash. We had known of the coming attack—but not the exact day I had always thought that the bombardment would develop gradually but the full force was almost instantaneous One moment we were walking along as normal, the next there were shells bursting all about us. We all ran like mad for cover.⁶³

The Germans used gas shells extensively. In areas where an infantry assault was not planned, they used mustard, a persistent agent. In the areas

where the German infantry would penetrate, the Germans delivered high explosive shells mixed with shells of chlorine and phosgene gas. The Germans also fired shells containing lachrymatory gas, a throat irritant. The Germans hoped that the irritant would penetrate the British masks, forcing the British soldiers to remove their masks, and thereby exposing themselves to the more lethal chlorine and phosgene. Despite its intricacy, this complex plan did not work.⁶⁴

The bombardment did achieve the overall desired effect, however. It disrupted British communications and left British units in confusion. The *British Official History* described the success of the German infantry assault:

Forward Zone as a whole was overrun at the first rush, the machineguns still in action hardly firing a shot. Making good use of the valleys, where the fog lay heaviest, the leading waves of German infantry swept onwards towards the Battle Zone, leaving the posts and redoubts still holding out in the Forward Zone to be dealt with by special parties.⁶⁵

The advancing German infantry found many British areas in complete disarray. The German artillery fire had been accurate, effective, and efficient.⁶⁶

The British Fifth Army, which bore the brunt of the first day's attack, lost considerable ground. (See map 4.) Of the three German armies attacking on 21 March, the Eighteenth Army (von Hutier) achieved the greatest success, although it had not been designated the principal attacking force of the field armies in the attack. Although the British had adopted a defensive system similar to the German one, the British had not understood the essential German concepts. The British had neither efficiently organized their army nor sufficiently modified their training program or their command structure to adapt the defensive concept.⁶⁷

Compared with previous Allied offensive efforts, the German tactical success of 21 March 1918 was impressive. In the Somme battles of 1916 the British and French had labored for 140 days at the cost of more than one-half million casualties to capture a total of ninety-eight square miles of ground. In twenty-four hours in March 1918 the Germans secured about 140 square miles at a cost in casualties of less than one-tenth the Allied expenditure at the Somme.

The approximate casualty figures for 21 March 1918 were:⁶⁸

	<i>Killed</i>	<i>Wounded</i>	<i>Prisoner</i>	<i>Total</i>
German	10,851	28,778	300	39,329
British	7,512	10,000	21,000	38,512

The number of British prisoners reveals how disrupted the British defense was and also suggests that total destruction by fire is not necessarily a prerequisite for a successful attack.

Map 4. Western Front, 1918.

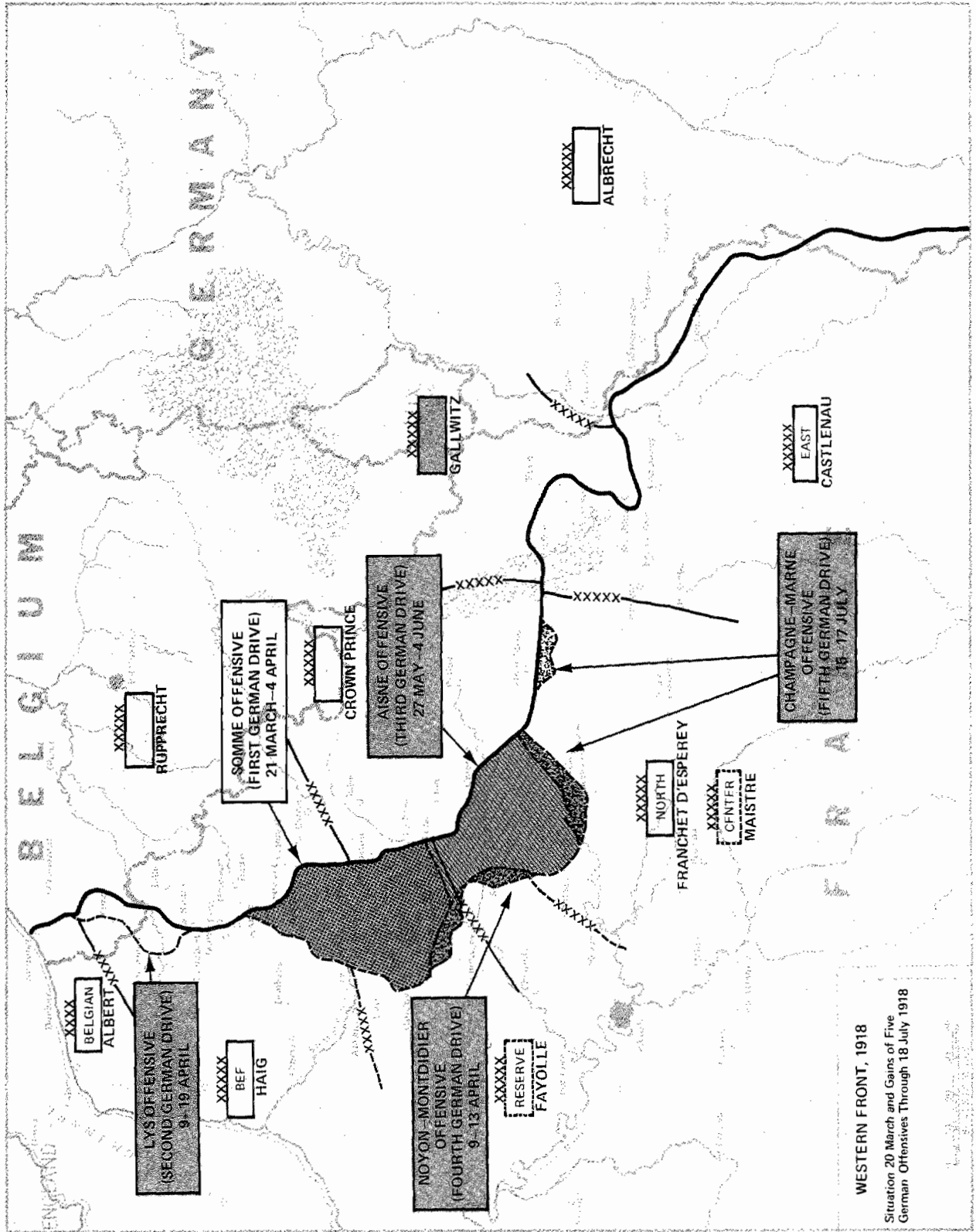

Despite the German tactical success in penetrating the British line, the Germans were unable to achieve a strategic breakthrough. Transport difficulties still plagued German operations. Despite techniques like using prefabricated, wooden travel-ways for artillery,⁶⁹ displacing the artillery was still difficult, because of weight, lack of prime movers, and terrain. Despite a severe shortage in horses in the Central Powers, Ludendorff had seemed to perform miracles in obtaining horses for transport for the offensive, but the ability to move the supporting units and the reserves to keep up with the attack still remained elusive. Some critics have also argued that tanks might have assisted in sustaining the momentum of the initial success and that the Germans should have pursued technological innovation more rigorously.⁷⁰ Georg Wetzell attributed failure of the German March offensive, however, to unexpected movement of French reinforcements by motor transport, German lack of discipline (soldiers stopped to loot the Allied supply depots which contained ample stocks of items, especially certain food, which their own army lacked because of the blockade), and the lack of drive (too many German units, especially divisions, still waited for permission from higher headquarters to advance, instead of proceeding on their own initiative).⁷¹

As the tactically impressive but strategically frustrating March offensive stalled, Ludendorff conducted offensives in other sectors of the western front until July 1918, desperately hoping to obtain the increasingly remote strategic breakthrough. Colonel Bruchmüller directed the centralized artillery efforts for OHL in these attempts. However, the German Army expended its forces while the Allies still had large reserves of manpower, specifically American and British. The Allies also had overwhelming superiority in industrial production.

The German offensive in the French sector at Chemin-des-Dames in late May 1918 also had excellent initial results. General Duchesne, commander of the French Sixth Army, had refused to position his forces in depth, although his superior, General Petain, had ordered him to do so. Duchesne, a follower of Foch (who, as overall Allied commander, was Petain's superior), refused to yield any ground elastically, preferring to mass his infantry in the forward trenches. Duchesne thought he was correctly applying the aggressive principles of Foch, that great advocate of the offensive, by placing forces forward and refusing to yield any ground to a German attack.

At 0100 on 27 May 1918 Bruchmüller's 3,179 guns fired on the French positions and about two and one-half hours later the German infantry advanced. French failure to destroy bridges across the Aisne River greatly helped the Germans advance twelve miles in one day.⁷²

The unenlightened leadership of the French Sixth Army greatly assisted the German efforts at Chemin-des-Dames, but when the Germans faced an enemy arrayed in depth, as other French units were, the Germans could not achieve such dramatic tactical success. The Allies continued to stall the German advances, and the Germans expended their irreplaceable attack divisions in their vain efforts to get the strategic breakthrough.

By August 1918, despite impressive territorial gains—by First World War standards—the German Army was exhausted. It had not broken the Allies and had not obtained the strategic breakthrough, despite several impressive tactical victories. The Allies, with superior resources, now took the initiative. Once again the Germans were on the defensive, now in a more desperate condition from the losses caused by their offensive. They also occupied large salients and now defended ground they had not had time to prepare. The Allies, especially forces of the British Empire, now displayed greater tactical finesse in their attacks than they had shown in previous years, using short artillery bombardments and integrating large numbers of tanks and aircraft in well executed attacks.⁷³ The German Army was no longer the effective force to stop these offensives. When it appeared to OHL that political, economic, and social conditions in Germany were going out of control, causing the German Army itself to be barely controllable, the German military leaders (now the virtual rulers of Germany) agreed to a cessation of hostilities. The Imperial German Army and Germany itself had been worn down by the Allies. That the army itself had not been crushed on the battlefield would create the frustration and bitterness of the “stab in the back” sentiment.

Tentative Generalizations

3



It is hazardous to give too much credit to any tactical doctrine; the conduct of battle is often very decentralized. Yet, doctrine exists to give order to these efforts. Despite the German defeat in the First World War, the German efforts in tactical doctrine deserve close attention. In the development and application of new tactics for their army, the Germans generally displayed superior ability. The German doctrine achieved the balance between the demands of precision for unity of effort and the demands of flexibility for decentralized application. With clearly stated principles, the doctrine provided thorough, consistent guidance for the training, equipping, and organizing of the army. However, this consistency was not rigid, for in its battlefield application, the doctrine provided sufficient flexibility to accommodate the demands of local conditions and the judgment of several commanders. In examining this accomplishment some tentative generalizations are apparent.

Methodology was a factor in German success. No tactical concept remained in the isolation of pure theory. The better German tacticians judged ideas according to the actual environment in which they would be applied. Their evaluation considered all influential factors: the condition of German forces, the enemy situation, weapons, terrain, space, and time. No tactical concept was a thing-in-itself with inherent strength: concepts crossed the gap from theory to reality. For example, the counterattack was not valuable simply because it was a "counterattack"; a counterattack *would* be valuable if it were delivered at the proper time by well-trained units on known terrain against a confused enemy. The Germans did not neglect the cause and effect relationships. They did not lull themselves into a sense of satisfaction by simply coining a catchword or catchphrase. Their tactics were viable principles to adapt to the battlefield, not impressive labels to hide ignorance. It is perhaps instructive to note that the German offensive tactics of 1918 did not receive a catchy name until the Allies tried to give them one (which was inaccurate, anyway).

The habit of considering the cause and effect relationships when developing tactical concepts made the Germans cautious and prudent about change. They did not advocate change for its own sake; they recommended change when conditions demanded improvement. The Germans knew how thoroughly change had to be imposed before it would have the desired effect. Therefore one can understand why Lieutenant Colonel Lucas of the French Army, in his

postwar study of tactical change, lamented that the French possessed many valuable prewar regulations, but ignored them in the war. During the war, French tactical change was too often exclusively a function of a single dominant personality, as shown, for example, in the variation of French defense organization in the spring of 1918, depending upon the individual field army commander's adherence to the ideas of Foch or Petain. In the British Army, there were several examples of innovative commanders. Unfortunately, an unimaginative and often unreflective High Command did not seek better tactical solutions with sufficient determination and flexibility of mind; tactical change for the entire BEF lacked the breadth, thoroughness, and speed which OHL achieved under von Hindenburg and Ludendorff. The Somme has provided a clear example: the British are still remembered as the great sufferers at the Somme, but it was the Germans who were the better learners from the experience.

The Germans treated change with caution and respect. Once they decided that a tactical change was necessary, they pursued it with the knowledge that several factors had to be changed in order for the doctrinal change to have the desired effect. For example, this understanding of the breadth of change accounts for their great respect for training: no tactical concept was considered workable unless the army could apply the concept. The Germans always remained very conscious of their army's ability to perform. *An army that adopts tactical doctrine that it cannot apply will greatly multiply its misfortune.* The Germans recognized the considerable training effort that their tactical changes required. Only by a great devotion to training were they able to develop high standards of execution which made their doctrine successful and which earned a great reputation for their army.

In developing doctrine, the Germans always considered another critical factor, the enemy. Unlike Nivelles, who unfortunately acted as if the success of his plans were utterly independent of the existence of his enemy, the Germans respected their enemies. The German consideration of the influential factors made the application of their doctrine an art, not a science.

The tactical principles were guides for the exercise of good judgment in unique situations, not formulas to eliminate the need for good judgment. While the various drills in the use of specific weapons and basic procedures were ingrained in the Imperial German Army through thorough training and repetition, the *application* of these techniques in the unique conditions of a battle was not done in a rigid fashion. The tactician was an artist who applied force according to the particular conditions of the terrain, the enemy, his own force, and his mission, using his own best judgment. Specific combat techniques or habits must be learned through rigid training so they can be repeated in a consistent manner irrespective of conditions. But *tactics* is the application of a variety of habits or techniques in combination in the unique conditions of a specific battle. The difference between techniques and tactics is significant: to instill techniques requires inflexibility and repetition; to develop a sense of tactics requires flexibility, good judgment, and creativity.

The German consideration of all influential factors created tactical concepts that encompassed the total battle. The positioning of forces for either offense or defense was based upon depth. The tactical principles themselves, both offensive and defensive, emphasized the physical depth of the battlefield and the engagement of the total enemy force. In their new tactical doctrine, the Germans avoided excessive emphasis on the struggle at the forward edge, where forces initially collided. The defensive principles discarded the rigid belief that the defended space must remain inviolate. The enemy attack penetrated the defended space, but the depth of the battlefield weakened the attacking force, preserved the defender, and enhanced the defender's success of retaliation through counterattack. In their offensive principles, the Germans did not aspire to achieve total destruction at the thin area of initial contact; they used firepower and maneuver in a complementary fashion to strike suddenly at the entire enemy organization. The offensive and defensive principles did not regard the enemy as an impediment or irritant to the methodical seizure or holding of terrain. The enemy force was the fundamental objective.

The process of developing principles to obtain this objective was a collective or corporate effort. Individual talents and personalities were essential, but the doctrine emerged in an atmosphere where ideas were discovered and shared, not invented and arbitrarily imposed. OHL solicited ideas and experiences from subordinate units, and this genuine interest gave the final product the wide ownership that eased the acceptance and application of the doctrine. There was also a remarkable tolerance of dissent within the process, but this tolerance did not weaken the determination to succeed. Certainly the German military leaders did not lack substantial egos, but their process of developing tactical doctrine transcended individual egos. The German Army respected and used talent, including that of the enemy. High rank was not a prerequisite for talent. All large armies possess men of talent like Capt. Hermann Geyer; few armies use such talent so efficiently.*

OHL directed the talent of Geyer and others to derive principles from combat experiences. These principles were sufficiently general to apply to a variety of tactical conditions, but sufficiently precise and specific to insure common understanding and unity of effort. Their flexibility was their strength, for these carefully and accurately developed principles could be modified without being discarded.² Evidence from the battlefield was more respected than the doctrine, both in development and execution. Therefore, the process of deriving the doctrine was inductive, and the application was in the same inductive spirit. Too often on the Allied side, tactics originally derived from experiences (either accurately or erroneously) became *deductive* formulas indiscriminately

*Geyer's remaining life and career had a bitter twist. Geyer was a *General der Infanterie* (equivalent of U.S. lieutenant general) in World War II, but he influenced the First World War much more as a captain. In World War II, Geyer commanded the IX Corps and received the Knight's Cross in June 1940. However, after Geyer's participation in the invasion of Russia in 1941, Hitler deprived him of his command, along with other highly respected officers, for little apparent reason. For the rest of the war his status was "awaiting orders." He committed suicide in 1946.¹

deemed appropriate for any situation, despite contradictory evidence or changed conditions. Nivelle's offensive was a tragic example. Tactical methods used successfully in a specific context, such as the Verdun counterattacks in late 1916, became universal formulas for success in the spring of 1917. The result was disaster physically *and* emotionally, for the formulas had been applied with such certainty. The Germans never attributed such certainty to their doctrine. This degree of uncertainty fostered a healthy curiosity and mental flexibility. No evidence was rejected or ignored simply because it did not "fit" the preconceived scheme. Therefore the Germans were often more receptive to new evidence or ideas than their Allied counterparts.

In his memoirs, Crown Prince Rupprecht expresses this warning: "There is no panacea. A formula is harmful. Everything must be applied according to the situation."³

For the Germans all tactical solutions were tentative: the Germans developed tactical doctrine inductively and applied and refined it in the same spirit. This process still demands much talent and ability, and it still requires a deliberate search for evidence. Glib solutions do not replace hard work.

Appendix 1. Table of German General Officer Ranks

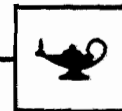

<i>German Name</i>	<i>Translation</i>	<i>U.S. Equivalent</i>
Generalmajor	Major General	Brigadier General
Generalleutnant	Lieutenant General	Major General
General der Infanterie ... der Artillerie, etc.	General of Infantry ... of Artillery, etc. (often translated simply as "General")	Lieutenant General
Generaloberst	Colonel General	General
Generalfeldmarschall	Field Marshal	General of the Army

Appendix 2. Promotions of Key German Officers During First World War



Ludendorff	Generalleutnant General der Infanterie	27 Nov 1914 29 Aug 1916
von Lossberg	Colonel Generalmajor	Jul 1915 3 Aug 1917
Wetzell	Lieutenant Colonel	17 Dec 1917
von Hindenburg	Field Marshal	27 Nov 1914
von Falkenhayn	General der Infanterie	20 Jan 1915

Sources: von Lossberg, Cron, Nash

Notes



Introduction

¹Wilhelm Balck, *Development of Tactics—World War*, trans. by Harry Bell (Ft. Leavenworth, 1922), p. 14. Wilhelm Balck's son, General Hermann Balck of the Second World War, writes of his father, "He was the last great tactical theorist, but also a practitioner," from Hermann Balck's memoirs, *Ordnung im Chaos* (Osnabrück, 1980), p. 5.

²Hermann von Kuhl, *Der Weltkrieg*, 2 vols. (Berlin, 1930), 2:9.

Chapter 1

¹Crown Prince Wilhelm of Germany, *My War Experiences* (London, 1923), p. 108; see also Balck, p. 18.

²Ludwig Renn, *Warfare* (Oxford, 1939), p. 135.

³Renn, p. 135.

⁴Balck, p. 178.

⁵Balck, p. 33.

⁶Pascal Lucas, *The Evolution of Tactical Ideas in France and Germany during the War of 1914—1918* (Paris, 1923), trans. P. V. Kieffer (Ft. Leavenworth, 1925), p. 6.

⁷Balck, p. 18; Lucas, p. 49; Sir James E. Edmonds, *History of the Great War Based on Official Documents: Military Operations, France and Belgium*, 1915 (London, 1927), vol. 1, p. 28. (This volume is part of a subcollection within a series hereafter cited as *British Official History*.)

⁸Friedrich Seesselberg, *Der Stellungskrieg 1914—1918* (Berlin, 1926), p. 103; Lucas, p. 33.

⁹Konrad Krafft von Dellmensinger, *Der Durchbruch* (Hamburg, 1937), p. 36.

¹⁰Lucas, p. 46.

¹¹Baron von Freytag-Loringhoven, *Deductions from the Great War*, trans. U.S. Army War College, 1918, p. 90.

¹²Lucas, p. 41.

¹³Seesselberg, p. 103.

¹⁴Balck, p. 55; Lucas, p. 48.

¹⁵Graeme C. Wynne, *If Germany Attacks* (reprint ed., Westport, Conn., 1976), p. 97. Captain Wynne of the British Army participated in the writing of the *British Official History*. Later he wrote *If Germany Attacks*, unfortunately published in London in 1940 when other events overshadowed studies of the First World War. Despite its title, the book describes the German tactical defense of the First World War. Wynne considered the new German defensive tactics of the latter half of the war to have been "the work of one master-mind," (p. 5), Fritz von Lossberg. I disagree, and wish to show that German tactical success was a corporate effort using the talent of several great soldiers, like von Lossberg. I feel that the Allies have been too prone to attribute German tactical success exclusively to one personality or another. Wynne's book was based on a series of articles he wrote for *Army Quarterly* in the late 1930s. In his first articles (1937) Wynne seemed rather skeptical of a revolution in thinking in German defense doctrine, but by his final articles (1939) he credited the Germans with a significant conceptual breakthrough which is a major

theme of his book. His *Army Quarterly* articles describe the different arguments about defense in OHL in greater detail than his book.

¹⁶Fritz von Lossberg, *Meine Tätigkeit im Weltkrieg 1914—1918* (Berlin, 1939), p. 177; Balck, p. 52; Wynne, p. 63.

¹⁷Crown Prince Wilhelm, p. 268; Balck, p. 37.

¹⁸Renn, p. 137.

¹⁹Balck, p. 59; see also Lucas, p. 47.

²⁰*British Official History* 1915, vol. 1, pp. 74—109.

²¹Wynne, p. 59.

²²Wynne, p. 106.

²³Balck, p. 36.

²⁴Martin Middlebrook, *The First Day on the Somme* (New York, 1972), pp. 72, 260.

²⁵Ernst Jünger, *The Storm of Steel*, trans. Basil Creighton (London, 1929), p. 107.

²⁶Wynne, pp. 101, 103.

²⁷Georg Wetzell, *From Falkenhayn to Hindenburg-Ludendorff*, trans. F. W. Merten (U.S. Army War College, 1935), p. 3.

²⁸Anonymous, *A Critique of the World War*, as quoted in Wetzell, p. 6. In an obituary written about Ludendorff in *Army Quarterly*, vol. 36 (April—July 1938) "Archimedes" described Ludendorff's ability to direct a corporate effort: "It is perhaps his foremost merit, itself a sign of greatness, that he selected and never hesitated to employ the best men. . . . In fact, under the name of Ludendorff is comprised, exactly what a staff should be, a composite brain."

²⁹Von Kuhl, *Der Weltkrieg*, 2:10. Wynne, p. 88, described a disagreement in the OHL operations staff in 1915 between the junior officers, who favored a fluid defense in a deep zone, and Col. Fritz von Lossberg, who was reluctant to allow the front line to be lost. This disagreement is important, for the views of the junior officers will largely prevail in 1917, and von Lossberg, who is a very crucial figure in the development of German doctrine, will modify his views. Liddell Hart in his memoirs (1:201) writes that General Werner von Blomberg told him in 1932 that the success of the German defense in 1917 was due to the younger officers' ideas, for the older officers were too slow to adjust. I wish to show that certain senior German officers, especially Ludendorff, to their great credit, *did* encourage the younger officers and *could* adjust their own views.

³⁰Wynne, p. 148.

³¹Erich Ludendorff, *Ludendorff's Own Story*, 2 vols. (New York, 1919), 1:324. Hereafter cited as *Ludendorff*.

³²*Ludendorff*, 1:324.

³³*Ludendorff*, 1:24.

³⁴Hermann von Kuhl, *The German General Staff in Preparation and Conduct of the World War*, 2d ed. rev. (Berlin, 1921; U.S. Army War College translation, n.d.), pp. 309, 312, 313.

³⁵Von Kuhl, *The German General Staff*, p. 314.

³⁶*Ludendorff*, 1:25.

³⁷Von Kuhl, *The German General Staff*, p. 306.

³⁸General von Moser, *Recollections of the Campaign*, as quoted in von Kuhl, *The German General Staff*, p. 303.

³⁹Wynne, p. 84.

⁴⁰Hermann Geyer, *Kriegserfahrungen und Cannae im Weltkrieg* (Berlin, 1924), p. 13.

⁴¹Von Lossberg finished the war as chief of staff to the army group of Duke Albrecht of Würtemberg. Von Lossberg was awarded the *Pour le mérite* on 9 September 1916 and oak leaves to that decoration on 24 April 1917.

⁴²Von Kuhl, *The German General Staff*, p. 316.

⁴³*Ludendorff*, 1:24.

⁴⁴Wynne, p. 85.

⁴⁵Lucas, p. 91.

⁴⁶von Kuhl, *The German General Staff*, p. 298.

⁴⁷*Ludendorff*, 1:316.

⁴⁸Oberkommando des Heeres, *Der Weltkrieg*, (German Official History), vol. 12, pp. 32—37.

⁴⁹*Ludendorff*, 1:458.

⁵⁰*German Official History*, vol. 12, p. 40.

⁵¹Erich Ludendorff, *Urkunden der Obersten Heeresleitung*, 2d ed. (Oxford, 1936) contains the 10

August 1918 edition of *Allgemeines über Stellungsbau*, hereafter called *Construction*; Balck, pp. 152–59; Wynne, pp. 150–56, also describes the defensive zones.

⁵²*Grundsätze für die Abwehrschlacht im Stellungskrieg*, 1 March 1917, translated as *The Principles of Command in the Defensive Battle in Position Warfare* by the British Expeditionary Force, 17 October 1918, p. 3. Hereafter cited as *Principles*. The 1 September 1917 edition, with amendments, of *Principles* was translated in October 1918. The text specifies which edition is quoted. One other important aspect of the German regulations was the use of airplanes to keep Allied aerial reconnaissance aircraft away from the German defense positions.

⁵³*Principles*, p. 7.

⁵⁴*Principles*, p. 8. Wynne, however, in his *Army Quarterly* article, vol. 34 (April–July 1937), stated that this shifting technique was accepted only gradually in 1917.

⁵⁵*Construction*, as recorded in *Urkunden der Obersten Heeresleitung*, 2d ed., p. 595.

⁵⁶Wynne, p. 151. In Wynne's *Army Quarterly* article, vol. 34 (April–July 1937), he stated that the concept of elasticity conflicted with the use of fortified positions. The result was a compromise, with application according to terrain.

⁵⁷Wynne, p. 313.

⁵⁸*Principles*, p. 59.

⁵⁹*Principles*, p. 6.

⁶⁰Balck, pp. 22, 61.

⁶¹Balck, p. 163. This is Balck's suggestion based on his experiences.

⁶²Balck, p. 163.

⁶³*Ludendorff*, 1:459.

⁶⁴Lucas, p. 68.

⁶⁵Eric J. Leed, *No Man's Land* (New York, 1979), p. 109.

⁶⁶*Ludendorff*, 1:460.

⁶⁷*Ludendorff*, 1:459.

⁶⁸Wynne, p. 168; Wilhelm, p. 255, attributes the reverses to poor morale of the troops. Ludendorff makes no mention of the relief in his memoirs.

⁶⁹Wynne, p. 161.

⁷⁰Crown Prince Wilhelm, p. 267.

⁷¹Renn, p. 137.

⁷²*Ludendorff*, p. 460. Wynne, p. 161, felt that Ludendorff had de-emphasized the elastic nature of the defense in his training manual in deference to the critics who feared a weakening of defensive spirit.

⁷³Von Kuhl, *The German General Staff*, p. 308.

⁷⁴Wynne, p. 145.

⁷⁵*Principles*, p. 20.

⁷⁶*Ludendorff*, 1:460.

⁷⁷Balck, p. 24.

⁷⁸Crown Prince Wilhelm, p. 145.

⁷⁹Crown Prince Wilhelm, p. 267.

⁸⁰*German Official History*, vol. 12, p. 59; Wynne, p. 162.

⁸¹*Ludendorff*, 1:461; von Kuhl, *Der Weltkrieg*, 2:11.

⁸²Crown Prince Wilhelm, p. 282.

⁸³*Ludendorff*, 1:458.

⁸⁴*Ludendorff*, 1:456. The Germans became very skilled in rotating units into and out of the front line in 1917. One of the most important aspects of the German defense, at corps and field army level (called by the Germans the "operational" level), was this ability to shift units.

⁸⁵*Ludendorff*, 1:398.

⁸⁶Jünger, p. 109.

⁸⁷*Ludendorff*, 1:401.

⁸⁸Balck, p. 180.

⁸⁹Wynne, p. 295. This reorganization was not immediate. It continued throughout the war.

⁹⁰Von Freytag-Loringhoven, p. 89.

⁹¹*Ludendorff*, 1:401. The results of the Hindenburg Program, however, were not universally beneficial. Gerd Hardach, *The First World War, 1914–1918, History of the World Economy in the Twentieth Century*, ed. Wolfram Fischer (Berkeley, 1977), pp. 63–73, described the strains of the

Hindenburg Program on long-term production, transportation, and labor. Hardach did state, however, that production goals for armaments like machine guns and light artillery were met.

⁹²Ludendorff, 1:313.

⁹³Most of the specific information on the storm units has been provided by Helmuth Gruss, *Die Deutschen Sturmabteilungen im Weltkrieg* (Berlin, 1939). A work which described the influence of the storm units on the Nazi political organization is Robert G. Waite's *Vanguard of Nazism* (New York, 1969).

⁹⁴Balck, p. 70.

⁹⁵Wynne, p. 147.

⁹⁶Crown Prince Wilhelm, p. 227.

⁹⁷Wynne, pp. 173, 179.

⁹⁸Ludendorff, 2:22.

⁹⁹Ibid.

¹⁰⁰Von Lossberg, pp. 288—89; Wynne, pp. 180—82.

¹⁰¹Wynne, pp. 180—81; *British Official History*, 1917, vol. 1, p. 354.

¹⁰²Von Lossberg, p. 283, described his decision not to hold every bit of ground at Arras. This showed great flexibility, for in the Champagne battles against the French in September 1915 (p. 168) and at the Somme against the British in July 1916 (p. 220) von Lossberg had given specific orders to units to hold to the last man where they stood, yielding no ground whatsoever, which he recorded with enthusiasm in his memoirs. I feel that Wynne, p. 214, was almost apologetic when he described von Lossberg's subsequent flexibility at Arras in 1917. A question for further study is how much a certain soldier in a Bavarian unit at the Somme, Adolf Hitler, was influenced by the "hold to the last man" defense orders of 1916, and whether Hitler ever realized that the defenses of 1917 were more flexible.

¹⁰³Casualty figures from World War I remain controversial. The Germans did not record lightly wounded returned to duty as casualties, whereas the British did. British accounts, such as that of Spears (see p. 434), often refer to the German method of casualty reporting as unreliable. Perhaps the attention paid to comparative casualty rates by some British historians is indicative of the "attrition mentality" which often justifies the British conduct of operations in the First World War. A detailed account of the devastating effectiveness of the German elastic defense-in-depth was given by Wynne, pp. 214—25. Wynne put the casualty figures for the Arras and Scarpe battles at roughly 85,000 German casualties against 142,000 British casualties, p. 254.

¹⁰⁴Wynne, pp. 226—57. See also Edward L. Spears, *Prelude to Victory* (London, 1939), pp. 430—31, for a more nationalistic account, which nonetheless acknowledges British lethargy.

¹⁰⁵Two very interesting accounts of the Nivelle offensive are *Dare Call It Treason*, by Richard M. Wette (New York, 1963), which also provides a moving account of the subsequent mutinies in the French Army, and a first-hand account by a British liaison officer, Edward L. Spears, in *Prelude to Victory*, describing the planning and execution of the offensive.

¹⁰⁶Spears, p. 31.

¹⁰⁷Alistair Horne, *The Price of Glory* (New York, 1952), pp. 225, 313.

¹⁰⁸Spears, p. 90.

¹⁰⁹Spears, p. 93.

¹¹⁰Crown Prince Wilhelm, p. 269.

¹¹¹Spears, p. 490, 492.

¹¹²Spears, p. 492.

¹¹³Crown Prince Wilhelm, p. 276.

¹¹⁴Spears, p. 504.

¹¹⁵Spears, p. 503. Yet another problem for the French was how well the Germans used airplanes in their defense. As the preparation for the Nivelle offensive began, the Germans massed fighters in the sector where the main French attack was to be directed. These German fighter aircraft kept French reconnaissance aircraft from observing the German defense positions.

¹¹⁶Ludendorff, 2:104; Lucas, p. 122. Balck, p. 158, stated that the British concentrated their artillery fire on targets deeper in the German zone in October 1917, hence the Germans placed more troops in the forward areas. He agreed that this modification by the Germans did not work.

¹¹⁷Ludendorff, 2:102.

¹¹⁸Crown Prince Wilhelm, p. 267.

¹¹⁹*British Official History*, 1918, vol. 1, p. 41. The original purpose for Wynne's articles in *Army*

Quarterly appears to be that he felt the British had never understood the German concept of defense, either in 1917 or in 1939.

Chapter 2

¹Martin Middlebrook, *The Kaiser's Battle* (London, 1978), p. 20.

²Von Below's order, as recorded in *Österreich-Ungarne Letzter Krieg*, vol. 6, p. 501, quoted in Ronald Seth, *Caporetto: The Scapegoat Battle* (London, 1965), p. 146. Erwin Rommel fought as a captain at Caporetto in a Württemberg mountain infantry unit, and won the *Pour le mérite* for his actions there. Rommel has described his First World War experiences in a book, *Infanterie Greift An*, published in 1937. While the book is an excellent description of company tactics and small unit leadership, I do not feel that it represented the epitome of assault tactics in the First World War (I feel the storm units do), nor do I believe that Rommel's book foreshadowed the concept of blitzkrieg, as some have suggested.

³S.L.A. Marshall, *The History of World War I*, (New York, 1964), p. 215.

⁴Crown Prince Wilhelm, pp. 169, 172; Balck, pp. 4, 79; Lucas, p. 72.

⁵Crown Prince Wilhelm, p. 292.

⁶Wynne, p. 57. Wynne's claim is particularly damaging to the British, for the U.S. Infantry Association translated Laffargue in 1916. Another influential captain, B. H. Liddell Hart, wrote in his memoirs (1:26) that in 1916 he had written a pamphlet on his experiences as a company commander, which the War Office had refused to publish for security reasons.

⁷Renn, p. 110.

⁸Andre Laffargue, *The Attack in Trench Warfare*, translated for the *Infantry Journal* (Washington, 1916), p. 6.

⁹Laffargue, p. 37.

¹⁰Richard M. Watt, *Dare Call It Treason* (New York, 1963), p. 91.

¹¹Ludendorff, 1:401, on introduction of light machine gun.

¹²Wynne, p. 58. I have not yet seen evidence which would connect Laffargue's ideas with the techniques of Nivelle, but the similarities make such a connection possible.

¹³For example, Sixth German Army, *Use of Artillery in Combat Against Tanks*, 25 March 1917, trans. the American Expeditionary Forces from an earlier French translation (U.S. Army War College, 1918).

¹⁴*British Official History*, 1917, vol. 3, p. 177.

¹⁵C.R.M.F. Cruttwell, *A History of the Great War 1914—1918*, 2d ed. (Oxford, 1936), p. 476.

¹⁶Ludendorff, 2:112.

¹⁷Crown Prince Rupprecht of Bavaria, *Mein Kriegstagebuch*, vol. 3, p. 193.

¹⁸*British Official History*, 1917, vol. 3, p. 221, see footnote.

¹⁹Donald J. Goodspeed, *Ludendorff: Genius of World War I*, (Boston, 1966), p. 244.

²⁰German General Staff, *Der Angriff im Stellungskrieg*, 1 January 1918, trans. B.E.F. Intelligence as *The Attack in Position Warfare* (G.H.Q., 1918), p. 12 (26 January 1918 Amendment). Hereafter cited as *Attack*.

²¹*Attack*, p. 10 (26 January 1918 Amendment).

²²*Attack*, p. 4.

²³Laszlo M. Alföldi, "The Hutier Legend," *Parameters* 5, no. 2 (1976): 69—74.

²⁴Balck, p. 266.

²⁵*Attack*, p. 7.

²⁶Balck, pp. 62, 81, 91; Lucas, pp. 43, 102.

²⁷*Attack*, p. 5.

²⁸*Attack*, p. 16.

²⁹Ludendorff, 2:206.

³⁰Gruss, pp. 65, 90, 121.

³¹Gruss, p. 73.

³²Gruss, p. 101; Middlebrook, pp. 54—55

³³Ludendorff, 2:205.

³⁴Georg Bruchmüller, *The German Artillery in the Breakthrough Battles of the World War*, 2d

ed. (Berlin, 1922), trans. J. H. Wallace and H. D. Kehr (U.S. Army Field Artillery School, Ft. Sill, n.d.), p. 41.

³⁵Bruchmüller, p. 65. His successful use of his techniques on a large scale in 1916 was at Tarnopol, July 1916. See Wynne, p. 294.

³⁶Bruchmüller, p. 72.

³⁷Bruchmüller, p. 70.

³⁸Balck, p. 244.

³⁹Bruchmüller, p. 74.

⁴⁰Bruchmüller, p. 43.

⁴¹Ludendorff, 2:238.

⁴²Georg Wetzell's memorandum as quoted in *The Causes of the German Collapse in 1918* by R. H. Lutz, trans. W. L. Campbell (Stanford, 1934), p. 16. According to Professor H. Deutsch of the U.S. Army War College, who interviewed Wetzell in the interwar years, Wetzell favored defeating Italy first, but Ludendorff favored attacking on the western front.

⁴³Ludendorff, 2:200.

⁴⁴Balck, p. 13; Crown Prince Wilhelm, p. 295; Ludendorff, 2:209.

⁴⁵Crown Prince Wilhelm, p. 295; Gruss, p. 121.

⁴⁶Jünger, p. 240.

⁴⁷Ibid.

⁴⁸Von Kuhl, *Genesis, Execution, and Collapse of the German Offensive in 1918*, trans. U.S. Army War College (Washington, 1933), pt. 2, p. 28. Hereafter cited as *Genesis*.

⁴⁹Ludendorff, 2:206.

⁵⁰Bruchmüller, p. 48.

⁵¹Herbert Sulzbach, *With the German Guns*, trans. Richard Thonger (London, 1973), p. 141.

⁵²Sulzbach, p. 179.

⁵³Von Kuhl, *Genesis*, pt. 1, p. 70.

⁵⁴Ibid., p. 72.

⁵⁵Ludendorff, 2:203.

⁵⁶Von Kuhl, *Genesis*, pt. 1, pp. 72—75; Balck, p. 277; Wynne, p. 321.

⁵⁷Ludendorff, 2:68, 73; see also Erich Ludendorff, *The General Staff and Its Problems*, vol. 2, trans. F. A. Holt (New York, 1934). This contains a copy of the document, "Outline of a Scheme of Patriotic Education for the Troops," issued by OHL, 29 July 1917.

⁵⁸Extract from OHL principles of leadership as recorded in Lutz, ed., *The Causes of the German Collapse in 1918*, p. 16.

⁵⁹Von Kuhl, *The German General Staff*, p. 345; Ludendorff, 2:345.

⁶⁰Balck, p. 17; Ludendorff, 2:248. The British had kept a leader reserve for their attacks since 1915. See Spears, p. 584.

⁶¹Von Kuhl, *Genesis*, pt. 2, p. 33.

⁶²Martin Middlebrook, *The Kaiser's Battle* (London, 1978), p. 147.

⁶³Middlebrook, p. 148.

⁶⁴Middlebrook, p. 153.

⁶⁵*British Official History*, 1918, vol. 1, p. 166. Despite the tactical success, the 1918 German offensive had many strategic flaws. Ludendorff used two army groups (Rupprecht's and Wilhelm's), instead of placing the attacking forces in one command. He also shifted the German efforts to five different sectors from March to July, rather than pressing home in one sector.

⁶⁶*British Official History*, 1918, vol. 1, pp. 159, 162; Middlebrook, pp. 155, 156.

⁶⁷*British Official History*, 1918, vol. 1, p. 39; Correlli Barnett, *The Swordbearers* (New York, 1964), pp. 297, 298.

⁶⁸Middlebrook, pp. 309, 322. Caution: These totals are not as "even" as they seem. Several wounded Germans eventually returned to fight in 1918; the British prisoners did not.

⁶⁹Horne, p. 64, footnote.

⁷⁰Von Kuhl as quoted in Lutz, *The Causes of the German Collapse in 1918*, p. 71. As the failure of the German offensive became apparent in July 1918, Ludendorff lost his confidence and his nerve and began to turn on his staff. Von Lossberg (p. 344) described a painful scene in which Ludendorff bitterly criticized Wetzell for having failed to judge correctly the fighting capacity of some German units that had recently performed poorly. Ironically, Ludendorff was losing control over his ego.

⁷¹Wetzell as quoted in Lutz, p. 19. The looting, which also had occurred during the Cambrai counterattack, was an indication that, despite the efforts of OHL, discipline in the German Army was becoming fragile.

⁷²Barrie Pitt, *1918: The Last Act* (New York, 1963), p. 147.

⁷³The Australian forces under General Sir John Monash were particularly effective tactically in 1918.

Chapter 3

¹Heinz Guderian mentions General Geyer in *Panzer Leader*, trans. Constantine Fitzgibbon (London, 1952), pp. 184, 185, 272. I am indebted to Lieutenant Colonel Boege, Bundeswehr Exchange Officer to the United States Military Academy, for obtaining information on General Geyer from the register of recipients of the Knight's Cross.

²*British Official History*, 1917, vol. 1, is an example of an Allied view of the war which was reluctant to recognize the flexibility of the Germans in tactics.

³Rupprecht, vol. 2, p. 270.

Bibliography

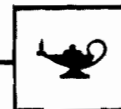

Documents

- Ludendorff, Erich, ed. *Urkunden der Obersten Heeresleitung*. Berlin: Mittler, 1922. Contains the following editions of these key German documents:
 “Allgemeines über Stellungsbau,” 10 August 1918.
 “Grundsätze für die Abwehrschlacht im Stellungskriege,” 20 September 1918.
 “Der Angriff im Stellungskriege,” 1 January 1918, with changes of 26 January 1918.
- General Staff (Intelligence), British Expeditionary Force. *The Attack in Position Warfare*, 1 January 1918. Translation of German text. BEF, 11 October 1918.
- . *The Principles of Command in the Defensive Battle in Position Warfare*, 1 March 1917 edition. Translation of German text. BEF, May 1917.
- . *The Principles of Command in the Defensive Battle in Position Warfare*, 1 September 1917 with amendments of 7 July 1918 and 8 August 1918. Translation of German text. BEF, 17 October 1918.
- Laffargue, Andre. *The Attack in Trench Warfare*, translated for the *Infantry Journal*. Washington: The United States Infantry Association, 1916.
- German Sixth Army. *Use of Artillery in Combat Against Tanks*, 25 March 1917, translated by the American Expeditionary Force from an earlier French translation. U.S. Army War College, January 1918.
- U.S. Government Printing Office. *German and Austrian Tactical Studies*, translation of captured documents. Washington, 1918.

Other Works

- Alfoldi, Laszlo M. “The Hutier Legend,” *Parameters* 5, no. 2 (1976).
- Agnew, James B.; Griffiths, William R.; and Franks, C. Reid. *The Great War*. West Point: Department of History, 1977.
- Balck, Wilhelm. *Development of Tactics—World War*. Translated by Harry Bell. Fort Leavenworth: General Service Schools Press, 1922.
- Barnett, Correlli. *The Swordbearers*. New York: Morrow, 1963.
- Bruchmüller, Georg. *The German Artillery in the Breakthrough Battles of the World War*. 2d ed. Berlin: Mittler, 1922. Translated by J. H. Wallace and H. D. Kehr. Ft. Sill, Okla.: U.S. Army Field Artillery School, n.d.

- Cron, Hermann. *Geschichte des Deutschen Heeres im Weltkriege 1914—1918*. Berlin: Karl Siegismund, 1937.
- Cruttwell, C.R.M.F. *A History of the Great War 1914—1918*, 2d ed. Oxford: Clarendon Press, 1936.
- Edmonds, Sir James E. *History of the Great War Based on Official Documents: Military Operations, France and Belgium, . . .* Compiled by the Historical Section of the Committee of Imperial Defence. London: Macmillan and Co., 1922—. 1914 (2 vols.), 1915 (2 vols.), 1916 (2 vols.), 1917 (3 vols.), 1918 (5 vols.).
- Falls, Cyril. *The Great War*. New York: Capricorn Books, 1959.
- von Freytag-Loringhoven, Baron. *Deductions from the World War*. Selections translated in 1918, available in Combined Arms Research Library, Ft. Leavenworth, Kansas.
- Geyer, Hermann. *Kriegserfahrungen und Cannae im Weltkriege*. Berlin: Eisenschmidts, 1924.
- Goodspeed, Donald J. *Ludendorff, Genius of World War I*. Boston: Houghton Mifflin, 1966.
- Gruss, Helmuth. *Die Deutsche Sturmabteilung im Weltkrieg*. Berlin: Junker and Dunnhaupt, 1939.
- Horne, Alistair. *The Price of Glory*. New York: St. Martins, 1962.
- Immanuel, Oberst (Colonel). *Siege und Niederlagen im Weltkriege*. Berlin: Mittler, 1919.
- Jünger, Ernst. *The Storm of Steel*. Translated by Basil Creighton. London: Chatto and Windus, 1929.
- Krafft von Dellmensingen, Konrad. *Der Durchbruch*. Hamburg: Hanseatische Verlagsanstalt, 1937.
- von Kuhl, Hermann. *Genesis, Execution, and Collapse of the German Defensive in 1918*. Translated by the U.S. Army War College, 1933.
- . *The German General Staff in Preparation and Conduct of the World War*, 2d rev. ed. Berlin: Mittler, 1921. Portions translated by U.S. Army War College.
- . *Der Weltkrieg*, 2 vols. Berlin, 1930.
- Leed, Eric J. *No Man's Land*. New York: Cambridge University Press, 1979.
- von Lossberg, Fritz. *Meine Tätigkeit im Weltkriege 1914—1918*. Berlin: Mittler, 1939.
- Lucas, Pascal. *The Evolution of Tactical Ideas in France and Germany during the War of 1914—1918*. Translated by P. V. Kieffer. Ft. Leavenworth, 1925. French publication, 1923.
- Ludendorff, Erich. *The General Staff and Its Problems*. 2 vols. Translated by F. A. Holt. New York: Dutton, 1934.
- . *Meine Kriegserinnerungen 1914—1918*. Berlin: Mittler, 1919. Available in translation as *Ludendorff's Own Story*, 2 vols. New York: Harpers, 1919.
- Lutz, Ralph H., ed. *The Causes of the German Collapse in 1918*. Translated by W. L. Campbell. Stanford University Press, 1934.
- Messenger, Charles. *Trench Fighting 1914—1918*. New York: Ballantine, 1972.
- Middlebrook, Martin. *The First Day on the Somme*. New York: Norton, 1972.
- . *The Kaiser's Battle*. London: Penguin, 1978.

- Nash, D. B. *Imperial German Army Handbook*. Shepperton, Surrey: Ian Allan, Ltd., 1980.
- Oberkommando des Heeres. *Der Weltkrieg*, Band 12. [German Official History, vol. 12]. Berlin: Mittler, 1939.
- Pitt, Barrie. *1918: The Last Act*. New York: Norton, 1963.
- Renn, Ludwig (pseudonym for Arnold Friedrich Vieth von Golssenau). *Warfare*. Oxford: OUP, 1939.
- Rommel, Erwin. *Attacks*. Translation of *Infanterie Greift An*, 1937, Vienna, Va.: Athena Press, 1979.
- Rupprecht, Crown Prince of Bavaria. *Mein Kriegstagebuch*, 3 vols. Berlin: Mittler, 1919.
- Schnitler, Gumund. *Der Weltkrieg 1914—1918*. Berlin: Verlag für Kulturpolitik, 1926.
- Seesselberg, Friedrich. *Der Stellungskrieg 1914—1918*. Berlin: Mittler, 1926.
- Spears, E. L. *Prelude to Victory*. London: Jonathan Cope, 1939.
- Sulzbach, Herbert. *With the German Guns*. Translated by Richard Thonger. London: Cooper, 1973.
- Waite, Robert G. L. *Vanguard of Nazism*. New York: Norton, 1969.
- Watt, Richard. *Dare Call It Treason*. New York: Simon and Schuster, 1963.
- Wetzell, Georg. *From Falkenhayn to Hindenburg-Ludendorff*. Translated by F. W. Merten. U.S. Army War College, 1935.
- Wilhelm, Crown Prince of Germany. *My War Experience*. London: Hurst and Blackett, Ltd., 1923.
- Wynne, Graeme C. "The Chain of Command." *Army Quarterly*, vol. 36, April—July 1938.
- . "The Development of the German Defensive Battles in 1917, and Its Influence on British Defence Tactics." Pts. 1 and 2. *Army Quarterly*, vol. 34, April—July 1937. Pt. 3, *Army Quarterly*, vol. 35, October 1937.
- . "The Hindenburg Line." *Army Quarterly*, vol. 37, October 1938—January 1939.
- . *If Germany Attacks*. London, 1940. Reprinted. Connecticut: Greenwood Press, 1976.
- . "The Legacy." *Army Quarterly*, vol. 39, October 1939—January 1940.
- . "The Wotan Position." *Army Quarterly*, vol. 38, April—July 1939.

STUDIES IN PROGRESS

Selected Operations of the Russo-Finnish War of 1939—40

Chemical Warfare: The Integrated Battlefield, 1917—18

Friendly Fire: The Problem of Friendly Fire in Modern War

Selected Ranger Operations in World War II

Arracourt: Armored Warfare in France, 1944

Light Infantry Operations in Korea, 1950

The Evolution of Air-Ground Doctrine, 1939 to 1980

Soviet Operations in Manchuria, 1945



Capt Timothy T. Lupfer

Capt. Timothy T. Lupfer is an assistant professor of military history at the United States Military Academy, West Point, New York, where he graduated in 1972. As a Rhodes Scholar, he received a bachelor's and master's degree in modern history from Oxford University. He has served as a tank company commander and a battalion operations officer at Fort Carson, Colorado. He is a term member of the Council on Foreign Relations, Inc., New York. He and his wife have two children.

COMBAT STUDIES INSTITUTE

Mission

The Combat Studies Institute was established on 18 June 1979 as a separate, department-level activity within the U.S. Army Command and General Staff College, Fort Leavenworth, Kansas, for the purpose of accomplishing the following missions:

1. Conduct original, interpretive research on historical topics pertinent to the current doctrinal concerns of the U.S. Army in accordance with priorities established by the Commander, U.S. Army Training and Doctrine Command, and to publish the results of such research in a variety of useful formats.
2. Prepare and present instruction in military history at the U.S. Army Command and General Staff College and to assist other College departments in integrating applicable military history materials into their instruction.
3. Act as the proponent agency for development and coordination of an integrated, progressive program of military history instruction in the U.S. Army Training and Doctrine Command service school system.



SYNOPSIS OF LEAVENWORTH PAPER 4

During the First World War a tactical stalemate developed on the western front which lasted for nearly four years. In this period the adversaries sought to develop ways of breaking the stalemate. The Allies tried strategic solutions (Gallipoli, Salonika), technological solutions (the tank), and most frequently a tactical solution using vast quantities of munitions to create a penetration in the front. The Germans responded to the Allied use of firepower in a very flexible way, developing in 1917 an elastic defense-in-depth which caused the Allies to waste much of their efforts, while the Germans conserved theirs. When strategic conditions favored a German offensive in the west in spring 1918, the Germans developed an offensive doctrine which incorporated many of the virtues of their elastic defense-in-depth and which avoided several of the pitfalls into which the Allied tactical doctrine had fallen.

The changes to the German tactical doctrine were profound. The defense no longer retained terrain arbitrarily and the success of the defense ultimately depended upon the skilled and timely use of counterattack forces. The new offensive doctrine described the complementary use of firepower and maneuver, using infantry forces which avoided strongpoints and plunged deeply into enemy positions, aided by highly efficient and effective artillery fire. These doctrinal changes were not invented by one mastermind. Rather, they were the product of a thorough collective effort which enlisted the advice and experience of every possible source. The tactical doctrine was disseminated to the units through a remarkable training program, and the entire procedure was directed with the knowledge that conditions and unique situations would always affect the application of the tactical doctrine.

