

# The 4th Armored Division in the Encirclement of Nancy

---

by  
Dr. Christopher R. Gabel

April 1986

CS-2003

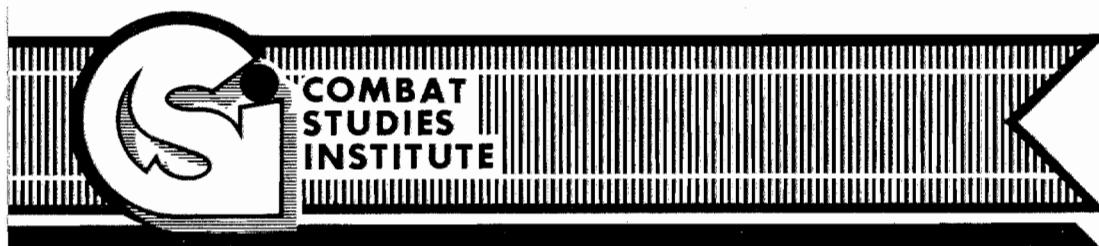

## FOREWORD

In 1944, the 4th Armored Division played a central role in one of the more remarkable campaigns in American military history—Third Army's pursuit across France, which was capped off by the encirclement and capture of Nancy. In the course of this campaign, the 4th Armored Division practiced a mode of warfare that has since become known to the Army as AirLand Battle. Inasmuch as the encirclement of Nancy is one of the few historical examples that shows American mechanized forces waging war in accordance with the tenets of AirLand Battle, anyone seeking a deeper appreciation of today's doctrine would do well to study this campaign carefully.

*The 4th Armored Division in the Encirclement of Nancy* originated at the U.S. Army Command and General Staff College as an introductory class for a course on modern division-level operations. It is a companion piece to *The Lorraine Campaign: An Overview, September–December 1944*, published in February 1985.

LOUIS D. F. FRASC   
Colonel, Infantry  
Director, Combat Studies Institute

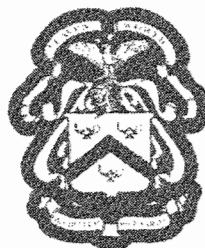

CSI publications cover a variety of military history topics. The views expressed in this CSI publication are those of the author and not necessarily those of the Department of the Army or the Department of Defense.

# The 4th Armored Division in the Encirclement of Nancy

---

by  
Dr. Christopher R. Gabel

April 1986

U.S. Army Command and General Staff College  
Fort Leavenworth, Kansas 66027-6900

27-2210

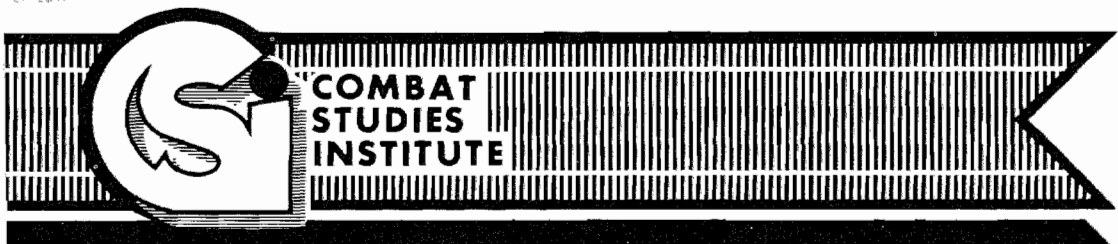

**Library of Congress Cataloging-in-Publication Data**

Gabel, Christopher R. (Christopher Richard), 1954--  
The 4th Armored Division in the encirclement of Nancy.

"April 1986."

Bibliography: p.

1. World War, 1939-1945--Campaigns--France--Nancy  
Region. 2. United States. Army. Armored Division,  
4th--History. 3. Nancy Region (France)--History.

I. Title. II. Title: Fourth Armored Division in the  
encirclement of Nancy.

D762.N28G33 1986 940.54'12'73 88-600057

## FIGURES

1. U.S. armored division, 1944 .....	1
2. Armored division attachments .....	3
3. Task organization, CCA, 28 August 1944 .....	4

---

## MAPS

1. 4th Armored Division's pursuit across France, August 1944 .....	7
2. The closing of the Lorraine gateway .....	9
3. XII Corps' plan to envelop Nancy (modified) .....	11
4. 4th Armored Division's encirclement of Nancy, 11-14 September 1944 .....	13
5. Consolidation of Nancy, 15-17 September 1944 .....	17
6. German counterattacks, 18-25 September 1944 .....	20
7. 4th Armored Division's static defense, 26-29 September 1944 .....	22
8. 4th Armored Division's operations, 10-29 September 1944 .....	24

---

The Lorraine campaign of 1944 was the most costly and least productive of the U.S. Third Army's World War II campaigns. Although the protracted conflict in Lorraine was indecisive, a number of instructive division-level operations took place during the fighting. One was the encirclement of Nancy conducted by the 4th Armored Division in September 1944. In one month, the 4th concluded an exhilarating pursuit across central France, crossed a major river, performed a classic armored penetration, and consolidated its gains with a skillful active defense. During that one month, the 4th Armored Division vividly illustrated many lessons of division-level combined arms warfare that still apply today.

As it was configured in 1944, the 4th Armored Division was a relatively light, but powerful, formation (see figure 1). Fourteen of the U.S. Army's sixteen armored divisions, including the 4th, each had an aggregate strength of just under 11,000 officers and enlisted men, 263 tanks, and 54 artillery pieces. The division's major fighting elements were its three tank battalions, three battalions of armored infantry, and three battalions of armored field artillery.

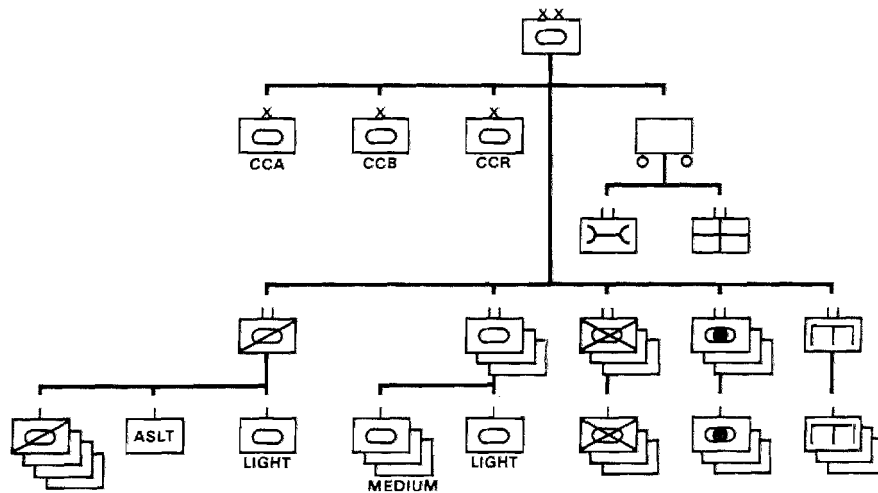

Figure 1. U.S. armored division, 1944

Each tank battalion within the armored division consisted of one company equipped with M-5 Stuart light tanks and three companies with M-4 Sherman medium tanks. Both the light and medium tanks were fully developed, proven designs with good

mobility and a favorable power-to-weight ratio and were especially prized for their mechanical reliability. However, the general-purpose 75-mm guns carried by most M-4s and the antiquated 37-mm pieces mounted on the M-5s were outclassed by the high-velocity 75-mm and 88-mm guns found on the German tanks of the day. Nonetheless, through superior teamwork and tactical mobility that allowed the Shermans to fire at the flanks and rear of the German tanks from close range, the 4th Armored Division established a favorable kill ratio over German armor.

The division's three field artillery battalions each possessed three firing batteries armed with the M-7 self-propelled 105-mm howitzer. Even though the M-7 was a hastily improvised design that carried inadequate armor, it was a highly effective weapon that combined two superb subsystems: the famous 105-mm howitzer and the rugged chassis of the versatile Sherman tank.

Three rifle companies armed with semiautomatic and automatic weapons made up each of the armored division's three infantry battalions. All the infantry rode to battle in M-3 half-tracks, but 1944 doctrine insisted that the riflemen dismount to fight. This was undoubtedly wise, for the half-track carried only minimal armor.

Other major elements of the armored division were its mechanized cavalry squadron armed with light tanks and armored cars, an engineer battalion, and the division trains. In addition, units from corps and army pools were usually attached to the armored division on a semipermanent basis (see figure 2). For the 4th Armored Division, these generally included a tank destroyer battalion armed with M-18s (76-mm self-propelled guns), an anti-aircraft artillery battalion, a battalion of 155-mm howitzers, three quartermaster truck companies, a quartermaster gasoline supply company, and an engineer treadway bridge company. Above and beyond these elements drawn from corps and army pools, the 4th Armored Division occasionally borrowed one or more infantry battalions from adjacent infantry divisions. This was because the three organic armored infantry battalions were often inadequate for the armored division's needs.

The commanding general of the 1944 armored division exercised command and control over the fighting battalions through three task force headquarters designated Combat Command A (CCA), Combat Command B (CCB), and Reserve Command. These commands possessed no organic fighting troops of their own but were allotted the combat and service support assets required to accomplish their individual missions. The CCA and

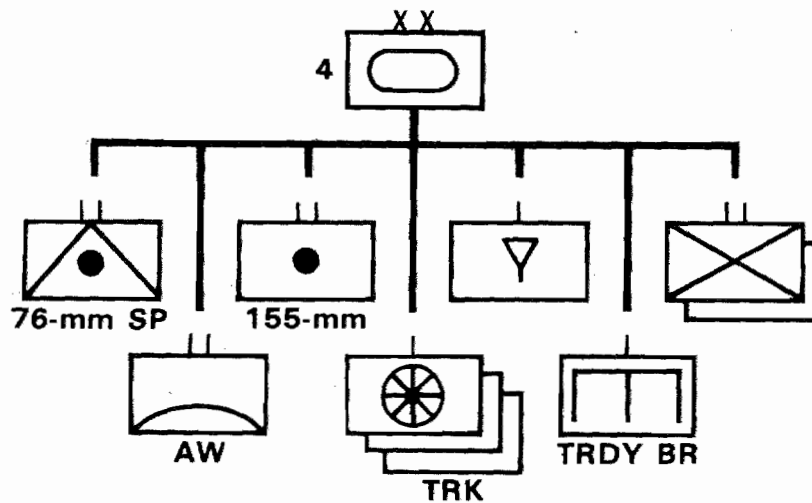

Figure 2. Armored division attachments

CCB headquarters each had about twelve officers and eighty enlisted men, enough to provide full staff functions for the combat command. In keeping with its intended role as a nontactical reserve, the Reserve Command had only three officers and five enlisted men. However, in some cases, an armored division commander would upgrade his Reserve Command to a status coequal to a combat command by assigning additional headquarters personnel to it. The 4th Armored Division, however, did not do so and, in battle, rarely employed its Reserve Command on independent missions.

Unlike some other armored divisions, the 4th never assigned elements to the combat commands on a fixed basis, preferring instead to retain a high degree of flexibility in its task organization (see figure 3). Typically, however, a combat command might consist of one troop from the cavalry reconnaissance squadron, one or two armored field artillery battalions supplemented with additional 155-mm howitzers, an antiaircraft artillery battery, a tank destroyer company, an engineer company, and combat command trains. These forces would be further subdivided among two or three battalion-sized columns or task forces, each including tanks, infantry, and artillery and each controlling its own maintenance and supply services. Thus, the 4th Armored Division's technique of task organization emphasized flexibility and provided for the close integration of the arms and services at the company, troop, and battery level.



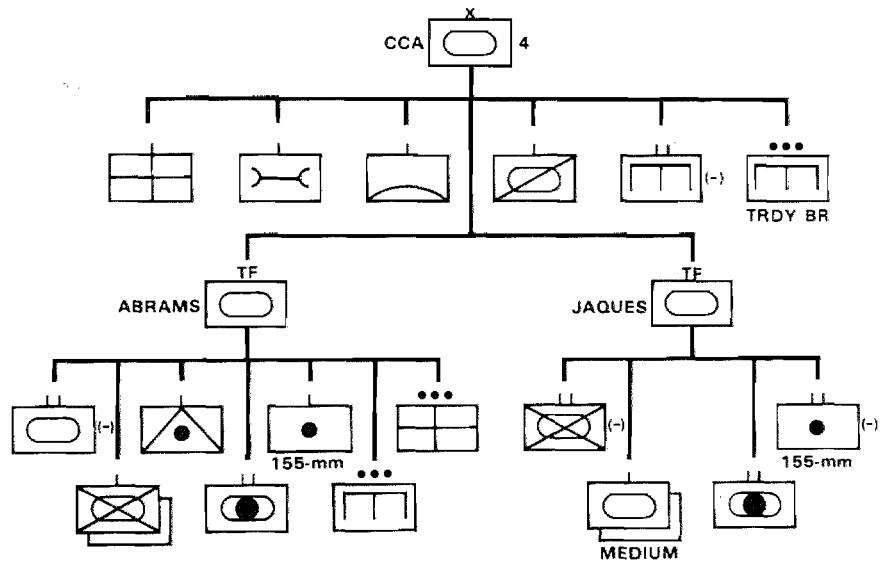

Figure 3. Task organization, CCA, 28 August 1944

The doctrine under which the 4th Armored Division operated in 1944 cast a rather specific mission for armored forces. According to the 1944 version of FM 17-100, *Armored Command Field Manual, The Armored Division*:

The armored division is organized primarily to perform missions that require great mobility and firepower. It is given decisive missions. It is capable of engaging in most forms of combat but its primary role is in offensive operations against hostile rear areas.<sup>1</sup>

.....  
The most profitable role of the armored division is exploitation . . . .<sup>2</sup>

To the 4th Armored Division, these doctrinal tenets were deeply engrained articles of faith. It is no exaggeration to say that the 4th had a distinct personality characterized by aggressiveness and teamwork. As a group, the division believed that the 4th's proper place was deep in the enemy rear. One tank commander, long accustomed to operating behind German lines, remarked, "They've got us surrounded again, the poor bastards!"<sup>3</sup> To the 4th Armored Division, the primary tank weapon was the machine gun, which became the weapon of choice when the division engaged in aggressive exploitation and pursuit.

The personality of the 4th Armored Division was a true reflection of its commander's character. Major General John S.

Wood took over the division in 1942 and trained it for two years before he led it into battle. This unusually long association between commander and unit fostered a high degree of rapport within the division and assured a continuity of effort from training to combat.

Wood was known to his contemporaries as "P" Wood, the "P" standing for "Professor." The distinguished British military analyst Basil H. Liddell Hart once referred to "P" Wood as "the Rommel of the American armored forces."<sup>4</sup> Like the legendary German field marshal, Wood's superiors had to restrain him rather than prod him into action. He preferred to bewilder his opponent through the "indirect approach" rather than to bludgeon him with brute force. Wood habitually commanded from the front, as did Rommel, utilizing a light liaison aircraft to personally channel mission-type orders from corps headquarters directly to his far-flung, fast-moving columns. Wood justified his frequent and prolonged absences from division headquarters by saying, "If you can't see it happen, it's too late to hear about it back in a rear area and meet it with proper force."<sup>5</sup>

Wood was an aggressive commander who always strove to knock the enemy off-balance through daring, violent action and then keep him off-balance with unrelenting pressure in unexpected areas. He did not, however, expend the lives of his men freely. Wood never forgot that his soldiers were sons, brothers, and fathers of loved ones back home, and he weighed every tactical decision on the grounds that the lives of his soldiers were an investment that demanded an appropriate military return.

During his long tenure as division commander, Wood was able to staff his division with many like-minded officers. Foremost among these were his two combat commanders, Colonel Bruce C. Clarke and Brigadier General Holmes E. Dager. A younger officer cast in the "P" Wood mold was the division's premier tank battalion commander, Lieutenant Colonel Creighton W. Abrams.

Major General Wood was close in temperament and military philosophy to his army commander, Lieutenant General George S. Patton Jr. In fact, the head of the tactical air command that supported Third Army once noted that Wood frequently "out-Pattoned" Patton. However, in the chain of command between Wood and Patton stood the commander of the XII Corps, Major General Manton S. Eddy, who was a wholly different type. Eddy

had earned the right to command the XII Corps with solid performances at the head of the 9th Infantry Division in North Africa, Sicily, and Normandy. By background and temperament, he was methodical and thorough rather than flashy and daring. Eddy did not mix well with Patton and Wood, nor did the officers of the 4th Armored Division hold him in high regard. Wood openly criticized Eddy's methodical style, and he believed that Eddy's overcautious methods resulted in lost opportunities that could only be redeemed later through unnecessarily hard fighting.

Wood's disagreements with Eddy eventually had serious repercussions, but the 4th Armored Division began its combat career so positively that such disagreements were easily forgotten. The division landed in France thirty-six days after D-day and was quickly earmarked to participate in Operation Cobra, the U.S. First Army's attempt to break out of the Normandy beach-head. On 28 July, after a carpet bombardment and an infantry attack had created a gap in the German lines near Saint-Lô, the 4th and three other armored divisions broke through. "It was like old home week at Fort Knox," wrote the division public relations officer.<sup>6</sup> With the 4th Armored Division leading the newly activated Third Army into Brittany and then eastward into the heart of France, the breakout became a pursuit (see map 1).

During the ensuing drive across France, Wood pushed his division hard and never gave the Germans an opportunity to forge a new defensive line. The 4th operated in two combat commands, each of which was divided into two to four task forces. In keeping with the fluidity of the situation, Wood reconfigured the combat commands about every three days. Frequently, task forces were formed, and mission-type orders were issued over the radio. Wood dispensed with phase lines, zones of advance, and secure flanks as the 4th drove deep into France.

A German defender unfortunate enough to find himself in the path of the 4th Armored Division in August 1944 first had to deal with the fighter-bombers of the XIX Tactical Air Command (TAC), which maintained constant patrols in advance of Wood's armored columns. Army Air Force liaison officers riding in the lead tanks called out targets for the fighter-bombers and kept the ground troops informed as to what lay ahead of the column. The 4th Armored Division reciprocated for this close cooperation by making every effort to rescue downed pilots and by sharing "liberated" booty with the XIX TAC.

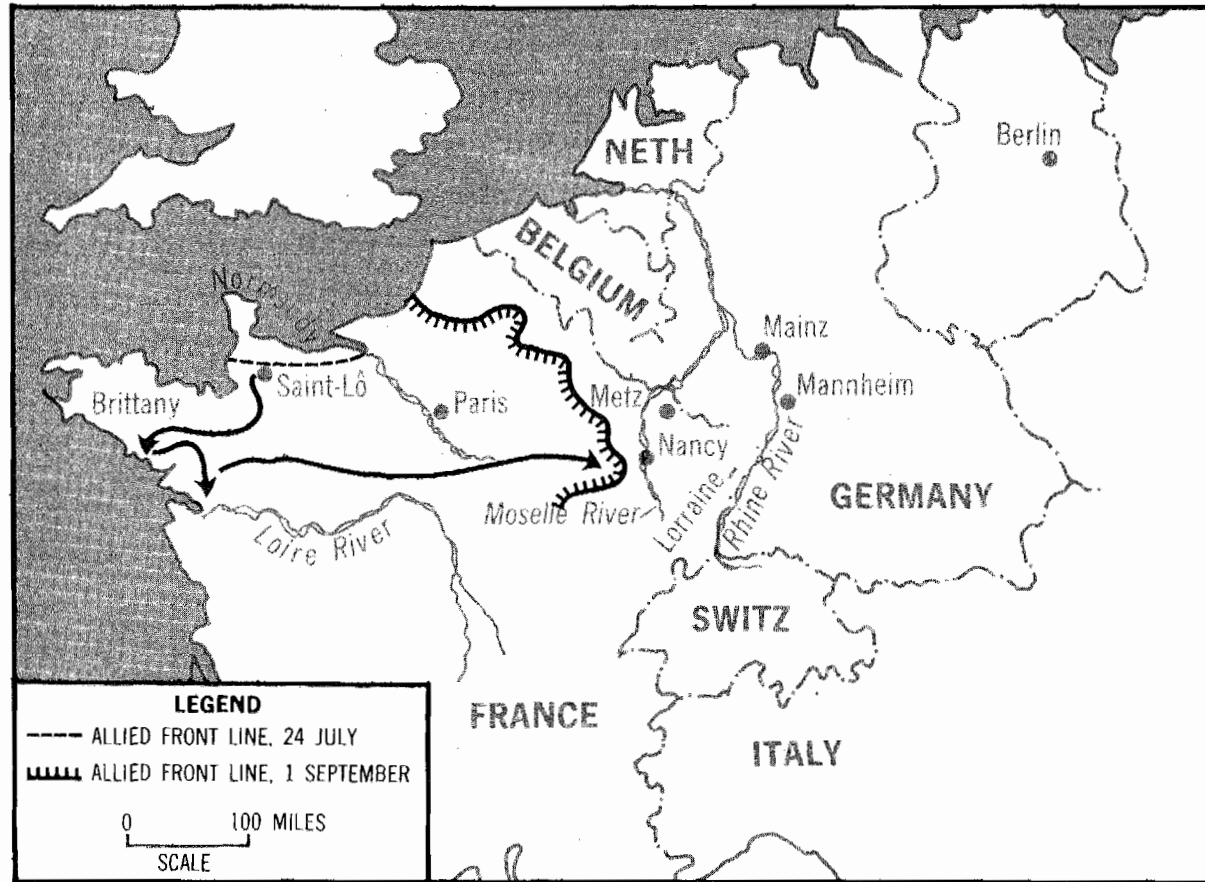

Map 1. 4th Armored Division's pursuit across France, August 1944

Behind the fighter-bombers came the division's light liaison aircraft, from which the combat commanders guided their columns around obstacles and strongpoints. Medium tanks usually led the columns, because experience had shown that the medium tanks could generally cut through any resistance encountered. Self-propelled artillery placed well forward in the column and ready to fire at the first sign of a target engaged any defenders too strongly emplaced for the medium tanks to dislodge. Engineers also accompanied the leading elements to remove obstacles. The 4th learned to travel the secondary roads, because the Germans tended to concentrate their obstacles and ambushes along the main highways.

The month-long pursuit demonstrated that the major logistical problem in a war of movement was fuel supply. Ammunition expenditures and battle casualties were relatively low, and a week's worth of rations could be carried on the combat vehicles themselves. Supply trucks were overloaded by 50 percent or more to keep up with the demand for gasoline. Clearly, the safest place for the combat command trains to travel during the pursuit was right behind the combat elements in the "vacuum" created by the tanks, infantry, artillery, and aircraft. Wood also took medical and maintenance detachments out of the division trains and added them to the combat command trains so these services were immediately available to the leading elements.

The 4th Armored Division capped off a pursuit of some 700 miles with a crossing of the Meuse River on 31 August in typical "P" Wood fashion (see map 2). Light tanks from CCA raced into the town of Commercy and seized its bridge intact before the startled defenders could detonate the charges emplaced on the span or even remove the canvas covers from the breeches of their antitank guns.

Unfortunately, the 4th Armored Division's arrival on the borders of the Lorraine province coincided with the onset of a theaterwide gasoline shortage. Dry gas tanks halted the division with the German frontier only seventy air miles away. Although disappointed at being stopped in midstride, Major General Wood had every reason to be proud of his command. For an entire month, the 4th Armored Division had waged a campaign that suited its doctrine, training, and personality to perfection. From the time of the Cobra breakout to the crossing of the Meuse, the division tanks ran over 1,000 miles on their tracks, and the overburdened supply vehicles that had kept the advance going

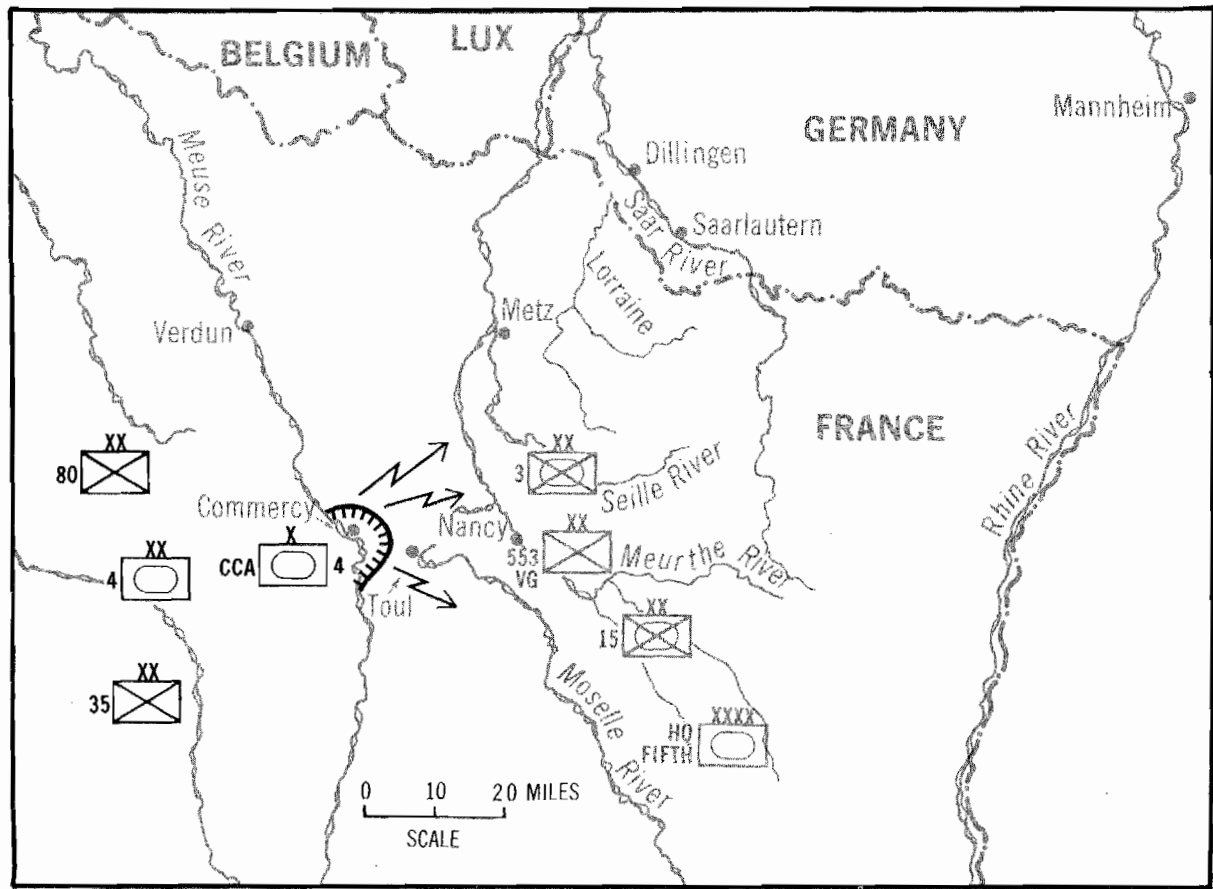

Map 2. The closing of the Lorraine gateway

logged 3,000 miles. During the pursuit, the 4th sent 11,000 prisoners to the rear, while losing only 1,100 total casualties itself.

Major General Wood hoped to carry the pursuit into Germany as soon as gasoline again became available. The division's cavalry squadron, running on gasoline siphoned from the rest of the division's vehicles, reported that the Lorraine gateway was still open. Only five days passed between the crossing of the Meuse and the resumption of the advance, but that was enough time for the Germans to bar the way. The Germans sent two depleted but still dangerous mechanized infantry divisions, the 3d and 15th *Panzergranadier*, from Italy to Lorraine, where they assumed positions along the Moselle River on either side of Nancy. The 553d *Volksgrenadier* Division, reinforced by a regiment drawn from German air force personnel, secured the city itself. Moreover, the German High Command reactivated the Fifth Panzer Army's headquarters for the express purpose of attacking Third Army in its open southern flank.

On 5 September, with gasoline once more flowing into Third Army's fuel tanks, Patton ordered Eddy's XII Corps to seize Nancy with the 80th Infantry and 4th Armored Divisions in preparation for an exploitation to the Rhine River. Eddy, in turn, instructed the 4th Armored Division to hurdle the Moselle with the same type of surprise attack that had carried it across the Meuse. For once, it was "P" Wood who argued against the audacious course of action and suggested instead a more methodical operation. He recognized that the Moselle, though only 150 feet wide and 6 to 8 feet deep, was a formidable obstacle. He also understood the difference between snatching an intact bridge on the dead run and forcing a river crossing against an enemy who had had a week to take defensive measures. Wood's misgivings were borne out when the 3d *Panzergranadier* Division handily repulsed a crossing of the Moselle mounted by the 80th Infantry Division on 5 September.

Having been repelled north of the city, Eddy decided to make the area south of Nancy the corps' main effort (see map 3). He ordered the 35th Infantry Division and 4th Armored Division to envelop Nancy from the south, because German resistance would be weaker there than in the north. Wood again objected to the corps' plan. He pointed out that the Moselle River was the only natural obstacle to contend with north of Nancy, whereas in the south, the 4th Armored Division would have to cross as many as seven tributaries and canals to gain the rear

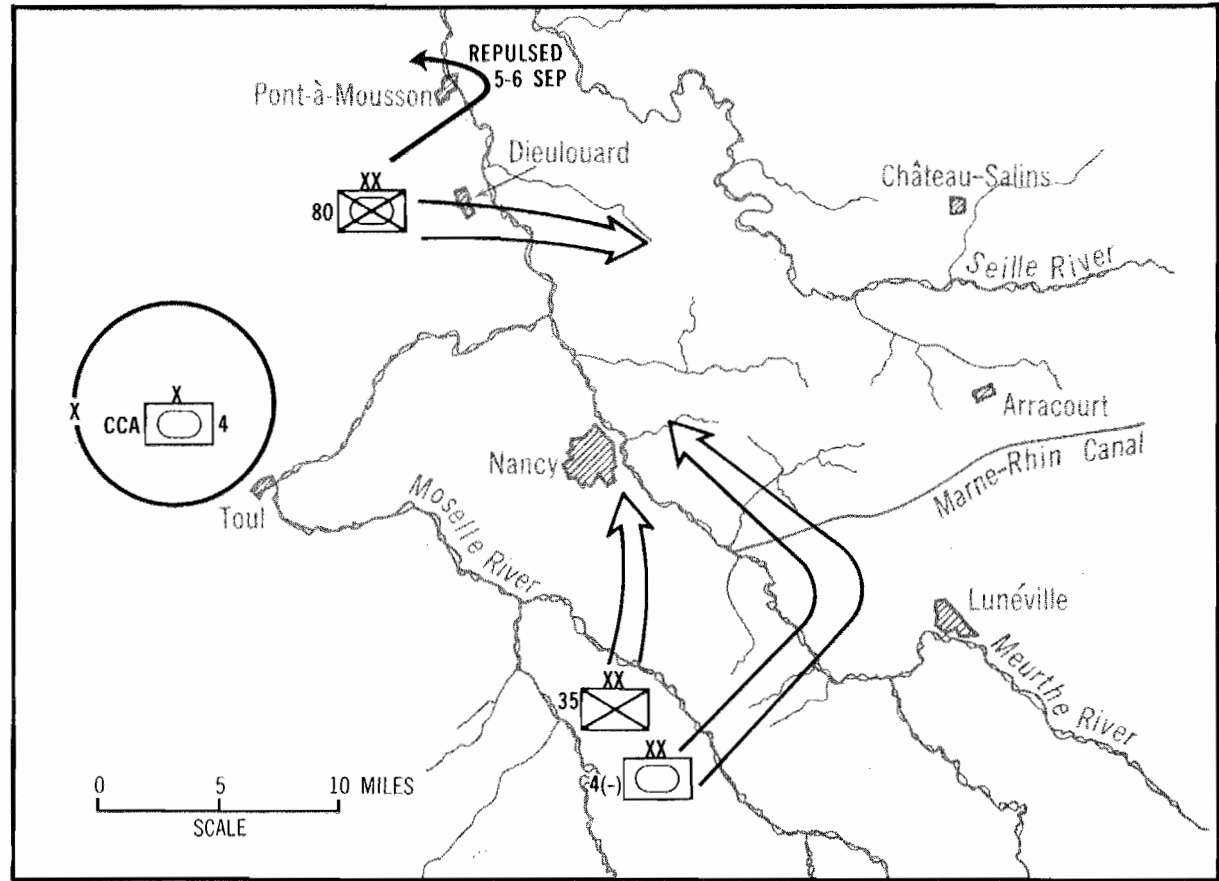

Map 3. XII Corps' plan to envelop Nancy (modified)



of Nancy. Therefore, Wood directed his staff to prepare an alternate plan that showed the entire division crossing north of the city.

Wood's objections led Eddy to modify the corps' plan once more. The 35th Division and the bulk of the 4th Armored Division would still make the main effort south of Nancy, but the 80th Division would also attempt another crossing north of the city. CCA of the 4th Armored Division would stand by in corps reserve, ready to exploit an opportunity on either wing. This loophole eventually enabled Wood to carry out the operation north of Nancy that he preferred.

On 11 September, the XII Corps crossed the Moselle River (see map 4). Against stiff opposition from the 15th *Panzer-grenadier* Division, the 35th Division established an infantry bridgehead south of Nancy. CCB, leading the 4th Armored Division's main effort, chose not to wait for heavy bridges to be constructed. Instead, the lead tanks improvised a crossing of the drained canal flanking the Moselle, forded the river, and established contact with the 35th Division while engineers constructed bridges behind them.

Defending the sector were elements of the 553d *Volksgrena-dier* and 15th *Panzergrena-dier* Divisions. A battalion-sized battle group sent to counterattack the CCB bridgehead was trapped and wiped out. Advancing in two columns, CCB located gaps between the overextended German forces and rapidly exploited them. Poor roads, rather than German resistance, proved to be the main impediment to CCB's drive toward the rear of Nancy. Three days after crossing the Moselle, CCB crossed the Meurthe River and approached the Marne-Rhin Canal, which was held in some force. The 4th Armored Division's forward command post, the Reserve Command, and the division trains followed CCB. German resistance and the depletion of the division's bridging equipment delayed CCB's crossing of the canal for two days, but Major General Wood had no intention of losing the initiative. For all practical purposes, Wood had already shifted the division's main effort to CCA, north of Nancy.

CCA, under Colonel Clarke, consisted of D Troop of the division reconnaissance squadron, a tank battalion, an armored infantry battalion, an infantry battalion borrowed from the 80th Division, three artillery battalions, and a reinforced engineer battalion. Clarke originally planned to cross the Moselle on his own, but when the 80th Division secured a bridgehead at Dieulouard on 12 September, one day after CCB crossed the river

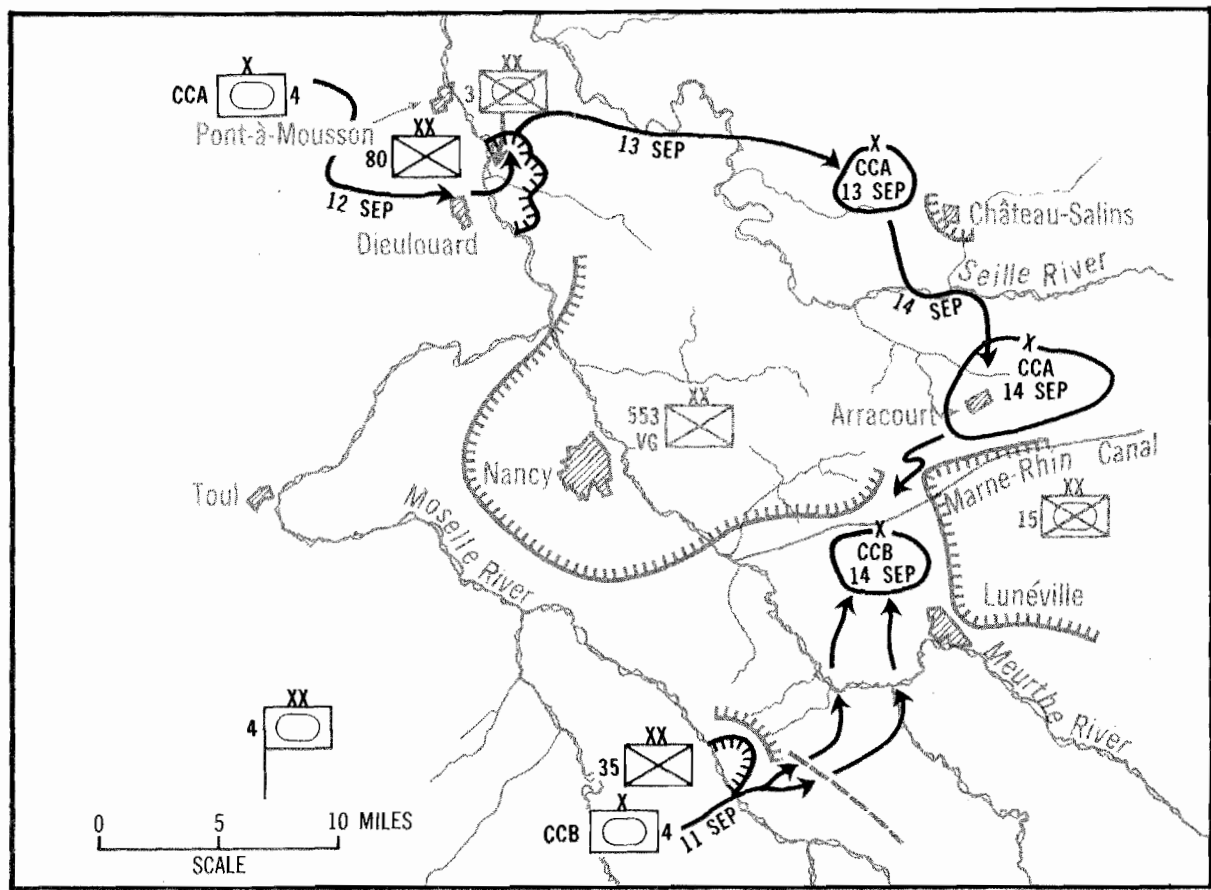

Map 4. 4th Armored Division's encirclement of Nancy, 11–14 September 1944

farther south, Wood quickly ordered CCA to use the infantry crossing. D Troop was the first CCA unit to reach the bridges late that night, but a corps control officer would not allow the cavalry to cross until all friendly artillery could be notified that American armor was entering the bridgehead.

The 80th Division had employed a careful deception and concealment plan to mount its successful crossing of the Moselle, but the Germans were not deceived for long. At 0100 on 13 September, the 3d *Panzergranadier* Division hit the Dieulouard bridgehead with a strong counterattack, causing the corps control officer to reconsider his decision to hold back the cavalry. When German infantry and assault guns had pressed to within rifle range of the bridges, the control officer finally sent D Troop across the Moselle. The cavalry's light tanks broke up the counterattack and drove forward until fire from the German assault guns halted them.

By daylight on 13 September, it was not at all clear that CCA should use the threatened Dieulouard bridgehead after all. The commanders of the XII Corps, 80th Division, 4th Armored Division, CCA, and 37th Tank Battalion convened near the bridges to arrive at a course of action. When the generals could not reach a decision, Colonel Clarke asked Lieutenant Colonel Abrams what he thought CCA should do. Pointing to the far shore, Abrams said, "That is the shortest way home." "Get going!" ordered Clarke.<sup>7</sup> Under heavy German shelling, Abrams' tanks led CCA across the Moselle at 0800 on 13 September.

CCA did not enter the Dieulouard bridgehead to defend it. Clarke's mission was to execute a deep attack, with the objective for the day being Château-Salins, some twenty miles distant. A tank-heavy task force led the way, followed by an infantry-heavy task force. A third task force, consisting of engineers, the borrowed infantry battalion, and the combat command trains laden with supplies for seven days, brought up the rear. It took more than five hours for the combat elements to cross the Moselle bridges, by which time the leading tanks had shouldered aside the Germans containing the north face of the bridgehead. CCA drove north through the gap thus created and then swung east toward Château-Salins. D Troop of the cavalry squadron moved out to cover the left flank, and a company of light tanks was detached to protect the right. CCA picked up speed as the battle for the bridgehead was left behind. As the advance accelerated, Clarke exercised command and control from a liaison

aircraft flying overhead. The frontage of the main column was twenty-two feet—the width of the pavement on the Château-Salins highway.

CCA met little opposition as it knifed into the German rear areas. Road blocks, tank detachments, and anti-aircraft emplacements were quickly knocked out by the guns of the lead tanks or the self-propelled artillery traveling near the head of the column. At one point, Abrams' tanks literally collided with an unsuspecting German infantry force marching along the road in formation. The Shermans roared straight through the German column, blazing away with every gun as the enemy infantry scrambled for cover.

The head of the CCA column reached high ground west of Château-Salins at 1700 and established a 360-degree defensive perimeter. Combat elements closed on the bivouac throughout the night. The combat command trains, which had bivouacked separately, arrived the next morning (14 September) and replenished the fighting forces. CCA's thrust to Château-Salins represented a penetration of twenty miles and had so far yielded 354 prisoners taken and 12 German tanks, 85 vehicles, and 5 guns destroyed. CCA's losses on 13 September were twelve dead and sixteen wounded.

The obvious course of action for CCA to pursue on 14 September was to capture Château-Salins, a road center of some importance. However, Château-Salins was a rather large town, and the volume of artillery fire coming from its vicinity indicated that it was held in force. More important, Major General Wood, who was in radio communication with Clarke, recognized that CCA had broken cleanly through the Germans defending the Moselle. In today's terminology, CCA had penetrated to operational depth. Wood responded accordingly by directing CCA to exploit weakness rather than attack strength. Over the radio, he ordered Colonel Clarke to bypass Château-Salins and drive south to the vicinity of Arracourt, cutting the German lines of communication to Nancy in the process. From Arracourt, CCA was to link up with CCB, which had reached the Marne-Rhin Canal that same day. In effect, CCA would be dropping its communications with Dieulouard, passing behind the enemy elements defending Nancy, and reestablishing lines of communication with the 4th Armored Division near Arracourt.

CCA began its raid on the afternoon of 14 September. Once more, Colonel Clarke boarded his liaison aircraft and directed

his columns along the undefended side roads. The ground was firm, the countryside rolling and open, the roadnet good, and German opposition minimal. CCA overran rear echelon and reserve troops who believed that the Americans were still safely contained at Dieulouard. In one encounter, a CCA task force overtook and dispersed a column of the 15th *Panzergrenadier* Division that was marching to oppose CCB. The day's advance netted a further 400 prisoners and cost the Germans 26 armored vehicles, 136 other vehicles, and 10 88-mm guns. CCA sustained a total of thirty-three casualties and lost two medium tanks.

At 1900, CCA began drawing into a perimeter defense around Arracourt. Clarke instructed his artillery to fire all night into every crossroad and town within range, which served to harass any Germans attempting to undertake countermeasures and to confuse the enemy as to CCA's location and intentions. In addition, Clarke sent out patrols to the south as far as the Marne-Rhin Canal, where they encountered reconnaissance elements from CCB.

On the morning of 15 September, CCA fanned out to begin a four-day campaign of destruction behind German lines (see map 5). Clarke sent raiding parties to the limits of artillery range and pressed his reconnaissance troop even farther to the east. Armored infantry outposted the main roads and captured large numbers of the German troops falling back from Nancy. CCA sent a battalion-sized task force to help CCB cross the Marne-Rhin Canal on 16 September, reuniting the division. Only the Reserve Command at Lunéville remained on the south bank of the canal.

CCA's raids and ambushes around Arracourt resulted in the capture of another 1,000 German troops and the destruction or capture of 8 tanks, 16 large-caliber guns, and 232 vehicles. CCA lost only three killed, fifteen wounded, and four tanks destroyed. More important, CCA's raid across the 553d *Volksgrenadier* Division's rear prompted the 553d to withdraw from Nancy, allowing the 35th Division to occupy the city on 15 September against little opposition.

To the officers of the 4th Armored Division, there was no question as to the reunited division's next move. The obvious path of action was to exploit the advantage immediately and keep the enemy on the run. The road to Germany was open. Colonel Clarke, for example, proposed an immediate advance to Sarrebourg as soon as he reached Arracourt. The Germans

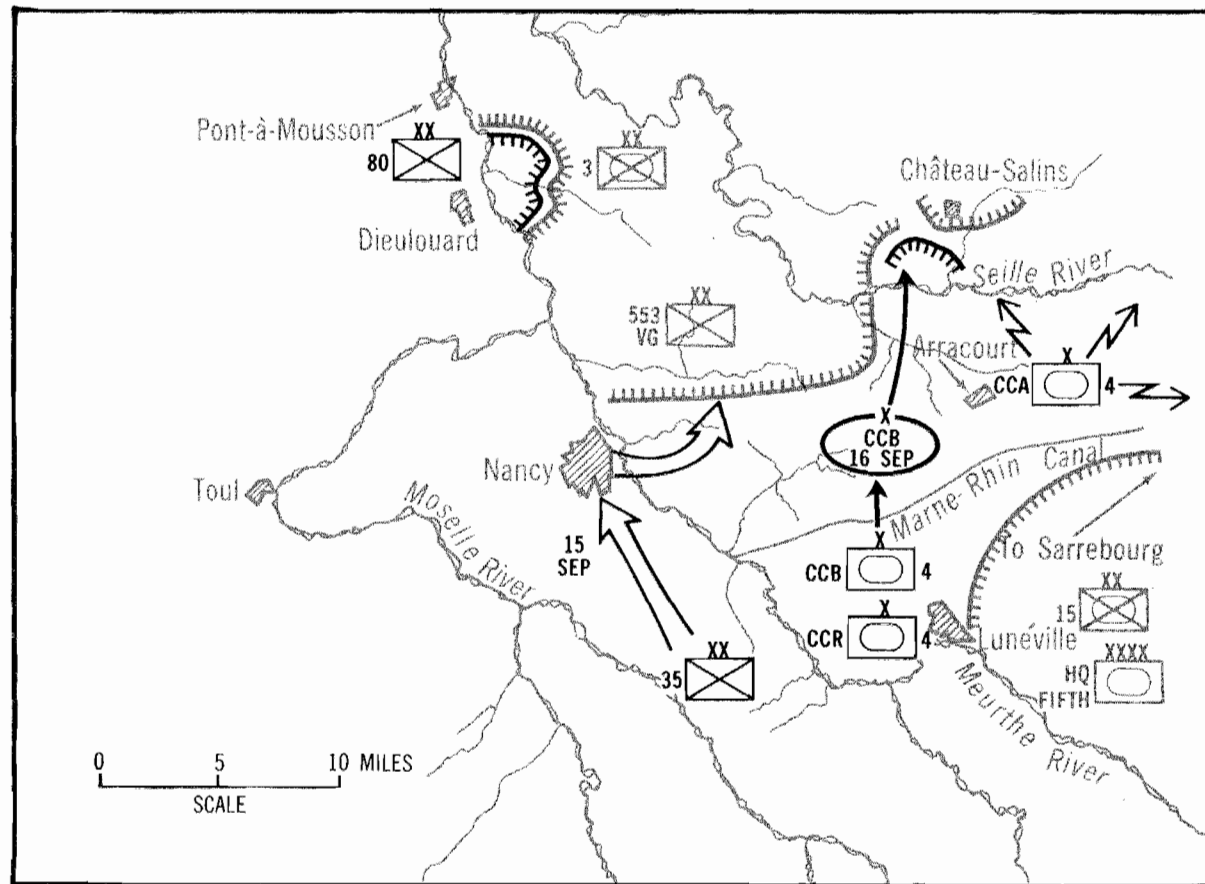

Map 5. Consolidation of Nancy, 15—17 September 1944

feared just such a move, for they had no reserves with which to block an armored advance eastward from Arracourt.

Major General Eddy, the corps commander, believed otherwise. He rejected Clarke's proposed Sarrebourg operation because Sarrebourg lay outside the corps' zone, which swung northeast, not east, from Nancy. Moreover, the XII Corps had made no provisions to support a continued armored advance. The two XII Corps infantry divisions were not available for a drive to the east, because the Germans at Nancy and Dieulouard had not collapsed and fled when the 4th Armored Division cut behind them. In fact, the 3d *Panzergranadier* Division was reinforced in its attacks against the 80th Division in the Dieulouard bridgehead, effectively cutting the route that CCA had taken to Château-Salins. And when the 553d *Volksgranadier* Division withdrew from Nancy, it simply fell back to the readily defended high ground northeast of the city and dug in. Finally, even Major General Wood had to admit that the volume of supplies reaching the 4th Armored Division was not sufficient to sustain a full-scale armored exploitation.

Instead of launching the 4th Armored Division on a renewal of the great pursuit, Eddy diverted this weapon of exploitation to assist the infantry in consolidating the ground around Nancy. No sooner had CCA reached Arracourt than Eddy ordered Clarke to relinquish the infantry battalion borrowed from the 80th Division, and on 17 September, Eddy directed CCB to pass behind CCA and relieve some of the pressure on the Dieulouard bridgehead. CCB encountered a fully prepared enemy near Château-Salins on ground that CCA had easily occupied four days earlier. The 35th Division, the only infantry formation that might have supported an armored exploitation, was sent instead to clear the high ground northeast of Nancy.

Major General Eddy expected that the XII Corps would be able to resume its general offensive on 18 September, with the 4th Armored Division and the 35th Division attacking in column. Bad weather forced a postponement until 19 September—five days after CCA had reached Arracourt. In fact, the attack was never launched, for the Arracourt springboard had become an endangered salient. The XII Corps and the 4th Armored Division had lost the initiative.

Major General Eddy's decision to consolidate before pressing on toward Germany may have strengthened the XII Corps' foothold across the Moselle, but it also proved to be a godsend to

the Germans. As CCB had already discovered, the German First Army utilized the time to concentrate reserves around Château-Salins, thus blocking one of the principal avenues to the east. In an even more ominous development, the Fifth Panzer Army began assembling forces for a major counteroffensive against the XII Corps' right flank. When General Hasso von Manteuffel took command of the Fifth Panzer Army on 11 September, his force consisted of a headquarters and no troops, but while Eddy paused to consolidate, Manteuffel acquired two panzer corps headquarters, the badly depleted but battlewise 11th Panzer Division, and the 111th and 113th Panzer Brigades. The panzer division boasted a wealth of experience but had virtually no tanks, whereas the panzer brigades possessed the newest tanks and fresh crews but had undergone little unit training, as evidenced by their lack of tactical skill (see map 6).

General Manteuffel's orders were to roll up Third Army's right flank with a massive counterblow; however, the 4th Armored Division's sudden thrust to Arracourt forced the Germans into a series of premature, piecemeal attacks strung out over twelve days. The first of these, mounted by the 111th Panzer Brigade, fell on the 4th Armored Division's Reserve Command and the XII Corps' reconnaissance group at Lunéville on 18 September. It took reinforcements from both the 4th and 6th Armored Divisions to drive the attackers off. Wood and Eddy, believing the Lunéville engagement to be only a local counter-attack, proceeded with their plans for the next day's corps offensive. Reports of increased German activity throughout the night of 18—19 September, however, forced them to delay their attack. In reality, the Fifth Panzer Army had simply bypassed Lunéville and was moving north to strike at CCA's exposed position around Arracourt. The battle that resulted was one of the largest armored engagements ever fought on the Western Front.

CCA held Arracourt with an extended tank-infantry-engineer outpost line supported by tanks, tank destroyers, and artillery. At 0800 on 19 September, company-sized elements of the 113th Panzer Brigade penetrated the outposts on the east and south faces of CCA's salient. Two tank destroyer platoons and a medium tank company engaged the panzers in a running fight that extended into the vicinity of CCA's headquarters, where a battalion of self-propelled 105-mm howitzers took the panzers under point-blank fire. The Germans discovered that the fog, which gave them tactical surprise and protected them from U.S. aircraft, worked to their disadvantage by negating the superior



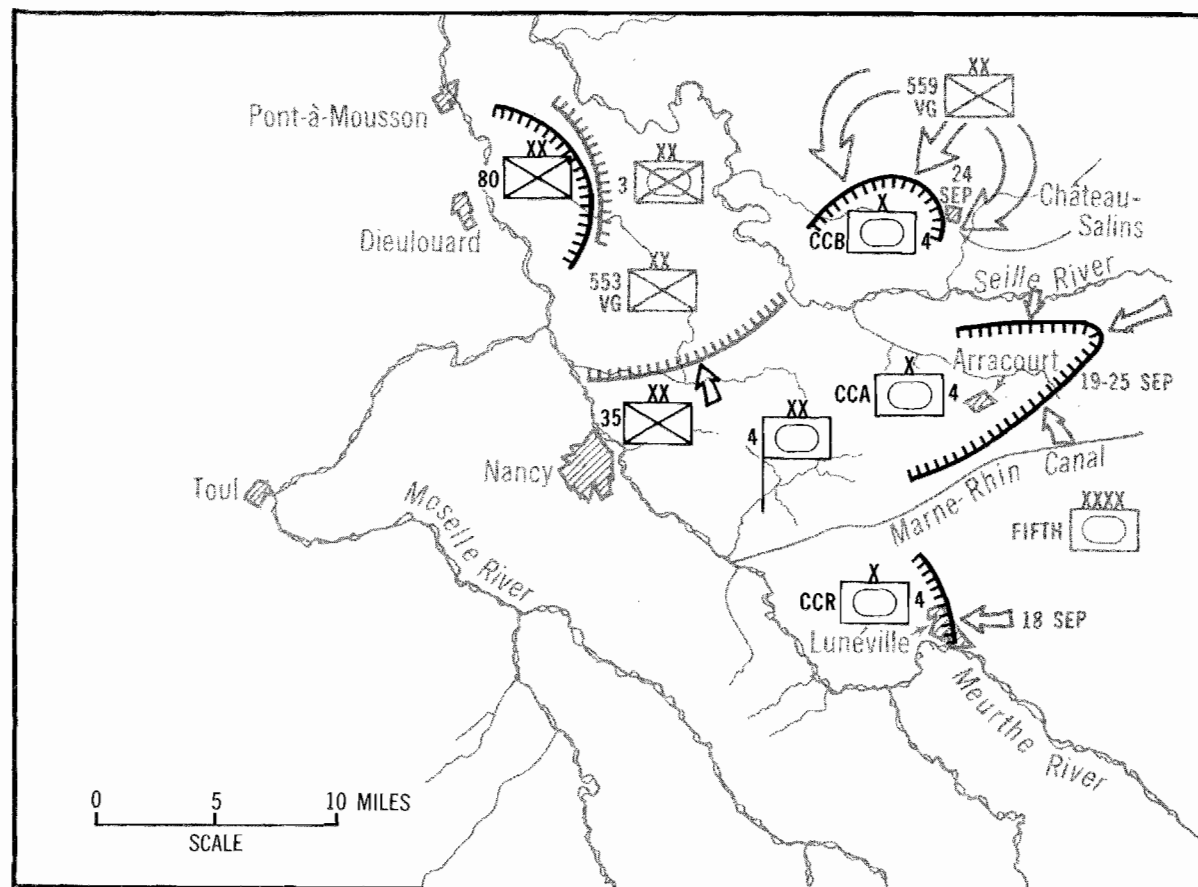

Map 6. German counterattacks, 18-25 September 1944

range of their tank guns. As the fighting surged back and forth through the fog, CCA's tanks and tank destroyers utilized their mobility to outmaneuver and ambush the larger panzers. By early afternoon, the German attack had stalled, and the inadequately trained panzer brigade lacked the ability to restart it. At that juncture, Colonel Clarke unleashed two medium tank companies on a sweep that took the panzers in flank and rear and drove the survivors back to their starting point. According to the Germans, the panzer assault of 19 September cost them fifty precious tanks and accomplished nothing.

From 20 to 25 September, the Fifth Panzer Army fed the 111th Panzer Brigade and the understrength 11th Panzer Division into a series of attacks against the Arracourt position. Each assault followed the pattern set on 19 September. The panzers attacked under the cover of morning fog, only to be disorganized by CCA's mobile defense and driven off by armored counterattacks in company or battalion strength. Major General Wood reinforced CCA with additional tank, infantry, and cavalry elements, and whenever the weather permitted, aircraft of the XIX TAC added to the collection of smoking panzer hulks.

On 24 September, the pattern of the Arracourt battle changed. The action shifted north to Château-Salins where the 559th *Volksgrenadier* Division of the German First Army nearly overwhelmed CCB until U.S. fighter-bombers routed the attackers. The next day, Third Army received orders to suspend all offensive operations and to consolidate gains. In compliance with corps orders, the 4th Armored Division reverted to a positional defense on 26 September (see map 7). CCA withdrew five miles to more defensible ground, and CCB, relieved at Château-Salins by the 35th Division, linked with CCA's right. The Fifth Panzer Army, by now down to twenty-five tanks, pressed its attacks unsuccessfully for three more days until clearing weather and increased American air activity forced the Germans to suspend their faltering counteroffensive altogether.

In the defensive actions fought around Arracourt, the 4th Armored Division claimed 281 German tanks destroyed, 3,000 Germans killed, and another 3,000 taken prisoner. The 4th sustained only 626 casualties in all, but the pressure of two continuous months in combat gradually rendered the division ineffective. Combat fatigue and noncombat casualties mounted alarmingly as the weather deteriorated and individuals surpassed the limits of their endurance. Also, weapons and equipment were

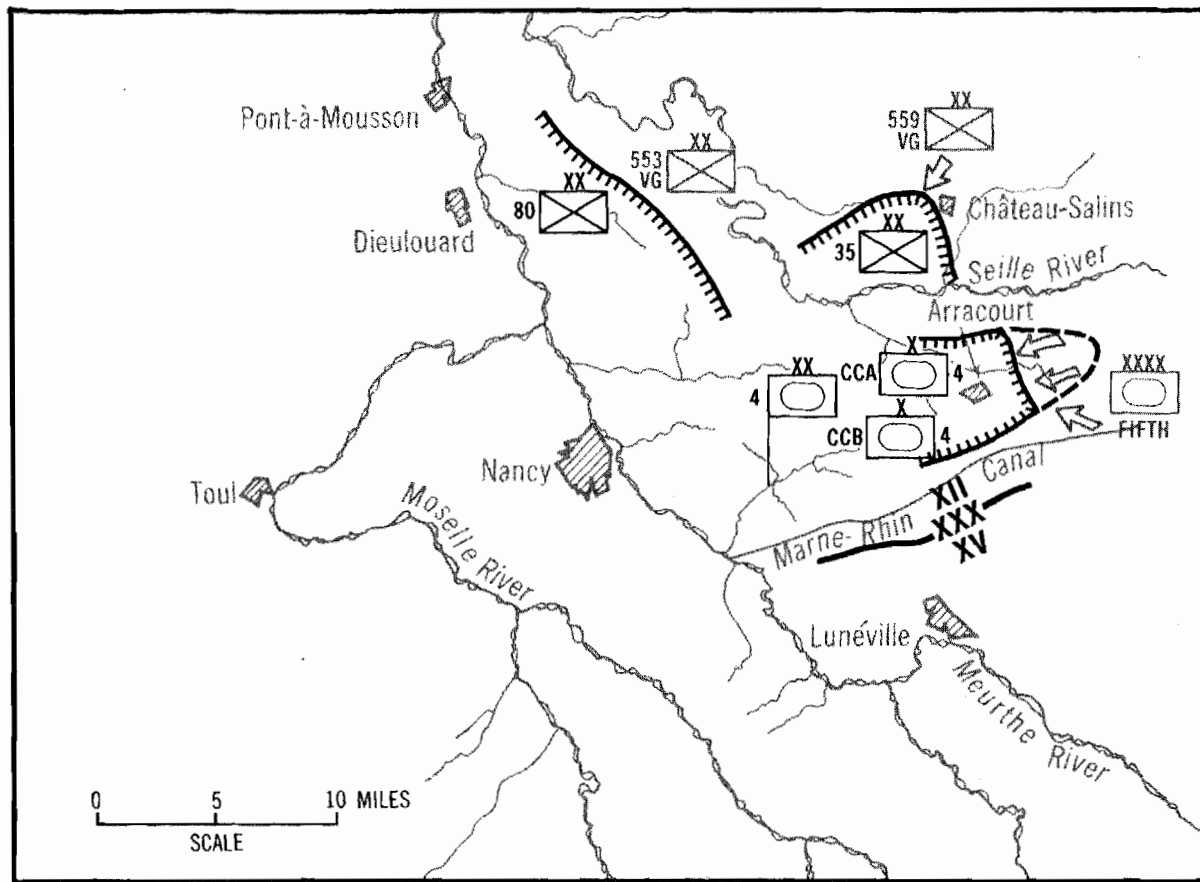

Map 7. 4th Armored Division's static defense, 26—29 September 1944

wearing out. Finally, on 12 October, the division was pulled out of the line for a month of rest and refitting.

When the 4th Armored Division reentered the battle in November, the Lorraine campaign had devolved into a brutal war of attrition mired down in mud and bloodshed. A brilliant episode in the annals of the 4th Armored Division had come to an end.

From the perspective of the 1980s, an analysis of the 4th Armored Division's operations around Nancy inevitably suggests that AirLand Battle doctrine is not really a new concept at all (see map 8). Rather, a strong case can be made for the assertion that Major General "P" Wood practiced AirLand Battle in 1944. Consider, for example, a comparison between the 4th Armored Division's operations and the tenets of AirLand Battle as listed in the 1982 version of FM 100-5, *Operations*: initiative, depth, agility, and synchronization.

Initiative was clearly a quality that both Wood and his division possessed in abundance. Wood and his subordinates were continually urging the higher commanders to exploit opportunities—they saw the possibilities, not the obstacles. An example of this was the enthusiasm with which small units passed over the Moselle and then drove deep behind German lines with a minimum of detailed supervision. Wood's ability to control the division with fragmentary orders and general guidance indicated the faith he placed in the initiative of his subordinates.

The 4th Armored Division certainly waged war in depth. As a unit, the 4th shared the belief that its proper function was to raise havoc behind enemy lines. CCA's classic deep attack from Dieulouard to Arracourt scattered German reserves, overran depots, and severed lines of communication while incurring a minimum of friendly casualties. The machine guns on CCA's rampaging tanks did as much to pry the Germans out of Nancy as did a frontal attack mounted by an entire infantry division and supported by corps artillery.

The 4th Armored Division demonstrated both physical and mental agility. Physical agility meant maintaining an offensive pace that precluded effective enemy countermeasures. It also meant never willingly standing still to be counterattacked. When on the defensive at Arracourt, the 4th showed agility by avoiding set battles, wresting the initiative from the attacker through mobile small-unit actions, and then counterattacking in force to

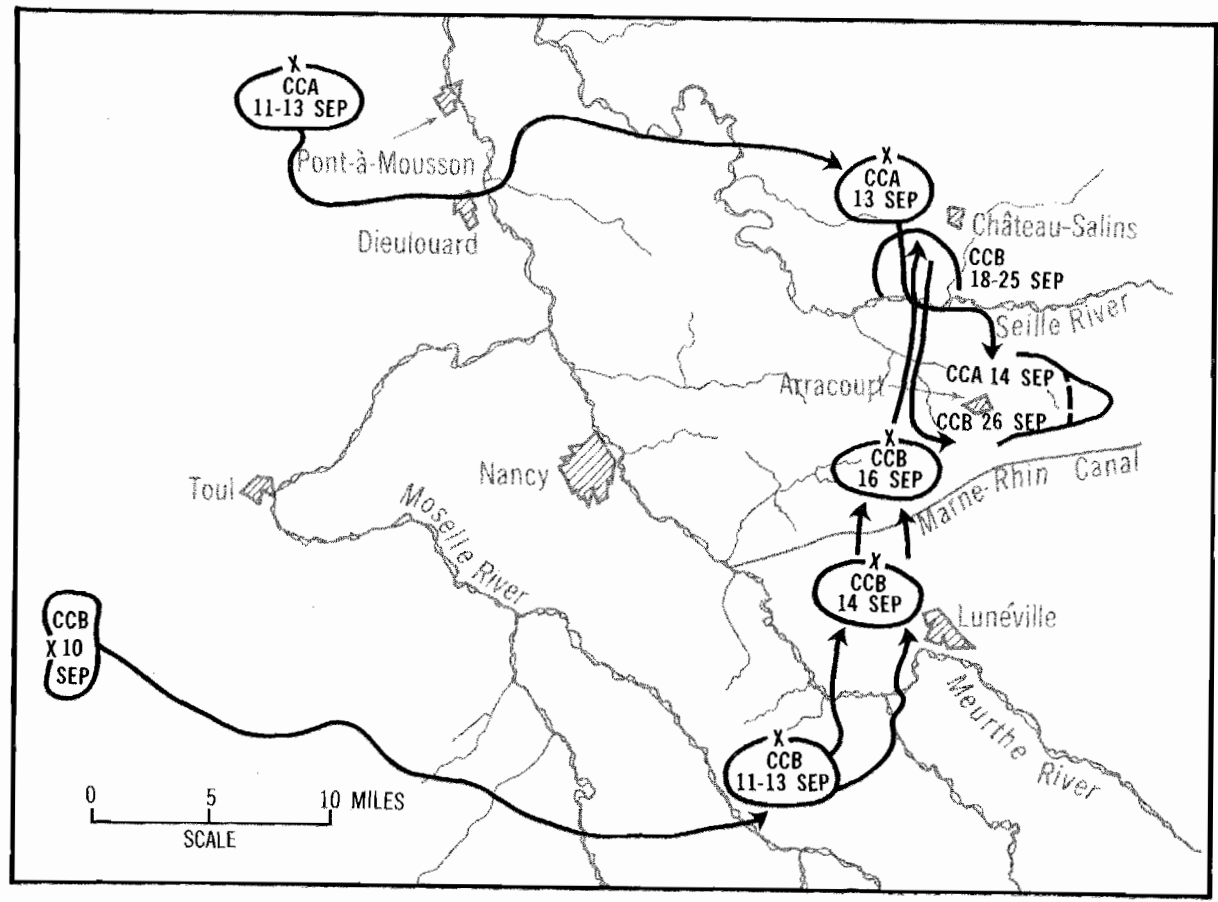

Map 8. 4th Armored Division's operations, 10-29 September 1944

drive him back. The smoothness with which the division reconfigured its combat commands and task forces was another sign of physical agility.

The 4th Armored Division was mentally agile as well. To Major General Wood, plans and orders were simply the foundation on which operations could be shaped while they were in progress. Witness the flexibility with which Wood shifted CCA to the Dieulouard crossing site and then converted its breakthrough into a deep attack to interdict German lines of communication at Arracourt. Such mental agility robbed the enemy of his options and forced the Germans into premature countermeasures.

Synchronization was also a hallmark of 4th Armored Division operations. Intensive emphasis on combined arms during training led to the closest of coordination in battle among the arms and services at the company and battalion level. This highly effective teamwork extended to the division's close relationship with the XIX Tactical Air Command. Timely, violent execution by all elements was a byword to the 4th Armored Division philosophy, as was the exploitation of the shock that such synchronization creates.

Thus, the 4th Armored Division clearly anticipated today's AirLand Battle tenets and, in September 1944, provided a practical, small-scale demonstration of deep battle and operational maneuver. This is not to suggest that "P" Wood simply ran the 4th according to a set of principles of war. Rather, Wood demonstrated the validity of an idea expressed in 1898 by a renowned British historian: "The rules of war only point out the dangers which are incurred by breaking them."<sup>8</sup>

Certainly, it is not the intent of this study to portray the encirclement of Nancy as a flawless operation. There was, for example, a distinct absence of synchronization within the XII Corps. Eddy's failure to translate 4th Armored Division's advantage into a decisive victory indicates clearly that a deep attack conducted without follow-on forces to consolidate gains leads only to a limited victory at best. Operational maneuver is a corps and army concern, even when it is spearheaded by a single division.

The poor synchronization that plagued the XII Corps in Lorraine was actually due in part to the 4th Armored Division itself. Consider the occasions when corps and division commanders worked at cross-purposes. One such instance arose when

Eddy wanted to envelop Nancy from the south, but Wood managed to have CCA conduct the northern envelopment that he had preferred all along. Another instance came when the 4th Armored Division planned an exploitation east from Arracourt, even though the corps' objectives lay to the northeast, not to the east. Finally, Wood expected Eddy's infantry divisions to support a continuation of the 4th Armored Division's advance, whereas Eddy chose instead to send armored elements back to help the infantry consolidate gains. Hindsight suggests that Wood was more often correct than Eddy in such confrontations, but a fundamental question remains unresolved: at what point should the initiative of the division commander give way to the corps commander's intent? Major General Wood's growing exasperation with Eddy, aggravated by his physical and mental fatigue, eventually led to Wood's relief from division command on 3 December.

The 4th Armored Division, however, never lost the "P" Wood flair. Throughout the rest of the war, Wood's aggressiveness, initiative, and flexibility continued to distinguish the division's operations. In its accustomed place at the head of Third Army, the 4th Armored Division went on from Lorraine to break the siege of Bastogne, crack the Westwall, and cross the Rhine River. In March 1945, the division finally took its version of the blitzkrieg into Germany itself.

The exploits of the 4th Armored Division in World War II earned it a Presidential Unit Citation. With forgivable hyperbole, Lieutenant General Patton once remarked that the achievements of the 4th were "unequaled in the history of warfare."<sup>9</sup> It is perhaps ironic that the soldiers of the 4th Armored Division never chose an official motto for their unit. As Major General John S. Wood once said of his men, "They shall be known by their deeds alone."<sup>10</sup>

---

## NOTES

1. U.S. War Department, FM 17-100, *Armored Command Field Manual, The Armored Division* (Washington, DC: U.S. Government Printing Office, 1944), 2.
  2. *Ibid.*, 68.
  3. Kenneth Koyen, *The Fourth Armored Division from the Beach to Bavaria* (Munich, Germany: Herder-Druck, 1946), 13.
  4. Hanson W. Baldwin, *Tiger Jack* [a biography of John S. Wood] (Fort Collins, CO, 1979), 18.
  5. *Ibid.*, 27.
  6. Koyen, *Fourth Armored Division*, 15.
  7. Hugh M. Cole, *The Lorraine Campaign, U.S. Army in World War II: European Theater of Operations* (Washington, DC: Historical Division, U.S. Army, 1950), 86.
  8. George F. R. Henderson, *Stonewall Jackson and the American Civil War* (reprint; Gloucester, MA: Peter Smith, 1968), 516.
  9. Baldwin, *Tiger Jack*, 132.
  10. Richard W. Smith and [?] Pelz, *Shoulder Sleeve Insignia of the U.S. Armed Forces, 1941-1945* (N.p., 1981), 73.
-



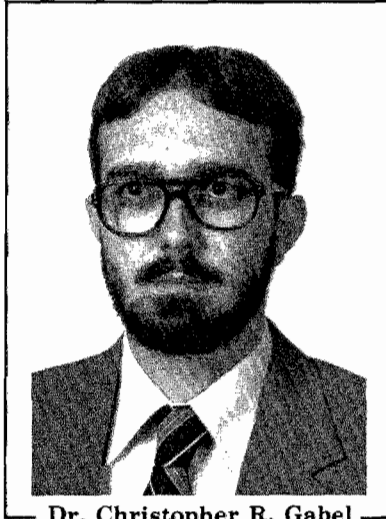

Dr. Christopher R. Gabel

Dr. Christopher R. Gabel is an associate professor at the Combat Studies Institute, U.S. Army Command and General Staff College, Fort Leavenworth, Kansas. He received his bachelor's degree at The Pennsylvania State University and earned M.A. and Ph.D. degrees in history at The Ohio State University. His graduate studies focused on the doctrine of the U.S. Army in the interwar and World War II periods. He is the author of a CSI special study, *The Lorraine Campaign: An Overview, September–December 1944* (February 1985) and Leavenworth Paper No. 12, *Seek, Strike, and Destroy: U.S. Army Tank Destroyer Doctrine in World War II* (September 1985).

## COMBAT STUDIES INSTITUTE

### *Missions*

The Combat Studies Institute was established on 18 June 1979 as a department-level activity within the U.S. Army Command and General Staff College, Fort Leavenworth, Kansas. CSI has the following missions:

1. Conduct research on historical topics pertinent to the doctrinal concerns of the Army and publish the results in a variety of formats for the Active Army and Reserve Components.
2. Prepare and present instruction in military history at USACGSC and assist other USACGSC departments in integrating military history into their instruction.
3. Serve as the U.S. Army Training and Doctrine Command's executive agent for the development and coordination of an integrated, progressive program of military history instruction in the TRADOC service school system.

U.S. Army Command and General Staff College  
Fort Leavenworth, Kansas

