

US Army Order of Battle 1919–1941

Volume 4

**The Services: Quartermaster,
Medical, Military Police, Signal Corps,
Chemical Warfare, and Miscellaneous
Organizations, 1919–41**

by

Lieutenant Colonel (Retired) Steven E. Clay



Combat Studies Institute Press
US Army Combined Arms Center
Fort Leavenworth, KS

Library of Congress Cataloging-in-Publication Data

Clay, Steven E., 1957-

US Army order of battle, 1919-1941 / Steven E. Clay.

p. cm.

Includes bibliographical references.

1. United States. Army--Organization--History--20th century--Encyclopedias. I. Title. II. Title: United States Army order of battle, 1919-1941.

UA25.C59 2010

355.30973'09041--dc22

2010022326



CSI Press publications cover a variety of military history topics. The views expressed in this CSI Press publication are those of the author and not necessarily those of the Department of the Army or the Department of Defense. A full list of CSI Press publications, many of them available for downloading, can be found at <http://usacac.army.mil/CAC2/CSI/>.

The seal of the Combat Studies Institute authenticates this document as an official publication of the CSI. It is prohibited to use CSI's official seal on any republication of this material without the written permission of the Director of CSI.

Contents

	<i>Page</i>
Explanatory Notes	v
Key to Abbreviations	xiii
Map and Illustration Symbols	xvii
Volume 4. The Services: Quartermaster, Medical, Military Police, Signal Corps, Chemical Warfare, and Miscellaneous Organizations, 1919–41	
Part IX. Quartermaster Corps Organizations	
Chapter 38. Quartermaster Trains	1919
Chapter 39. Field Remount Depots	1965
Chapter 40. Motor Repair Battalions, Quartermaster Corps	1975
Chapter 41. Service Battalions, Quartermaster Corps	1991
Chapter 42. Wagon Trains	2021
Chapter 43. Quartermaster Regiments and Squadrons	2029
Chapter 44. Port and Embarkation Units	2123
Chapter 45. US Army Transport Service	2135
Part X. Medical Corps Organizations	
Chapter 46. Medical Headquarters	2191
Chapter 47. Medical Regiments, Battalions, and Squadrons	2201
Chapter 48. Hospitals, Hospital Centers, and Surgical Groups	2271
Part XI. Military Police Organizations	
Chapter 49. Military Police Battalions	2567
Part XII. Signal Corps Organizations	
Chapter 50. Signal Corps Battalions	2581
Part XIII. Chemical Warfare Service Organizations	
Chapter 51. Chemical Regiments/Battalions	2607
Part XIV. Miscellaneous Organizations	
Chapter 52. Border Commands	2621
Chapter 53. ROTC Units	2629
Bibliography	2675
Appendixes	
Appendix A. Glossary of Terms	2693
Appendix B. Major Events of the US Army, 1919–41	2717
Appendix C. US Army Statistics, 1919–41	2743
Appendix D. Civilian Conservation Corps Organization, 1933–41	2747
Appendix E. Branch and Department Chiefs, 1917–41	2789
Appendix F. Annual Summer Training Camp Locations.....	2791
<i>Previous volumes include –</i>	
Volume 1. The Arms: Major Commands and Infantry Organizations, 1919–41	
Part I. Organization of the US Army	
Chapter 1. Genesis of the Modern American Army	3
Chapter 2. Geographical Organization and Tactical Commands of the US Army, 1898–1920	7
Chapter 3. Corps Areas and Departments	11

Chapter 4. General Headquarters and Field Armies	95
Chapter 5. Corps	137
Chapter 6. Corps Area Training Centers	187
Part II. Infantry Organizations	
Chapter 7. Infantry Divisions	195
Chapter 8. Infantry Brigades	291
Chapter 9. Infantry Regiments	351
Chapter 10. Infantry Battalions	519
Chapter 11. Tank Organizations	539
Volume 2. The Arms: Cavalry, Field Artillery, and Coast Artillery, 1919–41	
Part III. Cavalry Organizations	
Chapter 12. Cavalry Divisions	557
Chapter 13. Cavalry Brigades	593
Chapter 14. Cavalry Regiments	611
Chapter 15. Cavalry Squadrons	655
Chapter 16. Machine Gun Squadrons	665
Chapter 17. Armored Car Squadrons	677
Part IV. Field Artillery Organizations	
Chapter 18. Field Artillery Major Commands	685
Chapter 19. Field Artillery Brigades	697
Chapter 20. Field Artillery Regiments	749
Chapter 21. Field Artillery Battalions	927
Chapter 22. Field Artillery Observation Battalions	941
Chapter 23. Ammunition Trains	951
Part V. Coast Artillery Organizations	
Chapter 24. Coast Artillery Major Commands	985
Chapter 25. Coast Artillery Brigades	1037
Chapter 26. Coast Artillery Regiments and Battalions	1051
Chapter 27. Army Mine Planters	1175
Volume 3. The Services: Air Service, Engineers, and Special Troops, 1919–41	
Part VI. Air Service and Air Corps Organizations	
Chapter 28. Air Service and Air Corps Major Commands	1233
Chapter 29. Headquarters, Air Service	1259
Chapter 30. Groups	1287
Chapter 31. Squadrons, Heavier Than Air	1357
Chapter 32. Squadrons, Lighter Than Air	1549
Chapter 33. Squadrons, Non-Flying	1619
Part VII. Engineer Organizations	
Chapter 34. Engineer Major Commands	1667
Chapter 35. Engineer Regiments	1685
Chapter 36. Engineer Battalions/Squadrons	1755
Part VIII. Special Troops Organizations	
Chapter 37. Special Troops	1855

Explanatory Notes

Example Unit Entry (battalions, regiments, brigades)

<i>Unit Title and Type</i>	<i>Parenthetical</i>	<i>Component and Geographic Allotment</i>
↓	↓	↓
308th Cavalry Regiment (62d Cavalry Division)		Organized Reserve Maryland/Pennsylvania
HQ—Cumberland, MD, 1921–22; Pittsburgh, PA, 1923–41 ← <i>Headquarters Location</i>		

Demobilized 22 December 1918 at Camp Kearny, CA, as the 65th and 66th Field Artillery Regiments, and on 21 December 1918 as the 22d Trench Mortar Battery. All elements reconstituted in the Organized Reserves on 15 October 1921 and consolidated as the 308th Cavalry, assigned to the 62d Cavalry Division, and allotted to the Third Corps Area. Organized 10 November 1921 with regimental headquarters at Cumberland, MD. Regiment relocated about October 1922 to western Pennsylvania. Regimental headquarters concurrently organized at Pittsburgh. Reorganized 1 July 1929 as a three-squadron regiment. Concurrently, entire regiment relocated to Pittsburgh, PA. Typically conducted its Inactive Training Period meetings at the 107th Field Artillery’s Hunt Armory at the Post Office Building in Pittsburgh. Members built the 308th Cavalry Club in 1928 on property owned by the Aspinwall Hospital in Aspinwall, PA, and conducted some Inactive Training there. Facilities included equestrian, pistol, and saber training areas. Conducted regular equestrian training with the horses of the 107th Field Artillery. Conducted summer training with the 3d Cavalry Regiment at Fort Myer, VA, and at Fort Belvoir, VA. Trained with the units of the 52d Cavalry Brigade at Mount Gretna, PA, in July 1928. Conducted cavalry Citizens Military Training Camp (CMTC) training at Fort Myer as an alternate form of training. Designated mobilization training station was the York Concentration Area, PA. Location 7 December 1941—Pittsburgh, PA.

Unit Service Narrative

Organization Day: 24 February. Chosen to commemorate the regiment’s organization on 24 February 1918.

Status: Disbanded 11 November 1944 as the 66th Tank Destroyer Battalion. ← *Unit status as of 2001*

Events: 301 ← *Events in which the unit participated 1919–41 (see appendix B).*

Commanders, 308th Cavalry Regiment

Col. John J. Boniface	24 February 1918–25 April 1918	Col. Jean H.A. Day	15 September 1926–ao October 1926
Col. Hugh D. Berkeley	26 April 1918–24 September 1918	Col. Josiah L. Reese	ao March 1927–25 February 1930
<i>Demobilized/Inactive</i>	21 December 1918–10 November 1921	Col. George H. Cherrington	25 February 1930–January 1941
Lt. Col. Elmer J. Kingsbury	10 November 1921–October 1922	Unknown	January 1941–5 May 1941
Col. Josiah L. Reese	October 1922–15 September 1926	Lt. Col. John H. Schenkel	5 May 1941–6 November 1941

Purposes and Scope

The purposes of *US Army Order of Battle 1919–1941* are threefold. The first is to fill a void in the published record of US Army units documented by *Order of Battle of the United States Land Forces in the World War* published by the Center of Military History and Mr. Shelby L. Stanton’s *Order of Battle, U.S. Army World War II*. The second is to provide Army command historians, unit historians, and other individuals who are trying to research specific unit histories a basic overview of what these units were doing in the interwar period, where the units were located, and who commanded them. The third is to provide a private individual who had a relative who served during this period, and who wishes to know what that service may have consisted of, an account of the major activities in which the relative’s unit was involved. The scope of the work covers units from the size of separate battalions from all arms and services to field armies, as well as the actual order of battle of each as applicable.

Each unit is represented by a unit entry block. The entries contain a host of information that is standardized in its presentation as far as possible. Each entry includes the unit title and type, the headquarters to which the unit was assigned, the geographical area to which the unit was allotted (if National Guard or

Organized Reserve), the unit's headquarters location, the unit's physical location (or the unit's headquarters location if dispersed) on 7 December 1941, a unit service narrative, the unit's organization day, the unit's status as of 2001, and a chronological listing of the unit's commanding officers. Depending on the type of unit, additional information may include a listing of subordinate units and their years of assignment; "snapshot" orders of battle for divisions, corps, and armies for selected years; and the subordinate components of nonstandard units such as harbor defense commands. Also included in this work are the headquarters, a unit service narrative, commanders, and a "Major posts, camps, stations, airfields, and National Guard and Organized Reserve training facilities" section for each of the nine corps areas and three overseas departments. Though these were not tactical headquarters in the traditional sense, their importance to this period, and to this project, were such that I felt compelled to add their information.

Unit Title and Type

The unit title, in most cases, is the designation by which the unit was known for most of the 1919–41 period. In some cases, most notably the Air Service/Air Corps units, several unit titles followed by dates are given due to numerous redesignations.

Parentheticals

Titles are often followed by parenthetical information. Typically, the first of these will be the unit type or weapon, such as **(Antiaircraft)** or **(75-mm G)**. These designations will always be in boldface type. The notation (C) will follow some units. This indicates the unit was designated as a "Colored" unit and manned by African American personnel. The term "Colored" and the designation (C) were the standard usage of the period in mobilization documents and elsewhere and are used here for historical purposes. These designations too will always be in boldface type. Some units held the same designation at different times, but are not the same organization. These titles will be followed by a Roman numeral in parentheses, e.g., (I), (II), etc., to clearly differentiate the separate units. These designations will always be in standard type. The final example of parenthetical information is the major headquarters to which the unit was assigned, for example: (1st Division). This is typically the brigade, division, corps, or army to which the unit was assigned. For National Guard units, these reflect planned mobilization assignments for wartime and do not necessarily reflect actual peacetime command and control relationships. In some cases, again most often Air Service/Air Corps units, the organization was assigned to several different headquarters from 1919 to 1941. In those cases, I have attempted to designate that headquarters to which the unit was assigned for the longest period or, in some instances, the headquarters to which it was assigned in the initial mobilization plans of 1921–23. Admittedly, there are a few instances where these two examples will not apply, but in each of these exceptional cases, the rationale was different and it is not feasible to explain every reason. The headquarters designations will also be in standard type.

Component and Geographic Allotment

National Guard and Organized Reserve units are identified in this section of the unit entry. The state or states of allotment are also identified. In some cases, the unit was allotted for organization to more than one state. In those instances, the states of allotment will be identified with the conjunction "and" as such: **Alabama, Mississippi, and Louisiana National Guard**. Typically, the state to which the headquarters was allotted will appear first. In other cases, usually Organized Reserve units, the organization was withdrawn from allotment to one state or geographical area, and reallocated to another. In those instances, the initial state or states of allotment and the follow-on state or states will be differentiated with a slash "/", indicating the first, second, etc., areas of allotment as such: **Organized Reserve Missouri and Kansas/South Dakota**. In some cases for National Guard or Organized Reserve units, an organization was constituted but never allotted to a given state. In those instances, only the component (i.e., **National Guard** or **Organized Reserve**) is listed. Regular Army units that were generally in an inactive status between 1921 and 1939 are shown as **Regular Army Inactive (RAI)**. The vast majority of RAI units were organized with Reserve personnel during this period and thus are differentiated in this manner from Organized Reserve units and active Regular Army units. Many Organized Reserve units were withdrawn from the Reserve and allotted

to the Regular Army between 1927 and 1940. These units are all listed herein as Organized Reserve units as that is the component in which they were originally allotted. Active Regular Army units below division level and which headquarters were active for the majority of 1919 to 1941 will have no component listed.

Headquarters Location

The city or post and state or overseas location where the unit's headquarters was physically and permanently located, roughly between January 1919 and 7 December 1941, is listed here. Generally speaking, temporary locations are not included unless the absence from the permanent location was for 6 months or longer. The location and relocation dates for Regular Army and National Guard units are generally accurate, having been determined from unit data cards for the Regular Army and state annual or biennial reports and various other documents for National Guard units. While the majority of the initial organization dates and locations for Organized Reserve (O.R.) units are generally accurate, the relocation dates were somewhat problematic for these units. The primary document used to determine O.R. headquarters locations are 3"x5" index cards located at the Center of Military History at Fort McNair in Washington, DC. These cards were the methodology by which the Army tracked O.R. units in the interwar period. They usually (though not always) contain dates and headquarters location for the relocation of the units, but the relocation dates themselves are often that of the actual document that notified the individual who kept the cards rather than the actual date of the relocation. The date provided on the index card has typically been used as the date of relocation in the absence of the actual date. Those dates, however, while generally accurate, can be as much as a year off. In those instances where the actual relocation date has been located in other kinds of documents, the actual date has been used.

Unit Service Narrative

The service narrative generally provides an overview of the unit's permanent changes of station, assignment and reassignment to major commands, allotment to and withdrawal from component (Regular Army [R.A.], National Guard [N.G.], O.R.), allotment to corps area or overseas department, initial organization date and location, training activities and locations, activation and inactivation, and the location of the unit (or of the unit headquarters if the unit was dispersed) on 7 December 1941. Special events and activities, awards, and deployments are also covered. For R.A. units, support to the Civilian Conservation Corps and training support to O.R. units are covered. For N.G. units, callups for state emergencies of battalion-size or larger, dates of Federal recognition, dates of induction into Federal service, summer training camp locations, and mobilization training stations are covered. For O.R. units, locations for Inactive Training Period meetings, summer training camp locations, mobilization training stations, and Reserve Officers' Training Corps (ROTC) feeder units are covered. Regular Army Inactive (RAI) units are covered similarly to O.R. units with the addition of information on Active Associate units and affiliation with ROTC units. Dates provided for unit movements are generally the dates of arrival at the new location by the unit headquarters, unless specifically given as a departure date from the losing duty station. Subordinate elements of the unit may have arrived before or after that date.

Organization Day

The War Department's General Order #24, dated 10 June 1922, established the concept of "Organization Day" (sometimes referred to as "Regimental Day") for US Army units. The Organization Day was not necessarily the date on which the unit was organized. It could also be a special date in its history such as its baptism of fire in combat. In instances where an Organization Day had been adopted, the unit's chosen date for Organization Day, an explanation of the date's significance, and the date of adoption are given, if known.

Status

The unit's status (active, inactive, disbanded, etc.) and designation as of 2001 is given if known.

Events

The numbers represent events of significance in which the unit participated between 1919 and 1941. The details of each event number are located in appendix B.

Commanders

Where known, the unit's commanders and their inclusive dates of command are provided for regiment-size units and above, and selected battalion-size units. The dates of command are for the period 1 January 1919 to 7 December 1941, or the end date of command for the last pre-World War II commander, whichever is later. For infantry, cavalry, field artillery, coast artillery, and engineer regiments, the commanders for the World War I period are also provided if known, because those commander lists were not previously provided in the Center of Military History's *Order of Battle of the United States Land Forces in the World War*. For some N.G. units, the commanders will have a state abbreviation in parentheses following their name (e.g., (GA) for the state of Georgia) in those instances where the unit was a multistate organization to identify from which state the commander was assigned. If the commander of a N.G. or O.R. unit was an R.A. officer, the name will be followed by the abbreviation (R.A.). If the commander of a N.G. or R.A. unit was an O.R. officer, the name will be followed by the abbreviation (O.R.). If the name is not followed by an abbreviation, the commander is of the component or state to which the unit headquarters was allotted. If a commander is not known for a given period, the entry "Unknown" and the inclusive dates (at least month and year) are provided. In some instances, especially for O.R. units, the inclusive dates for a given commander are not known. In those cases, the entry "ao" (for "as of") followed by a month and year indicates the earliest or latest date known for that commander to be in command of the unit indicated. The example below indicates that Colonel William J. Smith was known to be in command from at least July 1937 to at least April 1940.

Example: Col. William J. Smith

ao July 1937–ao April 1940

Additionally, a single asterisk (*) beside a commander's name indicates he was an R.A. officer in command of an RAI unit. Two asterisks (**) indicates a Reserve officer who was in command of an RAI unit. Note that relatively few O.R. brigades and no RAI brigades were assigned a brigadier general as commanding general. These headquarters functioned as such on few occasions, usually at a command post exercise or occasionally during annual training. The brigade was strictly a tactical command during this period and exercised no administrative duties or responsibilities. Those duties were performed at the division and regimental levels. For that reason, O.R. and RAI brigades were generally "commanded" by majors or lieutenant colonels whose duties were primarily limited to planning, conducting, or supervising training in the brigade headquarters during the inactive training period. More often than not, personnel assigned to brigade headquarters simply conducted their inactive training with one of the subordinate regiments. At summer training, the senior regimental commander often served as the brigade commander when the brigade headquarters was intended to function as such. When assignment of Reserve officers to RAI regiments began in 1926, only a single reserve major (later changed to a lieutenant colonel) was authorized as the commander though the regiment could acquire its full quota of captains and lieutenants from the officer's Reserve Corps. In 1927, the command of these regiments was, in many cases, passed to selected Active Duty R.A. colonels and lieutenant colonels who, for the most part, were the professors of Military Science and Tactics at the college or university with which the RAI unit was affiliated. This practice seems to have effectively ended on 1 October 1933, though in some instances it was ended earlier, after which command was exercised by the senior Reserve officer assigned. Most units not affiliated with an educational institution were commanded by Reserve officers, though in a few cases they were commanded by R.A. officers who were assigned as an additional duty. This practice also seems to have ended on 1 October 1933. In many instances, brigades and regiments were commanded by captains and even lieutenants. Those organizations seem to have served more as Reserve pool units for mobilization assignment purposes than actual functional units. This was usually because the assigned personnel were geographically dispersed so as to prevent regular assembly for inactive training periods. Nonetheless, the senior officer assigned acted as the commanding officer during summer training unless a higher ranking officer was temporarily attached to assume command for the camp period.

Example Major Command Unit Entry (divisions, corps, armies)

Major command unit entries generally follow the same pattern as those for smaller unit entries with the exceptions detailed below.

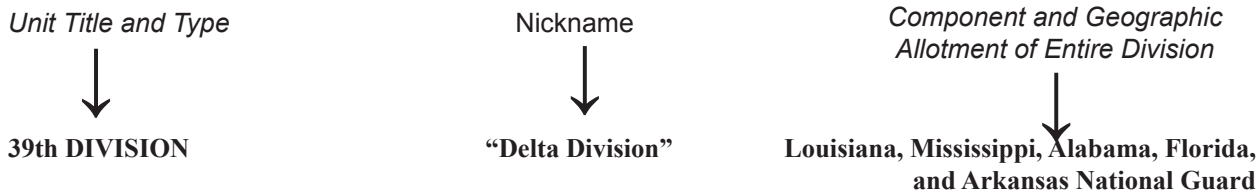

HQ—*Not organized, 1921–23* ← *Headquarters Location*

The 39th Division headquarters arrived at Newport News, VA, aboard the S.S. *Matoika* on 31 December 1918 after 4 months of overseas service and was demobilized 23 January 1919 at Camp Beauregard, LA. In accordance with the National Defense Act of 1920, the division was allotted to the states of Louisiana, Alabama, Mississippi, Florida, and Arkansas and assigned to the IV Corps in 1921. The division’s designated mobilization training station was Camp McClellan, AL. The division headquarters was not reorganized before the adjutants general of the several states from which the division was drawn petitioned the War Department to change the designation of the division to be formed as the 31st Division as that was the organization in which most of the states’ units served in World War I. The request was approved and the subordinate elements assigned to the 39th Division were withdrawn and assigned to the 31st Division, less the Arkansas elements, effective 1 July 1923.

Unit Service Narrative

Status: Headquarters and Headquarters Company currently active at Little Rock, AR, as HHC, 39th Infantry Brigade.

Division Commanders

No commanders assigned

**39th DIVISION
Organization 1923**

UNIT:	HQ LOCATION:
<i>Headquarters</i>	<i>Alabama N.G.*</i>
<i>Headquarters, Special Troops</i>	<i>Alabama N.G.*</i>
Headquarters Company	Mobile, AL
<i>39th Military Police Company</i>	<i>Florida N.G.*</i>
<i>39th Signal Company</i>	<i>Alabama N.G.*</i>
114th Ordnance Company (M)	Jacksonville, FL
39th Tank Company (L)	Ozark, AL
<i>Motorcycle Company No. 114</i>	<i>Florida N.G.*</i>
77th Infantry Brigade	Montgomery, AL
154th Infantry Regiment	Jacksonville, FL
167th Infantry Regiment	Gadsden, AL
78th Infantry Brigade	New Orleans, LA
155th Infantry Regiment	Vicksburg, MS
156th Infantry Regiment	New Orleans, LA
<i>64th Field Artillery Brigade</i>	<i>Louisiana N.G.*</i>
114th Ammunition Train	Elba, AL
<i>116th Field Artillery Regiment</i>	<i>Florida N.G.*</i>
<i>141st Field Artillery Regiment</i>	<i>Alabama N.G.*</i>
<i>114th Engineer Regiment</i>	<i>Mississippi N.G.*</i>
<i>114th Medical Regiment</i>	<i>Louisiana N.G.*</i>
<i>39th Division Train, Q.M.C.</i>	<i>Mississippi N.G.*</i>
39th Division Air Service	Birmingham, AL

Organization/
Order of Battle

*Indicates state of headquarters allocation; headquarters not organized or inactive.

Nickname

Many divisions adopted nicknames in the World War I period or, in a few cases, the nickname was adopted after the division was constituted or reconstituted in 1921. The nicknames are shown as illustrated.

Component and Geographic Allotment

For corps and armies, only the state to which the headquarters was allotted are listed. For divisions, every state that was allotted a unit in the division's order of battle is listed. The state to which the headquarters was originally allotted and organized will be listed first.

Organization/Order of Battle

Each division, corps, and field army has one or two "snapshot" orders of battle provided to illustrate how the command was organized at the time indicated. The 1939 order of battle provided for the R.A.'s 1st through 9th Divisions represent those divisions' final organization before the change to the "triangular" tables of organization in October 1939. Unit designations in italics indicate an inactive unit or a "not organized" or "not initiated" unit. Unit headquarters locations in italics represent the state of allotment for National Guard Inactive (NGI) units and the corps area of allotment for RAI and Organized Reserve Inactive (ORI) units. Partially active units (i.e., the headquarters was inactive, but some subordinate elements were active) are also shown in italics. For partially active units, the unit headquarters mobilization station/post is also shown in italics.

Division Commanders and Chiefs of Staff

Note that about half of the O.R. divisions actually had at least one general officer assigned as division commander sometime during this period, and none had a general assigned for the entire period. In most cases, one of the R.A. brigade commanders in the corps area was assigned as the commanding general of one of the three O.R. divisions as an additional duty. This practice seems to have been most widely used in the Second, Fourth, Fifth, and Seventh Corps Areas. In some cases, the corps area commander assigned that duty to himself. In two instances, those of the 77th and 95th Divisions, Reserve divisions were actually commanded by a Reserve officer. Generally speaking, the division's chief of staff exercised routine command in the name of the corps area commander or the assigned division commander. Thus, the names of the R.A. chiefs of staff assigned to O.R. divisions have been included in this *Order of Battle*.

Terminology and Abbreviations

The military and ethnic terminology and abbreviations used in this work are those that were used from 1919 to 1941; therefore, at the beginning of each volume is a Key to Abbreviations. See Appendix A, "Glossary of Terms," for definitions of the terminology used in this *Order of Battle*.

The National Guard

The N.G. poses several problems in preparing a work such as this because the rules by which the Center of Military History (and the states themselves) trace each unit's lineage do not always mirror those for the R.A. and O.R./US Army Reserve. For example, when a unit in the O.R. was relocated from one community to another, the unit retained its history and designation. In the case of the N.G., however, when a unit designation was relocated to a unit in another community, the history of the unit was retained in the organization located in the first community. Also, if a unit was demobilized (i.e., disbanded) in one community, and then in another community a unit is organized with the same designation, there was, in theory, no relation between the two units other than the fact that they happened to have shared the same designation. For example, the 120th Ammunition Train was organized at Bristow, OK, in May 1923. The unit in Bristow was disbanded in May 1924. A new 120th Ammunition Train was organized at Sperry, OK, in June 1924 and later reorganized as Headquarters Battery, 160th Field Artillery in June 1926. Another new 120th Ammunition Train was organized at Haskell, OK, also in June 1926, and later reorganized as Battery B,

160th Field Artillery in January 1927. In theory, there were three different organizations with the designation “120th Ammunition Train” and as such, each should merit a separate Unit Entry in this *Order of Battle*. To complicate matters, regimental, brigade, and division headquarters appear not to have been considered state- or community-specific units. For example, the Headquarters, 108th Cavalry at New Orleans, LA, was withdrawn from the state of Louisiana on 15 March 1929 and allotted to the state of Georgia and reorganized at Hinesville, GA. There appears to have been no loss of identity or history in the transfer of that unit designation between states, much less between communities in the same state. It is the same unit with the same lineage. Additionally, the Center of Military History does not consider N.G. units “constituted,” even though the Federal designations of those units were clearly “placed on the rolls of the army” (this is especially pertinent since the vast majority of N.G. units used Federal designations and not state designations during the period) and allotted to the various states in 1920–21 in accordance with the guidelines laid out in the 1920 amendment to the National Defense Act of 1916. The methodology appears to assume that the designation does not exist (at least on the rolls of the Army) until the day the unit is organized and federally recognized, even though letters and memorandums allotting the unit designation to a state, mobilization plans, and numerous other documents clearly refer to the existence of the unit designation before it was actually organized. In light of these pre-existing designations, for the purposes of this *Order of Battle*, I have chosen to consider the designation of N.G. units to have been constituted in the same manner as R.A. and O.R. units (i.e., when the designation of a unit was placed on the rolls of the Army). Therefore, those units that have a clearly differentiated identity (in other words, separate battalions, regiments, divisions, etc.) are treated as one and the same organization in the Unit Entries. Only in rare instances are two (or more) N.G. units with the same designation treated as separate and distinctly different organizations. The Unit Entries for these units generally makes the purpose for differentiation self-evident.

Key to Abbreviations

(AA)	antiaircraft	Aux	auxiliary
(C)	Colored	Avn.	aviation
(CA)	civilian airfield	AZ	Arizona
(CC)	civilian college	B.A.G.	Branch Assignment Group
(H)	heavy	Bkry	bakery
(HD)	horse drawn	Bln.	balloon
(HP)	heavy ponton	Bn.	battalion
(HT)	heavy tractor	Bomb.	bombardment
(HTA)	heavier-than-air	Brig.	brigade
(L)	light	Brig. Gen.	brigadier general
(LP)	light ponton	Btry	battery
(LT)	light tank	C.A.	coast artillery
(LTA)	lighter-than-air	C.A.C.	Coast Artillery Corps
(M&H)	medium & heavy	C.G.	commanding general
(M)	medium	C.O.	commanding officer
(MA)	military airfield	C.S.A.	Confederate States of America
(MC)	military college	C.W.S.	Chemical Warfare Service
(Mecz)	mechanized	C.Z.	Communications Zone
(MI)	military institute	CA	California
(MT)	medium tank	Camo	camouflage
(Mtd)	mounted	Capt.	Captain
(Mtzd)	motorized	CARL	Combined Arms Research Library
(NGF)	National Guard Aviation Facility	CARS	Combat Arms Regimental System
(PS)	Philippine Scouts	CASC	Corps Area Service Command
(RO)	railway operating	CASU	Corps Area Service Unit
(RY)	railway	Cav.	cavalry
(S&F)	sound and flash	Cbt	combat
(TD)	tractor/truck drawn	CCC	Civilian Conservation Corps
(Topo)	topographic	CCX	Command and Communications Exercise
(WS)	water supply	CD	Coast Defenses
A.A.	Active Associate	Chem.	Chemical
AAB	Army Air Base	CIA	Central Intelligence Agency
Abn	airborne	CM	civilian master
AC	Air Corps	Cmd	command
Adj.	adjutant	Cmpl.	Complement
Adm.	airdrome	CMTC	Citizens Military Training Camp
Admin	administration	CO	Colorado
AEF	American Expeditionary Force	Co.	company
AFG	American Forces, Germany	Col.	colonel
AFHRA	Air Force Historical Research Agency	Coll	collecting
AIT	advanced individual training	Commo	communications
AK	Alaska	Comp.	composite
AL	Alabama	Conv	convalescent
amb.	ambulance	Cos.	companies
ammo.	ammunition	Cpl.	Corporal
ao	as of	CPX	command post exercise
AP	airport	CST	common skills training
AR	Arkansas	CT	Connecticut
Armd.	armored	Ctr.	Center
Armt	armament	CZ	Canal Zone
Ars.	arsenal	DC	District of Columbia
Arty.	Artillery	DE	Delaware
AS	air service	Dent	dental
Ash.	airship	Dep	depot
Atk.	attack	Dept.	department
ATS	army transport service	Det.	detachment













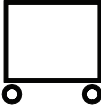



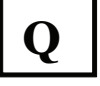

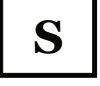

Disch.	Discharge	Instr.	Instructor
Dispry.	Dispensary	Intel	intelligence
Dist.	District	KKK	Ku Klux Klan
Div. Arty.	division artillery	KS	Kansas
Div.	division	KY	Kentucky
DNG	Deferred National Guard	LA	Louisiana
Doc	document	Lab	laboratory
DT	dump truck	LB	light bridge
e.g.	for example	LM	light maintenance
EEN&T	eyes, ears, nose & throat	Lt.	lieutenant
elmts	elements	Lt. Col.	lieutenant colonel
Engr.	engineer	Lt. Gen.	lieutenant general
Engrs.	engineers	LUTC	Local Unit Training Camp
ERC	Enlisted Reserve Corps	M. Rep. Bn.	Motor Repair Battalion
etc.	and so forth	M. Rep. Sec	Motor Repair Section
Evac	evacuation	M. Rep.	motor repair
F.A.	field artillery	M.C.	Medical Corps
Fin.	Finance	M.P.	military police
FL	Florida	M.T. Cmd.	motor transport command
Fld	field	M.T. Co.	motor transport company
G	gun	M.T.	motor transport
G.O.	General Order	M.T.C.	Motor Transport Corps
G.P.F.	Grande Puissance Filloux	MA	Massachusetts
GA	Georgia	Maint	maintenance
Gen.	General	Maj.	major
G-H	gun, horse drawn	Maj. Gen.	major general
GHQ	General Headquarters	Man'g	maneuvering
GHQR	General Headquarters Reserve	Max-Fac	maxillo-facial
Gonio	goniological	MD	Maryland
G-P	gun, portee	ME	Maine
Gp.	group	mecz	mechanized
GS	general support	Med.	Medical
GUTC	General Unit Training Camp	Met	meteorology
H	howitzer	MG	machine gun
Haw Div	Hawaiian Division	MGM	Metro-Goldwyn Mayer
HB	heavy bridge	MI	Michigan
HD	Harbor Defenses	Mil.	Military
HHB	headquarters and headquarters battery	Misc	miscellaneous
HHC	headquarters and headquarters company	MN	Minnesota
HHD	headquarters and headquarters detachment	MO	Missouri
HHS	headquarters and headquarters squadron	mob.	Mobilization
HHSC	headquarters and headquarters and service company	MR	military reservation
HHT	headquarters and headquarters troop	MS	Mississippi
HI	Hawaii	MT	Montana
HM	heavy maintenance	Mtcyl	motorcycle
Hosp.	hospital	mtz	motorized
Hosp Ctr	hospital center	N.G.	National Guard
HQ	headquarters	NC	North Carolina
Hv	heavy	NCO	noncommissioned officer
i.e.	that is	ND	North Dakota
I.G.	inspector general	NE	Nebraska
IA	Iowa	NGI	National Guard Inactive
ID	Idaho	NGR	National Guard Reserve
IL	Illinois	NH	New Hampshire
IN	Indiana	NJ	New Jersey
Induct.	Induction	NM	New Mexico
Inf.	Infantry	No.	number
		NV	Nevada

NY	New York	S.S.	steam ship
NYPOE	New York Port of Embarkation	San.	sanitary
O.R.	Organized Reserve	SC	South Carolina
Obsn.	observation	SCF	Southern Coastal Frontier
Ofc.	Office	Sch. B&C	School for Bakers and Cooks
OH	Ohio	Sch.	School
OK	Oklahoma	SD	South Dakota
Opns	operations	sec	section
OR	Oregon	Secr	secret
ORC	Officers Reserve Corps	Sect.	sector
Ord.	ordnance	Sel	selective
Org.	organization	Sep.	separate
ORI	Organized Reserve Inactive	SFPOE	San Francisco Port of Embarkation
OV	overseas	Sig.	signal
P.M.O.	Provost Marshal Office	Sp. Tps.	special troops
P2D	Provisional 2d Division	Sp.	Special
PA	Pennsylvania	Sq.	squadron
PC Div.	Panama Canal Division	SSD	Selective Service Detachment
Pers	personnel	Sta.	station
PG	Proving Ground	Sup	supply
Ph Div.	Philippine Division	Sup Dep	supply depot
PI	Philippine Islands	Surg.	surgeon/surgical
PID	Provisional Infantry Division	Sv	service
PL	Public Law	T/O	table of organization
Plt.	Platoon	TA	Territory of Alaska
PMS&T	Professor of Military Science and Tactics	Tact.	Tactical
POE	port of embarkation	TH	Territory of Hawaii
Port	portee	Tm	team
PR	Peurto Rico	TN	Tennessee
Prof Sv	professional services	Tn.	train
Prov.	provisional	Tng.	Training
Purs.	pursuit	Trp.	troop
Q.M.	quartermaster	Tr Mtr	trench mortar
Q.M.C.	quartermaster corps	Trans	transportation
R&I	Reception and Integration	Trk	truck
R.A.	Regular Army	TX	Texas
R.A.T.C.	Regular Army Training Center	U.S.A.C.S.	U.S. Army Cable Ship
Rad.	radio	U.S.A.J.M.P.	U.S. Army Junior Mine Planter
RAI	Regular Army Inactive	U.S.A.M.P.	U.S. Army Mine Planter
RAR	Regular Army Reserve	U.S.A.T.	U.S. Army Transport
Rcn.	reconnaissance	U.S.A.T.S.	U.S. Army Transport Service
Rct.	Recruit	U.S.C.G.C.	U.S. Coast Guard Cutter
Rctg.	Recruiting	U.S.C.G.T.	U.S. Coast Guard Tender
Rec'g	receiving	U.S.D.B.	United States Disciplinary Barracks
Recep.	Reception	U.S.L.H.T.	U.S. Light House Tender
Recr.	Recreation	U.S.M.C.	United States Marine Corps
Regt.	regiment	U.S.S.	United States Ship
Repl.	Replacement	U.S.V.	United States Volunteers
Res	reserve	US	United States
RI	Rhode Island	USARS	United States Army Regimental System
Rmt	remount	USN	United States Navy
Roent	roentgenology	UT	Utah
ROK	Republic of Korea	V.C.	Veterinary Corps
ROTC	Reserve Officers' Training Corps	VA	Virginia
RP	Republic of Panama	VI	Virgin Islands
Rpr	repair	VM	Vickers-Maxim
S.C.	Signal Corps	VT	Vermont
S.R.	sound ranging	WA	Washington

Wag	wagon
WDGMP	War Department General Mobilization Plan
WDGS	War Department General Staff
WI	Wisconsin
WPD	War Plans Division
WV	West Virginia
WX	weather
WY	Wyoming
XC	cross-country
Z.I.	Zone of the Interior

Military Map and Illustration Symbols

These symbols are used in the maps, tables of organization, and other illustrations presented in this *Order of Battle*. They reflect the common symbols in use from 1919 to 1941.

	Unit		Engineer unit
	Train or motorized unit		Special Troops unit
	Railway unit		Mine Planter
	Infantry unit		Quartermaster unit
	Cavalry unit		Transport unit
	Artillery unit		Military Police unit
	Ammunition unit		Signal Corps unit
	Tank unit		Ordnance unit
	Air service/air corps unit		Chemical Warfare unit
	Airship unit		Medical unit
	Balloon unit		Veterinary unit

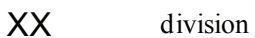
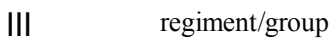
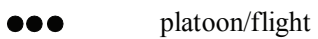
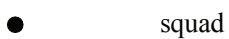
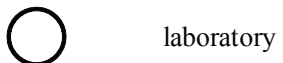
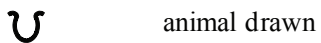
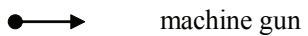
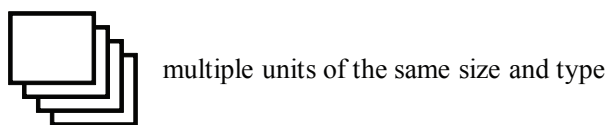

Part IX

Quartermaster Corps Organizations

1919-41

Chapter 38

Quartermaster Trains



Quartermaster Trains. Philippine Scouts of the Philippine Division Quartermaster Train on maneuver in 1928.

The quartermaster train functioned as the logistical headquarters for field armies, corps, and divisions. These headquarters and their subordinate units acquired and hauled the supplies and reserve ammunition needed for a specified period of time for their respective levels of command.

Organization

Of the six army quartermaster train headquarters constituted in 1921, five were Organized Reserve units, the remaining headquarters was allotted to the National Guard. The army train was a fully motorized organization by 1921. It consisted of the following components:

Headquarters, Army Train, Q.M.C.

- 4 Motor Repair Battalions
- 5 Motor Transport Commands
- 20 Motor Transport Companies
- 2 Motorcycle Companies
- 4 Motor Repair Sections

The five Reserve army train headquarters were organized in 1921-1922. The one National Guard train headquarters allotted to the state of Illinois was never organized. Each of the three lower numbered army trains (First through Third) possessed a number of Guard subordinate units, but similarly, very few of those Guard units were ever organized. Most army train subordinate units were in the Organized Reserve and the vast majority of those organizations were in fact initiated at some point. Of course, since most of these units

consisted of officer cadres, that also meant that most of these units consisted of only a handful of officers at any given time.

Of the eighteen corps quartermaster trains constituted in 1921, four were National Guard commands, the remainder were in the Organized Reserve. Unlike the army train, the corps train was 25 percent animal drawn and 75 percent motorized. The wagon train was intended to provide the logistic haul capability in the more forward areas where its units were expected to be required to move on unpaved roads or even cross-country. The motorized elements were expected to operate farther to the rear and largely on paved or improved roads. The corps train consisted of the following elements:

Headquarters, Corps Train, Q.M.C.

- 7 Motor Transport Commands
- 24 Motor Transport Companies
- 1 Motor Transport Company (Car)
- 2 Motorcycle Companies
- 8 Motor Repair Sections
- 1 Wagon Train
- 3 Wagon Companies

None of the four corps National Guard quartermaster train headquarters were ever organized in the Guard and all were withdrawn from allotment in 1927. These headquarters were replaced in 1928 by four new train headquarters. One was constituted in the Organized Reserve and three in the Regular Army as inactive units.

Just as with the army trains, all of the fourteen Reserve corps train headquarters were organized during 1921-1922. The four Guard train headquarters were all subsequently organized as Reserve units after being placed on the deferred list in 1923. Most of the lower numbered corps trains (I through IX) possessed at least a few Guard subordinate units. One, the V Corps Quartermaster Train, had none, and two others, the IV and VI Corps Quartermaster Trains, each possessed substantial numbers of Guard units. In every case, very few of these Guard units were ever organized. Most corps train subordinate units were in the Organized Reserve and the vast majority of those were organized at some point also primarily as officer cadres.

Each infantry and cavalry division also possessed a quartermaster train. The infantry division train was also partially animal drawn. In 1921 it consisted of:

Headquarters, Division Train, Q.M.C.

- 4 Motor Transport Companies
- 2 Motor Repair Sections
- 1 Motorcycle Company
- 2 Wagon Companies

The 1921 cavalry division train was entirely animal drawn. It consisted of:

Headquarters, Cavalry Division Train, Q.M.C.

- 2 Wagon Companies
- 4 Pack Trains, Q.M.C.

The 1928 reorganization of the cavalry division recognized the increased economy, speed, and reliability of motorized transport, and it was reflected in the new train. Thus the reorganized division train appeared as follows:

Headquarters, Cavalry Division Train, Q.M.C.

2 Motor Transport Companies

1 Motor Repair Section

1 Wagon Company

4 Pack Trains, Q.M.C.

The subordinate units of division trains were composed entirely of units in the same component to which their parent division was allotted. In the Regular Army, the only division quartermaster trains that were fully organized were those for the Hawaiian Division and the 1st Cavalry Division. In the other active Regular divisions two of the four authorized motor transport companies remained inactive, as well as at least one of the motor repair sections. The trains of the inactive divisions generally had one or two active elements to support the division's active units, but none of those train headquarters were active after 1921. Most of the inactive division quartermaster train subordinate units were, however, organized as RAI units between 1926 and 1928. Between 1923 and 1931, many of the Regular Army divisions' active motor transport and wagon companies were inactivated due to army budget cuts. In 1931, all active Regular Army division quartermaster train headquarters were inactivated pending a major reorganization of the army's quartermaster units.

In the National Guard, as with the Regular Army, few of the division quartermaster trains were ever fully organized and three division trains never possessed any active train units at all. The few fully organized trains were in single state divisions.

Each of the Organized Reserve division trains were fully organized at some point, but like their Regular and Guard counterparts, many experienced the inactivation of subordinate units from time to time, though not as drastically as with the other two components.

Between 1931 and 1936, the Army went through a five-year development and reorganization process of its quartermaster organizations. In May and June of 1936, all quartermaster trains were reorganized into quartermaster regiments and battalions.

Training

Regular Army division trains participated in the training events of their respective division or active brigades. These events were primarily the division, brigade, or corps area maneuvers held on an almost annual basis. During the non-training periods of the training year, the motorized elements of these trains kept busy running drivers and mechanics schools and supporting garrison activities. A few ran maintenance shops and training courses for the corps area at large.

Units of the National Guard trains participated in the standard weekly or monthly drills at an armory. They also often supported non-training events such a movement of supplies or personnel for administrative purposes. Given their logistical and transportation capabilities, the elements of Guard quartermaster trains were often called up to support disaster relief operations, martial law, strike duties, and other state emergencies.

The personnel assigned to Organized Reserve quartermaster trains (and other quartermaster units as well) tended to be spread out over large areas and thus assembly for unit training meetings was problematic. The personnel for some units were concentrated largely in a single large city and thus were able to hold Inactive Training meetings at the unit level. Most Reserve personnel assigned to trains, however, attended group schools or unit schools/training unrelated to their specific unit. Frequently, larger cities with a high concentration of quartermaster officers would hold conferences and schools that presented logistics or quartermaster-specific content. Other quartermaster officers often attended meetings with other units or non-branch specific training events. Generally, Reserve quartermaster personnel attended summer training that was conducted as quartermaster group camps. The training at these camps was not tailored to a specific

kind of quartermaster unit. The training tended to be focused on a broad range of quartermaster functions and skills. The camps were often held at quartermaster installations such as the Holabird, Normoyle, and Jeffersonville Quartermaster Depots. Others were held at posts or camps that were selected for convenience of travel for the corps area Reserve quartermaster officers. The best training events for these officers were situations where they were attached to a Regular Army or National Guard quartermaster train at summer training or for a major maneuver. These events gave the Reservist the most realistic training experience.

First Army Quartermaster Train

Organized Reserve New York

HQ-Not initiated 1921-22; Brooklyn, NY, 1922-36



Constituted in the Organized Reserve 15 October 1921 as the First Army Train, Q.M.C., assigned to the First Army, and allotted to the Second Corps Area. Headquarters initiated 23 February 1922 at Brooklyn, NY. Redesignated 23 March 1925 as the First Army Quartermaster Train. Consolidated 1 March 1927 with the 417th Motor Supply Train (a WWI unit organized in July 1918 at Camp Stuart, VA; demobilized 23 September 1919 at Camp Dix, NJ; reconstituted 1 March 1927). Withdrawn from the Organized Reserve 18 October 1927 and allotted to the Regular Army. Conducted summer training at Fort Hancock, NJ, and some years at Camp Dix, NJ. Redesignated 1 October 1933 as the First Army Provisional Train. Designated mobilization training station was the New York State Fairgrounds, Syracuse, NY, 1921-33 and Camp Dix, NJ, 1933-36. Demobilized 1 July 1936.

Commanders, First Army Quartermaster Train

Col. Kingsley G. Martin 23 Feb 22-1 Apr 36

Second Army Quartermaster Train

**Illinois National Guard/
Organized Reserve Michigan**

HQ-Not organized 1921-24; Detroit, MI, 1924-27; Inactive 1927-30; Third Corps Area 1930-36

Constituted in the National Guard 15 October 1921 as the Second Army Train, Q.M.C., assigned to the Second Army, and allotted to the state of Illinois. Placed on the deferred list 2 July 1923 and allotted to the Organized Reserve as a DNG unit. Headquarters initiated by December 1924 at Detroit, MI. Redesignated 23 March 1925 as the Second Army Quartermaster Train. Withdrawn from the National Guard in September 1927 and allotted to the Regular Army. Concurrently withdrawn from the Sixth Corps Area, allotted to the Third Corps Area, and relieved from assignment to the Second Army. Organized 1 May 1930 with Organized Reserve personnel as a RAI unit with headquarters in the Third Corps Area at large. Designated mobilization training station was the Michigan State Fairgrounds, Detroit, MI, 1924-27. Demobilized 1 July 1936.

Commanders, Second Army Quartermaster Train

Unknown	ao Dec 24-Sep 27	Capt. John K. Rogers	1 May 30-11 May 31
Inactive	Sep 27-1 May 30	Unknown	11 May 31-1 Jul 36

Third Army Quartermaster Train

Organized Reserve Arkansas/Minnesota

HQ-Little Rock, AR, 1921-31; Minneapolis, MN, 1931-36

Constituted in the Organized Reserve 15 October 1921 as the Third Army Train, Q.M.C., assigned to the Third Army, and allotted to the Seventh Corps Area. Headquarters initiated in November 1921 at Little Rock, AR. Redesignated 23 March 1925 as the Third Army Quartermaster Train. Headquarters relocated 12 October 1931 to Minneapolis, MN. Demobilized 1 July 1936.

Commanders, Third Army Quartermaster Train

Unknown Nov 21-1 Jul 36

Fourth Army Quartermaster Train

Organized Reserve New York/New Jersey

HQ-Not initiated 1921-22; Brooklyn, NY, 1922-23; Jersey City, NJ, 1923-33

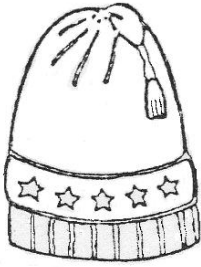

Constituted in the Organized Reserve 15 October 1921 as the Fourth Army Train, Q.M.C., assigned to the Fourth Army, and allotted to the Second Corps Area. Headquarters initiated in February 1922 at Brooklyn, NY. Headquarters relocated 5 April 1923 to Jersey City, NJ. Redesignated 23 March 1925 as the Fourth Army Quartermaster Train. Conducted summer training at Fort Hancock, NJ, and some years at Camp Dix, NJ. Designated mobilization training station was the New York State Fairgrounds, Syracuse, NY, 1921-33. Demobilized 1 July 1936.

Commanders, Fourth Army Quartermaster Train

Unknown	Feb 22-17 May 22	Lt. Col. Jeremiah O' Mahoney	Apr 23-ao May 23
Maj. Jeremiah O' Mahoney	17 May 22-18 May 22	Maj. Walter E. Grove	29 Dec 23-3 Feb 28
Lt. Col. Daniel L. Porter	18 May 22-Apr 23	Lt. Col. J. Raymond Keiper	11 May 28-ao Jul 30
	Col. Edward W. Fullam	ao May 31-1 May 36	

Fifth Army Quartermaster Train

Organized Reserve Michigan/ Iowa/Missouri

HQ-Detroit, MI, 1921-28; Des Moines, IA, 1928-31; Kansas City, MO, 1931-33

Constituted in the Organized Reserve 15 October 1921 as the Fifth Army Train, Q.M.C., assigned to the Fifth Army, and allotted to the Sixth Corps Area. Headquarters initiated 7 November 1921 at Detroit, MI. Redesignated 23 March 1925 as the Fifth Army Quartermaster Train. Inactivated 5 September 1928 at Detroit, MI, and withdrawn from the Sixth Corps Area. Concurrently, allotted to the Seventh Corps Area and reactivated at Des Moines, IA, with the personnel of the inactivated Sixth Army Quartermaster Train. Headquarters relocated 12 October 1931 to Kansas City, MO. Designated mobilization training station was the Michigan State Fairgrounds, Detroit, MI, 1921-28. Demobilized 1 October 1933.

Commanders, Fifth Army Quartermaster Train

Maj. Walter C. Cole	7 Nov 21-25 Jan 22	Lt. Col. Dexter M. Ferry, Jr.	25 Jan 22-5 Sep 28
	Unknown	5 Sep 28-1 Oct 33	

Sixth Army Quartermaster Train

Organized Reserve Iowa/Michigan

HQ-*Not initiated* 1921-22; Des Moines, IA, 1922-28; Detroit, MI, 1928-33

Constituted in the Organized Reserve 15 October 1921 as the Sixth Army Train, Q.M.C., assigned to the Sixth Army, and allotted to the Seventh Corps Area. Headquarters initiated in May 1922 at Des Moines, IA. Redesignated 23 March 1925 as the Sixth Army Quartermaster Train. Inactivated 5 September 1928 at Des Moines, IA, and withdrawn from the Seventh Corps Area. Concurrently, allotted to the Sixth Corps Area and reactivated at Detroit, MI, with the personnel of the inactivated Fifth Army Quartermaster Train. Designated mobilization training station was the Michigan State Fairgrounds, Detroit, MI, 1928-33. Demobilized 1 October 1933.

Commanders, Sixth Army Quartermaster Train

Unknown	May 22-5 Sep 29	Col. Walter C. Cole	1 Dec 29-ao Jul 30
Col. Dexter M. Ferry	5 Sep 28-1 Dec 29	Unknown	ao Jul 30-1 Oct 33

1st Corps Train Headquarters (I Corps)

Regular Army Inactive

HQ-*Not organized* 1928-36

Constituted in the Regular Army 5 September 1928, assigned to the I Corps, and allotted to the First Corps Area. Demobilized 1 May 1936.

2nd Corps Train Headquarters (II Corps)**Regular Army Inactive****HQ**-New York City, NY, 1928-36

Constituted in the Regular Army 5 September 1928, assigned to the II Corps, and allotted to the Second Corps Area. Organized 5 September 1928 with Organized Reserve personnel as a RAI unit with headquarters at New York City. Demobilized 1 May 1936.

Commanders, 2nd Corps Train Headquarters

Maj. William A. Darcy

5 Sep 28-ao Oct 29 Col. Edwin W. Fullam
 Lt. Col. Reginald K. Fessenden ao May 31-1 May 36

ao Apr 30-ao Aug 30

3rd Corps Train Headquarters (III Corps)**Regular Army Inactive****HQ**-*Not organized* 1928-30; Baltimore, MD, 1930-32; *Inactive* 1932-36

Constituted in the Regular Army 5 September 1928, assigned to the III Corps, and allotted to the Third Corps Area. Organized 25 February 1930 with Organized Reserve personnel as a RAI unit with headquarters at Baltimore, MD. Inactivated 17 December 1931 at Baltimore by relief of personnel. Demobilized 1 May 1936.

Commanders, 3rd Corps Train Headquarters

Maj. Thomas W. B. Shine

25 Feb 30-17 Dec 31

Inactive

17 Dec 31-1 May 36

15th Corps Train Headquarters (XV Corps)**Organized Reserve****HQ**-*Not initiated* 1928-36

Constituted in the Organized Reserve 5 September 1928, assigned to the XV Corps, and allotted to the Seventh Corps Area. Demobilized 1 May 1936.

I Corps Train, Q.M.C. (I Corps) (1921-23)**Organized Reserve Massachusetts****I Corps Quartermaster Train (I Corps) (1923-27)****4th Corps Train Headquarters (IV Corps) (1927-33)****21st Quartermaster Train (Army) (1933-36)****HQ**-*Not initiated* 1921-22; Boston, MA, 1922-27; *Inactive* 1927-36

Constituted in the Organized Reserve 29 July 1921 as the I Corps Train, Q.M.C., assigned to the I Corps, and allotted to the First Corps Area. Headquarters initiated 5 January 1922 at Boston, MA. Redesignated 23 March 1925 as the I Corps Quartermaster Train. Conducted summer training most years at the Holabird Quartermaster Depot, MD. Redesignated 13 October 1927 as the 4th Corps Train Headquarters. Withdrawn from the Organized Reserve 18 October 1927 and allotted to the Regular Army. Conducted summer training at Camp Devens, MA, Fort Hancock, NJ, or Camp Dix, NJ. Designated mobilization training station was Camp Devens, MA. Redesignated 27 January 1933 as the 21st Quartermaster Train (Army), relieved from the IV Corps, and assigned to the General Headquarters Reserve. Demobilized 1 May 1936.

Commanders, I Corps Quartermaster Train

Lt. Col. Roy D. Jones

5 Jan 22-12 Mar 23 Lt. Col. Howard Emerson
 Maj. Frank O. Robinson ao Apr 27-13 Oct 27

12 Mar 23-ao Jun 26

Commanders, 4th Corps Train Headquarters

Maj. Frank O. Robinson
 Lt. Col. Howard Emerson

13 Oct 27-ao May 28
 ao Jul 28-ao Jan 30

Unknown
 Maj. Albert E. Smith

ao Jan 30-ao Jun 31
 ao Jun 31-27 Jan 33

II Corps Train, Q.M.C. (II Corps) (1921-23)

New York National Guard/

II Corps Quartermaster Train (II Corps) (1923-27)

Organized Reserve New York

HQ-Not organized 1921-23; Brooklyn, NY, 1923-27

Constituted in the National Guard in 1921 as the II Corps Train, Q.M.C., assigned to the II Corps, and allotted to the state of New York. Placed on the deferred list 2 July 1923 and allotted to the Organized Reserve as a DNG unit. Headquarters initiated in December 1923 at Brooklyn, NY, with Organized Reserve personnel. Redesignated 23 March 1925 as the II Corps Quartermaster Train. Conducted summer training at Fort Hancock, NJ, and some years at Camp Dix, NJ. Withdrawn from the National Guard 17 September 1927.

Commanders, II Corps Quartermaster Train

Unknown

Dec 23-16 Apr 25

Maj. William A. Darcy

16 Apr 25-17 Sep 27

III Corps Train, Q.M.C. (III Corps) (1921-23)

Maryland National Guard/

III Corps Quartermaster Train (III Corps) (1923-27)

Organized Reserve Maryland

HQ-Not organized 1921-24; Baltimore, MD, 1924-27

Constituted in the National Guard in 1921 as the III Corps Train, Q.M.C., assigned to the III Corps, and allotted to the state of Maryland. Placed on the deferred list 2 July 1923 and allotted to the Organized Reserve as a DNG unit. Headquarters initiated by December 1924 at Baltimore, MD. Redesignated 23 March 1925 as the III Corps Quartermaster Train. Designated mobilization training station was the Southwest Baltimore Concentration Area. Withdrawn from the National Guard 17 September 1927.

Commanders, III Corps Quartermaster Train

Unknown

ao Dec 24-17 Sep 27

IV Corps Train, Q.M.C. (II Corps) (1921-23)

South Carolina National Guard/

IV Corps Quartermaster Train (IV Corps) (1923-27)

Organized Reserve Georgia

HQ-Not organized 1921-24; Atlanta, GA, 1924-27

Constituted in the National Guard 29 July 1921 as the IV Corps Train, Q.M.C., assigned to the IV Corps, and allotted to the state of South Carolina. Columbia, SC, designated as headquarters location upon organization, but the unit was never organized at that location. Placed on the deferred list 2 July 1923 and allotted to the Organized Reserve as a DNG unit. Headquarters initiated by December 1924 at Atlanta, GA. Redesignated 23 March 1925 as the IV Corps Quartermaster Train. Designated mobilization training station was Camp McClellan, AL. Withdrawn from the National Guard in 17 September 1927.

Commanders, IV Corps Quartermaster Train

Unknown

ao Dec 24-17 Sep 27

V Corps Train, Q.M.C. (V Corps) (1921-23)

Organized Reserve Ohio

V Corps Quartermaster Train (V Corps) (1923-27)

5th Corps Train Headquarters (V Corps) (1927-36)

HQ-Not initiated 1921-22; Cincinnati, OH, 1922-31; Columbus, OH, 1931-36

Constituted in the Organized Reserve 29 July 1921 as the VIII Corps Train, Q.M.C., assigned to the VIII Corps, and allotted to the Eighth Corps Area. Headquarters initiated 12 August 1922 at Oklahoma City, OK. Redesignated 23 March 1925 as the VIII Corps Quartermaster Train. Headquarters relocated 15 April 1925 to San Antonio, TX. Redesignated 5 September 1928 as the 16th Corps Train Headquarters, relieved from the VIII Corps, and assigned to the XVI Corps. Inactivated 28 August 1929 at San Antonio by relief of personnel. Conducted summer training most years at Fort Sam Houston, TX, and some years at Fort Sill, OK. Designated mobilization training station was Fort Clark, TX, 1928-36. Demobilized 1 May 1936.

Commanders, VIII Corps Quartermaster Train

Maj. Harry P. Cooper	12 Aug 22-15 May 25	Lt. Col. Randolph Smith	15 May 25-12 Jun 28
Lt. Col. George T. Leake	15 Jun 23-15 May 25	Maj. Perry A. Mead	13 Jun 28-5 Sep 28

Commanders, 16th Corps Train Headquarters

Maj. Perry A. Mead	5 Sep 28-28 Aug 29	<i>Inactive</i>	28 Aug 29-1 May 36
--------------------	--------------------	-----------------	--------------------

IX Corps Train, Q.M.C. (IX Corps) (1921-23)

Organized Reserve California/Washington

IX Corps Quartermaster Train (IX Corps) (1923-28)

13th Corps Train Headquarters (XIII Corps) (1928-36)

HQ-*Not initiated* 1921-22; San Francisco, CA, 1922-25; Seattle, WA, 1925-31; *Inactive* 1931-36

Constituted in the Organized Reserve 29 July 1921 as the IX Corps Train, Q.M.C., assigned to the IX Corps, and allotted to the Ninth Corps Area. Headquarters initiated 28 January 1922 at San Francisco, CA. Redesignated 23 March 1925 as the IX Corps Quartermaster Train. Redesignated 5 September 1928 as the 13th Corps Train Headquarters, relieved from the IX Corps, and assigned to the XIII Corps. Inactivated by June 1931 at Seattle by relief of personnel. Conducted summer training at Del Monte, CA, Presidio of Monterey, CA, or the Presidio of San Francisco, CA. Demobilized 1 May 1936.

Commanders, IX Corps Quartermaster Train

Maj. Samuel W. Shaffer	28 Jan 22-1 Feb 23	Maj. Don V. Walker	1 Feb 23-Dec 23
	Lt. Col. Chester P. Mader	Dec 23-5 Sep 28	

Commanders, 13th Corps Train Headquarters

Lt. Col. Chester P. Mader	5 Sep 28-ao Jun 29	Unknown	ao Jun 29-ao Jun 31
	<i>Inactive</i>	ao Jun 31-1 May 36	

XI Corps Train, Q.M.C. (XI Corps) (1921-23)

Organized Reserve Massachusetts

XI Corps Quartermaster Train (XI Corps) (1923-28)

14th Corps Train Headquarters (XIV Corps) (1928-36)

HQ-Worcester, MA, 1921-28; Springfield, MA, 1927-33; Boston, MA, 1933-36

Constituted in the Organized Reserve 29 July 1921 as the XI Corps Train, Q.M.C., assigned to the XI Corps, and allotted to the First Corps Area. Headquarters initiated 3 November 1921 at Worcester, MA. Redesignated 23 March 1925 as the XI Corps Quartermaster Train. Redesignated 5 September 1928 as the 14th Corps Train Headquarters, relieved from the XI Corps, and assigned to the XIV Corps. Headquarters concurrently relocated to Springfield, MA. Headquarters relocated in 1933 to Boston, MA. Conducted summer training most years at the Holabird Quartermaster Depot, MD. Demobilized 1 May 1936.

Commanders, XI Corps Quartermaster Train

Lt. Col. William L. Conrad	3 Nov 21-12 Mar 22	Lt. Col. William D. Bigelow	Aug 23-ao Jul 27
Col. Roy D. Jones	12 Mar 22-Aug 23	Unknown	ao Jul 27-5 Sep 28

Commanders, 14th Corps Train Headquarters

Maj. Hathaway J. Denman	21 Sep 29-ao Jan 30	Unknown	ao Jan 30-1 May 36
-------------------------	---------------------	---------	--------------------

XII Corps Train, Q.M.C. (XII Corps) (1921-23)**Organized Reserve New York****XII Corps Quartermaster Train (XII Corps) (1923-28)****6th Corps Train Headquarters (VI Corps) (1928-36)****HQ**-Yonkers, NY, 1921-33; Fort Jay, NY, 1933-36

Constituted in the Organized Reserve 29 July 1921 as the XII Corps Train, Q.M.C., assigned to the XII Corps, and allotted to the Second Corps Area. Headquarters initiated 17 October 1921 at New York City, NY. Redesignated 23 March 1925 as the XII Corps Quartermaster Train. Redesignated 5 September 1928 as the VI Corps Quartermaster Train, relieved from the XII Corps, and assigned to the VI Corps. Headquarters relocated in 1933 to Fort Jay, NY. Conducted summer training at Fort Hancock, NJ, and some years at Camp Dix, NJ. Designated mobilization training station was Camp Dix, NJ. Demobilized 1 May 1936.

Commanders, XII Corps Quartermaster Train

Lt. Col. F. J. Burnham	17 Oct 21-21 Jan 22	Maj. Ernest B. Goggin	17 Dec 24-ao Jul 26
Lt. Col. Howard W. Nichols	21 Jan 22-17 Dec 24	Unknown	ao Jul 26-ao Nov 27
	Lt. Col. Charles W. Yeomans	ao Nov 27-5 Sep 28	

Commanders, 6th Corps Train Headquarters

Lt. Col. Charles W. Yeomans	5 Sep 28-21 Nov 30	Lt. Col. Warren B. Bullock	18 Apr 32-7 Dec 33
Lt. Col. Robert M. Falkenau	21 Nov 30-18 Apr 32	Lt. Col. Walter V. Shipley	7 Dec 33-16 Dec 33
	Lt. Col. Taylor Belcher	16 Dec 33-1 May 36	

XIII Corps Train, Q.M.C. (XIII Corps) (1921-23)**Organized Reserve Pennsylvania/Maryland****XIII Corps Quartermaster Train (XIII Corps) (1923-28)****7th Corps Train Headquarters (VII Corps) (1928-36)****HQ**-Pittsburgh, PA, 1921-27 *Inactive* 1927-30; Pittsburgh, PA, 1930-33; Baltimore, MD, 1933-36

Constituted in the Organized Reserve 29 July 1921 as the XIII Corps Train, Q.M.C., assigned to the XIII Corps, and allotted to the Third Corps Area. Headquarters initiated in November 1921 at Pittsburgh, PA. Redesignated 23 March 1925 as the XIII Corps Quartermaster Train. Inactivated 26 September 1927 at Pittsburgh by relief of personnel. Redesignated 5 September 1928 as the 7th Corps Train Headquarters, relieved from the XIII Corps, and assigned to the VII Corps. Reorganized 17 January 1930 at Pittsburgh. Headquarters relocated by 1933 to Baltimore, MD. Demobilized 1 May 1936.

Commanders, XIII Corps Quartermaster Train

Maj. Frank S. Long	4 Feb 22-20 Sep 22	Lt. Col. Albert H. Kratzke	20 Sep 22-26 Sep 27
	<i>Inactive</i>	26 Sep 27-5 Sep 28	

Commanders, 7th Corps Train Headquarters

<i>Inactive</i>	5 Sep 28-17 Jan 30	Unknown	11 May 31-14 Mar 33
Maj. Allen R. Wrenn	17 Jan 30-10 Dec 30	Lt. Col. Percival B. Kauffman	14 Mar 33-15 Sep 34
Maj. Elmer M. Jones	10 Dec 30-11 May 31	Maj. Theodore J. Gould	18 Oct 34-7 Mar 35
	Capt. Adam A. Kleiber	7 Mar 35-1 May 36	

XIV Corps Train, Q.M.C. (XIV Corps) (1921-23)**Organized Reserve Alabama/Florida****XIV Corps Quartermaster Train (XIV Corps) (1923-28)****8th Corps Train Headquarters (VIII Corps) (1928-36)****HQ**-*Not initiated* 1921-22; Birmingham, AL, 1922-27; Jacksonville, FL, 1927-36

Constituted in the Organized Reserve 29 July 1921 as the XIV Corps Train, Q.M.C., assigned to the XIV Corps, and allotted to the Fourth Corps Area. Headquarters initiated in February 1922 at Birmingham, AL. Redesignated 23 March 1925 as the XIV Corps Quartermaster Train. Headquarters relocated 2 June 1927 to Jacksonville, FL. Redesignated 5 September 1928 as the 8th Corps Train Headquarters, relieved from the XIV Corps, and assigned to the VIII Corps. Designated mobilization training station was Camp McClellan, AL, 1922-36. Demobilized 1 May 1936.

Commanders, XIV Corps Quartermaster Train

Lt. Col. Robert B. Sturkie 28 Jun 22-5 Sep 28

Commanders, 8th Corps Train Headquarters

Lt. Col. Robert B. Sturkie	5 Sep 28-4 Oct 29	Lt. Col. Robert L. Seitner	5 Oct 29-21 Dec 29
	Unknown	21 Dec 29-1 May 36	

XV Corps Train, Q.M.C. (XV Corps) (1921-23)

Organized Reserve Ohio

XV Corps Quartermaster Train (XV Corps) (1923-28)

11th Corps Train Headquarters (XI Corps) (1928-36)

HQ-Not initiated 1921-22; Cleveland, OH, 1922-30; *Inactivated* 1930-36

Constituted in the Organized Reserve 29 July 1921 as the XV Corps Train, Q.M.C., assigned to the XV Corps, and allotted to the Fifth Corps Area. Headquarters initiated by December 1922 at Cleveland, OH. Redesignated 23 March 1925 as the XV Corps Quartermaster Train. Redesignated 5 September 1928 as the 11th Corps Train Headquarters, relieved from the XV Corps, and assigned to the XI Corps. Inactivated June 1930 at Cleveland, OH. Conducted summer training at Camp Knox, KY. Designated mobilization training station was Camp Grant, IL, 1922-30, and Camp Knox, KY, 1930-36. Demobilized 1 May 1936.

Commanders, XV Corps Quartermaster Train

Unknown	ao Dec 22-ao Nov 27	Lt. Col. Daniel H. Pond	ao Nov 27-5 Sep 28
---------	---------------------	-------------------------	--------------------

Commanders, 11th Corps Train Headquarters

Lt. Col. Daniel H. Pond	5 Sep 28-Jun 30	<i>Inactive</i>	Jun 30-1 May 36
-------------------------	-----------------	-----------------	-----------------

XVI Corps Train, Q.M.C. (XVI Corps) (1921-23)

Organized Reserve Wisconsin

XVI Corps Quartermaster Train (XVI Corps) (1923-28)

9th Corps Train Headquarters (IX Corps) (1928-36)

HQ-Not initiated 1921-22; Milwaukee, WI, 1922-36

Constituted in the Organized Reserve 29 July 1921 as the XVI Corps Train, Q.M.C., assigned to the XVI Corps, and allotted to the Sixth Corps Area. Headquarters initiated 6 July 1922 at Milwaukee, WI. Redesignated 23 March 1925 as the XVI Corps Quartermaster Train. Redesignated 5 September 1928 as the 9th Corps Train Headquarters, relieved from the XVI Corps, and assigned to the IX Corps. Conducted summer training most years at Fort Sheridan, IL. Designated mobilization training station was Camp Grant, IL, 1921-28 and the Illinois State Fairgrounds, Springfield, IL, 1928-36. Demobilized 1 May 1936.

Commanders, XVI Corps Quartermaster Train

Lt. Col. Alva E. Garey	6 Jul 22-19 Apr 24	Lt. Col. James T. French	17 Feb 26-13 Oct 26
Maj. Martin D. Imhoff	19 Apr 24-ao Jul 24	Maj. Myron D. Savage	13 Oct 26-11 Apr 28
Maj. Louis H. Rathke	ao Apr 25-17 Feb 26	Maj. Alexander L. Moll	11 Apr 28-23 Oct 28

Commanders, 9th Corps Train Headquarters

Maj. Alexander L. Moll	5 Sep 28-23 Oct 28	Maj. Charles W. Gentry	3 Jun 29-ao Jul 29
Lt. Col. John T. B. Jones	23 Oct 28-17 May 29	Unknown	ao Jul 29-1 May 36

XVII Corps Train, Q.M.C. (XVII Corps) (1921-23) Organized Reserve Missouri/ Massachusetts/Minnesota

XVII Corps Quartermaster Train (XVII Corps) (1923-28)

17th Corps Train Headquarters (XVII Corps) (1928-36)

HQ-Not initiated 1921-22; Kansas City, MO, 1922-28; *Inactive* 1928-29; Boston, MA, 1929-33; Duluth, MN, 1933-36

Constituted in the Organized Reserve 29 July 1921 as the XVII Corps Train, Q.M.C., assigned to the XVII Corps, and allotted to the Seventh Corps Area. Headquarters initiated 5 May 1922 at Kansas City, MO. Redesignated 23 March 1925 as the XVII Corps Quartermaster Train. Redesignated 5 September 1928 as the 17th Corps Train Headquarters, withdrawn from the Seventh Corps Area, and allotted to the First Corps Area. Headquarters reorganized 8 April 1929 at Boston, MA. Designated mobilization station was Camp Devens, MA. Withdrawn from the First Corps Area 1 October 1933 and allotted to the Seventh Corps Area. Duluth, MN, designated as headquarters upon reorganization, but the unit was never organized at that location. Conducted summer training at Fort Snelling, MN, or Fort Crook, NE. Demobilized 1 May 1936.

Commanders, XVII Corps Quartermaster Train

Maj. Rex W. Dunlap	5 May 22-18 May 22	Lt. Col. Carl R. Gray	13 Sep 22-ao Oct 22
Maj. Charles T. Hall	19 May 22-12 Sep 22	Unknown	ao Oct 22-ao Sep 25
	Lt. Col. Mert E. Rawdon	ao Sep 25-5 Sep 28	

Commanders, 17th Corps Train Headquarters

Unknown	8 Apr 29-1 Oct 33	<i>Inactive</i>	1 Oct 33-1 May 36
---------	-------------------	-----------------	-------------------

XVIII Corps Train, Q.M.C. (XVIII Corps) (1921-23)

Organized Reserve Oklahoma

XVIII Corps Quartermaster Train (XVIII Corps) (1923-28)

18th Corps Train Headquarters (XVIII Corps) (1928-36)

HQ-Not initiated 1921-22; Oklahoma City, OK, 1922-36

Constituted in the Organized Reserve 29 July 1921 as the XVIII Corps Train, Q.M.C., assigned to the XVIII Corps, and allotted to the Eighth Corps Area. Headquarters initiated by February 1922 at Oklahoma City, OK. Redesignated 23 March 1925 as the XVIII Corps Quartermaster Train. Redesignated 5 September 1928 as the 18th Corps Train Headquarters. Conducted summer training most years at Fort Sam Houston, TX, and some years at Fort Sill, OK. Designated mobilization training station was Fort Clark, TX, 1928-36. Demobilized 1 May 1936.

Commanders, XVIII Corps Quartermaster Train

Maj. James W. Barber	ao Feb 22-3 Oct 22	Unknown	13 Aug 26-ao Aug 28
Lt. Col. Franklin Carter	4 Oct 22-13 Aug 26	Lt. Col. Clarence H. Fitzgerald	ao Aug 28-5 Sep 28

Commanders, 18th Corps Train Headquarters

Lt. Col. Clarence H. Fitzgerald	5 Sep 28-9 Apr 29	Lt. Col. James T. Stockton	9 Apr 29-28 Aug 29
	Unknown	28 Aug 29-1 May 36	

XIX Corps Quartermaster Train (XIX Corps) (1923-28)

Organized Reserve California

XIX Corps Quartermaster Train (XIX Corps) (1923-28)

19th Corps Train Headquarters (XIX Corps) (1928-36)

HQ-Not initiated 1921-22; San Francisco, CA, 1922-29; *Inactive* 1929-36

Constituted in the Organized Reserve 29 July 1921 as the XIX Corps Train, Q.M.C., assigned to the XIX Corps, and allotted to the Ninth Corps Area. Headquarters initiated 28 January 1922 at San Francisco, CA. Redesignated 23 March 1925 as the XIX Corps Quartermaster Train. Redesignated 5 September 1928 as the 19th Corps Train Headquarters. Inactivated 20 October 1929 at San Francisco by relief of personnel. Conducted summer training at the Presidio of Monterey, CA, or Fort Lewis, WA. Demobilized 1 May 1936.

Commanders, XIX Corps Quartermaster Train

Maj. William Bramstedt	28 Jan 22-Jan 23	Lt. Col. Oliver C. Wyman	28 Sep 25-ao Jan 26
Maj. Don V. Walker	Jan 23-1 Feb 23	Unknown	ao Jan 26-ao Jun 27
Maj. Homer C. Ransom	1 Feb 23-28 Sep 25	Maj. William N. Copeland	ao Jun 27-5 Sep 28

Commanders, 19th Corps Train Headquarters

Maj. William N. Copeland	5 Sep 28-20 Oct 29	<i>Inactive</i>	20 Oct 29-1 May 36
--------------------------	--------------------	-----------------	--------------------

1st Division Quartermaster Train

HQ-Camp Dix, NJ, 1921-22; Fort Wadsworth, NY, 1922-23; Fort Jay, NY, 1923-28; Fort Hamilton, NY, 1928-31; *Inactive* 1931-36

Subordinate units: 1st and 2nd Motor Transport Companies 1921-36; 3rd and 4th Motor Transport Companies (RAI) 1924-36; 1st Motor Repair Section 1921-36; *2nd Motor Repair Section* 1924-36; 1st and 2nd Wagon Companies 1921-36; 1st Motorcycle Company 1921-36

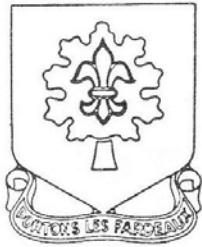

Constituted in the Regular Army 17 March 1921 as the 1st Division Train, Q.M.C. and assigned to the 1st Division. Headquarters organized 23 March 1921 at Camp Dix, NJ, with personnel and equipment from Headquarters, 1st Supply Train and Motor Command No. 1. The remainder of the train organized from elements of the 1st Supply Train. Transferred 30 September 1922 to Fort Wadsworth, NY. Transferred 13 November 1923 to Fort Jay, NY. Redesignated 23 March 1925 as Headquarters, 1st Division Quartermaster Train. Consolidated 29 January 1926 with the 1st Supply Train (a WWI unit organized 17 February 1918 at Nevil-la-Tour, France; demobilized 23 March 1921 at Camp Dix, NJ; reconstituted 29 January 1926). Transferred 6 March 1928 to Fort Hamilton, NY. Inactivated 15 June 1931 at Fort Hamilton, NY. Headquarters redesignated

as Headquarters, 1st Battalion, 1st Quartermaster Regiment 1 May 1936. Subordinate units concurrently redesignated as elements of the 1st Quartermaster Regiment. Headquarters, 1st Battalion, 1st Quartermaster Regiment disbanded 16 October 1939.

Organization Day: 16 June. Chosen to commemorate the anniversary of the Quartermaster Corps 16 June 1776.

Status: Active at Fort Riley, KS, as the 101st Support Battalion, an element of the 1st Infantry Division (Mechanized).

Events: 60, 63, 72, 89, 106, 153, 190, 203, 219

Commanders, 1st Division Quartermaster Train

Maj. Kenneth E. Kern	29 Mar 21-18 Aug 21	Lt. Col. Daniel D. Tompkins	6 Feb 29-8 May 29
Capt. Daniel J. Canty	18 Aug 21-27 Sep 21	Capt. William M. Wiener	8 May 29-3 Jun 29
Maj. Charles W. McClure	27 Sep 21-9 May 24	Maj. William H. Shutan	3 Jan 29-27 Jan 30
1st Lt. John P. Neu	9 May 24-11 Sep 24	Capt. Peter F. Meade	27 Jan 30-1 Jul 30
Lt. Col. John McH. Eby	11 Sep 24-31 Mar 26	Maj. George M. Herringshaw	1 Jul 30-4 Mar 31
Col. Alexis E. Jeutnet	31 Mar 26-6 Feb 29	Capt. Peter F. Meade	4 Mar 31-30 Apr 31
	Capt. William C. Thee	30 Apr 31-15 Jun 31	

1st Cavalry Division Quartermaster Train

HQ-Fort Bliss, TX, 1921-36

Subordinate units: 25th Wagon Company 1921-30; 26th Wagon Company 1921-36; 1st, 2nd, 3rd, and 4th Pack Trains 1921-36; 49th and 250th Motor Transport Companies 1930-36; 81st Motor Repair Section 1930-36



Constituted in the Regular Army 20 August 1921 as the 1st Cavalry Division Train, Q.M.C. and assigned to the 1st Cavalry Division. Headquarters organized 20 September 1921 at Fort Bliss, TX. Redesignated 23 March 1925 as the 1st Cavalry Division Quartermaster Train. Consolidated with the Quartermaster Section, 1st Cavalry Division Headquarters Detachment 1 April 1936, and reorganized and redesignated Headquarters and Headquarters Troop, 16th Quartermaster Squadron. Train subordinate elements redesignated as troops of the 16th Quartermaster Squadron.

Organization Day: 20 September. Chosen to commemorate the anniversary of the unit's original organization on 20 September 1921.

Status: Active as the 15th Support Battalion, a component of the 1st Cavalry Division at Fort Hood, Texas.

Events: 30, 65, 83, 97, 127, 146, 206,

Commanders, 1st Cavalry Division Quartermaster Train

Lt. Col. Milton G. Holliday	15 Sep 21-10 Sep 25	Maj. John A. Robenson	9 Feb 31-8 Aug 31
Maj. James R. Alfonte	10 Sep 25-10 Aug 26	Maj. Cuyler L. Clark	8 Aug 31-10 Jul 33
Maj. John M. True	10 Aug 26-22 Aug 28	Maj. Hans R. W. Herwig	11 Jul 33-5 Oct 33
Maj. James R. Hill	22 Aug 28-7 Aug 29	Maj. Horace T. Applington	5 Oct 33-7 May 35
Maj. William H. Kasten	7 Aug 29-19 Jan 31	Maj. Thomas G. Hanson, Jr.	7 May 35-1 Feb 36
Capt. George R. Ford	19 Jan 31-9 Feb 31	Lt. Col. Russell A. Osmun	1 Feb 36-1 Apr 36

2nd Division Quartermaster Train

HQ-Camp Travis, TX, 1921-22; Fort Sam Houston, TX, 1922-31; *Inactive* 1931-36

Subordinate units: 5th and 6th Motor Transport Companies; 7th and 8th Motor Transport Companies (RAI) 1921-36; 3rd and 4th Motor Repair Sections 1921-36; 3rd and 4th Wagon Companies 1921-36; 2nd Motorcycle Company 1921-36



Arrived at the Port of New York on the S.S. *Leviathan* 6 August 1919 as the 2nd Supply Train, an element of the 2nd Division. Transferred that day to Camp Merritt, NJ. Transferred 11 August 1919 to Camp Travis, TX. Headquarters reorganized and redesignated 18 February 1921 as the 2nd Division Train, Q.M.C. by consolidation of the Headquarters, 2nd Supply Train and Motor Command No. 3. The remainder of the train organized from elements of the 2nd Supply Train. Transferred in 1922 to Fort Sam Houston proper. Redesignated 23 March 1925 as Headquarters, 2nd Division Quartermaster Train. Inactivated 30 June 1931 at Fort Sam Houston, TX. Headquarters redesignated as Headquarters, 1st Battalion, 2nd Quartermaster Regiment 1 May 1936, and subordinate units redesignated as elements of the 2nd Quartermaster Regiment. Headquarters, 1st Battalion, 2nd Quartermaster Regiment disbanded 7 October 1939.

Organization Day: 1 October. Chosen to commemorate train's date of organization as the 2nd Supply Train at Chickamauga Battlefield Park, 1 October 1917. Adopted 21 July 1920.

Status: Active at Camp Hovey, Korea as the 2nd Support Battalion, an element of the 2nd Infantry Division.

Events: 45, 47, 55, 70, 74, 105, 125, 147, 163, 203

Commanders, 2nd Division Quartermaster Train

Lt. Col. Frank H. Adams	18 Feb 21-Sep 21	Capt. Charles A. McGarrigle	14 Jun 26-1 Jun 27
Maj. James R. Alfonte	Sep 21-8 Aug 23	Maj. Russell A. Osmun	1 Jun 27-28 Jul 28
Capt. Percival S. Holmes	8 Aug 23-25 Oct 23	Capt. Shelby C. Newman	28 Jul 28-8 Nov 28
Lt. Col. William K. Morre	25 Oct 23-21 Feb 24	Maj. George H. Huddleson	8 Nov 26-6 Feb 30
Maj. Henry D. F. Munnikhuysen	21 Feb 24-8 Sep 25	Capt. Shelby C. Newman	6 Feb 30-16 Sep 30
Capt. Frank Barr	8 Sep 25-Oct 25	Lt. Col. Joseph F. Taulbee	16 Sep 30-10 Feb 31
Maj. Russell A. Osmun	Oct 25-14 Jun 26	Capt. Oscar G. Fegan	10 Feb 31-1 Jun 31

2nd Cavalry Division Quartermaster Train

Regular Army Inactive

HQ-*Not organized* 1923-27; Seventh Corps Area at large 1927-36

Subordinate units: 27th and 28th Wagon Companies 1921-30; 25th Wagon Company 1930-36; 5th, 6th, 7th, and 8th Pack Trains 1921-36; 251st and 252nd Motor Transport Companies 1930-36; 97th Motor Repair Section 1930-36

Constituted in the Regular Army 24 March 1923 as the 2nd Cavalry Division Train, Q.M.C., assigned to the 2nd Cavalry Division, and allotted to the Seventh Corps Area. Redesignated 23 March 1925 as the 2nd Cavalry Division Quartermaster Train. Allotted to the Seventh Corps Area as a RAI unit 28 February 1927. Headquarters organized by December 1927 with Organized Reserve personnel as a RAI unit in the Seventh Corps Area at large. Under special orders from the War Department, the train was to be organized upon mobilization with personnel and equipment from the post quartermaster detachment at Fort Riley. Conducted summer training at Fort Bliss, TX, with the 1st Cavalry Division Quartermaster Train. Designated mobilization training station was Fort Riley, KS. Reorganized and redesignated 1 April 1936 as Headquarters Platoon, Headquarters Troop, 17th Quartermaster Squadron. Train subordinate elements redesignated as troops of the 17th Quartermaster Squadron.

Commanders, 2nd Cavalry Division Quartermaster Train

Unknown ao Dec 27-1 Apr 36

3rd Division Quartermaster Train

HQ-Camp Lewis, WA, 1921-23; Presidio of San Francisco, CA, 1923; Camp Lewis, WA, 1923-31; *Inactive* 1931-36

Subordinate units: 9th, 10th, *11th*, and *12th* Motor Transport Companies 1921-36; 5th and *6th* Motor Repair Sections 1921-36; 5th and 6th Wagon Companies 1921-36; 3rd Motorcycle Company 1921-36



Constituted in the Regular Army 17 March 1921 as the 3rd Division Train, Q.M.C. and assigned to the 3rd Division. Headquarters organized 26 March 1921 at Camp Pike, AR, with personnel and equipment from Headquarters, 3rd Supply Train and Motor Command No. 5. The remainder of the train was organized from elements of the 3rd Supply Train. Transferred 15 September 1921 to Camp Lewis, WA. Personnel at Camp Lewis relieved 1 January 1923 and entire train (records and colors only) concurrently transferred to the Presidio of San Francisco, CA. Records arrived at the Presidio of San Francisco 22 January 1923 and new personnel assigned to bring the train up to peace strength at the Presidio on that date. Transferred 1 November 1923, less personnel (records, colors, and one first sergeant only) to Camp Lewis, WA. Records arrived at

Fort Lewis 8 November 1923 and new personnel assigned on that date. Redesignated 23 March 1925 as Headquarters, 3rd Division Quartermaster Train. Consolidated 29 January 1926 with the 3rd Supply Train (a WWI unit organized 26 December 1917 at Fort Sam Houston, TX; demobilized 15 September 1921 at Camp Lewis, WA; reconstituted 29 January 1926). Inactivated 20 May 1931 at Fort Lewis, WA. Headquarters redesignated as Headquarters, 1st Battalion, 3rd Quartermaster Regiment 1 May 1936, and subordinate units redesignated as elements of the 3rd Quartermaster Regiment. Headquarters, 1st Battalion, 3rd Quartermaster Regiment disbanded 12 October 1939.

Organization Day: 15 July. Chosen to commemorate the 3rd Supply Train's participation in the battle of Chateau Thierry 15 July 1918. Adopted 5 February 1925.

Status: Active at Fort Stewart, GA, as the 3rd Support Battalion, an element of the 3rd Infantry Division (Mechanized).

Events: 57, 112, 114, 135, 145, 161

Commanders, 3rd Division Quartermaster Train

Capt. John H. Gage	26 Mar 21-15 Oct 21	Maj. Samuel R. Dishman	1 Nov 23-15 Jul 24
Capt. Ernest Kuehn	15 Oct 21-31 Dec 22	Maj. Rigby D. Valliant	15 Jul 24-28 Jun 28
Maj. John M. True	1 Jan 23-8 Oct 23	Capt. Edward J. L. Russell	28 Jun 28-1 Jan 29
Capt. Fred T. Neville	8 Oct 23-1 Nov 23	Capt. Edward Eccles	1 Jan 29-4 Apr 29
	Capt. Shirley W. McIlwain	4 Apr 29-20 May 31	

3rd Cavalry Division Quartermaster Train

Regular Army Inactive

HQ-*Not organized* 1923-32; Seventh Corps Area 1932-36

Subordinate units: 19th and 20th Wagon Companies (RAI) 1927-30; 27th Wagon Company (RAI) 1930-36; 9th, 10th, 11th, and 12th Pack Trains (RAI) 1927-36; *253rd* and *254th* Motor Transport Companies 1930-36; *98th* Motor Repair Section 1930-36

Constituted in the Regular Army 15 August 1927 as the 3rd Cavalry Division Quartermaster Train, assigned to the 3rd Cavalry Division, and allotted to the Seventh Corps Area. Designated mobilization training station was Fort Leavenworth, KS. Under special orders from the War Department, the train was to be organized upon mobilization with personnel and equipment from the post service detachment (Colored) at Fort Leavenworth. Headquarters organized by September 1932 with Organized Reserve personnel as a RAI unit in the Seventh Corps Area. Reorganized and redesignated 1 April 1936 as Headquarters Platoon, Headquarters Troop, 18th Quartermaster Squadron. Train subordinate elements redesignated as troops of the 18th Quartermaster Squadron.

Commanders, 3rd Cavalry Division Quartermaster Train

Unknown ao Sep 32-1 Apr 36

4th Division Quartermaster Train

Regular Army Inactive

HQ-Camp Lewis, WA, 1921; *Inactive* 1921-26; New Orleans, LA, 1926-36

Subordinate units: *13th and 14th Motor Transport Companies* 1921-36; *15th and 16th Motor Transport Companies* 1921-27; *29th and 100th Motor Transport Companies* 1927-33; *7th Motor Repair Section* 1921-36; *8th Motor Repair Section* 1921-36; *7th Wagon Company* 1921-36; *8th Wagon Company (RAI)* 1921-36; *4th Motorcycle Company (RAI)* 1921-36

Constituted in the Regular Army 17 March 1921 as the 4th Division Train, Q.M.C. and assigned to the 4th Division. Headquarters organized 15 April 1921 at Camp Lewis, WA, with personnel and equipment from Headquarters, 4th Supply Train and Motor Command No. 7. The remainder of the train organized from elements of the 4th Supply Train. Inactivated 22 September 1921 at Camp Lewis. Designated Active Associate was the Quartermaster General 1921-27. Designated mobilization training station was Camp McClellan, AL, 1921-27. Redesignated 23 March 1925 as Headquarters, 4th Division Quartermaster Train. Consolidated 29 January 1926 with the 4th Supply Train (a WWI unit organized in December 1917 at Camp Greene, NC; demobilized 15 April 1921 at Camp Lewis; reconstituted 29 January 1926). Headquarters organized 17 August 1926 with Organized Reserve personnel as a RAI unit at New Orleans, LA. Headquarters redesignated as Headquarters, 1st Battalion, 4th Quartermaster Regiment 1 May 1936, and subordinate units redesignated as elements of the 4th Quartermaster Regiment. Headquarters, 1st Battalion, 4th Quartermaster Regiment disbanded 16 October 1939.

Status: Active at Fort Hood, TX, as the 4th Support Battalion, an element of the 4th Infantry Division (Mechanized).

Commanders, 4th Division Quartermaster Train

Capt. John N. Douglas	15 Apr 21-22 Sep 21	Maj. Frederic W. Whitney*	17 Jun 27-15 Dec 27
<i>Inactive</i>	22 Sep 21-16 Aug 26	Unknown	17 Dec 27-2 Nov 35
1st Lt. LeClerc H. Hicks**	17 Aug 26-17 Jun 27	Capt. Hall S. Crane, Jr.**	2 Nov 35-1 Apr 36

** RAI Commanders: Organized Reserve officers.

5th Division Quartermaster Train

Regular Army Inactive

HQ-Camp Jackson, SC, 1921; *Inactive* 1921-26; Columbus, OH, 1926-36

Subordinate units: *17th and 18th Motor Transport Companies* 1921-36; *19th and 20th Motor Transport Companies* 1921-27; *69th and 72nd Motor Transport Companies* 1927-33; *9th Motor Repair Section* 1921-36; *10th Motor Repair Section* 1921-27; *15th Motor Repair Section* 1927-36; *9th and 10th Wagon Companies (RAI)* 1921-36; *5th Motorcycle Company (RAI)* 1921-36



Constituted in the Regular Army 17 March 1921 as the 5th Division Train, Q.M.C. and assigned to the 5th Division. Headquarters concurrently organized at Camp Jackson, SC, with personnel and equipment from Headquarters, 5th Supply Train and Motor Command No. 9. The remainder of the train organized from elements of the 5th Supply Train. Inactivated 25 September 1921 at Camp Jackson. Designated Active Associate was the Quartermaster General 1921-27. Redesignated 23 March 1925 as Headquarters, 5th Division Quartermaster Train. Consolidated 29 January 1926 with the 5th Supply Train (a WWI unit organized in December 1917 at Camp Joseph E. Johnston, FL; demobilized 24 April 1921 at Camp Jackson; reconstituted 29 January 1926). Headquarters organized 12 July 1926 with Organized Reserve personnel as a RAI unit at Columbus, OH. Conducted summer training at the Jeffersonville Quartermaster Depot, IN, or Camp Knox, KY. Headquarters redesignated as Headquarters, 1st Battalion, 5th Quartermaster Regiment 1 May 1936, and subordinate units redesignated as elements of the 5th Quartermaster Regiment. Headquarters, 1st Battalion, 5th Quartermaster Regiment disbanded 16 October 1939.

Commanders, 5th Division Quartermaster Train			
Maj. Robert C. Eddy	11 May 21-10 Aug 21	Unknown	10 Nov 27-ao Jun 30
<i>Inactive</i>	11 Aug 21-11 Jul 26	Capt. Edwin I. Nava**	ao Jun 30-ao Jul 30
Capt. Charles C. Wells**	12 Jul 26-10 Nov 27	Unknown	ao Jul 30-1 May 36

** RAI Commanders: Organized Reserve officers.

6th Division Quartermaster Train

Regular Army Inactive

HQ-Camp Grant, IL, 1921; *Inactive* 1921-26; Chicago, IL, 1926-36

Subordinate units: 21st, 22nd and 23rd Motor Transport Companies 1921-36; 24th Motor Transport Company 1921-27; 91st Motor Transport Company 1927-33; 11th Motor Repair Section 1921-36; 12th Motor Repair Section 1921-27; 88th Motor Repair Section 1927-36; 11th and 12th Wagon Companies (RAI) 1921-36; 6th Motorcycle Company (RAI) 1930-36

Constituted in the Regular Army 17 March 1921 as the 6th Division Train, Q.M.C. and assigned to the 6th Division. Headquarters organized 26 April 1921 at Camp Grant, IL, with personnel and equipment from Headquarters, 6th Supply Train and Motor Command No. 6. The remainder of the train organized from elements of the 6th Supply Train. Inactivated 20 September 1921 at Camp Grant. Designated Active Associate was the Quartermaster General 1921-27. Redesignated 23 March 1925 as Headquarters, 6th Division Quartermaster Train. Consolidated 29 January 1926 with the 6th Supply Train (a WWI unit organized in February 1918 at Camp McClellan, AL; demobilized 24 April 1921 at Camp Grant; reconstituted 29 January 1926). Headquarters organized 17 April 1926 with Organized Reserve personnel as a RAI unit at Chicago, IL. Designated mobilization training station was Camp Grant. Conducted summer training at Fort Sheridan, IL. Headquarters redesignated as Headquarters, 1st Battalion, 6th Quartermaster Regiment 1 May 1936, and subordinate units redesignated as elements of the 6th Quartermaster Regiment. Headquarters, 1st Battalion, 6th Quartermaster Regiment disbanded 16 October 1939.

Organization Day: 26 July. Chosen to commemorate the 6th Supply Train's arrival at the Port of Le Havre, France, 26 July 1918.

Status: Inactive as the 506th Support Battalion, an element of the 6th Infantry Division (Light).

Commanders, 6th Division Quartermaster Train			
Capt. Wallace A. Meade	30 Apr 21-23 Jun 21	Capt. John W. Vorhes**	8 Sep 26-ao Sep 28
Capt. James S. Clarke	23 Jun 21-19 Sep 21	Maj. Neil R. Markle**	ao Jan 29-ao Jun 29
<i>Inactive</i>	19 Sep 21-17 Apr 26	Maj. Don D. Dewey**	ao Jun 30-ao Sep 31
1st Lt. William C. Presto**	24 Apr 26-8 Sep 26	Capt. Frank R. Olin**	ao May 32-30 Apr 36

** RAI Commanders: Organized Reserve officers.

7th Division Quartermaster Train

Regular Army Inactive

HQ-Camp George G. Meade, MD, 1921; *Inactive* 1921-27; Fort Leavenworth, KS, 1927-36

Subordinate units: 25th, 26th, 27th, and 28th Motor Transport Companies 1921-36; 13th and 14th Motor Repair Sections 1921-36; 13th and 14th Wagon Companies 1921-36; 7th Motorcycle Company 1921-36

Constituted in the Regular Army 17 March 1921 as the 7th Division Train, Q.M.C. and assigned to the 7th Division. Headquarters organized 24 March 1921 at George G. Meade, MD, with personnel and equipment from Headquarters, 7th Supply Train and Motor Command No. 13. The remainder of the train organized from elements of the 7th Supply Train. Inactivated 24 September 1921 at Camp George G. Meade. Designated Active Associate was the Quartermaster General 1921-27. Redesignated 23 March 1925 as Headquarters, 7th Division Quartermaster Train. Consolidated 29 January 1926 with the 7th Supply Train (a WWI unit organized 10 May 1918 at Camp MacArthur, TX; demobilized 19 February 1921 at Camp George G. Meade; reconstituted 29 January 1926). Headquarters organized by June 1926 as a RAI unit with Organized Reserve personnel at Fort Leavenworth, KS. Designated mobilization training station was Fort Leavenworth. Conducted summer training most years at Fort Crook, NE, and some years at Fort Snelling, MN. Headquarters redesignated as Headquarters, 1st Battalion, 7th Quartermaster Regiment 1 May 1936, and subordinate units redesignated as elements of the 7th Quartermaster Regiment. Headquarters, 1st Battalion, 7th Quartermaster Regiment disbanded 16 October 1939.

Status: Inactive as the 7th Support Battalion, an element of the 7th Infantry Division (Light).

Commanders, 7th Division Quartermaster Train			
Capt. Elbert Cock	Mar 21-15 Apr 21	<i>Inactive</i>	30 Oct 21-Jun 26
Capt. C. Allan Schwarzwaelder	15 Apr 21-31 Oct 21	Unknown	Jun 26-ao Mar 36
	Capt. Harrison C. Kelley**	ao Mar 36-1 May 36	

** RAI Commanders: Organized Reserve officers.

8th Division Quartermaster Train

Regular Army Inactive

HQ-*Inactive* 1923-26; Washington, DC, 1926; *Inactive* 1926-27; Dayton, OH, 1927-33; *Inactive* 1933-36

Subordinate units: 29th, 30th, 31st, and 32nd Motor Transport Companies 1923-36; 15th and 16th Motor Repair Sections 1923-36; 15th and 16th Wagon Companies (RAI) 1923-36; 8th Motorcycle Company (RAI) 1921-36

Demobilized 20 February 1919 at Camp Lee, VA, as the 8th Supply Train. Reconstituted in the Regular Army 24 March 1923 as the 8th Division Train, Q.M.C., assigned to the 8th Division, and allotted to the Third Corps Area. Designated Active Associate was the Quartermaster General 1923-27. Redesignated 23 March 1925 as Headquarters, 8th Division Quartermaster Train. Headquarters organized 27 April 1926 as a RAI unit with Organized Reserve personnel at Washington, DC. Inactivated 29 November 1926 at Washington by relief of personnel. Withdrawn from the Third Corps Area 19 February 1927 and allotted to the Fifth Corps Area. Headquarters organized 16 November 1927 with Organized Reserve personnel as a RAI unit at Dayton, OH. Conducted summer training at the Jeffersonville Quartermaster Depot, IN, or Camp Knox, KY. Withdrawn from the Fifth Corps Area 1 October 1933 and allotted to the Third Corps Area. Headquarters redesignated as Headquarters, 1st Battalion, 8th Quartermaster Regiment 1 May 1936, and subordinate units redesignated as elements of the 8th Quartermaster Regiment. Headquarters, 1st Battalion, 8th Quartermaster Regiment disbanded 16 October 1939.

Status: Inactive as the 118th Support Battalion, an element of the 8th Infantry Division (Mechanized).

Commanders, 8th Division Quartermaster Train			
Capt. William J. Stevens**	27 Apr 26-29 Nov 26	1st Lt. Wendall B. Thompson**	9 Dec 27-ao Jan 28
<i>Inactive</i>	29 Nov 26-16 Nov 27	Unknown	ao Jan 28-1 Oct 33
2nd Lt. Francis J. McGowan**	16 Nov 27-9 Dec 27	<i>Inactive</i>	1 Oct 33-1 May 36

** RAI Commanders: Organized Reserve officers.

9th Division Quartermaster Train

Regular Army Inactive

HQ-*Inactive* 1923-27; Jersey City, NJ, 1927-33; Providence, RI, 1933-36

Subordinate units: 33rd, 34th, 35th, and 36th Motor Transport Companies 1923-36; 17th and 18th Motor Repair Sections 1923-36; 17th and 18th Wagon Companies 1923-36; 9th Motorcycle Company (RAI) 1930-36

Demobilized 7 February 1919 at Camp Sheridan, AL, as the 9th Supply Train. Reconstituted in the Regular Army 24 March 1923 as the 9th Division Train, Q.M.C., assigned to the 9th Division, and allotted to the First Corps Area. Designated Active Associate was the Quartermaster General 1923-27. Redesignated 23 March 1925 as Headquarters, 9th Division Quartermaster Train. Withdrawn from the First Corps Area 19 February 1927 and allotted to the Second

Corps Area. Headquarters organized by June 1927 with Organized Reserve personnel as a RAI unit at Jersey City, NJ. Withdrawn from the Second Corps Area 1 October 1933 and allotted to the First Corps Area. Headquarters organized in October 1933 with Organized Reserve personnel as a RAI unit at Providence, RI. Designated mobilization training station was Fort Devens, MA. Headquarters redesignated as Headquarters, 1st Battalion, 9th Quartermaster Regiment 1 May 1936, and subordinate units redesignated as elements of the 9th Quartermaster Regiment. Headquarters, 1st Battalion, 9th Quartermaster Regiment disbanded 1 June 1940.

Status: Inactive as the 109th Support Battalion, an element of the 9th Infantry Division (Motorized).

Commanders, 9th Division Quartermaster Train

Unknown	Jun 27-14 Feb 30	Maj. Manfred A. Pakas**	16 Dec 30-ao Jun 31
1st Lt. William F. Klemm**	14 Feb 30-16 Dec 30	Unknown	ao Jun 31-1 May 36

** RAI Commanders: Organized Reserve officers.

Panama Canal Division Quartermaster Train

HQ-Corozal, CZ, 1921-31; *Inactive* 1931-38

Subordinate units: 37th, 38th, and 39th Motor Transport Companies 1921-31; *40th Motor Transport Company* 1921-27; 19th Motor Repair Section 1921-31; 20th Motor Repair Section 1921-27; 19th and 20th Wagon Companies 1921-27; 16th Pack Train 1921-31; 10th Motorcycle Company 1930-31



Constituted in the Regular Army 1 November 1921 as the Panama Canal Division Train, Q.M.C. and assigned to the Panama Canal Division. Concurrently, headquarters organized at Corozal, CZ, with personnel and equipment from Motor Transport Command No. 29. Redesignated 23 March 1925 as the Panama Canal Division Quartermaster Train. Inactivated 1 June 1931 at Corozal, CZ, and subordinate elements attached to the Panama Canal Department Motor Transportation Pool. Demobilized 10 October 1938.

Events: 26, 31, 36, 40, 43, 53, 58, 69, 81, 101, 119, 179, 198

Commanders, Panama Canal Division Quartermaster Train

Capt. Arnold W. Ellis	1 Nov 21-2 Dec 21	Maj. Herbert J. Lawes	29 Feb 24-26 Feb 27
Maj. Frederick R. Palmer	2 Dec 21-23 May 23	Capt. Herman C. Kliber	26 Feb 27-1 Jan 28
Lt. Col. Richard T. Ellis	23 May 23-29 Feb 24	Maj. Drury K. Mitchell	1 Jan 28-3 May 29
	Lt. Col. Alexander H. Jones	3 May 29-1 Jun 31	

Hawaiian Division Quartermaster Train

HQ-Schofield Barracks, TH, 1921-31; *Inactive* 1931-36

Subordinate units: 41st, 42nd, 43rd, and 44th Motor Transport Companies 1921-36; 21st and 22nd Motor Repair Sections 1921-36; 21st and 22nd Wagon Companies 1921-36; 11th Motorcycle Company 1921-36



Constituted in the Regular Army 17 March 1921 as the Hawaiian Division Train, Q.M.C. and assigned to the Hawaiian Division. Headquarters organized 3 May 1921 at Schofield Barracks, TH, with personnel and equipment from Motor Transport Command No. 10. Redesignated 23 March 1925 as the Hawaiian Division Quartermaster Train. Inactivated 31 May 1931 at Schofield Barracks, TH. Headquarters redesignated as Headquarters, 1st Battalion, 11th Quartermaster Regiment 1 May 1936, and subordinate units redesignated as elements of the 11th Quartermaster Regiment.

Organization Day: 14 April. Adopted 23 March 1925.

Status: Inactive as the 24th Support Battalion, an element of the 24th Infantry Division (Mechanized).

Events: 33, 37, 48, 75, 88, 120, 138, 158, 189

Commanders, Hawaiian Division Quartermaster Train

Capt. Paul M. Arnold	3 May 21-28 Jul 21	Capt. Robert J. Wagoner	17 Nov 25-23 Mar 26
Capt. Ralph P. Terrell	28 Jul 21-12 Sep 21	Capt. George R. Ford	23 Mar 26-1 Jun 28
Maj. John M. Ritchie	12 Sep 21-17 Jun 24	Capt. Arthur V. Gairs	1 Jun 28-7 Apr 30
Capt. Paul R. Guthrie	17 Jun 24-16 Sep 24	Capt. Joe S. Underwood	7 Apr 30-1 May 30
Capt. Joe S. Underwood	16 Sep 24-26 Jun 25	Capt. James C. Longino	1 May 30-10 Nov 30
1st Lt. Harold Spigelmyre	26 Jun 25-21 Jul 25	Capt. Philip W. Ricamore	10 Nov 30-30 Mar 31
Capt. Robert J. Van Epps	21 Jul 25-17 Nov 25	1st Lt. Daniel D. Coons	30 Mar 31-31 May 31

Hawaiian Division Pack Train

HQ-Schofield Barracks, TH, 1938-41

Organized provisionally in the Regular Army 19 December 1938 at Schofield Barracks, TH, and assigned to the Hawaiian Division. Concurrently attached to Headquarters, Special Troops, Hawaiian Division for command and control purposes. Organized by consolidation of the pack train sections of the division's infantry regiment service companies. Relieved from the Hawaiian Division 26 August 1921, redesignated as the Hawaiian Pack Train, and assigned to the Hawaiian Department. Location 7 December 1941—Schofield Barracks, TH.

Status: Disbanded 30 June 1944.

Events: 276, 297, 312

Philippine Division Quartermaster Train

HQ-*Not organized* 1921-22; Manila, PI, 1922-33; Fort William McKinley, PI, 1933-36

Subordinate units: 45th, 46th, 47th, and 48th Motor Transport Companies 1921-36; 23rd and 24th Motor Repair Sections 1921-36; 23rd and 24th Wagon Companies 1921-36; 12th Motorcycle Company 1921-36; 34th and 35th Pack Trains 1932-36

Constituted in the Regular Army 6 September 1921 as the Philippine Division Train, Q.M.C. and assigned to the Philippine Division. Headquarters organized 5 January 1922 at Fort McKinley, PI, with personnel and equipment from Motor Transport Command No. 14. Redesignated 23 March 1925 as the Philippine Division Quartermaster Train. Headquarters transferred 10 October 1933 to Fort McKinley, PI. Demobilized 1 May 1936 at Fort McKinley, PI. Concurrently, subordinate units redesignated as elements of the 12th Quartermaster Regiment.

Status: Inactive as the 12th Quartermaster Company, an element of the 12th Infantry Division.

Events: 27, 35, 41, 52, 68, 82, 100, 118, 169, 189

Commanders, Philippine Division Quartermaster Train

Lt. Col. William K. Moore	5 Jan 22-6 Apr 23	1st Lt. William E. Watters	Jun 29-14 Oct 29
Maj. Laurence W. Redington	6 Apr 23-15 Jan 24	Capt. William E. Todd, Jr.	14 Oct 29-Jun 30
Maj. George H. Steel	15 Jan 24-Jun 24	Capt. Karol B. Kozlowski	Jun 30-10 Jun 31
Capt. Edward J. L. Russell	Jun 24-26 Feb 26	Capt. George A. Moore	18 Jun 31-14 Sep 31
Capt. Hiram K. Tuttle	26 Feb 26-23 Nov 26	Capt. Frank Tillotson	14 Sep 31-10 Oct 33
Capt. Harry L. Black	23 Nov 26-20 May 27	Maj. Frank Brezina	10 Oct 33-23 Mar 35
Capt. Hiram K. Tuttle	20 May 27-25 Jun 27	Maj. Rafael L. Garcia	24 Mar 35-31 Oct 35
Capt. Charles I. Bazire	25 Jun 27-4 Oct 27	Lt. Col. Frank Brezina	31 Oct 35-1 Dec 35
Capt. David McG. Speed	4 Oct 27-Jun 29	Lt. Col. James R. Hill	1 Dec 35-30 Apr 36

21st Cavalry Division Quartermaster Train

National Guard

HQ-*Not organized* 1921-36

Subordinate units: 145th and 146th Wagon Companies 1921-36; 140th, 141st, 142nd, and 143rd Pack Trains 1921-36

Constituted in the National Guard in 1921 as the 21st Cavalry Division Train, Q.M.C. and assigned to the 21st Cavalry Division. Redesignated in 1927 as the 21st Cavalry Division Quartermaster Train. Consolidated 1 April 1936 with the Quartermaster Section, 21st Cavalry Division Headquarters Detachment. Concurrently reorganized and redesignated as Headquarters and Headquarters Troop, 121st Quartermaster Squadron. Train subordinate elements concurrently redesignated as troops of the 121st Quartermaster Squadron.

22nd Cavalry Division Quartermaster Train

Wisconsin National Guard

HQ-*Not organized* 1921-36

Subordinate units: 147th and 148th Wagon Companies 1921-36; 144th, 145th, 146th, and 147th Pack Trains 1921-36

Constituted in the National Guard in 1921 as the 22nd Cavalry Division Train, Q.M.C., assigned to the 22nd Cavalry Division, and allotted to the state of Wisconsin. Phillips, WI, designated as headquarters location on organization, but the unit was never organized at that location. Redesignated in 1927 as the 22nd Cavalry Division Quartermaster Train. The 147th Wagon Company conducted annual summer training at Camp Douglas, WI. Designated mobilization training station for the entire train was Camp McCoy, WI. Consolidated 1 April 1936 with the Quartermaster Section, 22nd Cavalry Division Headquarters Detachment. Concurrently reorganized and redesignated as Headquarters and Headquarters Troop, 122nd Quartermaster Squadron. Train subordinate elements concurrently redesignated as troops of the 122nd Quartermaster Squadron.

23rd Cavalry Division Quartermaster Train

Texas and New Mexico National Guard

HQ-*Not organized* 1921-36

Subordinate units: 149th and 150th Wagon Companies 1921-36; 148th, 149th, 150th, and 151st Pack Trains 1921-36

Constituted in the National Guard in 1921 as the 23rd Cavalry Division Train, Q.M.C and assigned to the 23rd Cavalry Division. Allotted to the states of Texas and New Mexico by 1926. Redesignated in 1927 as the 23rd Cavalry Division Quartermaster Train. Designated mobilization training station was Fort Oglethorpe, GA. Consolidated 1 April 1936 with the Quartermaster Section, 23rd Cavalry Division Headquarters Detachment. Concurrently reorganized and redesignated as Headquarters and Headquarters Troop, 123rd Quartermaster Squadron. Train subordinate elements concurrently redesignated as troops of the 123rd Quartermaster Squadron.

24th Cavalry Division Quartermaster Train

Iowa National Guard

HQ-*Not organized* 1921-36

Subordinate units: 151st and 152nd Wagon Companies 1921-36; 152nd, 153rd, 154th, and 155th Pack Trains 1921-36

Constituted in the National Guard in 1921 as the 24th Cavalry Division Train, Q.M.C., assigned to the 24th Cavalry Division, and allotted to the state of Iowa. Redesignated in 1927 as the 24th Cavalry Division Quartermaster Train. Consolidated 1 April 1936 with the Quartermaster Section, 24th Cavalry Division Headquarters Detachment. Concurrently reorganized and redesignated as Headquarters and Headquarters Troop, 124th Quartermaster Squadron. Train subordinate elements concurrently redesignated as troops of the 124th Quartermaster Squadron.

26th Division Quartermaster Train

Massachusetts National Guard

HQ-Charlestown, MA, 1921-36

Subordinate units: 101st and 102nd Motor Transport Companies 1921-36; 101st Motor Repair Section 1921-36; 101st and 102nd Wagon Companies 1921-36; 101st Motorcycle Company 1921-36



Demobilized 29 April 1919 at Camp Devens, MA, as the 101st Supply Train. Reconstituted in the National Guard and organized 29 April 1919 as 101st Supply Train, Massachusetts Volunteer Militia with headquarters at Charlestown, MA. Redesignated 26 March 1921 as the 1st Supply Train. Redesignated 30 September 1921 as the 26th Division Quartermaster Train and assigned to the 26th Division. Redesignated 23 March 1925 as the 26th Division Quartermaster Train. Designated mobilization training station was Camp Devens, MA. Conducted annual summer training at Camp Devens, MA, 1921-34. Headquarters consolidated 26 May 1936 with the

Quartermaster Section, 26th Division Headquarters Detachment (organized and Federally recognized 23 May 1923 at Boston), and reorganized and redesignated as Headquarters, 101st Quartermaster Regiment. Subordinate elements of the train concurrently reorganized and redesignated as elements of the 101st Quartermaster Regiment.

Status: Active at Springfield, MA, as HHD, 101st Quartermaster Battalion.

Events: 190

Commanders, 26th Division Quartermaster Train

Maj. John B. Atkinson

26 Mar 21-1 Jun 28

Maj. William H. Mobbs

14 Jun 28-26 May 36

27th Division Quartermaster Train

New York National Guard

HQ-Brooklyn, NY, 1921-36

Subordinate units: 105th, 106th, 107th, and 108th Motor Transport Companies 1921-36; 103rd Motor Repair Section 1921-36; 103rd and 104th Wagon Companies 1921-36; 102nd Motorcycle Company 1921-36



Constituted in the National Guard 30 December 1920 as the 27th Division Train, Q.M.C., assigned to the 27th Division, and allotted to the state of New York. Organized 18 October 1921 by conversion and redesignation of the 47th Engineer Battalion (Mounted) (demobilized 20 May 1919 at Camp Upton, NY, as the 53rd Pioneer Infantry; reorganized 26 April 1920 in the New York National Guard at Brooklyn, NY, as the 47th Engineer Battalion [Mounted]) as the 27th Division Train, Q.M.C. Train headquarters organized and Federally recognized 4 November 1921 at Brooklyn. Redesignated 23 March 1925 as the 27th Division Quartermaster Train. Conducted annual summer training at Camp Smith, NY, 1922-34. Headquarters consolidated 1

April 1936 with the Quartermaster Section, 27th Division Headquarters Detachment (organized and Federally recognized 23 December 1921 at New York City, NY), and reorganized and redesignated as Headquarters, 102nd Quartermaster Regiment. Subordinate elements of the train concurrently reorganized and redesignated as elements of the 102nd Quartermaster Regiment.

Events: 61, 190

Commanders, 27th Division Quartermaster Train

Maj. Walter E. Corwin

4 Nov 21-29 Apr 28

Maj. Robert H. Platz

30 Apr 28-31 Mar 36

28th Division Quartermaster Train

Pennsylvania National Guard

HQ-Harrisburg, PA, 1921-36

Subordinate units: 109th and 110th Motor Transport Companies 1921-36; 105th Motor Repair Section 1921-36; 105th and 106th Wagon Companies 1921-36; 103rd Motorcycle Company 1921-36



Demobilized 20 May 1919 at Camp Dix, NJ, as the 103rd Supply Train. Reconstituted in the National Guard in 1921 as the 28th Division Train, Q.M.C., assigned to the 28th Division, and allotted to the state of Pennsylvania. Headquarters organized and Federally recognized 22 December 1921 at Harrisburg, PA. Redesignated 23 March 1925 as the 28th Division Quartermaster Train. The 110th Motor Transport Company called up to support units on strike duty at coal mines at Ebensburg and Cokeburg, PA, 21 July-7 September 1922. Conducted annual summer training at Mount Gretna, PA, 1922-34. Headquarters consolidated 17 April 1936 with the Quartermaster Section, 28th Division Headquarters Detachment (organized and

Federally recognized 22 December 1921 at Harrisburg), and reorganized and redesignated as Headquarters, 103rd Quartermaster Regiment. Subordinate elements of the train concurrently reorganized and redesignated as elements of the 103rd Quartermaster Regiment.

Events: 191, 203

Commanders, 28th Division Quartermaster Train

Maj. George P. Drake 22 Dec 21-16 Apr 36

29th Division Quartermaster Train

Maryland, Virginia, and
the District of Columbia National Guard

HQ-Not organized 1921-36

Subordinate units: 113th and 114th Motor Transport Companies 1921-36; 107th Motor Repair Section 1921-36; 107th and 108th Wagon Companies 1921-36; 104th Motorcycle Company 1921-36

Constituted in the National Guard in 1921 as the 29th Division Train, Q.M.C., assigned to the 29th Division, and allotted to the states of Maryland, Virginia, and the District of Columbia. Redesignated 23 March 1925 as the 29th Division Quartermaster Train. Headquarters consolidated 1 July 1936 with the Quartermaster Section, 29th Division Headquarters Detachment (organized and Federally recognized 1 July 1930) and reorganized and redesignated as Headquarters, 104th Quartermaster Regiment. Subordinate elements of the train concurrently reorganized and redesignated as elements of the 104th Quartermaster Regiment.

30th Division Quartermaster Train

South Carolina, Georgia, North Carolina,
and Tennessee National Guard

HQ-Not organized 1921-36

Subordinate units: 117th and 118th Motor Transport Companies 1921-36; 119th and 120th Motor Transport Companies 1929-36; 109th Motor Repair Section 1921-36; 110th Motor Repair Section 1929-36; 109th and 110th Wagon Companies 1921-36; 105th Motorcycle Company 1921-36



Constituted in the National Guard in 1921 as the 30th Division Train, Q.M.C., assigned to the 30th Division, and allotted to the states of Georgia, North Carolina, South Carolina, and Tennessee. Redesignated 23 March 1925 as the 30th Division Quartermaster Train. The 118th and 119th Motor Transport Companies called up to perform guard duties at the state penitentiary fire at Columbia, SC, 6-7 April 1932. Typically conducted annual summer training as follows: South Carolina elements at Camp Jackson, SC; North Carolina elements at Camp Glenn, NC; Tennessee elements at Camp Peay, TN. Headquarters consolidated 1 July 1936 with the Quartermaster Section, 30th Division Headquarters Detachment (inactive) and reorganized and redesignated as Headquarters, 105th Quartermaster Regiment. Subordinate elements of the train concurrently reorganized and redesignated as elements of the 105th Quartermaster Regiment.

31st Division Quartermaster Train**Mississippi, Alabama, Florida,
and Louisiana National Guard****HQ-***Not organized* 1921-24; Senatobia, MS, 1924-36**Subordinate units:** 121st and 122nd Motor Transport Companies 1923-36; ; 123rd and 124th Motor Transport Companies 1929-36; 111th Motor Repair Section 1923-36; *111th* and 112th Wagon Companies 1923-36; 106th Motorcycle Company 1921-36

Constituted in the National Guard in 1921 as the 39th Division Train, Q.M.C., assigned to the 39th Division, and allotted to the states of Mississippi, Alabama, Florida, and Louisiana. Redesignated 1 July 1923 as the 31st Division Train, Q.M.C. Headquarters organized and Federally recognized 11 August 1924 at Senatobia, MS. Redesignated 23 March 1925 as the 31st Division Quartermaster Train. Mississippi and Louisiana elements called up in support of relief duties for the Mississippi River floods during April-June 1927. Florida elements called up in support of hurricane relief duties in south Florida in September 1926 and September-November 1928. Typically conducted annual summer training as follows: train headquarters and Mississippi elements at Camp Benjamin F. McClellan, MS; Louisiana elements at Camp Beauregard, LA; Alabama elements at Camp McClellan, AL; Florida elements at Camp Clifford J. Foster, FL. For several training periods, however, the entire train was assembled at one location to conduct annual summer training at one of the posts listed above. Headquarters consolidated 19 May 1936 with the Quartermaster Section, 31st Division Headquarters Detachment (organized and Federally recognized 13 June 1924 at St. Augustine, FL) and reorganized and redesignated as Headquarters, 106th Quartermaster Regiment. Subordinate elements of the train concurrently reorganized and redesignated as elements of the 106th Quartermaster Regiment.

Events: 56**Commanders, 31st Division Quartermaster Train**

Maj. Albert T. Callicott 11 Aug 24-19 May 36

32nd Division Quartermaster Train**Wisconsin and Michigan National Guard****HQ-**Rhineland, WI, 1921-28; *Inactive* 1928-36**Subordinate units:** 125th and 126th Motor Transport Companies 1921-36; 113th Motor Repair Section 1921-36; 113th and 114th Wagon Companies 1921-36; 107th Motorcycle Company 1921-36

Constituted in the National Guard in 1921 as the 32nd Division Train, Q.M.C., assigned to the 32nd Division, and allotted to the states of Wisconsin and Michigan. Headquarters organized and Federally recognized in 1921 at Rhineland, WI. Redesignated 23 March 1925 as the 32nd Division Quartermaster Train. Headquarters inactivated 2 September 1928 at Rhineland. Wisconsin elements called up in support of forest fire fighting efforts near Palnets and Laona, WI, 15-23 May 1925. Typically conducted annual summer training as follows: train headquarters and Wisconsin elements at Camp Douglas, WI, 1922-27 and at Camp Williams 1928-39; Michigan elements at Camp Grayling, MI. Designated mobilization training station was Camp McCoy 1928-36. Headquarters consolidated 1 July 1936 with the Quartermaster Section, 32nd Division Headquarters Detachment (organized and Federally recognized 1 April 1926 at Madison, WI) and reorganized and redesignated as Headquarters, 107th Quartermaster Regiment. Subordinate elements of the train concurrently reorganized and redesignated as elements of the 107th Quartermaster Regiment.

Commanders, 32nd Division Quartermaster TrainMaj. Clarence J. Wesley 1 Jun 21-27 Sep 28 *Inactive* 27 Sep 28-1 Jul 36**33rd Division Quartermaster Train****Illinois National Guard****HQ-***Not organized* 1921-36**Subordinate units:** 129th and 130th Motor Transport Companies 1921-36; *115th Motor Repair Section* 1921-36; *115th* and *116th Wagon Companies* 1921-36; 108th Motorcycle Company 1921-36

Constituted in the National Guard in 1921 as the 33rd Division Train, Q.M.C., assigned to the 33rd Division, and allotted to the state of Illinois. Redesignated 23 March 1925 as the 33rd Division Quartermaster Train. Active elements conducted annual summer training at Camp Grant, IL. Designated mobilization training station was Camp Grant, IL, 1921-36. Headquarters consolidated 22 April 1936 with the Quartermaster Section, 33rd Division Headquarters Detachment (organized and Federally recognized 15 May 1923 at Chicago, IL) and reorganized and redesignated as Headquarters, 108th Quartermaster Regiment. Subordinate elements of the train concurrently reorganized and redesignated as elements of the 108th Quartermaster Regiment.

34th Division Quartermaster Train

Iowa, Minnesota, and South Dakota National Guard

HQ-*Not organized* 1921-36

Subordinate units: 133rd and 134th Motor Transport Companies 1921-36; 117th Motor Repair Section 1921-36; 118th Motor Repair Section 1929-36; 117th and 118th Wagon Companies 1921-36; 109th Motorcycle Company 1921-36

Constituted in the National Guard in 1921 as the 34th Division Train, Q.M.C., assigned to the 34th Division, and allotted to the states of Iowa, Minnesota, and South Dakota. Headquarters allotted to the state of South Dakota. Redesignated 23 March 1925 as the 34th Division Quartermaster Train. Headquarters withdrawn from allotment to South Dakota by 1930 and allotted to Iowa. Active elements conducted annual summer training most years at Camp Rapid, SD, and some years at Aberdeen, SD, or Mitchell, SD. Headquarters consolidated 24 August 1936 with the Quartermaster Section, 34th Division Headquarters Detachment (organized and Federally recognized 1 November 1924 at Osceola, IA) and reorganized and redesignated as Headquarters, 109th Quartermaster Regiment. Subordinate elements of the train concurrently reorganized and redesignated as elements of the 109th Quartermaster Regiment.

35th Division Quartermaster Train

Nebraska National Guard

HQ-*Not organized* 1921-23; Lincoln, NE, 1923-33; Kearney, NE, 1933-36

Subordinate units: 137th and 138th Motor Transport Companies 1921-36; 119th Motor Repair Section 1921-36; 119th and 120th Wagon Companies 1921-36; 110th Motorcycle Company 1921-36



Constituted in the National Guard in 1921 as the 35th Division Train, Q.M.C., assigned to the 35th Division, and allotted to the state of Nebraska. Headquarters organized and Federally recognized 7 June 1923 at Lincoln, NE. Redesignated 23 March 1925 as the 35th Division Quartermaster Train. Consolidated 14 July 1925 with the 110th Supply Train (a WWI unit organized 13 September 1917 at Camp Clark, MO; demobilized at Camp Funston, KS, 7 May 1919; reconstituted 14 July 1925) with consent of the Governor of Missouri and by order of the Secretary of War. Called up to support the 69th Infantry Brigade which was performing riot control duties in connection with a street car workers strike in Omaha, NE, 7-14 June 1935.

Headquarters relocated 4 January 1933 to Kearney, NE. Conducted annual summer training at Camp Ashland, NE. Headquarters consolidated 1 April 1936 with the Quartermaster Section, 35th Division Headquarters Detachment (organized and Federally recognized 30 December 1932 at Lincoln), and reorganized and redesignated as Headquarters, 110th Quartermaster Regiment. Subordinate elements of the train concurrently reorganized and redesignated as elements of the 110th Quartermaster Regiment.

Commanders, 35th Division Quartermaster Train

Maj. Marcus L. Poteet 7 Aug 23-31 Mar 36

36th Division Quartermaster Train

Texas National Guard

HQ-*Not organized* 1921-27; Austin, TX, 1927-36

Subordinate units: 141st and 142nd Motor Transport Companies 1921-36; 121st Motor Repair Section 1921-36; 121st and 122nd Wagon Companies 1921-36; 111th Motorcycle Company 1921-36

1946

Demobilized 20 June 1919 at Camp Bowie, TX, as the 111th Supply Train. Reconstituted in the National Guard in 1921 as the 36th Division Train, Q.M.C., assigned to the 36th Division, and allotted to the state of Texas. Redesignated 23 March 1925 as the 36th Division Quartermaster Train. Consolidated 23 January 1926 with the 117th Supply Train (a WWI unit constituted 30 May 1917 as the Supply Train, 15th Division; organized 4 June 1917 at Houston, TX; redesignated 20 August 1917 as the 117th Supply Train, an element of the 42nd Division; demobilized at Camp Bowie, TX, 15 May 1919; reconstituted 23 January 1926). Headquarters organized and Federally recognized 21 June 1927 at Austin, TX. Elements called up to support the 56th Cavalry Brigade in connection with martial law duties in the great East Texas Oilfield near Kilgore, TX, 17 August 1931-7 December 1932. Conducted annual summer training at Camp Hulen, TX. For at least one year, in 1933, the train also trained company-grade quartermaster officers of the 90th Division at Camp Hulen. Headquarters consolidated 9 April 1936 with the Quartermaster Section, 36th Division Headquarters Detachment (organized and Federally recognized 1 July 1928 at Houston), and reorganized and redesignated as Headquarters, 111th Quartermaster Regiment. Subordinate elements of the train concurrently reorganized and redesignated as elements of the 111th Quartermaster Regiment.

Status: Active in the Texas National Guard at Austin, Texas, as HHC, 111th Support Group.

Commanders, 36th Division Quartermaster Train

Maj. Stayton M. Hankins

21 Jun 27-6 May 31

Maj. Charles C. Ingram

7 May 31-31 Mar 36

37th Division Quartermaster Train

Ohio National Guard

HQ-Columbus, OH, 1921-36

Subordinate units: 145th and 147th Motor Transport Companies 1921-36; 123rd Motor Repair Section 1921-36; 123rd and 124th Wagon Companies 1921-36; 112th Motorcycle Company 1921-36



Demobilized 16 April 1919 at Camp Sherman, OH, as the 112th Supply Train. Reconstituted in the National Guard in 1921 as the 37th Division Train, Q.M.C., assigned to the 37th Division, and allotted to the state of Ohio. Headquarters organized and Federally recognized 14 November 1921 at Columbus, OH. Redesignated 23 March 1925 as the 37th Division Quartermaster Train. Called up in support of tornado relief duties near Lorain and Sandusky, OH, in July 1925 and to perform relief duties in connection with the Ohio State Penitentiary riot and fire 21 April-4 May 1930. Conducted annual summer training at Camp Perry, OH. Designated mobilization training station was Camp Perry, OH, 1921-36. Headquarters consolidated 15 May 1936 with the Quartermaster

Section, 37th Division Headquarters Detachment (organized and Federally recognized 31 August 1923 at Columbus, OH), and reorganized and redesignated as Headquarters, 112th Quartermaster Regiment. Subordinate elements of the train concurrently reorganized and redesignated as elements of the 112th Quartermaster Regiment.

Commanders, 37th Division Quartermaster Train

Maj. Robert S. McPeak

14 Nov 21-13 Dec 35

Lt. Col. John S. Shetler

14 Dec 35-14 May 36

38th Division Quartermaster Train

Kentucky and Indiana National Guard

HQ-Not organized 1921-24; Frankfort, KY, 1924-37

Subordinate units: 149th and 150th Motor Transport Companies 1921-36; 125th Motor Repair Section 1921-36; 126th Motor Repair Section 1929-36; 125th and 126th Wagon Companies 1921-36; 113th Motorcycle Company 1921-36



Demobilized 5 July 1919 at Camp Zachary Taylor, KY, as the 113th Supply Train. Reconstituted in the National Guard in 1921 as the 38th Division Train, Q.M.C., assigned to the 38th Division, and allotted to the states of Kentucky and Indiana. Headquarters organized and Federally recognized 7 July 1924 at Frankfort, KY. Redesignated 23 March 1925 as the 38th Division Quartermaster Train. The 149th Motor Transport Company called up to perform tornado relief duties in Vernon, IN, 7-10 July 1931. Conducted annual summer training at Camp Knox, KY. Designated mobilization training station was Camp Knox, KY, 1921-36. Headquarters consolidated 7 July 1937 with the Quartermaster Section, 38th Division Headquarters Detachment (organized and Federally recognized 23 March 1934 at Indianapolis, IN), and reorganized and redesignated as Headquarters, 113th Quartermaster Regiment. Subordinate elements of the train concurrently reorganized and redesignated as elements of the 113th Quartermaster Regiment.

Commanders, 38th Division Quartermaster Train

Maj. Thomas W. Woodyard 7 Jul 24-7 Jul 37

39th Division Quartermaster Train

Mississippi National Guard

HQ-Not organized 1921-23

Subordinate units: *153rd and 154th Motor Transport Companies 1921-23; 127th and 128th Motor Repair Sections 1921-23; 127th and 128th Wagon Companies 1921-23.*

Demobilized in January 1919 at Camp Beauregard, LA, as the 114th Supply Train. Reconstituted in the National Guard in 1921 as the 39th Division Train, Q.M.C., assigned to the 39th Division, and allotted to the states of Mississippi, Alabama, and Florida. Natchez, MS, designated as headquarters location upon organization, but the unit was never organized at that location. Designated mobilization station was Camp McClellan, AL. By mutual consent of the states to which the train was allotted, the 39th Division Train, Q.M.C., was withdrawn 1 July 1923 and the 31st Division Train, Q.M.C. allotted. All existing subordinate elements were concurrently redesignated as elements of the 31st Division Train.

40th Division Quartermaster Train

California National Guard

HQ-Not organized 1921-36

Subordinate units: *157th and 158th Motor Transport Companies 1921-36; 129th and 130th Motor Repair Sections 1921-36; 129th and 130th Wagon Companies 1921-36; 115th Motorcycle Company 1921-36*

Constituted in the National Guard in 1921 as the 40th Division Train, Q.M.C., assigned to the 40th Division, and allotted to the state of California. Redesignated 23 March 1925 as the 40th Division Quartermaster Train. Headquarters consolidated 1 April 1936 with the Quartermaster Section, 40th Division Headquarters Detachment (organized and Federally recognized 18 June 1926 at Berkeley, CA) and reorganized and redesignated as Headquarters, 115th Quartermaster Regiment. Subordinate elements of the train concurrently reorganized and redesignated as elements of the 115th Quartermaster Regiment.

41st Division Quartermaster Train

Washington, Oregon, and Montana National Guard

HQ-Not organized 1921-36

Subordinate units: *161st and 162nd Motor Transport Companies 1921-36; 131st and 132nd Motor Repair Sections 1921-36; 131st and 132nd Wagon Companies 1921-36; 116th Motorcycle Company 1921-36*

Constituted in the National Guard in 1921 as the 41st Division Train, Q.M.C., assigned to the 41st Division, and allotted to the states of Washington, Oregon, and Montana. Redesignated 23 March 1925 as the 41st Division Quartermaster Train. The 161st Motor Transport Company called up to support the 81st Infantry Brigade which was performing riot control duties in connection with a timber workers strike in Tacoma, WA, 15 June-25 July 1935. The 161st Motor Transport Company conducted annual summer training most years at Camp Murray, WA. Headquarters (inactive) consolidated 1 April 1936 with the Quartermaster Section, 41st Division Headquarters Detachment (organized and Federally recognized 1 April 1927 at Seattle, WA) and reorganized and redesignated as Headquarters, 116th Quartermaster Regiment. Subordinate elements of the train concurrently reorganized and redesignated as elements of the 116th Quartermaster Regiment.

43rd Division Quartermaster Train

**Vermont, Connecticut, New Hampshire,
and Rhode Island National Guard**

HQ-Not organized 1920-36

Subordinate units: *169th and 170th Motor Transport Companies 1921-36; 155th Motor Repair Section 1921-36; 135th and 136th Wagon Companies 1921-36; 118th Motorcycle Company 1921-36*

Constituted in the National Guard 14 December 1920 as the 43rd Division Train, Q.M.C., assigned to the 43rd Division, and allotted to the states of Vermont, Connecticut, New Hampshire, and Rhode Island. Train headquarters allotted to the state of Vermont. The 118th Motorcycle Company conducted annual summer training most years at Niantic, CT. Redesignated 23 March 1925 as the 43rd Division Quartermaster Train. Headquarters disbanded 1 April 1936.

Events: 190

44th Division Quartermaster Train

New Jersey National Guard

HQ-Not organized 1921-36

Subordinate units: *173rd and 174th Motor Transport Companies 1921-36; 137th Motor Repair Section 1921-36; 137th and 138th Wagon Companies 1921-36; 119th Motorcycle Company 1921-36*

Constituted in the National Guard in 1921 as the 44th Division Train, Q.M.C., assigned to the 44th Division, and allotted to the state of New Jersey. Redesignated 23 March 1925 as the 44th Division Quartermaster Train. The 173rd Motor Transport Company called up to support rescue work in connection with the massive ammunition explosion at the Dover Naval Arsenal 10-14 July 1926. Active elements conducted annual summer training at Sea Girt, NJ. Headquarters disbanded 1 April 1936.

Events: 190

45th Division Quartermaster Train

Oklahoma National Guard

HQ-Not organized 1921-24; Anadarko, OK, 1924-35; Oklahoma City, OK, 1935-36

Subordinate units: *179th and 180th Motor Transport Companies 1921-36; 139th Motor Repair Section 1921-36; 139th and 140th Wagon Companies 1921-36; 120th Motorcycle Company 1921-36*



Constituted in the National Guard in 1921 as the 45th Division Train, Q.M.C., assigned to the 45th Division, and allotted to the state of Oklahoma. Headquarters organized and Federally recognized 8 February 1924 at Anadarko, OK. Redesignated 23 March 1925 as the 45th Division Quartermaster Train. Headquarters relocated 1 January 1935 to Oklahoma City, OK. Conducted annual summer training most years at Fort Sill, OK. For at least one year, in 1933, the train also trained company-grade quartermaster officers of the 95th Division at Fort Sill. Headquarters consolidated 22 June 1936 with the Quartermaster Section, 45th Division Headquarters Detachment (organized and Federally recognized 15 December 1925 at Oklahoma City, OK), and reorganized and redesignated as Headquarters, 120th Quartermaster Regiment. Subordinate elements of the train concurrently reorganized and redesignated as elements of the 120th Quartermaster Regiment.

Commanders, 45th Division Quartermaster Train

Maj. Ernest A. Wallis

8 Feb 24-1 Sep 30

Maj. Fenton M. Wood

1 Sep 30-22 Jun 36

61st Cavalry Division Quartermaster Train

Organized Reserve New York

HQ-Not initiated 1921-22; Rochester, NY, 1922-36

Subordinate units: 431st Wagon Company 1921-30; 432nd Wagon Company 1921-36; 61st, 62nd, 63rd, and 64th Pack Trains 1921-36; 418th and 419th Motor Transport Companies 1930-36; 761st Motor Repair Section 1930-36

Constituted in the Organized Reserve 15 October 1921, assigned to the 61st Cavalry Division, and allotted to the Second Corps Area. Headquarters initiated 6 February 1922 at Rochester, NY. Conducted summer training most years at Fort Hancock, NJ, and some years at Camp Dix, NJ, or Fort Ethan Allen, VT. Designated mobilization training station was the New York State Fairgrounds, Syracuse, NY. Headquarters consolidated 1 July 1936 with the Quartermaster Section, 61st Cavalry Division Headquarters Detachment, and reorganized and redesignated as Headquarters and Headquarters Troop, 461st Quartermaster Squadron. The remainder of the train concurrently reorganized and redesignated as elements of the 461st Quartermaster Squadron.

Status: Disbanded 30 January 1942.

Commanders, 61st Cavalry Division Quartermaster Train

Capt. David M. Hoyt

6 Feb 22-ao Mar 22

Unknown

ao Aug 24-20 Jun 30

Maj. James Futherer

ao Jan 23-29 Jun 24

Maj. Earl LeR. Wood

20 Jun 30-19 Jul 33

Capt. Rudolf C. Siebert

29 Jun 24-ao Aug 24

Maj. Arthur A. Stewart

19 Jul 33-4 Sep 35

Maj. John P. Hanlon

4 Sep 35-1 Jul 36

62nd Cavalry Division Quartermaster Train

Organized Reserve Maryland/Virginia

HQ-Not initiated 1921-22; Towson, MD, 1922-28; Winchester, VA, 1928-36

Subordinate units: 433rd Wagon Company 1921-30; 434th Wagon Company 1921-36; 65th, 66th, 67th, and 68th Pack Trains 1921-36; 420th and 421st Motor Transport Companies 1930-36; 762nd Motor Repair Section 1930-36

Constituted in the Organized Reserve 15 October 1921, assigned to the 62nd Cavalry Division, and allotted to the Third Corps Area. Headquarters initiated in June 1922 at Towson, MD. Headquarters relocated about November 1928 to Winchester, VA. Designated mobilization training station was the York Concentration Area, York, PA. Conducted summer training most years at the Holabird Quartermaster Depot, MD, and some years at Fort Eustis, VA. Headquarters consolidated 1 July 1936 with the Quartermaster Section, 62nd Cavalry Division Headquarters Detachment, and reorganized and redesignated as Headquarters and Headquarters Troop, 462nd Quartermaster Squadron. The remainder of the train concurrently reorganized and redesignated as elements of the 462nd Quartermaster Squadron.

Status: Disbanded 30 January 1942.

Commanders, 62nd Cavalry Division Quartermaster Train

Capt. Wilmot H. Slep

Jun 22-ao Jan 26

Unknown

ao Jun 30-7 Nov 32

Maj. Charles E. Gibson

ao Jul 26-ao Aug 26

Maj. William F. Brown

7 Nov 32-ao Jun 35

Maj. Edward M. Nevils

ao Nov 26-ao Jun 30

Maj. Charles E. Gibson

ao Dec 35-26 Feb 36

Unknown

26 Feb 36-1 Jul 36

63rd Cavalry Division Quartermaster Train

Organized Reserve Louisiana

HQ-Not initiated 1921-23; Lake Charles, LA, 1923-30; New Orleans, LA, 1930-36

Subordinate units: 435th Wagon Company 1921-30; 436th Wagon Company 1921-36; 69th, 70th, 71st and 72nd Pack Trains 1921-36; 422nd and 423rd Motor Transport Companies 1930-36; 763rd Motor Repair Section 1930-36

Constituted in the Organized Reserve 15 October 1921, assigned to the 63rd Cavalry Division, and allotted to the Fourth Corps Area. Headquarters initiated in April 1923 at Lake Charles, LA. Headquarters relocated by 1930 to New Orleans, LA. Conducted summer training most years at Fort McPherson, GA. Designated mobilization training station was Camp Beauregard, LA. Headquarters consolidated 1 July 1936 with the Quartermaster Section, 63rd Cavalry Division Headquarters Detachment, and reorganized and redesignated as Headquarters and Headquarters Troop, 463rd Quartermaster Squadron. The remainder of the train concurrently reorganized and redesignated as elements of the 463rd Quartermaster Squadron.

Status: Disbanded 30 January 1942.

Commanders, 63rd Cavalry Division Quartermaster Train

Unknown	Apr 23-15 May 25	Maj. Lester A. Ballew	24 Feb 32-7 Dec 35
Maj. Harry P. Cooper	15 May 25-5 Nov 29	Maj. Fred M. Lewis	7 Dec 35-14 Mar 36
Capt. Moise Conrad	5 Nov 29-24 Feb 32	Lt. Col. Ira Stineman	14 Mar 36-30 Jun 36

64th Cavalry Division Quartermaster Train

Organized Reserve Kentucky

HQ-Not initiated 1921-22; Lexington, KY, 1922-30; Louisville, KY, 1930-33; Winchester, KY, 1933-36

Subordinate units: 437th Wagon Company 1921-30; 438th Wagon Company 1921-36; 73rd, 74th, 75th, and 76th Pack Trains 1921-36; 424th and 425th Motor Transport Companies 1930-36; 764th Motor Repair Section 1930-36

Constituted in the Organized Reserve 15 October 1921, assigned to the 64th Cavalry Division, and allotted to the Fifth Corps Area. Headquarters initiated in March 1922 at Lexington, KY. Headquarters relocated in 1930 to Louisville, KY. Headquarters relocated in 1933 to Winchester, KY. Conducted summer training most years at Jeffersonville Quartermaster Depot, IN, and some years at Camp Knox, KY, or Fort Benjamin Harrison, IN. Headquarters consolidated 1 July 1936 with the Quartermaster Section, 64th Cavalry Division Headquarters Detachment, and reorganized and redesignated as Headquarters and Headquarters Troop, 464th Quartermaster Squadron. The remainder of the train concurrently reorganized and redesignated as elements of the 464th Quartermaster Squadron.

Status: Disbanded 30 January 1942.

Commanders, 64th Cavalry Division Quartermaster Train

1st Lt. John W. Sefriet	Mar 22-17 Aug 22	Maj. O. H. Balch	Sep 22-ao Oct 22
Capt. Edwin I. Nava	17 Aug 22-Sep 22	Unknown	ao Oct 22-ao Jun 35
	Maj. Frank I. Josselson	ao Jun 35-30 Jun 36	

65th Cavalry Division Quartermaster Train

Organized Reserve Illinois

HQ-Not initiated 1921-22; Rock Island, IL, 1922-25; Ottawa, IL, 1925-36

Subordinate units: 439th Wagon Company 1921-30; 440th Wagon Company 1921-36; 67th, 68th, 69th, and 70th Pack Trains 1921-36; 426th and 427th Motor Transport Companies 1930-36; 765th Motor Repair Section 1930-36

Constituted in the Organized Reserve 15 October 1921, assigned to the 65th Cavalry Division, and allotted to the Sixth Corps Area. Headquarters initiated 19 May 1922 at Rock Island, IL. Headquarters relocated 28 July 1925 to Ottawa, IL. Conducted summer training at Fort Sheridan, IL, or Camp Custer, MI. Headquarters consolidated 1 July 1936 with the Quartermaster Section, 65th Cavalry Division Headquarters Detachment, and reorganized and redesignated as Headquarters and Headquarters Troop, 465th Quartermaster Squadron. The remainder of the train concurrently reorganized and redesignated as elements of the 465th Quartermaster Squadron.

Status: Disbanded 30 January 1942.

Commanders, 65th Cavalry Division Quartermaster Train

Capt. John O. Allen	19 May 22-6 Jan 23	Maj. J. F. Krauser	9 Apr 24-Feb 27
Capt. William J. Arnette	6 Jan 23-9 Apr 24	Capt. Silas Cartland	Feb 27-1 Jun 28
	Unknown	1 Jun 28-1 Jul 36	

66th Cavalry Division Quartermaster Train**Organized Reserve South Dakota****HQ-***Not initiated* 1921-22; Sioux Falls, SD, 1922-26; Rapid City, SD, 1926-36**Subordinate units:** 441st Wagon Company 1921-30; 442nd Wagon Company 1921-36; 71st, 72nd, 73rd, and 74th Pack Trains 1921-36; 428th and 429th Motor Transport Companies 1930-36; 766th Motor Repair Section 1930-36

Constituted in the Organized Reserve 15 October 1921, assigned to the 66th Cavalry Division, and allotted to the Seventh Corps Area. Headquarters initiated in March 1922 at Sioux Falls, SD. Headquarters relocated 26 May 1926 to Rapid City, SD. Conducted summer training at Fort Riley, KS. Headquarters consolidated 1 July 1936 with the Quartermaster Section, 66th Cavalry Division Headquarters Detachment, and reorganized and redesignated as Headquarters and Headquarters Troop, 466th Quartermaster Squadron. The remainder of the train concurrently reorganized and redesignated as elements of the 466th Quartermaster Squadron.

Status: Disbanded 30 January 1942.**Commanders, 66th Cavalry Division Quartermaster Train**

2nd Lt. Otto W. Budde	Mar 22-13 Sep 22	Unknown	ao Oct 22-ao Mar 31
Capt. Charles A. Page	13 Sep 22-ao Oct 22	Maj. James W. Thompson	ao Mar 31-1 Jul 36

76th Division Quartermaster Train**Organized Reserve Connecticut****HQ-***Not initiated* 1921-22; Hartford, CT, 1922-36**Subordinate units:** 301st, 302nd, 303rd, and 304th Motor Transport Companies 1921-36; 301st and 302nd Motor Repair Sections 1921-36; 301st and 302nd Wagon Companies 1921-36; 76th Division Service Company 1925-36; 301st Motorcycle Company 1921-36

Constituted in the Organized Reserve 24 June 1921 as the 76th Division Train, Q.M.C., assigned to the 76th Division, and allotted to the First Corps Area. Headquarters initiated in December 1922 at Hartford, CT. Consolidated 24 August 1928 with the 301st Supply Train (constituted 5 August 1917 and organized 29 August 1917 at Camp Devens, MA; demobilized 18 July 1919 at Camp Devens, MA; reconstituted 24 August 1928). Typically conducted Inactive Training Period meetings at the Federal Building in New Haven, CT. Conducted summer training most years at Camp Devens, MA, and some years at Holabird Quartermaster Depot, MD, or Fort Dix, NJ. Headquarters consolidated 1 July 1936 with the Quartermaster Section, 76th Division Headquarters Detachment, and reorganized and redesignated as Headquarters and Headquarters Company, 401st Quartermaster Regiment. The remainder of the train concurrently reorganized and redesignated as elements of the 401st Quartermaster Regiment.

Status: Inactive in the Army Reserve as Headquarters, 4th Brigade, 76th Division (Training).**Commanders, 76th Division Quartermaster Train**

Maj. James B. Moody	Dec 22-Dec 25	Maj. Bennett Bronson	Dec 25-1 Jul 36
---------------------	---------------	----------------------	-----------------

77th Division Quartermaster Train**Organized Reserve New York****HQ-**Manhattan, NY, 1921-36**Subordinate units:** 305th, 306th, 307th, and 308th Motor Transport Companies 1921-36; 303rd and 304th Motor Repair Sections 1921-36; 303rd and 304th Wagon Companies 1921-36; 77th Division Service Company 1925-36; 302nd Motorcycle Company 1921-36

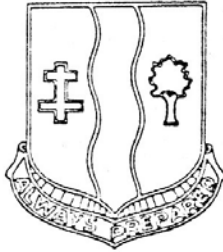

Constituted in the Organized Reserve 24 June 1921 as the 77th Division Train, Q.M.C., assigned to the 77th Division, and allotted to the Second Corps Area. Headquarters initiated 10 September 1921 at Manhattan, NY. Redesignated 23 March 1925 as the 77th Division Quartermaster Train. Conducted summer training most years at Fort Hancock, NJ, and some years at Holabird Quartermaster Depot, MD, or Camp Dix, NJ. Designated mobilization training station was Camp Dix. Headquarters consolidated 1 July 1936 with the Quartermaster Section, 77th Division Headquarters Detachment, and reorganized and redesignated as Headquarters and Headquarters Company, 402nd Quartermaster Regiment. The remainder of the train concurrently reorganized and redesignated as elements of the 402nd Quartermaster Regiment.

Status: Inactive in the Army Reserve as the 77th Supply & Transport Battalion, an element of the 77th Infantry Division.

Commanders, 77th Division Quartermaster Train

Maj. Percy K. Hexter	15 Sep 21-2 Jan 23	Unknown	ao Feb 24-ao Jul 26
Maj. Samuel H. Woods	2 Jan 23-ao Feb 24	Maj. Henry E. Russell	ao Jul 26-27 Sep 35
	Maj. Allen G. Brindley	27 Sep 35-1 Jul 36	

78th Division Quartermaster Train

Organized Reserve New Jersey

HQ-Atlantic City, NJ, 1921-22, Newark, NJ, 1922-36

Subordinate units: 309th, 310th, 311th, and 312th Motor Transport Companies 1921-36; 305th and 306th Motor Repair Sections 1921-36; 305th and 306th Wagon Companies 1921-36; 78th Division Service Company 1925-36; 303rd Motorcycle Company 1921-36

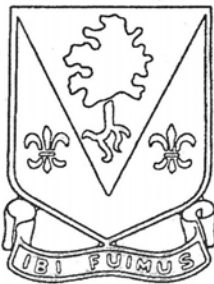

Constituted in the Organized Reserve 24 June 1921 as the 78th Division Train, Q.M.C., assigned to the 78th Division, and allotted to the Second Corps Area. Headquarters initiated 28 October 1921 at Atlantic City, NJ. Headquarters relocated about January 1922 to Newark, NJ. Redesignated 23 March 1925 as the 78th Division Quartermaster Train. Consolidated 3 June 1936 with the 303rd Supply Train (constituted 5 August 1917 and organized in December 1917 at Camp Dix, NJ; demobilized 8 June 1919 at Camp Dix, NJ; reconstituted 3 June 1936). Conducted summer training at Fort Hancock, NJ, and some years at Holabird Quartermaster Depot, MD, Camp Dix, NJ, or Miller Field, NY. Designated mobilization training station was Camp Dix. Headquarters consolidated 1 July 1936 with the Quartermaster Section, 78th Division Headquarters Detachment, and reorganized and redesignated as Headquarters and

Headquarters Company, 403rd Quartermaster Regiment. The remainder of the train concurrently reorganized and redesignated as elements of the 403rd Quartermaster Regiment.

Status: Active in the Regular Army at Fort Bragg, NC, as Headquarters, 4th Brigade, 78th Division (Training Support).

Commanders, 78th Division Quartermaster Train

Maj. Henry C. K. Mattison	28 Oct 21-7 Mar 24	Maj. Eugene H. Valle	11 Nov 24-16 Feb 31
Maj. Warren S. Hood	28 May 24-11 Nov 24	Maj. Benjamin B. Millenthal	16 Feb 31-1 Jul 36

79th Division Quartermaster Train

Organized Reserve Pennsylvania

HQ-Philadelphia, PA, 1921-36

Subordinate units: 313th, 314th, 315th, and 316th Motor Transport Companies 1921-36; 307th and 308th Motor Repair Sections 1921-36; 307th and 308th Wagon Companies 1921-36; 79th Division Service Company 1925-36; 304th Motorcycle Company 1921-36



Constituted in the Organized Reserve 24 June 1921 as the 79th Division Train, Q.M.C., assigned to the 79th Division, and allotted to the Third Corps Area. Headquarters initiated 22 October 1921 at Philadelphia, PA. Redesignated 23 March 1925 as the 79th Division Quartermaster Train. Conducted summer training most years at Holabird Quartermaster Depot, MD, and some years at Camp George G. Meade, MD. Designated mobilization training station was Camp George G. Meade. Headquarters consolidated 1 July 1936 with the Quartermaster Section, 79th Division Headquarters Detachment, and reorganized and redesignated as Headquarters and Headquarters Company, 404th Quartermaster Regiment.

The remainder of the train concurrently reorganized and redesignated as elements of the 404th Quartermaster Regiment.

Status: Inactive in the Army Reserve as the 79th Quartermaster Company, an element of the 79th Infantry Division.

Commanders, 79th Division Quartermaster Train

Maj. Joseph M. Ford	31 Oct 21-9 Feb 22	Unknown	ao Aug 23-ao May 25
Maj. James Duffy	9 Feb 22-ao Aug 23	Maj. Harold A. Roberts	ao May 25-12 Jan 32
	Maj. John P. Clark	12 Jan 32-1 Jul 36	

80th Division Quartermaster Train

Organized Reserve Virginia

HQ-Richmond, VA, 1921-36

Subordinate units: 317th, 318th, 319th, and 320th Motor Transport Companies 1921-36; 309th and 310th Motor Repair Sections 1921-36; 309th and 310th Wagon Companies 1921-36; 80th Division Service Company 1925-36; 305th Motorcycle Company 1921-36

Constituted in the Organized Reserve 24 June 1921 as the 80th Division Train, Q.M.C., assigned to the 80th Division, and allotted to the Third Corps Area. Headquarters initiated 3 December 1921 at Richmond, VA. Redesignated 23 March 1925 as the 80th Division Quartermaster Train. Conducted summer training most years at Holabird Quartermaster Depot, MD, and some years at Camp George G. Meade, MD. Designated mobilization training station was Camp George G. Meade. Headquarters consolidated 1 July 1936 with the Quartermaster Section, 80th Division Headquarters Detachment, and reorganized and redesignated as Headquarters and Headquarters Company, 405th Quartermaster Regiment. The remainder of the train concurrently reorganized and redesignated as elements of the 405th Quartermaster Regiment.

Status: Active in the Army Reserve at Charleston, WV, as Headquarters, 4th Brigade, 80th Division (Institutional Training).

Commanders, 80th Division Quartermaster Train

1st Lt. J. N. C. Egense	3 Dec 21-16 Dec 21	Unknown	ao Feb 23-ao Jul 28
Maj. Blair Wilson	16 Dec 21-4 Feb 22	Maj. Theophilus K. Harrison	ao Jul 28-ao Aug 28
Maj. James L. Kelly	4 Feb 22-30 Jan 23	Unknown	ao Aug 28-ao Jun 30
Maj. William E. Withgott	30 Jan 23-ao Feb 23	Maj. Robert S. Hudgins, Jr.	ao Jun 30-1 Jul 36

81st Division Quartermaster Train

Organized Reserve Tennessee

HQ-Memphis, TN, 1921-36

Subordinate units: 321st, 322nd, 323rd, and 324th Motor Transport Companies 1921-36; 311th and 312th Motor Repair Sections 1921-36; 311th and 312th Wagon Companies 1921-36; 81st Division Service Company 1925-36; 306th Motorcycle Company 1921-36

Constituted in the Organized Reserve 24 June 1921 as the 81st Division Train, Q.M.C., assigned to the 81st Division, and allotted to the Fourth Corps Area. Headquarters initiated 18 November 1921 at Memphis, TN. Redesignated 23 March 1925 as the 81st Division Quartermaster Train. Conducted summer training at Fort McPherson, GA, or Camp McClellan, AL. Headquarters consolidated 1 July 1936 with the Quartermaster Section, 81st Division Headquarters Detachment, and reorganized and redesignated as Headquarters and Headquarters Company, 406th Quartermaster Regiment. The remainder of the train concurrently reorganized and redesignated as elements of the 406th Quartermaster Regiment.

Status: Inactive in the Army Reserve as the 81st Supply & Transport Battalion, an element of the 81st Infantry Division.

Commanders, 81st Division Quartermaster Train

Maj. Robert O'Connell	18 Nov 21-ao Jan 22	Unknown	ao Sep 25-26 Jan 32
Unknown	ao Jan 22-ao Dec 23	Maj. John L. Godwin	26 Jan 32-ao Jun 32
Maj. Lewis W. McCary	ao Dec 23-ao Sep 25	Unknown	ao Jun 32-1 Jul 36

82nd Division Quartermaster Train

Organized Reserve Georgia/Florida

HQ-Athens, GA, 1921-30; Atlanta, GA, 1930-33; Jacksonville, FL, 1933-36

Subordinate units: 325th, 326th, 327th, and 328th Motor Transport Companies 1921-36; 313th and 314th Motor Repair Sections 1921-36; 313th and 314th Wagon Companies 1921-36; 82nd Division Service Company 1925-36; 307th Motorcycle Company 1921-36

Constituted in the Organized Reserve 24 June 1921 as the 82nd Division Train, Q.M.C., assigned to the 82nd Division, and allotted to the Fourth Corps Area. Headquarters initiated 18 November 1921 at Athens, GA. Redesignated 23 March 1925 as the 82nd Division Quartermaster Train. Headquarters successively relocated 1 August 1930 to Atlanta, GA, and 20 March 1933 to Jacksonville, FL. Conducted summer training at Fort McPherson, GA, or Fort Benning, GA. Designated mobilization training station was Fort McPherson. Headquarters consolidated 1 July 1936 with the Quartermaster Section, 82nd Division Headquarters Detachment, and reorganized and redesignated as Headquarters and Headquarters Company, 407th Quartermaster Regiment. The remainder of the train concurrently reorganized and redesignated as elements of the 407th Quartermaster Regiment.

Status: Active at Fort Bragg, NC as the 407th Support Battalion, an element of the 82nd Airborne Division.

Commanders, 82nd Division Quartermaster Train

Maj. Alexander P. Boyer	18 Nov 21-14 Jan 22	Maj. James A. Wood	14 Jan 22-ao Sep 24
	Lt. Col. Arthur V. Clifton	ao Sep 25-31 May 36	

83rd Division Quartermaster Train

Organized Reserve Ohio

HQ-*Not initiated* 1921-22; Cleveland, OH, 1922-36

Subordinate units: 329th, 330th, 331st, and 332nd Motor Transport Companies 1921-36; 315th and 316th Motor Repair Sections 1921-36; 315th and 316th Wagon Companies 1921-36; 83rd Division Service Company 1925-36; 308th Motorcycle Company 1921-36

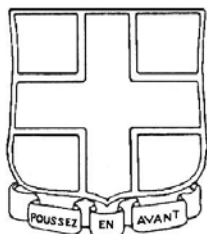

Constituted in the Organized Reserve 24 June 1921 as the 83rd Division Train, Q.M.C., assigned to the 83rd Division, and allotted to the Fifth Corps Area. Headquarters initiated by June 1922 at Cleveland, OH. Redesignated 23 March 1925 as the 83rd Division Quartermaster Train. Conducted summer training at Jeffersonville Quartermaster Depot, IN, or Camp Knox, KY. Headquarters consolidated 1 July 1936 with the Quartermaster Section, 83rd Division Headquarters Detachment, and reorganized and redesignated as Headquarters and Headquarters Company, 408th Quartermaster Regiment. The remainder of the train concurrently reorganized and redesignated as elements of the 408th Quartermaster Regiment.

Status: Inactive in the Army Reserve as the 83rd Supply & Transport Battalion, an element of the 83rd Infantry Division.

Commanders, 83rd Division Quartermaster Train

2nd Lt. Harry Y. Benner	ao Jun 22-ao Jul 22	Unknown	ao May 28-ao May 29
Maj. Clyde C. Miller	ao Nov 22-6 Nov 27	Lt. Col. William J. Walker	ao May 29-Jul 35 Maj.
Kirk C. Schaible	6 Nov 27-ao May 28	Maj. Rolland J. H. Mertz	Jul 35-31 May 36

84th Division Quartermaster Train**Organized Reserve Indiana****HQ**-South Bend, IN, 1921-36**Subordinate units:** 333rd, 334th, 335th, and 336th Motor Transport Companies 1921-36; 317th and 318th Motor Repair Sections 1921-36; 317th and 318th Wagon Companies 1921-36; 84th Division Service Company 1925-36; 309th Motorcycle Company 1921-36

Constituted in the Organized Reserve 24 June 1921 as the 84th Division Train, Q.M.C., assigned to the 84th Division, and allotted to the Fifth Corps Area. Headquarters initiated 24 October 1921 at South Bend, IN. Redesignated 23 March 1925 as the 84th Division Quartermaster Train. Conducted summer training at Jeffersonville Quartermaster Depot, IN, or Camp Knox, KY. Headquarters consolidated 1 July 1936 with the Quartermaster Section, 84th Division Headquarters Detachment, and reorganized and redesignated as Headquarters and Headquarters Company, 409th Quartermaster Regiment. The remainder of the train concurrently reorganized and redesignated as elements of the 409th Quartermaster Regiment.

Status: Active in the Army Reserve at Indianapolis, IN, as Headquarters, 4th Brigade, 84th Division (Institutional Training).**Commanders, 84th Division Quartermaster Train**

Maj. Clyde Paxon	24 Oct 21-ao Sep 24	Unknown	ao Sep 24-ao Jun 34
	Maj. Leo F. Tearney	ao Jun 34-31 May 36	

85th Division Quartermaster Train**Organized Reserve Michigan****HQ**-Kalamazoo, MI, 1921-24; Jackson, MI, 1924-25; Flint, MI, 1925-36**Subordinate units:** 337th, 338th, 339th, and 340th Motor Transport Companies 1921-36; 319th and 320th Motor Repair Sections 1921-36; 319th and 320th Wagon Companies 1921-36; 85th Division Service Company 1925-36; 310th Motorcycle Company 1921-36

Constituted in the Organized Reserve 24 June 1921 as the 85th Division Train, Q.M.C., assigned to the 85th Division, and allotted to the Sixth Corps Area. Headquarters initiated 15 November 1921 at Kalamazoo, MI. Headquarters relocated 1 February 1924 to Jackson, MI. Redesignated 23 March 1925 as the 85th Division Quartermaster Train. Headquarters relocated 31 July 1925 to Flint, MI. Conducted summer training at Fort Sheridan, IL, or Camp Custer, MI. Designated mobilization training station was the Michigan State Fairgrounds, Detroit, MI. Headquarters consolidated 1 July 1936 with the Quartermaster Section, 85th Division Headquarters Detachment, and reorganized and redesignated as Headquarters and Headquarters Company, 410th Quartermaster Regiment. The remainder of the train concurrently reorganized and redesignated as elements of the 410th Quartermaster Regiment.

Status: Active in the Regular Army at Fort Knox, KY, as the 4th Brigade, 85th Division (Training Support).**Commanders, 85th Division Quartermaster Train**

Capt. Arthur H. Anderson	15 Nov 21-30 Dec 21	Maj. Arthur H. Anderson	ao Jun 28-ao Jun 29
Maj. Elmer D. Greenamyre	30 Dec 21-6 Mar 24	Unknown	ao Jun 29-ao Jun 30
Maj. Harry E. Walsworth	7 Mar 24-ao Aug 27	Maj. Malcolm S. Wardrop	ao Jun 30-ao Jun 34
	Unknown	ao Jun 34-1 Jul 36	

86th Division Quartermaster Train**Organized Reserve Illinois****HQ**-*Not initiated* 1921-22; Chicago, IL, 1922-36**Subordinate units:** 341st, 342nd, 343rd, and 344th Motor Transport Companies 1921-36; 321st and 322nd Motor Repair Sections 1921-36; 321st and 322nd Wagon Companies 1921-36; 86th Division Service Company 1925-36; 312th Motorcycle Company 1921-36

Constituted in the Organized Reserve 24 June 1921 as the 86th Division Train, Q.M.C., assigned to the 86th Division, and allotted to the Sixth Corps Area. Headquarters initiated 1 April 1922 at Chicago, IL. Redesignated 23 March 1925 as the 86th Division Quartermaster Train. Conducted summer training at Fort Sheridan, IL, or Camp Custer, MI. Designated mobilization training station was Camp Grant, IL. Headquarters consolidated 1 July 1936 with the Quartermaster Section, 86th Division Headquarters Detachment, and reorganized and redesignated as Headquarters and Headquarters Company, 411th Quartermaster Regiment. The remainder of the train concurrently reorganized and redesignated as elements of the 411th Quartermaster Regiment.

Status: Inactive in the Army Reserve as the 86th Quartermaster Company, an element of the 86th Infantry Division.

Commanders, 86th Division Quartermaster Train

1st Lt. James M. Mozley	1 Apr 22-6 Jul 22	Lt. Col. Edward W. Chatterton	11 Jan 28-23 Aug 28
Maj. Frederick A. Thorpe	6 Jul 22-23 Dec 25	Maj. Neil R. Markle	23 Aug 28-ao Sep 28
Maj. Fred W. Hartz	23 Dec 25-ao May 26	Maj. Louis R. Kupfer	ao Jan 29-23 Apr 34
Maj. Daniel H. Burnham	ao May 27-11 Jan 28	Unknown	23 Apr 34-ao Mar 36
	Maj. Kenneth L. Van Sickle	ao Mar 36-1 Jul 36	

87th Division Quartermaster Train

Organized Reserve Louisiana

HQ-Pineville, LA, 1921-29; New Orleans, LA, 1929-36

Subordinate units: 345th, 346th, 347th, and 348th Motor Transport Companies 1921-36; 323rd and 324th Motor Repair Sections 1921-36; 323rd and 324th Wagon Companies 1921-36; 87th Division Service Company 1925-36; 313th Motorcycle Company 1921-36

Constituted in the Organized Reserve 24 June 1921 as the 87th Division Train, Q.M.C., assigned to the 87th Division, and allotted to the Fourth Corps Area. Headquarters initiated 12 December 1921 at Pineville, LA. Redesignated 23 March 1925 as the 87th Division Quartermaster Train. Headquarters relocated 22 October 1929 to New Orleans, LA. Conducted summer training at Fort McPherson, GA, or Camp McClellan, AL. Headquarters consolidated 1 July 1936 with the Quartermaster Section, 87th Division Headquarters Detachment, and reorganized and redesignated as Headquarters and Headquarters Company, 412th Quartermaster Regiment. The remainder of the train concurrently reorganized and redesignated as elements of the 412th Quartermaster Regiment.

Status: Active in the Regular Army at Fort Jackson, SC, as the 5th Brigade, 87th Division (Training Support).

Commanders, 87th Division Quartermaster Train

Maj. Alexander Fitz-Hugh	12 Dec 21-ao May 24	Unknown	ao Jan 29-26 Jan 32
Unknown	ao May 24-5 Dec 28	Maj. Leon Schwartz	26 Jan 32-22 Dec 34
Col. Charles R. Dalbey	5 Dec 28-ao Jan 29	Lt. Col. Charles Miller	22 Dec 34-9 Nov 35
	Lt. Col. Duckett F. Hopkins	9 Nov 35-1 Jul 36	

88th Division Quartermaster Train

Organized Reserve North Dakota

HQ-Bismarck, ND, 1921-22; Fargo, ND, 1922-36

Subordinate units: 349th, 350th, 351st, and 352nd Motor Transport Companies 1921-36; 325th and 326th Motor Repair Sections 1921-36; 325th and 326th Wagon Companies 1921-36; 88th Division Service Company 1925-36; 313th Motorcycle Company 1921-36

Constituted in the Organized Reserve 24 June 1921 as the 88th Division Train, Q.M.C., assigned to the 88th Division, and allotted to the Seventh Corps Area. Headquarters initiated 17 November 1921 at Bismarck, ND. Headquarters relocated 5 June 1922 to Fargo, ND. Redesignated 23 March 1925 as the 88th Division Quartermaster Train. Typically conducted Inactive Training Period meetings at the Gardner Hotel or at 514 Northern Pacific Avenue in Fargo. Conducted summer training at Fort Snelling, MN, or Fort Crook, NE. Headquarters consolidated 1 July 1936 with the Quartermaster Section, 88th Division Headquarters Detachment, and reorganized and redesignated as Headquarters and Headquarters Company, 413th Quartermaster Regiment. The remainder of the train concurrently reorganized and redesignated as elements of the 413th Quartermaster Regiment.

Status: Inactive in the Army Reserve as the 88th Quartermaster Company, an element of the 88th Infantry Division.

Commanders, 88th Division Quartermaster Train

Lt. Col. C. A. Watrous	17 Nov 21-ao Mar 22	Unknown	ao Aug 28-ao Dec 31
Unknown	ao Mar 22-ao Oct 25	Maj. Julius O. Arnson	ao Dec 31-ao Jan 32
Maj. Hardin Craig	ao Oct 25-ao Aug 28	Unknown	ao Jan 32-1 Jul 36

89th Division Quartermaster Train

Organized Reserve South Dakota

HQ-*Not initiated* 1921-22; Mitchell, SD, 1922-36

Subordinate units: 353rd, 354th, 355th, and 356th Motor Transport Companies 1921-36; 327th and 328th Motor Repair Sections 1921-36; 327th and 328th Wagon Companies 1921-36; 89th Division Service Company 1925-36; 314th Motorcycle Company 1921-36

Constituted in the Organized Reserve 24 June 1921 as the 89th Division Train, Q.M.C., assigned to the 89th Division, and allotted to the Seventh Corps Area. Headquarters initiated in January 1922 at Mitchell, SD. Redesignated 23 March 1925 as the 89th Division Quartermaster Train. Conducted summer training at Fort Snelling, MN, or Camp Crook, NE. Headquarters consolidated 1 July 1936 with the Quartermaster Section, 89th Division Headquarters Detachment, and reorganized and redesignated as Headquarters and Headquarters Company, 414th Quartermaster Regiment. The remainder of the train concurrently reorganized and redesignated as elements of the 414th Quartermaster Regiment.

Status: Inactive in the Army Reserve as the 89th Quartermaster Company, an element of the 89th Infantry Division.

Commanders, 89th Division Quartermaster Train

Unknown	Jan 22-ao Sep 25	Maj. Earl B. Rowley	ao Sep 25-ao Jun 27
	Unknown	ao Jun 27-1 Jul 36	

90th Division Quartermaster Train

Organized Reserve Texas

HQ-San Antonio, TX, 1921-36

Subordinate units: 357th, 358th, 359th, and 360th Motor Transport Companies 1921-36; 329th and 330th Motor Repair Sections 1921-36; 329th and 330th Wagon Companies 1921-36; 90th Division Service Company 1925-36; 315th Motorcycle Company 1921-36

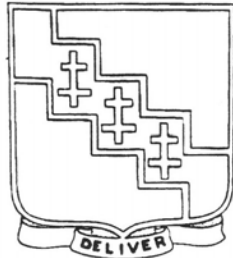

Constituted in the Organized Reserve 24 June 1921 as the 90th Division Train, Q.M.C., assigned to the 90th Division, and allotted to the Eighth Corps Area. Headquarters initiated 8 November 1921 at San Antonio, TX. Redesignated 23 March 1925 as the 90th Division Quartermaster Train. Consolidated 11 July 1931 with the 315th Supply Train (constituted and organized in September 1917 at Camp Travis, TX; demobilized in June 1919 at Camp Bowie, TX; reconstituted 11 July 1931). Typically conducted Inactive Training Period meetings at the Bexar County Courthouse and later at the Smith-Young Tower in San Antonio. Conducted summer training most years with the 2nd Division Quartermaster Train at Fort Sam Houston, TX, or Camp Bullis, TX, and some years at Normoyle Quartermaster Depot, TX. Designated mobilization training station was Fort Sam Houston. Headquarters consolidated 1 July 1936

with the Quartermaster Section, 90th Division Headquarters Detachment, and reorganized and redesignated as Headquarters and Headquarters Company, 415th Quartermaster Regiment. The remainder of the train concurrently reorganized and redesignated as elements of the 415th Quartermaster Regiment.

Status: Inactive in the Army Reserve as the 90th Supply & Transport Battalion, an element of the 90th Infantry Division.

Events: 147

Commanders, 90th Division Quartermaster Train

1st Lt. Ray Wingren	8 Nov 21-17 Apr 22	Lt. Col. Clarence H. Fitzgerald	9 Apr 29-7 Nov 31
Maj. Rollins C. Syfan	17 Apr 22-1 Jul 24	Unknown	7 Nov 31-14 Jan 33
Lt. Col. Britain R. Webb	1 Jul 24-Apr 25	Maj. Harold W. Keller	14 Jan 33-ao Feb 33
Maj. George E. Glover	Apr 25-9 Apr 29	Unknown	ao Feb 33-ao Mar 36
	Maj. M. S. Martin	ao Mar 36-1 Jul 36	

91st Division Quartermaster Train**Organized Reserve California****HQ**-Los Angeles, CA, 1921-36**Subordinate units:** 361st, 362nd, 363rd, and 364th Motor Transport Companies 1921-36; 331st and 332nd Motor Repair Sections 1921-36; 321st and 322nd Wagon Companies 1921-36; 91st Division Service Company 1925-36; 316th Motorcycle Company 1921-36

Constituted in the Organized Reserve 24 June 1921 as the 91st Division Train, Q.M.C., assigned to the 91st Division, and allotted to the Ninth Corps Area. Headquarters initiated in November 1921 at Los Angeles, CA. Redesignated 23 March 1925 as the 91st Division Quartermaster Train. Conducted summer training most years at Del Monte, CA, and some years at the Presidio of Monterey, CA, or the Presidio of San Francisco, CA. Headquarters consolidated 1 July 1936 with the Quartermaster Section, 91st Division Headquarters Detachment, and reorganized and redesignated as Headquarters and Headquarters Company, 416th Quartermaster Regiment. The remainder of the train concurrently reorganized and redesignated as elements of the 416th Quartermaster Regiment.

Status: Active in the Regular Army at Fort Lewis, WA, as the 4th Brigade, 91st Division (Training Support).**Commanders, 91st Division Quartermaster Train**

Maj. Edward S. Dobbin	11 Jan 22-ao Feb 28	Maj. Ralph J. Badgerow	ao Jun 29-ao Jul 34
Unknown	ao Feb 28-ao Jun 29	Unknown	ao Jul 34-ao Mar 36
	Maj. Leland S. Reeves	ao Mar 36-1 Jul 36	

94th Division Quartermaster Train**Organized Reserve Massachusetts****HQ**-Worcester, MA, 1921-36**Subordinate units:** 373rd, 374th, 375th, and 376th Motor Transport Companies 1921-36; 337th and 338th Motor Repair Sections 1921-36; 337th and 338th Wagon Companies 1921-36; 94th Division Service Company 1925-36; 319th Motorcycle Company 1921-36

Constituted in the Organized Reserve 24 June 1921 as the 94th Division Train, Q.M.C., assigned to the 94th Division, and allotted to the First Corps Area. Headquarters initiated 21 November 1921 at Worcester, MA. Redesignated 23 March 1925 as the 94th Division Quartermaster Train. Typically conducted Inactive Training Period meetings at the Kenmore Hotel in Boston, MA. Conducted summer training at Holabird Quartermaster Depot, MD, and some years at Fort Ethan Allen, VT, Camp Devens, MA, or Storrs, CT. Designated mobilization training station was Camp Devens. Headquarters consolidated 1 July 1936 with the Quartermaster Section, 94th Division Headquarters Detachment, and reorganized and redesignated as Headquarters and Headquarters Company, 419th Quartermaster Regiment. The remainder of the train concurrently reorganized and redesignated as elements of the 419th Quartermaster Regiment.

Status: Inactive in the Army Reserve as the 94th Quartermaster Company, an element of the 94th Infantry Division.**Commanders, 94th Division Quartermaster Train**

Capt. George T. Day	21 Nov 21-5 Dec 21	Maj. Herbert B. Fleischner	19 Apr 24-Oct 25
Maj. Joseph H. Lane	5 Dec 21-ao Jan 23	Maj. Charles W. Muldoon	Oct 25-ao Jun 31
Unknown	ao Jan 23-ao Nov 23	Maj. John J. McDonough	ao Jun 32-ao Jun 34
Maj. Thomas A. Ireland	ao Nov 23-19 Apr 24	Unknown	ao Jun 34-1 Jul 36

95th Division Quartermaster Train**Organized Reserve Oklahoma****HQ**-Lawton, OK, 1921-25; Oklahoma City, OK, 1925-36**Subordinate units:** 377th, 378th, 379th, and 380th Motor Transport Companies 1921-36; 339th and 340th Motor Repair Sections 1921-36; 339th and 340th Wagon Companies 1921-36; 95th Division Service Company 1925-36; 320th Motorcycle Company 1921-36

Constituted in the Organized Reserve 24 June 1921 as the 95th Division Train, Q.M.C., assigned to the 95th Division, and allotted to the Eighth Corps Area. Headquarters initiated 21 December 1921 at Lawton, OK. Redesignated 23 March 1925 as the 95th Division Quartermaster Train. Headquarters relocated 10 July 1925 to Oklahoma City, OK. Conducted summer training most years with the 2nd Division Quartermaster Train at Fort Sam Houston, TX, and some years at Fort Sill. Designated mobilization training station was Fort Sill, OK. Headquarters consolidated 1 July 1936 with the Quartermaster Section, 95th Division Headquarters Detachment, and reorganized and redesignated as Headquarters and Headquarters Company, 420th Quartermaster Regiment. The remainder of the train concurrently reorganized and redesignated as elements of the 420th Quartermaster Regiment.

Status: Active in the Army Reserve at Grand Prairie, TX, as Headquarters, 4th Brigade, 95th Division (Institutional Training).

Commanders, 95th Division Quartermaster Train

Maj. William R. Smith	21 Dec 21-ao Dec 24	Unknown	ao Feb 28-ao Feb 30
Unknown	ao Dec 24-ao Mar 26	Maj. Rochambeau B. Stewart	ao Feb 30-ao Mar 31
Maj. Arthur H. Bronson	ao Mar 26-ao Feb 28	Unknown	ao Mar 31-1 Jul 36

96th Division Quartermaster Train

Organized Reserve Oregon

HQ-*Not initiated* 1921-22; Portland, OR, 1922-36

Subordinate units: 381st, 382nd, 383rd, and 384th Motor Transport Companies 1921-36; 341st and 342nd Motor Repair Sections 1921-36; 341st and 342nd Wagon Companies 1921-36; 96th Division Service Company 1925-36; 321st Motorcycle Company 1921-36

Constituted in the Organized Reserve 24 June 1921 as the 96th Division Train, Q.M.C., assigned to the 96th Division, and allotted to the Ninth Corps Area. Headquarters initiated 3 May 1922 at Portland, OR. Redesignated 23 March 1925 as the 96th Division Quartermaster Train. Conducted summer training at Fort Lewis, WA. Designated mobilization training station was Fort Lewis. Headquarters consolidated 1 July 1936 with the Quartermaster Section, 96th Division Headquarters Detachment, and reorganized and redesignated as Headquarters and Headquarters Company, 421st Quartermaster Regiment. The remainder of the train concurrently reorganized and redesignated as elements of the 421st Quartermaster Regiment.

Status: Inactive in the Army Reserve as the 96th Quartermaster Company, an element of the 96th Infantry Division.

Commanders, 96th Division Quartermaster Train

Lt. Col. Wilmer B. Brinton	3 May 22-1 Jun 36
----------------------------	-------------------

97th Division Quartermaster Train

Organized Reserve Vermont

HQ-*Not initiated* 1921-22; Rutland, VT, 1922-36

Subordinate units: 385th, 386th, 387th, and 388th Motor Transport Companies 1921-36; 343rd and 344th Motor Repair Sections 1921-36; 343rd and 344th Wagon Companies 1921-36; 97th Division Service Company 1925-36; 322nd Motorcycle Company 1921-36

Constituted in the Organized Reserve 24 June 1921 as the 97th Division Train, Q.M.C., assigned to the 97th Division, and allotted to the First Corps Area. Headquarters initiated in January 1922 at Rutland, VT. Designated mobilization training station was Camp Devens, MA. Redesignated 23 March 1925 as the 97th Division Quartermaster Train. Conducted summer training at Fort Ethan Allen, VT, Camp Devens, MA, Holabird Quartermaster Depot, MD, or Storrs, CT. Headquarters consolidated 1 July 1936 with the Quartermaster Section, 97th Division Headquarters Detachment, and reorganized and redesignated as Headquarters and Headquarters Company, 422nd Quartermaster Regiment. The remainder of the train concurrently reorganized and redesignated as elements of the 422nd Quartermaster Regiment.

Status: Inactive in the Army Reserve as the 97th Quartermaster Company, an element of the 97th Infantry Division.

Commanders, 97th Division Quartermaster Train

Maj. Robert W. McCuen	Jan 22-ao Dec 22	Maj. Morris G. Hammond	Jun 25-ao Jun 31
Maj. Lynde Sullivan	ao Jun 23-ao Sep 23	Lt. Col. Howard Emerson	ao Oct 31-ao Oct 32
Unknown	ao Sep 23-ao Dec 24	Unknown	ao Oct 32-ao Jul 34
Maj. Louis G. Murphy	ao Dec 24-Jun 25	Capt. Charles R. Cheney	ao Jul 34-1Jul 36

98th Division Quartermaster Train

Organized Reserve New York

HQ-*Not initiated* 1921-22; Syracuse, NY, 1922-36

Subordinate units: 389th, 390th, 391st, and 392nd Motor Transport Companies 1921-36; 345th and 346th Motor Repair Sections 1921-36; 345th and 346th Wagon Companies 1921-36; 98th Division Service Company 1925-36; 323rd Motorcycle Company 1921-36

Constituted in the Organized Reserve 24 June 1921 as the 98th Division Train, Q.M.C., assigned to the 98th Division, and allotted to the Second Corps Area. Headquarters initiated 20 January 1922 at Syracuse, NY. Designated mobilization training station was the Syracuse Concentration Area. Redesignated 23 March 1925 as the 98th Division Quartermaster Train. Conducted summer training most years with the 1st Division Quartermaster Train at Fort Hancock, NJ, and some years at Fort Niagara, NY, Camp Dix, NJ, Holabird Quartermaster Depot, MD, or Miller Field, NY. Headquarters consolidated 1 July 1936 with the Quartermaster Section, 98th Division Headquarters Detachment, and reorganized and redesignated as Headquarters and Headquarters Company, 423rd Quartermaster Regiment. The remainder of the train concurrently reorganized and redesignated as elements of the 423rd Quartermaster Regiment.

Status: Active in the Army Reserve at West Hartford, CT, as Headquarters, 4th Brigade, 98th Division (Institutional Training).

Commanders, 98th Division Quartermaster Train

Maj. John G. Stamp, Jr.	20 Jan 22-ao Aug 24	Unknown	ao Aug 24-13 Apr 31
	Maj. Tharratt G. Best	13 Apr 31-31 May 36	

99th Division Quartermaster Train

Organized Reserve Pennsylvania

HQ-Pittsburgh, PA, 1921-36

Subordinate units: 393rd, 394th, 395th, and 396th Motor Transport Companies 1921-36; 347th and 348th Motor Repair Sections 1921-36; 347th and 348th Wagon Companies 1921-36; 99th Division Service Company 1925-36; 324th Motorcycle Company 1921-36

Constituted in the Organized Reserve 24 June 1921 as the 99th Division Train, Q.M.C., assigned to the 99th Division, and allotted to the Third Corps Area. Headquarters initiated 30 December 1921 at Pittsburgh, PA. Designated mobilization training station was Camp George G. Meade, MD. Redesignated 23 March 1925 as the 99th Division Quartermaster Train. Conducted summer training most years at Holabird Quartermaster Depot, MD. Conducted summer training with the 28th Division Quartermaster Train at Mount Gretna, PA, in 1932. Headquarters consolidated 1 July 1936 with the Quartermaster Section, 99th Division Headquarters Detachment, and reorganized and redesignated as Headquarters and Headquarters Company, 424th Quartermaster Regiment. The remainder of the train concurrently reorganized and redesignated as elements of the 424th Quartermaster Regiment.

Status: Inactive in the Army Reserve as the 99th Quartermaster Company, an element of the 99th Infantry Division.

Commanders, 99th Division Quartermaster Train

Maj. George Paull	30 Dec 21-4 Feb 22	Unknown	ao Oct 25-ao Jun 27
Maj. James L. Kelly	4 Feb 22-ao Oct 25	Maj. Clifford R. Crusan	ao Jun 27-1 Jul 36

100th Division Quartermaster Train**Organized Reserve West Virginia****HQ**-Huntington, WV, 1921-25; Wheeling, WV, 1925-31; Huntington, WV, 1931-36**Subordinate units:** 397th, 398th, 399th, and 400th Motor Transport Companies 1921-36; 349th and 350th Motor Repair Sections 1921-36; 349th and 350th Wagon Companies 1921-36; 100th Division Service Company 1925-36; 325th Motorcycle Company 1921-36

Constituted in the Organized Reserve 24 June 1921 as the 100th Division Train, Q.M.C., assigned to the 100th Division, and allotted to the Fifth Corps Area. Headquarters initiated 30 November 1921 at Huntington, WV. Redesignated 23 March 1925 as the 100th Division Quartermaster Train. Headquarters successively relocated to Wheeling, WV, 6 January 1925 and back to Huntington, 27 October 1931. Conducted summer training at Jeffersonville Quartermaster Depot, IN, Camp Knox, KY, or Fort Benjamin Harrison, IN. Headquarters consolidated 1 July 1936 with the Quartermaster Section, 100th Division Headquarters Detachment, and reorganized and redesignated as Headquarters and Headquarters Company, 425th Quartermaster Regiment. The remainder of the train concurrently reorganized and redesignated as elements of the 425th Quartermaster Regiment.

Status: Active in the Army Reserve at Montgomery, AL, as Headquarters, 4th Brigade, 100th Division (Training).**Commanders, 100th Division Quartermaster Train**

Maj. Alvaro B. McCutcheon	30 Nov 21-ao Sep 24	Lt. Col. George Jefferson	6 Jan 25-ao Feb 31
Maj. Earl Smith	ao Dec 24-6 Jan 25	Unknown	ao Feb 31-1 Jul 36

101st Division Quartermaster Train**Organized Reserve Wisconsin****HQ**-Milwaukee, WI, 1921-36**Subordinate units:** 401st, 402nd, 403rd, and 404th Motor Transport Companies 1921-36; 351st and 352nd Motor Repair Sections 1921-36; 351st and 352nd Wagon Companies 1921-36; 101st Division Service Company 1925-36; 326th Motorcycle Company 1921-36

Constituted in the Organized Reserve 24 June 1921 as the 101st Division Train, Q.M.C., assigned to the 101st Division, and allotted to the Fifth Corps Area. Headquarters initiated 8 November 1921 at Milwaukee, WI. Redesignated 23 March 1925 as the 101st Division Quartermaster Train. Conducted summer training at Fort Sheridan, IL, Camp McCoy, WI, or Camp Custer, MI. Designated mobilization training station was the Wisconsin State Fairgrounds, Milwaukee. Headquarters consolidated 1 July 1936 with the Quartermaster Section, 101st Division Headquarters Detachment, and reorganized and redesignated as Headquarters and Headquarters Company, 426th Quartermaster Regiment. The remainder of the train concurrently reorganized and redesignated as elements of the 426th Quartermaster Regiment.

Status: Active at Fort Campbell, KY, as the 426th Support Battalion, an element of the 101st Airborne Division.**Commanders, 101st Division Quartermaster Train**

Lt. Col. A. N. Besnah	8 Nov 21-20 Jan 22	Maj. Charles H. Clinton	5 Nov 28-ao Sep 30
Maj. Walter R. Reed	20 Jan 22-4 Jul 23	Unknown	ao Sep 30-ao Jun 32
Maj. Martin D. Imhoff	4 Jul 23-9 Apr 24	Lt. Col. Paul R. Wettig	ao Jun 32-ao Jul 33
Unknown	9 Apr 24-ao May 28	Unknown	ao Jul 33-ao Mar 36
Capt. Charles L. Marston, Jr.	ao May 28-5 Nov 28	Lt. Col. Garrit C. DeHeus	ao Mar 36-1 Jul 36

102nd Division Quartermaster Train**Organized Reserve Arkansas and Missouri****HQ**-Little Rock, AR, 1921-36**Subordinate units:** 405th, 406th, 407th, and 408th Motor Transport Companies 1921-36; 353rd and 354th Motor Repair Sections 1921-36; 353rd and 354th Wagon Companies 1921-36; 102nd Division Service Company 1925-36; 327th Motorcycle Company 1921-36

Constituted in the Organized Reserve 24 June 1921 as the 102nd Division Train, Q.M.C., assigned to the 102nd Division, and allotted to the Seventh Corps Area. Headquarters initiated 3 November 1921 at Little Rock, AR. Redesignated 23 March 1925 as the 102nd Division Quartermaster Train. Conducted summer training at Fort Snelling, MN, or Camp Crook, NE. Headquarters consolidated 1 July 1936 with the Quartermaster Section, 102nd Division Headquarters Detachment, and reorganized and redesignated as Headquarters and Headquarters Company, 427th Quartermaster Regiment. The remainder of the train concurrently reorganized and redesignated as elements of the 427th Quartermaster Regiment.

Status: Inactive in the Army Reserve as the 102nd Supply & Transport Battalion, an element of the 102nd Infantry Division.

Commanders, 102nd Division Quartermaster Train

Maj. Clyde N. Clarke Unknown	3 Nov 21-ao Jul 22 ao Jul 22-ao Sep 25	Maj. Edgar M. Rowe Unknown	ao Sep 25-ao Jun 32 ao Jun 32-1 Jul 36
---------------------------------	---	-------------------------------	---

103rd Division Quartermaster Train

Organized Reserve Colorado

HQ-Denver, CO, 1921-36

Subordinate units: 409th, 410th, 411th, and 412th Motor Transport Companies 1921-36; 355th and 356th Motor Repair Sections 1921-36; 355th and 356th Wagon Companies 1921-36; 103rd Division Service Company 1925-36; 328th Motorcycle Company 1921-36



Constituted in the Organized Reserve 24 June 1921 as the 103rd Division Train, Q.M.C., assigned to the 103rd Division, and allotted to the Eighth Corps Area. Headquarters initiated 9 November 1921 at Denver, CO. Redesignated 23 March 1925 as the 103rd Division Quartermaster Train. Typically conducted Inactive Training Period meetings at the Kitteridge Building in Denver. Conducted summer training with the post quartermaster detachment at Fort Francis E. Warren, WY, and some years with the 2nd Division Quartermaster Train at Fort Sam Houston, TX. Headquarters consolidated 1 July 1936 with the Quartermaster Section, 103rd Division Headquarters Detachment, and reorganized and redesignated as Headquarters and Headquarters Company, 428th Quartermaster Regiment. The remainder of the train concurrently reorganized and redesignated as elements of the 428th Quartermaster Regiment.

Status: Inactive in the Army Reserve as the 103rd Quartermaster Company, an element of the 103rd Infantry Division.

Events: 166

Commanders, 103rd Division Quartermaster Train

Capt. Norville H. Robinson Maj. Goddard Shackelford Unknown	9 Nov 21-15 Dec 21 15 Dec 21-ao Aug 27 ao Aug 27-Oct 29	Maj. Norville H. Robinson Unknown Capt. Jesse M. Dudley, Jr.	Oct 29-ao Aug 32 ao Aug 32-ao Aug 35 ao Aug 35-1 Jul 36
---	---	--	---

104th Division Quartermaster Train

Organized Reserve Utah

HQ-Salt Lake City, UT, 1921-36

Subordinate units: 413th, 414th, 415th, and 416th Motor Transport Companies 1921-36; 357th and 358th Motor Repair Sections 1921-36; 357th and 358th Wagon Companies 1921-36; 104th Division Service Company 1925-36; 329th Motorcycle Company 1921-36

Constituted in the Organized Reserve 24 June 1921 as the 104th Division Train, Q.M.C., assigned to the 104th Division, and allotted to the Ninth Corps Area. Headquarters initiated 22 December 1921 at Salt Lake City, UT. Redesignated 23 March 1925 as the 104th Division Quartermaster Train. Conducted summer training with the post quartermaster detachment at Fort Douglas, UT. Headquarters consolidated 1 July 1936 with the Quartermaster Section, 104th Division Headquarters Detachment, and reorganized and redesignated as Headquarters and Headquarters Company, 429th Quartermaster Regiment. The remainder of the train concurrently reorganized and redesignated as elements of the 429th Quartermaster Regiment.

Status: Active in the Army Reserve at Camp Parks, CA, as Headquarters, 4th Brigade, 104th Division (Institutional Training).

Commanders, 104th Division Quartermaster Train

Maj. Morton P. L. Buck
Maj. Willard G. Burton

22 Dec 21-1 Dec 24

1 Dec 24-ao Sep 27

Lt. Col. Maurice Anderson

Unknown

Lt. Col. David A. Smith

ao May 35-1 Jul 36

ao Sep 27-ao Jul 29

ao Jul 29-ao Aug 34

Chapter 39

Remount Depots

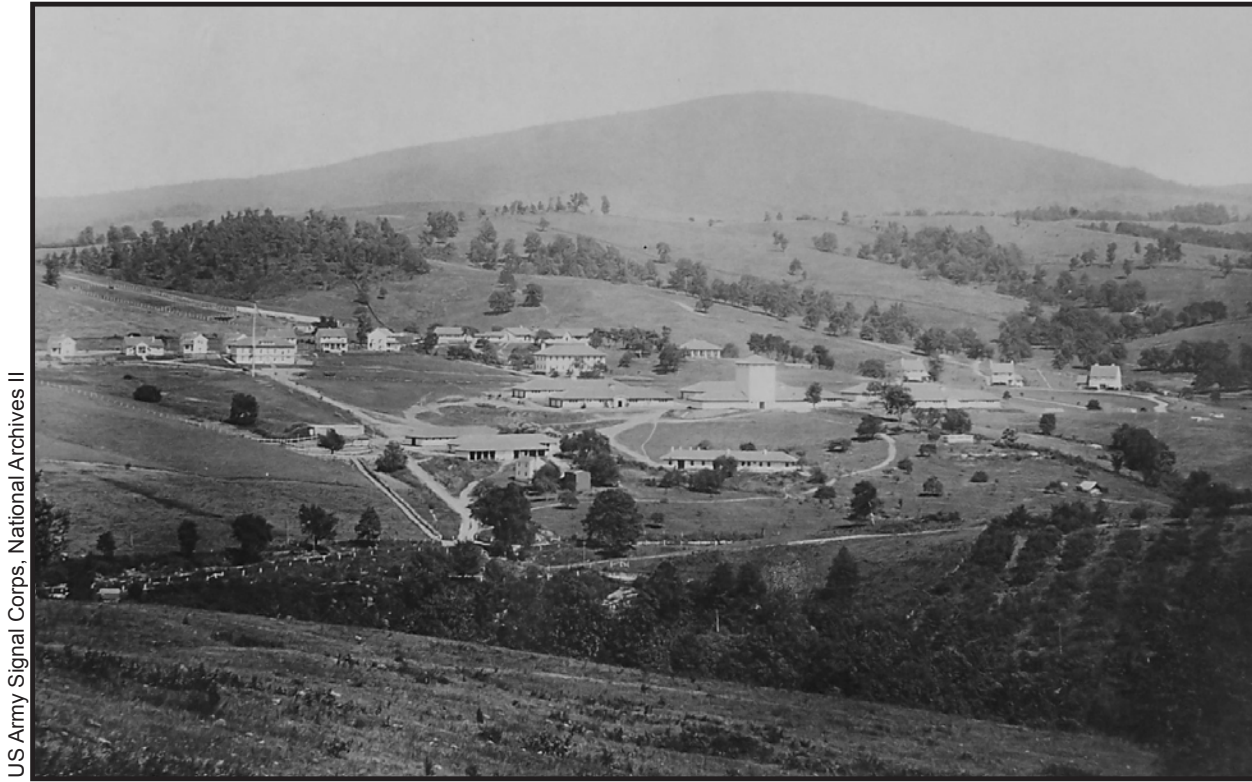

US Army Signal Corps, National Archives II

The Front Royal Remount Depot, at Front Royal, VA.

Remount depots were responsible for receiving, breaking, training, and issuing horses and mules for use by the animal-drawn units of the field army and corps.

Organization

In the interwar period, there were several quartermaster remount depots in operation around the United States. These included the Front Royal Remount Depot in Virginia, the Fort Reno Depot in Oklahoma, and the Fort Robinson Depot in Nebraska. These depots, however, were fixed facilities that were Zone of the Interior activities. There were also two types of field remount depots that were mobile units of the Army. The depot for the field army consisted of a headquarters, a headquarters section, and three remount troops. It could handle a total of 1,200 horses and/or mules at a time. The corps depot was similarly organized but only possessed one troop and had a capacity of 400 animals.

Training

There is no evidence that any of these depots were functional units during the Inactive Training Period. Most of the personnel assigned to remount organizations probably attended training at quartermaster conferences or with other units (see Chapter 37-Quartermaster Trains for a more detailed explanation of quartermaster training). Only eight of these organizations ever attended summer training as units. It appears that typically officers assigned to these units were sent to annual training as individuals to the various U.S. Army remount depots around the country.

HHD, Field Remount Depot No. 21 (1921-24) (XI Corps)

Organized Reserve Massachusetts

HHD, XI Corps Remount Depot (1924-28)

HHD, 311th Field Remount Depot (1928-36)

HQ-Southboro, MA, 1921-36

Subordinate units: 10th Remount Troop 1921-25; 310th Remount Troop 1925-36

Constituted in the Organized Reserve 29 July 1921 as Field Remount Depot No. 21, allotted to the First Corps Area, and assigned to the XI Corps. Headquarters initiated 21 December 1921 at Southboro, MA. Redesignated successively as the XI Corps Remount Depot on 31 March 1924 and 311th Field Remount Depot on 5 September 1928. Conducted summer training at Camp Holabird, MA. Demobilized 1 July 1936.

HHD, Field Remount Depot No. 22 (1921-24) (XII Corps)

Organized Reserve New Jersey

HHD, XII Corps Remount Depot (1924-28)

HHD, 312th Field Remount Depot (1928-36)

HQ-*Not initiated* 1921-22; Mount Holly, NJ, 1922-36

Subordinate units: 11th Remount Troop 1921-25; 311th Remount Troop 1925-36

Constituted in the Organized Reserve 29 July 1921 as Field Remount Depot No. 22, allotted to the Second Corps Area, and assigned to the XII Corps. Headquarters initiated 11 February 1922 at Mount Holly, NJ. Redesignated successively as the XII Corps Remount Depot on 31 March 1924 and 312th Field Remount Depot on 5 September 1928. Demobilized 1 July 1936.

HHD, Field Remount Depot No. 23 (1921-24) (XIII Corps)

Organized Reserve Pennsylvania

HHD, XIII Corps Remount Depot (1924-28)

HHD, 313th Field Remount Depot (1928-36)

HQ-Hanover, PA, 1921-29; York, PA, 1929-36

Subordinate units: 12th Remount Troop 1921-25; 312th Remount Troop 1925-36

Constituted in the Organized Reserve 29 July 1921 as Field Remount Depot No. 23, allotted to the Third Corps Area, and assigned to the XIII Corps. Headquarters initiated 22 December 1921 at Hanover, PA. Redesignated successively as the XIII Corps Remount Depot on 31 March 1924 and 313th Field Remount Depot on 5 September 1928. Headquarters relocated 11 December 1929 to York, PA. Demobilized 1 July 1936.

HHD, Field Remount Depot No. 24 (1921-24) (XIV Corps)

Organized Reserve North Carolina

HHD, XIV Corps Remount Depot (1924-28)

HHD, 314th Field Remount Depot (1928-36)

HQ-*Not initiated* 1921-22; Waynesville, NC, 1922-29; *Inactive* 1929-36

Subordinate units: 13th Remount Troop 1921-25; 313th Remount Troop 1925-36

Constituted in the Organized Reserve 29 July 1921 as Field Remount Depot No. 24, allotted to the Fourth Corps Area, and assigned to the XIV Corps. Headquarters initiated 7 April 1922 at Waynesville, NC. Redesignated successively as the XIV Corps Remount Depot on 31 March 1924 and 314th Field Remount Depot on 5 September 1928. Designated mobilization training station was Camp Jackson, SC 1922-36. Headquarters inactivated 1 October 1929 at Waynesville by relief of personnel. Demobilized 1 July 1936.

HHD, Field Remount Depot No. 25 (1921-24) (XV Corps)

Organized Reserve Ohio/Kentucky

HHD, XV Corps Remount Depot (1924-28)

HHD, 315th Field Remount Depot (1928-36)

HQ-Not initiated 1921-22; Akron, OH, 1922-31; Madisonville, KY, 1931-36

Subordinate units: 14th Remount Troop 1921-25; 314th Remount Troop 1925-36

Constituted in the Organized Reserve 29 July 1921 as Field Remount Depot No. 25, allotted to the Fifth Corps Area, and assigned to the XV Corps. Headquarters initiated in July 1922 at Akron, OH. Headquarters relocated 9 July 1931 to Madisonville, KY. Redesignated successively as the XV Corps Remount Depot on 31 March 1924 and 315th Field Remount Depot on 5 September 1928. Headquarters relocated 9 July 1931 to Madisonville, KY. Demobilized 1 July 1936.

HHD, Field Remount Depot No. 26 (1921-24) (XVI Corps)

Organized Reserve Wisconsin

HHD, XVI Corps Remount Depot (1924-28)

HHD, 316th Field Remount Depot (1928-36)

HQ-Not initiated 1921-22; Portage, WI, 1922-25; Superior, WI, 1925-36

Subordinate units: 15th Remount Troop 1921-25; 315th Remount Troop 1925-36

Constituted in the Organized Reserve 29 July 1921 as Field Remount Depot No. 26, allotted to the Sixth Corps Area, and assigned to the XVI Corps. Headquarters initiated in July 1922 at Portage, WI. Headquarters relocated 2 June 1925 to Superior, WI. Redesignated successively as the XVI Corps Remount Depot on 31 March 1924 and 316th Field Remount Depot on 5 September 1928. Designated mobilization training station was Camp McCoy, WI, 1923-36. Demobilized 1 July 1936.

HHD, Field Remount Depot No. 27 (1921-24) (XVII Corps)

Organized Reserve Missouri

HHD, XVII Corps Remount Depot (C) (1924-28)

HQ-Kansas City, MO, 1921-27; Inactive 1927-28

Subordinate units: 16th Remount Troop 1921-25; 316th Remount Troop 1925-36

Constituted in the Organized Reserve 29 July 1921 as Field Remount Depot No. 27, allotted to the Seventh Corps Area, and assigned to the XVII Corps. Headquarters initiated in December 1921 at Kansas City, MO. Redesignated as the XVII Corps Remount Depot on 31 March 1924 and designated a "Colored" unit. Withdrawn from the Seventh Corps Area 7 January 1927 and allotted to the Fourth Corps Area. Demobilized on 5 September 1928.

HHD, Field Remount Depot No. 28 (1921-24) (XVIII Corps)

Organized Reserve Texas

HHD, XVIII Corps Remount Depot (1924-28)

HHD, 318th Field Remount Depot (1928-36)

HQ-Not initiated 1921-22; Waco, TX, 1922-36

Subordinate units: 17th Remount Troop 1921-25; 317th Remount Troop 1925-36

Constituted in the Organized Reserve 29 July 1921 as Field Remount Depot No. 29, allotted to the Eighth Corps Area, and assigned to the XVIII Corps. Headquarters initiated 28 August 1922 at Waco, TX. Redesignated successively as

the XVIII Corps Remount Depot on 31 March 1924 and 318th Field Remount Depot on 5 September 1928. Conducted summer training at Fort Sam Houston, TX. Designated mobilization training station was Fort Clark, TX, 1923-36. Demobilized 1 July 1936.

HHD, Field Remount Depot No. 29 (1921-24) (XIX Corps)

Organized Reserve California

HHD, XIX Corps Remount Depot (C) (1924-28)

HHD, 319th Field Remount Depot (C) (1928-36)

HQ-Not initiated 1921-22; Pleasonton, CA, 1922-36

Subordinate units: *18th Remount Troop* 1921-25; 318th Remount Troop 1925-36

Constituted in the Organized Reserve 29 July 1921 as Field Remount Depot No. 21, allotted to the Ninth Corps Area, and assigned to the XIX Corps. Headquarters initiated 26 July 1922 at Pleasonton, CA. Redesignated as the XIX Corps Remount Depot on 31 March 1924 and concurrently designated a "Colored" unit. Redesignated 5 September 1928 as the 319th Field Remount Depot. Conducted summer training at the Presidio of Monterey, CA. Designated mobilization training station was the Pleasonton Remount Area, CA, 1923-36. Demobilized 1 July 1936.

HHD, Field Remount Depot No. 30 (1921-24) (I Corps)

Organized Reserve New York/New Jersey

HHD, I Corps Remount Depot (1924-28)

HHD, 301st Field Remount Depot (1928-36)

HQ-Not initiated 1921-22; Utica, NY, 1922-29; Hoboken, NJ, 1929-36

Subordinate units: 1st Remount Troop 1921-25; 301st Remount Troop 1925-36

Constituted in the Organized Reserve 29 July 1921 as Field Remount Depot No. 21, allotted to the First Corps Area, and assigned to the I Corps. Headquarters initiated 3 March 1922 at Utica, NY. Redesignated successively as the I Corps Remount Depot on 31 March 1924 and 301st Field Remount Depot on 5 September 1928. Headquarters relocated 2 July 1929 to Hoboken, NJ. Designated mobilization training station was Camp Dix, NJ, 1923-36. Conducted summer training at Fort Hancock, NJ. Demobilized 1 July 1936.

HHD, Field Remount Depot No. 31 (1921-24) (II Corps)

Organized Reserve New York

HHD, II Corps Remount Depot (1924-28)

HHD, 302nd HHD, Field Remount Depot (1928-36)

HQ-Not initiated 1921-22; Beacon City, NY, 1922-36

Subordinate units: 2nd Remount Troop 1921-25; 302nd Remount Troop 1925-36

Constituted in the Organized Reserve 29 July 1921 as Field Remount Depot No. 31, allotted to the Second Corps Area, and assigned to the II Corps. Headquarters initiated 27 January 1922 at Beacon City, NY. Redesignated successively as the II Corps Remount Depot on 31 March 1924 and 302nd Field Remount Depot on 5 September 1928. Conducted summer training at Fort Hancock, NJ. Demobilized 1 July 1936.

HHD, Field Remount Depot No. 11 (1921-23) (III Corps)

Pennsylvania National Guard

HHD, 38th Field Remount Depot (1923-24)

HHD, III Corps Remount Depot (1924-27)

HQ-Not initiated 1921-27

Subordinate units: *3rd Remount Troop* 1921-27

Constituted in the National Guard in 1921 as Field Remount Depot No. 11, allotted to the state of Pennsylvania, and assigned to the III Corps. Placed on the deferred list 2 July 1923 and allotted to the Organized Reserve as a Deferred National Guard unit. Concurrently redesignated as the 38th Field Remount Depot. Redesignated 31 March 1924 as the III Corps Remount Depot. Withdrawn from the Organized Reserve 22 June 1927 as a DNG unit. Withdrawn from the National Guard 17 September 1927 and demobilized.

HHD, Field Remount Depot No. 32 (1921-24) (IV Corps)

Organized Reserve Mississippi

HHD, IV Corps Remount Depot (1924-28)

HHD, 304th Field Remount Depot (1928-36)

HQ-Not initiated 1921-22; Oxford, MS, 1922-29; *Inactive* 1929-36

Subordinate units: 4th Remount Troop 1921-25; 304th Remount Troop 1925-36

Constituted in the Organized Reserve 29 July 1921 as Field Remount Depot No. 32, allotted to the Fourth Corps Area, and assigned to the IV Corps. Headquarters initiated 30 March 1922 at Oxford, MS. Redesignated successively as the IV Corps Remount Depot on 31 March 1924 and 304th Field Remount Depot on 5 September 1928. Designated mobilization training station was Camp McClellan, AL 1922-36. Headquarters inactivated 13 October 1929 by relief of personnel. Demobilized 1 July 1936.

HHD, Field Remount Depot No. 33 (1921-24) (V Corps)

Organized Reserve Kentucky

HHD, V Corps Remount Depot (1924-28)

HHD, 305th Field Remount Depot (1928-36)

HQ-Not initiated 1921-22; Bowling Green, KY, 1922-23; Louisville, KY, 1923-25; Madisonville, KY, 1925-31; Lexington, KY, 1931-36

Subordinate units: 5th Remount Troop 1921-25; 305th Remount Troop 1925-36

Constituted in the Organized Reserve 29 July 1921 as Field Remount Depot No. 34, allotted to the First Corps Area, and assigned to the V Corps. Headquarters initiated in January 1922 at Bowling Green, KY. Headquarters successively relocated to Louisville, KY, 14 December 1923; Madisonville, KY, 15 April 1925; and Lexington, KY, 9 July 1931. Redesignated successively as the V Corps Remount Depot on 31 March 1924 and 305th Field Remount Depot on 5 September 1928. Demobilized 1 July 1936.

HHD, Field Remount Depot No. 34 (1921-24) (VI Corps)

Organized Reserve Illinois

HHD, VI Corps Remount Depot (1924-28)

HHD, 306th Field Remount Depot (1928-36)

HQ-Not initiated 1921-22; East St. Louis, IL, 1922-36

Subordinate units: 6th Remount Troop 1921-25; 306th Remount Troop 1925-36

Constituted in the Organized Reserve 29 July 1921 as Field Remount Depot No. 35, allotted to the Sixth Corps Area, and assigned to the VI Corps. Headquarters initiated 1 April 1922 at East St. Louis, IL. Redesignated successively as the VI Corps Remount Depot on 31 March 1924 and 306th Field Remount Depot on 5 September 1928. Conducted summer training at Fort Sheridan, IL, or Jefferson Barracks, MO. Demobilized 1 July 1936.

HHD, Field Remount Depot No. 35 (1921-24) (VII Corps)

Organized Reserve Nebraska/Tennessee

HHD, VII Corps Remount Depot (C) (1924-28)

HHD, 307th Field Remount Depot (C) (1928-36)

HQ-Omaha, NE, 1921-27; Knoxville, TN, 1927-36

Subordinate units: 7th Remount Troop 1921-25; 307th Remount Troop 1925-36

Constituted in the Organized Reserve 29 July 1921 as Field Remount Depot No. 36, allotted to the Seventh Corps Area, and assigned to the VII Corps. Headquarters initiated 28 November 1921 at Omaha, NE. Redesignated as the VII Corps Remount Depot on 31 March 1924 and designated a "Colored" unit. Withdrawn from the Seventh Corps Area 7 January 1927 and allotted to the Fourth Corps Area. Headquarters reorganized in 1927 at Knoxville, TN. Redesignated as the 307th Field Remount Depot on 5 September 1928. Demobilized 1 July 1936.

HHD, Field Remount Depot No. 36 (1921-24) (VIII Corps)

**Organized Reserve Arizona/Texas/
North Carolina**

HHD, VIII Corps Remount Depot (C) (1924-28)

HHD, 308th Field Remount Depot (C) (1928-36)

HQ-*Not initiated* 1921-22; Phoenix, AZ, 1922-25; San Antonio, TX, 1925-27; *Inactive* 1927-29; Charlotte, NC, 1929-36

Subordinate units: 8th Remount Troop 1921-25; 308th Remount Troop 1925-36

Constituted in the Organized Reserve 29 July 1921 as Field Remount Depot No. 37, allotted to the Eighth Corps Area, and assigned to the VIII Corps. Headquarters initiated in July 1922 at Phoenix, AZ. Redesignated as the VIII Corps Remount Depot on 31 March 1924. Headquarters relocated 15 Apr 25 to San Antonio, TX. Withdrawn from the Eighth Corps Area 7 January 1927 and allotted to the Fourth Corps Area as a "Colored" unit. Redesignated 5 September 1928 as the 308th Field Remount Depot. Headquarters reorganized 22 October 1929 at Charlotte, NC. Conducted summer training at Fort Reno, OK. Demobilized 1 July 1936.

HHD, Field Remount Depot No. 37 (1921-24) (IX Corps)

Organized Reserve Kansas

HHD, IX Corps Remount Depot (C) (1924-28)

HQ-Leavenworth, KS, 1921-27; *Inactive* 1927-28

Subordinate units: 9th Remount Troop 1921-25; 309th Remount Troop 1925-36

Constituted in the Organized Reserve 29 July 1921 as Field Remount Depot No. 37, allotted to the Ninth Corps Area, and assigned to the IX Corps. Headquarters initiated in December 1921 at Leavenworth, KS. Redesignated as the IX Corps Remount Depot on 31 March 1924 and designated a "Colored" unit. Withdrawn from the Seventh Corps Area 7 January 1927 and allotted to the Fourth Corps Area. Demobilized on 5 September 1928.

HHD, I Corps Remount Depot (1927-36) (I Corps)

HQ-*Not organized* 1927-36

Constituted in the Regular Army 15 September 1927 as the I Corps Remount Depot, allotted to the Second Corps Area, and assigned to the I Corps. Designated mobilization training station was the State Fair Grounds, Syracuse, NY, 1927-36. Demobilized 1 July 1936.

HHD, II Corps Remount Depot (1927-36) (II Corps)

HQ-Not organized 1927-36

Constituted in the Regular Army 15 September 1927 as the II Corps Remount Depot, allotted to the Third Corps Area, and assigned to the II Corps. Designated mobilization training station was the State Fair Grounds, Syracuse, NY, 1927-36. Reorganized and redesignated 60th Quartermaster Regiment (Remount) 1 May 36.

HHD, III Corps Remount Depot (1927-36) (III Corps)

HQ-Not organized 1927-36

Constituted in the Regular Army 15 September 1927 as the III Corps Remount Depot, allotted to the Seventh Corps Area, and assigned to the III Corps. Fort Robinson, NE, designated as headquarters on organization, but the unit was never organized at that location. Reorganized and redesignated 63rd Quartermaster Regiment (Remount) 1 May 36.

HHD, First Army Remount Depot (1927-36) (First Army)

HQ-Not organized 1927-28; Fort Bliss, TX, 1928-36

Constituted in the Regular Army 18 September 1927 as the First Army Remount Depot, allotted to the Eighth Corps Area, and assigned to the First Army. Organized 5 Apr 28 with Organized Reserve personnel as a RAI unit with headquarters at Fort Bliss, TX. Designated mobilization training station was Fort Bliss, TX, 1927-33 and Camp Dix, NJ, 1933-36. Reorganized and redesignated 62nd Quartermaster Regiment (Remount) 1 May 36.

HHD, Field Remount Depot No. 16 (1921-23) (First Army)

New York National Guard

HHD, Field Remount Depot No. 39 (1923-25)

HHD, First Army Remount Depot (1925-27)

HHD, 1st Remount Depot (Army) (1927)

HQ-Not organized 1921-27

Subordinate units: *19th Remount Troop 1921-25; 20th Remount Troop 1921-25; 21st Remount Troop 1921-25; 319th Remount Troop 1925-27; 320th Remount Troop 1923-27; 321st Remount Troop 1923-27.*

Constituted in the National Guard in 1921 as the 16th Field Remount Depot, allotted to the state of New York, and assigned to the First Army. Syracuse, NY, designated as headquarters on organization, but the unit was never organized at that location. Placed on the deferred list 2 July 1923 and allotted to the Organized Reserve as a Deferred National Guard unit. Concurrently redesignated the Field Remount Depot No. 39. Redesignated successively as: First Army Remount Depot on 23 March 1925. and 1st Remount Depot (Army) on 22 June 1927. Withdrawn from the Organized Reserve 22 June 1927 as a DNG unit. Withdrawn from the National Guard 15 September 1927 and demobilized.

HHD, Field Remount Depot No. 44 (1921-25) (Second Army)

Organized Reserve Ohio/Kentucky

HHD, Second Army Remount Depot (1925-27)

HHD, 2nd Remount Depot (Army) (1927-28)

HQ-Not initiated 1921-22; Columbus, OH, 1922-25; Lexington, KY, 1925-28

Subordinate units: 22nd Remount Troop 1921-25; 23rd Remount Troop 1921-25; 24th Remount Troop 1921-25; 322nd Remount Troop 1922-28; 323rd Remount Troop 1925-28; 324th Remount Troop 1925-28.

Constituted in the Organized Reserve 15 October 1921 as Field Remount Depot No. 44, allotted to the Fifth Corps Area, and assigned to the Second Army. Headquarters initiated in April 1922 at Columbus, OH. Headquarters relocated by 1925 to Lexington, KY. Redesignated successively as: Second Army Remount Depot on 23 March 1925 and 2nd Remount Depot (Army) on 22 June 1927. Demobilized on 5 September 1928.

HHD, 402nd Field Remount Depot (1928-36) (Second Army)

Organized Reserve Wisconsin

HQ-*Not initiated* 1928-29; Milwaukee, WI, 1929-30; *Inactive* 1930-36

Subordinate units: 322nd Remount Troop 1928-36; 323rd Remount Troop 1928-36; 324th Remount Troop 1928-36.

Constituted in the Organized Reserve on 5 September 1928 as the 402nd Field Remount Depot, allotted to the Sixth Corps Area, and assigned to the Second Army. Headquarters initiated about October 1929 at Milwaukee, WI. Inactivated by December 1930 at Milwaukee by relief of personnel. Demobilized 1 July 1936.

HHD, Field Remount Depot No. 45 (1921-25) (Third Army)

Organized Reserve Iowa/Minnesota

HHD, Third Army Remount Depot (1925-27)

HHD, 3rd Remount Depot (Army) (1927-28)

HHD, 403rd HHD, Field Remount Depot (1928-36)

HQ-Duluth, MN, 1921-36

Subordinate units: 325th Remount Troop 1921-36; 326th Remount Troop 1921-36; 327th Remount Troop 1921-36.

Constituted in the Organized Reserve 15 October 1921 as Field Remount Depot No. 45, allotted to the Seventh Corps Area, and assigned to the Third Army. Headquarters initiated 19 December 1921 at Duluth, MN. Redesignated successively as: Third Army Remount Depot on 23 March 1925; 3rd Remount Depot (Army) on 22 June 1927; and 403rd Field Remount Depot on 5 September 1928. Demobilized 1 July 1936.

HHD, Field Remount Depot No. 41 (1921-25) (Fourth Army)

Organized Reserve Pennsylvania

HHD, Fourth Army Remount Depot (1925-27)

HHD, 4th Remount Depot (Army) (1927-28)

HHD, 404th Field Remount Depot (1928-36)

HQ-Warren, PA, 1921-24; Corry, PA, 1924-29; *Inactive* 1929-36

Subordinate units: 322nd Remount Troop 1921-36; 323rd Remount Troop 1921-36; 324th Remount Troop 1921-36.

Constituted in the Organized Reserve 15 October 1921 as Field Remount Depot No. 41, allotted to the Third Corps Area, and assigned to the Fourth Army. Headquarters initiated in December 1921 at Warren, PA. Headquarters relocated 25 November 1924 to Corry, PA. Headquarters inactivated 28 May 1929 at Waynesville by relief of personnel. Redesignated successively as: Fourth Army Remount Depot on 23 March 1925; 4th Remount Depot (Army) on 22 June 1927; and 404th Field Remount Depot on 5 September 1928. Designated mobilization training station was the Laurel, MD Mobilization Area 1928-36. Demobilized 1 July 1936.

HHD, Field Remount Depot No. 42 (1921-25) (Fifth Army)

Organized Reserve Michigan

HHD, Fifth Army Remount Depot (1925-27)

HHD, 5th Remount Depot (Army) (1927-28)

HHD, 405th Field Remount Depot (1928-36)

HQ-Lansing, MI, 1921-25; Jackson, MI, 1925-36

Subordinate units: 331st Remount Troop 1921-36; 332nd Remount Troop 1921-36; 333rd Remount Troop 1921-36.

Constituted in the Organized Reserve 15 October 1921 as Field Remount Depot No. 42, allotted to the Sixth Corps Area, and assigned to the Fifth Army. Headquarters initiated 10 November 1921 at Lansing, MI. Headquarters relocated 2 June 1925 to Jackson, MI. Redesignated successively as: Fifth Army Remount Depot on 23 March 1925; 5th Remount Depot (Army) on 22 June 1927; and 405th Field Remount Depot on 5 September 1928. Conducted summer training at Fort Sheridan, IL. Demobilized 1 July 1936.

HHD, Field Remount Depot No. 43 (1921-25) (Sixth Army)

Organized Reserve Minnesota

HHD, Sixth Army Remount Depot (1925-27)

HHD, 6th Remount Depot (Army) (1927-28)

HHD, 406th Field Remount Depot (1928-36)

HQ-*Not initiated* 1921-22; St. Paul, MN, 1922-26; Fergus Falls, MN, 1926-36

Subordinate units: 334th Remount Troop 1921-36; 335th Remount Troop 1921-36; 336th Remount Troop 1921-36.

Constituted in the Organized Reserve 15 October 1921 as Field Remount Depot No. 43, allotted to the Seventh Corps Area, and assigned to the Sixth Army. Headquarters initiated in August 1922 at St. Paul, MN. Headquarters relocated 26 May 1926 to Fergus Falls, MN. Redesignated successively as: Sixth Army Remount Depot on 23 March 1925; 6th Remount Depot (Army) on 22 June 1927; and 406th Field Remount Depot on 5 September 1928. Demobilized 1 July 1936.

Chapter 40

Motor Repair Battalions

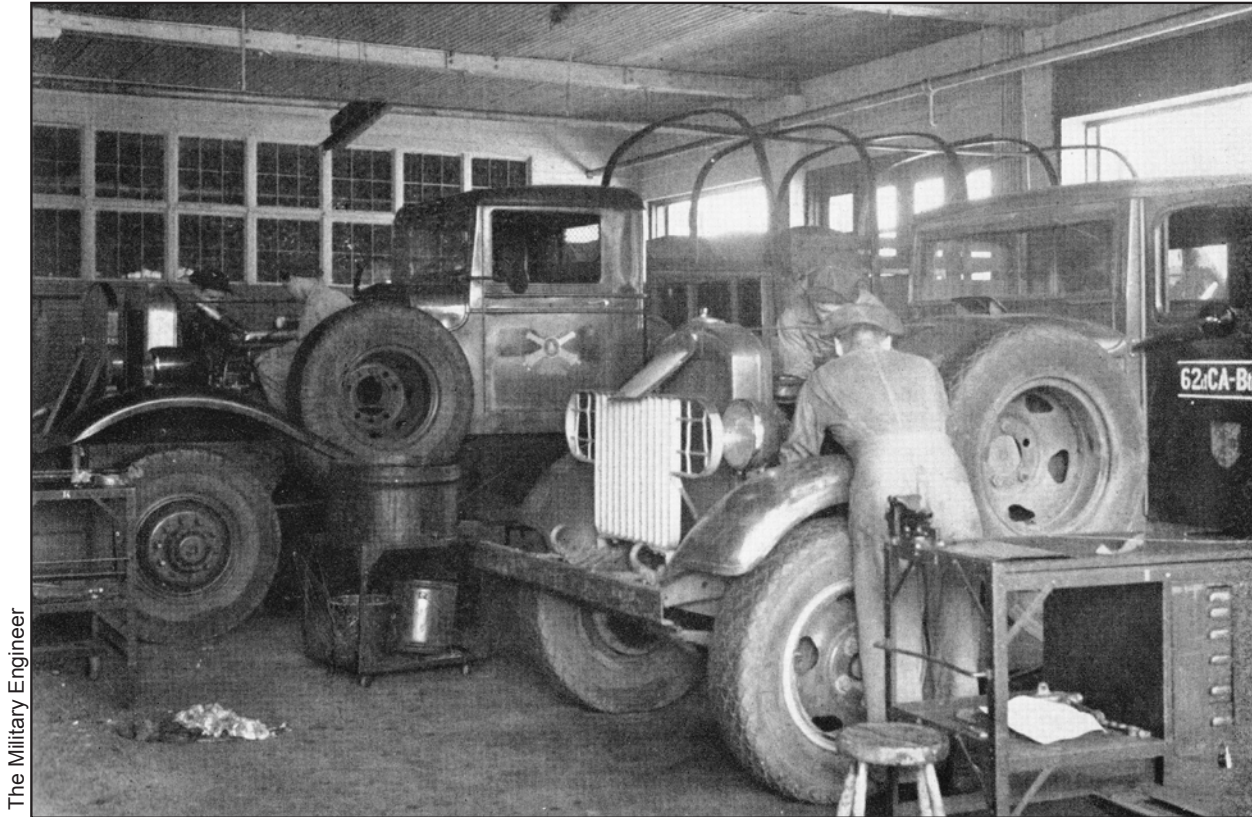

The Military Engineer

Motor Repair personnel conduct repairs on vehicles of the 62nd Coast Artillery.

The mission of the motor repair battalion was to provide repair, renovation, and limited rebuild capabilities for motorized, mechanized, and mechanical equipment at various echelons of command. These units typically performed these functions for corps and field army units, as well as higher echelons of maintenance and repair for divisional equipment.

Organization

The motor repair battalion consisted of a headquarters, a headquarters company, and four motor repair companies. Seventy-one motor repair battalions were constituted or organized in the US Army in the interwar period. Of these, nine were allotted to the Regular Army, none to the National Guard, and sixty-two to the Organized Reserve. Five of the Regular Army battalions were completely or partially organized and in active service between 1921 and 1936. The remaining four were organized as RAI units and none of those ever entered active service. All of the OR battalions were also organized, although sixteen were soon found to be excess to Army needs and demobilized in 1928. By 1930, another twenty battalions had been inactivated primarily to use those personnel to help organize various corps area service units which had a higher mobilization priority than the motor repair battalions. As part of the major 1936 reorganization of quartermaster organizations in the US Army, in May and July of that year all of the RA battalions were integrated into new quartermaster units. Twenty-nine of the OR battalions were demobilized and the Reserve personnel reassigned to new quartermaster units or units of the corps areas service commands. The remaining battalions were integrated as subordinate elements of various new quartermaster regiments.

Training

The active Regular Army battalions performed their real world mission on an almost daily basis. Thus the training for those organizations tended to focus on specialist schools, such as mechanic courses and the training of Reserve officers assigned to motor repair organizations. Few of these organizations spent much time in the field until the major field army maneuvers of the mid- to late 1930s and early 40s.

It is unlikely that very many, if any, of the Reserve motor repair battalions were ever functional organizations. Most of the personnel assigned to motor repair battalions probably attended training at quartermaster conferences or with other units during the Inactive Training period (see Chapter 37-Quartermaster Trains for a more detailed explanation of quartermaster training). Only a few of these battalions were ever ordered to summer training as cohesive units. In most instances, the personnel assigned to these units attended camp with other quartermaster units or attended one of the few camps in the various corps areas that provided motor repair training, usually at a quartermaster depot such as Holabird or Jeffersonville.

1st Motor Repair Battalion (GHQR)

HQ-Camp Holabird, MD, 1921-36

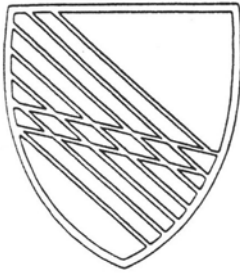

Stationed at Camp Holabird, MD, as of June 1919 as Motor Repair Unit No. 306. Redesignated Motor Repair Redesignated Motor Repair Battalion No. 1 on 22 March 1921, allotted to the Regular Army, and assigned to the General Headquarters Reserve. Assigned 13 June 1924 to the Zone of the Interior. Redesignated 23 March 1925 as the 1st Motor Repair Battalion. Reorganized and redesignated 1 June 1936 as the Company E, 23rd Quartermaster Regiment.

Status: Active in the Regular Army at Fort Eustis, VA, as the 5th Transportation Company.

2nd Motor Repair Battalion (GHQR)

HQ-Camp Holabird, MD, 1921-22; *Inactive* 1922-26; Holabird Quartermaster Depot, MD, 1926-27; *Inactive* 1927-36

Stationed at Camp Holabird, MD, as of June 1919 as Motor Repair Unit No. 305. Redesignated Motor Repair Battalion No. 2 on 22 March 1921, allotted to the Regular Army, and assigned to the General Headquarters Reserve. Inactivated 18 August 1922 at Camp Holabird. Assigned 13 June 1924 to the Zone of the Interior. Redesignated 23 March 1925 as the 2nd Motor Repair Battalion. The 1st Motor Repair Battalion made Active Associate 1922-27. Organized 24 May 1926 as a RAI unit with Organized Reserve personnel at Holabird Quartermaster Depot, MD. Inactivated 20 April 1927 at Holabird Quartermaster Depot by relief of personnel. Reorganized and redesignated 1 May 1936 as the 34th Quartermaster Regiment.

Status: Active in the Regular Army at Fort Richardson, AK, as the 167th Support Battalion.

3rd Motor Repair Battalion (GHQR)

HQ-Normoyle Quartermaster Depot, TX, 1921-36



Constituted in the Regular Army 18 March 1921 as Motor Repair Battalion No. 3, and assigned to the General Headquarters Reserve. Concurrently organized at Camp Normoyle, TX, (later redesignated Normoyle Quartermaster Depot) from Motor Repair Unit No. 304. Redesignated 23 March 1925 as the 3rd Motor Repair Battalion. Assigned by 1928 to the Zone of the Interior. Company A was transferred in 1931 to Jeffersonville Quartermaster Depot, IN, and Company C was transferred to Fort Mason, CA. Designated mobilization training station was Camp Normoyle, TX, for inactive elements. Redesignated 1 May 1936 as the 1st Battalion, 55th Quartermaster Regiment (Heavy Maintenance).

Status: Inactive in the Regular Army as the 188th Maintenance Battalion.

4th Motor Repair Battalion (GHQR)

HQ-Camp Boyd, TX, 1921-22; Fort Mason, CA, 1922-31; Holabird Quartermaster Depot, MD, 1931-36

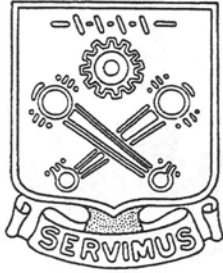

Constituted in the Regular Army 18 March 1921 as Motor Repair Battalion No. 4, and assigned to the General Headquarters Reserve. Concurrently organized, less Companies C and D, at Camp Boyd, TX, from Motor Repair Unit No. 315. Companies C and D organized at the Presidio of San Francisco, CA, from Sections 9, 10, 11, and 12, Motor Repair Unit No. 315. Headquarters and Companies C and D were transferred in 1922 to Fort Mason, CA. Concurrently, Company A was transferred to Camp Jesup, GA, and Company B transferred to Camp Normoyle, TX. Redesignated 23 March 1925 as the 4th Motor Repair Battalion. In 1927, Company A was transferred to Holabird Quartermaster Depot, MD, and Company B was transferred to Jeffersonville Quartermaster Depot, IN. Assigned by 1928 to the Zone of the Interior. Entire battalion, less D Company (inactive), transferred in 1931 to Holabird

Quartermaster Depot, MD. Reorganized and redesignated 1 May 1936 as the 1st Battalion, 53rd Quartermaster Regiment (Heavy Maintenance).

5th Motor Repair Battalion

Regular Army Inactive

HQ-Not constituted

Constituted in the Regular Army in 1924 to consist of A and B Companies only. Headquarters, Hawaiian Department designated Active Associate for Company A and Headquarters, Philippine Department designated Active Associate for Company B. Company A redesignated A Company, 90th Quartermaster Battalion 1 June 1936 and activated at Fort Armstrong, TH.

6th Motor Repair Battalion

Regular Army Inactive

HQ-*Not organized* 1927-32; Third Corps Area at large 1932-36

Constituted in the Regular Army 18 October 1927 and allotted to the Third Corps Area. Organized 22 April 1930 as a RAI unit with Organized Reserve personnel in the Third Corps Area at large. Designated mobilization station was Holabird Quartermaster Depot, MD. Reorganized and redesignated 1 May 1936 as the 53rd Quartermaster Regiment (Heavy Maintenance), less 1st Battalion.

Status: Active in the Regular Army at Fort Gillem, GA, as the 184th Ordnance Battalion.

7th Motor Repair Battalion

Regular Army Inactive

HQ-*Not organized* 1927-28; Cincinnati, OH, 1928-36

Constituted in the Regular Army 18 October 1927 and allotted to the Fifth Corps Area. Organized 3 January 1928 as a RAI unit with Organized Reserve personnel at Cincinnati, OH. Reorganized and redesignated 1 May 1936 as the 3rd Battalion, 56th Quartermaster Regiment (Heavy Maintenance).

Status: Active in the Regular Army in Germany as the 191st Ordnance Battalion.

8th Motor Repair Battalion

Regular Army Inactive

HQ-*Not organized* 1927-28; Flint, MI, 1928-36

Constituted in the Regular Army 18 October 1927 and allotted to the Sixth Corps Area. Organized 23 October 1928 as a RAI unit with Organized Reserve personnel at Flint, MI. Conducted summer training at Fort Sheridan, IL, or Camp Custer, MI. Reorganized and redesignated 1 May 1936 as the 57th Quartermaster Regiment (Heavy Maintenance), less 3rd Battalion.

1978

9th Motor Repair Battalion**Regular Army Inactive****HQ-Not organized** 1927-28; Detroit, MI, 1928-36

Constituted in the Regular Army 18 October 1927 and allotted to the Sixth Corps Area. Organized 29 October 1928 as a RAI unit with Organized Reserve personnel at Detroit, MI. Conducted summer training at Camp Custer, MI. Reorganized and redesignated 1 May 1936 as the 3rd Battalion, 57th Quartermaster Regiment (Heavy Maintenance).

301st Motor Repair Battalion (Fourth Army)**Organized Reserve Rhode Island/Indiana****HQ-Not initiated** 1921-22; Providence, RI, 1922-27; *Inactive* 1927-31; Peru, IN, 1931-36

Constituted in the Organized Reserve 15 October 1921, assigned to the Fourth Army, and allotted to the First Corps Area. Initiated 3 March 1922 with headquarters at Providence, RI. Withdrawn from the First Corps Area 7 January 1927 and allotted to the Fifth Corps Area. Inactivated 4 February 1927 at Providence by relief of personnel. Reorganized by June 1931 at Peru, IN. Demobilized 1 July 1936.

302nd Motor Repair Battalion (Fourth Army)**Organized Reserve New Jersey****HQ-Not initiated** 1921-22; Orange, NJ, 1922-36

Constituted in the Organized Reserve 15 October 1921, assigned to the Fourth Army, and allotted to the First Corps Area. Initiated 11 February 1922 with headquarters at Orange, NJ. Reorganized and redesignated 1 July 1936 as the 521st Quartermaster Regiment (Heavy Maintenance), less 2nd and 3rd Battalions.

303rd Motor Repair Battalion (Fourth Army)**Organized Reserve New York****HQ-Not initiated** 1921-22; Syracuse, NY, 1922-36

Constituted in the Organized Reserve 15 October 1921, assigned to the Fourth Army, and allotted to the Second Corps Area. Initiated 17 March 1922 with headquarters at Syracuse, NY. Reorganized and redesignated 1 July 1936 as the 2nd Battalion, 521st Quartermaster Regiment (Heavy Maintenance).

304th Motor Repair Battalion (Fourth Army)**Organized Reserve Pennsylvania****HQ-Not initiated** 1921-22; Beaver, PA, 1922-30; *Inactive* 1930-36

Constituted in the Organized Reserve 15 October 1921, assigned to the Fourth Army, and allotted to the Third Corps Area. Initiated 4 February 1922 at Beaver, PA. Inactivated 15 January 1930 at Beaver by relief of personnel. Reorganized and redesignated 1 July 1936 as the 522nd Quartermaster Regiment (Heavy Maintenance), less 2nd and 3rd Battalions.

305th Motor Repair Battalion (Fifth Army)**Organized Reserve Pennsylvania****HQ-Not initiated** 1921-22; Johnstown, PA, 1922-28

Constituted in the Organized Reserve 15 October 1921, assigned to the Fifth Army, and allotted to the Third Corps Area. Initiated 21 April 1922 with headquarters at Johnstown, PA. Withdrawn from the Third Corps Area 6 October 1928 and demobilized.

306th Motor Repair Battalion (First Army)

Organized Reserve Tennessee

HQ-Not initiated 1921-22; Nashville, TN, 1922-23; Knoxville, TN, 1923-36

Constituted in the Organized Reserve 15 October 1921, assigned to the First Army, and allotted to the Fourth Corps Area. Initiated 23 March 1922 with headquarters at Nashville, TN. Relocated by December 1923 to Knoxville, TN. Designated mobilization training station was Camp McClellan, AL. Demobilized 1 July 1936.

307th Motor Repair Battalion (Second Army)

Organized Reserve Indiana/Ohio

HQ-Not initiated 1921-22; Van Buren, IN, 1922-24; Salem, OH, 1924-36

Constituted in the Organized Reserve 15 October 1921, assigned to the Second Army, and allotted to the Fifth Corps Area. Initiated by December 1922 with headquarters at Van Buren, IN. Relocated by December 1924 to Salem, OH. Reorganized and redesignated 1 July 1936 as the 523rd Quartermaster Regiment (Heavy Maintenance), less 2nd and 3rd Battalions.

308th Motor Repair Battalion (Fifth Army)

Organized Reserve Indiana/Ohio

HQ-Not initiated 1921-22; Indianapolis, IN, 1922-24; Columbus, OH, 1923-27; *Inactive* 1927-36

Constituted in the Organized Reserve 15 October 1921, assigned to the Fifth Army, and allotted to the Fifth Corps Area. Initiated by December 1922 with headquarters at Indianapolis, IN. Relocated by December 1924 to Columbus, OH. Inactivated by June 1927 at Columbus by relief of personnel. Zanesville, OH, designated as headquarters on reorganization, but the unit was never organized at that location. Reorganized and redesignated 1 July 1936 as the 2nd Battalion, 523rd Quartermaster Regiment (Heavy Maintenance).

309th Motor Repair Battalion (Sixth Army)

Organized Reserve Illinois

HQ-Not initiated 1921-22; Kankakee, IL, 1922-23; Hinsdale, IL, 1923-25; Chicago Heights, IL, 1925-36

Constituted in the Organized Reserve 15 October 1921, assigned to the Sixth Army, and allotted to the Sixth Corps Area. Initiated 19 May 1922 with headquarters at Kankakee, IL. Relocated by June 1923 to Hinsdale, IL. Relocated 28 July 1925 to Chicago Heights, IL. Conducted summer training at Fort Sheridan, IL, or Camp Custer, MI. Reorganized and redesignated 1 July 1936 as the 524th Quartermaster Regiment (Heavy Maintenance), less 2nd and 3rd Battalions.

310th Motor Repair Battalion (Sixth Army)

Organized Reserve Illinois/Wisconsin

HQ-Not initiated 1921-22; Moline, IL, 1922-23; Dixon, IL, 1923-25; Kenosha, WI, 1925-30; *Inactive* 1930-36

Constituted in the Organized Reserve 15 October 1921, assigned to the Sixth Army, and allotted to the Sixth Corps Area. Initiated 19 May 1922 with headquarters at Moline, IL. Relocated by June 1923 to Dixon, IL. Relocated 2 June 1925 to Kenosha, WI. Inactivated by December 1930 at Kenosha by relief of personnel. Conducted summer training at Fort Sheridan, IL. Demobilized 1 July 1936.

311th Motor Repair Battalion (Sixth Army)

Organized Reserve Iowa

HQ-Not initiated 1921-22; Waterloo, IA, 1922-31; Humboldt, IA, 1931-36

Constituted in the Organized Reserve 15 October 1921, assigned to the Sixth Army, and allotted to the Seventh Corps Area. Initiated by 1922 with headquarters at Waterloo, IA. Relocated about 1931 to Humboldt, IA. Demobilized 1 July 1936.

312th Motor Repair Battalion (Sixth Army)

Organized Reserve California

HQ-Not initiated 1921-22; Oakland, CA, 1922-29; *Inactive* 1929-36

Constituted in the Organized Reserve 15 October 1921, assigned to the Sixth Army, and allotted to the Ninth Corps Area. Initiated 28 January 1922 with headquarters at Oakland, CA. Conducted summer training at the Presidio of San Francisco, CA. Inactivated 24 October 1929 at Oakland by relief of personnel. Demobilized 1 July 1936.

313th Motor Repair Battalion (First Army)

Organized Reserve Massachusetts/West Virginia

HQ-Not initiated 1921-22; Worcester, MA, 1922-27; Huntington, WV, 1927-36

Constituted in the Organized Reserve 15 October 1921, assigned to the First Army, and allotted to the First Corps Area. Initiated 11 October 1922 with headquarters at Worcester, MA. Withdrawn from the First Corps Area 7 January 1927 and allotted to the Fifth Corps Area. Inactivated 3 February 1927 at Worcester by relief of personnel. Reorganized by December 1927 at Huntington, WV. Reorganized and redesignated 1 July 1936 as the 3rd Battalion, 523rd Quartermaster Regiment (Heavy Maintenance).

314th Motor Repair Battalion (First Army)

Organized Reserve New York

HQ-Not initiated 1921-22; Manhattan, NY, 1922-31; *Inactive* 1931-36

Constituted in the Organized Reserve 15 October 1921, assigned to the First Army, and allotted to the Second Corps Area. Initiated 11 February 1922 with headquarters at Manhattan, NY. Inactivated by June 1931 at Manhattan by relief of personnel. Reorganized and redesignated 1 July 1936 as the 3rd Battalion, 521st Quartermaster Regiment (Heavy Maintenance).

315th Motor Repair Battalion (First Army)

Organized Reserve Pennsylvania

HQ-Not initiated 1921-22; New Castle, PA, 1922-36

Constituted in the Organized Reserve 15 October 1921, assigned to the First Army, and allotted to the Third Corps Area. Initiated by December 1922 with headquarters at New Castle, PA. Conducted summer training at Holabird Quartermaster Depot, MD. Reorganized and redesignated 1 July 1936 as the 2nd Battalion, 522nd Quartermaster Regiment (Heavy Maintenance).

316th Motor Repair Battalion (Sixth Army)

Organized Reserve Georgia

HQ-Not initiated 1921-22; Gainesville, GA, 1922-29; Atlanta, GA, 1929-36

Constituted in the Organized Reserve 15 October 1921, assigned to the Sixth Army, and allotted to the Fourth Corps Area. Initiated 10 March 1922 with headquarters at Gainesville, GA. Relocated 22 October 1929 to Atlanta, GA. Designated mobilization training station was Camp McClellan, AL. Demobilized 1 July 1936.

317th Motor Repair Battalion (Second Army)

Organized Reserve Ohio/West Virginia

HQ-Not initiated 1921-22; Cleveland, OH, 1922-30; Huntington, WV, 1930-36

Constituted in the Organized Reserve 15 October 1921, assigned to the Second Army, and allotted to the Fifth Corps Area. Initiated 4 March 1922 with headquarters at Cleveland, OH. Relocated by 1930 to Huntington, WV. Conducted summer training at Jeffersonville Quartermaster Depot, IN. Demobilized 1 July 1936.

318th Motor Repair Battalion (Second Army)**Organized Reserve Michigan/Illinois****HQ**-Detroit, MI, 1921-25; Aurora, IL, 1925-36

Constituted in the Organized Reserve 15 October 1921, assigned to the Second Army, and allotted to the Sixth Corps Area. Initiated 12 December 1921 with headquarters at Detroit, MI. Relocated 28 July 1925 to Aurora, IL. Conducted summer training at Fort Sheridan, IL, or Camp Custer, MI. Designated mobilization station was the Michigan State Fairgrounds in Detroit. Reorganized and redesignated 1 July 1936 as the 2nd Battalion, 524th Quartermaster Regiment (Heavy Maintenance).

319th Motor Repair Battalion (Second Army)**Organized Reserve Michigan/Illinois****HQ**-Lansing, MI, 1921-25; Chicago, IL, 1925-36

Constituted in the Organized Reserve 15 October 1921, assigned to the Second Army, and allotted to the Sixth Corps Area. Initiated 23 November 1921 with headquarters at Lansing, MI. Relocated 28 July 1925 to Chicago, IL. Conducted summer training at Fort Sheridan, IL, or Camp Custer, MI. Reorganized and redesignated 1 July 1936 as the 3rd Battalion, 524th Quartermaster Regiment (Heavy Maintenance).

320th Motor Repair Battalion (Third Army)**Organized Reserve Iowa/Nebraska****HQ**-*Not initiated* 1921-22; Des Moines, IA, 1922-28; Omaha, NE, 1928-29; *Inactive* 1929-36

Constituted in the Organized Reserve 15 October 1921, assigned to the Third Army, and allotted to the Seventh Corps Area. Initiated by 1922 with headquarters at Des Moines, IA. Relocated in late 1928 to Omaha, NE. Inactivated 8 October 1929 at Omaha by relief of personnel. Demobilized 1 July 1936.

321st Motor Repair Battalion (GHQR)**Organized Reserve Kansas/Arkansas****HQ**-*Not initiated* 1921-24; Wichita, KS, 1924-28; Little Rock, AR, 1928

Constituted in the Organized Reserve 15 October 1921, assigned to the General Headquarters Reserve, and allotted to the Seventh Corps Area. Initiated by 1924 with headquarters at Wichita, KS. Relocated 3 April 1928 to Little Rock, AR. Withdrawn from the Seventh Corps Area 6 October 1928 and demobilized.

322nd Motor Repair Battalion (GHQR)**Organized Reserve New York****HQ**-*Not initiated* 1921-22; Buffalo, NY, 1922-28

Constituted in the Organized Reserve 15 October 1921, assigned to the General Headquarters Reserve, and allotted to the Second Corps Area. Initiated 16 November 1921 with headquarters at Buffalo, NY. Withdrawn from the Second Corps Area 6 October 1928 and demobilized.

323rd Motor Repair Battalion (GHQR)**Organized Reserve Pennsylvania****HQ**-*Not initiated* 1921-22; Oxford, PA, 1922-36

Constituted in the Organized Reserve 15 October 1921, assigned to the General Headquarters Reserve, and allotted to the Third Corps Area. Initiated 7 April 1922 with headquarters at Oxford, PA. Demobilized 1 July 1936.

324th Motor Repair Battalion (GHQR)**Organized Reserve Alabama**

HQ-Not initiated 1921-22; Birmingham, AL, 1922-29; Jasper, AL, 1929-36

Constituted in the Organized Reserve 15 October 1921, assigned to the General Headquarters Reserve, and allotted to the Fourth Corps Area. Initiated 21 March 1922 with headquarters at Birmingham, AL. Relocated 22 October 1929 to Jasper, AL. Designated mobilization training station was Camp McClellan, AL. Demobilized 1 July 1936.

325th Motor Repair Battalion (GHQR)**Organized Reserve Ohio**

HQ-Not initiated 1921-22; Cleveland, OH, 1922-31; Youngstown, OH, 1931-36

Constituted in the Organized Reserve 15 October 1921, assigned to the General Headquarters Reserve, and allotted to the Fifth Corps Area. Initiated by December 1922 with headquarters at Cleveland, OH. Relocated by 1931 to Youngstown, OH. Conducted annual summer training with Company B, 4th Motor Repair Battalion and Company A, 3rd Motor Repair Battalion at Jeffersonville Quartermaster Depot, IN. Demobilized 1 July 1936.

326th Motor Repair Battalion (GHQR)**Organized Reserve Ohio**

HQ-Not initiated 1921-22; Cleveland, OH, 1922-30; *Inactive* 1930-36

Constituted in the Organized Reserve 15 October 1921, assigned to the General Headquarters Reserve, and allotted to the Fifth Corps Area. Initiated by December 1922 with headquarters at Cleveland, OH. Conducted annual summer training with Company B, 4th Motor Repair Battalion and Company A, 3rd Motor Repair Battalion at Jeffersonville Quartermaster Depot, IN. Inactivated by March 1930 at Cleveland by relief of personnel. Demobilized 1 July 1936.

327th Motor Repair Battalion (GHQR)**Organized Reserve Michigan**

HQ-Not initiated 1921-23; Flint, MI, 1923-30; *Inactive* 1930-36

Constituted in the Organized Reserve 15 October 1921, assigned to the General Headquarters Reserve, and allotted to the Sixth Corps Area. Initiated 30 December 1921 with headquarters at Flint, MI. Inactivated by June 1930 at Flint by relief of personnel. Conducted summer training at Camp Custer, MI. Designated mobilization station was the Michigan State Fairgrounds in Detroit. Demobilized 1 July 1936.

328th Motor Repair Battalion (GHQR)**Organized Reserve Illinois**

HQ-Not initiated 1921-22; Aurora, IL, 1922-24; Villa Park, IL, 1924-25; Chicago, IL, 1925-36

Constituted in the Organized Reserve 15 October 1921, assigned to the General Headquarters Reserve, and allotted to the Sixth Corps Area. Initiated 6 June 1922 with headquarters at Aurora, IL. Relocated 18 April 1924 to Villa Park, IL. Relocated 28 July 1925 to Chicago, IL. Conducted summer training at Fort Sheridan, IL, or Camp Custer, MI. Designated mobilization training station was Camp Grant, IL. Reorganized and redesignated 1 July 1936 as the 525th Quartermaster Regiment (Heavy Maintenance), less 2nd and 3rd Battalions.

329th Motor Repair Battalion (GHQR)**Organized Reserve Illinois**

HQ-Not initiated 1921-22; Sterling, IL, 1922-25; Chicago, IL, 1925-30; *Inactive* 1930-36

Constituted in the Organized Reserve 15 October 1921, assigned to the General Headquarters Reserve, and allotted to the Sixth Corps Area. Initiated in June 1922 with headquarters at Sterling, IL. Relocated 28 July 1925 to Chicago, IL. Inactivated by December 1930 at Chicago by relief of personnel. Conducted summer training at Fort Sheridan, IL. Reorganized and redesignated 1 July 1936 as the 2nd Battalion, 525th Quartermaster Regiment.

330th Motor Repair Battalion (GHQR)

Organized Reserve Minnesota

HQ-Not initiated 1921-22; Minneapolis, MN, 1922-28; Mankato, MN, 1928

Constituted in the Organized Reserve 15 October 1921, assigned to the General Headquarters Reserve, and allotted to the Seventh Corps Area. Initiated by 1922 with headquarters at Minneapolis, MN. Relocated 3 April 1928 to Mankato, MN. Withdrawn from the Seventh Corps Area 6 October 1928 and demobilized.

331st Motor Repair Battalion (GHQR)

Organized Reserve California

HQ-Not initiated 1921-23; Eighth Corps Area 1923-24; San Francisco, CA, 1924-36

Constituted in the Organized Reserve 15 October 1921, assigned to the General Headquarters Reserve, and allotted to the Eighth Corps Area. Initiated about April 1923 in the Eighth Corps Area. Withdrawn from the Eighth Corps Area 31 March 1924 and allotted to the Ninth Corps Area. Reorganized in 1924 with headquarters at San Francisco, CA. Conducted summer training at the Presidio of San Francisco, CA, or the Presidio of Monterey, CA. Demobilized 1 July 1936.

332nd Motor Repair Battalion (GHQR)

Organized Reserve California

HQ-Not initiated 1921-22; San Francisco, CA, 1922-28

Constituted in the Organized Reserve 15 October 1921, assigned to the General Headquarters Reserve, and allotted to the Ninth Corps Area. Initiated 28 January 1922 with headquarters at San Francisco, CA. Conducted summer training at the Presidio of San Francisco, CA. Withdrawn from the Ninth Corps Area 6 October 1928 and demobilized.

333rd Motor Repair Battalion (GHQR)

Organized Reserve Nebraska

HQ-Not initiated 1921-22; Omaha, NE, 1922-26; Lincoln, NE, 1926-29; *Inactive* 1929-36

Constituted in the Organized Reserve 15 October 1921, assigned to the General Headquarters Reserve, and allotted to the Seventh Corps Area. Initiated 16 December 1922 with headquarters at Omaha, NE. Relocated 26 May 1926 to Lincoln, NE. Inactivated 8 October 1929 at Lincoln by relief of personnel. Demobilized 1 July 1936.

334th Motor Repair Battalion (GHQR)

Organized Reserve New York

HQ-Not initiated 1921-22; Bronx, NY, 1922-28

Constituted in the Organized Reserve 15 October 1921, assigned to the General Headquarters Reserve, and allotted to the Second Corps Area. Initiated 13 March 1922 with headquarters at Bronx, NY. Withdrawn from the Second Corps Area 6 October 1928 and demobilized.

335th Motor Repair Battalion (GHQR)**Organized Reserve New York/New Jersey**

HQ-*Not initiated* 1921-22; Manhattan, NY, 1922-25; Jersey City, NJ, 1925-30; *Inactive* 1930-36

Constituted in the Organized Reserve 15 October 1921, assigned to the General Headquarters Reserve, and allotted to the Second Corps Area. Initiated 16 February 1922 with headquarters at Manhattan, NY. Relocated 2 March 1925 to Jersey City, NJ. Inactivated by June 1930 at Jersey City by relief of personnel. Demobilized 1 July 1936.

336th Motor Repair Battalion (GHQR)**Organized Reserve Pennsylvania**

HQ-Mauch Chunk, PA, 1921-30; *Inactive* 1930-36

Constituted in the Organized Reserve 15 October 1921, assigned to the General Headquarters Reserve, and allotted to the Third Corps Area. Initiated 26 November 1921 with headquarters at Mauch Chunk, PA. Inactivated by June 1930 at Mauch Chunk by relief of personnel. Demobilized 1 July 1936.

337th Motor Repair Battalion (GHQR)**Organized Reserve Louisiana**

HQ-*Not initiated* 1921-22; New Orleans, LA, 1922-28

Constituted in the Organized Reserve 15 October 1921, assigned to the General Headquarters Reserve, and allotted to the Fourth Corps Area. Initiated 20 March 1922 with headquarters at New Orleans, LA. Designated mobilization training station was Camp Beauregard, LA. Withdrawn from the Fourth Corps Area 6 October 1928 and demobilized.

338th Motor Repair Battalion (ZI)**Organized Reserve Ohio**

HQ-*Not initiated* 1921-22; Cincinnati, OH, 1922-27; *Inactive* 1927-28

Constituted in the Organized Reserve 15 October 1921, assigned to the Zone of the Interior, and allotted to the Fifth Corps Area. Initiated by December 1922 with headquarters at Cincinnati, OH. Inactivated by June 1927 at Cincinnati by relief of personnel. Conducted summer training at Jeffersonville Quartermaster Depot, IN. Withdrawn from the Fifth Corps Area 6 October 1928 and demobilized.

339th Motor Repair Battalion (GHQR)**Organized Reserve Ohio/Wisconsin**

HQ-*Not initiated* 1921-23; Canton, OH, 1923-27; *Inactive* 1927-28

Constituted in the Organized Reserve 15 October 1921, assigned to the General Headquarters Reserve and allotted to the Fifth Corps Area. Initiated in November 1923 with headquarters at Canton, OH. Inactivated by June 1927 at Canton by relief of personnel. Racine, WI, designated as headquarters on reorganization, but the unit was never organized at that location. Withdrawn from the Fifth Corps Area 6 October 1928 and demobilized.

340th Motor Repair Battalion (ZI)**Organized Reserve Wisconsin/Illinois**

HQ-*Not initiated* 1921-22; Milwaukee, WI, 1922-24; Chicago, IL, 1924-27; Milwaukee, WI, 1927-30; *Inactive* 1930-36

Constituted in the Organized Reserve 15 October 1921, assigned to the Zone of the Interior, and allotted to the Sixth Corps Area. Initiated 24 November 1922 with headquarters at Milwaukee, WI. Relocated 18 April 1924 to Chicago, IL. Relocated 7 January 1927 to Milwaukee. Inactivated by June 1930 at Milwaukee by relief of personnel. Conducted summer training at Fort Sheridan, IL. Designated mobilization training station was Camp Jesup, GA. Demobilized 1 July 1936.

341st Motor Repair Battalion (GHQR)**Organized Reserve Minnesota/North Dakota**

HQ-Not initiated 1921-22; St. Paul, MN, 1922-26; Duluth, MN, 1926-31; Fargo, ND, 1931-36

Constituted in the Organized Reserve 15 October 1921, assigned to the General Headquarters Reserve, and allotted to the Seventh Corps Area. Initiated by 1922 with headquarters at St. Paul, MN. Relocated 3 April 1928 to Duluth, MN. Relocated 12 October 1931 to Fargo, ND. Demobilized 1 July 1936.

342nd Motor Repair Battalion (GHQR)**Organized Reserve California**

HQ-Not initiated 1921-22; Los Angeles, CA, 1922-29; *Inactive* 1929-36

Constituted in the Organized Reserve 15 October 1921, assigned to the General Headquarters Reserve, and allotted to the Ninth Corps Area. Initiated 28 January 1922 with headquarters at Los Angeles, CA. Conducted summer training at the Presidio of San Francisco, CA. Inactivated 24 October 1929 at Los Angeles by relief of personnel. Demobilized 1 July 1936.

343rd Motor Repair Battalion (Third Army)**Organized Reserve Texas/Missouri**

HQ-Not initiated 1921-23; El Paso, TX, 1923-27; St. Louis, MO, 1927-36

Constituted in the Organized Reserve 15 October 1921, assigned to the Third Army, and allotted to the Eighth Corps Area. Initiated 26 February 1923 at El Paso, TX. Conducted summer training at Fort Bliss, TX, 1924-26. Withdrawn from the Eighth Corps Area 11 January 1927 and allotted to the Seventh Corps Area. Inactivated 9 February 1927 at El Paso by relief of personnel. Reorganized by December 1927 at St. Louis, MO. Reorganized and redesignated 1 July 1936 as the 526th Quartermaster Regiment (Heavy Maintenance), less 2nd and 3rd Battalions.

344th Motor Repair Battalion (Third Army)**Organized Reserve California**

HQ-Not initiated 1921-22; Los Angeles, CA, 1922-29; *Inactive* 1929-36

Constituted in the Organized Reserve 15 October 1921, assigned to the Third Army, and allotted to the Ninth Corps Area. Initiated 21 July 1922 with headquarters at Los Angeles, CA. Conducted summer training at the Presidio of San Francisco, CA. Inactivated 24 October 1929 at Los Angeles by relief of personnel. Demobilized 1 July 1936.

345th Motor Repair Battalion (Third Army)**Organized Reserve Washington**

HQ-Not initiated 1921-23; Seattle, WA, 1923-36

Constituted in the Organized Reserve 15 October 1921, assigned to the Third Army, and allotted to the Ninth Corps Area. Initiated by 1923 with headquarters at Seattle, WA. Conducted summer training at Fort Lewis, WA. Demobilized 1 July 1936.

346th Motor Repair Battalion (Sixth Army)**Organized Reserve Texas**

HQ-Not initiated 1921-25; Hallettsville, TX, 1925-28

Constituted in the Organized Reserve 15 October 1921, assigned to the Sixth Army, and allotted to the Eighth Corps Area. Initiated 19 January 1925 with headquarters at Hallettsville, TX. Inactivated 22 October 1928 at Hallettsville by relief of personnel. Conducted summer training at Fort Sam Houston, TX, or Fort Logan, CO. Withdrawn from the Eighth Corps Area 6 October 1928 and demobilized.

347th Motor Repair Battalion (GHQR)

Organized Reserve

HQ-Not initiated 1921-36

Constituted in the Organized Reserve 15 October 1921 and assigned to the General Headquarters Reserve. Unit apparently never allotted. Demobilized 1 July 1936.

348th Motor Repair Battalion (GHQR)

Organized Reserve

HQ-Not initiated 1921-22; Third Corps Area 1922-26; *Inactive* 1926-36

Constituted in the Organized Reserve 15 October 1921, assigned to the General Headquarters Reserve, and allotted to the Third Corps Area. Initiated by 1922 in the Third Corps Area. Inactivated by June 1926 by relief of personnel. Demobilized 1 July 1936.

349th Motor Repair Battalion (GHQR)

Organized Reserve Pennsylvania

HQ-Not initiated 1921-22; Greensburg, PA, 1922-30; *Inactive* 1930-36

Constituted in the Organized Reserve 15 October 1921, assigned to the General Headquarters Reserve, and allotted to the Third Corps Area. Initiated by 1922 with headquarters at Greensburg, PA. Inactivated 16 January 1930 at Greensburg by relief of personnel. Demobilized 1 July 1936.

350th Motor Repair Battalion (GHQR)

Organized Reserve Kentucky

HQ-Not initiated 1921-27; Louisville, KY, 1927-36

Constituted in the Organized Reserve 15 October 1921, assigned to the General Headquarters Reserve, and allotted to the Third Corps Area. Withdrawn from the Third Corps Area 11 January 1927 and allotted to the Fifth Corps Area. Initiated 20 January 1927 at Louisville, KY. Demobilized 1 July 1936.

351st Motor Repair Battalion (GHQR)

Organized Reserve Ohio

HQ-Not initiated 1921-23; Cleveland, OH, 1923-31; Toledo, OH, 1931-36

Constituted in the Organized Reserve 15 October 1921, assigned to the General Headquarters Reserve, and allotted to the Fifth Corps Area. Initiated by 1923 with headquarters at Cleveland, OH. Relocated by 1931 to Toledo, OH. Demobilized 1 July 1936.

352nd Motor Repair Battalion (GHQR)

Organized Reserve Ohio

HQ-Not initiated 1921-23; Beria, OH, 1923-28

Constituted in the Organized Reserve 15 October 1921, assigned to the General Headquarters Reserve, and allotted to the Fifth Corps Area. Initiated by 1923 with headquarters at Beria, OH. Withdrawn from the Fifth Corps Area 6 October 1928 and demobilized.

353rd Motor Repair Battalion (GHQR)**Organized Reserve Michigan/Wisconsin**

HQ-Not initiated 1921-23; Detroit, MI, 1923-29; Milwaukee, WI, 1929-30; *Inactive* 1930-36

Constituted in the Organized Reserve 15 October 1921, assigned to the General Headquarters Reserve, and allotted to the Sixth Corps Area. Initiated by 1923 with headquarters at Detroit, MI. Relocated 29 March 1929 to Milwaukee, WI. Inactivated by June 1930 at Milwaukee by relief of personnel. Conducted summer training at Camp Custer, MI. Designated mobilization station was the Michigan State Fairgrounds in Detroit. Reorganized and redesignated 1 July 1936 as the 3rd Battalion, 525th Quartermaster Regiment (Heavy Maintenance).

354th Motor Repair Battalion (GHQR)**Organized Reserve Illinois/Wisconsin**

HQ-Not initiated 1921-22; Milwaukee, WI, 1922-24; Chicago, IL, 1924-27; Milwaukee, WI, 1927-30; *Inactive* 1930-36

Constituted in the Organized Reserve 15 October 1921, assigned to the Zone of the Interior, and allotted to the Sixth Corps Area. Initiated 24 November 1922 with headquarters at Milwaukee, WI. Relocated 18 April 1924 to Chicago, IL. Relocated 7 January 1927 to Milwaukee. Inactivated by June 1930 at Milwaukee by relief of personnel. Conducted summer training at Fort Sheridan, IL. Designated mobilization training station was Camp Jesup, GA. Demobilized 1 July 1936.

355th Motor Repair Battalion (CZ)**Organized Reserve Ohio**

HQ-Not initiated 1921-23; Cincinnati, OH, 1923-28

Constituted in the Organized Reserve 15 October 1921, assigned to the Communications Zone, and allotted to the Fifth Corps Area. Initiated by 1923 with headquarters at Cincinnati, OH. Withdrawn from the Fifth Corps Area 6 October 1928 and demobilized.

356th Motor Repair Battalion (CZ)**Organized Reserve Ohio**

HQ-Not initiated 1921-23; Canton, OH, 1923-28

Constituted in the Organized Reserve 15 October 1921, assigned to the Communications Zone, and allotted to the Fifth Corps Area. Initiated by 1923 with headquarters at Canton, OH. Withdrawn from the Fifth Corps Area 6 October 1928 and demobilized.

357th Motor Repair Battalion (GHQR)**Organized Reserve Illinois**

HQ-Not initiated 1921-22; Chicago, IL, 1922-28

Constituted in the Organized Reserve 15 October 1921, assigned to the General Headquarters Reserve, and allotted to the Sixth Corps Area. Initiated 30 June 1922 with headquarters at Chicago, IL. Inactivated by June 1928 at Chicago by relief of personnel. Designated mobilization station was Camp Douglas, WI. Withdrawn from the Fifth Corps Area 6 October 1928 and demobilized.

358th Motor Repair Battalion (CZ)**Organized Reserve Michigan**

HQ-Not initiated 1921-24; Detroit, MI, 1924-28

Constituted in the Organized Reserve 15 October 1921, assigned to the Communication Zone, and allotted to the Sixth Corps Area. Initiated by 1924 with headquarters at Detroit, MI. Conducted summer training at Camp Custer, MI. Withdrawn from the Fifth Corps Area 6 October 1928 and demobilized.

359th Motor Repair Battalion (ZI)

Organized Reserve Kansas

HQ-Not initiated 1921-23; Topeka, KS, 1923-28; Pittsburg, KS, 1928-36

Constituted in the Organized Reserve 15 October 1921, assigned to the Zone of the Interior, and allotted to the Seventh Corps Area. Initiated by 1923 with headquarters at Topeka, KS. Relocated 3 April 1928 to Pittsburg, KS. Reorganized and redesignated 1 July 1936 as the 2nd Battalion, 526th Quartermaster Regiment (Heavy Maintenance).

360th Motor Repair Battalion (ZI)

Organized Reserve North Dakota/Nebraska

HQ-Not initiated 1921-24; Fargo, ND, 1924-28; Hastings, NE, 1928-36

Constituted in the Organized Reserve 15 October 1921, assigned to the Zone of the Interior, and allotted to the Seventh Corps Area. Initiated by 1924 with headquarters at Fargo, ND. Relocated 3 April 1928 to Hastings, NE. Reorganized and redesignated 1 July 1936 as the 3rd Battalion, 526th Quartermaster Regiment (Heavy Maintenance).

361st Motor Repair Battalion (ZI)

Organized Reserve South Dakota/Iowa

HQ-Sioux Falls, SD, 1924-26; Waterloo, IA, 1926-31; Des Moines, IA, 1931-36

Constituted in the Organized Reserve 31 March 1924, assigned to the Zone of the Interior, and allotted to the Seventh Corps Area. Initiated in November 1924 with headquarters at Sioux Falls, SD. Headquarters relocated 26 May 1926 to Waterloo, IA. Entire battalion relocated 12 October 1931 to Des Moines, IA. Demobilized 1 July 1936.

362nd Motor Repair Battalion (ZI)

Organized Reserve Texas

HQ-Not initiated 1924-25; Yoakum, TX, 1925; Camp Normoyle, TX, 1925-28

Constituted in the Organized Reserve 31 March 1924, assigned to the Zone of the Interior, and allotted to the Eighth Corps Area. Initiated in February 1925 with headquarters at Yoakum, TX. Relocated 15 April 1925 to Camp Normoyle, TX. Conducted summer training at Fort Sam Houston, TX. Designated mobilization training station was Camp Normoyle. Withdrawn from the Eighth Corps Area 6 October 1928 and demobilized.

Chapter 41

Service Battalions



National Archives II

Quartermaster service personnel manhandle supplies into position at a supply point during the 1935 First Army maneuver in upstate New York.

The mission of the service battalion was to provide logistics, service, and labor support to various echelons of command, typically at the corps level and higher.

Organization

The service battalion consisted of a headquarters, a headquarters and service company, and four service companies. The unit possessed no specialized equipment and performed no specialized functions. The units could be employed in various roles to include bulk supply loading and unloading, light construction and repair, and longshoreman missions. The unit could also supply manpower for other labor intensive missions as needed. Given the segregation policies of the time, it is therefore not surprising that many of these battalions were designated as “colored” organizations.

Almost 150 service battalions were constituted in the US Army in the interwar period. Of these, eleven were allotted the Regular Army, three in the National Guard, and the remainder in the Organized Reserve. All of the Regular Army battalions were organized as RAI units; none were in active service. None of the three NG battalions were ever organized. All were deferred in 1923, then withdrawn in 1927 and concurrently demobilized. Thirty-two of the OR battalions were never organized. Seventeen more were demobilized in 1928, and by 1929, about half of the others had been inactivated primarily to help organize various corps

area service units which had a higher mobilization priority than the service battalions. As part of the major 1936 reorganization of quartermaster organizations in the US Army, in May and July of that year, eight of the RA battalions and 102 of the OR battalions were demobilized and the Reserve personnel reassigned to new quartermaster units or units of the corps areas service commands. The remaining battalions were integrated as subordinate elements of various new quartermaster regiments.

Training

Though many of these organizations were organized in the Reserve, given their menial labor mission, they were understandably unpopular units which to be assigned. As a result, many remained understrength or not initiated throughout their existence. It is unlikely that very many, if any, of these battalions were ever functional organizations, and few were ever ordered to summer training as cohesive units. Most of the assigned personnel probably attended training at quartermaster conferences or with other units (see Chapter 37-Quartermaster Trains for a more detailed explanation of quartermaster training). In most instances, the personnel assigned to these units attended camp with other quartermaster units or attended one of the quartermaster branch camps in the corps area.

1st Service Battalion (C)**Regular Army Inactive****HQ-Not organized** 1927-30; Baltimore, MD, 1930-36

Constituted in the Regular Army 18 October 1927 and allotted to the Third Corps Area. Organized 17 January 1930 with Organized Reserve personnel as a RAI unit at Baltimore, MD. Demobilized 1 May 1936.

2nd Service Battalion (C)**Regular Army Inactive****HQ-Not organized** 1927-28; Columbia, SC, 1928-36

Constituted in the Regular Army 18 October 1927 and allotted to the Fourth Corps Area. Organized 17 March 1928 with Organized Reserve personnel as a RAI unit at Columbia, SC. Reorganized and redesignated as the 65th Quartermaster Regiment (Service) 1 April 1936.

Status: Disbanded 18 October 1943.**3rd Service Battalion (C)****Regular Army Inactive****HQ-Not organized** 1927-28; Fourth Corps Area 1928-36

Constituted in the Regular Army 18 October 1927 and allotted to the Fourth Corps Area. Organized 20 September 1928 with Organized Reserve personnel as a RAI unit in the Fourth Corps Area. Demobilized 1 May 1936.

4th Service Battalion (C)**Regular Army Inactive****HQ-Not organized** 1927-28; Fourth Corps Area 1928-36

Constituted in the Regular Army 18 October 1927 and allotted to the Fourth Corps Area. Organized 20 September 1928 with Organized Reserve personnel as a RAI unit in the Fourth Corps Area. Demobilized 1 May 1936.

5th Service Battalion (C)**Regular Army Inactive****HQ-Not organized** 1927-28; Jackson, MS, 1928-36

Constituted in the Regular Army 18 October 1927 and allotted to the Fourth Corps Area. Organized 20 September 1928 with Organized Reserve personnel as a RAI unit at Jackson, MS. Reorganized and redesignated as the 66th Quartermaster Regiment (Service) 1 May 1936 and allotted to the Fourth Corps Area.

Status: Disbanded 18 October 1943.**6th Service Battalion (C)****Regular Army Inactive****HQ-Not organized** 1927-28; Atlanta, GA, 1928-36

Constituted in the Regular Army 18 October 1927 and allotted to the Fourth Corps Area. Organized 10 May 1928 as a RAI unit with Organized Reserve personnel at Atlanta, GA. Demobilized 1 May 1936.

7th Service Battalion (C)**Regular Army Inactive****HQ-Not organized** 1927-28; Fourth Corps Area 1928-36

Constituted in the Regular Army 18 October 1927 and allotted to the Fourth Corps Area. Organized 30 August 1928 with Organized Reserve personnel as a RAI unit in the Fourth Corps Area. Demobilized 1 May 1936.

8th Service Battalion (C)**Regular Army Inactive****HQ-Not organized** 1927-28; Akron, OH, 1928-36

Constituted in the Regular Army 18 October 1927 and allotted to the Fifth Corps Area. Organized 8 February 1928 with Organized Reserve personnel as a RAI unit at Akron, OH. Demobilized 1 May 1936.

9th Service Battalion (C)**Regular Army Inactive****HQ-Not organized** 1927-28; Flint, MI, 1928-36

Constituted in the Regular Army 18 October 1927 and allotted to the Sixth Corps Area. Organized 8 August 1928 with Organized Reserve personnel as a RAI unit at Flint, MI. Conducted summer training at Camp Custer, MI. Demobilized 1 May 1936.

10th Service Battalion (C)**Regular Army Inactive****HQ-Not organized** 1927-30; Fourth Corps Area 1930-36

Constituted in the Regular Army 18 October 1927 and allotted to the Seventh Corps Area. Omaha, NE, designated as headquarters upon organization, but the unit was never organized at that location. Withdrawn from the Seventh Corps Area by 1930 and allotted to the Fourth Corps Area. Organized in 1930 with Organized Reserve personnel as a RAI unit in the Fourth Corps Area. Demobilized 1 May 1936.

11th Service Battalion**Regular Army Inactive****HQ-Not organized** 1927-28; San Antonio, TX, 1928-36

Constituted in the Regular Army 18 October 1927 and allotted to the Eighth Corps Area. Organized 5 April 1928 with Organized Reserve personnel as a RAI unit at San Antonio, TX. Conducted summer training at Fort Sam Houston, TX, with the Eighth Corps Area Quartermaster Section. Designated mobilization training station was Fort Sam Houston, TX. Demobilized 1 May 1936.

111th Service Battalion (IV Corps)**Mississippi National Guard****HQ-Not organized** 1921-27

Constituted in the National Guard in 1921 as the 111th Service Battalion, assigned to the IV Corps, and allotted to the state of Mississippi. Redesignated 2 July 1923 as the 111th Service Battalion. Concurrently placed on the deferred list, unit requirement transferred to the Organized Reserve, and redesignated as the 337th Service Battalion. Withdrawn from the National Guard 17 September 1927.

112th Service Battalion (V Corps)**West Virginia National Guard****HQ-Not organized** 1921-27

Constituted in the National Guard in 1921 as the 12th Service Battalion, assigned to the V Corps, and allotted to the state of West Virginia. Redesignated 2 July 1923 as the 112th Service Battalion. Concurrently placed on the deferred list, unit requirement transferred to the Organized Reserve, and redesignated as the 338th Service Battalion. Withdrawn from the National Guard 17 September 1927.

116th Service Battalion (First Army)**Virginia National Guard****HQ-Not organized** 1921-27

Constituted in the National Guard in 1921 as the 16th Service Battalion, assigned to the First Army, and allotted to the state of Virginia. Redesignated 2 July 1923 as the 116th Service Battalion. Concurrently placed on the deferred list, unit requirement transferred to the Organized Reserve, and redesignated as the 339th Service Battalion. Withdrawn from the National Guard 17 September 1927.

301st Service Battalion**Organized Reserve New York****HQ-Not initiated** 1921-36

Constituted in the Organized Reserve 15 October 1921 as the 301st Service Battalion and allotted to the Second Corps Area. Redesignated 2 July 1923 as the 1st Service Battalion. Redesignated 23 March 1925 as the 301st Service Battalion. Demobilized 1 July 1936.

302nd Service Battalion**Organized Reserve New York****HQ-Not initiated** 1921-36

Constituted in the Organized Reserve 15 October 1921 as the 302nd Service Battalion and allotted to the Second Corps Area. New York City, NY, designated as headquarters upon organization, but the unit was never organized at that location. Redesignated 2 July 1923 as the 2nd Service Battalion. Redesignated 23 March 1925 as the 302nd Service Battalion. Demobilized 1 July 1936.

303rd Service Battalion**Organized Reserve New Jersey****HQ-Not initiated** 1921-36

Constituted in the Organized Reserve 15 October 1921 as the 303rd Service Battalion and allotted to the Second Corps Area. Arlington, NJ, designated as headquarters upon organization, but the unit was never organized at that location. Redesignated 2 July 1923 as the 3rd Service Battalion. Redesignated 23 March 1925 as the 303rd Service Battalion. Demobilized 1 July 1936.

304th Service Battalion**Organized Reserve Pennsylvania****HQ-Not initiated** 1921-36

Constituted in the Organized Reserve 15 October 1921 as the 304th Service Battalion and allotted to the Third Corps Area. Pittsburgh, PA, designated as headquarters upon organization, but the unit was never organized at that location. Redesignated 2 July 1923 as the 4th Service Battalion. Redesignated 23 March 1925 as the 304th Service Battalion. Demobilized 1 July 1936.

305th Service Battalion**Organized Reserve Maryland**

HQ-Baltimore, MD, 1922-36

Constituted in the Organized Reserve 15 October 1921 as the 305th Service Battalion, assigned to the Fifth Army, and allotted to the Third Corps Area. Organized 3 March 1922 at Baltimore, MD. Redesignated 2 July 1923 as the 5th Service Battalion. Redesignated 23 March 1925 as the 305th Service Battalion. Demobilized 1 July 1936.

306th Service Battalion**Organized Reserve Tennessee**

HQ-*Not initiated* 1921-36

Constituted in the Organized Reserve 15 October 1921 as the 306th Service Battalion and allotted to the Fourth Corps Area. Nashville, TN, designated as headquarters upon organization, but the unit was never organized at that location. Redesignated 2 July 1923 as the 6th Service Battalion. Redesignated 23 March 1925 as the 306th Service Battalion. Demobilized 1 July 1936.

307th Service Battalion**Organized Reserve Indiana**

HQ-*Not initiated* 1921-36

Constituted in the Organized Reserve 15 October 1921 as the 307th Service Battalion and allotted to the Fifth Corps Area. Redesignated 2 July 1923 as the 7th Service Battalion. Redesignated 23 March 1925 as the 307th Service Battalion. Demobilized 1 July 1936.

308th Service Battalion**Organized Reserve Ohio**

HQ-*Not initiated* 1921-36

Constituted in the Organized Reserve 15 October 1921 as the 308th Service Battalion and allotted to the Fifth Corps Area. Columbus, OH, designated as headquarters upon organization, but the unit was never organized at that location. Redesignated 2 July 1923 as the 8th Service Battalion. Redesignated 23 March 1925 as the 308th Service Battalion. Demobilized 1 July 1936.

309th Service Battalion**Organized Reserve Illinois**

HQ-*Not initiated* 1921-36

Constituted in the Organized Reserve 15 October 1921 as the 309th Service Battalion and allotted to the Sixth Corps Area. Chicago, IL, designated as headquarters upon organization, but the unit was never organized at that location. Redesignated 2 July 1923 as the 9th Service Battalion. Redesignated 23 March 1925 as the 309th Service Battalion. Demobilized 1 July 1936.

310th Service Battalion**Organized Reserve Illinois**

HQ-*Not initiated* 1921-36

Constituted in the Organized Reserve 15 October 1921 as the 310th Service Battalion and allotted to the Sixth Corps Area. Chicago, IL, designated as headquarters upon organization, but the unit was never organized at that location. Redesignated 2 July 1923 as the 10th Service Battalion. Redesignated 23 March 1925 as the 310th Service Battalion. Demobilized 1 July 1936.

311th Service Battalion**Organized Reserve Iowa**

HQ-Not initiated 1921-36

Constituted in the Organized Reserve 15 October 1921 as the 311th Service Battalion and allotted to the Seventh Corps Area. Humboldt, IA, designated as headquarters upon organization, but the unit was never organized at that location. Redesignated 2 July 1923 as the 11th Service Battalion. Redesignated 23 March 1925 as the 311th Service Battalion. Demobilized 1 July 1936.

312th Service Battalion**Organized Reserve California**

HQ-Not initiated 1921-36

Constituted in the Organized Reserve 15 October 1921 as the 312th Service Battalion and allotted to the Ninth Corps Area. San Francisco, CA, designated as headquarters upon organization, but the unit was never organized at that location. Redesignated 2 July 1923 as the 12th Service Battalion. Redesignated 23 March 1925 as the 312th Service Battalion. Designated headquarters changed in 1925 to Oakland, CA. Demobilized 1 July 1936.

313th Service Battalion**Organized Reserve Massachusetts**

HQ-Not initiated 1921-36

Constituted in the Organized Reserve 15 October 1921 as the 313th Service Battalion and allotted to the First Corps Area. Worcester, MA, designated as headquarters upon organization, but the unit was never organized at that location. Redesignated 2 July 1923 as the 13th Service Battalion. Redesignated 23 March 1925 as the 313th Service Battalion. Demobilized 1 July 1936.

314th Service Battalion**Organized Reserve New York**

HQ-Not initiated 1921-36

Constituted in the Organized Reserve 15 October 1921 as the 314th Service Battalion and allotted to the Second Corps Area. Brooklyn, NY, designated as headquarters upon organization, but the unit was never organized at that location. Redesignated 2 July 1923 as the 14th Service Battalion. Redesignated 23 March 1925 as the 314th Service Battalion. Demobilized 1 July 1936.

315th Service Battalion (C)**Organized Reserve Alabama**

HQ-Not initiated 1921-24; Huntsville, AL, 1924-25; Inactive 1925-36

Constituted in the Organized Reserve 15 October 1921 as the 315th Service Battalion and allotted to the Fourth Corps Area. Redesignated 2 July 1923 as the 15th Service Battalion. Initiated in April 1924 with headquarters at Huntsville, AL. Inactivated by June 1925 at Huntsville by relief of personnel. Redesignated 23 March 1925 as the 315th Service Battalion. Demobilized 1 July 1936.

316th Service Battalion**Organized Reserve Mississippi**

HQ-Not initiated 1921-36

Constituted in the Organized Reserve 15 October 1921 as the 316th Service Battalion and allotted to the Fourth Corps Area. West Point, MS, designated as headquarters upon organization, but the unit was never organized at that location. Redesignated 2 July 1923 as the 16th Service Battalion. Redesignated 23 March 1925 as the 316th Service Battalion. Demobilized 1 July 1936.

317th Service Battalion

Organized Reserve Ohio

HQ-*Not initiated* 1921-36

Constituted in the Organized Reserve 15 October 1921 as the 317th Service Battalion and allotted to the Fifth Corps Area. Cleveland, OH, designated as headquarters upon organization, but the unit was never organized at that location. Redesignated 2 July 1923 as the 17th Service Battalion. Redesignated 23 March 1925 as the 317th Service Battalion. Demobilized 1 July 1936.

318th Service Battalion

Organized Reserve Illinois

HQ-*Not initiated* 1921-36

Constituted in the Organized Reserve 15 October 1921 as the 318th Service Battalion and allotted to the Sixth Corps Area. Rockford, IL, designated as headquarters upon organization, but the unit was never organized at that location. Redesignated 2 July 1923 as the 18th Service Battalion. Redesignated 23 March 1925 as the 318th Service Battalion. Demobilized 1 July 1936.

319th Service Battalion

Organized Reserve Illinois

HQ-*Not initiated* 1921-36

Constituted in the Organized Reserve 15 October 1921 as the 319th Service Battalion and allotted to the Sixth Corps Area. Rock Island, IL, designated as headquarters upon organization, but the unit was never organized at that location. Redesignated 2 July 1923 as the 19th Service Battalion. Redesignated 23 March 1925 as the 319th Service Battalion. Designated headquarters changed in 1925 to Chicago, IL, but the unit was never organized at that location. Demobilized 1 July 1936.

320th Service Battalion

Organized Reserve Iowa

HQ-*Not initiated* 1921-36

Constituted in the Organized Reserve 15 October 1921 as the 320th Service Battalion and allotted to the Seventh Corps Area. Des Moines, IA, designated as headquarters upon organization, but the unit was never organized at that location. Redesignated 2 July 1923 as the 20th Service Battalion. Redesignated 23 March 1925 as the 320th Service Battalion. Demobilized 1 July 1936.

321st Service Battalion (XI Corps)

Organized Reserve Massachusetts

HQ-Boston, MA, 1921-29; *Inactive* 1929-36

Constituted in the Organized Reserve 15 October 1921 as the 321st Service Battalion, allotted to the First Corps Area, and assigned to the XI Corps. Initiated 12 December 1921 with headquarters at Boston, MA. Redesignated 2 July 1923 as the 21st Service Battalion. Redesignated 23 March 1925 as the 321st Service Battalion. Inactivated by June 1929 at Boston by relief of personnel. Demobilized 1 July 1936.

322nd Service Battalion (XII Corps)**Organized Reserve New Jersey**

HQ-*Not initiated* 1921-22; Hoboken, NJ, 1922-29; *Inactive* 1929-36

Constituted in the Organized Reserve 15 October 1921 as the 322nd Service Battalion, allotted to the Second Corps Area, and assigned to the XII Corps. Initiated 11 February 1922 with headquarters at New Jersey, NJ. Redesignated 2 July 1923 as the 22nd Service Battalion. Redesignated 23 March 1925 as the 322nd Service Battalion. Inactivated by June 1929 at Hoboken by relief of personnel. Demobilized 1 July 1936.

323rd Service Battalion (XIII Corps)**Organized Reserve Pennsylvania**

HQ-Oxford, PA, 1921-29; *Inactive* 1929-36

Constituted in the Organized Reserve 15 October 1921 as the 323rd Service Battalion, allotted to the Third Corps Area, and assigned to the XIII Corps. Initiated 2 November 1921 with headquarters at Oxford, PA. Redesignated 2 July 1923 as the 23rd Service Battalion. Redesignated 23 March 1925 as the 323rd Service Battalion. Inactivated 12 February 1929 at Oxford by relief of personnel. Philadelphia, PA, designated as headquarters upon reorganization, but the unit was never organized at that location. Demobilized 1 July 1936.

324th Service Battalion (C) (XIV Corps)**Organized Reserve Florida**

HQ-*Not initiated* 1921-22; Talledega, FL, 1922-36

Constituted in the Organized Reserve 15 October 1921 as the 324th Service Battalion, allotted to the Fourth Corps Area, and assigned to the XIV Corps. Initiated in 1922 with headquarters at Talledega, FL. Redesignated 2 July 1923 as the 24th Service Battalion. Redesignated 23 March 1925 as the 324th Service Battalion. Designated mobilization training station was Camp McClellan, AL. Demobilized 1 July 1936.

325th Service Battalion (XV Corps)**Organized Reserve Ohio**

HQ-*Not initiated* 1921-22; Akron, OH, 1922-26; Toledo, OH, 1926-31; Cleveland, OH, 1931-36

Constituted in the Organized Reserve 15 October 1921 as the 325th Service Battalion, allotted to the Fifth Corps Area, and assigned to the XV Corps. Initiated by December 1922 with headquarters at Akron, OH. Redesignated 2 July 1923 as the 25th Service Battalion. Concurrently relieved from the XV Corps and assigned to the V Corps. Redesignated 23 March 1925 as the 325th Service Battalion. Relocated 9 July 1931 to Cleveland, OH. Demobilized 1 July 1936.

326th Service Battalion (C) (XVI Corps)**Organized Reserve Illinois**

HQ-*Not initiated* 1921-22; Chicago, IL, 1922-29; *Inactive* 1929-36

Constituted in the Organized Reserve 15 October 1921 as the 326th Service Battalion, allotted to the Sixth Corps Area, and assigned to the XVI Corps. Initiated 8 August 1922 with headquarters at Chicago, IL. Redesignated 2 July 1923 as the 26th Service Battalion. Redesignated 23 March 1925 as the 326th Service Battalion. Inactivated by June 1929 at Chicago by relief of personnel. Designated mobilization training station was Camp Grant, IL. Demobilized 1 July 1936.

327th Service Battalion (XVII Corps)

Organized Reserve Kansas

HQ-Not initiated 1921-22; Manhattan, KS, 1922-29; *Inactive* 1929-36

Constituted in the Organized Reserve 15 October 1921 as the 327th Service Battalion, allotted to the Seventh Corps Area, and assigned to the XVII Corps. Initiated in 1922 with headquarters at Manhattan, KS. Redesignated 2 July 1923 as the 27th Service Battalion. Redesignated 23 March 1925 as the 327th Service Battalion. Conducted summer training at Fort Crook, NE. Inactivated 18 October 1929 at Manhattan by relief of personnel. Demobilized 1 July 1936.

328th Service Battalion (XVIII Corps)

Organized Reserve Texas

HQ-Not initiated 1921-22; Palestine, TX, 1922-28

Constituted in the Organized Reserve 15 October 1921 as the 328th Service Battalion, allotted to the Eighth Corps Area, and assigned to the XVIII Corps. Initiated 14 November 1922 with headquarters at Palestine, TX. Redesignated 2 July 1923 as the 28th Service Battalion. Redesignated 23 March 1925 as the 328th Service Battalion. Inactivated 22 October 1928 at Palestine by relief of personnel. Conducted summer training at Fort Sam Houston, TX. Withdrawn from Eighth Corps Area 6 October 1928 and demobilized.

329th Service Battalion (C) (XIX Corps)

Organized Reserve Washington

HQ-Not initiated 1921-22; Seattle, WA, 1922-36

Constituted in the Organized Reserve 15 October 1921 as the 329th Service Battalion, allotted to the Ninth Corps Area, and assigned to the XIX Corps. Initiated 11 August 1922 with headquarters at Seattle, WA. Redesignated 2 July 1923 as the 29th Service Battalion. Redesignated 23 March 1925 as the 329th Service Battalion. Demobilized 1 July 1936.

330th Service Battalion (I Corps)

Organized Reserve New York

HQ-Not initiated 1921-22; Buffalo, NY, 1922-29; *Inactive* 1929-36

Constituted in the Organized Reserve 15 October 1921 as the 330th Service Battalion, allotted to the Second Corps Area, and assigned to the I Corps. Initiated 3 March 1922 with headquarters at Buffalo, NY. Redesignated 2 July 1923 as the 30th Service Battalion. Redesignated 23 March 1925 as the 330th Service Battalion. Inactivated by June 1929 at Buffalo by relief of personnel. Demobilized 1 July 1936.

331st Service Battalion (II Corps)

Organized Reserve New York

HQ-Not initiated 1921-22; Brooklyn, NY, 1922-29; *Inactive* 1929-36

Constituted in the Organized Reserve 15 October 1921 as the 331st Service Battalion, allotted to the Second Corps Area, and assigned to the II Corps. Initiated 27 January 1922 with headquarters at Brooklyn, NY. Redesignated 2 July 1923 as the 31st Service Battalion. Redesignated 23 March 1925 as the 331st Service Battalion. Inactivated by June 1929 at Brooklyn by relief of personnel. Demobilized 1 July 1936.

332nd Service Battalion (III Corps)**Organized Reserve Pennsylvania**

HQ-Media, PA, 1921-30; *Inactive* 1930-36

Constituted in the Organized Reserve 15 October 1921 as the 332nd Service Battalion, allotted to the Third Corps Area, and assigned to the III Corps. Initiated 12 November 1921 with headquarters in Media, PA. Redesignated 2 July 1923 as the 32nd Service Battalion. Redesignated 23 March 1925 as the 332nd Service Battalion. Inactivated 26 January 1930 at Media by relief of personnel. Demobilized 1 July 1936.

333rd Service Battalion (C) (VI Corps)**Organized Reserve Illinois/North Carolina**

HQ-*Not initiated* 1921-22; LaSalle, IL, 1922-27; *Inactive* 1927-36

Constituted in the Organized Reserve 15 October 1921 as the 333rd Service Battalion, allotted to the Sixth Corps Area, and assigned to the VI Corps. Initiated 4 May 22 with headquarters at LaSalle, IL. Redesignated 2 July 1923 as the 33rd Service Battalion. Redesignated 23 March 1925 as the 333rd Service Battalion. Withdrawn from the Sixth Corps Area 11 January 1927 and allotted to the Fourth Corps Area. Orangeburg, NC, designated as headquarters upon reorganization, but the unit was never organized at that location. Designated mobilization training station was Camp Custer, MI, 1922-27. Demobilized 1 July 1936.

334th Service Battalion (C) (VII Corps)**Organized Reserve Arkansas**

HQ-Hot Springs, AR, 1921-28; Little Rock, AR, 1928-31; Arkadelphia, AR, 1931-36

Constituted in the Organized Reserve 15 October 1921 as the 334th Service Battalion, allotted to the Seventh Corps Area, and assigned to the VII Corps. Initiated 29 December 1921 with headquarters at Hot Springs, AR. Redesignated 2 July 1923 as the 34th Service Battalion. Redesignated 23 March 1925 as the 334th Service Battalion. Relocated 3 April 1928 to Little Rock, AR. Relocated 12 October 1931 to Arkadelphia, AR. Demobilized 1 July 1936.

335th Service Battalion (C) (VIII Corps)**Organized Reserve Texas/Georgia**

HQ-*Not initiated* 1921-22; Houston, TX, 1922-27; Atlanta, GA, 1927-36

Constituted in the Organized Reserve 15 October 1921 as the 335th Service Battalion, allotted to the Eighth Corps Area, and assigned to the VIII Corps. Initiated 23 September 1922 with headquarters at Houston, TX. Redesignated 2 July 1923 as the 35th Service Battalion. Redesignated 23 March 1925 as the 335th Service Battalion. Conducted summer training at Fort Sam Houston, TX. Withdrawn from the Eighth Corps Area 11 January 1927 and allotted to the Fourth Corps Area. Inactivated 9 February 1927 at Houston by relief of personnel. Organized in 1927 at Atlanta, GA. Demobilized 1 July 1936.

336th Service Battalion (IX Corps)**Organized Reserve California/Utah/Georgia**

HQ-*Not initiated* 1921-22; San Francisco, CA, 1922-25; *Inactive* 1925-36

Constituted in the Organized Reserve 15 October 1921 as the 336th Service Battalion, allotted to the Eighth Corps Area, and assigned to the VIII Corps. Initiated 28 January 1922 with headquarters at San Francisco, CA. Redesignated 2 July 1923 as the 36th Service Battalion. Redesignated 23 March 1925 as the 336th Service Battalion. Inactivated in 1925 at San Francisco by relief of personnel. Salt Lake City, UT, designated as headquarters upon reorganization, but the unit was never organized at that location. Withdrawn from the Ninth Corps Area 11 January 1927 and allotted to the Fourth Corps Area as a "Colored" unit. Augusta, GA, designated as headquarters upon reorganization, but the unit was never organized at that location. Demobilized 1 July 1936.

337th Service Battalion (IV Corps)**Organized Reserve Louisiana****HQ-Not initiated** 1921-27

Constituted in the National Guard in 1921 as the 11th Service Battalion, allotted to the state of Mississippi, and assigned to the IV Corps. Redesignated 2 July 1923 as the 111th Service Battalion. Concurrently placed on the deferred list, unit requirement transferred to the Organized Reserve, redesignated as the 37th Service Battalion, and assigned to the XIV Corps. Donaldsonville, LA, designated as headquarters upon organization, but the unit was never organized at that location. Redesignated 23 March 1925 as the 337th Service Battalion. Withdrawn from the National Guard 17 September 1927.

338th Service Battalion (V Corps)**Organized Reserve West Virginia****HQ-Not initiated** 1921-27

Constituted in the National Guard in 1921 as the 12th Service Battalion, allotted to the state of West Virginia, and assigned to the V Corps. Redesignated 2 July 1923 as the 112th Service Battalion. Concurrently placed on the deferred list, unit requirement transferred to the Organized Reserve, redesignated as the 38th Service Battalion, and assigned to the XV Corps. Redesignated 23 March 1925 as the 338th Service Battalion. Withdrawn from the National Guard 17 September 1927.

339th Service Battalion (First Army)**Organized Reserve Virginia****HQ-Not initiated** 1921-27

Constituted in the National Guard in 1921 as the 16th Service Battalion, allotted to the state of Virginia, and assigned to the First Army. Redesignated 2 July 1923 as the 116th Service Battalion. Concurrently placed on the deferred list, unit requirement transferred to the Organized Reserve, and redesignated as the 39th Service Battalion. Redesignated 23 March 1925 as the 339th Service Battalion. Withdrawn from the National Guard 17 September 1927.

340th Service Battalion (ZI)**Organized Reserve Minnesota****HQ-Not initiated** 1921-36

Constituted in the Organized Reserve 15 October 1921 as the 340th Service Battalion, assigned to the Zone of the Interior, and allotted to the Seventh Corps Area. Minneapolis, MN, designated as headquarters upon organization, but the unit was never organized at that location. Redesignated 2 July 1923 as the 40th Service Battalion. Redesignated 23 March 1925 as the 340th Service Battalion. Demobilized 1 July 1936.

341st Service Battalion (ZI)**Organized Reserve North Dakota****HQ-Not initiated** 1921-36

Constituted in the Organized Reserve 15 October 1921 as the 341st Battalion, assigned to the Zone of the Interior, and allotted to the Seventh Corps Area. Fargo, ND, designated as headquarters upon organization, but the unit was never organized at that location. Redesignated 2 July 1923 as the 41st Service Battalion. Redesignated 23 March 1925 as the 341st Service Battalion. Demobilized 1 July 1936.

342nd Service Battalion (GHQR)**Organized Reserve California****HQ-Not initiated** 1921-36

Constituted in the Organized Reserve 15 October 1921 as the 342nd Service Battalion, assigned to the General Headquarters Reserve, and allotted to the Seventh Corps Area. Pasadena, CA, designated as headquarters upon organization, but the unit was never organized at that location. Redesignated 2 July 1923 as the 42nd Service Battalion. Redesignated 23 March 1925 as the 342nd Service Battalion. Demobilized 1 July 1936.

343rd Service Battalion (Third Army)**Organized Reserve Texas****HQ-Not initiated** 1921-36

Constituted in the Organized Reserve 15 October 1921 as the 343rd Service Battalion, assigned to the Third Army, and allotted to the Eighth Corps Area. El Paso, TX, designated as headquarters upon organization, but the unit was never organized at that location. Redesignated 2 July 1923 as the 43rd Service Battalion. Redesignated 23 March 1925 as the 343rd Service Battalion. Demobilized 1 July 1936.

344th Service Battalion (Third Army)**Organized Reserve California****HQ-Not initiated** 1921-36

Constituted in the Organized Reserve 15 October 1921 as the 344th Service Battalion, assigned to the Third Army, and allotted to the Ninth Corps Area. Santa Monica, CA, designated as headquarters upon organization, but the unit was never organized at that location. Redesignated 2 July 1923 as the 44th Service Battalion. Redesignated 23 March 1925 as the 344th Service Battalion. Demobilized 1 July 1936.

345th Service Battalion (Third Army)**Organized Reserve Washington****HQ-Not initiated** 1921-36

Constituted in the Organized Reserve 15 October 1921 as the 345th Service Battalion, assigned to the Third Army, and allotted to the Ninth Corps Area. Centralia, WA, designated as headquarters upon organization, but the unit was never organized at that location. Redesignated 2 July 1923 as the 45th Service Battalion. Redesignated 23 March 1925 as the 345th Service Battalion. Demobilized 1 July 1936.

346th Service Battalion (Sixth Army)**Organized Reserve Texas****HQ-Not initiated** 1921-36

Constituted in the Organized Reserve 15 October 1921 as the 346th Service Battalion, assigned to the Sixth Army, and allotted to the Eighth Corps Area. San Antonio, TX, designated as headquarters upon organization, but the unit was never organized at that location. Redesignated 2 July 1923 as the 46th Service Battalion. Redesignated 23 March 1925 as the 346th Service Battalion. Demobilized 1 July 1936.

347th Service Battalion (GHQR)**Organized Reserve****HQ-Not initiated** 1921-36

Constituted in the Organized Reserve 15 October 1921 as the 347th Service Battalion, assigned to the General Headquarters Reserve, and apparently never allotted to a corps area. Redesignated 2 July 1923 as the 47th Service Battalion. Redesignated 23 March 1925 as the 347th Service Battalion. Demobilized 1 July 1936.

348th Service Battalion (GHQR)**Organized Reserve****HQ-Not initiated** 1921-36

Constituted in the Organized Reserve 15 October 1921 as the 348th Service Battalion, assigned to the General Headquarters Reserve, and apparently never allotted to a corps area. Redesignated 2 July 1923 as the 48th Service Battalion. Redesignated 23 March 1925 as the 348th Service Battalion. Demobilized 1 July 1936.

349th Service Battalion (GHQR)**Organized Reserve****HQ-Not initiated** 1921-36

Constituted in the Organized Reserve 15 October 1921 as the 349th Service Battalion, assigned to the General Headquarters Reserve, and apparently never allotted to a corps area. Redesignated 2 July 1923 as the 49th Service Battalion. Redesignated 23 March 1925 as the 349th Service Battalion. Demobilized 1 July 1936.

350th Service Battalion (GHQR)**Organized Reserve****HQ-Not initiated** 1921-36

Constituted in the Organized Reserve 15 October 1921 as the 350th Service Battalion, assigned to the General Headquarters Reserve, and apparently never allotted to a corps area. Redesignated 2 July 1923 as the 50th Service Battalion. Redesignated 23 March 1925 as the 350th Service Battalion. Demobilized 1 July 1936.

351st Service Battalion (C) (Fourth Army)**Organized Reserve North Carolina****HQ-Not organized** 1921-22; Wilmington, NC, 1922-36

Constituted in the Organized Reserve 15 October 1921 as the 351st Service Battalion, assigned to the Fourth Army, and allotted to the Fourth Corps Area. Initiated 28 February 1922 with headquarters at Wilmington, NC. Redesignated 2 July 1923 as the 51st Service Battalion. Designated as a "Colored" unit 31 March 1924. Redesignated 23 March 1925 as the 351st Service Battalion (C). Designated mobilization training station was Fort Bragg, NC. Demobilized 1 July 1936.

352nd Service Battalion (C) (Fourth Army)**Organized Reserve Tennessee****HQ-Not initiated** 1921-22; Jackson, TN, 1922-29; Memphis, TN, 1929-36

Constituted in the Organized Reserve 15 October 1921 as the 352nd Service Battalion, assigned to the Fourth Army, and allotted to the Fourth Corps Area. Initiated 23 March 1922 with headquarters at Jackson, TN. Redesignated 2 July 1923 as the 52nd Service Battalion. Designated as a "Colored" unit 31 March 1924. Redesignated 23 March 1925 as the 352nd Service Battalion (C). Relocated 22 October 1929 to Memphis, TN. Designated mobilization training station was the Memphis Mobilization Area, TN. Demobilized 1 July 1936.

353rd Service Battalion (C) (Fourth Army)**Organized Reserve South Carolina****HQ-Not initiated** 1921-22; Greenwood, SC, 1922-29; Greenville, SC, 1929-36

Constituted in the Organized Reserve 15 October 1921 as the 353rd Service Battalion, assigned to the Fourth Army, and allotted to the Fourth Corps Area. Initiated 22 March 1922 with headquarters at Greenwood, SC. Redesignated 2 July 1923 as the 53rd Service Battalion. Designated as a "Colored" unit 31 March 1924. Redesignated 23 March 1925 as the 353rd Service Battalion (C). Relocated 22 October 1929 to Greenville, SC. Designated mobilization training station was Camp Jackson, SC. Demobilized 1 July 1936.

354th Service Battalion (C) (Fourth Army)

Organized Reserve South Carolina

HQ-Not initiated 1921-22; Columbia, SC, 1922-36

Constituted in the Organized Reserve 15 October 1921 as the 354th Service Battalion, assigned to the Fourth Army, and allotted to the Fourth Corps Area. Initiated 22 March 1922 with headquarters at Columbia, SC. Redesignated 2 July 1923 as the 54th Service Battalion. Designated as a "Colored" unit 31 March 1924. Redesignated 23 March 1925 as the 354th Service Battalion (C). Designated mobilization training station was Camp Jackson, SC. Demobilized 1 July 1936.

355th Service Battalion (C) (Fourth Army)

Organized Reserve Georgia

HQ-Not initiated 1921-22; Newnan, GA, 1922-36

Constituted in the Organized Reserve 15 October 1921 as the 355th Service Battalion, assigned to the Fourth Army, and allotted to the Fourth Corps Area. Initiated 23 March 1922 with headquarters at Newnan, GA. Redesignated 2 July 1923 as the 55th Service Battalion. Designated as a "Colored" unit 31 March 1924. Redesignated 23 March 1925 as the 355th Service Battalion (C). Designated mobilization training station was Camp Wheeler, GA. Demobilized 1 July 1936.

356th Service Battalion (C) (Fourth Army)

Organized Reserve Georgia

HQ-Not initiated 1921-22; Columbus, GA, 1922-36

Constituted in the Organized Reserve 15 October 1921 as the 356th Service Battalion, assigned to the Fourth Army, and allotted to the Fourth Corps Area. Initiated 23 March 1922 with headquarters at Columbus, GA. Redesignated 2 July 1923 as the 56th Service Battalion. Designated as a "Colored" unit 31 March 1924. Redesignated 23 March 1925 as the 356th Service Battalion (C). Designated mobilization training station was Camp Wheeler, GA. Demobilized 1 July 1936.

357th Service Battalion (C) (Fourth Army)

Organized Reserve Florida

HQ-Tampa, FL, 1921-36

Constituted in the Organized Reserve 15 October 1921 as the 357th Service Battalion, assigned to the Fourth Army, and allotted to the Fourth Corps Area. Initiated 14 December 1921 with headquarters at Tampa, FL. Redesignated 2 July 1923 as the 57th Service Battalion. Designated as a "Colored" unit 31 March 1924. Redesignated 23 March 1925 as the 357th Service Battalion (C). Designated mobilization training station was Camp Joseph E. Johnston, FL, (later redesignated Camp J. Clifford R. Foster) 1922-30 and later Camp Wheeler, GA, 1930-36. Redesignated as the 541st Quartermaster Regiment (Service), less 2nd, 3rd, and 4th Battalions 1 May 1936.

358th Service Battalion (C) (Fourth Army)

Organized Reserve Alabama

HQ-Not initiated 1921-22; Birmingham, AL, 1922-36

Constituted in the Organized Reserve 15 October 1921 as the 358th Service Battalion, assigned to the Fourth Army, and allotted to the Fourth Corps Area. Initiated 31 March 1922 with headquarters at Birmingham, AL. Redesignated 2 July 1923 as the 58th Service Battalion. Designated as a "Colored" unit 31 March 1924. Redesignated 23 March 1925 as the 358th Service Battalion (C). Designated mobilization training station was Camp McClellan, AL. Reorganized and redesignated 1 July 1936 as the 2nd Battalion, 541st Quartermaster Regiment.

359th Service Battalion (C) (Fifth Army)

Organized Reserve Mississippi

HQ-Not initiated 1921-22; Aberdeen, MS, 1922-36

Constituted in the Organized Reserve 15 October 1921 as the 359th Service Battalion, assigned to the Fifth Army, and allotted to the Fourth Corps Area. Initiated 30 March 1922 with headquarters at Aberdeen, MS. Redesignated 2 July 1923 as the 59th Service Battalion. Designated as a "Colored" unit 31 March 1924. Redesignated 23 March 1925 as the 359th Service Battalion (C). Designated mobilization training station was the Memphis Mobilization Area, TN. Reorganized and redesignated 1 July 1936 as the 3rd Battalion, 541st Quartermaster Regiment.

360th Service Battalion (C) (Fifth Army)

Organized Reserve Mississippi

HQ-Not initiated 1921-22; Greenwood, MS, 1922-36

Constituted in the Organized Reserve 15 October 1921 as the 360th Service Battalion, assigned to the Fifth Army, and allotted to the Fourth Corps Area. Initiated 30 March 1922 with headquarters at Greenwood, MS. Redesignated 2 July 1923 as the 60th Service Battalion. Designated as a "Colored" unit 31 March 1924. Redesignated 23 March 1925 as the 360th Service Battalion (C). Designated mobilization training station was the Memphis Mobilization Area, TN. Reorganized and redesignated 1 July 1936 as the 4th Battalion, 541st Quartermaster Regiment.

361st Service Battalion (C) (Fifth Army)

Organized Reserve Louisiana

HQ-Not initiated 1921-22; De Ridder, LA, 1922-29; *Inactive* 1929-36

Constituted in the Organized Reserve 15 October 1921 as the 361st Service Battalion, assigned to the Fifth Army, and allotted to the Fourth Corps Area. Initiated 16 March 1922 with headquarters at De Ridder, LA. Redesignated 2 July 1923 as the 61st Service Battalion. Designated as a "Colored" unit 31 March 1924. Redesignated 23 March 1925 as the 361st Service Battalion (C). Inactivated 1 October 1929 at De Ridder by relief of personnel. Designated mobilization training station was Camp Beauregard, LA, and later, Camp Shelby, MS. Demobilized 1 July 1936.

362nd Service Battalion (C) (Fifth Army)

Organized Reserve Louisiana

HQ-Not initiated 1921-22; Nachitoches, LA, 1922-29; *Inactive* 1929-36

Constituted in the Organized Reserve 15 October 1921 as the 362nd Service Battalion, assigned to the Fifth Army, and allotted to the Fourth Corps Area. Initiated 16 March 1922 with headquarters at Nachitoches, LA. Redesignated 2 July 1923 as the 62nd Service Battalion. Designated as a "Colored" unit 31 March 1924. Redesignated 23 March 1925 as the 362nd Service Battalion (C). Inactivated 1 October 1929 at Nachitoches by relief of personnel. Designated mobilization training station was Camp Beauregard, LA, and later, Camp Shelby, MS. Demobilized 1 July 1936.

363rd Service Battalion (C) (Fifth Army)

Organized Reserve Texas

HQ-Not initiated 1921-23; Texarkana, TX, 1923-24; Chickasha, OK, 1924-25; Texarkana, TX, 1925-28

Constituted in the Organized Reserve 15 October 1921 as the 363rd Service Battalion, assigned to the Fifth Army, and allotted to the Eighth Corps Area. Initiated 26 February 1923 with headquarters at Texarkana, TX. Redesignated 2 July 1923 as the 63rd Service Battalion. Designated as a "Colored" unit 31 March 1924. Relocated 16 July 1924 to Chickasha, OK. Redesignated 23 March 1925 as the 363rd Service Battalion (C). Inactivated 20 January 1925 at Chickasha by relief of personnel. Reorganized 15 April 1925 at Texarkana, TX. Conducted summer training at Fort Sam Houston, TX. Withdrawn from Eighth Corps Area 6 October 1928 and demobilized.

364th Service Battalion (C) (Fifth Army)

Organized Reserve Texas

HQ-Not initiated 1921-23; Cleburne, TX, 1923-25; Dallas, TX, 1925-28

Constituted in the Organized Reserve 15 October 1921 as the 364th Service Battalion, assigned to the Fifth Army, and allotted to the Eighth Corps Area. Initiated 26 February 1923 with headquarters at Cleburne, TX. Redesignated 2 July 1923 as the 64th Service Battalion. Designated as a "Colored" unit 31 March 1924. Redesignated 23 March 1925 as the 364th Service Battalion (C). Relocated 15 April 1925 to Dallas, TX. Personnel from the Cleburne area relieved 8 May 25. Conducted summer training at Fort Sam Houston, TX. Withdrawn from Eighth Corps Area 6 October 1928 and demobilized.

365th Service Battalion (C) (Fifth Army)

Organized Reserve Texas

HQ-Not initiated 1921-23; Laredo, TX, 1923-25; Houston, TX, 1925-36

Constituted in the Organized Reserve 15 October 1921 as the 365th Service Battalion, assigned to the Fifth Army, and allotted to the Eighth Corps Area. Initiated 26 February 1923 with headquarters at Laredo, TX. Redesignated 2 July 1923 as the 65th Service Battalion. Designated as a "Colored" unit 31 March 1924. Redesignated 23 March 1925 as the 365th Service Battalion (C). Relocated 15 April 1925 to Houston, TX. Personnel from the Laredo area relieved 8 May 25. Conducted summer training at Fort Sam Houston, TX. Designated mobilization training station was Fort Clark, TX. Demobilized 1 July 1936.

366th Service Battalion (C) (Fifth Army)

Organized Reserve Texas

HQ-Not initiated 1921-23; Port Arthur, TX, 1923-36

Constituted in the Organized Reserve 15 October 1921 as the 366th Service Battalion, assigned to the Fifth Army, and allotted to the Eighth Corps Area. Initiated 26 February 1923 with headquarters at Port Arthur, TX. Redesignated 2 July 1923 as the 66th Service Battalion. Designated as a "Colored" unit 31 March 1924. Redesignated 23 March 1925 as the 366th Service Battalion (C). Conducted summer training at Fort Sam Houston, TX. Designated mobilization training station was Fort Clark, TX. Demobilized 1 July 1936.

367th Service Battalion (Sixth Army)

Organized Reserve Missouri

HQ-Not initiated 1921-22; Poplar Bluff, MO, 1922-28

Constituted in the Organized Reserve 15 October 1921 as the 367th Service Battalion, assigned to the Sixth Army, and allotted to the Seventh Corps Area. Initiated in April 1922 with headquarters at Poplar Bluff, MO. Redesignated 2 July 1923 as the 67th Service Battalion. Redesignated 23 March 1925 as the 367th Service Battalion. Withdrawn from Seventh Corps Area 6 October 1928 and demobilized.

368th Service Battalion (Sixth Army)**Organized Reserve Arkansas**

HQ-Not initiated 1921-22; Pine Bluff, AR, 1922-26; Blytheville, AR, 1926-36

Constituted in the Organized Reserve 15 October 1921 as the 368th Service Battalion, assigned to the Sixth Army, and allotted to the Seventh Corps Area. Initiated in April 1922 with headquarters at Poplar Bluff, AR. Redesignated 2 July 1923 as the 68th Service Battalion. Redesignated 23 March 1925 as the 368th Service Battalion. Relocated 26 May 1926 to Blytheville, AR. Demobilized 1 July 1936.

369th Service Battalion (C) (Sixth Army)**Organized Reserve Missouri**

HQ-Not initiated 1921-22; Helena, AR, 1922-26; Jonesboro, AR, 1926-28

Constituted in the Organized Reserve 15 October 1921 as the 369th Service Battalion, assigned to the Sixth Army, and allotted to the Seventh Corps Area. Initiated in April 1922 with headquarters at Helena, AR. Redesignated 2 July 1923 as the 69th Service Battalion. Designated as a "Colored" unit 31 March 1924. Redesignated 23 March 1925 as the 369th Service Battalion (C). Relocated 26 May 1926 to Jonesboro, AR. Withdrawn from the Seventh Corps Area 6 October 1928 and demobilized.

370th Service Battalion (Sixth Army)**Organized Reserve Minnesota**

HQ-Not initiated 1921-22; Minneapolis, MN 1922-29; *Inactive* 1929-36

Constituted in the Organized Reserve 15 October 1921 as the 370th Service Battalion, assigned to the Sixth Army, and allotted to the Seventh Corps Area. Initiated in February 1922 with headquarters at Minneapolis, MN. Redesignated 2 July 1923 as the 70th Service Battalion. Redesignated 23 March 1925 as the 370th Service Battalion. Conducted summer training at Fort Crook, NE, or Fort Snelling, MN. Inactivated 18 October 1929 at Minneapolis by relief of personnel. Demobilized 1 July 1936.

371st Service Battalion (Sixth Army)**Organized Reserve Texas/Louisiana**

HQ-Not initiated 1921-23; Del Rio, TX, 1923-25; Marshall, TX, 1925-27; Shreveport, LA, 1927-29; *Inactive* 1929-36

Constituted in the Organized Reserve 15 October 1921 as the 371st Service Battalion, assigned to the Sixth Army, and allotted to the Eighth Corps Area. Initiated 26 February 1923 with headquarters at Del Rio, TX. Redesignated 2 July 1923 as the 71st Service Battalion. Redesignated 23 March 1925 as the 371st Service Battalion. Relocated 15 April 1925 to Marshall, TX. Personnel from the Del Rio area relieved 8 May 25. Conducted summer training at Fort Sam Houston, TX, 1922-26. Withdrawn from the Eighth Corps Area 11 January 1927 and allotted to the Fourth Corps Area. Inactivated 8 February 1927 at Marshall by relief of personnel. Organized in 1927 at Shreveport, LA. Inactivated 1 October 1929 at Shreveport by relief of personnel. Demobilized 1 July 1936.

372nd Service Battalion (Sixth Army)**Organized Reserve Colorado /Texas/Louisiana**

HQ-Not initiated 1921-23; Denver, CO, 1923-25; Marshall, TX, 1925-27; Shreveport, LA, 1927-28

Constituted in the Organized Reserve 15 October 1921 as the 372nd Service Battalion, assigned to the Sixth Army, and allotted to the Eighth Corps Area. Initiated 26 February 1923 with headquarters at Denver, CO. Redesignated 2 July 1923 as the 72nd Service Battalion. Redesignated 23 March 1925 as the 371st Service Battalion. Relocated 15 April 1925 to Marshall, TX. Conducted summer training at Fort Sam Houston, TX. Withdrawn from the Eighth Corps Area 11 January 1927 and allotted to the Fourth Corps Area. Organized in 1927 at Shreveport, LA. Inactivated 1 October 1929 at Shreveport by relief of personnel. Withdrawn from Fourth Corps Area 6 October 1928 and demobilized.

373rd Service Battalion (Sixth Army)

Organized Reserve New Mexico/Missouri

HQ-Not initiated 1921-23; Gallup, NM, 1923-24; Moberly, MO, 1924-36

Constituted in the Organized Reserve 15 October 1921 as the 373rd Service Battalion, assigned to the Sixth Army, and allotted to the Eighth Corps Area. Initiated 26 February 1923 with headquarters at Gallup, NM. Redesignated 2 July 1923 as the 73rd Service Battalion. Withdrawn from the Eighth Corps Area 31 March 1924 and allotted to the Seventh Corps Area. Reorganized in November 1924 with headquarters at Moberly, MO. Redesignated 23 March 1925 as the 373rd Service Battalion. Conducted summer training at Fort Crook, NE, and Fort Snelling, MN. Demobilized 1 July 1936.

374th Service Battalion (Sixth Army)

Organized Reserve Arizona/California

HQ-Not initiated 1921-23; Phoenix, AZ, 1923-24; *Inactive* 1924-25; San Francisco, CA, 1925-36

Constituted in the Organized Reserve 15 October 1921 as the 374th Service Battalion, assigned to the Sixth Army, and allotted to the Eighth Corps Area. Initiated 26 February 1923 with headquarters at Phoenix, AZ. Redesignated 2 July 1923 as the 74th Service Battalion. Withdrawn from the Eighth Corps Area 31 March 1924 and allotted to the Ninth Corps Area. Redesignated 23 March 1925 as the 374th Service Battalion. Reorganized in April 1925 with headquarters at San Francisco, CA. Conducted summer training at the Presidio of San Francisco, CA, or the Presidio of Monterey, CA. Demobilized 1 July 1936.

375th Service Battalion (First Army)

Organized Reserve Pennsylvania

HQ-Not initiated 1921-22; Pittsburgh, PA, 1922-30; *Inactive* 1930-36

Constituted in the Organized Reserve 15 October 1921 as the 375th Service Battalion, assigned to the First Army, and allotted to the Third Corps Area. Initiated 19 January 1922 with headquarters at Pittsburgh, PA. Redesignated 2 July 1923 as the 75th Service Battalion. Redesignated 23 March 1925 as the 375th Service Battalion. Inactivated by June 1930 at Pittsburgh by relief of personnel. Demobilized 1 July 1936.

376th Service Battalion (First Army)

Organized Reserve Pennsylvania

HQ-Not initiated 1921-22; Du Bois, PA, 1922-28

Constituted in the Organized Reserve 15 October 1921 as the 376th Service Battalion, assigned to the First Army, and allotted to the Third Corps Area. Initiated 25 January 1922 with headquarters at Du Bois, PA. Redesignated 2 July 1923 as the 76th Service Battalion. Redesignated 23 March 1925 as the 376th Service Battalion. Withdrawn from the Third Corps Area 6 October 1928 and demobilized.

377th Service Battalion (First Army)

Organized Reserve Pennsylvania

HQ-Not initiated 1921-22; Huntingdon, PA, 1922-28

Constituted in the Organized Reserve 15 October 1921 as the 377th Service Battalion, assigned to the First Army, and allotted to the Third Corps Area. Initiated in October 1922 with headquarters at Huntingdon, PA. Redesignated 2 July 1923 as the 77th Service Battalion. Redesignated 23 March 1925 as the 377th Service Battalion. Withdrawn from the Third Corps Area 6 October 1928 and demobilized.

378th Service Battalion (C) (First Army)**Organized Reserve North Carolina**

HQ-Not initiated 1921-22; Charlotte, NC, 1922-32; *Inactive* 1932-36

Constituted in the Organized Reserve 15 October 1921 as the 378th Service Battalion, assigned to the First Army, and allotted to the Fourth Corps Area. Initiated 15 March 1922 with headquarters at Charlotte, NC. Redesignated 2 July 1923 as the 78th Service Battalion. Designated as a "Colored" unit 31 March 1924. Redesignated 23 March 1925 as the 378th Service Battalion (C). Inactivated by June 1932 at Charlotte by relief of personnel. Designated mobilization training station was Fort Bragg, NC. Reorganized and redesignated 1 July 1936 as the 544th Quartermaster Regiment (Service) less 2nd, 3rd, and 4th Battalions.

379th Service Battalion (C) (First Army)**Organized Reserve Tennessee**

HQ-Not initiated 1921-22; Knoxville, TN, 1922-36

Constituted in the Organized Reserve 15 October 1921 as the 379th Service Battalion, assigned to the First Army, and allotted to the Fourth Corps Area. Initiated 23 March 1922 with headquarters at Knoxville, TN. Redesignated 2 July 1923 as the 79th Service Battalion. Designated as a "Colored" unit 31 March 1924. Redesignated 23 March 1925 as the 379th Service Battalion. Designated mobilization training station was Fort Bragg, NC. Reorganized and redesignated 1 July 1936 as the 1st Battalion, 544th Quartermaster Regiment (Service).

380th Service Battalion (C) (First Army)**Organized Reserve South Carolina**

HQ-Not initiated 1921-22; Walterboro, SC, 1922-36

Constituted in the Organized Reserve 15 October 1921 as the 380th Service Battalion, assigned to the First Army, and allotted to the Fourth Corps Area. Initiated 22 March 1922 with headquarters at Walterboro, SC. Redesignated 2 July 1923 as the 80th Service Battalion. Designated as a "Colored" unit 31 March 1924. Redesignated 23 March 1925 as the 380th Service Battalion. Designated mobilization training station was Camp Jackson, SC. Reorganized and redesignated 1 July 1936 as the 2nd Battalion, 544th Quartermaster Regiment (Service).

381st Service Battalion (C) (First Army)**Organized Reserve Georgia**

HQ-Not initiated 1921-22; Warrenton, GA, 1922-36

Constituted in the Organized Reserve 15 October 1921 as the 381st Service Battalion, assigned to the First Army, and allotted to the Fourth Corps Area. Initiated 16 March 1922 with headquarters at Warrenton, GA. Redesignated 2 July 1923 as the 81st Service Battalion. Designated as a "Colored" unit 31 March 1924. Redesignated 23 March 1925 as the 381st Service Battalion. Designated mobilization training station was Camp Wheeler, GA. Reorganized and redesignated 1 July 1936 as the 3rd Battalion, 544th Quartermaster Regiment (Service).

382nd Service Battalion (C) (Third Army)**Organized Reserve Georgia**

HQ-Not initiated 1921-22; Swainsboro, GA, 1922-36

Constituted in the Organized Reserve 15 October 1921 as the 382nd Service Battalion, assigned to the Third Army, and allotted to the Fourth Corps Area. Initiated 16 March 1922 with headquarters at Warrenton, GA. Redesignated 2 July 1923 as the 82nd Service Battalion. Designated as a "Colored" unit 31 March 1924. Redesignated 23 March 1925 as the 382nd Service Battalion. Designated mobilization training station was Camp Wheeler, GA. Reorganized and redesignated 1 July 1936 as the 4th Battalion, 544th Quartermaster Regiment (Service).

383rd Service Battalion (C) (Third Army)**Organized Reserve Florida****HQ**-Pensacola, FL, 1921-29; *Inactive* 1929-36

Constituted in the Organized Reserve 15 October 1921 as the 383rd Service Battalion, assigned to the Third Army, and allotted to the Fourth Corps Area. Initiated 31 December 1921 with headquarters at Pensacola, FL. Redesignated 2 July 1923 as the 83rd Service Battalion. Designated as a "Colored" unit 31 March 1924. Redesignated 23 March 1925 as the 383rd Service Battalion. Inactivated 1 October 1929 at Pensacola by relief of personnel. Designated mobilization training station was Camp McClellan, AL. Demobilized 1 July 1936.

384th Service Battalion (C) (Third Army)**Organized Reserve Alabama****HQ**-*Not initiated* 1921-22; Selma, AL, 1922-29; *Inactive* 1929-36

Constituted in the Organized Reserve 15 October 1921 as the 384th Service Battalion, assigned to the Third Army, and allotted to the Fourth Corps Area. Initiated 31 March 1922 with headquarters at Selma, AL. Redesignated 2 July 1923 as the 84th Service Battalion. Designated as a "Colored" unit 31 March 1924. Redesignated 23 March 1925 as the 384th Service Battalion. Inactivated 1 October 1929 at Selma by relief of personnel. Designated mobilization training station was Camp McClellan, AL. Demobilized 1 July 1936.

385th Service Battalion (C) (Third Army)**Organized Reserve Mississippi****HQ**-*Not initiated* 1921-22; Rosedale, MS, 1922-29; *Inactive* 1929-36

Constituted in the Organized Reserve 15 October 1921 as the 385th Service Battalion, assigned to the Third Army, and allotted to the Fourth Corps Area. Initiated 30 March 1922 with headquarters at Rosedale, MS. Redesignated 2 July 1923 as the 85th Service Battalion. Designated as a "Colored" unit 31 March 1924. Redesignated 23 March 1925 as the 385th Service Battalion. Inactivated 1 October 1929 at Rosedale by relief of personnel. Designated mobilization training station was the Memphis Mobilization Area, TN. Demobilized 1 July 1936.

386th Service Battalion (C) (Third Army)**Organized Reserve Louisiana****HQ**-*Not initiated* 1921-22; New Orleans, LA, 1922-29; *Inactive* 1929-36

Constituted in the Organized Reserve 15 October 1921 as the 386th Service Battalion, assigned to the Third Army, and allotted to the Fourth Corps Area. Initiated 15 March 1922 with headquarters at New Orleans, LA. Redesignated 2 July 1923 as the 86th Service Battalion. Designated as a "Colored" unit 31 March 1924. Redesignated 23 March 1925 as the 386th Service Battalion. Inactivated 1 October 1929 at New Orleans by relief of personnel. Designated mobilization training station was Camp Beauregard, LA, and later, Camp Shelby, MS. Demobilized 1 July 1936.

387th Service Battalion (C) (Third Army)**Organized Reserve Louisiana****HQ**-*Not initiated* 1921-22; New Orleans, LA, 1922-29; *Inactive* 1929-36

Constituted in the Organized Reserve 15 October 1921 as the 387th Service Battalion, assigned to the Third Army, and allotted to the Fourth Corps Area. Initiated 24 February 1922 with headquarters at New Orleans, LA. Redesignated 2 July 1923 as the 87th Service Battalion. Designated as a "Colored" unit 31 March 1924. Redesignated 23 March 1925 as the 387th Service Battalion. Inactivated 1 October 1929 at New Orleans by relief of personnel. Designated mobilization training station was Camp Beauregard, LA, and later, Camp Shelby, MS. Demobilized 1 July 1936.

388th Service Battalion (C) (Second Army)**Organized Reserve Indiana/West Virginia**

HQ-Not initiated 1921-22; Indianapolis, IN, 1922-27; *Inactive* 1927-36

Constituted in the Organized Reserve 15 October 1921 as the 388th Service Battalion, assigned to the Second Army, and allotted to the Fifth Corps Area. Initiated in April 1922 with headquarters at Indianapolis, IN. Redesignated 2 July 1923 as the 88th Service Battalion. Designated as a "Colored" unit 31 March 1924. Redesignated 23 March 1925 as the 388th Service Battalion. Inactivated by June 1927 at Indianapolis by relief of personnel. Charleston, WV, designated as headquarters upon reorganization, but the unit was never organized at that location. Demobilized 1 July 1936.

389th Service Battalion (C) (Second Army)**Organized Reserve Kentucky**

HQ-Not initiated 1921-22; Louisville, KY, 1922-27; *Inactive* 1927-36

Constituted in the Organized Reserve 15 October 1921 as the 389th Service Battalion, assigned to the Second Army, and allotted to the Fifth Corps Area. Initiated in January 1922 with headquarters at Louisville, KY. Redesignated 2 July 1923 as the 89th Service Battalion. Designated as a "Colored" unit 31 March 1924. Redesignated 23 March 1925 as the 389th Service Battalion. Inactivated by June 1927 at Louisville by relief of personnel. Covington, KY, designated as headquarters upon reorganization, but the unit was never organized at that location. Demobilized 1 July 1936.

390th Service Battalion (C) (Second Army)**Organized Reserve Kentucky/Alabama**

HQ-Not initiated 1921-22; Lebanon, KY, 1922-27; *Inactive* 1927-29; Birmingham, AL, 1929-36

Constituted in the Organized Reserve 15 October 1921 as the 390th Service Battalion, assigned to the Second Army, and allotted to the Fifth Corps Area. Initiated in January 1922 with headquarters at Louisville, KY. Redesignated 2 July 1923 as the 90th Service Battalion. Designated as a "Colored" unit 31 March 1924. Redesignated 23 March 1925 as the 390th Service Battalion. Withdrawn from the Fifth Corps Area 11 January 1927 and allotted to the Fourth Corps Area. Reorganized 22 October 1929 with headquarters at Birmingham, AL. Demobilized 1 July 1936.

391st Service Battalion (C) (Second Army)**Organized Reserve Kentucky/Georgia**

HQ-Not initiated 1921-22; Clarksburg, KY, 1922-27; *Inactive* 1927-29; Macon, GA, 1929-36

Constituted in the Organized Reserve 15 October 1921 as the 391st Service Battalion, assigned to the Second Army, and allotted to the Fifth Corps Area. Initiated in March 1922 with headquarters at Louisville, KY. Redesignated 2 July 1923 as the 91st Service Battalion. Designated as a "Colored" unit 31 March 1924. Redesignated 23 March 1925 as the 391st Service Battalion. Withdrawn from the Fifth Corps Area 11 January 1927 and allotted to the Fourth Corps Area. Reorganized by October 1929 with headquarters at Macon, GA. Demobilized 1 July 1936.

392nd Service Battalion (C) (Second Army)**Organized Reserve West Virginia/Louisiana**

HQ-Not initiated 1921-22; Princeton, WV 1922-27; *Inactive* 1927-29; Baton Rouge, LA, 1929-36

Constituted in the Organized Reserve 15 October 1921 as the 392nd Service Battalion, assigned to the Second Army, and allotted to the Fifth Corps Area. Initiated in May 22 with headquarters at Louisville, KY. Redesignated 2 July 1923 as the 92nd Service Battalion. Designated as a "Colored" unit 31 March 1924. Redesignated 23 March 1925 as the 392nd Service Battalion. Withdrawn from the Fifth Corps Area 11 January 1927 and allotted to the Fourth Corps Area. Reorganized 22 October 1929 with headquarters at Baton Rouge, LA. Demobilized 1 July 1936.

393rd Service Battalion (C) (Second Army)

Organized Reserve Michigan

HQ-Not initiated 1921-22; Flint, MI, 1922-29; Detroit, MI, 1929-30; *Inactive* 1930-36

Constituted in the Organized Reserve 15 October 1921 as the 393rd Service Battalion, assigned to the Second Army, and allotted to the Sixth Corps Area. Initiated 1 April 1922 with headquarters at Flint, MI. Redesignated 2 July 1923 as the 93rd Service Battalion. Designated as a “Colored” unit 31 March 1924. Redesignated 23 March 1925 as the 393rd Service Battalion. Relocated 29 March 1929 to Detroit, MI. Inactivated by June 1930 at Detroit by relief of personnel. Demobilized 1 July 1936.

394th Service Battalion (C) (Second Army)

Organized Reserve Illinois/Florida

HQ-Not initiated 1921-22; Murphysboro, IL, 1922-27; *Inactive* 1927-29; Miami, FL, 1929-36

Constituted in the Organized Reserve 15 October 1921 as the 394th Service Battalion, assigned to the Second Army, and allotted to the Sixth Corps Area. Initiated 8 August 1922 with headquarters at Murphysboro, IL. Redesignated 2 July 1923 as the 94th Service Battalion. Designated as a “Colored” unit 31 March 1924. Redesignated 23 March 1925 as the 394th Service Battalion. Designated mobilization training station was Camp Grant, IL, 1922-27. Withdrawn from the Sixth Corps Area 11 January 1927 and allotted to the Fourth Corps Area. Reorganized by October 1929 with headquarters at Miami, FL. Demobilized 1 July 1936.

395th Service Battalion (C) (Second Army)

Organized Reserve Michigan

HQ-Not initiated 1921-22; Detroit, MI, 1922-29; *Inactive* 1929-36

Constituted in the Organized Reserve 15 October 1921 as the 395th Service Battalion, assigned to the Second Army, and allotted to the Sixth Corps Area. Initiated in August 1922 with headquarters at Detroit, MI. Redesignated 2 July 1923 as the 95th Service Battalion. Designated as a “Colored” unit 31 March 1924. Redesignated 23 March 1925 as the 395th Service Battalion. Inactivated by June 1929 at Detroit by relief of personnel. Designated mobilization training station was Camp Douglas, WI. Demobilized 1 July 1936.

396th Service Battalion (C) (Third Army)

Organized Reserve Missouri

HQ-Not initiated 1921-22; Kansas City, MO, 1922-28

Constituted in the Organized Reserve 15 October 1921 as the 396th Service Battalion, assigned to the Third Army, and allotted to the Seventh Corps Area. Initiated 20 December 1921 with headquarters at Kansas City, MO. Redesignated 2 July 1923 as the 96th Service Battalion. Designated as a “Colored” unit 31 March 1924. Redesignated 23 March 1925 as the 396th Service Battalion. Withdrawn from the Seventh Corps Area 6 October 1928 and demobilized.

397th Service Battalion (C) (Third Army)

Organized Reserve Arkansas

HQ-Not initiated 1921-22; Little Rock, AR, 1921-26; Arkadelphia, AR, 1926-28

Constituted in the Organized Reserve 15 October 1921 as the 397th Service Battalion, assigned to the Third Army, and allotted to the Seventh Corps Area. Initiated 20 December 1921 with headquarters at Little Rock, AR. Redesignated 2 July 1923 as the 97th Service Battalion. Designated as a “Colored” unit 31 March 1924. Redesignated 23 March 1925 as the 397th Service Battalion. Relocated 26 May 1926 to Arkadelphia, AR. Withdrawn from the Seventh Corps Area 6 October 1928 and demobilized.

398th Service Battalion (GHQR)**Organized Reserve****HQ-Not initiated** 1921-36

Constituted in the Organized Reserve 15 October 1921 as the 398th Service Battalion, assigned to the General Headquarters Reserve, and apparently never allotted to a corps area. Redesignated 2 July 1923 as the 98th Service Battalion. Redesignated 23 March 1925 as the 398th Service Battalion. Demobilized 1 July 1936.

399th Service Battalion (GHQR)**Organized Reserve Tennessee****HQ-Not initiated** 1921-36

Constituted in the Organized Reserve 15 October 1921 as the 399th Service Battalion, assigned to the General Headquarters Reserve, and allotted to the Fourth Corps Area. Nashville, TN, designated as headquarters upon organization, but the unit was never organized at that location. Redesignated 2 July 1923 as the 99th Service Battalion. Redesignated 23 March 1925 as the 399th Service Battalion. Demobilized 1 July 1936.

400th Service Battalion (GHQR)**Organized Reserve****HQ-Not initiated** 1921-36

Constituted in the Organized Reserve 15 October 1921 as the 398th Service Battalion, assigned to the General Headquarters Reserve, and apparently never allotted to a corps area. Redesignated 2 July 1923 as the 98th Service Battalion. Redesignated 23 March 1925 as the 400th Service Battalion. Demobilized 1 July 1936.

401st Service Battalion (C) (ZI)**Organized Reserve Virginia****HQ-Not initiated** 1923-25; Lynchburg, VA, 1925-36

Constituted in the Organized Reserve 2 July 1923 as the 101st Service Battalion, allotted to the Third Corps Area, and assigned to the Zone of the Interior. Assigned to the Communications Zone 31 March 1924. Organized in March 1925 with headquarters at Lynchburg, VA. Redesignated 23 March 1925 as the 401st Service Battalion. Demobilized 1 July 1936.

402nd Service Battalion (ZI)**Organized Reserve Tennessee****HQ-Not initiated** 1923-24; Nashville, TN, 1924-29; *Inactive* 1929-36

Constituted in the Organized Reserve 2 July 1923 as the 102nd Service Battalion, allotted to the Fourth Corps Area, and assigned to the Zone of the Interior. Assigned to the Communications Zone 31 March 1924. Organized in October 1924 with headquarters at Nashville, TN. Inactivated 22 October 1929 at Nashville by relief of personnel. Redesignated 23 March 1925 as the 402nd Service Battalion. Designated mobilization training station was Camp McClellan, AL. Demobilized 1 July 1936.

403rd Service Battalion (CZ)**Organized Reserve Massachusetts/Alabama****HQ-Not initiated** 1923-24; Lowell, MA, 1924-27; *Inactive* 1927-36

Constituted in the Organized Reserve 2 July 1923 as the 103rd Service Battalion, allotted to the First Corps Area, and assigned to the Communications Zone. Initiated in October 1924 with headquarters at Lowell, MA. Redesignated 23 March 1925 as the 403rd Service Battalion. Withdrawn from the First Corps Area 7 January 1927 and allotted to

the Fourth Corps Area. Concurrently designated a "Colored" unit. Inactivated 7 February 1927 at Lowell by relief of personnel. Montgomery, AL, designated as headquarters upon reorganization, but the unit was never organized at that location. Demobilized 1 July 1936.

404th Service Battalion (CZ)

Organized Reserve Massachusetts/Alabama

HQ-Not initiated 1923-24; Lawrence, MA, 1924-27; Inactive 1927-36

Constituted in the Organized Reserve 2 July 1923 as the 104th Service Battalion, allotted to the First Corps Area, and assigned to the Communications Zone. Initiated in November 1924 with headquarters at Lawrence, MA. Redesignated 23 March 1925 as the 404th Service Battalion. Withdrawn from the First Corps Area 7 January 1927 and allotted to the Fourth Corps Area. Inactivated 7 February 1927 at Lawrence by relief of personnel. Anniston, AL, designated as headquarters upon reorganization, but the unit was never organized at that location. Demobilized 1 July 1936.

405th Service Battalion (CZ)

Organized Reserve New York

HQ-Not initiated 1923-24; Brooklyn, NY, 1924-28

Constituted in the Organized Reserve 2 July 1923 as the 105th Service Battalion, allotted to the Second Corps Area, and assigned to the Communications Zone. Initiated in October 1924 with headquarters at Brooklyn, NY. Redesignated 23 March 1925 as the 405th Service Battalion. Withdrawn from the Second Corps Area 6 October 1928 and demobilized.

406th Service Battalion (CZ)

Organized Reserve New York

HQ-Not initiated 1923-27; Manhattan, NY, 1927-28

Constituted in the Organized Reserve 2 July 1923 as the 106th Service Battalion, allotted to the Second Corps Area, and assigned to the Communications Zone. Initiated 18 March 1927 with headquarters at Manhattan, NY. Redesignated 23 March 1925 as the 406th Service Battalion. Withdrawn from the Second Corps Area 6 October 1928 and demobilized.

407th Service Battalion (CZ)

Organized Reserve Alabama

HQ-Not initiated 1923-25; Third Corps Area at large 1925-27; Inactive 1927-36

Constituted in the Organized Reserve 2 July 1923 as the 107th Service Battalion, allotted to the Third Corps Area, and assigned to the Communications Zone. Initiated in February 1925 in the Third Corps Area. Redesignated 23 March 1925 as the 407th Service Battalion. Withdrawn from the Third Corps Area 7 January 1927 and allotted to the Fourth Corps Area. Concurrently designated a "Colored" unit. Gadsden, AL, designated as headquarters upon reorganization, but the unit was never organized at that location. Demobilized 1 July 1936.

408th Service Battalion (CZ)

Organized Reserve Alabama

HQ-Not initiated 1923-25; Third Corps Area at large 1925-27; Inactive 1927-36

Constituted in the Organized Reserve 2 July 1923 as the 108th Service Battalion, allotted to the Third Corps Area, and assigned to the Communications Zone. Initiated in March 1925 in the Third Corps Area. Redesignated 23 March 1925 as the 408th Service Battalion. Conducted summer training at Camp George G. Meade, MD. Withdrawn from

the Third Corps Area 7 January 1927 and allotted to the Fourth Corps Area. Concurrently designated a "Colored" unit. Livingston, AL, designated as headquarters upon reorganization, but the unit was never organized at that location. Demobilized 1 July 1936.

409th Service Battalion (CZ)

Organized Reserve District of Columbia

HQ-*Not initiated* 1923-24; Washington, DC 1924-30; *Inactive* 1930-36

Constituted in the Organized Reserve 2 July 1923 as the 109th Service Battalion, allotted to the Third Corps Area, and assigned to the Communications Zone. Initiated by April 1924 with headquarters at Washington, DC. Redesignated 23 March 1925 as the 409th Service Battalion. Inactivated 16 January 1930 at Washington by relief of personnel. Reorganized and redesignated 1 July 1936 as the 1st Battalion, 473rd Quartermaster Regiment.

410th Service Battalion (CZ)

Organized Reserve Tennessee

HQ-*Not initiated* 1923-24; Clarksville, TN, 1924-29; *Inactive* 1929-36

Constituted in the Organized Reserve 2 July 1923 as the 110th Service Battalion, allotted to the Fourth Corps Area, and assigned to the Communications Zone. Initiated in April 1924 with headquarters at Clarksville, TN. Redesignated 23 March 1925 as the 410th Service Battalion. Inactivated 1 October 1929 at Clarksville by relief of personnel. Demobilized 1 July 1936.

411th Service Battalion (CZ)

Organized Reserve South Carolina

HQ-*Not initiated* 1923-24; Marion, SC, 1924-28

Constituted in the Organized Reserve 2 July 1923 as the 111th Service Battalion, allotted to the Fourth Corps Area, and assigned to the Communications Zone. Initiated in April 1924 with headquarters at Marion, SC. Redesignated 23 March 1925 as the 411th Service Battalion. Withdrawn from the Fourth Corps Area 6 October 1928 and demobilized.

412th Service Battalion (CZ)

Organized Reserve Georgia

HQ-*Not initiated* 1923-24; Moultrie, GA, 1924-28

Constituted in the Organized Reserve 2 July 1923 as the 112th Service Battalion, allotted to the Fourth Corps Area, and assigned to the Communications Zone. Initiated 30 April 1924 with headquarters at Moultrie, GA. Redesignated 23 March 1925 as the 412th Service Battalion. Withdrawn from the Fourth Corps Area 6 October 1928 and demobilized.

413th Service Battalion (CZ)

Organized Reserve Indiana

HQ-*Not initiated* 1923-24; Jeffersonville, IN, 1924-36

Constituted in the Organized Reserve 2 July 1923 as the 113th Service Battalion, allotted to the Fifth Corps Area, and assigned to the Communications Zone. Initiated in September 1924 with headquarters at Jeffersonville, IN. Redesignated 23 March 1925 as the 413th Service Battalion. Demobilized 1 July 1936.

414th Service Battalion (CZ)**Organized Reserve Kentucky**

HQ-Not initiated 1923-30; Lexington, KY, 1930-36

Constituted in the Organized Reserve 2 July 1923 as the 114th Service Battalion, allotted to the Fifth Corps Area, and assigned to the Communications Zone. Initiated by March 1930 with headquarters at Lexington, KY. Redesignated 23 March 1925 as the 414th Service Battalion. Demobilized 1 July 1936.

415th Service Battalion (CZ)**Organized Reserve Ohio**

HQ-Not initiated 1923-30; Charleston, WV 1930-36

Constituted in the Organized Reserve 2 July 1923 as the 115th Service Battalion, allotted to the Fifth Corps Area, and assigned to the Communications Zone. Initiated by March 1930 with headquarters at Charleston, WV. Redesignated 23 March 1925 as the 415th Service Battalion. Demobilized 1 July 1936.

416th Service Battalion (CZ)**Organized Reserve Michigan**

HQ-Not initiated 1923-26; Detroit, MI, 1926-32; Battle Creek, MI, 1932-36

Constituted in the Organized Reserve 2 July 1923 as the 116th Service Battalion, allotted to the Sixth Corps Area, and assigned to the Communications Zone. Redesignated 23 March 1925 as the 416th Service Battalion. Initiated 17 March 1926 with headquarters at Detroit, MI. Relocated 27 Sep 32 to Battle Creek, MI. Conducted summer training at Camp Custer, MI. Demobilized 1 July 1936.

417th Service Battalion (CZ)**Organized Reserve Illinois**

HQ-Not initiated 1923-26; Chicago, IL, 1926-36

Constituted in the Organized Reserve 2 July 1923 as the 117th Service Battalion, allotted to the Sixth Corps Area, and assigned to the Communications Zone. Redesignated 23 March 1925 as the 417th Service Battalion. Initiated 17 March 1926 with headquarters at Chicago, IL. Conducted summer training at Fort Sheridan, IL. Demobilized 1 July 1936.

418th Service Battalion (CZ)**Organized Reserve Illinois**

HQ-Not initiated 1923-26; Chicago, IL, 1926-36

Constituted in the Organized Reserve 2 July 1923 as the 118th Service Battalion, allotted to the Sixth Corps Area, and assigned to the Communications Zone. Redesignated 23 March 1925 as the 418th Service Battalion. Initiated 17 March 1926 with headquarters at Chicago, IL. Conducted summer training at Camp McCoy, WI, or Fort Sheridan, IL. Demobilized 1 July 1936.

419th Service Battalion (CZ)**Organized Reserve Missouri/Arkansas**

HQ-Not initiated 1923-24; St. Louis, MO, 1924-26; Fort Smith, AR, 1926-36

Constituted in the Organized Reserve 2 July 1923 as the 119th Service Battalion, allotted to the Seventh Corps Area, and assigned to the Communications Zone. Initiated in November 1924 with headquarters at St. Louis, MO. Redesignated 23 March 1925 as the 419th Service Battalion. Relocated 26 May 1926 to Fort Smith, AR. Conducted summer training at Fort Crook, NE. Demobilized 1 July 1936.

420th Service Battalion (CZ)**Organized Reserve Kansas**

HQ-Not initiated 1923-24; Fort Scott, KS, 1924-26; Abilene, KS, 1926-36

Constituted in the Organized Reserve 2 July 1923 as the 120th Service Battalion, allotted to the Seventh Corps Area, and assigned to the Communications Zone. Initiated in November 1924 with headquarters at Fort Scott, KS. Redesignated 23 March 1925 as the 420th Service Battalion. Relocated 26 May 1926 to Abilene, KS. Reorganized and redesignated 1 July 1936 as the 1st Battalion, 477th Quartermaster Regiment.

421st Service Battalion (C) (CZ)**Organized Reserve Texas/North Carolina**

HQ-Not initiated 1923-26; Laredo, TX, 1926-27; *Inactive* 1927-29; Asheville, NC, 1929-36

Constituted in the Organized Reserve 2 July 1923 as the 121st Service Battalion, allotted to the Eighth Corps Area, and assigned to the Communications Zone. Redesignated 23 March 1925 as the 421st Service Battalion. Initiated in January 1926 with headquarters at Laredo, TX. Withdrawn from the Eighth Corps Area 7 January 1927 and allotted to the Fourth Corps Area as a "Colored" unit. Inactivated 9 February 1927 at Laredo by relief of personnel. Organized 22 October 1929 at Asheville, NC. Demobilized 1 July 1936.

422nd Service Battalion (CZ)**Organized Reserve Texas**

HQ-Not initiated 1923-26; Houston, TX, 1926-27; *Inactive* 1927-28

Constituted in the Organized Reserve 2 July 1923 as the 122nd Service Battalion, allotted to the Eighth Corps Area, and assigned to the Communications Zone. Initiated in February 1926 with headquarters at Houston, TX. Redesignated 23 March 1925 as the 422nd Service Battalion. Withdrawn from the Eighth Corps Area 7 January 1927 and allotted to the Fourth Corps Area as a "Colored" unit. Withdrawn from the Fourth Corps Area 6 October 1928 and demobilized.

423rd Service Battalion (CZ)**Organized Reserve California/Missouri**

HQ-Not initiated 1923-25; San Francisco, CA, 1925-27; Hannibal, MO, 1927-36

Constituted in the Organized Reserve 2 July 1923 as the 123rd Service Battalion, allotted to the Ninth Corps Area, and assigned to the Communications Zone. Redesignated 23 March 1925 as the 422nd Service Battalion. Initiated 11 August 1925 with headquarters at San Francisco, CA. Withdrawn from the Ninth Corps Area 11 January 1927 and allotted to the Seventh Corps Area. Organized 3 August 1927 at Hannibal, MO. Demobilized 1 July 1936.

424th Service Battalion (CZ)**Organized Reserve California**

HQ-Not initiated 1923-25; San Francisco, CA, 1925-36

Constituted in the Organized Reserve 2 July 1923 as the 124th Service Battalion, allotted to the Ninth Corps Area, and assigned to the Communications Zone. Initiated in January 1925 with headquarters at San Francisco, CA. Redesignated 23 March 1925 as the 424th Service Battalion. Conducted summer training at the Presidio of San Francisco, CA, or the Presidio of Monterey, CA. Demobilized 1 July 1936.

425th Service Battalion (C) (ZI)**Organized Reserve Massachusetts**

HQ-Not initiated 1924-25; Camp Devens, MA, 1925-30; *Inactive* 1930-36

Constituted in the Organized Reserve 31 March 1924 as the 125th Service Battalion, allotted to the First Corps Area, and assigned to the Zone of the Interior. Initiated in February 1925 with headquarters at Camp Devens, MA. Redesignated 23 March 1925 as the 425th Service Battalion. Unit was designated 27 September 1927 to be manned by colored officers. Inactivated by June 1930 at Camp Devens by relief of personnel. Designated mobilization training station was Camp Devens. Demobilized 1 July 1936.

426th Service Battalion (ZI)**Organized Reserve New York**

HQ-Not initiated 1924-26; Brooklyn, NY, 1926-30; *Inactive* 1930-36

Constituted in the Organized Reserve 31 March 1924 as the 126th Service Battalion, allotted to the Second Corps Area, and assigned to the Zone of the Interior. Redesignated 23 March 1925 as the 426th Service Battalion. Initiated 19 January 1926 with headquarters at Brooklyn, NY. Inactivated 15 January 1930 at Brooklyn by relief of personnel. Demobilized 1 July 1936.

427th Service Battalion (C) (ZI)**Organized Reserve Pennsylvania**

HQ-Not initiated 1924-26; Philadelphia, PA, 1926-30; *Inactive* 1930-36

Constituted in the Organized Reserve 31 March 1924 as the 127th Service Battalion, allotted to the Third Corps Area, and assigned to the Zone of the Interior. Redesignated 23 March 1925 as the 427th Service Battalion. Initiated in March 1926 with headquarters at Philadelphia, PA. Inactivated 13 January 1930 at Philadelphia by relief of personnel. Demobilized 1 July 1936.

428th Service Battalion (C) (ZI)**Organized Reserve**

HQ-Not initiated 1924-28

Constituted in the Organized Reserve 31 March 1924 as the 128th Service Battalion, allotted to the Fourth Corps Area, and assigned to the Zone of the Interior. Redesignated 23 March 1925 as the 428th Service Battalion. Withdrawn from the Fourth Corps Area 6 October 1928 and demobilized.

429th Service Battalion (C) (ZI)**Organized Reserve**

HQ-Not initiated 1924-28

Constituted in the Organized Reserve 31 March 1924 as the 129th Service Battalion, allotted to the Fifth Corps Area, and assigned to the Zone of the Interior. Redesignated 23 March 1925 as the 429th Service Battalion. Withdrawn from the Fifth Corps Area 6 October 1928 and demobilized.

430th Service Battalion (ZI)**Organized Reserve Illinois**

HQ-Not initiated 1924-26; Chicago, IL, 1926-36

Constituted in the Organized Reserve 31 March 1924 as the 130th Service Battalion, allotted to the Sixth Corps Area, and assigned to the Zone of the Interior. Redesignated 23 March 1925 as the 430th Service Battalion. Initiated 7 March 1926 with headquarters at Chicago, IL. Conducted summer training at Camp McCoy, WI, or Fort Sheridan, IL. Demobilized 1 July 1936.

431st Service Battalion (C) (ZI)

Organized Reserve Missouri/Arkansas/Kansas

HQ-Poplar Bluff, MO, 1924-26; Helena, AR, 1926-31; Kansas City, KS, 1931-36

Constituted in the Organized Reserve 31 March 1924 as the 131st Service Battalion, allotted to the Seventh Corps Area, and assigned to the Zone of the Interior. Initiated in November 1924 with headquarters at Poplar Bluff, MO. Redesignated 23 March 1925 as the 431st Service Battalion. Relocated 26 May 1926 to Helena, AR. Relocated 12 October 1931 to Kansas City, KS. Demobilized 1 July 1936.

432nd Service Battalion (C) (ZI)

Organized Reserve Texas

HQ-*Not initiated* 1924-26; Fort Sam Houston, TX, 1926-36

Constituted in the Organized Reserve 31 March 1924 as the 132nd Service Battalion, allotted to the Eighth Corps Area, and assigned to the Zone of the Interior. Fort Worth, TX, designated as headquarters upon organization, but the unit was never organized at that location. Redesignated 23 March 1925 as the 432nd Service Battalion. Initiated in January 1926 with headquarters at Fort Sam Houston, TX. Conducted summer training at Fort Sam Houston, Fort Bliss, TX, or Fort Sill, OK. Demobilized 1 July 1936.

433rd Service Battalion (C) (ZI)

Organized Reserve California/Washington

HQ-*Not initiated* 1924-25; Oakland, CA, 1925-29; *Inactive* 1929-36

Constituted in the Organized Reserve 31 March 1924 as the 133rd Service Battalion, allotted to the Ninth Corps Area, and assigned to the Zone of the Interior. Initiated in January 1925 with headquarters at Oakland, CA. Redesignated 23 March 1925 as the 433rd Service Battalion. Inactivated 1 October 1929 at Oakland by relief of personnel. Seattle, WA, designated as headquarters upon reorganization, but the unit was never organized at that location. Demobilized 1 July 1936.

Chapter 42

Wagon Trains



Quartermaster Review

A wagon train of the Missouri National Guard in the field near Camp Clark, MO.

Wagon trains provided animal-drawn transport and resupply capabilities to subordinate units of the corps.

Organization

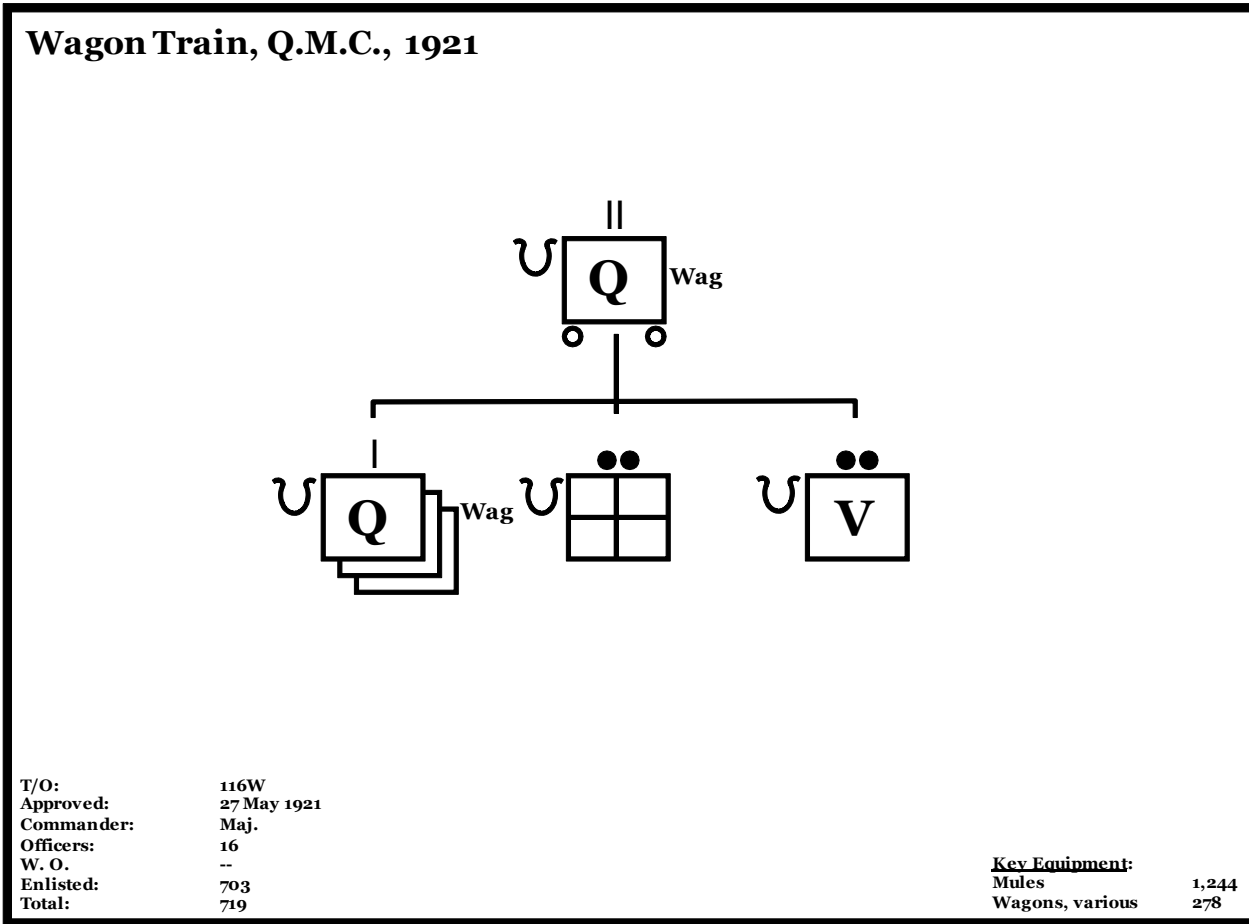

Wagon Train TOE.

Wagon trains were the animal-drawn division of the corps quartermaster train (the motor division being provided by the seven motor transport commands). The key components of the wagon train consisted of a headquarters and three wagon companies. This organization was intended to provide the logistic haul capability in the corps forward areas where its units were expected to move on unpaved roads or cross-country. The train's haul capacity was provided by 478 wagons pulled by over 1,200 horses and mules. Therefore, the wagon train also included a small veterinary section for animal care and food inspection purposes. The wagon train was only found in the corps quartermaster train.

Training

There is no evidence that any of the initiated wagon trains were functional units during the Inactive Training Period. Most of the assigned personnel probably attended training at quartermaster conferences or with other units (see Chapter 37-Quartermaster Trains for a more detailed explanation of quartermaster training). Six were known to have attended summer training as units.

HHD, 1st Wagon Train (Corps)**Regular Army Inactive****HQ**-*Not organized* 1927-36**Subordinate units:** *33rd Wagon Company* 1928-36; *34th Wagon Company* 1928-36; *35th Wagon Company* 1928-36
Constituted in the Regular Army 18 October 1927 as the 1st Wagon Train (Corps) and allotted to the Second Corps Area. Designated mobilization training station was Fort Devens, MA, 1927-36. Demobilized 1 May 1936.**HHD, 2nd Wagon Train (Corps)****Regular Army Inactive****HQ**-*Not organized* 1927-30; Altoona, PA, 1930-36**Subordinate units:** *29th Wagon Company* 1928-36; *30th Wagon Company* 1928-36; *31st Wagon Company* 1928-36
Constituted in the Regular Army 18 October 1927 as the 2nd Wagon Train (Corps) and allotted to the Third Corps Area. Organized 16 January 1930 with Organized Reserve personnel as a RAI unit with headquarters at Altoona, PA. Designated mobilization training station was Camp Dix, NJ, 1927-36. Demobilized 1 May 1936.**HHD, 3rd Wagon Train (Corps)****Regular Army Inactive****HQ**-*Not organized* 1927-36**Subordinate units:** *32nd Wagon Company* 1928-36; *36th Wagon Company* 1928-36; *37th Wagon Company* 1928-36
Constituted in the Regular Army 18 October 1927 as the 3rd Wagon Train (Corps) and allotted to the Seventh Corps Area. Fort Leavenworth, KS, designated as headquarters on organization, but the unit was never organized at that location. Designated mobilization training station was the Laurel (MD) Mobilization Area 1928-36. Demobilized 1 May 1936.**HHD, 7th Wagon Train (Corps) (1928-36)****Organized Reserve****HQ**-*Not initiated* 1928-36**Subordinate units:** *359th Wagon Company* 1928-36; *360th Wagon Company* 1928-36; *361st Wagon Company* 1928-36
Constituted in the Organized Reserve 5 September 1928 as the 7th Wagon Train (Corps) and allotted to the Seventh Corps Area. Demobilized 1 July 1936.**HHD, 16th Wagon Train (Corps) (1928-36)****Organized Reserve California****HQ**-Sacramento, CA, 1928-29; *Inactive* 1929-36**Subordinate units:** *362nd Wagon Company* 1928-36; *363rd Wagon Company* 1928-36; *364th Wagon Company* 1928-36
Constituted in the Organized Reserve 5 September 1928 as the 16th Wagon Train (Corps) and allotted to the Ninth Corps Area. Headquarters initiated in 1928 at Sacramento, CA. Inactivated 16 October 1929 at Sacramento by relief of personnel. Demobilized 1 July 1936.**HHD, 51st Wagon Train (1921-23) (II Corps)****New York National Guard****HHD, 74th Wagon Train (1923-25) (II Corps)****HHD, II Corps Wagon Train (1925-27)****HQ**-*Not organized* 1921-27**Subordinate units:** *161st Wagon Company* 1921-23; *162nd Wagon Company* 1921-23; *163rd Wagon Company* 1921-23; *410th Wagon Company* 1923-27; *411th Wagon Company* 1923-27; *412th Wagon Company* 1923-27
Constituted in the National Guard 29 July 1921 as the 51st Wagon Train, allotted to the state of New York, and assigned to the II Corps. Placed on the deferred list 2 July 1923 and allotted to the Organized Reserve as a Deferred National Guard unit. Concurrently redesignated as the as the 74th Wagon Train. Rochester, NY, designated as headquarters on organization, but the unit was never organized at that location. Redesignated 23 March 1925 as the II Corps Wagon Train. Withdrawn from the Organized Reserve 22 June 1927 as a DNG unit. Withdrawn from the National Guard 17 September 1927 and demobilized.

HHD, 52nd Wagon Train (1921-23) (III Corps)

Pennsylvania National Guard

HHD, 75th Wagon Train (1921-25) (III Corps)

HHD, III Corps Wagon Train (1925-27)

HQ-Not organized 1921-27

Subordinate units: *164th Wagon Company 1921-23; 165th Wagon Company 1921-23; 166th Wagon Company 1921-23; 413th Wagon Company 1923-27; 414th Wagon Company 1923-27; 415th Wagon Company 1923-27*

Constituted in the National Guard 29 July 1921 as the 52nd Wagon Train, allotted to the state of Pennsylvania and assigned to the III Corps. Placed on the deferred list 2 July 1923 and allotted to the Organized Reserve as a Deferred National Guard unit. Concurrently redesignated as the 75th Wagon Train. Redesignated 23 March 1925 as the XI Corps Wagon Train. Withdrawn from the Organized Reserve 22 June 1927 as a DNG unit. Withdrawn from the National Guard 17 September 1927 and demobilized.

HHD, 53rd Wagon Train (1921-23) (IV Corps)

Tennessee National Guard

HHD, 76th Wagon Train (1923-26) (IV Corps)

HHD, IV Corps Wagon Train (1926-27)

HQ-Not organized 1921-27

Subordinate units: *167th Wagon Company 1921-23; 168th Wagon Company 1921-23; 169th Wagon Company 1921-23; 416th Wagon Company 1923-27; 417th Wagon Company 1923-27; 418th Wagon Company 1923-27*

Constituted in the National Guard 29 July 1921 as the 53rd Wagon Train, allotted to the state of Tennessee, and assigned to the IV Corps. Placed on the deferred list 2 July 1923 and allotted to the Organized Reserve as a Deferred National Guard unit. Concurrently redesignated as the 76th Wagon Train, withdrawn from the state of Tennessee, and allotted to the state of North Carolina. Waynesville, NC designated as headquarters on organization, but the unit was never organized at that location. Redesignated 23 March 1925 as the IV Corps Wagon Train. Designated mobilization training station was Fort Bragg, NC 1921-23 and Charlotte Mobilization Area 1923-27. Withdrawn from the Organized Reserve 22 June 1927 as a DNG unit. Withdrawn from the National Guard 17 September 1927 and demobilized.

HHD, 54th Wagon Train (1921-23) (VI Corps)

Illinois National Guard

HHD, 77th Wagon Train (1923-26) (VI Corps)

HHD, XVI Corps Wagon Train (1926-27)

HQ-Not organized 1921-27

Subordinate units: *170th Wagon Company 1921-23; 171st Wagon Company 1921-23; 172nd Wagon Company 1921-23; 419th Wagon Company 1923-27; 420th Wagon Company 1923-27; 421st Wagon Company 1923-27*

Constituted in the National Guard 29 July 1921 as the 54th Wagon Train, allotted to the state of Illinois, and assigned to the VI Corps. Placed on the deferred list 2 July 1923 and allotted to the Organized Reserve as a Deferred National Guard unit. Concurrently redesignated as the 77th Wagon Train, relieved from the VI Corps, and assigned to the XVI Corps. Redesignated 23 March 1925 as the XVI Corps Wagon Train. Designated mobilization training station was Camp Grant, IL 1923-27. Withdrawn from the Organized Reserve 22 June 1927 as a DNG unit. Withdrawn from the National Guard 17 September 1927 and demobilized.

HHD, 55th Wagon Train (1921-23) (VII Corps)

Kansas National Guard

HHD, 78th Wagon Train (1923-26) (VII Corps)

HHD, VII Corps Wagon Train (1926-27)

HQ-Not organized 1921-27

Subordinate units: *173rd Wagon Company 1921-23; 174th Wagon Company 1921-23; 175th Wagon Company 1921-23; 422nd Wagon Company 1923-27; 423rd Wagon Company 1923-27; 424th Wagon Company 1923-27*

Constituted in the National Guard 29 July 1921 as the 55th Wagon Train, allotted to the state of Kansas, and assigned to the VII Corps. Kansas City, KS, designated as headquarters on organization, but the unit was never organized at that location. Placed on the deferred list 2 July 1923 and allotted to the Organized Reserve as a Deferred National Guard unit. Concurrently redesignated as the 78th Wagon Train. Designated headquarters location changed 13 January 1925 to Mankato, MN. Redesignated 23 March 1925 as the VII Corps Wagon Train. Withdrawn from the Organized Reserve 22 June 1927 as a DNG unit. Withdrawn from the National Guard 17 September 1927 and demobilized.

HHD, 61st Wagon Train (1921-26) (XI Corps)

Organized Reserve Massachusetts

HHD, XI Corps Wagon Train (1926-27)

HHD, 11th Wagon Train (Corps) (1927-36)

HQ-Springfield, MA, 1921-36

Subordinate units: 371st Wagon Company 1921-36; 372nd Wagon Company 1921-36; 373rd Wagon Company 1921-36

Constituted in the Organized Reserve 29 July 1921 as the 61st Wagon Train, allotted to the First Corps Area, and assigned to the XI Corps. Headquarters initiated 12 December 1921 at Springfield, MA. Redesignated 23 March 1925 as the XI Corps Wagon Train. Redesignated as the 11th Wagon Train (Corps) 22 June 1927 and relieved from the XI Corps. Conducted summer training at Camp Holabird, MA. Demobilized 1 July 1936.

HHD, 62nd Wagon Train (1921-26) (XII Corps)

Organized Reserve New York

HHD, XII Corps Wagon Train (1926-27)

HHD, 12th Wagon Train (Corps) (1927-36)

HQ-*Not initiated* 1921-22; Syracuse, NY, 1922-36

Subordinate units: 374th Wagon Company 1921-36; 375th Wagon Company 1921-36; 376th Wagon Company 1921-36

Constituted in the Organized Reserve 29 July 1921 as the 62nd Wagon Train, allotted to the Second Corps Area, and assigned to the XII Corps. Headquarters initiated 3 March 1922 at Syracuse, NY. Redesignated 23 March 1925 as the XII Corps Wagon Train. Redesignated as the 12th Wagon Train (Corps) 22 June 1927 and relieved from the XII Corps. Demobilized 1 July 1936.

HHD, 63rd Wagon Train (1921-26) (XIII Corps)

Organized Reserve Pennsylvania/West Virginia

HHD, XIII Corps Wagon Train (1926-27)

HHD, 13th Wagon Train (Corps) (1927-36)

HQ-West Reading, PA, 1921-27; Huntington, WV, 1927-36

Subordinate units: 377th Wagon Company 1921-36; 378th Wagon Company 1921-36; 379th Wagon Company 1921-36

Constituted in the Organized Reserve 29 July 1921 as the 63rd Wagon Train, allotted to the Third Corps Area, and assigned to the XIII Corps. Headquarters initiated 2 November 1921 at West Reading, PA. Redesignated 23 March 1925 as the XIII Corps Wagon Train. Withdrawn from the Third Corps Area 7 January 1927 and allotted to the Fifth Corps Area. Headquarters reorganized in 1927 at Huntington, WV. Redesignated as the 13th Wagon Train (Corps) 22 June 1927 and relieved from the XIII Corps. Demobilized 1 July 1936.

HHD, 64th Wagon Train (1921-26) (XIV Corps)

Organized Reserve Mississippi

HHD, XIV Corps Wagon Train (1926-27)

HHD, 14th Wagon Train (Corps) (1927-36)

HQ-*Not initiated* 1921-22; West Point, MS 1922-36

Subordinate units: 380th Wagon Company 1921-36; 381st Wagon Company 1921-36; 382nd Wagon Company 1921-36

Constituted in the Organized Reserve 29 July 1921 as the 64th Wagon Train, allotted to the Fourth Corps Area, and assigned to the XIV Corps. Headquarters initiated 6 May 1922 at West Point, MS. Redesignated 23 March 1925 as the XIV Corps Wagon Train. Redesignated as the 14th Wagon Train (Corps) 22 June 1927 and relieved from the XIV Corps. Designated mobilization training station was Camp McClellan, AL 1923-36. Demobilized 1 July 1936.

HHD, 65th Wagon Train (1921-26) (XV Corps)

Organized Reserve Kentucky

XV Corps Wagon Train (1926-27)

15th Wagon Train (Corps) (1927-36)

HQ-*Not initiated* 1921-22; Bowling Green, KY, 1922-30; *Inactive* 1930-36

Subordinate units: 383rd Wagon Company 1921-36; 384th Wagon Company 1921-36; 385th Wagon Company 1921-36

Constituted in the Organized Reserve 29 July 1921 as the 65th Wagon Train, allotted to the Fifth Corps Area, and assigned to the XV Corps. Headquarters initiated in 1922 at Bowling Green, KY. Redesignated 23 March 1925 as the XV Corps Wagon Train. Redesignated as the 15th Wagon Train (Corps) 22 June 1927 and relieved from the XV Corps. Inactivated by March 1930 at Bowling Green by relief of personnel. Demobilized 1 July 1936.

HHD, 66th Wagon Train (1921-26) (XVI Corps)

Organized Reserve Wisconsin

HHD, VI Corps Wagon Train (1926-27)

HHD, 6th Wagon Train (Corps) (1927-36)

HQ-Not initiated 1921-22; Fennimore, WI, 1922-25; Wausau, WI, 1925-36

Subordinate units: 386th Wagon Company 1921-36; 387th Wagon Company 1921-36; 388th Wagon Company 1921-36

Constituted in the Organized Reserve 29 July 1921 as the 66th Wagon Train, allotted to the Sixth Corps Area, and assigned to the XVI Corps. Headquarters initiated in 1922 at Fennimore, WI. Redesignated 23 March 1925 as the VI Corps Wagon Train. Headquarters relocated 2 June 1925 to Wausau, WI. Redesignated as the 6th Wagon Train (Corps) 22 June 1927 and relieved from the VI Corps. Conducted summer training at Camp McCoy, WI or Fort Sheridan, IL. Designated mobilization training station was the State Fairgrounds, Springfield, IL 1923-36. Demobilized 1 July 1936.

HHD, 67th Wagon Train (1921-26) (XVII Corps)

Organized Reserve Minnesota/Missouri

HHD, XVII Corps Wagon Train (1926-27)

HHD, 17th Wagon Train (Corps) (1927-36)

HQ-Not initiated 1921-22; Moorhead, MN, 1922-28; Kansas City, MO, 1928-36

Subordinate units: 389th Wagon Company 1921-36; 399th Wagon Company 1921-36; 391st Wagon Company 1921-36

Constituted in the Organized Reserve 29 July 1921 as the 67th Wagon Train, allotted to the Seventh Corps Area, and assigned to the XVII Corps. Headquarters initiated in 1922 at Moorhead, MN. Redesignated 23 March 1925 as the XVII Corps Wagon Train. Headquarters relocated 3 April 1928 to Kansas City, MO. Redesignated as the 17th Wagon Train (Corps) 22 June 1927 and relieved from the XVII Corps. Demobilized 1 July 1936.

HHD, 68th Wagon Train (1921-26) (XVIII Corps)

Organized Reserve Oklahoma/Texas

HHD, XVIII Corps Wagon Train (1926-27)

HHD, 18th Wagon Train (Corps) (1927-36)

HQ-Not initiated 1921-23; 101 Ranch, OK, 1923-27; San Antonio, TX, 1927-29; *Inactive* 1929-36

Subordinate units: 392nd Wagon Company 1921-36; 393rd Wagon Company 1921-36; 394th Wagon Company 1921-36

Constituted in the Organized Reserve 29 July 1921 as the 68th Wagon Train, allotted to the Eighth Corps Area, and assigned to the XVIII Corps. Headquarters initiated 6 January 1923 at 101 Ranch, OK. Redesignated 23 March 1925 as the XVIII Corps Wagon Train. Headquarters relocated in 1927 to San Antonio, TX. Redesignated as the 18th Wagon Train (Corps) 22 June 1927 and relieved from the XVIII Corps. Inactivated 28 August 1929 at San Antonio by relief of personnel. Conducted summer training at Fort Sill, OK or Fort Sam Houston, TX. Designated mobilization training station was Fort Clark, TX 1923-36. Demobilized 1 July 1936.

HHD, 69th Wagon Train (1921-26) (XIX Corps)

Organized Reserve California

HHD, IX Corps Wagon Train (1926-27)

HHD, 9th Wagon Train (Corps) (1927-36)

HQ-Not initiated 1921-25; Los Angeles, CA, 1925-36

Subordinate units: 395th Wagon Company 1921-36; 396th Wagon Company 1921-36; 397th Wagon Company 1921-36

Constituted in the Organized Reserve 29 July 1921 as the 69th Wagon Train, allotted to the Ninth Corps Area, and assigned to the XIX Corps. Relieved from the XIX Corps 2 July 1923 and assigned to the IX Corps. Redesignated 23 March 1925 as the IX Corps Wagon Train. Headquarters initiated 11 August 1925 at Los Angeles, CA. Redesignated

as the 9th Wagon Train (Corps) 22 June 1927 and relieved from the IX Corps. Conducted summer training at the Presidio of Monterey, CA, or Del Monte, CA. Demobilized 1 July 1936.

HHD, 70th Wagon Train (1921-26) (I Corps) **Organized Reserve New Jersey**

HHD, I Corps Wagon Train (1926-27)

HHD, 1st Wagon Train (Corps) (1927-28)

HHD, 4th Wagon Train (Corps) (1928-36)

HQ-Not initiated 1921-22; South Orange, NJ, 1922-26

Subordinate units: 398th Wagon Company 1921-36; 399th Wagon Company 1921-36; 400th Wagon Company 1921-36

Constituted in the Organized Reserve 29 July 1921 as the 70th Wagon Train, allotted to the Second Corps Area, and assigned to the I Corps. Headquarters initiated 17 March 1922 at South Orange, NJ. Redesignated 23 March 1925 as the I Corps Wagon Train. Redesignated as the 1st Wagon Train (Corps) 22 June 1927 and relieved from the I Corps. Redesignated as the 4th Wagon Train (Corps) 5 September 1928. Conducted summer training at Camp Holabird, MA. Demobilized 1 July 1936.

HHD, 71st Wagon Train (Colored) (1921-26) (V Corps) **Organized Reserve Indiana**

HHD, V Corps Wagon Train (Colored) (1926-27)

HHD, 5th Wagon Train (Corps) (Colored) (1927-36)

HQ-Not initiated 1921-22; Jeffersonville, IN, 1922-30; *Inactive* 1930-36

Subordinate units: 401st Wagon Company 1921-36; 402nd Wagon Company 1921-36; 403rd Wagon Company 1921-36

Constituted in the Organized Reserve 29 July 1921 as the 71st Wagon Train, allotted to the Fifth Corps Area, and assigned to the V Corps. Headquarters initiated in 1922 at Jeffersonville, IN. Redesignated 23 March 1925 as the V Corps Wagon Train. Redesignated as the 5th Wagon Train (Corps) 22 June 1927 and relieved from the V Corps. Inactivated by March 1930 at Jeffersonville by relief of personnel. Designated mobilization training station was the Jeffersonville Quartermaster Depot, Jeffersonville, IN 1923-33. Demobilized 1 July 1936.

HHD, 72nd Wagon Train (Colored) (1921-26) (VIII Corps) **Organized Reserve Oklahoma/Texas**

HHD, VIII Corps Wagon Train (Colored) (1926-27)

HHD, 8th Wagon Train (Corps) (Colored) (1927-36)

HQ-Not initiated 1921-22; Perry, OK, 1922-25; San Antonio, TX, 1925-29; *Inactive* 1929-36

Subordinate units: 404th Wagon Company 1921-36; 405th Wagon Company 1921-36; 406th Wagon Company 1921-36

Constituted in the Organized Reserve 29 July 1921 as the 72nd Wagon Train, allotted to the Eighth Corps Area, and assigned to the VIII Corps. Headquarters initiated in 1922 at Perry, OK. Redesignated 23 March 1925 as the VIII Corps Wagon Train. Headquarters relocated 15 Apr 25 to San Antonio, TX. Redesignated as the 8th Wagon Train (Corps) 22 June 1927 and relieved from the VIII Corps. Inactivated 28 August 1929 at San Antonio by relief of personnel. Conducted summer training at Fort Sill, OK or Fort Sam Houston, TX. Designated mobilization training station was Fort Clark, TX 1923-36. Demobilized 1 July 1936.

HHD, 73rd Wagon Train (1921-26) (IX Corps) **Organized Reserve Minnesota/South Dakota**

HHD, XIX Corps Wagon Train (1926-27)

HHD, 19th Wagon Train (Corps) (1927-36)

HQ-Not initiated 1921-22; St. Paul, MN, 1922-28; Sioux Falls, SD, 1928-36

Subordinate units: 407th Wagon Company 1921-36; 408th Wagon Company 1921-36; 409th Wagon Company 1921-36

Constituted in the Organized Reserve 29 July 1921 as the 73rd Wagon Train, allotted to the Seventh Corps Area, and assigned to the IX Corps. Headquarters initiated in 1922 at St. Paul, MN. Redesignated 23 March 1925 as the XIX Corps Wagon Train 23 March 1925, relieved from the IX Corps, and assigned to the XIX Corps. Redesignated as the

19th Wagon Train (Corps) 22 June 1927 and relieved from the XIX Corps. Headquarters relocated 3 April 1928 to Sioux Falls, SD. Conducted summer training at Fort Crook, NE. Demobilized 1 July 1936.

Chapter 43

Quartermaster Regiments, Battalions, and Squadrons



The Military Engineer

Trucks of a quartermaster truck regiment on a cross-country convoy circa 1938.

The mission of quartermaster regiments, battalions, and squadrons was to plan, coordinate, and conduct operations to provide logistical support to army, corps, and division mobile units within the combat and communications zones.

Organization

In 1931, the Quartermaster Corps began a comprehensive study on how best to organize its mobile units for combat. In June of that year all active quartermaster trains in the Regular Army were inactivated (although their active subordinate elements were not) pending the results of that study. In 1935, tables of organization were approved for a series of new quartermaster organizations. Unlike the previous system of trains and other commands that were very flexible in terms of cross-attachment of subordinate companies, these new-system organizations were organized as fixed regiments and battalions. The new units were constituted in May and July 1936 and soon after organization and initiation of these units began, mostly through consolidation with existing pre-1931 units. The following table illustrates the allotment of the types of units to the various components through 1940.

Types of units to the various components.

Organizations	Q.M. Regt. Div.	Q.M. Regt. Truck-Army	Q.M. Regt. Truck-Corps	Q.M. Regt. Light Maint.	Q.M. Regt. Heavy Maint.	Q.M. Regt. Rmt.	Q.M. Regt. Sv.
RA	5	0	0	0	0	0	0
RAI	6	8	9	9	9	4	6
NG	18	0	0	0	0	0	0
OR	27	5	9	9	6	4	12
Totals	56	13	18	18	15	8	18

Organizations	Q.M. Sq. Cav. Div.	Q.M. Bn. Truck-Army	Q.M. Bn. Bakery	Q.M. Bn. Light Maint.	Q.M. Bn. Heavy Maint.	Q.M. Bn. Sales Comm.
RA	2	0	0	5	0	0
RAI	1	7	4	7	1	0
NG	4	0	0	0	0	0
OR	6	0	16	2	0	3
Totals	13	7	20	14	1	3

Organizations	Q.M. Bn. Car	Q.M. Bn. Wagon	Q.M. Bn. Salv.	Q.M. Bn. Cloth. & Bath	Q.M. Bn. Grave Regis.	Q.M. Bn. Laundry
RA	0	0	0	0	0	0
RAI	5	0	0	0	0	0
NG	0	0	0	0	0	0
OR	2	3	4	4	5	9
Totals	7	3	4	4	5	9

In general, the new regiments were assigned to field armies, corps, and divisions, the one exception being the service regiments which were GHQR units. The new battalions were assigned to field armies, corps, and the GHQR, depending on the type of unit. This new system quickly came under criticism as its fixed nature was found to be too inflexible for the myriad quartermaster requirements on the future battlefield. The divisional units were the most short-lived of these new-system units. In 1939, the Regular Army's divisional regiments were reorganized into battalions as part of the adoption of the triangular division structure. In 1940 new T/Os were issued that modified many of the remaining organizations. The general trend was to standardize similar T/Os and to dispense with most of the larger fixed organizations. The heavy maintenance regiment survived into World War II relatively unchanged. However, the army and corps truck regiments were melded into a single type regiment, but few of them were ever fully organized or activated and none functioned as a true regiment. Most of the remaining regiments were broken up into separate battalions and companies. Many of the separate battalions constituted in 1936 were also broken up into separate companies and the battalion headquarters were disbanded.

Division Quartermaster Regiment, 1935

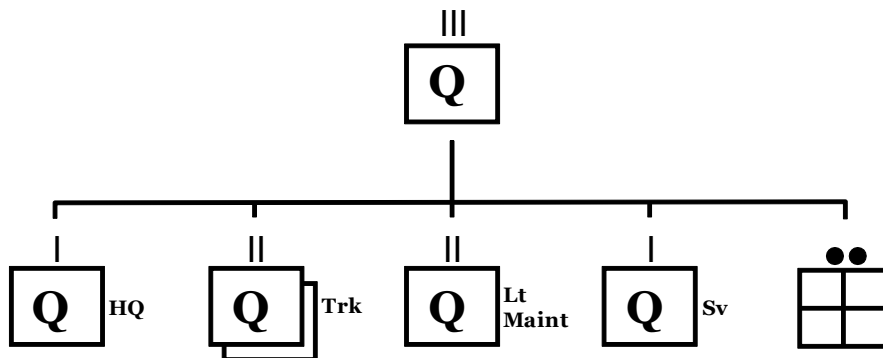

T/O: 91W
 Effective: 20 May 1935
 Commander: Col.
 Officers: 41
 W. O.: 1
 Enlisted: 845
 Total: 887

Key Equipment:
 Cars, various 25
 Trucks, various 282
 Rifles 454

Quartermaster Regiment, Service, 1935

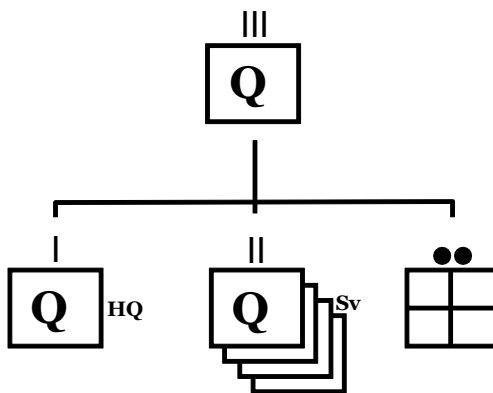

T/O: 295W
 Effective: 13 June 1935
 Commander: Col.
 Officers: 83
 W. O.: --
 Enlisted: 4,515
 Total: 4,598

Key Equipment:
 Cars, various 6
 Trucks, various 46

Various QM Regiment and Squadron TOEs.

Quartermaster Regiment, Truck-Army, 1935

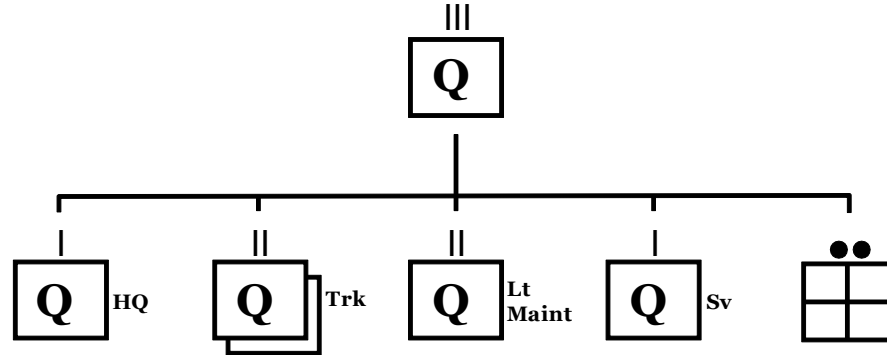

T/O: 91W
 Effective: 20 May 1935
 Commander: Col.
 Officers: 41
 W. O.: 1
 Enlisted: 845
 Total: 887

Key Equipment:
 Cars, various 25
 Trucks, various 282
 Rifles 454

Quartermaster Regiment, Truck-Corps, 1935

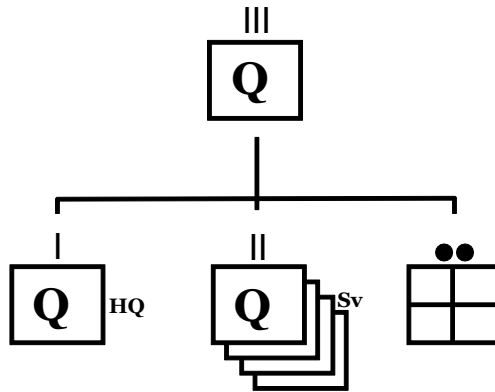

T/O: 295W
 Effective: 13 June 1935
 Commander: Col.
 Officers: 83
 W. O.: --
 Enlisted: 4,515
 Total: 4,598

Key Equipment:
 Cars, various 6
 Trucks, various 46

Various QM Regiment and Squadron TOEs.

Quartermaster Regiment, Light Maintenance, 1935

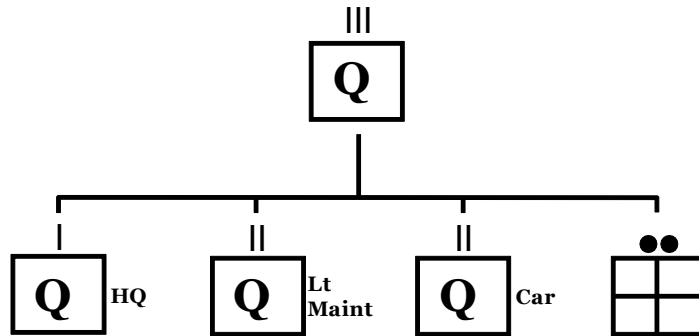

T/O: 91W
 Effective: 20 May 1935
 Commander: Col.
 Officers: 41
 W. O.: 1
 Enlisted: 845
 Total: 887

Key Equipment:
 Cars, various 25
 Trucks, various 282
 Rifles 454

Quartermaster Regiment, Heavy Maintenance, 1935

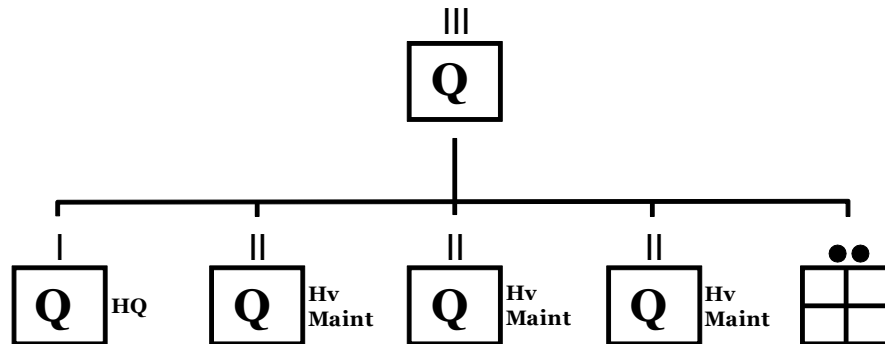

T/O: ???W
 Effective: 13 June 1935
 Commander: Col.
 Officers: 45
 W. O.: -
 Enlisted: 2,921
 Total: 2,270

Key Equipment:
 Cars, various 6
 Trucks, various 46

Various QM Regiment and Squadron TOEs.

Quartermaster Regiment, Light Maintenance, 1935

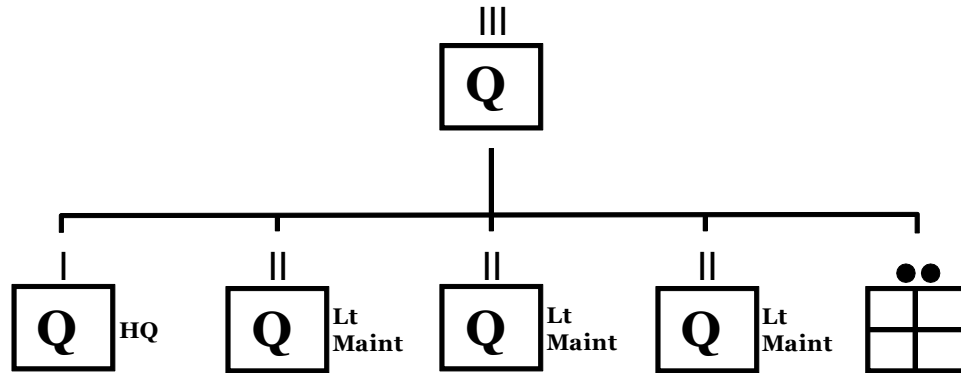

T/O: 91W
 Effective: 20 May 1935
 Commander: Col.
 Officers: 41
 W. O.: 1
 Enlisted: 845
 Total: 887

Key Equipment:
 Cars, various 25
 Trucks, various 282
 Rifles 454

Various QM Regiment and Squadron TOEs.

Five active Regular Army division quartermaster regiments were organized in 1936. Other than the organization of various subordinate elements of several other divisional, heavy maintenance, and truck regiments, none of the other Regular Army quartermaster regiments were organized before the beginning of World War II. Several of the separate battalions were organized before the war, as well as companies from several others. Additionally, two of the quartermaster squadrons assigned to cavalry divisions were organized before Pearl Harbor as well.

Most of the remaining Regular Army quartermaster regiments, battalions, and squadrons were organized as RAI units at some point during the five and a half years before the start of the war. The majority of these units, however, were not functional organizations.

The only new-system quartermaster units allotted to the National Guard were the eighteen regiments assigned to infantry divisions and the four cavalry division squadrons. All of the divisional regiments were organized before the Federalization of the National Guard in 1940 and 1941. Only two of the squadrons ever organized any units and only one of those was a fully organized squadron. All of the squadrons were disbanded in the fall of 1940.

Like their RAI counterparts, most of the Organized Reserve units were initiated before World War II. Far fewer than half of these units, however, were functional organizations. The 1940 reorganizations eliminated a substantial number of these units and, other than the divisional regiments (which were activated during the war as battalions), only a handful of the remainder were activated for service in World War II.

Quartermaster Regiment, Remount, 1935

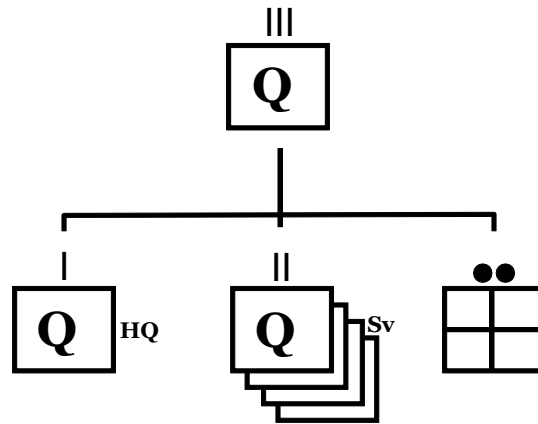

T/O: 295W
 Effective: 13 June 1935
 Commander: Col.
 Officers: 83
 W. O. --
 Enlisted: 4,515
 Total: 4,598

Key Equipment:
 Cars, various 6
 Trucks, various 46

Remount Depot TOE.

Training

The Regular Army regiments were active in supporting the activities of the divisions to which they were assigned. These regiments were able to test the new structure in the various army, corps area, and department maneuvers of the late 1930s. In addition to the maneuvers, these regiments also supported the training of Organized Reserve units as well.

National Guard regiments and squadrons conducted the usual armory drills during the inactive training period. The units also supported the training of their respective divisions during summer training and also participated in the various army maneuvers of the late 1930s and early 1940s. Due to their motorization and haul capabilities, elements of Guard quartermaster regiments were also called up to support a number of disaster relief efforts.

The new-system OR and RAI quartermaster units that were functional units, and most of those were the divisional regiments, conducted their training meetings in a variety of places. These included post office buildings, Federal buildings, chamber of commerce buildings, and National Guard armories, among others. Most of the divisional regiments attended summer training as units either every year or every other year. Many of the RAI regiments also attended summer training as units as did a handful of the non-divisional OR regiments. Few of the RAI and OR battalions were either functional or attended summer training as units. The personnel of most of those units attended home station and summer training with functional regiments.

1st Quartermaster Regiment (1st Division)

HQ-Fort Hamilton, NY, 1936-39

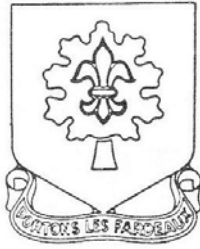

Constituted in the Regular Army 1 May 1936 and assigned to the 1st Division. Headquarters concurrently organized with the personnel and equipment of the demobilized Quartermaster Section, Headquarters, 1st Division at Fort Hamilton, NY. Remainder of the regiment was organized from the units of the 1st Division Quartermaster Train as follows:

Service Company from the 1st Service Company, Q.M.C. (RAI) at New York City, NY.

Headquarters, 1st Battalion from *Headquarters, 1st Division Quartermaster Train*.

A Company from the 1st Motor Transport Company, active at Fort Jay, NY.

B Company from the 2nd Motor Transport Company, active at Army Base, Brooklyn, NY.

Headquarters, 2nd Battalion from the *1st Wagon Company*.

C Company from the 3rd Motor Transport Company (RAI) at New York City, NY.

D Company from the 4th Motor Transport Company (RAI) at Jersey City, NJ.

Headquarters, 3rd Battalion from the *2nd Wagon Company*.

E Company from the consolidation of the 1st and 2nd Motor Repair Sections, active at Fort Hancock, NJ.

F Company from the *1st Motorcycle Company*.

Company E responsible for operating the Second Corps Area Motor Repair Shops at Fort Hancock. Reorganized and redesignated 11 October 1939 as the 1st Quartermaster Battalion.

Organization Day: 16 June. Chosen to commemorate the anniversary of the Quartermaster Corps 16 June 1776.

Status: Active in the Regular Army at Fort Riley, KS, as the 101st Forward Support Battalion, an element of the 1st Infantry Division (Mechanized).

Events: 280, 287, 292, 296, 301, 323, 330

Commanders, 1st Quartermaster Regiment

Maj. George E. Hartman	1 May 36-13 Aug 36	Lt. Col. Irving H. Engleman	19 Jan 37-19 May 37
Maj. James L. Garza	13 Aug 36-10 Sep 36	Capt. F. Clough Gee	19 May 37-14 Jun 37
Capt. James V. Cagne	10 Sep 36-19 Jan 37	Lt. Col. William R. Wright	14 Jun 37-5 Jul 38
	Maj. Frank A. Heywood	5 Jul 38-11 Oct 39	

2nd Quartermaster Regiment (2nd Division)

HQ-Fort Sam Houston, TX, 1936-39



Constituted in the Regular Army 1 May 1936 and assigned to the 2nd Division. Headquarters concurrently organized with the personnel and equipment of the demobilized Quartermaster Section, Headquarters, 2nd Division at Fort Sam Houston, TX. Remainder of the regiment was organized from the units of the 2nd Division Quartermaster Train as follows:

Service Company from the 2nd Service Company, Q.M.C. (RAI) at Fort Sam Houston, TX.
 Headquarters, 1st Battalion from Headquarters, 2nd Division Quartermaster Train (RAI) at Fort Sam Houston, TX.
 A Company from the 5th Motor Transport Company, active at Fort Sam Houston, TX.
 B Company from the 6th Motor Transport Company, active at Fort Sam Houston, TX.
 Headquarters, 2nd Battalion from the *3rd Wagon Company*.
 C Company from the 7th Motor Transport Company, active at Fort Sam Houston, TX.
 D Company from the 8th Motor Transport Company (RAI) at Fort Sam Houston, TX.
 Headquarters, 3rd Battalion from the 4th Wagon Company (RAI) at Fort Sam Houston, TX.
 E Company from the 3rd Motor Repair Section, active at Fort Sam Houston, TX.
 F Company from the *2nd Motorcycle Company*.

Assigned Reserve officers conducted summer training with the regiment at Fort Sill. Reorganized and redesignated 16 October 1939 as the 2nd Quartermaster Battalion.

Organization Day: 1 October. Chosen to commemorate the 2nd Supply Train's date of organization at Chickamauga Battlefield Park, 1 October 1917. Adopted 21 July 1920.

Status: Active in the Regular Army at Camp Hovey, Korea as the 2nd Forward Support Battalion, an element of the 2nd Infantry Division.

Events: 242, 258, 282, 288, 295, 296, 298, 300, 317, 328

Commanders, 2nd Quartermaster Regiment

Maj. Ernest A. Kindervater	1 May 36-30 Nov 36	Maj. John P. Neu	10 Jan 37-17 Aug 37
Maj. Harry B. Smith	30 Nov 36-10 Jan 37	Maj. Charles R. Lehner	17 Aug 37-16 Oct 39

3rd Quartermaster Regiment (3rd Division)

HQ-Fort Lewis, WA, 1936-39



Constituted in the Regular Army 1 May 1936, assigned to the 3rd Division. Headquarters concurrently organized with the personnel and equipment of the demobilized Quartermaster Section, Headquarters, 3rd Division at Fort Lewis, WA. Remainder of the regiment was organized from the units of the 3rd Division Quartermaster Train as follows:

Service Company from the *3rd Service Company, Q.M.C.*.
 Headquarters, 1st Battalion from *Headquarters, 3rd Division Quartermaster Train*.
 A Company from the 9th Motor Transport Company, active at the Presidio of San Francisco, CA.
 B Company from the 10th Motor Transport Company, active at Fort Lewis, WA.
 Headquarters, 2nd Battalion from the *5th Wagon Company*.
 C Company from the *11th Motor Transport Company*.
 D Company from the *12th Motor Transport Company*.
 Headquarters, 3rd Battalion from the *6th Wagon Company*.
 E Company from the consolidation of the 48th and 49th Motor Repair Sections, active at the Presidio of San Francisco, CA.
 F Company from the *3rd Motorcycle Company*.

Reorganized and redesignated 27 October 1939 as the 3rd Quartermaster Battalion.

Organization Day: 15 July. Chosen to commemorate the 3rd Supply Train's participation in the battle of Chateau Thierry 15 July 1918. Adopted 5 February 1925.

Status: Active in the Regular Army at Fort Stewart, GA, as the 3rd Forward Support Battalion, an element of the 3rd Infantry Division (Mechanized).

Events: 208, 226, 231, 238, 251, 273, 289, 294, 304, 306, 309, 314

Commanders, 3rd Quartermaster Regiment

Maj. Otho H. Humphries	1 May 36-16 Jun 38 Lt. Col. John H. Mellom	Maj. Ralph Pollock, Jr. 20 Jul 38-27 Oct 39	16 Jun 38-20 Jul 38
------------------------	---	--	---------------------

4th Quartermaster Regiment (4th Division)

Regular Army Inactive

HQ-Atlanta, GA, 1936-39

Constituted in the Regular Army 1 May 1936, assigned to the 4th Division, and allotted to the Fourth Corps Area. Headquarters organized with Organized Reserve personnel of the Quartermaster Section, Headquarters, 4th Division at Atlanta, GA. Remainder of the regiment was organized from the units of the 4th Division Quartermaster Train as follows:

Service Company from the *4th Service Company, Q.M.C.*.

Headquarters, 1st Battalion from Headquarters, 4th Division Quartermaster Train (RAI) at New Orleans, LA.

A Company from the *100th Motor Transport Company*.

B Company from the 8th Motor Repair Section, active at Fort Bragg, NC.

Headquarters, 2nd Battalion from the *7th Wagon Company*.

C Company from the *13th Motor Transport Company*.

D Company from the *14th Motor Transport Company*.

Headquarters, 3rd Battalion from the 8th Wagon Company (RAI).

E Company from the 86th Motor Repair Section, active at Fort McClellan, AL.

F Company from the 4th Motorcycle Company (RAI) at Atlanta.

Designated mobilization station was Fort McClellan, AL. Reorganized and redesignated 16 October 1939 as the 4th Quartermaster Battalion.

Status: Active in the Regular Army at Fort Hood, TX, as the 4th Forward Support Battalion, an element of the 4th Infantry Division (Mechanized).

Events: 296, 310, 330

Commanders, 4th Quartermaster Regiment

Capt. Hall S. Crane, jr.**	1 May 36-16 Oct 39
----------------------------	--------------------

** RAI Commanders: Organized Reserve officers.

5th Quartermaster Regiment (5th Division)

Regular Army Inactive

HQ-Dayton, OH, 1936-39



Constituted in the Regular Army 1 May 1936, assigned to the 5th Division, and allotted to the Fifth Corps Area. Headquarters organized with Organized Reserve personnel of the Quartermaster Section, Headquarters, 5th Division at Dayton, OH. Remainder of the regiment was organized from the units of the 5th Division Quartermaster Train as follows:

Service Company from the 5th Service Company, Q.M.C. (RAI) at Cleveland, OH.

Headquarters, 1st Battalion from Headquarters, 5th Division Quartermaster Train (RAI) at Columbus, OH.

A Company from the 28th Motor Repair Section, active at Fort Knox, KY.

B Company from Detachment, Company A, 3rd Motor Repair Battalion, active at Fort Benjamin Harrison, IN.

Headquarters, 2nd Battalion from the 9th Wagon Company (RAI) at Zanesville, OH.

C Company from the 17th Motor Transport Company (RAI) at Akron, OH.

D Company from the 18th Motor Transport Company (RAI) at Canton, OH.

Headquarters, 3rd Battalion from the 10th Wagon Company (RAI) at Clarksburg, WV.

E Company from the consolidation of the 9th and 28th Motor Repair Sections, active at Fort Knox, KY.

F Company from the 5th Motorcycle Company (RAI).

Reorganized and redesignated 16 October 1939 as the 5th Quartermaster Battalion.

Events: 213, 214, 220, 293, 296, 302, 316, 328

Inactive in the Regular Army as the 5th Supply & Transport Battalion, an element of the 5th Infantry Division (Mechanized).

Commanders, 5th Quartermaster Regiment

Unknown	1 May 36-ao May 39	Capt. John H. Brown**	ao May 39-16 Oct 39
---------	--------------------	-----------------------	---------------------

** RAI Commanders: Organized Reserve officers.

6th Quartermaster Regiment (6th Division)

Regular Army Inactive

HQ-Chicago, IL, 1936-39

Constituted in the Regular Army 1 May 1936, assigned to the 6th Division, and allotted to the Sixth Corps Area. Headquarters organized with Organized Reserve personnel of the Quartermaster Section, Headquarters, 6th Division at Chicago, IL. Remainder of the regiment was organized from the units of the 6th Division Quartermaster Train as follows:

Service Company from the 6th Service Company, Q.M.C. (RAI) at Chicago, IL.

Headquarters, 1st Battalion from Headquarters, 6th Division Quartermaster Train (RAI) at Chicago, IL.

A Company from the 228th Motor Transport Company (RAI) at Chicago, IL.

B Company from the 21st Motor Transport Company (RAI) at Chicago, IL.

Headquarters, 2nd Battalion from the 11th Wagon Company (RAI) at Chicago, IL.

C Company from the 22nd Motor Transport Company (RAI) at Chicago, IL.

D Company from the 23rd Motor Transport Company (RAI) at Chicago, IL.

Headquarters, 3rd Battalion from the 12th Wagon Company (RAI) at Chicago, IL.

E Company from Detachment, Company A, 3rd Motor Repair Battalion, active at Fort Sheridan, IL.

F Company from the 6th Motorcycle Company (RAI) at Chicago, IL.

Reorganized and redesignated 16 October 1939 as the 6th Quartermaster Battalion.

Organization Day: 26 July. Chosen to commemorate the 6th Supply Train's arrival at the Port of Le Havre, France 26 July 1918.

Status: Inactive in the Regular Army as the 506th Forward Support Battalion, an element of the 6th Infantry Division (Light).

Events: 214, 264, 274, 293, 296, 303, 316, 328

Commanders, 6th Quartermaster Regiment

Maj. Lloyd S. Burgess**

1 May 36-26 Apr 37
Maj. Frank R. Olin**

Capt. Drew Castle**
16 Dec 38-29 Nov 39

26 Apr 37-16 Dec 38

** RAI Commanders: Organized Reserve officers.

7th Quartermaster Regiment (7th Division)

Regular Army Inactive

HQ-Leavenworth, KS, 1936-39



Constituted in the Regular Army 1 May 1936, assigned to the 7th Division, and allotted to the Seventh Corps Area. Headquarters consolidated with the Quartermaster Section, Headquarters, 7th Division. Headquarters organized 27 September 1936 with Organized Reserve personnel as a RAI unit with headquarters at Leavenworth, KS. Remainder of the regiment was organized from the units of the 7th Division Quartermaster Train as follows:

Service Company from the *7th Service Company, Q.M.C.*

Headquarters, 1st Battalion from Headquarters, 7th Division Quartermaster Train (RAI) at Leavenworth, KS.

A Company from the 72nd Motor Transport Company, active at Fort Leavenworth, KS.

B Company from Detachment, 72nd Motor Transport Company, active at Fort Omaha, NE.

Headquarters, 2nd Battalion from the *13th Wagon Company*.

C Company from the *25th Motor Transport Company*.

D Company from the *26th Motor Transport Company*.

Headquarters, 3rd Battalion from the *14th Wagon Company*.

E Company from the 88th Motor Repair Section, active at Fort Leavenworth, KS.

F Company from the *7th Motorcycle Company*.

Designated mobilization station was Fort Leavenworth, KS. Reorganized and redesignated 1 October 1939 as the 7th Quartermaster Battalion.

Status: Inactive in the Regular Army as the 7th Forward Support Battalion, an element of the 7th Infantry Division (Light).

Events: 274, 314, 326

Commanders, 7th Quartermaster Regiment

Maj. Fred O. Kelso**

27 Sep 36-21 Feb 37

Maj. Henry E. Renken**

21 Feb 37-1 Oct 39

** RAI Commanders: Organized Reserve officers.

8th Quartermaster Regiment (8th Division)**Regular Army Inactive****HQ-***Not organized 1936-37; Baltimore, MD, 1937-39*

Constituted in the Regular Army 18 November 1935 as the Quartermaster Section, Headquarters, 8th Division, and allotted to the Third Corps Area. Reorganized and redesignated 1 May 1936 as Headquarters and Headquarters Company, 8th Quartermaster Regiment. Headquarters organized 1 March 1937 with Organized Reserve personnel as a RAI unit with headquarters at Baltimore, MD. Remainder of the regiment was organized from the units of the 8th Division Quartermaster Train as follows:

Service Company from the *8th Service Company, Q.M.C.*

Headquarters, 1st Battalion from *Headquarters, 8th Division Quartermaster Train*.

A Company from Detachment, 1st Motor Repair Battalion, active at Fort George G. Meade, MD.

B Company from the *31st Motor Transport Company*.

Headquarters, 2nd Battalion from the *15th Wagon Company*.

C Company from the 29th Motor Transport Company, active at Washington, DC.

D Company from Detachment, 1st Motor Repair Battalion, active at Langley Field, VA.

Headquarters, 3rd Battalion from the *16th Wagon Company*.

E Company from the 15th Motor Repair Section, active at Fort Myer, VA.

F Company from the 8th Motorcycle Company (RAI) at Washington, DC.

Reorganized and redesignated 16 October 1939 as the 8th Quartermaster Battalion.

Status: Inactive in the Regular Army as the 118th Forward Support Battalion, an element of the 8th Infantry Division (Mechanized).

Events: 240, 301, 330

Commanders, 8th Quartermaster Regiment

Capt. John F. Heise**	1 Mar 37-24 Apr 37	Unknown	ao Jun 37-ao Jun 38
Maj. Jason H. Conyer**	24 Apr 37-ao Jun 37	Capt. John F. Heise**	ao Jun 38-23 Jan 39
	1st Lt. Eugene J. Alexander**	23 Jan 39-16 Oct 39	

** RAI Commanders: Organized Reserve officers.

9th Quartermaster Regiment (9th Division)**Regular Army Inactive****HQ-***Providence, RI, 1936-40*

Constituted in the Regular Army 18 November 1935 as the Quartermaster Section, Headquarters, 9th Division, and allotted to the First Corps Area. Reorganized and redesignated 1 May 1936 as Headquarters and Headquarters Company, 9th Quartermaster Regiment. Headquarters organized 5 October 1936 with Organized Reserve personnel as a RAI unit at Providence, RI. Remainder of the regiment was organized from the units of the 9th Division Quartermaster Train as follows:

Service Company from the 9th Service Company, Q.M.C. (RAI) in the First Corps Area.

Headquarters, 1st Battalion from Headquarters, 9th Division Quartermaster Train (RAI) at Providence, RI.

A Company from the *33rd Motor Transport Company*.

B Company from the *34th Motor Transport Company*.

Headquarters, 2nd Battalion from the *17th Wagon Company*.

C Company from the 35th Motor Transport Company, active at Washington, DC.

D Company from the *36th Motor Transport Company*.

Headquarters, 3rd Battalion from the *18th Wagon Company*.

E Company from the 2nd Motor Repair Section, active at Fort Ethan Allen, VT.

F Company from the 9th Motorcycle Company (RAI) at Boston.

Designated mobilization station was Fort Devens, MA. Reorganized and redesignated 1 June 1940 as the 9th Quartermaster Battalion.

Status: Inactive in the Regular Army as the 109th Forward Support Battalion, an element of the 9th Infantry Division (Motorized).

Events: 280, 296, 301, 330

Commanders, 9th Quartermaster Regiment

Capt. Thomas Martin**	5 Oct 36-ao Jun 39	Unknown	ao Jun 39-1 Jun 40
-----------------------	--------------------	---------	--------------------

** RAI Commanders: Organized Reserve officers.

11th Quartermaster Regiment (Hawaiian Division)

HQ-Schofield Barracks, TH 1936-41



Constituted in the Regular Army 1 May 1936 as Headquarters and Headquarters Company, 11th Quartermaster Regiment and assigned to the Hawaiian Division. Headquarters concurrently organized with the personnel and equipment of the demobilized Quartermaster Section, Headquarters, Hawaiian Division at Schofield Barracks, TH. Remainder of the regiment was organized from the units of the Hawaiian Division Quartermaster Train as follows:

Service Company from the *11th Service Company, Q.M.C.*

Headquarters, 1st Battalion from *Headquarters, Hawaiian Division Quartermaster Train.*

A Company from the 41st Motor Transport Company, active at Fort Armstrong, TH.

B Company from the 42nd Motor Transport Company, active at Fort Armstrong, TH.

Headquarters, 2nd Battalion constituted new but remained inactive.

C Company from the 43rd Motor Transport Company, active at Schofield Barracks, TH.

D Company from the 44th Motor Transport Company, active at Schofield Barracks, TH.

Headquarters, 3rd Battalion constituted new but remained inactive.

E Company from the consolidation of the 21st and 22nd Motor Repair Sections, active at Schofield Barracks, TH.

F Company from the *11th Motorcycle Company.*

The regiment was responsible for the operation of the Hawaiian Department Motor School. Reorganized and redesignated 1 October 1941 as the 24th Quartermaster Battalion.

Organization Day: 14 April. Adopted 23 March 1925.

Status: Inactive in the Regular Army as the 24th Forward Support Battalion, an element of the 24th Infantry Division (Mechanized).

Events: 211, 225, 248, 276, 297, 312

Commanders, 11th Quartermaster Regiment

Col. George H. Huddleson	1 May 36-7 Jul 38	Col. Henry D. F. Munnikhuisen	7 Jul 38-11 May 40
	Col. William R. Wright	11 May 40-1 Oct 41	

12th Quartermaster Regiment (PS) (Philippine Division)

HQ-Fort William P. McKinley, PI 1936-41



Constituted in the Regular Army 1 May 1936 as Headquarters and Headquarters Company, 12th Quartermaster Regiment, and assigned to the Philippine Division. Headquarters concurrently organized with the personnel and equipment of the demobilized Quartermaster Section, Headquarters, Philippine Division at Fort William P. McKinley, PI. Remainder of the regiment was organized from the units of the Philippine Division Quartermaster Train as follows:

Service Company from the *12th Service Company, Q.M.C.*

Headquarters, 1st Battalion constituted new but remained inactive.

A Company from the 45th Motor Transport Company, active at Manila, PI.

B Company from the 46th Motor Transport Company, active at Manila, PI.

Headquarters, 2nd Battalion constituted new but remained inactive.

C Company from the 47th Motor Transport Company, active at Fort William P. McKinley, PI.

D Company from the 48th Motor Transport Company, active at Fort Stotsenberg, PI.

Headquarters, 3rd Battalion constituted new but remained inactive.

E Company from the consolidation of the 23rd and 24th Motor Repair Sections, active at Fort William P. McKinley, PI.

F Company from the 11th Motorcycle Company, active at Fort William P. McKinley, PI.

Headquarters and headquarters detachments of the 1st, 2nd, and 3rd Battalions activated 19 April 1941 at Fort McKinley. Location 7 December 1941—Fort William P. McKinley, PI.

Status: Inactive in the Regular Army as the 12th Quartermaster Company, an element of the 12th Infantry Division.

Events: 227, 245, 270

Commanders, 12th Quartermaster Regiment

Maj. James R. Hill	1 May 36-11 May 37	Maj. Samuel I. Zeidner	15 Nov 37-13 Jun 39
Maj. Rafael L. Garcia	11 May 37-3 Jul 37	Maj. Humphrey S. Evans	13 Jun 39-19 Jul 39
Maj. Irving H. Engleman	3 Jul 37-15 Nov 37	Lt. Col. Alfred S. Balsam	19 Jul 39-9 Apr 42

16th Quartermaster Squadron (1st Cavalry Division)

HQ-Fort Bliss, TX, 1936-41



Constituted in the Regular Army 1 May 1936 and assigned to the 1st Cavalry Division. Headquarters concurrently organized from the personnel and equipment of the Quartermaster Section, Headquarters, 1st Cavalry Division and Headquarters, 1st Cavalry Division Quartermaster Train, both concurrently demobilized. Remainder of the squadron organized from the units of the 1st Cavalry Division Quartermaster Train as follows:

A Troop from the 49th Motor Transport Company, active at Fort Bliss, TX.

B Troop from the 250th Motor Transport Company, active at Fort Bliss, TX.

C Troop from the *26th Wagon Company*.

D Troop from the *84th Motor Transport Company*.

E Troop from the consolidation of the 1st, 2nd, 3rd, and 4th Pack Trains, active at Fort Bliss, TX.

F Troop from the 81st Motor Repair Section, active at Fort Bliss, TX.

Assigned Reserve officers conducted summer training with the squadron at Fort Bliss. Troop E activated 15 November 1940 at Fort Riley, KS, from personnel and assets from Troop E, 17th Quartermaster Squadron. Troop D activated 15 January 1941 at Fort Ringgold, TX. Location 7 December 1941—Fort Bliss, TX.

Status: Active in the Regular Army as the 15th Support Battalion, a component of the 1st Cavalry Division at Fort Hood, Texas.

Events: 250, 259, 284, 295, 296, 300, 315, 328

Commanders, 16th Quartermaster Squadron

Lt. Col. Russell A. Osmun	1 May 36-Mar 37 Unknown	Lt. Col. James R. Hill Jul 40-7 Dec 41	Mar 37-Jul 40
---------------------------	----------------------------	---	---------------

17th Quartermaster Squadron (2nd Cavalry Division)

Regular Army Inactive

HQ-Seventh Corps Area 1936-41; Fort Riley, KS, 1941

Constituted in the Regular Army 24 March 1923 as the 2nd Cavalry Division Train, Q.M.C., assigned to the 2nd Cavalry Division, and allotted to the Seventh Corps Area. Redesignated the 2nd Cavalry Division Quartermaster Train 23 March 1925. Consolidated 1 April 1936 with the Quartermaster Section, Headquarters, 2nd Cavalry Division and concurrently redesignated as Headquarters and Headquarters Troop, 17th Quartermaster Squadron. Headquarters organized 27 September 1936 with Organized Reserve personnel as a RAI unit in the Seventh Corps Area. Remainder of the squadron organized from the units of the 2nd Cavalry Division Quartermaster Train as follows:

A Troop from Detachment, 72nd Motor Transport Company, active at Fort Riley, KS.

B Troop from the *251st Motor Transport Company*.

C Troop from the *252nd Motor Transport Company*.

D Troop from the *25th Wagon Company*.

E Troop from the consolidation of the 5th, 6th, 7th, and 8th Pack Trains, active at Forts Ringgold, Clark, and Huachuca.

F Troop constituted new and organized from Detachment, 88th Motor Repair Section at Fort Riley, KS.

Troop E inactivated 15 November 1940 and personnel and assets transferred to Troop E, 16th Quartermaster Squadron. Troop C organized 15 January 1941 at Fort Riley from the personnel and assets from Troop F, 18th Quartermaster Squadron. Troop D concurrently organized at Fort Riley. Headquarters and Headquarters Troop activated 1 November 1941 at Fort Riley. Location 7 December 1941—Fort Riley, KS.

Status: Inactive in the Regular Army as the 166th Transportation Corps Truck Battalion.

Events: 188, 324, 328

Commanders, 17th Quartermaster Squadron

Capt. Walter H. Bezosky**	27 Sep 36-1 Aug 37	2nd Lt. Carl H. Overby**	20 Feb 41-19 May 41
Capt. Irl W. Foyzie**	1 Aug 37-ao Sep 37	Lt. Col. George C. Pilkington**	19 May 41-1 Nov 41
Unknown	ao Sep 37-20 Feb 41	Unknown	1 Nov 41-7 Dec 41

** RAI Commanders: Organized Reserve officers.

18th Quartermaster Squadron (3rd Cavalry Division)

Regular Army Inactive

HQ-St. Louis, MO, 1936-41

Constituted in the Regular Army 18 October 1927 as the 3rd Cavalry Division Quartermaster Train, assigned to the 3rd Cavalry Division, and allotted to the Seventh Corps Area. Consolidated 1 April 1936 with the Quartermaster Section, Headquarters, 3rd Cavalry Division and concurrently reorganized and redesignated Headquarters and Headquarters Troop, 18th Quartermaster Squadron. Headquarters organized 27 September 1936 with Organized Reserve personnel as a RAI unit at St. Louis, MO. Remainder of the squadron organized from the units of the 3rd Cavalry Division Quartermaster Train as follows:

A Troop from the 253rd Motor Transport Company.

B Troop from the 254th Motor Transport Company.

C Troop from the 98th Motor Repair Section.

D Troop from the 27th Wagon Company.

E Troop from the consolidation of the 9th, 10th, 11th, and 12th Pack Trains .

F Troop constituted new and organized from Detachment, 88th Motor Repair Section, active at Fort Des Moines, IA.

Redesignated 18th Quartermaster Battalion 16 December 1940 and relieved from the 3rd Cavalry Division. Troop F inactivated 15 January 1941 at Fort Riley and personnel and assets transferred to Troop C, 17th Quartermaster Squadron.

Events: 236, 256, 274, 285

Commanders, 18th Quartermaster Squadron

2nd Lt. Gordon H. Brown**	27 Sep 36-1 Aug 37 Unknown	Capt. Joseph F. Herbst** ao Jan 38-16 Dec 40	1 Aug 37-ao Jan 38
---------------------------	-------------------------------	---	--------------------

** RAI Commanders: Organized Reserve officers.

21st Quartermaster Regiment (Truck-Corps) (I Corps)

Regular Army Inactive

HQ-*Not organized* 1936-37; Fort Devens, MA, 1937-41; *Inactive* 1941

Constituted in the Regular Army 1 May 1936, assigned to the I Corps, and allotted to the First Corps Area. Regiment organized 20 September 1936 with Organized Reserve personnel as a RAI unit at Fort Devens, MA. Redesignated 8 January 1940 as the 21st Quartermaster Regiment (Truck) (Colored). Inactivated in 1941 at Fort Devens by relief of personnel. Designated mobilization station was Fort Devens. Location 7 December 1941—*Inactive*.

Status: Inactive in the Regular Army as HHC, 21st Quartermaster Group; 1st Battalion is active in Germany as the 39th Transportation Battalion.

Commanders, 21st Quartermaster Regiment

Capt. Napoleon Racicot**	20 Sep 36-ao Oct 36 Unknown	Maj. Mayo A. Darling** ao Aug 39-ao Jan 41	ao Jun 37-ao Jul 39
--------------------------	--------------------------------	---	---------------------

** RAI Commanders: Organized Reserve officers.

22nd Quartermaster Regiment (Truck-Corps) (II Corps)

Regular Army Inactive

HQ-New York City, NY, 1936-41; *Inactive* 1941

Constituted in the Regular Army 1 May 1936, assigned to the II Corps, and allotted to the Second Corps Area. Regiment, less Company E, organized 30 October 1936 with Organized Reserve personnel as a RAI unit at New York City, NY. Subordinate elements later activated at the following locations: Company A, Camp Edwards, MA; HHD, 2nd Battalion, Fort Dix, NJ; Company E, West Point, NY; Companies F and G, Fort Dix, NJ; Companies K and L, Fort Knox, KY. Redesignated 8 January 1940 as the 22nd Quartermaster Regiment (Truck). Designated mobilization training station was Camp Lee, VA. RAI elements inactivated in July 1941 at New York City by relief of personnel. Location 7 December 1941—*Inactive* (less active elements).

Status: Regimental Headquarters and Headquarters Company, 22nd Quartermaster Regiment is active in the Regular Army at Vicenza, Italy, as HHC, 22nd Support Group; 1st Battalion is active in Germany as the 37th Transportation Command.

Events: 324, 330

Commanders, 22nd Quartermaster Regiment

Capt. Lewis S. Parody**	30 Oct 36-21 Oct 38	Capt. Gus Lewis**	28 Nov 38-9 Dec 39
Capt. Julian B. Anuskewicz**	21 Oct 38-28 Nov 38	Capt. Franklin G. Smith**	22 Feb 40-Jul 41

** RAI Commanders: Organized Reserve officers.

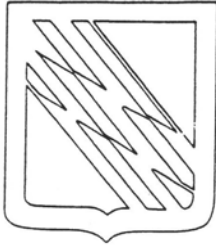
23rd Quartermaster Regiment (Truck-Corps) (III Corps)**Regular Army Inactive****HQ**-Not organized 1936-37; Third Corps Area 1937-41; *Inactive* 1941

Constituted in the Regular Army 1 May 1936, assigned to the III Corps, and allotted to the Third Corps Area. Regiment organized 19 February 1937 with Organized Reserve personnel as a RAI unit in the Third Corps Area. Subordinate elements active at the following locations: Company A, Fort Benning, GA; Company B, Boston Army Base; Company E, Holabird Quartermaster Depot, MD; Company I, Fort Sill, OK; Company K, Fort Francis E. Warren, WY. Redesignated 8 January 1940 as the 23rd Quartermaster Regiment (Truck). Designated mobilization training station was Camp Lee, VA. RAI elements inactivated by July 1941 at by relief of personnel. Location 7 December 1941—*Inactive* (less active elements).

Status: Regimental Headquarters and Headquarters Company, 23rd Quartermaster Regiment is active in the Regular Army at Fort Lee, VA, as HHC, 23rd Quartermaster Brigade.

Events: 214, 280, 330**Commanders, 23rd Quartermaster Regiment**

Capt. Harry P. Bork**	19 Feb 37-3 Mar 38	Capt. Louis E. Diaz**	20 Apr 38-ao Jun 40
Capt. Walter J. Cress**	3 Mar 38-20 Apr 38	Unknown	ao Jun 40-Jul 41

** RAI Commanders: Organized Reserve officers.

24th Quartermaster Regiment (Truck-Corps) (IV Corps)**Regular Army Inactive****HQ**-Mobile, AL, 1936-41

Constituted in the Regular Army 1 May 1936, assigned to the IV Corps, and allotted to the Fourth Corps Area. Regiment organized 15 December 1936 with Organized Reserve personnel as a RAI unit at Mobile, AL. Redesignated 8 January 1940 as the 24th Quartermaster Regiment (Truck). Location 7 December 1941—Mobile, AL.

Status: Regimental Headquarters and Headquarters Company, 24th Quartermaster Regiment is inactive in the Regular Army as HHC, 24th Quartermaster Group; 1st Battalion is active as the 24th Transportation Battalion.

Commanders, 24th Quartermaster Regiment

Capt. Paul G. Cramer**	15 Dec 36-14 Feb 37	Lt. Col. Gladstone Yeuell**	14 Feb 37-ao May 40
	Unknown	ao May 40-7 Dec 41	

** RAI Commanders: Organized Reserve officers.

25th Quartermaster Regiment (Truck-Corps) (V Corps)**Regular Army Inactive****HQ**-Akron, OH, 1936-41

Constituted in the Regular Army 1 May 1936, assigned to the V Corps, and allotted to the Fifth Corps Area. Regiment organized by December 1936 with Organized Reserve personnel as a RAI unit at Akron, OH. Redesignated 8 January 1940 as the 25th Quartermaster Regiment (Truck). Conducted summer training at the Jeffersonville Quartermaster Depot, IN, or Camp Knox, KY. Location 7 December 1941—Akron, OH.

Status: Disbanded 18 October 1943.**Commanders, 25th Quartermaster Regiment**

Unknown	ao Dec 36-ao Jan 38	Capt. Melville N. Shreves**	ao Nov 38-ao Jan 39
Capt. Robert W. Hughes**	ao Jan 38-ao Feb 38	Unknown	ao Jan 39-7 Dec 41

** RAI Commanders: Organized Reserve officers.

26th Quartermaster Regiment (Truck-Corps) (VI Corps)**Regular Army Inactive****HQ**-Not organized 1936-37; Springfield, IL, 1937-41

Constituted in the Regular Army 1 May 1936, assigned to the VI Corps, and allotted to the Sixth Corps Area. Regiment organized 15 January 1937 with Organized Reserve personnel as a RAI unit at Springfield, IL. Designated mobilization training station was Camp Shelby, MS. Redesignated 8 January 1940 as the 26th Quartermaster Regiment (Truck). Location 7 December 1941—Springfield, IL.

Status: Active in the Regular Army in Germany as HHC, 26th Support Group; 1st Battalion active as the 26th Support Battalion; 2nd Battalion active as the 57th Transportation Battalion.

Commanders, 26th Quartermaster Regiment

Maj. Lowell H. Tuttle**	15 Jan 37-26 Apr 37	Maj. Elbert W. Weeks **	6 Sep 38-16 Dec 38
Maj. Walter B. Hughes**	26 Apr 37-21 Mar 38	Maj. Lowell H. Tuttle **	16 Dec 38-Nov 39
Lt. Col. Neal R. Markle**	2 Jun 38-6 Sep 38	Maj. William F. Kalisz**	Nov 39-7 Dec 41

** RAI Commanders: Organized Reserve officers.

27th Quartermaster Regiment (Truck-Corps) (VII Corps)**Regular Army Inactive****HQ**-Kansas City, MO, 1936-41

Constituted in the Regular Army 1 May 1936, assigned to the VII Corps, and allotted to the Seventh Corps Area. Regiment organized 27 September 1936 with Organized Reserve personnel as a RAI unit at Kansas City, MO. Redesignated 8 January 1940 as the 27th Quartermaster Regiment (Truck). Location 7 December 1941—Kansas City, MO.

Status: Inactive as HHC, 27th Quartermaster Group; the 1st Battalion is active in the Regular Army in Germany as the 27th Transportation Center; the 2nd Battalion is active in the Regular Army at Fort Leonard Wood, MO, as the 58th Transportation Battalion.

Commanders, 27th Quartermaster Regiment

Capt. Dudley T. Horton**	27 Sep 36-14 Feb 37	Capt. George H. Dolph**	1 Aug 37-ao Sep 37
Capt. William K. Heimbaugh**	14 Feb 37-1 Aug 37	Unknown	ao Sep 37-7 Dec 41

** RAI Commanders: Organized Reserve officers.

28th Quartermaster Regiment (Truck-Corps) (VIII Corps)**Regular Army Inactive****HQ**-Fort Worth, TX, 1936-41; Camp Shelby, MS, 1941

Constituted in the Regular Army 1 May 1936, assigned to the VIII Corps, and allotted to the Eighth Corps Area. Regiment organized 1 September 1936 with Organized Reserve personnel as a RAI unit at Fort Worth, TX. Subordinate elements activated at the following locations: 1st Battalion at Camp Shelby, MS; 2nd Battalion, less Companies E and F, at Fort Jackson, SC; Companies E and F, at Fort Francis E. Warren, WY, and Fort Sill, OK, respectively; 3rd Battalion, at Camp Livingston, LA. Redesignated 8 January 1940 as the 28th Quartermaster Regiment (Truck) (Colored). Regimental headquarters and headquarters detachment, less Reserve personnel, activated 7 June 1941 at Camp Shelby, MS, and assigned to the Third Army. Location 7 December 1941—Camp Shelby, MS.

Status: Inactive as HHC, 28th Quartermaster Group; the 1st Battalion is active in the Regular Army as the 28th Transportation Battalion.

Events: 324, 330

Commanders, 28th Quartermaster Regiment

Capt. Newton D. Chaney**	25 Nov 36-ao Jan 37	Unknown	ao Jan 37-7 Dec 41
--------------------------	---------------------	---------	--------------------

** RAI Commanders: Organized Reserve officers.

29th Quartermaster Regiment (Truck-Corps) (IX Corps)

Regular Army Inactive

HQ-Los Angeles, CA, 1936-40; *Inactive* 1940-41

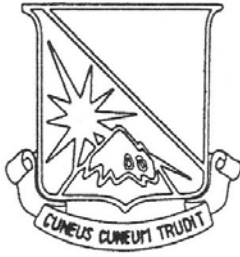

Constituted in the Regular Army 1 May 1936, assigned to the IX Corps, and allotted to the Ninth Corps Area. Regiment organized 29 May 1936 with Organized Reserve personnel as a RAI unit at Los Angeles, CA. Subordinate elements activated at the following locations: Company E active at Fort Mason, CA; 1st Battalion at Fort Leonard Wood, MO. Redesignated 8 January 1940 as the 29th Quartermaster Regiment (Truck). Typically conducted Inactive Training Period meetings at the Chamber of Commerce Building in Los Angeles. Designated mobilization training station was Fort Douglas, UT. RAI elements conducted summer training at Camp Ord, Del Monte, CA. Inactivated 31 December 1940 at Los Angeles by relief of personnel. Location 7 December 1941—*Inactive*.

Status: Regimental Headquarters and Headquarters Company, 29th Quartermaster Regiment is active in the Regular Army at Kaiserslautern, Germany, as HHC, 29th Area Support Group; the 1st Battalion is active in the Regular Army at Fort Campbell, KY, as the 129th Support Battalion.

Commanders, 29th Quartermaster Regiment

Maj. Leland S. Reeves**	29 May 36-6 Oct 36	Maj. N. A. Evalenke**	ao Oct 39-ao Jan 40
Capt. Harold O. Sexsmith	6 Oct 36-ao Jun 39	Unknown	ao Jan 40-31 Dec 40
	<i>Inactive</i>	31 Dec 40-7 Dec 41	

** RAI Commanders: Organized Reserve officers.

32nd Quartermaster Regiment (Light Maintenance) (I Corps)

Regular Army Inactive

HQ-Not organized 1936-37; Concord, NH, 1937-40

Constituted in the Regular Army 1 May 1936, assigned to the I Corps, and allotted to the First Corps Area. Regiment organized by June 1937 with Organized Reserve personnel as a RAI unit at Concord, NH. Regiment, less 1st Battalion, disbanded 1 June 1940. The 1st Battalion concurrently redesignated as the 70th Quartermaster Battalion (Light Maintenance).

Status: The 1st Battalion is inactive in the Regular Army as the 70th Ordnance Battalion.

Commanders, 32nd Quartermaster Regiment

Unknown	ao Jun 37-1 Jun 40
---------	--------------------

** RAI Commanders: Organized Reserve officers.

33rd Quartermaster Regiment (Light Maintenance) (II Corps)

Regular Army Inactive

HQ-Englewood, NJ 1936-37; *Inactive* 1937; Englewood, NJ 1937-40

Constituted in the Regular Army 1 May 1936, assigned to the II Corps, and allotted to the Second Corps Area. Regiment, less Company E, organized 30 October 1936 with Organized Reserve personnel as a RAI unit at Englewood, NJ. Company E active at West Point, NY. Designated mobilization training station was Camp Lee, VA. Reserve personnel relieved 25 August 1937 and unit inactivated, less active elements. Reorganized 28 December 1937 at Englewood. Regiment, less 1st Battalion, disbanded 1 June 1940. The 1st Battalion concurrently redesignated as the 66th Quartermaster Battalion (Light Maintenance).

Status: The 1st Battalion is active in the Regular Army as the 66th Maintenance Battalion.

Events: 302, 330

Commanders, 33rd Quartermaster Regiment

Capt. Louis Segall**	30 Oct 36-25 Aug 37	<i>Inactive</i>	25 Aug 37-28 Dec 37
	Unknown	28 Dec 37-1 Jun 40	

** RAI Commanders: Organized Reserve officers.

34th Quartermaster Regiment (Light Maintenance) (III Corps)**Regular Army Inactive****HQ-Not organized** 1936-37; Havre de Grace, MD, 1937-40

Stationed at Camp Holabird, MD, as of June 1919 as Motor Repair Unit No. 305. Redesignated Motor Repair Battalion No. 2 on 22 March 1921 and allotted to the Regular Army. Inactivated at Camp Holabird 18 August 1922. Redesignated 23 March 1925 as the 2nd Motor Repair Battalion. The 1st Motor Repair Battalion made Active Associate 1922-27. Allotted 18 October 1927 to the Third Corps Area. Reorganized and redesignated 34th Quartermaster Regiment 1 May 1936, assigned to the III Corps, and allotted to the Third Corps Area. Regiment, less Company A, organized 10 March 1937 with Organized Reserve personnel as a RAI unit at Havre de Grace, MD. Company A active at Holabird Quartermaster Depot, MD. Companies B and C activated in October 1939 at Fort Benning, GA, and Fort Bragg, NC, respectively. Regiment, less 1st Battalion, disbanded 1 June 1940. The 1st Battalion concurrently redesignated as the 67th Quartermaster Battalion (Light Maintenance).

Status: The 1st Battalion is inactive in the Regular Army as the 67th Maintenance Battalion.**Events:** 214, 293, 296**Commanders, 34th Quartermaster Regiment**

Capt. Arthur J. LaDou**	10 Mar 37-23 Feb 38	Unknown	ao Jun 38-ao May 39
Capt. Harold P. Pierce**	23 Feb 38-ao Jun 38	Capt. Thomas E. Adams**	ao May 39-23 Jun 39
	Unknown	23 Jun 39-1 Jun 40	

** RAI Commanders: Organized Reserve officers.

35th Quartermaster Regiment (Light Maintenance) (IV Corps)**Regular Army Inactive****HQ-Jacksonville, FL, 1936-40**

Constituted in the Regular Army 1 May 1936, assigned to the IV Corps, and allotted to the Fourth Corps Area. Regiment organized 15 December 1936 with Organized Reserve personnel as a RAI unit at Jacksonville, FL. Regiment, less 1st Battalion, disbanded 1 June 1940. The 1st Battalion concurrently redesignated as the 71st Quartermaster Battalion (Light Maintenance).

Status: The 1st Battalion is inactive in the Regular Army as the 71st Support Battalion.**Commanders, 35th Quartermaster Regiment**

Capt. Leon B. Schuh**	15 Dec 36-ao Jan 37	Capt. Taylor Smith**	1 Mar 38-28 May 39
Capt. Arthur B. Foreman**	ao Nov 37-1 Mar 38	Capt. Berendt E. Johnson**	28 May 39-ao Sep 39
	Unknown	ao Sep 39-1 Jun 40	

** RAI Commanders: Organized Reserve officers.

36th Quartermaster Regiment (Light Maintenance) (V Corps)**Regular Army Inactive****HQ-Fort Wayne, IN, 1936-40**

Constituted in the Regular Army 1 May 1936, assigned to the V Corps, and allotted to the Fifth Corps Area. Regiment organized by December 1936 with Organized Reserve personnel as a RAI unit at Fort Wayne, IN. Conducted summer training at the Jeffersonville Quartermaster Depot, IN, or Camp Knox, KY. Regiment, less 1st Battalion, disbanded 1 June 1940. The 1st Battalion concurrently redesignated as the 72nd Quartermaster Battalion (Light Maintenance).

Status: The 1st Battalion is inactive in the Regular Army as the 72nd Ordnance Battalion.**Commanders, 36th Quartermaster Regiment**

Unknown	ao Dec 36-ao Nov 37	Capt. Clem C. Hiser**	ao Nov 37-1 Jun 40
---------	---------------------	-----------------------	--------------------

** RAI Commanders: Organized Reserve officers.

37th Quartermaster Regiment (Light Maintenance) (VI Corps)**Regular Army Inactive****HQ-***Not organized* 1936-37; Moline, IL, 1937-40

Constituted in the Regular Army 18 October 1927 as the 12th Motor Transport Command. Redesignated HHC, 37th Quartermaster Regiment (Light Maintenance) 1 May 1936, assigned to the VI Corps, and allotted to the Sixth Corps Area. Concurrently the 13th Motor Transport Command redesignated HHC, 1st Battalion and the 14th Motor Transport Command at Detroit, MI, redesignated HHC, 2nd Battalion. Regiment organized 26 April 1937 with Organized Reserve personnel as a RAI unit with headquarters at Moline, IL. Regiment, less 1st Battalion, disbanded 1 June 1940. The 1st Battalion concurrently redesignated as the 73rd Quartermaster Battalion (Light Maintenance).

Status: The 1st Battalion is active in the Regular Army as the 73rd Ordnance Battalion.**Commanders, 37th Quartermaster Regiment**

Capt. Samuel Ader**	26 Apr 37-29 Nov 39	Maj. Frank R. Olin**	29 Nov 39-1 Jun 40
---------------------	---------------------	----------------------	--------------------

** RAI Commanders: Organized Reserve officers.

38th Quartermaster Regiment (Light Maintenance) (VII Corps)**Regular Army Inactive****HQ-**Little Rock, AR, 1936-40

Constituted in the Regular Army 18 October 1927 as the 19th Motor Transport Command. Redesignated HHC, 38th Quartermaster Regiment (Light Maintenance) 1 May 1936, assigned to the VII Corps, and allotted to the Seventh Corps Area. Concurrently the 21st Motor Transport Command at Little Rock, AR, redesignated 2nd Battalion. Regiment organized 27 September 1936 with Organized Reserve personnel as a RAI unit at Little Rock. Regiment, less 1st Battalion, disbanded 1 June 1940. The 1st Battalion concurrently redesignated as the 74th Quartermaster Battalion (Light Maintenance).

Status: The 1st Battalion is active in the Regular Army as the 74th Maintenance Battalion.**Commanders, 38th Quartermaster Regiment**

Capt. Homer V. Carson**	27 Sep 36-1 Aug 37	Capt. Henry W. Larsen**	1 Aug 37-ao Sep 37
	Unknown	ao Sep 37-1 Jun 40	

** RAI Commanders: Organized Reserve officers.

39th Quartermaster Regiment (Light Maintenance) (VIII Corps)**Regular Army Inactive****HQ-**Oklahoma, City, OK, 1936-40

Constituted in the Regular Army 1 May 1936, assigned to the VIII Corps, and allotted to the Eighth Corps Area. Company A active at Fort Francis E. Warren, WY, Company B active at Fort Sill, OK, and Company C active at Normoyle Quartermaster Depot, TX, 1936-40. Organized 1 September 1936 with Organized Reserve personnel as a RAI unit with headquarters at Oklahoma, City, OK. Designated mobilization training station was Fort Sam Houston, TX. Regiment, less 1st Battalion, disbanded 1 June 1940. The 1st Battalion concurrently redesignated as the 68th Quartermaster Battalion (Light Maintenance).

Status: The 1st Battalion is inactive in the Regular Army as the 68th Maintenance Battalion.**Events:** 258, 295, 296, 300**Commanders, 39th Quartermaster Regiment**

Unknown	1 Sep 36-25 Nov 36	Capt. Joseph Lambert**	25 Nov 36-ao Jan 37
	Unknown	ao Jan 37-1 Jun 40	

** RAI Commanders: Organized Reserve officers.

40th Quartermaster Regiment (Light Maintenance) (IX Corps)**Regular Army Inactive****HQ**-Los Angeles, CA, 1936-40

Constituted in the Regular Army 18 October 1927 as the 94th Motor Transport Company. Redesignated HHC, 40th Quartermaster Regiment (Light Maintenance) 1 May 1936, assigned to the IX Corps, and allotted to the Ninth Corps Area. Regiment organized 14 May 1936 with Organized Reserve personnel as a RAI unit at Los Angeles, CA. Company A active at Fort Lewis, WA. Typically conducted Inactive Training Period meetings at the Chamber of Commerce Building in Los Angeles. RAI elements conducted summer training at Camp Ord, Del Monte, CA. Designated mobilization training station was Fort Douglas, UT. Regiment, less 1st Battalion, disbanded 1 June 1940. The 1st Battalion concurrently redesignated as the 69th Quartermaster Battalion (Light Maintenance).

Status: The 1st Battalion is inactive in the Regular Army as the 69th Maintenance Battalion.**Commanders, 40th Quartermaster Regiment**

Capt. William E. Hicks**	14 May 36-27 Oct 36	Unknown	ao Jun 37-ao Oct 39
Capt. Milton W. Ball**	27 Oct 36-ao Jun 37	Maj. Edward J. Lewis**	ao Oct 39-1 Jun 40

** RAI Commanders: Organized Reserve officers.

43rd Quartermaster Regiment (Truck-Army) (First Army)**Regular Army Inactive****HQ**-New York City, NY, 1936-41; *Inactive* 1941

Constituted in the Regular Army 1 May 1936, assigned to the First Army, and allotted to the Second Corps Area. Regiment organized 30 October 1936 with Organized Reserve personnel as a RAI unit at New York City, NY. Inactivated in July 1941 at New York City by relief of personnel. Location 7 December 1941—*Inactive*.

Status: Disbanded 18 October 1943.**Events:** 234**Commanders, 43rd Quartermaster Regiment**

Capt. John P. Mason**	30 Oct 36-30 Apr 37	2nd Lt. Arthur Goodfriend**	4 Jan 39-ao Oct 39
Capt. Albert E. Barton**	30 Apr 37-4 Jan 39	Unknown	ao Oct 39-Jul 41

** RAI Commanders: Organized Reserve officers.

44th Quartermaster Regiment (Truck-Army) (Second Army)**Regular Army Inactive****HQ**-*Not organized* 1936-37; Flint, MI, 1937-41; *Inactive* 1941

Constituted in the Regular Army 1 May 1936, assigned to the Second Army, and allotted to the Sixth Corps Area. Regiment organized by June 1937 with Organized Reserve personnel as a RAI unit at Flint, MI. Conducted summer training at Camp McCoy, WI. Designated mobilization training station was Camp Shelby, MS. Inactivated in July 1941 at Flint by relief of personnel. Location 7 December 1941—*Inactive*.

Status: Disbanded 18 October 1943.**Commanders, 44th Quartermaster Regiment**

Unknown	ao Jun 37-ao Jan 39	Unknown	ao Feb 39-ao Jul 39
Maj. Ray H. Green**	ao Jan 39-ao Feb 39	Maj. Albert H. Kain**	ao Jul 39-ao Aug 39
	Unknown	ao Aug 39-Jul 41	

** RAI Commanders: Organized Reserve officers.

45th Quartermaster Regiment (Truck-Army) (Third Army)**Regular Army Inactive****HQ**-Houston, TX, 1936-41

Constituted in the Regular Army 1 May 1936, assigned to the Third Army, and allotted to the Eighth Corps Area. Organized 30 November 1936 with Organized Reserve personnel as a RAI unit with headquarters at Houston, TX. Location 7 December 1941—Houston, TX.

Status: Active in the Regular Army as HHC, 45th Support Group at Schofield Barracks, TH; 2nd Battalion inactive as the 68th Support Battalion.

Commanders, 45th Quartermaster Regiment

Capt. Clarence F. Vogel** 30 Nov 36-ao Jan 37 Unknown ao Jan 37-7 Dec 41
** RAI Commanders: Organized Reserve officers.

46th Quartermaster Regiment (Truck-Army) (Third Army)

Regular Army Inactive

HQ-Fort Worth, TX, 1936-41

Constituted in the Regular Army 1 May 1936, assigned to the Third Army, and allotted to the Eighth Corps Area. Regiment organized about 1936 with Organized Reserve personnel as a RAI unit at Fort Worth, TX. Location 7 December 1941—Fort Worth, TX.

Status: Regimental headquarters and headquarters company is inactive as HHC, 46th Support Group; the 1st Battalion is active in the Regular Army at Fort Drum, NY, as the 46th Support Battalion.

Commanders, 46th Quartermaster Regiment

Unknown ao Dec 36-7 Dec 41

47th Quartermaster Regiment (Truck-Army) (First Army)

Regular Army Inactive

HQ-*Not organized* 1936-37; Richmond, VA, 1937-39; *Inactive* 1939-41

Constituted in the Regular Army 1 May 1936, assigned to the First Army, and allotted to the Third Corps Area. Regiment organized 15 March 1937 with Organized Reserve personnel as a RAI unit at Richmond, VA. Designated mobilization training station was Camp Lee, VA. Withdrawn from the Third Corps Area 2 October 1939 and allotted to the Ninth Corps Area. Unit personnel in Richmond concurrently reassigned to the 60th and 405th Quartermaster Regiments. Relieved from the First Army 16 October 1939 and assigned to the IX Corps. Redesignated 29 October 1939 as the 47th Quartermaster Regiment (Truck-Corps). Redesignated 8 January 1940 as the 47th Quartermaster Regiment (Truck), relieved from the IX Corps, and assigned to the Fourth Army. Subordinate elements activated in 1940 at the following locations: 1st Battalion at Fort Ord, CA; 2nd Battalion at Fort Lewis, WA. Location 7 December 1941—*Inactive* (less active elements).

Status: Regimental Headquarters and Headquarters Company, 47th Quartermaster Regiment is inactive as HHC, 47th Support Group; 2nd Battalion active in the Regular Army as the 70th Transportation Battalion.

Events: 234, 300, 330

Commanders, 47th Quartermaster Regiment

1st Lt. Harold H. Shaller** 28 Mar 37-ao Jun 37 Unknown ao Jun 37-2 Oct 39
Inactive 3 Oct 39-7 Dec 41

** RAI Commanders: Organized Reserve officers.

48th Quartermaster Regiment (Truck-Army) (First Army)

Regular Army Inactive

HQ-*Not organized* 1936-37; Dayton, OH, 1937-41; Fort Benning, GA, 1941

Constituted in the Regular Army 1 May 1936, assigned to the First Army, and allotted to the Fifth Corps Area. Regiment organized by June 1937 with Organized Reserve personnel as a RAI unit at Dayton, OH. Conducted summer training at Fort Knox, KY. Designated mobilization training station was Camp Shelby, MS. Withdrawn from the Fifth Corps Area 2 October 1939 and allotted to the Fourth Corps Area. Redesignated 16 October 1939 as the 48th Quartermaster Regiment (Truck-Corps). New mobilization training station was Camp Foster, FL. Companies A, B, C, D, E, F, G, H, I, K, L, and M activated 15-20 October 1939, less Reserve personnel, at various posts across the United States. Redesignated 8 January 1940 as the 48th Quartermaster Regiment (Truck) (Colored). HHD, 1st Battalion

activated 1 August 1940 at Fort Bragg, NC. HHD, 2nd Battalion concurrently activated at Fort Custer, MI. Regimental headquarters activated 10 February 1941 at Fort Benning, GA. Location 7 December 1941—Fort Benning, GA.

Status: Inactive in the Regular Army as HHC, 48th Quartermaster Group; the 1st Battalion inactive in the Regular Army as the 324th Support Battalion, a component of the 24th Infantry Division; the 3rd Battalion inactive in the Regular Army as the 524th Support Battalion.

Events: 251, 295, 296, 300, 302, 324, 328, 330

Commanders, 48th Quartermaster Regiment

Unknown	ao Jun 37-ao Dec 37	Capt. Russell E. Dittmar**	ao Nov 38-ao Jan 39
Capt. Herman A. Ackerman**	ao Dec 37-ao Jan 38	Unknown	ao Jan 39-7 Dec 41

** RAI Commanders: Organized Reserve officers.

49th Quartermaster Regiment (Truck-Army) (Second Army)

Regular Army Inactive

HQ-Louisville, KY, 1936-41

Constituted in the Regular Army 1 May 1936, assigned to the Second Army, and allotted to the Fifth Corps Area. Regiment organized by December 1936 with Organized Reserve personnel as a RAI unit at Louisville, KY. Redesignated 29 October 1939 as the 49th Quartermaster Regiment (Truck-Corps). Redesignated 8 January 1940 as the 49th Quartermaster Regiment (Truck) (Colored). Location 7 December 1941—Louisville, KY.

Status: Regimental Headquarters and Headquarters Company, 49th Quartermaster Regiment is in the Regular Army active at Fort Lee, VA, as HHC, 49th Quartermaster Group; the 1st Battalion is active in the Regular Army at Fort Hood, TX, as the 49th Transportation Center; the 3rd Battalion active in the Regular Army in Germany as the 125th Support Battalion, a component of the 1st Armored Division.

Commanders, 49th Quartermaster Regiment

Unknown	ao Dec 36-7 Dec 41
---------	--------------------

50th Quartermaster Regiment (Truck-Army) (Fourth Army)

Regular Army Inactive

HQ-Omaha, NE, 1936-41

Constituted in the Regular Army 1 May 1936, assigned to the Fourth Army, and allotted to the Seventh Corps Area. Regiment organized 27 September 1936 with Organized Reserve personnel as a RAI unit at Omaha, NE. Location 7 December 1941—Omaha, NE.

Commanders, 50th Quartermaster Regiment

Capt. Joseph Rytlewski**	27 Sep 36-ao Jan 37	Unknown	ao Jan 37-7 Dec 41
--------------------------	---------------------	---------	--------------------

** RAI Commanders: Organized Reserve officers.

51st Quartermaster Regiment (Heavy Maintenance) (I Corps)

Regular Army Inactive

HQ-Fort Devens, MA, 1936-41

Constituted in the Regular Army 1 May 1936, assigned to the I Corps, and allotted to the First Corps Area. Regiment organized in 1936 with Organized Reserve personnel as a RAI unit at Fort Devens, MA. Location 7 December 1941—Fort Devens, MA.

Status: Disbanded 7 October 1942 as the 51st Ordnance Regiment (Heavy Maintenance).

Commanders, 51st Quartermaster Regiment

Unknown	ao Dec 36-7 Dec 41
---------	--------------------

52nd Quartermaster Regiment (Heavy Maintenance) (II Corps)**Regular Army Inactive**HQ-*Not organized* 1936-41

Constituted in the Regular Army 1 May 1936, assigned to the II Corps, and allotted to the Second Corps Area. Location 7 December 1941—*Not organized*.

Status: Disbanded 7 October 1942 as the 52nd Ordnance Regiment (Heavy Maintenance).**53rd Quartermaster Regiment (Heavy Maintenance)****Regular Army Inactive**HQ-*Not organized* 1936-37; Third Corps Area at large 1937-41

Constituted in the Regular Army 18 October 1927 as the 6th Motor Repair Battalion and allotted to the Third Corps Area. Redesignated 1 May 1936 as the 53rd Quartermaster Regiment (Heavy Maintenance), less 1st Battalion. Concurrently, the 1st Battalion organized at Holabird Quartermaster Depot, MD, by redesignation of the 4th Motor Repair Battalion. Regiment, less 1st Battalion, organized 1 March 1937 in the Third Corps Area as a RAI unit with Organized Reserve personnel. HHD, 2nd Battalion activated in 1940 at Fort Benning, GA, and HHD, 3rd Battalion activated at Fort Bragg, NC. Location 7 December 1941—Third Corps Area at large (less active elements).

Status: Disbanded 7 October 1942 (less the 1st and 3rd Battalions) as the 53rd Ordnance Regiment (Heavy Maintenance); the 1st Battalion inactive in the Regular Army as the 182nd Ordnance Battalion; the 3rd Battalion active in the Regular Army as the 184th Ordnance Battalion.

Events: 301, 330**Commanders, 53rd Quartermaster Regiment**

Maj. Edmund L. Manges**	1 Mar 37-ao May 38 Unknown	Capt. Albert J. Schenedenann** ao Jan 41-7 Dec 41	ao Jun 38-ao Jan 41
-------------------------	-------------------------------	--	---------------------

1st Battalion

Maj. Edwin Van Deusen	1 May 36-16 Jul 36	Maj. Clarence W. Richmond	1 Jul 37-5 May 38
Capt. Llyod M. Garner	16 Jul 36-24 Aug 36	Maj. George H. Rarey	5 May 38-12 Sep 38
Capt. George H. Rarey	24 Aug 36-9 Nov 36	Maj. Clarence W. Richmond	12 Sep 38-7 Mar 39
Maj. Richard N. Atwell	9 Nov 36-1 Jul 37 Unknown	Maj. George H. Rarey ao Jan 40-7 Dec 41	7 Mar 39-ao Jan 40

** RAI Commanders: Organized Reserve officers.

54th Quartermaster Regiment (Heavy Maintenance) (First Army)**Regular Army Inactive**HQ-New York City, NY, 1936-41; *Inactive* 1941

Constituted in the Regular Army 1 May 1936, assigned to the First Army, and allotted to the Second Corps Area. Regiment, less Companies A and B, organized 30 October 1936 with Organized Reserve personnel as a RAI unit at New York City, NY. Companies A and B active 1936-40 at the New York Port of Embarkation, NY, and Army Base, Boston, MA, respectively. Designated mobilization training station was Camp Lee, VA. The remainder of the 1st Battalion was activated 1 June 1941 at Fort Devens, MA. HHD, 2nd Battalion was concurrently activated at Fort Dix, NJ. RAI elements inactivated 1 August 1941 at New York City, NY, by relief of personnel. Location 7 December 1941—*Inactive*.

Status: Disbanded 7 October 1942 (less the 1st and 3rd Battalions) as the 54th Ordnance Regiment (Heavy Maintenance); the 1st Battalion is active in the Regular Army at Wheeler Army Air Field as the 209th Support Battalion; the 3rd Battalion active in the Regular Army as the 187th Ordnance Battalion.

Events: 296**Commanders, 54th Quartermaster Regiment**

Capt. Foster G. Jackson**	30 Oct 36-1 Aug 41
---------------------------	--------------------

** RAI Commanders: Organized Reserve officers.

55th Quartermaster Regiment (Heavy Maintenance) (V Corps)**Regular Army Inactive****HQ**-San Antonio, TX, 1936-39; Normoyle Quartermaster Depot, TX, 1939-41

Constituted in the Regular Army 1 May 1936 (less 1st Battalion), assigned to the V Corps, and allotted to the Fifth Corps Area. Concurrently, the 1st Battalion organized by redesignation of the 3rd Motor Repair Battalion at Normoyle Quartermaster Depot, TX. Regiment, less the 1st Battalion, organized 25 November 1936 with Organized Reserve personnel as a RAI unit at San Antonio, TX. RAI elements conducted summer training at Normoyle Quartermaster Depot with active elements of the regiment. Headquarters and Headquarters Detachment activated about October 1939, less Reserve personnel, at Normoyle Quartermaster Depot, TX. Designated mobilization training station was Normoyle Quartermaster Depot, TX, for inactive

elements. HHD, 2nd Battalion activated at Fort Sill, OK, and HHD, 3rd Battalion activated at Fort Bliss, TX. Location 7 December 1941—Normoyle Quartermaster Depot, TX.

Status: Disbanded 7 October 1942 (less the 1st, 2nd, and 3rd Battalions) as the 55th Ordnance Regiment (Heavy Maintenance); the 1st Battalion inactive in the Regular Army as the 188th Ordnance Battalion; the 2nd Battalion active in the Regular Army as the 189th Support Battalion; the 3rd Battalion active in the U. S. Army Reserve as the 300th Supply and Service Battalion.

Events: 213, 214, 258, 296, 300**Commanders, 55th Quartermaster Regiment**

Maj. William B. Sharp**	25 Nov 36-ao Jun 37	Lt. Col. John McD. Thompson	Oct 39-20 Jul 40
Unknown	ao Jun 37-Oct 39	Lt. Col. George P. Barnes	20 Jul 40-26 Jan 42

** RAI Commanders: Organized Reserve officers.

1st Battalion

Lt. Col. John McD. Thompson	1 May 36-Oct 39
-----------------------------	-----------------

56th Quartermaster Regiment (Heavy Maintenance)**Regular Army Inactive****HQ**-Not organized 1936-41; Fort Leonard Wood, MO, 1941

Constituted 15 August 1927 in the Regular Army as the 7th Motor Repair Battalion and allotted to the Fifth Corps Area. Reorganized and redesignated the 56th Quartermaster Regiment (Heavy Maintenance) 1 May 1936. Company A active at Jeffersonville Quartermaster Depot, IN, 1936-39. Company A transferred in 1939 to Fort Knox, KY. Designated mobilization training station was Camp Shelby, MS. Regimental headquarters activated 9 June 1941, less organic companies, at Fort Leonard Wood, MO. Location 7 December 1941—Fort Leonard Wood, MO.

Status: Disbanded 7 October 1942 (less the 1st, 2nd, and 3rd Battalions) as the 56th Ordnance Regiment (Heavy Maintenance); the 1st Battalion active in the Regular Army as the 191st Ordnance Battalion; the 2nd Battalion inactive in the Regular Army as the 192nd Maintenance Battalion; and the 3rd Battalion inactive in the Regular Army as the 193rd Support Battalion.

Events: 213, 214, 220, 324**Commanders, 56th Quartermaster Regiment**

Unknown	9 Jun 41-7 Dec 41
---------	-------------------

57th Quartermaster Regiment (Heavy Maintenance)**Regular Army Inactive****HQ**-Flint, MI, 1936-41; *Inactive* 1941

Constituted 15 August 1927 in the Regular Army as the 8th Motor Repair Battalion and allotted to the Sixth Corps Area. Redesignated 57th Quartermaster Regiment (Heavy Maintenance), less 3rd Battalion, 1 May 1936. Concurrently, the 9th Motor Repair Battalion redesignated 3rd Battalion. Regiment organized about 15 December 1936 with Organized Reserve personnel as a RAI unit at Flint, MI. HHD, 1st Battalion activated 25 April 1941 at Camp Shelby, MS. HHD, 2nd Battalion concurrently activated at Camp Livingston, LA. RAI elements inactivated in 1941 at Flint by relief of personnel. Location 7 December 1941—*Inactive* (less active elements).

Status: Disbanded 7 October 1942 (less the 1st, 2nd, and 3rd Battalions) as the 57th Ordnance Regiment (Heavy Maintenance); the 1st Battalion active in the Regular Army as the 194th Maintenance Battalion; the 2nd Battalion active in the Regular Army as the 195th Ordnance Battalion; the 3rd Battalion active in the Regular Army as the 196th Ordnance Battalion.

57th Quartermaster Regiment

Capt. William K. Heimbaugh**	15 Dec 36-14 Feb 37	Unknown	17 Feb 37-25 Apr 41
	Lt. Col. James L. Keasler	25 Apr 41-1 Jan 42	

** RAI Commanders: Organized Reserve officers.

58th Quartermaster Regiment (Heavy Maintenance) (GHQR)

Regular Army Inactive

HQ-Los Angeles, CA, 1936-41

Constituted in the Regular Army 1 May 1936, assigned to the General Headquarters Reserve, and allotted to the Ninth Corps Area. Regiment organized 14 May 1936 with Organized Reserve personnel as a RAI unit at Los Angeles, CA. Companies A and B activated 1936-40 at the Presidio of San Francisco, CA, and Fort Lewis, WA, respectively. RAI elements typically conducted Inactive Training Period meetings at the Chamber of Commerce Building in Los Angeles. Conducted summer training at Camp Ord, Del Monte, CA. Relieved from the First Army in 1939 and assigned to the IX Corps. HHD, 1st Battalion activated 20 January 1941 at Fort Lewis, WA. HHD, 2nd Battalion concurrently activated at Fort Ord, CA. Location 7 December 1941—Los Angeles, CA.

Status: Disbanded 7 October 1942 (less the 1st, 2nd, and 3rd Battalions) as the 58th Ordnance Regiment (Heavy Maintenance); the 1st Battalion inactive in the Regular Army as the 197th Ordnance Battalion; the 2nd Battalion inactive in the Regular Army as the 198th Maintenance Battalion; the 3rd Battalion inactive in the Regular Army as the 199th Ordnance Heavy Maintenance Battalion.

Events: 251, 314, 326

Commanders, 58th Quartermaster Regiment

Maj. George C. Person**	14 May 36-17 Oct 36	Maj. William P. Baer**	17 Oct 36-ao Jun 38
	Unknown	ao Jun 38-7 Dec 41	

** RAI Commanders: Organized Reserve officers.

59th Quartermaster Regiment (Heavy Maintenance) (IX Corps)

Regular Army Inactive

HQ-*Not organized* 1936-41

Constituted in the Regular Army 1 May 1936, assigned to the IX Corps, and allotted to the Ninth Corps Area. Location 7 December 1941—*Not organized*.

Status: Disbanded 7 October 1942 as the 59th Ordnance Regiment (Heavy Maintenance).

60th Quartermaster Regiment (Remount) (First Army)

Regular Army Inactive

HQ-*Not organized* 1936-37; Richmond, VA, 1937-40

Constituted in the Regular Army 15 August 1927 as the II Corps Remount Depot, assigned to the II Corps, and allotted to the Third Corps Area. Redesignated 60th Quartermaster Regiment (Remount) 1 May 1936 and assigned to the First Army. Regiment organized 15 March 1937 with Organized Reserve personnel as a RAI unit at Richmond, VA. Reorganized and redesignated 1 July 1940 as the 251st Quartermaster Squadron (Remount).

Commanders, 60th Quartermaster Regiment

1st Lt. J. M. McKenzie**	15 Mar 37-23 Jan 40	Capt. Stephan A. Davis**	23 Jan 40-1 Jul 40
--------------------------	---------------------	--------------------------	--------------------

** RAI Commanders: Organized Reserve officers.

61st Quartermaster Regiment (Remount) (Second Army)**Regular Army Inactive****HQ**-East St. Louis, IL, 1936-40

Constituted in the Regular Army 1 May 1936, assigned to the Second Army, and allotted to the Sixth Corps Area. Regiment organized by December 1936 with Organized Reserve personnel as a RAI unit at East St. Louis, IL. Designated mobilization training station was Fort Douglas, UT. Reorganized and redesignated 1 July 1940 as the 253rd Quartermaster Squadron (Remount).

Commanders, 61st Quartermaster Regiment

Unknown	ao Dec 36-1 Jul 40
---------	--------------------

62nd Quartermaster Regiment (Remount) (Third Army)**Regular Army Inactive****HQ**-Fort Bliss, TX, 1936; Fort Worth, TX, 1936-40

Constituted in the Regular Army 15 August 1927 as the First Army Remount Depot, assigned to the First Army, and allotted to the Eighth Corps Area. Organized 5 April 1928 with Organized Reserve personnel as a RAI unit with headquarters at Fort Bliss, TX. Redesignated 62nd Quartermaster Regiment (Remount) 1 June 1936, assigned to the Third Army, and allotted to the Eighth Corps Area. Headquarters relocated 25 November 1936 to Fort Worth, TX. Designated mobilization training station was Fort Clark, TX. Conducted summer training at Fort Logan, CO. Also conducted C.M.T.C. training some years at Fort Logan as an alternate form of annual training. Reorganized and redesignated 1 July 1940 as the 254th Quartermaster Squadron (Remount).

Status: Disbanded 11 November 1944.**Commanders, 62nd Quartermaster Regiment**

Unknown	1 Jun 36-25 Nov 36	Capt. Henri J. Walters**	25 Nov 36-ao Aug 37
	Unknown	ao Aug 37-1 Jul 40	

** RAI Commanders: Organized Reserve officers.

63rd Quartermaster Regiment (Remount) (Fourth Army)**Regular Army Inactive****HQ**-Seventh Corps Area, 1936-40

Constituted in the Regular Army 15 August 1927 as the III Corps Remount Depot, assigned to the III Corps, and allotted to the Third Corps Area. Redesignated as the 63rd Quartermaster Regiment (Remount) 1 May 1936, and assigned to the Fourth Army and allotted to the Seventh Corps Area. Organized 27 September 1936 with Organized Reserve personnel as a RAI unit in the Seventh Corps Area. Reorganized and redesignated 1 July 1940 as the 252nd Quartermaster Squadron (Remount).

Commanders, 63rd Quartermaster Regiment

1st Lt. Jesse D. Sickler**	27 Sep 36-1 Aug 37	Capt. William K. Heimbaugh**	1 Aug 37-ao Sep 37
	Unknown	ao Sep 37-1 Jun 40	

** RAI Commanders: Organized Reserve officers.

65th Quartermaster Regiment (Service) (C) (GHQR)**Regular Army Inactive****HQ**-Columbia, SC, 1936-40

Constituted in the Regular Army 15 August 1927 as the 2nd Service Battalion, assigned to the General Headquarters Reserve, and allotted to the Fourth Corps Area. Organized 17 March 1928 with Organized Reserve personnel as a RAI unit at Columbia, SC. Expanded and redesignated as the 65th Quartermaster Regiment (Service) 1 May 1936, and allotted to the Fourth Corps Area. Regiment organized 15 December 1936 with Organized Reserve personnel as a RAI unit at Columbia, SC. Designated mobilization training station was Camp J. Clifford R. Foster, FL. Reorganized and redesignated 1 July 1940 as the 354th Quartermaster Regiment (Service) (Colored).

Commanders, 65th Quartermaster Regiment

Capt. Claude R. Garmany**

27 Dec 36-ao Sep 39

Unknown

ao Sep 39-1 Jun 40

** RAI Commanders: Organized Reserve officers.

66th Quartermaster Regiment (Service) (C) (GHQR)

Regular Army Inactive

HQ-Jackson, MS, 1936-40

Constituted in the Regular Army 15 August 1927 as the 5th Service Battalion, assigned to the General Headquarters Reserve, and allotted to the Fourth Corps Area. Organized 20 September 1928 with Organized Reserve personnel as a RAI unit at Jackson, MS. Expanded and redesignated as the 66th Quartermaster Regiment (Service) 1 May 1936, and allotted to the Fourth Corps Area. Regiment organized 27 December 1936 with Organized Reserve personnel as a RAI unit at Jackson, MS. Designated mobilization training station was Camp J. Clifford R. Foster, FL. Reorganized and redesignated 1 July 1940 as the 355th Quartermaster Regiment (Service) (Colored).

Commanders, 66th Quartermaster Regiment

Capt. Paul H. Floyd**

27 Dec 36-ao Sep 39

Unknown

ao Sep 39-1 Jul 40

** RAI Commanders: Organized Reserve officers.

67th Quartermaster Battalion (Light Maintenance)

Regular Army Inactive

HQ-Not organized 1936-41; Fort Leonard Wood, MO, 1941



Constituted in the Regular Army 1 May 1936 and allotted to the Seventh Corps Area. Activated 9 June 1941 at Fort Leonard Wood, MO. Location 7 December 1941—Fort Leonard Wood, MO.

Status: Active in the Regular Army at Fort Stewart, GA, as the 87th Support Battalion.

Events: 300, 301, 303, 323, 330

68th Quartermaster Battalion (Car) (First Army)

Regular Army Inactive

HQ-New York City, NY, 1936-40

Constituted in the Regular Army 15 August 1927 as the 1st Motor Transport Command, assigned to the First Army, and allotted to the Second Corps Area. Redesignated as the 68th Quartermaster Battalion (Car) 1 May 1936, assigned to the First Army, and allotted to the Second Corps Area. Organized 30 October 1936 with Organized Reserve personnel as a RAI unit at New York City, NY. Designated mobilization training station was Camp Lee, VA. HHD disbanded 1 July 1940 and subordinate companies redesignated as separate Quartermaster companies.

Events: 234, 300

69th Quartermaster Battalion (Car) (Second Army)

Regular Army Inactive

HQ-Saginaw, MI, 1936-40

Constituted in the Regular Army 15 August 1927 as the 15th Motor Transport Command, assigned to the Second Army, and allotted to the Sixth Corps Area. Redesignated as the 69th Quartermaster Battalion (Car) 1 May 1936, assigned to the Second Army, and allotted to the Sixth Corps Area. Battalion organized about 1936 with Organized Reserve personnel as a RAI unit at Saginaw, MI. Designated mobilization training station was Camp Shelby, MS. Company B activated about June 1940 at Fort Snelling, MN. HHD disbanded 1 July 1940 and subordinate companies redesignated as separate Quartermaster companies.

Events: 303

70th Quartermaster Battalion (Car) (Third Army)

Regular Army Inactive

HQ-Fort Sam Houston, TX, 1936-40

Constituted in the Regular Army 15 August 1927 as the 22nd Motor Transport Command, assigned to the Third Army, and allotted to the Eighth Corps Area. Organized in June 1930 with Organized Reserve personnel as a RAI unit at Fort Sam Houston, TX. Redesignated as the 70th Quartermaster Battalion (Car) 1 May 1936. Designated mobilization training station was Fort Clark, TX. Inactivated 25 June 1940 at Fort Sam Houston by relief of personnel. HHD disbanded 1 July 1940 and subordinate companies redesignated as separate Quartermaster companies.

71st Quartermaster Battalion (Car) (Fourth Army)

Regular Army Inactive

HQ-Little Rock, AR, 1936-40

Constituted in the Regular Army 15 August 1927 as the 18th Motor Transport Command, assigned to the Fourth Army, and allotted to the Seventh Corps Area. Redesignated as the 71st Quartermaster Battalion (Car) 1 May 1936, assigned to the Fourth Army, and allotted to the Seventh Corps Area. Battalion organized 27 September 1936 with Organized Reserve personnel as a RAI unit at Little Rock, AR. Designated mobilization training station was Fort Douglas, UT. HHD disbanded 1 July 1940 and subordinate companies redesignated as separate Quartermaster companies.

72nd Quartermaster Battalion (Car)

Regular Army Inactive

HQ-*Not organized* 1936-37; Third Corps Area 1937-40

Constituted in the Regular Army 15 August 1927 as the 7th Motor Transport Command, assigned to the General Headquarters Reserve, and allotted to the Third Corps Area. Redesignated as the 72nd Quartermaster Battalion (Car) 1 May 1936, assigned to the Special Troops, General Headquarters, and allotted to the Third Corps Area. Concurrently, the 13th and 15th Motorcycle Companies redesignated Companies A and B respectively. Battalion organized 15 March 1937 with Organized Reserve personnel as a RAI unit in the Third Corps Area. Designated mobilization training station was Camp Lee, VA. HHD disbanded 1 July 1940 and subordinate companies redesignated as separate Quartermaster companies.

75th Quartermaster Battalion (Truck-Army) (First Army)

Regular Army Inactive

HQ-New York City, NY, 1936-40

Constituted in the Regular Army 15 August 1927 as the 192nd Motor Transport Company, assigned to the General Headquarters Reserve, and allotted to the Second Corps Area. Redesignated as the 75th Quartermaster Battalion (Truck-Army) 1 May 1936, assigned to the First Army, and allotted to the Second Corps Area. Organized 30 October 1936 with Organized Reserve personnel as a RAI unit with headquarters at New York City, NY. Subordinate companies organized from the 193rd-195th Motor Transport Companies. Reorganized and redesignated 1 July 1940 as the 201st Quartermaster Battalion (Gas Supply).

76th Quartermaster Battalion (Truck-Army) (Second Army)

Regular Army Inactive

HQ-Parkersburg, WV 1936-40

Constituted in the Regular Army 8 April 1924 as the 19th Motor Transport Company, assigned to the General Headquarters Reserve, and allotted to the Fifth Corps Area. Redesignated as the 76th Quartermaster Battalion (Truck-Army) 1 May 1936, assigned to the Second Army, and allotted to the Fifth Corps Area. Subordinate companies organized from the 20th, 70th, and 71st Motor Transport Companies. Battalion organized about 1936 with Organized Reserve personnel as a RAI unit at Parkersburg, WV. Reorganized and redesignated 1 July 1940 as the 203rd Quartermaster Battalion (Gas Supply).

77th Quartermaster Battalion (Truck-Army) (Third Army)

Regular Army Inactive

HQ-St. Petersburg, FL, 1936-40

Constituted in the Regular Army 8 April 1924 as the 15th Motor Transport Company, assigned to the 8th Division, and allotted to the Fourth Corps Area. Redesignated as the 15th Motor Transport Company 23 March 1925. Redesignated as HHC, 77th Quartermaster Battalion (Truck-Army) 1 May 1936, assigned to the Third Army, and allotted to the Fourth Corps Area. Subordinate companies organized from the 16th, 65th, and 66th Motor Transport Companies. Battalion organized 15 December 1936 with Organized Reserve personnel as a RAI unit at St. Petersburg, FL. Reorganized and redesignated 1 July 1940 as the 205th Quartermaster Battalion (Gas Supply).

78th Quartermaster Battalion (Truck-Army) (Fourth Army)

Regular Army Inactive

HQ-*Not organized* 1936-38; Los Angeles, CA, 1938-41

Constituted in the Regular Army 1 May 1936 and allotted to the Ninth Corps Area. Battalion organized 6 February 1938 with Organized Reserve personnel as a RAI unit at Los Angeles, CA. Typically conducted Inactive Training Period meetings at the Chamber of Commerce Building in Los Angeles. Reorganized and redesignated 1 July 1940 as the 213th Quartermaster Battalion (Gas Supply).

80th Quartermaster Battalion (Light Maintenance)

Regular Army Inactive

HQ-Baltimore, MD, 1937-41; Holabird Army Depot, MD, 1941

Constituted in the Regular Army 18 October 1927 as the 6th Motor Transport Command, and allotted to the Third Corps Area. Redesignated as the 80th Quartermaster Battalion (Light Maintenance) 1 May 1936, assigned to the General Headquarters Reserve, and allotted to the Third Corps Area. Battalion organized 15 March 1937 with Organized Reserve personnel as a RAI unit in the Baltimore area. Companies A and C active at Holabird Quartermaster Depot, MD, Company B active at Fort Belvoir, VA, and Company D active at Fort Myer, VA. HHD activated, less Reserve personnel, 10 February 1941 at Holabird Army Depot, MD. Location 7 December 1941—Holabird Army Depot, MD.

Status: Active in the Regular Army as the 80th Ordnance Battalion at Fort Lewis, WA.

Events: 330

81st Quartermaster Battalion (Light Maintenance) (First Army)

Regular Army Inactive

HQ-*Not organized* 1936-38; Saginaw, MI, 1938-41

Constituted in the Regular Army 18 October 1927 as the 16th Motor Transport Command, and allotted to the Sixth Corps Area. Redesignated as the 81st Quartermaster Battalion (Light Maintenance) 1 May 1936, assigned to the First Army and allotted to the Sixth Corps Area. Battalion organized by December 1938 with Organized Reserve personnel as a RAI unit at Saginaw, MI. Company A active at Fort Custer, MI, and Company C active at Fort Sheridan, IL. Conducted summer training at Camp McCoy, WI. Designated mobilization training station was Camp Shelby, MS. Location 7 December 1941—Detroit, MI.

Status: Inactive in the Regular Army as the 81st Maintenance Battalion.

Events: 302

82nd Quartermaster Battalion (Light Maintenance) (Second Army)

Regular Army Inactive

HQ-Cleveland, OH, 1936-41

Constituted in the Regular Army 1 May 1936, assigned to the Second Army and allotted to the Fifth Corps Area. Organized about 1936 with Organized Reserve personnel as a RAI unit at Cleveland, OH. Location 7 December 1941—Cleveland, OH.

Status: Inactive in the Regular Army as the 82nd Maintenance Battalion.

83rd Quartermaster Battalion (Light Maintenance) (Fourth Army)

Regular Army Inactive

HQ-Seventh Corps Area 1936-41

Constituted in the Regular Army 18 October 1927 as the 17th Motor Transport Command, and allotted to the Seventh Corps Area. Redesignated 83rd Quartermaster Battalion (Light Maintenance) 1 May 1936, and assigned to the Fourth Army and allotted to the Seventh Corps Area. Battalion organized 27 September 1936 with Organized Reserve personnel as a RAI unit in the Seventh Corps Area. Company A active at Fort Francis E. Warren, WY, by 1940. Location 7 December 1941—Seventh Corps Area at large.

Status: Active in the Regular Army as the 83rd Ordnance Battalion at Akizuki, Japan.

84th Quartermaster Battalion (Light Maintenance) (Fourth Army)

Regular Army Inactive

HQ-Los Angeles, CA, 1936-40; Fort Devens, MA, 1941

Constituted in the Regular Army 1 May 1936, assigned to the Fourth Army and allotted to the Ninth Corps Area. Organized 30 October 1936 with Organized Reserve personnel as a RAI unit at Los Angeles, CA. Typically conducted Inactive Training Period meetings at the Chamber of Commerce Building in Los Angeles. Withdrawn from the Ninth Corps Area 1 August 1940 and allotted to the First Corps Area. Company A active at Fort Ethan Allen, VT, and Company B active at Fort Devens, MA. HHD activated 1 June 1941 at Fort Devens, MA. Location 7 December 1941—Fort Devens, MA.

Status: Inactive in the Regular Army as the 84th Ordnance Battalion.

85th Quartermaster Battalion (Light Maintenance)**Regular Army Inactive****HQ**-Clarksburg, WV 1936-41

Constituted in the Regular Army 1 May 1936 and allotted to the Fifth Corps Area. Organized about 1936 with Organized Reserve personnel as a RAI unit at Clarksburg, WV. Company A active at Fort Benjamin Harrison, IN. Location 7 December 1941—Clarksburg, WV (less active elements).

Status: Active in the Regular Army in Germany as the 485th Support Battalion.

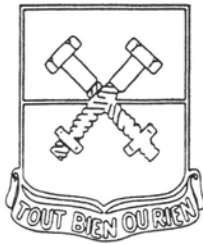
86th Quartermaster Battalion (Light Maintenance)**Regular Army Inactive****HQ**-Toledo, OH, 1936-41; Fort Benning, GA, 1941

Constituted in the Regular Army 8 April 1924 as Motor Repair Section No. 10, allotted to the Fifth Corps Area, and assigned to the 5th Division. Redesignated 10th Motor Repair Section 23 March 1925. Redesignated 86th Quartermaster Battalion (Light Maintenance) 1 May 1936, relieved from the 5th Division, and allotted to the Fifth Corps Area. Companies A-D organized from the 35th-38th Repair Sections, respectively. Organized by late 1936 with Organized Reserve personnel as a RAI unit at Toledo, OH. Company A active at Fort McPherson, GA. Remainder of the battalion activated 1 June 1941 at Fort Benning, GA, and assigned to the Third Army. Location 7 December 1941—Fort Benning, GA.

Status: Active in the Regular Army as the 86th Ordnance Battalion.

Events: 330

87th Quartermaster Battalion (Light Maintenance)**Regular Army Inactive****HQ**-*Not organized* 1936-41; Fort Leonard Wood, MO, 1941

Constituted in the Regular Army 1 May 1936, assigned to the Fourth Army and allotted to the Seventh Corps Area. By 1939, Company A active at Fort Des Moines, IA, Company B active at Fort Snelling, MN, and Companies C and D active at Fort Meade, SD. HHD activated in June 1941 at Fort Leonard Wood, MO. Location 7 December 1941—Fort Leonard Wood, MO.

88th Quartermaster Battalion (Light Maintenance)**Regular Army Inactive****HQ**-*Not organized* 1936-41

Constituted in the Regular Army 1 May 1936 and assigned to the General Headquarters Reserve. By 1938, Company A active at McChord Field, WA, Company B active at MacDill Field FL, and Company C active at Mitchel Field, NY. Location 7 December 1941—*Not organized* (less active elements).

89th Quartermaster Battalion (Light Maintenance)**Regular Army Inactive****HQ**-*Not organized* 1936-41

Constituted in the Regular Army 1 May 1936 and assigned to the General Headquarters Reserve. By 1939, Company A active at Langley Field, WA, Company B active at MacDill Field FL, and Company C active at March Field, CA. Location 7 December 1941—*Not organized* (less active elements).

90th Quartermaster Battalion (Heavy Maintenance)**Regular Army Inactive****HQ**—*Not organized* 1936-41

Constituted in the Regular Army 15 August 1927 as the 90th Motor Repair Section, assigned to the General Headquarters Reserve, and allotted to the Hawaiian Department. Redesignated as the 90th Quartermaster Battalion (Heavy Maintenance) 1 May 1936, assigned to the General Headquarters Reserve, and allotted to the Hawaiian Department. Company A activated at Fort Armstrong, TH, by redesignation of Company A, 5th Motor Repair Battalion. Location 7 December 1941—*Not organized* (less active elements).

94th Quartermaster Battalion (Light Maintenance)**Regular Army Inactive****HQ**—*Not organized* 1936-41

Constituted in the Regular Army 1 May 1936, assigned to the General Headquarters Reserve, and allotted to the Second Corps Area. New York City, NY, designated as headquarters upon organization, but the unit was never organized at that location. Designated mobilization training station was Camp Lee, VA. Location 7 December 1941—*Not organized*.

Events: 330**95th Quartermaster Battalion (Bakery)****Regular Army Inactive****HQ**—New York City, NY, 1936-41

Constituted in the Regular Army 15 August 1927 as the 11th Bakery Company, assigned to the General Headquarters Reserve, and allotted to the Second Corps Area. Redesignated as the 95th Quartermaster Battalion (Bakery) 1 May 1936, assigned to the General Headquarters Reserve, and allotted to the Second Corps Area. Organized 30 October 1936 at New York City, NY. By 1941, Company A active at Fort Slocum, NY, and Company B active at Fort Dix, NJ. Designated mobilization training station was Camp Lee, VA. Location 7 December 1941—*Not organized* (less active elements).

Status: Inactive in the Regular Army as the 95th Supply and Service Battalion.**Events:** 330**96th Quartermaster Battalion (Bakery)****Regular Army Inactive****HQ**—*Not organized* 1936-41

Constituted in the Regular Army 15 August 1927 as the 2nd Bakery Company, assigned to the General Headquarters Reserve, and allotted to the Seventh Corps Area. Redesignated as the 96th Quartermaster Battalion (Bakery) 1 May 1936, assigned to the General Headquarters Reserve, and allotted to the Seventh Corps Area. Company A active at Fort Riley, KS. Designated mobilization training station was Fort Douglas, UT. Location 7 December 1941—*Not organized* (less active elements).

Status: Inactive in the Regular Army as the 96th Supply and Service Battalion.**97th Quartermaster Battalion (Bakery)****Regular Army Inactive****HQ**—San Antonio, TX, 1936-41; *Inactive* 1941

Constituted in the Regular Army 15 August 1927 as the 1st Bakery Company, assigned to the General Headquarters Reserve, and allotted to the Eighth Corps Area. Redesignated as the 97th Quartermaster Battalion (Bakery) 1 May 1936, assigned to the General Headquarters Reserve, and allotted to the Eighth Corps Area. Headquarters organized 25 November 1936 with Organized Reserve personnel as a RAI unit at San Antonio, TX. By 1939, Company A active at Fort Sam Houston, TX, Company B active at Fort Sill, OK, and Company C active at Fort Benning, GA. Fort

Sam Houston, TX, designated as location of battalion headquarters upon activation. Designated mobilization training station was Camp Bullis, TX. Location 7 December 1941—*Inactive* (less active elements).

Status: Inactive in the Regular Army as the 97th Quartermaster Battalion.

Events: 314, 326

98th Quartermaster Battalion (Bakery)

Regular Army Inactive

HQ-San Francisco, CA, 1936-40; *Inactive* 1940-41

Constituted in the Regular Army 15 August 1927 as the 3rd Bakery Company, assigned to the General Headquarters Reserve, and allotted to the Ninth Corps Area. Redesignated as the 98th Quartermaster Battalion (Bakery) 1 May 1936, assigned to the General Headquarters Reserve, and allotted to the Ninth Corps Area. Company A active at the Presidio of San Francisco, CA. Remainder of the battalion organized 14 May 1936 with Organized Reserve personnel as a RAI unit at San Francisco. Designated mobilization training station was the Presidio of San Francisco. Inactivated 30 July 1940 at San Francisco by relief of personnel.

Location 7 December 1941—*Inactive*.

Status: Active in the Regular Army at Yongsan Garrison, Korea, as the 498th Corps Support Battalion.

101st Quartermaster Regiment (26th Division)

Massachusetts National Guard

HQ-West Newton, MA, 1936-41



Constituted in the Massachusetts National Guard in 1921 as the Quartermaster Section, 26th Division Headquarters. Organized and federally recognized 24 May 1923 at Boston, MA. Consolidated with Headquarters, 26th Division Quartermaster Train (organized and federally recognized 29 April 1919 at Charlestown, MA) and redesignated 26 May 1936 at West Newton, MA, as Headquarters, 101st Quartermaster Regiment. Remainder of the regiment was organized from the units of the 26th Division Quartermaster Train as follows:

Service Company from the *26th Service Company, Q.M.C.*

Headquarters, 1st Battalion constituted new and organized 22 June 1936 at West Newton, MA.

A Company from the 101st Motor Transport Company, active at Natick, MA.

B Company from the 102nd Motor Transport Company, active at Woburn, MA.

Headquarters, 2nd Battalion constituted new and organized 1 July 1937 at Framingham, MA.

C Company constituted new and organized 27 May 1937 at Framingham, MA.

D Company from the 102nd Wagon Company, active at Lawrence, MA.

Headquarters, 3rd Battalion constituted new and organized 16 November 1937 at Everett, MA.

E Company from the 101st Motor Repair Section at Natick, MA.

F Company from the 101st Motorcycle Company (*inactive*); organized 16 November 1937 at Everett, MA.

Called up to perform hurricane relief duties 21-28 September 1938 at Everett, MA. Conducted annual summer training most years at the Massachusetts Military Reservation at Falmouth, 1936-38. Inducted into active federal service 16 January 1941 at West Newton. Transferred 21 January 1941 to Fort Devens, MA. Location 7 December 1941—Fort Devens, MA.

Status: Headquarters, 101st Quartermaster Regiment active in the Massachusetts National Guard at Springfield, MA, as HHD, 101st Quartermaster Battalion.

Events: 280, 301, 330

2064

Commanders, 101st Quartermaster Regiment

Col. Edward T. Ryan 26 May 36-12 Feb 42

102nd Quartermaster Regiment (27th Division)

New York National Guard

HQ-Brooklyn, NY, 1936-41



Constituted in the New York National Guard in 1921 as the Quartermaster Section, 27th Division Headquarters. Organized and federally recognized 23 December 1921 at New York City, NY. Consolidated with Headquarters, 27th Division Quartermaster Train (organized and federally recognized 4 November 1921 at Brooklyn, NY) and redesignated 1 April 1936 at Brooklyn as Headquarters, 102nd Quartermaster Regiment. Remainder of the regiment was organized from the units of the 27th Division Quartermaster Train as follows:

Service Company from the *27th Service Company, Q.M.C.*

Headquarters, 1st Battalion constituted new and organized 27 April 1936 at Brooklyn, NY.

A Company from the 105th Motor Transport Company, active at Brooklyn, NY.

B Company from the 106th Motor Transport Company, active at Brooklyn, NY.

Headquarters, 2nd Battalion constituted new and organized 23 April 1936 at Brooklyn, NY.

C Company from the 107th Motor Transport Company, active at Brooklyn, NY.

D Company from the 108th Motor Transport Company, active at Brooklyn, NY.

Headquarters, 3rd Battalion constituted new and organized 5 May 1936 at Brooklyn, NY.

E Company from the 103rd Motor Repair Section, active at Brooklyn, NY.

F Company from the 102nd Motorcycle Company, active at Brooklyn, NY.

Conducted annual summer training most years at Camp Smith, NY, 1936-38. Inducted into active federal service 15 October 1940 at Brooklyn, NY. Transferred 25 October 1940 to Fort McClellan, AL. Location 7 December 1941—Fort McClellan, AL.

Events: 280, 301, 316, 324, 328

Commanders, 102nd Quartermaster Regiment

Col. Foster G. Hetzel 1 Apr 36-Sep 42

103rd Quartermaster Regiment (28th Division)

Pennsylvania National Guard

HQ-Harrisburg, PA, 1936-41



Constituted in the Pennsylvania National Guard in 1921 as the Quartermaster Section, 28th Division Headquarters. Organized and federally recognized 22 December 1921 at Carlisle, PA. Consolidated with Headquarters, 28th Division Quartermaster Train (organized and federally recognized 22 December 1921 at Harrisburg, PA) and redesignated 17 April 1936 at Harrisburg as Headquarters, 103rd Quartermaster Regiment. Remainder of the regiment was organized from the units of the 28th Division Quartermaster Train as follows:

Service Company from the *28th Service Company, Q.M.C.*.

Headquarters, 1st Battalion constituted new and organized 17 April 1936 at Harrisburg, PA.

A Company from the 109th Motor Transport Company, active at Huntingdon, PA.

B Company from the 110th Motor Transport Company, active at York, PA.

Headquarters, 2nd Battalion constituted new and organized 13 May 1936 at Pine Grove, PA.

C Company from the 105th Wagon Company, active at Pine Grove, PA.

D Company from the 106th Wagon Company, active at Hamburg, PA.

Headquarters, 3rd Battalion constituted new and organized 17 April 1936 at Harrisburg, PA.

E Company from the 105th Motor Repair Section, active at Gettysburg, PA.

F Company from the 103rd Motorcycle Company, active at Philadelphia, PA.

Conducted annual summer training most years at Mount Gretna, PA, 1936-38. Inducted into active federal service 17 February 1941 at Harrisburg. Transferred 21 February 1941 to Indiantown Gap, PA. Location 7 December 1941—Indiantown Gap, PA.

Events: 280, 301, 330

Commanders, 103rd Quartermaster Regiment

Lt. Col. Franklin P. Haller

17 Apr 36-22 Nov 40

Lt. Col. John L. Heilman

Col. George J. Shoemaker

20 Dec 41-7 Feb 42

22 Nov 40-20 Dec 41

104th Quartermaster Regiment (29th Division)

**Maryland, District of Columbia, and Virginia
National Guard**

HQ-Baltimore, MD, 1936-41



Constituted in the National Guard in 1921 as the Quartermaster Section, 29th Division Headquarters. Organized and federally recognized 1 July 1930 at Washington, DC. Redesignated 1 July 1936 at Baltimore, MD, as Headquarters, 104th Quartermaster Regiment. Remainder of the regiment was organized as follows:

Service Company from the *29th Service Company, Q.M.C.*.

Headquarters, 1st Battalion constituted new and organized 22 June 1937 at Washington, DC.

A Company constituted new and organized 22 June 1937 at Washington, DC.

B Company constituted new and organized 8 June 1937 at Washington, DC.

Headquarters, 2nd Battalion constituted new and organized 25 March 1937 at Richmond, VA.

C Company constituted new and organized 25 May 1937 at Richmond, VA.

D Company constituted new and organized 3 April 1939 at Denton, PA.

Headquarters, 3rd Battalion constituted new and organized 30 June 1939 at Baltimore, MD.

E Company constituted new and organized 1 April 1939 at Camp Ritchie, MD.

F Company from the 104th Motorcycle Company (*inactive*); organized 30 June 1939 at Richmond, VA.

Conducted annual summer training most years at Camp Ritchie, MD, 1936-38. Inducted into active federal service 16 September 1940 at Baltimore. Transferred 23 September 1940 to Fort Dix, NJ. Location 7 December 1941—En route to Fort Dix from the Carolina Maneuver Area.

Events: 280, 301, 330

Commanders, 104th Quartermaster Regiment

Col. Ralph Hutchins

1 Jul 36-Sep 41

Col. Samuel R. Millar, Jr.

Sep 41-Feb 42

105th Quartermaster Regiment (30th Division)

**South Carolina, North Carolina,
Georgia and Tennessee National Guard**

HQ-Not organized 1936-37; Charleston, SC, 1937-41



Constituted in the South Carolina National Guard in 1921 as the Quartermaster Section, 30th Division Headquarters. Consolidated 1 April 1936 with Headquarters, 30th Division Quartermaster Train (*inactive*) and reorganized and redesignated as Headquarters and Headquarters Company, 105th Quartermaster Regiment. Remainder of the regiment was organized from the units of the 30th Division Quartermaster Train as follows:

Service Company from the *30th Service Company, Q.M.C.*

Headquarters, 1st Battalion constituted new and organized 13 August 1937 at Henderson, NC.

A Company constituted new and organized 28 June 1937 at Winston-Salem, NC

B Company constituted new and organized 14 November 1936 at Warrensville, SC.

Headquarters, 2nd Battalion constituted new and organized 8 February 1937 at Union, SC.

C Company from the 118th Motor Transport Company, active at Columbia, SC.

D Company from the 119th Motor Transport Company, active at Columbia, SC.

Headquarters, 3rd Battalion constituted new and organized 11 July 1936 at Nashville, TN.

E Company from the 120th Motor Transport Company, active at Nashville, TN.

F Company from the 105th Motorcycle Company redesignated 1 May 1936 at Knoxville, TN.

Regimental headquarters organized and federally recognized 1 January 1937 at Charleston, SC. Conducted annual summer training at Camp Jackson, SC, 1936-39, less Tennessee elements which trained at Camp Peay, TN. Inducted into active federal service 16 September 1940 at Charleston, SC. Transferred 23 September 1940 to Fort Jackson, SC. Location 7 December 1941—Fort Jackson, SC.

Events: 255, 300, 316, 330

Commanders, 105th Quartermaster Regiment

Col. James L. Gantt

1 Jan 37-Feb 42

106th Quartermaster Regiment (31st Division)

**Florida, Mississippi, Louisiana,
and Alabama National Guard**

HQ-St. Augustine, FL, 1936-41



Constituted in the Florida National Guard in 1921 as the Quartermaster Section, 31st Division Headquarters. Organized and federally recognized 13 June 1924 at St. Augustine, FL. Consolidated 19 May 1936 with Headquarters, 31st Division Quartermaster Train (organized and federally recognized 11 August 1924 at Senatobia, MS) and redesignated as Headquarters, 106th Quartermaster Regiment. Remainder of the regiment was organized from the units of the 31st Division Quartermaster Train as follows:

Service Company from the *31st Service Company, Q.M.C.*

Headquarters, 1st Battalion constituted new and organized 13 May 1936 at Alexandria, LA.

A Company from the 122nd Motor Transport Company, active at Senatobia, MS.

B Company from the 123rd Motor Transport Company, active at Alexandria, LA.

Headquarters, 2nd Battalion constituted new and organized 21 May 1936 at Tallahassee, FL.

C Company from the 124th Motor Transport Company, active at Jacksonville, FL.

D Company from the 121st Motor Transport Company, active at Ramer, AL.

Headquarters, 3rd Battalion constituted new and organized 4 June 1936 at Montgomery, AL.

E Company from the 111th Motor Repair Section, redesignated 1 May 1936 at Montgomery, AL.

F Company from the 106th Motorcycle Company, redesignated 1 May 1936 at Foley, AL.

Conducted annual summer training 1936-39 at locations as follows: Camp J. Clifford R. Foster, FL, for Florida elements; Fort McClellan, AL, for Alabama and Mississippi elements; and Camp Beauregard, LA, for Louisiana elements. Inducted into active federal service 25 November 1940 at St. Augustine. Transferred 22 December 1940 to Camp Blanding, FL. Location 7 December 1941—Camp Blanding, FL.

Events: 255, 300, 325, 328, 330

Commanders, 106th Quartermaster Regiment

Col. Jacob H. Spengler

19 May 36-10 Feb 42

107th Quartermaster Regiment (32nd Division)

Wisconsin and Michigan National Guard

HQ-Madison, WI, 1936-40; Detroit, MI, 1940; Madison, WI, 1940-41



Constituted in the Wisconsin National Guard in 1921 as the Quartermaster Section, 32nd Division Headquarters. Organized and federally recognized 1 April 1926 at Madison, WI. Consolidated 1 July 1936 with Headquarters, 32nd Division Quartermaster Train (organized and federally recognized in 1921 at Rhinelander, WI; inactivated 2 September 1928 at Rhinelander) and reorganized and redesignated as Headquarters and Headquarters Company, 107th Quartermaster Regiment at Madison, WI. Remainder of the regiment was organized as follows:

Service Company from the *32nd Service Company, Q.M.C.*

Headquarters, 1st Battalion constituted new and organized 9 December 1937 at New Richmond, WI.

A Company constituted new and organized 16 June 1936 at Clintonville, WI.

B Company constituted new and organized 1 November 1937 at Janesville, WI.

Headquarters, 2nd Battalion constituted new and organized 1 April 1938 at Detroit, MI.

C Company constituted new and organized 9 February 1938 at Detroit, MI.

D Company constituted new and organized 7 March 1938 at Detroit, MI.

Headquarters, 3rd Battalion constituted new and organized 3 April 1939 at Detroit, MI.

E Company constituted new and organized 3 April 1939 at Detroit, MI.

F Company from the 106th Motorcycle Company, redesignated 20 December 1936 at Midland, MI.

The regimental Medical Department Detachment was called up to provide medical support during the following state duties: riot control during the "Milk Strike" at Shawano, WI, 15-20 May 1933; strike duty during the labor disturbances at Kohler, WI, 28 Jul-20 August 1934. Conducted annual summer training at Camp Williams, WI, 1936-39, less Michigan elements which trained at Camp Grayling, MI. Headquarters relocated in 1940 to Detroit, MI. Michigan elements reorganized and integrated into the 177th Field Artillery 20 September 1940. The entire regiment concurrently allotted to the state of Wisconsin and organized there. Headquarters concurrently relocated back to Madison, WI. Regiment inducted into active federal service 15 October 1940 at Madison. Transferred 21 October 1940 to Camp Beauregard, LA. Transferred 15 February 1941 to Camp Livingston, LA. Location 7 December 1941—Camp Livingston, LA.

Events: 214, 302, 320, 328

Commanders, 107th Quartermaster Regiment

Lt. Col. Francis X. Ritger (WI)	1 Jul 39-ao Jun 40	Col. Russel G. Simpson (MI)	ao Sep 40-17 Sep 40
	Col. John C. P. Hanley (WI)	18 Sep 40-16 Jan 42	

108th Quartermaster Regiment (33rd Division)

Illinois National Guard

HQ-Chicago, IL, 1936-41



Constituted in the Illinois National Guard in 1921 as the Quartermaster Section, 33rd Division Headquarters. Organized and federally recognized 15 May 1923 at Chicago, IL. Redesignated 22 April 1936 at Chicago as Headquarters, 108th Quartermaster Regiment. Remainder of the regiment was organized from the units of the 33rd Division Quartermaster Train as follows:

Service Company from the *33rd Service Company, Q.M.C.*

Headquarters, 1st Battalion constituted new and organized 18 May 1936 at Chicago, IL.

A Company from the 129th Motor Transport Company, redesignated 28 April 1936 at Chicago, IL.

B Company from the 130th Motor Transport Company, active at Chicago, IL.

Headquarters, 2nd Battalion constituted new and organized 7 June 1937 at Bloomington, IL.

C Company constituted new and organized 14 April 1937 at Bloomington, IL.

D Company constituted new and organized 14 April 1937 at Bloomington, IL.

Headquarters, 3rd Battalion constituted new and organized 31 July 1937 at Chicago, IL.

E Company constituted new and organized 18 June 1936 at Camp Grant, IL.

F Company constituted new and organized 1 June 1937 at Chicago, IL.

Company E called up for flood relief work along the Ohio River in southern Illinois 21 Jan-5 April 1937. Conducted annual summer training at Camp Grant, IL, 1936-39. For at least one year, in 1937, the regiment also trained company-grade quartermaster officers of the 86th Division at Camp Grant. Inducted into active federal service 5 March 1941 at Chicago. Transferred 12 March 1941 to Camp Forrest, TN. Location 7 December 1941—Camp Forrest, TN.

Status: Active in the Illinois National Guard as the 108th Maintenance Battalion.

Events: 214, 302, 316, 324, 328

Commanders, 108th Quartermaster Regiment

Col. Harold A. Moore	22 Apr 36-15 May 40	Col. Richard Smykal	25 May 40-18 Feb 42
----------------------	---------------------	---------------------	---------------------

109th Quartermaster Regiment (34th Division)

**Iowa, South Dakota, and
Minnesota National Guard**

HQ-Osceola, IA, 1936-41



Constituted in the Iowa National Guard in 1921 as the Quartermaster Section, 34th Division Headquarters. Organized and federally recognized 1 November 1924 at Council Bluffs, IA. Reorganized and redesignated 24 August 1936 at Osceola, IA, as Headquarters, 109th Quartermaster Regiment. Remainder of the regiment was organized from the units of the 34th Division Quartermaster Train as follows:

Service Company from the *34th Service Company, Q.M.C.*

Headquarters, 1st Battalion constituted new and organized 3 June 1937 at Vermillion, SD.

A Company from the 133rd Motor Transport Company, redesignated 1 April 1936 at Edgemont, SD.

B Company constituted new and organized 6 August 1936 at Brookings, SD.

Headquarters, 2nd Battalion constituted new but remained inactive.

C Company constituted new and organized 2 April 1939 at Pierre, SD.

D Company constituted new and organized 16 April 1937 at Camp Ripley, MN.

Headquarters, 3rd Battalion constituted new and organized 6 October 1939 at St. Paul, MN.

E Company from the 118th Motor Repair Section, redesignated 1 May 1936 at Camp Ripley, MN.

F Company constituted new and organized 1 September 1939 at Zumbrota, MN.

Conducted annual summer training 1936-39 at locations as follows: Camp Dodge, IA, for Iowa elements; Camp Ripley, MN, for Minnesota elements; and Camp Rapid, SD, for South Dakota elements. For at least one year, in 1940, the regiment trained nine company-grade officers of the 88th Division at Camp Ripley, MN. Inducted into active federal service 10 February 1941 at Osceola. Transferred 20 February 1941 to Camp Claiborne, LA. Location 7 December 1941—Camp Claiborne, LA.

Status: The 1st Battalion is active in the Minnesota National Guard as the 134th Support Battalion, a component of the 34th Infantry Division.

Events: 233, 303, 320, 328

Commanders, 109th Quartermaster Regiment

Col. Roy B. Gault 24 Aug 36-Feb 42

110th Quartermaster Regiment (35th Division)

Nebraska National Guard

HQ-Lincoln, NE, 1936-41



Constituted in the Nebraska National Guard in 1921 as the Quartermaster Section, 35th Division Headquarters. Organized and federally recognized 30 December 1932 at Lincoln, NE. Consolidated with Headquarters, 35th Division Quartermaster Train (organized and federally recognized 7 June 1923 at Lincoln) and redesignated 1 April 1936 at Lincoln as Headquarters, 110th Quartermaster Regiment. Remainder of the regiment was organized from the units of the 35th Division Quartermaster Train as follows:

Service Company from the *35th Service Company, Q.M.C.*

Headquarters, 1st Battalion constituted new and organized 1 April 1936 at Holdrege, NE.

A Company from the 137th Motor Transport Company, active at Holdrege, NE.

B Company from the 138th Motor Transport Company, active at Fremont, NE.

Headquarters, 2nd Battalion constituted new and organized 8 April 1936 at Holdrege, NE.

C Company from the 119th Wagon Company, active at Lexington, NE.

D Company from the 120th Wagon Company, active at Kearney, NE.

Headquarters, 3rd Battalion constituted new and organized 20 May 1939 at Fremont, NE.

E Company from the 119th Motor Repair Section, active at Fremont, NE.

F Company constituted new and organized 6 April 1939 at Broken Bow, NE.

Conducted annual summer training at Camp Ashland, NE, 1936-39. For at least two years, in 1938 and 1940, the regiment trained nine company-grade officers of the 88th Division at Camp Ashland and Camp Ripley, MN. Inducted into active federal service 23 December 1940 at Lincoln. Transferred 29 December 1940 to Camp Joseph T. Robinson, AR. Transferred 23 October 1941 to Fort Ord, CA. Location 7 December 1941—Fort Ord, CA.

Events: 236, 303, 316, 324, 328

Commanders, 110th Quartermaster Regiment

Col. Marcus L. Poteet

1 Apr 36-ao Feb 42

111th Quartermaster Regiment (36th Division)

Texas National Guard

HQ-Austin, TX, 1936-41



Constituted in the Texas National Guard in 1921 as the Quartermaster Section, 36th Division Headquarters. Organized and federally recognized 1 July 1928 at Houston, TX. Consolidated with Headquarters, 36th Division Quartermaster Train (organized and federally recognized 21 June 1927 at Austin, TX) and redesignated 1 April 1936 at Austin as Headquarters, 111th Quartermaster Regiment. Remainder of the regiment was organized from the units of the 36th Division Quartermaster Train as follows:

Service Company from the *36th Service Company, Q.M.C.*

Headquarters, 1st Battalion constituted new and organized 17 June 1936 at Houston, TX.

A Company from the 141st Motor Transport Company, active at Austin, TX.

B Company from the 142nd Motor Transport Company, active at Austin, TX.

Headquarters, 2nd Battalion constituted new and organized 1 April 1937 at Austin, TX.

C Company constituted new and organized 1 April 1937 at Camp Mabry, TX.

D Company constituted new and organized 1 April 1937 at Camp Mabry, TX.

Headquarters, 3rd Battalion constituted new and organized 17 June 1936 at Dallas, TX.

E Company from the 121st Motor Repair Section, active at Austin, TX.

F Company constituted new and organized 16 June 1936 at Austin, TX.

Conducted annual summer training at Camp Hulen, TX, 1936-39. Inducted into active federal service 25 November 1940 at Austin. Transferred 14 December 1940 to Camp Bowie, TX. Location 7 December 1941—Camp Bowie, TX.

Status: HHC, 111th Quartermaster Regiment active in the Texas National Guard at Austin, TX, as HHC, 111th Support Group.

Events: 258, 300, 317, 328

Commanders, 111th Quartermaster Regiment

Col. Earnest O. Thompson

1 Apr 36-10 Nov 41

Col. Carl L. Phinney

11 Nov 41-Feb 42

112th Quartermaster Regiment (37th Division)

Ohio National Guard

HQ-Columbus, OH, 1936-41



Constituted in the Ohio National Guard in 1921 as the Quartermaster Section, 37th Division Headquarters. Organized and federally recognized 31 August 1923 at Columbus, OH. Consolidated with Headquarters, 37th Division Quartermaster Train and redesignated 15 May 1936 at Columbus as Headquarters, 112th Quartermaster Regiment. Remainder of the regiment was organized from the units of the 37th Division Quartermaster Train as follows:

Service Company from the *37th Service Company, Q.M.C.*

Headquarters, 1st Battalion constituted new and organized 15 May 1936 at Columbus, OH.

A Company from the 123rd Wagon Company, active at Lima, OH.

B Company from the 124th Wagon Company, active at Cincinnati, OH.

Headquarters, 2nd Battalion constituted new and organized 15 May 1936 at Fremont, OH.

C Company constituted new and organized 10 February 1937 at Kent, OH.

D Company from the 147th Motor Transport Company, active at Columbus, OH.

Headquarters, 3rd Battalion constituted new and organized 15 May 1936 at Columbus, OH.

E Company from the 123rd Motor Repair Section, active at Columbus, OH.

F Company from the 112th Motorcycle Company, active at St. Marys, OH.

The regiment, or elements thereof, called up to perform the following state duties: flood relief along the Ohio River, January-March 1937; riot control during a workers' strike at the Mahoning Valley steel plants 22 Jun 1-15 July 1937. Conducted annual summer training at Camp Perry, OH, 1936-39. Inducted into active federal service 15 October 1940 at Columbus. Transferred 20 December 1940 to Camp Shelby, MS. Location 7 December 1941—Camp Shelby, MS.

Events: 213, 220, 278, 302, 320, 328

Commanders, 112th Quartermaster Regiment

Lt. Col. John S. Shetler

15 May 36-31 Mar 37

Col. Edward P. Lawlor

1 Apr 37-1 Oct 40

Col. Stanley Wolfe

1 Oct 40-Feb 42

113th Quartermaster Regiment (38th Division)

Indiana and Kentucky National Guard

HQ-Indianapolis, IN, 1937-41



Constituted in the Indiana National Guard in 1921 as the Quartermaster Section, 38th Division Headquarters. Organized and federally recognized 23 March 1934 at Indianapolis, IN. Redesignated 7 July 1937 at Indianapolis as Headquarters, 113th Quartermaster Regiment. Remainder of the regiment was organized from the units of the 38th Division Quartermaster Train as follows:

Service Company from the *38th Service Company, Q.M.C.*.

Headquarters, 1st Battalion constituted new and organized 27 May 1937 at Indianapolis, IN.

A Company from the 149th Motor Transport Company, redesignated 5 May 1937 at Indianapolis, IN.

B Company constituted new and organized 27 May 1937 at Indianapolis, IN.

Headquarters, 2nd Battalion constituted new and organized 1 July 1937 at Frankfort, KY.

C Company from the 125th Wagon Company, redesignated 1 July 1937 at Hopkinsville, KY.

D Company from the 126th Wagon Company, redesignated 1 July 1937 at Pikeville, KY.

Headquarters, 3rd Battalion constituted new and organized 9 January 1939 at Hopkinsville, KY.

E Company from the 113th Motorcycle Company, redesignated 5 May 1937 at Indianapolis, IN.

F Company constituted new and organized 1 April 1938 at Campbellsville, KY.

Entire regiment called up to perform flood relief duties along both sides of the Ohio River Jan-February 1937. Conducted annual summer training at Fort Knox, KY, 1936-39. Inducted into active federal service 17 January 1941 at Indianapolis. Transferred 26 January 1941 to Camp Shelby, MS. Location 7 December 1941—Camp Shelby, MS.

Events: 213, 220, 302, 320, 328, 331

Commanders, 113th Quartermaster Regiment

Col. Forrest H. Spencer
Maj. Louis G. Bumen

7 Jul 37-15 Nov 40
15 Nov 40-26 Dec 40

Col. Kenneth P. Williams
Unknown

26 Dec 40-11 Nov 41
11 Nov 41-Feb 42

115th Quartermaster Regiment (40th Division)

California National Guard

HQ-Berkeley, CA, 1936-41



Constituted in the California National Guard in 1921 as the Quartermaster Section, 40th Division Headquarters. Organized and federally recognized 18 June 1926 at Berkeley, CA. Redesignated 1 April 1936 at Berkeley as Headquarters, 115th Quartermaster Regiment. Remainder of the regiment was organized as follows:

Service Company from the *40th Service Company, Q.M.C.*.

Headquarters, 1st Battalion constituted new and organized 6 April 1937 at Berkeley, CA.

A Company from D Company, 117th Engineers, reconstituted and redesignated 14 April 1937 at Berkeley, CA.

B Company constituted new and organized 6 April 1937 at Martinez, CA

Headquarters, 2nd Battalion constituted new and organized 2 April 1937 at Los Angeles, CA.

C Company from E Company, 117th Engineers, reconstituted and redesignated 1 April 1937 at Los Angeles, CA.

D Company constituted new and organized 1 April 1937 at Los Angeles, CA.

Headquarters, 3rd Battalion constituted new and organized 18 April 1939 at Sacramento, CA.

E Company constituted new and organized 18 June 1936 at Camp Grant, IL.

F Company constituted new and organized 18 April 1939 at Los Angeles, CA.

Conducted annual summer training at Camp San Luis Obispo, CA, 1936-39. Inducted into active federal service 3 March 1941 at Berkeley. Transferred 10 March 1941 to Camp San Luis Obispo. Location 7 December 1941—Camp San Luis Obispo, CA.

Events: 231, 304, 314, 318, 326

Commanders, 115th Quartermaster Regiment

Col. William F. Daugherty

1 Apr 36-ao Dec 40

Col. Floyd W. Stewart

ao Nov 41-Feb 42

116th Quartermaster Regiment (41st Division)

**Washington, Montana, and
Wyoming National Guard**

HQ-Seattle, WA, 1936-41



Constituted in the Washington National Guard in 1921 as the Quartermaster Section, 41st Division Headquarters. Organized and federally recognized 2 April 1927 at Seattle, WA. Redesignated 1 April 1936 at Seattle as Headquarters, 116th Quartermaster Regiment. Remainder of the regiment was organized as follows:

Service Company from the *41st Service Company, Q.M.C.*

Headquarters, 1st Battalion constituted new and organized 1 April 1937 at Walla Walla, WA.

A Company from the 161st Motor Transport Company, active at Seattle, WA.

B Company constituted new and organized 1 April 1937 at Walla Walla, WA.

Headquarters, 2nd Battalion constituted new and organized 21 August 1937 at Malta, MT.

C Company from Detachment, K Troop, 115th Cavalry, redesignated 1 April 1939 at Lusk, WY.

D Company constituted new and organized 17 April 1937 at Malta, MT.

Headquarters, 3rd Battalion constituted new and organized 5 April 1939 at Seattle, WA.

E Company constituted new and organized 5 April 1939 at Seattle, WA.

F Company constituted new and organized 5 April 1939 at Seattle, WA.

Conducted annual summer training at Camp Murray, WA, 1936-39. Inducted into active federal service 16 September 1940 at Seattle. Transferred 20 September 1940 to Camp Murray, WA. Transferred 20 March 1941 to Fort Lewis, WA. Location 7 December 1941—Fort Lewis, WA.

Events: 238, 304, 309, 314 326

Commanders, 116th Quartermaster Regiment

Lt. Col. Orlo W. Brown

1 Apr 36-12 Oct 40

Unknown

12 Oct 40-7 Dec 41

118th Quartermaster Regiment (43rd Division)

**Connecticut, Vermont, Maine, and
Rhode Island National Guard**

HQ-West Hartford, CT, 1936-41



Constituted in the Connecticut National Guard 1 April 1936. Organized and federally recognized 9 June 1937 at West Hartford, CT. Remainder of the regiment was organized as follows:

Service Company from the *43rd Service Company, Q.M.C.*.

Headquarters, 1st Battalion constituted new and organized 10 May 1937 at Montpelier, VT.

A Company constituted new and organized 14 May 1936 at St. Albans, VT.

B Company constituted new and organized 10 May 1937 at Waterbury, VT.

Headquarters, 2nd Battalion constituted new and organized 27 April 1937 at Portland, ME.

C Company constituted new and organized 1 April 1937 at Portland, ME.

D Company constituted new and organized 23 April 1937 at Providence, RI.

Headquarters, 3rd Battalion constituted new and organized 2 May 1939 at Groton, CT.

E Company constituted new and organized 11 May 1939 at Groton, CT.

F Company constituted new and organized 2 May 1939 at Groton, CT.

Conducted annual summer training at Niantic, CT, 1936-38. Inducted into active federal service 24 February 1941 at West Hartford. Transferred 13 March 1941 to Camp Blanding, FL. Location 7 December 1941—Camp Blanding, FL.

Events: 280, 301, 325, 328, 330

Commanders, 118th Quartermaster Regiment

Col. George E. Cole 9 Jun 37-9 Jan 42

119th Quartermaster Regiment (44th Division)

New Jersey National Guard

HQ-Trenton, NJ 1936-41



Constituted in the New Jersey National Guard in 1921 as the Quartermaster Section, 44th Division Headquarters. Organized and federally recognized 28 April 1924 at Trenton, NJ. Redesignated 1 January 1937 at Trenton as Headquarters, 119th Quartermaster Regiment. Remainder of the regiment was organized as follows:

Service Company from the *44th Service Company, Q.M.C.*.

Headquarters, 1st Battalion constituted new and organized 7 June 1937 at Orange, NJ.

A Company constituted new but remained inactive.

B Company constituted new and organized 11 May 1937 at Freehold, NJ.

Headquarters, 2nd Battalion constituted new and organized 10 June 1937 at Jersey City, NJ.

C Company constituted new and organized 7 June 1937 at Jersey City, NJ.

D Company constituted new and organized 1 June 1937 at Jersey City, NJ.

Headquarters, 3rd Battalion constituted new and organized 27 June 1938 at Sea Girt, NJ.

E Company constituted new and organized 27 June 1938 at Sea Girt, NJ.

F Company from the 119th Motorcycle Company, active at Flemington, NJ.

Conducted annual summer training at Sea Girt, NJ, 1936-38. Inducted into active federal service 16 September 1940 at Trenton. Transferred 23 September 1940 to Fort Dix, NJ. Location 7 December 1941—Fort Dix, NJ.

Events: 280, 301, 330

Commanders, 119th Quartermaster Regiment

Unknown 1 Jan 37-ao Feb 37 Col. David S. Hill ao Feb 39-1 Oct 41

120th Quartermaster Regiment (45th Division)

**Oklahoma, Colorado, and
Arizona National Guard**

HQ-Oklahoma City, OK, 1936-40; Fort Sill, OK, 1940-41; Camp Barkeley, TX, 1941



Constituted in the Oklahoma National Guard in 1921 as the Quartermaster Section, 45th Division Headquarters. Organized and federally recognized 15 December 1925 at Oklahoma City, OK. Consolidated with Headquarters, 45th Division Quartermaster Train and redesignated 22 June 1936 at Oklahoma City as Headquarters, 120th Quartermaster Regiment. Remainder of the regiment was organized from the units of the 45th Division Quartermaster Train as follows:

Service Company from the *45th Service Company, Q.M.C.*

Headquarters, 1st Battalion constituted new and organized 1 May 1937 at Oklahoma City, OK.

A Company from the 179th Motor Transport Company, active at Claremore, OK.

B Company from the 180th Motor Transport Company, active at Healdton, OK.

Headquarters, 2nd Battalion constituted new but remained inactive.

C Company constituted new and organized 1 April 1937 at Camp George West, CO.

D Company constituted new and organized 1 April 1937 at Phoenix, AZ.

Headquarters, 3rd Battalion constituted new and organized 1 May 1937 at Ponca City, OK.

E Company from the 139th Motor Repair Section, active at Oklahoma City, OK.

F Company constituted new and organized 1 May 1937 at Anadarko, OK.

Colorado elements called up to perform duties in connection with grasshopper infestations in eastern Colorado 28 Jun-26 August 1937 and for the Green Mountain mine strike near Kremmling, CO, 3-31 August 1939. Conducted annual summer training at Fort Sill, OK, 1936-39. Inducted into active federal service 16 September 1940 at Oklahoma City. Transferred 23 September 1940 to Fort Sill. Transferred 23 February 1941 to Camp Barkeley, TX. Location 7 December 1941—Camp Barkeley, TX.

Events: 258, 261, 300, 317, 328

Commanders, 120th Quartermaster Regiment

Col. Roger G. Maus (OK)

1 May 37-7 Aug 41

Lt. Col. Hugh Askew (OK)

7 Aug 41-11 Feb 42

121st Quartermaster Squadron (21st Cavalry Division)

Massachusetts National Guard

HQ-Not organized 1936-41

Constituted in the National Guard in 1921 as the Quartermaster Section, 21st Cavalry Division Headquarters. Consolidated with Headquarters, 21st Cavalry Division Quartermaster Train and redesignated 1 April 1936 as Headquarters, 121st Quartermaster Squadron. Remainder of squadron constituted from the authorized units of the 21st Cavalry Division Quartermaster Train. Allotted 1 January 1939 to the Massachusetts National Guard. Troops A and C organized 1 April 1939 at Boston, MA, from elements of the 101st Ammunition Train. Active elements were inactivated 1 October 1940 and the squadron was disbanded.

122nd Quartermaster Squadron (22nd Cavalry Division)

**Pennsylvania and Kentucky
National Guard**

HQ-Not organized 1936-40; Harrisburg, PA, 1940

Constituted in the National Guard in 1921 as the Quartermaster Section, 22nd Cavalry Division Headquarters. Consolidated with Headquarters, 22nd Cavalry Division Quartermaster Train and redesignated 1 April 1936 as Headquarters, 122nd Quartermaster Squadron. Remainder of regiment constituted from the authorized units of the 22nd Cavalry Division Quartermaster Train. Squadron, less Troop A, allotted 1 April 1939 to the Pennsylvania National Guard. Troop A allotted to Kentucky and organized 1 October 1939 at Carlisle, KY, from Howitzer Company, 149th Infantry. Squadron headquarters and headquarters detachment organized and federally recognized 7 March 1940 at Harrisburg, PA. Squadron, less Troop A, consolidated 23 September 1940 with Headquarters Troop, 22nd Cavalry Division and 122nd Medical Squadron, and consolidated unit reorganized and redesignated the 105th Anti-Tank Battalion. Troop A concurrently reorganized and redesignated as Headquarters Battery, 103rd Separate Coast Artillery Battalion.

Events:

Commanders, 122nd Quartermaster Squadron

Maj. Clarence E. Whipple 7 Mar 40-23 Sep 40

123rd Quartermaster Squadron (23rd Cavalry Division)

Illinois National Guard

HQ-Not organized 1936-41

Constituted in the National Guard in 1921 as the Quartermaster Section, 23rd Cavalry Division Headquarters. Consolidated with Headquarters, 23rd Cavalry Division Quartermaster Train and redesignated 1 April 1936 as Headquarters, 123rd Quartermaster Squadron. Remainder of regiment constituted from the authorized units of the 23rd Cavalry Division Quartermaster Train. Allotted to the Illinois National Guard 1 April 1939. The squadron was disbanded 6 October 1940.

124th Quartermaster Squadron (24th Cavalry Division)

Iowa National Guard

HQ-Not organized 1936-41

Constituted in the National Guard in 1921 as the Quartermaster Section, 24th Cavalry Division Headquarters. Consolidated with Headquarters, 24th Cavalry Division Quartermaster Train and redesignated 1 April 1936 as Headquarters, 124th Quartermaster Squadron. Remainder of squadron constituted from the authorized units of the 24th Cavalry Division Quartermaster Train. Allotted to the Iowa National Guard 1 April 1939. The squadron was disbanded 1 October 1940.

301st Motor Transport Regiment (GHQR)

Organized Reserve New York

HQ-Not initiated 1933-36

Constituted in the Organized Reserve 1 October 1933, assigned to the General Headquarters Reserve, and allotted to the Second Corps Area. Demobilized 1 May 1936.

301st Motor Repair Regiment (GHQR)

Organized Reserve New York

HQ-Not initiated 1933-36

Constituted in the Organized Reserve 1 October 1933, assigned to the General Headquarters Reserve, and allotted to the Second Corps Area. Demobilized 1 May 1936.

301st Quartermaster Service Regiment

Organized Reserve Tennessee

HQ-Not initiated 1933-36

Constituted in the Organized Reserve 1 October 1933, assigned to the General Headquarters Reserve, and allotted to the Fourth Corps Area. Knoxville, TN, designated as headquarters upon organization, but the unit was never organized at that location. Demobilized 1 May 1936.

301st Quartermaster Battalion (Graves Registration)

Organized Reserve New York

HQ-Not initiated 1936-41

Constituted in the Organized Reserve 1 July 1936, assigned to the General Headquarters Reserve, and allotted to the Second Corps Area. Location 7 December 1941—*Not organized*.

302nd Quartermaster Service Regiment (First Army)

Organized Reserve

HQ-Not initiated 1933-36

Constituted in the Organized Reserve 1 October 1933 and assigned to the General Headquarters Reserve. Demobilized 1 May 1936.

303rd Motor Transport Regiment (GHQR)

Organized Reserve Illinois

HQ-Not initiated 1933-36

Constituted in the Organized Reserve 1 October 1933, assigned to the General Headquarters Reserve, and allotted to the Sixth Corps Area. Chicago, IL, designated as headquarters upon organization, but the unit was never organized at that location. Redesignated 1 July 1936 as the 513th Quartermaster Regiment (Truck-Army).

303rd Motor Repair Regiment (GHQR)

Organized Reserve Ohio

HQ-Not initiated 1933-36

Constituted in the Organized Reserve 1 October 1933, assigned to the General Headquarters Reserve, and allotted to the Fifth Corps Area. Akron, OH, designated as headquarters upon organization, but the unit was never organized at that location. Demobilized 1 May 1936.

303rd Quartermaster Regiment (Remount) (GHQR)

Organized Reserve Kentucky

HQ-Not initiated 1933-36

Constituted in the Organized Reserve 1 October 1933, assigned to the General Headquarters Reserve, and allotted to the Fifth Corps Area. Danville, KY, designated as headquarters upon organization, but the unit was never organized at that location. Demobilized 1 May 1936.

304th Motor Repair Regiment (GHQR)**Organized Reserve Michigan****HQ-Not initiated** 1933-36

Constituted in the Organized Reserve 1 October 1933, assigned to the General Headquarters Reserve, and allotted to the Sixth Corps Area. Flint, MI, designated as headquarters upon organization, but the unit was never organized at that location. Redesignated 1 July 1936 as the 524th Quartermaster Regiment (Heavy Maintenance).

304th Quartermaster Regiment (Remount)**Organized Reserve Mississippi****HQ-Not initiated** 1933-36

Constituted in the Organized Reserve 1 October 1933, assigned to the General Headquarters Reserve, and allotted to the Fourth Corps Area. Greenville, MS, designated as headquarters upon organization, but the unit was never organized at that location. Demobilized 1 May 1936.

305th Motor Repair Regiment (GHQR)**Organized Reserve Wisconsin****HQ-Not initiated** 1933-36

Constituted in the Organized Reserve 1 October 1933, assigned to the General Headquarters Reserve, and allotted to the Sixth Corps Area. Milwaukee, WI, designated as headquarters upon organization, but the unit was never organized at that location. Redesignated 1 July 1936 as the 525th Quartermaster Regiment (Heavy Maintenance).

305th Quartermaster Service Regiment (Second Army)**Organized Reserve West Virginia****HQ-Not initiated** 1933-36

Constituted in the Organized Reserve 1 October 1933, assigned to the General Headquarters Reserve, and allotted to the Fifth Corps Area. Parkersburg, WV, designated as headquarters upon organization, but the unit was never organized at that location. Demobilized 1 May 1936.

306th Quartermaster Service Regiment (Second Army)**Organized Reserve Illinois****HQ-Not initiated** 1933-36

Constituted in the Organized Reserve 1 October 1933, assigned to the General Headquarters Reserve, and allotted to the Sixth Corps Area. Chicago, IL, designated as headquarters upon organization, but the unit was never organized at that location. Redesignated 1 July 1936 as the 546th Quartermaster Regiment (Service).

311th Quartermaster Battalion (Sales Commissary) (GHQR)**Organized Reserve New York****HQ-Not initiated** 1936-38; New York City, NY, 1938-41

Constituted in the Organized Reserve 1 July 1936, assigned to the General Headquarters Reserve, and allotted to the Second Corps Area. Initiated 17 March 1938 with headquarters at New York City. Location 7 December 1941—New York City, NY.

312th Quartermaster Service Regiment (GHQR)**Organized Reserve Illinois****HQ**-*Not initiated* 1933-36

Constituted in the Organized Reserve 1 October 1933, assigned to the General Headquarters Reserve, and allotted to the Sixth Corps Area. Chicago, IL, designated as headquarters upon organization, but the unit was never organized at that location. Redesignated 1 July 1936 as the 552nd Quartermaster Regiment (Service).

350th Quartermaster Regiment (Service) (Colored) (Fourth Army)**Regular Army Inactive****HQ**-Knoxville, TN, 1938-41

Constituted in the Organized Reserve 15 October 1921 as the 357th Service Battalion, assigned to the Fourth Army, and allotted to the Fourth Corps Area. Organized by November 1922 with headquarters at Tampa, FL. Reorganized and redesignated 541st Quartermaster Regiment (Service) at Knoxville, TN. Redesignated 1 January 1938 as the 350th Quartermaster Regiment (Service) (C). Concurrently withdrawn from the Organized Reserve and allotted to the Regular Army as an RAI unit. Location 7 December 1941—Knoxville, TN.

Status: Disbanded 18 October 1943.**351st Quartermaster Regiment (Service) (Colored) (XI Corps)****Regular Army Inactive****HQ**-*Not organized* 1936-41

Constituted in the Organized Reserve 1 July 1936 and allotted to the Third Corps Area. Withdrawn from the Organized Reserve and allotted to the Regular Army as an RAI unit. Designated mobilization training station was Camp Lee, VA. Location 7 December 1941—*Not organized*.

Status: Disbanded 18 October 1943**351st Motor Transport Service Regiment (XI Corps)****Organized Reserve Connecticut****HQ**-*Not initiated* 1933-36

Constituted in the Organized Reserve 1 October 1933, assigned to the XI Corps, and allotted to the First Corps Area. Demobilized 1 May 1936.

352nd Quartermaster Regiment (Service) (Colored) (Fourth Army)**Regular Army Inactive****HQ**-New Orleans, LA, 1938-41

Constituted in the Organized Reserve 15 October 1921 as the 378th Service Battalion, assigned to the First Army, and allotted to the Fourth Corps Area. Organized by March 1922 with headquarters at Charlotte, NC. Relocated by 1936 to New Orleans. Reorganized and redesignated 1 July 1936 as the 544th Quartermaster Regiment (Service), less 1st, 2nd, 3rd, and 4th Battalions. Concurrently, the 1st, 2nd, 3rd, and 4th Battalions organized from existing units as follows: 379th Service Battalion as the 1st Battalion, 380th Service Battalion as the 2nd Battalion, 381st Service Battalion as the 3rd Battalion, and 382nd Service Battalion as the 4th Battalion. Redesignated 1 January 1938 as the 352nd Quartermaster Regiment (Service) (Colored). Concurrently withdrawn from the Organized Reserve and allotted to the Regular Army as an RAI unit. Location 7 December 1941—New Orleans, LA.

352nd Motor Transport Service Regiment (XII Corps)

Organized Reserve

HQ-Not initiated 1933-36

Constituted in the Organized Reserve 1 October 1933, assigned to the General Headquarters Reserve, and allotted to the Second Corps Area. Demobilized 1 May 1936.

353rd Quartermaster Regiment (Service) (Colored)

Regular Army Inactive

HQ-Not initiated 1936-37; Colorado Springs, CO, 1937-38

Constituted in the Organized Reserve 1 July 1936 as the 548th Quartermaster Regiment (Service) (Colored) and allotted to the Eighth Corps Area. Initiated by June 1937 with headquarters at Colorado Springs, CO. Redesignated 1 January 1938 as the 353rd Quartermaster Regiment (Service) (Colored). Concurrently withdrawn from the Organized Reserve and allotted to the Regular Army as an RAI unit. Designated mobilization training station was Camp Lee, VA. Location 7 December 1941—Colorado Springs, CO.

Status: Disbanded 18 October 1943.

354th Quartermaster Regiment (XIV Corps)

Organized Reserve Louisiana

HQ-Not initiated 1933-41

Constituted in the Organized Reserve 1 October 1933, assigned to the XIV Corps, and allotted to the Sixth Corps Area. New Orleans, LA, designated as headquarters upon organization, but the unit was never organized at that location. Location 7 December 1941— *Not organized*.

Status: Disbanded 18 October 1943.

355th Quartermaster Regiment (XV Corps)

Organized Reserve Indiana

HQ-Not initiated 1933-41

Constituted in the Organized Reserve 1 October 1933, assigned to the XV Corps, and allotted to the Sixth Corps Area. South Bend, IN, designated as headquarters upon organization, but the unit was never organized at that location. Location 7 December 1941— *Not organized*.

Status: Disbanded 18 October 1943.

355th Motor Transport Service Regiment (XV Corps)

Organized Reserve Ohio

HQ-Not initiated 1933-36

Constituted in the Organized Reserve 1 October 1933, assigned to the XV Corps, and allotted to the Fifth Corps Area. Cincinnati, OH, designated as headquarters upon organization, but the unit was never organized at that location. Demobilized 1 May 1936.

356th Quartermaster Regiment (XVI Corps)

Organized Reserve Wisconsin

HQ-Not initiated 1933-36

Constituted in the Organized Reserve 1 October 1933, assigned to the XVI Corps, and allotted to the Sixth Corps Area. Milwaukee, WI, designated as headquarters upon organization, but the unit was never organized at that location. Demobilized 1 May 1936.

356th Motor Transport Service Regiment (XVI Corps)

Organized Reserve Wisconsin

HQ-Not initiated 1933-36

Constituted in the Organized Reserve 1 October 1933, assigned to the XVI Corps, and allotted to the Sixth Corps Area. Milwaukee, WI, designated as headquarters upon organization, but the unit was never organized at that location. Demobilized 1 May 1936.

357th Motor Transport Service Regiment (XVII Corps)

Organized Reserve

HQ-Not initiated 1933-36

Constituted in the Organized Reserve 1 October 1933, assigned to the XVII Corps, and allotted to the Seventh Corps Area. Demobilized 1 May 1936.

358th Motor Transport Service Regiment (XVIII Corps)

Organized Reserve

HQ-Not initiated 1933-36

Constituted in the Organized Reserve 1 October 1933, assigned to the XVIII Corps, and allotted to the Eighth Corps Area. Demobilized 1 May 1936.

359th Motor Transport Service Regiment (XIX Corps)

Organized Reserve California

HQ-Not organized 1933-36

Constituted in the Organized Reserve 1 October 1933, assigned to the XIX Corps, and allotted to the Ninth Corps Area. Sacramento, CA, designated as headquarters upon organization, but the unit was never organized at that location. Demobilized 1 May 1936.

401st Quartermaster Regiment (76th Division)

Organized Reserve Connecticut

HQ-Hartford, CT, 1936-41



Constituted in the Organized Reserve 29 July 1921 as the Quartermaster Section, 76th Division Headquarters. Organized in November 1921 at Hartford, CT. Consolidated with Headquarters, 76th Division Quartermaster Train and redesignated 1 July 1936 at Hartford, CT, as Headquarters and Headquarters Company, 401st Quartermaster Regiment. The remainder of the regiment organized from units of the 76th Division Quartermaster Train as follows:

- Service Company from the 76th Service Company, Q.M.C. at Bridgeport, CT.
- Headquarters, 1st Battalion from the 301st Motor Repair Section at New London, CT.
 - A Company from the 301st Motor Transport Company at New Haven, CT.
 - B Company from the 302nd Motor Transport Company at Norwalk, CT.
- Headquarters, 2nd Battalion from the 301st Wagon Company at Hartford, CT.
 - C Company from the 303rd Motor Transport Company at New London, CT.
 - D Company from the 304th Motor Transport Company at Waterburg, CT.

Headquarters, 3rd Battalion from the 302nd Wagon Company at Wallingford, CT.

E Company from the 302nd Motor Repair Section at Stamford, CT.

F Company from the 301st Motorcycle Company at Hartford, CT.

Conducted summer training most years at Fort Devens, MA, and some years at Camp Dix, NJ. Location 7 December 1941—Hartford, CT.

Status: Inactive in the Army Reserve as Headquarters, 4th Brigade, 76th Division (Training).

Commanders, 401st Quartermaster Regiment

Col. Bennet Bronson

1 Jun 36-ao Jul 40

Unknown

ao Jul 40-7 Dec 41

402nd Quartermaster Regiment (77th Division)

Organized Reserve New York

HQ-Manhattan, NY, 1936-41

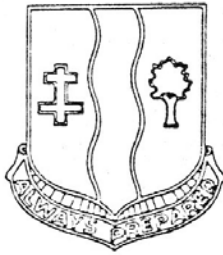

Constituted in the Organized Reserve 24 June 1921 as the Quartermaster Section, 77th Division Headquarters. Organized in November 1921 at Manhattan, NY. Consolidated with Headquarters, 77th Division Quartermaster Train and redesignated 1 July 1936 at Manhattan, NY, as Headquarters and Headquarters Company, 402nd Quartermaster Regiment. The remainder of the regiment organized from units of the 77th Division Quartermaster Train as follows:

Service Company from the 77th Service Company, Q.M.C. at Manhattan, NY.

Headquarters, 1st Battalion from the 303rd Motor Repair Section at Bronx, NY.

A Company from the 305th Motor Transport Company at Brooklyn, NY.

B Company from the 306th Motor Transport Company at Manhattan, NY.

Headquarters, 2nd Battalion from the 303rd Wagon Company at Port Jefferson, LI, NY.

C Company from the 307th Motor Transport Company at Manhattan, NY.

D Company from the 308th Motor Transport Company at Bronx, NY.

Headquarters, 3rd Battalion from the 304th Wagon Company at Tarrytown, NY.

E Company from the 304th Motor Repair Section at Brooklyn, NY.

F Company from the 302nd Motorcycle Company at Manhattan, NY.

Conducted summer training most years at Camp Dix, NJ, and at Fort George G. Meade, MD, in 1940. Location 7 December 1941—Manhattan, NY.

Status: Inactive in the Army Reserve as the 77th Supply & Transport Battalion, an element of the 77th Infantry Division.

Commanders, 402nd Quartermaster Regiment

Col. Julian I. Marks

7 Jul 36-4 Jun 41

403rd Quartermaster Regiment (78th Division)

Organized Reserve New Jersey

HQ-Newark, NJ 1936-41



Constituted in the Organized Reserve 24 June 1921 as the Quartermaster Section, 78th Division Headquarters. Organized in November 1921 at Newark, NJ. Consolidated with Headquarters, 78th Division Quartermaster Train and redesignated 1 July 1936 at Jersey City as Headquarters and Headquarters Company, 403rd Quartermaster Regiment. The remainder of the regiment organized from units of the 78th Division Quartermaster Train as follows:

Service Company from the 78th Service Company, Q.M.C. at Newark, NJ.

Headquarters, 1st Battalion from the 305th Motor Repair Section at Newark, NJ.

A Company from the 309th Motor Transport Company at Newark, NJ.

B Company from the 310th Motor Transport Company at Jersey City, NJ.

Headquarters, 2nd Battalion from the 305th Wagon Company at Hoboken, NJ.

C Company from the 311th Motor Transport Company at Camden, NJ.

D Company from the 312th Motor Transport Company at Elizabeth, NJ.

Headquarters, 3rd Battalion from the 306th Wagon Company at Hoboken, NJ.

E Company from the 306th Motor Repair Section at Newark, NJ.

F Company from the 303rd Motorcycle Company at Newark, NJ.

Typically conducted Inactive Training Period meetings at the armory of the 119th Quartermaster Regiment in Trenton. Conducted summer training most years at Camp Dix, NJ, and at Holabird Quartermaster Depot, MD, in 1940. Location 7 December 1941—Newark, NJ.

Status: Active in the Regular Army at Fort Bragg, NC, as Headquarters, 4th Brigade, 78th Division (Training Support).

Commanders, 403rd Quartermaster Regiment

Col. Warren S. Hood

7 Jul 36-28 Sep 39

Lt. Col. John E. Kennedy

Lt. Col. Karl C. Sackman

29 Feb 40-10 Sep 41

30 Sep 39-29 Feb 40

404th Quartermaster Regiment (79th Division)

Organized Reserve Pennsylvania

HQ-Philadelphia, PA, 1922-41



Constituted in the Organized Reserve 24 June 1921 as the Quartermaster Section, 79th Division Headquarters. Organized in 1922 at Philadelphia, PA. Consolidated with Headquarters, 79th Division Quartermaster Train and redesignated 1 July 1936 at Philadelphia as Headquarters and Headquarters Company, 404th Quartermaster Regiment. The remainder of the regiment organized from units of the 79th Division Quartermaster Train as follows:

Service Company from the 79th Service Company, Q.M.C. at West Chester, PA.

Headquarters, 1st Battalion from the 305th Motor Repair Section at Philadelphia, PA.

A Company from the 309th Motor Transport Company at Philadelphia, PA.

B Company from the 310th Motor Transport Company at Philadelphia, PA.

Headquarters, 2nd Battalion from the 305th Wagon Company at Philadelphia, PA.

C Company from the 311th Motor Transport Company at Philadelphia, PA.

D Company from the 312th Motor Transport Company at Philadelphia, PA.

Headquarters, 3rd Battalion from the 306th Wagon Company at Philadelphia, PA.

E Company from the 306th Motor Repair Section at Philadelphia, PA.

F Company from the 303rd Motorcycle Company at Philadelphia, PA.

Conducted summer training at Fort George G. Meade, MD. Location 7 December 1941—Philadelphia, PA.

Status: Inactive in the Army Reserve as the 79th Quartermaster Company, an element of the 79th Infantry Division.

Commanders, 404th Quartermaster Regiment

Lt. Col. John Truitt

10 Nov 36-ao Dec 38

Unknown

ao Dec 38-10 Jan 40

Lt. Col. Arthur R. Bell

10 Jan 40-7 Aug 41

405th Quartermaster Regiment (80th Division)

Organized Reserve Virginia

HQ-Richmond, VA, 1936-41

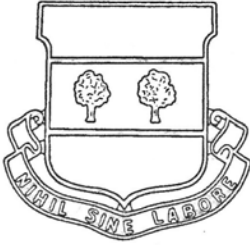

Constituted in the Organized Reserve 24 June 1921 as the Quartermaster Section, 80th Division Headquarters. Organized in December 1921 at Richmond, VA. Consolidated with Headquarters, 80th Division Quartermaster Train and redesignated 1 July 1936 at Richmond as Headquarters and Headquarters Company, 405th Quartermaster Regiment. The remainder of the regiment organized from units of the 80th Division Quartermaster Train as follows:

Service Company from the 80th Service Company, Q.M.C. at Norfolk, VA.

Headquarters, 1st Battalion from the 309th Motor Repair Section at Fredericksburg, VA.

A Company from the 317th Motor Transport Company at Norfolk, VA.

B Company from the 318th Motor Transport Company at Newport, News, VA.

Headquarters, 2nd Battalion from the 309th Wagon Company at Newport, News, VA.

C Company from the 319th Motor Transport Company at Petersburg, VA.

D Company from the 320th Motor Transport Company at Danville, VA.

Headquarters, 3rd Battalion from the 310th Wagon Company at Buchanan, VA.

E Company from the 310th Motor Repair Section at Alexandria, VA.

F Company from the 305th Motorcycle Company at Richmond, VA.

Typically conducted Inactive Training Period meetings at the Post Office Building in Baltimore. Conducted summer training at Fort George G. Meade, MD. Location 7 December 1941—Richmond, VA.

Status: Active in the Army Reserve at Charleston, WV, as Headquarters, 4th Brigade, 80th Division (Institutional Training).

Commanders, 405th Quartermaster Regiment

Col. Stuart C. Hopper

1 Jul 36-ao Aug 41

406th Quartermaster Regiment (81st Division)

Organized Reserve Tennessee

HQ-Memphis, TN, 1936-41

Constituted in the Organized Reserve 24 June 1921 as the Quartermaster Section, 81st Division Headquarters. Organized in December 1921 at Knoxville, TN. Consolidated with Headquarters, 81st Division Quartermaster Train and redesignated 1 July 1936 at Memphis, TN, as Headquarters and Headquarters Company, 406th Quartermaster Regiment. The remainder of the regiment organized from units of the 81st Division Quartermaster Train as follows:

Service Company from the 81st Service Company, Q.M.C. at Memphis, TN.
 Headquarters, 1st Battalion from the 311th Motor Repair Section at Dyersburg, TN.
 A Company from the 321st Motor Transport Company at Memphis, TN.
 B Company from the 322nd Motor Transport Company at Memphis, TN.
 Headquarters, 2nd Battalion from the 311th Wagon Company at Bells, TN.
 C Company from the 323rd Motor Transport Company at Covington, TN.
 D Company from the 324th Motor Transport Company at Bolivar, TN.
 Headquarters, 3rd Battalion from the 312th Wagon Company at Paris, TN.
 E Company from the 312th Motor Repair Section at Dyersburg, TN.
 F Company from the 306th Motorcycle Company at Brownsville, TN.

Entire regiment relocated 15 July 1936 to Memphis. Conducted summer training at Fort McClellan, AL, or Fort McPherson, GA. Location 7 December 1941—Memphis, TN.

Status: Inactive in the Army Reserve as the 81st Supply & Transport Battalion, an element of the 81st Infantry Division.

Commanders, 406th Quartermaster Regiment

Lt. Col. Fred M. Lewis	1 Jul 36-ao Feb 39	Unknown	ao Feb 39-7 Dec 41
------------------------	--------------------	---------	--------------------

407th Quartermaster Regiment (82nd Division) Organized Reserve Georgia and South Carolina
HQ-Augusta, GA, 1936-41

Constituted in the Organized Reserve 24 June 1921 as the Quartermaster Section, 82nd Division Headquarters. Organized 23 September 1921 at Columbia, SC. Consolidated with Headquarters, 82nd Division Quartermaster Train and redesignated 1 July 1936 at Augusta, GA, as Headquarters and Headquarters Company, 407th Quartermaster Regiment. The remainder of the regiment organized from units of the 82nd Division Quartermaster Train as follows:

Service Company from the 82nd Service Company, Q.M.C. at Columbia, SC.
 Headquarters, 1st Battalion from the 313th Motor Repair Section at Rome, GA.
 A Company from the 325th Motor Transport Company at Newnan, GA.
 B Company from the 326th Motor Transport Company at Cedartown, GA.
 Headquarters, 2nd Battalion from the 313th Wagon Company at Dalton, GA.
 C Company from the 327th Motor Transport Company at Griffin, GA.
 D Company from the 328th Motor Transport Company at Decatur, GA.
 Headquarters, 3rd Battalion from the 314th Wagon Company at Elberton, GA.
 E Company from the 314th Motor Repair Section at Rome, GA.
 F Company from the 307th Motorcycle Company at Lawrenceville, GA.

Entire regiment relocated 9 October 1936 to Augusta. Conducted summer training at Fort McPherson, GA, or Fort Benning, GA. Location 7 December 1941—Augusta, GA.

Status: Active at Fort Bragg, NC, as the 407th Forward Support Battalion, an element of the 82nd Airborne Division.

Commanders, 407th Quartermaster Regiment

Lt. Col. Arthur V. Clifton	1 Jul 36-30 Jan 37	Col. Ellis F. Altman	31 Jan 37-4 Oct 40
	Lt. Col. Harry C. Murphy	4 Oct 40-ao Jan 41	

408th Quartermaster Regiment (83rd Division)

Organized Reserve Ohio

HQ-Cleveland, OH, 1936-41

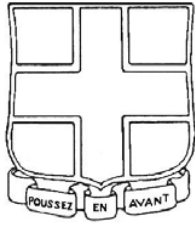

Constituted in the Organized Reserve 24 June 1921 as the Quartermaster Section, 83rd Division Headquarters. Organized 27 September 1921 at Columbus, OH. Consolidated with Headquarters, 83rd Division Quartermaster Train and redesignated 1 July 1936 at Cleveland, OH, as Headquarters and Headquarters Company, 408th Quartermaster Regiment. The remainder of the regiment organized from units of the 83rd Division Quartermaster Train as follows:

- Service Company from the 83rd Service Company, Q.M.C. at Columbus, OH.
- Headquarters, 1st Battalion from the 315th Motor Repair Section at Cleveland, OH.
 - A Company from the 329th Motor Transport Company at Cleveland, OH.
 - B Company from the 330th Motor Transport Company at Cleveland, OH.
- Headquarters, 2nd Battalion from the 315th Wagon Company at Cleveland, OH.
 - C Company from the 331st Motor Transport Company at Cleveland, OH.
 - D Company from the 332nd Motor Transport Company at Cleveland, OH.
- Headquarters, 3rd Battalion from the 316th Wagon Company at Cleveland, OH.
 - E Company from the 316th Motor Repair Section at Cleveland, OH.
 - F Company from the 308th Motorcycle Company at Cleveland, OH.

Conducted summer training at Fort Knox, KY. Location 7 December 1941—Cleveland, OH.

Status: Inactive in the Army Reserve as the 83rd Supply & Transport Battalion, an element of the 83rd Infantry Division.

Commanders, 408th Quartermaster Regiment

Lt. Col. K.C. Schaible	1 Jul 36-Jul 37 Unknown	Lt. Col. Harold E. Schlesinger ao Sep 38-7 Dec 41	Jul 37-ao Sep 38
------------------------	----------------------------	--	------------------

409th Quartermaster Regiment (84th Division)

Organized Reserve Indiana

HQ-Indianapolis, IN, 1936-41

Constituted in the Organized Reserve 24 June 1921 as the Quartermaster Section, 84th Division Headquarters. Organized 27 September 1921 at Indianapolis, IN. Consolidated with Headquarters, 84th Division Quartermaster Train and redesignated 1 July 1936 at Indianapolis as Headquarters and Headquarters Company, 409th Quartermaster Regiment. The remainder of the regiment organized from units of the 84th Division Quartermaster Train as follows:

- Service Company from the 84th Service Company, Q.M.C. at Marion, IN.
- Headquarters, 1st Battalion from the 317th Motor Repair Section at Indianapolis, IN.
 - A Company from the 333rd Motor Transport Company at Indianapolis, IN.
 - B Company from the 334th Motor Transport Company at Indianapolis, IN.
- Headquarters, 2nd Battalion from the 317th Wagon Company at Indianapolis, IN.
 - C Company from the 335th Motor Transport Company at Indianapolis, IN.
 - D Company from the 336th Motor Transport Company at Indianapolis, IN.
- Headquarters, 3rd Battalion from the 318th Wagon Company at Indianapolis, IN.
 - E Company from the 318th Motor Repair Section at Indianapolis, IN.
 - F Company from the 309th Motorcycle Company at Indianapolis, IN.

Conducted summer training at Fort Knox, KY. Location 7 December 1941—Indianapolis, IN.

Status: Active in the Army Reserve at Indianapolis, IN, as Headquarters, 4th Brigade, 84th Division (Institutional Training).

Commanders, 409th Quartermaster Regiment

Unknown

1 Jul 36-ao Feb 38
Unknown

Lt. Col. Howard Long
ao Sep 38-7 Dec 41

ao Feb 38-ao Sep 38

410th Quartermaster Regiment (85th Division)

Organized Reserve Michigan

HQ-Detroit, MI, 1936-41



Constituted in the Organized Reserve 24 June 1921 as the Quartermaster Section, 85th Division Headquarters. Organized 10 September 1921 at Detroit, MI. Consolidated with Headquarters, 85th Division Quartermaster Train and redesignated 1 July 1936 at Detroit as Headquarters and Headquarters Company, 410th Quartermaster Regiment. The remainder of the regiment organized from units of the 85th Division Quartermaster Train as follows:

Service Company from the 85th Service Company, Q.M.C. at Grand Rapids, MI.

Headquarters, 1st Battalion from the 319th Motor Repair Section at Durand, MI.

A Company from the 337th Motor Transport Company at Port Huron, MI.

B Company from the 338th Motor Transport Company at Flint, MI.

Headquarters, 2nd Battalion from the 319th Wagon Company at Tawas City, MI.

C Company from the 339th Motor Transport Company at Rochester, MI.

D Company from the 340th Motor Transport Company at Bay City, MI.

Headquarters, 3rd Battalion from the 320th Wagon Company at Alpena, MI.

E Company from the 320th Motor Repair Section at Pontiac, MI.

F Company from the 310th Motorcycle Company at Mount Pleasant, MI.

Entire regiment relocated 28 July 1937 to Detroit. Conducted summer training at Camp Custer, MI. Location 7 December 1941—Detroit, MI.

Status: Active in the Regular Army at Fort Knox, KY, as the 4th Brigade, 85th Division (Training Support).

Commanders, 410th Quartermaster Regiment

Lt. Col. Harold E. Schlessinger

1 Jul 36-Jul 37
Unknown

Lt. Col. William F. Bowles
ao Jun 39-7 Dec 41

Jul 37-ao Jun 39

411th Quartermaster Regiment (86th Division)

Organized Reserve Illinois

HQ-Chicago, IL, 1936-41



Constituted in the Organized Reserve 24 June 1921 as the Quartermaster Section, 86th Division Headquarters. Organized 10 September 1921 at Chicago, IL. Consolidated with Headquarters, 86th Division Quartermaster Train and redesignated 1 July 1936 at Chicago as Headquarters and Headquarters Company, 411th Quartermaster Regiment. The remainder of the regiment organized from units of the 86th Division Quartermaster Train as follows:

Service Company from the 86th Service Company, Q.M.C. at Chicago, IL.
 Headquarters, 1st Battalion from the 321st Motor Repair Section at Chicago, IL.
 A Company from the 341st Motor Transport Company at Chicago, IL.
 B Company from the 342nd Motor Transport Company at Chicago, IL.
 Headquarters, 2nd Battalion from the 321st Wagon Company at Chicago, IL.
 C Company from the 343rd Motor Transport Company at Chicago, IL.
 D Company from the 344th Motor Transport Company at Chicago, IL.
 Headquarters, 3rd Battalion from the 322nd Wagon Company at Chicago, IL.
 E Company from the 322nd Motor Repair Section at Chicago, IL.
 F Company from the 311th Motorcycle Company at Chicago, IL.

Conducted summer training at Camp Custer, MI. Location 7 December 1941—Chicago, IL.

Status: Inactive in the Army Reserve as the 86th Quartermaster Company, an element of the 86th Infantry Division.

Commanders, 411th Quartermaster Regiment

Col. Edward W. Chatterton	1 Jul 36-26 Apr 37	Maj. Albert W. Weeks	6 Sep 38-16 Oct 38
Lt. Col. Neal R. Markle	26 Apr 37-2 Jun 38	Lt. Col. Phillip G. Murphy	16 Oct 38-ao Sep 39
Lt. Col. Phillip G. Murphy	2 Jun 38-6 Sep 38	Unknown	ao Sep 39-7 Dec 41

412th Quartermaster Regiment (87th Division)

Organized Reserve Louisiana and Mississippi

HQ-New Orleans, LA, 1936-41

Constituted in the Organized Reserve 24 June 1921 as the Quartermaster Section, 87th Division Headquarters. Organized 23 September 1921 at New Orleans, LA. Consolidated with Headquarters, 87th Division Quartermaster Train and redesignated 1 July 1936 at New Orleans as Headquarters and Headquarters Company, 412th Quartermaster Regiment. The remainder of the regiment organized from units of the 87th Division Quartermaster Train as follows:

Service Company from the 87th Service Company, Q.M.C. at Lumberton, MS.
 Headquarters, 1st Battalion from the 323rd Motor Repair Section at Oakdale, LA.
 A Company from the 345th Motor Transport Company at Bunkie, LA.
 B Company from the 346th Motor Transport Company at Nachitoches, LA.
 Headquarters, 2nd Battalion from the 323rd Wagon Company at Rushton, LA.
 C Company from the 347th Motor Transport Company at Shreveport, LA.
 D Company from the 348th Motor Transport Company at Winnfield, LA.
 Headquarters, 3rd Battalion from the 324th Wagon Company at Bastrop, LA.
 E Company from the 324th Motor Repair Section at Leesville, LA.
 F Company from the 312th Motorcycle Company at Ville Platte, LA.

Typically conducted Inactive Training Period meetings at the St. Charles Hotel in New Orleans. Conducted summer training at Fort McClellan, AL, or Fort McPherson, GA. Location 7 December 1941—New Orleans, LA.

Status: Active in the Regular Army at Fort Jackson, SC, as the 5th Brigade, 87th Division (Training Support).

Commanders, 412th Quartermaster Regiment

Col. Duckett F. Hopkins	1 Jul 36-ao Mar 37	Col. Charles M. Miller	ao Oct 37-May 40
	Col. Francis R. Barnard	May 40-7 Dec 41	

413th Quartermaster Regiment (88th Division)**Organized Reserve North Dakota****HQ**-Fargo, ND, 1936-41

Constituted in the Organized Reserve 24 June 1921 as the Quartermaster Section, 88th Division Headquarters. Organized in September 1921 at Minneapolis, MN. Consolidated with Headquarters, 88th Division Quartermaster Train and redesignated 1 July 1936 at Fargo, ND, as Headquarters and Headquarters Company, 413th Quartermaster Regiment. The remainder of the regiment organized from units of the 88th Division Quartermaster Train as follows:

Service Company from the 88th Service Company, Q.M.C. at St. Paul, MN.

Headquarters, 1st Battalion from the 325th Motor Repair Section at Fargo, ND.

A Company from the 349th Motor Transport Company at Fargo, ND.

B Company from the 350th Motor Transport Company at Fargo, ND.

Headquarters, 2nd Battalion from the 325th Wagon Company at Wahpeton, ND.

C Company from the 351st Motor Transport Company at Grand Forks, ND.

D Company from the 352nd Motor Transport Company at Grand Forks, ND.

Headquarters, 3rd Battalion from the 326th Wagon Company at Wahpeton, ND.

E Company from the 326th Motor Repair Section at Grand Forks, ND.

F Company from the 313th Motorcycle Company at Wahpeton, ND.

Typically conducted Inactive Training Period meetings at the Gardner Hotel or 514 Northern Pacific Avenue in Fargo and at the Court House in Grand Forks. Conducted summer training at Camp Ripley, MN, in 1937. Location 7 December 1941—Fargo, ND.

Status: Inactive in the Army Reserve as the 88th Quartermaster Company, an element of the 88th Infantry Division.

Commanders, 413th Quartermaster Regiment

Unknown

1 Jul 36-ao Mar 38
UnknownCol. W. L. Conrad
ao Apr 38-7 Dec 41

ao Mar 38-ao Apr 38

414th Quartermaster Regiment (89th Division)**Organized Reserve South Dakota****HQ**-Mitchell, SD, 1936-41

Constituted in the Organized Reserve 24 June 1921 as the Quartermaster Section, 89th Division Headquarters. Organized in September 1921 at Omaha, NE. Consolidated with Headquarters, 89th Division Quartermaster Train and redesignated 1 July 1936 at Mitchell, SD, as Headquarters and Headquarters Company, 414th Quartermaster Regiment. The remainder of the regiment organized from units of the 89th Division Quartermaster Train as follows:

Service Company from the 89th Service Company, Q.M.C. at Omaha, NE.

Headquarters, 1st Battalion from the 327th Motor Repair Section at Vermillion, SD.

A Company from the 353rd Motor Transport Company at Mitchell, SD.

B Company from the 354th Motor Transport Company at Watertown, SD.

Headquarters, 2nd Battalion from the 327th Wagon Company at Mobridge, SD.

C Company from the 355th Motor Transport Company at Redfield, SD.

D Company from the 356th Motor Transport Company at Brookings, SD.

Headquarters, 3rd Battalion from the 328th Wagon Company at Wagner, SD.

E Company from the 328th Motor Repair Section at Yankton, SD.

F Company from the 314th Motorcycle Company at Sioux Falls, SD.

Conducted summer training at Fort Riley, KS, in 1937. Location 7 December 1941—Mitchell, SD.

Status: Inactive in the Army Reserve as the 89th Quartermaster Company, an element of the 89th Infantry Division.

Commanders, 414th Quartermaster Regiment

Unknown	1 Jul 36-1 Dec 37	Lt. Col. George F. Smith	23 Mar 38-16 Sep 39
Lt. Col. Emil Bergdahl	1 Dec 37-5 Jan 38	Lt. Col. Sidney C. Patemen	16 Sep 39-ao Jan 40
	Unknown	ao Jan 40-7 Dec 41	

415th Quartermaster Regiment (90th Division)

Organized Reserve Texas

HQ-San Antonio, TX, 1936-41



Constituted in the Organized Reserve 24 June 1921 as the Quartermaster Section, 90th Division Headquarters. Organized in November 1921 at San Antonio, TX. Consolidated with Headquarters, 90th Division Quartermaster Train and redesignated 1 July 1936 at San Antonio as Headquarters and Headquarters Company, 415th Quartermaster Regiment. The remainder of the regiment organized from units of the 90th Division Quartermaster Train as follows:

- Service Company from the 90th Service Company, Q.M.C. at San Antonio, TX.
- Headquarters, 1st Battalion from the 329th Motor Repair Section at San Antonio, TX.
 - A Company from the 357th Motor Transport Company at San Antonio, TX.
 - B Company from the 358th Motor Transport Company at Fort Worth, TX.
- Headquarters, 2nd Battalion from the 329th Wagon Company at Fort Worth, TX.
 - C Company from the 359th Motor Transport Company at Dallas, TX.
 - D Company from the 360th Motor Transport Company at Houston, TX.
- Headquarters, 3rd Battalion from the 330th Wagon Company at San Antonio, TX.
 - E Company from the 330th Motor Repair Section at Dallas, TX.
 - F Company from the 315th Motorcycle Company at San Antonio, TX.

Typically conducted Inactive Training Period meetings at the San Antonio Vocational and Technical School. Conducted summer training at Camp Bullis, TX. Location 7 December 1941—San Antonio, TX.

Status: Inactive in the Army Reserve as the 90th Supply & Transport Battalion, an element of the 90th Infantry Division.

Commanders, 415th Quartermaster Regiment

Lt. Col. Ray Leeman	3 Oct 36-ao Dec 36	Lt. Col. A. M. Nicholson	ao Jan 40-ao Feb 40
Unknown	ao Dec 36-ao Jan 40	Unknown	ao Feb 40-7 Dec 41

416th Quartermaster Regiment (91st Division)

Organized Reserve California

HQ-Los Angeles, CA, 1936-41



Constituted in the Organized Reserve 24 June 1921 as the Quartermaster Section, 91st Division Headquarters. Organized in November 1921 at the Presidio of San Francisco, CA. Consolidated with Headquarters, 91st Division Quartermaster Train and redesignated 1 July 1936 at Los Angeles, CA, as Headquarters and Headquarters Company, 416th Quartermaster Regiment. The remainder of the regiment organized from units of the 91st Division Quartermaster Train as follows:

Service Company from the 91st Service Company, Q.M.C. at Los Angeles, CA.
 Headquarters, 1st Battalion from the 331st Motor Repair Section at Los Angeles, CA.
 A Company from the 361st Motor Transport Company at Los Angeles, CA.
 B Company from the 362nd Motor Transport Company at Los Angeles, CA.
 Headquarters, 2nd Battalion from the 331st Wagon Company at Los Angeles, CA.
 C Company from the 363rd Motor Transport Company at Los Angeles, CA.
 D Company from the 364th Motor Transport Company at Los Angeles, CA.
 Headquarters, 3rd Battalion from the 332nd Wagon Company at Los Angeles, CA.
 E Company from the 332nd Motor Repair Section at Los Angeles, CA.
 F Company from the 316th Motorcycle Company at Los Angeles, CA.

Typically conducted Inactive Training Period meetings at the Chamber of Commerce Building in Los Angeles.
 Conducted summer training at Camp Ord, CA. Location 7 December 1941—Los Angeles, CA.

Status: Active in the Regular Army at Fort Lewis, WA, as the 4th Brigade, 91st Division (Training Support).

Commanders, 416th Quartermaster Regiment

Col. Chester P. Mader	4 Sep 36-ao Oct 37	Lt. Col. Edward S. Dobbin	ao Oct 39-ao Jan 40
Col. Theodore H. Kruttschnitt	ao Sep 38-ao Jul 39	Unknown	ao Jan 40-7 Dec 41

419th Quartermaster Regiment (94th Division)

Organized Reserve Massachusetts

HQ-Boston, MA, 1936-41



Constituted in the Organized Reserve 24 June 1921 as the Quartermaster Section, 94th Division Headquarters. Organized in November 1921 at the Boston, MA. Consolidated with Headquarters, 91st Division Quartermaster Train and redesignated 1 July 1936 at Boston as Headquarters and Headquarters Company, 419th Quartermaster Regiment. The remainder of the regiment organized from units of the 94th Division Quartermaster Train as follows:

Service Company from the 94th Service Company, Q.M.C. at Boston, MA.
 Headquarters, 1st Battalion from the 337th Motor Repair Section at Walpole, MA.
 A Company from the 373rd Motor Transport Company at Deerfield, MA.
 B Company from the 374th Motor Transport Company at Springfield, MA.
 Headquarters, 2nd Battalion from the 337th Wagon Company at Northampton, MA.
 C Company from the 375th Motor Transport Company at Ware, MA.
 D Company from the 376th Motor Transport Company at Worcester, MA.
 Headquarters, 3rd Battalion from the 338th Wagon Company at Gardner, MA.
 E Company from the 338th Motor Repair Section at Taunton, MA.
 F Company from the 319th Motorcycle Company at Worcester, MA.

Conducted summer training at Fort Devens, MA. Location 7 December 1941—Boston, MA.

Status: Inactive in the Army Reserve as the 94th Quartermaster Company, an element of the 94th Infantry Division.

Commanders, 419th Quartermaster Regiment

Lt. Col. Charles W. Muldoon	1 Jun 36-ao Jul 40	Unknown	ao Jul 40-7 Dec 41
-----------------------------	--------------------	---------	--------------------

420th Quartermaster Regiment (95th Division)**Organized Reserve Oklahoma****HQ**-Lawton, OK, 1936-41

Constituted in the Organized Reserve 24 June 1921 as the Quartermaster Section, 95th Division Headquarters. Organized in November 1921 at Oklahoma City, OK. Consolidated with Headquarters, 95th Division Quartermaster Train and redesignated 1 July 1936 at Lawton, OK, as Headquarters and Headquarters Company, 420th Quartermaster Regiment. The remainder of the regiment organized from units of the 95th Division Quartermaster Train as follows:

Service Company from the 95th Service Company, Q.M.C. at Oklahoma City, OK.

Headquarters, 1st Battalion from the 339th Motor Repair Section at Durant, OK.

A Company from the 377th Motor Transport Company at Durant, OK.

B Company from the 378th Motor Transport Company at Durant, OK.

Headquarters, 2nd Battalion from the 339th Wagon Company at Oklahoma City, OK.

C Company from the 379th Motor Transport Company at Atoka, OK.

D Company from the 380th Motor Transport Company at Colgate, OK.

Headquarters, 3rd Battalion from the 340th Wagon Company at Oklahoma City, OK.

E Company from the 340th Motor Repair Section at Colgate, OK.

F Company from the 320th Motorcycle Company at Oklahoma City, OK.

Conducted summer training at Fort Sill, OK. Location 7 December 1941—Lawton, OK.

Status: Active in the Army Reserve at Grand Prairie, TX, as Headquarters, 4th Brigade, 95th Division (Institutional Training).

Commanders, 420th Quartermaster Regiment

Maj. Solomon O. Henshaw

6 Oct 36-ao Nov 36

Unknown

ao Nov 36-7 Dec 41

421st Quartermaster Regiment (96th Division)**Organized Reserve Oregon and Washington****HQ**-Portland, OR, 1936-41

Constituted in the Organized Reserve 24 June 1921 as the Quartermaster Section, 96th Division Headquarters. Organized 7 October 1921 at Portland, OR. Consolidated with Headquarters, 96th Division Quartermaster Train and redesignated 1 July 1936 at Portland as Headquarters and Headquarters Company, 421st Quartermaster Regiment. The remainder of the regiment organized from units of the 96th Division Quartermaster Train as follows:

Service Company from the 96th Service Company, Q.M.C. at Seattle, WA.

Headquarters, 1st Battalion from the 341st Motor Repair Section at Seattle, WA.

A Company from the 381st Motor Transport Company at Portland, OR.

B Company from the 382nd Motor Transport Company at Salem, OR.

Headquarters, 2nd Battalion from the 341st Wagon Company at Wasco, OR.

C Company from the 383rd Motor Transport Company at Shelton, WA.

D Company from the 384th Motor Transport Company at Elma, WA.

Headquarters, 3rd Battalion from the 342nd Wagon Company at Okanogan, WA

E Company from the 342nd Motor Repair Section at Seattle, WA.

F Company from the 321st Motorcycle Company at Vancouver, WA.

Conducted summer training at Fort Lewis, WA. Location 7 December 1941—Portland, OR.

Status: Inactive in the Army Reserve as the 96th Quartermaster Company, an element of the 96th Infantry Division.

Commanders, 421st Quartermaster Regiment

Col. Charles Steinhauser

9 Jul 36-ao Jul 39
Col. Marmion D. Mills

Unknown
ao Feb 41-7 Dec 41

ao Jul 39-ao Feb 41

422nd Quartermaster Regiment (97th Division)

Organized Reserve Vermont and New Hampshire

HQ-Rutland, VT, 1936-41

Constituted in the Organized Reserve 24 June 1921 as the Quartermaster Section, 97th Division Headquarters. Organized 7 October 1921 at Augusta, ME. Relocated in September 1922 to Manchester, NH. Consolidated with Headquarters, 97th Division Quartermaster Train and redesignated 1 July 1936 at Rutland, VT, as Headquarters and Headquarters Company, 422nd Quartermaster Regiment. The remainder of the regiment organized from units of the 97th Division Quartermaster Train as follows:

Service Company from the 97th Service Company, Q.M.C. at Peterboro, NH.

Headquarters, 1st Battalion from the 343rd Motor Repair Section at Springfield, VT.

A Company from the 385th Motor Transport Company at Burlington, VT.

B Company from the 386th Motor Transport Company at Brattleboro, VT.

Headquarters, 2nd Battalion from the 343rd Wagon Company at St. Johnsbury, VT.

C Company from the 387th Motor Transport Company at Barre, VT.

D Company from the 388th Motor Transport Company at Rutland, VT.

Headquarters, 3rd Battalion from the 344th Wagon Company at Ludlow, VT.

E Company from the 344th Motor Repair Section at St. Albans, VT.

F Company from the 322nd Motorcycle Company at Plymouth, NH.

Conducted summer training at Fort Devens, MA. Location 7 December 1941—Rutland, VT.

Status: Inactive in the Army Reserve as the 97th Quartermaster Company, an element of the 97th Infantry Division.

Commanders, 422nd Quartermaster Regiment

Col. Frank O. Robinson

1 Jun 36-ao Jul 40

Unknown

ao Jul 40-7 Dec 41

423rd Quartermaster Regiment (98th Division)

Organized Reserve New York

HQ-Syracuse, NY, 1936-41



Constituted in the Organized Reserve 24 June 1921 as the Quartermaster Section, 98th Division Headquarters. Organized 18 August 1921 at Syracuse, NY. Consolidated with Headquarters, 98th Division Quartermaster Train and redesignated 1 July 1936 at Syracuse as Headquarters and Headquarters Company, 423rd Quartermaster Regiment. The remainder of the regiment organized from units of the 98th Division Quartermaster Train as follows:

Service Company from the 98th Service Company, Q.M.C. at Syracuse, NY.

Headquarters, 1st Battalion from the 345th Motor Repair Section at Schenectady, NY.

A Company from the 389th Motor Transport Company at Troy, NY.

B Company from the 390th Motor Transport Company at Utica, NY.

Headquarters, 2nd Battalion from the 345th Wagon Company at Albany, NY.

C Company from the 391st Motor Transport Company at Rochester, NY.

D Company from the 392nd Motor Transport Company at Buffalo, NY.

Headquarters, 3rd Battalion from the 346th Wagon Company at Buffalo, NY.

E Company from the 346th Motor Repair Section at Buffalo, NY.

F Company from the 323rd Motorcycle Company at Syracuse, NY.

Conducted summer training most years at Camp Dix, NJ, and at Holabird Quartermaster Depot, MD, in 1940. Location 7 December 1941—Syracuse, NY.

Status: Active in the Army Reserve at West Hartford, CT, as Headquarters, 4th Brigade, 98th Division (Institutional Training).

Commanders, 423rd Quartermaster Regiment

Lt. Col. Thurratt G. Best 1 Jun 36-26 Sep 41

424th Quartermaster Regiment (99th Division)

Organized Reserve Pennsylvania

HQ-Pittsburgh, PA, 1936-41



Constituted in the Organized Reserve 24 June 1921 as the Quartermaster Section, 99th Division Headquarters. Organized in November 1921 at Pittsburgh, PA. Consolidated with Headquarters, 99th Division Quartermaster Train and redesignated 1 July 1936 at Pittsburgh as Headquarters and Headquarters Company, 424th Quartermaster Regiment. The remainder of the regiment organized from units of the 99th Division Quartermaster Train as follows:

Service Company from the 99th Service Company, Q.M.C. at Pittsburgh, PA.

Headquarters, 1st Battalion from the 347th Motor Repair Section at Pittsburgh, PA.

A Company from the 393rd Motor Transport Company at Pittsburgh, PA.

B Company from the 394th Motor Transport Company at Pittsburgh, PA.

Headquarters, 2nd Battalion from the 347th Wagon Company at Pittsburgh, PA.

C Company from the 395th Motor Transport Company at Pittsburgh, PA.

D Company from the 396th Motor Transport Company at Pittsburgh, PA.

Headquarters, 3rd Battalion from the 348th Wagon Company at Pittsburgh, PA.

E Company from the 348th Motor Repair Section at Pittsburgh, PA.

F Company from the 324th Motorcycle Company at Pittsburgh, PA.

Conducted summer training at Fort Washington, MD. Location 7 December 1941—Pittsburgh, PA.

Status: Inactive in the Army Reserve as the 99th Quartermaster Company, an element of the 99th Infantry Division.

Commanders, 424th Quartermaster Regiment

Col. Clyde C. Miller

1 Jul 36-9 Sep 39

Col. Clyde C. Miller

Lt. Col. Clifford R. Crusan

Jan 40-7 Dec 41

9 Sep 39-Jan 40

425th Quartermaster Regiment (100th Division)**Organized Reserve West Virginia****HQ**-Huntington, WV 1936-41

Constituted in the Organized Reserve 24 June 1921 as the Quartermaster Section, 100th Division Headquarters. Organized 27 September 1921 at Charleston, WV. Relocated 30 June 1928 to Huntington, WV. Consolidated with Headquarters, 100th Division Quartermaster Train and redesignated 1 July 1936 at Huntington as Headquarters and Headquarters Company, 425th Quartermaster Regiment. The remainder of the regiment organized from units of the 100th Division Quartermaster Train as follows:

- Service Company from the 100th Service Company, Q.M.C. at Huntington, WV.
- Headquarters, 1st Battalion from the 349th Motor Repair Section at Wheeling, WV.
 - A Company from the 397th Motor Transport Company at Wheeling, WV.
 - B Company from the 398th Motor Transport Company at Fairmont, WV.
- Headquarters, 2nd Battalion from the 349th Wagon Company at Wheeling, WV.
 - C Company from the 399th Motor Transport Company at Parkersburg, WV.
 - D Company from the 400th Motor Transport Company at Huntington, WV.
- Headquarters, 3rd Battalion from the 350th Wagon Company at Huntington, WV.
 - E Company from the 350th Motor Repair Section at Huntington, WV.
 - F Company from the 325th Motorcycle Company at Huntington, WV.

Entire regiment relocated 9 July 1936 to Huntington. Conducted summer training at Fort Knox, KY. Location 7 December 1941—Huntington, WV.

Status: Active in the Army Reserve at Montgomery, AL, as Headquarters, 4th Brigade, 100th Division (Institutional Training).

Commanders, 425th Quartermaster Regiment

Unknown	1 Jul 36-ao Jun 37 Col. Alvaro B. McCutcheon	Maj. Edmund L. Jones Jul 38-ao Jan 41	ao Jun 37-Jul 38
---------	---	--	------------------

426th Quartermaster Regiment (101st Division)**Organized Reserve Wisconsin****HQ**-Milwaukee, WI, 1936-41

Constituted in the Organized Reserve 24 June 1921 as the Quartermaster Section, 101st Division Headquarters. Organized 10 September 1921 at Milwaukee, WI. Consolidated with Headquarters, 101st Division Quartermaster Train and redesignated 1 July 1936 at Milwaukee as Headquarters and Headquarters Company, 426th Quartermaster Regiment. The remainder of the regiment organized from units of the 101st Division Quartermaster Train as follows:

- Service Company from the 101st Service Company, Q.M.C. at South Milwaukee, WI.
- Headquarters, 1st Battalion from the 351st Motor Repair Section at Kenosha, WI.
 - A Company from the 401st Motor Transport Company at La Crosse, WI.
 - B Company from the 402nd Motor Transport Company at Wausau, WI.
- Headquarters, 2nd Battalion from the 351st Wagon Company at Medford, WI.
 - C Company from the 403rd Motor Transport Company at Ellsworth, WI.
 - D Company from the 404th Motor Transport Company at Hayward, WI.

Headquarters, 3rd Battalion from the 352nd Wagon Company at Sparta, WI.

E Company from the 352nd Motor Repair Section at Racine, WI.

F Company from the 326th Motorcycle Company at Kenosha, WI.

Typically conducted Inactive Training Period meetings at the headquarters of the Wisconsin Military Area in Milwaukee. Conducted summer training at Fort Sheridan, IL, and Camp McCoy, WI. Location 7 December 1941—Milwaukee, WI.

Status: Active at Fort Campbell, KY, as the 426th Forward Support Battalion, an element of the 101st Airborne Division.

Commanders, 426th Quartermaster Regiment

Col. Garrit C. DeHeus

1 Jun 36-ao Sep 39

Unknown

ao Sep 39-7 Dec 41

427th Quartermaster Regiment (102nd Division)

Organized Reserve Arkansas

HQ-Texarkana, AR, 1936-41

Constituted in the Organized Reserve 24 June 1921 as the Quartermaster Section, 102nd Division Headquarters. Organized in November 1921 at St. Louis, MO. Consolidated with Headquarters, 102nd Division Quartermaster Train and redesignated 1 July 1936 at Texarkana, AR, as Headquarters and Headquarters Company, 427th Quartermaster Regiment. The remainder of the regiment organized from units of the 102nd Division Quartermaster Train as follows:

Service Company from the 102nd Service Company, Q.M.C. at Kansas City, MO.

Headquarters, 1st Battalion from the 353rd Motor Repair Section at Little Rock, AR.

A Company from the 405th Motor Transport Company at Fort Smith, AR.

B Company from the 406th Motor Transport Company at Fort Smith, AR.

Headquarters, 2nd Battalion from the 353rd Wagon Company at Little Rock, AR.

C Company from the 407th Motor Transport Company at Kansas City, MO.

D Company from the 408th Motor Transport Company at Kansas City, MO.

Headquarters, 3rd Battalion from the 354th Wagon Company at Hope, AR.

E Company from the 354th Motor Repair Section at Kansas City, MO.

F Company from the 327th Motorcycle Company at St. Louis, MO.

Conducted summer training at Fort Riley, KS. Location 7 December 1941—Texarkana, AR.

Status: Inactive in the Army Reserve as the 102nd Supply & Transport Battalion, an element of the 102nd Infantry Division.

Commanders, 427th Quartermaster Regiment

Unknown

1 Jul 36-ao Jul 39
Unknown

Lt. Col. Frank H. Earhart
ao Sep 39-7 Dec 41

ao Jul 39-ao Sep 39

428th Quartermaster Regiment (103rd Division)

Organized Reserve Colorado

HQ-Denver, CO, 1936-41



Constituted in the Organized Reserve 24 June 1921 as the Quartermaster Section, 103rd Division Headquarters. Organized in November 1921 with headquarters at the state capitol in Oklahoma City, OK. Relocated in 1922 to Denver, CO. Consolidated with Headquarters, 103rd Division Quartermaster Train and redesignated 1 July 1936 at Denver as Headquarters and Headquarters Company, 428th Quartermaster Regiment. The remainder of the regiment organized from units of the 103rd Division Quartermaster Train as follows:

- Service Company from the 103rd Service Company, Q.M.C. at Denver, CO.
- Headquarters, 1st Battalion from the 355th Motor Repair Section at Denver, CO.
 - A Company from the 409th Motor Transport Company at Denver, CO.
 - B Company from the 410th Motor Transport Company at Loveland, CO.
- Headquarters, 2nd Battalion from the 355th Wagon Company at Denver, CO.
 - C Company from the 411th Motor Transport Company at Pueblo, CO.
 - D Company from the 412th Motor Transport Company at Colorado Springs, CO.
- Headquarters, 3rd Battalion from the 356th Wagon Company at Denver, CO.
 - E Company from the 356th Motor Repair Section at Denver, CO.
 - F Company from the 328th Motorcycle Company at Denver, CO.

Typically conducted Inactive Training Period meetings at the Kitteridge Building in Denver. Conducted summer training at Fort Francis E. Warren, WY. Location 7 December 1941—Denver, CO.

Status: Inactive in the Army Reserve as the 103rd Quartermaster Company, an element of the 103rd Infantry Division.

Commanders, 428th Quartermaster Regiment

Col. Edmond D. Potvin

28 Aug 36-ao Dec 36

Unknown

ao Dec 36-7 Dec 41

429th Quartermaster Regiment (104th Division)

**Organized Reserve Utah, Idaho,
Montana, and Wyoming**

HQ-Salt Lake City, UT, 1936-41

Constituted in the Organized Reserve 24 June 1921 as the Quartermaster Section, 104th Division Headquarters. Organized 7 October 1921 at Fort Douglas, UT. Relocated in 1923 to Salt Lake City, UT. Consolidated with Headquarters, 104th Division Quartermaster Train and redesignated 1 July 1936 at Salt Lake City as Headquarters and Headquarters Company, 429th Quartermaster Regiment. The remainder of the regiment organized from units of the 104th Division Quartermaster Train as follows:

- Service Company from the 104th Service Company, Q.M.C. at Salt Lake City, UT.
- Headquarters, 1st Battalion from the 357th Motor Repair Section at Helena, MT.
 - A Company from the 413th Motor Transport Company at Casper, WY.
 - B Company from the 414th Motor Transport Company at Helena, MT.
- Headquarters, 2nd Battalion from the 357th Wagon Company at Helena, MT.
 - C Company from the 415th Motor Transport Company at Helena, MT.
 - D Company from the 416th Motor Transport Company at Pocatello, ID.

Headquarters, 3rd Battalion from the 358th Wagon Company at Twin Falls, ID.

E Company from the 358th Motor Repair Section at Pocatello, ID.

F Company from the 329th Motorcycle Company at Salt Lake City, UT.

Conducted summer training at Fort Lewis, WA. Location 7 December 1941—Salt Lake City, UT.

Status: Active in the Army Reserve at Camp Parks, CA, as Headquarters, 4th Brigade, 104th Division (Institutional Training).

Commanders, 429th Quartermaster Regiment

Col. Maurice Anderson

1 Jul 36-ao Aug 40

Unknown

ao Aug 40-7 Dec 41

461st Quartermaster Squadron (61st Cavalry Division)

Organized Reserve New York

HQ-Rochester, NY, 1936-41

Constituted in the Organized Reserve 15 October 1921 as the Quartermaster Section, 61st Cavalry Division Headquarters. Organized 4 February 1922 at Manhattan, NY. Reorganized and redesignated 1 July 1936 at Rochester, NY, as Headquarters and Headquarters Troop, 461st Quartermaster Squadron. Remainder of the squadron organized from the units of the 61st Cavalry Division Quartermaster Train as follows:

A Troop from Headquarters, 61st Cavalry Division Quartermaster Train at Rochester, NY.

B Troop from the 418th Motor Transport Company at Rochester, NY.

C Troop from the 419th Motor Transport Company at Rochester, NY.

D Troop from the 432nd Wagon Company at Elmira, NY.

E Troop from the consolidation of the 361st through 364th Pack Trains at Rochester, Elmira, and Genesee, NY.

F Troop from the 761st Motor Repair Section at Rochester, NY.

Conducted annual summer training at Fort Dix, NJ, or Fort Ethan Allen, VT. Location 7 December 1941—Rochester, NY.

Status: Disbanded 30 January 1942.

Commanders, 461st Quartermaster Squadron

Lt. Col. Louis E. De Forrest

1 Jul 36-5 Dec 39

Maj. Milton A. Lowenberg

12 Oct 38-ao Feb 41

462nd Quartermaster Squadron (62nd Cavalry Division)

Organized Reserve Virginia and Maryland

HQ-Winchester, VA, 1936-41

Constituted in the Organized Reserve 15 October 1921 as the Quartermaster Section, 62nd Cavalry Division Headquarters. Organized in July 1922 at Towson, MD. Reorganized and redesignated 1 July 1936 at Winchester, VA, as Headquarters and Headquarters Troop, 462nd Quartermaster Squadron. Remainder of the squadron organized from the units of the 62nd Cavalry Division Quartermaster Train as follows:

A Troop from Headquarters, 62nd Cavalry Division Quartermaster Train at Winchester, VA.

B Troop from the 420th Motor Transport Company at Winchester, VA.

C Troop from the 421st Motor Transport Company at Baltimore, MD.

D Troop from the 434th Wagon Company at Winchester, VA.

E Troop from the consolidation of the 365th through 368th Pack Trains at Winchester, VA.

F Troop from the 762nd Motor Repair Section at Baltimore, MD.

Conducted annual summer training at Holabird Quartermaster Depot, MD. Location 7 December 1941—Winchester, VA.

Status: Disbanded 30 January 1942.

Commanders, 462nd Quartermaster Squadron

Maj. William F. Brown

1 Jul 36-8 Jul 39
Lt. Col. Edward F. Ludvigsen

Maj. Charles W. Griffin
3 Feb 40-14 Oct 41

8 Jul 39-2 Feb 40

463rd Quartermaster Squadron (63rd Cavalry Division)

Organized Reserve Louisiana/Mississippi

HQ-New Orleans, LA, 1936; Vicksburg, MS, 1936-41

Constituted in the Organized Reserve 15 October 1921 as the Quartermaster Section, 63rd Cavalry Division

Headquarters. Organized in April 1923 at New Orleans, LA. Reorganized and redesignated 1 July 1936 as Headquarters and Headquarters Troop, 463rd Quartermaster Squadron. Remainder of the squadron organized from the units of the 63rd Cavalry Division Quartermaster Train as follows:

A Troop from Headquarters, 63rd Cavalry Division Quartermaster Train at New Orleans, LA.

B Troop from the 422nd Motor Transport Company at Lake Charles, LA.

C Troop from the 423rd Motor Transport Company at Shreveport, LA.

D Troop from the 436th Wagon Company at Rayne, LA.

E Troop from the consolidation of the 369th through 372nd Pack Trains.

F Troop from the 763rd Motor Repair Section at Lake Charles, LA.

Entire squadron relocated by December 1936 to Vicksburg, MS. Conducted annual summer training at Fort Oglethorpe, GA. Location 7 December 1941—Vicksburg, MS.

Status: Disbanded 30 January 1942.

Commanders, 463rd Quartermaster Squadron

Lt. Col. Ira Stineman

1 Jul 36-ao Aug 39

Unknown

ao Aug 39-7 Dec 41

464th Quartermaster Squadron (64th Cavalry Division)

Organized Reserve Kentucky

HQ-Louisville, KY, 1936-37; Winchester, KY, 1937-41

Constituted in the Organized Reserve 15 October 1921 as the Quartermaster Section, 64th Cavalry Division

Headquarters. Organized in March 1922 at Louisville, KY. Reorganized and redesignated 1 July 1936 at Louisville, KY, as Headquarters and Headquarters Troop, 464th Quartermaster Squadron. Remainder of the squadron organized from the units of the 64th Cavalry Division Quartermaster Train as follows:

A Troop from Headquarters, 64th Cavalry Division Quartermaster Train at Louisville, KY.

B Troop from the 424th Motor Transport Company at Louisville, KY.

C Troop from the 425th Motor Transport Company at Louisville, KY.

D Troop from the 440th Wagon Company at Louisville, KY.

E Troop from the consolidation of the 373rd through 376th Pack Trains at Louisville, KY.

F Troop from the 764th Motor Repair Section at Louisville, KY.

Entire squadron relocated 5 April 1937 to Winchester, KY. Location 7 December 1941—Winchester, KY.

Status: Disbanded 30 January 1942.

Commanders, 464th Quartermaster Squadron

Maj. Frank I. Josselson

1 Jul 36-ao Aug 38

Unknown

ao Aug 38-7 Dec 41

465th Quartermaster Squadron (65th Cavalry Division)**Organized Reserve Illinois****HQ**-Ottawa, IL, 1936-37; Chicago, IL, 1937-41

Constituted in the Organized Reserve 15 October 1921 as the Quartermaster Section, 65th Cavalry Division

Headquarters. Organized in May 1922 at Chicago, IL. Reorganized and redesignated 1 July 1936 at Ottawa, IL, as Headquarters and Headquarters Troop, 465th Quartermaster Squadron. Remainder of the squadron organized from the units of the 65th Cavalry Division Quartermaster Train as follows:

- A Troop from Headquarters, 65th Cavalry Division Quartermaster Train at Ottawa, IL.
- B Troop from the *426th Motor Transport Company*.
- C Troop from the *427th Motor Transport Company*.
- D Troop from the 440th Wagon Company at Spring Valley, IL.
- E Troop from the consolidation of the 377th through 380th Pack Trains at Streator, IL.
- F Troop from the 765th Motor Repair Section at Wilmette, IL.

Conducted annual summer training at Camp Custer, MI. Entire squadron relocated 28 July 1937 to Chicago, IL. Location 7 December 1941—Chicago, IL.

Status: Disbanded 30 January 1942.**Commanders, 465th Quartermaster Squadron**

Lt. Col. Marmion D. Mills	1 Jul 36-26 Apr 37	Lt. Col. Marmion D. Mills	26 Oct 37-13 Dec 39
Maj. Harry J. Audette	26 Apr 37-26 Oct 37	Maj. Rolland J. H. Mertz	14 Dec 39-ao Feb 41

466th Quartermaster Squadron (66th Cavalry Division)**Organized Reserve South Dakota****HQ**-Rapid City, SD, 1936-38; *Inactive* 1938-41

Constituted in the Organized Reserve 15 October 1921 as the Quartermaster Section, 66th Cavalry Division

Headquarters. Organized March 1922 at Omaha, NE. Reorganized and redesignated 1 July 1936 at Rapid City, SD, as Headquarters and Headquarters Troop, 466th Quartermaster Squadron. Remainder of the squadron organized from the units of the 66th Cavalry Division Quartermaster Train as follows:

- A Troop from Headquarters, 66th Cavalry Division Quartermaster Train at Rapid City, SD.
- B Troop from the 428th Motor Transport Company.
- C Troop from the 429th Motor Transport Company.
- D Troop from the 442nd Wagon Company at Lead, SD.
- E Troop from the consolidation of the 381st through 384th Pack Trains at Buffalo and Bison, SD.
- F Troop from the 766th Motor Repair Section.

Inactivated 23 March 1938 at Rapid City by relief of personnel. Location 7 December 1941—*Inactive***Status:** Disbanded 30 January 1942.**Commanders, 466th Quartermaster Squadron**

Lt. Col. George F. Smith	1 Jul 36-23 Mar 38	Inactive	23 Mar 38-7 Dec 41
--------------------------	--------------------	----------	--------------------

471st Quartermaster Regiment (Truck-Corps) (XI Corps)**Organized Reserve Massachusetts****HQ**-*Not initiated* 1936-41Constituted in the Organized Reserve 1 July 1936, assigned to the XI Corps, and allotted to the First Corps Area. Location 7 December 1941—*Not organized*.

472nd Quartermaster Regiment (Truck-Corps) (XII Corps)**Organized Reserve New York**

HQ-New York City, NY, 1936-41



Constituted in the Organized Reserve 29 July 1921 as HHD, 308th Motor Transport Command, assigned to the XII Corps, and allotted to the Second Corps Area. Initiated in 1922 with headquarters at Catskill, NY. Reorganized and redesignated 1 July 1936 as HHC, 472nd Quartermaster Regiment (Truck-Corps). Relocated 30 October 1936 to New York City, NY, and reorganized there by assignment of personnel. Subordinate units organized at New York City as follows: 1st Battalion constituted new; 2nd Battalion organized from the 361st Motor Transport Command; 3rd Battalion organized from the 376th Motor Transport Command; 4th Battalion organized from the 377th Motor Transport Command. Location 7 December 1941—New York City, NY.

Commanders, 472nd Quartermaster Regiment

Col. Lewis Landes

30 Oct 36-15 Jun 41

Col. Fred E. Bridgetts

15 Jun 41-ao Dec 41

473rd Quartermaster Regiment (Truck-Corps) (XIII Corps)**Organized Reserve Pennsylvania**

HQ-Lancaster, PA, 1936-41

Constituted in the Organized Reserve 29 July 1921 as the 340th Motor Transport Command, assigned to the XIII Corps, and allotted to the Third Corps Area. Reorganized and redesignated 1 July 1936 as HHC, 473rd Quartermaster Regiment (Truck-Corps) and organized with headquarters at Lancaster, PA. Subordinate battalions organized from existing units as follows: 409th Service Battalion as the 1st Battalion; 504th Motor Transport Command as the 2nd Battalion; 357th Motor Transport Command as the 3rd Battalion; and 358th Motor Transport Command as the 4th Battalion. Location 7 December 1941—Lancaster, PA.

Commanders, 473rd Quartermaster Regiment

Unknown

1 Jul 36-7 Dec 41

474th Quartermaster Regiment (Truck-Corps) (XIV Corps)**Organized Reserve South Carolina**

HQ-Spartanburg, SC, 1936-41

Constituted in the Organized Reserve 1 July 1936, assigned to the XIV Corps, and allotted to the Fourth Corps Area. Initiated in July 1936 with headquarters at Spartanburg, SC. Location 7 December 1941—Spartanburg, SC.

Commanders, 474th Quartermaster Regiment

Unknown

1 Jul 36-7 Dec 41

475th Quartermaster Regiment (Truck-Corps) (XV Corps)**Organized Reserve Indiana**

HQ-Clarksburg, WV 1936-37; Vincennes, IN, 1937-41

Constituted in the Organized Reserve 29 July 1921 as the 414th Motor Transport Command, assigned to the V Corps, and allotted to the Fifth Corps Area. Initiated in 1922 with headquarters at Clarksburg, WV. Reorganized and redesignated 1 July 1936 as HHC, 475th Quartermaster Regiment (Truck-Corps). Subordinate battalions organized from existing units as follows: 1st Battalion constituted new; 429th Motor Transport Command as the 2nd Battalion; 432nd Motor Transport Command as the 3rd Battalion; and 507th Motor Transport Command as the 4th Battalion. Entire regiment relocated 5 April 1937 to Vincennes, IN. Location 7 December 1941—Vincennes, IN.

Status: HHD active in the U. S. Army Reserve at Farrell, PA, as HHD, 475th Quartermaster Group.

Commanders, 475th Quartermaster Regiment

Unknown

1 Jul 36-7 Dec 41

476th Quartermaster Regiment (Truck-Corps) (XVI Corps)**Organized Reserve Wisconsin/Michigan****HQ**-Sheboygan Falls, WI, 1936-37; Lansing, MI, 1937-41

Constituted in the Organized Reserve 29 July 1921 as the 324th Motor Transport Command, assigned to the XVI Corps, and allotted to the Sixth Corps Area. Initiated in 1922 with headquarters at Antigo, WI. Relocated 7 January 1927 to Sheboygan Falls, WI. Reorganized and redesignated 1 July 1936 as HHC, 476th Quartermaster Regiment (Truck-Corps). Subordinate battalions organized from existing units as follows: 1st Battalion constituted new; 366th Motor Transport Command as the 2nd Battalion; 367th Motor Transport Command as the 3rd Battalion; and 390th Motor Transport Command as the 4th Battalion. Relocated 28 July 1937 to Lansing, MI. Location 7 December 1941—Lansing, MI.

Commanders, 476th Quartermaster Regiment

Unknown 1 Jul 36-7 Dec 41

477th Quartermaster Regiment (Truck-Corps) (XVII Corps)**Organized Reserve****HQ**-Des Moines, IA, 1936-41

Constituted in the Organized Reserve 29 July 1921 as the 346th Motor Transport Command, assigned to the XVII Corps, and allotted to the Seventh Corps Area. Initiated in 1922 with headquarters at Des Moines, IA. Reorganized and redesignated 1 July 1936 as HHC, 477th Quartermaster Regiment (Truck-Corps). Subordinate battalions organized from existing units as follows: 420th Service Battalion as the 1st Battalion; 347th Motor Transport Command as the 2nd Battalion; 348th Motor Transport Command as the 3rd Battalion; and 375th Motor Transport Command as the 4th Battalion. Location 7 December 1941—Des Moines, IA.

Status: Disbanded 31 December 1943.**Commanders, 477th Quartermaster Regiment**

Unknown 1 Jul 36-7 Dec 41

478th Quartermaster Regiment (Truck-Corps) (XVIII Corps)**Organized Reserve Texas****HQ**-San Antonio, TX, 1936-41

Constituted in the Organized Reserve 1 July 1936, assigned to the XVIII Corps, and allotted to the Eighth Corps Area. Initiated in 1936 with headquarters at San Antonio, TX. Location 7 December 1941—San Antonio, TX.

Commanders, 478th Quartermaster Regiment

Unknown 1 Jul 36-7 Dec 41

479th Quartermaster Regiment (Truck-Corps) (XIX Corps)**Organized Reserve California****HQ**-San Francisco, CA, 1936-41

Constituted in the Organized Reserve 29 July 1921 as the 350th Motor Transport Command, assigned to the IX Corps, and allotted to the Ninth Corps Area. Initiated by December 1922 with headquarters at Los Angeles, CA. Reorganized and redesignated 1 July 1936 as HHC, 479th Quartermaster Regiment (Truck-Corps) at San Francisco, CA. Subordinate battalions organized from existing units as follows: 1st Battalion constituted new; 401st Motor Transport Command as the 2nd Battalion; 426th Motor Transport Command as the 3rd Battalion; and 513th Motor Transport Command as the 4th Battalion. Location 7 December 1941—San Francisco, CA.

Status: Disbanded 18 October 1943.**Commanders, 479th Quartermaster Regiment**

Unknown 1 Jul 36-7 Dec 41

491st Quartermaster Regiment (Light Maintenance) (XI Corps)

Organized Reserve Massachusetts

HQ-Boston, MA, 1936-40

Constituted in the Organized Reserve 29 July 1921 as the 301st Motor Transport Command, assigned to the XI Corps, and allotted to the First Corps Area. Initiated by December 1922 with headquarters at Boston, MA. Reorganized and redesignated 1 July 1936 as HHC, 491st Quartermaster Regiment (Light Maintenance). Subordinate battalions organized from existing units as follows: 337th Motor Transport Command as the 1st Battalion and 338th Motor Transport Command as the 2nd Battalion. Regiment, less 1st Battalion, disbanded 1 June 1940. The 1st Battalion reorganized and redesignated 590th Quartermaster Battalion (Light Maintenance).

Commanders, 491st Quartermaster Regiment

Unknown 1 Jul 36-1 Jun 40

492nd Quartermaster Regiment (Light Maintenance) (XII Corps)

Organized Reserve New York

HQ-New York City 1936-40



Constituted in the Organized Reserve 29 July 1921 as the 305th Motor Transport Command, assigned to the XII Corps, and allotted to the Second Corps Area. Initiated in 1922 with headquarters at New York City, NY. Reorganized and redesignated 1 July 1936 as HHC, 492nd Quartermaster Regiment (Light Maintenance). Reorganized 30 October 1936 at New York City by assignment of personnel. Subordinate battalions organized from existing units as follows: 307th Motor Transport Command as the 1st Battalion and 308th Motor Transport Command as the 2nd Battalion. Conducted annual summer training at Camp Dix, NJ, 1936-39. Regiment, less 1st Battalion, disbanded 1 June 1940. The 1st Battalion reorganized and redesignated 592nd Quartermaster Battalion (Light Maintenance).

Status: The 1st Battalion is inactive in the U. S. Army Reserve as the 329th Ordnance Battalion.

Commanders, 492nd Quartermaster Regiment

Col. Robert A. Falkenau 30 Oct 36-1 Jun 39 Col. Warren B. Bullock 22 Jul 39-7 Nov 39
Lt. Col. Allen G. Brindley 23 Dec 39-1 Jun 40

493rd Quartermaster Regiment (Light Maintenance) (XIII Corps)

Organized Reserve Pennsylvania

HQ-Bedford, PA, 1936-40

Constituted in the Organized Reserve 29 July 1921 as the 310th Motor Transport Command, assigned to the XIII Corps, and allotted to the Third Corps Area. Initiated by 1922 with headquarters at Bedford, PA. Reorganized and redesignated 1 July 1936 as HHC, 493rd Quartermaster Regiment (Light Maintenance). Subordinate battalions organized from existing units as follows: 311th Motor Transport Command as the 1st Battalion and 312th Motor Transport Command as the 2nd Battalion. Regiment, less 1st Battalion, disbanded 1 June 1940. The 1st Battalion reorganized and redesignated 593rd Quartermaster Battalion (Light Maintenance).

Commanders, 493rd Quartermaster Regiment

Unknown 1 Jul 36-1 Jul 40

494th Quartermaster Regiment (Light Maintenance) (XIV Corps)

Organized Reserve Louisiana

HQ-New Orleans, LA, 1936-40

Constituted in the Organized Reserve 29 July 1921 as the 411th Motor Transport Command, assigned to the IV Corps, and allotted to the Fourth Corps Area. Initiated by February 1923 with headquarters at New Orleans, LA. Reorganized and redesignated 1 July 1936 as HHC, 494th Quartermaster Regiment (Light Maintenance). Subordinate battalions organized from existing units as follows: 313th Motor Transport Command as the 1st Battalion and 314th Motor

Transport Command as the 2nd Battalion. Regiment, less 1st Battalion, disbanded 1 June 1940. The 1st Battalion reorganized and redesignated 594th Quartermaster Battalion (Light Maintenance).

Commanders, 494th Quartermaster Regiment

Unknown 1 Jul 36-1 Jul 40

495th Quartermaster Regiment (Light Maintenance) (XV Corps)

Organized Reserve Ohio

HQ-Cincinnati, OH, 1936-37; *Inactive* 1937-40

Constituted in the Organized Reserve 29 July 1921 as the 317th Motor Transport Command, assigned to the XV Corps, and allotted to the Fifth Corps Area. Initiated by 1922 with headquarters at Clarksburg, WV. Reorganized and redesignated 1 July 1936 as HHC, 495th Quartermaster Regiment (Light Maintenance) at Cincinnati, OH. Subordinate battalions organized from existing units as follows: 318th Motor Transport Command as the 1st Battalion and 381st Motor Transport Command as the 2nd Battalion. Inactivated by April 1937 at Cincinnati by relief of personnel. Regiment, less 1st Battalion, disbanded 1 June 1940. The 1st Battalion reorganized and redesignated 595th Quartermaster Battalion (Light Maintenance).

Commanders, 494th Quartermaster Regiment

Unknown 1 Jul 36-Apr 37 *Inactive* Apr 37-1 Jul 40

496th Quartermaster Regiment (Light Maintenance) (XVI Corps)

Organized Reserve Wisconsin

HQ-Beloit, WI, 1936-37; Wausau, WI, 1937-40

Constituted in the Organized Reserve 29 July 1921 as the 321st Motor Transport Command, assigned to the XVI Corps, and allotted to the Sixth Corps Area. Initiated by 1922 with headquarters at Beloit, WI. Reorganized and redesignated 1 July 1936 as HHC, 496th Quartermaster Regiment (Light Maintenance). Subordinate battalions organized from existing units as follows: 322nd Motor Transport Command as the 1st Battalion and 323rd Motor Transport Command as the 2nd Battalion. Relocated 28 July 1937 to Wausau, WI. Regiment, less 1st Battalion, disbanded 1 June 1940. The 1st Battalion reorganized and redesignated 596th Quartermaster Battalion (Light Maintenance).

Commanders, 496th Quartermaster Regiment

Unknown 1 Jul 36-1 Jun 40

497th Quartermaster Regiment (Light Maintenance) (XVII Corps)

Organized Reserve Kansas

HQ-Kansas City, MO, 1936-40

Constituted in the Organized Reserve 29 July 1921 as the 325th Motor Transport Command, assigned to the XVII Corps, and allotted to the Seventh Corps Area. Initiated by 1922 with headquarters at Hannibal, MO. Reorganized and redesignated 1 July 1936 as HHC, 497th Quartermaster Regiment (Light Maintenance) at Kansas City, MO. Subordinate battalions organized from existing units as follows: 326th Motor Transport Command as the 1st Battalion and 345th Motor Transport Command as the 2nd Battalion. Regiment, less 1st Battalion, disbanded 1 June 1940. The 1st Battalion reorganized and redesignated 597th Quartermaster Battalion (Light Maintenance).

Commanders, 497th Quartermaster Regiment

Unknown 1 Jul 36-1 Jul 40

498th Quartermaster Regiment (Light Maintenance) (XVIII Corps)**Organized Reserve****HQ-Not initiated** 1936-40

Constituted in the Organized Reserve 1 July 1936, assigned to the XVIII Corps, and allotted to the Eighth Corps Area. Regiment, less 1st Battalion, disbanded 1 June 1940. The 1st Battalion reorganized and redesignated 598th Quartermaster Battalion (Light Maintenance).

499th Quartermaster Regiment (Light Maintenance) (XIX Corps)**Organized Reserve California****HQ-San Francisco, CA, 1936-37; Oakland, CA, 1937-40**

Constituted in the Organized Reserve 29 July 1921 as the 333rd Motor Transport Command, assigned to the XIX Corps, and allotted to the Ninth Corps Area. Initiated by 1922 with headquarters at San Francisco, CA. Reorganized and redesignated 1 July 1936 as HHC, 499th Quartermaster Regiment (Light Maintenance). Subordinate battalions organized from existing units as follows: 335th Motor Transport Command as the 1st Battalion and 336th Motor Transport Command as the 2nd Battalion. Relocated 14 May 1937 to Oakland, CA. Conducted annual summer training at Camp Ord, CA. Regiment, less 1st Battalion, disbanded 1 June 1940. The 1st Battalion reorganized and redesignated 599th Quartermaster Battalion (Light Maintenance).

Commanders, 499th Quartermaster Regiment

Maj. Benjamin F. Rice	1 Jun 36-1 Dec 36	Col. Theodore H. Kruttschnitt	22 Feb 38-ao Nov 38
Lt. Col. Homer C. Ransom	1 Dec 36-22 Feb 38	Unknown	ao Nov 38-1 Jun 40

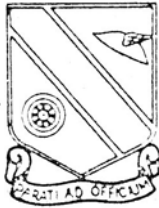
511th Quartermaster Regiment (Truck-Army)**Organized Reserve New York****HQ-Manhattan, NY, 1936-41**

Constituted in the Organized Reserve 29 July 1921 as the 354th Motor Transport Command, assigned to the XII Corps, and allotted to the Second Corps Area. Initiated by 1922 with headquarters at Manhattan, NY. Reorganized and redesignated 1 July 1936 as HHC, 511th Quartermaster Regiment (Truck-Army). Reorganized 30 October 1936 at Manhattan by assignment of personnel. Subordinate battalions organized from existing units as follows: 363rd Motor Transport Command as the 1st Battalion, 378th Motor Transport Command as the 2nd Battalion, and 406th Motor Transport Command as the 3rd Battalion. Conducted annual summer training at Fort Dix, NJ. Location 7 December 1941—Manhattan, NY.

Status: Disbanded 18 October 1943.**Commanders, 511th Quartermaster Regiment**

Col. Charles T. Arrighi	30 Oct 36-30 Mar 40	Col. Robert A. Falkenau	18 May 40-15 Jun 41
-------------------------	---------------------	-------------------------	---------------------

512th Quartermaster Regiment (Truck-Army) (Colored)**Organized Reserve Pennsylvania****HQ-Not initiated** 1936-40; Philadelphia, PA, 1940-41; *Inactive* 1941

Constituted in the Organized Reserve 1 July 1936 and allotted to the Third Corps Area. Initiated by April 1940 with headquarters at Philadelphia, PA. Inactivated by August 1941 at Philadelphia by relief of personnel. Location 7 December 1941—*Inactive*.

Commanders, 512th Quartermaster Regiment

Unknown	Apr 40-ao Aug 41	<i>Inactive</i>	ao Aug 41-7 Dec 41
---------	------------------	-----------------	--------------------

513th Quartermaster Regiment (Truck-Army) (Colored)**Organized Reserve Illinois****HQ**-Shelbyville, IL, 1936-37; Chicago, IL, 1937-41

Constituted in the Organized Reserve 29 July 1921 as the 722nd Motor Transport Company, assigned to the XVI Corps, and allotted to the Sixth Corps Area. Initiated by 1922 with headquarters at Shelbyville, IL. Reorganized and redesignated 1 July 1936 as HHC, 513th Quartermaster Regiment (Truck-Army) at Shelbyville, IL. Subordinate battalions organized from existing units as follows: 722nd Motor Transport Company as the 1st Battalion, 509th Motor Transport Command as the 2nd Battalion, and 510th Motor Transport Command as the 3rd Battalion. Inactivated by June 1937 at Shelbyville by relief of personnel. Reorganized 28 July 1937 at Chicago, IL. Location 7 December 1941—Chicago, IL.

Commanders, 513th Quartermaster Regiment

Unknown	1 Jul 36-ao Jun 37 Unknown	<i>Inactive</i> 28 Jul 37-7 Dec 41	ao Jun 37-28 Jul 37
---------	-------------------------------	---------------------------------------	---------------------

514th Quartermaster Regiment (Truck-Army) (Colored)**Organized Reserve Mississippi****HQ**-Greenville, MS, 1936-41

Constituted in the Organized Reserve 29 July 1921 as the 574th Motor Transport Company, assigned to the VII Corps, and allotted to the Seventh Corps Area. Organized by 1922 with headquarters at Fargo, ND. Withdrawn from the Seventh Corps Area 11 January 1927 and allotted to the Fourth Corps Area. Initiated at Pulaski, TN. Reorganized and redesignated 1 July 1936 as HHC, 514th Quartermaster Regiment (Truck-Army). Subordinate battalions organized from existing units as follows: 575th Motor Transport Company as the 1st Battalion, 738th Motor Transport Company as the 2nd Battalion, and 753rd Motor Transport Company as the 3rd Battalion. Organized 9 October 1936 at Greenville, MS. Location 7 December 1941—Greenville, MS.

Commanders, 514th Quartermaster Regiment

Unknown	9 Oct 36-7 Dec 41
---------	-------------------

515th Quartermaster Regiment (Truck-Army)**Organized Reserve Arkansas****HQ**-Augusta, AR, 1936-41

Constituted in the Organized Reserve 29 July 1921 as the 381st Motor Transport Command, assigned to the Third Army, and allotted to the Seventh Corps Area. Initiated by 1922 with headquarters at Omaha, NE. Reorganized and redesignated 1 July 1936 as HHC, 515th Quartermaster Regiment (Truck-Army) at Augusta, AR. Subordinate battalions organized from existing units as follows: 382nd Motor Transport Command as the 1st Battalion, 383rd Motor Transport Command as the 2nd Battalion, and 384th Motor Transport Command as the 3rd Battalion. Location 7 December 1941—Augusta, AR.

Status: Disbanded 18 October 1943.**Commanders, 515th Quartermaster Regiment**

Unknown	1 Jul 36-7 Dec 41
---------	-------------------

521st Quartermaster Regiment (Heavy Maintenance)**Organized Reserve New York**

HQ-Manhattan, NY, 1936-41



Constituted in the Organized Reserve 15 October 1921 as the 302nd Motor Repair Battalion, assigned to the Fourth Army, and allotted to the Second Corps Area. Initiated by November 1922 with headquarters at Manhattan, NY. Reorganized and redesignated 1 July 1936 as 521st Quartermaster Regiment (Heavy Maintenance), less 2nd and 3rd Battalions at Manhattan. Concurrently, the 2nd and 3rd Battalions organized from existing units as follows: 303rd Motor Repair Battalion as the 2nd Battalion and 314th Motor Repair Battalion as the 3rd Battalion. Reorganized 30 October 1936 at Manhattan by assignment of personnel. Conducted annual summer training at Camp Dix, NJ. Location 7 December 1941—Manhattan, NY.

Commanders, 521st Quartermaster Regiment

Col. Kingsley G. Martin 30 Oct 36-15 Jun 41

522nd Quartermaster Regiment (Heavy Maintenance)**Organized Reserve Pennsylvania**

HQ-Beaver, PA, 1936-41

Constituted in the Organized Reserve 15 October 1921 as the 304th Motor Repair Battalion, assigned to the Fourth Army, and allotted to the Second Corps Area. Initiated 21 April 1922 at Beaver, PA. Reorganized and redesignated 1 July 1936 as 522nd Quartermaster Regiment (Heavy Maintenance), less 2nd and 3rd Battalions, on 1 July 1936 at Beaver, PA. Concurrently, the 2nd and 3rd Battalions organized from existing units as follows: 315th Motor Repair Battalion as the 2nd Battalion and 323rd Motor Repair Battalion as the 3rd Battalion. Location 7 December 1941—Beaver, PA.

Commanders, 522nd Quartermaster Regiment

Unknown 1 Jul 36-7 Dec 41

523rd Quartermaster Regiment (Heavy Maintenance)**Organized Reserve Ohio**

HQ-Akron, OH, 1936-41

Constituted in the Organized Reserve 15 October 1921 as the 307th Motor Repair Battalion, assigned to the Second Army, and allotted to the Fifth Corps Area. Initiated by December 1922 with headquarters at Van Buren, IN. Relocated by December 1924 to Salem, OH. Reorganized and redesignated 1 July 1936 as 523rd Quartermaster Regiment (Heavy Maintenance), less 2nd and 3rd Battalions, at Akron, OH. Concurrently, the 2nd and 3rd Battalions organized from existing units as follows: 308th Motor Repair Battalion as the 2nd Battalion and 313th Motor Repair Battalion as the 3rd Battalion. Location 7 December 1941—Akron, OH.

Commanders, 523rd Quartermaster Regiment

Unknown 1 Jul 36-7 Dec 41

524th Quartermaster Regiment (Heavy Maintenance)**Organized Reserve Illinois**

HQ-Chicago Heights, IL, 1936-41

Constituted in the Organized Reserve 15 October 1921 as the 309th Motor Repair Battalion, assigned to the Sixth Army, and allotted to the Sixth Corps Area. Initiated in 1922 with headquarters at Hinsdale, IL. Relocated by 1928 Chicago Heights, IL. Reorganized and redesignated 1 July 1936 as 524th Quartermaster Regiment (Heavy Maintenance), less 2nd and 3rd Battalions, on 1 July 1936 at Chicago Heights, IL. Concurrently, the 2nd and 3rd Battalions organized from existing units as follows: 318th Motor Repair Battalion as the 2nd Battalion and 319th Motor Repair Battalion as the 3rd Battalion. Location 7 December 1941—Chicago Heights, IL.

Commanders, 524th Quartermaster Regiment

Unknown 1 Jul 36-7 Dec 41

525th Quartermaster Regiment (Heavy Maintenance)

Organized Reserve Wisconsin

HQ-Racine, WI, 1936-41

Constituted in the Organized Reserve 15 October 1921 as the 328th Motor Repair Battalion, assigned to the General Headquarters Reserve, and allotted to the Sixth Corps Area. Initiated in June 1922 with headquarters at Aurora, IL. Relocated 18 April 1924 to Villa Park, IL. Relocated 7 January 1927 to Chicago, IL. Reorganized and redesignated 1 July 1936 as 525th Quartermaster Regiment (Heavy Maintenance), less 2nd and 3rd Battalions, at Racine, WI. Concurrently, the 2nd and 3rd Battalions organized from existing units as follows: 329th Motor Repair Battalion as the 2nd Battalion and 353rd Motor Repair Battalion as the 3rd Battalion. Location 7 December 1941—Racine, WI.

Commanders, 525th Quartermaster Regiment

Unknown 1 Jul 36-7 Dec 41

526th Quartermaster Regiment (Heavy Maintenance)

Organized Reserve Missouri

HQ-Kansas City, MO, 1936-41

Constituted in the Organized Reserve 15 October 1921 as the 343rd Motor Repair Battalion, assigned to the Third Army, and allotted to the Eighth Corps Area. Initiated in February 1923 with headquarters at El Paso, TX. Conducted annual summer training at Fort Bliss, TX. Withdrawn from the Eighth Corps Area 11 January 1927 and allotted to the Seventh Corps Area. Organized in 1927 at St. Louis, MO. Reorganized and redesignated 1 July 1936 as 526th Quartermaster Regiment (Heavy Maintenance), less 2nd and 3rd Battalions, at Kansas City, MO. Concurrently, the 2nd and 3rd Battalions organized from existing units as follows: 359th Motor Repair Battalion as the 2nd Battalion and 360th Motor Repair Battalion as the 3rd Battalion. Location 7 December 1941—Kansas City, MO.

Commanders, 526th Quartermaster Regiment

Unknown 1 Jul 36-7 Dec 41

531st Quartermaster Regiment (Remount) (Colored)

Organized Reserve North Carolina

HQ-Charlotte, NC, 1936-40

Constituted in the Organized Reserve 15 October 1921 as the 372nd Remount Troop, assigned to the Zone of the Interior, and allotted to the Fourth Corps Area. Initiated in 1922 at Charlotte, NC. Reorganized and redesignated 1 July 1936 as HHC, 531st Quartermaster Regiment (Remount). Subordinate battalions organized from existing units as follows: 373rd Remount Troop as the 1st Battalion and 374th Remount Troop as the 2nd Battalion. Regiment reorganized and redesignated 1 July 1940 as the 701st Quartermaster Squadron (Remount).

Status: Disbanded 18 October 1943.

Commanders, 531st Quartermaster Regiment

Unknown 1 Jul 36-1 Jul 40

532nd Quartermaster Regiment (Remount) (GHQR)**Organized Reserve New York****HQ**-Rochester, NY, 1936-40

Constituted in the Organized Reserve 1 July 1936, assigned to the General Headquarters Reserve, and allotted to the Second Corps Area. Initiated in 1936 at Rochester, NY. Regiment reorganized and redesignated 1 July 1940 as the 702nd Quartermaster Squadron (Remount).

Status: Disbanded 18 October 1943.**Commanders, 532nd Quartermaster Regiment**

Unknown	1 Jul 36-1 Jul 40
---------	-------------------

533rd Quartermaster Regiment (Remount) (GHQR)**Organized Reserve Kentucky****HQ**-Danville, KY, 1936-40

Constituted in the Organized Reserve 1 July 1936, assigned to the General Headquarters Reserve, and allotted to the Fifth Corps Area. Initiated in 1936 at Danville, KY. Regiment reorganized and redesignated 1 July 1940 as the 703rd Quartermaster Squadron (Remount).

Status: Disbanded 18 October 1943.**Commanders, 533rd Quartermaster Regiment**

Unknown	1 Jul 36-1 Jul 40
---------	-------------------

541st Quartermaster Regiment (Service) (Colored)**Organized Reserve Tennessee****HQ**-Knoxville, TN, 1936-41

Constituted in the Organized Reserve 15 October 1921 as the 357th Service Battalion, assigned to the Fourth Army, and allotted to the Fourth Corps Area. Initiated by November 1922 with headquarters at Tampa, FL. Reorganized and redesignated 1 July 1936 as 541st Quartermaster Regiment (Service), less 2nd, 3rd, and 4th Battalions, 1 July 1936 at Knoxville, TN. Concurrently, the 2nd, 3rd, and 4th Battalions organized from existing units as follows: 358th Service Battalion as the 2nd Battalion, 359th Service Battalion as the 3rd Battalion, and 360th Service Battalion as the 4th Battalion. Redesignated 1 January 1938 as the 350th Quartermaster Regiment (Service). Concurrently withdrawn from the Organized Reserve and allotted to the Regular Army as an RAI unit. Location 7 December 1941—Knoxville, TN.

Status: Disbanded 18 October 1943**Commanders, 541st Quartermaster Regiment**

Unknown	1 Jul 36-1 Jan 38
---------	-------------------

542nd Quartermaster Regiment (Service) (Colored)**Organized Reserve New York****HQ**-*Not initiated* 1936-37; New York City, NY, 1937-41

Constituted in the Organized Reserve 1 July 1936 and allotted to the Second Corps Area. Initiated by April 1937 with headquarters at New York City, NY. Location 7 December 1941—New York City, NY.

Commanders, 542nd Quartermaster Regiment

Unknown	ao Apr 37-7 Dec 41
---------	--------------------

543rd Quartermaster Regiment (Service) (Colored)**Organized Reserve****HQ**-*Not initiated* 1936-41

Constituted in the Organized Reserve 1 July 1936 and allotted to the Third Corps Area. Unit was apparently not organized. Redesignated 1 January 1938 as the 351st Quartermaster Regiment (Service) (Colored). Concurrently withdrawn from the Organized Reserve and allotted to the Regular Army as an RAI unit. Designated mobilization training station was Camp Lee, VA. Location 7 December 1941—*Not organized*.

Status: Disbanded 18 October 1943**544th Quartermaster Regiment (Service) (Colored)****Organized Reserve Louisiana****HQ**-New Orleans, LA, 1936-41

Constituted in the Organized Reserve 15 October 1921 as the 378th Service Battalion, assigned to the First Army, and allotted to the Fourth Corps Area. Initiated by March 1922 with headquarters at Charlotte, NC. Reorganized and redesignated 1 July 1936 as 544th Quartermaster Regiment (Service), less 1st, 2nd, 3rd, and 4th Battalions, at New Orleans, LA. Concurrently, the 1st, 2nd, 3rd, and 4th Battalions organized from existing units as follows: 379th Service Battalion as the 1st Battalion, 380th Service Battalion as the 2nd Battalion, 381st Service Battalion as the 3rd Battalion, and 382nd Service Battalion as the 4th Battalion. Redesignated 1 January 1938 as the 352nd Quartermaster Regiment (Service) (Colored). Concurrently withdrawn from the Organized Reserve and allotted to the Regular Army as an RAI unit. Location 7 December 1941—New Orleans, LA.

Commanders, 544th Quartermaster Regiment

Unknown 1 Jul 36-1 Jan 38

545th Quartermaster Regiment (Service) (Colored)**Organized Reserve West Virginia****HQ**-*Not initiated* 1936-37; Parkersburg, WV 1937-41

Constituted in the Organized Reserve 1 July 1936 and allotted to the Fifth Corps Area. Initiated by April 1937 with headquarters at Parkersburg, WV. Location 7 December 1941—Parkersburg, WV.

Commanders, 545th Quartermaster Regiment

Unknown ao Apr 37-7 Dec 41

546th Quartermaster Regiment (Service) (Colored)**Organized Reserve Illinois****HQ**-*Not initiated* 1936-37; Chicago, IL, 1937-41

Constituted in the Organized Reserve 1 July 1936 and allotted to the Sixth Corps Area. Initiated by April 1937 with headquarters at Chicago, IL. Location 7 December 1941—Chicago, IL.

Commanders, 546th Quartermaster Regiment

Unknown ao Apr 37-7 Dec 41

547th Quartermaster Regiment (Service) (Colored)**Organized Reserve****HQ**-*Not initiated* 1936-41

Constituted in the Organized Reserve 1 July 1936 and allotted to the Seventh Corps Area. Location 7 December 1941—*Not initiated*.

548th Quartermaster Regiment (Service) (Colored)**Organized Reserve Colorado****HQ-Not initiated** 1936-37; Colorado Springs, CO, 1937-38

Constituted in the Organized Reserve 1 July 1936 and allotted to the Eighth Corps Area. Initiated by June 1937 with headquarters at Colorado Springs, CO. Redesignated 1 January 1938 as the 353rd Quartermaster Regiment (Service) (Colored). Concurrently withdrawn from the Organized Reserve and allotted to the Regular Army as an RAI unit.

Commanders, 548th Quartermaster Regiment

Unknown ao Jun 37-1 Jan 38

549th Quartermaster Regiment (Service) (Colored)**Organized Reserve Georgia/Florida****HQ-Savannah, GA, 1936-40; Miami, FL, 1940-41**

Constituted in the Organized Reserve 1 July 1936 and allotted to the Fourth Corps Area. Initiated 9 October 1936 with headquarters at Savannah, GA. Relocated 24 October 1940 to Miami, FL. Typically conducted Inactive Training Period meetings at the Federal Building in Miami. Location 7 December 1941—Miami, FL, (Inactivated 16 March 1942).

Commanders, 549th Quartermaster Regiment

Unknown 9 Oct 36-7 Dec 41

550th Quartermaster Regiment (Service) (Colored)**Organized Reserve South Carolina****HQ-Charleston, SC, 1936-41**

Constituted in the Organized Reserve 1 July 1936 and allotted to the Fourth Corps Area. Initiated 31 July 1936 with headquarters at Charleston, SC. Location 7 December 1941—Charleston, SC.

Commanders, 550th Quartermaster Regiment

Unknown 31 Jul 36-7 Dec 41

551st Quartermaster Regiment (Service)**Organized Reserve New York****HQ-Not initiated** 1936-40; New York City, NY, 1940-41

Constituted in the Organized Reserve 1 July 1936 and allotted to the Second Corps Area. Initiated by April 1940 with headquarters at New York City, NY. Location 7 December 1941—New York City, NY.

Commanders, 551st Quartermaster Regiment

Unknown ao Apr 40-7 Dec 41

552nd Quartermaster Regiment (Service)**Organized Reserve Michigan****HQ-Not initiated** 1936-37; Lansing, MI, 1937-41

Constituted in the Organized Reserve 1 July 1936 and allotted to the Sixth Corps Area. Initiated 28 June 1937 with headquarters at Lansing, MI. Location 7 December 1941—Lansing, MI.

Commanders, 552nd Quartermaster Regiment

Unknown 28 Jun 37-7 Dec 41

571st Quartermaster Battalion (Car) (GHQR)**Organized Reserve New Jersey****HQ**-Englewood NJ 1936-37; *Inactive* 1937-40

Constituted in the Organized Reserve 29 July 1921 as the 387th Motorcycle Company, assigned to the First Army, and allotted to the Second Corps Area. Initiated by March 1922 with headquarters at Manhattan, NY. Reorganized and redesignated 1 July 1936 as the 571st Quartermaster Battalion (Car). Concurrently relocated to Englewood, NJ. Inactivated by April 1937 at Englewood by relief of personnel. HHD disbanded 1 June 1940.

572nd Quartermaster Battalion (Car) (GHQR)**Organized Reserve Michigan****HQ**-Detroit, MI, 1936-40

Constituted in the Organized Reserve 29 July 1921 as the 351st Motorcycle Company, assigned to the Second Army, and allotted to the Sixth Corps Area. Initiated by March 1922 with headquarters at Detroit, MI. Reorganized and redesignated 1 July 1936 as 572nd Quartermaster Battalion (Car) at Detroit. HHD disbanded 1 June 1940.

591st Quartermaster Battalion (Light Maintenance)**Organized Reserve District of Columbia****HQ**-Washington, DC 1936-39; *Inactive* 1939-41

Constituted in the Organized Reserve 15 October 1921 as the 390th Motor Repair Section, assigned to the III Corps, and allotted to the Third Corps Area. Initiated by July 1923 with headquarters at Washington, DC. Reorganized and redesignated 1 July 1936 as HHC, 591st Quartermaster Battalion, less 1st, 2nd, 3rd, and 4th Battalions, at Washington, DC. Typically conducted Inactive Training Period meetings at the Graham Building at 1402 E Street, NW, in Washington. Inactivated by August 1939 at Washington, DC, by relief of personnel. Location 7 December 1941—*Inactive*.

599th Quartermaster Battalion (Light Maintenance)**Organized Reserve California****HQ**-San Francisco, CA, 1936-40; *Inactive* 1940-41

Constituted in the Organized Reserve 29 July 1921 as the 335th Motor Transport Command, assigned to the XIX Corps, and allotted to the Ninth Corps Area. Initiated by 1922 with headquarters at San Francisco, CA. Reorganized and redesignated 1 July 1936 as 1st Battalion, 499th Quartermaster Regiment (Light Maintenance). Conducted annual summer training at Camp Ord, CA. Regiment, less 1st Battalion, disbanded 1 June 1940. The 1st Battalion reorganized and redesignated 1 June 1940 as the 599th Quartermaster Battalion (Light Maintenance). Inactivated 1 October 1940 at San Francisco by relief of personnel. Location 7 December 1941—*Inactive*.

611th Quartermaster Battalion (Bakery) (GHQR)**Organized Reserve New York****HQ**- New York City, NY, 1936-41

Constituted in the Regular Army 1 July 1936, assigned to the General Headquarters Reserve, and allotted to the Second Corps Area. Initiated about 1936 with Organized Reserve personnel as a RAI unit at New York City, NY. Designated mobilization training station was Camp Lee, VA. Location 7 December 1941—New York City, NY.

612th Quartermaster Battalion (Bakery) (GHQR)

Organized Reserve New York

HQ-*Not initiated* 1936-38; New York City, NY, 1938-41

Constituted in the Organized Reserve 2 July 1923 as the 604th Bakery Company, assigned to the General Headquarters Reserve, and allotted to the Second Corps Area. Reorganized and redesignated 1 July 1936 as HHC, 612th Quartermaster Battalion (Bakery) at New York City, NY. Initiated 17 March 1938 with headquarters at New York City. Location 7 December 1941—New York City, NY.

613th Quartermaster Battalion (Bakery)

Organized Reserve New York

HQ-*Not initiated* 1936-38; New York City, NY, 1938-41

Constituted in the Organized Reserve 2 July 1923 as the 705th Bakery Company, assigned to the General Headquarters Reserve, and allotted to the Second Corps Area. Reorganized and redesignated 1 July 1936 as HHC, 612th Quartermaster Battalion (Bakery) at New York City, NY. Initiated 24 March 1938 with headquarters at New York City. Designated mobilization training station was Camp Lee, VA. Location 7 December 1941—New York City, NY.

614th Quartermaster Battalion (Bakery)

Organized Reserve

HQ-*Not initiated* 1936-41

Constituted in the Organized Reserve 2 July 1923 as the 630th Bakery Company, assigned to the General Headquarters Reserve, and allotted to the Third Corps Area. Reorganized and redesignated 1 July 1936 as HHC, 614th Quartermaster Battalion (Bakery). Location 7 December 1941—*Not initiated*.

615th Quartermaster Battalion (Bakery) (GHQR)

Organized Reserve Pennsylvania

HQ-Bethlehem, PA, 1936-41

Constituted in the Organized Reserve 2 July 1923 as the 606th Bakery Company, assigned to the General Headquarters Reserve, and allotted to the Third Corps Area. Initiated in 1929 at Bethlehem, PA. Reorganized and redesignated 1 July 1936 as HHC, 615th Quartermaster Battalion (Bakery). Location 7 December 1941—Bethlehem, PA.

Status: Active in the U. S. Army Reserve at Stigler, OK, as the 316th Quartermaster Battalion.

616th Quartermaster Battalion (Bakery)

Organized Reserve

HQ-*Not initiated* 1936-41

Constituted in the Organized Reserve 2 July 1923 as the 612th Bakery Company, assigned to the General Headquarters Reserve, and allotted to the Fifth Corps Area. Reorganized and redesignated 1 July 1936 as HHC, 616th Quartermaster Battalion (Bakery). Location 7 December 1941—*Not initiated*.

617th Quartermaster Battalion (Bakery) (GHQR)

Organized Reserve Indiana

HQ-Indianapolis, IN, 1936-41

Constituted in the Organized Reserve 2 July 1923 as the 613th Bakery Company, assigned to the General Headquarters Reserve, and allotted to the Fifth Corps Area. Organized by 1936 at Indianapolis, IN. Reorganized and redesignated 1 July 1936 as HHC, 617th Quartermaster Battalion (Bakery). Location 7 December 1941—Indianapolis, IN.

618th Quartermaster Battalion (Bakery) (GHQR)

Organized Reserve Illinois

HQ-*Not initiated* 1936-37; Chicago, IL, 1937-41

Constituted in the Organized Reserve 2 July 1923 as the 615th Bakery Company, assigned to the General Headquarters Reserve, and allotted to the Sixth Corps Area. Initiated 27 April 1937 at Chicago, IL. Reorganized and redesignated 1 July 1936 as HHC, 618th Quartermaster Battalion (Bakery). Location 7 December 1941—Chicago, IL.

Status: Active in the U. S. Army Reserve at Montgomery, AL, as HHD, 361st Support Battalion.

619th Quartermaster Battalion (Bakery) (GHQR)

Organized Reserve Illinois

HQ-Chicago, IL, 1936-41

Constituted in the Organized Reserve 2 July 1923 as the 639th Bakery Company, assigned to the General Headquarters Reserve, and allotted to the Sixth Corps Area. Initiated by 1936 at Chicago, IL. Reorganized and redesignated 1 July 1936 as the 618th Quartermaster Battalion (Bakery). Location 7 December 1941—Chicago, IL.

620th Quartermaster Battalion (Bakery) (GHQR)

Organized Reserve

HQ-*Not initiated* 1936-41

Constituted in the Regular Army 1 July 1936, assigned to the General Headquarters Reserve, and allotted to the Fourth Corps Area. Location 7 December 1941—*Not initiated*.

621st Quartermaster Battalion (Bakery) (GHQR)

Organized Reserve

HQ-*Not initiated* 1936-41

Constituted in the Organized Reserve 2 July 1923 as the 634th Bakery Company, assigned to the General Headquarters Reserve, and allotted to the Fourth Corps Area. Reorganized and redesignated 1 July 1936 as HHC, 621st Quartermaster Battalion (Bakery). Location 7 December 1941—*Not initiated*.

622nd Quartermaster Battalion (Bakery) (GHQR)

Organized Reserve New York

HQ-New York City, NY, 1936-41

Constituted in the Organized Reserve 1 July 1936, assigned to the General Headquarters Reserve, and allotted to the Second Corps Area. Organized about 1936 with Initiated Reserve personnel as a RAI unit at New York City, NY. Designated mobilization training station was Camp Lee, VA. Location 7 December 1941—New York City, NY.

623rd Quartermaster Battalion (Bakery) (GHQR)

Organized Reserve New York

HQ-New York City, NY, 1936-41

Constituted in the Organized Reserve 1 July 1936, assigned to the General Headquarters Reserve, and allotted to the Second Corps Area. Organized about 1936 with Initiated Reserve personnel as a RAI unit at New York City, NY. Designated mobilization training station was Camp Lee, VA. Location 7 December 1941—New York City, NY.

624th Quartermaster Battalion (Bakery) (GHQR)

Organized Reserve

HQ—*Not initiated* 1936-41

Constituted in the Organized Reserve 2 July 1923 as the 618th Bakery Company, assigned to the General Headquarters Reserve, and allotted to the Seventh Corps Area. Location 7 December 1941—*Not initiated*.

625th Quartermaster Battalion (Bakery) (GHQR)

Organized Reserve

HQ—*Not initiated* 1936-41

Constituted in the Organized Reserve 2 July 1923 as the 642nd Bakery Company, assigned to the General Headquarters Reserve, and allotted to the Seventh Corps Area. Location 7 December 1941—*Not initiated*.

626th Quartermaster Battalion (Bakery) (GHQR)

Organized Reserve Illinois

HQ-Chicago, IL, 1936-41

Constituted in the Organized Reserve 1 July 1936, assigned to the General Headquarters Reserve, and allotted to the Sixth Corps Area. Initiated by 1936 at Chicago, IL. Location 7 December 1941—Chicago, IL.

641st Quartermaster Battalion (Wagon) (GHQR)

Organized Reserve North Carolina

HQ-Charlotte, NC, 1936-41

Constituted in the Regular Army 1 July 1936, assigned to the General Headquarters Reserve, and allotted to the Fourth Corps Area. Initiated about 1936 at Charlotte, NC. Location 7 December 1941—Charlotte, NC.

Status: Disbanded 18 October 1943

642nd Quartermaster Battalion (Wagon) (GHQR)

Organized Reserve North Dakota

HQ-Minot, ND, 1936-41

Constituted in the Organized Reserve 29 July 1921 as the 469th Wagon Company, General Headquarters Reserve, and allotted to the Seventh Corps Area. Initiated by March 1922 with headquarters at Minot, ND. Reorganized and redesignated 1 July 1936 as 642nd Quartermaster Battalion (Wagon) at Minot. Location 7 December 1941—Minot, ND.

Status: Disbanded 18 October 1943

643rd Quartermaster Battalion (Wagon) (GHQR)

Organized Reserve New York

HQ-Rochester, NY, 1936-41

Constituted in the Regular Army 1 July 1936, assigned to the General Headquarters Reserve, and allotted to the Second Corps Area. Initiated about 1936 at Rochester, NY. Location 7 December 1941—Rochester, NY.

Status: Disbanded 18 October 1943

661st Quartermaster Battalion (Sales Commissary) (GHQR)

Organized Reserve New York

HQ-*Not initiated* 1936-38; New York City, NY, 1938-41

Constituted in the Organized Reserve 2 July 1923 as the 328th Sales Commissary Unit, assigned to the General Headquarters Reserve, and allotted to the Second Corps Area. Reorganized and redesignated 1 July 1936 as HHC, 661st Quartermaster Battalion (Sales Commissary). Initiated 17 March 1938 with headquarters at New York City. Location 7 December 1941—New York City, NY.

662nd Quartermaster Battalion (Sales Commissary) (GHQR)

Organized Reserve Ohio

HQ-Cleveland, OH, 1936-41

Constituted in the Organized Reserve 2 July 1923 as the 337th Sales Commissary Unit, assigned to the General Headquarters Reserve, and allotted to the Fifth Corps Area. Reorganized and redesignated 1 July 1936 as HHC, 662nd Quartermaster Battalion (Sales Commissary). Initiated about 1936 with Organized Reserve personnel at Cleveland, OH. Location 7 December 1941—Cleveland, OH.

671st Quartermaster Battalion (Salvage) (GHQR)

Organized Reserve New York

HQ-*Not initiated* 1936-38; New York City, NY, 1938-41

Constituted in the Organized Reserve 2 July 1923 as the 755th Salvage Company, assigned to the General Headquarters Reserve, and allotted to the Second Corps Area. Reorganized and redesignated 1 July 1936 as HHC, 671st Quartermaster Battalion (Salvage). Initiated 17 March 1938 with headquarters at New York City. Designated mobilization training station was Camp Lee, VA. Location 7 December 1941—New York City, NY.

672nd Quartermaster Battalion (Salvage)

Organized Reserve Illinois

HQ-Chicago, IL, 1936-41

Constituted in the Organized Reserve 2 July 1923 as the 768th Salvage Company, assigned to the General Headquarters Reserve, and allotted to the Sixth Corps Area. Reorganized and redesignated 1 July 1936 as HHC, 672nd Quartermaster Battalion (Salvage). Initiated about 1936 with Organized Reserve personnel at Chicago, IL. Location 7 December 1941—Chicago, IL.

673rd Quartermaster Battalion (Salvage) (C) (GHQR)

Organized Reserve North Carolina

HQ-Wilmington, NC, 1936-41

Constituted in the Organized Reserve 2 July 1923 as the 804th Salvage Company, assigned to the General Headquarters Reserve, and allotted to the Fourth Corps Area. Reorganized and redesignated 1 July 1936 as HHC, 673rd Quartermaster Battalion (Salvage). Initiated about 1936 with Organized Reserve personnel at Wilmington, NC. Location 7 December 1941—Wilmington, NC.

674th Quartermaster Battalion (Salvage)

Organized Reserve California

HQ-Los Angeles, CA, 1936-40; *Inactive* 1940-41

Constituted in the Organized Reserve 2 July 1923 as the 775th Salvage Company, assigned to the General Headquarters Reserve, and allotted to the Ninth Corps Area. Reorganized and redesignated 1 July 1936 as HHC, 674th Quartermaster Battalion (Salvage). Initiated about 1936 with Organized Reserve personnel at Los Angeles, CA. Typically conducted Inactive Training Period meetings at the Chamber of Commerce Building in Los Angeles. Inactivated 1 October 1940 at Los Angeles by relief of personnel. Location 7 December 1941—*Inactive*.

681st Quartermaster Battalion (Clothing & Bath)

Organized Reserve New York

HQ-*Not initiated* 1936-38; New York City, NY, 1938-41

Constituted in the Organized Reserve 2 July 1923 as the 304th Clothing & Bath Unit, assigned to the General Headquarters Reserve, and allotted to the Second Corps. Reorganized and redesignated 1 July 1936 as HHC, 681st Quartermaster Battalion (Clothing & Bath). Initiated 24 March 1938 with headquarters at New York City. Designated mobilization training station was Camp Lee, VA. Location 7 December 1941—New York City, NY.

682nd Quartermaster Battalion (Clothing & Bath)

Organized Reserve Ohio

HQ-Columbus, OH, 1936-41

Constituted in the Organized Reserve 2 July 1923 as the 306th Clothing & Bath Unit, assigned to the General Headquarters Reserve, and allotted to the Fifth Corps Area. Reorganized and redesignated 1 July 1936 as HHC, 682nd Quartermaster Battalion (Clothing & Bath). Initiated about 1936 with Organized Reserve personnel as a RAI unit at Columbus, OH. Location 7 December 1941—Columbus, OH.

683rd Quartermaster Battalion (Clothing & Bath)

Organized Reserve Ohio

HQ-Cincinnati, OH, 1936-41

Constituted in the Organized Reserve 2 July 1923 as the 312th Clothing & Bath Unit, assigned to the General Headquarters Reserve, and allotted to the Fifth Corps Area. Reorganized and redesignated 1 July 1936 as HHC, 683rd Quartermaster Battalion (Clothing & Bath). Initiated about 1936 with Organized Reserve personnel as a RAI unit at Cincinnati, OH. Location 7 December 1941—Cincinnati, OH.

684th Quartermaster Battalion (Clothing & Bath)**Organized Reserve Michigan****HQ**-Detroit, MI, 1936-41

Constituted in the Organized Reserve 2 July 1923 as the 315th Clothing & Bath Unit, assigned to the General Headquarters Reserve, and allotted to the Sixth Corps Area. Reorganized and redesignated 1 July 1936 as HHC, 684th Quartermaster Battalion (Clothing & Bath). Initiated about 1936 with Organized Reserve personnel as a RAI unit at Detroit, MI. Location 7 December 1941—Detroit, MI.

691st Quartermaster Battalion (Laundry) (GHQR)**Organized Reserve New York****HQ**-*Not initiated* 1936-37; New York City, NY, 1937-41

Constituted in the Organized Reserve 1 July 1936, assigned to the General Headquarters Reserve, and allotted to the Second Corps Area. Initiated in 1937 at New York City, NY. Location 7 December 1941—New York City, NY.

692nd Quartermaster Battalion (Laundry) (GHQR)**Organized Reserve New York****HQ**-*Not initiated* 1936-37; New York City, NY, 1937-39; *Inactive* 1939-41

Constituted in the Organized Reserve 2 July 1923 as the 731st Laundry Company, assigned to the General Headquarters Reserve, and allotted to the Second Corps Area. Reorganized and redesignated 1 July 1936 as HHC, 692nd Quartermaster Battalion (Laundry). Initiated in 1937 at New York City, NY. Inactivated by June 1939 at New York City by relief of personnel. Location 7 December 1941—*Inactive*.

693rd Quartermaster Battalion (Laundry) (GHQR)**Organized Reserve****HQ**-*Not initiated* 1936-41

Constituted in the Organized Reserve 2 July 1923 as the 734th Laundry Company, assigned to the General Headquarters Reserve, and allotted to the Fourth Corps Area. Reorganized and redesignated 1 July 1936 as HHC, 693rd Quartermaster Battalion (Laundry). Location 7 December 1941—*Not initiated*.

694th Quartermaster Battalion (Laundry) (GHQR)**Organized Reserve New York****HQ**-*Not initiated* 1936-37; New York City, NY, 1937-41

Constituted in the Organized Reserve 1 July 1936, assigned to the General Headquarters Reserve, and allotted to the Second Corps Area. Initiated in 1937 at New York City, NY. Location 7 December 1941—New York City, NY.

Status: Active in the U. S. Army Reserve at Cleveland, OH, as the 319th Quartermaster Battalion.

695th Quartermaster Battalion (Laundry) (GHQR)**Organized Reserve****HQ**-*Not initiated* 1936-41

Constituted in the Organized Reserve 2 July 1923 as the 740th Laundry Company, assigned to the General Headquarters Reserve, and allotted to the Fifth Corps Area. Reorganized and redesignated 1 July 1936 as HHC, 695th Quartermaster Battalion (Laundry). Location 7 December 1941—*Not initiated*.

696th Quartermaster Battalion (Laundry) (GHQR)

Organized Reserve

HQ-*Not initiated* 1936-41

Constituted in the Organized Reserve 2 July 1923 as the 743rd Laundry Company, assigned to the General Headquarters Reserve, and allotted to the Sixth Corps Area. Reorganized and redesignated 1 July 1936 as HHC, 696th Quartermaster Battalion (Laundry). Location 7 December 1941—*Not initiated*.

697th Quartermaster Battalion (Laundry) (GHQR)

Organized Reserve

HQ-*Not initiated* 1936-41

Constituted in the Organized Reserve 1 July 1936, assigned to the General Headquarters Reserve, and allotted to the Seventh Corps Area. Location 7 December 1941—*Not initiated*.

698th Quartermaster Battalion (Laundry) (GHQR)

Organized Reserve New York

HQ-*Not initiated* 1936-37; New York City, NY, 1937-41

Constituted in the Organized Reserve 1 July 1936, assigned to the General Headquarters Reserve, and allotted to the Second Corps Area. Initiated in 1937 at New York City, NY. Location 7 December 1941—New York City, NY.

699th Quartermaster Battalion (Laundry) (GHQR)

Organized Reserve

HQ-*Not initiated* 1936-39; Third Corps Area 1939-41

Constituted in the Organized Reserve 1 July 1936, assigned to the General Headquarters Reserve, and allotted to the Third Corps Area. Initiated 1 October 1939 in the Third Corps Area. Location 7 December 1941—Third Corps Area.

711th Quartermaster Battalion (Graves Registration)

Organized Reserve New York

HQ-*Not initiated* 1936-38; New York City, NY, 1938-41

Constituted in the Organized Reserve 2 July 1923 as the 350th Graves Registration Unit, assigned to the General Headquarters Reserve, and allotted to the Second Corps Area. Reorganized and redesignated 1 July 1936 as HHC, 711th Quartermaster Battalion (Graves Registration). Initiated 17 March 1938 with headquarters at New York City. Location 7 December 1941—New York City, NY.

712th Quartermaster Battalion (Graves Registration)

Organized Reserve Michigan

HQ-Detroit, MI, 1936-41

Constituted in the Organized Reserve 2 July 1923 as the 354th Graves Registration Unit, assigned to the General Headquarters Reserve, and allotted to the Sixth Corps Area. Reorganized and redesignated 1 July 1936 as HHC, 712th Quartermaster Battalion (Graves Registration). Initiated 24 November 1936 at Detroit, MI. Location 7 December 1941—Detroit, MI.

713th Quartermaster Battalion (Graves Registration)

Organized Reserve

HQ—*Not initiated* 1936-41

Constituted in the Organized Reserve 2 July 1923 as the 352nd Graves Registration Unit, assigned to the General Headquarters Reserve, and allotted to the Fourth Corps Area. Reorganized and redesignated 1 July 1936 as HHC, 713th Quartermaster Battalion (Graves Registration). Location 7 December 1941—*Not initiated*.

714th Quartermaster Battalion (Graves Registration)

Organized Reserve

HQ—*Not initiated* 1936-41

Constituted in the Organized Reserve 2 July 1923 as the 355th Graves Registration Unit, assigned to the General Headquarters Reserve, and allotted to the Seventh Corps Area. Reorganized and redesignated 1 July 1936 as HHC, 714th Quartermaster Battalion (Graves Registration). Location 7 December 1941—*Not initiated*.

Chapter 44

Port and Embarkation Organizations

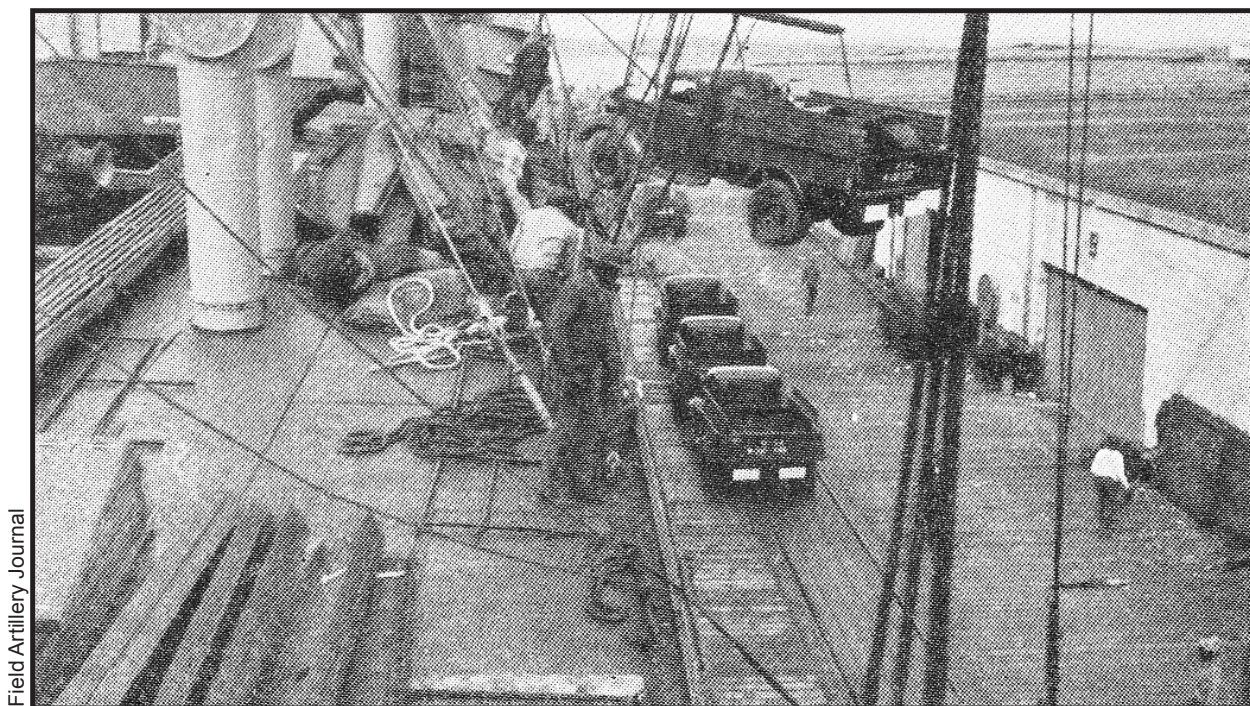

Field Artillery Journal

Port and Embarkation Units. Port handling personnel load an army truck on a US Army transport.

Port and embarkation organizations provided the Army its ability to manage port, embarkation, and debarkation operations as well as load and unload the large number of vessels required to transport the troops, animals, equipment, and other supplies of the Army by sea.

Organization

The Quartermaster Corps possessed three primary kinds of port organizations in the interwar period. These were the embarkation center command, the port headquarters, and port battalions. The embarkation center commands were essentially large personnel management organizations designed to manage the reception, movement, support, and manifesting of large numbers of troops arriving at or departing from a seaport. The commands included attached (not assigned) elements to support and sustain their assigned and transient personnel. These included motor transportation units, bakery and messing units, medical and veterinary units, and engineers. The commands also included several camps and stations for the temporary housing of transient personnel.

Port Headquarters, 1928

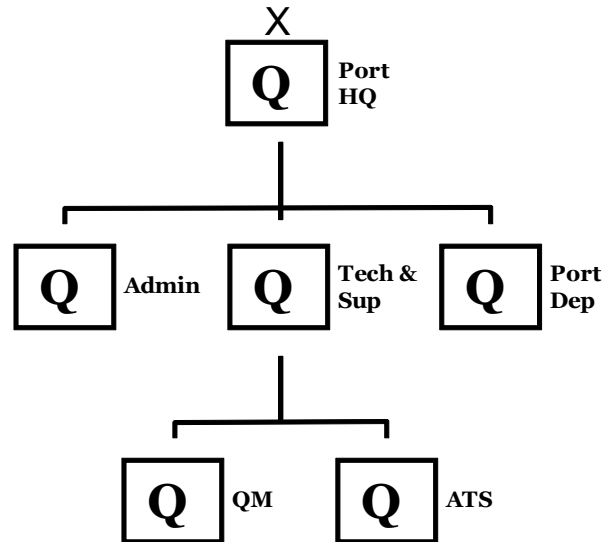

T/O: 692W
 Approved: 12 May 1928
 Commander: Brig. Gen.
 Officers: 133
 W. O.: 1
 Nurses: 1
 Enlisted: 175
 Total: 310

Additional units such as port battalions, motor transport companies, service companies, medical dispensaries, etc., were attached to port headquarters based on the throughput capacity of each port.

Port HQ TOE.

Port headquarters managed the reception, movement, and manifesting of equipment, animals, and supplies arriving at or departing from a seaport. In addition to a number of attached port battalions (the number being determined by the throughput of the seaport), the port headquarters also received additional attachments to support various operations of the port.

Port Battalion, 1929

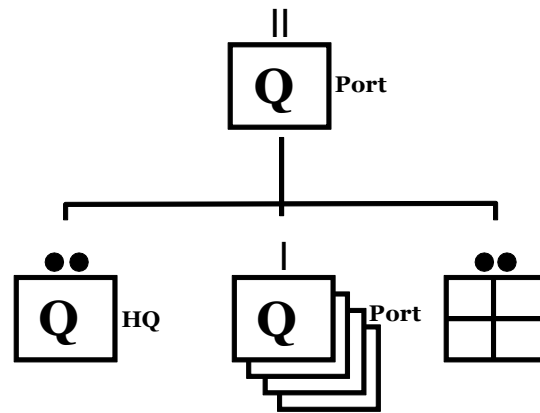

T/O:	693W
Approved:	1 July 1929
Commander:	Lt. Col.
Officers:	46
W. O.:	--
Enlisted:	1,184
Total:	1,230

Port Battalion TOE.

Port battalions conducted the reception, positioning, loading, and unloading of equipment, animals, and supplies arriving at, or departing from, a seaport. The battalion consisted of a headquarters section and four port handling companies.

Training

The active Regular Army embarkation commands at New York and San Francisco performed their mission on a daily basis. The training of those organizations was presumably focused on integrating personnel newly assigned to the command or on newly adopted port, embarkation, or debarkation procedures and operations.

There is no evidence that any of the Organized Reserve and Regular Army Inactive port organizations were functional units during the Inactive Training Period. Most of the assigned personnel probably attended training at quartermaster conferences or with other units (see Chapter 37-Quartermaster Trains for a more detailed explanation of quartermaster training). Only four of these organizations were known to have attended summer training as units.

HQ, New York Port of Embarkation

HQ—Army Base Brooklyn, NY, 1919-20; *Inactive* 1920-32; Army Base Brooklyn, NY, 1932-41

Active at Hoboken, NJ, as of January 1919. Managed the reception of the American Expeditionary Force from France in 1919. The ports of Boston and Baltimore functioned as subports of the NYPOE. The NYPOE also managed the transport, support, and return of the American Forces in Germany during 1919-23. Additionally, the NYPOE managed the transport of personnel to and from Army garrisons in Puerto Rico and the Panama, Canal Zone until the command was discontinued on 24 April 1920. These duties were then returned to the General Superintendent, Army Transport Service at Brooklyn. Reestablished 6 May 1932 with headquarters at the Army Base Brooklyn, NY. The command assumed control of the Atlantic branch of the Army Transport Service and the New York General Quartermaster Depot at the Army Base Brooklyn, and the Overseas Replacement and Discharge Service at Fort Slocum, NY. Location 7 December 1941—Army Base Brooklyn, NY.

Commanders, New York Port of Embarkation

Brig. Gen. William M. Wright	1 Jul 17-1 Aug 17	Brig. Gen. Thomas W. Darrah	21 Sep 34-15 May 37
Maj. Gen. David C. Shanks	1 Aug 17-9 Sep 18	Col. George C. Lewis	15 May 37-30 Jun 37
Brig. Gen. William V. Judson	9 Sep 18-19 Nov 18	Brig. Gen. Walter S. Grant	30 Jun 37-25 Mar 38
Brig. Gen. George H. McManus	19 Nov 18-5 Dec 18	Col. George C. Lewis	25 Mar 38-6 Jul 38
Maj. Gen. David C. Shanks	5 Dec 18-24 Apr 20	Brig. Gen. Evan H. Humphrey	6 Jul 38-31 Mar 39
<i>Inactive</i>	24 Apr 20-6 May 32	Maj. Gen. Frank W. Rowell	1 Apr 39-6 Jul 40
Brig. Gen. Louis M. Nuttman	6 May 32-8 Jan 34	Col. Conseulo A. Seoane	6 Jul 40-30 Sep 40
Brig. Gen. John W. Gulick	8 Jan 34-14 Sep 37	Col. O. S. Albright	30 Sep 40-7 Nov 40
	Maj. Gen. Homer M. Groninger	7 Nov 40-30 Jun 45	

HQ, San Francisco Port of Embarkation

HQ—Fort Mason, San Francisco, CA, 1932-41

Established 6 May 1932 with headquarters at Fort Mason, CA. The command assumed control of the Pacific branch of the Army Transport Service and the San Francisco General Quartermaster Depot at Fort Mason, and the Overseas Replacement and Discharge Service at Fort McDowell, CA. Location 7 December 1941—Fort Mason, CA.

Commanders, San Francisco Port of Embarkation

Brig. Gen. Charles S. Lincoln	6 May 32-26 Jan 35	Brig. Gen. Duncan A. Major	13 Oct 38-1 Feb 40
Brig. Gen. James A. Woodruff	9 Feb 35-12 Mar 36	Col. Arthur E. Ahrends	1 Feb 40-31 Jul 40
Col. Arthur E. Ahrends	12 Mar 36-23 Jan 37	Unknown	31 Jul 40-Oct 40
Brig. Gen. Robert S. Abernathy	23 Jan 37-4 Aug 38	Brig. Gen. John C. H. Lee	Oct 40-14 Nov 41
Col. Arthur E. Ahrends	4 Aug 38-13 Oct 38	Maj. Gen. Frederick Gilbreath	14 Nov 41-15 Jun 44

HQ, Newport News Port of Embarkation

HQ—Newport News, VA, 1919

Active at Newport News, VA, as of January 1919. Managed the reception of American Expeditionary Force units returning from France in 1919. The port of Charleston functioned as a subport of the NNPOE. The port was discontinued in December 1919.

Commanders, Newport News Port of Embarkation

Maj. Gen. Grote Hutcheson	27 Jul 17-12 Nov 18	Maj. Gen. Adelbert Cronkhite	29 May 19-16 Sep 19
Brig. Gen. Harley B. Ferguson	12 Nov 18-29 May 19	Col. Ellison L. Gilmer	16 Sep 19-2 Oct 19
	Brig. Gen. George H. McManus	2 Oct 19-23 Dec 19	

HQ, New Orleans Port of Embarkation

HQ—New Orleans, LA, 1941

Established in the Regular Army on 15 June 1941 at New Orleans, LA. The command assumed control of the New Orleans Quartermaster Depot and Jackson Barracks, LA. Location 7 December 1941—New Orleans, LA.

Commanders, New Orleans Port of Embarkation

Brig. Gen. George B. Hunter 3 Jul 41-30 Sep 43

1st Embarkation Center Command

Regular Army Inactive

HQ-Not organized 1933-36; New York City, NY, 1936-41

Constituted in the Regular Army 1 October 1933, allotted to the Second Corps Area, and assigned to the General Headquarters Reserve. Organized 30 October 1936 with headquarters at New York City, NY. Mobilization mission was to reinforce the command functions of the New York Port of Embarkation. Designated mobilization station was the Brooklyn Army Base, NY.

Commanders, 1st Embarkation Center Command

Capt. Selsen F. Wheeler 30 Oct 36-ao May 37 Unknown ao May 37-7 Dec 41

** RAI Commanders: Organized Reserve officers.

2nd Embarkation Center Command

Regular Army Inactive

HQ-Not organized 1933-38; San Francisco, CA, 1938-41

Constituted in the Regular Army 1 October 1933, allotted to the Ninth Corps Area, and assigned to the General Headquarters Reserve. Organized 2 February 1938 with headquarters at San Francisco, CA. Mobilization mission was to reinforce the command functions of the San Francisco Port of Embarkation. Designated mobilization station was Fort Mason, CA.

Commanders, 2nd Embarkation Center Command

Maj. James O. Jenson** 2 Feb 38-ao May 39 Unknown ao May 39-7 Dec 41

** RAI Commanders: Organized Reserve officers.

501st Embarkation Center Command

Organized Reserve New York

HQ-Not initiated 1928-29; New York City, NY, 1929-36

Constituted in the Organized Reserve 5 September 1928, allotted to the Second Corps Area, and assigned to the General Headquarters Reserve. Initiated 9 November 1929 with headquarters at New York City, NY. Mobilization mission was to reinforce the command functions of the New York Port of Embarkation. Assigned by June 1931 to the Second Corps Area Service Command. Demobilized 1 July 1936.

Commanders, 501st Embarkation Center Command

Capt. Frank K. John	9 Nov 29-9 Jan 30	Col. Lemuel C. Bolles	22 Mar 34-15 Apr 35
Lt. Col. Stanley Bulkley	9 Jan 30-2 Nov 31	Col. Jerome Kingsbury	15 Apr 35-12 Jun 35
Col. Walter H. Metcalf	2 Nov 31-22 Mar 34	Unknown	12 Jun 35-19 Nov 35
	Lt. Col. Harry C. Byrnes	19 Nov 35-1 Jul 36	

502nd Embarkation Center Command

Organized Reserve Louisiana

HQ-Not initiated 1928-32; New Orleans, LA, 1932-36

Constituted in the Organized Reserve 5 September 1928, allotted to the Fourth Corps Area, and assigned to the General Headquarters Reserve. Initiated 23 August 1932 with headquarters at New Orleans, LA. Mobilization mission was to reestablish and assume command of the New Orleans Port of Embarkation. Demobilized 1 July 1936.

Commanders, 502nd Embarkation Center Command

Unknown 23 Aug 32-1 Jul 36

503rd Embarkation Center Command

Organized Reserve Ohio

HQ-Not initiated 1928-29; Cleveland, OH, 1929-30; *Inactive* 1930-36

Constituted in the Organized Reserve 5 September 1928, allotted to the Fifth Corps Area, and assigned to the General Headquarters Reserve. Initiated by December 1929 with headquarters at Cleveland, OH. Inactivated by Mar 30 at Cleveland, OH. Demobilized 1 July 1936.

Commanders, 503rd Embarkation Center Command

Unknown Dec 29-Mar 30 *Inactive* Mar 30-1 Jul 36

504th Embarkation Center Command

Organized Reserve

HQ-Not initiated 1928-36

Constituted in the Organized Reserve 5 September 1928, allotted to the Seventh Corps Area, and assigned to the General Headquarters Reserve. Demobilized 1 July 1936.

505th Embarkation Center Command

Organized Reserve California

HQ-Not initiated 1928-31; San Francisco, CA, 1931-36

Constituted in the Organized Reserve 5 September 1928, allotted to the Ninth Corps Area, and assigned to the General Headquarters Reserve. Initiated by June 1931 with headquarters at San Francisco, CA. Mobilization mission was to reinforce the command functions of the San Francisco Port of Embarkation. Designated mobilization station was Fort Mason, CA. Conducted summer training in 1932 and 1934 at the Presidio of Monterey, CA. Demobilized 1 July 1936.

Commanders, 505th Embarkation Center Command

Lt. Col. Orvin D. Miller ao Jun 31-8 Dec 35 Lt. Col. Oliver H. Balch 8 Dec 35-1 Jul 36

501st Port Headquarters

Organized Reserve Massachusetts

HQ-Not initiated 1928-29; Boston, MA, 1929-36

Constituted in the Organized Reserve 5 September 1928, allotted to the First Corps Area, and assigned to the General Headquarters Reserve. Initiated 17 October 1929 with headquarters at Boston, MA. Mobilization mission was to reestablish and assume command of the Army port operations at Boston Harbor. Demobilized 1 July 1936.

Commanders, 501st Port Headquarters

Maj. Leon C. Cox 17 Oct 29-1 Jul 36

502nd Port Headquarters

Organized Reserve New Jersey

HQ-Not initiated 1928-29; Hoboken, NJ, 1929-36

Constituted in the Organized Reserve 5 September 1928, allotted to the Second Corps Area, and assigned to the General Headquarters Reserve. Initiated 9 November 1929 with headquarters at Hoboken, NJ. Mobilization mission was to reestablish and assume command of the Army port operations at Hoboken. Assigned by June 1931 to the Second Corps Area Service Command. Demobilized 1 July 1936.

Commanders, 502nd Port Headquarters

Maj. George A. Hauck	9 Nov 29-9 Jan 30	Lt. Col. Eugene H. Valle	16 Feb 31-25 Apr 32
Lt. Col. Arthur A. Stewart	9 Jan 30-16 Feb 31	Lt. Col. Warren B. Bullock	25 Apr 32-Jun 35
	Lt. Col. Robert M. Falkenau	Jun 35-1 Jul 36	

503rd Port Headquarters

Organized Reserve Maryland

HQ-Not initiated 1928-30; Baltimore, MD, 1930-36

Constituted in the Organized Reserve 5 September 1928, allotted to the Third Corps Area, and assigned to the General Headquarters Reserve. Initiated 13 January 1930 with headquarters at Baltimore, MD. Mobilization mission was to reestablish and assume command of the Army port operations at Baltimore Harbor. Demobilized 1 July 1936.

Commanders, 503rd Port Headquarters

Lt. Co. John Truitt	13 Jan 30-1 Feb 30	Col. Charles I. Faddis	18 Jul 30-23 Sep 30
Lt. Col. Thomas Leonard	1 Feb 30-18 Jul 30	Col. Harry D. McClusky	23 Sep 30-1 Jul 36

504th Port Headquarters

Organized Reserve Louisiana

HQ-Not initiated 1928-29; New Orleans, LA, 1929-36

Constituted in the Organized Reserve 5 September 1928, allotted to the Fourth Corps Area, and assigned to the General Headquarters Reserve. Initiated 14 September 1929 with headquarters at New Orleans, LA. Mobilization mission was to reestablish and assume command of the Army port operations at New Orleans. Demobilized 1 July 1936.

Commanders, 504th Port Headquarters

Lt. Col. John Truitt	13 Jan 30-1 Feb 30	Unknown	1 Feb 30-1 Jul 36
----------------------	--------------------	---------	-------------------

505th Port Headquarters

Organized Reserve California

HQ-Not initiated 1928-29; San Francisco, CA, 1929-36

Constituted in the Organized Reserve 5 September 1928, allotted to the Ninth Corps Area, and assigned to the General Headquarters Reserve. Initiated 5 October 1929 with headquarters at San Francisco, CA. Mobilization mission was to reestablish and assume command of the Army port operations at San Francisco Harbor. Conducted summer training at the Presidio of Monterey, CA. Demobilized 1 July 1936.

Commanders, 505th Port Headquarters

Unknown	2 Oct 29-ao May 35	Lt. Col. Charles L. Blylock	15 Jun 35-8 Dec 35
Lt. Col. Homer C. Ransom	ao May 35-15 Jun 35	Maj. Alfred W. Weeks	15 Jun 35-1 Jul 36

1st Port Battalion

Regular Army Inactive

HQ-Not organized 1933-36

Constituted in the Regular Army 1 October 1933, allotted to the Second Corps Area, and assigned to the General Headquarters Reserve. Demobilized 1 July 1936.

2nd Port Battalion

Regular Army Inactive

HQ-Not organized 1933-36

Constituted in the Regular Army 1 October 1933, allotted to the Second Corps Area, and assigned to the General Headquarters Reserve. Demobilized 1 July 1936.

3rd Port Battalion**Regular Army Inactive****HQ**-*Not organized* 1933-36

Constituted in the Regular Army 1 October 1933, allotted to the Second Corps Area, and assigned to the General Headquarters Reserve. Demobilized 1 July 1936.

4th Port Battalion**Regular Army Inactive****HQ**-*Not organized* 1933-34; Oakland, CA, 1934-35; *Inactive* 1935-36

Constituted in the Regular Army 1 October 1933, allotted to the Ninth Corps Area, and assigned to the General Headquarters Reserve. Organized by December 1934 at Oakland, CA. Withdrawn from the Ninth Corps Area 12 September 1935. Demobilized 1 July 1936.

5th Port Battalion**Regular Army Inactive****HQ**-*Not organized* 1933-34; San Francisco, CA, 1934-35; *Inactive* 1935-36

Constituted in the Regular Army 1 October 1933, allotted to the Ninth Corps Area, and assigned to the General Headquarters Reserve. Organized by December 1934 at San Francisco, CA. Withdrawn from the Ninth Corps Area 12 September 1935. Demobilized 1 July 1936.

6th Port Battalion**Regular Army Inactive****HQ**-*Not organized* 1933-34; Bakersfield, CA, 1934-35; *Inactive* 1935-36

Constituted in the Regular Army 1 October 1933, allotted to the Ninth Corps Area, and assigned to the General Headquarters Reserve. Organized by December 1934 at Bakersfield, CA. Withdrawn from the Ninth Corps Area 12 September 1935. Demobilized 1 July 1936.

391st Quartermaster Battalion (Port)**Regular Army Inactive****HQ**-New York City, NY, 1936-41

Constituted in the Regular Army 1 May 1936, assigned to the General Headquarters Reserve, and allotted to the Second Corps Area. Organized 30 October 1936 with Organized Reserve personnel as a RAI unit at New York City, NY. Designated mobilization training station was Camp Lee, VA. Location 7 December 1941—New York City, NY.

392nd Quartermaster Battalion (Port)**Regular Army Inactive****HQ**-New York City, NY, 1936-41; Fort Hamilton, NY, 1941

Constituted in the Regular Army 1 May 1936, assigned to the General Headquarters Reserve, and allotted to the Second Corps Area. Organized 30 October 1936 with Organized Reserve personnel as a RAI unit at New York City, NY. Designated mobilization training station was Camp Lee, VA. Activated 1 June 1941, less reserve personnel, at Fort Hamilton, NY, and assigned to the New York Port of Embarkation. Location 7 December 1941—Fort Hamilton, NY.

Status: Inactive in the U. S. Army Reserve as the 392nd Transportation Battalion.

393rd Quartermaster Battalion (Port)**Regular Army Inactive****HQ**-Newark, NJ, 1936-38; *Inactive* 1938-41

Constituted in the Regular Army 1 May 1936, assigned to the General Headquarters Reserve, and allotted to the Second Corps Area. Organized 30 October 1936 with Organized Reserve personnel as a RAI unit at Newark, NJ. Inactivated in 1938 at Newark by relief of personnel. Location 7 December 1941—*Inactive*.

394th Quartermaster Battalion (Port)**Regular Army Inactive****HQ**-Oakland, CA, 1936-41

Constituted in the Regular Army 1 May 1936, assigned to the General Headquarters Reserve, and allotted to the Ninth Corps Area. Organized 29 May 1936 with Organized Reserve personnel as a RAI unit at Oakland, CA. Designated mobilization training station was the Presidio of San Francisco, CA. Activated 27 June 1941, less Reserve personnel, at Oakland, CA. Location 7 December 1941—Oakland, CA.

Status: Inactive in the Regular Army as the 394th Transportation Battalion.

395th Quartermaster Battalion (Port)**Regular Army Inactive****HQ**-San Francisco, CA, 1936-41

Constituted in the Regular Army 1 May 1936, assigned to the General Headquarters Reserve, and allotted to the Ninth Corps Area. Organized 29 May 1936 with Organized Reserve personnel as a RAI unit at San Francisco, CA. Designated mobilization training station was the Presidio of San Francisco, CA. Location 7 December 1941—San Francisco, CA.

396th Quartermaster Battalion (Port)**Regular Army Inactive****HQ**-Los Angeles, CA, 1936-41; Fort Hamilton, NY, 1941

Constituted in the Regular Army 1 May 1936, assigned to the General Headquarters Reserve, and allotted to the Ninth Corps Area. Organized 10 October 1936 as a RAI unit with Organized Reserve personnel at Los Angeles, CA. Activated 1 October 1941, less Reserve personnel, at Fort Hamilton, NY, and assigned to the New York Port of Embarkation. Location 7 December 1941—Fort Hamilton, NY.

Status: Active in the Regular Army at Fort Eustis, VA, as the 11th Transportation Battalion.

501st Port Battalion (GHQR)**Organized Reserve****HQ**-*Not initiated* 1928-29; Third Corps Area 1929-36

Constituted in the Organized Reserve 5 September 1928, allotted to the Third Corps Area, and assigned to the General Headquarters Reserve. Initiated 14 October 1929 with headquarters in the Third Corps Area. Demobilized 1 July 1936.

502nd Port Battalion (GHQR)

Organized Reserve New York

HQ-Not initiated 1928-29; Yonkers, NY, 1929-36

Constituted in the Organized Reserve 5 September 1928, allotted to the Second Corps Area, and assigned to the General Headquarters Reserve. Initiated 5 November 1929 with headquarters at Yonkers, NY. Demobilized 1 July 1936.

510th Port Battalion (GHQR)

Organized Reserve Massachusetts

HQ-Not initiated 1928-30; Boston, MA, 1930-36

Constituted in the Organized Reserve 5 September 1928, allotted to the First Corps Area, and assigned to the General Headquarters Reserve. Initiated by June 1930 with headquarters at Boston, MA. Demobilized 1 July 1936.

511th Port Battalion (GHQR)

Organized Reserve New Jersey

HQ-Not initiated 1928-29; Port Newark, NJ, 1929-36

Constituted in the Organized Reserve 5 September 1928, allotted to the Second Corps Area, and assigned to the General Headquarters Reserve. Initiated 5 November 1929 with headquarters at Port Newark, NJ. Demobilized 1 July 1936.

512th Port Battalion (GHQR)

Organized Reserve New Jersey

HQ-Not initiated 1928-29; Trenton, NJ, 1929-36

Constituted in the Organized Reserve 5 September 1928, allotted to the Second Corps Area, and assigned to the General Headquarters Reserve. Initiated 2 December 1929 with headquarters at Trenton, NJ. Demobilized 1 July 1936.

513th Port Battalion (GHQR)

Organized Reserve Maryland

HQ-Not initiated 1928-30; Baltimore, MD, 1930-36

Constituted in the Organized Reserve 5 September 1928, allotted to the Third Corps Area, and assigned to the General Headquarters Reserve. Initiated 17 January 1930 with headquarters at Baltimore, MD. Demobilized 1 July 1936.

514th Port Battalion (GHQR)

Organized Reserve Pennsylvania

HQ-Not initiated 1928-30; Philadelphia, PA, 1930-36

Constituted in the Organized Reserve 5 September 1928, allotted to the Third Corps Area, and assigned to the General Headquarters Reserve. Initiated 17 January 1930 with headquarters at Philadelphia, PA. Demobilized 1 July 1936.

515th Port Battalion (C) (GHQR)

Organized Reserve Virginia

HQ-Not initiated 1928-31; Newport News, VA, 1931-36

Constituted in the Organized Reserve 5 September 1928, allotted to the Third Corps Area, and assigned to the General Headquarters Reserve. Initiated 10 December 1931 with headquarters at Newport News, VA. Demobilized 1 July 1936.

516th Port Battalion (C) (GHQR)

Organized Reserve South Carolina

HQ-Not initiated 1928-32; Charleston, SC, 1932-36

Constituted in the Organized Reserve 5 September 1928, allotted to the Fourth Corps Area, and assigned to the General Headquarters Reserve. Initiated by June 1932 with headquarters at Charleston, SC. Demobilized 1 July 1936.

517th Port Battalion (C) (GHQR)

Organized Reserve Georgia

HQ-Not initiated 1928-32; Savannah, GA, 1932-36

Constituted in the Organized Reserve 5 September 1928, allotted to the Fourth Corps Area, and assigned to the General Headquarters Reserve. Initiated by June 1932 with headquarters at Savannah, GA. Demobilized 1 July 1936.

518th Port Battalion (C) (GHQR)

Organized Reserve Florida

HQ-Not initiated 1928-31; Jacksonville, FL, 1931-36

Constituted in the Organized Reserve 5 September 1928, allotted to the Fourth Corps Area, and assigned to the General Headquarters Reserve. Initiated by July 1931 with headquarters at Jacksonville, FL. Demobilized 1 July 1936.

519th Port Battalion (C) (GHQR)

Organized Reserve Louisiana

HQ-Not initiated 1928-33; New Orleans, LA, 1933-36

Constituted in the Organized Reserve 5 September 1928, allotted to the Fourth Corps Area, and assigned to the General Headquarters Reserve. Initiated by January 1933 with headquarters at New Orleans, LA. Demobilized 1 July 1936.

520th Port Battalion (GHQR)

Organized Reserve Ohio

HQ-Not initiated 1928-30; Cleveland, OH, 1930-36

Constituted in the Organized Reserve 5 September 1928, allotted to the Fifth Corps Area, and assigned to the General Headquarters Reserve. Initiated by March 1930 with headquarters at Cleveland, OH. Demobilized 1 July 1936.

521st Port Battalion (GHQR)

Organized Reserve California

HQ-Not initiated 1928-29; San Francisco, CA, 1929-36

Constituted in the Organized Reserve 5 September 1928, allotted to the Ninth Corps Area, and assigned to the General Headquarters Reserve. Initiated 5 October 1929 with headquarters at San Francisco, CA. Conducted summer training at Del Monte, CA. Demobilized 1 July 1936.

522nd Port Battalion (GHQR)

Organized Reserve New Jersey

HQ-Not initiated 1928-30; Elizabeth, NJ, 1930-36

Constituted in the Organized Reserve 5 September 1928, allotted to the Second Corps Area, and assigned to the General Headquarters Reserve. Initiated 23 January 1930 with headquarters at Elizabeth, NJ. Demobilized 1 July 1936.

523rd Port Battalion (GHQR)

Organized Reserve New Jersey

HQ-Not initiated 1928-29; Jersey City, NJ, 1929-36

Constituted in the Organized Reserve 5 September 1928, allotted to the Second Corps Area, and assigned to the General Headquarters Reserve. Initiated 10 December 1929 with headquarters at Jersey City, NJ. Demobilized 1 July 1936.

524th Port Battalion (GHQR)

Organized Reserve Illinois

HQ-Not initiated 1928-30; Chicago, IL, 1930-36

Constituted in the Organized Reserve 5 September 1928, allotted to the Sixth Corps Area, and assigned to the General Headquarters Reserve. Initiated by June 1930 with headquarters at Chicago, IL. Demobilized 1 July 1936.

525th Port Battalion (GHQR)

Organized Reserve Illinois

HQ-Not initiated 1928-30; Chicago, IL, 1930-36

Constituted in the Organized Reserve 5 September 1928, allotted to the Sixth Corps Area, and assigned to the General Headquarters Reserve. Initiated by June 1930 with headquarters at Chicago, IL. Demobilized 1 July 1936.

526th Port Battalion (C) (GHQR)

Organized Reserve Texas

HQ-Not initiated 1928-29; Houston, TX, 1929-36

Constituted in the Organized Reserve 5 September 1928, allotted to the Eighth Corps Area, and assigned to the General Headquarters Reserve. Initiated 9 April 1929 with headquarters at Houston, TX. Conducted summer training at Fort Sam Houston, TX. Designated mobilization training station was Fort Clark, TX. Demobilized 1 July 1936.

527th Port Battalion (GHQR)

Organized Reserve California

HQ-Not initiated 1928-29; San Francisco, CA, 1929-36

Constituted in the Organized Reserve 5 September 1928, allotted to the Ninth Corps Area, and assigned to the General Headquarters Reserve. Initiated 16 October 1929 with headquarters at San Francisco, CA. Demobilized 1 July 1936.

528th Port Battalion (GHQR)

Organized Reserve California

HQ-Not initiated 1928-29; San Francisco, CA, 1929-36

Constituted in the Organized Reserve 5 September 1928, allotted to the Ninth Corps Area, and assigned to the General Headquarters Reserve. Initiated 28 October 1929 with headquarters at San Francisco, CA. Demobilized 1 July 1936.

529th Port Battalion (GHQR)

Organized Reserve Washington

HQ-Not initiated 1928-29; Seattle, WA, 1929-36

Constituted in the Organized Reserve 5 September 1928, allotted to the Ninth Corps Area, and assigned to the General Headquarters Reserve. Initiated 3 June 1929 with headquarters at Seattle, WA. Demobilized 1 July 1936.

Chapter 45

United States Army Transport Service

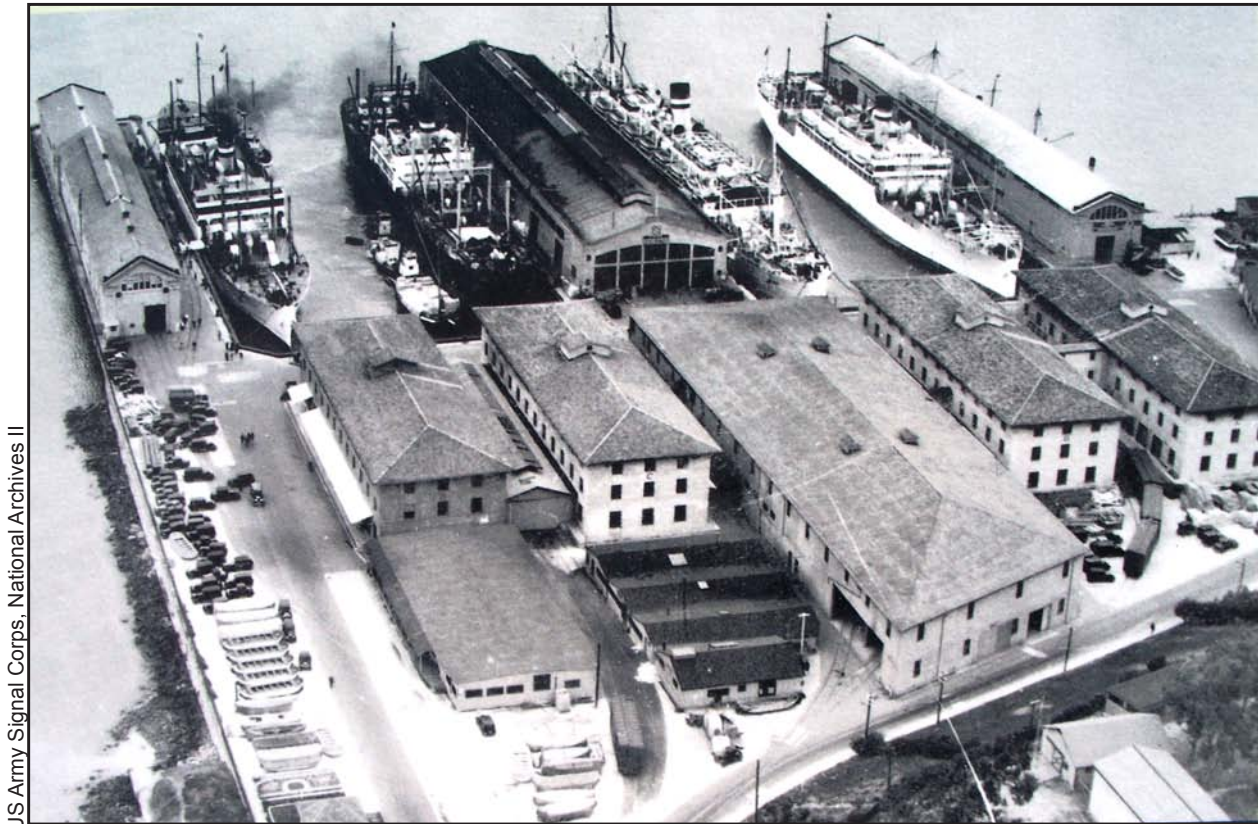

U.S. Army Signal Corps, National Archives II

A collection of US Army transports berthed at the USATS docks at Fort Mason, CA, about 1929.

The U.S. Army has been transporting large bodies of troops overseas since the War with Mexico in 1847-48. Then, due to the navy's refusal to use its ships to transport soldiers, the Quartermaster General was forced to charter ships to get troops and supplies to the theater of operations. That system held through the Civil War and post-Civil War years. However, it was not until the advent of the Spanish-American War in 1898 and the resultant exposure of how poorly prepared the army was to get large bodies of soldiers overseas, that the antecedents of United States Army Transport Service (U.S.A.T.S.) was created. Officially established in the fall of 1898, by the beginning of the First World War, the U.S.A.T.S. was a going concern with thirteen large ships in service conducting troop transport, animal transport, undersea cable repair, and cargo duties. This number did not include over fifty smaller boats in service with the Quartermaster Corps' harbor boat service, nor did it include numerous other vessels in the employ of the Corps of Engineers, or the mine planters of the Coast Artillery. During the war, the larger troop-carrying ships of the U.S.A.T.S. were temporarily handed over to the Naval Overseas Transport Service for the purposes of unity of command regarding the convoy system that was created to move the American Expeditionary Force to France. By late 1919, all of the army's ships had been returned to its control after the bulk of the AEF had been repatriated to the United States. In July of that year the U.S.A.T.S. had 168 ships performing trans-ocean operations, but the service shrank rapidly. One year later only twenty-three passenger/cargo ships were still in operation, and by July 1922, the number was almost half of that figure.

Though the U.S.A.T.S. only averaged about eight transport ships and three ships of other types in service during the period 1922 to 1939, this was arguably the heyday of its existence. During what many consider

a rather sleepy period in army activity the U.S.A.T.S. participated in many newsworthy events of the era. In 1919, the U.S.A.T. *Buford* deported to Finland over 240 Bolsheviks and other revolutionaries who had been responsible for some of that year's labor upheavals in the United States. During the first six months of 1920, eleven army transports participated in the repatriation of the famous Czech Legion from Vladivostok, Russia to Trieste and Fiume. Ships of the U.S.A.T.S. regularly sailed between New York and Antwerp in the early 1920s transporting troops and supplies to and from the American Forces in Germany, the American force still occupying the Rhine bridgehead at Coblenz until 1923 when the service brought them all home. The U.S.A.T.S. also supported the marine and army expeditions to Nicaragua in the late 1920s and early 1930s. The U.S.A.T. *Chateau Thierry* brought supplies, food and other aid to the island of Puerto Rico after it was struck by a huge hurricane 1928. Army transports took marines and soldiers from the Philippines to Shanghai and back in 1932 when trouble between the Nationalists and Communists threatened to engulf that city and its large foreign population in open warfare. In the 1930s and early 1940s, the U.S.A.T.S. was also closely linked to the development of the development and testing of amphibious warfare doctrine. Its ships participated in numerous amphibious training exercises in Hawaii, California, Puerto Rico and North Carolina, and conclusively proved, if nothing else, that the army's ships (and incidentally the navy ships of the time as well) were poorly designed to support such operations.

What the U.S.A.T.S. is most fondly remembered for, however, was the usually enjoyable and exciting voyages the soldiers and officers, and their wives and children experienced while sailing to their new duty stations in exotic places like Puerto Rico, Panama, Hawaii, the Philippines, and China. Letters and diaries describe pleasant meals shared with new acquaintances and merry evenings spent on deck discussing the latest news or other hot topics in the cool ocean breeze. Army transports were not exactly the Cunard Line, but in many respects (other than the private soldier's sleeping accommodations) were a step up in the lifestyle of most soldiers of the period. For a short time, they could pretend they were among the elite of the world, at least until they arrived at their port of debarkation. Few military personnel, or family members, who underwent a voyage on an army transport in the interwar period expressed a dislike for the experience—unless the ship encountered rough seas. Usually, they wrote fondly of the ships as if they were old friends. The U.S.A.T.S. is an almost forgotten part of the U.S. Army's history, but it was once a very well-known and highly regarded part of the Army.

Organization of the Transportation Service and Division of the Army

During World War I, the U.S.A.T.S. functioned as a component of the wartime Transportation Service. As part of the peacetime downsizing of the U.S. Army, on 3 March 1919 this service was consolidated with the Inland Traffic Service, but retained its status as a separate branch of the Army. On 1 July 1920, however, Congress made the Transportation Service a component of the Quartermaster Corps, as it had been prior to the war. The organization retained the title Transportation Service, however, and was charged with the transportation of the personnel, equipment, and supplies of the Army by water and land. The service at that time was reorganized into five divisions as follows:

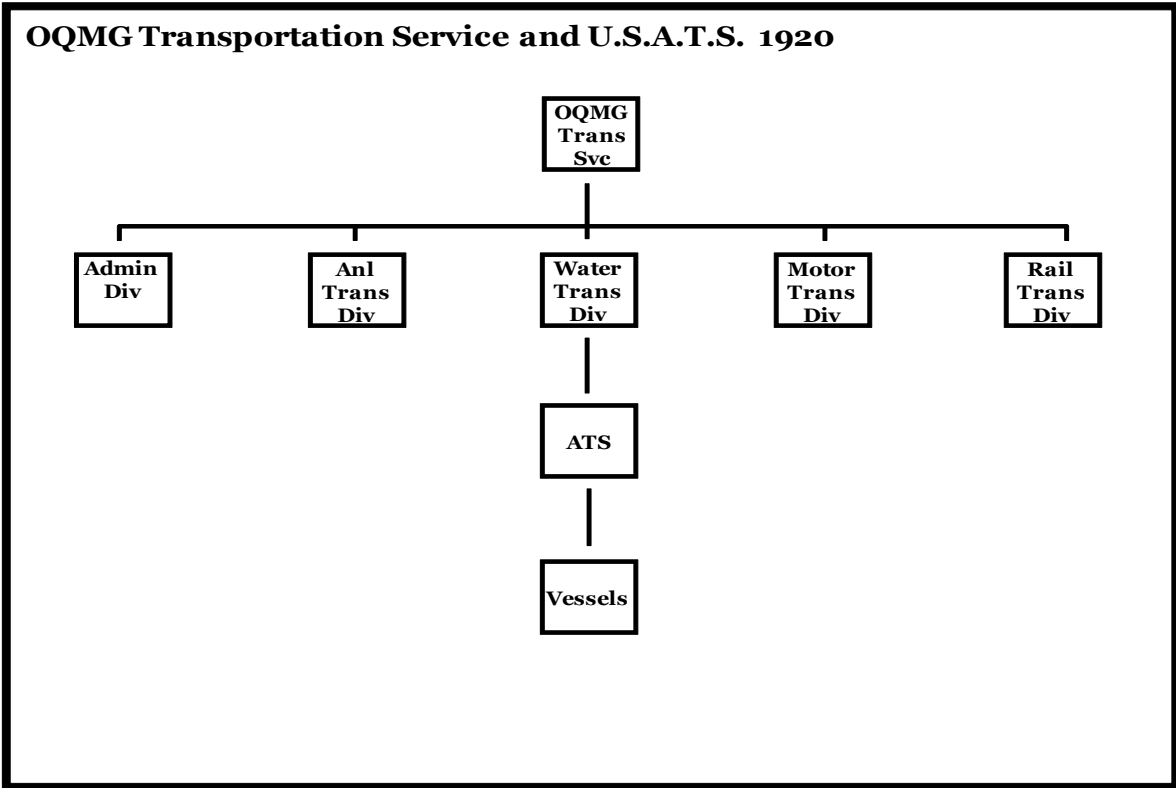

Transportation Service organization.

The organization of the Transportation Service remained unchanged until 15 June 1930 when the service was redesignated as the Transportation Division and reorganized into three separate branches as follows:

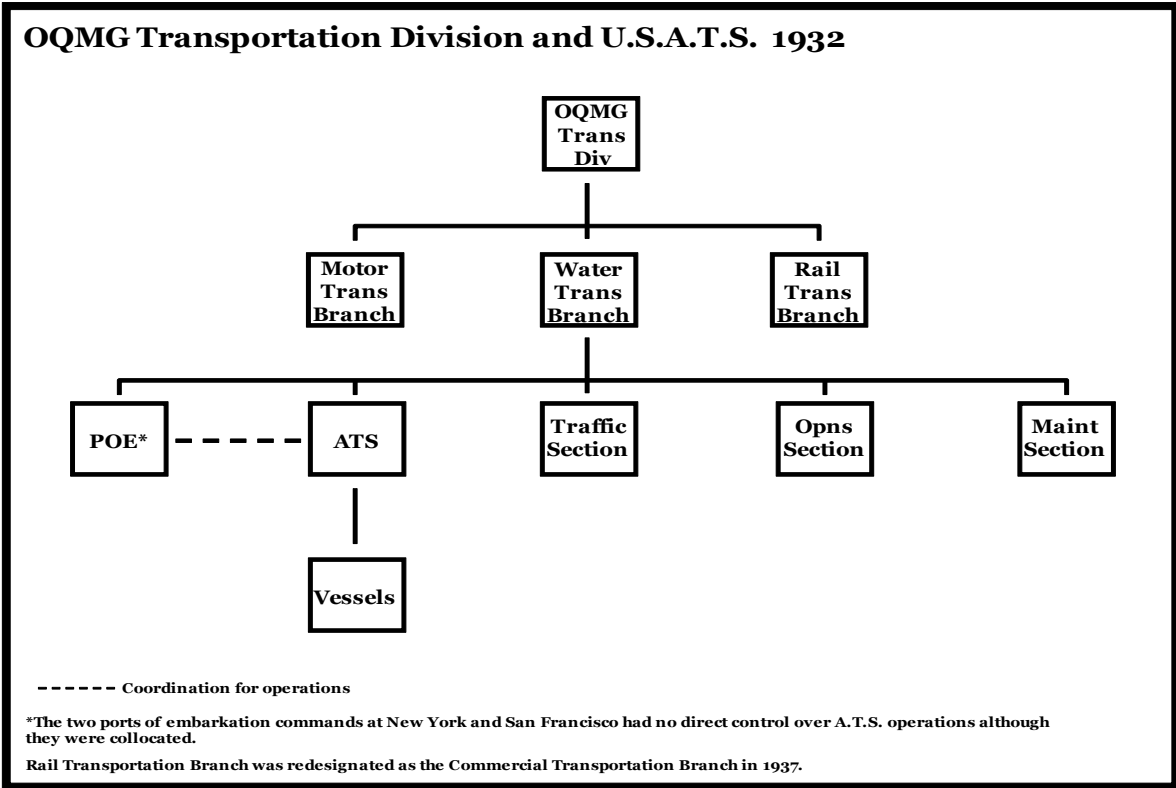

Transportation Division organization.

During the interwar period the two primary stateside A.T.S. ports were at New York and San Francisco. However, the service also maintained Army port terminals at Boston, Charleston, Hoboken, Norfolk, Philadelphia, and Seattle, as well as overseas terminals at Manila, Honolulu, the Canal Zone, and San Juan, Puerto Rico. In 1932, the two primary ports at New York and San Francisco were reestablished as ports of embarkation, but the U.S.A.T.S. operations at those locations remained directly under the Water Transportation Branch of the Quartermaster General's office. This was essentially how the U.S.A.T.S. fit into the Army's transportation structure up until 1940 when the Quartermaster Corps began to expand for World War II service.

Though there were several divisions under the U.S.A.T.S. in the interwar period, this chapter primarily covers its main operating units of the Water Transportation Branch which were the various vessels of the Army Transport Service.

Organization of an Army Transport Vessel

Organizationally, each vessel consisted of three primary sections: the ship's complement (crew), troop operations, and quartermaster operations. The ship's civilian transport master was in charge of all aspects of operating and navigating the ship itself. The master's duties included, among others, the following: command, accountability, and discipline of the ship's crew (which was composed of civilian merchantmen, not soldiers); preparation, maintenance and submission of the ship's log, records, and reports; cleanliness and good operating order of the ship (less the engine department which was the engineer's direct responsibility) and all auxiliary machinery; superintend the movement, loading, and unloading of the ship; the safe conduct of the ship in all cases, including instances when a pilot is aboard, and especially in bad weather and when approaching or departing land; and for the overall safety of all persons on board.

The Commanding Officer of Troops (C.O.T.) was responsible for all military personnel on board the ship including passengers and the quartermaster and his section. Until 1930, the C.O.T. was the senior Army officer on board the ship for a given voyage. This officer was often the commanding officer of a unit being transported to a new destination, but more usually, he was simply the senior officer in a group of Army passengers. On 8 March 1930, the War Department began assigning field grade officers as the permanent C.O.T. That order was amended in 1932 to authorize officers senior in grade to the permanent C.O.T. to function as the C.O.T. when on board. The permanent C.O.T. was to act as the executive officer in those instances. The duties of the C.O.T. were separate and distinct from that of the transport master. While the C.O.T. was the direct representative of the commanding officer of the port, and orders directing the sailing times and movement of the ship while in port came through him, the C.O.T. had no authority in terms of the actual functioning of the ship or the ship's crew. The C.O.T.'s responsibilities were as follows: inspect passenger accommodations, troop compartments, and galleys to ensure cleanliness and proper and efficient operations of the ship in regard to the passengers; command all military personnel (including military personnel attached to the ship) and other passengers (including dependents and civilians), and ensure good order and discipline of same; act as the conduit for all orders and requests from the port commander and the Transport Master to members of the troop complement; render all requests regarding crew services and discipline through the Transport Master; command the ship's quartermaster in all military aspects, but not in regard to the technical functioning of the quartermaster section.

The ship's quartermaster was a military officer who commanded a small section attached to the ship which performed various quartermaster functions. These functions included the loading, security, maintenance, and unloading of supplies, animals, and equipment. The quartermaster also functioned as the C.O.T. when there was no C.O.T. on board (usually when the ship was not carrying passengers).

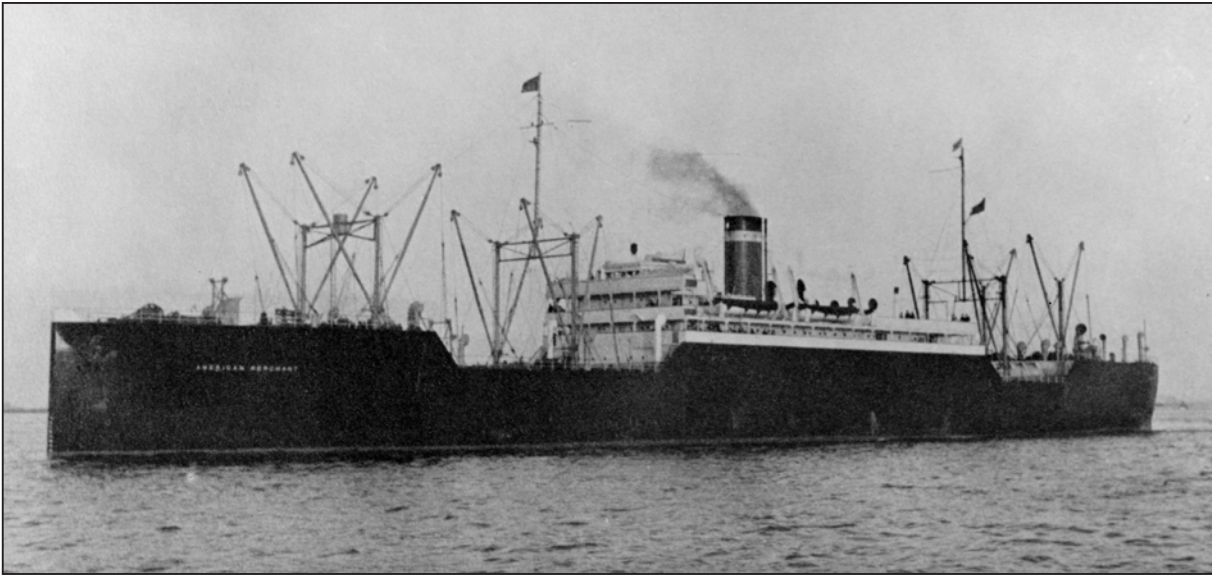
Pictured as the S.S. *American Merchant***U.S.A.T. *Aisne*****Home Port**—Norfolk, VA, 1921-23

Built by American International Shipbuilding Company at Hog Island, PA, and launched 5 June 1920. Named in honor of the U.S. Army's participation in the Aisne campaign in World War I. The *Aisne* was the last ship built by the American International Shipbuilding Company for World War I service. Delivered to the U.S. Shipping Board 27 January 1921. Transferred to the War Department 29 January 1921 and assigned to the A.T.S. Atlantic Fleet with home port at Norfolk. Laid up 2 February 1921 at Norfolk, VA. Directed by Executive Order dated 1 February 1922 to be turned over to the U.S. Shipping Board. Turned over to the U.S. Shipping Board in 9 January 1923. Sold to the American Merchant Line and renamed as the S.S. *American Merchant*.

Status: Sold in 1940 to the Société Maritime Anversoise, a Belgian shipping firm as the S.S. *Ville de Namur*; sunk by the U-52 on 19 June 1940 off La Rochelle, Belgium.

Length: 448 ft.

Beam: 58 ft.

Draft: 28 ft.

Displacement: 9,050 tons

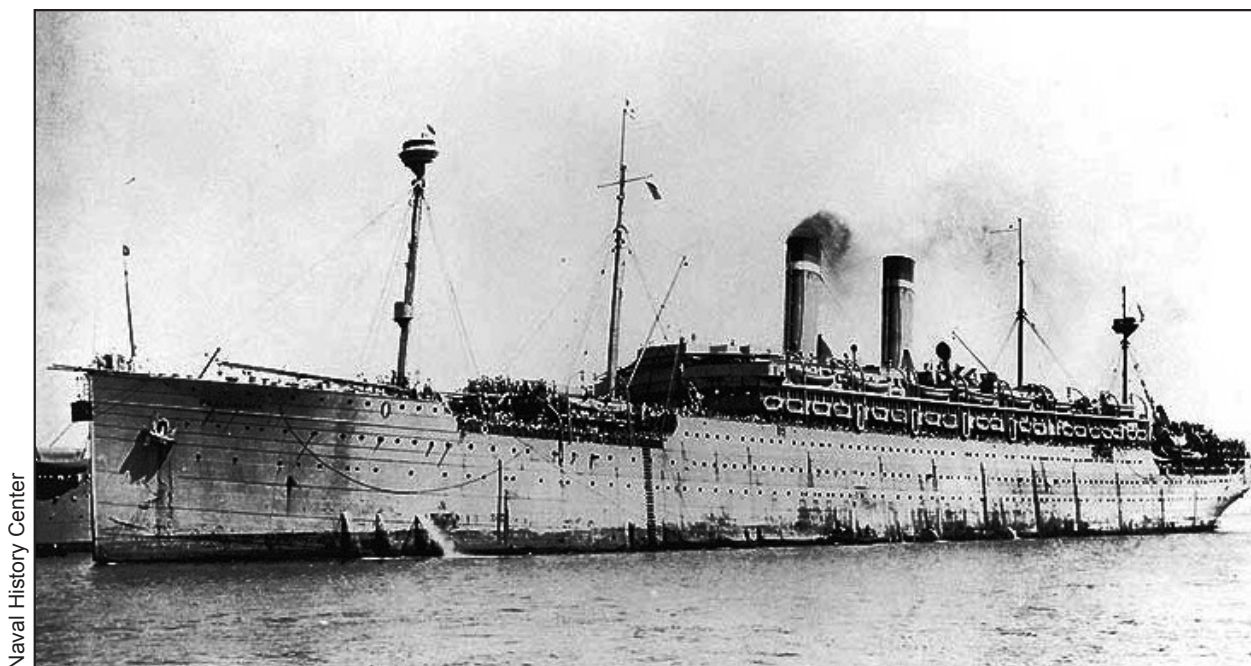

Naval History Center

U.S.A.T. *America*

Home Port—New York POE, Army Supply Base, Brooklyn, NY, 1919-20 and 1940-41

Built by Harland and Wolff in Belfast, Ireland, and launched in 1905 as the German-owned S.S. *Amerika*. Acquired as a war prize in April 1917. In U.S. Navy service from 20 October 1917 to 26 September 1919 as the U.S.S. *America* when it was turned over to the U.S. Army Transport Service and renamed the U.S.A.T. *America*. Assigned to the A.T.S. Atlantic Fleet with home port at the New York POE, Army Supply Base, Brooklyn, NY. Made two journeys between January 1920 and August 1920 to evacuate elements of the Czech Legion at Vladivostok, Russia and disembark them at Trieste, Italy. Performed its final voyage for the U.S. Army Transport Service in September 1920 and was turned over to the U.S. Shipping Board. Reacquired from the U.S. Maritime Commission reserve fleet 17 October 1940, rehabilitated for active service as a troopship at Baltimore and renamed the U.S.A.T. *Edmund B. Alexander*. Served as a floating barracks at St John's, Newfoundland January-June 1941. Serviced the New Orleans—Panama route for the rest of 1941.

Status: Served as the attack transport U.S.A.T. *Edmund B. Alexander* in World War II; scrapped in January 1957.

Events: 16

Length: 687 ft. Beam: 74 ft. Draft: 34 ft. Displacement: 21,329 tons

Masters, U.S.A.T. *America*

Capt. J. W. Ford 26 Sep 19-22 Dec 19 Capt. William Rind 22 Dec 19-22 Sep 20



U.S.A.T. *American Legion*

Home Port—New York POE, Army Supply Base, Brooklyn, NY, 1940-41

Built by the New York Shipbuilding Company at Camden, NJ; laid down 21 January 1919 and launched 11 October 1919 as the S.S. *Badger State*. Delivered to the U.S. Shipping Board 15 July 1921 and laid up in the reserve fleet. Placed into commercial service with the Munson Line in 18 December 1925. Returned to the U.S. Maritime Commission reserve fleet 13 March 1939. Removed from the reserve fleet and renovated as a troopship. Acquired by the U.S. Army Transport Service 21 February 1939 and renamed as the U.S.A.T. *American Legion*. Assigned to the A.T.S. Atlantic Fleet with home port at the New York POE, Army Supply Base, Brooklyn, NY. The *American Legion* generally serviced the Brooklyn—Panama—Puerto Rico route. Dispatched to Norway in August 1940 to evacuate almost 900 American citizens, and several members of the Norwegian Royal family, from the port of Petsamo after the invasion of that country by the Germans. Carried a Swedish Bofors 40mm gun system on board back for study and replication in the U.S.; this system became the primary antiaircraft gun aboard U.S. Navy ships in World War II. Resumed regular service between New York and Panama until April 1941 when she began transporting troops to Bermuda and Trinidad. Transported the first contingent of U.S. troops to Iceland in early August 1941. Transferred to the U.S. Navy 26 August 1941 as the U.S.S. *American Legion*, AP-35.

Status: Sold to Zidell Ship Dismantling Company for scrap 5 February 1948; scrapped at Portland, OR.

Events:

Length: 535 ft. Beam: 72 ft. Draft: 32 ft. Displacement: 13,529 tons

Masters, U.S.A.T. *American Legion*

Capt. Bror E. Torning 21 Nov 39-ao Sep 40 Unknown ao Sep 40-7 Dec 41



U.S.A.T. *Argonne*

Home Port—Philadelphia, PA, 1920-21

Built by American International Shipbuilding Company at Hog Island, PA, and launched 24 February 1920. Named in honor of the U.S. Army’s participation in the Meuse-Argonne campaign in World War I. Delivered to the U.S. Shipping Board in December 1920. Transferred to the War Department in early 1921 and assigned to the U.S. Army Transport Service. Laid up in February 1921 at Philadelphia, PA. Transferred “on loan” to the U.S. Navy 3 November 1921 and renamed the U.S.S. *Argonne*. Permanently transferred 6 August 1924 by Executive Order to the U.S. Navy.

Status: Present at Pearl Harbor, 7 December 1941. Sold to the Boston Metals Company on 14 August 1950 and scrapped.

Length: 448 ft.

Beam: 58 ft.

Draft: 28 ft.

Displacement: 9,050 tons

Masters, U.S.A.T. *Argonne*

Capt. Wilbur Smith

Jan 21-3 Nov 21

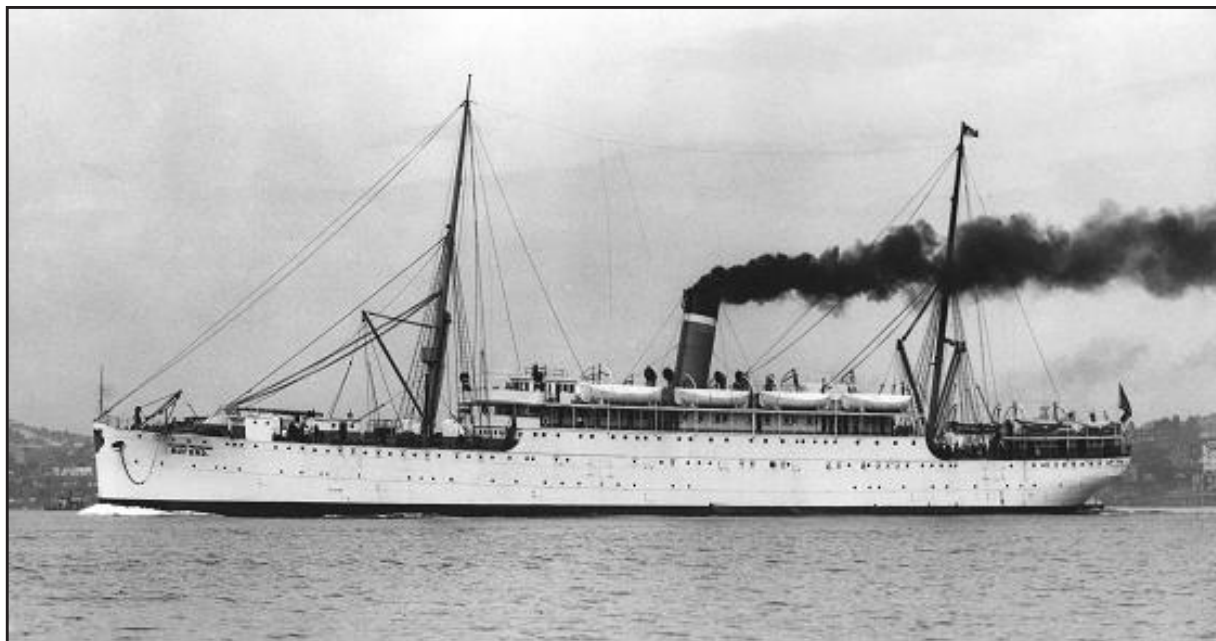

U.S.A.T. *Buford*

Home Port—Army Supply Base, Brooklyn, NY, 1919-20; Fort Mason, CA, 1920-22

Built by Harland and Wolff in Belfast, Ireland, and launched in 1890 as the S.S. *Mississippi*. Purchased by the Quartermaster Department 14 July 1898 from the Atlantic Transport Company and assigned to the U.S. Army Transport Service. Renamed the U.S.A.T. *Buford* in February 1899 in honor of Brig. Gen. John Buford, hero of Gettysburg. During World War I, the *Buford* was the only A.T.S. owned transport to regularly make voyages between the U.S. and France in support of the war effort. Transferred to U.S. Navy service on 14 January 1919 until 2 September 1919 when it was returned to the U.S. Army Transport Service. Exported Emma Goldman, Alexander Berkman, and over 240 other Communists and radicals in December 1919 from the New York POE to Hango, Finland. Transferred in 1920 to the A.T.S. Pacific Fleet with home port at Fort Mason, CA. Assigned to service the San Francisco—Honolulu—Seattle route and made occasional port calls at Seward, TA, Seattle, WA, Tacoma, WA, and Nagasaki, Japan. Rescued the crew of the S.S. *Tokuyo Maru* off the New Jersey coast on 2 May 1921. Performed its final voyage for the U.S. Army Transport Service in August 1922. Decommissioned 2 September 1922 and turned over to the U.S. Shipping Board.

Status: Sold 20 December 1922 to the firm of Linderman & Ogden; scrapped in Japan in 1929.

Length: 370.8 ft. Beam: 44.2 ft. Draft: 26.6 ft. Displacement: 4,805 tons

Masters, U.S.A.T. *Buford*

Capt. Charles C. McCarthy	14 Jun 17-3 Mar 18	Capt. James C. Hitchcock	30 Aug 19-1 Oct 20
Capt. H. G. Eaton	3 Mar 18-14 Jan 19	Capt. Robert A. Bartlett	1 Oct 20-21 Feb 21
Lt. Cdr. Charles A. Olsen*	14 Jan 19-22 Aug 19	Capt. L.R.M. Kerr	21 Feb 21-2 Sep 22

* In U.S. Navy Service.

National Archives
(RG 111-US Army Signal Corps still photo collection)

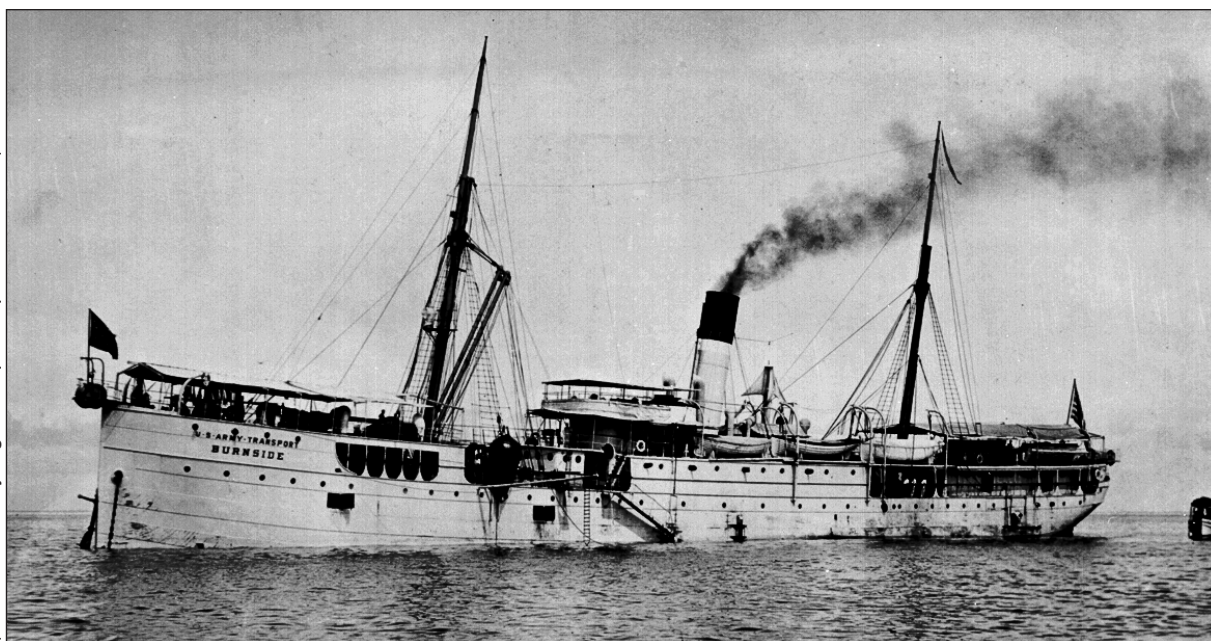

U.S.A.T. *Burnside*

Home Port—Seattle, WA, 1919-23

Built by Campbell, MacIntosh, and Bowstead at Newcastle, England in 1882 as a cargo ship for Lund's Blue Anchor Line. Sold to Vapores Serra at Bilboa, Spain in 1891 and renamed the S.S. *Rita*. Captured 8 May 1898 by the U.S.S. *Yale* off Puerto Rico. Acquired by the Quartermaster Department 8 July 1898 from the U.S. prize court and assigned to the Army Transport Service. Renamed U.S.A.T. *Burnside* in February 1899 in honor of Maj. Gen. Ambrose P. Burnside, commander of the Army of the Potomac 1862-63. . Assigned to the A.T.S. Pacific Fleet with home port at Seattle, WA. Maintained the cable network of the Washington-Alaska Military Cable and Telegraph System (WAMCATS) between Seattle and posts in Alaska. Condemned 17 March 1923 and sold.

Events: Scrapped at Oakland, CA, in June 1924.

Length: 276.8 ft.

Beam: 36.7 ft.

Draft: 17.8 ft.

Displacement: 2,4 tons

Masters, U.S.A.T. *Burnside*

Capt. Robert W. Shears

20 Apr 12-17 Mar 23

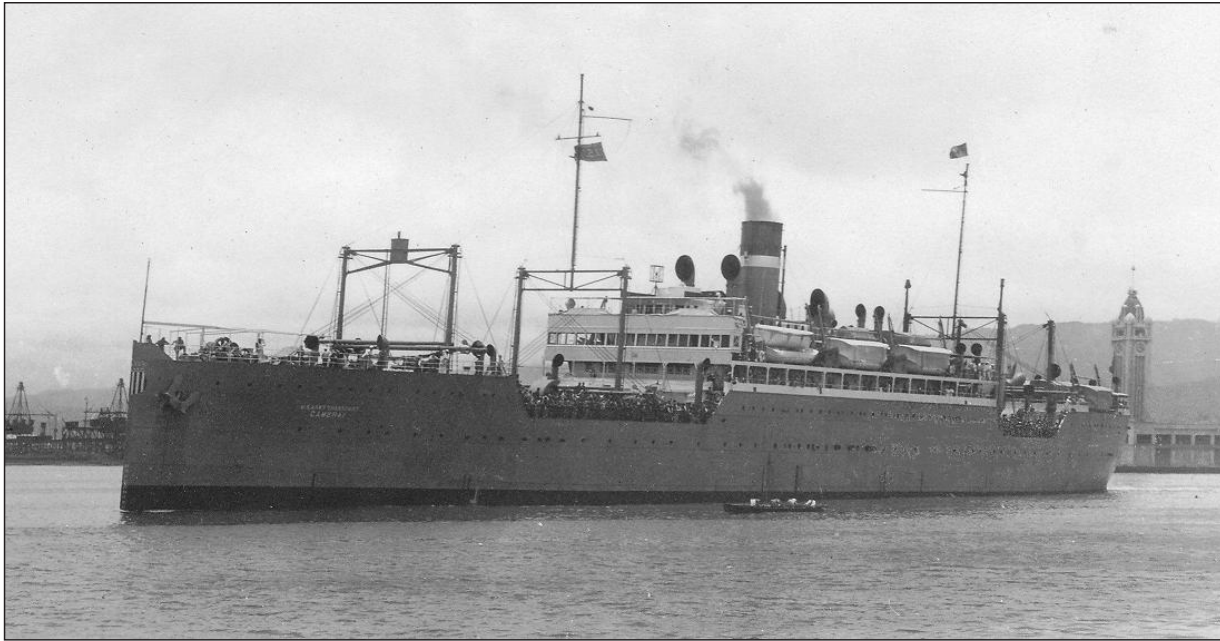

U.S.A.T. *Cambrai*

Home Port—New York POE, Army Supply Base, Brooklyn, NY, 1920-22; Fort Mason, CA, 1922-31

Built by American International Shipbuilding Company at Hog Island, PA, and launched 6 December 1919. Delivered to the U.S. Shipping Board 30 October 1920. Transferred to the War Department in November 1920 and assigned to the U.S. Army Transport Service. Named in honor of the U.S. Army's participation in the Battle of Cambrai in World War I. Assigned to the A.T.S. Atlantic Fleet with home port at Army Supply Base, Brooklyn. The *Cambrai* generally serviced the New York—Antwerp and the New York—San Juan—Panama routes 1920-22. Performed its first voyage for the Army Transport Service 10 December 1920. Laid up 6 June 1921 at New York. Recommissioned 10 November 1921. Transferred in 1922 to the A.T.S. Pacific fleet with home port at Fort Mason, CA. Assigned to service the San Francisco—Honolulu route 1922-31. Transported earthquake relief supplies to Yokohama after the disastrous earthquake that hit Japan in September 1923. Beginning November 1928, about every other voyage was made between Fort Mason and the Army Supply Base, Brooklyn. Made occasional voyages to Panama, Puerto Rico, and the Philippines. Supported the U.S. Marine expedition to Nicaragua 1928-32. Struck a reef at Corinto, Nicaragua, in 1929. The damage was moderate, but required dry-dock repairs upon the ship's return to San Francisco. Turned over to the U.S. Shipping Board 27 October 1931 and sold to the United States Line as the S.S. *American Traveler*.

Status: Transferred to Belgian service in 1940 as the S.S. *Ville d'Arlon* when she was believed to have been sunk by a German U-boat 12 December 1940.

Events: 28

Length: 448 ft. Beam: 58 ft. Draft: 28 ft. Displacement: 9,050 tons

Masters, U.S.A.T. *Cambrai*

Capt. Norman Ferguson	30 Oct 20-Nov 20	Capt. Charles F. Williams	30 Jun 21-12 Jun 28
Capt. James C. Hitchcock	Nov 20-Dec 20	Capt. Francis A. Pfeiffer	12 Jun 28-2 Apr 29
Capt. Norman Ferguson	Dec 20-30 Jun 21	Capt. Bror E. Torning	2 Apr 29-8 Aug 30
	Capt. Daniel Pumphrey	9 Aug 30-27 Oct 31	

Commanding Officer of Troops, U.S.A.T. *Cambrai*

Lt. Col. James L. Long, C.A.C.	31 May 30-5 Nov 30	Maj. Cyril A. W. Dawson, C.A.C.	Dec 30-27 Oct 31
--------------------------------	--------------------	---------------------------------	------------------



U.S.A.T. *Cantigny*

Home Port—New York POE, Army Supply Base, Brooklyn, NY, 1920-22

Built by American International Shipbuilding Company at Hog Island, PA, and launched 27 October 1919. Delivered to the U.S. Shipping Board 23 August 1920. Transferred to the War Department about September 1920 and assigned to the U.S. Army Transport Service. Named in honor of the U.S. Army's participation in the Battle of Cantigny in World War I. Assigned to the A.T.S. Atlantic Fleet with home port at Army Supply Base, Brooklyn. Performed its first voyage for the Army Transport Service 7 September 1920 to Antwerp, Belgium, to bring US troops home from occupation duty in Germany. The *Cantigny* generally serviced the New York—Antwerp and the New York—San Juan—Panama routes. Performed its final voyage for the U.S. Army Transport Service in July 1922. Laid up 28 July 1922 at Norfolk, VA. Ordered to be turned over to the U.S. Shipping Board 31 September 1922. Turned over to the U.S. Shipping Board 3 July 1923. Sold in 1924 to the United States Line as the S.S. *American Banker*.

Status: Transferred to Belgian service in 1940 as the S.S. *Ville d'Anvers*; scrapped in Bruges, Belgium, in May 1959 as the S.S. *Arosa Kulm*.

Length: 448 ft.

Beam: 58 ft.

Draft: 28 ft.

Displacement: 9,050 tons

Masters, U.S.A.T. *Cantigny*

Capt. James C. Hitchcock

Dec 20-Aug 22

Commanding Officer of Troops, U.S.A.T. *Chateau Thierry*

Maj. Charles W. Mason, Inf.
Maj. Thornton Rogers, Inf.
Maj. Gilmer M. Bell, Inf.

2 Jun 30-Jan 31
Jan 31-28 Sep 34
11 Oct 34-26 Sep 36

Capt. Harry Lynch, S.C.
Maj. Glenn D. Hufford, Inf.
Maj. John P. Crehan, F.A.

26 Sep 36-8 Oct 36
8 Oct 36-24 Aug 38
24 Aug 38-5 Apr 39

Naval History Center

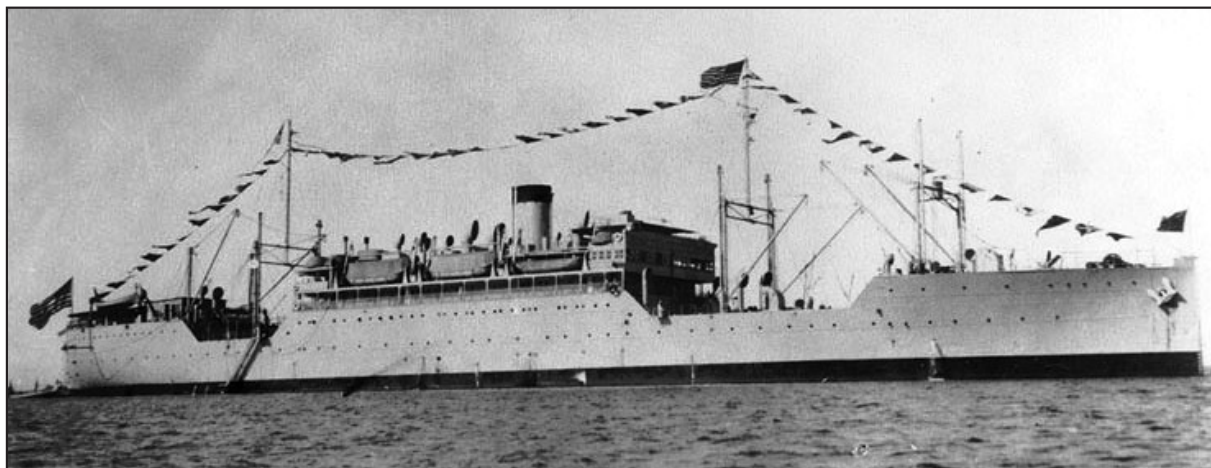

U.S.A.T. *Chaumont*

Home Port—Philadelphia, PA, 1921

Built by American International Shipbuilding Company at Hog Island, PA, and launched 31 March 1920. Delivered to the U.S. Shipping Board in November 1920. Transferred to the War Department 15 December 1920 and assigned to the U.S. Army Transport Service. Named in honor of the American Expeditionary Force's headquarters at Chaumont, France in World War I. Transferred "on loan" to the U.S. Navy 3 November 1921 and renamed the U.S.S. *Chaumont*, AP-5. Permanently transferred 6 August 1924 by Executive Order to the U.S. Navy. On 7 December 1941, the *Chaumont* was en route to the Philippines as part of the "Pensacola Convoy" resupply mission until ordered to sail to Australia.

Status: Sold and scrapped at Oakland, CA, in 1948.

Length: 448 ft.

Beam: 58 ft.

Draft: 28 ft.

Displacement: 9,050 tons

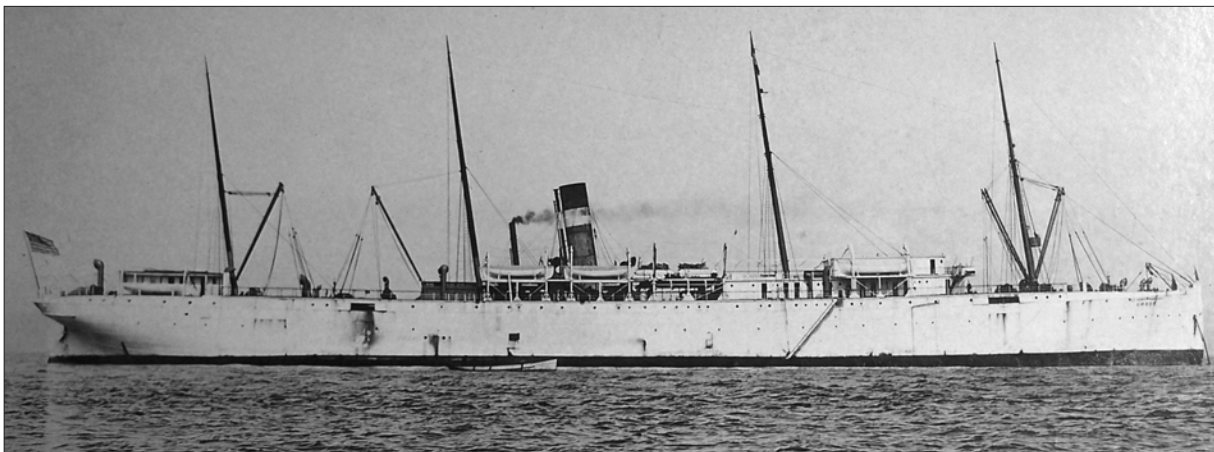

U.S.A.T. Crook

Home Port—Manila, PI 1919-20; Army Supply Base, Brooklyn, NY, 1920-21

Built by Murray Shipbuilding Company at Dumbarton, Scotland, and launched 23 December 1882 as the S.S. *Richmond Hill*. Later renamed as the S.S. *Roumanian*. Purchased by the Quartermaster Department 12 July 1898 from the Twin Screw Line and assigned to the U.S. Army Transport Service. Renamed U.S.A.T. *Crook* in February 1899 in honor of Maj. Gen. George Crook, famous Indian fighter and commanding general of the Arizona Territory and the Department of the Platte in the 1870s and 80s. Assigned to the A.T.S. Pacific Fleet with home port at Manila, PI, and further assigned to the Inter-Island Service. Transported troops of the American Expeditionary Force, Siberia, from Vladivostok to Manila in February and April 1920. Transferred to the A.T.S. Atlantic Fleet in May 1920 with home port at Army Supply Base, Brooklyn. Transported troops of the 2nd Brigade, A.F.G. from Antwerp to New York in December 1921. Laid up 21 January 1922 at Norfolk, VA. Sold 20 June 1922 to the Seven Seas Steamship Company.

Status: Resold 20 December 1922 to the Ammunition Products Company and scrapped at Baltimore, MD, in January 1923.

Length: 420 ft. Beam: 47 ft. Draft: 26.5 Displacement: 4,225 tons

Masters, U.S.A.T. Crook

Capt. Frank S. Randall	Apr 16-4 Mar 21	Capt. Charles Baker	4 Mar 21-18 Mar 21
	Capt. Frank J. Reppa	18 Mar 21-20 Jun 22	

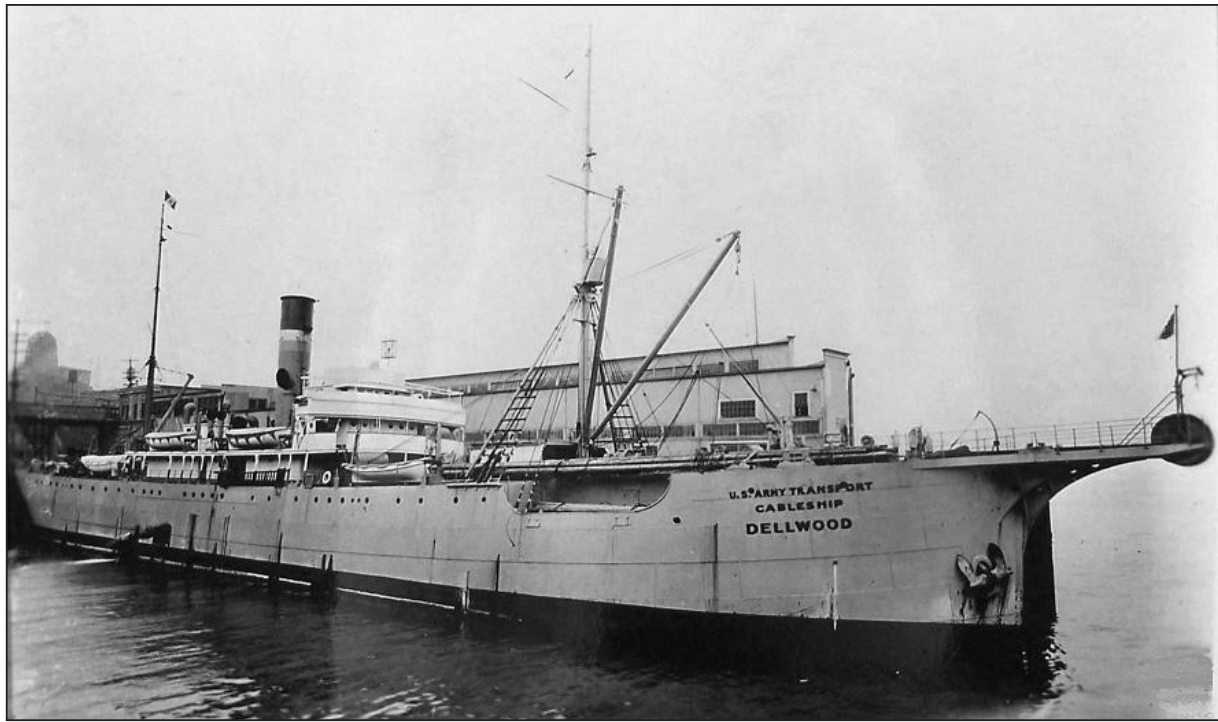

U.S.A.T. *Dellwood*

Home Port—Seattle, WA, 1921-32

Built by Hanson Dry Dock & Shipbuilding Company and launched in 1919 at Oakland, CA. Completed in April 1920. Purchased by the Quartermaster Corps 19 November 1921 at San Francisco and assigned to the U.S. Army Transport Service. Performed its initial voyage for the Army Transport Service beginning 26 November 1921. Designated to replace the aging *Burnside* in the A.T.S. Pacific Fleet and refitted as a cable ship in 1922 at the Todd Shipyard at Harbor Island, WA. Conducted support and repair operations on the Washington-Alaska Military Cable and Telephone System (WAMCATS) 1922-31. The *Dellwood* generally serviced the Seattle—Anchorage route. Made several voyages to England and the Azores in 1924 for the purposes of equipment modification and retrieval of new submarine cable purchased by the U.S. Government. The need for the *Dellwood* diminished after radio became the primary communications means between Alaska and Seattle. Turned over to the U.S. Shipping Board on 31 August 1932 at Seattle.

Status: Reacquired by the U.S. Army in 1942 as a cable ship to service the WAMCATS; struck an underwater pinnacle 19 July 1943 and sank in Massacre Bay off Attu in the Aleutian Islands.

Length: 320.9 ft. Beam: 46 ft. Draft: 26.9 ft. Displacement: 3,478 tons

Masters, U.S.A.T. *Dellwood*

Capt. Harry K. Poole	19 Nov 21-23 Mar 22	<i>Out of commission for refit</i>	3 Mar 22-18 Mar 23
	Capt. Robert W. Shears	18 Mar 23-31 Aug 32	

Commanding Officer of Troops, U.S.A.T. *Dellwood*

Capt. Wilton B. Persons, S.C.	18 Mar 23-10 Jan 24	Capt. Fred P. Andrews, S.C.	23 Apr 27-1 Jul 31
1st Lt. Harold F. Hubbell, S.C.	10 Jan 24-23 Apr 27	Lt. Col. Dawson Olmstead, S.C.	1 Jul 31-31 Aug 32

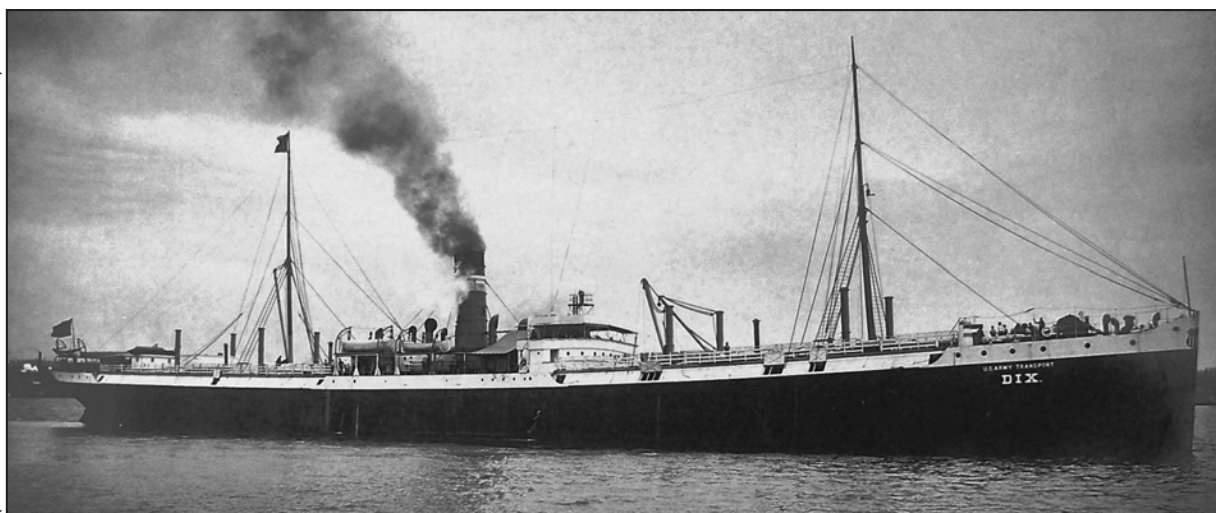

U.S.A.T. *Dix*

Home Port—Fort Mason, CA, 1919-22

Built by William Doxford & Sons Shipbuilding Company at Pallion, Sunderland, England, and launched 22 October 1892 as the S.S. *Samoa*. Purchased at Hong Kong by the Quartermaster Department 31 December 1900 from Mr. Ansil L. White. Assigned to the U.S. Army Transport Service. Renamed U.S.A.T. *Dix* in February 1901 in honor of Maj. Gen. John A. Dix, who was commanding general of the Departments of Maryland and of the East during the Civil War. Assigned to the A. T.S. Pacific Fleet with home port at Fort Mason, CA. The *Dix* was a supply ship and animal transport that generally serviced the Seattle—Honolulu—Manila route with occasional port calls at San Francisco. Transported all horses, mules, and horse drawn equipment supporting the U.S. Army forces in Siberia from Vladivostok, Russia, to Manila, PI, in February 1920. Transported part of the last contingent of U.S. troops from Vladivostok, Russia, to Manila, PI, 1 April 1920. Laid up 10 December 1921 at Fort Mason, CA. Ran aground 6 February 1922 at Alcatraz Island in San Francisco Bay. Directed by Executive Order dated 1 July 1922 to be turned over to the U.S. Shipping Board. Turned over 13 November 1922 to the U.S. Shipping Board.

Status: Sold 12 December 1922 to the Robert Dollar Steamship Company and renamed the S.S. *Grace Dollar*; scrapped in November 1928 at Kobe, Japan.

Length: 436.4 Ft. Beam: 52.1 ft. Draft: 23.8 ft. Displacement: 7,212 tons

Masters, U.S.A.T. *Dix*

Capt. L.R.M. Kerr	ao Dec 18-15 Jul 19	Capt. A. N. Rasmussen	22 Apr 20-28 May 21
Capt. Isaac L. Smith	15 Jul 19-22 Apr 20	Capt. Carl A. Olsen	28 May 21-16 Jan 22



US Coast Guard

Pictured as the S.S. *American Seaman*

U.S.A.T. *Edgemoor*

Home Port—Army Supply Base, Brooklyn, NY, 1920-21; 1922-26

Built by Skinner & Eddy Shipbuilding Company at Seattle, WA, and launched 29 March 1919. Delivered to the U.S. Shipping Board in 1919. Transferred to the War Department 15 July 1920 at New York harbor and assigned to the Army Transport Service. Further assigned to the A.T.S. Atlantic Fleet with home port at Army Supply Base, Brooklyn. The *Edgemoor* generally serviced the New York—Panama—San Francisco route. Returned 2 September 1921 to the U.S. Shipping Board. Transferred to the War Department 10 April 1922 at New York harbor and assigned to the A.T.S. Atlantic Fleet with home port at Army Supply Base, Brooklyn. The ship underwent an extensive, but rapid, overhaul in April 1925 at the Hanson Drydock and Shipyard in Oakland, CA. Returned 15 July 1926 to the U.S. Shipping Board and laid up at Seattle.

Status: Sold in the late 1920s to the Lykes Brothers-Ripley Steamship Company; acquired by the US Merchant Marine Academy 22 May 1939, renamed as the S.S. *American Seaman*, and operated by the US Coast Guard as a training ship through WWII. Scrapped in 1952 at Baltimore, MD.

Length: 410.5 ft. Beam: 54 ft. Draft: 37.9 ft. Displacement: 6,999 tons

Masters, U.S.A.T. *Edgemoor*

Capt. B. Christensen 15 Jul 20-19 Jul 21 Capt. Robert A. Bartlett 19 Jul 21-2 Sep 21

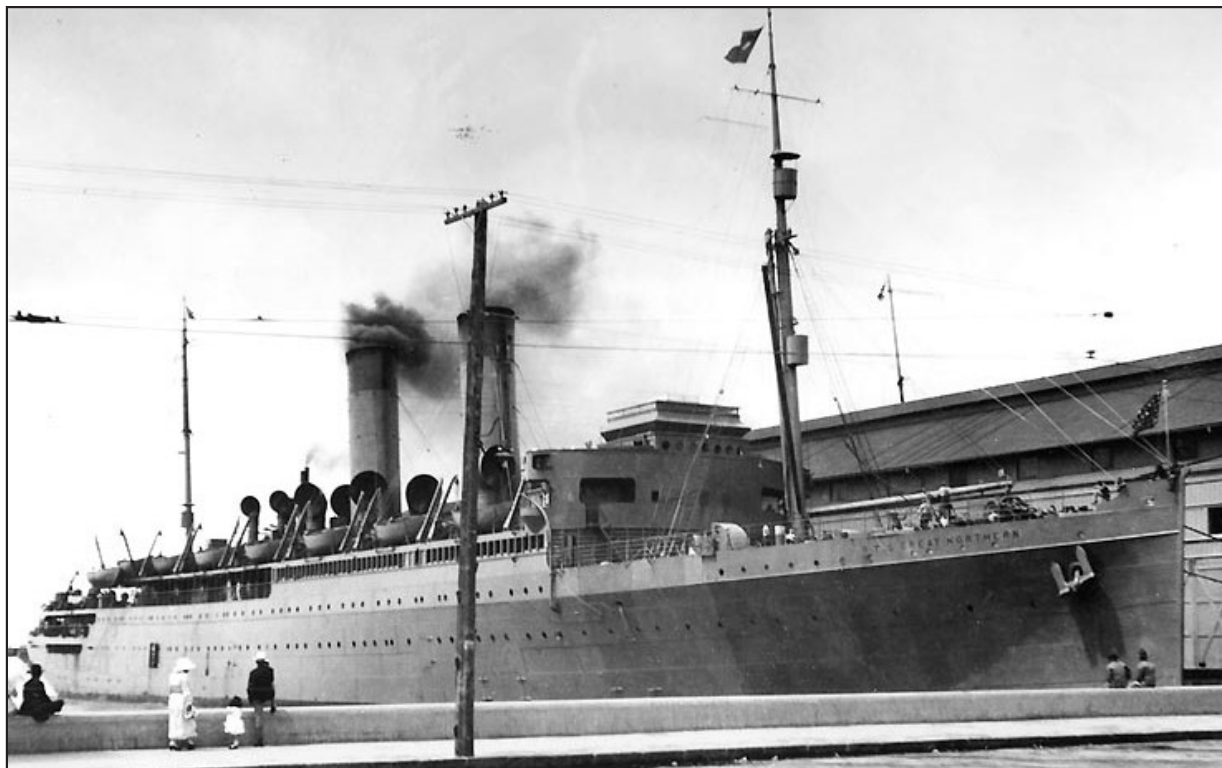

U.S.A.T. *Great Northern*

Home Port—New York POE, Army Supply Base, Brooklyn, NY, 1919-20; Fort Mason, CA, 1920-21

Built by William Cramp & Sons Shipbuilding Company at Philadelphia, PA, and launched 7 October 1914. Completed in April 1915 and delivered to the Great Northern Pacific Steam Ship Company of Astoria, OR. Acquired by the U.S. Navy on 23 September 1917 and renamed as the U.S.S. *Great Northern*. Transferred to the Army Transport Service 15 August 1919 and renamed as the U.S.A.T. *Great Northern*. Assigned to the A.T.S. Atlantic Fleet and stationed at the Army Supply Base, Brooklyn, NY. Transferred in early 1920 to the A.T.S. Pacific Fleet and stationed at Fort Mason, CA. Transported Y.M.C.A. and Red Cross workers supporting the U.S. Army forces in Siberia from Vladivostok, Russia, to San Francisco, CA, in February 1920. Transported part of the last contingent of U.S. troops from Vladivostok, Russia, to Manila, PI, 1 April 1920. Transported three Senators and thirty-one Congressmen on a fact-finding mission to Honolulu, Manila, and Shanghai 9 July-24 August 1920. Laid up 1 November 1920 at San Francisco, CA. Turned over by executive order to the U.S. Navy 29 July 1921 and renamed as the U.S.S. *Columbia*.

Status: Scrapped at Baltimore, MD, in 1948.

Length: 509.5 Ft.

Beam: 63 ft.

Draft: 21 ft.

Displacement: 8,255 tons

Masters, U.S.A.T. *Great Northern*

Capt. James J. Murphy

15 Aug 19-17 Jun 20

Capt. L.R.M. Kerr

17 Jun 20-1 Nov 20



Pictured as the S.S. *Heffron*

U.S.A.T. *Heffron*

Home Port—Fort Mason, CA, 1920-21

Built by Bethlehem Steel Company at Alameda, CA, and launched 31 December 1918. Completed in May 1919. Acquired by the Quartermaster Corps 7 April 1920 from the U.S. Shipping Board and assigned to the U.S. Army Transport Service. Further assigned to the A.T.S. Pacific Fleet with home port at Fort Mason, CA. Evacuated the last elements of the Czech Legion from Vladivostok, Russia, 2 September 1920 and disembarked them at Trieste, Italy 10 November 1920. Transferred to the U.S. Shipping Board reserve fleet 7 January 1921 at New York.

Status: Sunk by a mine 5 July 1942 off Straumnes, Iceland.

Length: 440 ft.

Beam: 56 ft.

Draft: 35.2 ft.

Displacement: 7,611 tons

Masters, U.S.A.T. *Heffron*

Capt. James W. Scott

7 Apr 20-7 Jan 21

Pictured as the S.S. *President Jefferson***U.S.A.T. *Henry T. Allen*****Home Port**—San Francisco POE, Fort Mason, CA, 1940-41

Built by the New York Shipbuilding Company at Camden, NJ. Originally laid down in early 1919 as an Army transport and launched 25 May 1919. Completed in June 1921 as the S.S. *Wenatchee*, but determined to be excess to Army needs. Sold to the Pacific Steamship Company and placed into commercial service. Purchased by the Admiral Orient Line in November 1922 and renamed the S.S. *President Jefferson*. Returned to the U.S. Maritime Commission reserve fleet at Seattle, WA, in 1938. Acquired by the U.S. Army Transport Service from the Maritime Commission reserve fleet 1 November 1940 at Seattle. Assigned to the A.T.S. Pacific Fleet with home port at Fort Mason, CA. Renamed 12 February 1941 as the U.S.A.T. *Henry T. Allen*. Transferred to the U.S. Navy 6 December 1941 as the U.S.S. *Henry T. Allen*, AP-30. Location 7 December 1941—Mare Island Navy Yard, CA.

Status: Sold to Boston Metals Company, and scrapped in March 1948 at Baltimore, MD.**Events:**

Length: 535 ft.

Beam: 72 ft.

Draft: 32 ft.

Displacement: 13,529 tons

Masters, U.S.A.T. *Henry T. Allen*

Capt. James McPherson

11 Nov 40-6 Dec 41

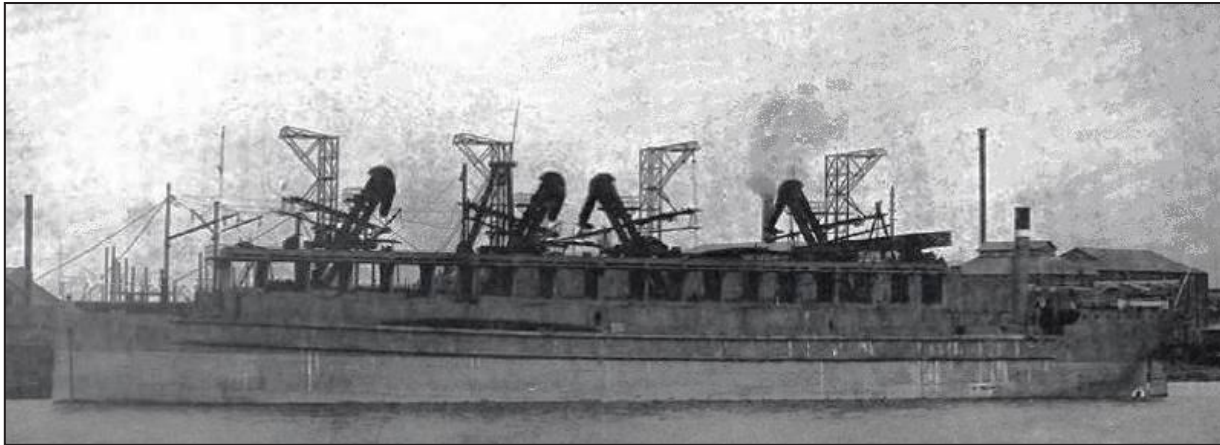

U.S.A.T. *Hubert L. Wigmore*

Home Port—Manila, PI, 1919-26

Built for the U.S. Army by Shanghai Dock & Engineering Company and launched at Shanghai, China, in 1914 as U.S.A.T. *Collier No. 1*. Completion was delayed due to technical problems with the coaling elevators and the grounding of the vessel at Yang-Tse-Poo, China, on 29 July 1915 during a typhoon. Accepted by the Quartermaster Department about October 1916 and assigned to the Army Transport Service at Manila Harbor. Renamed in honor of Major Hubert L. Wigmore, Corps of Engineers, who was the military attaché to Japan and who died suddenly on 2 September 1913 at Chusenji. Typically moored in Manila harbor and operated by the port Quartermaster for the purposes of coaling U.S. Army transports and other government vessels as required. The loading capacity of the Wigmore was 6,000 tons of coal per day. Stationed at the Quartermaster Depot, Manila, PI. Sold 25 February 1926 to the Madrigal Company of Manila.

Status: Unknown

Length: 350 ft.

Beam: 50 ft.

Draft: 20 ft.

Displacement: 3,500 tons

Masters, U.S.A.T. *Hubert L. Wigmore*

Unknown

ao Jan 19-25 Feb 26

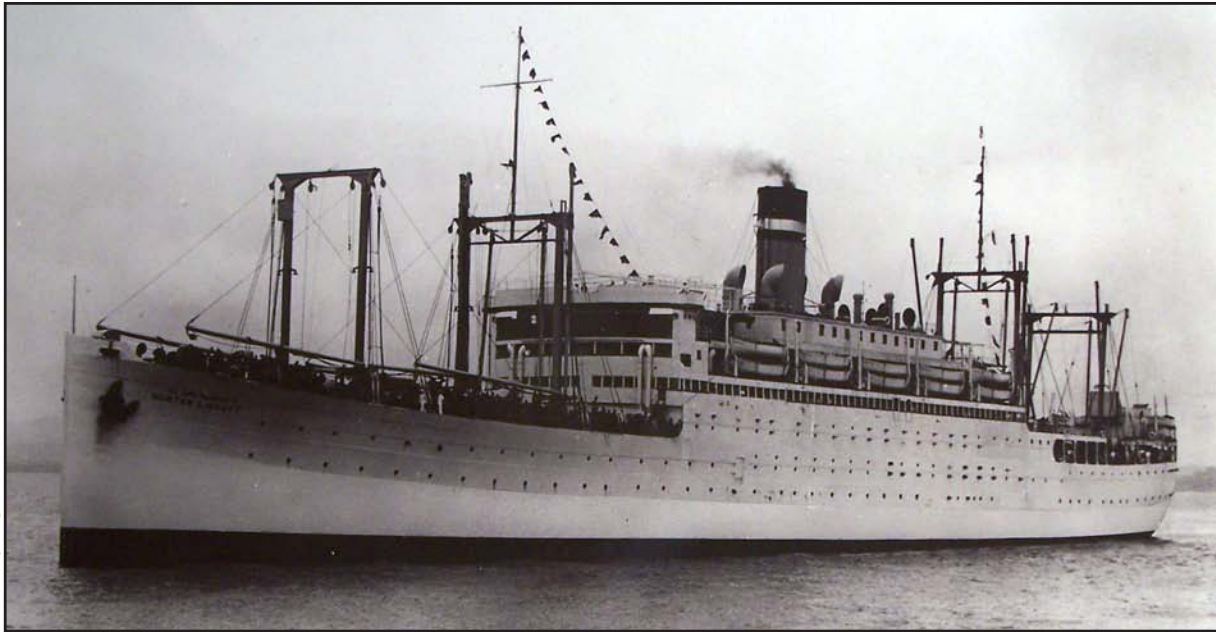

U.S.A.T. *Hunter Liggett*

Home Port—New York POE, Army Supply Base, Brooklyn, NY, 1939-41

Built by the Bethlehem Shipbuilding Company at Sparrow's Point, MD, as the S.S. *Pan America* and launched 4 June 1921. Delivered to the Munson Line 25 February 1922. Returned to control of the U.S. Maritime Commission in November 1938. Acquired by the U.S. Army Transport Service from the Maritime Commission reserve fleet 21 February 1939 at Bayonne, NJ, and assigned to the New York Port of Embarkation. Renamed as the U.S.A.T. *Hunter Liggett* in honor of Lt. Gen. Hunter Liggett, commander of the First U.S. Army in World War I. Conducted her shake down cruise on 10 April 1939 and departed four days later for San Francisco via the Panama Canal. The *Hunter Liggett* generally serviced the New York—Panama—San Francisco route and made occasional port calls at Charleston, San Juan, and Honolulu. Transported elements of the 1st Division to Charleston, SC, in November 1939 for participation in division tests at Fort Benning, GA. Underwent additional modifications to increase troop capacity in June-July 1940 at the Atlantic Basin Iron Works in Brooklyn. Transferred to the U.S. Navy 3 June 1941 at New York as the U.S.S. *Hunter Liggett*, AP-27.

Status: Sold to Boston Metals Company, and scrapped in January 1948 at Baltimore, MD.

Events:

Length: 535 ft.

Beam: 72 ft.

Draft: 41 ft.

Displacement: 13,712 tons

Masters, U.S.A.T. *Hunter Liggett*

Capt. Lyle C. Fordyce

6 Apr 39-8 Dec 41

Commanding Officer of Troops, U.S.A.T. *Hunter Liggett*

Maj. John P. Crehan, F.A.

6 Apr 39-3 Jun 41



U.S.A.T. *Irvin L. Hunt*

Home Port—San Francisco POE, Fort Mason, CA, 1940-41

Built by Skinner & Eddy Shipbuilding Company at Seattle, WA, and launched 9 November 1918 as the S.S. *Edenton*. Completed 5 December 1918 and turned over to the U.S. Navy as the U.S.S. *Edenton*. Acquired by the Army Transport Service from the U.S. Maritime Commission reserve fleet in February 1941. Assigned to the A.T.S. Pacific Fleet with home port at Fort Mason, CA. Renamed 8 March 1941 as the U.S.A.T. *Irvin L. Hunt*, in honor of Col. Irvin L. Hunt, Q.M.C., who died 21 August 1933 at Walter Reed General Hospital. Serviced the San Francisco—Honolulu—Manila route. Ran aground about July 1941 in the Makassar Strait, Netherlands East Indies. Served throughout World War II in the Pacific as a U.S. Army cargo transport.

Status: Placed in the Maritime Commission reserve fleet at Astoria, OR, in January 1947; sold for scrap in March 1948.

Length: 423 ft.

Beam: 54 ft.

Draft: 26.9 ft.

Displacement: 6,958 tons

Masters, U.S.A.T. *Irvin L. Hunt*

Unknown

Feb 41-7 Dec 41

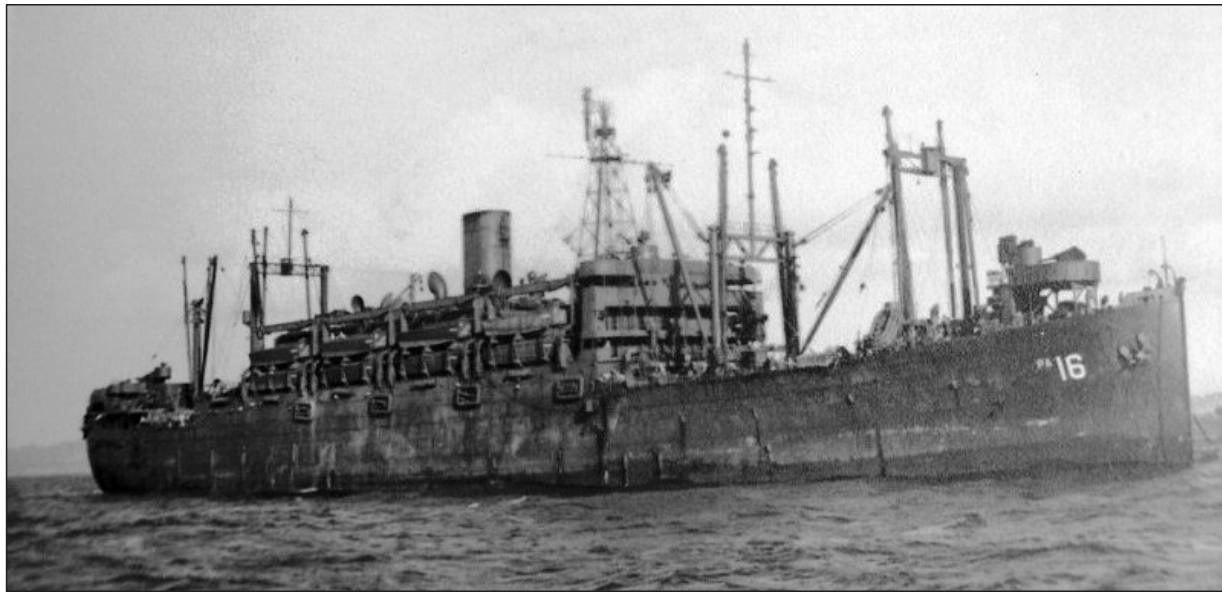

U.S.A.T. *J. Franklin Bell*

Home Port—San Francisco POE, Fort Mason, CA, 1940-41

Built by the New York Shipbuilding Company at Camden, NJ, and launched 5 May 1920 as the S.S. *Keystone State*. Delivered to the Pacific Steamship Company 28 May 1921 and renamed the S.S. *President McKinley* on 9 June 1922. Placed into commercial service with the Admiral Orient Line in 21 December 1922. Returned to the U.S. Maritime Commission reserve fleet at Seattle, WA, in 1938. Acquired by the U.S. Army Transport Service 26 October 1940. Assigned to the A.T.S. Pacific Fleet with home port at the San Francisco POE, Fort Mason, CA. Renamed 12 February 1941 as the U.S.A.T. *J. Franklin Bell*. Transferred to the U.S. Navy 2 December 1941 as the U.S.S. *J. Franklin Bell*, AP-16.

Status: Sold to Boston Metals Company, and scrapped in April 1948 at Baltimore, MD.

Events:

Length: 535 ft.

Beam: 72 ft.

Draft: 32 ft.

Displacement: 13,529 tons

Masters, U.S.A.T. *J. Franklin Bell*

Unknown 24 Oct 40 -7 Dec 41

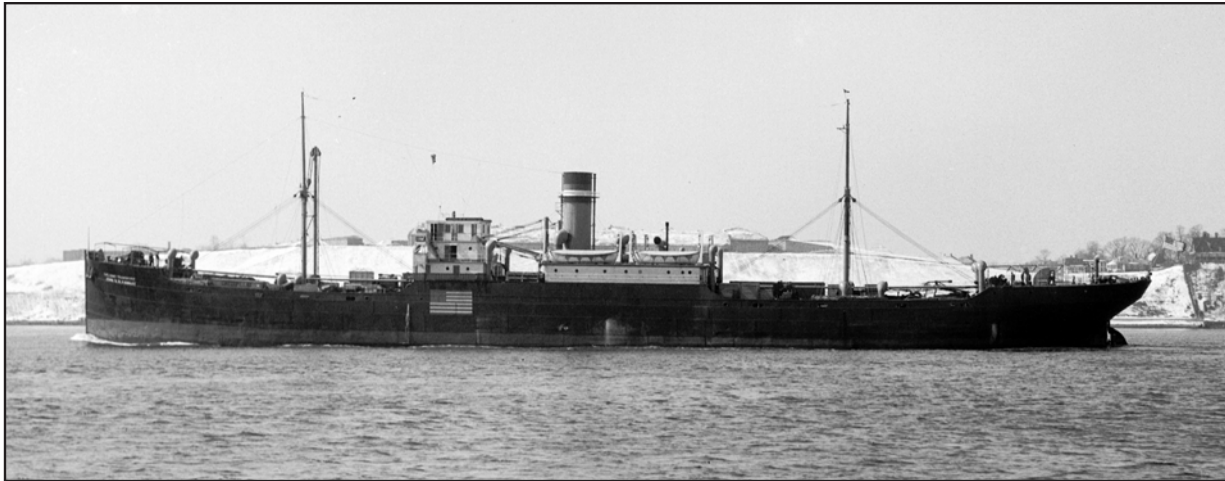

U.S.A.T. *John R.R. Hannay*

Home Port—Army Supply Base, Brooklyn, NY, 1940-41

Built by Federal Shipbuilding and Dry Dock Company, Kearny, NJ, and launched 31 March 1919 as the S.S. *Waukegan*. Completed in May 1919. Turned over to the U.S. Shipping Board. Acquired by the Army Transport Service from the U.S. Maritime Commission reserve fleet 23 August 1940 at New York. Assigned to the A.T.S. Atlantic Fleet with home port at Army Supply Base, Brooklyn, NY. Rehabilitated for active service as a supply ship at New York harbor. Renamed 8 March 1941 as the U.S.A.T. *John R.R. Hannay*, in honor of Col. John R.R. Hannay, Q.M.C., a former General Superintendent of the A.T.S. at San Francisco. Serviced the New York—San Juan—Canal Zone route. Served throughout World War II as a U.S. Army cargo transport.

Status: Scrapped in 1947 at New Orleans, LA.

Length: 395 ft.

Beam: 55 ft.

Draft: 31.4 ft.

Displacement: 6,629 tons

Masters, U.S.A.T. *John R.R. Hannay*

Capt. C. W. Lorin

8 Mar 41-ao Dec 41

Pictured as the S.S. *President Roosevelt*

U.S.A.T. *Joseph T. Dickman*

Home Port—New York POE, Army Supply Base, Brooklyn, NY, 1940-41

Built by the New York Shipbuilding Company at and launched 7 July 1921 at Camden, NJ, as the S.S. *Peninsular State*. Delivered to the U.S. Shipping Board in January 1922. Placed into commercial service with the United States Line as the S.S. *President Roosevelt* 1922-40. Acquired by the U.S. Army Transport Service 22 October 1940 at New York. Renamed 12 February 1941 as the U.S.A.T. *Joseph T. Dickman* in honor of Maj. Gen. Joseph T. Dickman, Commanding General of the Third Army in World War I. Assigned to the A.T.S. Atlantic Fleet with home port at the New York POE, Army Supply Base, Brooklyn, NY. Converted as a troop transport during February-June 1941 by the Atlantic Basin Iron Works at Brooklyn, NY. Transferred to the U.S. Navy in August 1941 as the U.S.S. *Joseph T. Dickman*, AP-26.

Status: Scrapped in 1948 at Oakland, CA.

Events:

Length: 516 ft.

Beam: 72 ft.

Draft: 32 ft.

Displacement: 13,869 tons

Masters, U.S.A.T. *Joseph T. Dickman*

Unknown

22 Oct 40 -7 Dec 41

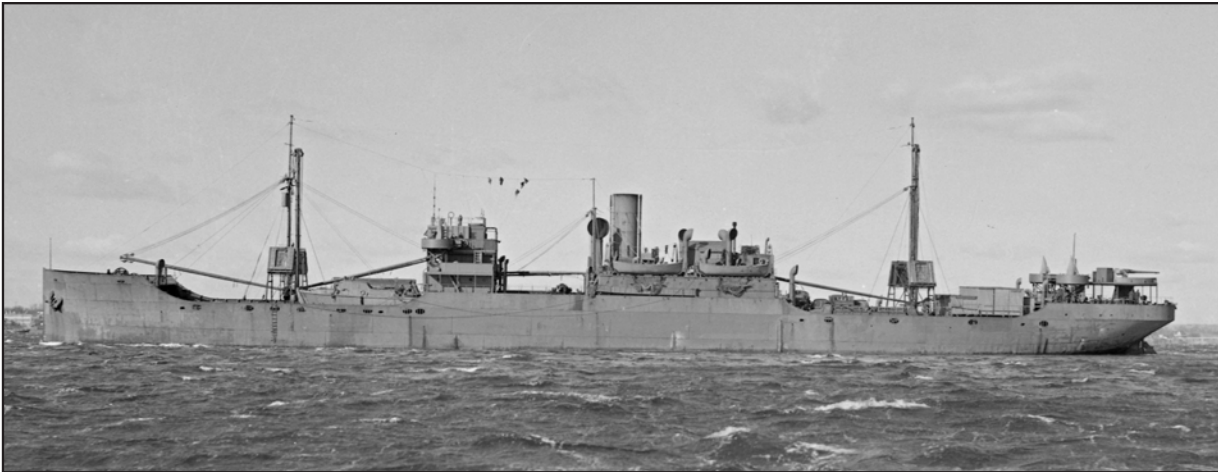
Pictured as the S.S. *Kofresi*

U.S.A.T. *Kenowis*

Home Port—Army Supply Base, Brooklyn, NY, 1926-32

Built by American International Shipbuilding Company at Hog Island, PA. Laid down 4 June 1919 and launched 26 November 1919 as the S.S. *Kenowis*. Delivered to the U.S. Shipping Board 16 January 1920. Assigned to the U.S. Army Transport Service 22 April 1926. Assigned to the A.T.S. Atlantic Fleet with home port at the Army Supply Base, Brooklyn, NY. The *Kenowis* served as a supply ship which transported ammunition, equipment, vehicles, and rations to support U.S. Army garrisons overseas. Generally serviced the New York—Panama—San Francisco route. Participated in the rescue of civilian flyers Ernest L. Smith and Emory B. Bronte, who made the first non-stop flight from the continental U.S. (Oakland, CA) to Hawaii, and crash-landed on Molokai in July 1927. Participated in hurricane relief operations in September 1928 by transporting food and other supplies to San Juan, PR. Supported the return of the U.S. Army Nicaraguan Canal Survey in July 1931. Turned over to the U.S. Shipping Board 5 September 1931. Sold to the Waterman Steamship Corporation 14 September 1931.

Status: Renamed as the S.S. *Kofresi* in 1939; sunk 17 July 1944 to serve as a breakwater off Normandy, France.

Length: 390 ft.

Beam: 54 ft.

Draft: 27 ft.

Displacement: 5,590 tons

Masters, U.S.A.T. *Kenowis*

Capt. Frank S. Randell

22 Apr 25-22 Jun 27

Capt. John A. Syverson

10 Jul 27-14 Sep 31

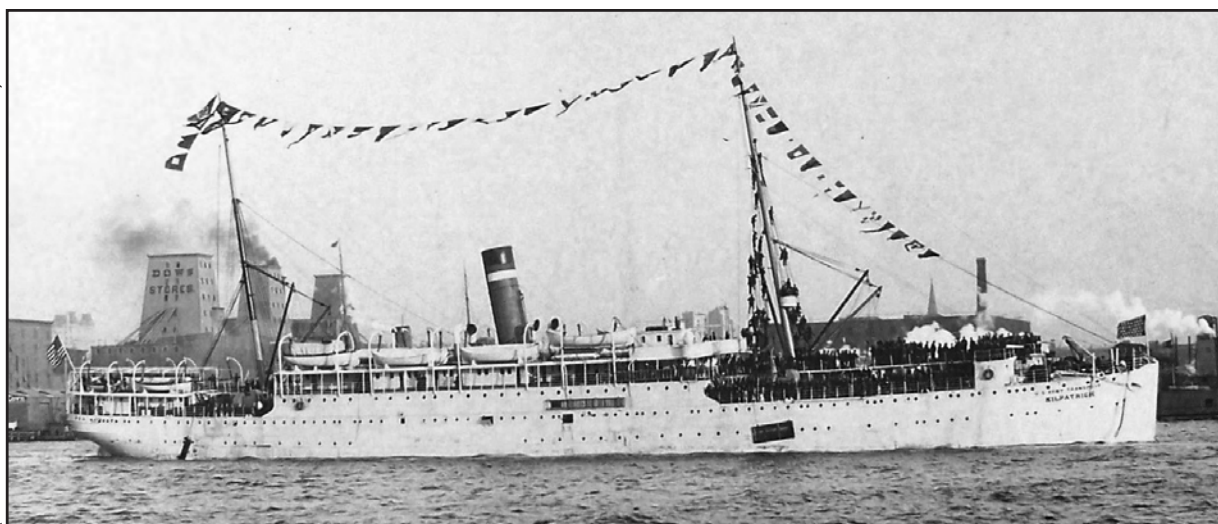

U.S.A.T. *Kilpatrick*

Home Port—New Orleans, LA, 1917-19; Newport News, VA, 1919-21

Built by Harland & Wolff Shipbuilding Company at Belfast, Ireland, and launched 19 April 1890 as the S.S. *Michigan*. Purchased by the Quartermaster Department on 14 July 1898 and assigned to the U.S. Army Transport Service. Renamed U.S.A.T. *Kilpatrick* in February 1899 in honor of Brig. Gen. Hugh Judson Kilpatrick, commanding general of the 3rd Division Cavalry Corps, Army of the Cumberland. Assigned to the A.T.S. Atlantic Fleet with home port at New Orleans, LA. Serviced the New Orleans—San Juan—Panama route 1917-19. Transferred in 1919 back to Newport News. Serviced the Newport News—Antwerp routes 1919-20. Sold 4 February 1921 to the American Black Sea Line and renamed the S.S. *Acropolis*.

Status: Scrapped in 1924 at Genoa, Italy, as the S.S. *Great Canton*.

Length: 370.8 ft. Beam: 44.2 ft. Draft: 26.6 ft. Displacement: 5,046 tons

Masters, U.S.A.T. *Kilpatrick*

Capt. James W. Scott	19 Apr 17-7 Apr 20	Capt. W. J. Rague	31 Aug 20-19 Oct 20
Capt. Norman Ferguson	27 Jul 20-31 Aug 20	1st Off. Frank J. Reppa	19 Oct 20-16 Dec 20
	Capt. James W. Scott	16 Dec 20-30 Jan 21	

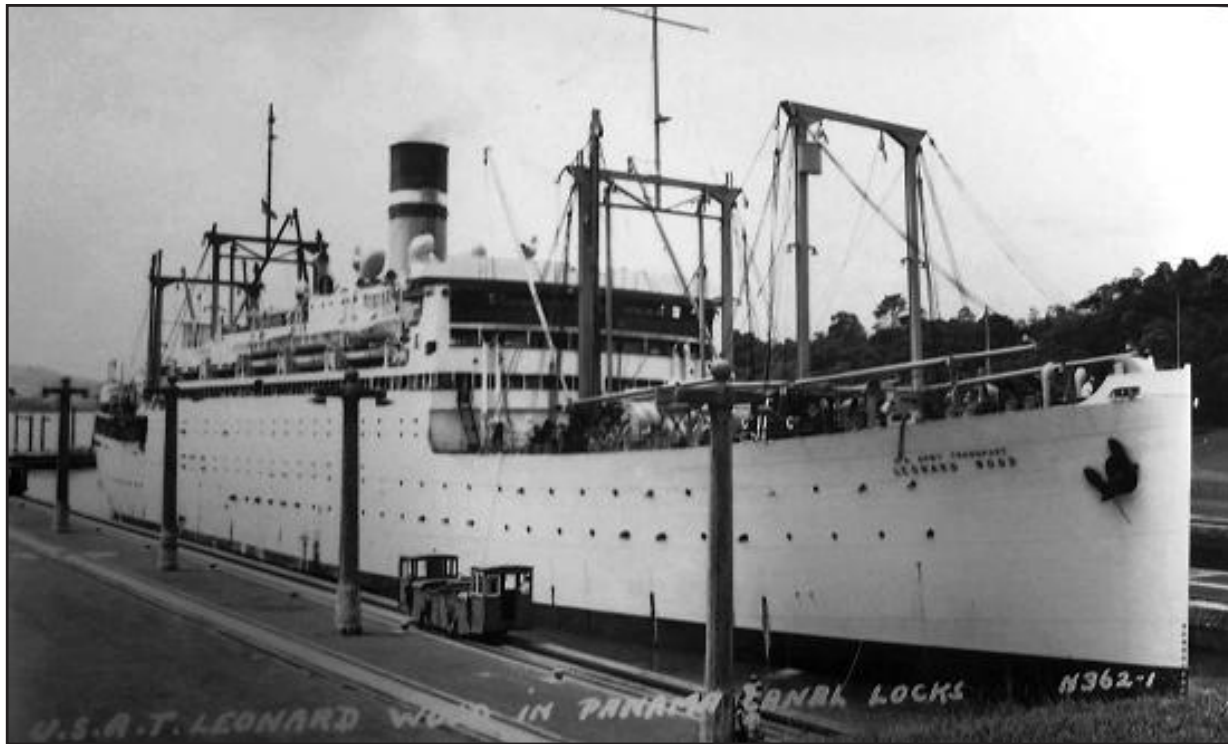

U.S.A.T. *Leonard Wood*

Home Port—San Francisco POE, Fort Mason, CA, 1939-41

Built by the Bethlehem Shipbuilding Company at Sparrows Point, MD, as the S.S. *Nutmeg State* and launched 17 September 1921. Completed in May 1922 and soon after renamed the S.S. *Western World*. Delivered to the U.S. Shipping Board 9 May 1922. Removed from the Maritime Commission reserve fleet and renovated as a troopship. Acquired by the U.S. Army Transport Service 21 February 1939. Renamed as the U.S.A.T. *Leonard Wood* in honor of Maj. Gen. Leonard Wood, the original commander of the famous “Rough Riders” in the Spanish-American War and of the 89th Division in World War I. Assigned to the A.T.S. Pacific Fleet with home port at as the San Francisco POE, Fort Mason, CA. The *Leonard Wood* generally serviced the San Francisco—Panama—Honolulu route, but made occasional port calls at Charleston, SC, San Juan, PR, and Seward, TA. Transferred to the U.S. Navy 3 June 1941 as the U.S.S. *Leonard Wood*, AP-25.

Status: Sold and scrapped in 1948.

Events: 289

Length: 535 ft.

Beam: 72 ft.

Draft: 31 ft.

Displacement: 13,712 tons

Masters, U.S.A.T. *Leonard Wood*

Capt. Clarence A. McMullen 28 Jul 39-ao Jan 40

Commanding Officer of Troops, U.S.A.T. *Leonard Wood*

Maj. Walter W. Boon, Cav. 27 Jul 39-3 Jun 41

National Archives
(RG 92-Records of the Quartermaster General)

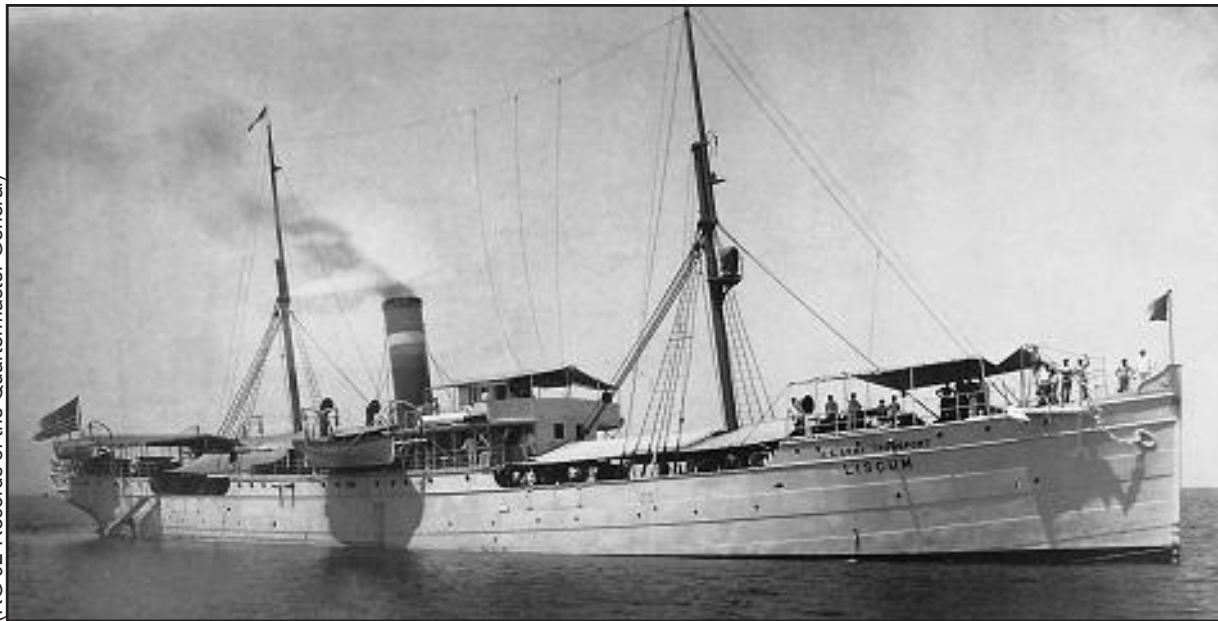

U.S.A.T. *Liscum*

Home Port—Manila, PI, 1919-23

Built by the R. W. Hawthorn Shipbuilding Company at Newcastle-on-Tyne, England, and launched in 1878 as the S.S. *Kong See*. Purchased by the Quartermaster Department 28 March 1901 from Mr. Warner Barnes at Hong Kong and assigned into the U.S. Army Transport Service. Further assigned to the Philippine Inter-Island Service with home port at Manila, PI. Renamed in honor of Col. Emerson H. Liscum, commander of the 9th Infantry, who was killed in action 13 July 1900 at Tientsen, China. Generally transported troops and supplies between garrisons in the Philippines, but made occasional voyages to transfer troops and supplies to garrisons in China. Sold 15 May 1923 in Manila and renamed the S.S. *Nuestra Señora de Alba*.

Status: Renamed as the S.S. *Yung Shun* in 1934; scrapped in 1939.

Length: 248 ft.

Beam: 31.2 ft.

Draft: 17.9 ft.

Displacement: 1,072 tons

Masters, U.S.A.T. *Liscum*

Capt. W. C. Barclay

6 Dec 14-ao Nov 20

Unknown

ao Nov 20-15 May 23

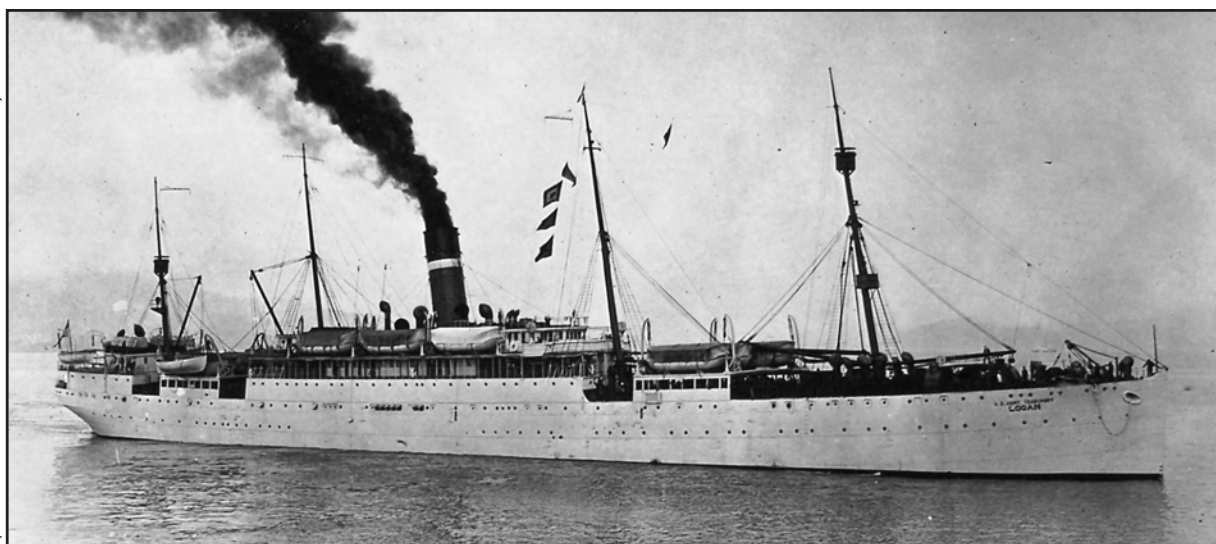

U.S.A.T. *Logan*

Home Port—Fort Mason, CA, 1919-22

Built by Harland and Wolff in Belfast, Ireland, and launched 28 January 1892 as the S.S. *Manitoba*. Purchased by the Quartermaster Department 20 July 1898 from the Atlantic Transport Line and assigned to the U.S. Army Transport Service. Renamed U.S.A.T. *Logan* in February 1899 in honor of Maj. Gen. John A. Logan, commander of the XV Corps, Army of the Tennessee during the Civil War. Assigned to the A.T.S. Pacific Fleet with home port at Fort Mason, CA. Transported elements of the U.S. Army Siberian Expedition to Vladivostok, Russia in December 1918. Transported the 27th Infantry from Vladivostok to San Francisco in September-October 1919. Evacuated elements of the Czech Legion at Vladivostok in January 1920 and disembarked them at Fiume, Croatia. Performed its final voyage for the U.S. Army Transport Service in October 1922. Sold 9 November 1922 to millionaire Asa Candler of Atlanta to be used as a floating school for young men.

Status: Scrapped in 1925 at Baltimore, MD.

Events:

Length: 445.5 ft.

Beam: 49.2 ft.

Draft: 30 ft.

Displacement: 7,519 tons

Masters, U.S.A.T. *Logan*

Capt. Charles F. Williams

ao Jun 12-17 Oct 22

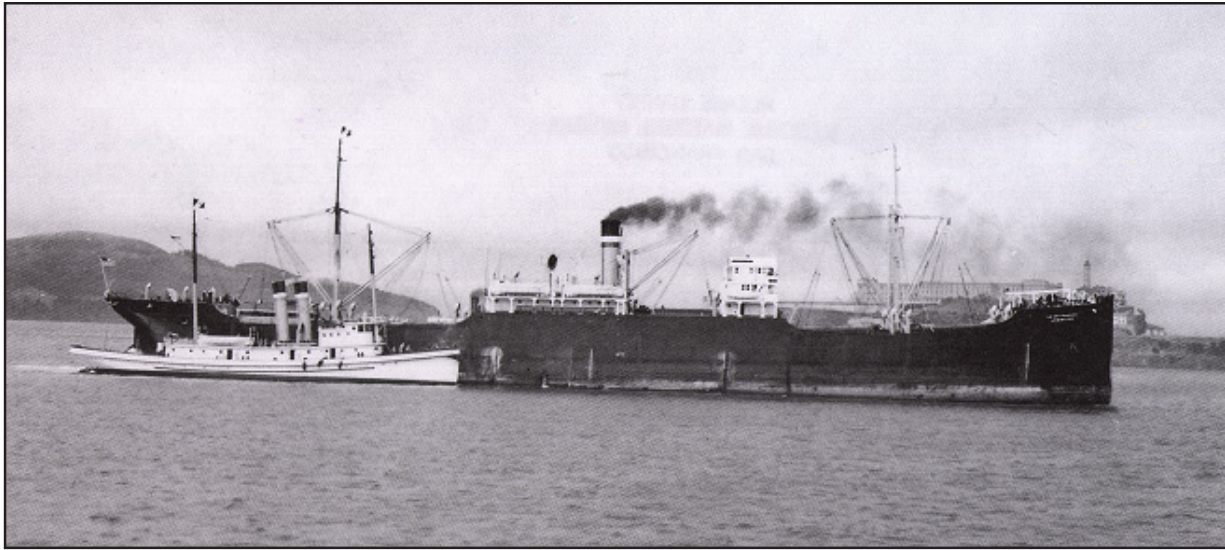

U.S.A.T. *Ludington*

Home Port—Army Supply Base, Brooklyn, NY, 1931-32; Fort Mason, CA, 1932-34; Army Supply Base, Brooklyn, NY, 1934-41

Built by Pusey and Jones Shipbuilding Company and launched at Gloucester, NJ, and launched 24 July 1920 as the S.S. *James Otis*. Delivered to the U.S. Shipping Board in August 1920. Transferred 1 May 1931 from the U.S. Shipping Board to the U.S. Army Transport Service. Renamed U.S.A.T. *Ludington* in honor of Maj. Gen. Marshall I. Ludington, 21st Quartermaster General of the U.S. Army 1898-1903 and founder of the U.S. Army Transport Service. Commissioned 1 August 1931 and assigned to the A.T.S. Atlantic Fleet with home port at the Army Supply Base, Brooklyn, NY. Initially serviced the New York—Canal Zone—San Francisco route. The *Ludington* served as a supply ship which transported ammunition, equipment, vehicles, and rations to support U.S. Army garrisons overseas. The ship also had accommodations for horses and as such, served as an animal transport in a secondary role. Transferred to the A.T.S. Pacific Fleet in November 1932 with home port at Seattle, WA. Serviced the San Francisco—Honolulu—Manila route with occasional stops in the Canal Zone. Transferred to the A.T.S. Atlantic Fleet in August 1934 with home port at the Army Supply Base, Brooklyn, NY. Serviced the New York—Canal Zone—San Francisco route. Laid up for extensive repairs 12 June 1936-4 February 1937. Caught fire in June 1937 in the Gulf of Mexico while carrying ammunition between New York and Cristobal, CZ; the crew successfully extinguished the blaze and averted disaster. On 7 December 1941, the *Ludington* was en route to the Philippines as part of the “Pensacola Convoy” resupply mission until ordered to sail to Australia.

Status: Sold and scrapped in 1947 at Hillside, NJ.

Length: 439 ft.

Beam: 60 ft.

Draft: 30 ft.

Displacement: 8,266 tons

Masters, U.S.A.T. *Ludington*

Capt. J. A. Syverson

14 Sep 33-30 Sep 33

Unknown

30 Sep 33-7 Dec 41



Pictured as the S.S. *American Trader*

U.S.A.T. *Marne*

Home Port—Army Supply Base, Brooklyn, NY, 1921; Norfolk, VA, 1921-23

Built by American International Shipbuilding Company at Hog Island, PA, and launched 16 April 1920. Delivered to the U.S. Shipping Board 24 December 1920. Transferred to the War Department 30 December 1920 and assigned to the U.S. Army Transport Service. Named in honor of the U.S. Army's participation in the Marne campaign in World War I. Laid up in December 1921 at Norfolk, VA. Directed by Executive Order dated 1 July 1922 to be turned over to the U.S. Shipping Board. Turned over to the U.S. Shipping Board 18 January 1923. Sold to the American Merchant Line in early 1924 and renamed the S.S. *American Trader*.

Status: Sold to the Société Maritime Anversoise, a Belgian shipping firm, as the S.S. *Ville de Hasselt*; sunk 31 August 1940 by the U-46 near St. Kilda off the west coast of Scotland.

Length: 448 ft.

Beam: 58 ft.

Draft: 28 ft.

Displacement: 7,555 tons

Masters, U.S.A.T. *Marne*

Capt. John Chambers

30 Dec 20-Dec 21

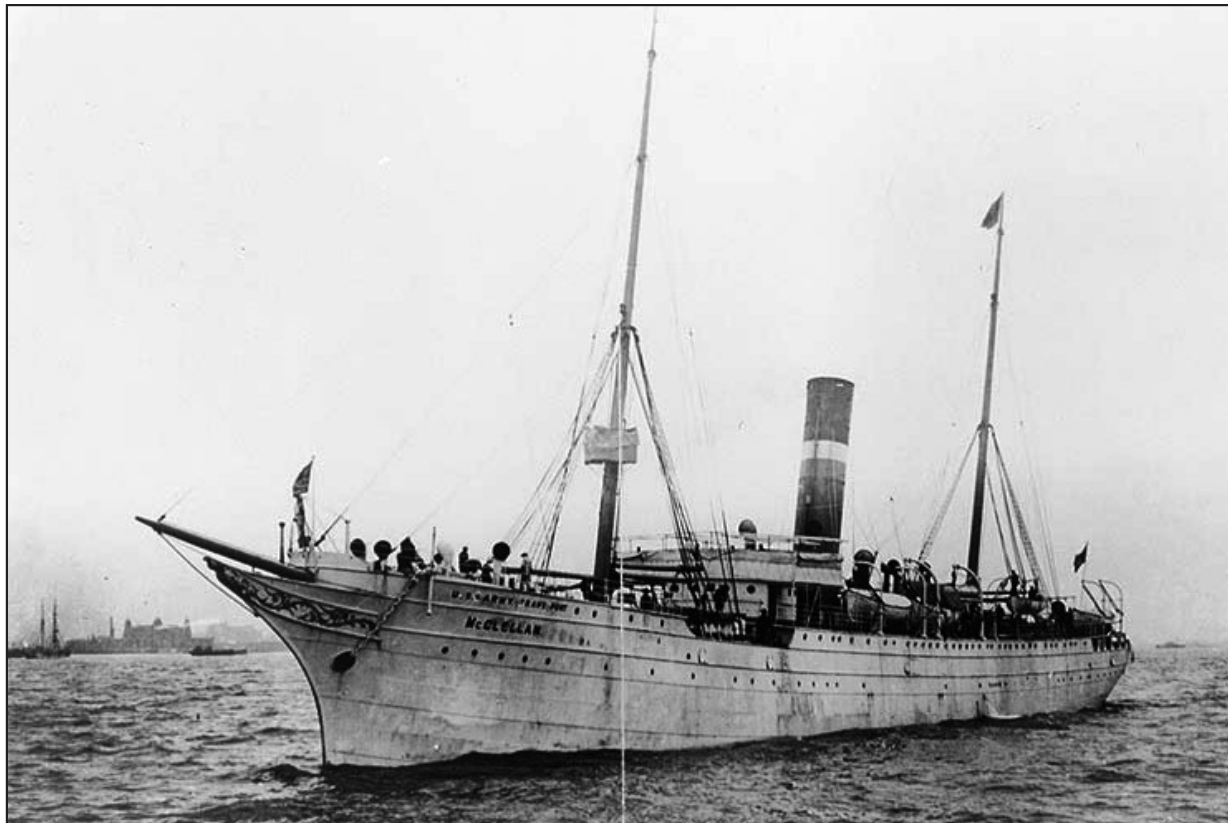

U.S.A.T. *McClellan*

Home Port—St. Nazaire, France, 1917-19

Built by Wigham Richardson & Company and launched at Newcastle, England, and launched in 1885 as the S.S. *Port Victor*. Purchased by the Quartermaster Department 8 July 1898 from the Irwin, McBride, and Catherwood Company and assigned into the U.S. Army Transport Service. Renamed U.S.A.T. *McClellan* in February 1899 in honor of Maj. Gen. George B. McClellan, commanding general of the Army of the Potomac, 1861-62. Assigned to the A.T.S. Atlantic Fleet and laid up at Pier No. 1 at the Newport News Shipyard. Recommissioned by May 1917. Sailed to France 16 June 1917 and arrived at St. Nazaire 1 July. Remained at St. Nazaire under the control of the port Quartermaster and functioned as a refrigerator storage ship throughout World War I. Sold to the French government 3 December 1919 and renamed the S.S. *Hastler*.

Status: Caught fire at Antwerp, Belgium, in 1920; sold and scrapped in 1922.

Length: 336 ft.

Beam: 38.2 ft.

Draft: 27.5 ft.

Displacement: 3,006 tons

Masters, U.S.A.T. *McClellan*

Capt. R. W. Tucker

11 Jun 17-19 Jun 18



U.S.A.T. Meigs

Home Port—Fort Mason, CA, 1922-41

Built by the Los Angeles Shipbuilding Company at San Pedro, CA, and launched 24 February 1921 as the S.S. *West Lewark*. Delivered to the U.S. Shipping Board in June 1921. Directed by Executive Order dated 7 January 1922 to be turned over to the War Department. Turned over at Seattle, WA, and assigned to the U.S. Army Transport Service. Assigned to the A.T.S. Pacific Fleet with home port at Fort Mason, CA.. Renamed 25 May 1922 as the U.S.A.T. *Meigs* in honor of Maj. Gen. Montgomery C. Meigs, Quartermaster General of the U.S. Army during the Civil War. The *Meigs* was a basically a refrigerator/supply ship. It was also an animal transport and held stalls for 268 animals. As such, the Commanding Officer of Troops for the *Meigs* was typically a U.S. Army Veterinary Corps officer. The *Meigs* generally serviced the San Francisco—Honolulu—Manila route. Made occasional voyages to Panama and Puerto Rico. Transported earthquake relief supplies to Yokohama after the disastrous earthquake that hit Japan in September 1923. On 7 December 1941, the *Meigs* was en route to the Philippines as part of the “Pensacola Convoy” on a resupply mission until ordered to sail to Australia.

Status: Sunk 19 February 42 during a Japanese air raid at Port Darwin, Australia.

Length: 430.4 ft. Beam: 54 ft. Draft: 38.3 ft. Displacement: 7,358 tons

Masters, U.S.A.T. Meigs

Capt. Carl A. Olsen	31 Dec 21-Aug 28	Capt. L.R.M. Kerr	Jun 30-ao Jan 36
Capt. Daniel Pumphrey	Aug 28-Oct 28	Unknown	ao Jan 36-ao Jun 38
Capt. James W. Scott	Oct 28-Jun 30	Capt. John P. Cotter	ao Jun 38-24 Jan 40
	Capt. Frank S. Link	24 Jan 40-19 Feb 42	

Commanding Officer of Troops, U.S.A.T. Montgomery C. Meigs

1st Lt. Maurice W. Hale, Vet.	ao Jan 32-12 Jul 33	Capt. Lloyd C. Teske, Vet.	2 Sep 37-15 Oct 37
Capt. Edgerton L. Watson, Vet.	12 Jul 33-27 Sep 35	Contr. Surg. James Fleming	15 Oct 37-12 Mar 38
Capt. Clarence L. Taylor, Vet.	27 Sep 35-16 Jun 37	Lt. Col. Seth C. Dildine, Vet.	12 Mar 38-Jun 38
1st Lt. Andrew J. Sirilo, Vet.	16 Jun 37-2 Sep 37	Capt. Lloyd C. Teske, Vet.	Jun 38-30 Sep 39

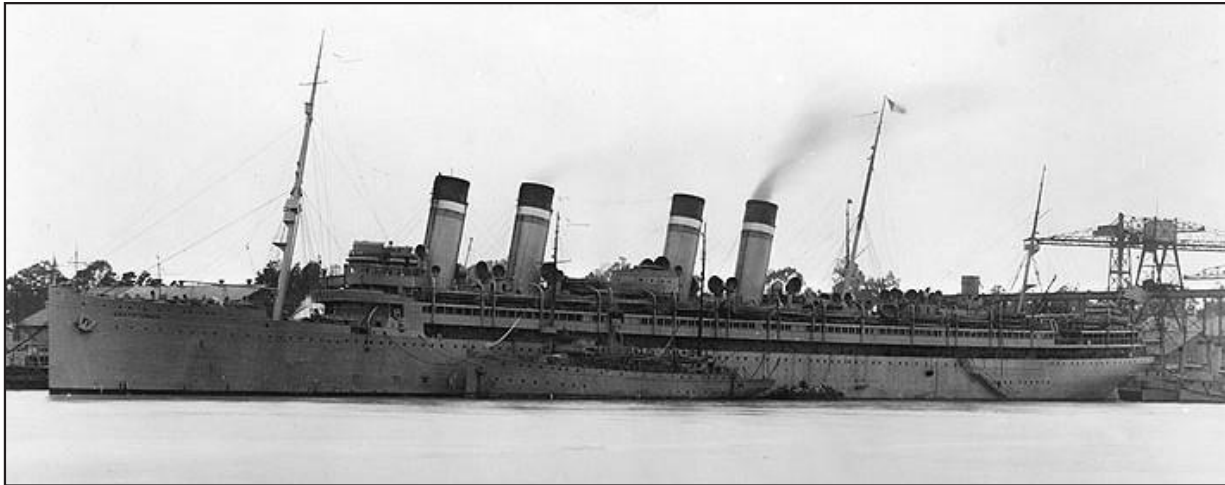

U.S.A.T. *Mount Vernon*

Home Port—Fort Mason, CA, 1919-20

Built by Actien Gesellschaft in Stettin, Germany, and launched in 1906 as the German-owned S.S. *Kronprinzessen Cecilie*. Acquired as a war prize in April 1917 at Bar Harbor, ME. Turned over to the U.S. Navy control in July 1917. In U.S. Navy service from July 1917 to September 1919 as the U.S.S. *Mount Vernon*. Torpedoed 5 September 1918 about 250 miles off the coast of France en route to the United States and sustained heavy damage. Transferred to the U.S. Army Transport Service 17 October 1919 and renamed the U.S.A.T. *Mount Vernon*. Assigned to the A.T.S. Pacific Fleet with home port at Fort Mason, CA. Made one journey between March and July 1920 to evacuate elements of the Czech Legion and 700 German prisoners of war at Vladivostok, Russia, and disembark them at Trieste, Italy and Hamburg, Germany, respectively. Turned over to the U.S. Shipping Board about August 1920.

Status: Laid up with the U.S. Shipping Board reserve fleet at Solomons Island, MD, 1920-40; scrapped 13 September 1940 at Boston, MA.

Events:

Length: 706.4 ft.

Beam: 72 ft.

Draft: 31.1 ft.

Displacement: 19,506 tons

Masters, U.S.A.T. *Mount Vernon*

Capt. Charles J. Bruguiere

Dec 19-Aug 20

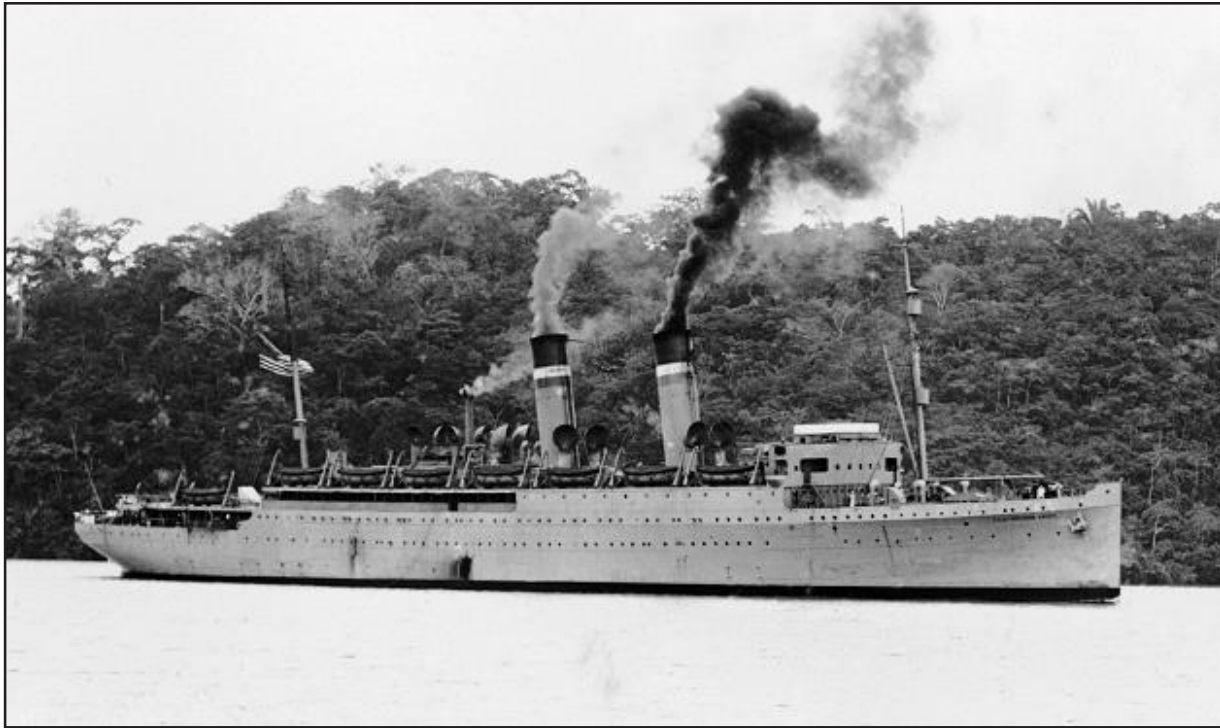

U.S.A.T. *Northern Pacific*

Home Port—Fort Mason, CA, 1919-21

Built by William Cramp & Sons Shipbuilding Company at Philadelphia, PA, and launched 7 July 1914. Completed in January 1915 and delivered to the Great Northern Pacific Steam Ship Company of Astoria, OR. Acquired by the U.S. Navy 21 September 1917 for service as a troop transport during World War I and renamed as the USS *Northern Pacific*. The *Northern Pacific* made at least thirteen voyages during and after the war carrying troops and supplies to and from France. On 20 August 1919 she was turned over to the Army Transport Service and renamed U.S.A.T. *Northern Pacific*. Assigned to the A.T.S. Pacific Fleet with home port at Fort Mason, CA. The ship departed 12 September 1919 en route to Vladivostok to transport troops of the Siberian Expeditionary Force to the Philippines. Delivered 22 December 1921 to the U.S. Shipping Board reserve fleet at New York and later sold.

Status: Destroyed by fire on 2 August 1922 twenty-five miles southeast of Cape May, NJ.

Length: 509.5 Ft.

Beam: 63 ft.

Draft: 21 ft.

Displacement: 8,255 tons

Masters, U.S.A.T. *Northern Pacific*

Capt. A. O. Lustie

21 Aug 19-22 Dec 21

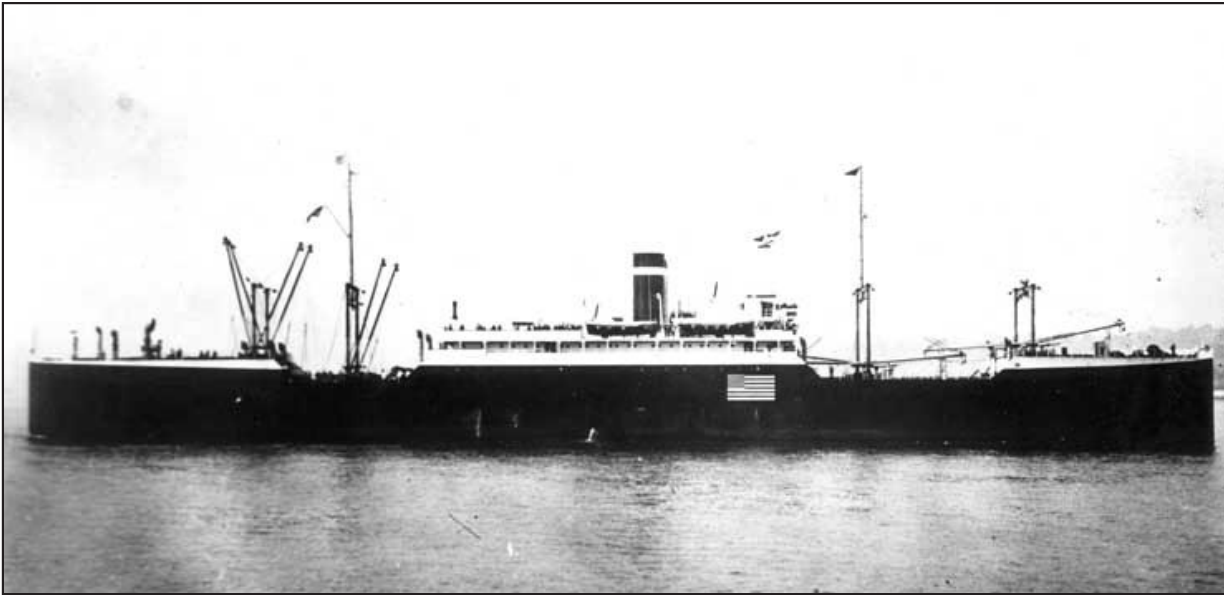
Pictured as the S.S. *American Farmer***U.S.A.T. *Ourcq*****Home Port**—Norfolk, VA, 1921-23

Built by American International Shipbuilding Company at Hog Island, PA, and launched 17 June 1920. Delivered to the U.S. Shipping Board in December 1920. Transferred to the War Department 6 January 1921 and assigned to the U.S. Army Transport Service. Assigned to the A.T.S. Atlantic Fleet with home port at Norfolk, VA. Named in honor of the U.S. Army's participation in the Ourcq campaign in World War I. Laid up 13 January 1921 at Norfolk, VA. Directed by Executive Order dated 1 July 1922 to be turned over to the U.S. Shipping Board. Turned over to the U.S. Shipping Board 5 January 1923. Sold to the American Merchant Line in early 1924 and renamed the S.S. *American Farmer*.

Status: Sold to the Société Maritime Anversoise, a Belgian shipping firm as the S.S. *Ville de Liege*; sunk 13 April 1941 by the U-52 off the east coast of Greenland.

Length: 448 ft.

Beam: 58 ft.

Draft: 28 ft.

Displacement: 7,555 tons

Masters, U.S.A.T. *Ourcq*

Unknown

6 Jan 21-13 Jan 21

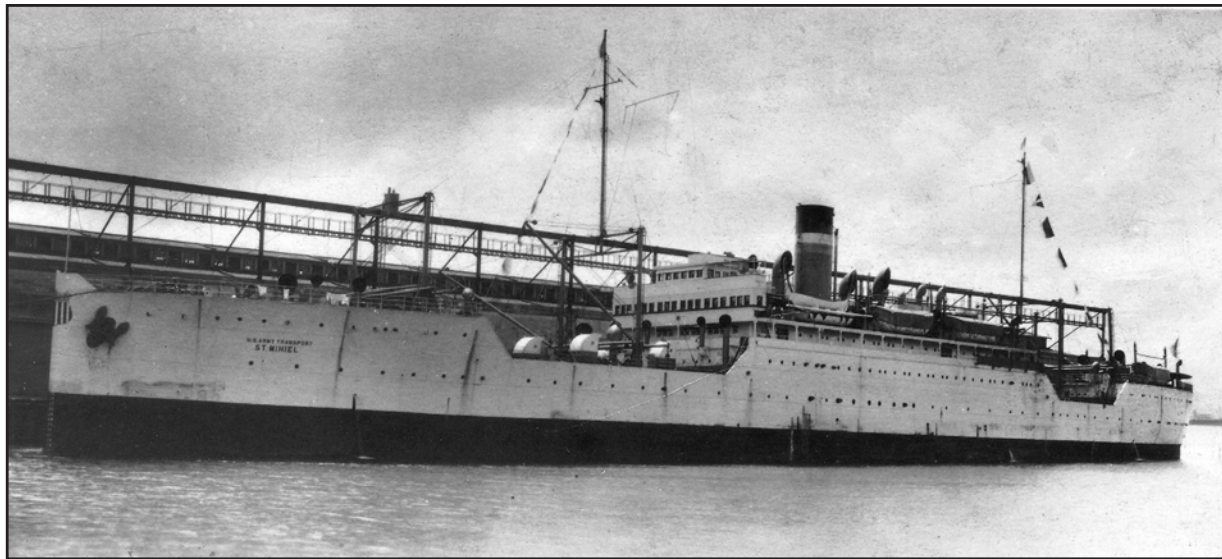

U.S.A.T. *St. Mihiel*

Home Port—Army Supply Base, Brooklyn, NY, 1919-31; San Francisco POE, Fort Mason, CA, 1931-41

Built by American International Shipbuilding Company and launched at Hog Island, PA 19 November 1919. Delivered to the U.S. Shipping Board in 1920. Transferred to the War Department 29 October 1920 and assigned to the U.S. Army Transport Service. Named in honor of the U.S. Army's participation in the Battle of St. Mihiel in World War I. Assigned to the A.T. S. Atlantic Fleet with home port at Army Supply Base, Brooklyn, NY. The *St. Mihiel* generally serviced the New York—Antwerp route, 1920-23, and the New York—San Juan—Panama route, 1923-26. Awarded the Efficiency ("E") pennant for Atlantic-based transports for 1922. Transported the last contingent of the American Forces in Germany from Antwerp, Belgium, to the port of New York in January 1923. Transported the 213th Coast Artillery from Philadelphia, PA to Fort Monroe, VA, in July 1926 for that regiment's participation in annual summer training. Participated in hurricane relief operations in September 1928 by transporting food and other supplies to San Juan, PR. Transferred to the A.T.S. Pacific Fleet with home port San Francisco Port of Embarkation, Fort Mason, CA. Serviced the San Francisco—Honolulu—Panama—New York route 1931-32. Transported the 30th Infantry to Hawaii in January–February 1932 to participate in a Hawaiian Department amphibious exercise and maneuver. Laid up 16 November 1932 at Fort Mason, CA. Returned to active service in April 1935 to transport 287 Midwestern farmers and family members who were on relief due to the depression to a new life in Alaska. Laid up 28 July 1939 at Brooklyn, NY, and crew transferred to the U.S.A.T. *Leonard Wood*. Returned to active service 15 Sep 1939. Service route changed in April 1940 to the San Francisco—Alaska route and with occasional port calls at Yaktat, Sitka, Dutch Harbor, Unimak, Honolulu, and Seattle. Transferred to the U.S. Navy on 22 July 1941 as the U.S.S. *St. Mihiel*, AP-32.

Status: Served in World War II as the U.S. Army Hospital Ship *St. Mihiel*; reverted to transport service in 1946; scrapped in 1957 at Baltimore, MD.

Events: 141, 222, 289

Length: 448 ft. Beam: 58 ft. Draft: 40 ft. Displacement: 7,555 tons

Masters, U.S.A.T. *St. Mihiel*

Capt. Woodbridge T. Oliver	Sep 20-12 Jul 28	Capt. Woodbridge T. Oliver	29 Jul 30-27 Jun 32
Capt. Bror E. Torning	12 Jul 28-11 May 29	Capt. Carl A. Olsen	27 Jun 32-16 Nov 32
Capt. Woodbridge T. Oliver	11 May 29-Jul 29	<i>Out of commission</i>	16 Nov 32-Apr 35
Ch. Off. Lyle C. Fordyce	Jul 29-22 Nov 29	Capt. Daniel Pumphrey	Apr 35-1 Nov 35
Capt. Woodbridge T. Oliver	22 Nov 29-13 Jan 30	Capt. Carl A. Olsen	1 Nov 35-28 May 37
Ch. Off. Lyle C. Fordyce	13 Jan 30-18 Mar 30	Capt. Clarence A. McMullen	28 May 37-28 Jul 39
Capt. Woodbridge T. Oliver	18 Mar 30-9 May 30	<i>Out of commission</i>	28 Jul 39-15 Sep 39
Ch. Off. Lyle C. Fordyce	9 May 30-29 Jul 30	Unknown	15 Sep 39-24 Jan 40
	Capt. John P. Cotter	24 Jan 40-22 Jan 41	

Commanding Officer of Troops, U.S.A.T. *St. Mihiel*

Maj. Robert E. Jones, Inf.	11 Apr 30-27 Aug 30	Col. Frank S. Bowen, F.A.	11 Jun 35-28 Jun 35
Maj. Paul N. Starling, Inf.	27 Aug 30-Nov 31	Col. Clifton R. Norton, C.A.C.	28 Jun 35-31 Mar 36
Maj. Cyril A. W. Dawson, C.A.C.	Nov 31-16 Nov 32	Maj. Anthony P. Lagorio	4 Nov 36-19 May 37
<i>Out of commission</i>	16 Nov 32-Apr 35	Maj. Walter W. Boon, Cav.	19 May 37-27 Jul 39
	<i>Out of commission</i>	28 Jul 39-15 Sep 39	

National Archives
(RG 32-Records of the United States Shipping Board)

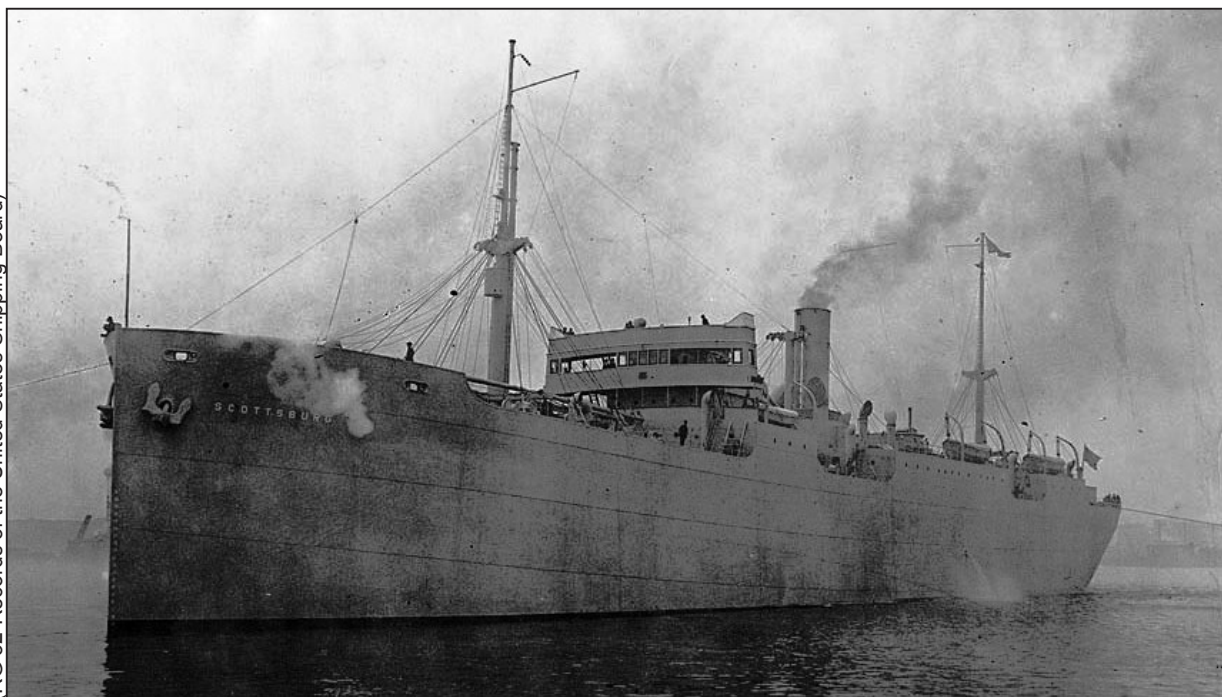

U.S.A.T. *Scottsburg*

Home Port—New York POE, Army Supply Base, Brooklyn, NY, 1936-37

Built by the New York Shipbuilding Company at Camden, NJ, and launched 20 September 1919 as the S.S. *Scottsburg*. Delivered to the U.S. Shipping Board 29 November 1919. Transferred to the War Department 2 May 1936 at New Orleans, LA, and assigned to the U.S. Army Transport Service as a temporary replacement for the U.S.A.T. *Ludington* as it underwent a major overhaul. Assigned to the A.T.S. Atlantic Fleet with home port at Army Supply Base, Brooklyn, NY. The *Scottsburg* generally serviced the New York—Canal Zone—San Francisco—Hawaii route. Turned over to the U.S. Maritime Commission 12 February 1937 at Galveston, TX, when the *Ludington* returned to service. The *Scottsburg* was sold on that date to the Lykes Brothers—Ripley Steamship Company at San Francisco.

Status: Torpedoed and sunk 14 June 1942 off Florida in the Caribbean.

Length: 419.5 ft. Beam: 56.5 ft. Draft: 30.2 ft. Displacement: 7,772 tons

Masters, U.S.A.T. *Scottsburg*

1st Off. Trygve Sorenson	4 May 36-26 May 36	Capt. Walter J. Bernard	26 May 36-Sep 36
	Capt. Daniel Pumphrey	Sep 36-12 Feb 37	

National Archives(RG 111-US Army
Signal Corps still photo collection)

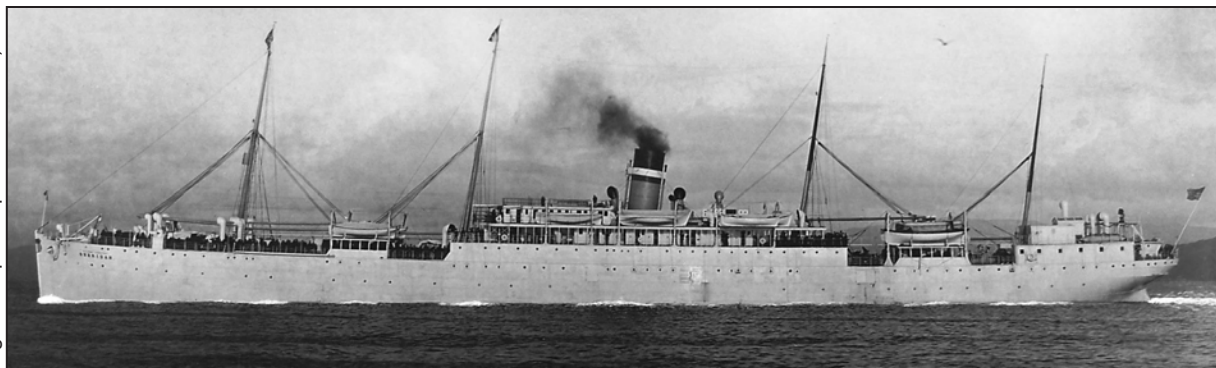

U.S.A.T. *Sheridan*

Home Port—Fort Mason, CA, 1919-22

Built by Harland and Wolff in Belfast, Ireland, and launched 17 December 1891 as the S.S. *Massachusetts*. Completed 5 March 1892. Purchased by the Quartermaster Department 14 July 1898 from the Atlantic Transport Line and assigned to the U.S. Army Transport Service. Renamed U.S.A.T. *Sheridan* 9 January 1899 in honor of Lt. Gen. Philip H. Sheridan, commanding general of the U.S. Army 1883-88. Assigned to the A.T.S. Pacific Fleet with home port at Fort Mason, CA. Made several voyages between 15 February and 5 July 1920 to evacuate elements of the Czech Legion from Vladivostok and disembarked them at Fiume, Croatia. Performed its final voyage for the U.S. Army Transport Service in June 1922 and soon after turned over to the U.S. Shipping Board. Sold 29 December 1922 to the Union Construction Company of Oakland, CA.

Status: Scrapped in October 1923 at San Francisco, CA.

Events: 16

Length: 445.5 ft.

Beam: 49.2 ft.

Draft: 30 ft.

Displacement: 7,496 tons

Masters, U.S.A.T. *Sheridan*

Capt. William A. Carleton
Capt. James J. Murphy

Jan 16-Jun 18
Jun 18-8 Mar 20

Capt. W. C. Johnson
Capt. James J. Murphy

8 Mar 20-8 Jul 21
8 Jul 21-29 Dec 22

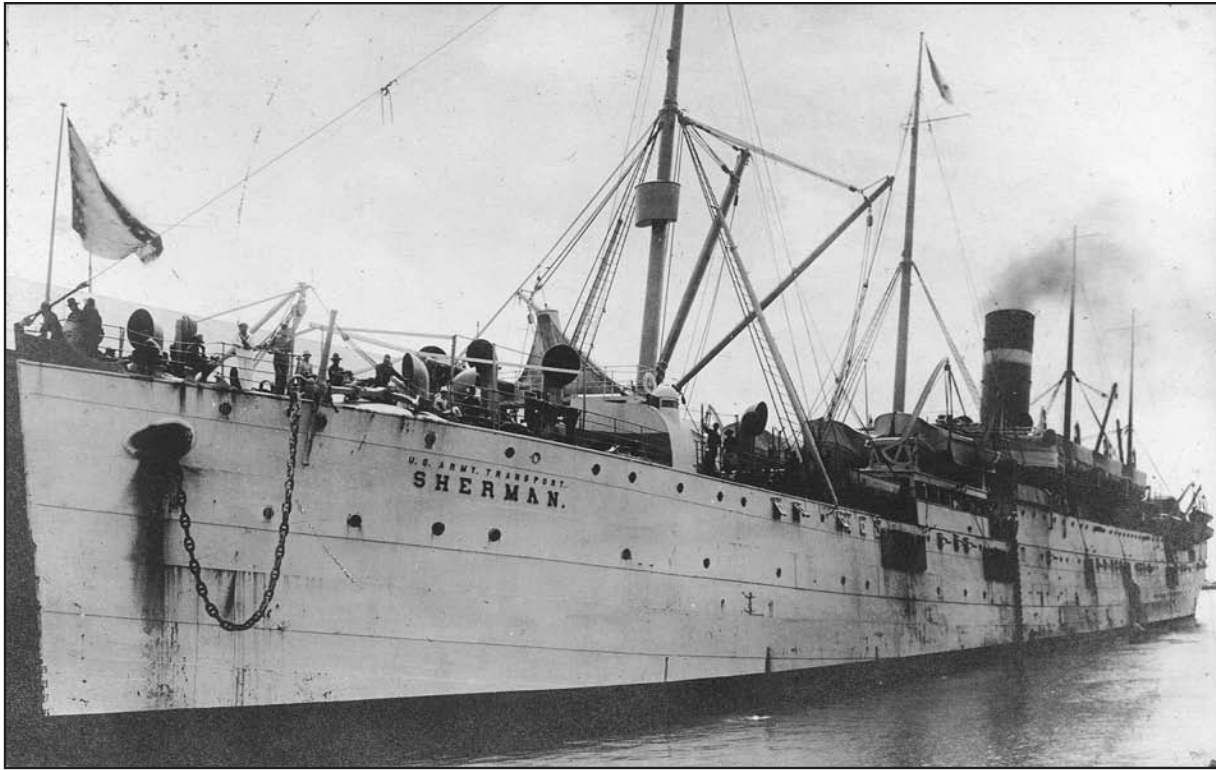

U.S.A.T. *Sherman*

Home Port—Fort Mason, CA, 1919-22

Built by Harland and Wolff in Belfast, Ireland, and launched 17 November 1892 as the S.S. *Mobile*. Completed 27 July 1893. Purchased from the African Steamship Company 14 July 1898 and assigned to the U.S. Army Transport Service. Renamed U.S.A.T. *Sherman* 9 January 1899 in honor of Lt. Gen. William T. Sherman, commanding general of the Army of the Tennessee and of the Military Division of the Mississippi during the Civil War, and of the U.S. Army 1869-83. Assigned to the A.T.S. Pacific Fleet with home port at Fort Mason, CA. Made several voyages between 14 May and 30 July 1920 to evacuate elements of the Czech Legion from Vladivostok and disembarked them at Fiume, Croatia. Awarded the “E” banner for Pacific-based transports for 1921. Performed its final voyage for the U.S. Army Transport Service in June 1922. Laid up 10 June 1922 at San Francisco and turned over to the U.S. Shipping Board. Sold to the Los Angeles Steam Ship Company 15 November 1922 and renamed as the S.S. *Calawaii*.

Status: Scrapped in December 1933 at Osaka, Japan.

Events: 16

Length: 445.5 ft. Beam: 50.2 ft. Draft: 30 ft. Displacement: 7,271 tons

Masters, U.S.A.T. *Sherman*

Unknown	ao Jan 19-3 Aug 20	Capt. Edgar S. McLellan	14 Sep 20-Apr 22
Capt. H. C. Fish	3 Aug 20-14 Sep 20	Capt. L. R. M. Kerr	Apr 22-15 Nov 22

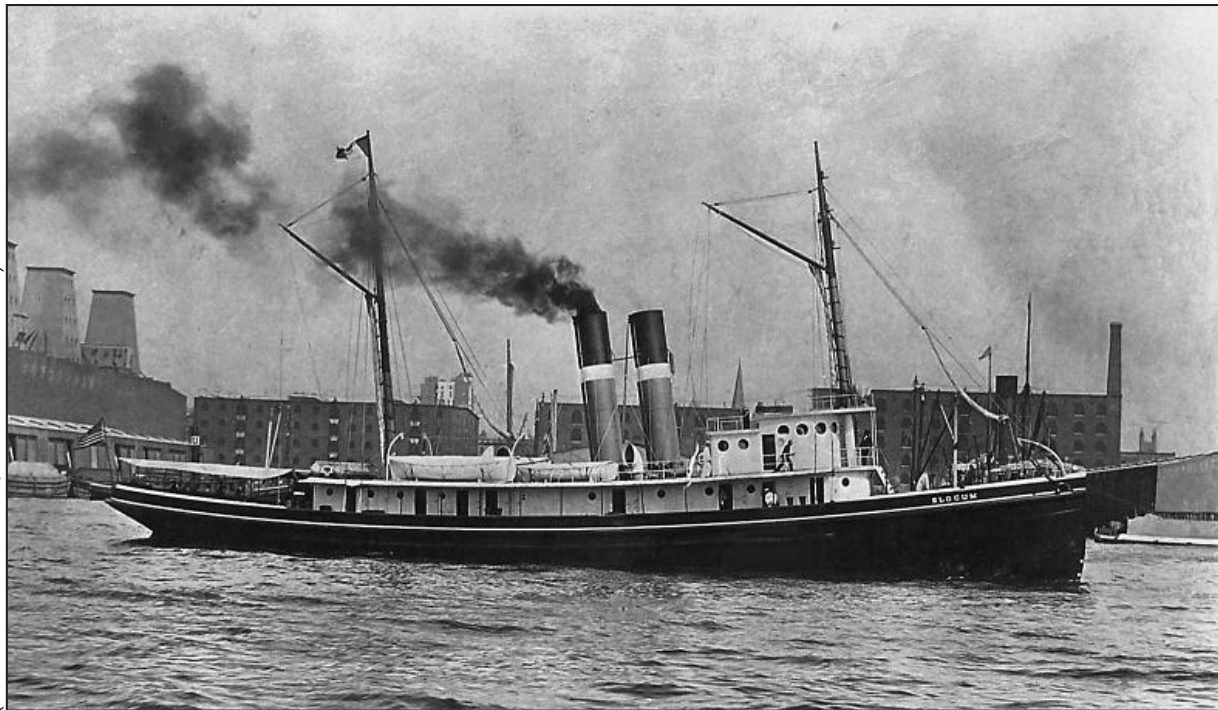

U.S.A.T. *Slocum*

Home Port—Brest, France 1919; Fort Mason, CA, 1919-1946

Built by Hillman Shipbuilding Company and launched at Philadelphia, PA, in early 1898 as the S.S. *Gypsum King*. Purchased by the Quartermaster Department 25 July 1898 from the J. B. King Transportation Company and assigned to the Army Transport Service. Named in honor of Major General Henry W. Slocum, commanding general of the XII Corps, Army of the Potomac, at the battle of Gettysburg. Assigned to the Army Transport Service at New York Harbor. Assigned to the A.T.S. and stationed at the Harbor of Brest, France, as of January 1919. Provided harbor tug services to the Army Transport Service and the U.S. Navy's Cruiser and Transport Force at French ports. Departed St. Nazaire, France, 16 August 1919 and arrived at New York 17 December 1919. Returned to San Francisco in early 1920 via the Panama Canal and reassigned to the A.T.S. Pacific Fleet. Converted from coal to oil during August-September 1932.

Status: Ran aground off Alaska in February 1943. Although salvaged, the *Slocum* was ultimately declared a loss, was not repaired, and did not reenter service with the A.T.S. Sold and scrapped in 1946.

Length: 148.4 ft. Beam: 29.3 ft. Draft: 18 ft. Displacement: 587 tons

Masters, U.S.A.T. *Slocum*

Capt. Isaac L. Smith	Jun 1902-Oct 17	Unknown	ao Feb 21-ao Jan 22
Capt. C. Case	Oct 17-9 Nov 17	Capt. Isaac L. Smith	ao Jan 22-ao Mar 23
Capt. Harry K. Poole	9 Nov 17-Jul 18	Unknown	ao Mar 23-ao Jun 24
Capt. A. Neuf Eglise	Jul 18-8 Dec 18	Capt. Brinkley	ao Jun 24-ao Jul 24
Capt. Francis A. Pfeiffer	8 Dec 18-20 Dec 18	Unknown	ao Jul 24-ao Sep 32
Capt. A. Neuf Eglise	20 Dec 18-4 Feb 19	Capt. F. Van Vleck	ao Sep 32-ao Jan 33
Capt. Harry K. Poole	4 Feb 19-Dec 19	Unknown	ao Jan 33-ao Aug 36
Capt. A. Hansen	Dec 19-ao Feb 21	Capt. Frank S. Link	ao Aug 36-ao May 38
	Unknown	ao Mat 38-7 Dec 41	

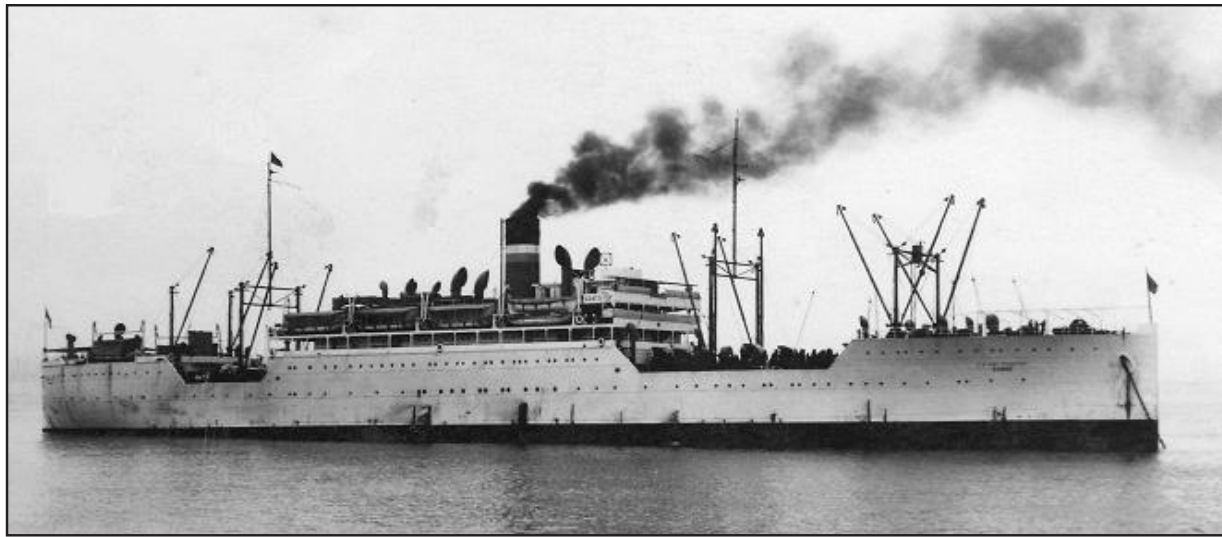

U.S.A.T. Somme

Home Port—Army Supply Base, Brooklyn, NY, 1919-22; Fort Mason, CA, 1922-31

Built by American International Shipbuilding Company at Hog Island, PA, and launched 17 March 1920. Named in honor of the U.S. Army's participation in the Battle of the Somme in World War I. Delivered to the U.S. Shipping Board 24 November 1920. Transferred to the War Department 24 December 1920 and assigned to the U.S. Army Transport Service. Assigned to the A.T.S. Atlantic Fleet with home port at Army Supply Base, Brooklyn, NY. The *Somme* generally serviced the New York—Antwerp and the New York—San Juan—Panama routes 1920-22. Performed its first voyage for the Army Transport Service 24 December 1920. On 17 March 1921, the *Somme* repatriated 1,609 bodies of U.S. servicemen who died in France in World War I and landed them at Hoboken, NJ. Laid up 12 August 1921 at Pier No. 1, Army Supply Base, Norfolk, VA. Recommissioned 23 December 1921. Transferred to the A.T.S. Pacific Fleet about August 1922. Assigned to service the San Francisco—Honolulu and the San Francisco—New York routes 1922-31. Made occasional voyages to Manila, Nagasaki, and Yokohama. Laid up 7 October 1922 at San Francisco. Recommissioned 7 September 1923. Transported earthquake relief supplies to Yokohama after the disastrous earthquake that hit Japan in September 1923. Laid up in February 1925 at San Francisco. Recommissioned in August 1925. Provided occasional support to the U.S. Marine expedition and the U.S. Army topographic survey mission to Nicaragua 1928-32. Turned over to the U.S. Shipping Board 27 October 1931 at New York harbor and sold to the United States Line as the S.S. *American Importer*. Shortly thereafter renamed the S.S. *American Traveler*.

Status: Sold to the Société Maritime Anversoise, a Belgian shipping firm as the S.S. *Ville de Gand*; sunk 13 August 1941 by the U-47 off the northwest coast of Ireland.

Length: 448 ft. Beam: 58 ft. Draft: 28 ft. Displacement: 9,050 tons

Masters, U.S.A.T. Somme

1st Off. Thomas F. Quinn	25 Nov 20-30 Nov 20	Capt. Carl A. Olsen	7 Sep 23-ao Oct 23
1st Off. Louis DeVere	30 Nov 20-14 Dec 20	Capt. Edgar S. McLellan	ao Jul 24-20 Dec 24
Capt. W. J. Rague	14 Dec 20-9 Jan 21	1st Off. John Brevick	20 Dec 24-4 Apr 26
Capt. James W. Scott	9 Jan 21-15 Aug 21	Capt. Frank Hall	4 Apr 26-Feb 27
Capt. William S. Bartlett	15 Aug 21-25 Jan 22	Capt. James W. Scott	Feb 27-ao Oct 27
Capt. Harry K. Poole	23 Mar 22-7 Oct 22	1st Off. Daniel Pumphrey	ao Feb 28-Aug 28
Capt. Edgar S. McLellan	7 Oct 22-7 Sep 23	Capt. Carl A. Olsen	Aug 28-30 Aug 31
	Capt. Woodbridge T. Oliver	30 Aug 31-27 Oct 31	

Commanding Officer of Troops, U.S.A.T. Somme

Maj. Joseph J. Koch	9 May 30-ao Jul 30	Col. Edward B. Mitchell, Inf.	ao Jan 31-10 Aug 31
---------------------	--------------------	-------------------------------	---------------------

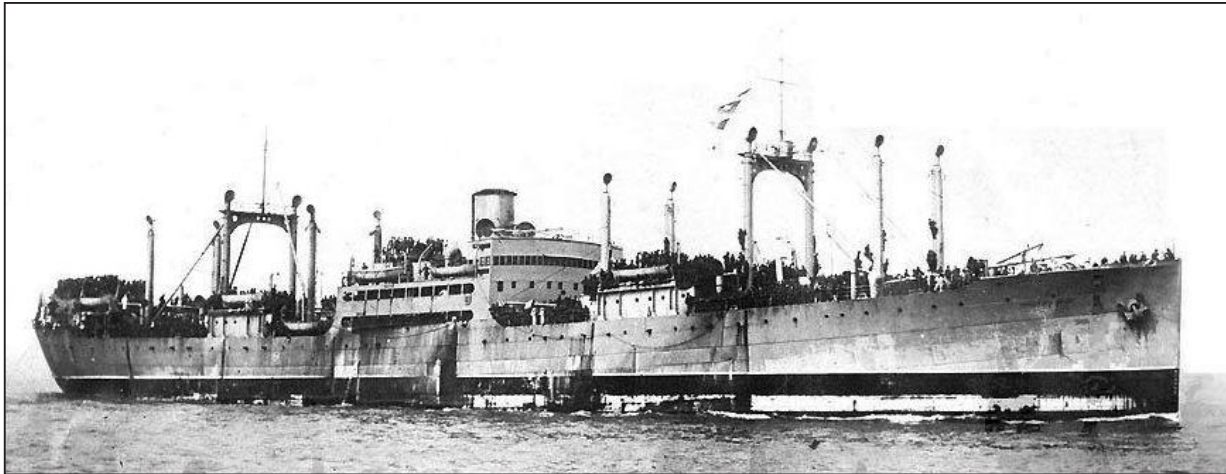

U.S.A.T. *South Bend*

Home Port—Fort Mason, CA, 1919-20

Built by the Sun Shipbuilding & Dry Dock Company in Chester, PA, and launched in 29 October 1918 as the S.S. *South Bend*. Turned over to the U.S. Shipping Board and allotted to the U.S. Navy 7 March 1919. In U.S. Navy service from March 1919 to September 1919 as the U.S.S. *South Bend*. Transferred to the U.S. Army Transport Service 3 September 1919 and renamed the U.S.A.T. *South Bend*. Assigned to the A.T.S. Pacific Fleet with home port at Fort Mason, CA. Returned to the U.S. Shipping Board about August 1920.

Status: Laid up with the U.S. Shipping Board reserve fleet; sold in 1922 to the Luckenbach Steam Ship Company and renamed as the S.S. *J. L. Luckenbach*; scrapped in 1959.

Events: 16

Length: 448.9 ft.

Beam: 60.2 ft.

Draft: 28.3 ft.

Displacement: 8, 738 tons

Masters, U.S.A.T. *South Bend*

Unknown 3 Sep 19-Aug 20

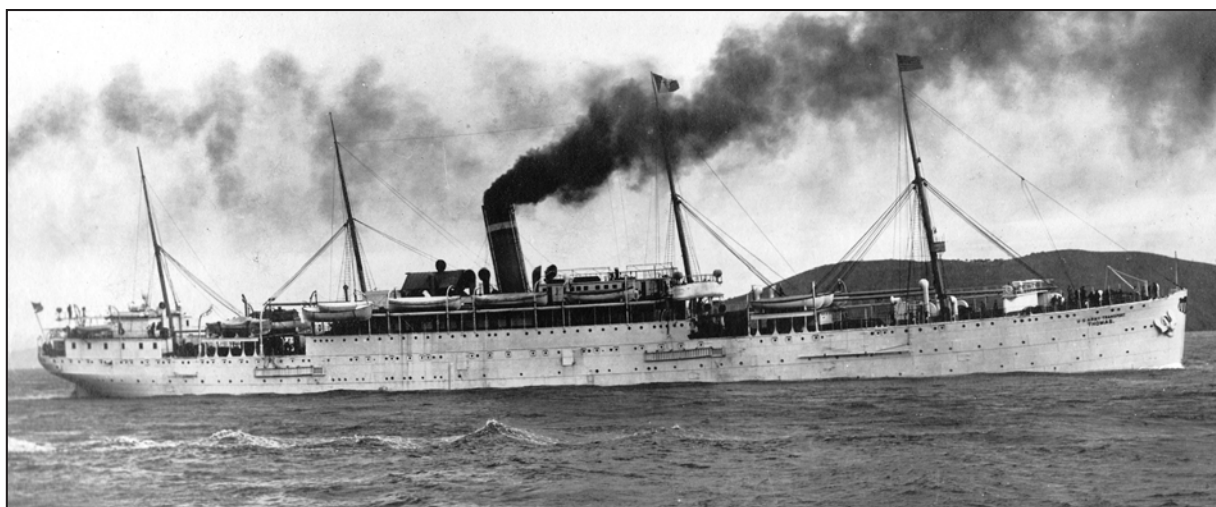

U.S.A.T. *Thomas*

Home Port—Fort Mason, CA, 1919-28

Built by Harland and Wolff in Belfast, Ireland, and launched 8 May 1894 as the S.S. *Minnewaska*. Completed 15 July 1894. Purchased from the Atlantic Transport Line 26 July 1898 and assigned to the U.S. Army Transport Service. Renamed U.S.A.T. *Thomas* in February 1899 in honor of Maj. Gen. George H. Thomas, commanding general of the XIV Corps and the Army of the Cumberland 1862-1865. Assigned to the A.T.S. Pacific Fleet with home port at Fort Mason, CA. Serviced the San Francisco—Honolulu—Manila route and made occasional port calls at Chinwangtao, China, and Nagasaki, Japan. Made several voyages between 10 June and 22 September 1920 to evacuate elements of the Czech Legion from Vladivostok and disembark them at Trieste, Italy. Participated in the rescue of 217 passengers and crew members of the S.S. *City of Honolulu* which caught fire 12 October 1922 about 670 miles northeast of the Hawaiian Islands. Awarded the Efficiency (“E”) pennant for Pacific-based transports for 1925. Performed its final voyage for the U.S. Army Transport Service in March 1928 and was turned over to the U.S. Shipping Board. Sold to American Iron and Metal Company 14 May 1929 for scrapping. Scrapped in August 1929 at Oakland, CA.

Events: 16, 28

Length: 445.5 ft. Beam: 50.2 ft. Draft: 29.8 ft. Displacement: 7,685 tons

Masters, U.S.A.T. *Thomas*

Capt. Frank Hall ao Dec 16-4 Apr 26 Capt. Edgar S. McLellan 4 Apr 26-Mar 28

Pictured as the S.S. *American Shipper***U.S.A.T. *Tours*****Home Port**—Norfolk, VA, 1921-23

Built by American International Shipbuilding Company at Hog Island, PA, and launched 6 July 1920. Named in honor of the city of Tours, headquarters of the Army Transport Service in France during World War I. Delivered to the U.S. Shipping Board 21 January 1921. Transferred to the War Department 22 January 1921 and assigned to the U.S. Army Transport Service. Assigned to the A.T.S. Atlantic Fleet with home port at Norfolk, VA. Concurrently laid up at Norfolk. Directed by Executive Order dated 1 July 1922 to be turned over to the U.S. Shipping Board. Turned over to the U.S. Shipping Board 11 January 1923. Sold to the American Merchant Line in early 1924 and renamed the S.S. *American Shipper*.

Status: Sold to the Société Maritime Anversoise, a Belgian shipping firm as the S.S. *Ville de Mons*; sunk 2 September 1940 by the U-47 off the coast of Northern Ireland/Scotland.

Length: 448 ft.

Beam: 58 ft.

Draft: 28 ft.

Displacement: 7,555 tons

Masters, U.S.A.T. *Tours*

Unknown

6 Jan 21-22 Jan 21



U.S.A.T. U.S. Grant

Home Port—Fort Mason, CA, 1919-41

Built by A. G. Vulcan Shipbuilding Company and launched at Stettin, Germany, on 20 July 1907 as the S.S. *König Wilhelm II*. Operated by the Hamburg-American Line until interned in the United States in 1914 at Hoboken, NJ. Seized as a war prize at Hoboken on 6 April 1917. Turned over to the U.S. Navy which operated the vessel as the troop transport U.S.S. *Madawaska* in World War I. Transferred on loan to the U.S. Army Transport Service 2 September 1919 and renamed as the U.S.A.T. *Madawaska*. Made several voyages between 21 February and 7 July 1920 to evacuate elements of the Czech Legion from Vladivostok and disembark them at Fiume, Croatia. Participated in the Polish Relief Expedition in January-February 1921. Laid up 1 April 1921 at New York. Permanently transferred 30 June 1921 by Executive Order to the War Department. The ship underwent a major refit and overhaul December 1921-April 1922. Renamed 3 June 1922 as the U.S.A.T. *U.S. Grant* in honor of Lt. Gen. Ulysses S. Grant, commanding general of the U.S. Army 1864-66 and 18th president of the United States. Assigned to the A.T.S. Pacific Fleet with home port at Fort Mason, CA. Serviced the San Francisco—Honolulu—Manila—Chinwangtao route and made occasional port calls at Guam and Nagasaki, Japan. Made occasional voyages on the San Francisco—Canal Zone—Puerto Rico—New York route. Laid up at San Francisco during April 1925-June 1927 for reboiling from coal to oil and other major renovations. Supported the U.S. Marine expedition and the U.S. Army topographic survey mission to Nicaragua 1928-32. Transported Emiliano Aguinaldo, famed Filipino guerilla leader from Manila to the U.S. in January 1929 for a tour of the country. Transported the 15th Infantry on its return from China to Tacoma, WA, in March 1938. Ran aground 19 May 1939 at Guam, but was successfully pulled off the reef with only minor damage. Transferred to the U.S. Navy 16 June 1941 as the U.S.S. *U.S. Grant*, AP-29.

Status: Sold and scrapped in 1947.

Events: 16

Length: 490.4 ft. Beam: 55.3 ft. Draft: 27.6 ft. Displacement: 9,410 tons

Masters, U.S.A.T. U.S. Grant

Capt. L. R. N. Kerr	21 Jun 17-20 Feb 21	Capt. James W. Scott	ao Mar 28-ao Jun 28
Capt. Robert A. Bartlett	20 Feb 21-Jul 22	Capt. Edgar S. McLellan	ao Sep 28-12 Sep 32
Capt. James W. Scott	Jul 22-Feb 27	Capt. Robert W. Shears	12 Sep 32-ao Jun 35
Capt. Frank Hall	Feb 27-ao Mar 27	Unknown	ao Jun 35-16 Jun 41

Commanding Officer of Troops, U.S.A.T. U.S. Grant

Capt. William H. Roberts, Inf.	7 Apr 30-30 Apr 30	Lt. Col. Cyril A. W. Dawson, C.A.C.	12 Nov 32-10 Aug 37
Capt. Thomas Banbury, Q.M.C.	30 Apr 30-1 May 30	Maj. Paul B. Robinson, Inf.	10 Aug 37-22 Nov 39
Lt. Col. William A. Alfonte, Inf.	1 May 30-12 Nov 32	Maj. Lloyd L. Hamilton, Inf.	22 Nov 39-ao Jun 40
	Unknown	ao Jun 40-7 Dec 41	

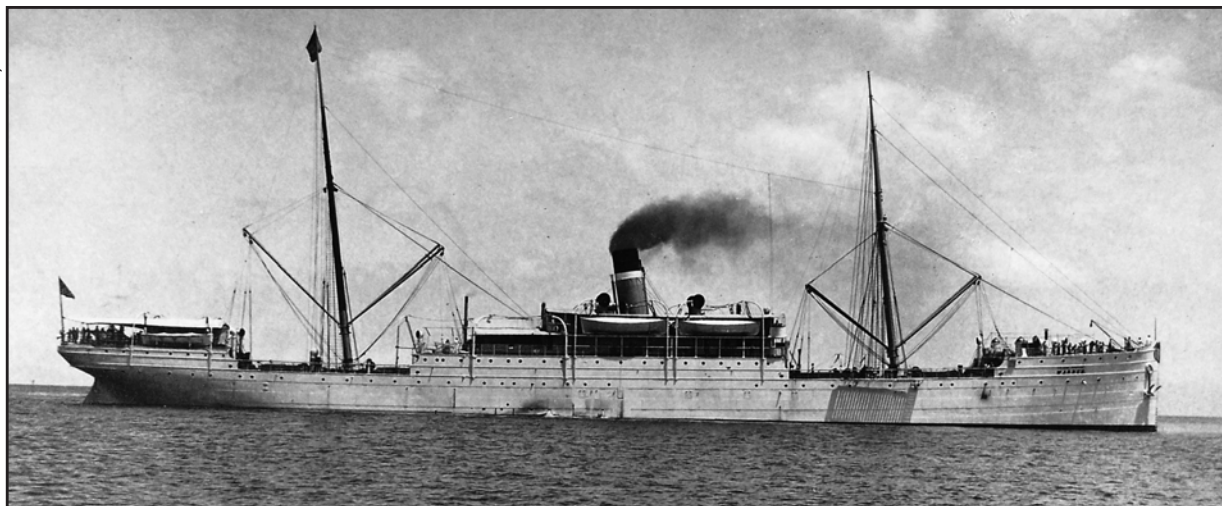

U.S.A.T. *Warren*

Home Port—Manila, PI, 1919-22

Built by A. G. Vulcan Shipbuilding Company at Stettin, Germany, and launched 24 August 1889 as the S.S. *Scandia*. Purchased by the Quartermaster Department 5 July 1898 from the Hamburg-American Line and assigned to the Army Transport Service. Renamed U.S.A.T. *Warren* in March 1899 in honor of Maj. Gen. Gouverneur K. Warren, commanding general of the II and V Corps, Army of the Potomac, 1863-65. Assigned to the Philippine Inter-Island Service with home port at Manila, PI. Made routine voyages to Chingwangtao to transport troops and supplies to and from Manila. Made several voyages in early 1920 to evacuate elements of the Czech Legion from Vladivostok and disembark them at Trieste, Italy. Sold 28 December 1922 to Le Seug Giap and Company at Manila.

Status: Sunk in May 1924 in the Whampoo River, Shanghai Harbor; raised and later scrapped in 1929.

Length: 370.7 ft. Beam: 44.3 ft. Draft: 26.5 ft. Displacement: 4,243 tons

Masters, U.S.A.T. *Warren*

Capt. Charles Baker	ao Jan 19-ao Oct 19	Unknown	ao Oct 19-4 Mar 21
	Capt. Frank S. Randall	4 Mar 21-Nov 22	

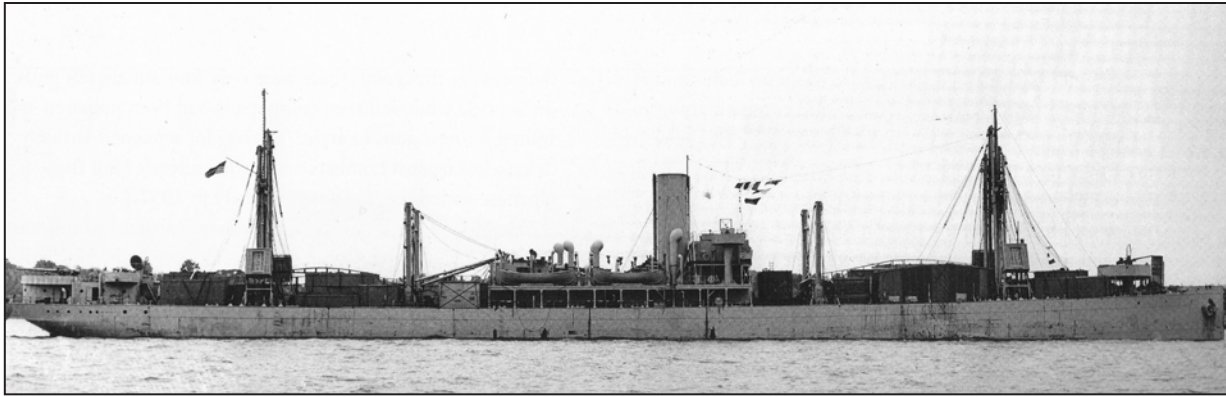

U.S.A.T. *Wheaton*

Home Port—New York POE, Army Supply Base, Brooklyn, NY, 1920-22

Built by Bethlehem Shipbuilding Company at Sparrow Point, MD, and launched 21 September 1918 as the S.S. *War Jupiter*. Completed in November 1918 and turned over to the U.S. Shipping Board. Turned over to the U.S. Army Transport Service 8 Oct 1920 and refitted as a refrigerator ship. Renamed in honor of Maj. Gen. Frank Wheaton, commander of the 3rd Division, Sheridan's Cavalry Corps, 1864-65. Assigned to the A.T.S. Atlantic Fleet with home port at the Army Supply Base, Brooklyn, NY. Serviced the New York—Antwerp route. Performed its first voyage for the Army Transport Service 20 July 1921 to Antwerp, Belgium to bring the bodies of US war dead home from France. The *Wheaton* made numerous trips between Antwerp and New York repatriating the bodies of American soldiers killed in action in France during World War I. Turned over 15 July 1922 to the U.S. Shipping Board at New York harbor. Sold by the U.S. Shipping Board in 1928 and renamed the S.S. *Alaskan*.

Status: Torpedoed, shelled, and sunk 28 November 1942 by the U-172 off the coast of Brazil.

Length: 415 ft.

Beam: 53.7 ft.

Draft: 28.3 ft.

Displacement: 6,867 tons

Masters, U.S.A.T. *Wheaton*

Capt. E. E. McCarthy

1 Oct 20-15 Jul 22



U.S.A.T. *Will H. Point*

Home Port—Seattle, WA, 1940-41

Built by Columbia River Shipbuilding Company, Portland, OR, and launched 2 January 1919 as the S.S. *West Corum*. Completed 10 February 1919 and turned over to the U.S. Shipping Board. Acquired 29 October 1940 by the Army Transport Service from the U.S. Maritime Commission reserve fleet at New Orleans. Assigned to the A.T.S. Pacific Fleet with home port at Seattle, WA. Rehabilitated for active service as a supply ship at the Todd-Johnson Dry Dock Company at New Orleans, LA. Renamed 8 March 1941 as the U.S.A.T. *Will H. Point* in honor of Col. Will H. Point, Q.M.C., who died 20 September 1940 at Letterman General Hospital. Serviced the Seattle—Alaska and Seattle—Honolulu—San Francisco routes. Served throughout World War II in the Pacific as a U.S. Army cargo transport. Location 7 December 1941—Dock # 3, Fort Mason, CA.

Status: Placed in the Maritime Commission reserve fleet at Astoria, OR, on 6 January 1947; sold for scrap 22 August 1947; scrapped 26 December 1947.

Length: 410 ft.

Beam: 54 ft.

Draft: 24 ft.

Displacement: 5,795 tons

Masters, U.S.A.T. *Will H. Point*

Unknown

29 Oct 40-7 Dec 41

No image available

U.S.A.T. *William R. Gibson*

Home Port—Seattle, WA, 1940-41

Built by the Northwest Steel Company, Portland, OR, and launched in 1919 as the S.S. *West Segovia*. Completed in August 1919 and turned over to the U.S. Shipping Board. Acquired 23 August 1940 by the Army Transport Service from the U.S. Maritime Commission reserve fleet. Assigned to the A.T.S. Pacific Fleet with home port at Seattle, WA. Rehabilitated for active service as a supply ship by the Todd-Galveston Company at Galveston, TX. Renamed 8 March 1941 as the U.S.A.T. *William R. Gibson*, in honor of Brig. Gen. William R. Gibson, Assistant Quartermaster General. Serviced the Seattle—Alaska and Seattle—Honolulu—San Francisco routes. Served throughout World War II as a U.S. Army cargo transport.

Status: Placed in the Maritime Commission reserve fleet on 29 July 1946; sold to a Panamanian firm and renamed as the S.S. *Ourania Gounares*; foundered 14 January 1960 about 900 miles due east of Tokyo while under tow to Japan to be scrapped.

Length: 410 ft.

Beam: 54 ft.

Draft: 24 ft.

Displacement: 5,701 tons

Masters, U.S.A.T. *William R. Gibson*

Unknown

23 Aug 40-7 Dec 41

Part X

Medical Corps Organizations

1919-41

Chapter 46

Medical Headquarters



Army and Navy Publishing

Medics of E Company, 135th Medical Regiment (VI Corps), Wisconsin National Guard, practice loading a "casualty" during training 1938.

Medical headquarters provided command and control for corps and army level medical units in the combat zone and for medical units in the communications zone.

Organization

Six army medical headquarters were constituted in the Organized Reserve in 1921 to provide command and control of medical units assigned to each field army. Each consisted of the following components:

Headquarters, Army Medical Headquarters

- 3 Medical Regiments
- 1 Army Medical Laboratory
- 1 Army Medical Supply Depot
- 15 Evacuation Hospitals
- 12 Surgical Hospitals
- 1 Convalescent Hospital
- 3 Veterinary Evacuation Hospitals
- 1 Veterinary Convalescent Hospital

Although the structure for the field army medical service was theoretically fixed, in actual operations the structure could be readily modified by the detachment of units to supplement the army's subordinate corps to support those commands' operations. Likewise, the field army could be supplemented by medical units from the Communications Zone or the General Headquarters Reserve as needed to support an increased operational tempo at the army level.

All of the army medical headquarters were initiated during 1921-1922. Each of the three lower numbered army medical headquarters (First through Third) possessed at least one National Guard medical regiment, but none of those units were ever organized. The remainder of the armies' subordinate units were in the Organized Reserve and the vast majority of those were organized in the 1920s.

Of the eighteen corps medical headquarters constituted in 1921, three were National Guard units, the remainder were in the Organized Reserve. None of the National Guard headquarters were ever organized, though all of the Reserve headquarters were. Besides the corps medical headquarters, the only other medical unit assigned to the corps was a medical regiment. However, additional medical units could be attached to the corps from a field army, the Communications Zone, or the General Headquarters Reserve.

In 1924, two "medical headquarters, communications zone" were constituted to provide a controlling headquarters for communications zone medical units. Both commands were constituted in the Organized Reserve. These commands were both demobilized in 1928 and replaced by a single "headquarters, medical service, communications zone" in 1933.

By 1928, all of the major medical command headquarters had been inactivated and demobilized or withdrawn. The majority of the armies' subordinate units remained active until 1933 when many were demobilized due to the reorganization of the army into the four army configuration, or to make way for new RAI organizations that came into the force structure. The configuration of the corps medical service remained unaffected.

Training

None of these headquarters served on active duty in the interwar period and none functioned as actual headquarters. These units were primarily pool units and used for mobilization assignments of Organized Reserve officers with professional medical skills gained from their civilian employment or medical command and staff experience during World War I. There's no evidence any functioned as units during the Inactive Training period or attended a training camp, CPX, or maneuver, as a unit.

First Medical Headquarters, Communications Zone (C. Z.)**Organized Reserve New York****HQ-Not initiated** 1924-25; Manhattan, NY, 1925-28

Constituted in the Organized Reserve in 1924, assigned to the Communications Zone, and allotted to the Second Corps Area. Headquarters initiated 22 April 1925 at Manhattan, NY. Unit mission was to provide command and control of Communications Zone medical units in a theater of operations. Withdrawn from the Organized Reserve and Second Corps Area 5 September 1928.

Commanders, First Medical Headquarters, Communications Zone

Lt. Col. William B. Cook	22 Apr 25-7 Nov 25 Unknown	Col. William G. Schauffler 23 Mar 26-5 Sep 28	7 Nov 25-23 Mar 26
--------------------------	-------------------------------	--	--------------------

Second Medical Headquarters, Communications Zone (C. Z.)**Organized Reserve Illinois****HQ-Chicago, IL, 1924-28**

Constituted in the Organized Reserve in 1924, assigned to the Communications Zone, and allotted to the Sixth Corps Area. Headquarters initiated about September 1924 at Chicago, IL. Unit mission was to provide command and control of Communications Zone medical units in a theater of operations. Withdrawn from the Organized Reserve and Sixth Corps Area 5 September 1928.

Commanders, Second Medical Headquarters, Communications Zone

Col. Joseph E. Donnelly	Sep 24-ao Jan 25	Maj. William W. Bonner	ao May 25-5 Sep 28
-------------------------	------------------	------------------------	--------------------

Headquarters, Medical Service, Communications Zone (C. Z.)**Organized Reserve****HQ-Not initiated** 1933-41

Constituted in the Organized Reserve 1 October 1933, assigned to the Communications Zone, and allotted to the Third Corps Area. Unit mission was to provide command and control of all Communications Zone medical units in a theater of operations. Location 7 December 1941—*Not initiated*.

First Army Medical Headquarters (First Army)**Organized Reserve Delaware****HQ-Not initiated** 1921-22; Dover, NH, 1922-28

Constituted in the Organized Reserve 15 October 1921, assigned to the First Army, and allotted to the Second Corps Area. Headquarters initiated 8 September 1922 at Dover, NH. Withdrawn from the Organized Reserve and Second Corps Area 5 September 1928.

Commanders, First Army Medical Headquarters

Col. Hans Zinsser	8 Sep 22-ao Dec 24 Col. Henry M. Lyle	Unknown ao Sep 27-5 Sep 28	ao Dec 24-ao Sep 27
-------------------	--	-------------------------------	---------------------

Second Army Medical Headquarters (Second Army)**Organized Reserve Illinois****HQ-Not initiated** 1921-22; Chicago, IL, 1922-28

Constituted in the Organized Reserve 15 October 1921, assigned to the Second Army, and allotted to the Sixth Corps Area. Headquarters initiated 30 March 1922 at Chicago, IL. Withdrawn from the Organized Reserve and Sixth Corps Area 5 September 1928.

Commanders, Second Army Medical Headquarters

Lt. Col. Hardie R. Hays	30 Mar 22-3 Jan 23 Col. Hugh H. Young	Unknown ao Sep 27-5 Sep 28	3 Jan 23-ao Sep 27
-------------------------	--	-------------------------------	--------------------

Third Army Medical Headquarters (Third Army)**Organized Reserve Nebraska****HQ-Not initiated** 1921-22; Omaha, NE, 1922-28

Constituted in the Organized Reserve 15 October 1921, assigned to the Third Army, and allotted to the Seventh Corps Area. Headquarters initiated by December 1922 at Omaha, NE. Withdrawn from the Organized Reserve and Seventh Corps Area 5 September 1928.

Commanders, Third Army Medical Headquarters

Unknown	ao Dec 22-ao Sep 27	Col. Jonathan E. Burns	ao Sep 27-5 Sep 28
---------	---------------------	------------------------	--------------------

Fourth Army Medical Headquarters (Fourth Army)**Organized Reserve New York****HQ-Not initiated** 1921-22; New York City, NY, 1922-28

Constituted in the Organized Reserve 15 October 1921, assigned to the Fourth Army, and allotted to the Second Corps Area. Headquarters initiated 15 May 1922 at New York City, NY. Withdrawn from the Organized Reserve and Second Corps Area 5 September 1928.

Commanders, Fourth Army Medical Headquarters

Lt. Col. James L. Young	15 May 22-9 Oct 23	Lt. Col. Stanhope Bayne-Jones	ao Nov 26-17 Dec 26
Col. Charles Willcox	9 Oct 23-ao May 26	Col. Nathaniel Allison	ao Mar 27-5 Sep 28

Fifth Army Medical Headquarters (Fifth Army)**Organized Reserve Ohio****HQ-Not initiated** 1921-22; Cleveland, OH, 1922-28

Constituted in the Organized Reserve 15 October 1921, assigned to the Fifth Army, and allotted to the Fifth Corps Area. Headquarters initiated by December 1922 at Cleveland, OH. Withdrawn from the Organized Reserve and Fifth Corps Area 5 September 1928.

Commanders, Fifth Army Medical Headquarters

Unknown	ao Dec 22-ao Sep 27	Col. Herbert C. Woolley	ao Sep 27-5 Sep 28
---------	---------------------	-------------------------	--------------------

Sixth Army Medical Headquarters (Sixth Army)**Organized Reserve Nebraska****HQ-Not initiated** 1921-22; Omaha, NE, 1922-28

Constituted in the Organized Reserve 15 October 1921, assigned to the Sixth Army, and allotted to the Seventh Corps Area. Headquarters initiated by December 1922 at Omaha, NE. Withdrawn from the Organized Reserve and Seventh Corps Area 5 September 1928.

Commanders, Sixth Army Medical Headquarters

Unknown	ao Dec 22-ao Sep 27	Col. John Butler	ao Sep 27-5 Sep 28
---------	---------------------	------------------	--------------------

I Corps Medical Headquarters (I Corps)**Organized Reserve Massachusetts****HQ-Boston, MA, 1921-28**

Constituted in the Organized Reserve 15 October 1921, assigned to the I Corps, and allotted to the First Corps Area. Headquarters initiated 8 November 1921 at Boston, MA. Withdrawn from the Organized Reserve and Seventh Corps Area 5 September 1928.

Commanders, I Corps Medical Headquarters

Col. Paul Waterman	8 Nov 21-ao Mar 23	Unknown	15 Jun 24-ao Jun 25
Lt. Col. William J. Collins	ao Dec 23-15 Jun 24	Maj. William S. Buckley	ao Jun 25-5 Sep 28

II Corps Medical Headquarters (II Corps)**Organized Reserve New York****HQ-Not initiated** 1921-22; New York City, NY, 1922-28

Constituted in the Organized Reserve 15 October 1921, assigned to the II Corps, and allotted to the Second Corps Area. Headquarters initiated 2 May 1922 at New York City, NY. Withdrawn from the Organized Reserve 18 October 1927 and allotted to the Regular Army. Withdrawn from the Second Corps Area 5 September 1928.

Commanders, II Corps Medical Headquarters

Col. Richard Derby	2 May 22-5 Sep 28
--------------------	-------------------

III Corps Medical Headquarters (III Corps)**Pennsylvania National Guard****HQ-Not organized** 1921-23; Third Corps Area 1923-28

Constituted in the National Guard 15 October 1921, assigned to the III Corps, and allotted to the state of Pennsylvania. Placed on the deferred list 2 July 1923 and allotted to the Organized Reserve as a Deferred National Guard unit. Headquarters concurrently initiated in the Third Corps Area. Withdrawn from the Pennsylvania National Guard 22 June 1927 and permanently allotted to the Organized Reserve. Demobilized 5 September 1928.

Commanders, III Corps Medical Headquarters

Lt. Col. Albert P. Francine	2 Jul 23-9 Feb 24	Unknown	9 Feb 24-5 Sep 28
-----------------------------	-------------------	---------	-------------------

IV Corps Medical Headquarters (IV Corps)**Organized Reserve Georgia****HQ-Not initiated** 1921-22; Atlanta, GA, 1922-28

Constituted in the Organized Reserve 15 October 1921, assigned to the IV Corps, and allotted to the Fourth Corps Area. Headquarters initiated 17 April 1922 at Atlanta, GA. Withdrawn from the Organized Reserve and Fourth Corps Area 5 September 1928.

Commanders, IV Corps Medical Headquarters

Lt. Col. Henry Norris	17 Apr 22-ao May 24	Unknown	ao May 24-5 Sep 28
-----------------------	---------------------	---------	--------------------

V Corps Medical Headquarters (V Corps)**Ohio National Guard****HQ-Not organized** 1921-25; Fifth Corps Area 1925-27

Constituted in the National Guard 15 October 1921, assigned to the V Corps, and allotted to the state of Ohio. Placed on the deferred list 2 July 1923 and allotted to the Organized Reserve as a Deferred National Guard unit. Headquarters initiated in July 1925 in the Fifth Corps Area. Withdrawn from the Ohio National Guard 22 June 1927 and permanently allotted to the Organized Reserve. Demobilized 5 September 1928.

Commanders, V Corps Medical Headquarters

Col. John C. Darby	Jul 25-Aug 28
--------------------	---------------

VI Corps Medical Headquarters (VI Corps)**Wisconsin National Guard****HQ-Not organized** 1921-25; Sixth Corps Area 1925-27

Constituted in the National Guard 15 October 1921, assigned to the VI Corps, and allotted to the state of Wisconsin. Placed on the deferred list 2 July 1923 and allotted to the Organized Reserve as a Deferred National Guard unit. Headquarters initiated 1 April 1925 in the Sixth Corps Area. Withdrawn from the Wisconsin National Guard 22 June 1927 and permanently allotted to the Organized Reserve. Demobilized 5 September 1928.

Commanders, VI Corps Medical Headquarters

Unknown	1 Apr 25-5 Sep 28
---------	-------------------

VII Corps Medical Headquarters (VII Corps)**Organized Reserve Iowa****HQ-**Des Moines, IA 1921-28

Constituted in the Organized Reserve 15 October 1921, assigned to the VII Corps, and allotted to the Seventh Corps Area. Headquarters initiated 5 November 1921 at Des Moines, IA. Withdrawn from the Seventh Corps Area 5 September 1928.

Commanders, VII Corps Medical Headquarters

Col. Donald MacRea, Jr.	8 Nov 21-5 Sep 28
-------------------------	-------------------

VIII Corps Medical Headquarters (VIII Corps)**Organized Reserve Texas****HQ-***Not initiated* 1921-22; San Antonio, TX 1922-28

Constituted in the Organized Reserve 15 October 1921, assigned to the VIII Corps, and allotted to the Eighth Corps Area. Headquarters initiated 9 September 1922 at San Antonio, TX. Conducted summer training most years at Fort Sam Houston, TX. Withdrawn from the Eighth Corps Area 5 September 1928.

Commanders, VIII Corps Medical Headquarters

Lt. Col. Frederick J. Combe	9 Sep 22-ao Apr 24	Lt. Col. Ernest H. Stark	ao Jan 25-5 Sep 28
-----------------------------	--------------------	--------------------------	--------------------

IX Corps Medical Headquarters (IX Corps)**Organized Reserve California****HQ-***Not initiated* 1921-22; San Francisco, CA, 1922-28

Constituted in the Organized Reserve 15 October 1921, assigned to the IX Corps, and allotted to the Ninth Corps Area. Headquarters initiated in February 1922 at San Francisco, CA. Withdrawn from the Ninth Corps Area 5 September 1928.

Commanders, IX Corps Medical Headquarters

Unknown	Feb 22-22 Aug 22	Col. John W. Shiels	22 Apr 25-Mar 26
Lt. Col. Ernest K. Johnstone	22 Aug 22-21 Apr 25	Lt. Col. Neal N. Wood	Mar 26-Mar 27
	Col. David C. Hall *	ao Sep 27-5 Sep 28	

*Concurrently C.O., 349th Med Regt

XI Corps Medical Headquarters (XI Corps)**Organized Reserve Massachusetts****HQ-**Boston, MA, 1921-28

Constituted in the Organized Reserve 15 October 1921, assigned to the XI Corps, and allotted to the First Corps Area. Headquarters initiated 3 November 1921 at Boston, MA. Withdrawn from the First Corps Area 5 September 1928.

Commanders, XI Corps Medical Headquarters

Lt. Col. Frank W. Snow	3 Nov 21-18 Jan 22	Brig. Gen. Joel E. Goldthwaite	18 Jan 22-Jan 23
	Col. George F. Keenan	Jan 23-5 Sep 28	

XII Corps Medical Headquarters (XII Corps)**Organized Reserve New Jersey****HQ-***Not initiated* 1921-22; Newark, NJ, 1922-28

Constituted in the Organized Reserve 15 October 1921, assigned to the XII Corps, and allotted to the Second Corps Area. Headquarters initiated 15 May 1922 at Newark, NJ. Withdrawn from the Second Corps Area 5 September 1928.

Commanders, XII Corps Medical Headquarters

Lt. Col. Harold D. Corbusier	15 May 22-Oct 26	Col. James T. Wykoff *	Oct 26-5 Sep 28
------------------------------	------------------	------------------------	-----------------

*Concurrently C.O., 342nd Med Regt

XIII Corps Medical Headquarters (XIII Corps)**Organized Reserve Pennsylvania****HQ-Not initiated** 1921-22; Altoona, PA, 1922-28

Constituted in the Organized Reserve 15 October 1921, assigned to the XIII Corps, and allotted to the Third Corps Area. Headquarters initiated 21 February 1922 at Altoona, PA. Withdrawn from the Third Corps Area 5 September 1928.

Commanders, XIII Corps Medical Headquarters

Col. John A. Hawkins	21 Feb 22-27 Dec 26	Unknown	27 Dec 26-5 Sep 28
----------------------	---------------------	---------	--------------------

XIV Corps Medical Headquarters (XIV Corps)**Organized Reserve Alabama****HQ-Not initiated** 1921-22; Birmingham, AL, 1922-28

Constituted in the Organized Reserve 15 October 1921, assigned to the XIV Corps, and allotted to the Fourth Corps Area. Headquarters initiated 6 March 1922 at Birmingham, AL. Withdrawn from the Fourth Corps Area 5 September 1928.

Commanders, XIV Corps Medical Headquarters

Lt. Col. Nolan Stewart	6 Mar 22-3 May 22	Lt. Col. Burr Ferguson	3 May 22-23 Oct 24
	Col. James S. McAlester	23 Oct 24-5 Sep 28	

XV Corps Medical Headquarters (XV Corps)**Organized Reserve Ohio/Kentucky****HQ-Not initiated** 1921-22; Cincinnati, OH, 1922-25; Covington, KY, 1925-28

Constituted in the Organized Reserve 15 October 1921, assigned to the XV Corps, and allotted to the Fifth Corps Area. Headquarters initiated in May 1922 at Cincinnati, OH. Headquarters relocated 15 April 1925 to Covington, KY. Withdrawn from the Fifth Corps Area 5 September 1928.

Commanders, XV Corps Medical Headquarters

Lt. Col. Joseph A. Hall	May 22-ao Jan 23	Unknown	ao Jan 23-ao Sep 27
	Maj. Otto E. Johnson	ao Sep 27-5 Sep 28	

XVI Corps Medical Headquarters (XVI Corps)**Organized Reserve Michigan****HQ-Detroit, MI, 1921-28**

Constituted in the Organized Reserve 15 October 1921, assigned to the XVI Corps, and allotted to the Sixth Corps Area. Headquarters initiated 28 October 1921 at Detroit, MI. Withdrawn from the Sixth Corps Area 5 September 1928.

Commanders, XVI Corps Medical Headquarters

Col. Angus B. McLean	28 Oct 21-May 26	Maj. John W. Bachelor	May 26-ao Jun 26
	Unknown	ao Jun 26-5 Sep 28	

XVII Corps Medical Headquarters (XVII Corps)**Organized Reserve Minnesota****HQ-Not initiated** 1921-22; Minneapolis, MN, 1922-28

Constituted in the Organized Reserve 15 October 1921, assigned to the XVII Corps, and allotted to the Seventh Corps Area. Headquarters initiated in Aug 22 at Minneapolis, MN. Withdrawn from the Seventh Corps Area 5 September 1928.

Commanders, XVII Corps Medical Headquarters

Unknown	Aug 22-ao Sep 25	Lt. Col. Robert H. Monahan	ao Sep 25-5 Sep 28
---------	------------------	----------------------------	--------------------

XVIII Corps Medical Headquarters (XVIII Corps)

Organized Reserve Texas

HQ-Not initiated 1921-22; Dallas, TX, 1922-25; San Antonio, TX, 1925-28

Constituted in the Organized Reserve 15 October 1921, assigned to the XVIII Corps, and allotted to the Eighth Corps Area. Headquarters initiated 5 September 1922 at Dallas, TX. Headquarters relocated 15 April 1925 to San Antonio, TX. Conducted summer training most years at Fort Sam Houston, TX. Withdrawn from the Eighth Corps Area 5 September 1928.

Commanders, XVIII Corps Medical Headquarters

Col. John O. MacReynolds 5 Sep 22-5 Sep 28

XIX Corps Medical Headquarters (XIX Corps)

Organized Reserve California

HQ-Not initiated 1921-22; San Francisco, CA, 1922-27; *Inactive* 1927-28

Constituted in the Organized Reserve 15 October 1921, assigned to the XIX Corps, and allotted to the Ninth Corps Area. Headquarters initiated in April 1922 at San Francisco, CA. Inactivated in January 1927 at San Francisco by relief of personnel. Withdrawn from the Ninth Corps Area 5 September 1928.

Commanders, XIX Corps Medical Headquarters

Unknown Apr 22-22 Aug 22 Lt. Col. George K. Herzog 22 Aug 22-Jan 27
Inactive Jan 27-5 Sep 28

Chapter 47

Medical Regiments, Battalions, and Squadrons



US Army Signal Corps, National Archives II

Medics of a collecting company of the 1st Medical Regiment set up a demonstration aid station in Washington, DC, May 1927.

The mission of medical regiments, battalions, and squadrons was to plan, coordinate, and conduct operations to provide medical support to mobile units within the combat zone.

Organization

The medical regiment in the post-war Army was a modified version of the divisional sanitary train that served in World War I. The post-war medical units directly supporting the combat zone consisted of four basic types of organization. These were the field army and corps medical regiments, the infantry division medical regiment, the separate medical battalion, and the medical squadron of the cavalry division.

The following table illustrates the allotment of the types of units to the various components through 1940.

Types of units to the various components.

Organizations	Med. Regt. Army/Corps	Med. Regt. Div.	Med. Bn.	Med. Sq.
RA	0	5	1	1
RAI	11	7	2	3
NG	14	19	1	4
OR	33	27	0	6
Totals	58	58	4	14

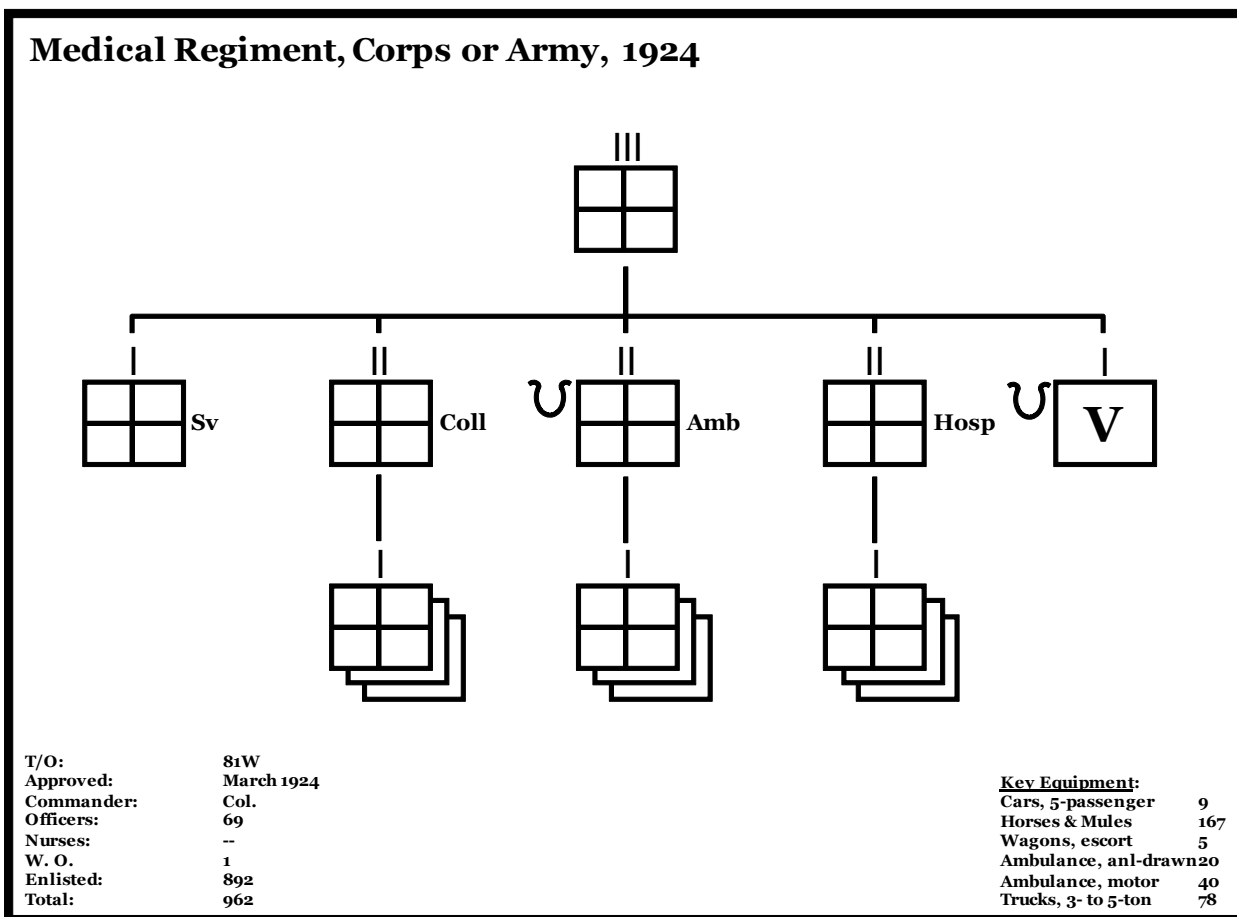

Army/Corps Medical Regiment TOE.

The army and corps medical regiments were identical in organization. The regiments originally consisted of three battalions of three companies each. Additionally, the regiment was assigned a service company and a veterinary company as well. Both the ambulance battalion and the veterinary company were animal organizations. The battalions were originally designated as “collecting,” “ambulance,” and “sanitary” battalions. Each battalion’s companies were similarly designated each with distinctive identification numbers (i.e., the 301st, 302nd, and 303rd Collecting Companies, 301st, 302nd, and 303rd Ambulance Companies, etc.). In 1924, the sanitary battalions were redesignated as “hospital” battalions. In 1926, the companies of many of these regiments underwent redesignations due to the constitution of new regiments. These regiments underwent another change in 1936 when the collecting, ambulance, and hospital battalions were redesignated as the 1st, 2nd, and 3rd Battalions respectively. Concurrently, the companies were redesignated as lettered companies with A, B, and C allotted to the 1st Battalion, D, E, and F allotted to the 2nd Battalion, etc.

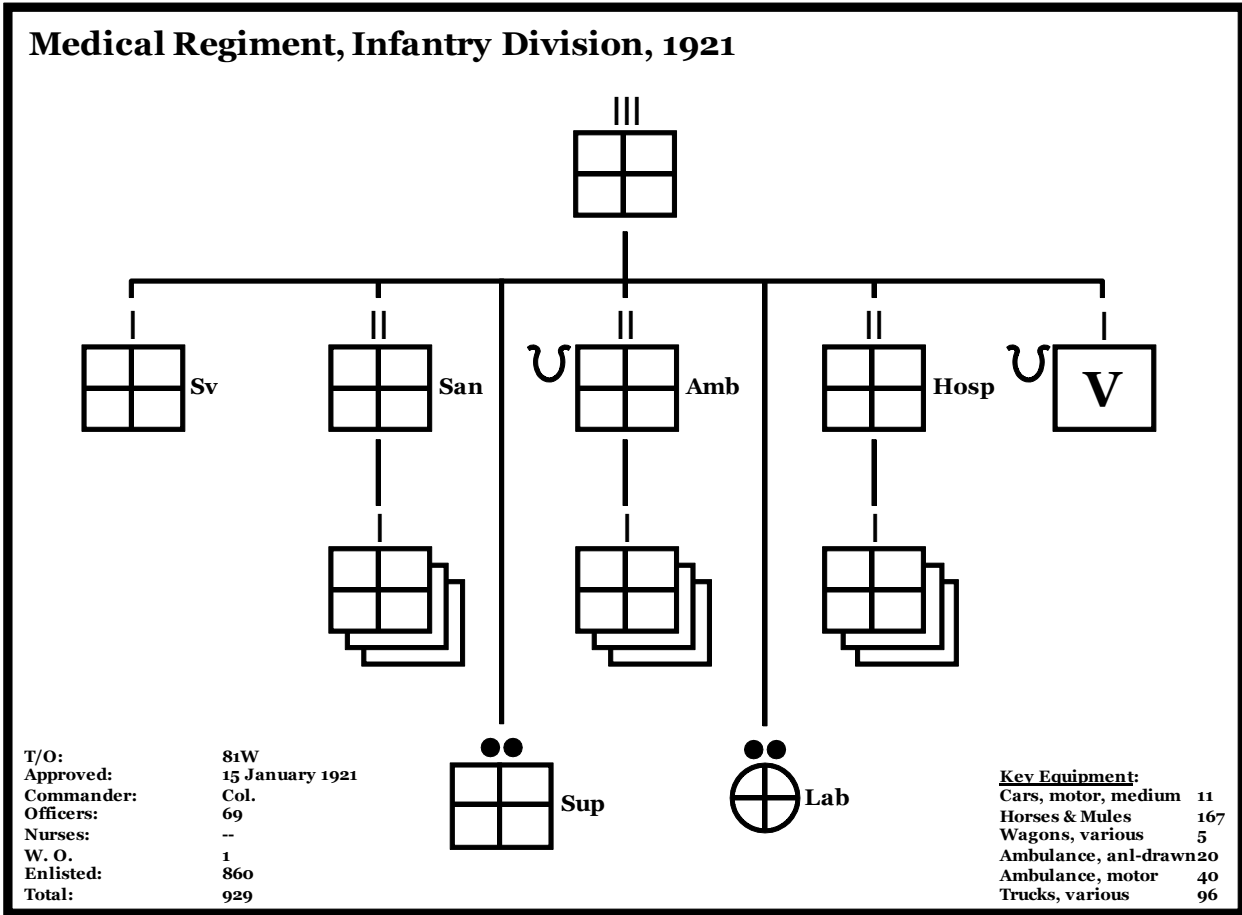

Divisional Medical Regiment TOE.

The divisional regiments were direct descendants of the divisional sanitary trains of the World War. In 1921, the trains were reorganized and redesignated as medical regiments. These regiments were organized similarly to the army/corps regiments, with the exceptions that that these regiments included a medical laboratory and a medical supply section. Also similar to the army/corps regiments, the divisional regiments underwent all the same reorganizations and redesignations as their higher level counterparts, except that the divisional regiments maintained their original company designations until renamed as lettered companies in 1936.

The four medical battalions constituted in the interwar period were ambulance units, two of which were animal drawn and two were motorized. The animal drawn units were apparently motorized by the time of Pearl Harbor.

Medical Squadron, 1925

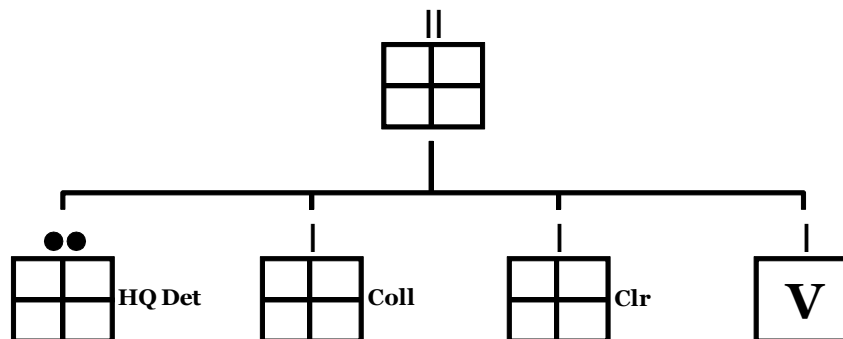

Approved: 14 January 1925
Commander: Lt. Col.
Officers: 17
Nurses: --
W. O.: --
Enlisted: 216
Total: 233

Key Equipment:
 Cars, 5-passenger 9
 Horses & Mules 223
 Wagons, various 10
 Ambulance, an1-drawn 10
 Ambulance, motor 10
 Trucks, 3- to 5-ton 7

Cavalry Division Medical Squadron TOE.

The medical squadrons of the cavalry division were organized in 1925 by the consolidation of the ambulance and veterinary troops originally allotted to each cavalry division into a squadron organization. The squadron consisted of a squadron headquarters, a headquarters detachment, and three medical troops. The three troops consisted of one collecting, clearing, and veterinary troop each.

Less the 1st Medical Squadron, the five Regular Army medical regiments active between 1921 and 1939 composed almost the entire active complement of US Army Medical Corps mobile units. Even so, given the drastic budget problems of the period, these regiments were largely inactive organizations. Typically, the active components of these regiments consisted of the regimental headquarters, the service company, the veterinary company, and one each collecting, ambulance, and hospital companies. All other elements, including the three battalion headquarters were inactive elements of the regiments. Indeed, for the period of 1922-1934, no elements of the 3rd Medical Regiment were active. In addition to these regiments, the 1st Medical Squadron was partially organized to support the 1st Cavalry Division.

Almost all of the remaining Regular Army medical regiments and squadrons were organized as RAI units in the interwar period. A slight majority of these were functional organizations. Some of the regiments were affiliated with R.O.T.C. programs between 1928 and 1930, but most of those affiliations were discontinued by 1940. Affiliated RAI units were often commanded by Regular Army officers prior to 1933, and most of those were the P.M.S.&T. of the affiliated R.O.T.C. unit. In October 1933, this practice was eliminated and the senior Reserve officer assigned to the regiment or squadron was appointed as the acting commander to provide those officers with practical command experience. These acting commanders were typically captains, majors, or lieutenant colonels which left the colonel's position open for a Regular Army commander in the event of mobilization. In a few instances, a Reserve full colonel commanded these units, no doubt with the understanding that the officer would vacate the position in the event of mobilization.

Twenty-one of the National Guard medical regiments were fully or partially organized at some point between 1921 and 1940, though there were never that many organized at a single time. All but three of the army/corps regiments were demobilized in 1927. One of these regiments (the 136th) was reorganized as a divisional regiment for the 34th Division, and that division's regiment (the 109th) was concurrently demobilized. Of the other two corps regiments, one was organized in the 1920s and the other was disbanded in 1940 in an inactive status. A new regiment (the 134th), however, was constituted and organized in 1940 in the state of New York.

The great majority of the Guard regiments were assigned to the eighteen NG infantry divisions. All of the divisional regiments were fully or largely organized during this period and were ultimately called to active duty in 1940 and 1941. Two of the medical squadrons were fully or partially organized but neither survived the War Department planners' axes in the fall of 1940. Both were used to organize newly authorized organizations.

Almost all of the Organized Reserve units were initiated during the interwar period. Less than half of these units, however, were functional organizations. Most of these units remained active throughout the period, but two regiments were demobilized in 1933 and at least fourteen of the other regiments were inactivated at some point between 1929 and 1940. All of the divisional regiments and squadrons were active throughout the period and most of those were functional organizations.

Training

The two overseas Regular Army regiments were active in supporting the activities of the divisions to which they were assigned. The three (sometimes two) stateside divisional regiments also supported their respective divisions, and supported the training of various Organized Reserve medical units as well. These regiments also provided support to the C.C.C., the C.M.T.C., R.O.T.C., and occasionally were tasked to support other events such as disaster relief efforts. As with all other units in the Army, the quality and frequency of training for Regular Army medical regiments was directly affected by the small Army budgets of the period. Like most Army units, medical units were able to go to the field for about two to three weeks a year. That time was usually spent in brigade, division, or corps area maneuvers in the summer or fall after the unit had supported the training of the reserve components.

National Guard medical regiments participated in the usual armory drill periods at their respective home stations during the inactive training period. They also supported the training of their respective divisions at their states' training areas. Due to their primary missions, Guard medical units were also frequently called upon their governors to support disaster relief efforts. Though these were not military operations per se, these events did give Guard units the chance to exercise military skills that were directly or indirectly applicable to combat.

The challenge of conducting quality training for Organized Reserve (and Regular Army Inactive) medical units was far more difficult than it was for their active Regular Army and National Guard counterparts. Besides being short enlisted personnel, these units possessed virtually no supplies and equipment to support training during the Inactive Training period. Those that were functional units conducted their training meetings in a variety of places. These included post office buildings, Federal buildings, chamber of commerce buildings, schools, R.O.T.C. buildings, Regular Army installations, and National Guard armories, among many others. Those units fortunate enough to meet at the latter two types of locality were particularly fortunate as local commanders often loaned the use of equipment or training facilities to enhance the Reservists' training experiences. Most of these regiments attended summer training as units either every year or every other year. Often training was limited to conferences and lectures in a school room environment. Most of the field training consisted of demonstrations conducted by a Regular Army medical unit and occasionally "hands-on" training exercises where the Reservists had the opportunity to set up and operate various types of medical equipment. This kind of training was most prevalent for units in the First, Second, and Third

Corps Areas (which attended training at Carlisle Barracks with the 1st Medical Regiment), units in the Eighth Corps Area (which attended training at Fort Sam Houston with the 2nd Medical Regiment or at Fort Bliss with the 1st Medical Squadron), and the units in the Ninth Corps Area (which attended training at Fort Lewis with the 3rd Medical Regiment). Units in other corps areas tended to attend training at various post and station hospitals within their respective corps areas. A few were lucky enough to train with a National Guard unit as well, but that was relatively uncommon. A number of these regiments were also ordered to camp to support the conduct of C.M.T.C. training, though that opportunity was also uncommon.

1st Medical Regiment (1st Division)

HQ-Camp Dix, NJ 1921-22; Carlisle Barracks, PA, 1922-40; Fort Ord, CA, 1940-41

Subordinate elements-Regt'l HQ; HQ & Svc Co 1921-41; 1st Vet Co 1921-41; 1st Med Sup Sect 1921-24; 1st Med Lab Sect 1921-24; 1st San Co 1921-25; *HQ Amb Bn* 1929-36; 1st Amb Co 1921-36; 2nd Amb Co 1921-36; *3rd Amb Co* 1929-36; *HQ Hosp Bn* 1929-36; 1st Hosp Co 1921-36; *2nd Hosp Co* 1929-36; *3rd Hosp Co* 1929-36; *HQ Col Bn* 1929-36; 1st Col Co 1925-36; *2nd Col Co* 1929-36; *3rd Col Co* 1929-36



Arrived at the port of Hoboken 5 September 1919 on the U.S.S. *DeKalb* after nine months of occupation duty near Coblenz, Germany, as the 1st Sanitary Train, an element of the 1st Division. Participated in the 1st Division victory parade down 5th Avenue in New York City 10 September 1919 and in Washington, DC, 17 September 1919. Temporarily posted to Camp George G. Meade, MD, where emergency period personnel were discharged. Transferred to Camp Zachary Taylor, KY, and arrived there in October 1919. Transferred in September 1920 to Camp Dix, NJ. Reorganized and redesignated 10 February 1921 as the 1st Medical Regiment. Transferred 15 June 1922 to Carlisle Barracks, PA. Supported the training of students at the Army Field Medical School and units of the Organized Reserve from the First,

Second, and Third Corps Areas on a regular basis. Regiment provided medical support to CCC camps in Pennsylvania and at Camp Knox, KY, 1933-39. Company G deployed to Camp Knox, KY, in January-February 1937 to assist in emergency relief efforts during major flooding of the Ohio River. Regiment provided medical support in July 1938 to the Blue and Gray Reunion at Gettysburg, PA. Organized Reserve officers assigned to the regiment were from the District of Columbia and Pennsylvania, and trained with the regiment during summer camp. Relieved from the 1st Division 8 October 1939 and assigned to the IV Corps. Reorganized 1 March 1940, relieved from the IV Corps, and assigned to the Fourth Army. Transferred 15 June 1940 to Fort Ord, CA. Location 7 December 1941—Fort Ord, CA.

Organization Day: 28 May. Chosen to commemorate the regiment's baptism of fire at the Battle of Cantigny, 28 May 1918.

Status: Active in the Regular Army at Fort Sam Houston, TX, as HHC, 1st Medical Brigade.

Events: 60, 63, 72, 89, 106, 153, 190, 219, 220, 240, 280, 295, 296, 304, 314, 326

Commanders, 1st Medical Regiment

Lt. Col. Frank A. Pyles	6 Oct 21-3 Feb 22	Maj. Jacob L. Hartman	6 Jun 33-30 Nov 33
Capt. William C. Russell	4 Feb 22-23 Aug 22	Maj. Frank S. Matlack	30 Nov 33-24 Jun 34
Capt. Joe A. Carden	23 Aug 22-9 Nov 22	Lt. Col. Lamphear W. Webb, Jr.	24 Jun 34-1 Dec 35
Maj. Joseph E. Bastion	10 Nov 22-18 Jul 23	Maj. Howard T. Wickert	2 Dec 35-6 Sep 36
Maj. Gerald L. McKinney	18 Jul 23-19 Jul 28	Lt. Col. George F. Lull	7 Sep 36-30 Jun 37
Maj. Robert P. Williams	19 Jul 28-26 Jul 28	Col. Paul R. Hawley	1 Jul 37-31 Aug 38
Maj. John M. Willis	26 Jul 28-30 Aug 29	Maj. Alvin C. Gorby	31 Aug 38-7 Jun 40
Maj. Frank S. Matlack	30 Aug 29-31 Jul 30	Lt. Col. Robert P. Williams	8 Jun 40-24 Sep 40
Lt. Col. Larry B. McAfee	1 Aug 30-30 Aug 30	Col. Wilson C. von Kessler	24 Sep 40-18 Dec 40
Maj. Frank S. Matlack	31 Aug 30-5 Jun 33	Lt. Col. Paul R. E. Sheppard	18 Dec 40-ao Jan 41

1st Medical Squadron (1st Cavalry Division)

HQ-Fort Bliss, TX, 1926-41

Subordinate elements-Sq. HQ; 1st Vet Tp 1925-41; 1st Amb Tp 1925-36; *1st Hosp Tp* 1925-36; *1st Col Tp* 1925-36



Constituted in the Regular Army 23 March 1925, assigned to the 1st Cavalry Division, and allotted to the Eighth Corps Area. Organized 1 June 1926 at Fort Bliss, TX. Reserve officers assigned to the squadron conducted annual summer training with the squadron at Fort Bliss. Location 7 December 1941—Fort Bliss, TX.

Organization Day: 1 June. Chosen to commemorate the squadron's organization on 1 June 1926.

Status: Active in the Regular Army at Fort Hood, TX, as the 15th Support Battalion, a component of the 1st Cavalry Division.

Events: 65, 83, 97, 127, 146, 206, 250, 259, 284, 295, 296, 300, 315, 328

Commanders, 1st Medical Squadron

Maj. Charles C. Demmer	1 Jun 26-15 Oct 28	Maj. Richard T. Arnest	12 Jul 34-3 Sep 36
Lt. Col. Charles E. Freeman	16 Oct 28-Jun 30	Maj. Lucius K. Patterson	3 Sep 36-7 Oct 36
Maj. Robert P. Williams	Jun 30-30 Jun 34	Lt. Col. Ralph G. Devoe	7 Oct 36-1 Jul 39
Maj. Lucius K. Patterson	30 Jun 34-12 Jul 34	Lt. Col. Charles W. Riley	1 Jul 39-ao Oct 40
Unknown	ao Oct 40-7 Dec 41		

2nd Medical Regiment (2nd Division)

HQ-Fort Sam Houston, TX, 1921-39

Subordinate elements-Regt'l HQ; HQ & Svc Co 1921-41; 2nd Vet Co 1921-41; 2nd Med Sup Sect 1921-24; 2nd Med Lab Sect 1921-24; 2nd San Co 1921-24; *HQ Amb Bn* 1929-36; 4th Amb Co 1921-36; 5th Amb Co 1921-36; *6th Amb Co* 1929-36; *HQ Hosp Bn* 1929-36; 4th Hosp Co 1921-36; *5th Hosp Co* 1929-36; *6th Hosp Co* 1929-36; *HQ COL Bn* 1929-36; 4th Col Co 1924-36; *5th Col Co* 1929-36; *6th Col Co* 1929-36

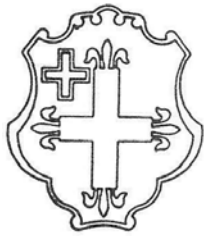

Arrived the port of New York 5 August 1919 on the S.S. *Julia Luckenbach* after seven months of occupation duty in Coblenz, Germany, as the 2nd Sanitary Train, an element of the 2nd Division. Transferred the same day to Camp Mills, NY. Transferred 11 August 1919 to Camp Travis, TX. Reorganized and redesignated 17 February 1921 as the 2nd Medical Regiment. Transferred in June 1922 to main post, Fort Sam Houston, TX. Regularly supported annual summer training of Organized Reserve medical units from the Eighth Corps Area. Reserve officers assigned to the regiment conducted summer training with the regiment at Fort Sam Houston. Performed hurricane relief duty in September 1933 at Harlingen, TX. Provided medical support to CCC camps in the Texas, Arizona, and New Mexico CCC Districts 1933-39. Reorganized and redesignated as the 2nd Medical Battalion 10 October 1939 at Fort Sam Houston.

Organization Day: 11 August. Chosen to commemorate the regiment's initial organization as the 2nd Sanitary Train on 11 August 1917.

Status: Active in the Regular Army at Camp Casey, Korea, as the 302nd Support Battalion, a component of the 2nd Infantry Division.

Events: 45, 47, 55, 70, 74, 105, 125, 147, 163, 242, 258, 282, 288, 295, 296, 299, 300, 317, 328

Commanders, 2nd Medical Regiment

Lt. Col. Paul S. Halloran	28 Jan 21-27 Sep 21	Col. William N. Bispham	7 Dec 27-28 Aug 28
Maj. Frederick S. Wright	27 Sep 21-11 Jan 23	Lt. Col. Edward G. Huber	28 Aug 28-13 Sep 28
Maj. James C. Magee	11 Jan 23-6 Sep 23	Col. George H. Scott	13 Sep 28-6 Jan 32
Maj. James E. Baylis	6 Sep 23-9 Nov 23	Maj. Betram F. Duckwell	6 Jan 32-22 Sep 32
Lt. Col. John H. Allen	9 Nov 23-18 Nov 24	Col. Louis Brechimin, Jr.	22 Sep 32-31 May 34
Maj. John W. Sherwood	18 Nov 24-24 Feb 25	Maj. Jay D. Mingos	31 May 34-20 Aug 34
Lt. Col. Ernest L. Ruffner	24 Feb 25-10 Jan 27	Col. Joseph E. Bastion	20 Aug 34-4 Oct 38
Maj. Frank S. Matlack	10 Jan 27-7 Dec 27	Lt. Col. Jarrett M. Huddleston	4 Oct 38-1 Feb 39
	Col. Taylor E. Darby		1 Feb 39-16 Oct 39

2nd Medical Squadron (2nd Cavalry Division)

Regular Army Inactive

HQ-Dallas, TX, 1927; Kansas City, MO, 1927-40; Fort Riley, KS, 1941

Subordinate elements-Sq. HQ; 2nd Vet Tp 1925-41; 2nd Amb Tp 1925-36; 2nd Hosp Tp 1925-36; 2nd Col Tp 1925-36

Constituted in the Regular Army 23 March 1925, assigned to the 2nd Cavalry Division, and allotted to the Seventh Corps Area. Withdrawn from the Seventh Corps Area 28 February 1927 and allotted to the Eighth Corps Area. Affiliated with the Baylor University Medical School R.O.T.C. in Dallas, TX, and organized 10 June 1927 as a RAI unit with personnel from the R.O.T.C. Detachment and Reserve officers commissioned from the program. Withdrawn from the Eighth Corps Area 15 August 1927 and allotted to the Seventh Corps Area. Under special instructions issued by the Adjutant General 15 August 1927 the squadron was to be organized on order for mobilization purposes from medical personnel stationed at Fort Leavenworth, KS. Organized by December 1927 with Organized Reserve personnel as a RAI unit with headquarters at Kansas City, MO. Typically conducted Inactive Training Period meetings at the 110th Engineers armory or the Medical Arts Building in Kansas City. Conducted summer training at Fort Snelling, MN. Partially activated 1 April 1940 at Fort Riley, KS. Headquarters and remainder of the squadron, less Reserve personnel, activated 1 April 1941 at Fort Riley, KS. Location 7 December 1941—Fort Riley, KS.

Events: 188, 328

Commanders, 2nd Medical Squadron

Lt. Col. Cosam J. Bartlett*	10 Jun 27-15 Aug 27	Unknown**	Dec 27-85 Oct 41
	Maj. Charles M. Downs	15 Oct 41-ao Jan 42	

* RAI Mobilization Commanders: Regular Army officers who were concurrently PMS&T at Baylor University Medical School.

** RAI Commanders: Organized Reserve officers.

3rd Medical Regiment (3rd Division)

HQ-Camp Pike, AR, 1919-21; Camp Lewis, WA, 1921-22; *Inactive* 1922-27; Presidio of San Francisco, CA, 1927-34; *Inactive* 1930-34; Fort Lewis, WA, 1934-39; Presidio of San Francisco, CA, 1939

Subordinate elements-Regt'l HQ; HQ & Svc Co 1921-41; 3rd Vet Co 1921-41; 3rd Med Sup Sect 1921-24; 3rd Med Lab Sect 1921-24; 3rd San Co 1921-24; *HQ, Amb Bn* 1929-36; 7th Amb Co 1921-36; 8th Amb Co 1921-36; 9th Amb Co 1929-36; *HQ, Hosp Bn* 1929-36; 7th Hosp Co 1921-36; 8th Hosp Co 1929-36; 9th Hosp Co 1929-36; *HQ, Col Bn* 1929-36; 7th Col Co 1924-36; 8th Col Co 1929-36; 9th Col Co 1929-36

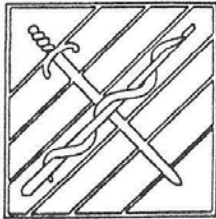

Arrived the port of New York 25 August 1919 on the S.S. *Manchuria* after seven months of occupation duty in Mayen, Germany, as the 3rd Sanitary Train, an element of the 3rd Division. Transferred the same day to Camp Merritt, NJ. Transferred with the 3rd Division to Camp Pike, AR, and arrived there 31 August 1919. Reorganized and redesignated 18 February 1921 as the 3rd Medical Regiment. Transferred 21 September 1921 to Camp Lewis, WA. Inactivated 31 October 1922 at Camp Lewis. Active associates were Headquarters, Fort Lewis 1922-23 and the Office of the Surgeon General 1923-27. Regiment partially organized 20 June 1927 as a

RAI unit with Organized Reserve and selected Regular Army personnel at Letterman General Hospital, Presidio of San Francisco, CA. Allotted to the Ninth Corps Area for mobilization responsibility 15 August 1927. Under special instructions issued by the War Department 15 August 1927, the regiment was to be mobilized with personnel from Letterman General Hospital in San Francisco. Conducted summer training at Fort Lewis, Letterman General Hospital, or the Presidio of Monterey, CA. Regimental headquarters inactivated in June 1930 at Letterman General Hospital. Regimental headquarters and 7th Hospital Company activated 1 April 1934, less Reserve personnel, at Fort Lewis, WA. Provided medical support to CCC camps in the Montana and Idaho CCC Districts 1934-35. Regularly supported the annual summer training of the Organized Reserve medical units from the Ninth Corps Area. Transferred 1 February 1939 to Letterman General Hospital, Presidio of San Francisco. Reorganized and redesignated 13 October 1939 as the 3rd Medical Battalion at the Presidio of San Francisco.

Organization Day: 15 July. Chosen to commemorate the regiment's participation in the battle of Chateau Thierry and the beginning of the Marne Defensive 15 July 1918. Adopted 10 September 1920.

Status: Active in the Regular Army at Fort Benning, GA, as the 203rd Support Battalion, a component of the 3rd Infantry Division.

Events: 57, 114, 208, 226, 238, 251, 273, 289, 294, 304, 306, 309, 314, 326

Commanders, 3rd Medical Regiment

Lt. Col. Alexander Murray	19 Feb 21-24 Aug 21	<i>Inactive</i>	Jun 30-31 Mar 34
Maj. James S. Fox	24 Aug 21-22 Sep 21	Maj. Carlton L. Vanderboget	1 Apr 34-22 Sep 36
Maj. Charles E. Freeman	22 Sep 21-30 Sep 22	Maj. Emery E. Alling	22 Sep 36-21 Jan 38
Capt. Harry E. Fraser	30 Sep 22-31 Oct 22	Lt. Col. Walcott Denison	21 Jan 38-1 Oct 38
<i>Inactive</i>	31 Oct 22-Jun 27	Lt. Col. John R. Oswalt	1 Oct 38-1 Feb 39
Maj. Arturo Carbonell	Jun 27-Jun 29	Col. Robert C. McDonald	1 Feb 39-30 Jun 39
Col. Frederick S. Wright	Jun 29-Jun 30	Lt. Col. Elias E. Cooley	30 Jun 39-18 Sep 39
	Lt. Col. Frederick A. Blesse	18 Sep 39-13 Oct 39	

3rd Medical Squadron (3rd Cavalry Division)

Regular Army Inactive

HQ-St. Louis, MO, 1928-38; Des Moines, IA, 1938-40

Subordinate elements-Sq. HQ; 3rd Vet Tp 1925-40; 3rd Amb Tp 1925-36; 3rd Hosp Tp 1925-36; 3rd Col Tp 1925-36

Constituted in the Regular Army 15 August 1927, assigned to the 3rd Cavalry Division, and allotted to the Seventh Corps Area. Organized by May 1928 with Organized Reserve personnel as a RAI unit with headquarters at St. Louis, MO. Entire squadron relocated about 1938 to Des Moines, IA. Subordinate elements located in the states of Missouri, Iowa, and Kansas. Conducted summer training at Fort Snelling, MN. Disbanded 15 July 1940.

Commanders, 3rd Medical Squadron

Maj. Charles E. Brown**	Jul 28-Feb 30	Capt. Louie J. Beyer**	ao Sep 37-3 Oct 37
Unknown	Feb 30-ao Jan 36	Capt. Byron A. Bennett**	3 Oct 37-ao Jan 38
Capt. Edgar P. Murdock**	ao Feb 36-29 Mar 36	Unknown	ao Jan 38-4 Oct 39
Unknown	29 Mar 36-ao Sep 37	Capt. Robert W. Allen	4 Oct 39-15 Jul 40

** RAI Commanders: Organized Reserve officers.

4th Medical Regiment (4th Division)

Regular Army Inactive

HQ-*Inactive* 1921-26; Pittsburgh, PA, 1926-33; Nashville, TN, 1933-39; Fort Benning, GA, 1939

Subordinate elements-Regt'l HQ (RAI) 1921-39; HQ & Svc Co 1921-39; 4th Vet Co 1921-39; 4th Med Sup Sect 1925-24; 4th Med Lab Sect 1925-24; 4th San Co 1925-24; HQ, Amb Bn 1929-36; 10th Amb Co 1921-36; 11th Amb Co 1921-36; 12th Amb Co 1929-36; HQ, Hosp Bn 1929-36; 10th Hosp Co 1921-36; 11th Hosp Co 1929-36; 12th Hosp Co 1929-36; HQ, Col Bn 1929-36; 10th Col Co 1924-36; 11th Col Co 1929-36; 12th Col Co 1929-36



Arrived the port of New York 1 August 1919 on the S.S. *Mount Vernon* after seven months of occupation duty in Adenau and Ahrweiler, Germany, as the 4th Sanitary Train, an element of the 4th Division. Transferred to Camp Dodge, IA, and arrived there 8 August 1919. Transferred to Camp Lewis, WA, and arrived there 2 September 1920. Reorganized and redesignated 12 February 1921 as the 4th Medical Regiment. Inactivated 21 September 1921 at Camp Lewis. Active associates were Headquarters, Fort Lewis 1921-23 and the Office of the Surgeon General 1923-27. Organized 12 August 1926 with Organized Reserve personnel as a RAI unit with headquarters at Pittsburgh, PA. Allotted to the Third Corps Area for mobilization

responsibility 15 August 1927. Under special instructions issued by the War Department on 15 August 1927, the regiment was to be mobilized with personnel from Walter Reed General Hospital. Withdrawn from the Third Corps Area 1 October 1933 and allotted to the Fourth Corps Area. Concurrently affiliated with Vanderbilt University School of Medicine R.O.T.C. and organized as a RAI unit with personnel from the R.O.T.C. Detachment and Reserve officers commissioned from the program. Other Organized Reserve personnel drawn from the states of Tennessee, Alabama, Georgia, South Carolina, Florida, and Louisiana. Designated mobilization training station was Fort Oglethorpe, GA. Activated 1 February 1939, less Reserve personnel, at Fort Benning, GA. Reorganized and redesignated as the 4th Medical Battalion 19 October 1939 at Fort Benning, GA.

Status: Inactive in the Regular Army as the 5th Support Battalion, a component of the 5th Infantry Division (Mechanized).

Events: 293, 296, 302, 316, 328

Commanders, 4th Medical Regiment

Maj. Charles E. Freeman	28 Jan 21-5 Aug 21	<i>Inactive</i>	1 Oct 33-14 Nov 33
<i>Inactive</i>	5 Aug 21-12 Aug 26	Maj. Harry R. Cogburn**	14 Nov 33-ao Jan 34
Capt. Sparkman B. Johnson**	12 Aug 26-17 Aug 26	Maj. Walter L. Tatum**	ao Jul 34-ao Aug 34
Maj. John K. Ross**	17 Aug 26-22 Oct 26	Unknown	ao Aug 34-21 Mar 37
Lt. Col. Norborne P. Cooke**	22 Oct 26-14 Feb 29	Capt. Miles S. Crowder**	21 Mar 37-25 Jun 39
Lt. Col. Charles S. Flagler**	14 Feb 29-1 Oct 33	Col. William R. Dear	1 Feb 39-16 Oct 39

** RAI Commanders: Organized Reserve officers.

4th Medical Squadron (Mecz) (7th Cavalry Brigade)

HQ-Camp Knox, KY, 1939-40

Constituted in the Regular Army 7 September 1939, assigned to the 7th Cavalry Brigade, and allotted to the Fifth Corps Area. Activated 1 February 1939 with personnel from the Medical Department Detachment at Fort Knox, KY. Reorganized and redesignated as the 4th Medical Troop 1 February 1940. Reorganized and redesignated as the 47th Medical Battalion 15 July 1940 at Fort Knox and assigned to the 1st Armored Division.

Status: Active in the Regular Army at Baumholder, Germany as the 47th Support Battalion, a component of the 1st Armored Division.

Events: 302, 328, 330

Commanders, 4th Medical Squadron

Maj. L. Holmes Ginn, Jr. 1 Feb 39-1 Feb 40

5th Medical Regiment (5th Division)

Regular Army Inactive

HQ-*Inactive* 1921-27; Nashville, TN, 1926-33; Columbus, OH, 1933-34; Akron, OH, 1934-39

Subordinate elements-Regt'l HQ (RAI) 1921-39; HQ & Svc Co 1921-39; 5th Vet Co 1921-39; 5th Med Sup Sect 1925-24; 5th Med Lab Sect 1925-24; 5th San Co 1925-24; HQ, Amb Bn 1929-36; 13th Amb Co 1921-36; 14th Amb Co 1921-36; 15th Amb Co 1929-36; HQ, Hosp Bn 1929-36; 13th Hosp Co 1921-36; 14th Hosp Co 1929-36; 15th Hosp Co 1929-36; HQ, Col Bn 1929-36; 13th Col Co 1924-36; 14th Col Co 1929-36; 15th Col Co 1929-36



Arrived the port of New York 21 July 1919 on the S.S. *Agamemnon* after six months of occupation duty in Luxembourg as the 5th Sanitary Train, an element of the 5th Division. Transferred the same day to Camp Merritt, NJ. Transferred 24 July 1919 to Camp Gordon, GA. Transferred 12 October 1920 to Camp Jackson, SC. Reorganized and redesignated 11 February 1921 as the 5th Medical Regiment. Inactivated 15 September 1921 at Camp Jackson. Active associates were the 2nd Medical Regiment 1921-23 and the Office of the Surgeon General 1923-27. Organized in September 1926 with Organized Reserve personnel as a RAI unit with headquarters at Nashville, TN. Under special instructions issued by the War

Department on 15 August 1927, the regiment was to be mobilized with personnel from the Fort Benning station hospital. Affiliated 21 April 1930 with Vanderbilt University School of Medicine R.O.T.C. at Nashville, TN. Concurrently reorganized with personnel from the R.O.T.C. Detachment and Reserve officers commissioned from the program. Affiliation with Vanderbilt University ended 1 October 1933. Regiment concurrently withdrawn from the Fourth Corps Area and allotted to the Fifth Corps Area. Organized on the same date with Organized Reserve personnel as a RAI unit with headquarters at Columbus, OH. Headquarters relocated 23 April 1934 to Akron, OH. Organized Reserve personnel drawn from the states of Ohio, Indiana, and Kentucky. Conducted summer training most years at Camp Knox, KY, and some years at Carlisle Barracks, PA. Reorganized and redesignated as the 4th Medical Battalion 1 July 1940.

Status: Active in the Regular Army at Fort Hood, TX, as the 204th Support Battalion, a component of the 4th Infantry Division (Mechanized).

Events: 310, 330

Commanders, 5th Medical Regiment

Lt. Col. Kent Nelson	28 Jan 21-15 Sep 21	Maj. Richard K. Cole *	20 Jun 29-1 Oct 33
<i>Inactive</i>	15 Sep 21-Sep 26	Maj. Daniel P. Card**	1 Oct 33-ao Nov 33
Unknown	Sep 26-14 Jul 27	Unknown	ao Nov 33-ao Jul 35
Maj. Nicholas A. Albanese*	15 Jul 27-15 Jun 29	Col. Chester M. Peters**	ao Jul 35-ao Jun 38
	Unknown	ao Jun 38-1 Jul 40	

* RAI Commanders: Regular Army officers.
 ** RAI Commanders: Organized Reserve officers.

6th Medical Regiment (6th Division)

Regular Army Inactive

HQ-Camp Grant, IL, 1919-21; *Inactive* 1921-26; Chicago, IL, 1926-27; Denver, CO, 1927-33; Chicago, IL, 1933-40

Subordinate elements-Regt'l HQ (RAI) 1921-39; HQ & Svc Co 1921-39; 6th Vet Co 1921-39; 6th Med Sup Sect 1925-24; 6th Med Lab Sect 1925-24; 6th San Co 1925-24; HQ, Amb Bn 1929-36; 16th Amb Co 1921-36; 17th Amb Co 1921-36; 18th Amb Co 1929-36; HQ, Hosp Bn 1929-36; 16th Hosp Co 1921-36; 17th Hosp Co 1929-36; 18th Hosp Co 1929-36; HQ, Col Bn 1929-36; 16th Col Co 1924-36; 17th Col Co 1929-36; 18th Col Co 1929-36

Arrived at the port of New York 19 June 1919 on the U.S.S. *Kaiserin Auguste Victoria* after six months of occupation duty in the vicinity of Aignay-le-Duc, France, and Bad Bertrich, Germany, as the 6th Sanitary Train, an element of the 6th Division. Transferred 20 June 1919 Camp Mills, NY. Transferred in June 1919 to Camp Grant, IL. Reorganized and redesignated 28 February 1921 as the 6th Medical Regiment. Inactivated 24 September 1921 at Camp Grant. Active associates were the 1st Medical Regiment 1921-23 and the Office of the Surgeon General 1923-27. Organized 17 April 1926 with Organized Reserve personnel as a RAI unit with headquarters at Chicago, IL. Unit inactivated at Chicago 15 August 1927, withdrawn from the Sixth Corps Area, and allotted to the Eighth Corps Area for mobilization responsibility. Under special instructions issued by the War Department 15 August 1927, the regiment was to be mobilized with personnel from Fitzsimmons General Hospital. Reorganized 24 April 1928 with Organized Reserve personnel as a RAI unit with headquarters at Denver, CO. Designated mobilization training station was Fitzsimmons Army Hospital 1927-33. Regiment withdrawn from the Eighth Corps Area 1 October 1933 and allotted to the Sixth Corps Area. Organized in October 1933 with Organized Reserve personnel as a RAI unit with headquarters at Chicago, IL. Conducted summer training most years at the Fort Snelling station hospital and some years at Fort Sheridan, IL, or Fitzsimmons General Hospital, Aurora, CO. Relieved from the 6th Division 16 October 1939. Reorganized and redesignated as the 7th Medical Battalion 1 July 1940 and assigned to the 7th Division.

Commanders, 6th Medical Regiment

Lt. Col. James W. Van Deusen	1 Mar 21-24 Sep 21	Maj. Morris J. Krohn**	8 Oct 29-26 Sep 32
<i>Inactive</i>	24 Sep 21-16 Apr 26	Capt. Otis K. Asher**	26 Sep 32-6 Oct 32
Maj. Albert L. Field*	17 Apr 26-15 Aug 27	Unknown	6 Oct 32-ao Jul 35
<i>Inactive</i>	15 Aug 27-24 Aug 28	Maj. Edward Del Baccaro**	ao Jul 35-12 Oct 36
Maj. Willard P. Earngey**	24 Apr 28-8 Oct 29	Unknown	12 Oct 36-ao Jul 38
	Capt. Sidney Forkosh**	ao Jul 38-15 Oct 39	

* RAI Commanders: Regular Army officers.
 ** RAI Commanders: Organized Reserve officers.

7th Medical Regiment (7th Division)

Regular Army Inactive

HQ-Camp Funston, KS, 1919-21; Camp George G. Meade, MD, 1921; *Inactive* 1921-26; St. Louis, MO, 1926-39

Subordinate elements-Regt'l HQ (RAI) 1921-39; HQ & Svc Co 1921-39; 7th Vet Co 1921-39; 7th Med Sup Sect 1925-24; 7th Med Lab Sect 1925-24; 7th San Co 1925-24; HQ, Amb Bn 1929-36; 19th Amb Co 1921-36; 20th Amb Co 1921-36; 21st Amb Co 1929-36; HQ, Hosp Bn 1929-36; 19th Hosp Co 1921-36; 20th Hosp Co 1929-36; 21st Hosp Co 1929-36; HQ, Col Bn 1929-36; 19th Col Co 1924-36; 20th Col Co 1929-36; 21st Col Co 1929-36



Arrived the port of Newport News, VA, 30 June 1919 on the S.S. *Matsonia* after six months of occupation duty in the vicinity of the Puvencelle Sector and the Colombey-les-Belles Training Area, France, as the 7th Sanitary Train, an element of the 7th Division. Transferred to Camp Funston, KS, and arrived there 6 July 1919. Transferred to Camp George G. Meade, MD, and arrived there 8 September 1921. Reorganized and redesignated 15 February 1921 as the 7th Medical Regiment. Inactivated 10 September 1921 at Camp Meade. Active associates were the 1st Medical Regiment 1921-23 and the Office of the Surgeon General 1923-27. Organized by September 1926 with Organized Reserve personnel as a RAI unit with headquarters at St. Louis, MO. Allotted to the Seventh Corps Area for mobilization responsibility 15 August 1927.

Conducted summer training at the Fort Snelling station hospital. Redesignated as the 7th Medical Battalion 26 September 1939; further redesignated as the 6th Medical Battalion 1 July 1940.

Status: Inactive in the Regular Army as the 306th Support Battalion, a component of the 6th Infantry Division (Light).

Events: 293, 296, 303

Commanders, 7th Medical Regiment

Lt. Col. George P. Reed	28 Feb 21-10 Sep 21	Maj. Jean V. Cooke**	Dec 30-ao Jan 31
<i>Inactive</i>	10 Sep 21-Sep 26	Unknown	ao Jan 31-11 Oct 36
Maj. Smiley Blanton**	Oct 26-30 Jun 27	Maj. Ross A. Thuma**	11 Oct 36-22 Aug 37
Maj. Francis E. Bouza**	30 Jun 27-Dec 30	Unknown	22 Aug 37-7 Sep 39

** RAI Commanders: Organized Reserve officers.

8th Medical Regiment (8th Division)

Regular Army Inactive

HQ-Inactive 1923-26; Washington, DC, 1926-27; Albany, NY, 1926-39

Subordinate elements-Regt'l HQ (RAI) 1921-39; HQ & Svc Co 1921-39; 8th Vet Co 1921-39; 8th Med Sup Sect 1923-24; 8th Med Lab Sect 1923-24; 8th San Co 1923-24; HQ, Amb Bn 1929-36; 22nd Amb Co 1923-36; 23rd Amb Co 1923-36; 24th Amb Co 1929-36; HQ, Hosp Bn 1929-36; 22nd Hosp Co 1923-36; 23rd Hosp Co 1929-36; 24th Hosp Co 1929-36; HQ, Col Bn 1929-36; 22nd Col Co 1924-36; 23rd Col Co 1929-36; 24th Col Co 1929-36

Demobilized in February 1919 at Camp Lee, VA, as the 8th Sanitary Train, an element of the 8th Division. Reconstituted in the Regular Army 24 March 1923 as the 8th Medical Regiment, assigned to the 8th Division, and allotted to the Third Corps Area. Active associate was the Office of the Surgeon General 1923-27. Organized 11 May 1926 with Organized Reserve personnel as a RAI unit with headquarters at Washington, DC. To be activated upon mobilization with personnel from the 1st Medical Regiment under special instructions from the War Department. Typically conducted Inactive Training Period meetings at the Ambassador Hotel or the Medical Society Building, 1718 M Street, NW, in Washington. Inactivated 24 November 1926 at Washington, DC, by relief of personnel. Withdrawn from the Third Corps Area 19 February 1927 and allotted to the Second Corps Area. Concurrently affiliated with the Albany Medical School R.O.T.C. in Albany, NY. Reorganized 1 June 1927 as a RAI unit with personnel from the R.O.T.C. Detachment and Reserve officers commissioned from the program. Typically conducted Inactive Training Period meetings at the Army Building, 39 Whitehall Street in New York City. Conducted summer training at Carlisle Barracks, PA, with the 1st Medical Regiment. Affiliation changed by 1935 to the Albany Medical College and the University of Buffalo. Affiliation with the R.O.T.C. ended 2 October 1939 when the regiment was withdrawn from the Second Corps Area and allotted to the Third Corps Area. Concurrently, reorganized and redesignated as the 8th Medical Battalion.

Status: Active in the Regular Army in Germany as the 201st Support Battalion, a component of the 1st Infantry Division (Mechanized).

Events: 293, 296, 301, 323, 330

Commanders, 8th Medical Regiment

Maj. John K. Reinoehl**	11 May 26-24 Nov 26	Lt. Col. Ray W. Ergen*	1 Jun 27-17 Jun 31
<i>Inactive</i>	25 Nov 26-1 Jun 27	Maj. James H. Blackwell**	17 Jun 31-1 Oct 31
	Lt. Col. Julius M. Blank**	1 Oct 31-2 Oct 39	

* RAI Commanders: Regular Army officers who were concurrently PMS&T at the Albany Medical School.

** RAI Commanders: Organized Reserve officers.

9th Medical Regiment (9th Division)**Regular Army Inactive****HQ-***Inactive* 1923-27; Syracuse, NY, 1927-39**Subordinate elements-**Regt'l HQ (RAI) 1921-39; HQ & Svc Co 1921-39; 9th Vet Co 1921-39; 9th Med Sup Sect 1923-24; 9th Med Lab Sect 1923-24; 9th San Co 1923-24; HQ, Amb Bn 1929-36; 25th Amb Co 1923-36; 26th Amb Co 1923-36; 27th Amb Co 1929-36; HQ, Hosp Bn 1929-36; 25th Hosp Co 1923-36; 26th Hosp Co 1929-36; 27th Hosp Co 1929-36; HQ, Col Bn 1929-36; 25th Col Co 1924-36; 26th Col Co 1929-36; 27th Col Co 1929-36

Demobilized 5 February 1919 at Camp Sheridan, AL, as the 9th Sanitary Train, an element of the 9th Division. Reconstituted in the Regular Army 24 March 1923 as the 9th Medical Regiment, assigned to the 9th Division, and allotted to the First Corps Area. Active associate was the Office of the Surgeon General 1923-27. Withdrawn from the First Corps Area 19 February 1927 and allotted to the Second Corps Area. Under special instructions issued by the War Department on 15 August 1927, the regiment was to be mobilized with personnel from the 1st Medical Regiment. Concurrently affiliated with Syracuse University School of Medicine R.O.T.C. Organized 12 October 1927 as a RAI unit with personnel from the R.O.T.C. Detachment and Reserve officers commissioned from the program. Affiliation changed by 1935 to the Cornell University Medical College. Conducted summer training at Carlisle Barracks, PA, with the 1st Medical Regiment. Affiliation with the R.O.T.C. ended about 1939. Reorganized and redesignated as the 9th Medical Battalion 16 October 1939.

Status: Inactive in the Regular Army as the 9th Medical Battalion, a component of the 9th Infantry Division (Motorized).**Events:** 6330**Commanders, 9th Medical Regiment**

Maj. Lester L. Roose**	12 Oct 27-1 Oct 28	Lt. Col. Ralph C. DeVoe*	15 Aug 30-1 Oct 33
Unknown	1 Oct 28-12 May 29	Unknown	1 Oct 33-2 Mar 34
Maj. George E. Perkins**	13 May 29-1 Jun 30	Col. Albert Pfeiffer**	2 Mar 34-25 Sep 35
Maj. Thomas C. Tousey**	1 Jun 30-1 Oct 33	Lt. Col. Gilbert W. Crissey**	25 Sep 35-16 Oct 39

* RAI Commanders: Regular Army officers who were concurrently PMS&T at the Syracuse University School of Medicine.

** RAI Commanders: Organized Reserve officers.

10th Medical Regiment (I) (Panama Canal Division)**Regular Army Inactive****HQ-***Not organized* 1921-22**Subordinate elements-***Regt'l HQ; HQ & Svc Co 1921-22; 10th Vet Co 1921-22; 10th Med Sup Sect 1921-22; 10th Med Lab Sect 1921-22; 57th San Co 1921-22; 57th Amb Co 1921-22; 57th Hosp Co 1921-22*

Constituted in the Regular Army in 1921, assigned to the Panama Canal Division, and allotted to the Panama Canal Department. Demobilized in 1922.

10th Medical Regiment (II) (IV Corps)**Regular Army Inactive****HQ-***Not organized* 1927-28; Fayetteville, NC, 1928-41**Subordinate elements-**Regt'l HQ (RAI); HQ & Svc Co 1927-39; 10th Vet Co 1929-39; HQ, Amb Bn 1929-36; 28th Amb Co 1929-36; 29th Amb Co 1929-36; 30th Amb Co 1929-36; HQ, Hosp Bn 1929-36; 28th Hosp Co 1929-36; 29th Hosp Co 1929-36; 30th Hosp Co 1929-36; HQ, Col Bn 1929-36; 28th Col Co 1929-36; 29th Col Co 1929-36; 30th Col Co 1929-36

Constituted in the Regular Army 18 October 1927, allotted to the Fourth Corps Area, and assigned to the IV Corps. Organized 5 March 1928 with Organized Reserve personnel as a RAI unit with headquarters at Fayetteville, NC. Assigned Reserve personnel were from the states of North Carolina, South Carolina, Tennessee, and Mississippi. Designated mobilization training station was Fort Bragg, NC. Location 7 December 1941—Fayetteville, NC.

Status: Disbanded 18 October 1943.

Commanders, 10th Medical Regiment

Maj. Jeff N. Webb**	5 Mar 28-ao Jun 28	Lt. Col. Arthur E. Rodgers**	ao May 31-24 Feb 32
Unknown	ao Jun 28-ao Jan 30	Col. Thaddeus S. Troy**	24 Feb 32-8 Mar 32
Lt. Col. Kay W. Constantine**	ao Jan 30-20 Mar 30	Unknown	8 Mar 32-ao Mar 33
Lt. Col. Orren T. Goodwin**	20 Mar 30-10 May 30	Lt. Col. William P. Nicholson**	ao Mar 33-18 Apr 33
Lt. Col. Clarke B. Weeks**	10 May 30-14 Jun 30	Unknown	18 Apr 33-ao Jul 36
Unknown	14 Jun 30-ao May 31	Lt. Col. Lucien F. Farmer**	ao Jul 36-30 Aug 36
	Unknown	20 Aug 36-7 Dec 41	

** RAI Commanders: Organized Reserve officers.

11th Medical Regiment (Hawaiian Division)

HQ-Schofield Barracks, TH, 1922-41

Subordinate elements-Regt'l HQ; HQ & Svc Co 1922-41; 11th Vet Co 1922-41; 11th Med Sup Sect 1922-25; 11th Med Lab Sect 1922-25; 31st San Co 1923-24; *HQ, Amb Bn* 1929-36; *31st Amb Co* 1925-36; 32nd Amb Co 1923-36; *33rd Amb Co* 1929-36; 59th Amb Co 1922-23; *HQ, Hosp Bn* 1929-36; 31st Hosp Co 1923-36; *32nd Hosp Co* 1925-36; *33rd Hosp Co* 1929-36; *HQ, Col Bn* 1929-36; 31st Col Co 1924-36; *32nd Col Co* 1922-36; *33rd Col Co* 1929-36



Constituted in the Regular Army 12 July 1922 and assigned to the Hawaiian Division. Organized 1 December 1922 at Schofield Barracks, TH. Reorganized and redesignated as the 24th Medical Battalion 1 October 1941 and assigned to the 24th Infantry Division.

Organization Day: 1 December. Chosen to commemorate the regiment's organization on 1 December 1922.

Status: Inactive in the Regular Army as the 224th Support Battalion, a component of the 24th Infantry Division (Mechanized).

Events: 33, 37, 48, 75, 88, 120, 138, 141, 158, 189, 211, 225, 248, 276, 297, 312

Commanders, 11th Medical Regiment

Col. Jere B. Clayton	1 Dec 22-25 Jan 23	Col. Allie W. Williams	1 Nov 29-22 Jun 30
Col. Frederick M. Hartseck	25 Jan 23-8 Aug 25	Col. Jay W. Grissinger	22 Jun 30-21 Jan 33
Lt. Col. Henry F. Pipes	8 Aug 25-5 Jan 26	Col. Herbert C. Gibner	21 Jan 33-7 Jul 36
Col. Douglas F. Duval	5 Jan 26-1 Sep 27	Col. Condon C. McCornack	7 Jul 36-19 Jul 38
Col. Carroll D. Buck	1 Sep 27-1 Nov 29	Col. Paul W. Gibson	19 Jul 38-14 Sep 39
	Col. Roy C. Heflebower	14 Sep 39-1 Oct 41	

12th Medical Regiment (PS) (Philippine Division)

HQ-Fort William McKinley, PI, 1922-41

Subordinate elements-Regt'l HQ; HQ & Svc Co 1922-41; 12th Vet Co 1922-41; 12th Med Sup Sect 1922-25; 12th Med Lab Sect 1922-25; 34th San Co 1922-25; *HQ, Amb Bn* 1929-36; 34th Amb Co 1925-36; 35th Amb Co 1925-36; *36th Amb Co* 1929-36; 54th Amb Co 1922-25; 55th Amb Co 1922-25; *HQ, Hosp Bn* 1929-36; 34th Hosp Co 1925-36; *35th Hosp Co* 1925-36; *36th Hosp Co* 1929-36; 56th Hosp Co 1922-25; *HQ, Col Bn* 1929-36; *34th Col Co* 1924-36; *35th Col Co* 1924-36; *36th Col Co* 1929-36



Constituted in the Regular Army 7 December 1921 and assigned to the Philippine Division. Designated as a Philippine Scout organization 17 July 1922. Organized 1 September 1922 at Fort William McKinley, PI. Headquarters detachments for Collecting Battalion, Ambulance Battalion, and Hospital Battalion constituted and activated 26 March 1929. Battalions reorganized and redesignated 13 July 1936 as the 1st, 2nd, and 3rd Battalions, respectively. Location 7 December 1941—Fort William McKinley, PI.

Organization Day: 1 January. Chosen to commemorate the regiment's organization on 1 January 1922.

Status: Inactivated 30 April 1947 at Camp O'Donnell, Luzon, PI, as the 12th Medical Battalion (PS), a component of the 12th Infantry Division (PS).

Events: 27, 35, 41, 68, 82, 100, 118, 139, 169, 179, 198, 224, 245, 270

Commanders, 12th Medical Regiment

Lt. Col. George H. Scott	1 Jan 22-12 Jul 22	Col. James F. Hall	5 Feb 28-12 Oct 29
Lt. Col. Arthur S. Pendleton	12 Jul 22-27 Aug 22	Col. Philip W. Huntington	12 Oct 29-8 Dec 30
Maj. Walcott Denison	27 Aug 22-9 Oct 22	Col. Kent Nelson	8 Dec 30-3 Mar 32
Col. Edwin P. Wolfe	9 Oct 22-15 Aug 24	Col. William H. Tefft	3 Mar 32-10 Apr 34
Lt. Col. Fred H. Blumhardt	15 Aug 24-9 Nov 24	Lt. Col. John R. McKnight	10 Apr 34-26 Jan 35
Col. Elmer A. Dean	9 Nov 24-4 Feb 26	Col. W. Lee Hart	26 Jan 35-1 Dec 36
Lt. Col. Howard H. Bailey	4 Feb 26-22 Feb 26	Lt. Col. Charles W. Riley	1 Dec 36-5 May 38
Col. Christopher C. Collins	22 Feb 26-5 Jul 26	Col. Henry C. Michie	5 May 38-1 Jun 39
Lt. Col. Howard H. Bailey	5 Jul 26-5 Jul 27	Col. Hew B. McMurdo	1 Jun 39-9 Oct 40
Col. Paul S. Halloran	5 Jul 27-5 Feb 28	Col. James W. Duckworth	9 Oct 40-ao Dec 41

13th Medical Regiment (Third Army)

Regular Army Inactive

HQ-*Not organized* 1927-28; Fort Sam Houston, TX, 1928-32; *Inactive* 1932-34; Fort Sam Houston, TX, 1934-35; *Inactive* 1935-36; Dallas, TX, 1936-41

Subordinate elements-Regt'l HQ (RAI) 1927-41; HQ & Svc Co 1927-41; 13th Vet Co 1927-41; HQ, Amb Bn 1927-36; 37th Amb Co 1927-36; 38th Amb Co 1927-36; 39th Amb Co 1927-36; HQ, Hosp Bn 1927-36; 37th Hosp Co 1927-36; 38th Hosp Co 1927-36; 39th Hosp Co 1927-36; HQ, Col Bn 1927-36; 37th Col Co 1924-36; 38th Col Co 1927-36; 39th Col Co 1927-36

Constituted in the Regular Army 18 October 1927, allotted to the Eighth Corps Area, and assigned to the Third Army. Organized by December 1928 with Organized Reserve personnel as a RAI unit with headquarters at Fort Sam Houston, TX. Inactivated 26 September 1932 at Fort Sam Houston by relief of Reserve personnel. Reorganized 16 June 1934 with Organized Reserve personnel as a RAI unit with headquarters at Fort Sam Houston. Inactivated 20 September 1935 at Fort Sam Houston by relief of Reserve personnel. Reorganized 25 November 1936 with Organized Reserve personnel as a RAI unit with headquarters at Dallas, TX. Designated mobilization training station was Fort Sam Houston, TX. Typically conducted Inactive Training Period meetings at the Jefferson Hotel or Parkland Hospital in Dallas. Conducted summer training at Fort Sam Houston, TX, with the 2nd Medical Regiment. Location 7 December 1941—Dallas, TX.

Status: Disbanded 18 October 1943.

Commanders, 13th Medical Regiment

Maj. Oscar H. Peterson**	ao Dec 28-26 Sep 32	Capt. Leslie D. Hancock**	25 Nov 36-26 Jan 37
<i>Inactive</i>	26 Sep 32-16 Jun 34	Unknown	27 Jan 37-ao Jun 39
Capt. Robert N. Graham**	16 Jun 34-20 Sep 35	Capt. Leo B. Burgin**	ao Jun 39-ao Jul 39
<i>Inactive</i>	21 Sep 35-24 Nov 36	Unknown	ao Jul 39-7 May 41

** RAI Commanders: Organized Reserve officers.

14th Medical Regiment (I Corps)

Regular Army Inactive

HQ-*Not organized* 1927-28; Boston, MA, 1928-41

Subordinate elements-Regt'l HQ (RAI) 1927-41; HQ & Svc Co 1927-41; 14th Vet Co 1929-41; HQ, Amb Bn 1929-36; 40th Amb Co 1929-36; 41st Amb Co 1929-36; 42nd Amb Co 1929-36; HQ, Hosp Bn 1929-36; 40th Hosp Co 1929-36; 41st Hosp Co 1929-36; 42nd Hosp Co 1929-36; HQ, Col Bn 1929-36; 40th Col Co 1929-36; 41st Col Co 1929-36; 42nd Col Co 1929-36

Constituted in the Regular Army 18 October 1927, allotted to the First Corps Area, and assigned to the I Corps. Affiliated with Harvard University School of Medicine R.O.T.C. and organized by April 1928 as a RAI unit with personnel from the R.O.T.C. Detachment and Reserve officers commissioned from the program. Subordinate elements constituted and assigned 26 March 1929. Conducted summer training at Carlisle Barracks, PA, with the 1st Medical Regiment. Assigned to the Third Army 24 September 1941. Redesignated 64th Medical Regiment 28 May 1941.

Status: Headquarters inactive in the Regular Army at as HHC, 64th Medical Group.

Commanders, 14th Medical Regiment

Maj. Harry G. Wyer**	1 Jun 28-27 Aug 31	Unknown	Jun 32-ao Jun 34
Maj. Ralph Duffy**	27 Aug 31-Jun 32	Capt. Alvin A. Morris	ao Jun 34-ao Jun 35
	Unknown	ao Jun 35-28 May 41	

** RAI Commanders: Organized Reserve officers.

15th Medical Regiment (V Corps)

Regular Army Inactive

HQ-Dayton, OH, 1927-41; Fort Oglethorpe, GA, 1941

Subordinate elements-Regt'l HQ (RAI) 1927-41; HQ & Svc Co 1927-41; 15th Vet Co 1929-41; HQ Amb Bn 1929-36; 43rd Amb Co 1929-36; 44th Amb Co 1929-36; 45th Amb Co 1929-36; HQ Hosp Bn 1929-36; 43rd Hosp Co 1929-36; 44th Hosp Co 1929-36; 45th Hosp Co 1929-36; HQ Col Bn 1929-36; 43rd Col Co 1929-36; 44th Col Co 1929-36; 45th Col Co 1929-36



Constituted in the Regular Army 18 October 1927, allotted to the Fifth Corps Area, and assigned to the V Corps. Organized 7 November 1927 with Organized Reserve personnel as a RAI unit with headquarters at Dayton, OH. Subordinate elements constituted and assigned 26 March 1929. Conducted summer training most years at the Camp Knox station hospital and some years at Carlisle Barracks, PA, with the 1st Medical Regiment. Designated mobilization training station was Fort Oglethorpe, GA. Assigned to the Third Army 24 September 1941. Redesignated 65th Medical Regiment 28 May 1941. Activated 1 June 1941, less Reserve personnel, at Fort Oglethorpe, GA, and assigned to the IV Corps.

Status: Headquarters inactive in the Regular Army as HHC, 65th Medical Group.

Events: 325, 328, 330

Commanders, 15th Medical Regiment

1st Lt. Robert A. Russell**	7 Nov 27-13 Jan 28	Unknown	ao Sep 32-ao Jun 34
Maj. Edwin R. Yost**	13 Jan 28-12 Oct 29	Col. Charles T. Hunt**	ao Jun 34-ao Jun 35
Lt. Col. Harvey N. Trumbull	12 Oct 29-ao Jan 30	Unknown	ao Jun 35-ao Jul 36
Unknown	ao Jan 30-ao Jul 32	Maj. Raymond H. George**	ao Jul 36-Jun 37
Maj. Edwin M. Kennedy**	ao Jul 32-ao Sep 32	Lt. Col. Hew B. McMurdo*	Jun 37-31 May 39
	Unknown	31 May 39-28 May 41	

* RAI Commanders: Regular Army officers.

** RAI Commanders: Organized Reserve officers.

16th Medical Regiment (VII Corps)

Regular Army Inactive

HQ-*Not organized* 1927-28; Kansas City, KS, 1928-39; Fort Adams, RI, 1939; Fort Devens, MA, 1939-40; Camp Joseph T. Robinson, AR, 1940-41

Subordinate elements-Regt'l HQ (RAI) 1927-41; HQ & Svc Co 1927-41; 16th Vet Co 1927-36; HQ, Amb Bn 1927-36; 46th Amb Co 1927-36; 47th Amb Co 1927-36; 48th Amb Co 1927-36; HQ, Hosp Bn 1927-36; 46th Hosp Co 1927-36; 47th Hosp Co 1927-36; 48th Hosp Co 1927-36; HQ, Col Bn 1927-36; 46th Col Co 1924-36; 47th Col Co 1927-36; 48th Col Co 1927-36



Constituted in the Regular Army 18 October 1927, allotted to the Seventh Corps Area, and assigned to the VII Corps. Organized in April 1928 with Organized Reserve personnel as a RAI unit with headquarters at Kansas City, MO. Assigned Reserve personnel were from the states of Missouri, Kansas, Arkansas, Minnesota, Iowa, North Dakota, and South Dakota. Kansas City area personnel typically conducted Inactive Training Period meetings at the 110th Engineers armory or the Medical Arts Building in Kansas City. Conducted summer training most years at the Fort Snelling station hospital and some years at Camp Joseph T. Robinson, AR. Designated mobilization training station was Fort Francis E. Warren, WY. Withdrawn from the Seventh Corps Area 16 October 1939 and allotted to the First Corps

Area. Activated 21 October 1939, less Reserve personnel, at Fort Adams, RI, and assigned to the I Corps. Transferred 25 October 1939 to Fort Devens, MA. Transferred in 1940 to Camp Joseph T. Robinson, AR. Relieved from the I Corps 16 December 1940 and assigned to the First Army. Location 7 December 1941—Fort Devens, MA.

Events: 293, 296, 301,, 330

Commanders, 16th Medical Regiment

Capt. George A. Field**	Apr 28-May 28	Unknown	Jul 30-ao Jun 37
Maj. Walter N. Mundell**	May 28-Aug 29	Maj. Lee C. Gamill**	ao Jun 37-1 Oct 39
Unknown	Aug 29-May 30	<i>Inactive</i>	1 Oct 39-21 Oct 39
Maj. Homer Davis**	May 30-Jul 30	Col. Henry P. Carter	21 Oct 39-27 Jan 41
	Lt. Col. Alexander Kelley	27 Jan 41-ao Dec 41	

** RAI Commanders: Organized Reserve officers.

17th Medical Regiment (IX Corps)

Regular Army Inactive

HQ-*Not organized* 1927-28; Los Angeles, CA, 1928-41

Subordinate elements-Regt'l HQ (RAI) 1927-41; HQ & Svc Co 1927-41; 17th Vet Co 1927-41; HQ, Amb Bn 1927-36; 49th Amb Co 1927-36; 50th Amb Co 1927-36; 51st Amb Co 1927-36; HQ, Hosp Bn 1927-36; 49th Hosp Co 1927-36; 50th Hosp Co 1927-36; 51st Hosp Co 1927-36; HQ, Col Bn 1927-36; 49th Col Co 1924-36; 50th Col Co 1927-36; 51st Col Co 1927-36



Constituted in the Regular Army 18 October 1927, allotted to the Ninth Corps Area, and assigned to the IX Corps. Organized by May 1928 with Organized Reserve personnel as a RAI unit with headquarters at Los Angeles, CA. Typically conducted Inactive Training Period meetings at the Professional Building in Los Angeles. Conducted summer training most years at Del Monte, CA, and some years at the Presidio of Monterey, CA, or Fort Lewis, WA. Redesignated as the 67th Medical Regiment 28 May 1941.

Status: Disbanded 18 October 1943.

Commanders, 17th Medical Regiment

Maj. Gou O. Shirey**	ao Apr 28-25 Jun 28	Capt. Robert E. Wyers**	ao Jan 35-8 Mar 35
Maj. Charles W. McClanahan**	25 Jun 28-Jan 30	Capt. Wymond W. Ekhart**	8 Mar 35-ao Jun 35
Unknown	ao Jan 30-ao Jun 32	Lt. Col. William P. Corry**	ao May 36-18 Jun 36
1st Lt. Charles A. Hubbard**	ao Jun 32-ao Jul 32	Maj. Joseph Saylin**	18 Jun 36-31 Mar 37
Unknown	ao Jul 32-ao Jan 35	Lt. Col. C. Zeno Holt**	31 Mar 37-ao Oct 39
	Unknown	ao Oct 39-28 May 41	

** RAI Commanders: Organized Reserve officers.

18th Medical Regiment (II Corps)

Regular Army Inactive

HQ-*Not organized* 1927-30; Rochester, NY, 1930-41

Subordinate elements-Regt'l HQ (RAI) 1927-41; HQ & Svc Co 1927-41; 18th Vet Co 1927-41; HQ, Amb Bn 1927-36; 52nd Amb Co 1927-36; 53rd Amb Co 1927-36; 54th Amb Co 1927-36; HQ, Hosp Bn 1927-36; 52nd Hosp Co 1927-36; 53rd Hosp Co 1927-36; 54th Hosp Co 1927-36; HQ, Col Bn 1927-36; 52nd Col Co 1924-36; 53rd Col Co 1927-36; 54th Col Co 1927-36



Constituted in the Regular Army 18 October 1927, allotted to the Second Corps Area, and assigned to the II Corps. Organized 9 September 1930 with Organized Reserve personnel as a RAI unit with headquarters at Rochester, NY. Assigned Reserve personnel were from the states of New York and New Jersey. Designated mobilization training station was the Syracuse Mobilization Camp. New York City elements typically conducted Inactive Training Period meetings at 641 Washington Street in New York City. Conducted summer training at Carlisle Barracks, PA, with the 1st Medical Regiment. Assigned to the Second Army 24 September 1941. Redesignated as the 68th Medical Regiment 28 May 1941.

Status: Headquarters inactive as HHC, 68th Medical Group.

Events: 324, 328

Commanders, 18th Medical Regiment

Col. Louis L. Goldblatt** 9 Jan 30-25 May 41

** RAI Commanders: Organized Reserve officers.

19th Medical Regiment (VI Corps)

Regular Army Inactive

HQ-Not organized 1927-28; Chicago, IL, 1928-41

Subordinate elements-Regt'l HQ (RAI) 1927-41; HQ & Svc Co 1927-41; 19th Vet Co 1927-41; HQ, Amb Bn 1927-36; 55th Amb Co 1927-36; 56th Amb Co 1927-36; 57th Amb Co 1927-36; HQ, Hosp Bn 1927-36; 55th Hosp Co 1927-36; 56th Hosp Co 1927-36; 57th Hosp Co 1927-36; HQ, Col Bn 1927-36; 55th Col Co 1924-36; 56th Col Co 1927-36; 57th Col Co 1927-36

Constituted in the Regular Army 18 October 1927, allotted to the Sixth Corps Area, and assigned to the VI Corps. Organized 23 March 1928 with Organized Reserve personnel as a RAI unit with headquarters at Chicago, IL. Assigned Reserve personnel were from the states of Michigan, Wisconsin, and Illinois. Conducted summer training most years at the Fort Snelling station hospital. Designated mobilization training station was Fort Oglethorpe, GA. Redesignated as the 69th Medical Regiment 28 May 1941.

Commanders, 19th Medical Regiment

Capt. Tom F. Beveridge**	23 Mar 28-11 Apr 28	Unknown	ao Oct 30-ao Jun 32
Maj. Isaac F. Clark**	11 Apr 28-15 Oct 28	Col. Henry W. Lang**	ao Jun 32-12 Oct 36
Lt. Col. W. Lee Hart*	15 Oct 28-12 Aug 30	Unknown	12 Oct 36- ao Sep 38
Maj. Isaac F. Clark**	12 Aug 30-ao Oct 30	Capt. Louis Fishman**	ao Sep 38-ao Jan 40
	Unknown	ao Jan 40-28 May 41	

** RAI Commanders: Organized Reserve officers.

20th Medical Regiment (Panama Canal Department)

Regular Army Inactive

HQ-Not organized 1935-41

Constituted in the Regular Army 12 December 1935 and allotted to the Panama Canal Department. Location 7 December 1941—*Not organized*.

Status: Disbanded 18 October 1943.

30th Medical Regiment (Fourth Army)

Regular Army Inactive

HQ-Not organized 1933-34; Butte, MT, 1934-36; *Inactive* 1936-41

Subordinate elements-Regt'l HQ (RAI) 1933-41; HQ & Svc Co 1933-41; 30th Vet Co 1933-41; HQ, Amb Bn 1933-36; 418th Amb Co 1933-36; 419th Amb Co 1933-36; 420th Amb Co 1933-36; HQ, Hosp Bn 1933-36; 418th Hosp Co 1933-36; 419th Hosp Co 1933-36; 420th Hosp Co 1933-36; HQ, Col Bn 1933-36; 418th Col Co 1924-36; 419th Col Co 1933-36; 420th Col Co 1933-36

Constituted in the Regular Army 1 October 1933, allotted to the Ninth Corps Area, and assigned to the Fourth Army. Organized by December 1934 with Organized Reserve personnel as a RAI unit with headquarters at Butte, MT. Withdrawn from the Ninth Corps Area 5 June 1936 and allotted to the Seventh Corps Area. Designated mobilization training station was Fort Francis E. Warren, WY, 1933-36. Location 7 December 1941—*Inactive*.

Status: Active in the Regular Army at Heidelberg, Germany, as HHC, 30th Medical Brigade.

Commanders, 30th Medical Regiment

Unknown	ao Dec 34-5 Jun 36	<i>Inactive</i>	5 Jun 36-7 Dec 41
---------	--------------------	-----------------	-------------------

31st Medical Regiment (First Army)

Regular Army Inactive

HQ—*Not organized* 1933-34; Boston, MA, 1934-36; Syracuse, NY, 1936-41

Subordinate elements—Regt'l HQ (RAI) 1933-41; HQ & Svc Co 1933-41; 31st Vet Co 1933-41, HQ, Amb Bn 1933-36; 421st Amb Co 1933-36; 422nd Amb Co 1933-36; 423rd Amb Co 1933-36; HQ, Hosp Bn 1933-36; 421st Hosp Co 1933-36; 422nd Hosp Co 1933-36; 423rd Hosp Co 1933-36; HQ, Col Bn 1933-36; 421st Col Co 1924-36; 422nd Col Co 1933-36; 423rd Col Co 1933-36



Constituted in the Regular Army 1 October 1933, allotted to the First Corps Area, and assigned to the First Army. Organized by September 1934 with Organized Reserve personnel as a RAI unit with headquarters at Boston, MA. Withdrawn from the First Corps Area 5 June 1936 and allotted to the Second Corps Area. Organized 16 December 1936 with Organized Reserve personnel as a RAI unit with headquarters at Syracuse, NY. Organized by transfer of personnel from the 362nd Medical Regiment. Conducted summer training most years at Carlisle Barracks, PA, with the 1st Medical Regiment. Also medically processed candidates for C.M.T.C. training at Fort Dix, NJ, for the unit's summer training in 1940. Designated mobilization training station was Fort George G. Meade, MD. Inactivated 17 September 1941 by relief of Reserve personnel. Location 7 December 1941—*Inactive*.

Status: Inactive as HHC, 31st Medical Group.

Commanders, 31st Medical Regiment

Unknown	ao Jan 34-5 Jun 36	Lt. Col. Raeburn J. Wharton**	10 Jun 37-28 Jul 37
<i>Inactive</i>	5 Jun 36-16 Dec 36	Capt. Preston W. Ports**	28 Jul 37-9 Feb 38
Capt. Milton J. Daus**	16 Dec 36-10 Jun 37	Maj. James H. Van Marter**	9 Feb 38-18 Dec 40
	Capt. Harold A. Pooler**	5 Jun 40-17 Sep 41	

** RAI Commanders: Organized Reserve officers.

31st Ambulance Battalion (Motorized)

Regular Army Inactive

HQ—*Not organized* 1933-36; Cedar Rapids, IA, 1936-41

Constituted in the Regular Army 1 October 1933, allotted to the Seventh Corps Area, and assigned to the General Headquarters Reserve. Organized 11 October 1936 with Organized Reserve personnel as a RAI unit with headquarters at Cedar Rapids, IA. Location 7 December 1941—Cedar Rapids, IA.

Commanders, 31st Ambulance Battalion (Motorized)

Unknown	11 Oct 36-7 Dec 41
---------	--------------------

32nd Medical Battalion (Ambulance) (Animal Drawn) (GHQR)

HQ-Carlisle Barracks, PA, 1940-41



Constituted in the Regular Army 1 June 1940 as the Provisional Medical Battalion and concurrently activated at Carlisle Barracks, PA, with personnel and equipment drawn from the 1st Medical Regiment. Consolidated 11 August 1941 with the 32nd Medical Battalion (Ambulance) (Animal Drawn) (constituted 2 August 1940). Assigned to the Field Medical School to support the training and education of Medical Corps officers and units of the Organized Reserve. Location 7 December 1941—Carlisle Barracks, PA.

Status: Headquarters active at Fort Sam Houston, TX, as HHC, 32nd Medical Brigade.

Events: 302

Commanders, 32nd Medical Battalion (Ambulance) (Animal Drawn)

Maj. William E. Shambora 1 Jun 40-ao Aug 41

40th Medical Battalion (Animal Drawn) (GHQR)

Regular Army Inactive

HQ-Not organized 1939-41

Constituted in the Regular Army 16 October 1939, allotted to the Third Corps Area, and assigned to the General Headquarters Reserve. Concurrently, Company A activated at Carlisle Barracks, PA. Company A transferred about November 1941 to Fort Leavenworth, KS, and assigned to the Second Army. Location 7 December 1941—Fort Leavenworth, KS, (Company A only).

101st Medical Regiment (26th Division)

Massachusetts National Guard

HQ-Inactive 1921-24; Boston, MA, 1924-41; Camp Edwards, MA, 1941

Subordinate elements-Regt'1 HQ; HQ & Svc Co 1921-41; 101st Vet Co 1921-41; 101st Med Sup Sect 1921-24; 101st Med Lab Sect 1921-24; 101st San Co 1921-24; HQ, Amb Bn 1929-36; 101st Amb Co 1921-36; 102nd Amb Co 1921-36; 103rd Amb Co 1929-36; HQ, Hosp Bn 1929-36; 101st Hosp Co 1921-36; 102nd Hosp Co 1929-36; 103rd Hosp Co 1929-36; HQ, Col Bn 1929-36; 101st Col Co 1924-36; 102nd Col Co 1929-36; 103rd Col Co 1929-36



Demobilized 29 April 1919 at Camp Devens, MA, as the 101st Sanitary Train, an element of the 26th Division. Concurrently reorganized in the Massachusetts National Guard as the 101st Sanitary Train with headquarters at Boston, MA. Demobilized 10 March 1921. Reconstituted in the National Guard in 1921 as the 101st Medical Regiment, assigned to the 26th Division, and allotted to the state of Massachusetts. Headquarters reorganized 21 March 1923 at Boston and Federally recognized 4 June 1924. Conducted annual summer training at Camp Devens, MA, 1924-35 and at the Massachusetts Military Reservation at Falmouth 1936-38. Inducted into Federal service 16 September 1941 at Boston, MA. Transferred to Camp Edwards, MA. Location 7 December 1941—Camp Edwards, MA.

Status: Elements active in the Massachusetts National Guard as Company A, 118th Medical Battalion.

Events: 190, 280, 301, 330

Commanders, 101st Medical Regiment

Col. Frank P. Williams
Col. Thomas L. Jenkins

4 Jun 24-13 May 29
13 May 29-14 Nov 30
Col. Karl R. Bailey

Col. Frank P. Williams
Col. Oscar A. Dudley
8 Jul 39-12 Feb 42

14 Nov 30-6 Jul 32
6 Jul 32-8 Jul 39

102nd Medical Regiment (27th Division)

New York National Guard

HQ-New York City, NY, 1921-40; Fort McClellan, AL, 1940-41

Subordinate elements-Regt'l HQ; HQ & Svc Co 1921-41; 102nd Vet Co 1921-41; 102nd Med Sup Sect 1921-24; 102nd Med Lab Sect 1921-24; 104th San Co 1921-24; HQ, Amb Bn 1929-36; 104th Amb Co 1921-36; 105th Amb Co 1921-36; 106th Amb Co 1929-36; HQ, Hosp Bn 1929-36; 104th Hosp Co 1921-36; 105th Hosp Co 1929-36; 106th Hosp Co 1929-36; HQ, Col Bn 1929-36; 104th Col Co 1924-36; 105th Col Co 1929-36; 106th Col Co 1929-36



Demobilized 8 April 1919 at Camp Upton, NY, as the 102nd Sanitary Train, an element of the 27th Division. Reconstituted in the National Guard 30 December 1920 as the 102nd Medical Regiment, assigned to the 27th Division, and allotted to the state of New York. Regimental headquarters organized and Federally recognized 6 June 1921 at New York City, NY. Elements were called up to perform flood relief work near Binghamton, NY, 18-20 March 1936. Conducted annual summer training most years at Camp Smith, NY, 1922-38. Inducted into Federal service 15 October 1940 at New York City, NY. Transferred 25 October 1940 to Fort McClellan, AL. Location 7 December 1941—Fort McClellan, AL.

Status: Inactive in the New York National Guard as the 102nd Medical Battalion.

Events: 190, 280, 301, 316, 324, 328

Commanders, 102nd Medical Regiment

Col. Lucius A. Salisbury 6 Jun 21-Feb 42

103rd Medical Regiment (28th Division)

Pennsylvania National Guard

HQ-Harrisburg, PA, 1921-24; Coraopolis, PA, 1924-35; Lancaster, PA, 1935-40; Indiantown Gap, PA, 1941

Subordinate elements-Regt'l HQ; HQ & Svc Co 1921-41; 103rd Vet Co 1921-41; 103rd Med Sup Sect 1921-24; 103rd Med Lab Sect 1921-24; *107th San Co 1921-24*; HQ, Amb Bn 1929-36; 107th Amb Co 1921-36; 108th Amb Co 1921-36; 109th Amb Co 1929-36; HQ, Hosp Bn 1929-36; 107th Hosp Co 1921-36; 108th Hosp Co 1929-36; 109th Hosp Co 1929-36; *HQ, Col Bn 1929-36*; 107th Col Co 1924-36; *108th Col Co 1929-36*; *109th Col Co 1929-36*

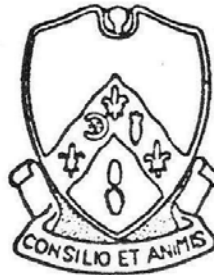

Demobilized 18 May 1919 at Camp Dix, NJ, as the 103rd Sanitary Train, an element of the 28th Division. Reconstituted in the National Guard in 1921 as the 103rd Medical Regiment, assigned to the 28th Division, and allotted to the state of Pennsylvania. Regimental headquarters organized and Federally recognized 15 December 1921 at Harrisburg, PA. Headquarters successively relocated 18 December 1924 to Coraopolis, PA, and 23 July 1935 to Lancaster, PA. Conducted annual summer training most years at Mount Gretna, PA, 1922-34 and at Indiantown Gap, PA, 1935-38. Inducted into Federal service 17 February 1941 at Lancaster, PA. Transferred 21 February 1941 to Indiantown Gap Military Reservation, PA. Location 7 December 1941—En route to Indiantown Gap, PA.

Status: Active in the Pennsylvania National Guard as the 328th Support Battalion, a component of the 28th Infantry Division.

Events: 191, 203, 281, 301, 330

Commanders, 103rd Medical Regiment

Col. Edward M. Iland 15 Dec 21-22 Jun 35 Col. Charles P. Stahr 18 Jul 35-27 Apr 41
Col. Charles S. Hendricks 27 Apr 41-7 Feb 42

104th Medical Regiment (29th Division)

Maryland and Virginia National Guard

HQ-Not organized 1921-24; Baltimore, MD, 1923-41; Fort George G. Meade, MD, 1941

Subordinate elements—Regt'l HQ; HQ & Svc Co 1921-41; *104th Vet Co* 1921-36; 104th Med Sup Sect 1921-24; 104th Med Lab Sect 1921-24; 113th San Co 1921-24; *HQ, Amb Bn* 1927-36; 110th Amb Co 1921-36; *111th Amb Co* 1921-36; 113th Amb Co 1927-36; *HQ, Hosp Bn* 1927-36; 110th Hosp Co 1921-36; *112th Hosp Co* 1927-36; 113th Hosp Co 1921-36; *HQ, Col Bn* 1927-36; *111th Col Co* 1924-36; *112th Col Co* 1927-36; 113th Col Co 1927-36



Constituted in the National Guard in 1921, assigned to the 29th Division, and allotted 20 September 1921 to the states of Maryland and Virginia. Regimental headquarters organized and Federally recognized 26 March 1923 at Baltimore, MD. Conducted annual summer training most years at Carlisle Barracks, PA, 1923-38. Inducted into Federal service 3 February 1941 at Baltimore, MD. Transferred 4 February 1941 to Fort George G. Meade, MD. Location 7 December 1941—En route to Fort George G. Meade, MD.

Events: 191, 281, 301, 330

Commanders, 104th Medical Regiment

Col. Frederick H. Vinup

26 Mar 23-1 Feb 40
Col. William H. Triplett

Col. Dwight H. Mohr
May 41-11 Mar 42

1 Feb 40-May 41

105th Medical Regiment (30th Division)

North Carolina, Georgia, and South Carolina National Guard

HQ-Not organized 1921-24; Henderson, NC, 1924-40; Fort Jackson, SC, 1940-41

Subordinate elements—Regt'l HQ; HQ & Svc Co 1921-41; 105th Vet Co 1921-41; 105th Med Sup Sect 1921-24; 105th Med Lab Sect 1921-24; 115th San Co 1921-24; HQ, Amb Bn 1927-36; 111th Amb Co 1927-36; 114th Amb Co 1921-36; 115th Amb Co 1921-36; *HQ, Hosp Bn* 1927-36; *111th Hosp Co* 1921-36; 114th Hosp Co 1921-36; 115th Hosp Co 1927-36; *HQ, Col Bn* 1927-36; *110th Col Co* 1927-36; *114th Col Co* 1927-36; 115th Col Co 1924-36



Constituted in the National Guard in 1921, assigned to the 30th Division, and allotted to the states of North Carolina, Georgia, and South Carolina. Regimental Headquarters, and Headquarters and Service Company were allotted to the state of North Carolina; the Sanitary (later redesignated "Collecting") Battalion was allotted to the state of Tennessee; the Hospital Battalion was allotted to the state of Georgia; and the Ambulance Battalion was allotted to the state of South Carolina. Headquarters organized and Federally recognized 10 September 1924 at Henderson, NC. Regiment consolidated 8 June 1926 with the 105th Sanitary Train (a WWI unit organized in October 1917 at Camp Sevier, SC; demobilized in April 1919 at Camp Jackson, SC; reconstituted 8 June 1926). Conducted annual summer training most years at Camp Jackson and some years at Camp

McClellan, AL, or Fort Bragg, NC. Inducted into Federal service 16 September 1940 at Henderson, NC. Transferred 21 September 1940 to Fort Jackson, SC. Location 7 December 1941—Fort Jackson, SC.

Status: Inactive in the Tennessee National Guard as the 230th Medical Battalion.

Events: 255, 300, 316, 330

Commanders, 105th Medical Regiment

Col. Hodge A. Newell (NC)

10 Jan 24-Feb 42

106th Medical Regiment (31st Division)**Louisiana, Alabama, and Florida National Guard**

HQ-*Not organized* 1921-36; New Orleans, LA, 1936-40; Camp Blanding, FL, 1940-41

Subordinate elements-Regt'l HQ; HQ & Svc Co 1921-41; 106th Vet Co 1923-41; *106th Med Sup Sect* 1923-24; *106th Med Lab Sect* 1923-24; *106th San Co* 1923-24; *HQ, Amb Bn* 1927-36; 116th Amb Co 1923-36; *117th Amb Co* 1923-36; 118th Amb Co 1927-36; *HQ, Hosp Bn* 1927-36; 116th Hosp Co 1923-36; *117th Hosp Co* 1927-36; *118th Hosp Co* 1927-36; *HQ, Col Bn* 1927-36; *116th Col Co* 1924-36; *117th Col Co* 1927-36; *118th Col Co* 1927-36



Constituted in the National Guard 2 July 1923, assigned to the 31st Division, and allotted to the states of Louisiana, Alabama, and Florida. Regimental headquarters, Headquarters and Service Company, and the Sanitary (later redesignated "Collecting") Battalion were allotted to the state of Louisiana; the Hospital Battalion was allotted to the state of Florida; and the Ambulance Battalion and Veterinary Company were allotted to the state of Alabama. Several subordinate elements organized 1 July 1923 from active units of the 114th Medical Regiment. Louisiana elements called up for flood duty at communities flooded by the Mississippi River 26 Apr-19 June 1927. Alabama elements called up for flood relief duty at Samson, AL, in 1929. Regimental headquarters organized and Federally recognized 28 July 1936 at New Orleans, LA. Regimental units typically conducted annual summer training at Camp McClellan, AL, or Fort Oglethorpe, GA, for Alabama elements; Camp Beauregard, LA, for Louisiana elements; and Camp J. Clifford R. Foster, FL, for Florida elements. Assembled as a complete unit for the first time at the 1937 summer training at Camp Foster, FL. Conducted War Department directed extra winter training at Camp Beauregard in December 1939. Inducted into Federal service 25 November 1940 at New Orleans, LA. Transferred 22 December 1940 to Camp Blanding, FL. Location 7 December 1941—Camp Blanding, FL.

Events: 255, 300, 325, 328, 330

Commanders, 106th Medical Regiment

Col. Anees Mogabgab (LA) 28 Jul 36-ao Jan 41

107th Medical Regiment (32nd Division)**Michigan National Guard**

HQ-*Not organized* 1921-23; Detroit, MI, 1923-40; Camp Beauregard, LA, 1940-41; Camp Livingston, LA, 1941

Subordinate elements-Regt'l HQ; HQ & Svc Co 1921-41; 107th Vet Co 1921-41; 107th Med Sup Sect 1921-24; 107th Med Lab Sect 1921-24; *107th San Co* 1925-24; *HQ, Amb Bn* 1927-36; 119th Amb Co (Mtzd) 1921-36; 120th Amb Co (AD) 1921-36; 121st Amb Co (Mtzd) 1927-36; *HQ, Hosp Bn* 1927-36; 119th Hosp Co 1921-36; *120th Hosp Co* 1927-36; *121st Hosp Co* 1927-36; *HQ, Col Bn* 1927-36; 119th Col Co 1924-36; *120th Col Co* 1927-36; *121st Col Co* 1927-36



Constituted in the National Guard in 1921 as the 107th Medical Regiment, assigned to the 32nd Division, and allotted to the state of Michigan. Regimental headquarters organized and Federally recognized 20 April 1923 at Detroit, MI. Companies D and E called up to support units on riot control duty at the auto workers strike at Flint, MI, 13 January-16 February 1937. Conducted annual summer training most years at Camp Grayling, MI, 1923-39. Conducted joint summer training at Camp Grayling with the 310th Medical Regiment in 1928. For at least one year, in 1937, the regiment also trained several company-grade medical officers of the 85th Division at Camp Grayling. Inducted into Federal service 15 October 1940 at Detroit, MI. Transferred 21 October 1940 to Camp Beauregard, LA. Transferred 15 February 1941 to Camp Livingston, LA. Location 7 December 1941—Camp Livingston, LA.

Status: Active in the Michigan National Guard as the 207th Evacuation Hospital.

Events: 214, 302, 320, 328

Commanders, 107th Medical Regiment

Col. John D. Buck 20 Apr 23-Feb 42

108th Medical Regiment (33rd Division)

Illinois National Guard

HQ-Inactive 1921-24; Chicago, IL, 1924-41; Camp Forrest, TN, 1941

Subordinate elements-Regt'l HQ; HQ & Svc Co 1921-41; *108th Vet Co* 1921-41; 108th Med Sup Sect 1921-24; 108th Med Lab Sect 1921-24; *108th San Co* 1925-24; *HQ, Amb Bn* 1927-36; 122nd Amb Co (AD) 1921-36; 123rd Amb Co (Mtzd) 1921-36; *124th Amb Co (Mtzd)* 1927-36; *HQ, Hosp Bn* 1927-36; 122nd Hosp Co 1921-36; *123rd Hosp Co* 1927-36; *124th Hosp Co* 1927-36; *HQ, Col Bn* 1927-36; 122nd Col Co 1924-36; *123rd Col Co* 1927-36; *124th Col Co* 1927-36



Demobilized 8 June 1919 at Camp Grant, IL, as the 108th Sanitary Train, an element of the 33rd Division. Reconstituted in the National Guard in 1921 as the 108th Medical Regiment, assigned to the 33rd Division, and allotted to the state of Illinois. Regimental headquarters organized and Federally recognized 10 July 1924 at Chicago, IL. 122nd and 123rd Ambulance Companies and 122nd Hospital Company called up to perform tornado relief duty at Carbondale, IL, 19-28 March 1925. Conducted annual summer training most years at Camp Grant, IL, 1924-39. For at least one year, in 1937, the regiment also trained some 13 company-grade medical officers of the 86th Division at Camp Grant. Inducted into Federal service 5 March 1941 at Detroit, MI. Transferred 12 March 1941 to Camp Forrest, TN. Location 7 December 1941—Camp Forrest, TN.

Events: 214, 302, 316, 324, 328

Commanders, 108th Medical Regiment

Col. Harry D. Orr

10 Jul 24-1 Feb 26
Col. Philip M. Bedessem

Col. James J. McKinley
7 Oct 41-18 Feb 42

28 Jun 26-7 Oct 41

109th Medical Regiment (34th Division)

Minnesota and North Dakota National Guard

HQ-Not organized 1921-27

Subordinate elements-Regt'l HQ; HQ & Svc Co 1921-27; *109th Vet Co* 1921-27; *109th Med Sup Sect* 1925-24; *109th Med Lab Sect* 1925-24; *109th San Co* 1925-24; *HQ, Amb Bn* 1921-27; *125th Amb Co* 1921-27; *126th Amb Co* 1921-27; *127th Amb Co* 1921-27; *HQ, Hosp Bn* 1921-27 *125th Hosp Co* 1921-27; *125th Hosp Co* 1921-27; *127th Hosp Co* 1921-27; *HQ, Col Bn* 1924-27; *125th Col Co* 1924-27; *126th Col Co* 1924-27; *127th Col Co* 1924-27

Constituted in the National Guard in 1921, assigned to the 34th Division, and allotted to the states of Minnesota and North Dakota. Regiment, less the 125th Ambulance Company and the 126th Hospital Company, allotted to the state of Minnesota; the 125th Ambulance Company and the 126th Hospital Company allotted to the state of North Dakota. Relieved from assignment to the 34th Division in February 1927 and assigned to the VII Corps. Concurrently, North Dakota elements withdrawn and allotted to the state of Minnesota. Withdrawn from the National Guard 17 September 1927.

110th Medical Regiment (35th Division)

Nebraska National Guard

HQ-Lincoln, NE, 1924-40; Camp Joseph T. Robinson, AR, 1940-41

Subordinate elements-Regt'l HQ; HQ & Svc Co 1921-41; *110th Vet Co* 1921-41; *110th Med Sup Sect* 1925-24; *110th Med Lab Sect* 1925-24; *130th San Co* 1925-24; *HQ, Amb Bn* 1927-36; *128th Amb Co* 1921-36; *129th Amb Co* 1927-36; *130th Amb Co* 1921-36; *HQ, Hosp Bn* 1927-36; *128th Hosp Co* 1921-36; *129th Hosp Co* 1927-36; *130th Hosp Co* 1921-27; *166th Hosp Co* 1927-36; *HQ, Col Bn* 1927-36; *128th Col Co* 1924-36; *129th Col Co* 1927-36; *130th Col Co* 1927-36



Demobilized 8 May 1919 at Camp Funston, KS, as the 110th Sanitary Train, an element of the 35th Division. Constituted in the National Guard in 1921 as the 110th Medical Regiment, assigned to the 35th Division, and allotted to the state of Nebraska. Regimental headquarters organized and Federally recognized 29 June 1923 at Lincoln, NE. Conducted annual summer training most years at Ashland, NE, 1924-40. For at least two years, in 1938 and 1940, the regiment also trained some 12 company-grade officers of the 89th Division at Ashland. Inducted into Federal service 23 December 1940 at Lincoln, NE. Transferred 29 December 1940 to Camp Joseph T. Arkansas, AR. Location 7 December 1941—Camp Joseph T. Robinson, AR.

Status: Active in the Nebraska National Guard at Lincoln, NE, as the 110th Medical Battalion.

Events: 236, 303, 316, 324, 328

Commanders, 110th Medical Regiment

Col. H. Winnett Orr
Col. David C. Hilton

23 Jun 22-Apr 25 Col. Philip H. Bartholomew
11 May 25-8 Sep 40 Lt. Col. Hans Schaerrer

9 Sep 40-5 Dec 41
5 Dec 41-Feb 42

111th Medical Regiment (36th Division)

Texas National Guard

HQ-Fort Worth, TX, 1925-40; Camp Bowie, TX, 1940-41

Subordinate elements-Regt'l HQ; HQ & Svc Co 1921-41; *111th Vet Co* 1921-41; *111th Med Sup Sect* 1925-24; *111th Med Lab Sect* 1925-24; *131st San Co* 1925-24; *HQ, Amb Bn* 1927-36; 131st Amb Co 1921-36; 132nd Amb Co 1921-36; *133rd Amb Co* 1921-36; *HQ, Hosp Bn* 1927-36; *131st Hosp Co* 1921-36; *132nd Hosp Co* 1921-36; *133rd Hosp Co* 1921-36; *HQ, Col Bn* 1927-36; 131st Col Co 1924-36; *132nd Col Co* 1927-36; *133rd Col Co* 1927-36



Demobilized at 19 June 1919 Camp Bowie, TX, as the 111th Sanitary Train, an element of the 36th Division. Reconstituted in the National Guard in 1921 as the 111th Medical Regiment, assigned to the 36th Division, and allotted to the state of Texas. Regimental headquarters organized and Federally recognized 23 July 1925 at Fort Worth, TX. Elements called up to perform martial law duties in the East Texas Oilfields at Kilgore, TX, 17 August-8 September 1931. Conducted annual summer training most years at Camp Hulen, TX, and some years at Camp Mabry, TX, or Fort Crockett, TX. For at least one year, in 1933, the regiment also trained 13 company-grade medical officers of the 90th Division at Camp Hulen. Inducted into Federal service 25 November 1940 at Fort Worth, TX. Transferred 14 December 1940 to Camp Bowie, TX. Location 7 December 1941—Camp Bowie, TX.

Status: Inactive in the Texas National Guard as the 111th Support Battalion.

Events: 258, 300, 317, 328

Commanders, 111th Medical Regiment

Col. John J. O'Reilly

23 Jul 25-Feb 42

112th Medical Regiment (37th Division)

Ohio National Guard

HQ-Columbus, OH, 1922-40; Camp Shelby, MS, 1940-41

Subordinate elements-Regt'l HQ; HQ & Svc Co 1921-41; 112th Vet Co 1921-41; *112th Med Sup Sect* 1925-24; *112th Med Lab Sect* 1925-24; *134th San Co* 1925-24; *HQ, Amb Bn* 1927-36; 134th Amb Co 1921-36; 135th Amb Co 1921-36; 136th Amb Co 1927-36; *HQ, Hosp Bn* 1927-36; 134th Hosp Co 1921-36; 135th Hosp Co 1921-36; 136th Hosp Co 1927-36; *HQ, Col Bn* 1927-36; 135th Col Co 1924-36; 135th Col Co 1927-36; *136th Col Co* 1927-36



Demobilized 12 April 1919 at Camp Perry, OH, as the 112th Sanitary Train, an element of the 37th Division. Reconstituted in the National Guard in 1921 as the 112th Medical Regiment, assigned to the 37th Division, and allotted to the state of Ohio. Regimental headquarters organized and Federally recognized 25 April 1921 at Columbus, OH. The regiment, or elements thereof, called up to perform the following state duties: tornado relief duty at Lorain and Sandusky, OH, 28 June-10 July 1924; relief duties in connection with the Ohio State Penitentiary riot and fire 21 April-4 May 1930; relief duties for the Ohio River Flood during January-February 1937; two ambulance companies provided relief after an explosion at the Willow Grove Mine in Belmont County 16 March 1940. Conducted annual summer training most years at Camp Perry, OH, 1921-

39. Inducted into Federal service 15 October 1940 at Cleveland, OH. Transferred 20 October 1940 to Camp Shelby, MS. Location 7 December 1941—Camp Shelby, MS.

Status: Headquarters inactive in the Ohio National Guard as HHC, 112th Medical Brigade.

Events: 213, 220, 302, 320, 328

Commanders, 112th Medical Regiment

Col. Harry H. Snively

25 Apr 21-Jul 31

Col. Harry D. Jackson

3 Aug 31-Feb 42

113th Medical Regiment (38th Division)

Indiana and Kentucky National Guard

HQ-*Not organized* 1921-23; Indianapolis, IN, 1923-41; Camp Shelby, MS, 1941

Subordinate elements-*Regt'l HQ; HQ & Svc Co* 1921-41; *113th Vet Co* 1921-41; *113th Med Sup Sect* 1925-24; *113th Med Lab Sect* 1925-24; *137th San Co* 1925-24; *HQ, Amb Bn* 1927-36; *137th Amb Co* 1921-36; *138th Amb Co* 1921-36; *139th Amb Co* 1927-36; *HQ, Hosp Bn* 1927-36; *137th Hosp Co* 1921-36; *138th Hosp Co* 1921-36; *139th Hosp Co* 1927-36; *HQ, Col Bn* 1927-36; *137th Col Co* 1924-36; *138th Col Co* 1927-36; *139th Col Co* 1927-36



Demobilized in February 1919 at Camp Zachary Taylor, KY, as the 113th Sanitary Train, an element of the 38th Division. Reconstituted in the National Guard 14 February 1921, assigned to the 38th Division, and allotted to the states of Indiana and Kentucky. Regimental headquarters, Sanitary (later redesignated "Collecting") Battalion, and Ambulance Battalion were allotted to the state of Indiana and the Hospital Battalion was allotted to the state of Kentucky. Regimental headquarters organized and Federally recognized 16 February 1923 at Indianapolis, IN. The regiment, or elements thereof, called up to perform the following state duties: riot control during labor troubles in Vanderburg and Warwick Counties 22 February-23 March 1926; relief duty at coal miners' strike in Harlan County, KY, 6 May-30 June 1931; riot control during a coal miners' strike at the Dixie Bee Mine during August-October 1932; entire regiment for relief duty for the Ohio River Flood during January-February 1937. Conducted annual summer training most years at Camp Knox, KY, 1923-39. Inducted into Federal service 17 September 1941 at Camp Shelby, MS. Transferred 26 September 1941 to Camp Shelby, MS. Location 7 December 1941—Camp Shelby, MS.

Status: Active in the Indiana National Guard at Columbus, IN, as the 113th Support Battalion.

Events: 213, 220, 302, 320, 328

Commanders, 113th Medical Regiment

Col. John J. Boaz

16 Feb 23-7 Jan 40

Col. Franklin T. Hallam

7 Jan 40-Feb 42

114th Medical Regiment (39th Division)

Louisiana, Alabama, and Florida National Guard

HQ-*Not organized* 1921-23

Subordinate elements-*Regt'l HQ; HQ & Svc Co* 1921-41; *114th Vet Co* 1921-23; *114th Med Sup Sect* 1921-23; *114th Med Lab Sect* 1921-23; *140th San Co* 1921-23; *140th Amb Co* 1921-23; *141st Amb Co* 1921-23; *140th Hosp Co* 1921-23; *141st Hosp Co* 1921-23

Constituted in the National Guard in 1921, assigned to the 39th Division, and allotted to the states of Louisiana, Alabama, and Florida. Regimental headquarters and the Hospital Battalion were allotted to the state of Louisiana, the Sanitary (later redesignated “Collecting”) Battalion was allotted to the state of Florida and the Ambulance Battalion and Veterinary Company were allotted to the state of Alabama. Designated mobilization training station was Camp McClellan, AL. Organized elements absorbed into the 106th Medical Regiment 1 July 1923.

115th Medical Regiment (40th Division)

California and Utah National Guard

HQ-Not organized 1921-39; Los Angeles, CA, 1939-41; Camp San Luis Obispo, CA, 1941

Subordinate elements-Regt'l HQ; *HQ & Svc Co* 1921-41; *115th Vet Co* 1921-41; *115th Med Sup Sect* 1925-24; *115th Med Lab Sect* 1925-24; *143rd San Co* 1925-24; *HQ, Amb Bn* 1927-36; *143rd Amb Co* 1921-36; *144th Amb Co* 1921-36; *145th Amb Co* 1927-36; *HQ, Hosp Bn* 1927-36; *143rd Hosp Co* 1921-36; *144th Hosp Co* 1921-36; *145th Hosp Co* 1927-36; *HQ, Col Bn* 1927-36; *143rd Col Co* 1924-36; *144th Col Co* 1927-36; *145th Col Co* 1927-36



Constituted in the National Guard in 1921, assigned to the 40th Division, and allotted to the states of California and Utah. Sanitary (later redesignated “Collecting”) Battalion, and Ambulance Battalion were allotted to the state of California and the Hospital Battalion was allotted to the state of Utah. Regimental headquarters organized and Federally recognized 13 September 1939 at Los Angeles, CA. Active elements conducted annual summer training as follows: at Del Monte, CA, for California units and at Camp W. G. Williams, UT, for Utah units. Entire regiment conducted annual summer training at Camp San Luis Obispo, CA, in 1939 and 1940. Inducted into Federal service 3 March 1941 at Los Angeles, CA. Transferred 10 March 1941 to Camp San Luis Obispo, CA. Location 7 December 1941—Camp San Luis Obispo, CA.

Status: Active in the California National Guard as elements of the 40th and 540th Support Battalions.

Events: 231, 304, 314, 326

Commanders, 115th Medical Regiment

Lt. Col. Edwin R. Butterfield	13 Sep 39-Jan 40	Col. Sam R. Downing	Jan 40-Feb 41
	Col. Daniel B. Mac Callum	4 Feb 41-Feb 42	

116th Medical Regiment (41st Division)

Washington, Oregon, and Montana National Guard

HQ-Not organized 1921-37; Seattle, WA, 1937-40; Camp Murray, WA, 1940-41; Fort Lewis, WA, 1941

Subordinate elements-Regt'l HQ; *HQ & Svc Co* 1921-41; *116th Vet Co* 1921-41; *116th Med Sup Sect* 1925-24; *116th Med Lab Sect* 1925-24; *143rd San Co* 1925-24; *HQ, Amb Bn* 1927-36; *146th Amb Co* 1921-36; *147th Amb Co* 1921-36; *148th Amb Co* 1927-36; *HQ, Hosp Bn* 1927-36; *146th Hosp Co* 1921-26; *147th Hosp Co* 1921-36; *148th Hosp Co* 1927-36; *167th Hosp Co* 1926-36; *HQ, Col Bn* 1927-36; *146th Col Co* 1924-36; *147th Col Co* 1927-36; *148th Col Co* 1927-36



Constituted in the National Guard in 1921, assigned to the 41st Division, and allotted to the states of Washington, Oregon, and Montana. Headquarters and the Sanitary (later redesignated “Collecting”) Battalion were allotted to the state of Washington, the Hospital Battalion was allotted to the state of Oregon, and the Ambulance Battalion was allotted to the state of Montana. Regimental headquarters organized and Federally recognized 10 June 1937 at Seattle, WA. Conducted annual summer training most years at Camp Murray, WA, for Washington units and at Camp Clatsop, OR, for Oregon units. Inducted into Federal service 16 September 1940 at Seattle, WA. Transferred 20 September 1940 to Camp Murray, WA. Transferred 20 March 1941 to Fort Lewis, WA. Location 7 December 1941—Fort Lewis, WA.

Status: As HQ and Company A, 116th Medical Battalion, consolidated with HQ Company, 41st Infantry Division 1 March 1968; consolidated unit active in the Washington National Guard as Headquarters and Headquarters Company, 81st Infantry Brigade.

Events: 231, 304, 314, 326

Commanders, 116th Medical Regiment

Col. George W. Beeler

10 Jun 37-ao Jan 41

Lt. Col. Kenneth G. White

ao May 41-ao Jul 41

118th Medical Regiment (43rd Division) Connecticut, Rhode Island, and Vermont National Guard

HQ-*Not organized* 1921-23; New Haven, CT, 1923-41; Camp Blanding, FL, 1941

Subordinate elements-Regt'1 HQ; HQ & Svc Co 1921-41; 118th Vet Co 1921-41; *118th Med Sup Sect* 1925-24; *118th Med Lab Sect* 1925-24; *152nd San Co* 1925-24; HQ, Amb Bn 1927-36; 152nd Amb Co 1921-36; 153rd Amb Co 1921-36; 154th Amb Co 1927-36; *HQ, Hosp Bn* 1927-36; 152nd Hosp Co 1921-36; 153rd Hosp Co 1921-36; 154th Hosp Co 1927-36; *HQ, Col Bn* 1927-36; 152nd Col Co 1924-36; *153rd Col Co* 1927-36; *154th Col Co* 1927-36

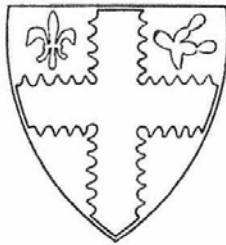

Constituted in the National Guard in 1921, assigned to the 43rd Division, and allotted to the states of Connecticut, Rhode Island, and Vermont. Regimental headquarters organized and Federally recognized 5 December 1923 at New Haven, CT. The regiment, or elements thereof, were called up to perform the following state duties: 152nd Ambulance Company to support strike duties at Manville, RI, 31 August-3 September 1926; riot control at the textile workers strike at Putnam, CT, in September 1934; flood relief at Hartford, CT, 19 March-1 April 1936; flood relief duties along the Pawtuxet River at Norwood, RI, 24-26 July 1938; Connecticut and Rhode Island elements for hurricane relief duty at Providence, Westerly, and Newport, RI, and Rockville, CT, 21-27 September 1938. Conducted annual summer training most years at

Niantic, CT. Inducted into Federal service 24 February 1941 at New Haven, CT. Transferred 13 March 1941 to Camp Blanding, FL. Location 7 December 1941—Camp Blanding, FL.

Events: 190, 280, 301, 325, 328, 330

Commanders, 118th Medical Regiment

Col. Charles W. Comfort

5 Dec 23-Feb 42

119th Medical Regiment (44th Division) New Jersey National Guard

HQ-Trenton, NJ 1922-40; Fort Dix, NJ 1940-41

Subordinate elements-Regt'1 HQ; HQ & Svc Co 1921-41; *119th Vet Co* 1921-41; *119th Med Sup Sect* 1925-24; *119th Med Lab Sect* 1925-24; *155th San Co* 1925-24; HQ, Amb Bn 1927-36; 155th Amb Co 1921-36; 156th Amb Co 1921-36; 157th Amb Co 1927-36; *HQ, Hosp Bn* 1927-36; 155th Hosp Co 1921-36; *156th Hosp Co* 1921-36; *157th Hosp Co* 1927-36; *HQ, Col Bn* 1927-36; *155th Col Co* 1924-36; *156th Col Co* 1927-36; *157th Col Co* 1927-36



Constituted in the National Guard in 1921, assigned to the 44th Division, and allotted to the state of New Jersey. Regimental headquarters organized and Federally recognized 21 April 1922 at Trenton, NJ. Conducted annual summer training most years at Sea Girt, NJ. Inducted into Federal service 16 September 1940 at Trenton, NJ. Transferred 23 September 1940 to Fort Dix, NJ. Location 7 December 1941—En route to Fort Dix, NJ.

Events: 190, 280, 301, 330

Commanders, 119th Medical Regiment

Col. John H. McCullough

21 Apr 22-Oct 35

Col. George A. Enion

8 Nov 35- ao Jul 41

120th Medical Regiment (45th Division)**Oklahoma National Guard**

HQ-*Not organized* 1921-23; Oklahoma City, OK, 1923-40; Fort Sill, OK, 1940-41; Camp Barkeley, TX, 1941

Subordinate elements-Regt'l HQ; HQ & Svc Co 1921-41; 120th Vet Co 1921-41; *120th Med Sup Sect* 1925-24; *120th Med Lab Sect* 1925-24; *158th San Co* 1925-24; *HQ, Amb Bn* 1927-36; *158th Amb Co* 1927-36; 159th Amb Co 1921-36; 160th Amb Co 1921-36; *HQ, Hosp Bn* 1927-36; *158th Hosp Co* 1927-36; 159th Hosp Co 1921-36; 160th Hosp Co 1921-36; *HQ, Col Bn* 1927-36; 158th Col Co 1924-36; *159th Col Co* 1927-36; *160th Col Co* 1927-36

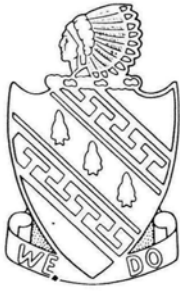

Constituted in the National Guard in 1921, assigned to the 45th Division, and allotted to the state of Oklahoma. Regimental headquarters organized and Federally recognized 23 May 1923 at Oklahoma City, OK. The regiment, or elements thereof, were called up to perform the following state duties: flood relief duty at Oklahoma City, OK, 10-15 September 1923; elements performed oil well disaster relief at Oklahoma City 30 October-1 November 1930; flood relief duty at Atoka, OK, in February 1938. Conducted annual summer training most years at Fort Sill, OK. For at least one year, in 1933, the regiment also trained 14 company-grade medical officers of the 95th Division at Fort Sill. Inducted into Federal service 16 September 1940 at Oklahoma City, OK. Transferred 23 September 1940 to Fort Sill, OK. Transferred 28 February 1941 to Camp Barkeley, TX. Location 7 December 1941—Camp San Luis Obispo, CA.

Events: 259, 300, 317, 328

Commanders, 120th Medical Regiment

Col. Floyd J. Bolend

23 May 23-23 Jul 29

Col. Rex G. Bolend

23 Jul 29-15 Feb 42

121st Medical Squadron (21st Cavalry Division)**New York National Guard**

HQ-*Not organized* 1925-40

Subordinate elements-*Sq. HQ; 121st Vet Tp* 1925-40; *121st Amb Tp* 1925-36; *121st Hosp Tp* 1925-36; *121st Col Tp* 1925-36

Constituted in the National Guard in 1925 and assigned to the 21st Cavalry Division. Allotted to the state of New York 12 October 1939, but never organized. Disbanded 1 November 1940.

122nd Medical Squadron (22nd Cavalry Division)**Wisconsin/Indiana/Pennsylvania
and Ohio National Guard**

HQ-*Not organized* 1925-40; Harrisburg, PA, 1940

Subordinate elements-*Sq. HQ; 122nd Vet Tp* 1925-40; *122nd Amb Tp* 1925-36; *122nd Hosp Tp* 1925-36; *122nd Col Tp* 1925-36

Constituted in the National Guard in 1925, assigned to the 22nd Cavalry Division, and allotted to the state of Wisconsin. Withdrawn from the state of Wisconsin in 1938 and allotted to the state of Indiana. Withdrawn from the state of Indiana 1 February 1939 and allotted to the state of Pennsylvania, less Troop A. Concurrently, Troop A allotted to the state of Ohio. Troop A organized 15 December 1939 at Bedford, OH; Troop B organized in 1940 at Philadelphia, PA; and Troop C organized in September 1940 at Fleetwood, PA. Squadron headquarters organized and Federally recognized in 1940 at Harrisburg, PA. Reorganized and redesignated (less Troop A) as the 105th Anti-Tank Battalion 23 September 1940.

Events: 302

Commanders, 122nd Medical Squadron

Lt. Col. Edgar H. Everhart

Jul 40-23 Sep 40

123rd Medical Squadron (23rd Cavalry Division)

Alabama National Guard

HQ-Not organized 1925-40

Subordinate elements-Sq. HQ; 123rd Vet Tp 1925-40; 123rd Amb Tp 1925-36; 123rd Hosp Tp 1925-36; 123rd Col Tp 1925-36



Constituted in the National Guard in 1925 and assigned to the 23rd Cavalry Division. Allotted to the state of Alabama in December 1925. The 123rd Ambulance Troop (organized at Ramer, AL, 1 April 1922 as 140th Ambulance Company; redesignated 123rd Ambulance Troop 1 February 1926) and 123rd Veterinary Troop (organized at Samson, AL, 4 September 1922 as 114th Veterinary Company; redesignated 2 July 1923 as 106th Veterinary Company; redesignated 123rd Veterinary Troop 1 February 1926; redesignated C Troop 1 August 1939) were the only elements organized. Active elements conducted annual summer training most years at Fort Oglethorpe, GA. Troop C redesignated Headquarters and Service Company, 106th Medical Regiment, and the remainder of the squadron disbanded 1 November 1940.

124th Medical Squadron (24th Cavalry Division)

Colorado National Guard

HQ-Not organized 1925-40

Subordinate elements-Sq. HQ; 124th Vet Tp 1925-40; 124th Amb Tp 1925-36; 124th Hosp Tp 1925-36; 124th Col Tp 1925-36

Constituted in the National Guard in 1925 and assigned to the 24th Cavalry Division. Allotted to the state of Colorado 28 September 1926. Designated mobilization training station was Fort Francis E. Warren, WY. Disbanded 1 November 1940.

131st Medical Regiment (I Corps)

Vermont National Guard

HQ-Not organized 1921-27

Subordinate elements-Regt'l HQ; HQ & Svc Co 1921-27; 131st Vet Co 1921-27; 131st Med Sup Sect 1921-27; 131st Med Lab Sect 1921-27; 171st San Co 1925-24; HQ, Amb Bn 1921-27 171st Amb Co 1921-27; 172nd Amb Co 1921-27; 173rd Amb Co 1921-27; HQ, Hosp Bn 1921-27 171st Hosp Co 1921-27; 172nd Hosp Co 1921-27; 173rd Hosp Co 1921-27; HQ, Col Bn 1924-27; 171st Col Co 1924-27; 172nd Col Co 1924-27; 173rd Col Co 1927

Constituted in the National Guard in 1921, assigned to the I Corps, and allotted to the states of Maine, Vermont, New Hampshire, and Rhode Island. Regimental Headquarters, Headquarters and Service Company, and the Ambulance and Hospital Battalions were allotted to the state of Maine. One hospital company was allotted to the state of New Hampshire; one ambulance company and the veterinary company were allotted to the state of Vermont; and one each ambulance and hospital companies were allotted to the state of Rhode Island. The 172nd Ambulance Company (organized at Wallingford, VT, 10 December 1921; redesignated 154th Ambulance Company 1 December 1926) was the only element organized. Placed on the deferred list 10 December 1926 and unit requirement transferred to the Organized Reserve as the 352nd Medical Regiment, a Deferred National Guard unit. Concurrently, entire regiment allotted to the Second Corps Area. Withdrawn from the National Guard 7 September 1927, permanently allotted to the Organized Reserve, and redesignated 331st Medical Regiment. Concurrently withdrawn from the Second Corps Area and allotted to the Fifth Corps Area.

Status: Headquarters and Headquarters and Service Company active in the U.S. Army Reserve as HHD, 331st Medical Group at Wichita, KS.

132nd Medical Regiment (III Corps)**Pennsylvania National Guard**

HQ-Not organized 1921-27

Subordinate elements-*Regt'l HQ; HQ & Svc Co 1921-27; 132nd Vet Co 1921-27; 132nd Med Sup Sect 1921-27; 132nd Med Lab Sect 1921-27; 174th San Co 1925-24; HQ, Amb Bn 1921-27 174th Amb Co 1921-27; 175th Amb Co 1921-27; 176th Amb Co 1921-27; HQ, Hosp Bn 1921-27 174th Hosp Co 1921-27; 175th Hosp Co 1921-27; 176th Hosp Co 1921-27; HQ, Col Bn 1924-27; 174th Col Co 1924-27; 175th Col Co 1924-27; 176th Col Co 1924-27*

Constituted in the National Guard in 1921, assigned to the III Corps, and allotted to the state of Pennsylvania. Regiment placed on the deferred list 2 July 1923 and unit requirement transferred to the Organized Reserve as the 353rd Medical Regiment. Withdrawn from the National Guard 17 September 1927.

133rd Medical Regiment (IV Corps)**Alabama, Georgia, and Louisiana National Guard**

HQ-Not organized 1921-27

Subordinate elements-*Regt'l HQ; HQ & Svc Co 1921-27; 133rd Vet Co 1921-27; 133rd Med Sup Sect 1921-27; 133rd Med Lab Sect 1921-27; 177th San Co 1925-24; HQ, Amb Bn 1921-27 177th Amb Co 1921-27; 178th Amb Co 1921-27; 179th Amb Co 1921-27; HQ, Hosp Bn 1921-27 177th Hosp Co 1921-27; 178th Hosp Co 1921-27; 179th Hosp Co 1921-27; HQ, Col Bn 1924-27; 177th Col Co 1924-27; 178th Col Co 1924-27; 179th Col Co 1924-27*

Constituted in the National Guard in 1921, assigned to the IV Corps, and allotted to the states of Alabama, Georgia, and Louisiana. The Ambulance Battalion allotted to the state of Georgia, the Hospital Battalion allotted to the state of Alabama, and the Sanitary (later redesignated "Collecting") Battalion, Service Company, and Veterinary Company allotted to the state of Louisiana. New Orleans, LA, designated as headquarters on organization, but the unit was never organized at that location. Regiment placed on the deferred list 2 July 1923 and unit requirement transferred to the Organized Reserve as the 354th Medical Regiment. Alabama elements withdrawn 10 September 1925 and allotted to the state of Louisiana. Withdrawn from the National Guard 17 September 1927.

134th Medical Regiment (I) (V Corps)**Kentucky National Guard**

HQ-Not organized 1921-27

Subordinate elements-*Regt'l HQ; HQ & Svc Co 1921-27; 134th Vet Co 1921-27; 134th Med Sup Sect 1921-27; 134th Med Lab Sect 1921-27; 180th San Co 1925-24; HQ, Amb Bn 1921-27 180th Amb Co 1921-27; 181st Amb Co 1921-27; 182nd Amb Co 1921-27; HQ, Hosp Bn 1921-27 180th Hosp Co 1921-27; 181st Hosp Co 1921-27; 182nd Hosp Co 1921-27; HQ, Col Bn 1924-27; 180th Col Co 1924-27; 181st Col Co 1924-27; 182nd Col Co 1924-27*

Constituted in the National Guard in 1921, assigned to the V Corps, and allotted to the state of Kentucky. Regiment placed on the deferred list 2 July 1923 and unit requirement transferred to the Organized Reserve as the 355th Medical Regiment. Withdrawn from the National Guard 17 September 1927.

134th Medical Regiment (Corps) (II)**New York National Guard**

HQ-Albany, NY, 1940-41; Fort Bragg, NC, 1941



Constituted in the National Guard 1 September 1940, assigned to the II Corps, and allotted to the state of New York. Headquarters and subordinate elements organized and Federally recognized 26 September 1940 at Albany, NY, from the 3rd Battalion, 102nd Medical Regiment. Assigned to the First Army 30 December 1940. Inducted into Federal service 27 September 1941 at Albany. Transferred to Fort Bragg, NC, and arrived there 10 February 1941. Further assigned to the IV Corps. Location 7 December 1941—Fort Bragg, NC.

Status: Inactive in the New York National Guard as the 134th Medical Battalion.

Events: 330

Commanders, 134th Medical Regiment

Col. Francis W. Moore

24 Sep 40-7 Aug 42

135th Medical Regiment (VI Corps)

Wisconsin National Guard

HQ-Not organized 1921-24; Milwaukee, WI, 1924-29; Madison, WI, 1929-39; Milwaukee, WI, 1939-41; Camp Shelby, MS, 1941

Subordinate elements-Regt'l HQ; HQ & Svc Co 1921-41; 135th Vet Co 1921-41; 135th Med Sup Sect 1921-24; 135th Med Lab Sect 1921-24; *183rd San Co* 1925-24; HQ, Amb Bn 1927-36; 183rd Amb Co (Mtzd) 1927-36; 184th Amb Co (Mtzd) 1921-36; 185th Amb Co (AD) 1921-36; *HQ, Hosp Bn* 1927-36; 183rd Hosp Co 1927-36; *184th Hosp Co* 1921-36; *185th Hosp Co* 1921-36; *HQ, Col Bn* 1927-36; *183rd Col Co* 1924-36; *184th Col Co* 1927-36; *185th Col Co* 1927-36



Constituted in the National Guard in 1921, assigned to the VI Corps, and allotted to the state of Wisconsin. Regimental headquarters organized and Federally recognized 1 November 1924 at Milwaukee, WI. Regiment consolidated 5 August 1927 with the 107th Sanitary Train (a WWI unit organized 13 October 1917 at Camp MacArthur, TX; demobilized 29 May 1919 at Camp Grant, IL; reconstituted 5 August 1927). Relieved from the VI Corps 18 August 1927 and assigned to the Second Army. Headquarters relocated 4 February 1929 to Madison, WI. Headquarters relocated 1 November 1939 to Milwaukee. Conducted annual summer training at Camp Douglas, WI, 1922-27 and Camp Williams, WI, 1928-39. Designated mobilization training station was Camp Douglas, WI, 1924-33 and Fort Oglethorpe, GA, 1933-40. Inducted into Federal service 15 October 1940 at Madison. Assigned to the Third Army 30 December 1940. Transferred to Camp Shelby, MS, and arrived there 13 March 1941. Location 7 December 1941—Camp Shelby, MS.

Status: Headquarters and Service Company active as Headquarters, State Area Command, Wisconsin National Guard.

Events: 214, 265, 302

Commanders, 135th Medical Regiment

Col. Gilbert E. Seaman
Col. Edgar C. Barnes
Col. William F. Lorenz

1 Nov 24-Nov 26
Nov 26-4 Feb 29

4 Feb 29-11 Oct 32

Col. William J. Bleckwenn

Col. James P. Dean

Col. William J. McKillip

Col. Victor E. Ekblad

Oct 40-Apr 44

11 Oct 32-18 Oct 39

19 Oct 39-30 Jul 40

31 Jul 40-Oct 40

136th Medical Regiment (VII Corps)

Iowa and South Dakota National Guard

HQ-Not organized 1921-36; Ames, IA, 1936-41; Camp Claiborne, LA, 1941

Subordinate elements-Regt'l HQ; *HQ & Svc Co* 1921-41; *136th Vet Co* 1921-41; *136th Med Sup Sect* 1925-24; *136th Med Lab Sect* 1925-24; *186th San Co* 1925-24; *HQ, Amb Bn* 1927-36; 186th Amb Co 1927-36; *187th Amb Co* 1921-36; *188th Amb Co* 1921-36; *HQ, Hosp Bn* 1927-36; 186th Hosp Co 1927-36; *187th Hosp Co* 1921-36; *188th Hosp Co* 1921-36; *HQ, Col Bn* 1927-36; *186th Col Co* 1924-36; *187th Col Co* 1927-36; *188th Col Co* 1927-36



Constituted in the National Guard in 1921, assigned to the VII Corps, and allotted to the states of Iowa and South Dakota. Regiment, less the 187th and 188th Hospital Companies, allotted to the state of Iowa; the 187th and 188th Hospital Companies allotted to the state of South Dakota. Relieved from assignment to the VII Corps in February 1927 and assigned to the 34th Division. Concurrently, South Dakota elements withdrawn and allotted to the state of Iowa. Regimental headquarters organized and Federally recognized 1 August 1936 at Ames, IA. Conducted annual summer training at Camp Dodge, IA. For at least two years, in 1938 and 1940, the regiment also trained 14 company-grade officers of the 88th Division at Camp Dodge. Designated mobilization training station was Fort Oglethorpe, GA. Inducted into Federal service 10 February 1941 at Ames. Transferred 20 February 1941 to Camp Claiborne, LA. Location 7 December 1941—Camp Claiborne, LA.

Ames. Transferred 20 February 1941 to Camp Claiborne, LA. Location 7 December 1941—Camp Claiborne, LA.

Status: Active at Iowa City, IA, as the 109th Medical Battalion.

Events: 233, 303, 320, 328

Commanders, 136th Medical Regiment

Col. Earl B. Bush

1 Aug 36-5 Oct 41

Lt. Col. Arthur S. Fourn

5 Oct 41-ao Dec 41

137th Medical Regiment (VIII Corps)

Colorado National Guard

HQ-*Not organized 1921-40*

Subordinate elements-*Regt'l HQ; HQ & Svc Co 1921-40; 137th Vet Co 1921-40; 137th Med Sup Sect 1925-24; 137th Med Lab Sect 1925-24; 189th San Co 1925-24; HQ, Amb Bn 1921-36; 189th Amb Co 1921-36; 190th Amb Co 1921-36; 191st Amb Co 1921-36; HQ, Hosp Bn 1921-36; 189th Hosp Co 1921-36; 190th Hosp Co 1921-36; 191st Hosp Co 1921-36; HQ, Col Bn 1924-36; 189th Col Co 1924-36; 190th Col Co 1924-36; 191st Col Co 1924-36*

Constituted in the National Guard in 1921, assigned to the VIII Corps, and allotted to the state of Colorado. Regiment placed on the deferred list 2 July 1923 and unit requirement transferred to the Organized Reserve as the 358th Medical Regiment and assigned to the XVIII Corps. Withdrawn from the Organized Reserve in February 1928 and reallocated to the Colorado National Guard as the 137th Medical Regiment. Denver, CO, designated as headquarters on organization, but the unit was never organized at that location. Relieved from the XVIII Corps by October 1932 and assigned to the VIII Corps. Designated mobilization training station was Camp Bullis, TX. Disbanded in May 1940.

138th Medical Regiment (IX Corps)

California, Oregon, and Idaho National Guard

HQ-*Not organized 1921-27*

Subordinate elements-*Regt'l HQ; HQ & Svc Co 1921-27; 138th Vet Co 1921-27; 138th Med Sup Sect 1921-27; 138th Med Lab Sect 1921-27; 192nd San Co 1925-24; HQ, Amb Bn 1921-27 192nd Amb Co 1921-27; 193rd Amb Co 1921-27; 194th Amb Co 1921-27; HQ, Hosp Bn 1921-27 192nd Hosp Co 1921-27; 193rd Hosp Co 1921-27; 194th Hosp Co 1921-27; HQ, Col Bn 1924-27; 192nd Col Co 1924-27; 193rd Col Co 1924-27; 194th Col Co 1924-27*

Constituted in the National Guard in 1921, assigned to the IX Corps, and allotted to the states of California, Oregon, and Idaho. Hospital Battalion allotted to the state of Idaho, Ambulance Battalion allotted to the state of Oregon, and remainder of the regiment allotted to the state of California. Regiment placed on the deferred list 2 July 1923 and unit requirement transferred to the Organized Reserve as the 351st Medical Regiment. Withdrawn from the National Guard 17 September 1927.

141st Medical Regiment (First Army)

New York National Guard

HQ-*Not organized 1921-27*

Subordinate elements-*Regt'l HQ; HQ & Svc Co 1921-27; 141st Vet Co 1921-27; 141st Med Sup Sect 1921-27; 141st Med Lab Sect 1921-27; 201st San Co 1925-24; 202nd San Co 1925-24; 203rd San Co 1925-24; HQ, Amb Bn 1921-27; 201st Amb Co 1921-27; 202nd Amb Co 1921-27; 203rd Amb Co 1921-27; HQ, Hosp Bn 1921-27; 201st Hosp Co 1921-27; 202nd Hosp Co 1921-27; 203rd Hosp Co 1921-27; HQ, Col Bn 1921-27; 201st Col Co 1924-27; 202nd Col Co 1924-27; 203rd Col Co 1924-27*

Constituted in the National Guard in 1921, assigned to the First Army, and allotted to the state or New York. Regiment placed on the deferred list 2 July 1923 and unit requirement transferred to the Organized Reserve as the 380th Medical Regiment. Withdrawn from the National Guard 17 September 1927.

142nd Medical Regiment (First Army)**Pennsylvania National Guard**

HQ-Not organized 1921-27

Subordinate elements-*Regt'l HQ; HQ & Svc Co 1921-27; 142nd Vet Co 1921-27; 142nd Med Sup Sect 1921-27; 142nd Med Lab Sect 1921-27; 204th San Co 1925-24; 205th San Co 1925-24; 206th San Co 1925-24; HQ, Amb Bn 1921-27; 204th Amb Co 1921-27; 205th Amb Co 1921-27; 206th Amb Co 1921-27; HQ, Hosp Bn 1921-27; 204th Hosp Co 1921-27; 205th Hosp Co 1921-27; 206th Hosp Co 1921-27; HQ, Col Bn 1921-27; 201st Col Co 1924-27; 205th Col Co 1924-27; 206th Col Co 1924-27*

Constituted in the National Guard in 1921, assigned to the First Army and allotted to the state of Pennsylvania. Regiment placed on the deferred list 2 July 1923 and unit requirement transferred to the Organized Reserve as the 381st Medical Regiment. Withdrawn from the National Guard 17 September 1927.

143rd Medical Regiment (Second Army)**West Virginia National Guard**

HQ-Not organized 1921-27

Subordinate elements-*Regt'l HQ; HQ & Svc Co 1921-27; 143rd Vet Co 1921-27; 143rd Med Sup Sect 1921-27; 143rd Med Lab Sect 1921-27; 207th San Co 1925-24; 208th San Co 1925-24; 209th San Co 1925-24; HQ, Amb Bn 1921-27; 207th Amb Co 1921-27; 208th Amb Co 1921-27; 209th Amb Co 1921-27; HQ, Hosp Bn 1921-27; 207th Hosp Co 1921-27; 208th Hosp Co 1921-27; 209th Hosp Co 1921-27; HQ, Col Bn 1921-27; 201st Col Co 1924-27; 208th Col Co 1924-27; 209th Col Co 1924-27*

Constituted in the National Guard in 1921, assigned to the Second Army, and allotted to the state of West Virginia. Regiment placed on the deferred list 2 July 1923 and unit requirement transferred to the Organized Reserve as the 382nd Medical Regiment. Withdrawn from the National Guard 17 September 1927.

144th Medical Regiment (Second Army)**Michigan National Guard**

HQ-Not organized 1921-27

Subordinate elements-*Regt'l HQ; HQ & Svc Co 1921-27; 144th Vet Co 1921-27; 144th Med Sup Sect 1921-27; 144th Med Lab Sect 1921-27; 210th San Co 1925-24; 211th San Co 1925-24; 212th San Co 1925-24; HQ, Amb Bn 1921-27; 210th Amb Co 1921-27; 211th Amb Co 1921-27; 212th Amb Co 1921-27; HQ, Hosp Bn 1921-27; 210th Hosp Co 1921-27; 211th Hosp Co 1921-27; 212th Hosp Co 1921-27; HQ, Col Bn 1921-27; 210th Col Co 1924-27; 211th Col Co 1924-27; 212th Col Co 1924-27*

Constituted in the National Guard in 1921 and assigned to the Second Army. Allotted to the state of Michigan 20 April 1921. Regiment placed on the deferred list 2 July 1923 and unit requirement transferred to the Organized Reserve as the 383rd Medical Regiment. Withdrawn from the National Guard 17 September 1927.

145th Medical Regiment (Third Army)**Arkansas and Missouri National Guard**

HQ-Not organized 1921-31

Constituted in the National Guard in 1921, assigned to the Third Army, and allotted to the states of Arkansas and Missouri. The 216th Hospital Company (organized 15 September 1922 at Hot Springs, AR) and the 216th Ambulance Company (organized 23 June 1923 at Carlisle, AR) were the only elements organized. Active elements conducted annual summer training at Camp Pike, AR. Regiment, less active companies, placed on the deferred list 2 July 1923 and unit requirement transferred to the Organized Reserve as the 384th Medical Regiment. The 216th Hospital Company and the 216th Ambulance Company were demobilized 26 June 1931. Allotment concurrently withdrawn from the National Guard and the remainder of the regiment demobilized.

151st Medical Battalion (VII Corps)**Ohio National Guard****HQ**-Akron, OH, 1940; Camp McClellan, AL, 1940-41

Constituted in the National Guard in October 1940 and allotted to the state of Ohio. Headquarters organized 17 November 1940 and Federally recognized at Akron, OH. Subordinate companies organized from F and I Companies, 112th Medical Regiment and A Troop, 122nd Medical Squadron. Assigned to the VII Corps 30 December 1940. Inducted into Federal service 6 September 1941 at Akron. Transferred to Camp McClellan, AL, and arrived there 12 September 1941. Location 7 December 1941—Camp McClellan, AL.

Events: 316, 324, 328**Commanders, 151st Medical Battalion**

Lt. Col. Horace Groom	17 Nov 40-ao Jan 42
-----------------------	---------------------

301st Medical Regiment (76th Division)**Organized Reserve Connecticut and Rhode Island****HQ**-*Not initiated* 1921-22; New Haven, CT, 1922-23; Hartford, CT, 1923-41

Subordinate elements-Regt'l HQ; HQ & Svc Co 1921-41; 301st Vet Co 1921-41; 301st Med Sup Sect 1921-24; 301st Med Lab Sect 1921-24; HQ, San Bn 1921-25; 301st San Co 1921-24; 302nd San Co 1921-24; 303rd San Co 1921-24; HQ, Amb Bn 1921-36; 301st Amb Co 1921-36; 302nd Amb Co 1921-36; 303rd Amb Co 1921-36; HQ, Hosp Bn 1921-36; 301st Hosp Co 1921-36; 302nd Hosp Co 1921-36; 303rd Hosp Co 1921-36; HQ, Col Bn 1924-36; 301st Col Co 1924-36; 302nd Col Co 1924-36; 303rd Col Co 1924-36



Constituted in the Organized Reserve 24 June 1921, assigned to the 76th Division, and allotted to the First Corps Area. Initiated in March 1922 with regimental headquarters at New Haven, CT. Subordinate battalion headquarters concurrently organized as follows: Hospital Battalion at New Haven; Sanitary Battalion at Hartford, CT; and Ambulance Battalion at Hartford, CT. Regimental headquarters relocated in December 1923 to Hartford and Sanitary (later redesignated "Collecting") Battalion concurrently relocated to Providence, RI. Consolidated 24 April 1925 with the 301st Sanitary Train (a WWI unit organized in September 1917 at Camp Devens, MA; demobilized 17 February 1919 at Camp Devens; reconstituted 24 April 1925). Typically conducted Inactive Training Period meetings at the Goffe Street Armory in

New Haven; the State Armory in Hartford; and at 216 Broadway in Providence. Conducted summer training most years with the 1st Medical Regiment at Carlisle Barracks, PA. Conducted summer training in 1927 with the 118th Medical Regiment at Niantic, CT. Location 7 December 1941—Hartford, CT.

Status: Disbanded 1 May 1959.**Commanders, 301st Medical Regiment**

Lt. Col. Frank Harndon	Nov 21-15 Jan 23	Lt. Col. LeVerne Holmes	ao Jan 38-26 Mar 38
Col. Walter S. Lay	Mar 23-Jun 34	Maj. Herbert E. Tiesing	26 Mar 38-ao Jul 39
Col. Everette C. Brennand	Jun 34-ao Jul 37	Col. Everette C. Brennand	ao May 40-Dec 41

302nd Medical Regiment (77th Division)**Organized Reserve New York****HQ**-Manhattan, NY, 1921-41

Subordinate elements-Regt'l HQ; HQ & Svc Co 1921-41; 302nd Vet Co 1921-41; 302nd Med Sup Sect 1921-24; 302nd Med Lab Sect 1921-24; HQ, San Bn 1921-25; 304th San Co 1921-24; 305th San Co 1921-24; 306th San Co 1921-24; HQ, Amb Bn 1921-36; 304th Amb Co 1921-36; 305th Amb Co 1921-36; 306th Amb Co 1921-36; HQ, Hosp Bn 1921-36; 304th Hosp Co 1921-36; 305th Hosp Co 1921-36; 306th Hosp Co 1921-36; HQ, Col Bn 1924-36; 304th Col Co 1924-36; 305th Col Co 1924-36; 306th Col Co 1924-36



Constituted in the Organized Reserve 24 June 1921, assigned to the 77th Division, and allotted to the Second Corps Area. Initiated 28 September 1921 with regimental headquarters at Manhattan, NY. Subordinate battalion headquarters concurrently organized as follows: Ambulance Battalion at Manhattan; Sanitary (later redesignated "Collecting") Battalion at Brooklyn, NY; and Hospital Battalion at Bronx, NY. Consolidated 4 September 1925 with the 302nd Sanitary Train (a WWI unit organized in September 1917 at Camp Upton, NY; demobilized in April 1919 at Camp Upton; reconstituted 4 September 1925). Regiment assisted the medical processing of over 4,000 CCC and CMTC members at Camp Dix, NJ, in the summer of 1938.

Typically conducted Inactive Training Period meetings at the Army Building, 39 Whitehall Street in New York City. Conducted summer training most years with the 1st Medical Regiment at Carlisle Barracks, PA, and some years at Camp Dix. Designated mobilization training station was Camp Dix. Location 7 December 1941—New York City, NY.

Commanders, 302nd Medical Regiment

Maj. Charles E. Clayton	28 Sep 21-11 Oct 21	Col. Jay D. Whitman	21 Dec 23-17 Feb 26
Lt. Col. J. R. LeComte	11 Oct 21-1 Mar 22	Col. Joseph C. DeVries	17 Feb 26-Dec 27
Col. Harlow Brooks	1 Mar 22-21 Dec 23	Col. Charles F. Claussen	Dec 27-15 Jun 41

303rd Medical Regiment (78th Division)

Organized Reserve New Jersey

HQ-Newark, NJ 1921-41

Subordinate elements-Regt'l HQ; HQ & Svc Co 1921-41; 303rd Vet Co 1921-41; 303rd Med Sup Sect 1921-24; 303rd Med Lab Sect 1921-24; HQ, San Bn 1921-25; 307th San Co 1921-24; 308th San Co 1921-24; 309th San Co 1921-24; HQ, Amb Bn 1921-36; 307th Amb Co 1921-36; 308th Amb Co 1921-36; 309th Amb Co 1921-36; HQ, Hosp Bn 1921-36; 307th Hosp Co 1921-36; 308th Hosp Co 1921-36; 309th Hosp Co 1921-36; HQ, Col Bn 1924-36; 307th Col Co 1924-36; 308th Col Co 1924-36; 309th Col Co 1924-36



Constituted in the Organized Reserve 24 June 1921, assigned to the 78th Division, and allotted to the Second Corps Area. Initiated 22 October 1921 with regimental headquarters at Newark, NJ. Subordinate battalion headquarters concurrently organized as follows: Sanitary (later redesignated "Collecting") Battalion at Passaic, NJ; Ambulance Battalion at Elizabeth, NJ; and Hospital Battalion at Jersey City, NJ. Consolidated 28 September 1926 with the 303rd Sanitary Train (a WWI unit organized in October 1917 at Camp Dix, NJ; demobilized in May 1919 at Camp Dix; reconstituted 28 September 1926). Conducted summer training most years with the 1st Medical Regiment at Carlisle Barracks, PA, and some years at Camp Dix.

Conducted C.M.T.C. at Camp Dix, NJ, in 1931 and 1937 as an alternate form of summer training. Designated mobilization training station was Camp Dix, NJ. Location 7 December 1941—Newark, NJ.

Commanders, 303rd Medical Regiment

Col. David A. Kraker	22 Oct 21-Jan 42
----------------------	------------------

304th Medical Regiment (79th Division)

Organized Reserve Pennsylvania

HQ-Philadelphia, PA, 1921-41

Subordinate elements-Regt'l HQ; HQ & Svc Co 1921-41; 304th Vet Co 1921-41; 304th Med Sup Sect 1921-24; 304th Med Lab Sect 1921-24; HQ, San Bn 1921-25; 310th San Co 1921-24; 311th San Co 1921-24; 312th San Co 1921-24; HQ, Amb Bn 1921-36; 310th Amb Co 1921-36; 311th Amb Co 1921-36; 312th Amb Co 1921-36; HQ, Hosp Bn 1921-36; 310th Hosp Co 1921-36; 311th Hosp Co 1921-36; 312th Hosp Co 1921-36; HQ, Col Bn 1924-36; 310th Col Co 1924-36; 311th Col Co 1924-36; 312th Col Co 1924-36



Constituted in the Organized Reserve 24 June 1921, assigned to the 79th Division, and allotted to the Third Corps Area. Initiated 12 October 1921 with the entire regiment located at Philadelphia, PA. Consolidated 24 November 1936 with the 304th Sanitary Train (a WWI unit organized in October 1917 at Camp Meade, MD; demobilized in June 1919 at Camp Dix, NJ; reconstituted 24 November 1936). Conducted summer training most years with the 1st Medical Regiment at Carlisle Barracks, PA, and some years at Camp George G. Meade, MD. Location 7 December 1941—Philadelphia, PA.

Commanders, 304th Medical Regiment

Lt. Col. John A. McKenna	12 Oct 21-25 Oct 22	Col. Walter S. Cornell	21 Nov 28-ao Oct 33
Lt. Col. Henry Pleasants, jr.	26 Oct 22-ao Jun 25	Unknown	ao Oct 33-ao Jun 35
Col. William C. Davis	ao Mar 26-Nov 28	Col. Rudolph Bloom	ao Jun 35-26 Aug 41

305th Medical Regiment (80th Division)

Organized Reserve Virginia

HQ-Richmond, VA, 1921-41

Subordinate elements-Regt'l HQ; HQ & Svc Co 1921-41; 305th Vet Co 1921-41; 305th Med Sup Sect 1921-24; 305th Med Lab Sect 1921-24; HQ, San Bn 1921-25; 313th San Co 1921-24; 314th San Co 1921-24; 315th San Co 1921-24; HQ, Amb Bn 1921-36; 313th Amb Co 1921-36; 314th Amb Co 1921-36; 315th Amb Co 1921-36; HQ, Hosp Bn 1921-36; 313th Hosp Co 1921-36; 314th Hosp Co 1921-36; 315th Hosp Co 1921-36; HQ, Col Bn 1924-36; 313th Col Co 1924-36; 314th Col Co 1924-36; 315th Col Co 1924-36

Constituted in the Organized Reserve 24 June 1921, assigned to the 80th Division, and allotted to the Third Corps Area. Initiated 26 October 1921 with regimental headquarters at Richmond, VA. Subordinate battalion headquarters concurrently organized as follows: Hospital Battalion at Richmond; Sanitary (later redesignated "Collecting") Battalion at Charlottesville, VA; and Ambulance Battalion at Roanoke, VA. Consolidated 24 November 1936 with the 305th Sanitary Train (a WWI unit organized in September 1917 at Camp Lee, VA; demobilized in June 1919 at Camp Dix, NJ; reconstituted 24 November 1936). Conducted summer training most years with the 1st Medical Regiment at Carlisle Barracks, PA, and some years at Camp George G. Meade, MD. Primary R.O.T.C. feeder school was the Medical College of Virginia. Location 7 December 1941—Richmond, VA.

Commanders, 305th Medical Regiment

Col. Wilbur M. Phelps	26 Oct 21-26 Dec 39	Lt. Col. William R. Weisiger	26 Dec 39-29 Dec 39
	Col. Charles H. Halliday	29 Dec 39-ao Aug 41	

306th Medical Regiment (81st Division)

Organized Reserve North Carolina

HQ-Raleigh, NC, 1921-41

Subordinate elements-Regt'l HQ; HQ & Svc Co 1921-41; 306th Vet Co 1921-41; 306th Med Sup Sect 1921-24; 306th Med Lab Sect 1921-24; HQ, San Bn 1921-25; 316th San Co 1921-24; 317th San Co 1921-24; 318th San Co 1921-24; HQ, Amb Bn 1921-36; 316th Amb Co 1921-36; 317th Amb Co 1921-36; 318th Amb Co 1921-36; HQ, Hosp Bn 1921-36; 316th Hosp Co 1921-36; 317th Hosp Co 1921-36; 318th Hosp Co 1921-36; HQ, Col Bn 1924-36; 316th Col Co 1924-36; 317th Col Co 1924-36; 318th Col Co 1924-36

Constituted in the Organized Reserve 24 June 1921, assigned to the 81st Division, and allotted to the Fourth Corps Area. Initiated in November 1921 with regimental headquarters at Raleigh, NC. Subordinate battalion headquarters concurrently organized as follows: Sanitary (later redesignated "Collecting") Battalion at Raleigh; Ambulance Battalion at Washington, NC; and Hospital Battalion at Goldboro, NC. Consolidated 24 November 1936 with the 306th Sanitary Train (a WWI unit organized in September 1917 at Camp Jackson, SC; demobilized in June 1919 at Camp Jackson; reconstituted 24 November 1936). Conducted summer training at various locations to include Fort Oglethorpe, GA, Fort McPherson, GA, Fort Bragg, NC, and Camp Jackson. Conducted summer training in 1936 with the 105th Medical Regiment at Camp Jackson. Attended summer camp as individuals in 1937 at Carlisle Barracks, PA. Location 7 December 1941—Raleigh, NC.

Status: Inactive in the U. S. Army Reserve as the 306th Medical Battalion, a component of the 81st Infantry Division.

Commanders, 306th Medical Regiment

Lt. Col. Percy O. Chaudron	14 Dec 21-12 Oct 22	Lt. Col. William E. Park	ao Jun 25-ao Sep 25
Lt. Col. Coit L. Sherrill	12 Oct 22-Dec 23	Unknown	ao Sep 25-ao Jul 27
Lt. Col. Abram R. Winston	Dec 23-15 Jan 24	Col. Coit L. Sherrill	ao Jul 27-9 Oct 34
Col. John W. Long	15 Jan 24-ao Apr 25	Lt. Col. James B. Bullitt	9 Oct 34-21 Mar 37
Unknown	ao Apr 25-ao Jun 25	Maj. William B. Hunter	21 Mar 37-ao May 40
	Unknown	ao May 40-7 Dec 41	

307th Medical Regiment (82nd Division)

Organized Reserve Georgia/Florida

HQ-*Not initiated* 1921-22; Macon, GA, 1922-40; Jacksonville, FL, 1940-41

Subordinate elements-Regt'l HQ; HQ & Svc Co 1921-41; 307th Vet Co 1921-41; 307th Med Sup Sect 1921-24; 307th Med Lab Sect 1921-24; HQ, San Bn 1921-25; 319th San Co 1921-24; 320th San Co 1921-24; 321st San Co 1921-24; HQ, Amb Bn 1921-36; 319th Amb Co 1921-36; 320th Amb Co 1921-36; 321st Amb Co 1921-36; HQ, Hosp Bn 1921-36; 319th Hosp Co 1921-36; 320th Hosp Co 1921-36; 321st Hosp Co 1921-36; HQ, Col Bn 1924-36; 319th Col Co 1924-36; 320th Col Co 1924-36; 321st Col Co 1924-36

Constituted in the Organized Reserve 24 June 1921, assigned to the 82nd Division, and allotted to the Fourth Corps Area. Initiated in September 1922 with regimental headquarters at Macon, GA. Subordinate battalion headquarters concurrently organized as follows: Sanitary (later redesignated "Collecting") Battalion at Marietta, GA; Hospital Battalion at Columbus, GA; and Ambulance Battalion at Sandersville, GA. Entire regiment relocated 22 October 1929 to Macon. Consolidated 24 November 1936 with the 307th Sanitary Train (a WWI unit organized 20 September 1917 at Camp Gordon, GA; demobilized 9 May 1919 at Camp Dix, NJ; reconstituted 24 November 1936). Entire regiment relocated in October 1940 to Jacksonville, FL. Conducted summer training at various locations to include Fort Moultrie, GA, Fort McPherson, GA, and Camp Jackson, SC. Conducted summer training in 1935 with the 105th Medical Regiment at Camp Jackson. Attended summer camp as individuals in 1937 at Carlisle Barracks, PA. Location 7 December 1941—Jacksonville, FL.

Status: Active at Fort Bragg, NC, as the 307th Support Battalion, a component of the 82nd Airborne Division.

Commanders, 307th Medical Regiment

Col. James E. Daniel	20 Dec 21-Nov 31	Col. Will L. Wood	12 Sep 37-ao May 40
Unknown	Nov 31-12 Sep 37	Unknown	ao May 40-7 Dec 41

308th Medical Regiment (83rd Division)

Organized Reserve Ohio

HQ-Columbus, OH, 1921-41

Subordinate elements-Regt'l HQ; HQ & Svc Co 1921-41; 308th Vet Co 1921-41; 308th Med Sup Sect 1921-24; 308th Med Lab Sect 1921-24; HQ, San Bn 1921-25; 322nd San Co 1921-24; 323rd San Co 1921-24; 324th San Co 1921-24; HQ, Amb Bn 1921-36; 322nd Amb Co 1921-36; 323rd Amb Co 1921-36; 324th Amb Co 1921-36; HQ, Hosp Bn 1921-36; 322nd Hosp Co 1921-36; 323rd Hosp Co 1921-36; 324th Hosp Co 1921-36; HQ, Col Bn 1924-36; 322nd Col Co 1924-36; 323rd Col Co 1924-36; 324th Col Co 1924-36

Constituted in the Organized Reserve 24 June 1921, assigned to the 83rd Division, and allotted to the Fifth Corps Area. Initiated 8 November 1921 with regimental headquarters at Columbus, OH. Subordinate battalion headquarters concurrently organized as follows: Sanitary (later redesignated "Collecting") Battalion at Dover, OH; Hospital Battalion at Scottsville, OH; and Ambulance Battalion at Shelby, OH. Entire regiment relocated 9 July 1931 to Columbus. Consolidated 16 October 1934 with the 308th Sanitary Train (a WWI unit organized in September 1918 at Camp Sherman, OH; demobilized in February 1919 at Camp Sherman; reconstituted 16 October 1934). Conducted summer training most years with the station hospital at Camp Knox, KY, and some years at Fort Benjamin Harrison, IN. Attended summer camp in 1936 at Carlisle Barracks, PA. Location 7 December 1941—Columbus, OH.

Commanders, 308th Medical Regiment

Col. Charles H. MacFarland	8 Nov 21-ao Jan 22	Col. Eugene F. McCampbell	ao May 26-Jun 28
Maj. Robert W. Williams	ao Jun 22-27 Apr 23	Col. Frank Harnden	Jun 28-ao Jun 35
Col. Charles H. MacFarland	27 Apr 23-ao Mar 24	Unknown	ao Jun 35-ao Jun 36
Unknown	ao Mar 24-ao May 26	Lt. Col. Nelson C. Dysart	ao Jun 36-ao Jun 37
	Unknown	ao Jun 37-7 Dec 41	

309th Medical Regiment (84th Division)**Organized Reserve Indiana****HQ**-Indianapolis, IN, 1921-41

Subordinate elements-Regt'l HQ; HQ & Svc Co 1921-41; 309th Vet Co 1921-41; 309th Med Sup Sect 1921-24; 309th Med Lab Sect 1921-24; HQ, San Bn 1921-25; 325th San Co 1921-24; 326th San Co 1921-24; 327th San Co 1921-24; HQ, Amb Bn 1921-36; 325th Amb Co 1921-36; 326th Amb Co 1921-36; 327th Amb Co 1921-36; HQ, Hosp Bn 1921-36; 325th Hosp Co 1921-36; 326th Hosp Co 1921-36; 327th Hosp Co 1921-36; HQ, Col Bn 1924-36; 325th Col Co 1924-36; 326th Col Co 1924-36; 327th Col Co 1924-36

Constituted in the Organized Reserve 24 June 1921, assigned to the 84th Division, and allotted to the Fifth Corps Area. Initiated 21 December 1921 with regimental headquarters at Indianapolis, IN. Subordinate battalion headquarters concurrently organized as follows: Sanitary (later redesignated "Collecting") Battalion at Indianapolis; Hospital Battalion at Newcastle, IN; and Ambulance Battalion at Bloomington, IN. Entire regiment relocated 9 July 1931 to Indianapolis. Consolidated 15 September 1931 with the 309th Sanitary Train (a WWI unit organized in August 1917 at Camp Zachary Taylor, KY; demobilized in September 1919 at Camp Zachary Taylor; reconstituted 15 September 1931). Conducted summer training most years with the station hospital at Camp Knox, KY, and some years at Carlisle Barracks, PA, or Fort Benjamin Harrison, IN. Location 7 December 1941—Indianapolis, IN.

Commanders, 309th Medical Regiment

Col. Larue D. Carter
Unknown
Unknown

21 Dec 21-ao Jan 31
ao Jan 31-ao Jun 34
ao Jan 40-7 Dec 41

Col. Walter U. Kennedy
Col. John S. Lambie, jr.

ao Jun 34-Apr 39
Apr 39-ao Jan 40

310th Medical Regiment (85th Division)**Organized Reserve Michigan****HQ**-Detroit, MI, 1921-41

Subordinate elements-Regt'l HQ; HQ & Svc Co 1921-41; 310th Vet Co 1921-41; 310th Med Sup Sect 1921-24; 310th Med Lab Sect 1921-24; HQ, San Bn 1921-25; 328th San Co 1921-24; 329th San Co 1921-24; 330th San Co 1921-24; HQ, Amb Bn 1921-36; 328th Amb Co 1921-36; 329th Amb Co 1921-36; 330th Amb Co 1921-36; HQ, Hosp Bn 1921-36; 328th Hosp Co 1921-36; 329th Hosp Co 1921-36; 330th Hosp Co 1921-36; HQ, Col Bn 1924-36; 328th Col Co 1924-36; 329th Col Co 1924-36; 330th Col Co 1924-36



Constituted in the Organized Reserve 24 June 1921, assigned to the 85th Division, and allotted to the Sixth Corps Area. Initiated 14 October 1921 with the entire regiment at Detroit, MI. Consolidated 7 February 1927 with the 310th Sanitary Train (a WWI unit organized in September 1918 at Camp Custer, MI; demobilized 29 April 1919 at Camp Custer; reconstituted 7 February 1927). Conducted summer training most years with the station hospitals at Fort Snelling, MN, and Camp Custer. Conducted summer training with the 107th Medical Regiment at Camp Grayling, MI, in 1928. Location 7 December 1941—Detroit, MI.

Commanders, 310th Medical Regiment

Col. Burt R. Shurly
Unknown

14 Oct 21-ao Jun 32
ao Jun 32-ao May 35

Col. John S. Lambie, jr.
Unknown

ao May 35-Apr 39
Apr 39-7 Dec 41

311th Medical Regiment (86th Division)**Organized Reserve Illinois****HQ**-*Not initiated* 1921-22; Springfield, IL, 1922-37; Chicago, IL, 1937-41

Subordinate elements-Regt'l HQ; HQ & Svc Co 1921-41; 311th Vet Co 1921-41; 311th Med Sup Sect 1921-24; 311th Med Lab Sect 1921-36; HQ, San Bn 1921-25; 331st San Co 1921-24; 332nd San Co 1921-24; 333rd San Co 1921-24; HQ, Amb Bn 1921-36; 331st Amb Co 1921-36; 332nd Amb Co 1921-36; 333rd Amb Co 1921-36; HQ, Hosp Bn 1921-36; 331st Hosp Co 1921-36; 332nd Hosp Co 1921-36; 333rd Hosp Co 1921-36; HQ, Col Bn 1924-36; 331st Col Co 1924-36; 332nd Col Co 1924-36; 333rd Col Co 1924-36



Constituted in the Organized Reserve 24 June 1921, assigned to the 86th Division, and allotted to the Sixth Corps Area. Initiated 15 February 1922 with regimental headquarters at Springfield, IL. Subordinate battalion headquarters concurrently organized as follows: Sanitary (later redesignated "Collecting") Battalion at East St. Louis, IL; Hospital Battalion at Lincoln, IL; and Ambulance Battalion at Mattoon, IL. Consolidated 30 July 1925 with the 311th Sanitary Train (a WWI unit organized 17 August 1917 at Camp Grant, IL; demobilized 17 February 1919 at Camp Grant; reconstituted 30 July 1925). Entire regiment relocated 28 July 1937 to Chicago, IL. Conducted summer training with the station hospitals at Fort Snelling, MN, and Fort Sheridan, IL, and some years at Camp Custer, MI, or Jefferson

Barracks, MO. Also medically processed candidates for C.M.T.C. training at Fort Sheridan for the unit's summer training in 1931. Location 7 December 1941—Chicago, IL.

Commanders, 311th Medical Regiment

Lt. Col. John W. H. Pollard	15 Feb 22-Jun 22	Unknown	ao Jan 31-ao Jul 31
Lt. Col. Fred S. O'Hara	Jun 22-11 Jun 24	Col. Thomas E. Cherry	ao Jul 31-5 May 36
Col. John C. Dallenbach	20 Jun 24-17 Apr 26	Col. Cleveland C. MacLane	5 May 36-ao Jan 40
Col. Harry S. Gradle	17 Apr 26-ao Jan 31	Unknown	ao Jan 40-7 Dec 41

312th Medical Regiment (87th Division)

Organized Reserve Louisiana

HQ-Not initiated 1921-22; New Orleans, LA, 1922-41

Subordinate elements-Regt'l HQ; HQ & Svc Co 1921-41; 312th Vet Co 1921-41; 312th Med Sup Sect 1921-24; 312th Med Lab Sect 1921-36; HQ, San Bn 1921-25; 334th San Co 1921-24; 335th San Co 1921-24; 336th San Co 1921-24; HQ, Amb Bn 1921-36; 334th Amb Co 1921-36; 335th Amb Co 1921-36; 336th Amb Co 1921-36; HQ, Hosp Bn 1921-36; 334th Hosp Co 1921-36; 335th Hosp Co 1921-36; 336th Hosp Co 1921-36; HQ, Col Bn 1924-36; 334th Col Co 1924-36; 335th Col Co 1924-36; 336th Col Co 1924-36

Constituted in the Organized Reserve 24 June 1921, assigned to the 87th Division, and allotted to the Fourth Corps Area. Initiated in September 1922 with the entire regiment at New Orleans, LA. Consolidated 16 December 1925 with the 312th Sanitary Train (a WWI unit organized in September 1917 at Camp Pike, AR; demobilized 8 February 1919 at Camp Dix, NJ; reconstituted 16 December 1925). Conducted summer training most years with the station hospital at Fort Oglethorpe, GA, and at Fort Sam Houston, TX, with the 2nd Medical Regiment in 1936. Attended summer camp as individuals in 1937 at Carlisle Barracks, PA. Location 7 December 1941—New Orleans, LA.

Commanders, 312th Medical Regiment

Maj. Louis H. Webb	11 Jan 22-17 Aug 22	Lt. Col. James B. Guthrie	23 Mar 28-12 Feb 29
Lt. Col. Warren P. Morrill	17 Aug 22-5 Feb 23	Col. Seale Harris	12 Feb 29-14 Sep 29
Col. John B. Elliot	5 Feb 23-3 Apr 24	Col. James B. Guthrie	14 Sep 29-Mar 32
Col. John W. Barksdale	3 Apr 24-1 Feb 26	Col. John A. Lanford	3 May 32-1 Jul 40
Col. Edmund Moss	1 Feb 26-22 Mar 28	Unknown	1 Jul 40-7 Dec 41

313th Medical Regiment (88th Division)

Organized Reserve Minnesota

HQ-Minneapolis, MN, 1921-41

Subordinate elements-Regt'l HQ; HQ & Svc Co 1921-41; 313th Vet Co 1921-41; 313th Med Sup Sect 1921-24; 313th Med Lab Sect 1921-36; HQ, San Bn 1921-25; 337th San Co 1921-24; 338th San Co 1921-24; 339th San Co 1921-24; HQ, Amb Bn 1921-36; 337th Amb Co 1921-36; 338th Amb Co 1921-36; 339th Amb Co 1921-36; HQ, Hosp Bn 1921-36; 337th Hosp Co 1921-36; 338th Hosp Co 1921-36; 339th Hosp Co 1921-36; HQ, Col Bn 1924-36; 337th Col Co 1924-36; 338th Col Co 1924-36; 339th Col Co 1924-36

Constituted in the Organized Reserve 24 June 1921, assigned to the 88th Division, and allotted to the Seventh Corps Area. Initiated 8 November 1921 with regimental headquarters at Minneapolis, MN. Subordinate battalion headquarters concurrently organized as follows: Sanitary (later redesignated "Collecting") Battalion at Mankato, MN; Hospital Battalion at St. Paul, MN; and Ambulance Battalion at Rochester, MN. Consolidated 10 February 1926 with the 313th Sanitary Train (a WWI unit organized in August 1917 at Camp Dodge, IA; demobilized in June 1919 at Camp Dodge; reconstituted 10 February 1926). Entire regiment relocated 12 October 1931 to Minneapolis. Typically conducted Inactive Training Period meetings at the station hospital at Fort Snelling. Conducted summer training most years with the station hospital at Fort Snelling and in 1940 at Camp Joseph T. Robinson, AR. Location 7 December 1941—Minneapolis, MN, (Inactivated 22 September 1942).

Commanders, 313th Medical Regiment

Col. Louis B. Baldwin	8 Nov 21-Mar 26	Col. Robert W. Brace	17 Mar 33-ao Jan 36
Col. Harold L. Lamb	Mar 26-17 Mar 33	Col. Ray R. Knight	ao Mar 36-Aug 41
	Lt. Col. Harold E. Robertson	Aug 41-Apr 42	

314th Medical Regiment (89th Division)

Organized Reserve Kansas/Nebraska

HQ-Junction City, KS, 1921-26; Kansas City, KS, 1926-29; Omaha, NE, 1929-41

Subordinate elements-Regt'l HQ; HQ & Svc Co 1921-41; 314th Vet Co 1921-41; 314th Med Sup Sect 1921-24; 314th Med Lab Sect 1921-36; HQ, San Bn 1921-25; 340th San Co 1921-24; 341st San Co 1921-24; 342nd San Co 1921-24; HQ, Amb Bn 1921-36; 340th Amb Co 1921-36; 341st Amb Co 1921-36; 342nd Amb Co 1921-36; HQ, Hosp Bn 1921-36; 340th Hosp Co 1921-36; 341st Hosp Co 1921-36; 342nd Hosp Co 1921-36; HQ, Col Bn 1924-36; 340th Col Co 1924-36; 341st Col Co 1924-36; 342nd Col Co 1924-36



Constituted in the Organized Reserve 24 June 1921, assigned to the 89th Division, and allotted to the Seventh Corps Area. Initiated 17 November 1921 with regimental headquarters at Junction City, KS. Subordinate battalion headquarters concurrently organized as follows: Ambulance Battalion at Fredonia, KS; Sanitary (later redesignated "Collecting") Battalion at Kansas City, KS; and Hospital Battalion at Wichita, KS. Regimental headquarters relocated 26 May 1926 to Kansas City. Entire regiment relocated 15 June 1929 to Omaha, NE. Consolidated 24 November 1936 with the 314th Sanitary Train (a WWI unit organized in September 1917 at Camp Funston, KS; demobilized in June 1919 at Camp Dodge; reconstituted 24 November 1936). Kansas City elements typically conducted Inactive Training Period meetings at the 110th Engineers armory or the Medical Arts Building in Kansas City. Conducted summer training most years with the station hospital at Fort Snelling, MN, and at Camp Joseph T. Robinson, AR, in 1940. Conducted C.M.T.C. at Fort Crook, NE, in 1938 as an alternate form of summer training. Location 7 December 1941—Omaha, NE.

Status: Disbanded 30 September 1959 as the 314th Medical Battalion.

Commanders, 314th Medical Regiment

Lt. Col. F. W. O' Donnell	17 Nov 21-ao Jan 22	Col. Edgar C. Duncan	ao Jul 27-12 Sep 39
Unknown	ao Jan 22-ao Jul 27	Col. Frank W. Shelton	16 Sep 39-ao Jan 40
	Unknown	ao Jan 40-7 Dec 41	

315th Medical Regiment (90th Division)

Organized Reserve Texas

HQ-San Antonio, TX, 1921-41

Subordinate elements-Regt'l HQ; HQ & Svc Co 1921-41; 315th Vet Co 1921-41; 315th Med Sup Sect 1921-24; 315th Med Lab Sect 1921-36; HQ, San Bn 1921-25; 343rd San Co 1921-24; 344th San Co 1921-24; 345th San Co 1921-24; HQ, Amb Bn 1921-36; 343rd Amb Co 1921-36; 344th Amb Co 1921-36; 345th Amb Co 1921-36; HQ, Hosp Bn 1921-36; 343rd Hosp Co 1921-36; 344th Hosp Co 1921-36; 345th Hosp Co 1921-36; HQ, Col Bn 1924-36; 343rd Col Co 1924-36; 344th Col Co 1924-36; 345th Col Co 1924-36



Constituted in the Organized Reserve 24 June 1921, assigned to the 90th Division, and allotted to the Eighth Corps Area. Initiated 21 December 1921 with regimental headquarters at San Antonio, TX. Subordinate battalion headquarters concurrently organized as follows: Sanitary (later redesignated "Collecting") Battalion at Kerrville, TX; Hospital Battalion at Dallas, TX; and Ambulance Battalion at Houston, TX. Consolidated 8 May 1925 with the 315th Sanitary Train (a WWI unit organized in October 1917 at Camp Travis, TX; demobilized in June 1919 at Camp Bowie, TX; reconstituted 8 May 1925). Typically conducted Inactive Training Period meetings at the Medical Arts Building and the Nix Professional Building in San Antonio.

Conducted summer training most years with the 2nd Medical Regiment at Fort Sam Houston, TX, and some years at Camp Bullis, TX. Location 7 December 1941—San Antonio, TX.

Status: Inactive in the U. S. Army Reserve as the 315th Medical Battalion, a component of the 90th Infantry Division.

Events: 147, 163, 216

Commanders, 315th Medical Regiment

Maj. Earl L. Parmenter	21 Dec 21-23 Jan 22	Col. Charles McC. Hendricks	23 Jan 22-Dec 41
------------------------	---------------------	-----------------------------	------------------

316th Medical Regiment (91st Division)

Organized Reserve California

HQ-*Not initiated* 1921-22; San Francisco, CA, 1922-41

Subordinate elements-Regt'l HQ; HQ & Svc Co 1921-41; 316th Vet Co 1921-41; 316th Med Sup Sect 1921-24; 316th Med Lab Sect 1921-36; HQ, San Bn 1921-25; 346th San Co 1921-24; 347th San Co 1921-24; 348th San Co 1921-24; HQ, Amb Bn 1921-36; 346th Amb Co 1921-36; 347th Amb Co 1921-36; 348th Amb Co 1921-36; HQ, Hosp Bn 1921-36; 346th Hosp Co 1921-36; 347th Hosp Co 1921-36; 348th Hosp Co 1921-36; HQ, Col Bn 1924-36; 346th Col Co 1924-36; 347th Col Co 1924-36; 348th Col Co 1924-36



Constituted in the Organized Reserve 24 June 1921, assigned to the 91st Division, and allotted to the Ninth Corps Area. Initiated 11 September 1922 with regimental headquarters at San Francisco, CA. Subordinate battalion headquarters concurrently organized as follows: Sanitary (later redesignated "Collecting") Battalion at San Francisco; Hospital Battalion at Los Angeles, CA; and Ambulance Battalion at Pasadena, CA. Consolidated 13 November 1925 with the 315th Sanitary Train (a WWI unit organized in September 1917 at Camp Lewis, WA; demobilized 9 May 1919 at Camp Lewis; reconstituted 13 November 1925). Entire regiment relocated 14 September 1929 to San Francisco, CA. Typically conducted Inactive Training Period meetings at the Merchants Exchange Building in San Francisco, or at the Latham Square Building in Oakland, CA. Conducted summer training with the station hospital at Fort Lewis, WA, the Presidio of Monterey, CA, and at Del Monte, CA. Location 7 December 1941—San Francisco, CA.

Status: Disbanded 1 May 1959 as the 316th Medical Battalion.

Commanders, 316th Medical Regiment

Lt. Col. Stanley F. Berry	11 Jan 22-Jan 23	Col. Earnest K. Johnstone	21 Apr 25-2 Mar 37
Maj. Richard J. Dowdall	Jan 23-ao Dec 23	Col. Charles E. Mordoff	2 Mar 37-7 May 40
Col. Harry X. Cline	ao Jun 24-20 Apr 25	Lt. Col. Herbert D. Crall	17 May 40-ao Jun 40
	Unknown	ao Jun 40-7 Dec 41	

319th Medical Regiment (94th Division)

Organized Reserve Massachusetts

HQ-Boston, MA, 1921-41

Subordinate elements-Regt'l HQ; HQ & Svc Co 1921-41; 319th Vet Co 1921-41; 319th Med Sup Sect 1921-24; 319th Med Lab Sect 1921-36; HQ, San Bn 1921-25; 355th San Co 1921-24; 356th San Co 1921-24; 357th San Co 1921-24; HQ, Amb Bn 1921-36; 355th Amb Co 1921-36; 356th Amb Co 1921-36; 357th Amb Co 1921-36; HQ, Hosp Bn 1921-36; 355th Hosp Co 1921-36; 356th Hosp Co 1921-36; 357th Hosp Co 1921-36; HQ, Col Bn 1924-36; 355th Col Co 1924-36; 356th Col Co 1924-36; 357th Col Co 1924-36



Constituted in the Organized Reserve 24 June 1921, assigned to the 94th Division, and allotted to the First Corps Area. Initiated 29 October 1921 with regimental headquarters at Boston, MA. Subordinate battalion headquarters concurrently organized as follows: Sanitary (later redesignated "Collecting") Battalion at Boston; Hospital Battalion at Brockton, MA; and Ambulance Battalion at Lowell, MA. Typically conducted Inactive Training Period meetings at the Boston Medical Library in Boston. Conducted summer training most years at Camp Devens, MA, and some years with the 1st Medical Regiment at Carlisle Barracks, PA. Conducted summer training in 1938 with the 101st Medical Regiment at the Massachusetts Military Reservation at Falmouth, MA. Location 7 December 1941—Boston, MA.

Commanders, 319th Medical Regiment

Col. George F. Keenan	29 Oct 21-Jan 23	Col. William J. Collins	15 Jun 24-ao Jan 40
Lt. Col. William M. Tenney	Jan 23-15 Jun 24	Unknown	ao Jan 40-7 Dec 41

320th Medical Regiment (95th Division)

Organized Reserve Oklahoma

HQ-*Not initiated* 1921-22; Okmulgee, OK, 1922-25; Oklahoma City, OK, 1925-41

Subordinate elements-Regt'l HQ; HQ & Svc Co 1921-41; 320th Vet Co 1921-41; 320th Med Sup Sect 1921-24; 320th Med Lab Sect 1921-36; HQ, San Bn 1921-25; 358th San Co 1921-24; 359th San Co 1921-24; 360th San Co 1921-24; HQ, Amb Bn 1921-36; 358th Amb Co 1921-36; 359th Amb Co 1921-36; 360th Amb Co 1921-36; HQ, Hosp Bn 1921-36; 358th Hosp Co 1921-36; 359th Hosp Co 1921-36; 360th Hosp Co 1921-36; HQ, Col Bn 1924-36; 358th Col Co 1924-36; 359th Col Co 1924-36; 360th Col Co 1924-36

Constituted in the Organized Reserve 24 June 1921, assigned to the 95th Division, and allotted to the Eighth Corps Area. Initiated 3 September 1922 with regimental headquarters at Okmulgee, OK. Subordinate battalion headquarters concurrently organized as follows: Sanitary (later redesignated "Collecting") Battalion at Ada, OK; Hospital Battalion at Tulsa, OK; and Ambulance Battalion at Muskogee, OK. Regimental headquarters relocated 10 July 1925 to Oklahoma City, OK. Conducted summer training most years with the 2nd Medical Regiment at Fort Sam Houston, TX, and some years at Fort Sill, OK, or Camp Bullis, TX. Location 7 December 1941—Oklahoma City, OK.

Commanders, 320th Medical Regiment

Lt. Col. Fred H. Clark	3 Jan 22-Jul 22	Col. Leonard S. Willour	Jul 22-4 Mar 36
	Unknown	4 Mar 36-7 Dec 41	

321st Medical Regiment (96th Division)

Organized Reserve Washington and Oregon

HQ-*Not initiated* 1921-22; Seattle, WA, 1922-41

Subordinate elements-Regt'l HQ; HQ & Svc Co 1921-41; 321st Vet Co 1921-41; 321st Med Sup Sect 1921-24; 321st Med Lab Sect 1921-24; HQ, San Bn 1921-25; 361st San Co 1921-24; 362nd San Co 1921-24; 363rd San Co 1921-24; HQ, Amb Bn 1921-36; 361st Amb Co 1921-36; 362nd Amb Co 1921-36; 363rd Amb Co 1921-36; HQ, Hosp Bn 1921-36; 361st Hosp Co 1921-36; 362nd Hosp Co 1921-36; 363rd Hosp Co 1921-36; HQ, Col Bn 1924-36; 361st Col Co 1924-36; 362nd Col Co 1924-36; 363rd Col Co 1924-36



Constituted in the Organized Reserve 24 June 1921, assigned to the 96th Division, and allotted to the Ninth Corps Area. Initiated in February 1922 with regimental headquarters at Seattle, WA. Subordinate battalion headquarters concurrently organized as follows: Sanitary (later redesignated "Collecting") Battalion at Portland, OR; Hospital Battalion at Buckley, WA; and Ambulance Battalion at Portland, OR. Conducted summer training with the 3rd Medical Regiment at Fort Lewis, WA. Location 7 December 1941—Seattle, WA.

Commanders, 321st Medical Regiment

Col. David C. Hall	27 Feb 22-17 Aug 25	Col. Conner O. Reed	ao Apr 29-19 Aug 36
Col. John G. Strohm	17 Aug 25-ao Sep 27	Col. Horace M. Francis	19 Aug 36-12 Jun 41
Unknown	ao Sep 27-ao Apr 29	Unknown	12 Jun 41-7 Dec 41

322nd Medical Regiment (97th Division) Organized Reserve New Hampshire, Maine, and Vermont

HQ-*Not initiated* 1921-22; Manchester, NH, 1922-28; Augusta, ME, 1928-41

Subordinate elements-Regt'l HQ; HQ & Svc Co 1921-41; 322nd Vet Co 1921-41; 322nd Med Sup Sect 1921-24; 322nd Med Lab Sect 1921-24; HQ, San Bn 1921-25; 364th San Co 1921-24; 365th San Co 1921-24; 366th San Co 1921-24; HQ, Amb Bn 1921-36; 364th Amb Co 1921-36; 365th Amb Co 1921-36; 366th Amb Co 1921-36; HQ, Hosp Bn 1921-36; 364th Hosp Co 1921-36; 365th Hosp Co 1921-36; 366th Hosp Co 1921-36; HQ, Col Bn 1924-36; 364th Col Co 1924-36; 365th Col Co 1924-36; 366th Col Co 1924-36



Constituted in the Organized Reserve 24 June 1921, assigned to the 97th Division, and allotted to the First Corps Area. Initiated in June 1922 with regimental headquarters at Manchester, NH. Subordinate battalion headquarters concurrently organized as follows: Sanitary (later redesignated "Collecting") Battalion at Portland, ME; Hospital Battalion at Manchester, NH; and Ambulance Battalion at Concord, NH. Headquarters relocated in 1928 to Augusta, ME. Conducted summer training with the 1st Medical Regiment at Carlisle Barracks, PA. Location 7 December 1941—Augusta, ME.

Commanders, 322nd Medical Regiment

Lt. Col. John G. Towne	Jun 22-May 25	Unknown	ao Jul 27-ao Mar 29
Col. Frank B. Foster	May 25-ao Jul 27	Col. George C. Wilkins	ao Oct 28-27 Mar 40
	Lt. Col. Forrest J. Drury	27 Mar 40-ao Jan 41	

323rd Medical Regiment (98th Division) Organized Reserve New York

HQ-Buffalo, NY, 1921-41

Subordinate elements-Regt'l HQ; HQ & Svc Co 1921-41; 323rd Vet Co 1921-41; 323rd Med Sup Sect 1921-24; 323rd Med Lab Sect 1921-24; HQ, San Bn 1921-25; 367th San Co 1921-24; 368th San Co 1921-24; 369th San Co 1921-24; HQ, Amb Bn 1921-36; 367th Amb Co 1921-36; 368th Amb Co 1921-36; 369th Amb Co 1921-36; HQ, Hosp Bn 1921-36; 367th Hosp Co 1921-36; 368th Hosp Co 1921-36; 369th Hosp Co 1921-36; HQ, Col Bn 1924-36; 367th Col Co 1924-36; 368th Col Co 1924-36; 369th Col Co 1924-36



Constituted in the Organized Reserve 24 June 1921, assigned to the 98th Division, and allotted to the Second Corps Area. Initiated 10 September 1922 with regimental headquarters at Buffalo, NY. Subordinate battalion headquarters concurrently organized as follows: Sanitary (later redesignated "Collecting") Battalion at Buffalo; Hospital Battalion at Albany, NY; and Ambulance Battalion at Syracuse, NY. Conducted summer training most years with the 1st Medical Regiment at Carlisle Barracks, PA. Conducted C.M.T.C. at Fort Niagara, NY, in 1931 and at Plattsburg Barracks, NY, in 1940 as an alternate form of summer training. Designated mobilization training station was the Syracuse Concentration Area. Primary R.O.T.C. feeder school was the University of Buffalo. Location 7 December 1941—Buffalo, NY.

Commanders, 323rd Medical Regiment

Maj. Walter D. McKenna	10 Jan 22-12 May 22	Col. Nelson G. Russell	30 Jan 34-15 Sep 36
Col. Nelson G. Russell	12 May 22-24 May 30	Col. Edward N. Wentworth	15 Sep 36-10 Nov 38
Col. Harold D. Cochrane	24 May 30-20 Jan 32	Col. Raymond G. Bell	10 Nov 38-28 Jan 41
Col. Albert Pfeiffer	20 Jan 32-30 Jan 34	Lt. Col. Frank E. Brundage	28 Jan 41-ao Dec 41

324th Medical Regiment (99th Division)**Organized Reserve Pennsylvania****HQ**-Pittsburgh, PA, 1921-41

Subordinate elements-Regt'l HQ; HQ & Svc Co 1921-41; 324th Vet Co 1921-41; 324th Med Sup Sect 1921-24; 324th Med Lab Sect 1921-24; HQ, San Bn 1921-25; 370th San Co 1921-24; 371st San Co 1921-24; 372nd San Co 1921-24; HQ, Amb Bn 1921-36; 370th Amb Co 1921-36; 371st Amb Co 1921-36; 372nd Amb Co 1921-36; HQ, Hosp Bn 1921-36; 370th Hosp Co 1921-36; 371st Hosp Co 1921-36; 372nd Hosp Co 1921-36; HQ, Col Bn 1924-36; 370th Col Co 1924-36; 371st Col Co 1924-36; 372nd Col Co 1924-36

Constituted in the Organized Reserve 24 June 1921, assigned to the 99th Division, and allotted to the Third Corps Area. Initiated 7 December 1921 with the entire regiment at Pittsburgh, PA. Conducted summer training most years with the 1st Medical Regiment at Carlisle Barracks, PA, and some years at Indiantown Gap, PA, or Fort Washington, MD. Location 7 December 1941—Pittsburgh, PA.

Commanders, 324th Medical Regiment

Col. Carey J. Vaux	7 Dec 21-27 Jul 27	Col. David O. Thomas	2 Jan 36-8 Feb 38
Lt. Col. David O. Thomas	27 Jul 27-23 Dec 27	Col. Jesse H. Swick	8 Feb 38-7 Sep 39
Col. James S. Hammers	23 Dec 27-2 Jan 36	Col. Earl B. Miller	25 Sep 39-ao Aug 41

325th Medical Regiment (100th Division)**Organized Reserve West Virginia****HQ**-Huntington, WV, 1921-31; Fairmont, WV, 1931-41

Subordinate elements-Regt'l HQ; HQ & Svc Co 1921-41; 325th Vet Co 1921-41; 325th Med Sup Sect 1921-24; 325th Med Lab Sect 1921-24; HQ, San Bn 1921-25; 373rd San Co 1921-24; 374th San Co 1921-24; 375th San Co 1921-24; HQ, Amb Bn 1921-36; 373rd Amb Co 1921-36; 374th Amb Co 1921-36; 375th Amb Co 1921-36; HQ, Hosp Bn 1921-36; 373rd Hosp Co 1921-36; 374th Hosp Co 1921-36; 375th Hosp Co 1921-36; HQ, Col Bn 1924-36; 373rd Col Co 1924-36; 374th Col Co 1924-36; 375th Col Co 1924-36

Constituted in the Organized Reserve 24 June 1921, assigned to the 100th Division, and allotted to the Fifth Corps Area. Initiated 30 November 1921 with regimental headquarters at Huntington, WV. Headquarters relocated 9 July 1931 to Fairmont, WV. Conducted summer training most years with the station hospital at Camp Knox, KY, several years at Carlisle Barracks, PA, and one year at Fort Thomas, KY. Location 7 December 1941—Fairmont, WV.

Commanders, 325th Medical Regiment

Maj. Rowley H. Powell	30 Nov 21-ao Jan 23	Col. George Fordham	ao Feb 24-Jul 37
Unknown	ao Jan 23-ao Feb 24	Lt. Col. Carson A. Willis	Jul 37-ao Sep 38
	Unknown	ao Sep 38-7 Dec 41	

326th Medical Regiment (101st Division)**Organized Reserve Wisconsin****HQ**-*Not initiated* 1921-22; Milwaukee, WI, 1922-41

Subordinate elements-Regt'l HQ; HQ & Svc Co 1921-41; 326th Vet Co 1921-41; 326th Med Sup Sect 1921-24; 326th Med Lab Sect 1921-24; HQ, San Bn 1921-25; 376th San Co 1921-24; 377th San Co 1921-24; 378th San Co 1921-24; HQ, Amb Bn 1921-36; 376th Amb Co 1921-36; 377th Amb Co 1921-36; 378th Amb Co 1921-36; HQ, Hosp Bn 1921-36; 376th Hosp Co 1921-36; 377th Hosp Co 1921-36; 378th Hosp Co 1921-36; HQ, Col Bn 1924-36; 376th Col Co 1924-36; 377th Col Co 1924-36; 378th Col Co 1924-36

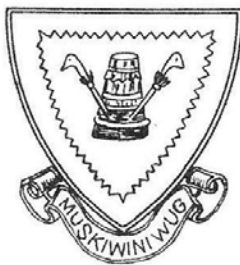

Constituted in the Organized Reserve 24 June 1921, assigned to the 101st Division, and allotted to the Sixth Corps Area. Initiated 17 October 1921 with regimental headquarters at Milwaukee, WI. Subordinate battalion headquarters concurrently organized as follows: Sanitary (later redesignated "Collecting") Battalion at Holcombe, WI; Hospital Battalion at Prairie du Chien, WI; and Ambulance Battalion at Elroy, WI. Hospital Battalion and Headquarters, Collecting Battalion relocated by 1934 to Milwaukee. Conducted summer training most years with the station hospital at Fort Snelling, MN. Location 7 December 1941—Milwaukee, WI.

Status: Active at Fort Campbell, KY, as the 326th Support Battalion, a component of the 101st Airborne Division.

Commanders, 326th Medical Regiment

Col. Gustavus I. Hogue	17 Oct 21-1 Nov 22	Unknown	ao Jul 29-ao May 30
Lt. Col. Frank F. Bowman	24 Nov 22-6 Dec 23	Lt. Col. Walter G. Darling	ao May 30-ao Jul 30
Col. George Van Ingen Brown	6 Dec 23-Aug 27	Unknown	ao Jul 30-ao May 37
Col. Carl R. Gray, Jr.	Aug 27-ao Aug 28	Col. Harvey E. Webb	ao May 37-12 Jun 37
Unknown	ao Aug 28-ao Jun 29	Unknown	13 Jun 37-12 Jul 37
Maj. Ralph T. Gilchrist	ao Jun 29-ao Jul 29	Col. William H. Braddock	13 Jul 37-ao Jan 41
	Unknown	ao Jan 41-7 Dec 41	

327th Medical Regiment (102nd Division)

Organized Reserve Missouri

HQ-St. Louis, MO, 1921-41

Subordinate elements-Regt'l HQ; HQ & Svc Co 1921-41; 327th Vet Co 1921-41; 327th Med Sup Sect 1921-24; 327th Med Lab Sect 1921-24; HQ, San Bn 1921-25; 379th San Co 1921-24; 380th San Co 1921-24; 381st San Co 1921-24; HQ, Amb Bn 1921-36; 379th Amb Co 1921-36; 380th Amb Co 1921-36; 381st Amb Co 1921-36; HQ, Hosp Bn 1921-36; 379th Hosp Co 1921-36; 380th Hosp Co 1921-36; 381st Hosp Co 1921-36; HQ, Col Bn 1924-36; 379th Col Co 1924-36; 380th Col Co 1924-36; 381st Col Co 1924-36

Constituted in the Organized Reserve 24 June 1921, assigned to the 102nd Division, and allotted to the Seventh Corps Area. Initiated 18 November 1921 with regimental headquarters at St. Louis, MO. Subordinate battalion headquarters concurrently organized as follows: Hospital Battalion at St. Louis; Sanitary (later redesignated "Collecting") Battalion at Hannibal, MO; and Ambulance Battalion at Poplar Bluff, MO. Entire regiment relocated 12 October 1931 to St. Louis. Conducted summer training most years with the station hospital at Fort Snelling, MN, and some years at Fort Riley, KS, or Camp Joseph T. Robinson, AR. Location 7 December 1941—St. Louis, MO.

Status: Inactive in the U. S. Army Reserve as the 327th Medical Battalion, a component of the 102nd Infantry Division.

Commanders, 327th Medical Regiment

Col. Hanau W. Loeb	18 Nov 21-Dec 26	Unknown	ao Jan 32-ao Jul 39
Col. Oliver H. Campbell	Dec 26-ao Jan 32	Col. Robert E. Brown	ao Jul 39-ao Aug 41

328th Medical Regiment (103rd Division)

Organized Reserve Colorado and New Mexico

HQ-*Not initiated* 1921-22; Denver, CO, 1922-41

Subordinate elements-Regt'l HQ; HQ & Svc Co 1921-41; 328th Vet Co 1921-41; 328th Med Sup Sect 1921-24; 328th Med Lab Sect 1921-24; HQ, San Bn 1921-25; 382nd San Co 1921-24; 383rd San Co 1921-24; 384th San Co 1921-24; HQ, Amb Bn 1921-36; 382nd Amb Co 1921-36; 383rd Amb Co 1921-36; 384th Amb Co 1921-36; HQ, Hosp Bn 1921-36; 382nd Hosp Co 1921-36; 383rd Hosp Co 1921-36; 384th Hosp Co 1921-36; HQ, Col Bn 1924-36; 382nd Col Co 1924-36; 383rd Col Co 1924-36; 384th Col Co 1924-36



Constituted in the Organized Reserve 24 June 1921, assigned to the 103rd Division, and allotted to the Eighth Corps Area. Initiated 9 September 1922 with regimental headquarters at Denver, CO. Subordinate battalion headquarters concurrently organized as follows: Hospital Battalion at Denver; Sanitary (later redesignated "Collecting") Battalion at Santa Fe, NM; and Ambulance Battalion at Las Vegas, NM. Regimental headquarters and Hospital Battalion typically conducted Inactive Training Period meetings at the Post Office Building in Denver. Conducted summer training at various locations to include: Fort Bliss, TX, with the 1st Medical Squadron; Fort Sam Houston, TX, or Camp Bullis, TX, with the 2nd Medical Regiment; Fitzsimmons Army Medical Center, CO; and Fort Francis E. Warren, WY. Location 7 December 1941—Denver, CO.

Events: 152, 166, 232

Commanders, 328th Medical Regiment

Lt. Col. William P. Harlow	9 Jan 22-ao Dec 22	Lt. Col. Herman L. Fowler	Dec 32-ao Sep 36
Col. Henry A. Ingalls	ao May 23-5 Mar 30	Unknown	ao Sep 36-ao Oct 41
Col. Jacob C. Epler	5 Mar 30-Dec 32	Lt. Col. R. C. Bowie	ao Oct 41-ao Dec 41

329th Medical Regiment (104th Division)

Organized Reserve Utah, Idaho, Wyoming, and Montana

HQ-Salt Lake City, UT, 1921-41

Subordinate elements-Regt'l HQ; HQ & Svc Co 1921-41; 329th Vet Co 1921-41; 329th Med Sup Sect 1921-24; 329th Med Lab Sect 1921-24; HQ, San Bn 1921-25; 385th San Co 1921-24; 386th San Co 1921-24; 387th San Co 1921-24; HQ, Amb Bn 1921-36; 385th Amb Co 1921-36; 386th Amb Co 1921-36; 387th Amb Co 1921-36; HQ, Hosp Bn 1921-36; 385th Hosp Co 1921-36; 386th Hosp Co 1921-36; 387th Hosp Co 1921-36; HQ, Col Bn 1924-36; 385th Col Co 1924-36; 386th Col Co 1924-36; 387th Col Co 1924-36

Constituted in the Organized Reserve 24 June 1921, assigned to the 104th Division, and allotted to the Ninth Corps Area. Initiated in December 1921 with regimental headquarters at Salt Lake City, UT. Subordinate battalion headquarters concurrently organized as follows: Sanitary (later redesignated "Collecting") Battalion at Boise, ID; Hospital Battalion at Helena, MT; and Ambulance Battalion at Casper, WY. Conducted summer training most years with the station hospital at Fort Lewis, WA, and some years at Fort Douglas, UT. Location 7 December 1941—Salt Lake City, UT.

Status: Disbanded 30 April 1959 as the 329th Medical Battalion.

Commanders, 329th Medical Regiment

Col. Willard Christopherson	16 Oct 22-ao Jun 34	Unknown	ao Jun 34-9 Feb 37
	Col. Howard P. Kirtley	9 Feb 37-ao Aug 41	

331st Medical Regiment (XV Corps)

Organized Reserve Indiana

HQ-*Not initiated* 1927-33; South Bend, IN, 1933-41

Subordinate elements-Regt'l HQ; HQ & Svc Co 1927-41; 331st Vet Co 1927-41; 331st Med Sup Sect 1927-24; 331st Med Lab Sect 1927-24; HQ, San Bn 1927-25; 391st San Co 1927-24; 392nd San Co 1927-24; 393rd San Co 1927-24; HQ, Amb Bn 1927-36; 391st Amb Co 1927-36; 392nd Amb Co 1927-36; 393rd Amb Co 1927-36; HQ, Hosp Bn 1927-36; 391st Hosp Co 1927-36; 392nd Hosp Co 1927-36; 393rd Hosp Co 1927-36; HQ, Col Bn 1927-36; 391st Col Co 1927-36; 392nd Col Co 1927-36; 393rd Col Co 1927-36

Constituted in the National Guard in 1921 as the 131st Medical Regiment, assigned to the I Corps, and allotted to the states of Maine, Vermont, New Hampshire, and Rhode Island. Regimental Headquarters, Headquarters and Service Company, and the Ambulance and Hospital Battalions were allotted to the state of Maine. One hospital company was allotted to the state of New Hampshire; one ambulance company was allotted to the state of Vermont; and one each ambulance and hospital companies were allotted to the state of Rhode Island. The 172nd Ambulance Company (organized at Wallingford, VT, 10 December 1921; redesignated 154th Ambulance Company 1 December 1926) was the only element organized. Placed on the deferred list 10 December 1926 and unit requirement transferred to the Organized Reserve as the 352nd Medical Regiment, a Deferred National Guard unit. Concurrently, entire regiment allotted to the Second Corps Area. Withdrawn from the National Guard 7 September 1927, permanently allotted to the Organized Reserve, and redesignated as the 331st Medical Regiment. Concurrently withdrawn from the Second Corps Area and allotted to the Fifth Corps Area. Assigned to the XV Corps 1 October 1933. Initiated in December 1933 with regimental headquarters at South Bend, IN. Conducted summer training with the station hospital at Fort Benjamin Harrison, IN. Location 7 December 1941—South Bend, IN.

Status: Headquarters and Headquarters and Service Company active in the U.S. Army Reserve as HHD, 331st Medical Group at Wichita, KS.

Commanders, 331st Medical Regiment

Unknown	Dec 33-7 Dec 41
---------	-----------------

341st Medical Regiment (XI Corps)**Organized Reserve Massachusetts**

HQ-Not initiated 1921-22; Boston, MA, 1922-41

Subordinate elements*-Regt'l HQ; HQ & Svc Co 1921-41; 341st Vet Co 1921-41; 341st Med Sup Sect 1921-24; 341st Med Lab Sect 1921-24; HQ, San Bn 1921-25; 401st San Co 1921-24; 402nd San Co 1921-24; 403rd San Co 1921-24; HQ, Amb Bn 1921-36; 401st Amb Co 1921-36; 402nd Amb Co 1921-36; 403rd Amb Co 1921-36; HQ, Hosp Bn 1921-36; 401st Hosp Co 1921-36; 402nd Hosp Co 1921-36; 403rd Hosp Co 1921-36; HQ, Col Bn 1924-36; 401st Col Co 1924-36; 402nd Col Co 1924-36; 403rd Col Co 1924-36

*Designations for ambulance, hospital, and collecting companies changed from 401st, 402nd and 403rd to 421st, 422nd and 423rd respectively on 4 Feb 26.

Constituted in the Organized Reserve 29 July 1921, assigned to the XI Corps, and allotted to the First Corps Area. Initiated 18 September 1922 with regimental headquarters at Boston, MA. Subordinate battalion headquarters concurrently organized as follows: Sanitary (later redesignated "Collecting") Battalion at Brockton, MA; Ambulance Battalion at Springfield, MA; and Hospital Battalion at Amherst, MA. Conducted summer training with the 1st Medical Regiment at Carlisle Barracks, PA. Location 7 December 1941—Boston, MA.

Status: Headquarters and Headquarters and Service Company active in the U.S. Army Reserve as HHD, 341st Medical Battalion (Evacuation) at Mesquite, TX.

Commanders, 341st Medical Regiment

Col. Walter R. Weiser	18 Jan 22-Oct 22	Col. Horace D. Arnold	Nov 22-Jul 23
Lt. Col. Frederick L. Bogan	Oct 22-Nov 22	Col. Alexander S. Begg	Jul 23-16 Sep 40
	Unknown	16 Sep 40-7 Dec 41	

342nd Medical Regiment (XII Corps)**Organized Reserve New Jersey**

HQ-Not initiated 1921-22; Paterson, NJ 1922-37; Englewood, NJ 1937-41

Subordinate elements*-Regt'l HQ; HQ & Svc Co 1921-41; 342nd Vet Co 1921-41; 342nd Med Sup Sect 1921-24; 342nd Med Lab Sect 1921-24; HQ, San Bn 1921-25; 404th San Co 1921-24; 405th San Co 1921-24; 406th San Co 1921-24; HQ, Amb Bn 1921-36; 404th Amb Co 1921-36; 405th Amb Co 1921-36; 406th Amb Co 1921-36; HQ, Hosp Bn 1921-36; 404th Hosp Co 1921-36; 405th Hosp Co 1921-36; 406th Hosp Co 1921-36; HQ, Col Bn 1924-36; 404th Col Co 1924-36; 405th Col Co 1924-36; 406th Col Co 1924-36

*Designations for ambulance, hospital, and collecting companies changed from 404th, 405th and 406th to 424th, 425th and 426th respectively on 4 Feb 26.



Constituted in the Organized Reserve 29 July 1921, assigned to the XII Corps, and allotted to the Second Corps Area. Initiated 15 May 1922 with regimental headquarters at Paterson, NJ. Subordinate battalion headquarters concurrently organized as follows: Sanitary (later redesignated "Collecting") Battalion at Hoboken, NJ; Ambulance Battalion at Newark, NJ; and Hospital Battalion at Atlantic City, NJ. Entire regiment relocated 5 April 1937 to Englewood, NJ. Conducted summer training most years with the 1st Medical Regiment at Carlisle Barracks, PA, and some years at Camp Dix, NJ. Location 7 December 1941—Englewood, NJ.

Status: Headquarters and Headquarters and Service Company inactive in the U. S. Army Reserve as HHD, 342nd Medical Battalion.

Commanders, 342nd Medical Regiment

Col. James T. Wyckoff	15 May 22-ao Sep 27	Unknown	1 Jul 30-30 Sep 37
Unknown	ao Sep 27-ao Jun 30	Lt. Col. Donald A. Curtis	30 Sep 37-Jan 41
Maj. Joseph W. Williams	ao Jun 30-1 Jul 30	Unknown	Jan 41-31 Jul 41
	Col. Earl LeR. Wood	1 Aug 41-5 Sep 41	

343rd Medical Regiment (XIII Corps)**Organized Reserve Pennsylvania****HQ**-DuBois, PA, 1921-32; Mechanicsburg, PA, 1932-41**Subordinate elements***-Regt'l HQ; HQ & Svc Co 1921-41; 343rd Vet Co 1921-41; 343rd Med Sup Sect 1921-24; 343rd Med Lab Sect 1921-24; HQ, San Bn 1921-25; 407th San Co 1921-24; 408th San Co 1921-24; 409th San Co 1921-24; HQ, Amb Bn 1921-36; 407th Amb Co 1921-36; 408th Amb Co 1921-36; 409th Amb Co 1921-36; HQ, Hosp Bn 1921-36; 407th Hosp Co 1921-36; 408th Hosp Co 1921-36; 409th Hosp Co 1921-36; HQ, Col Bn 1924-36; 407th Col Co 1924-36; 408th Col Co 1924-36; 409th Col Co 1924-36

*Designations for ambulance, hospital, and collecting companies changed from 407th, 408th and 409th to 427th, 428th and 429th respectively on 4 Feb 26.

Constituted in the Organized Reserve 29 July 1921, assigned to the XIII Corps, and allotted to the Third Corps Area. Initiated 22 December 1921 with regimental headquarters at DuBois, PA. Subordinate battalion headquarters concurrently organized as follows: Sanitary (later redesignated "Collecting") Battalion at New Castle, PA; Ambulance Battalion at Ridgway, PA; and Hospital Battalion at Warren, PA. Entire regiment relocated 14 December 1932 to Mechanicsburg, PA. Withdrawn from Organized Reserve 1 October 1933 and allotted to the Regular Army as an RAI unit. Typically conducted Inactive Training Period meetings at Carlisle Barracks, PA. Conducted summer training with the 1st Medical Regiment at Carlisle Barracks. Location 7 December 1941—Mechanicsburg, PA.

Commanders, 343rd Medical Regiment

Capt. William C. Browne	22 Dec 21-21 Apr 22	Col. Thomas N. McKee	Mar 24-1 Dec 31
Maj. Frederick A. Rupp	21 Apr 22-Mar 24	Col. Richard R. Spahr	1 Dec 31-ao Jan 41

344th Medical Regiment (XIV Corps)**Organized Reserve Louisiana****HQ**-*Not initiated* 1921-22; Baton Rouge, LA, 1922-41**Subordinate elements***-Regt'l HQ; HQ & Svc Co 1921-41; 344th Vet Co 1921-41; 344th Med Sup Sect 1921-24; 344th Med Lab Sect 1921-24; HQ, San Bn 1921-25; 410th San Co 1921-24; 411th San Co 1921-24; 412th San Co 1921-24; HQ, Amb Bn 1921-36; 410th Amb Co 1921-36; 411th Amb Co 1921-36; 412th Amb Co 1921-36; HQ, Hosp Bn 1921-36; 410th Hosp Co 1921-36; 411th Hosp Co 1921-36; 412th Hosp Co 1921-36; HQ, Col Bn 1924-36; 410th Col Co 1924-36; 411th Col Co 1924-36; 412th Col Co 1924-36

*Designations for ambulance, hospital, and collecting companies changed from 410th, 411th and 412th to 430th, 431st and 432nd respectively on 4 Feb 26.

Constituted in the Organized Reserve 29 July 1921, assigned to the XIV Corps, and allotted to the Fourth Corps Area. Initiated 10 April 1922 with regimental headquarters at Baton Rouge, LA. Relieved from the XIV Corps 1 October 1933 and assigned to the Second Army. Conducted summer training with the station hospital at Fort Barrancas, FL, or Fort Oglethorpe, GA. Attended summer camp as individuals in 1937 at Carlisle Barracks, PA. Designated mobilization training station was Fort Oglethorpe, GA. Location 7 December 1941—Baton Rouge, LA.

Status: Disbanded 18 October 1943.**Commanders, 344th Medical Regiment**

Maj. Dulane S. Calhoun	10 Apr 22-31 May 22	Lt. Col. Arthur E. Rodgers	ao Jul 28-5 Nov 29
Maj. John F. Dunshie	31 May 22-7 Oct 22	Lt. Col. James W. Davidson	5 Nov 29-4 Jan 33
Col. Inman W. Cooper	7 Oct 22-ao Sep 26	Col. Byron S. Bruce	4 Jan 33-ao May 40
Unknown	ao Sep 26-ao Jul 28	Unknown	ao May 40-7 Dec 41

345th Medical Regiment (XV Corps)**Organized Reserve Ohio/Kentucky**

HQ-*Not initiated* 1921-22; Toledo, OH, 1922-30; *Inactive* 1930-33; Madisonville, KY, 1933-40; Cincinnati, OH, 1940-41

Subordinate elements*-Regt'l HQ; HQ & Svc Co 1921-41; 345th Vet Co 1921-41; 345th Med Sup Sect 1921-24; 345th Med Lab Sect 1921-24; HQ, San Bn 1921-25; 413th San Co 1921-24; 414th San Co 1921-24; 415th San Co 1921-24; HQ, Amb Bn 1921-36; 413th Amb Co 1921-36; 414th Amb Co 1921-36; 415th Amb Co 1921-36; HQ, Hosp Bn 1921-36; 413th Hosp Co 1921-36; 414th Hosp Co 1921-36; 415th Hosp Co 1921-36; HQ, Col Bn 1924-36; 413th Col Co 1924-36; 414th Col Co 1924-36; 415th Col Co 1924-36

*Designations for ambulance, hospital, and collecting companies changed from 413th, 414th and 415th to 433rd, 434th and 435th respectively on 4 Feb 26.

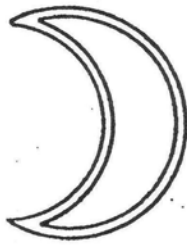

Constituted in the Organized Reserve 29 July 1921, assigned to the XV Corps, and allotted to the Fifth Corps Area. Initiated in May 1922 with regimental headquarters at Toledo, OH. Relieved from the XV Corps 2 July 1923 and assigned to the V Corps. Relieved from the V Corps 18 October 1927 and assigned to the XV Corps. Inactivated in September 1930 at Toledo by relief of personnel. Relieved from the XV Corps 1 October 1933 and assigned to the Second Army. Reorganized 21 December 1933 at Madisonville, KY. Relocated 23 February 1940 to Cincinnati, OH. Conducted summer training most years with the station hospital at Camp Knox, KY. Location 7 December 1941—Cincinnati, OH.

Status: Disbanded 18 October 1943.

Commanders, 345th Medical Regiment

Maj. Daniel C. Handley	May 22- ao Sep 24	<i>Inactive</i>	Jan 30-21 Dec 33
Unknown	ao Sep 24-ao May 26	Col. David C. Donan	21 Dec 34-ao Sep 35
Lt. Col. George B. Booth	ao May 26-Jan 30	Unknown	ao Sep 35-7 Dec 41

346th Medical Regiment (XVI Corps)**Organized Reserve Illinois**

HQ-*Not initiated* 1921-22; Chicago, IL, 1922-41

Subordinate elements*-Regt'l HQ; HQ & Svc Co 1921-41; 346th Vet Co 1921-41; 346th Med Sup Sect 1921-24; 346th Med Lab Sect 1921-24; HQ, San Bn 1921-25; 416th San Co 1921-24; 417th San Co 1921-24; 418th San Co 1921-24; HQ, Amb Bn 1921-36; 416th Amb Co 1921-36; 417th Amb Co 1921-36; 418th Amb Co 1921-36; HQ, Hosp Bn 1921-36; 416th Hosp Co 1921-36; 417th Hosp Co 1921-36; 418th Hosp Co 1921-36; HQ, Col Bn 1924-36; 416th Col Co 1924-36; 417th Col Co 1924-36; 418th Col Co 1924-36

*Designations for ambulance, hospital, and collecting companies changed from 416th, 417th and 418th to 436th, 437th and 438th respectively on 4 Feb 26.

Constituted in the Organized Reserve 29 July 1921, assigned to the XVI Corps, and allotted to the Sixth Corps Area. Initiated in September 1922 with the entire regiment at Chicago, IL. Relieved from the XVI Corps 2 July 1923 and assigned to the VI Corps. Relieved from the VI Corps 1 October 1933 and assigned to the Second Army. Concurrently withdrawn from Organized Reserve and allotted to the Regular Army as an RAI unit. Typically conducted Inactive Training Period meetings at the Army and Navy Club in Chicago. Conducted summer training most years with the station hospital at Fort Snelling, MN, and some years at Fort Sheridan, IL. Designated mobilization training station was Fort Oglethorpe, GA. Location 7 December 1941—Chicago, IL.

Status: Disbanded 18 October 1943.

Commanders, 346th Medical Regiment

Col. Harry D. Orr	16 Jan 22-1 Apr 22	Col. Cleveland C. MacLane	1 Mar 28-5 May 36
Col. Daniel W. Rogers	1 Apr 22-28 Feb 28	Col. John C. Dallenbach	5 May 36-ao Dec 41

347th Medical Regiment (XVII Corps)**Organized Reserve Iowa****HQ**-Marshalltown, IA, 1921-26; Des Moines, IA, 1926-31; Marshalltown, IA, 1931-41**Subordinate elements***-Regt'l HQ; HQ & Svc Co 1921-41; 347th Vet Co 1921-41; 347th Med Sup Sect 1921-24; 347th Med Lab Sect 1921-24; HQ, San Bn 1921-25; 419th San Co 1921-24; 420th San Co 1921-24; 421st San Co 1921-24; HQ, Amb Bn 1921-36; 419th Amb Co 1921-36; 420th Amb Co 1921-36; 421st Amb Co 1921-36; HQ, Hosp Bn 1921-36; 419th Hosp Co 1921-36; 420th Hosp Co 1921-36; 421st Hosp Co 1921-36; HQ, Col Bn 1924-36; 419th Col Co 1924-36; 420th Col Co 1924-36; 421st Col Co 1924-36

*Designations for ambulance, hospital, and collecting companies changed from 419th, 420th and 421st to 439th, 440th and 441st, respectively on 4 Feb 26.

Constituted in the Organized Reserve 29 July 1921, assigned to the XVII Corps, and allotted to the Seventh Corps Area. Initiated in May 1922 with regimental headquarters at Marshalltown, IA. Subordinate battalion headquarters concurrently organized as follows: Sanitary (later redesignated "Collecting") Battalion at Des Moines, IA; Ambulance Battalion at Council Bluffs; IA; and Hospital Battalion at Sioux City, IA. Regimental headquarters relocated 26 May 1926 to Des Moines. Entire regiment relocated 12 December 1931 to Marshalltown. Typically conducted Inactive Training Period meetings at the National Guard Club in Marshalltown. Conducted summer training most years with the station hospital at Fort Snelling, MN. Conducted summer training for 1939 and 1940 at Camp Joseph T. Robinson, AR. Conducted C.M.T.C. at Fort Des Moines, IA, in 1938 as an alternate form of summer training. Location 7 December 1941—Marshalltown, IA, (Inactivated 22 September 1942).

Status: Disbanded 18 October 1943.**Commanders, 347th Medical Regiment**

Unknown	May 22-ao Apr 25	Unknown	ao Jul 27-ao Apr 29
Col. Aaron C. Conaway	ao Apr 25-ao Sep 25	Col. Aaron C. Conaway	ao Apr 29-16 Oct 39
Unknown	ao Sep 25-ao May 27	Col. Frederick H. Roost	16 Oct 39-ap Jan 40
Col. John O. Cook	ao May 27-ao Jul 27	Unknown	ao Jan 40-7 Dec 41

348th Medical Regiment (XVIII Corps)**Organized Reserve Texas/Arizona****HQ**-*Not initiated* 1921-22; Dallas, TX, 1922-36; Tucson, AZ, 1936-41**Subordinate elements***-Regt'l HQ; HQ & Svc Co 1921-41; 348th Vet Co 1921-41; 348th Med Sup Sect 1921-24; 348th Med Lab Sect 1921-24; HQ, San Bn 1921-25; 422nd San Co 1921-24; 423rd San Co 1921-24; 424th San Co 1921-24; HQ, Amb Bn 1921-36; 422nd Amb Co 1921-36; 423rd Amb Co 1921-36; 424th Amb Co 1921-36; HQ, Hosp Bn 1921-36; 422nd Hosp Co 1921-36; 423rd Hosp Co 1921-36; 424th Hosp Co 1921-36; HQ, Col Bn 1924-36; 422nd Col Co 1924-36; 423rd Col Co 1924-36; 424th Col Co 1924-36

*Designations for ambulance, hospital, and collecting companies changed from 422nd, 423rd, and 424th, to 442nd, 443rd and 444th respectively on 4 Feb 26.



Constituted in the Organized Reserve 29 July 1921, assigned to the XVIII Corps, and allotted to the Eighth Corps Area. Initiated 23 August 1922 with regimental headquarters at Dallas, TX. Subordinate battalion headquarters concurrently organized as follows: Sanitary (later redesignated "Collecting") Battalion at Denison, TX; Ambulance Battalion at Palestine, TX; and Hospital Battalion at Wichita Falls, TX. Relieved from the XVIII Corps 2 July 1923 and assigned to the VIII Corps. Withdrawn from Organized Reserve 1 October 1933 and allotted to the Regular Army as an RAI unit. Entire regiment relocated by June 1936 to Tucson, AZ. Typically conducted Inactive Training Period meetings at the Federal Building in Dallas. Conducted summer training most years with the 2nd Medical Regiment at Fort Sam Houston, TX, 1924-36 and at Fort Francis E. Warren, WY, or Fort Bliss, TX, 1937-40. Designated mobilization training station was Camp Bullis, TX. Location 7 December 1941—Tucson, AZ.

Status: Disbanded 18 October 1943.**Events:** 232**Commanders, 348th Medical Regiment**

Lt. Col. William K. Read	23 Aug 22-11 Oct 22	Col. William R. Jamieson	29 Jan 32-6 Feb 39
Col. Thomas J. McCamant	11 Oct 22-29 Jan 32	Unknown	6 Feb 39-7 Dec 41

349th Medical Regiment (XIX Corps)**Organized Reserve California/Oregon and Washington**

HQ-*Not initiated* 1921-22; San Francisco, CA, 1922-30; Seattle, WA, 1930-36; *Inactive* 1936-41

Subordinate elements*-Regt'l HQ; HQ & Svc Co 1921-41; 349th Vet Co 1921-41; 349th Med Sup Sect 1921-24; 349th Med Lab Sect 1921-24; HQ, San Bn 1921-25; 425th San Co 1921-24; 426th San Co 1921-24; 427th San Co 1921-24; HQ, Amb Bn 1921-36; 425th Amb Co 1921-36; 426th Amb Co 1921-36; 427th Amb Co 1921-36; HQ, Hosp Bn 1921-36; 425th Hosp Co 1921-36; 426th Hosp Co 1921-36; 427th Hosp Co 1921-36; HQ, Col Bn 1924-36; 425th Col Co 1924-36; 426th Col Co 1924-36; 427th Col Co 1924-36

*Designations for ambulance, hospital, and collecting companies changed from 425th, 426th and 427th to 445th, 446th and 447th respectively on 4 Feb 26.

Constituted in the Organized Reserve 29 July 1921, assigned to the XIX Corps, and allotted to the Ninth Corps Area. Initiated 22 August 1922 with regimental headquarters at San Francisco, CA. Subordinate battalion headquarters concurrently organized as follows: Sanitary (later redesignated "Collecting") Battalion at San Francisco; Ambulance and Hospital Battalions at Los Angeles, CA. Relieved from the XIX Corps 2 July 1923 and assigned to the IX Corps. Regimental headquarters relocated 28 September 1930 to Seattle, WA. Subordinate battalions concurrently relocated as follows: Collecting Battalion to Seattle; Ambulance Battalion to Pendleton, OR; and Hospital Battalion to Portland, OR. Withdrawn from Organized Reserve 1 October 1933 and allotted to the Regular Army as an RAI unit. Concurrently, relieved from the IX Corps and assigned to the Fourth Army. Withdrawn from the Ninth Corps Area 1 July 1936, allotted to the Seventh Corps Area, and assigned to the Fourth Army. Conducted summer training with the 3rd Medical Regiment at Fort Lewis, WA. Location 7 December 1941—*Inactive*.

Status: Disbanded 18 October 1943.

Commanders, 349th Medical Regiment

Maj. Edwin E. Hobby
Col. Eugene R. Lewis

22 Aug 22-6 Sep 22
6 Sep 22-16 Aug 25

Col. David C. Hall
Inactive

17 Aug 25-1 Jun 36
1 Jun 36-7 Dec 41

350th Medical Regiment (II Corps)**Organized Reserve New York**

HQ-*Not initiated* 1921-22; New York City, NY, 1922-41

Subordinate elements*-Regt'l HQ; HQ & Svc Co 1921-41; 350th Vet Co 1921-41; 350th Med Sup Sect 1921-24; 350th Med Lab Sect 1921-24; HQ, San Bn 1921-25; 428th San Co 1921-24; 429th San Co 1921-24; 430th San Co 1921-24; HQ, Amb Bn 1921-36; 428th Amb Co 1921-36; 429th Amb Co 1921-36; 430th Amb Co 1921-36; HQ, Hosp Bn 1921-36; 428th Hosp Co 1921-36; 429th Hosp Co 1921-36; 430th Hosp Co 1921-36; HQ, Col Bn 1924-36; 428th Col Co 1924-36; 429th Col Co 1924-36; 430th Col Co 1924-36

*Designations for ambulance, hospital, and collecting companies changed from 428th, 429th and 430th to 448th, 449th and 450th respectively on 4 Feb 26.



Constituted in the Organized Reserve 29 July 1921, assigned to the II Corps, and allotted to the Second Corps Area. Initiated 21 March 1922 with regimental headquarters at Manhattan, NY. Subordinate battalion headquarters concurrently organized as follows: Sanitary (later redesignated "Collecting") Battalion at Brooklyn, NY; Ambulance Battalion at Bronx, NY; and Hospital Battalion at Manhattan. Withdrawn from Organized Reserve 1 October 1933 and allotted to the Regular Army as an RAI unit. Conducted summer training with the 1st Medical Regiment at Carlisle Barracks, PA. Location 7 December 1941—New York City, NY.

Status: Disbanded 18 October 1943.

Events: 234

Commanders, 350th Medical Regiment

Col. Emanuel Giddings

2 May 22-14 Aug 36

Col. Vincenzo Pascale

14 Aug 36-15 Jun 41

351st Medical Regiment (XIX Corps)**Organized Reserve California**

HQ-*Not initiated* 1923-33; Los Angeles, CA, 1933-41

Subordinate elements*-Regt'l HQ; HQ & Svc Co 1921-41; 351st Vet Co 1923-41; 351st Med Sup Sect 1923-24; 351st Med Lab Sect 1923-24; HQ, San Bn 1923-24; 431st San Co 1923-24; 432nd San Co 1923-24; 433rd San Co 1923-24; HQ, Amb Bn 1923-36; 431st Amb Co 1923-36; 432nd Amb Co 1923-36; 433rd Amb Co 1923-36; HQ, Hosp Bn 1923-36; 431st Hosp Co 1923-36; 432nd Hosp Co 1923-36; 433rd Hosp Co 1923-36; HQ, Col Bn 1924-36; 431st Col Co 1924-36; 432nd Col Co 1924-36; 433rd Col Co 1924-36

*Designations for ambulance, hospital, and collecting companies changed from 431st, 432nd, and 433rd to 451st, 452nd and 453rd respectively on 4 Feb 26.

Constituted in the National Guard in 1921 as the 138th Medical Regiment, assigned to the IX Corps, and allotted to the state of California. Placed on the deferred list 2 July 1923 and unit requirement transferred to the Organized Reserve as the 351st Medical Regiment, a Deferred National Guard unit. Withdrawn from the National Guard 11 September 1927, redesignated 351st Medical Regiment, and allotted to the Organized Reserve in the Ninth Corps Area. Initiated in December 1933 with regimental headquarters at Los Angeles, CA. Typically conducted Inactive Training Period meetings at the Professional Building in Los Angeles. Conducted summer training with the 3rd Medical Regiment at Letterman Army Hospital in San Francisco or at Fort Lewis, WA. Location 7 December 1941—Los Angeles, CA.

Commanders, 351st Medical Regiment

Unknown Dec 33-7 Dec 41

352nd Medical Regiment (I Corps)**Organized Reserve**

HQ-*Not initiated* 1926-27

Subordinate elements*-Regt'l HQ; HQ & Svc Co 1926-27; 352nd Vet Co 1926-27; HQ, Amb Bn 1926-27; 454th Amb Co 1926-27; 455th Amb Co 1926-27; 456th Amb Co 1926-27; HQ, Hosp Bn 1926-27; 454th Hosp Co 1926-27; 455th Hosp Co 1926-27; 456th Hosp Co 1926-27; HQ, Col Bn 1926-27; 454th Col Co 1926-27; 455th Col Co 1926-27; 456th Col Co 1926-27

Constituted in the National Guard in 1921 as the 131st Medical Regiment, assigned to the I Corps, and allotted to the states of Maine, Vermont, New Hampshire, and Rhode Island. Placed on the deferred list 10 December 1926 and unit requirement transferred to the Organized Reserve as the 352nd Medical Regiment, a Deferred National Guard unit. Concurrently, the entire regiment was allotted to the Second Corps Area. Withdrawn from the National Guard 7 September 1927, permanently allotted to the Organized Reserve, and redesignated as the 331st Medical Regiment.

353rd Medical Regiment (III Corps)**Organized Reserve**

HQ-*Not initiated* 1923-27

Subordinate elements*-Regt'l HQ; HQ & Svc Co 1923-27; 353rd Vet Co 1923-27; 353rd Med Sup Sect 1923-24; 353rd Med Lab Sect 1923-24; HQ, San Bn 1923-24; 437th San Co 1923-24; 438th San Co 1923-24; 439th San Co 1923-24; HQ, Amb Bn 1923-27; 437th Amb Co 1923-27; 438th Amb Co 1923-27; 439th Amb Co 1923-27; HQ, Hosp Bn 1923-27; 437th Hosp Co 1923-27; 438th Hosp Co 1923-27; 439th Hosp Co 1923-27; HQ, Col Bn 1924-27; 437th Col Co 1924-27; 438th Col Co 1924-27; 439th Col Co 1924-27

*Designations for ambulance, hospital, and collecting companies changed from 437th, 438th, and 439th to 457th, 458th and 459th respectively on 4 Feb 26.

Constituted in the National Guard in 1921 as the 132nd Medical Regiment, assigned to the III Corps, and allotted to the Third Corps Area. Placed on the deferred list 2 July 1923 and unit requirement transferred to the Organized Reserve as the 353rd Medical Regiment, a Deferred National Guard unit. Withdrawn from the National Guard 11 September 1927 and demobilized.

354th Medical Regiment (XIV Corps)**Organized Reserve Alabama, Georgia, and Louisiana**

HQ-*Not initiated* 1923-24; Birmingham, AL, 1924-27

Subordinate elements*-Regt'l HQ; HQ & Svc Co 1923-27; 354th Vet Co 1923-27; 354th Med Sup Sect 1923-24; 354th Med Lab Sect 1923-24; HQ, San Bn 1923-24; 440th San Co 1923-24; 441st San Co 1923-24; 442nd San Co 1923-24; HQ, Amb Bn 1923-27; 440th Amb Co 1923-27; 441st Amb Co 1923-27; 442nd Amb Co 1923-27; HQ, Hosp Bn 1923-27; 440th Hosp Co 1923-27; 441st Hosp Co 1923-27; 442nd Hosp Co 1923-27; HQ, Col Bn 1924-27; 440th Col Co 1924-27; 441st Col Co 1924-27; 442nd Col Co 1924-27

*Designations for ambulance, hospital, and collecting companies changed from 440th, 441st, and 442nd to 460th, 461st and 462nd respectively on 4 Feb 26.

Constituted in the National Guard in 1921 as the 133rd Medical Regiment, assigned to the XIV Corps, and allotted to the states of Alabama, Georgia, and Louisiana. Placed on the deferred list 2 July 1923 and unit requirement transferred to the Organized Reserve as the 354th Medical Regiment, a Deferred National Guard unit. Regimental headquarters organized in January 1924 at Birmingham, AL. Designated mobilization training station was Fort Oglethorpe, GA. Withdrawn from the National Guard 11 September 1927 and demobilized.

Commanders, 354th Medical Regiment

Col. James S. McAlester Jan 24-11 Jan 27

355th Medical Regiment (I) (XV Corps)**Organized Reserve Kentucky**

HQ-*Not initiated* 1923-27

Subordinate elements*-Regt'l HQ; HQ & Svc Co 1923-27; 355th Vet Co 1923-27; 355th Med Sup Sect 1923-24; 355th Med Lab Sect 1923-24; HQ, San Bn 1923-24; 443rd San Co 1923-24; 444th San Co 1923-24; 445th San Co 1923-24; HQ, Amb Bn 1923-27; 443rd Amb Co 1923-27; 444th Amb Co 1923-27; 445th Amb Co 1923-27; HQ, Hosp Bn 1923-27; 443rd Hosp Co 1923-27; 444th Hosp Co 1923-27; 445th Hosp Co 1923-27; HQ, Col Bn 1924-27; 443rd Col Co 1924-27; 444th Col Co 1924-27; 445th Col Co 1924-27

*Designations for ambulance, hospital, and collecting companies changed from 443rd, 444th, and 445th to 463rd, 464th and 465th respectively on 4 Feb 26.

Constituted in the National Guard in 1921 as the 134th Medical Regiment, assigned to the V Corps, and allotted to the state of Kentucky. Placed on the deferred list 2 July 1923 and unit requirement transferred to the Organized Reserve as the 355th Medical Regiment, a Deferred National Guard unit. Concurrently relieved from the V Corps and assigned to the XV Corps. Regimental unit locations designated to be located as follows: headquarters at Covington, KY; Collecting Battalion at Hardinsburg, KY; Ambulance Battalion at Leitchfield, KY; and Hospital Battalion at Hartford, KY. These elements were never organized at these locations. Withdrawn from the National Guard 11 September 1927 and demobilized.

355th Medical Regiment (II) (XV Corps)**Organized Reserve Texas**

HQ-*Not initiated* 1928-36; Dallas, TX, 1936-41

Constituted in the Organized Reserve 5 September 1928 as the 355th Medical Regiment, assigned to the XV Corps, and allotted to the Seventh Corps Area. Withdrawn from the Seventh Corps Area 1 October 1933, allotted to the Eighth Corps Area, and assigned to the XVIII Corps. Regiment organized 25 November 1936 at Dallas, TX. Typically conducted Inactive Training Period meetings at the Jefferson Hotel or Parkland Hospital in Dallas. Conducted summer training with the 2nd Medical Regiment at Fort Sam Houston, TX. Location 7 December 1941—Dallas, TX.

Status: Disbanded 18 October 1943.

Commanders, 355th Medical Regiment

Maj. James P. Hollars 25 Nov 36-ao Jan 37 Unknown ao Jan 37-7 Dec 41

356th Medical Regiment (XVI Corps)**Organized Reserve***HQ-Not initiated 1923-27*

Subordinate elements-*Regt'l HQ; HQ & Svc Co 1921-27; 356th Vet Co 1923-27; 356th Med Sup Sect 1923-24; 356th Med Lab Sect 1923-24; HQ, San Bn 1923-25; 446th San Co 1923-24; 447th San Co 1923-24; 448th San Co 1923-24; HQ, Amb Bn 1923-27; 446th Amb Co 1923-27; 447th Amb Co 1923-27; 448th Amb Co 1923-27; HQ, Hosp Bn 1923-27; 446th Hosp Co 1923-27; 447th Hosp Co 1923-27; 448th Hosp Co 1923-27; HQ, Col Bn 1924-27; 446th Col Co 1924-27; 447th Col Co 1924-27; 448th Col Co 1924-27*

Constituted in the National Guard in 1921 as the 135th Medical Regiment, assigned to the VI Corps, and allotted to the state of Wisconsin. Unorganized elements of the 135th Medical Regiment placed on the deferred list 2 July 1923 and unit requirements transferred to the Organized Reserve as the 356th Medical Regiment, a Deferred National Guard unit. Designated mobilization training station was Camp Douglas, WI. Unorganized unit requirements returned to the control of the Wisconsin National Guard 11 September 1927 as elements of the 135th Medical Regiment.

357th Medical Regiment (VII Corps)**Organized Reserve***HQ-Not initiated 1923-27*

Constituted in the National Guard in 1921 as the 136th Medical Regiment, assigned to the VII Corps, and allotted to the state of Iowa. Unorganized elements placed on the deferred list 2 July 1923 and unit requirements transferred to the Organized Reserve as the 357th Medical Regiment, a Deferred National Guard unit. Unorganized unit requirements returned to the control of the Iowa National Guard 11 September 1927 as elements of the 136th Medical Regiment.

358th Medical Regiment (VIII Corps)**Organized Reserve***HQ-Not initiated 1927-28*

Constituted in the National Guard in 1921 as the 137th Medical Regiment, assigned to the VIII Corps, and allotted to the state of Colorado. Withdrawn from the National Guard 11 September 1927, redesignated 358th Medical Regiment, and allotted to the Organized Reserve in the Eighth Corps Area. Concurrently relieved from the VIII Corps and assigned to the XVIII Corps. Withdrawn from the Organized Reserve in February 1928 and reallocated to the Colorado National Guard as the 137th Medical Regiment.

361st Medical Regiment (Fourth Army)**Organized Reserve New Jersey/New York***HQ-Not initiated 1921-22; Newark, NJ 1922-37; New York City, NY, 1937-41*

Subordinate elements**-Regt'l HQ; HQ & Svc Co 1921-41; 361st Vet Co 1921-41; 361st Med Sup Sect 1921-24; 361st Med Lab Sect 1921-24; HQ, San Bn 1921-25; 441st San Co 1921-24; 442nd San Co 1921-24; 443rd San Co 1921-24; HQ, Amb Bn 1921-36; 441st Amb Co 1921-36; 442nd Amb Co 1921-36; 443rd Amb Co 1921-36; HQ, Hosp Bn 1921-36; 441st Hosp Co 1921-36; 442nd Hosp Co 1921-36; 443rd Hosp Co 1921-36; HQ, Col Bn 1924-36; 441st Col Co 1924-36; 442nd Col Co 1924-36; 443rd Col Co 1924-36*

**Designations for ambulance, hospital, and collecting companies changed from 441st, 442nd and 443rd to 481st, 482nd and 483rd, respectively on 4 Feb 26.*

Constituted in the Organized Reserve 15 October 1921, assigned to the Fourth Army, and allotted to the Second Corps Area. Initiated 15 May 1922 with regimental headquarters at Newark, NJ. Subordinate battalion headquarters concurrently organized as follows: Sanitary (later redesignated "Collecting") Battalion at Jersey City, NJ; Ambulance Battalion at Camden, NJ; and Hospital Battalion at Hackensack, NJ. Relieved from the Fourth Army 1 October 1933 and assigned to the First Army. Entire regiment relocated 20 November 1937 to New York City, NY. Conducted summer training most years with the 1st Medical Regiment at Carlisle Barracks, PA. Location 7 December 1941—New York City, NY.

Status: Disbanded 18 October 1943.

Commanders, 361st Medical Regiment

Col. Alvin W. Schoenleber	15 May 22-4 Mar 30	Unknown	4 Mar 30-7 Dec 41
---------------------------	--------------------	---------	-------------------

361st Medical Squadron (61st Cavalry Division)

Organized Reserve New York

HQ-Buffalo, NY, 1925-41

Subordinate elements-Sq. HQ; 361st Vet Tp 1925-41; 361st Amb Tp 1925-36; 361st Hosp Tp 1925-36; 361st Col Tp 1925-36

Constituted in the Organized Reserve 1 September 1925, assigned to the 61st Cavalry Division, and allotted to the Second Corps Area. Initiated 25 March 1925 with squadron headquarters at Buffalo, NY. The remainder of the squadron organized by redesignation of the 501st Ambulance and 501st Veterinary Troops as the 361st Ambulance and 361st Veterinary Troops; the 361st Collecting and 361st Hospital Troops concurrently constituted and organized. Conducted summer training most years with the 1st Medical Regiment at Carlisle Barracks, PA, and some years at Fort Ethan Allen, VT. Conducted C.M.T.C. at Fort Niagara, NY, in 1931 as an alternate form of summer training. Also medically processed personnel of the 61st Cavalry Division during a mobilization exercise at Fort Ethan Allen for the unit's summer training in 1940. Designated mobilization training station was Suffolk County, NY. Location 7 December 1941—Buffalo, NY.

Status: Disbanded 30 September 191942.

Commanders, 361st Medical Squadron

Capt. William L. Wilson	8 Apr 26-12 Apr 26	Maj. Joseph Lampert	15 Aug 30-17 Jun 37
Lt. Col. Edgar T. Flint	12 Apr 26-7 Feb 27	Maj. Charles A. Krauss	17 May 37-ao Jun 38
Lt. Col. Samuel McCullaugh	7 Feb 27-5 Aug 30	Lt. Col. Earle LeR. Wood	ao Aug 38-30 Nov 40
Lt. Col. John F. Schafmeister	5 Aug 30-15 Aug 30	Unknown	30 Nov 40-7 Dec 41

362nd Medical Regiment (Fourth Army)

Organized Reserve New York

HQ-*Not initiated* 1921-22; Buffalo 1922-30; *Inactive* 1930-37; Buffalo 1937; *Inactive* 1937-41

Subordinate elements*-Regt'l HQ; HQ & Svc Co 1921-41; 362nd Vet Co 1921-41; 362nd Med Sup Sect 1921-24; 362nd Med Lab Sect 1921-24; HQ, San Bn 1921-25; 444th San Co 1921-24; 445th San Co 1921-24; 336th San Co 1921-24; HQ, Amb Bn 1921-36; 444th Amb Co 1921-36; 445th Amb Co 1921-36; 446th Amb Co 1921-36; HQ, Hosp Bn 1921-36; 444th Hosp Co 1921-36; 445th Hosp Co 1921-36; 446th Hosp Co 1921-36; HQ, Col Bn 1924-36; 444th Col Co 1924-36; 445th Col Co 1924-36; 446th Col Co 1924-36

*Designations for ambulance, hospital, and collecting companies changed from 444th, 445th and 446th to 484th, 485th and 486th, respectively on 4 Feb 26.

Constituted in the Organized Reserve 15 October 1921, assigned to the Fourth Army, and allotted to the Second Corps Area. Initiated 24 April 1922 with regimental headquarters at Buffalo, NY. Subordinate battalion headquarters concurrently organized as follows: Sanitary (later redesignated "Collecting") Battalion at Buffalo, NY; Ambulance Battalion at Rochester, NY; and Hospital Battalion at Hornell, NY. Inactivated 6 March 1930 at Buffalo by relief of personnel. Relieved from the Fourth Army 1 October 1933 and assigned to the First Army. Reorganized 8 May 1937 with the entire regiment at Buffalo, NY. Inactivated 9 June 1937 at Buffalo by relief of personnel. Concurrently personnel transferred to the 31st Medical Regiment (RAI). Conducted summer training with the 1st Medical Regiment at Carlisle Barracks, PA. Designated mobilization training station was Syracuse Concentration Area, NY. Location 7 December 1941—*Inactive*.

Status: Disbanded 18 October 1943.

Commanders, 362nd Medical Regiment

Col. Isaac W. Brewer	22 Apr 22-4 Jul 28	<i>Inactive</i>	7 Mar 30-8 May 37
Col. Albert Pfeiffer	5 Jul 28-6 Mar 30	Lt. Col. Raeburn J. Wharton	8 May 37-9 Jun 37
	<i>Inactive</i>	9 Jun 37-7 Dec 41	

362nd Medical Squadron (62nd Cavalry Division)**Organized Reserve Maryland****HQ**-Towson, MD, 1925-29; Baltimore, MD, 1929-41**Subordinate elements**-Sq. HQ; 362nd Vet Tp 1925-41; 362nd Amb Tp 1925-36; 362nd Hosp Tp 1925-36; 362nd Col Tp 1925-36

Constituted in the Organized Reserve 1 September 1925, assigned to the 62nd Cavalry Division, and allotted to the Third Corps Area. Initiated 25 March 1925 with squadron headquarters at Towson, MD. The remainder of the squadron organized by redesignation of the 502nd Ambulance and 502nd Veterinary Troops as the 362nd Ambulance and 362nd Veterinary Troops; the 362nd Collecting and 362nd Hospital Troops concurrently constituted and organized. Conducted summer training with the 1st Medical Regiment at Carlisle Barracks, PA. Designated mobilization training station was Syracuse Concentration Area, NY. Location 7 December 1941—Baltimore, MD.

Status: Disbanded 30 September 1942.**Commanders, 362nd Medical Squadron**

Maj. D. H. Mohr	25 Mar 25-ao Apr 25	Maj. David M. Davis	23 Nov 28-Dec 30
Unknown	ao Apr 25-ao Dec 25	Maj. John W. Ebert	Dec 30-13 Oct 31
Maj. Rastus R. Norris	ao Dec 25-Dec 27	Lt. Col. Francis M. B. Schramm	13 Oct 31-8 Jul 39
Maj. Percy R. Fisher	Dec 27-23 Nov 28	1st Lt. George Baer	8 Jul 39-1 Dec 39
	Maj. Carlton E. Marcus	1 Dec 39-ao Aug 41	

363rd Medical Regiment (Fourth Army)**Organized Reserve New York****HQ**-*Not initiated* 1921-22; Syracuse, NY, 1922-30; *Inactive* 1930-41**Subordinate elements***-Regt'1 HQ; HQ & Svc Co 1921-41; 363rd Vet Co 1921-41; 363rd Med Sup Sect 1921-24; 363rd Med Lab Sect 1921-24; HQ, San Bn 1921-25; 447th San Co 1921-24; 448th San Co 1921-24; 449th San Co 1921-24; HQ, Amb Bn 1921-36; 447th Amb Co 1921-36; 448th Amb Co 1921-36; 449th Amb Co 1921-36; HQ, Hosp Bn 1921-36; 447th Hosp Co 1921-36; 448th Hosp Co 1921-36; 449th Hosp Co 1921-36; HQ, Col Bn 1924-36; 447th Col Co 1924-36; 448th Col Co 1924-36; 449th Col Co 1924-36

*Designations for ambulance, hospital, and collecting companies changed from 447th, 448th and 449th to 487th, 488th and 489th, respectively on 4 Feb 26.



Constituted in the Organized Reserve 15 October 1921, assigned to the Fourth Army, and allotted to the Second Corps Area. Initiated 24 April 1922 with regimental headquarters at Syracuse, NY. Subordinate battalion headquarters concurrently organized as follows: Sanitary (later redesignated "Collecting") Battalion at Ilion, NY; Ambulance Battalion at Binghamton, NY; and Hospital Battalion at Albany, NY. Inactivated 7 August 1930 at Syracuse by relief of personnel. Relieved from the Fourth Army 1 October 1933 and assigned to the First Army. Conducted summer training with the 1st Medical Regiment at Carlisle Barracks, PA. Designated mobilization training station was Syracuse Concentration Area, NY. Location 7 December 1941—*Inactive*.

Status: Disbanded 18 October 1943.**Commanders, 363rd Medical Regiment**

Col. Isedor M. Unger	25 Apr 22-7 Aug 30	<i>Inactive</i>	7 Aug 30-7 Dec 41
----------------------	--------------------	-----------------	-------------------

363rd Medical Squadron (63rd Cavalry Division)**Organized Reserve Alabama****HQ**-Chattanooga, TN, 1925-41**Subordinate elements**-Sq. HQ; 363rd Vet Tp 1925-41; 363rd Amb Tp 1925-36; 363rd Hosp Tp 1925-36; 363rd Col Tp 1925-36

Constituted in the Organized Reserve 1 September 1925, assigned to the 63rd Cavalry Division, and allotted to the Fourth Corps Area. Initiated 25 March 1925 with squadron headquarters at Chattanooga, TN. The remainder of the squadron organized by redesignation of the 503rd Ambulance and 503rd Veterinary Troops as the 363rd Ambulance

and 363rd Veterinary Troops; the 363rd Collecting and 363rd Hospital Troops concurrently constituted and organized. Conducted summer training with the station hospital at Fort Oglethorpe, GA. Designated mobilization training station was Fort Oglethorpe, GA. Location 7 December 1941—Chattanooga, TN.

Status: Disbanded 30 September 191942.

Commanders, 363rd Medical Squadron

Unknown.	25 Mar 25-ao Jul 27	Maj. James W. McClaren	Dec 29-14 Mar 33
Lt. Col. Jackson H. Barnett	ao Jul 27-Dec 29	Maj. Robert C. Robertson	14 Mar 33-ao Apr 33
	Unknown	ao Apr 33-7 Dec 41	

364th Medical Regiment (Fourth Army) Organized Reserve District of Columbia and Pennsylvania

HQ-*Not initiated* 1921-22; Harrisburg, PA, 1922-29; Washington, DC, 1929-41

Subordinate elements*-Regt'l HQ; HQ & Svc Co 1921-41; 364th Vet Co 1921-41; 364th Med Sup Sect 1921-24; 364th Med Lab Sect 1921-24; HQ, San Bn 1921-25; 450th San Co 1921-24; 451st San Co 1921-24; 452nd San Co 1921-24; HQ, Amb Bn 1921-36; 450th Amb Co 1921-36; 451st Amb Co 1921-36; 452nd Amb Co 1921-36; HQ, Hosp Bn 1921-36; 450th Hosp Co 1921-36; 451st Hosp Co 1921-36; 452nd Hosp Co 1921-36; HQ, Col Bn 1924-36; 450th Col Co 1924-36; 451st Col Co 1924-36; 452nd Col Co 1924-36

*Designations for ambulance, hospital, and collecting companies changed from 450th, 451st and 452nd to 490th, 491st and 492nd, respectively on 4 Feb 26.

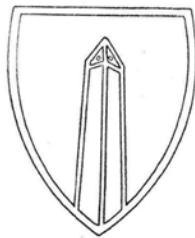

Constituted in the Organized Reserve 15 October 1921, assigned to the Fourth Army, and allotted to the Third Corps Area. Initiated 2 November 1921 with regimental headquarters at Harrisburg, PA. Subordinate battalion headquarters concurrently organized as follows: Sanitary (later redesignated "Collecting") Battalion at Reading, PA; Ambulance Battalion at Lancaster, PA; and Hospital Battalion at Chester, PA. Entire regiment relocated 11 December 1929 to Washington, DC. Withdrawn from the Organized Reserve 1 October 1933 and allotted to the Regular Army as an RAI unit. Typically conducted Inactive Training Period meetings at the Ambassador Hotel, the Medical Society Building, 1718 M Street, NW, or the Munitions Building in Washington.

Conducted summer training with the 1st Medical Regiment at Carlisle Barracks, PA. Location 7 December 1941—Washington, DC.

Status: Disbanded 18 October 1943.

Commanders, 364th Medical Regiment

Lt. Col. Theodore B. Appel	2 Nov 21-12 Nov 21	Col. Warren P. Morrill	8 Mar 26-12 Mar 29
Col. Edward Martin	12 Nov 21-ao Jan 24	Col. Herbert C. Woolley	28 Mar 29-23 Feb 37
Unknown	ao Jan 24-ao Jun 25	Col. Dunlap R. Penhallow	23 Feb 37-29 Sep 41
Lt. Col. John B. McCreary	ao Jun 25-8 Mar 26	Lt. Col. James F. Defendorf	29 Sep 41-Dec 41

364th Medical Squadron (64th Cavalry Division) Organized Reserve Kentucky

HQ-Paris, KY, 1925-41

Subordinate elements-Sq. HQ; 364th Vet Tp 1925-41; 364th Amb Tp 1925-36; 364th Hosp Tp 1925-36; 364th Col Tp 1925-36

Constituted in the Organized Reserve 1 September 1925, assigned to the 64th Cavalry Division, and allotted to the Fifth Corps Area. Initiated 25 March 1925 with squadron headquarters at Paris, KY. The remainder of the squadron organized by redesignation of the 504th Ambulance and 504th Veterinary Troops as the 364th Ambulance and 364th Veterinary Troops; the 364th Collecting and 364th Hospital Troops concurrently constituted and organized. Conducted summer training most years with the station hospital at Camp Knox, KY, and in 1936 at Carlisle Barracks, PA. Location 7 December 1941—Paris, KY.

Status: Disbanded 30 September 191942.

Commanders, 364th Medical Squadron

Maj. E. H. Tanolia	Sep 25-ao Oct 25	Unknown	ao Aug 27-ao Jul 36
Unknown	ao Oct 25-ao Jul 27	Lt. Col. Charles M. Strotz	ao Jul 36-ao Aug 36
Lt. Col. Fred L. Koontz	ao Jul 27-ao Aug 27	Unknown	ao Aug 36-7 Dec 41

365th Medical Regiment (Fifth Army)

Organized Reserve Pennsylvania

HQ-Scranton, PA, 1921-29; *Inactive* 1929-41

Subordinate elements*-Regt'l HQ; HQ & Svc Co 1921-41; 365th Vet Co 1921-41; 365th Med Sup Sect 1921-24; 365th Med Lab Sect 1921-24; HQ, San Bn 1921-25; 453rd San Co 1921-24; 454th San Co 1921-24; 455th San Co 1921-24; HQ, Amb Bn 1921-36; 453rd Amb Co 1921-36; 454th Amb Co 1921-36; 455th Amb Co 1921-36; HQ, Hosp Bn 1921-36; 453rd Hosp Co 1921-36; 454th Hosp Co 1921-36; 455th Hosp Co 1921-36; HQ, Col Bn 1924-36; 453rd Col Co 1924-36; 454th Col Co 1924-36; 455th Col 1925-36

*Designations for ambulance, hospital, and collecting companies changed from 453rd, 454th and 455th to 493rd, 494th and 495th, respectively on 4 Feb 26.

Constituted in the Organized Reserve 15 October 1921, assigned to the Fifth Army, and allotted to the Third Corps Area. Initiated 2 November 1921 with regimental headquarters at Scranton, PA. Inactivated 18 September 1929 at Scranton by relief of personnel. Conducted summer training with the 1st Medical Regiment at Carlisle Barracks, PA. Location 7 December 1941—*Inactive*.

Status: Disbanded 18 October 1943.

Commanders, 365th Medical Regiment

Maj. Charles S. Flagler	2 Nov 21-8 Nov 21	Unknown	ao Jan 24-ao Oct 25
Lt. Col. Jonathan M. Wainwright	8 Nov 21-27 Apr 22	Col. Robert S. McCombs	ao Oct 25-18 Sep 29
Lt. Col. Charles H. Tait	27 Apr 22-ao Jan 24	<i>Inactive</i>	18 Sep 29-7 Dec 41

365th Medical Squadron (65th Cavalry Division)

Organized Reserve Illinois

HQ-Chicago, IL, 1925-41

Subordinate elements-Sq. HQ; 365th Vet Tp 1925-41; 365th Amb Tp 1925-36; 365th Hosp Tp 1925-36; 365th Col Tp 1925-36

Constituted in the Organized Reserve 1 September 1925, assigned to the 65th Cavalry Division, and allotted to the Sixth Corps Area. Initiated 25 March 1925 with squadron headquarters at Chicago, IL. The remainder of the squadron organized by redesignation of the 505th Ambulance and 505th Veterinary Troops as the 365th Ambulance and 365th Veterinary Troops; the 365th Collecting and 365th Hospital Troops concurrently constituted and organized. Conducted summer training with the station hospital at Fort Snelling, MN. Location 7 December 1941—Chicago, IL.

Status: Disbanded 30 September 1942.

Commanders, 365th Medical Squadron

Lt. Col. Harry M. Hedge	17 Apr 26-25 Oct 26	Lt. Col. John H. Gaff	14 Mar 31-24 Apr 35
Lt. Col. Albert E. McEvers	25 Oct 26-14 Mar 31	Lt. Col. Peter P. O'Connor	24 Apr 35-24 Feb 39
	Lt. Col. Alwyn J. Holden	24 Feb 39-Dec 41	

366th Medical Regiment (Fifth Army)**Organized Reserve North Carolina**

HQ-*Not initiated* 1921-22; Asheville, NC, 1922-41

Subordinate elements*-Regt'l HQ; HQ & Svc Co 1921-41; 366th Vet Co 1921-41; 366th Med Sup Sect 1921-24; 366th Med Lab Sect 1921-24; HQ, San Bn 1921-25; 456th San Co 1921-24; 457th San Co 1921-24; 458th San Co 1921-24; HQ, Amb Bn 1921-36; 456th Amb Co 1921-36; 457th Amb Co 1921-36; 458th Amb Co 1921-36; HQ, Hosp Bn 1921-36; 456th Hosp Co 1921-36; 457th Hosp Co 1921-36; 458th Hosp Co 1921-36; HQ, Col Bn 1924-36; 456th Col Co 1924-36; 457th Col Co 1924-36; 458th Col Co 1924-36

*Designations for ambulance, hospital, and collecting companies changed from 456th, 457th and 458th to 496th, 497th and 498th, respectively on 4 Feb 26.

Constituted in the Organized Reserve 15 October 1921, assigned to the Fifth Army, and allotted to the Fourth Corps Area. Initiated 12 April 1922 with regimental headquarters at Asheville, NC. Subordinate battalion headquarters concurrently organized as follows: Sanitary (later redesignated "Collecting") Battalion at Waynesville, NC; Ambulance Battalion at Lawndale, NC; and Hospital Battalion at Greensboro, NC. Withdrawn from Organized Reserve 1 October 1933 and allotted to the Regular Army as an RAI unit. Concurrently, relieved from the Fifth Army and assigned to the Third Army. Conducted summer training with the station hospital at Fort McPherson, GA, or Fort Bragg, NC. Designated mobilization training station was Fort Bragg, NC. Location 7 December 1941—Asheville, NC.

Status: Disbanded 18 October 1943.

Commanders, 366th Medical Regiment

Lt. Col. John W. McConnell	15 Apr 22-ao Jul 24	Lt. Col. James B. Bullitt	8 Nov 30-9 Oct 34
Unknown	ao Jul 24-ao Jun 26	Lt. Col. Rezin C. Shawhan	9 Oct 34-22 Jan 35
Lt. Col. Harry C. Parker	ao Jun 26-Sep 26	Col. James W. Davis	22 Jan 35-ao Mar 35
Col. Inman W. Cooper	ao Jun 28-27 Jun 29	Unknown	ao Mar 35-7 Dec 41

366th Medical Squadron (66th Cavalry Division)**Organized Reserve Kansas**

HQ-Wichita, KS, 1925-41

Subordinate elements-Sq. HQ; 366th Vet Tp 1925-41; 366th Amb Tp 1925-36; 366th Hosp Tp 1925-36; 366th Col Tp 1925-36

Constituted in the Organized Reserve 1 September 1925, assigned to the 66th Cavalry Division, and allotted to the Seventh Corps Area. Initiated 25 March 1925 with squadron headquarters at Wichita, KS. The remainder of the squadron organized by redesignation of the 506th Ambulance and 506th Veterinary Troops as the 366th Ambulance and 366th Veterinary Troops; the 366th Collecting and 366th Hospital Troops concurrently constituted and organized. Conducted summer training most years with the station hospital at Fort Snelling, MN, and at Camp Joseph T. Robinson, AR, in 1940. Location 7 December 1941—Wichita, KS.

Status: Disbanded 30 September 191942.

Commanders, 366th Medical Squadron

Unknown	25 Mar 25-Mar 26	Unknown	25 Mar 25-ao Mar 31
Maj. Lester R. Smith	Mar 26-ao Jun 27	Maj. George K. Purvis	ao Mar 31-ao Apr 31
Capt. Chester A. Poe	ao Jul 27-ao Aug 27	Unknown	ao Apr 31-7 Dec 41

367th Medical Regiment (Second Army)**Organized Reserve Ohio, Kentucky, and Indiana/West Virginia**

HQ-*Not initiated* 1921-22; Ravenna, OH, 1922-23; Canton, OH, 1923-30; *Inactive* 1930-40; Cleveland, OH, 1940-41

Subordinate elements*-Regt'l HQ; HQ & Svc Co 1921-41; 367th Vet Co 1921-41; 367th Med Sup Sect 1921-24; 367th Med Lab Sect 1921-24; HQ, San Bn 1921-25; 459th San Co 1921-24; 460th San Co 1921-24; 461st San Co 1921-24; HQ, Amb Bn 1921-36; 459th Amb Co 1921-36; 460th Amb Co 1921-36; 461st Amb Co 1921-36; HQ, Hosp Bn 1921-36; 459th Hosp Co 1921-36; 460th Hosp Co 1921-36; 461st Hosp Co 1921-36; HQ, Col Bn 1924-36; 459th Col Co 1924-36; 460th Col Co 1924-36; 461st Col Co 1924-36

*Designations for ambulance, hospital, and collecting companies changed from 459th, 460th and 461st to 499th, 500th and 501st, respectively on 4 Feb 26.

Constituted in the Organized Reserve 15 October 1921, assigned to the Second Army, and allotted to the Fifth Corps Area. Initiated in May 1922 with regimental headquarters at Ravenna, OH. Relocated by June 1923 to Canton, OH. Inactivated in March 1930 at Canton by relief of personnel. Sistersville, WV, designated as headquarters upon reorganization, but the unit was never organized at that location. Reorganized 23 February 1940 at Cleveland, OH. Conducted summer training with the station hospital at Camp Knox, KY. Location 7 December 1941—Cleveland, OH.

Status: Disbanded 18 October 1943.

Commanders, 367th Medical Regiment

Lt. Col. Paul H. Zinkhan	May 22- ao Jan 23	Lt. Col. Gerald P. Lawrence	Jul 29-Mar 30
Unknown	ao Jan 23-ao Apr 26	<i>Inactive</i>	Mar 30-23 Feb 40
Lt. Col. Edison K. Westhafer	ao Apr 26-Jul 29	Lt. Col. R. J. Thoman	23 Feb 40-7 Dec 41

368th Medical Regiment (Sixth Army)

Organized Reserve Indiana/Ohio

HQ-*Not initiated* 1921-22; Anderson, IN, 1922-31; Cleveland, OH, 1931-41

Subordinate elements*-Regt'l HQ; HQ & Svc Co 1921-41; 368th Vet Co 1921-41; 368th Med Sup Sect 1921-24; 368th Med Lab Sect 1921-24; HQ, San Bn 1921-25; 462nd San Co 1921-24; 463rd San Co 1921-24; 464th San Co 1921-24; HQ, Amb Bn 1921-36; 462nd Amb Co 1921-36; 463rd Amb Co 1921-36; 464th Amb Co 1921-36; HQ, Hosp Bn 1921-36; 462nd Hosp Co 1921-36; 463rd Hosp Co 1921-36; 464th Hosp Co 1921-36; HQ, Col Bn 1924-36; 462nd Col Co 1924-36; 463rd Col Co 1924-36; 464th Col Co 1924-36

*Designations for ambulance, hospital, and collecting companies changed from 462nd, 463rd and 464th to 502nd, 503rd and 504th, respectively on 4 Feb 26.



Constituted in the Organized Reserve 15 October 1921, assigned to the Sixth Army, and allotted to the Fifth Corps Area. Initiated in July 1922 with regimental headquarters at Anderson, IN. Subordinate battalion headquarters concurrently organized as follows: Sanitary (later redesignated "Collecting") Battalion at Delphia, IN; Ambulance and Hospital Battalions at Berne, IN. Entire regiment relocated 9 July 1931 to Cleveland, OH. Typically conducted Inactive Training Period meetings at the Medical Library at Western Reserve University or the Cleveland Grays Armory in Cleveland. Conducted summer training with the station hospital at Camp Knox, KY, or at Carlisle Barracks, PA. Withdrawn from Organized Reserve 1 October 1933 and allotted to the

Regular Army as an RAI unit. concurrently relieved from the Sixth Army and assigned to the Second Army. Location 7 December 1941—Cleveland, OH.

Status: Disbanded 18 October 1943.

Commanders, 368th Medical Regiment

Maj. Daniel D. Jones	27 Oct 22-ao Sep 24	Col. John C. Darby	Jul 29-Jun 38
Unknown	ao Sep 24-ao May 26	Col. William L. Fox	Jun 38-Feb 41
Col. Charles H. McFarland	ao May 26-Jul 29	Unknown	Feb 41-7 Dec 41

369th Medical Regiment (Fifth Army)

Organized Reserve Michigan, Illinois, and Wisconsin/California

HQ-*Not initiated* 1921-22; Battle Creek, MI, 1922-25; Detroit, MI, 1925-30; *Inactive* 1930-37; San Bernardino, CA, 1937-41

Subordinate elements*-Regt'l HQ; HQ & Svc Co 1921-33; 369th Vet Co 1921-33; 369th Med Sup Sect 1921-24; 369th Med Lab Sect 1921-24; HQ, San Bn 1921-25; 465th San Co 1921-24; 466th San Co 1921-24; 467th San Co 1921-24; HQ, Amb Bn 1921-33; 465th Amb Co 1921-33; 466th Amb Co 1921-33; 467th Amb Co 1921-33; HQ, Hosp Bn 1921-33; 465th Hosp Co 1921-33; 466th Hosp Co 1921-33; 467th Hosp Co 1921-33; HQ, Col Bn 1924-33; 465th Col Co 1924-33; 466th Col Co 1924-33; 467th Col Co 1924-33

*Designations for ambulance, hospital, and collecting companies changed from 465th, 466th and 467th to 505th, 506th and 507th respectively on 4 Feb 26.



Constituted in the Organized Reserve 15 October 1921, assigned to the Fifth Army, and allotted to the Sixth Corps Area. Initiated in September 1922 with regimental headquarters at Battle Creek, MI. Regimental headquarters relocated 2 June 1925 to Detroit, MI. Inactivated by December 1930 at Detroit by relief of personnel. Withdrawn from the Sixth Corps Area 1 October 1933 and allotted to the Ninth Corps Area. Concurrently relieved from the Fifth Army and assigned to the XIX Corps. Regimental headquarters organized 25 February 1937 at San Bernardino, CA. Conducted summer training with the station hospitals at Fort Snelling, MN, and Camp Custer, MI, 1924-33 and at Del Monte, CA, 1937-39. Location 7 December 1941—San Bernardino, CA, (Inactivated 22 September 191942).

Status: Disbanded 18 October 1943.

Commanders, 369th Medical Regiment

Maj. Alexander B. McNab	25 Jan 22-4 May 22	Unknown	ao Jul 27-ao Dec 30
Lt. Col. Frederick C. Warnshuis	4 May 22-11 Apr 23	<i>Inactive</i>	ao Dec 30-24 Feb 37
Col. Rollin C. Winslow	11 Apr 23-ao Jul 27	Col. Earl H. Welcome	25 Feb 37-ao Jan 40
	Unknown	ao Jan 40-7 Dec 41	

370th Medical Regiment (Fifth Army)

Organized Reserve Wisconsin

HQ-Not initiated 1921-22; Sheboygan, WI, 1922-25; Milwaukee, WI, 1925-29; *Inactive* 1929-31; Milwaukee, WI, 1931-37; Fond du Lac, WI, 1937-41

Subordinate elements*-Regt'l HQ; HQ & Svc Co 1921-33; 370th Vet Co 1921-33; 370th Med Sup Sect 1921-24; 370th Med Lab Sect 1921-24; HQ, San Bn 1921-25; 468th San Co 1921-24; 469th San Co 1921-24; 470th San Co 1921-24; HQ, Amb Bn 1921-33; 468th Amb Co 1921-33; 469th Amb Co 1921-33; 470th Amb Co 1921-33; HQ, Hosp Bn 1921-33; 468th Hosp Co 1921-33; 469th Hosp Co 1921-33; 470th Hosp Co 1921-33; HQ, Col Bn 1924-33; 468th Col Co 1924-33; 469th Col Co 1924-33; 470th Col Co 1924-33

*Designations for ambulance, hospital, and collecting companies changed from 468th, 469th and 470th to 508th, 509th and 510th respectively on 4 Feb 26.

Constituted in the Organized Reserve 15 October 1921, assigned to the Fifth Army, and allotted to the Sixth Corps Area. Initiated in July 1922 with regimental headquarters at Sheboygan, WI. Subordinate battalion headquarters concurrently organized as follows: Sanitary (later redesignated "Collecting") Battalion at Milwaukee, WI; Ambulance Battalion at Marinette, WI; and Hospital Battalion at Wausau, WI. Regimental headquarters relocated 2 June 1925 to Milwaukee, WI. Inactivated about April 1929 at Milwaukee by relief of personnel. Reorganized by June 1931 at Milwaukee. Relieved from the Fifth Army 1 October 1933 and assigned to the Second Army. Entire regiment relocated 25 February 1937 to Fond du Lac, WI. Withdrawn from Organized Reserve 1 September 1938 and allotted to the Regular Army as an RAI unit. Typically conducted Inactive Training Period meetings at the Hotel Retlaw in Fond du Lac. Conducted summer training with the station hospital at Fort Snelling, MN. Designated mobilization training station was Fort Oglethorpe, GA. Location 7 December 1941—Milwaukee, WI.

Status: Disbanded 18 October 1943.

Commanders, 370th Medical Regiment

Lt. Col. Edward J. Barrett	6 Jul 22-24 Nov 22	Unknown	ao Jun 31-ao Jun 35
Col. George Van Ingen Brown	24 Nov 22-6 Dec 23	Col. Clarendon J. Combs	ao Jun 35-28 Nov 38
Lt. Col. Thomas Willett	6 Dec 23-Apr 29	Lt. Col. Walter A. Ford	28 Nov 38-ao Jun 41
<i>Inactive</i>	Apr 29-ao Jun 30	Unknown	ao Jun 41-7 Dec 41

371st Medical Regiment (Sixth Army)

Organized Reserve Missouri

HQ-*Not initiated* 1921-22; Kansas City, MO, 1922-33

Subordinate elements*-Regt'l HQ; HQ & Svc Co 1921-33; 371st Vet Co 1921-33; 371st Med Sup Sect 1921-24; 371st Med Lab Sect 1921-24; HQ, San Bn 1921-25; 471st San Co 1921-24; 472nd San Co 1921-24; 473rd San Co 1921-24; HQ, Amb Bn 1921-33; 471st Amb Co 1921-33; 472nd Amb Co 1921-33; 473rd Amb Co 1921-33; HQ, Hosp Bn 1921-33; 471st Hosp Co 1921-33; 472nd Hosp Co 1921-33; 473rd Hosp Co 1921-33; HQ, Col Bn 1924-33; 471st Col Co 1924-33; 472nd Col Co 1924-33; 473rd Col Co 1924-33

*Designations for ambulance, hospital, and collecting companies changed from 471st, 472nd and 473rd to 511th, 512th and 513th respectively on 4 Feb 26.



Constituted in the Organized Reserve 15 October 1921, assigned to the Sixth Army, and allotted to the Seventh Corps Area. Initiated in February 1922 with regimental headquarters at Kansas City, MO. Subordinate battalion headquarters concurrently organized as follows: Sanitary (later redesignated "Collecting") Battalion at Springfield, MO; Ambulance Battalion at St. Joseph, MO; and Hospital Battalion at Sedalia, MO. Subordinate battalions relocated 26 May 1926 as follows: Collecting Battalion to Sedalia, MO; Ambulance Battalion to Joplin, MO; and Hospital Battalion to Springfield, MO. Entire regiment relocated in September 1927 to Kansas City. Typically conducted Inactive Training Period meetings at the 110th Engineers armory or the

Medical Arts Building in Kansas City. Conducted summer training with the station hospital at Fort Snelling, MN. Demobilized 1 October 1933.

Status: Disbanded 18 October 1943.

Commanders, 371st Medical Regiment

Maj. John H. George	Feb 22-14 Jun 22	Unknown	ao Aug 22-ao Aug 25
Lt. Col. John A. Hornsby	14 Jun 22-ao Aug 22	Col. Edward H. Skinner	ao Aug 25-Sep 26
	Col. Calvin L. Cooper	Sep 26-1 Oct 33	

372nd Medical Regiment (Sixth Army)

Organized Reserve Nebraska/Kansas

HQ-*Not initiated* 1921-22; Omaha, NE, 1922-26; Norfolk, NE, 1926-29; *Inactive* 1929-31; Kansas City, KS, 1931-41

Subordinate elements*-Regt'l HQ; HQ & Svc Co 1921-41; 372nd Vet Co 1921-41; 372nd Med Sup Sect 1921-24; 372nd Med Lab Sect 1921-24; HQ, San Bn 1921-25; 474th San Co 1921-24; 475th San Co 1921-24; 476th San Co 1921-24; HQ, Amb Bn 1921-36; 474th Amb Co 1921-36; 475th Amb Co 1921-36; 476th Amb Co 1921-36; HQ, Hosp Bn 1921-36; 474th Hosp Co 1921-36; 475th Hosp Co 1921-36; 476th Hosp Co 1921-36; HQ, Col Bn 1924-36; 474th Col Co 1924-36; 475th Col Co 1924-36; 476th Col Co 1924-36

*Designations for ambulance, hospital, and collecting companies changed from 474th, 475th and 476th to 514th, 515th and 516th respectively on 4 Feb 26.

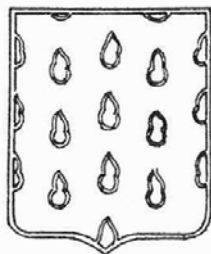

Constituted in the Organized Reserve 15 October 1921, assigned to the Sixth Army, and allotted to the Seventh Corps Area. Initiated in September 1922 with regimental headquarters at Omaha, NE. Subordinate battalion headquarters concurrently organized as follows: Sanitary (later redesignated "Collecting") Battalion at Fairmont, NE; Ambulance Battalion at Grand Island, NE; and Hospital Battalion at Omaha, NE. Headquarters relocated 26 May 1926 to Norfolk, NE. Subordinate battalions relocated as follows: Collecting Battalion at O'Neill, NE; Ambulance Battalion at Wayne, NE; and Hospital Battalion at Broken Bow, NE. Inactivated 18 October 1929 at Omaha by relief of personnel. Entire regiment reorganized 12 October 1931 at Kansas City, KS. Withdrawn from Organized Reserve 1 October 1933 and allotted to the Regular Army

as an RAI unit. Concurrently relieved from the Sixth Army and assigned to the Fourth Army. Conducted summer training most years with the station hospital at Fort Snelling, MN. Conducted C.M.T.C. at Fort Crook, NE, in 1938 as an alternate form of summer training. Conducted summer training at Camp Joseph T. Robinson, AR, in 1939 and 1940. Location 7 December 1941—Kansas City, KS.

Status: Disbanded 18 October 1943.

Commanders, 372nd Medical Regiment

Unknown	Jan 22-ao May 27	<i>Inactive</i>	18 Oct 29-12 Oct 31
Col. Erskine M. Barnes	ao May 27-18 Oct 29	Unknown	12 Oct 31-7 Dec 41

373rd Medical Regiment (First Army)

Organized Reserve New York

HQ-*Not initiated* 1921-22; Brooklyn, NY, 1922-33

Subordinate elements*-Regt'l HQ; HQ & Svc Co 1921-33; 373rd Vet Co 1921-33; 373rd Med Sup Sect 1921-24; 373rd Med Lab Sect 1921-24; HQ, San Bn 1921-25; 477th San Co 1921-24; 478th San Co 1921-24; 479th San Co 1921-24; HQ, Amb Bn 1921-33; 477th Amb Co 1921-33; 478th Amb Co 1921-33; 479th Amb Co 1921-33; HQ, Hosp Bn 1921-33; 477th Hosp Co 1921-33; 478th Hosp Co 1921-33; 479th Hosp Co 1921-33; HQ, Col Bn 1924-33; 477th Col Co 1924-33; 478th Col Co 1924-33; 479th Col Co 1924-33

*Designations for ambulance, hospital, and collecting companies changed from 477th, 478th and 479th to 517th, 518th and 519th respectively on 4 Feb 26.

Constituted in the Organized Reserve 15 October 1921, assigned to the First Army, and allotted to the Second Corps Area. Initiated 21 March 1922 with the entire regiment, less the Hospital Battalion, at Brooklyn, NY. The Hospital Battalion concurrently organized at Bronx, NY. Typically conducted Inactive Training Period meetings at the Army Building, 39 Whitehall Street in New York City. Conducted summer training with the 1st Medical Regiment at Carlisle Barracks, PA. Demobilized 1 October 1933.

Commanders, 373rd Medical Regiment

1st Lt. George Rittenhouse	21 Mar 22-2 May 22	Col. Walter Bensel	2 May 22-16 Jan 30
	Lt. Col. John S. Dorian	16 Jan 30-1 Oct 33	

374th Medical Regiment (First Army)

Organized Reserve New York

HQ-*Not initiated* 1921-22; Manhattan, NY, 1922-41

Subordinate elements*-Regt'l HQ; HQ & Svc Co 1921-41; 374th Vet Co 1921-41; 374th Med Sup Sect 1921-24; 374th Med Lab Sect 1921-24; HQ, San Bn 1921-25; 480th San Co 1921-24; 481st San Co 1921-24; 482nd San Co 1921-24; HQ, Amb Bn 1921-36; 480th Amb Co 1921-36; 481st Amb Co 1921-36; 482nd Amb Co 1921-36; HQ, Hosp Bn 1921-36; 480th Hosp Co 1921-36; 481st Hosp Co 1921-36; 482nd Hosp Co 1921-36; HQ, Col Bn 1924-36; 480th Col Co 1924-36; 481st Col Co 1924-36; 482nd Col Co 1924-36

*Designations for ambulance, hospital, and collecting companies changed from 480th, 481st and 482nd to 520th, 521st and 522nd respectively on 4 Feb 26.



Constituted in the Organized Reserve 15 October 1921, assigned to the First Army, and allotted to the Second Corps Area. Initiated 2 May 1922 with the entire regiment, less the Ambulance Battalion, at Manhattan, NY. The Ambulance Battalion concurrently organized at Queens, NY. Withdrawn from Organized Reserve 1 October 1933 and allotted to the Regular Army as an RAI unit. Typically conducted Inactive Training Period meetings at the Army Building, 39 Whitehall Street in New York City. Conducted summer training with the 1st Medical Regiment at Carlisle Barracks, PA. Location 7 December 1941—Manhattan, NY.

Status: Disbanded 18 October 1943.

Commanders, 374th Medical Regiment

Col. Gustave R. Manning	2 May 22-Oct 31	Unknown	ao Jun 36-ao Mar 38
Col. Walter Bensel	7 Jan 32-ao Jun 36	Lt. Col. John S. Dorian	ao Mar 38-1 Oct 41

375th Medical Regiment (First Army)**Organized Reserve Pennsylvania****HQ**-Pittsburgh, PA, 1921-29; *Inactive* 1929-41

Subordinate elements*-Regt'l HQ; HQ & Svc Co 1921-41; 375th Vet Co 1921-41; 375th Med Sup Sect 1921-24; 375th Med Lab Sect 1921-24; HQ, San Bn 1921-25; 483rd San Co 1921-24; 484th San Co 1921-24; 485th San Co 1921-24; HQ, Amb Bn 1921-36; 483rd Amb Co 1921-36; 484th Amb Co 1921-36; 485th Amb Co 1921-36; HQ, Hosp Bn 1921-36; 483rd Hosp Co 1921-36; 484th Hosp Co 1921-36; 485th Hosp Co 1921-36; HQ, Col Bn 1924-36; 483rd Col Co 1924-36; 484th Col Co 1924-36; 485th Col Co 1924-36

*Designations for ambulance, hospital, and collecting companies changed from 483rd, 484th and 485th to 523rd, 524th and 525th respectively on 4 Feb 26.

Constituted in the Organized Reserve 15 October 1921, assigned to the First Army, and allotted to the Third Corps Area. Initiated 22 December 1921 with regimental headquarters at Pittsburgh, PA. Inactivated 9 September 1929 at Pittsburgh by relief of personnel. Harrisburg, PA, designated as headquarters upon reorganization, but the unit was never organized at that location. Conducted summer training with the 1st Medical Regiment at Carlisle Barracks, PA. Location 7 December 1941—*Inactive*.

Status: Disbanded 18 October 1943.**Commanders, 375th Medical Regiment**

Maj. Jesse H. Swick	22 Dec 21-10 Dec 23	Col. Frederick A. Hartung	Dec 25-9 Sep 29
Lt. Col. Leonard D. Frescoln	10 Dec 23-Dec 25	<i>Inactive</i>	9 Sep 29-7 Dec 41

376th Medical Regiment (Second Army)**Organized Reserve Mississippi****HQ**-*Not initiated* 1921-22; Jackson, MS, 1922-29; *Inactive* 1929-40; Jackson, MS, 1940-41

Subordinate elements*-Regt'l HQ; HQ & Svc Co 1921-41; 376th Vet Co 1921-41; 376th Med Sup Sect 1921-24; 376th Med Lab Sect 1921-24; HQ, San Bn 1921-25; 486th San Co 1921-24; 487th San Co 1921-24; 488th San Co 1921-24; HQ, Amb Bn 1921-36; 486th Amb Co 1921-36; 487th Amb Co 1921-36; 488th Amb Co 1921-36; HQ, Hosp Bn 1921-36; 486th Hosp Co 1921-36; 487th Hosp Co 1921-36; 488th Hosp Co 1921-36; HQ, Col Bn 1924-36; 486th Col Co 1924-36; 487th Col Co 1924-36; 488th Col Co 1924-36

*Designations for ambulance, hospital, and collecting companies changed from 486th, 487th and 488th to 526th, 527th and 528th respectively on 4 Feb 26.

Constituted in the Organized Reserve 15 October 1921, assigned to the Second Army, and allotted to the Fourth Corps Area. Initiated 16 March 1922 with regimental headquarters at Jackson, MS. Subordinate battalion headquarters concurrently organized as follows: Sanitary (later redesignated "Collecting") Battalion at Water Valley, MS; Ambulance Battalion at Gulfport, MS; and Hospital Battalion at Brookhaven, MS. Inactivated 12 September 1929 at Jackson by relief of personnel. Reorganized 18 August 1940 with the entire regiment at Jackson. Conducted summer training with the station hospital at Camp McClellan, AL. Designated mobilization training station was Camp McClellan, AL. Location 7 December 1941—Jackson, MS.

Status: Disbanded 18 October 1943.**Commanders, 376th Medical Regiment**

Lt. Col. David W. Jackson	16 Mar 22-3 Jan 23	<i>Inactive</i>	12 Sep 29-18 Aug 40
Col. Hardie R. Hays	3 Jan 23-12 Sep 29	Unknown	18 Aug 40-7 Dec 41

377th Medical Regiment (Second Army)**Organized Reserve Ohio/Texas****HQ**-*Not initiated* 1921-22; Cincinnati, OH, 1922-33; *Inactive* 1933-36; Fort Worth, TX, 1936-41**Subordinate elements***-Regt'l HQ; HQ & Svc Co 1921-41; 377th Vet Co 1921-41; 377th Med Sup Sect 1921-24; 377th Med Lab Sect 1921-24; HQ, San Bn 1921-25; 489th San Co 1921-24; 490th San Co 1921-24; 491st San Co 1921-24; HQ, Amb Bn 1921-36; 489th Amb Co 1921-36; 490th Amb Co 1921-36; 491st Amb Co 1921-36; HQ, Hosp Bn 1921-36; 489th Hosp Co 1921-36; 490th Hosp Co 1921-36; 491st Hosp Co 1921-36; HQ, Col Bn 1924-36; 489th Col Co 1924-36; 490th Col Co 1924-36; 491st Col Co 1924-36

*Designations for ambulance, hospital, and collecting companies changed from 489th, 490th and 491st to 529th, 530th and 531st respectively on 4 Feb 26.

Constituted in the Organized Reserve 15 October 1921, assigned to the Second Army, and allotted to the Fifth Corps Area. Initiated 28 April 1922 with regimental headquarters at Cincinnati, OH. Conducted summer training with the station hospital at Camp Knox, KY. Withdrawn from the Fifth Corps Area 1 October 1933 and allotted to the Eighth Corps Area. Concurrently relieved from the Second Army and assigned to the Third Army. Reorganized 25 November 1936 with the entire regiment at Fort Worth, TX. Location 7 December 1941—Fort Worth, TX.

Status: Disbanded 18 October 1943.**Commanders, 377th Medical Regiment**

Maj. Thomas L. McCullough	28 Apr 22-ao May 22	Unknown	26 Nov 27-1 Oct 33
Unknown	ao May 22-ao Jul 27	<i>Inactive</i>	1 Oct 33-24 Nov 36
Lt. Col. Charles S. Dryer	ao Jul 27-26 Nov 27	1st Lt. Chester A. Washburn	25 Nov 36-ao Dec 36
	Unknown	ao Dec 36-7 Dec 41	

378th Medical Regiment (Third Army)**Organized Reserve Illinois****HQ**-*Not initiated* 1921-22; Chicago, IL, 1922-37; *Inactive* 1937-41**Subordinate elements***-Regt'l HQ; HQ & Svc Co 1921-33; 378th Vet Co 1921-33; 378th Med Sup Sect 1921-24; 378th Med Lab Sect 1921-24; HQ, San Bn 1921-25; 492nd San Co 1921-24; 493rd San Co 1921-24; 494th San Co 1921-24; HQ, Amb Bn 1921-33; 492nd Amb Co 1921-33; 493rd Amb Co 1921-33; 494th Amb Co 1921-33; HQ, Hosp Bn 1921-33; 492nd Hosp Co 1921-33; 493rd Hosp Co 1921-33; 494th Hosp Co 1921-33; HQ, Col Bn 1924-33; 492nd Col Co 1924-33; 493rd Col Co 1924-33; 494th Col Co 1924-33

*Designations for ambulance, hospital, and collecting companies changed from 492nd, 493rd and 494th to 532nd, 533rd and 534th respectively on 4 Feb 26.

Constituted in the Organized Reserve 15 October 1921, assigned to the Third Army, and allotted to the Sixth Corps Area. Initiated in February 1922 with the entire regiment at Chicago, IL. Relieved from the Third Army 1 October 1933 and assigned to XVI Corps. Inactivated 20 November 1937 at Chicago by relief of personnel. Conducted summer training with the station hospital at Fort Snelling, MN, and some years at Jefferson Barracks, MO, or Fort Sheridan, IL. Location 7 December 1941—*Inactive*.**Status:** Disbanded 18 October 1943.**Commanders, 378th Medical Regiment**

Col. George De Tarnowsky	18 Nov 21-ao Sep 36	Lt. Col. Pashupati J. Sarma	ao Jun 37-20 Nov 37
	<i>Inactive</i>	20 Nov 37-7 Dec 41	

379th Medical Regiment (Third Army)**Organized Reserve North Dakota and South Dakota /Oklahoma**

HQ-Bismarck, ND, 1921-33; *Inactive* 1933-35; Oklahoma City, OK, 1935-39; *Inactive* 1939-41

Subordinate elements*-Regt'l HQ; HQ & Svc Co 1921-41; 379th Vet Co 1921-41; 379th Med Sup Sect 1921-24; 379th Med Lab Sect 1921-24; HQ, San Bn 1921-25; 495th San Co 1921-24; 496th San Co 1921-24; 497th San Co 1921-24; HQ, Amb Bn 1921-36; 495th Amb Co 1921-36; 496th Amb Co 1921-36; 497th Amb Co 1921-36; HQ, Hosp Bn 1921-36; 495th Hosp Co 1921-36; 496th Hosp Co 1921-36; 497th Hosp Co 1921-36; HQ, Col Bn 1924-36; 495th Col Co 1924-36; 496th Col Co 1924-36; 497th Col Co 1924-36

*Designations for ambulance, hospital, and collecting companies changed from 495th, 496th and 497th to 535th, 536th and 537th respectively on 4 Feb 26.

Constituted in the Organized Reserve 15 October 1921, assigned to the Third Army, and allotted to the Seventh Corps Area. Initiated 28 December 1921 with regimental headquarters at Bismarck, ND. Subordinate battalion headquarters concurrently organized as follows: Sanitary (later redesignated "Collecting") Battalion at Bismarck; Hospital Battalion at Wessington Springs, SD; and Ambulance Battalion at Sisseton, SD. Typically conducted Inactive Training Period meetings at the Memorial Building in Bismarck. Withdrawn from the Seventh Corps Area 1 October 1933, and allotted to the Eighth Corps Area. Regimental headquarters organized 26 February 1935 at Oklahoma City, OK. Inactivated about May 1939 at Oklahoma City by relief of personnel. Conducted summer training with the station hospital at Fort Snelling, MN, 1922-33. Conducted C.M.T.C. at Fort Sill, OK, in 1938 as an alternate form of summer training. Location 7 December 1941—*Inactive*.

Status: Disbanded 18 October 1943.

Commanders, 379th Medical Regiment

Col. Eric P. Quinn	28 Dec 21-Jun 27	<i>Inactive</i>	1 Oct 33-26 Feb 35
Lt. Col. Floyd S. Kidd	5 Sep 27-Jul 29	Col. Paul R. Brown	26 Feb 35-May 39
Unknown	Jul 29-1 Oct 33	<i>Inactive</i>	May 39-7 Dec 41

380th Medical Regiment (First Army)**Organized Reserve New York**

HQ-*Not initiated* 1923-25; Brooklyn, NY, 1925-26; *Inactive* 1926-27

Subordinate elements-Regt'l HQ; HQ & Svc Co 1921-27; 380th Vet Co 1923-27; 380th Med Sup Sect 1923-24; 380th Med Lab Sect 1923-24; HQ, San Bn 1923-25; 498th San Co 1923-24; 499th San Co 1923-24; 500th San Co 1923-24; HQ, Amb Bn 1923-27; 498th Amb Co 1923-27; 499th Amb Co 1923-27; 500th Amb Co 1923-27; HQ, Hosp Bn 1923-27; 498th Hosp Co 1923-27; 499th Hosp Co 1923-27; 500th Hosp Co 1923-27; HQ, Col Bn 1924-27; 498th Col Co 1924-27; 499th Col Co 1924-27; 500th Col Co 1924-27

Constituted in the National Guard 15 October 1921 as the 141st Medical Regiment, assigned to the First Army, and allotted to the state of New York. Regiment placed on the deferred list 2 July 1923 and unit requirement transferred to the Organized Reserve as the 380th Medical Regiment. Initiated 2 December 1925 at Brooklyn, NY. Inactivated 18 February 1926 at Brooklyn by relief of personnel. Personnel concurrently transferred to the 302nd Medical Regiment. Withdrawn from the National Guard 17 September 1927.

Commanders, 380th Medical Regiment

Col. Joseph C. Devries	2 Dec 25-18 Feb 26	<i>Inactive</i>	18 Feb 26-17 Sep 27
------------------------	--------------------	-----------------	---------------------

381st Medical Regiment (GHQR)**Organized Reserve**

HQ-*Not initiated* 1923-27

Subordinate elements-Regt'l HQ; HQ & Svc Co 1921-27; 381st Vet Co 1923-27; 381st Med Sup Sect 1923-24; 381st Med Lab Sect 1923-24; HQ, San Bn 1923-25; 501st San Co 1923-24; 502nd San Co 1923-24; 503rd San Co 1923-24; HQ, Amb Bn 1923-27; 501st Amb Co 1923-27; 502nd Amb Co 1923-27; 503rd Amb Co 1923-27; HQ, Hosp Bn 1923-27; 501st Hosp Co 1923-27; 502nd Hosp Co 1923-27; 503rd Hosp Co 1923-27; HQ, Col Bn 1924-27; 501st Col Co 1924-27; 502nd Col Co 1924-27; 503rd Col Co 1924-27

Constituted in the National Guard 15 October 1921 as the 142nd Medical Regiment, assigned to the First Army, and allotted to the state of Pennsylvania. Regiment placed on the deferred list 2 July 1923 and unit requirement transferred to the Organized Reserve as the 381st Medical Regiment. Withdrawn from the National Guard 17 September 1927.

382nd Medical Regiment (Second Army)

Organized Reserve

HQ-Not initiated 1923-27

Subordinate elements-*Regt'l HQ; HQ & Svc Co 1921-27; 382nd Vet Co 1923-27; 382nd Med Sup Sect 1923-24; 382nd Med Lab Sect 1923-24; HQ, San Bn 1923-25; 504th San Co 1923-24; 505th San Co 1923-24; 506th San Co 1923-24; HQ, Amb Bn 1923-27; 504th Amb Co 1923-27; 505th Amb Co 1923-27; 506th Amb Co 1923-27; HQ, Hosp Bn 1923-27; 504th Hosp Co 1923-27; 505th Hosp Co 1923-27; 506th Hosp Co 1923-27; HQ, Col Bn 1924-27; 504th Col Co 1924-27; 505th Col Co 1924-27; 506th Col Co 1924-27*

Constituted in the National Guard 15 October 1921 as the 143rd Medical Regiment, assigned to the Second Army, and allotted to the state of West Virginia. Regiment placed on the deferred list 2 July 1923 and unit requirement transferred to the Organized Reserve as the 382nd Medical Regiment. Withdrawn from the National Guard 17 September 1927.

383rd Medical Regiment (GHQR)

Organized Reserve Michigan

HQ-Not initiated 1923-27

Subordinate elements-*Regt'l HQ; HQ & Svc Co 1921-27; 383rd Vet Co 1923-27; 383rd Med Sup Sect 1923-24; 383rd Med Lab Sect 1923-24; HQ, San Bn 1923-25; 507th San Co 1923-24; 508th San Co 1923-24; 509th San Co 1923-24; HQ, Amb Bn 1923-27; 507th Amb Co 1923-27; 508th Amb Co 1923-27; 509th Amb Co 1923-27; HQ, Hosp Bn 1923-27; 507th Hosp Co 1923-27; 508th Hosp Co 1923-27; 509th Hosp Co 1923-27; HQ, Col Bn 1924-27; 507th Col Co 1924-27; 508th Col Co 1924-27; 509th Col Co 1924-27*

Constituted in the National Guard 15 October 1921 as the 144th Medical Regiment, assigned to the Second Army, and allotted to the state of Michigan. Regiment placed on the deferred list 2 July 1923 and unit requirement transferred to the Organized Reserve as the 383rd Medical Regiment. Designated mobilization training station was Camp Custer, MI. Withdrawn from the National Guard 17 September 1927.

384th Medical Regiment (GHQR)

Organized Reserve Minnesota

HQ-Not initiated 1923-26; St. Cloud, MN, 1926-27

Subordinate elements-*Regt'l HQ; HQ & Svc Co 1921-27; 384th Vet Co 1923-27; 384th Med Sup Sect 1923-24; 384th Med Lab Sect 1923-24; HQ, San Bn 1923-25; 550th San Co 1923-24; 551st San Co 1923-24; 552nd San Co 1923-24; HQ, Amb Bn 1923-27; 550th Amb Co 1923-27; 551st Amb Co 1923-27; 552nd Amb Co 1923-27; HQ, Hosp Bn 1923-27; 550th Hosp Co 1923-27; 551st Hosp Co 1923-27; 552nd Hosp Co 1923-27; HQ, Col Bn 1924-27; 550th Col Co 1924-27; 551st Col Co 1924-27; 552nd Col Co 1924-27*

Constituted in the National Guard 15 October 1921 as the 145th Medical Regiment, assigned to the Third Army, and allotted to the state of Arkansas. Regiment placed on the deferred list 2 July 1923 and unit requirement allotted to the Organized Reserve as the 384th Medical Regiment. Initiated in May 1926 with regimental headquarters at St. Cloud, MN; Sanitary Collecting Battalion at Willmar, MN; Ambulance Battalion at Marshall, MN; and Hospital Battalion at New Ulm, MN. Withdrawn from the National Guard 17 September 1927.

Commanders, 384th Medical Regiment

Unknown May 26-11 Sep 27

385th Medical Regiment (ZI)**Organized Reserve Alabama and Georgia**

HQ-*Not initiated* 1924-29; Birmingham, AL, 1929-41

Subordinate elements-Regt'l HQ; HQ & Svc Co 1921-41; 385th Vet Co 1921-41; 385th Med Sup Sect 1921-24; 385th Med Lab Sect 1921-24; HQ, San Bn 1921-25; 553rd San Co 1921-24; 554th San Co 1921-24; 555th San Co 1921-24; HQ, Amb Bn 1921-36; 553rd Amb Co 1921-36; 554th Amb Co 1921-36; 555th Amb Co 1921-36; HQ, Hosp Bn 1921-36; 553rd Hosp Co 1921-36; 554th Hosp Co 1921-36; 555th Hosp Co 1921-36; HQ, Col Bn 1924-36; 553rd Col Co 1924-36; 554th Col Co 1924-36; 555th Col Co 1924-36

Constituted in the Organized Reserve 31 March 1924, assigned to the Zone of the Interior, and allotted to the Fourth Corps Area. Initiated by May 1929 with regimental headquarters at Birmingham, AL. Mobilization mission was to function as a training regiment for the medical replacement training center at Fort Oglethorpe, GA. Designated mobilization training station was Fort Oglethorpe. Conducted summer training with the station hospital at Fort Oglethorpe. Location 7 December 1941—Birmingham, AL.

Status: Disbanded 18 October 1943.

Commanders, 385th Medical Regiment

Lt. Col. French H. Craddock

ao May 29-9 Sep 29

Unknown

9 Sep 29-7 Dec 41

900th Medical Regiment (Z.I.)**Organized Reserve Pennsylvania**

HQ-Philadelphia, PA, 1940-41

Constituted in the Organized Reserve in 1940, assigned to the Zone of the Interior, and allotted to the Third Corps Area. Initiated 11 September 1940 at Philadelphia, PA. Mobilization mission was to function as a training regiment for the Field Medical School at Carlisle Barracks, PA. Location 7 December 1941—Philadelphia, PA.

Commanders, 900th Medical Regiment

Unknown

11 Sep 40-7 Dec 41

901st Medical Regiment (Z.I.)**Organized Reserve Pennsylvania**

HQ-Pittsburgh, PA, 1940-41; *Inactive* 1941

Constituted in the Organized Reserve in 1940, assigned to the Zone of the Interior, and allotted to the Third Corps Area. Initiated by December 1940 at Pittsburgh, PA. Inactivated 19 August 1941 by relief of personnel. Location 7 December 1941—*Inactive*.

Commanders, 901st Medical Regiment

Col. John T. Keiser

Dec 40-19 Aug 41

Chapter 48

Centers, Groups, and Hospitals

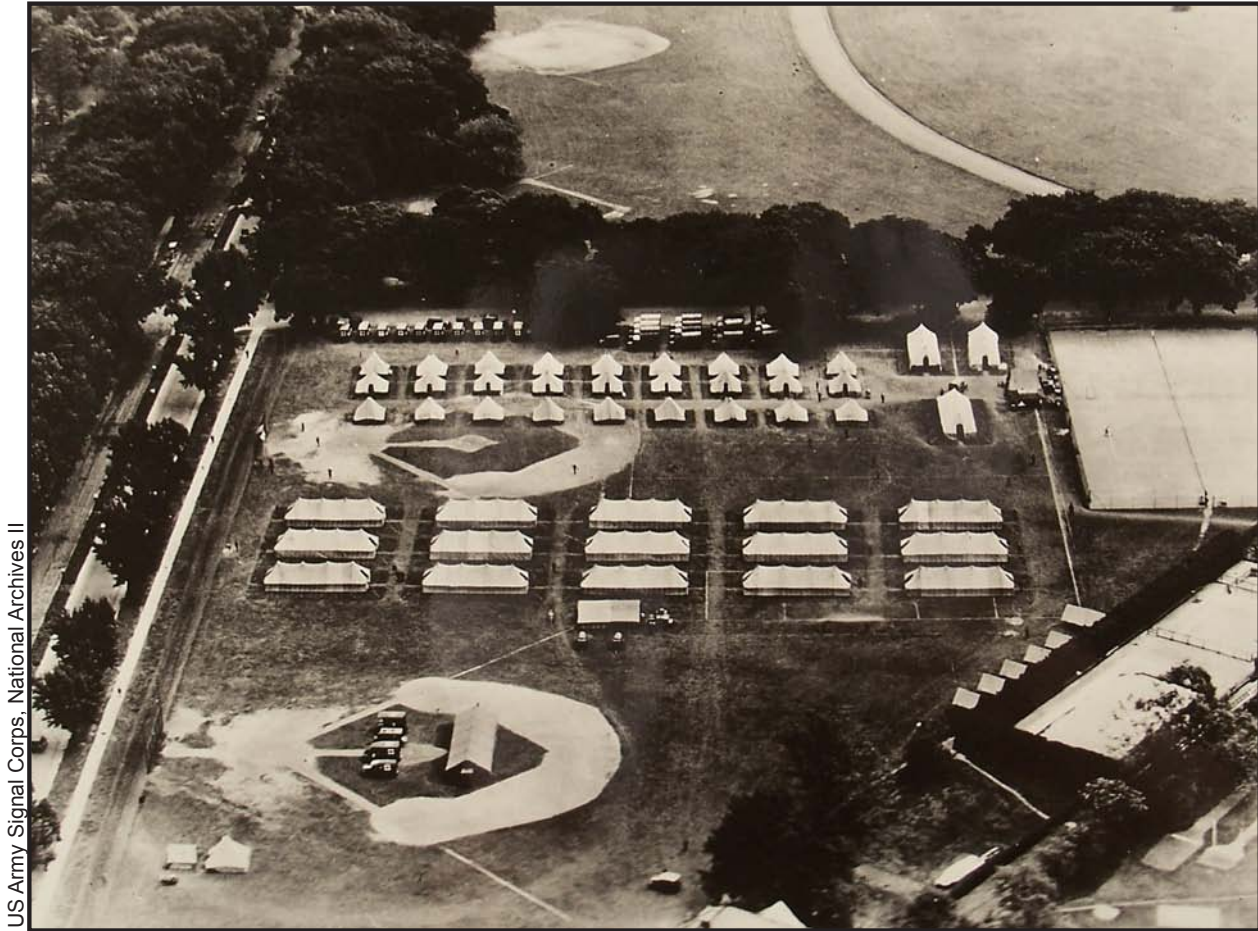

US Army Signal Corps, National Archives II

Army hospital set up on a baseball field near the Washington Monument, May 1928.

The mission of the various medical centers, groups, and hospitals are provided before each type of unit below.

Organization

The post-World War I medical units were organized similarly to their wartime counterparts. The primary difference was changes in the names of some of the organizations. The wartime base and mobile hospitals for example, became the post-war general and surgical hospitals, respectively.

Many of the post-war hospitals were authorized by the Surgeon General as early as June 1922 for organization as Reserve units at affiliated medical institutions across the United States. Most of these affiliations involved municipal hospitals, and college and university medical schools. In those cases, the Surgeon General, by letter, authorized those institutions to reorganize units which they previously organized before, or during, World War I. As part of the authorization, the Surgeon General simply reassigned to those institutions the designations of the units which they had organized, but with the updated designation. For example, Bellevue Hospital in New York City had organized Base Hospital No. 1 just before the war. In March 1923, the Surgeon General authorized Bellevue to organize General Hospital No. 1. It is not clear as to the actual status of these authorized units, that is, whether they were in a provisional status or actually

constituted by the Surgeon General, as the constitution of new units was a responsibility of the Adjutant General. Further clouding the issue is the fact the same units appear to have been constituted again by the July 1923 War Department General Mobilization Plan (WDGMP).

The initial post-war centers, groups, and hospitals as outlined in the 1923 WDGMP were constituted exclusively in the Organized Reserves. Beginning in 1928, however, War Department planners began re-allotting many of these units to the Regular Army. In most instances, the units were simply withdrawn from the Organized Reserve and re-allotted to the Regular Army. For some unknown reason, in some instances the Reserve units were apparently demobilized and a new Regular Army unit with the same designation was constituted in its place. Unfortunately, the records detailing these changes are often unclear and have led to a number of cases where the actual intent of the War Department planners cannot be fully ascertained as to whether a unit was demobilized and reconstituted or simply re-allotted. This is particularly true in the cases of hospital units involved in the four-army plan reorganization of October 1933. Additional units were withdrawn from the Reserves in 1936 and 1938 and allotted to the Regular Army. Then in 1940, again inexplicably, while some units were withdrawn from the Reserve and re-allotted to the Regular Army, other former Reserve units were withdrawn from the Regular Army and re-allotted to the Organized Reserve.

In 1928 and 1929, some corps areas began organizing hospitals and hospital augmentation units to support the posts, camps, and stations of the Corps Area Service Command. These units, in some cases, were named after the installation they were to serve (e.g., Camp Grant Station Hospital), and in others, were provided a number in accordance with the CASC numbering system (e.g., 1501st Station Hospital). Additionally, a number were constituted or established as augmentation units to existing general hospitals such as Walter Reed, Fitzsimons, Letterman, Strenberg.

The following tables illustrate the original allotment of the types of units to the two components through 1940. It reflects only original allotments and not cases where units were withdrawn and re-allotted.

Allotment of the types of units to the two components.

Organizations	Med. Dept. Conc. Ctr.	Hosp. Ctr.	Aux. Surg. Gp.	Conv. Hosp.	Evac. Hosp.	Gen. Hosp.	Sta. Hosp.	Surg. Hosp.
RA/RAI	0	0	2	3	24	37	1	11
OR	2	24	6	6	90	304	233	75
Totals	2	24	8	9	114	341	234	86

Organizations	Vet. Conv. Hosp.	Vet. Evac. Hosp.	Vet. Gen. Hosp.	Vet. Sta. Hosp.
RA/RAI	1	18	7	1
OR	6	24	65	39
Totals	7	36	72	40

Prior to 1940, none of these units were on active duty. Between August of that year and Pearl Harbor, however, numerous hospital units were activated as part of the mobilization leading up to America's entry into World War II. By 7 December 1941, no less than 19 evacuation hospitals, 29 general hospitals, 24 station hospitals, 10 surgical hospitals, and 3 veterinary hospitals were activated. Hundreds of others would be activated, many at affiliated medical colleges and hospitals, during the war.

In general, the medical department concentration centers, hospital centers, general hospitals, and station hospitals, were assigned to the Communications Zone, Zone of the Interior, or the General Headquarters Reserve. The convalescent hospitals, evacuation hospitals, and surgical hospitals were assigned to field armies. None of these latter units were assigned below the field army level, but could be attached to a corps

for specific operations, and in the case of the surgical hospital, were placed as far forward as the division rear area in direct support of a given division.

Training

Most of these organizations were organized as Reserve or RAI units during the interwar years. Though some of the hospitals were functional units and held training meetings during the Inactive Training Period, the majority were not functional. Every corps area used some of these hospitals as pool units for lieutenants or otherwise excess medical personnel. Functional units typically held their meetings at the hospital or medical school with which they were affiliated. In other cases, they often held meetings at other local medical facilities, nearby military medical facilities, or medical society buildings. A popular training event for Reserve medical personnel to attend was any one of several military-medico symposiums held at various locations across the country. These seminars started in the 1920s with a free training course offered to military reservists by Reserve Brigadier Generals Charles and William Mayo at the Mayo Clinic in Rochester, Minnesota. Brigadier General George Crile, also a reservist, saw the value in the Mayos' training efforts and in 1932 also offered a similar course to Reservists at Lakeshore Hospital in Cleveland, Ohio. Within a short time, additional courses were offered annually at Tulane University, Kansas City, Vanderbilt University, and Chicago. These seminars were excellent training events for the Reservists and typically lasted one to two weeks. Food and lodging was often provided free of charge leaving only travel as the only expense the Reservists had to bear. Given that the Reservists were not paid to attend the symposiums as they would be if they attended a summer camp, the free room and board was a welcome benefit, especially during the depression years.

Only a few of the corps areas ordered hospital units to attend summer training as units. This technique was used mostly in the Second, Sixth, Seventh, Eighth, and Ninth Corps Areas. The other four corps areas did not send hospital units to summer training. Instead, those corps areas sent their medical reservists to attend training at a post military hospital or to one of several military medical courses offered at the Army Medical School at Carlisle Barracks, or at a regional general hospital such as Walter Reed, Fitzsimons, and Letterman. Even when ordered to camp as a unit, most of the training provided to these reservists was either classroom seminars or medical training demonstrations. Often Medical Reservists would supplement hospital personnel at a post hospital, or support the inprocessing physicals and medical care for CMTC and ROTC camps. In some instances, units or individuals were also attached to Regular Army and National Guard medical regiments for training. The final training opportunity for Reserve hospital personnel during the interwar years was the CCC. Hundreds of Reserve doctors, dentists, and veterinarians volunteered for a one-year tour to provide medical support to the young men and veterans who composed America's "tree army" from 1933 to 1939.

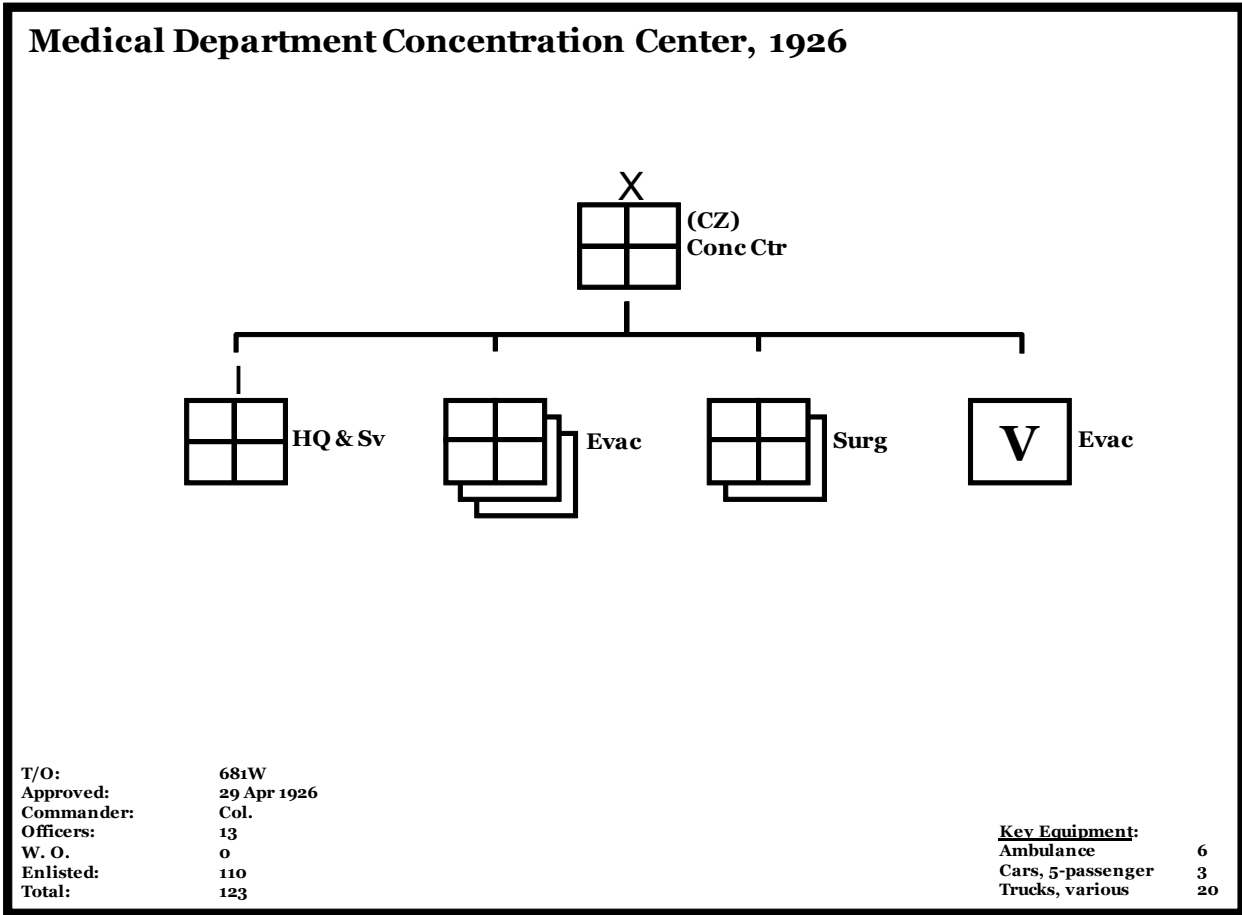

Medical Department Concentration Center TOE.

Medical Department Concentration Center mission: Provide the overhead for the administration of medical and veterinary units that are withdrawn from the combat zone for the purposes of reconstitution and rehabilitation (maximum capacity is three evacuation hospitals, two surgical hospitals, and one veterinary evacuation hospital). This effort would be required in cases where multiple medical units of the field army have been reduced by enemy action or require significant influx of personnel, equipment or supplies for some other reason.

1st Medical Department Concentration Center (C.Z.)

Organized Reserve District of Columbia

HQ-*Not initiated* 1923-27; Washington, DC, 1927-35; *Inactive* 1935-41

Constituted in the Organized Reserve 2 July 1923 as Concentration Center No. 1, assigned to the Communications Zone, and allotted to the Third Corps Area. Redesignated 23 March 1925 as the 1st Medical Department Concentration Center. Initiated by June 1927 at Washington, DC. Withdrawn from the Organized Reserve 1 October 1933 and allotted to the Regular Army. Concurrently, relieved from the Communications Zone and assigned to the General Headquarters Reserve. Inactivated by June 1934 at Washington, DC, by relief of personnel. Location 7 December 1941—*Inactive*.

Status: Inactive in the U.S. Army Reserve as the 411th Medical Concentration Center.

Commanders, 1st Medical Concentration Center

Unknown	ao Jun 27-Jun 34	<i>Inactive</i>		Jun 34-7 Dec 41
---------	------------------	-----------------	--	-----------------

2nd Medical Department Concentration Center (C.Z.)

Organized Reserve Kansas

HQ-*Not initiated* 1923-25; Junction City, KS, 1925-33

Constituted in the Organized Reserve 2 July 1923 as Concentration Center No. 2, assigned to the Communications Zone, and allotted to the Seventh Corps Area. Redesignated 23 March 1925 as the 2nd Medical Department Concentration Center. Initiated by August 1925 at Junction City, KS. Mobilization mission was to establish a medical concentration center at Camp Funston, KS. Demobilized 1 October 1933.

Commanders, 2nd Medical Concentration Center

Lt. Col. Oliver C. Wenger

ao Aug 25-Oct 30
Col. Leon Matassarin

Lt. Col. Leonard S. Steadman
Feb 31-1 Oct 33

Nov 30-Feb 31

Hospital Center, 1926

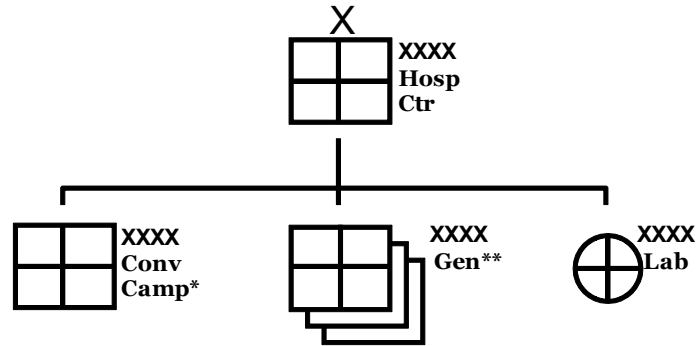

T/O: 688W
 Approved: 2 April 1926
 Commander: Brig. Gen.
 Officers: 46
 W. O.: 1
 Nurses: 2
 Enlisted: 342
 Total: 391

* The hospital center convalescent camp has a 1,000 bed capacity.
 ** Each hospital center may control 3 to 10 general hospitals.
 A hospital center will include a laundry, motor transport, bakery, and other Quartermaster Corps personnel, as well as Military Police, Finance, Postal, and Signal Corps detachments. The number of additional personnel depends upon the size of the center and whether the center is located in the Zone of the Interior or the Communications Zone.

Hospital Center TOE.

Hospital Center mission: Provide command, control, and administration of a group General Hospitals and other attached units which compose the center. These centers allow for a more efficient administration of a group of General Hospitals and application of specialized medical care.

1st Hospital Center (C.Z.)

Organized Reserve Pennsylvania

HQ—Not initiated 1923-25; Philadelphia, PA, 1925-40; Inactive 1940-41

Constituted in the Organized Reserve 2 July 1923, assigned to the Communications Zone, and allotted to the Fifth Corps Area. Designated 12 September 1923 as Hospital Center No. 1. Initiated 12 January 1925 at Philadelphia, PA. Redesignated 23 March 1925 as the 1st Hospital Center. Withdrawn from the Organized Reserve 1 October 1933 and allotted to the Regular Army. Concurrently, relieved from the Communications Zone and assigned to the General Headquarters Reserve. Inactivated 13 September 1940 at Philadelphia by relief of personnel. Location 7 December 1941—Inactive.

Status: Disbanded 11 November 1944.

Commanders, 1st Hospital Center

Maj. Richard J. Dehan	12 Jan 25-13 Jan 25	Col. Walter S. Cornell	30 Nov 26-21 Nov 28
Lt. Col. Charles H. Frazier	13 Jan 25-17 Jan 25	Col. Robert D. Brown	21 Nov 28-ao Jun 37
Lt. Col. William G. Turnbull	17 Jan 25-17 May 26	Unknown	ao Jun 37-13 Sep 40
Lt. Col. Robert D. Brown	17 May 26-30 Nov 26	Inactive	13 Sep 40-7 Dec 41

2nd Hospital Center (Z.I.)**Organized Reserve Maryland/Pennsylvania**

HQ—*Not initiated* 1923-25; Baltimore, MD, 1925-30; *Inactive* 1930-34; Philadelphia, PA, 1934-40; *Inactive* 1940-41

Constituted in the Organized Reserve 2 July 1923, assigned to the Communications Zone, and allotted to the Third Corps Area. Designated 12 September 1923 as Hospital Center No. 2. Initiated 12 January 1925 at Baltimore, MD. Redesignated 23 March 1925 as the 2nd Hospital Center. Inactivated by June 1930 at Baltimore by relief of personnel. Withdrawn from the Organized Reserve 1 October 1933 and allotted to the Regular Army. Concurrently, relieved from the Communications Zone and assigned to the General Headquarters Reserve. Reorganized 22 October 1934 with Organized Reserve personnel as a RAI unit with headquarters at Philadelphia, PA. Inactivated 13 September 1940 at Philadelphia by relief of personnel. Location 7 December 1941—*Inactive*.

Status: Disbanded 11 November 1944.

Commanders, 2nd Hospital Center

Lt. Col. Ross V. Patterson	12 Jan 25-17 Jan 25	Lt. Col. John B. McCreary	6 Sep 29-ao Jan 30
Lt. Col. Adam T. Finch	17 Jan 25-16 Feb 26	<i>Inactive</i>	ao Jun 30-22 Oct 34
Col. Charles Willcox	16 Feb 26-ao Jun 27	Lt. Col. Howard E. Ashbury	22 Oct 34-ao Jun 37
Lt. Col. John T. Sprague	ao Jun 28-10 Aug 29	Unknown	ao Jun 37-13 Sep 40
	<i>Inactive</i>	13 Sep 40-7 Dec 41	

3rd Hospital Center (Z.I.)**Organized Reserve Pennsylvania**

HQ—*Not initiated* 1923-25; Philadelphia, PA, 1925-29; *Inactive* 1929-34; Pittsburgh, PA, 1934-41

Constituted in the Organized Reserve 2 July 1923, assigned to the Communications Zone, and allotted to the Third Corps Area. Designated 12 September 1923 as Hospital Center No. 3. Initiated 12 January 1925 at Philadelphia, PA. Redesignated 23 March 1925 as the 3rd Hospital Center. Inactivated 11 September 1929 at Philadelphia by relief of personnel. Withdrawn from the Organized Reserve 1 October 1933 and allotted to the Regular Army. Concurrently, relieved from the Communications Zone and assigned to the General Headquarters Reserve. Reorganized by June 1934 at Pittsburgh, PA. Location 7 December 1941—Pittsburgh, PA.

Status: Disbanded 11 November 1944.

Commanders, 3rd Hospital Center

Maj. Clifford B. Farr	12 Jan 25-13 Jan 25	<i>Inactive</i>	11 Sep 29-ao Jun 34
Lt. Col. David Riesmann	13 Jan 25-26 Nov 26	Unknown	ao Jun 34-ao Aug 38
Col. Alfred J. Ostheimer	26 Nov 26-6 Sep 29	Col. John T. Keiser	ao Aug 38-14 Sep 38
Lt. Col. David Riesmann	6 Sep 26-11 Sep 26	Unknown	14 Sep 38-30 Sep 39
	Col. John T. Keiser	30 Sep 39-ao Aug 41	

4th Hospital Center (Z.I.)**Organized Reserve New York**

HQ—*Not initiated* 1923-25; Manhattan, NY, 1925-41

Authorized 28 December 1922 by the Surgeon General to be organized at Manhattan, NY. Constituted in the Organized Reserve 2 July 1923, assigned to the Communications Zone, and allotted to the Second Corps Area. Designated 12 September 1923 as Hospital Center No. 4. Initiated 23 January 1925 at Manhattan, NY. Redesignated 23 March 1925 as the 4th Hospital Center. Withdrawn from the Organized Reserve 1 October 1933 and allotted to the Regular Army. Concurrently, relieved from the Communications Zone and assigned to the General Headquarters Reserve. Location 7 December 1941—Manhattan, NY.

Status: Disbanded 11 November 1944.

Commanders, 4th Hospital Center

Lt. Col. Joseph A. Lanahan	23 Jan 25-21 Apr 25	Col. Owen H. Kenan	30 Mar 30-14 Jan 31
Col. Jean F. Wolfs	21 Apr 25-29 Jan 30	Lt. Col. Harry C. Saunders	14 Jan 31-ao Jun 32
Lt. Col. Samuel W. Hamilton	27 Feb 30-30 Mar 30	Unknown	ao Jun 32-9 Aug 34
	Col. Joseph Haas	9 Aug 34-ao Oct 41	

5th Hospital Center (Z.I.)**Organized Reserve New York****HQ-Not initiated** 1923-25; Manhattan, NY, 1925-41

Constituted in the Organized Reserve 2 July 1923, assigned to the Communications Zone, and allotted to the Second Corps Area. Designated 12 September 1923 as Hospital Center No. 5. Initiated 20 March 1925 at Manhattan, NY. Redesignated 23 March 1925 as the 5th Hospital Center. Withdrawn from the Organized Reserve 1 October 1933 and allotted to the Regular Army. Concurrently, relieved from the Communications Zone and assigned to the General Headquarters Reserve. Location 7 December 1941—Manhattan, NY.

Status: Disbanded 11 November 1944.**Commanders, 5th Hospital Center**

Lt. Col. Robert H. Halsey	20 Mar 25-2 Dec 25	Col. Howard Fox	2 Dec 25-20 Jul 37
	Col. Seigfried Block	20 Jul 37-ao Jun 41	

6th Hospital Center (Z.I.)**Organized Reserve New York****HQ-Not initiated** 1923-25; Brooklyn, NY, 1925-41

Constituted in the Organized Reserve 2 July 1923, assigned to the Communications Zone, and allotted to the Second Corps Area. Designated 12 September 1923 as Hospital Center No. 6. Redesignated 23 March 1925 as the 6th Hospital Center. Initiated 2 June 1925 at Brooklyn, NY. Withdrawn from the Organized Reserve 1 October 1933 and allotted to the Regular Army. Concurrently, relieved from the Communications Zone and assigned to the General Headquarters Reserve. Typically conducted Inactive Training Period meetings at the Army Building, 39 Whitehall Street in New York City. Location 7 December 1941—Brooklyn, NY.

Status: Disbanded 11 November 1944.**Commanders, 6th Hospital Center**

Lt. Col. Edmund P. Fowler	2 Jun 25-Sep 26	Unknown	Mar 30-16 Jan 35
Col. John H. Telfair	Sep 26-19 Dec 29	Col. Edmund P. Fowler	16 Jan 35-25 Jan 37
Col. Joseph C. DeVries	19 Dec 29-Mar 30	Lt. Col. Harold I. Gosline	25 Jan 37-ao Jan 41

7th Hospital Center (C.Z.)**Organized Reserve Massachusetts****HQ-Not initiated** 1923-25; Boston, MA, 1925-33; Fort Devens, MA, 1933-41

Constituted in the Organized Reserve 2 July 1923, assigned to the Communications Zone, and allotted to the First Corps Area. Designated 12 September 1923 as Hospital Center No. 7. Redesignated 23 March 1925 as the 7th Hospital Center. Initiated by June 1925 at Boston, MA. Relocated by 1933 to Fort Devens, MA. Withdrawn from the Organized Reserve 1 October 1933 and allotted to the Regular Army. Concurrently, relieved from the Communications Zone and assigned to the General Headquarters Reserve. Location 7 December 1941—Fort Devens, MA.

Status: Disbanded 11 November 1944.**Commanders, 7th Hospital Center**

Lt. Col. Leslie H. Spooner	ao Jun 25-5 Mar 26	Lt. Col. Leon S. Medalia	Aug 29-9 Jan 30
Lt. Col. Miles D. Chisholm	5 Mar 26-ao Sep 26	Col. Frank L. Morse	9 Jan 30-ao Jun 39
Lt. Col. Frederick L. Bogan	ao May 27-Aug 29	Unknown	ao Jun 39-7 Dec 41

8th Hospital Center (Z.I.)**Organized Reserve Connecticut/New York****HQ-Not initiated** 1923-25; Hartford, CT, 1925-33; *Inactive* 1933-37; Brooklyn, NY, 1937-41

Constituted in the Organized Reserve 2 July 1923, assigned to the Zone of the Interior, and allotted to the First Corps Area. Designated 12 September 1923 as Hospital Center No. 8. Redesignated 23 March 1925 as the 8th Hospital Center. Initiated 25 May 1925 at Hartford, CT. Withdrawn from the First Corps Area 1 October 1933 and allotted

to the Second Corps Area. Concurrently withdrawn from the Organized Reserve and allotted to the Regular Army. Additionally relieved from assignment to the Zone of the Interior and assigned to the General Headquarters Reserve. Organized by January 1937 at Brooklyn, NY. Location 7 December 1941—Brooklyn, NY.

Status: Disbanded 11 November 1944.

Commanders, 8th Hospital Center

Maj. Ralph W. Nauss	25 May 25-ao Jun 25	<i>Inactive</i>	1 Oct 33-ao Jan 37
Lt. Col. James C. Graves	ao Feb 26-Dec 29	Col. Henry A. Fisher	ao Jan 37-12 Oct 39
Unknown	Dec 29-1 Oct 33	Lt. Col. Charles E. Remy	12 Oct 39-19 Apr 41

9th Hospital Center (Z.I.)

Organized Reserve Rhode Island/Kentucky

HQ-*Not initiated* 1923-25; Providence, RI, 1925-27; *Inactive* 1927-41

Constituted in the Organized Reserve 2 July 1923, assigned to the Zone of the Interior, and allotted to the First Corps Area. Designated 12 September 1923 as Hospital Center No. 9. Redesignated 23 March 1925 as the 9th Hospital Center. Initiated in November 1925 at Providence, RI. Withdrawn from the First Corps Area 11 January 1927 and allotted to the Fifth Corps Area. Inactivated 5 February 1927 at Providence by relief of personnel. Covington, KY, designated as headquarters on reorganization, but the unit was never organized at that location. Location 7 December 1941—*Inactive*.

Status: Inactive in the U.S. Army Reserve as the 312th Station Hospital.

Commanders, 9th Hospital Center

Lt. Col. Murray S. Danforth	Nov 25-5 Feb 27	<i>Inactive</i>	5 Feb 27-7 Dec 41
-----------------------------	-----------------	-----------------	-------------------

10th Hospital Center (Z.I.)

Organized Reserve Georgia

HQ-*Not initiated* 1923-25; Atlanta, GA, 1925-31; Decatur, GA, 1931-41

Constituted in the Organized Reserve 2 July 1923, assigned to the Zone of the Interior, and allotted to the Fourth Corps Area. Designated 12 September 1923 as Hospital Center No. 10. Redesignated 23 March 1925 as the 10th Hospital Center. Initiated by June 1925 at Atlanta, GA. Relocated in September 1931 to Decatur, GA. Location 7 December 1941—Decatur, GA.

Status: Inactive in the U.S. Army Reserve as the 313th Station Hospital.

Commanders, 10th Hospital Center

Lt. Col. Samuel H. Long	ao Jun 25-ao Sep 25	Lt. Col. William P. Nicolson	18 Mar 30-14 Jun 30
Unknown	ao Sep 25-ao Jun 27	Lt. Col. Clarke B. Weeks	14 Jun 30-8 Mar 32
Lt. Col. Thomas R. W. Wilson	ao Jun 27-ao Jul 27	Col. Thaddeus S. Troy	8 Mar 32-1 Aug 37
Lt. Col. Nowdigate M. Owensby	ao Feb 28-22 Mar 28	Unknown	1 Aug 37-21 Aug 38
Unknown	22 Mar 28-18 Mar 30	Col. John H. Musser	21 Aug 38-ao Jan 41

11th Hospital Center (Z.I.)

Organized Reserve Louisiana

HQ-*Not initiated* 1923-25; New Orleans, LA, 1925-41

Constituted in the Organized Reserve 2 July 1923, assigned to the Zone of the Interior, and allotted to the Fourth Corps Area. Designated 12 September 1923 as Hospital Center No. 11. Redesignated 23 March 1925 as the 11th Hospital Center. Initiated by June 1925 at New Orleans, LA. Location 7 December 1941—New Orleans, LA.

Status: Inactive in the U.S. Army Reserve as the 314th Station Hospital.

Commanders, 11th Hospital Center

Lt. Col. Duke C. Bradford	ao Jun 25-12 Sep 29	Col. John A. Lanford	ao Apr 31-ao Jan 32
Unknown	12 Sep 29-ao Apr 31	Unknown	ao Jan 32-7 Dec 41

12th Hospital Center (C.Z.)**Organized Reserve Indiana****HQ-Not initiated** 1923-25; Fort Benjamin Harrison, IN, 1925-27; Indianapolis, IN, 1927-41

Constituted in the Organized Reserve 2 July 1923, assigned to the Communications Zone, and allotted to the Fifth Corps Area. Designated 12 September 1923 as Hospital Center No. 12. Redesignated 23 March 1925 as the 12th Hospital Center. Initiated by November 1925 at Fort Benjamin Harrison, IN. Relocated in 1927 to Indianapolis, IN. Location 7 December 1941—Indianapolis, IN.

Status: Active in the U.S. Army Reserve as the 313th Surgical Hospital at Vancouver, WA.**Commanders, 12th Hospital Center**

Lt. Col. Perry C. Traver	ao Nov 25-ao Jan 26	Unknown	ao Jun 35-ao Jul 38
Unknown	ao Jan 26-ao Jun 27	Lt. Col. Edward O. Little	ao Jul 38-ao Aug 38
Col. Waldo C. Farnham	ao Jun 27-ao Jun 35	Unknown	ao Aug 38-7 Dec 41

13th Hospital Center (Z.I.)**Organized Reserve Kentucky/Ohio**

HQ-Not initiated 1923-26; Fort Thomas, KY, 1926-27; Cincinnati, OH, 1927-29; *Inactive* 1929. Constituted in the Organized Reserve 2 July 1923, assigned to the Zone of the Interior, and allotted to the Fifth Corps Area. Designated 12 September 1923 as Hospital Center No. 13. Redesignated 23 March 1925 as the 13th Hospital Center. Initiated by May 1926 at Fort Thomas, KY. Relocated in 1927 to Cincinnati, OH. Inactivated in August 1929 at Cincinnati by relief of personnel. Location 7 December 1941—*Inactive*.

Status: Disbanded 30 January 1942.**Commanders, 13th Hospital Center**

Col. Cary P. McCord	ao May 26-Aug 29	<i>Inactive</i>	Aug 29-7 Dec 41
---------------------	------------------	-----------------	-----------------

14th Hospital Center (Z.I.)**Organized Reserve Kentucky****HQ-Not initiated** 1923-27; Camp Knox, KY, 1927; Louisville, KY, 1927-34; *Inactive* 1934-41

Constituted in the Organized Reserve 2 July 1923, assigned to the Zone of the Interior, and allotted to the Fifth Corps Area. Designated 12 September 1923 as Hospital Center No. 14. Redesignated 23 March 1925 as the 14th Hospital Center. Initiated by June 1927 at Camp Knox, KY. Relocated in late 1927 to Louisville, KY. Inactivated by June 1934 at Louisville by relief of personnel. Location 7 December 1941—*Inactive*.

Status: Disbanded 30 January 1942.**Commanders, 14th Hospital Center**

Lt. Col. Joseph G. Gaither	ao Jun 27-ao Oct 30	Col. James A. Duff	ao Apr 31-ao Jan 32
Unknown	ao Oct 30-ao Apr 31	Unknown	ao Jan 32-ao Jun 34
	<i>Inactive</i>	ao Jun 34-7 Dec 41	

15th Hospital Center (C.Z.)**Organized Reserve Michigan****HQ-Not initiated** 1923-24; Ann Arbor, MI, 1924-25; Detroit, MI, 1925-32; Saginaw, MI, 1932-41

Constituted in the Organized Reserve 2 July 1923, assigned to the Communications Zone, and allotted to the Sixth Corps Area. Designated 12 September 1923 as Hospital Center No. 15. Initiated in December 1924 at Ann Arbor, MI. Redesignated 23 March 1925 as the 15th Hospital Center. Relocated 10 April 1925 to Detroit, MI. Relocated 27 September 1932 to Saginaw, MI. Conducted summer training at the station hospital, Camp Custer, MI. Location 7 December 1941—Saginaw, MI.

Status: Inactive in the U.S. Army Reserve as the 301st Hospital Center.

Commanders, 15th Hospital Center

Unknown	Dec 24-10 Apr 25	Unknown	ao Jan 27-ao Dec 28
Lt. Col. Edward S. Blaine	10 Apr 25-16 Jun 25	Lt. Col. Edward S. Blaine	ao Dec 28-13 Jan 29
Col. Charles H. Peck	16 Jun 25-ao Jan 27	Lt. Col. James J. Haviland	13 Jan 29-Feb 32
	Unknown	Feb 32-7 Dec 41	

16th Hospital Center (Z.I.)

Organized Reserve Michigan

HQ-*Not initiated* 1923-24; Detroit, MI, 1924-41

Constituted in the Organized Reserve 2 July 1923, assigned to the Communications Zone, and allotted to the Sixth Corps Area. Designated 12 September 1923 as Hospital Center No. 16. Initiated in December 1924 at Detroit, MI. Redesignated 23 March 1925 as the 16th Hospital Center. Conducted summer training at the station hospital, Fort Snelling, MN. Location 7 December 1941—Detroit, MI.

Status: Inactive in the U.S. Army Reserve as the 315th Station Hospital.

Commanders, 16th Hospital Center

Unknown	Dec 24-ao Sep 25	Unknown	ao Jan 29-ao Jun 34
Lt. Col. John T. Sample	ao Sep 25-Jun 28	Lt. Col. Walter A. DeFoe	ao Jun 34-ao Jun 36
Maj. Frederick W. Baesleek	Jul 28-ao Jun 29	Unknown	ao Jun 36-7 Dec 41

17th Hospital Center (Z.I.)

Organized Reserve Illinois

HQ-*Not initiated* 1923-24; Chicago, IL, 1924-41

Constituted in the Organized Reserve 2 July 1923, assigned to the Communications Zone, and allotted to the Sixth Corps Area. Designated 12 September 1923 as Hospital Center No. 17. Initiated in December 1924 at Chicago, IL. Redesignated 29 June 1929 as the 17th Hospital Center. Conducted summer training at the station hospital, Fort Snelling, MN, or Fort Sheridan, IL. Location 7 December 1941—Chicago, IL.

Status: Inactive in the U.S. Army Reserve as the 316th Station Hospital.

Commanders, 17th Hospital Center

Col. Ralph Kaysen	Dec 24-20 May 26	Unknown	ao Jun 30-10 Nov 31
Lt. Col. William L. Baum	ao Jan 27-ao Jun 27	Col. Dudley T. Dawson	10 Nov 31-1 Jun 36
Unknown	ao Jun 27-15 Jan 29	Col. John C. Dallenbach	1 Jun 36-ao Jun 39
Lt. Col. Edward S. Blaine	15 Jan 29-ao Jun 30	Unknown	ao Jun 39-7 Dec 41

18th Hospital Center (Z.I.)

Organized Reserve Missouri/Minnesota

HQ-*Not initiated* 1923-25; Kansas City, MO, 1925-26; St. Paul, MN, 1926-41

Constituted in the Organized Reserve 2 July 1923, assigned to the Zone of the Interior, and allotted to the Seventh Corps Area. Designated 12 September 1923 as Hospital Center No. 18. Initiated in September 1925 at Kansas City, MO. Relocated 26 May 1926 to St. Paul, MN. Redesignated 29 June 1929 as the 18th Hospital Center. Location 7 December 1941—St. Paul, MN.

Status: Inactive in the Regular Army as the 317th Station Hospital.

Commanders, 18th Hospital Center

Unknown	Sep 25-ao Jun 27	Col. Lindsay S. Milne	Jul 29-19 May 38
Lt. Col. John R. Gardner	ao Jun 27-Jan 28	Col. Czar C. Johnson	19 May 38-22 Aug 38
Col. Czar C. Johnson	Jan 28-Jul 29	Unknown	22 Aug 38-7 Dec 41

19th Hospital Center (C.Z.)**Organized Reserve Texas/New York****HQ-Not initiated** 1923-25; Fort Sam Houston, TX, 1925-36; *Inactive* 1936-41

Constituted in the Organized Reserve 2 July 1923, assigned to the Communications Zone, and allotted to the Eighth Corps Area. Designated 12 September 1923 as Hospital Center No. 19. Redesignated 23 March 1925 as the 19th Hospital Center. Initiated 12 March 1925 at Fort Sam Houston, TX. Designated mobilization training station was Camp Stanley, TX. Withdrawn from the Eighth Corps Area 5 June 1936 and allotted to the Second Corps Area. New York City, NY, designated as headquarters on reorganization, but the unit was never organized at that location. Location 7 December 1941—*Inactive*.

Status: Inactive in the U.S. Army Reserve as the 318th Station Hospital.**Commanders, 19th Hospital Center**

Lt. Col. John W. Turner	12 Mar 25-15 Dec 27	Lt. Col. Charles E. Scull	8 Dec 28-ao Feb 32
Lt. Col. Orville D. Wescott	15 Dec 27-8 Dec 28	Unknown	ao Feb 29-5 Jun 36
	<i>Inactive</i>	5 Jun 36-7 Dec 41	

20th Hospital Center (Z.I.)**Organized Reserve Texas/New York****HQ-Not initiated** 1923-25; Houston, TX, 1925-36; *Inactive* 1936-41

Constituted in the Organized Reserve 2 July 1923, assigned to the Communications Zone, and allotted to the Eighth Corps Area. Designated 12 September 1923 as Hospital Center No. 20. Redesignated 23 March 1925 as the 20th Hospital Center. Initiated 23 September 1925 at Houston, TX. Designated mobilization training station was Camp Stanley, TX. Withdrawn from the Eighth Corps Area 5 June 1936 and allotted to the Second Corps Area. New York City, NY, designated as headquarters on reorganization, but the unit was never organized at that location. Location 7 December 1941—*Inactive*.

Status: Disbanded 30 January 1942.**Commanders, 20th Hospital Center**

Lt. Col. Harold I. Gosline	23 Sep 25-15 Dec 27	Lt. Col. James G. Flynn	8 Dec 28-ao Feb 32
Maj. William W. M. Johnson	15 Dec 27-8 Dec 28	Unknown	ao Feb 32-5 Jun 36
	<i>Inactive</i>	5 Jun 36-7 Dec 41	

21st Hospital Center (Z.I.)**Organized Reserve Colorado/New York****HQ-Not initiated** 1923-25; Denver, CO, 1925-36; *Inactive* 1936-41

Constituted in the Organized Reserve 2 July 1923, assigned to the Communications Zone, and allotted to the Eighth Corps Area. Designated 12 September 1923 as Hospital Center No. 21. Redesignated 23 March 1925 as the 21st Hospital Center. Initiated in April 1925 at Denver, CO. Conducted summer training at the station hospital, Fort Sam Houston, TX. Designated mobilization training station was Camp Stanley, TX, 1923-36. Withdrawn from the Eighth Corps Area 5 June 1936 and allotted to the Second Corps Area. Inactivated 12 November 1936 at Denver by relief of personnel. New York City, NY, designated as headquarters on reorganization, but the unit was never organized at that location. Location 7 December 1941—*Inactive*.

Status: Disbanded 30 January 1942.**Commanders, 21st Hospital Center**

Lt. Col. Gerald B. Webb	9 Feb 26-21 Apr 29	Col. Henry W. Pickett	7 Apr 33-29 Aug 33
Lt. Col. George E. Orsborn	21 Apr 29-12 Jun 31	Unknown	29 Aug 33-4 Jun 34
Unknown	12 Jun 31-7 Apr 33	Col. Thomas J. McCamant	4 Jun 34-12 Nov 36
	<i>Inactive</i>	12 Nov 36-7 Dec 41	

22nd Hospital Center (C.Z.)**Organized Reserve California****HQ-Not initiated** 1923-25; San Francisco, CA, 1925-41

Constituted in the Organized Reserve 2 July 1923, assigned to the Communications Zone, and allotted to the Ninth Corps Area. Designated 12 September 1923 as Hospital Center No. 22. Redesignated 23 March 1925 as the 22nd Hospital Center. Initiated about December 1925 at San Francisco, CA. Conducted summer training at the station hospital, Presidio of Monterey, CA, or Letterman General Hospital, San Francisco, CA. Location 7 December 1941—San Francisco, CA (inactivated 21 January 1942).

Status: Disbanded 11 November 1944.**Commanders, 22nd Hospital Center**

Lt. Col. Walter H. Winterberg	Dec 25-ao Mar 26	Lt. Col. Daniel L. High	Sep 31-23 Jan 35
Unknown	ao Mar 26-ao Jun 27	Lt. Col. Lynn C. Smith	23 Jan 35-28 Oct 35
Lt. Col. Louis J. E. Gouguet	ao Jun 27-ao Sep 27	Lt. Col. Philip J. Lipsett	28 Oct 35-24 Feb 37
Unknown	ao Sep 27-ao Dec 30	Col. Charles E. Mordoff	24 Feb 37-2 Mar 37
Lt. Col. Earl H. Welcome	ao Dec 30-Jan 31	Col. Elliot P. Smart	2 Mar 37-4 Oct 37
Unknown	Jan 31- Sep 31	Col. Philip H. Potter	4 Oct 37-ao Jun 38
	Unknown	ao Jun 38-7 Dec 41	

23rd Hospital Center (Z.I.)**Organized Reserve Washington/Indiana****HQ-Not initiated** 1923-25; Tacoma, WA, 1925-36; *Inactive* 1936-37; Hammond, IN, 1937-41

Constituted in the Organized Reserve 2 July 1923, assigned to the Communications Zone, and allotted to the Ninth Corps Area. Designated 12 September 1923 as Hospital Center No. 23. Redesignated 23 March 1925 as the 23rd Hospital Center. Initiated in November 1925 at Tacoma, WA. Withdrawn from the Ninth Corps Area 5 June 1936 and allotted to the Fifth Corps Area. Reorganized 5 April 1937 at Hammond, IN. Occasionally conducted Inactive Training Period meetings at the Henry Building in Seattle, WA. Location 7 December 1941—Hammond, IN.

Status: Disbanded 30 January 1942.**Commanders, 23rd Hospital Center**

Lt. Col. Charles F. Eikenberry	Nov 25-ao Jun 27	Unknown	ao Jun 31-ao Jun 34
Lt. Col. Robert L. Benson	ao Jun 27-ao Jul 27	Col. Ralph A. Fenton	ao Jun 34-26 May 36
Unknown	ao Jul 27-ao Apr 31	<i>Inactive</i>	26 May 36-5 Apr 37
Col. Alexander H. Peacock	ao Apr 31-ao Jun 31	Unknown	5 Apr 37-7 Dec 41

24th Hospital Center (Z.I.)**Organized Reserve California****HQ-Not initiated** 1923-25; Los Angeles, CA, 1925-37; *Inactive* 1937-41

Constituted in the Organized Reserve 2 July 1923, assigned to the Communications Zone, and allotted to the Ninth Corps Area. Designated 12 September 1923 as Hospital Center No. 24. Redesignated 23 March 1925 as the 24th Hospital Center. Initiated in November 1925 at Los Angeles, CA. Inactivated 4 March 1937 at Los Angeles by relief of personnel. Conducted summer training at the station hospital, Presidio of Monterey, CA. Location 7 December 1941—*Inactive*.

Status: Disbanded 11 November 1944.**Commanders, 24th Hospital Center**

Lt. Col. William H. Roberts	Nov 25-Mar 26	Lt. Col. Clarence M. Hyland	12 May 32-ao Jun 31
Lt. Col. Frank H. Paterson	Mar 26-ao Jun 27	Unknown	ao Jun 31-ao Jun 32
Unknown	ao Jun 27-ao Dec 30	Col. Joseph G. Evans	ao Jun 32-22 Apr 35
Lt. Col. Bryant R. Simpson	ao Dec 30-Jan 31	Col. Charles E. Sisson	22 Apr 35-11 Jun 35
Lt. Col. Earl H. Welcome	Jan 31-15 May 32	Col. Ralph Kayson	11 Jun 35-4 Mar 37
	<i>Inactive</i>	4 Mar 37-7 Dec 41	

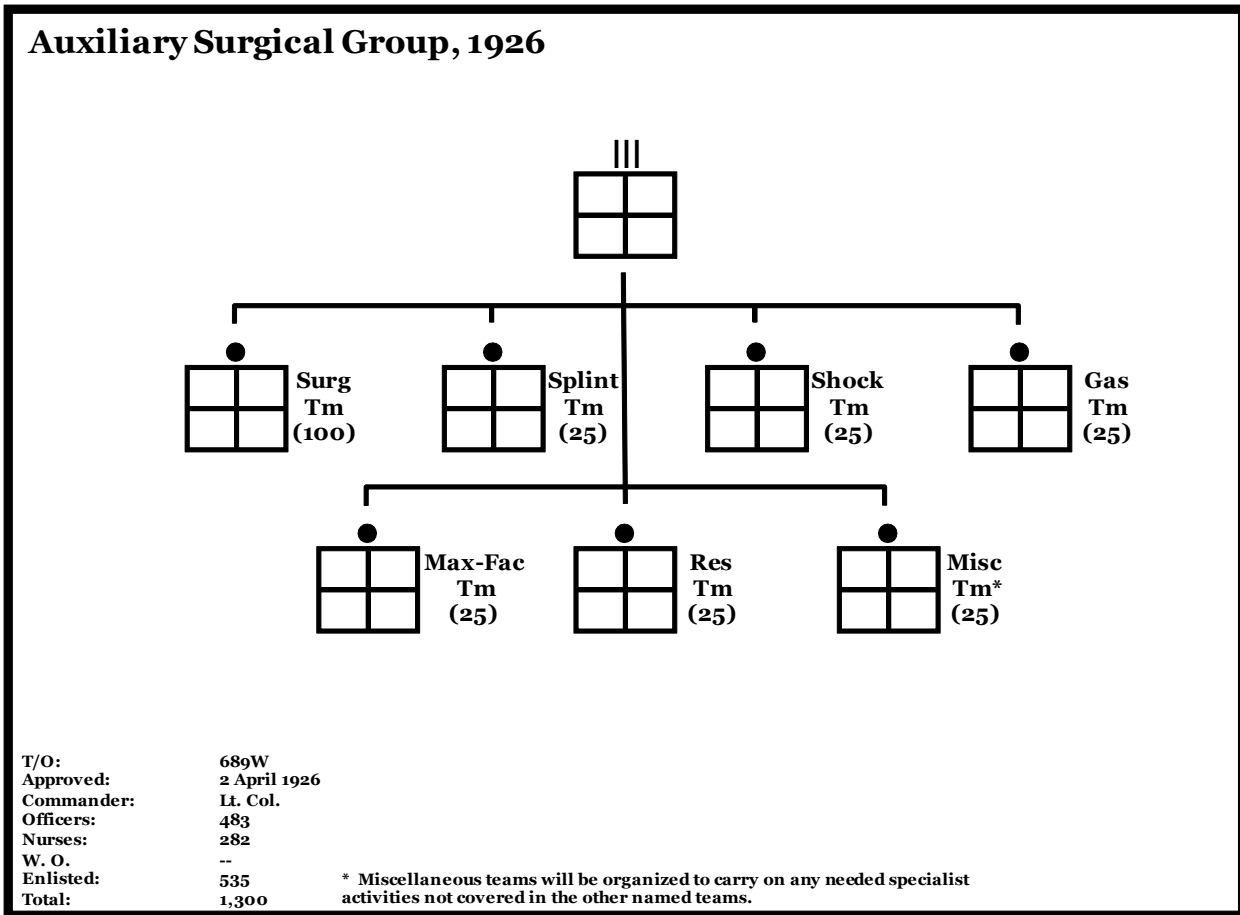

Auxiliary Surgical Group TOE.

Auxiliary Surgical Group mission: Organize and manage teams that provide specialized medical care such as maxillo-facial reconstruction, specialized surgery, splints, and gas casualties.

1st Auxiliary Surgical Group (C.Z.)

Organized Reserve Massachusetts/New York

HQ-*Not initiated 1923-26; Boston, MA, 1926-36; Inactive 1936-41*

Constituted in the Organized Reserve 12 September 1923 as Specialist Group No. 1, assigned to the Communications Zone, and allotted to the First Corps Area. Redesignated 23 March 1925 as the 1st Specialist Group. Initiated by April 1926 at Boston, MA. Redesignated 5 September 1928 as the 1st Auxiliary Surgical Group. Relieved from assignment to the Communications Zone 1 October 1933 and assigned to the General Headquarters Reserve. Withdrawn from the First Corps Area 5 June 1936 and allotted to the Second Corps Area. New York City, NY, designated as headquarters on reorganization, but the unit was never organized at that location. Location 7 December 1941—*Inactive*.

Commanders, 1st Auxiliary Surgical Group

Unknown	ao Apr 26-Mar 29	Maj. Frederick W. Day	15 Jan 30-ao Feb 30
Maj. George A. Cloutier	Mar 29-15 Jan 30	Unknown	ao Feb 30-5 Jun 36
	<i>Inactive</i>	5 Jun 36-7 Dec 41	

2nd Auxiliary Surgical Group (I) (C.Z.)**Organized Reserve Ohio****HQ-Not initiated** 1923-30; Cleveland, OH, 1930-33

Constituted in the Organized Reserve 12 September 1923 as Specialist Group No. 2, assigned to the Communications Zone, and allotted to the Fifth Corps Area. Redesignated 23 March 1925 as the 2nd Specialist Group. Redesignated 5 September 1928 as the 2nd Auxiliary Surgical Group. Initiated by February 1930 at Cleveland, OH. Demobilized 1 October 1933.

Commanders, 2nd Auxiliary Surgical Group (I)

Lt. Col. John H. Blackburn	ao Feb 30-1 Oct 33
----------------------------	--------------------

2nd Auxiliary Surgical Group (II) (C.Z.)**Regular Army Inactive****HQ-Not organized** 1933-34; Evanston, IL, 1934-37; Chicago, IL, 1937-41

Constituted in the Regular Army 1 October 1933, assigned to the General Headquarters Reserve, and allotted to the Sixth Corps Area. Organized by June 1934 at Evanston, IL. Relocated 9 October 1937 to Chicago, IL. Designated mobilization station was Fort Oglethorpe, GA. Location 7 December 1941—Chicago, IL.

Commanders, 2nd Auxiliary Surgical Group (II)

Unknown	ao Jun 34-ao Jun 36	Lt. Col. Henry L. Wenner**	ao Jan 37-9 Oct 37
Lt. Col. Claude H. Ogden**	ao Jun 36-ao Sep 36	Lt. Col. James C. Cerny**	9 Oct 37-ao Jan 40
	Unknown	ao Jan 40-7 Dec 41	

** RAI Commanders: Organized Reserve officers.

3rd Auxiliary Surgical Group (GHQR)**Regular Army Inactive****HQ-Not organized** 1928-30; New York City, NY, 1930-41

Constituted in the Regular Army 5 September 1928, assigned to the General Headquarters Reserve, and allotted to the Second Corps Area. Organized 6 February 1930 at New York City, NY. This unit functioned as a Medical Reserve Corps pool unit in 1940-41. All medical officers in the Second Corps Area that were assigned to hospitals and other medical organizations that had been activated, less assigned Organized Reserve personnel, during that period were reassigned to this group. Location 7 December 1941—New York City, NY.

Status: Active in the U.S. Army Reserve as HHC, 3rd Medical Command at Decatur, GA.**Commanders, 3rd Auxiliary Surgical Group**

Maj. James H. Van Marter**	6 Feb 30-ao May 30	Col. Alvin W. Schoenleber**	23 Jul 36-9 Nov 38
Unknown	ao May 30-16 Dec 34	Unknown	9 Nov 38-8 Dec 39
Col. William C. Davis**	16 Dec 34-23 Jul 36	Col. Henry A. Fisher**	8 Dec 39-30 Jul 41
	Col. Charles F. Claussen**	30 Jul 41-ao Dec 41	

** RAI Commanders: Organized Reserve officers.

4th Auxiliary Surgical Group (GHQR)**Organized Reserve Pennsylvania****HQ-Not initiated** 1928-29; Philadelphia, PA, 1929; *Inactive* 1929-41

Constituted in the Organized Reserve 5 September 1928, assigned to the General Headquarters Reserve, and allotted to the Third Corps Area. Initiated by July 1929 at Philadelphia, PA. Inactivated 16 August 1929 at Philadelphia by relief of personnel. Location 7 December 1941—*Inactive*.

Status: Active in the U.S. Army Reserve as HHC, 4th Medical Brigade at Heidelberg, Germany.**Commanders, 4th Auxiliary Surgical Group**

Lt. Col. Matthew L. Carr	ao Jul 29-16 Aug 29	<i>Inactive</i>	16 Aug 29-7 Dec 41
--------------------------	---------------------	-----------------	--------------------

5th Auxiliary Surgical Group (GHQR)**Organized Reserve Illinois****HQ**-*Not initiated* 1928-29; Chicago, IL, 1929-37; *Inactive* 1937-41

Constituted in the Organized Reserve 5 September 1928, assigned to the General Headquarters Reserve, and allotted to the Sixth Corps Area. Initiated 23 August 1929 at Chicago, IL. Inactivated 9 October 1937 at Chicago by transfer of personnel to the 2nd Auxiliary Surgical Group. Conducted summer training at the station hospital, Fort Sheridan, IL. Location 7 December 1941—*Inactive*.

Status: Active in the U.S. Army Reserve as HHC, 5th Medical Group at Birmingham, AL.**Commanders, 5th Auxiliary Surgical Group**

Maj. Loren D. Sayre	23 Aug 29-3 Jan 30	Lt. Col. Emery B. Neff	ao Jun 33-1 Sep 36
Maj. George H. Edgington	3 Jan 30-ao Jun 32	Lt. Col. James C. Cerny	1 Sep 36-9 Oct 37
	<i>Inactive</i>	9 Oct 37-7 Dec 41	

6th Auxiliary Surgical Group (GHQR)**Organized Reserve California/New York****HQ**-*Not initiated* 1928-30; San Francisco, CA, 1928-30; *Inactive* 1930-41

Constituted in the Organized Reserve 5 September 1928, assigned to the General Headquarters Reserve, and allotted to the Ninth Corps Area. Initiated by December 1928 at San Francisco, CA. Inactivated 15 April 1930 at San Francisco by relief of personnel. Withdrawn from the Ninth Corps Area 5 June 1936 and allotted to the Second Corps Area. New York City, NY, designated as headquarters on reorganization, but the unit was never organized at that location. Location 7 December 1941—*Inactive*.

Commanders, 6th Auxiliary Surgical Group

Unknown	ao Dec 28-15 Apr 30	<i>Inactive</i>	15 Apr 30-7 Dec 41
---------	---------------------	-----------------	--------------------

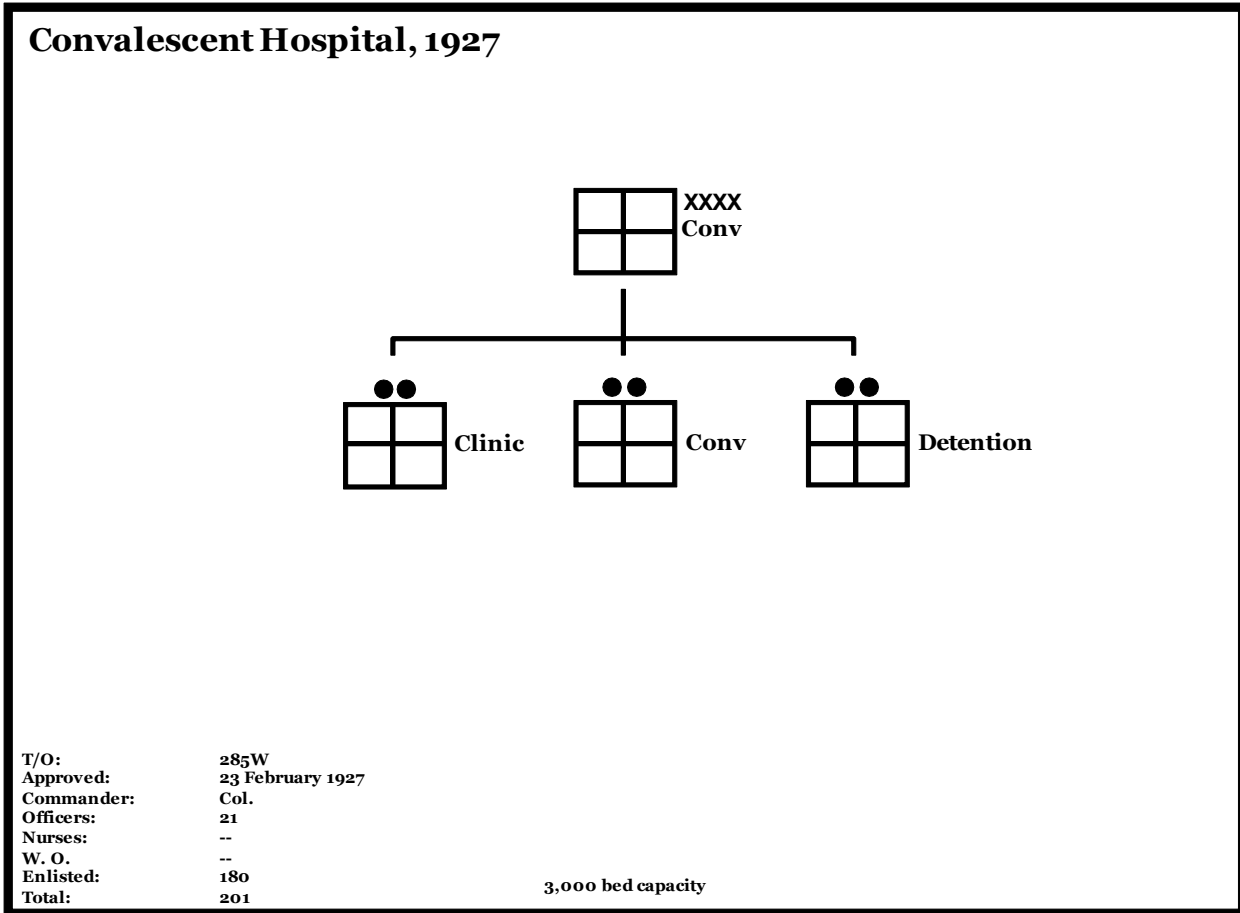

Convalescent Hospital TOE.

Convalescent Hospital mission: Render treatment to cases whose nature does not warrant further definitive treatment in an evacuation hospital and whose duration and prognosis does not warrant transfer to a general hospital in the Communications Zone.

1st Convalescent Hospital (I) (Fourth Army)

Organized Reserve Rhode Island/Massachusetts

HQ-*Not initiated* 1923-25; Providence, RI, 1925-27; Worcester, MA, 1927-33

Constituted in the Organized Reserve 2 July 1923, assigned to the Fourth Army, and allotted to the First Corps Area. Designated 12 September 1923 as Convalescent Hospital No. 1. Redesignated 23 March 1925 as the 1st Convalescent Hospital. Initiated by November 1925 at Providence, RI. Relocated by September 1927 to Worcester, MA. Demobilized 1 October 1933.

Commanders, 1st Convalescent Hospital (I)

Maj. Harold W. Wright

ao Nov 25-ao Jul 28

Unknown

ao Jul 28-ao Apr 31

Maj. Warner A. Walker

ao Apr 31-1 Oct 33

1st Convalescent Hospital (II) (First Army)

Regular Army Inactive

HQ-*Not organized* 1933-34; New York City, NY, 1934-41

Constituted in the Regular Army 1 October 1933, assigned to the First Army, and allotted to the Second Corps Area. Organized about March 1934 at New York City, NY. Location 7 December 1941—New York City, NY.

Commanders, 1st Convalescent Hospital (I)

1st Lt. Paul W. Seldon**	Mar 34-3 Jul 34	Unknown	22 Oct 36-ao Dec 37
Capt. Frederick M. Dimas **	2 Jul 34-21 Dec 34	Col. Arthur W. Slee**	ao Dec 37-10 Mar 38
Capt. John D. Cooney**	21 Dec 34-22 Oct 36	Capt. Isadore A. Kramer**	10 Mar 38-9 Jan 40
	1st Lt. Benjamin Dinerman **	9 Jan 40-26 Feb 41	

**RAI Commanders: Organized Reserve officers.

2nd Convalescent Hospital (I) (Sixth Army)

Organized Reserve Texas

HQ-*Not initiated* 1923-25; Fort Bliss, TX, 1925-29; *Inactive* 1929-33

Constituted in the Organized Reserve 2 July 1923, assigned to the Sixth Army, and allotted to the Eighth Corps Area. Designated 12 September 1923 as Convalescent Hospital No. 2. Redesignated 23 March 1925 as the 2nd Convalescent Hospital. Initiated 27 July 1925 at Fort Bliss, TX. Inactivated 2 January 1929 at Fort Bliss by relief of personnel. Conducted summer training at the station hospital, Fort Sam Houston, TX. Demobilized 1 October 1933.

Commanders, 2nd Convalescent Hospital (I)

Col. Frederic J. Pierce	27 Jul 25-11 Mar 27	Maj. Pedro R. Casellas	22 Oct 28-2 Jan 29
Lt Col. Herbert E. Stevenson	11 Mar 27-22 Oct 28	<i>Inactive</i>	2 Jan 29-1 Oct 33

2nd Convalescent Hospital (II) (Second Army)

Regular Army Inactive

HQ-Maywood, IL 1933-40; Chicago, IL, 1940-41

Constituted in the Regular Army 1 October 1933, assigned to the Second Army, and allotted to the Sixth Corps Area. Organized by December 1933 at Maywood, IL. Relocated 2 January 1940 to Chicago, IL. Location 7 December 1941—Chicago, IL.

Commanders, 2nd Convalescent Hospital (II)

Unknown	ao Dec 33-7 Dec 41
---------	--------------------

3rd Convalescent Hospital (I) (Third Army)

Organized Reserve California

HQ-*Not initiated* 1923-26; San Francisco, CA, 1926-30; *Inactive* 1930-33

Constituted in the Organized Reserve 2 July 1923, assigned to the Third Army, and allotted to the Ninth Corps Area. Designated 12 September 1923 as Convalescent Hospital No. 3. Redesignated 23 March 1925 as the 3rd Convalescent Hospital. Initiated in March 1926 at San Francisco, CA. Inactivated 15 April 1930 at San Francisco by relief of personnel. Demobilized 1 October 1933.

Commanders, 3rd Convalescent Hospital (I)

Col. John W. Shields	31 Mar 26-15 Apr 30	<i>Inactive</i>	15 Apr 30-1 Oct 33
----------------------	---------------------	-----------------	--------------------

3rd Convalescent Hospital (II) (Fourth Army)

Regular Army Inactive

HQ-*Not organized* 1933-36; Ventura, CA, 1936-41

Constituted in the Regular Army 1 October 1933, assigned to the Fourth Army, and allotted to the Ninth Corps Area. Organized 27 May 1936 at Ventura, CA. Conducted summer training at Letterman General Hospital, San Francisco, CA. Location 7 December 1941—Ventura, CA.

Commanders, 3rd Convalescent Hospital (II)

Maj. Lloyd H. Mott** 27 May 36-4 Mar 37 Unknown 4 Mar 37-7 Dec 41
** RAI Commanders: Organized Reserve officers.

4th Convalescent Hospital (First Army) Organized Reserve South Carolina/Georgia

HQ—*Not initiated* 1923-25; Columbia, SC, 1925-39; Augusta, GA 1939-40; *Inactive* 1940-41

Reconstituted in the Organized Reserve 2 July 1923, assigned to the First Army, and allotted to the Fourth Corps Area. Designated 12 September 1923 as Convalescent Hospital No. 4. Redesignated 23 March 1925 as the 4th Convalescent Hospital. Initiated 8 May 1925 at Columbia, SC. Withdrawn from the Organized Reserve 5 September 1928 and allotted to the Regular Army. Relieved from the First Army 1 October 1933 and assigned to Third Army. Relocated by June 1939 to Augusta, GA. Inactivated 28 August 1940 at Augusta by relief of personnel. Location 7 December 1941—*Inactive*.

Status: Inactive in the U.S. Army Reserve as the 372nd Convalescent Hospital.

Commanders, 4th Convalescent Hospital

Maj. Albert G. Tillman	8 May 25-ao Jun 25	Lt. Col. John D. Gable	14 Sep 29-Feb 31
Unknown	ao Jun 25-ao Jun 27	Lt. Col. Hathaway J. Denman	Mar 31-ao Jul 31
Col. Seale Harris	ao Jun 27-12 Feb 29	Unknown	ao Jul 31-28 Aug 40
Maj. James M. Doll	12 Feb 29-14 Sep 29	<i>Inactive</i>	28 Aug 40-7 Dec 41

5th Convalescent Hospital (Second Army) Organized Reserve Indiana

HQ—*Not initiated* 1923-25; Fort Benjamin Harrison, IN, 1925-27; Martinsville, IN, 1927-33

Constituted in the Organized Reserve 2 July 1923 as Convalescent Hospital No. 5, assigned to the Second Army, and allotted to the Fifth Corps Area. Designated 12 September 1923 as Convalescent Hospital No. 5. Redesignated 23 March 1925 as the 5th Convalescent Hospital. Initiated by October 1925 at Fort Benjamin Harrison, IN. Relocated by 1927 to Martinsville, IN. Demobilized 1 October 1933. Reconstituted 1 July 1940 in the Regular Army. Location 7 December 1941—*Inactive*.

Status: Inactive in the U.S. Army Reserve as the 373rd Convalescent Center.

Commanders, 5th Convalescent Hospital

Lt. Col. Ithimer M. Casebeer	ao Oct 25-ao May 30	Unknown	ao May 30-1 Oct 33
	<i>Demobilized/Inactive</i>	1 Oct 33-7 Dec 41	

6th Convalescent Hospital (Fifth Army) Organized Reserve Kansas

HQ—*Not initiated* 1923-27; Camp Funston, KS, 1927-28; Topeka, KS, 1928-33

Reconstituted in the Organized Reserve 2 July 1923, assigned to the Fifth Army, and allotted to the Seventh Corps Area. Designated 12 September 1923 as Convalescent Hospital No. 6. Redesignated 23 March 1925 as the 6th Convalescent Hospital. Initiated by June 1927 at Camp Funston, KS. Relocated 3 April 1928 to Topeka, KS. Demobilized 1 October 1933.

Commanders, 6th Convalescent Hospital

Col. Benjamin W. Kelly	ao Jun 27-Feb 30	Col. Charles W. Hibbett	Feb 30-Mar 30
	Col. Gilbert G. Cottam	Mar 30-1 Oct 33	

603rd Convalescent Hospital

Regular Army Inactive

HQ-*Not organized* 1927-28

Constituted in the Regular Army 18 October 1927 and allotted to the Ninth Corps Area. Withdrawn from the Ninth Corps Area 5 September 1928. Demobilized 21 December 1928.

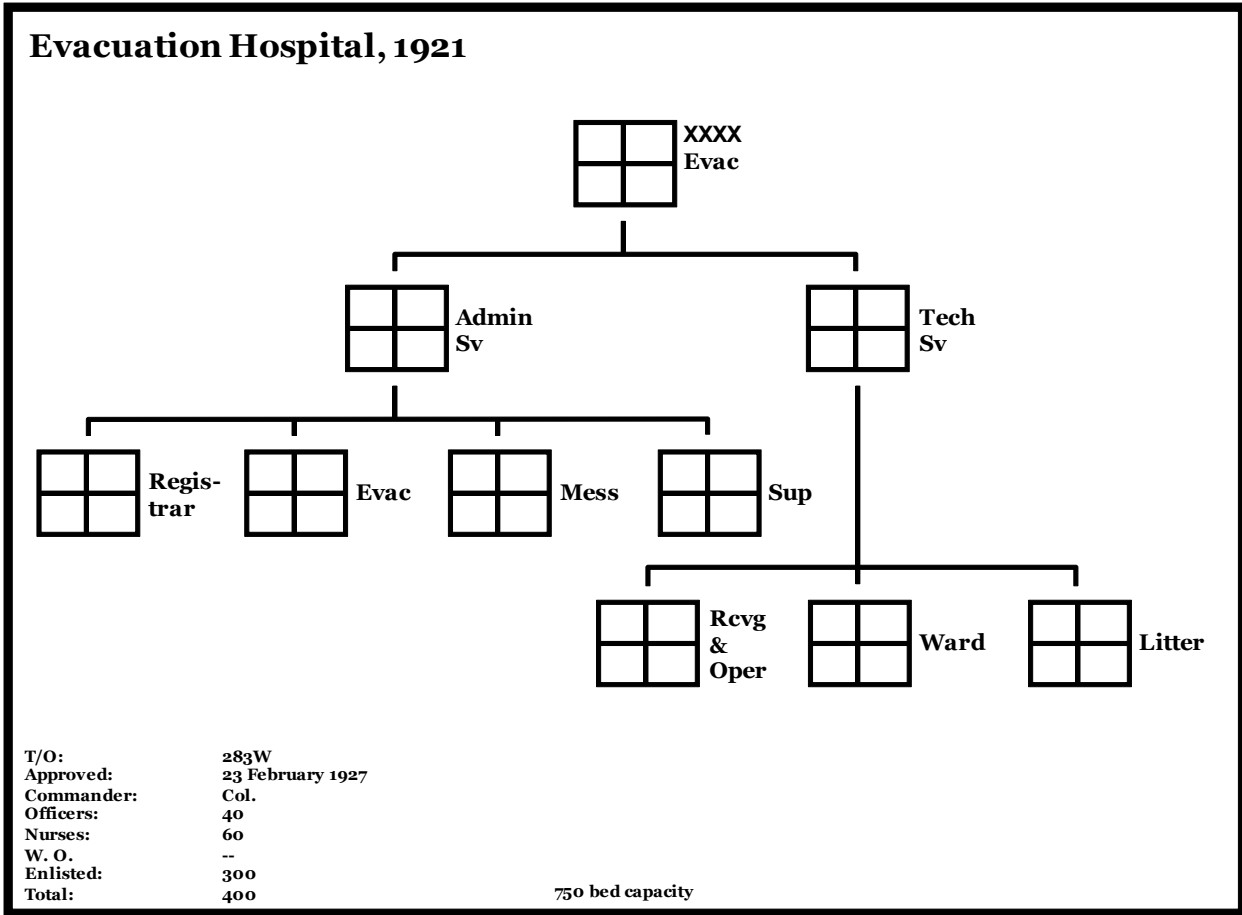

Evacuation Hospital TOE.

Evacuation Hospital mission: The principal medical hospital in the Combat Zone. As near the front line as possible, provide facilities for major medical and surgical procedures; conduct the efficient collection and mass evacuation of casualties from the army rear area to convalescent or general hospitals, or a hospital center in the Communications Zone.

1st Evacuation Hospital (First Army)

Organized Reserve Maryland

HQ-Not initiated 1923-25; Baltimore, MD, 1925-40; Fort George G. Meade, MD, 1940-41



Authorized by the Surgeon General 30 January 1923 for organization at, and affiliation with, Johns-Hopkins Hospital in Baltimore, MD. Constituted in the Organized Reserve 12 September 1923 as Evacuation Hospital No. 1, assigned to the First Army, and allotted to the Third Corps Area. Redesignated 23 March 1925 as the 1st Evacuation Hospital. Initiated by April 1925 at Baltimore. Withdrawn from the Organized Reserve 1 October 1933 and allotted to the Regular Army. Consolidated in November 1936 with Evacuation Hospital No. 1 (a WWI unit organized in October 1917 at Fort Riley, KS; demobilized in May 1919 at Camp Funston, KS; reconstituted in November 1936). Designated mobilization station was Carlisle Barracks, PA. Activated 1 August 1940, less Reserve personnel, at Fort George G. Meade, MD, and assigned to the First Army. Location 7 December 1941—Fort George G. Meade, MD.

Status: Inactive in the Regular Army as the 248th General Hospital.

Events: 301, 330

Commanders, 1st Evacuation Hospital

Maj. Alan C. Sutton	ao Apr 25-ao Jan 26	Unknown	19 Jan 31-1 Aug 40
Lt. Col. Raymond R. Decker	ao Jun 26-13 Nov 29	Lt. Col. Edwin B. Maynard*	1 Aug 40-ao Jan 41
Maj. Daniel C. W. Smith	13 Nov 29-19 Jan 31	Lt. Col. R. G. Devoe*	ao Aug 41-ao Jan 42

* Regular Army active duty commanders

** RAI Commanders: Organized Reserve officers.

2nd Evacuation Hospital (I) (First Army)

Organized Reserve New York

HQ-New York City, NY, 1922-28

Authorized by the Surgeon General 26 February 1923 for organization at, and affiliation with, St. Luke's Hospital in New York City, NY. Constituted in the Organized Reserve 12 September 1923 as Evacuation Hospital No. 2, assigned to the First Army, and allotted to the Second Corps Area. Redesignated 23 March 1925 as the 2nd Evacuation Hospital. Withdrawn from the Second Corps Area 6 October 1928 and demobilized.

Commanders, 2nd Evacuation Hospital (I)

Col. H. M. M. Lyle	26 Feb 23-ao Jan 24	Unknown	ao Jan 24-6 Oct 28
--------------------	---------------------	---------	--------------------

2nd Evacuation Hospital (II) (First Army)

Regular Army Inactive

HQ-*Not organized* 1928-29; Springfield, MA, 1929-36; *Inactive* 1936-37; Syracuse, NY, 1937-40; New York City, NY, 1940-41

Constituted in the Regular Army 21 December 1928, assigned to the First Army, and allotted to the First Corps Area. Organized by June 1929 at Springfield, MA. Withdrawn from the First Corps Area 5 June 1936 and allotted to the Second Corps Area. Consolidated 5 November 1936 with Evacuation Hospital No. 2 (a WWI unit organized in July 1917 at Fort Benjamin Harrison, IN; demobilized 7 May 1919 at Camp Zachary Taylor, KY; reconstituted 5 November 1936). Reorganized 23 May 1937 at Syracuse, NY. Relocated 30 August 1940 to New York City. Concurrently affiliation established with St. Luke's Hospital. Conducted summer training at Carlisle Barracks, PA. Location 7 December 1941—New York City, NY.

Status: Active in the Regular Army as the 502nd Surgical Hospital.

Commanders, 2nd Evacuation Hospital

Lt. Col. Gustave P. Grabfield**	ao Jun 29-5 Jun 36	1st Lt. Phillip G. Baker**	23 May 37-28 Jul 37
<i>Inactive</i>	5 Jun 36-30 May 37	Lt. Col. Raeburn J. Wharton**	28 Jul 37-16 Sep 41
	Maj. Duncan R. McCusig	16 Sep 41-ao Oct 41	

* Regular Army active duty commanders

** RAI Commanders: Organized Reserve officers.

3rd Evacuation Hospital (First Army)

Organized Reserve New York

HQ-*Not initiated* 1923-25; New York City, NY, 1925-40; Fort Benning, GA, 1940-41

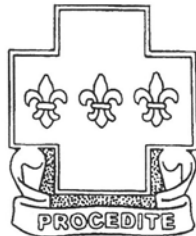

Constituted in the Organized Reserve 12 September 1923 as Evacuation Hospital No. 3, assigned to the First Army, and allotted to the Second Corps Area. Authorized by the Surgeon General 16 January 1924 for organization at, and affiliation with, New York Post Graduate Medical School and Hospital in New York City, NY. Organized 23 January 1925 at New York City. Redesignated 23 March 1925 as the 3rd Evacuation Hospital. Withdrawn from the Organized Reserve 1 October 1933 and allotted to the Regular Army. Consolidated in October 1936 with Evacuation Hospital No. 3 (a WWI unit organized in September 1917 at Fort Oglethorpe, GA; demobilized 22 April 1919 at Camp Dix, NJ; reconstituted in October 1936). Activated 1 August 1940, less Reserve personnel, at Fort Benning, GA, and assigned to the Third Army. Location 7 December 1941—Fort Benning, GA.

Status: Disbanded 24 August 1942.

Events: 328

Commanders, 3rd Evacuation Hospital

Capt. Joseph Z. Biegeleisen	23 Jan 25-3 Feb 25	Col. John J. Moorhead	7 Oct 25-1 Mar 29
Maj. John D. Stewart	3 Feb 25-6 Feb 25	Unknown	1 Mar 29-2 Jul 35
Lt. Col. John F. Erdman	6 Feb 25-1 Oct 25	Lt. Col. Samuel Zwerling**	2 Jul 35-1 Aug 40
Col. William F. Snow	1 Oct 25-7 Oct 25	Unknown	1 Aug 40-7 Dec 41

** RAI Commanders: Organized Reserve officers.

4th Evacuation Hospital (Sixth Army)

Organized Reserve Missouri

HQ-Not initiated 1923-25; St. Louis, MO, 1925-41; Fort Devens, MA, 1941

Authorized by the Surgeon General 30 January 1923 for organization at, and affiliation with, Washington University Medical School in St. Louis, MO. Constituted in the Organized Reserve 12 September 1923 as Evacuation Hospital No. 4, assigned to the Sixth Army, and allotted to the Seventh Corps Area. Redesignated 23 March 1925 as the 4th Evacuation Hospital. Initiated by September 1925 at St. Louis. Withdrawn from the Organized Reserve 1 October 1933 and allotted to the Regular Army. Concurrently relieved from the Sixth Army and assigned to the Fourth Army. Consolidated in October 1936 with Evacuation Hospital No. 4 (a WWI unit organized in November 1917 at Fort Oglethorpe, GA; demobilized in May 1919 at Camp Upton, NY; reconstituted in October 1936). Conducted summer training at the station hospital, Fort Snelling, MN. Designated mobilization station was Camp Dodge, IA. Activated 10 February 1941, less Reserve personnel, at Fort Devens, MA, and assigned to the First Army. Location 7 December 1941—Fort Devens, MA.

Status: Disbanded 13 August 1942.

Commanders, 4th Evacuation Hospital

Unknown	ao Sep 25-ao Jun 27	Lt. Col. Elmer B. M. Casey**	22 Aug 37-ao Sep 37
Lt. Col. Lawrence B. Post	ao Jun 27-ao Jan 32	Unknown	ao Sep 37-10 Feb 41
Unknown	ao Jan 32-22 Aug 37	Capt. Pyle A. Radke*	10 Feb 41-ao Dec 41

* Regular Army active duty commanders

** RAI Commanders: Organized Reserve officers.

5th Evacuation Hospital (Second Army)

Organized Reserve Massachusetts/New York

HQ-Not initiated 1923-23; Boston, MA, 1923-30; *Inactive* 1930-37; New York City, NY, 1937-41

Constituted in the Organized Reserve 12 September 1923 as Evacuation Hospital No. 5, assigned to the Second Army, and allotted to the First Corps Area. Authorized by the Surgeon General 17 November 1923 for organization at, and affiliation with, Massachusetts Homeopathic Hospital in Boston, MA. Concurrently initiated at Boston. Redesignated 23 March 1925 as the 5th Evacuation Hospital. Inactivated 11 January 1930 at Boston by relief of personnel. Withdrawn from the Organized Reserve 1 October 1933 and allotted to the Regular Army. Withdrawn from the First Corps Area 5 June 1936 and allotted to the Second Corps Area. Consolidated 9 November 1936 with Evacuation Hospital No. 5 (a WWI unit organized 20 November 1917 at Fort Oglethorpe, GA; demobilized 14 March 1919 at Camp Upton, NY; reconstituted 5 November 1936). Reorganized 14 August 1937 at New York City, NY. Conducted summer training at Carlisle Barracks, PA. Designated mobilization station was Fort Devens, MA, 1923-36. Primary R.O.T.C. feeder school was Cornell University Medical School. Location 7 December 1941—New York City, NY.

Status: Active in the Regular Army as the 5th Surgical Hospital at Fort Bragg, NC.

Commanders, 5th Evacuation Hospital

Lt. Col. Thomas E. Chandler	17 Nov 23-ao Jun 27	Capt. Alexander T. McPherson	ao Dec 29-11 Jan 30
Unknown	ao Jun 27-ao Dec 29	<i>Inactive</i>	11 Jan 30-14 Aug 37
	Col. Harry C. Saunders**	14 Aug 37-ao Jun 41	

** RAI Commanders: Organized Reserve officers.

6th Evacuation Hospital (Second Army)**Organized Reserve Rhode Island/New York**

HQ-*Not initiated* 1923-26; Providence, RI, 1926-33; *Inactive* 1933-37; New York City, NY, 1937-41; Camp Blanding, FL, 1941

Constituted in the Organized Reserve 12 September 1923 as Evacuation Hospital No. 6, assigned to the Second Army, and allotted to the First Corps Area. Authorized by the Surgeon General 21 August 1924 for organization at, and affiliation with, Rhode Island Hospital in Providence, RI. Redesignated 23 March 1925 as the 6th Evacuation Hospital. Initiated by March 1926 at Providence. Withdrawn from the Organized Reserve 1 October 1933 and allotted to the Regular Army. Concurrently relieved from the Second Army and assigned to the First Army. Withdrawn from the First Corps Area 5 June 1936 and allotted to the Second Corps Area. Consolidated in October 1936 with Evacuation Hospital No. 6 (a WWI unit organized in November 1917 at Fort Oglethorpe, GA; demobilized 1 May 1919 at Camp Upton, NY; reconstituted in October 1936). Reorganized by January 1937 at New York City, NY. Activated 8 February 1941, less Reserve personnel, at Camp Blanding, FL. Concurrently relieved from the First Army and assigned to the Third Army. Location 7 December 1941—Camp Blanding, FL.

Status: Disbanded 24 August 1942.

Commanders, 6th Evacuation Hospital

Lt. Col. Charles F. Ghormley	ao Mar 26-Dec 29	<i>Inactive</i>	5 Jun 36-ao Jan 37
Unknown	Dec 29-5 Jun 36	Lt. Col. Edward Adams**	ao Jan 37-8 Feb 41
	Capt. Norman E. King**	8 Feb 41-ao Mar 41	

* Regular Army active duty commanders

** RAI Commanders: Organized Reserve officers.

7th Evacuation Hospital (I) (Second Army)**Organized Reserve Massachusetts**

HQ-*Not initiated* 1923-24; Worcester, MA, 1924-28

Constituted in the Organized Reserve 12 September 1923 as Evacuation Hospital No. 7, assigned to the Second Army, and allotted to the First Corps Area. Initiated 21 August 1924 at Worcester, MA. Redesignated 23 March 1925 as the 7th Evacuation Hospital. Withdrawn from the Organized Reserve 6 October 1928 and demobilized.

Commanders, 7th Evacuation Hospital

Lt. Col. Robert J. Graves	21 Aug 24-6 Oct 28
---------------------------	--------------------

7th Evacuation Hospital (II) (Second Army)**Regular Army Inactive**

HQ-Worcester, MA, 1928-36; *Inactive* 1936-38; Newark, NJ, 1938-41

Constituted in the Regular Army 21 December 1928, assigned to the Second Army, and allotted to the First Corps Area. Concurrently organized at Worcester, MA. Relieved from the Second Army 1 October 1933 and assigned to the First Army. Withdrawn from the First Corps Area 5 June 1936 and allotted to the Second Corps Area. Consolidated 9 November 1936 with Evacuation Hospital No. 7 (a WWI unit organized in November 1917 at Fort Riley, KS; demobilized 1 May 1919 at Camp Devens, MA; reconstituted 9 November 1936). Reorganized about 7 January 1938 at Newark, NJ. Designated mobilization station was Fort Devens, MA, 1923-36. Location 7 December 1941—Newark, NJ.

Status: Active in the Regular Army as the 7th Combat Support Hospital at Pirmasens, Germany.

Commanders, 7th Evacuation Hospital

Lt. Col. Robert J. Graves**	21 Dec 28-31 Aug 29	1st Lt. Chester M. Tirrell**	7 Jan 38-2 Dec 38
Unknown	31 Aug 29-5 Jun 36	Lt. Col. Charles M. Strotz**	2 Dec 38-15 Mar 39
<i>Inactive</i>	5 Jun 36-7 Jan 38	Maj. Augustus L. L. Baker**	15 Mar 39-ao Jul 41

** RAI Commanders: Organized Reserve officers.

8th Evacuation Hospital (I) (Second Army)**Organized Reserve Massachusetts****HQ-Not initiated** 1923-25; Springfield, MA, 1925-28

Constituted in the Organized Reserve 12 September 1923 as Evacuation Hospital No. 8, assigned to the Second Army, and allotted to the First Corps Area. Initiated 22 May 1925 at Springfield, MA. Redesignated 23 March 1925 as the 8th Evacuation Hospital. Withdrawn from the First Corps Area 6 October 1928 and demobilized.

Commanders, 8th Evacuation Hospital

Unknown	22 May 25-ao Apr 26	Lt. Col. William P. Ryan	ao Apr 26-ao May 27
	Col. Charles F. Lynchao	Jun 27-27 Dec 28	

8th Evacuation Hospital (II) (GHQR)**Regular Army Inactive****HQ-Not organized** 1928-40; Richmond, VA, 1940-41

Constituted in the Regular Army 21 December 1928, assigned to the General Headquarters Reserve, and allotted to the Third Corps Area. Consolidated in November 1936 with Evacuation Hospital No. 8 (a WWI unit organized in November 1917 at Fort Riley, KS; demobilized 1 June 1919 at Camp Upton, NY; reconstituted in November 1936). Affiliated 1 January 1940 with the University of Virginia School of Medicine and concurrently organized at Richmond, VA. Location 7 December 1941—Richmond, VA.

Status: Inactive in the Regular Army as the 8th Evacuation Hospital.**Commanders, 8th Evacuation Hospital**

Lt. Col. Staige D. Blackford	1 Jan 40-7 Dec 41
------------------------------	-------------------

9th Evacuation Hospital (Second Army)**Organized Reserve Connecticut/New Jersey****HQ-Not initiated** 1923-25; Hartford, CT, 1925-29; *Inactive* 1929-37; East Orange, NJ, 1937-1941

Constituted in the Organized Reserve 12 September 1923 as Evacuation Hospital No. 9, assigned to the Second Army, and allotted to the First Corps Area. Initiated 13 January 1925 at Hartford, CT. Redesignated 23 March 1925 as the 9th Evacuation Hospital. Inactivated at Hartford about December 1929 by relief of personnel. Relieved from the Second Army 1 October 1933 and assigned to the First Army. Withdrawn from the First Corps Area 5 June 1936 and allotted to the Second Corps Area. Reorganized 2 October 1937 at East Orange, NJ. Location 7 December 1941—East Orange, NJ.

Commanders, 9th Evacuation Hospital

Maj. Harry S. Carmany	13 Jan 25-20 Mar 26	<i>Inactive</i>	Dec 29-2 Oct 37
Lt. Col. Howard A. Lanpher	20 Mar 26-16 Jun 27	Maj. Earl H. Snively	2 Oct 37-ao Aug 39
Lt. Col. Robert F. Souther	16 Jun 27-Dec 29	Col. Harrison S. Martland	ao Mar 40-18 May 40
	Unknown	18 May 40-7 Dec 41	

10th Evacuation Hospital (Fourth Army)**Organized Reserve Massachusetts****HQ-Not initiated** 1923-25; Fall River, MA, 1925-28; *Inactive* 1928-30; Brooklyn, NY, 1930-41; Fort Knox, KY 1941

Constituted in the Organized Reserve 12 September 1923 as Evacuation Hospital No. 10, assigned to the Fourth Army, and allotted to the First Corps Area. Initiated by November 1925 at Fall River, MA. Withdrawn from the Organized Reserve 6 October 1928 and allotted to the Regular Army. Concurrently withdrawn from the First Corps Area and allotted to the Second Corps Area. Reorganized 4 February 1930 at Brooklyn, NY. Relieved from the Fourth Army 1 October 1933 and assigned to the First Army. Typically conducted Inactive Training Period meetings at the 101st Cavalry Regiment armory in Brooklyn, NY, or at the Army Building, 39 Whitehall Street in Manhattan. Conducted summer training at Carlisle Barracks, PA. Activated 10 February 1941, less Reserve personnel, at Fort Knox, KY. Concurrently relieved from the First Army and assigned to the Second Army. Reserve personnel relieved 5 June 1941. Location 7 December 1941—Fort Knox, KY.

Events: 328

Commanders, 10th Evacuation Hospital

Maj. Frank E. Lewis <i>Inactive</i>	ao Nov 25-6 Oct 28 6 Oct 28-4 Feb 30 Unknown	Col. Howard W. Barker Lt. Col. Charles A. Smith 10 Feb 41-7 Dec 41	4 Feb 30-16 Dec 34 16 Dec 34-10 Feb 41
--	--	--	---

11th Evacuation Hospital (I) (Fourth Army)

Organized Reserve Connecticut

HQ-*Not initiated* 1923-26; Bridgeport, CT, 1926-28

Constituted in the Organized Reserve 12 September 1923 as Evacuation Hospital No. 11, assigned to the Fourth Army, and allotted to the First Corps Area. Initiated by April 1926 at Bridgeport, CT. Withdrawn from the First Corps Area 6 October 1928 and demobilized.

Commanders, 11th Evacuation Hospital (I)

Unknown	ao Apr 26-20 Dec 26 Maj.	Maurice L. Cheney	20 Dec 26-6 Oct 28
---------	--------------------------	-------------------	--------------------

11th Evacuation Hospital (II) (Fourth Army)

Regular Army Inactive

HQ-*Not organized* 1928-30; Rochester, NY, 1930-41; Camp Joseph T. Robinson, AR, 1941



Constituted in the Regular Army 21 December 1928, assigned to the Fourth Army, and allotted to the Second Corps Area. Organized 4 February 1930 at Rochester, NY. Relieved from the Fourth Army 1 October 1933 and assigned to the First Army. Consolidated 7 November 1936 with Evacuation Hospital No. 11 (a WWI unit organized in March 1918 at Fort Riley, KS; demobilized 31 May 1919 at Camp Zachary Taylor, KY; reconstituted 7 November 1936). Primary R.O.T.C. feeder school was the Medical College of Syracuse University. Activated 11 February 1941, less Reserve personnel, at Camp Joseph T.

Robinson, AR. Concurrently relieved from the Fourth Army and assigned to the Second Army. Location 7 December 1941—Camp Joseph T. Robinson, AR.

Organization Day: 11 February. Chosen to commemorate the unit's initial activation date 11 February 1941.

Events: 324, 328

Commanders, 11th Evacuation Hospital (II)

Lt. Col. Albert K. Detwiller**	4 Feb 30-2 Nov 31	Lt. Col. Clyde O. Barney**	16 Dec 35-21 Jan 39
Unknown	2 Nov 31-16 Dec 35	Col. Harry A. Steckel **	21 Jan 39-11 Feb 41
	Lt. Col. Lee R. Pierce*	11 Feb 41-ao Oct 41	

* Regular Army active duty commanders

** RAI Commanders: Organized Reserve officers.

12th Evacuation Hospital (Fourth Army)

Organized Reserve Massachusetts/Connecticut/New York

HQ-*Not initiated* 1923-25; Boston, MA, 1925-28; Hartford, CT, 1928-36; *Inactive* 1936-37; Syracuse, NY, 1937-38; Utica, NY, 1938-41

Constituted in the Organized Reserve 12 September 1923 as Evacuation Hospital No. 12, assigned to the Fourth Army, and allotted to the First Corps Area. Redesignated 23 March 1925 as the 12th Evacuation Hospital. Initiated 13 April 1925 at Boston, MA. Relocated by December 1928 to Hartford, CT. Relieved from the Fourth Army 1 October 1933 and assigned to the First Army. Withdrawn from the First Corps Area 5 June 1936 and allotted to the Second Corps Area. Consolidated 10 November 1936 with Evacuation Hospital No. 12 (a WWI unit organized 3 January 1918 at Fort Riley, KS; demobilized 7 July 1919 at Camp Dodge, IA; reconstituted 10 November 1936). Reorganized in April 1937 at Syracuse, NY. Relocated in October 1938 to Utica, NY. Location 7 December 1941—Utica, NY.

Status: Active in the Regular Army as the 212th Mobile Army Surgical Hospital at Miesau Army Depot, Miesau, Germany.

Commanders, 12th Evacuation Hospital

Unknown	13 Apr 25-30 Nov 26	Maj. William D. McFee	Sep 29-ao Feb 30
Lt. Col. Gaspare E. Lentine	30 Nov 26-Mar 27	Unknown	ao Feb 30-5 Jun 36
Lt. Col. Peer P. Johnson	Mar 27-Sep 29	<i>Inactive</i>	5 Jun 36-Apr 37
	Unknown	Apr 37-7 Dec 41	

13th Evacuation Hospital (Fourth Army)

Organized Reserve Rhode Island/Massachusetts

HQ-Not initiated 1923-25; Providence, RI, 1925-27; Camp Devens, MA, 1927-28

Constituted in the Organized Reserve 12 September 1923 as Evacuation Hospital No. 13, assigned to the Fourth Army, and allotted to the First Corps Area. Redesignated 23 March 1925 as the 13th Evacuation Hospital. Initiated by November 1925 at Providence, RI. Relocated in 1927 to Camp Devens, MA. Inactivated 6 October 1928 at Camp Devens by relief of personnel. Withdrawn from the First Corps Area 27 December 1928 and demobilized.

Commanders, 13th Evacuation Hospital

Lt. Col. Charles H. Holt	ao Nov 25-6 Oct 28
--------------------------	--------------------

14th Evacuation Hospital (Fourth Army)

Organized Reserve Connecticut/New York

HQ-Not initiated 1923-25; New Haven, CT, 1925-36; *Inactive* 1936-39; New York City, NY, 1939-40; *Inactive* 1940-41

Constituted in the Organized Reserve 12 September 1923 as Evacuation Hospital No. 14, assigned to the Fourth Army, and allotted to the First Corps Area. Initiated 25 May 1925 at New Haven, CT. Redesignated 23 March 1925 as the 14th Evacuation Hospital. Relieved from the Fourth Army 1 October 1933 and assigned to the First Army. Withdrawn from the First Corps Area 5 June 1936 and allotted to the Second Corps Area. Concurrently inactivated at New Haven by relief of personnel. Consolidated 10 November 1936 with Evacuation Hospital No. 14 (a WWI unit organized in February 1918 at Camp Greenleaf; GA; demobilized 19 May 1919 at Camp Sherman, OH; reconstituted 10 November 1936). Reorganized by December 1939 at New York City, NY. Inactivated by June 1940 at New York City by relief of personnel. Location 7 December 1941—*Inactive*.

Status: Disbanded 30 January 1942; reconstituted 5 April 1942; active in the US Army Reserve at San Antonio, TX, as the 114th Evacuation Hospital.

Commanders, 14th Evacuation Hospital

Capt. Max Climan	25 May 25-ao Jun 25	Unknown	ao Jul 28-5 Jun 36
Unknown	ao Jun 25-ao Jun 27	<i>Inactive</i>	5 Jun 36-ao Dec 39
Lt. Col. Willard B. Soper	ao Jun 27-ao Jul 28	Unknown	ao Dec 39-Jun 40
	<i>Inactive</i>	Jun 40-7 Dec 41	

15th Evacuation Hospital (First Army)

Organized Reserve New Jersey/New York

HQ-Not initiated 1923-25; Jersey City, NJ, 1925-28; *Inactive* 1928-35; New York City, NY, 1935-41; Fort George G. Meade, MD, 1941

Constituted in the Organized Reserve 12 September 1923 as Evacuation Hospital No. 15, assigned to the First Army, and allotted to the Second Corps Area. Affiliated with the Cornell University Medical College. Initiated 4 March 1925 at Jersey City, NJ. Concurrently redesignated as the 15th Evacuation Hospital. Inactivated by December 1928 at Jersey City by relief of personnel. Withdrawn from the Organized Reserve 1 October 1933 and allotted to the Regular Army. Reorganized 1 April 1935 at New York City, NY. Consolidated 9 November 1936 with Evacuation Hospital No. 15 (a WWI unit organized 21 March 1918 at Fort Riley, KS; demobilized 28 June 1919 at Camp Lewis, WA; reconstituted 9 November 1936). Conducted summer training at Carlisle Barracks, PA. Primary R.O.T.C. feeder school was Cornell University. Activated 1 June 1941, less Reserve personnel, at Fort George G. Meade, MD, and assigned to the First Army. Reserve personnel relieved 25 July 1941. Location 7 December 1941—Fort George G. Meade, MD.

Status: Active in the Regular Army as the 115th Field Hospital at Fort Polk, LA.

Events: 330

Commanders, 15th Evacuation Hospital

Maj. Donald A. Curtis	4 Mar 25-23 Mar 25	Maj. William James	19 May 27-ao May 28
Col. William F. Snow	23 Mar 25-Sep 26	<i>Inactive</i>	ao Dec 28-1 Apr 35
Col. Junius H. McHenry	Sep 26-19 May 27	Lt. Col. Charles G. Darlington**	1 Apr 35-29 Mar 41
	Maj. Donald Y. Shaffer*	1 Jun 41-7 Dec 41	

* Regular Army active duty commanders

** RAI Commanders: Organized Reserve officers.

16th Evacuation Hospital (First Army)

Organized Reserve New York

HQ-*Not initiated* 1923-25; New York City, NY, 1925-41

Constituted in the Organized Reserve 12 September 1923 as Evacuation Hospital No. 16, assigned to the First Army, and allotted to the Second Corps Area. Initiated 6 March 1925 at New York City, NY. Redesignated 23 March 1925 as the 16th Evacuation Hospital. Conducted summer training most years at Carlisle Barracks, PA. Location 7 December 1941—New York City, NY.

Status: Inactive in the U.S. Army Reserve as the 116th General Hospital.

Commanders, 16th Evacuation Hospital

Maj. Julius Blank	6 Mar 25-26 Aug 25	Lt. Col. Julius Blank	26 Nov 30-2 Nov 31
Lt. Col. Edwin G. Ramsdell	26 Aug 25-ao Aug 27	Col. Albert K. Detwiller	2 Nov 31-27 Jan 32
Unknown	ao Aug 27-26 Nov 30	Col. Edwin G. Ramsdell	27 Jan 32-5 Aug 41
	Lt. Col. Edward H. Marsh	5 Aug 41-ao Dec 41	

17th Evacuation Hospital (First Army)

Organized Reserve New York

HQ-*Not initiated* 1923-25; Schenectady, NY, 1925-30; *Inactive* 1930-41

Constituted in the Organized Reserve 12 September 1923 as Evacuation Hospital No. 17, assigned to the First Army, and allotted to the Second Corps Area. Initiated 13 January 1925 at, and affiliated with, Ellis Hospital in Schenectady, NY. Redesignated 23 March 1925 as the 17th Evacuation Hospital. Inactivated 6 March 1930 at Schenectady by relief of personnel. Location 7 December 1941—*Inactive*.

Status: Disbanded 30 January 1942.

Commanders, 17th Evacuation Hospital

Capt. Edward D. Scanlan	13 Jan 25-Sep 25	Maj. Charles W. Woodall	Sep 25-6 Mar 30
	<i>Inactive</i>	6 Mar 30-7 Dec 41	

18th Evacuation Hospital (Second Army)

Organized Reserve Indiana

HQ-Indianapolis, IN 1922-28; Bloomington, IN, 1928-30; *Inactive* 1930-35; Bloomington, IN, 1935-40; Indianapolis, IN 1940-41

Authorized by the Surgeon General 18 November 1922 for organization at, and affiliation with, the Methodist Episcopal Hospital in Indianapolis, IN. Constituted in the Organized Reserve 12 September 1923 as Evacuation Hospital No. 18, assigned to the Second Army, and allotted to the Fifth Corps Area. Redesignated 23 March 1925 as the 18th Evacuation Hospital. Relocated by 1928 to Bloomington, IN. Inactivated in February 1930 at Indianapolis by relief of personnel. Withdrawn from the Organized Reserve 1 October 1933 and allotted to the Regular Army. Reorganized by June 1935 at Bloomington. Consolidated 7 November 1936 with Evacuation Hospital No. 18 (a WWI unit organized 13 June 1918 at Fort Riley, KS; demobilized 14 May 1919 at Camp Pike, AR; reconstituted 7 November 1936). Relocated 30 August 1940 to Indianapolis. Concurrently, affiliation reestablished with Methodist Episcopal Hospital. Designated mobilization station was Fort Oglethorpe, GA. Location 7 December 1941—Indianapolis, IN.

Status: Inactive in the U.S. Army Reserve as the 418th General Hospital.

Commanders, 18th Evacuation Hospital

Col. Carleton B. McCullough	18 Nov 22-Feb 30 Unknown	<i>Inactive</i> ao Jun 35-7 Dec 41	Feb 30-ao Jun 35
-----------------------------	-----------------------------	---------------------------------------	------------------

19th Evacuation Hospital (First Army)

Organized Reserve Georgia

HQ-Not initiated 1923-25; Atlanta, GA, 1925-36; Augusta, GA, 1936-41; Fort Dix, NJ, 1941

Authorized by the Surgeon General 25 November 1922 for organization at, and affiliation with, the Davis-Fischer Sanitarium Unit in Atlanta, GA. Constituted in the Organized Reserve 12 September 1923 as Evacuation Hospital No. 19, assigned to the First Army, and allotted to the Fourth Corps Area. Initiated 8 May 1925 at Atlanta, GA. Redesignated 23 March 1925 as the 19th Evacuation Hospital. Withdrawn from the Organized Reserve 1 October 1933 and allotted to the Regular Army. Concurrently relieved from the First Army and assigned to the Third Army. Relocated by 1936 to Augusta, GA. Activated 1 June 1941, less Reserve personnel, at Fort Dix, NJ, and assigned to the First Army. Location 7 December 1941—Fort Dix, NJ.

Status: Disbanded 25 August 1942.

Events: 330

Commanders, 19th Evacuation Hospital

Maj. Roscoe C. Stewart	8 May 25-ao Jun 25	Col. Arthur N. Rogers**	Oct 31-14 Jun 34
Unknown	ao Jun 25-ao Jun 27	Lt. Col. Clinton R. Riner**	14 Jun 34-14 Dec 34
Lt. Col. Ray H. Davies	ao Jun 27-25 Oct 28	Unknown	14 Dec 34-4 Apr 37
Maj. Roscoe C. Stewart	12 Sep 29-7 Dec 29	Col. William P. Nicholson**	4 Apr 37-18 Apr 37
Lt. Col. Esley T. Lake	21 Dec 29-ao Jun 30	Lt. Col. Will L. Wood**	20 Dec 36-12 Sep 37
Unknown	ao Jun 30-Oct 31	Lt. Col. Laurie J. Arnold**	12 Sep 37-ao May 38
	Unknown	ao May 38-7 Dec 41	

** RAI Commanders: Organized Reserve officers.

20th Evacuation Hospital (Fourth Army)

Organized Reserve New York

HQ-Not initiated 1923-26; New York City, NY, 1926-38; *Inactive* 1938-41

Authorized by the Surgeon General 5 July 1922 for organization at, and affiliation with, the Flower General Hospital in New York City, NY. Constituted in the Organized Reserve 12 September 1923 as Evacuation Hospital No. 20, assigned to the Fourth Army, and allotted to the Second Corps Area. Redesignated 23 March 1925 as the 20th Evacuation Hospital. Withdrawn from the Organized Reserve 1 October 1933 and allotted to the Regular Army. Inactivated by June 1938 at New York City by relief of personnel. Location 7 December 1941—*Inactive*.

Status: Disbanded 30 January 1942.

Commanders, 20th Evacuation Hospital

Lt. Col. Frederick M. Dearborn	5 Jul 22-7 Oct 25	Unknown	ao Jun 27-ao Jun 38
Lt. Col. Lewellyn E. Hetrick	7 Oct 25-ao Jun 27	<i>Inactive</i>	ao Jun 38-7 Dec 41

21st Evacuation Hospital (Second Army)

Organized Reserve Indiana/Pennsylvania

HQ-Not initiated 1923-34; Evansville, IN, 1934-36; *Inactive* 1936-37; Philadelphia, PA, 1937-41

Authorized by the Surgeon General 1 August 1922 for organization at, and affiliation with, St. Anthony's Hospital in Terre Haute, IN. Constituted in the Organized Reserve 12 September 1923 as Evacuation Hospital No. 21, assigned to the Second Army, and allotted to the Fifth Corps Area. Terre Haute, IN, designated as headquarters on organization, but the unit was never organized at that location. Redesignated 23 March 1925 as the 21st Evacuation Hospital. Withdrawn from the Organized Reserve 1 October 1933 and allotted to the Regular Army. Initiated by June 1934 at Evansville, IN. Withdrawn from the Fifth Corps Area 5 June 1936 and allotted to the Third Corps Area. Reorganized

by June 1937 at Philadelphia, PA. Designated mobilization station was Fort Oglethorpe, GA. Location 7 December 1941—Philadelphia, PA.

Commanders, 21st Evacuation Hospital

Unknown	ao Jun 34-5 Jun 36	Unknown	ao Sep 37-ao Aug 38
<i>Inactive</i>	5 Jun 36-ao Jun 37	Lt. Col. William R. Davidson**	ao Aug 38-ao Sep 38
Lt. Col. John C. Glackman	ao Jun 37-ao Sep 37	Unknown	ao Sep 38-7 Dec 41

** RAI Commanders: Organized Reserve officers.

22nd Evacuation Hospital (Fifth Army)

Organized Reserve Wisconsin

HQ-*Not initiated* 1923-25; Milwaukee, WI, 1925-32; Green Bay, WI, 1932-40; *Inactive* 1940-41

Authorized by the Surgeon General 15 January 1923 for organization at, and affiliation with, the Milwaukee Surgical Society in Milwaukee, WI. Constituted in the Organized Reserve 12 September 1923 as Evacuation Hospital No. 22, assigned to the Fifth Army, and allotted to the Sixth Corps Area. Redesignated 23 March 1925 as the 22nd Evacuation Hospital. Initiated by September 1925 at Milwaukee. Relocated in 1932 to Green Bay, WI. Withdrawn from the Organized Reserve 1 October 1933 and allotted to the Regular Army. Concurrently, relieved from the Fifth Army and assigned to the Second Army. Inactivated 25 August 1940 at Green Bay by relief of personnel. Conducted summer training at the station hospital, Fort Snelling, MN, Camp Custer, MI, or Camp McCoy, WI. Designated mobilization station was Fort Oglethorpe, GA. Location 7 December 1941—*Inactive*.

Status: Inactive in the U.S. Army Reserve as the 122nd General Hospital.

Commanders, 22nd Evacuation Hospital

Capt. Harr R. Foerster	24 Mar 25-ao Aug 25	Unknown	ao Jun 35-ao Jun 37
Col. Curtis A. Evans	ao Sep 25-ao Jun 27	Maj. A. J. Shimek**	ao Jun 37-ao Jun 39
Unknown	ao Jun 27-ao Jun 30	Unknown	ao Jun 39-25 Aug 40
Lt. Col. Clarendon J. Combs**	ao Jun 30-ao Jun 35	<i>Inactive</i>	25 Aug 40-7 Dec 41

** RAI Commanders: Organized Reserve officers.

23rd Evacuation Hospital (Fourth Army)

Organized Reserve New York/Pennsylvania

HQ-*Not initiated* 1923-25; Troy, NY, 1925-28; *Inactive* 1928-29; Carlisle Barracks, PA, 1929-38; Philadelphia, PA, 1938-39; *Inactive* 1939-41; Fort Custer, MI, 1941

Constituted in the Organized Reserve 12 September 1923 as Evacuation Hospital No. 23, assigned to the Fourth Army, and allotted to the Second Corps Area. Initiated 4 March 1925 at, and affiliated with, Troy Hospital in Troy, NY. Redesignated 23 March 1925 as the 23rd Evacuation Hospital. Withdrawn from the Organized Reserve 6 October 1928 and allotted to the Regular Army. Concurrently withdrawn from the Second Corps Area and allotted to the Third Corps Area. Reorganized 13 January 1929 at Carlisle Barracks, PA. Relieved from the Fourth Army 1 October 1933 and assigned to the First Army. Relocated 24 February 1938 to Philadelphia, PA. Inactivated by June 1939 at Philadelphia by relief of personnel. Designated mobilization station was Carlisle Barracks, PA. Activated 16 May 1941, less Reserve personnel, at Fort Custer, MI, and assigned to the Second Army. Location 7 December 1941—Fort Custer, MI.

Status: Disbanded 18 August 1942.

Commanders, 23rd Evacuation Hospital

Maj. Waller N. Mercer	4 Mar 25-20 Mar 25	Lt. Col. Charles H. Halliday**	18 Mar 29-24 Feb 38
Lt. Col. Walter M. Brickner	20 Mar 25-11 Apr 25	1st Lt. John R. Liscomb**	24 Feb 38-ao Mar 38
1st Lt. Olney P. Smith	ao Jun 27-6 Oct 28	Unknown	ao Mar 38-ao Jun 39
<i>Inactive</i>	6 Oct 28-13 Jan 29	<i>Inactive</i>	ao Jun 39-16 May 41
Lt. Col. David O. Thomas**	13 Jan 29-18 Mar 29	Unknown	16 May 41-7 Dec 41

** RAI Commanders: Organized Reserve officers.

24th Evacuation Hospital (Sixth Army)**Organized Reserve Arkansas****HQ**-Little Rock, AR, 1923-41

Authorized by the Surgeon General 3 January 1923 for organization at, and affiliation with, St. Vincent's Infirmary in Little Rock, AR. Constituted in the Organized Reserve 12 September 1923 as Evacuation Hospital No. 24, assigned to the Sixth Army, and allotted to the Sixth Corps Area. Redesignated 23 March 1925 as the 24th Evacuation Hospital. Withdrawn from the Organized Reserve 1 October 1933 and allotted to the Regular Army. Concurrently, relieved from the Sixth Army and assigned to the Fourth Army. Conducted summer training at the station hospital, Fort Snelling, MN. Designated mobilization station was Camp Dodge, IA. Location 7 December 1941—Little Rock, AR.

Commanders, 24th Evacuation Hospital

Col. Francis Vinsonhaler	3 Jan 23-12 Aug 27	Unknown	14 Jun 36-11 Oct 36
Col. Homer Scott**	12 Aug 27-14 Jun 36	Lt. Col. Irl Thomas**	11 Oct 36-ao Jun 38
	Unknown	ao Jun 38-7 Dec 41	

** RAI Commanders: Organized Reserve officers.

25th Evacuation Hospital (Fifth Army)**Organized Reserve Illinois****HQ**-*Not initiated* 1923-25; Oak Park, IL, 1925-40; Chicago, IL, 1940-41

Authorized by the Surgeon General 5 March 1923 for organization at, and affiliation with, the West Suburban Hospital in Oak Park, IL. Constituted in the Organized Reserve 12 September 1923 as Evacuation Hospital No. 25, assigned to the Fifth Army, and allotted to the Sixth Corps Area. Redesignated 23 March 1925 as the 25th Evacuation Hospital. Initiated 17 March 1925 at Oak Park, IL. Withdrawn from the Organized Reserve 1 October 1933 and allotted to the Regular Army. Concurrently, relieved from the Fifth Army and assigned to the Second Army. Consolidated in October 1936 with Evacuation Hospital No. 25 (a WWI unit organized 16 June 1918 at Camp Greenleaf, GA; demobilized 16 May 1919 at Camp Dodge, IA; reconstituted in October 1936). Relocated 2 January 1940 to Chicago, IL. Conducted summer training at the station hospital, Fort Sheridan, IL, or Camp Custer, MI. Designated mobilization station was Fort Oglethorpe, GA. Location 7 December 1941— Chicago, IL.

Status: Inactive in the U.S. Army Reserve as the 45th Evacuation Hospital.**Commanders, 25th Evacuation Hospital**

Capt. Leslie W. Beebe	17 Mar 25-24 Mar 25	Lt. Col. George C. Shockey	ao Sep 25-ao Aug 29
Maj. Ward F. Seeley	24 Mar 25-ao Jun 25	Col. Otto A. Kreml**	ao May 30-ao Jan 40
	Unknown	ao Jan 40-7 Dec 41	

** RAI Commanders: Organized Reserve officers.

26th Evacuation Hospital (Fourth Army)**Organized Reserve New York****HQ**-*Not initiated* 1923-25; Manhattan, NY, 1925-41

Authorized by the Surgeon General 5 March 1923 for organization at, and affiliation with, St. Vincent's Hospital in Manhattan, NY. Constituted in the Organized Reserve 12 September 1923 as Evacuation Hospital No. 26, assigned to the Fourth Army, and allotted to the Second Corps Area. Redesignated 23 March 1925 as the 26th Evacuation Hospital. Initiated 1 October 1925 at Manhattan. Location 7 December 1941—Manhattan, NY.

Commanders, 26th Evacuation Hospital

Col. Raymond P. Sullivan	1 Oct 25-5 Mar 30	Lt. Col. Ralph T. Knight	ao Oct 32-ao Nov 32
Unknown	5 Mar 30-ao Oct 32	Unknown	ao Nov 32-7 Dec 41

27th Evacuation Hospital (Fourth Army)**Organized Reserve New York****HQ**-*Not initiated* 1923-25; New York City, NY, 1925-41



Constituted in the Organized Reserve 12 September 1923 as Evacuation Hospital No. 27, assigned to the Fourth Army, and allotted to the Second Corps Area. Redesignated 23 March 1925 as the 27th Evacuation Hospital. Initiated 16 April 1925 at, and affiliated with, Beth Israel Hospital in New York City, NY. Consolidated 13 May 1936 with Evacuation Hospital No. 27 (a WWI unit organized 16 June 1918 at Fort Oglethorpe, GA; demobilized 14 September 1919 at Camp Dix, NJ; reconstituted 13 May 1936). Typically conducted Inactive Training Period meetings at the 104th Field Artillery Armory or the Beth Israel Hospital in New York City. Conducted summer training at Carlisle Barracks, PA.

Location 7 December 1941—New York City, NY.

Status: Inactive in the U.S. Army Reserve as the 427th General Hospital.

Commanders, 27th Evacuation Hospital

Capt. John H. Mullin	16 Apr 25-May 25	Lt. Col. Louis J. Ladin	21 Dec 26-ao Jun 30
Col. Charles H. Peck	May 25-15 Jun 25	Maj. Leopold Marcus	ao Sep 30-4 Mar 39
Lt. Col. Clarence A. McWilliams	15 Jun 25-21 Dec 26	Maj. M. Arthur Weiss	4 Mar 39-Dec 40
	Lt. Col. Charles B. Puestow	Dec 40-ao Dec 41	

28th Evacuation Hospital (Fourth Army)

Organized Reserve New York

HQ-*Not initiated* 1923-25; Brooklyn, NY, 1925-30; *Inactive* 1930-41

Constituted in the Organized Reserve 12 September 1923 as Evacuation Hospital No. 28, assigned to the Fourth Army, and allotted to the Second Corps Area. Redesignated 23 March 1925 as the 28th Evacuation Hospital. Initiated 24 March 1925 at Brooklyn, NY. Inactivated 4 March 1930 at Brooklyn by relief of personnel. Location 7 December 1941—*Inactive*.

Status: Disbanded 30 January 1942.

Commanders, 28th Evacuation Hospital

Maj. Samuel Zwerling	24 Mar 25-9 Oct 25	Col. Edward W. Pinkham	9 Oct 25-4 Mar 30
	<i>Inactive</i>	4 Mar 30-7 Dec 41	

29th Evacuation Hospital (First Army)

Organized Reserve Pennsylvania

HQ-*Not initiated* 1923-25; Philadelphia, PA, 1925-36; Pittsburgh, PA, 1936-41

Constituted in the Organized Reserve 12 September 1923 as Evacuation Hospital No. 29, assigned to the First Army, and allotted to the Third Corps Area. Affiliated 3 January 1924 with the Roxborough Memorial Hospital in Philadelphia, PA. Redesignated 23 March 1925 as the 29th Evacuation Hospital. Initiated by September 1925 at Philadelphia, PA. Withdrawn from the Organized Reserve 1 October 1933 and allotted to the Regular Army. Relocated by December 1936 to Pittsburgh, PA. Designated mobilization station was Carlisle Barracks, PA. Location 7 December 1941—Pittsburgh, PA.

Status: Inactive in the Regular Army as the 29th Evacuation Hospital.

Commanders, 29th Evacuation Hospital

Maj. Harry S. Carmony	ao Sep 25-13 Dec 26	Unknown	ao Dec 34-23 Dec 39
Lt. Col. Charles S. Flagler	13 Dec 26-29 Aug 27	Maj. Francis St. C. Reilly**	23 Dec 39-ao Jan 40
Col. David O. Thomas**	29 Aug 27-ao Jun 34	Unknown	ao Jan 40-7 Dec 41

** RAI Commanders: Organized Reserve officers.

30th Evacuation Hospital (First Army)

Organized Reserve District of Columbia/Maryland

HQ-*Not initiated* 1923-25; Washington, DC, 1925-29; *Inactive* 1929-40; Baltimore, MD, 1940-41

Constituted in the Organized Reserve 12 September 1923 as Evacuation Hospital No. 30, assigned to the First Army, and allotted to the Third Corps Area. Initiated 22 January 1925 at, and affiliated with, Providence Hospital in Washington, DC. Redesignated 23 March 1925 as the 30th Evacuation Hospital. Inactivated 9 September 1929 at Washington by relief of personnel. Reorganized about June 1940 at Baltimore, MD. Location 7 December 1941—Baltimore, MD.

Status: Active in the U.S. Army Reserve as the 406th Combat Support Hospital at Denver, CO.

Commanders, 30th Evacuation Hospital

Col. Charles C. Marbury	22 Jan 25-6 Aug 29	<i>Inactive</i>	9 Sep 29-ao Jun 40
Lt. Col. Llewellyn Powell	6 Aug 29-9 Sep 29	Unknown	ao Jun 40-7 Dec 41

31st Evacuation Hospital (First Army)

Organized Reserve District of Columbia

HQ-Not initiated 1923-25; Washington, DC, 1925-41

Constituted in the Organized Reserve 12 September 1923 as Evacuation Hospital No. 31, assigned to the First Army, and allotted to the Third Corps Area. Affiliated 26 April 1924 with Emergency Hospital in Washington, DC. Initiated 17 January 1925 at Washington, DC. Redesignated 23 March 1925 as the 31st Evacuation Hospital. Withdrawn from the Organized Reserve 6 October 1928 and allotted to the Regular Army. Designated mobilization station was Carlisle Barracks, PA. Location 7 December 1941—Washington, DC.

Commanders, 31st Evacuation Hospital

Lt. Col. James F. Mitchell	17 Jan 25-6 Jun 27	Lt. Col. James H. Truitt**	21 Jan 32-ao Jan 33
Lt. Col. John F. Byrne**	6 Jun 27-6 Aug 29	Unknown	ao Jan 33-ao Dec 34
Unknown	6 Aug 29-8 Nov 30	Maj. Clarence E. Imbrie**	ao Dec 34-ao Jan 35
Lt. Col. Louis H. Webb**	8 Nov 30-5 Jan 31	Unknown	ao Jan 35-29 Sep 39
Unknown	5 Jan 31-21 Jan 32	Maj. Rollo J. Sample**	29 Sep 39-ao Jun 40
	Unknown	ao Jun 40-7 Dec 41	

** RAI Commanders: Organized Reserve officers.

32nd Evacuation Hospital (First Army)

Organized Reserve Pennsylvania

HQ-Not initiated 1923-25; Pittsburgh, PA, 1925-41

Constituted in the Organized Reserve 12 September 1923 as Evacuation Hospital No. 32, assigned to the First Army, and allotted to the Third Corps Area. Initiated 15 January 1925 at Pittsburgh, PA. Redesignated 23 March 1925 as the 32nd Evacuation Hospital. Withdrawn from the Organized Reserve 1 October 1933 and allotted to the Regular Army. Location 7 December 1941—Pittsburgh, PA.

Status: Active in the U.S. Army Reserve as the 410th Evacuation Hospital at Topeka, KS.

Commanders, 32nd Evacuation Hospital

Maj. Thomas M. Barrett	15 Jan 25-22 Jan 25	Col. John A. Hawkins	27 Dec 26-20 Feb 30
Lt. Col. Frederick A. Rupp	22 Jan 25-Oct 26	Lt. Col. William W. Babcock	20 Feb 30-27 Oct 31
Col. William K. Nisbet	Oct 26-27 Dec 26	Lt. Col. David Dale**	27 Oct 31-ao Jun 34
	Unknown	ao Jan 34-7 Dec 41	

** RAI Commanders: Organized Reserve officers.

33rd Evacuation Hospital (Fourth Army)

Organized Reserve Pennsylvania

HQ-Not initiated 1923-25; Pittsburgh, PA, 1925-38; *Inactive* 1938-41

Constituted in the Organized Reserve 12 September 1923 as Evacuation Hospital No. 33, assigned to the Fourth Army, and allotted to the Third Corps Area. Affiliated 1 November 1924 with the South Side Hospital in Pittsburgh, PA. Initiated 22 January 1925 at Pittsburgh. Redesignated 23 March 1925 as the 33rd Evacuation Hospital. Inactivated 1 June 1938 at Pittsburgh by relief of personnel. Conducted summer training at Carlisle Barracks, PA. Location 7 December 1941—*Inactive*.

Commanders, 33rd Evacuation Hospital

Col. Archibald A. MacLachlan	22 Jan 25-23 Apr 28	Col. William C. Browne	21 Apr 30-ao Nov 36
Unknown	23 Apr 28-21 Apr 30	Unknown	ao Nov 36-1 Jun 38
	<i>Inactive</i>	1 Jun 38-7 Dec 41	

34th Evacuation Hospital (Fourth Army)**Organized Reserve Pennsylvania****HQ**-*Not initiated* 1923-25; Philadelphia, PA, 1925-29; *Inactive* 1929-41

Constituted in the Organized Reserve 12 September 1923 as Evacuation Hospital No. 34, assigned to the Fourth Army, and allotted to the Third Corps Area. Initiated 13 January 1925 at Philadelphia, PA. Redesignated 23 March 1925 as the 34th Evacuation Hospital. Inactivated 6 September 1929 at Philadelphia by relief of personnel. Location 7 December 1941—*Inactive*.

Commanders, 34th Evacuation Hospital

Col. Astley P. Ashhurst	13 Jan 25-31 May 27	Lt. Col. William W. Babcock	31 May 27-6 Sep 29
	<i>Inactive</i>	6 Sep 29-7 Dec 41	

35th Evacuation Hospital (Fourth Army)**Organized Reserve Maryland****HQ**-*Not initiated* 1923-25; Baltimore, MD, 1925-29; *Inactive* 1929-34; Baltimore, MD, 1934-41

Constituted in the Organized Reserve 12 September 1923 as Evacuation Hospital No. 35, assigned to the Fourth Army, and allotted to the Third Corps Area. Initiated 17 January 1925 at Baltimore, MD. Redesignated 23 March 1925 as the 35th Evacuation Hospital. Inactivated 14 September 1929 at Omaha by relief of personnel. Withdrawn from the Organized Reserve 1 October 1933 and allotted to the Regular Army. Concurrently relieved from the Zone of the Interior and assigned to the General Headquarters Reserve. Reorganized by June 1934 with Organized Reserve personnel as a RAI unit with headquarters at Baltimore. Functioned as a pool unit for excess medical corps lieutenants 1934-41. Location 7 December 1941—Baltimore.

Status: *Inactive* in the U.S. Army Reserve as the 435th General Hospital.**Commanders, 35th Evacuation Hospital**

Col. Andrew J. N. Reik	17 Jan 25-1 May 29	Maj. Moses S. Levy	9 Sep 29-14 Sep 29
Lt. Col. Firmadge K. Nichols	1 May 29-9 Sep 29	<i>Inactive</i>	14 Sep 29-ao Jun 34
	Unknown	ao Jun 34-7 Dec 41	

36th Evacuation Hospital (I) (Fourth Army)**Organized Reserve Pennsylvania****HQ**-*Not initiated* 1923-25; Harrisburg, PA, 1925-28

Constituted in the Organized Reserve 12 September 1923 as Evacuation Hospital No. 36, assigned to the Fourth Army, and allotted to the Third Corps Area. Initiated 12 January 1925 at Harrisburg, PA. Redesignated 23 March 1925 as the 36th Evacuation Hospital. Withdrawn from the Organized Reserve 6 October 1928 and demobilized.

Commanders, 36th Evacuation Hospital

Col. Clarence P. Franklin	13 Jan 25-Jun 27	Maj. Anthony S. Giordano	Jun 27-6 Oct 28
---------------------------	------------------	--------------------------	-----------------

36th Evacuation Hospital (II) (Fourth Army)**Regular Army Inactive****HQ**-*Not organized* 1928-29; Augusta, GA, 1929-41; Fort Sam Houston, TX, 1941

Constituted in the Regular Army 21 December 1928, assigned to the Fourth Army, and allotted to the Fourth Corps Area. Organized 12 February 1929 with Organized Reserve personnel as a RAI unit with headquarters at Augusta, GA. Relieved from the Fourth Army 1 October 1933 and assigned to the Third Army. Activated 1 June 1941, less Reserve personnel, at Fort Sam Houston, TX, and assigned to the Third Army. Location 7 December 1941—Fort Sam Houston, TX.

Commanders, 36th Evacuation Hospital

Lt. Col. Richard W. Soper**	12 Feb 29-22 Mar 29	Lt. Col. Ralph Chaney**	24 Aug 35-20 Dec 36
Lt. Col. Walter J. Bristow**	22 Mar 29-21 Apr 34	Lt. Col. Rufus E. Graham**	20 Dec 36-28 Nov 37
Unknown	21 Apr 34-24 Aug 35	Lt. Col. Moses S. Levy**	28 Nov 37-1 Jun 41
	Lt. Col. Simeon Hulsey	1 Jun 41-ao Dec 43	

** RAI Commanders: Organized Reserve officers.

37th Evacuation Hospital (Fourth Army)

Organized Reserve Pennsylvania

HQ-Not initiated 1923-25; Philadelphia, PA, 1925-29; *Inactive* 1929-34; Pittsburgh, PA, 1934-41; Fort McClellan, AL, 1941



Constituted in the Organized Reserve 12 September 1923 as Evacuation Hospital No. 37, assigned to the Fourth Army, and allotted to the Third Corps Area. Initiated 13 January 1925 at Philadelphia, PA. Redesignated 23 March 1925 as the 37th Evacuation Hospital. Inactivated 10 September 1929 at Philadelphia by relief of personnel. Reorganized by June 1934 at Pittsburgh, PA. Withdrawn from the Organized Reserve 1 October 1933 and allotted to the Regular Army. Concurrently, relieved from the Fourth Army and assigned to the General Headquarters Reserve. Activated 1 June 1941, less Reserve personnel, at Fort McClellan, AL, and assigned to the Third Army. Location 7 December 1941—Fort McClellan, AL.

Status: Disbanded 13 November 1942.

Commanders, 37th Evacuation Hospital

Col. Richard H. Harte	13 Jan 25-ao Mar 25	<i>Inactive</i>	10 Sep 29-ao Jun 34
Lt. Col. William Bates	ao Sep 25-Jun 27	Unknown	ao Jun 34-16 Mar 38
Col. Clarence P. Franklin	Jun 27-1 Oct 28	Lt. Col. Thomas L. McCullough**	16 Mar 38-ao Jun 40
Lt. Col. William Bates	1 Oct 28-10 Sep 29	Unknown	ao Jun 40-7 Dec 41

** RAI Commanders: Organized Reserve officers.

38th Evacuation Hospital (First Army)

Organized Reserve North Carolina

HQ-Not initiated 1923-25; Greensboro, NC, 1925-36; Charlotte, NC, 1936-41

Constituted in the Organized Reserve 12 September 1923 as Evacuation Hospital No. 38, assigned to the First Army, and allotted to the Fourth Corps Area. Initiated 8 May 1925 at, and affiliated with, Wesley Long Hospital in Greensboro, NC. Redesignated 23 March 1925 as the 38th Evacuation Hospital. Withdrawn from the Organized Reserve 1 October 1933 and allotted to the Regular Army. Concurrently relieved from the First Army and assigned to the Third Army. Relocated in 1936 to Charlotte, NC. Affiliation established 9 January 1941 with Charlotte Memorial Hospital. Location 7 December 1941—Charlotte, NC.

Status: Inactive in the US Army Reserve as the 138th Combat Support Hospital.

Commanders, 38th Evacuation Hospital

Maj. Eli C. Boyette	8 May 25-ao Jun 25	Unknown	ao Sep 27-11 Sep 29
Unknown	ao Jun 25-ao Jun 27	Lt. Col. James W. Davis**	11 Sep 29-9 Oct 34
Lt. Col. Herbert H. Ogburn	ao Jun 27-ao Sep 27	Lt. Col. Thomas J. Holton**	9 Oct 34-9 Jan 41
	Lt. Col. Brodie C. Nalle	9 Jan 41-7 Dec 41	

** RAI Commanders: Organized Reserve officers.

39th Evacuation Hospital (First Army)**Organized Reserve Tennessee****HQ-Not initiated** 1923-25; Knoxville, TN, 1925-41

Constituted in the Organized Reserve 12 September 1923 as Evacuation Hospital No. 39, assigned to the First Army, and allotted to the Fourth Corps Area. Affiliated 9 May 1924 with the Knoxville General Hospital in Knoxville, TN. Redesignated 23 March 1925 as the 39th Evacuation Hospital. Initiated 8 May 1925 at Knoxville. Relieved from the First Army 1 October 1933 and assigned to the Third Army. Consolidated in October 1936 with Evacuation Hospital No. 39 (a WWI unit organized in October 1918 at Camp Greenleaf, GA; demobilized in December 1918 at Camp Greenleaf; reconstituted in October 1936). Location 7 December 1941—Knoxville, TN.

Status: Active in the U.S. Army Reserve as the 405th Combat Support Hospital at Hartford, CT.**Commanders, 39th Evacuation Hospital**

Maj. Edwin B. Rhea	8 May 25-ao Jun 25	Col. Edward C. Ellett	8 Nov 30-ao Jun 32
Unknown	ao Jun 25-ao Jun 27	Unknown	ao Jun 32-9 Oct 34
Maj. Herbert H. McCampbell	ao Jun 27-ao Jul 27	Col. Percy A. Perkins	9 Oct 34-14 Mar 36
Unknown	ao Jul 27-22 Oct 29	Unknown	14 Mar 38-2 Oct 38
Lt. Col. Jack T. Cappel	22 Oct 29-8 Nov 30	Col. James M. Tribble	2 Oct 38-ao Jan 39
	Unknown	ao Jan 39-7 Dec 41	

40th Evacuation Hospital (First Army)**Organized Reserve Georgia****HQ-Not initiated** 1923-24; Augusta, GA, 1924-27; *Inactive* 1927-41

Reconstituted in the Organized Reserve 12 September 1923 as Evacuation Hospital No. 40, assigned to the First Army, and allotted to the Fourth Corps Area. Initiated 21 May 1924 at, and affiliated with, the University of Georgia Medical School in Augusta, GA. Redesignated 23 March 1925 as the 40th Evacuation Hospital. Inactivated by June 1927 at Augusta by relief of personnel. Withdrawn from the Fourth Corps Area 27 December 1928. Relieved from the First Army 1 October 1933 and assigned to the General Headquarters Reserve. Location 7 December 1941—*Inactive*.

Commanders, 40th Evacuation Hospital

Unknown	21 May 24-Jun 27	<i>Inactive</i>	Jun 27-7 Dec 41
---------	------------------	-----------------	-----------------

41st Evacuation Hospital (First Army)**Organized Reserve Alabama****HQ-Not initiated** 1923-25; Mobile, AL, 1925-36; *Inactive* 1936-41; Fort Bragg, NC, 1941

Reconstituted in the Organized Reserve 12 September 1923 as Evacuation Hospital No. 41, assigned to the First Army, and allotted to the Fourth Corps Area. Redesignated 23 March 1925 as the 41st Evacuation Hospital. Initiated 8 May 1925 at Mobile, AL. Relieved from the First Army 1 October 1933 and assigned to the Third Army. Inactivated 20 December 1936 at Mobile by relief of personnel. Withdrawn from the Organized Reserve 1 January 1938 and allotted to the Regular Army. Activated 1 June 1941, less Reserve personnel, at Fort Bragg, NC, and assigned to the First Army. Location 7 December 1941—Fort Bragg, NC.

Commanders, 41st Evacuation Hospital

Maj. August J. Podesta	8 May 25-ao Jun 25	Lt. Col. James P. Wall	12 Sep 29-ao Jan 30
Unknown	ao Jun 25-ao Jun 27	Unknown	ao Jan 30-Sep 31
Maj. Thomas F. Long	ao Jun 26-ao Jul 26	Lt. Col. James A. McDevitt	Sep 31-6 Sep 36
Unknown	ao Jul 26-ao Jun 26	Lt. Col. Herbert H. Forcheimer	6 Sep 36-20 Dec 36
Lt. Col. Enoch M. Mason	ao Jun 27-17 Mar 28	<i>Inactive</i>	20 Dec 36-1 Jun 41
Unknown	17 Mar 28-12 Sep 29	Unknown	1 Jun 41-7 Dec 41

42nd Evacuation Hospital (Third Army)**Organized Reserve Georgia****HQ-Not initiated** 1923-25; Rome, GA, 1925-29; *Inactive* 1929-41; Fort Leonard Wood, MO, 1941

Reconstituted in the Organized Reserve 12 September 1923 as Evacuation Hospital No. 42, assigned to the Third Army, and allotted to the Fourth Corps Area. Redesignated 23 March 1925 as the 42nd Evacuation Hospital. Initiated 8 May 1925 at Rome, GA. Relieved from the Third Army and assigned to the Fifth Army. Inactivated 12 September 1929 at Rome by relief of personnel. Withdrawn from the Organized Reserve 1 January 1938 and allotted to the Regular Army. Activated 1 June 1941, less Reserve personnel, at Fort Leonard Wood, MO, and assigned to the Second Army. Location 7 December 1941—Fort Leonard Wood, MO.

Status: Disbanded 15 October 1942.

Commanders, 42nd Evacuation Hospital

Maj. Benjamin F. Adams	8 May 25-ao Jun 25	Lt. Col. William C. Thomas	30 Apr 29-12 Sep 29
Unknown	ao Jun 25-ao Jun 27	<i>Inactive</i>	12 Sep 29-1 Jun 41
Col. James S. McLester	ao Jun 27-30 Apr 29	Unknown	1 Jun 41-7 Dec 41

43rd Evacuation Hospital (Third Army)

Organized Reserve Georgia

HQ-Not initiated 1923-27; Athens, GA, 1927-41; Camp Claiborne, LA, 1941

Reconstituted in the Organized Reserve 12 September 1923 as Evacuation Hospital No. 43, assigned to the Third Army, and allotted to the Fourth Corps Area. Initiated by June 1927 at Athens, GA. Redesignated 23 March 1925 as the 43rd Evacuation Hospital. Relieved from the Third Army and assigned to the Fifth Army. Withdrawn from the Organized Reserve 1 January 1938 and allotted to the Regular Army. Activated 1 June 1941, less Reserve personnel, at Camp Claiborne, LA, and assigned to the Third Army. Location 7 December 1941—Camp Claiborne, LA.

Status: Disbanded 15 August 1942.

Events: 328

Commanders, 43rd Evacuation Hospital

Col. Walter R. Weiser	ao Jun 27-14 Sep 29	Lt. Col. Walter A. Norton	ao Jul 31-ao Aug 31
Lt. Col. James A. Wood	14 Sep 29-Jul 30	Unknown	ao Aug 31-1 Jun 41
Unknown	Jul 30-ao Jul 31	Maj. Frederick T. Pohle*	1 Jun 41-ao Sep 41

* Regular Army active duty commanders

44th Evacuation Hospital (Third Army)

Organized Reserve Georgia

HQ-Not initiated 1923-25; Augusta, GA, 1925-29; *Inactive* 1929-41

Reconstituted in the Organized Reserve 12 September 1923 as Evacuation Hospital No. 44, assigned to the Third Army, and allotted to the Fourth Corps Area. Redesignated 23 March 1925 as the 44th Evacuation Hospital. Initiated in January 1925 at Augusta, GA. Concurrently relieved from the Third Army and assigned to the Fifth Army. Inactivated 5 November 1929 at Augusta by relief of personnel. Location 7 December 1941—*Inactive*.

Status: Active in the U.S. Army Reserve as the 44th Evacuation Hospital at Oklahoma City, OK.

Commanders, 44th Evacuation Hospital

Col. Thomas D. Coleman	Jan 25-ao Jun 27	Lt. Col. James H. Somerville	ao May 29-12 Sep 29
Unknown	ao Jun 27-ao May 29	Maj. Charley K. Wall	12 Sep 29-5 Nov 29
	<i>Inactive</i>	5 Nov 29-7 Dec 41	

45th Evacuation Hospital (Third Army)

Organized Reserve Louisiana

HQ-Not initiated 1923-25; New Orleans, LA, 1925-29; *Inactive* 1929-41

Reconstituted in the Organized Reserve 12 September 1923 as Evacuation Hospital No. 45, assigned to the Third Army, and allotted to the Fourth Corps Area. Redesignated 23 March 1925 as the 45th Evacuation Hospital. Initiated 5 June 1925 at New Orleans, LA. Inactivated 11 September 1929 at Omaha by relief of personnel. Withdrawn from the Organized Reserve 1 October 1933 and allotted to the Regular Army. Concurrently relieved from the Third Army and assigned to the Fifth Army. Location 7 December 1941—*Inactive*.

Status: Disbanded 30 January 1942

Commanders, 45th Evacuation Hospital

Maj. Daniel S. Johnson	5 Jun 25-ao Jun 25	Col. James B. Guthrie	ao Jun 27-28 Mar 28
Unknown	ao Jun 25-ao Jun 27	Lt. Col. Floyd H. Randall	28 Mar 28-11 Sep 29
	<i>Inactive</i>	11 Sep 29-7 Dec 41	

46th Evacuation Hospital (I) (Third Army)

Organized Reserve Louisiana

HQ-*Not initiated* 1923-25; New Orleans, LA, 1925-28

Reconstituted in the Organized Reserve 12 September 1923 as Evacuation Hospital No. 46, assigned to the Third Army, and allotted to the Fourth Corps Area. Redesignated 23 March 1925 as the 46th Evacuation Hospital. Initiated 8 May 1925 at New Orleans, LA. Withdrawn from the Organized Reserve 6 October 1928 and demobilized.

Commanders, 46th Evacuation Hospital (I)

Maj. Henry E. Parnell	8 May 25-ao Jun 25	Unknown	ao Jun 25-ao Jun 27
	Col. Livier L. Pothier	ao Jun 27-6 Oct 28	

46th Evacuation Hospital (II) (Third Army)

Regular Army Inactive

HQ-*Not organized* 1928-29; Birmingham, AL, 1929-36; Tampa, FL, 1936-40; *Inactive* 1940-41

Constituted in the Regular Army 21 December 1928, assigned to the Third Army, and allotted to the Fourth Corps Area.. Organized 12 February 1929 with Organized Reserve personnel as a RAI unit with headquarters at Augusta, GA. Birmingham, AL. Relocated by December 1936 to Tampa, FL. Affiliation established 6 August 1940 with the University of Georgia School of Medicine at Augusta, GA. Inactivated 25 August 1940 at Tampa by relief of personnel. Designated mobilization station was Fort Oglethorpe, GA. Location 7 December 1941—*Inactive*.

Status: Inactive in the U.S. Army Reserve as the 446th General Hospital.

Commanders, 46th Evacuation Hospital (II)

Lt. Col. Ross C. Speir**	12 Feb 29-ao Aug 30	Unknown	14 Dec 34-20 Dec 36
Unknown	ao Aug 30-Apr 31	Lt. Col. Gordon T. Crozier**	20 Dec 36-18 Jul 37
Lt. Col. Fred S. Gay**	Apr 31-12 Jan 32	Unknown	18 Jul 37-9 Oct 38
Lt. Col. Fred J. Cringle**	12 Jan 32-14 Dec 34	Lt. Col. Frank S. Adams**	9 Oct 38-6 Aug 40
	<i>Inactive</i>	6 Aug 40-7 Dec 41	

** RAI Commanders: Organized Reserve officers.

47th Evacuation Hospital (Second Army)

Organized Reserve Ohio

HQ-*Not initiated* 1923-25; Columbus, OH, 1925-30; *Inactive* 1930-34; Columbus, OH, 1934-37; *Inactive* 1937-41

Constituted in the Organized Reserve 12 September 1923 as Evacuation Hospital No. 47, assigned to the Second Army, and allotted to the Fifth Corps Area. Affiliated 14 December 1923 with Grant Hospital in Columbus, OH. Redesignated 23 March 1925 as the 47th Evacuation Hospital. Initiated in April 1925 at Columbus, OH. Inactivated by March 1930 at Columbus by relief of personnel. Reorganized by June 1934 at Columbus, OH. Inactivated by June 1937 at Columbus by relief of personnel. Location 7 December 1941—*Inactive*.

Commanders, 47th Evacuation Hospital

Col. Fred Fletcher	Apr 25-ao Jun 27	<i>Inactive</i>	Mar 30-ao Jun 34
Unknown	ao Jun 27-Mar 30	Unknown	ao Jun 34-ao Jun 37
	<i>Inactive</i>	ao Jun 37-7 Dec 41	

48th Evacuation Hospital (Second Army)**Organized Reserve Indiana/Rhode Island****HQ**-*Not initiated* 1923-25; Indianapolis, IN, 1925-34; Fort Wayne, IN, 1934-40; Providence, RI, 1940-41

Constituted in the Organized Reserve 12 September 1923 as Evacuation Hospital No. 48, assigned to the Second Army, and allotted to the Fifth Corps Area. Affiliated 1 February 1924 with St. Vincent's Hospital in Indianapolis, IN. Redesignated 23 March 1925 as the 48th Evacuation Hospital. Initiated in April 1925 at Indianapolis. Relocated 22 March 1934 to Fort Wayne, IN. Withdrawn from the Organized Reserve 1 January 1938 and allotted to the Regular Army. Withdrawn from the Fifth Corps Area 1 July 1940 and allotted to the First Corps Area. Affiliated in August 1940 with Rhode Island Hospital and reorganized at Providence, RI. Designated mobilization station was Fort Oglethorpe, GA. Location 7 December 1941—Providence, RI.

Status: Inactive in the U.S. Army Reserve as the 448th General Hospital.**Commanders, 48th Evacuation Hospital**

Lt. Col. Bernays Kennedy	Apr 25-Apr 29 Unknown	Col. Carleton B. McCullough ao Mar 30-7 Dec 41	Feb 30-ao Mar 30
--------------------------	--------------------------	---	------------------

49th Evacuation Hospital (Second Army)**Organized Reserve Kentucky/Ohio****HQ**-*Not initiated* 1923-25; Fort Thomas, KY, 1925-30; *Inactive* 1930-34 Covington, KY, 1934-41; Columbus, OH, 1941

Constituted in the Organized Reserve 12 September 1923 as Evacuation Hospital No. 49, assigned to the Second Army, and allotted to the Fifth Corps Area. Redesignated 23 March 1925 as the 49th Evacuation Hospital. Initiated in July 1925 at Fort Thomas, KY. Inactivated in February 1930 at Fort Thomas by relief of personnel. Reorganized by June 1934 at Covington, KY. Withdrawn from the Organized Reserve 1 January 1938 and allotted to the Regular Army. Affiliated 19 July 1941 with Ohio State University School of Medicine and reorganized at Columbus, OH. Designated mobilization station was Fort Oglethorpe, GA. Location 7 December 1941—Columbus, OH.

Status: Inactive in the US Army Reserve as the 449th General Hospital.**Commanders, 49th Evacuation Hospital**

Col. Charles W. Hibbett	Jul 25-Feb 30 Unknown	<i>Inactive</i> ao Jun 34-7 Dec 41	Feb 30-ao Jun 34
-------------------------	--------------------------	---------------------------------------	------------------

50th Evacuation Hospital (I) (Second Army)**Organized Reserve Kentucky****HQ**-*Not initiated* 1923-26; Fort Thomas, KY, 1926-28

Constituted in the Organized Reserve 12 September 1923 as Evacuation Hospital No. 50, assigned to the Second Army, and allotted to the Fifth Corps Area. Initiated by December 1926 at Fort Thomas, KY. Redesignated 23 March 1925 as the 50th Evacuation Hospital. Withdrawn from the Organized Reserve 27 December 1928 and demobilized.

Commanders, 50th Evacuation Hospital

Lt. Col. John H. Schroeder	ao Dec 26-Jun 28	Col. Eugene F. McCampbell	Jun 28-6 Oct 28
----------------------------	------------------	---------------------------	-----------------

50th Evacuation Hospital (II) (Second Army)**Regular Army Inactive****HQ**-Cleveland, OH, 1928-40; *Inactive* 1940-41

Constituted in the Regular Army 21 December 1928, assigned to the Second Army, and allotted to the Fifth Corps Area. Affiliated 8 September 1932 with Western Reserve University in Cleveland, OH. Concurrently organized at Cleveland. Withdrawn from the Fifth Corps Area 1 July 1940 and allotted to the First Corps Area. Worcester, MA, designated as headquarters on reorganization, but the unit was never organized at that location. Designated mobilization station was Fort Oglethorpe, GA. Location 7 December 1941—*Inactive*.

Commanders, 50th Evacuation Hospital

Maj. Franklyn A. Rice**	8 Dec 32-ao May 37 <i>Inactive</i>	Unknown 1 Jul 40-7 Dec 41	ao May 37-1 Jul 40
-------------------------	---------------------------------------	------------------------------	--------------------

** RAI Commanders: Organized Reserve officers.

51st Evacuation Hospital (Second Army)

Organized Reserve Kentucky/West Virginia

HQ-*Not initiated* 1923-25; Camp Knox, KY, 1925-30; *Inactive* 1930-41

Constituted in the Organized Reserve 12 September 1923 as Evacuation Hospital No. 51, assigned to the Second Army, and allotted to the Fifth Corps Area. Initiated in June 1925 at Camp Knox, KY. Redesignated 23 March 1925 as the 51st Evacuation Hospital. Inactivated by March 1930 at Camp Knox by relief of personnel. Wheeling, WV, designated 9 July 1931 as headquarters on reorganization, but the unit was never organized at that location. Location 7 December 1941—*Inactive*.

Status: Inactive in the U.S. Army Reserve as the 151st General Hospital.

Commanders, 51st Evacuation Hospital

Col. Scott D. Breckenridge	Jun 25-ao Jun 27 <i>Inactive</i>	Unknown ao Mar 30-7 Dec 41	ao Jun 27-ao Mar 30
----------------------------	-------------------------------------	-------------------------------	---------------------

52nd Evacuation Hospital (Second Army)

Organized Reserve Kentucky/Ohio/Pennsylvania

HQ-*Not initiated* 1923-26; Camp Knox, KY, 1926-30; Columbus, OH, 1930-40; Philadelphia, PA, 1940-41

Constituted in the Organized Reserve 12 September 1923 as Evacuation Hospital No. 52, assigned to the Second Army, and allotted to the Fifth Corps Area. Redesignated 23 March 1925 as the 52nd Evacuation Hospital. Initiated by December 1926 at Camp Knox, KY. Withdrawn from the Organized Reserve 27 December 1928 and allotted to the Regular Army. Relocated 28 April 1930 to Columbus, OH. Concurrently reorganized at, and affiliated with, Ohio State University. Designated mobilization station was Fort Oglethorpe, GA. Withdrawn from the Fifth Corps Area 1 July 1940 and allotted to the Third Corps Area. Concurrently reorganized at, and affiliated with the Pennsylvania Hospital in Philadelphia, PA. Location 7 December 1941—Philadelphia, PA.

Status: Inactive in the U.S. Army Reserve as the 364th Station Hospital.

Commanders, 52nd Evacuation Hospital

Col. William K. Nisbet	ao Dec 26-ao Jun 27	Maj. Herman W. Bennett**	ao Jun 30-ao Jul 30
Unknown	ao Jun 27-ao Jun 30	Unknown	ao Jul 30-1 Jul 40
	Col. Charles F. Mitchell**	1 Jul 40-7 Dec 41	

** RAI Commanders: Organized Reserve officers.

53rd Evacuation Hospital (Second Army)

Organized Reserve Kentucky/Ohio

HQ-*Not initiated* 1923-25; Camp Knox, KY, 1925-30; *Inactive* 1930-34; Cincinnati, OH, 1934-41; Camp San Luis Obispo, CA, 1941



Constituted in the Organized Reserve 12 September 1923 as Evacuation Hospital No. 53, assigned to the Second Army, and allotted to the Fifth Corps Area. Redesignated 23 March 1925 as the 53rd Evacuation Hospital. Initiated in August 1925 at Camp Knox, KY. Inactivated by March 1930 at Camp Knox by relief of personnel. Hamilton, OH, designated 9 July 1931 as headquarters on reorganization, but the unit was never organized at that location. Withdrawn from the Organized Reserve 1 October 1933 and allotted to the Regular Army. Reorganized 22 March 1934 at Cincinnati, OH. Conducted summer training at the station hospital, Fort Knox, KY. Activated 1 June 1941, less Reserve personnel, at Camp San Luis Obispo, CA, and assigned to the Fourth Army. Location 7 December 1941—Camp San Luis Obispo, CA.

Status: Disbanded 17 August 1942.

Commanders, 53rd Evacuation Hospital

Unknown	Aug 25-Oct 26	Unknown	ao Aug 29-ao Mar 30
Lt. Col. Luther P. Howell	Oct 26-Jan 27	<i>Inactive</i>	ao Mar 30-22 Mar 34
Lt. Col. Harrison A. Coleman	ao Jun 27-Jul 29	Lt. Col. Marcellus L. Peterson**	22 Mar 34-ao Jul 38
Lt. Col. Scott C. Reynolds	Jul 29-ao Aug 29	Unknown	ao Jul 38-1 Jun 41
	Capt. J. H. Saylor*	1 Jun 41-ao Dec 41	

* Regular Army active duty commanders

** RAI Commanders: Organized Reserve officers.

54th Evacuation Hospital (Second Army)

Organized Reserve Ohio

HQ-*Not initiated* 1923-26; Cleveland, OH, 1926-41; Camp Shelby, MS, 1941

Constituted in the Organized Reserve 12 September 1923 as Evacuation Hospital No. 54, assigned to the Second Army, and allotted to the Fifth Corps Area. Redesignated 23 March 1925 as the 54th Evacuation Hospital. Initiated by February 1926 at Cleveland, OH. Withdrawn from the Organized Reserve 1 October 1933 and allotted to the Regular Army. Typically conducted Inactive Training Period meetings at the Toledo Medical Building in Toledo. Activated 1 June 1941, less Reserve personnel, at Camp Shelby, MS, and assigned to the Third Army. Location 7 December 1941—Camp Shelby, MS.

Commanders, 54th Evacuation Hospital

Col. Nathaniel M. Jones	ao Feb 26-Jul 31	Lt. Col. Scott L. Runnels**	Jul 31-ao Aug 38
	Unknown	ao Aug 38-7 Dec 41	

** RAI Commanders: Organized Reserve officers.

55th Evacuation Hospital (Fifth Army)

Organized Reserve Wisconsin

HQ-*Not initiated* 1923-25; Oshkosh, WI, 1925-37; *Inactive* 1937-39; Oshkosh, WI, 1939-40; Janesville, WI, 1940; *Inactive* 1940-41

Constituted in the Organized Reserve 12 September 1923 as Evacuation Hospital No. 55, assigned to the Fifth Army, and allotted to the Sixth Corps Area. Affiliated 16 November 1923 with St. Mary's Hospital in Oshkosh, WI. Initiated 17 March 1925 at Oshkosh. Redesignated 23 March 1925 as the 55th Evacuation Hospital. Relieved from the Fifth Army 1 October 1933 and assigned to the Second Army. Inactivated 30 March 1937 at Oshkosh by relief of personnel. Withdrawn from the Organized Reserve 1 January 1938 and allotted to the Regular Army. Reorganized by June 1939 at Oshkosh. Relocated 2 January 1940 to Janesville, WI. Withdrawn from the Sixth Corps Area 1 July 1940 and allotted to the Seventh Corps Area. Affiliated 14 August 1940 with Ancker Hospital in St. Paul, MN, but the unit was never organized at that location. Conducted summer training at the station hospital, Fort Snelling, MN. Designated mobilization station was Fort Oglethorpe, GA. Location 7 December 1941—*Inactive*.

Status: Inactive in the US Army Reserve as the 255th General Hospital.

Commanders, 55th Evacuation Hospital

Capt. John F. Stein	17 Mar 25-21 Jul 25	Maj. George N. Pratt	ao Mar 36-30 Mar 37
Maj. Frank G. Connell	21 Jul 25-Aug 25	<i>Inactive</i>	30 Mar 37-ao Jun 39
Lt. Col. Clarendon J. Combs	Aug 25-ao Feb 35	Unknown	ao Jun 39-1 Jul 40
Unknown	ao Feb 35-ao Mar 36	<i>Inactive</i>	1 Jul 40-7 Dec 41

56th Evacuation Hospital (Fifth Army)

Organized Reserve Michigan/Illinois

HQ-*Not initiated* 1923-25; Detroit, MI, 1925; *Inactive* 1925-26; Chicago, IL, 1926-40; Peoria, IL, 1940-41

Constituted in the Organized Reserve 12 September 1923 as Evacuation Hospital No. 56, assigned to the Fifth Army, and allotted to the Sixth Corps Area. Initiated 17 March 1925 at Detroit, MI. Redesignated 23 March 1925 as the 56th Evacuation Hospital. Inactivated by September 1925 at Detroit by relief of personnel. Reorganized 20 January 1926 at Chicago, IL. Though headquartered in Chicago, most personnel lived in Peoria, IL, and surrounding areas. Relieved from the Fifth Army 1 October 1933 and assigned to the Second Army. Relocated 2 January 1940 to Peoria. Typically conducted Inactive Training Period meetings at the Organized Reserve offices at 110 ½ North Madison Street in Peoria. Conducted summer training at the station hospital, Fort Snelling, MN, Fort Sheridan, IL, or Camp McCoy, WI. Designated mobilization station was Fort Oglethorpe, GA. Location 7 December 1941—Peoria, IL.

Status: Active in the U.S. Army Reserve as the 256th Combat Support Hospital at Cleveland, OH.

Commanders, 56th Evacuation Hospital

Maj. Carl H. Bartling <i>Inactive</i>	17 Mar 25-ao May 25 ao Sep 25-20 Jan 26	Col. Maurice L. Goodkind Col. Arthur F. Stotts Unknown	17 Apr 26-8 Jan 29 8 Jan 29-Sep 39 Sep 39-7 Dec 41
Maj. William J. Pickett	20 Jan 26-17 Apr 26		

57th Evacuation Hospital (Fifth Army)

Organized Reserve Michigan

HQ-*Not initiated* 1923-24; Detroit, MI, 1924-30; *Inactive* 1930-35; Detroit, MI, 1935-40; *Inactive* 1940-41

Constituted in the Organized Reserve 12 September 1923 as Evacuation Hospital No. 57, assigned to the Fifth Army, and allotted to the Sixth Corps Area. Initiated in December 1924 at Detroit, MI. Redesignated 23 March 1925 as the 57th Evacuation Hospital. Inactivated by December 1930 at Detroit by relief of personnel. Relieved from the Fifth Army 1 October 1933 and assigned to the Second Army. Reorganized by June 1935 at Detroit. Withdrawn from the Organized Reserve 1 January 1938 and allotted to the Regular Army. Withdrawn from the Sixth Corps Area 1 July 1940 and allotted to the Eighth Corps Area. Dallas, TX, designated as headquarters on reorganization, but the unit was never organized at that location. Affiliated with Baylor University Medical School. Conducted summer training at the station hospital, Fort Snelling, MN. Location 7 December 1941—*Inactive*

Status: Disbanded 11 November 1944.

Commanders, 57th Evacuation Hospital

Col. Harry M. Malejan <i>Inactive</i>	Dec 24-ao Jun 30 ao Dec 30-ao Jun 35	Unknown <i>Inactive</i>	ao Jun 35-1 Jul 40 1 Jul 40-7 Dec 41
--	---	----------------------------	---

58th Evacuation Hospital (Fifth Army)

Organized Reserve Michigan

HQ-*Not initiated* 1923-24; Detroit, MI, 1924-29; *Inactive* 1929-34; Detroit, MI, 1934-41

Constituted in the Organized Reserve 12 September 1923 as Evacuation Hospital No. 58, assigned to the Fifth Army, and allotted to the Sixth Corps Area. Initiated in November 1924 at Detroit, MI. Redesignated 23 March 1925 as the 58th Evacuation Hospital. Withdrawn from the Organized Reserve 6 October 1928 and allotted to the Regular Army. Inactivated 14 January 1929 at Detroit by relief of personnel. Relieved from the Fifth Army 1 October 1933 and assigned to the Second Army. Reorganized by June 1934 at Detroit. Location 7 December 1941—Detroit, MI.

Commanders, 58th Evacuation Hospital

Col. Grover C. Penberthy	Nov 24-14 Jan 29 Unknown	<i>Inactive</i> ao Jun 34-7 Dec 41	14 Jan 29-ao Jun 34
--------------------------	-----------------------------	---------------------------------------	---------------------

59th Evacuation Hospital (I) (Fifth Army)

Organized Reserve Michigan

HQ-*Not initiated* 1923-26; Detroit, MI, 1926-28

Constituted in the Organized Reserve 12 September 1923 as Evacuation Hospital No. 59, assigned to the Fifth Army, and allotted to the Sixth Corps Area. Redesignated 23 March 1925 as the 59th Evacuation Hospital. Initiated by December 1926 at Detroit, MI. Withdrawn from the Organized Reserve 6 October 1928 and demobilized.

Commanders, 59th Evacuation Hospital (I)

Col. Frederick C. Warnshuis ao Dec 26-6 Oct 28

59th Evacuation Hospital (II) (Second Army)

Regular Army Inactive

HQ-*Not organized 1928-29; Chicago, IL, 1929-31; Rock Island, IL, 1931-40; Quincy, IL, 1940; Inactive 1940-41*

Constituted in the Regular Army 21 December 1928, assigned to the Second Army, and allotted to the Sixth Corps Area. Concurrently relieved from the Fifth Army and assigned to the Second Army. Organized 10 June 1929 with Organized Reserve personnel as a RAI unit with headquarters at Chicago, IL. Relocated 14 March 1931 to Rock Island, IL. Relocated 2 January 1940 to Quincy, IL. Withdrawn from the Sixth Corps Area 1 July 1940 and allotted to the Ninth Corps Area. Conducted summer training at the station hospital, Fort Snelling, MN, Jefferson Barracks, MO, or Camp Custer, MI. Designated mobilization station was Fort Oglethorpe, GA. Location 7 December 1941—*Inactive*.

Status: Inactive in the U.S. Army Reserve as the 159th General Hospital.

Commanders, 59th Evacuation Hospital (II)

Unknown	10 Jun 29-13 Aug 29	Lt. Col. Albert E. McEvers**	14 Mar 31-ao Jun 33
Lt. Col. Gerald R. Allaben**	13 Aug 29-14 Mar 31	Lt. Col. Herbert P. Miller**	ao Jun 34-1 Jul 40
	<i>Inactive</i>	1 Jul 40-7 Dec 41	

** RAI Commanders: Organized Reserve officers.

60th Evacuation Hospital (Fifth Army)

Organized Reserve Michigan

HQ-*Not initiated 1923-24; Detroit, MI, 1924-30; Inactive 1930-34; Detroit, MI, 1934-41*

Constituted in the Organized Reserve 12 September 1923 as Evacuation Hospital No. 60, assigned to the Fifth Army, and allotted to the Sixth Corps Area. Initiated in November 1924 at Detroit, MI. Redesignated 23 March 1925 as the 60th Evacuation Hospital. Inactivated by December 1930 at Detroit by relief of personnel. Relieved from the Fifth Army 1 October 1933 and assigned to the Second Army. Reorganized by June 1934 at Detroit. Conducted summer training at the station hospital, Fort Snelling, MN. Location 7 December 1941—Detroit, MI.

Status: Disbanded 11 November 1944.

Commanders, 60th Evacuation Hospital

Unknown	Nov 24-24 Apr 26	Col. Grover C. Penberthy	14 Jan 29-ao Jun 29
Col. Arthur F. Stotts	24 Apr 26-8 Jan 29	<i>Inactive</i>	ao Dec 30-ao Jun 34
	Unknown	ao Jun 34-7 Dec 41	

61st Evacuation Hospital (Fifth Army)

Organized Reserve Wisconsin

HQ-*Not initiated 1923-24; Racine, WI, 1924-32; Madison, WI, 1932-41*

Constituted in the Organized Reserve 12 September 1923 as Evacuation Hospital No. 61, assigned to the Fifth Army, and allotted to the Sixth Corps Area. Initiated in December 1924 at Racine, WI. Redesignated 23 March 1925 as the 61st Evacuation Hospital. Relocated in 1932 to Madison, WI. Withdrawn from the Organized Reserve 1 October 1933 and allotted to the Regular Army. Conducted summer training at the station hospital, Fort Snelling, MN, Fort Sheridan, IL, or Fort Brady, MI. Location 7 December 1941—Madison, WI.

Status: Disbanded 11 November 1944.

Commanders, 61st Evacuation Hospital

Capt. Maxwell Lando	Dec 24-12 May 25	Lt. Col. John Willett	18 Mar 29-ao Jun 30
Unknown	12 May 25-20 May 26	Unknown	ao Jun 30-ao Jun 32
Col. Ralph Kaysen	20 May 26-18 Mar 29	Lt. Col. John C. Johnson**	ao Jun 32-Jun 36
	Col. Harry A. Keenan**	Jun 36-ao Jun 41	

** RAI Commanders: Organized Reserve officers.

62nd Evacuation Hospital (Fifth Army)**Organized Reserve Illinois****HQ-Not initiated** 1923-24; Chicago, IL, 1924-36; Springfield, IL, 1936-41

Constituted in the Organized Reserve 12 September 1923 as Evacuation Hospital No. 62, assigned to the Fifth Army, and allotted to the Sixth Corps Area. Initiated in December 1924 at Chicago, IL. Redesignated 23 March 1925 as the 62nd Evacuation Hospital. Withdrawn from the Organized Reserve 1 October 1933 and allotted to the Regular Army. Relocated about November 1936 to Springfield, IL. Location 7 December 1941—Springfield, IL.

Status: Disbanded 11 November 1944.**Commanders, 62nd Evacuation Hospital**

Unknown	Dec 24-17 Mar 25	Col. Walter G. Bain**	16 Feb 35-25 Dec 35
1st Lt. Lloyd V. Boynton	17 Mar 25-10 Apr 25	Lt. Col. C. W. Compton**	25 Dec 35-2 Mar 39
Maj. Frank P. Thometz	10 Apr 25-24 Apr 26	Col. F. G. Norbury**	2 Mar 39-ao Jan 40
Col. Henry W. Lang**	24 Apr 26-16 Feb 35	Unknown	ao Jan 40-7 Dec 41

** RAI Commanders: Organized Reserve officers.

63rd Evacuation Hospital (Third Army)**Organized Reserve Kansas****HQ-Not initiated** 1923-24; Kansas City, KS, 1924-41

Authorized 28 February 1923 by the Surgeon General for organization at, and affiliation with, St. Margaret's Hospital in Kansas City, KS. Constituted in the Organized Reserve 12 September 1923 as Evacuation Hospital No. 63, assigned to the Third Army, and allotted to the Seventh Corps Area. Initiated in November 1924 at Kansas City. Redesignated 23 March 1925 as the 63rd Evacuation Hospital. Relieved from the Third Army 1 October 1933 and assigned to the Fourth Army. Conducted summer training at the station hospital, Fort Snelling, MN, or Camp McCoy, WI. Designated mobilization station was Camp Dodge, IA. Location 7 December 1941—Kansas City, KS.

Status: Disbanded 11 November 1944.**Commanders, 63rd Evacuation Hospital**

Unknown	Nov 24-ao May 27	Maj. Samuel W. Connor**	10 Nov 35-ao Dec 35
Col. Clifford C. Nesselrode	ao May 27-ao Jul 30	Unknown	ao Dec 35-ao May 38
Unknown	ao Jul 30-10 Nov 35	Lt. Col. Alvin M. Fortney**	ao May 38-8 Jun 38
	Unknown	8 Jun 38-7 Dec 41	

** RAI Commanders: Organized Reserve officers.

64th Evacuation Hospital (Sixth Army)**Organized Reserve Missouri****HQ-Not initiated** 1923-24; Kansas City, MO, 1924-41

Constituted in the Organized Reserve 12 September 1923 as Evacuation Hospital No. 64, assigned to the Sixth Army, and allotted to the Seventh Corps Area. Affiliated 21 January 1924 with Grace Hospital in Kansas City, MO. Organized about November 1924 at Kansas City. Redesignated 23 March 1925 as the 64th Evacuation Hospital. Relieved from the Third Army 1 October 1933 and assigned to the Fourth Army. Conducted summer training at the station hospital, Fort Snelling, MN. Designated mobilization station was Camp Dodge, IA. Location 7 December 1941—Kansas City, MO.

Status: Disbanded 11 November 1944.**Commanders, 64th Evacuation Hospital**

Unknown	Nov 24-ao Mar 26	Lt. Col. David C. Bosserman	21 Jul 35-ao Aug 35
Lt. Col. Claude E. Frazier	ao Mar 26-ao Dec 29	Unknown	ao Aug 35-ao Sep 37
Unknown	ao Dec 29-21 Jul 35	Maj. George W. Smith	ao Sep 37-3 Oct 37
	Unknown	3 Oct 37-7 Dec 41	

65th Evacuation Hospital (Third Army)**Organized Reserve Kansas/Iowa****HQ-Not initiated** 1923-24; Junction City, KS, 1924-25; Burlington, IA, 1925-41

Constituted in the Organized Reserve 12 September 1923 as Evacuation Hospital No. 65, assigned to the Third Army, and allotted to the Seventh Corps Area. Initiated 14 April 1924 at Junction City, KS. Redesignated 23 March 1925 as the 65th Evacuation Hospital. Relocated by October 1925 to Burlington, IA. Relieved from the Third Army 1 October 1933 and assigned to the Fourth Army. Affiliated 14 April 1934 with Burlington Hospital in Burlington. Designated mobilization station was Camp Dodge, IA. Location 7 December 1941—Burlington, IA (inactivated 22 January 1942).

Status: Disbanded 11 November 1944.**Commanders, 65th Evacuation Hospital**

Unknown	14 Apr 24-ao Sep 25	Maj. John I. Marker	ao Oct 32-ao Jan 33
Maj. Ernest I. Woodbury	ao Sep 25-ao Jun 27	Unknown	ao Jan 33-ao Jul 37
Unknown	ao Jun 27-ao Oct 32	Col. Gilbert G. Cottam	ao Jul 37-8 Aug 37
	Unknown	8 Aug 37-7 Dec 41	

66th Evacuation Hospital (Third Army)**Organized Reserve Iowa****HQ-Not initiated** 1923-24; Des Moines, IA, 1924-41

Constituted in the Organized Reserve 12 September 1923 as Evacuation Hospital No. 66, assigned to the Third Army, and allotted to the Seventh Corps Area. Initiated 6 May 1924 at Des Moines. Concurrently affiliated with Mercy Hospital in Des Moines. Redesignated 23 March 1925 as the 65th Evacuation Hospital. Designated mobilization station was Camp Dodge, IA. Location 7 December 1941—Des Moines, IA.

Status: Disbanded 11 November 1944.**Commanders, 66th Evacuation Hospital**

Unknown	6 May 24-ao Sep 25	Lt. Col. Howard A. Lanpher	Dec 29-Feb 30
Lt. Col. Robert F. Throckmorton	ao Sep 25-Dec 29	Unknown	Feb 30-7 Dec 41

67th Evacuation Hospital (Sixth Army)**Organized Reserve Missouri****HQ-Not initiated** 1923-24; St. Louis, MO, 1924-41

Constituted in the Organized Reserve 12 September 1923 as Evacuation Hospital No. 67, assigned to the Sixth Army, and allotted to the Seventh Corps Area. Affiliated 21 July 1924 with the Missouri Baptist Sanitarium in St. Louis, MO. Initiated in November 1924 at St. Louis, MO. Redesignated 23 March 1925 as the 67th Evacuation Hospital. Withdrawn from the Organized Reserve 1 October 1933 and allotted to the Regular Army. Concurrently relieved from the Sixth Army and assigned to the General Headquarters Reserve. Location 7 December 1941—St. Louis, MO.

Status: Active in the Regular Army as the 67th Combat Support Hospital at Würzburg, Germany.**Commanders, 67th Evacuation Hospital**

Unknown	Nov 24-22 Jul 25	Unknown	ao Jan 32-11 Oct 36
Lt. Col. Harry M. Moore	22 Jul 25-ao Aug 25	Lt. Col. Edwin D. Edwards**	11 Oct 36-22 Aug 37
Lt. Col. William H. Luedde	ao Sep 25-ao Jan 32	Lt. Col. Robert E. Owen **	22 Aug 37-ao Sep 37
	Unknown	ao Sep 37-7 Dec 41	

** RAI Commanders: Organized Reserve officers.

68th Evacuation Hospital (Sixth Army)**Organized Reserve Iowa/Minnesota****HQ-Not initiated** 1923-24; Fort Des Moines, IA, 1924-29; Minneapolis, MN, 1929-41; Fort Lewis, WA, 1941

Constituted in the Organized Reserve 12 September 1923 as Evacuation Hospital No. 68, assigned to the Sixth Army, and allotted to the Seventh Corps Area. Initiated in November 1924 at Fort Des Moines, IA. Redesignated 23 March 1925 as the 68th Evacuation Hospital. Relocated in December 1929 to Minneapolis, MN. Withdrawn from the Organized Reserve 1 October 1933 and allotted to the Regular Army. Concurrently relieved from the Sixth Army and assigned to the General Headquarters Reserve. Conducted summer training at the station hospital, Camp Pike, AR. Activated 20 January 1941, less Reserve personnel, at Fort Lewis, WA, and assigned to the Fourth Army. Location 7 December 1941—Fort Lewis, WA.

Status: Disbanded 23 October 1942.

Commanders, 68th Evacuation Hospital

Unknown	Nov 24-ao Sep 25	Lt. Col. George L. Johnson	Oct 31-ao Oct 32
Col. Hans Hansen	Sep 25-Dec 29	Col. Benjamin W. Kelly	ao Mar 33-ao Apr 33
Lt. Col. Floyd S. Kidd	Dec 29-Mar 30	Unknown	ao Apr 33-ao Jun 35
Lt. Col. Paul F. Rice	Mar 30-Feb 31	Col. Hans Hansen**	ao Jun 35-1 Dec 35
Col. Floyd S. Kidd	Feb 31-Oct 31	Unknown	1 Dec 35-7 Dec 41

** RAI Commanders: Organized Reserve officers.

69th Evacuation Hospital (Third Army)

Organized Reserve Nebraska

HQ-Not initiated 1923-24; Fort Robinson, NE, 1924-26; Grand Island, NE, 1926-41

Constituted in the Organized Reserve 12 September 1923 as Evacuation Hospital No. 69, assigned to the Third Army, and allotted to the Seventh Corps Area. Initiated in November 1924 at Fort Robinson, NE. Redesignated 23 March 1925 as the 69th Evacuation Hospital. Relocated 26 May 1926 to Grand Island, NE. Location 7 December 1941—Grand Island, NE.

Status: Disbanded 30 January 1942.

Commanders, 69th Evacuation Hospital

Unknown	Nov 24-ao Sep 25	Unknown	Jul 29-ao Oct 32
Col. Frederick H. Roost	ao Sep 25-Jul 29	Lt. Col. F. C. E. Kuhlmann	ao Oct 32-ao Jan 33
	Unknown	ao Jan 33-7 Dec 41	

70th Evacuation Hospital (Third Army)

Organized Reserve Kansas/Missouri

HQ-Not initiated 1923-24; Fort Leavenworth, KS, 1924-26; Kansas City, KS, 1926-31; St. Louis, MO, 1931-41

Constituted in the Organized Reserve 12 September 1923 as Evacuation Hospital No. 70, assigned to the Third Army, and allotted to the Seventh Corps Area. Initiated in November 1924 at Fort Leavenworth, KS. Redesignated 23 March 1925 as the 70th Evacuation Hospital. Relocated 26 May 1926 to Kansas City, KS. Relocated 12 October 1931 to St. Louis, MO. Relieved from the Third Army about 1936 and assigned to the General Headquarters Reserve. Conducted summer training at the station hospital, Camp Pike, AR. Location 7 December 1941—St. Louis, MO.

Status: Disbanded 11 November 1944.

Commanders, 70th Evacuation Hospital

Unknown	Nov 24-ao Sep 25	Unknown	ao Jan 32-ao Oct 32
Col. Borden S. Veeder	ao Sep 25-ao Jan 32	Lt. Col. Robert G. Hall	ao Oct 32-ao Jan 33
	Unknown	ao Jan 33-7 Dec 41	

71st Evacuation Hospital (Sixth Army)

Organized Reserve Texas/Colorado

HQ-Not initiated 1923-25; Fort Sam Houston, TX, 1925-36; Fort Logan, CO, 1936-41

Constituted in the Organized Reserve 12 September 1923 as Evacuation Hospital No. 71, assigned to the Sixth Army, and allotted to the Eighth Corps Area. Redesignated 23 March 1925 as the 71st Evacuation Hospital. Initiated 21 May 1925 at Fort Sam Houston, TX. Withdrawn from the Organized Reserve 1 October 1933 and allotted to the Regular Army. Concurrently relieved from the Sixth Army and assigned to the Third Army. Relocated in 1936 to Fort Logan, CO. Conducted summer training at the station hospital, Fort Sam Houston, TX. Also supported C.M.T.C. training at Fort Logan, CO, in 1938 as an alternate form of summer training. Designated mobilization training station was Camp Stanley, TX. Location 7 December 1941—Fort Logan, CO.

Status: Inactive in the U.S. Army Reserve as the 71st Evacuation Hospital.

Commanders, 71st Evacuation Hospital

Capt. William C. Morgan	21 May 25-1 Oct 25	Lt. Col. Charles D. Dixon	23 Aug 32-12 Sep 32
Lt. Col. Charles S. Venable	1 Oct 25-15 Dec 25	Lt. Col. W. Claude Copeland	12 Sep 32-29 Sep 32
Col. Clarence E. Yount	15 Dec 25-22 Mar 26	Col. Warren M. Wier**	29 Sep 32-4 Jun 34
Lt. Col. Charles S. Venable	22 Mar 26-12 Apr 26	Lt. Col. James D. Blevins**	4 Jun 34-8 Mar 36
Maj. Witten B. Russ	12 Apr 26-23 Oct 29	Unknown	8 Mar 36-25 Nov 36
Lt. Col. Joseph M. Hancock	23 Oct 29-23 Aug 32	Lt. Col. Lloyd R. Allen**	25 Nov 36-ao Jun 37
	Unknown	ao Jun 37-7 Dec 41	

** RAI Commanders: Organized Reserve officers.

72nd Evacuation Hospital (Sixth Army)

Organized Reserve Texas/Colorado

HQ-Not initiated 1923-26; Fort Sam Houston, TX, 1926-36; Colorado Springs, CO, 1936-41

Constituted in the Organized Reserve 12 September 1923 as Evacuation Hospital No. 72, assigned to the Sixth Army, and allotted to the Eighth Corps Area. Redesignated 23 March 1925 as the 72nd Evacuation Hospital. Initiated in October 1925 at Fort Sam Houston, TX. Concurrently relieved from the Sixth Army and assigned to the Third Army. Withdrawn from the Organized Reserve 1 October 1933 and allotted to the Regular Army. Relocated in 1936 to Colorado Springs, CO. Supported C.M.T.C. training in 1938 at Fort Logan, CO. Designated mobilization training station was Camp Stanley, TX. Location 7 December 1941—Colorado Springs, CO.

Commanders, 72nd Evacuation Hospital

Unknown	Oct 25-ao Mar 26	Unknown	21 Oct 29-28 Sep 34
Lt. Col. Charles D. Dixon	ao Mar 26-8 Dec 28	Lt. Col. George E. Orsborn**	28 Sep 34-25 Nov 36
Col. Jacob C. Epler	8 Dec 28-21 Oct 29	Lt. Col. Edwin G. Condit**	25 Nov 36-ao Jun 38
	Unknown	ao Jun 38-7 Dec 41	

** RAI Commanders: Organized Reserve officers.

73rd Evacuation Hospital (I) (Sixth Army)

Organized Reserve Texas

HQ-Not initiated 1923-26; Fort Sam Houston, TX, 1926-28

Constituted in the Organized Reserve 12 September 1923 as Evacuation Hospital No. 73, assigned to the Sixth Army, and allotted to the Eighth Corps Area. Redesignated 23 March 1925 as the 73rd Evacuation Hospital. Initiated 26 March 1926 at Fort Sam Houston, TX. Withdrawn from the Organized Reserve 6 October 1928 and demobilized.

Commanders, 73rd Evacuation Hospital (I)

Lt. Col. Charles E. Scull	26 Mar 26-6 Oct 28
---------------------------	--------------------

73rd Evacuation Hospital (II) (Second Army)

Regular Army Inactive

HQ-Not organized 1928-29; Chicago, IL, 1929-40; Rockford, IL, 1940; Los Angeles, CA, 1940-41



Constituted in the Regular Army 21 December 1928, assigned to the Second Army, and allotted to the Sixth Corps Area. Organized 14 January 1929 with Organized Reserve personnel as a RAI unit with headquarters at Chicago, IL. Relocated 2 January 1940 to Rockford, IL. Withdrawn from the Sixth Corps Area 1 July 1940 and allotted to the Ninth Corps Area. Affiliated 10 September 1940 with, and reorganized at, the Los Angeles County Hospital in Los Angeles, CA. Conducted summer training at the station hospital, Fort Snelling, MN, Fort Sheridan, IL, or Camp Custer, MI. Designated mobilization station was Fort Oglethorpe, GA. Location 7 December 1941—Los Angeles, CA.

Status: Inactive in the US Army Reserve as the 73rd Evacuation Hospital.

Commanders, 73rd Evacuation Hospital (ii)

Unknown	14 Jan 29-8 Aug 29	Col. Anfin Egdahl**	ao Jan 31-1 Jul 40
Maj. Harry H. Hammell**	8 Aug 29-23 Aug 29	<i>Inactive</i>	1 Jul 40-10 Sep 40
Lt. Col. Thomas Dobbins**	23 Aug 29-ao Aug 30	Lt. Col. Albert W. Christianson**	10 Sep 40-7 Dec 41

** RAI Commanders: Organized Reserve officers.

74th Evacuation Hospital (Sixth Army)

Organized Reserve Texas

HQ-*Not initiated* 1923-25; Dallas, TX, 1925-29

Constituted in the Organized Reserve 12 September 1923 as Evacuation Hospital No. 74, assigned to the Sixth Army, and allotted to the Eighth Corps Area. Redesignated 23 March 1925 as the 74th Evacuation Hospital. Initiated 20 March 1925 at Dallas, TX. Conducted summer training at the station hospital, Fort Sam Houston, TX. Withdrawn from the Organized Reserve 27 December 1928 and demobilized.

Commanders, 74th Evacuation Hospital

2nd Lt. Tom A. Lockridge	20 Mar 25-28 Sep 25	Lt. Col. William K. Read	28 Sep 25-27 Dec 28
--------------------------	---------------------	--------------------------	---------------------

75th Evacuation Hospital (I) (Sixth Army)

Organized Reserve Texas

HQ-*Not initiated* 1923-25; Dallas, TX, 1925-28

Constituted in the Organized Reserve 12 September 1923 as Evacuation Hospital No. 75, assigned to the Sixth Army, and allotted to the Eighth Corps Area. Redesignated 23 March 1925 as the 75th Evacuation Hospital. Initiated in May 1925 at Dallas, TX. Withdrawn from the Organized Reserve 6 October 1928 and demobilized.

Commanders, 75th Evacuation Hospital (I)

Maj. Arthur L. Mobley	May 25-6 Oct 28
-----------------------	-----------------

75th Evacuation Hospital (II) (Sixth Army)

Organized Reserve Minnesota

HQ-*Not organized* 1928-29; Wichita, KS, 1929; Rochester, MN, 1929-41.

Constituted in the Regular Army 21 December 1928, assigned to the Sixth Army, and allotted to the Seventh Corps Area. Organized 14 January 1929 at Wichita, KS. Relocated in December 1929 to Rochester, MN. Relieved from the Sixth Army 1 October 1933 and assigned to the Fourth Army. Conducted summer training with the station hospital, Fort Snelling, MN. Designated mobilization station was Camp Dodge, IA. Location 7 December 1941—Rochester, MN.

Commanders, 75th Evacuation Hospital (II)

Lt. Col. Bernard J. Callahan	14 Jan 29-May 29	Unknown	ao Jun 30-ao Aug 32
Maj. Raymond Russell	May 29-Dec 29	Lt. Col. Ole Olson	ao Aug 32-ao Sep 33
Lt. Col. Clifford E. Harkey	Dec 29-May 30	Unknown	ao Sep 33-9 Feb 36
Lt. Col. Robert F. Throckmorton	May 30-ao Jun 30	Lt. Col. Alfred W. Adson	9 Feb 36-ao Mar 36
Lt. Col. Elmer B. M. Casey	15 Nov 36-22 Aug 37	Lt. Col. John P. Freeman	ao Oct 36-15 Nov 36
	Unknown	15 Nov 36-7 Dec 41	

76th Evacuation Hospital (Third Army)**Organized Reserve Texas****HQ-Not initiated** 1923-25; Fort Worth, TX, 1925-41

Constituted in the Organized Reserve 12 September 1923 as Evacuation Hospital No. 76, assigned to the Third Army, and allotted to the Eighth Corps Area. Redesignated 23 March 1925 as the 76th Evacuation Hospital. Initiated 28 February 1925 at Fort Worth, TX. Conducted summer training at the station hospital, Fort Sam Houston, TX. Designated mobilization training station was Camp Stanley, TX. Location 7 December 1941—Fort Worth, TX.

Status: Disbanded 11 November 1944.**Commanders, 76th Evacuation Hospital**

Maj. James H. Davis	28 Feb 25-11 Mar 26	Col. Frank H. McGregor	3 Dec 30-12 Sep 32
Lt. Col. Henry W. Pickett	11 Mar 26-3 Dec 30	Col. John F. Park	12 Sep 32-1 Jul 36
	Unknown	1 Jul 36-7 Dec 41	

77th Evacuation Hospital (I) (Third Army)**Organized Reserve Texas****HQ-Not initiated** 1923-25; Fort Worth, TX, 1925-26; *Inactive* 1926-28; Fort Worth, TX, 1928

Constituted in the Organized Reserve 12 September 1923 as Evacuation Hospital No. 77, assigned to the Third Army, and allotted to the Eighth Corps Area. Redesignated 23 March 1925 as the 77th Evacuation Hospital. Initiated in March 1925 at Fort Worth, TX. Inactivated by March 1926 at Fort Worth by relief of personnel. Reorganized by June 1928 at Fort Worth. Withdrawn from the Organized Reserve 6 October 1928 and demobilized.

Commanders, 77th Evacuation Hospital (I)

Unknown	Mar 25-ao Mar 26	<i>Inactive</i>	ao Mar 26-ao Jun 27
	Capt. George L. Montgomery	ao Jun 28-5 Nov 28	

77th Evacuation Hospital (II) (Fourth Army)**Regular Army Inactive****HQ-Not initiated** 1928-29; Little Rock, AR, 1929-40; Kansas City, MO, 1940-41

Constituted in the Regular Army 21 December 1928, assigned to the Fourth Army, and allotted to the Seventh Corps Area. Organized about March 1929 with Organized Reserve personnel as a RAI unit with headquarters at Little Rock, AR. Relieved from the Fourth Army about 1936 and assigned to the General Headquarters Reserve. Affiliated 19 September 1940 with the University of Kansas Hospital and reorganized at Kansas City, MO. Conducted summer training at the station hospital, Fort Snelling, MN. Also supported C.M.T.C. training at Fort Crook, NE, in 1936 as an alternate form of summer training. Designated mobilization station was Camp Dodge, IA. Location 7 December 1941—Kansas City, MO.

Status: Inactive in the US Army Reserve as the 77th General Hospital.**Commanders, 77th Evacuation Hospital (II)**

Lt. Col. William B. Leighton	Mar 29-ao Jan 32	Maj. Goronowy Y. Broun	ao Jul 36-15 Nov 36
Unknown	ao Jna 32-ao Jul 36	Col. Orren P. Goodwin	15 Nov 36-ao Jan 38
	Unknown	ao Jan 38-7 Dec 41	

78th Evacuation Hospital (Third Army)**Organized Reserve Oklahoma****HQ-Not initiated** 1923-25; Oklahoma City, OK, 1925-41

Constituted in the Organized Reserve 12 September 1923 as Evacuation Hospital No. 78, assigned to the Third Army, and allotted to the Eighth Corps Area. Redesignated 23 March 1925 as the 78th Evacuation Hospital. Initiated by March 1925 at Oklahoma City, OK. Conducted summer training most years at William Beaumont General Hospital at El Paso, TX, or at the station hospital, Fort Sam Houston, TX. Designated mobilization training station was Camp Stanley, TX. Location 7 December 1941—Oklahoma City, OK.

Status: Disbanded 11 November 1944.

Commanders, 78th Evacuation Hospital

Maj. George L. Langworthy	20 Mar 25-8 Feb 26	Lt. Col. Herman L. Fowler	22 May 29-1 Jul 36
Col. Clarence B. Ingraham	8 Feb 26-22 May 29	Col. John F. Park	1 Jul 36-ao Jan 38
	Unknown	ao Jan 38-7 Dec 41	

79th Evacuation Hospital (Third Army)

Organized Reserve Oklahoma/Texas

HQ-Not initiated 1923-25; Oklahoma City, OK, 1925-28; *Inactive* 1928-29; Fort Clark, TX, 1929-36; Fort Worth, TX, 1936-41

Constituted in the Organized Reserve 12 September 1923 as Evacuation Hospital No. 79, assigned to the Third Army, and allotted to the Eighth Corps Area. Redesignated 23 March 1925 as the 79th Evacuation Hospital. Initiated 26 March 1925 at Oklahoma City, OK. Withdrawn from the Organized Reserve 6 October 1928 and allotted to the Regular Army. Inactivated 5 November 1928 at Oklahoma City by relief of personnel. Reorganized 19 February 1929 at Fort Clark, TX. Relocated by 1936 to Fort Worth, TX. Conducted summer training at the station hospital, Fort Sam Houston, TX. Conducted summer training at the station hospital, Fort Sam Houston, TX, or Fort Clark, TX. Designated mobilization training station was Fort Clark. Location 7 December 1941—Fort Worth, TX.

Commanders, 79th Evacuation Hospital

Capt. Allen J. Carroll	26 Mar 25-8 Feb 26	Lt. Col. John E. White	19 Feb 29-16 Jan 35
Col. Jacob C. Epler	8 Feb 26-5 Nov 28	Lt. Col. William J. Kesterson	16 Jan 35-26 Jan 37
<i>Inactive</i>	5 Nov 28-18 Feb 29	Unknown	26 Jan 37-7 Dec 41

80th Evacuation Hospital (Third Army)

Organized Reserve Texas/Colorado

HQ-Not initiated 1923-26; Fort Sam Houston, TX, 1926-27; *Inactive* 1927-29; Fort Logan, CO, 1929-36; Denver, CO 1936-41

Constituted in the Organized Reserve 12 September 1923 as Evacuation Hospital No. 80, assigned to the Third Army, and allotted to the Eighth Corps Area. Redesignated 23 March 1925 as the 80th Evacuation Hospital. Initiated in March 1926 at Fort Sam Houston, TX. Inactivated by June 1927 at Fort Sam Houston by relief of personnel. Withdrawn from the Organized Reserve 6 October 1928 and allotted to the Regular Army. Reorganized 19 February 1929 at Fort Logan, CO. Relocated by 1936 to Denver, CO. Designated mobilization training station was Fort Logan, CO. Conducted summer training at the station hospital, Fort Sam Houston, TX, or Fort Logan, CO. Location 7 December 1941—Denver, CO.

Commanders, 80th Evacuation Hospital

Lt. Col. Irvy L. McClason	Mar 26-ao May 26	Unknown	30 Dec 31-5 Apr 32
Unknown	ao May 26-ao Jun 27	Lt. Col. James C. Hawkins**	5 Apr 32-14 Apr 32
<i>Inactive</i>	ao Jun 27-19 Feb 29	Lt. Col. Cornelius P. Munday**	14 Apr 32-4 Aug 34
Lt. Col. John F. Park**	19 Feb 29-26 Jan 31	Unknown	4 Aug 34-25 Nov 36
Lt. Col. Clarence E. Earnest**	26 Jan 31-28 Nov 31	Lt. Col. Edward Vonden-Steinen**	25 Nov 36-ao Jan 37
Lt. Col. Howard N. Batson	28 Nov 31-30 Dec 31	Unknown	ao Jan 37-7 Dec 41

** RAI Commanders: Organized Reserve officers.

81st Evacuation Hospital (Third Army)

Organized Reserve California

HQ-Not initiated 1923-25; Los Angeles, CA, 1925-41



Constituted in the Organized Reserve 12 September 1923 as Evacuation Hospital No. 81, assigned to the Third Army, and allotted to the Ninth Corps Area. Affiliated 21 August 1924 with the Los Angeles General Hospital in Los Angeles, CA. Redesignated 23 March 1925 as the 81st Evacuation Hospital. Initiated 27 May 1925 at Los Angeles. Withdrawn from the Organized Reserve 1 October 1933 and allotted to the Regular Army. Concurrently relieved from the Third Army and assigned to the Fourth Army. Conducted summer training at Del Monte, CA, the Presidio of Monterey, CA, or Letterman General Hospital, San Francisco, CA. Location 7 December 1941—Los Angeles, CA.

Status: Disbanded 11 November 1944.

Commanders, 81st Evacuation Hospital

Maj. Clarence B. Wood	27 May 25-Jun 25	Unknown	Jan 31-2 Mar 37
Lt. Col. Charles T. Sturgeon	Jul 25-ao Jun 27	Lt. Col. John H. Schaefer**	2 Mar 37-19 Jul 37
Unknown	ao Jun 27-19 Feb 29	Lt. Col. Joseph Saylin **	19 Jul 37-ao Sep 37
Maj. Leroy B. Sherry	19 Feb 29-Jan 31	Unknown	ao Sep 37-7 Dec 41

** RAI Commanders: Organized Reserve officers.

82nd Evacuation Hospital (Third Army)

Organized Reserve Oregon/California

HQ-Not initiated 1923-25; Portland, OR, 1925-30; *Inactive* 1930-37; Pasadena, CA, 1937-41

Constituted in the Organized Reserve 12 September 1923 as Evacuation Hospital No. 82, assigned to the Third Army, and allotted to the Ninth Corps Area. Affiliated 9 September 1924 with the Portland General Hospital in Portland, OR. Redesignated 23 March 1925 as the 82nd Evacuation Hospital. Initiated in July 1925 at Portland. Withdrawn from the Organized Reserve 1 October 1933 and allotted to the Regular Army. Concurrently relieved from the Third Army and assigned to the Fourth Army. Inactivated 30 March 1930 at Portland by relief of personnel. Reorganized 17 February 1937 at Pasadena, CA. Location 7 December 1941—Pasadena, CA.

Commanders, 82nd Evacuation Hospital

Lt. Col. Ferdinand H. Dammasch	Jul 25-Jan 30	Lt. Col. Frank Van Dorn**	17 Feb 37-12 Nov 37
Maj. George George N. Pease	Jan 30-30 Mar 30	Lt. Col. Hathaway Denman**	20 Dec 37-5 Aug 38
<i>Inactive</i>	30 Mar 30-17 Feb 37	Col. Joseph A. Pettit**	5 Aug 38-25 Aug 39
	Col. Connor O. Reed**	19 Sep 39-ao Aug 41	

** RAI Commanders: Organized Reserve officers.

83rd Evacuation Hospital (Third Army)

Organized Reserve Oregon/California

HQ-Not initiated 1923-24; Portland, OR, 1924-36; Berkeley, CA, 1936-41

Constituted in the Organized Reserve 12 September 1923 as Evacuation Hospital No. 83, assigned to the Third Army, and allotted to the Ninth Corps Area. Affiliated 11 September 1924 with, and organized at, the Good Samaritan Hospital in Portland, OR. Redesignated 23 March 1925 as the 83rd Evacuation Hospital. Withdrawn from the Organized Reserve 1 October 1933 and allotted to the Regular Army. Concurrently relieved from the Third Army and assigned to the Fourth Army. Relocated in 1936 to Berkeley, CA. Location 7 December 1941—Berkeley, CA, (inactivated 30 January 1942).

Status: Disbanded 11 November 1944.

Commanders, 83rd Evacuation Hospital

Col. Archie C. Van Cleave	11 Sep 24-Mar 31	Col. Joseph A. Pettit**	23 Nov 33-30 Dec 37
Col. Carl W. Robbins**	Mar 31-23 Nov 33	Col. Archie C. Van Cleave**	30 Dec 37-30 Jan 42

** RAI Commanders: Organized Reserve officers.

84th Evacuation Hospital (Third Army)

Organized Reserve Oregon/California

HQ-Not initiated 1923-24; Portland, OR, 1924-36; Stockton, CA, 1936-37; *Inactive* 1937-41

Constituted in the Organized Reserve 12 September 1923 as Evacuation Hospital No. 84, assigned to the Third Army, and allotted to the Ninth Corps Area. Affiliated 25 September 1924 with, and organized at, the Emmanuel Hospital in Portland, OR. Redesignated 23 March 1925 as the 84th Evacuation Hospital. Relocated in 1936 to Stockton, CA. Inactivated 17 February 1937 at Stockton by relief of personnel. Conducted summer training at the station hospital, Fort Lewis, WA. Location 7 December 1941—*Inactive*.

Status: Disbanded 11 November 1944.

Commanders, 84th Evacuation Hospital

Maj. John G. Abele	25 Sep 24-ao Jan 25	Col. Ralph A. Fenton	26 May 36-26 Jun 36
Lt. Col. Benjamin N. Wade	ao Sep 25-ao Mar 32	Col. Connor O. Reed	19 Aug 36-17 Feb 37
Unknown	ao Mar 32-26 May 36	<i>Inactive</i>	17 Feb 37-7 Dec 41

85th Evacuation Hospital (I) (Third Army)**Organized Reserve Washington****HQ-Not initiated** 1923-25; Spokane, WA, 1925-28

Constituted in the Organized Reserve 12 September 1923 as Evacuation Hospital No. 85, assigned to the Third Army, and allotted to the Ninth Corps Area. Redesignated 23 March 1925 as the 85th Evacuation Hospital. Initiated by September 1925 at Spokane, WA. Withdrawn from the Organized Reserve 6 October 1928 and demobilized.

Commanders, 85th Evacuation Hospital (I)

Unknown	ao Sep 25-Oct 26	Lt. Col. Charles E. Butts	Oct 26-6 Oct 28
---------	------------------	---------------------------	-----------------

85th Evacuation Hospital (II) (Third Army)**Regular Army Inactive****HQ-Not organized** 1928-31; Spokane, WA, 1931-36; San Francisco, CA, 1936-41

Constituted in the Regular Army 21 December 1928, assigned to the Third Army, and allotted to the Ninth Corps Area. Organized about June 1931 with Organized Reserve personnel as a RAI unit with headquarters at Spokane, WA. Relieved from the Third Army 1 October 1933 and assigned to the Fourth Army. Relocated in 1936 to San Francisco, CA. Conducted summer training at the station hospital, Fort Lewis, WA. Location 7 December 1941—San Francisco, CA.

Status: Active in the Regular Army as the 85th Combat Support Hospital at Frankfurt, Germany.**Commanders, 85th Evacuation Hospital (II)**

Lt. Col. August E. Gerhardt**	Jun 31-27 Sep 34	Col. William L. Jackson**	8 Feb 37-ao Jul 37
Lt. Col. Thomas H. Higgins**	10 Oct 34-8 Feb 37	Unknown	ao Jul 37-7 Dec 41

** RAI Commanders: Organized Reserve officers.

86th Evacuation Hospital (I) (Sixth Army)**Organized Reserve Washington****HQ-Not initiated** 1923-25; Seattle, WA, 1925-28

Constituted in the Organized Reserve 12 September 1923 as Evacuation Hospital No. 86, assigned to the Sixth Army, and allotted to the Ninth Corps Area. Initiated 21 February 1925 at Seattle, WA. Redesignated 86th Evacuation Hospital 23 March 1925. Typically conducted Inactive Training Period meetings at the Henry Building in Seattle. Withdrawn from the Organized Reserve 6 October 1928 and demobilized.

Commanders, 86th Evacuation Hospital (I)

Unknown	21 Feb 25-Sep 25	Maj. Earle F. Ristine	Sep 25-Jun 28
	Lt. Col. Copeland Plummer	Jun 28-6 Oct 28	

86th Evacuation Hospital (II) (Sixth Army)**Regular Army Inactive****HQ-Not organized** 1928-31; Seattle, WA, 1931-36; Los Angeles, CA, 1936-41

Constituted in the Regular Army 21 December 1928, assigned to the Sixth Army, and allotted to the Ninth Corps Area. Organized about June 1931 with Organized Reserve personnel as a RAI unit with headquarters at Seattle, WA. Relieved from the Sixth Army 1 October 1933 and assigned to the Fourth Army. Relocated in 1936 to Los Angeles, CA. Conducted summer training at the station hospital, Fort Lewis, WA. Location 7 December 1941—Los Angeles, CA.

Status: Active in the Regular Army as the 86th Combat Support Hospital at Fort Campbell, KY.**Commanders, 86th Evacuation Hospital**

Lt. Col. James E. Durrant**	Jun 31-31 Aug 34	Lt. Col. Charles H. Soll**	8 Feb 37-20 Aug 37
Lt. Col. Jacob S. Smith**	31 Aug 34-18 Oct 35	Lt. Col. Charles G. Sabin**	20 Aug 37-ao Apr 40
Lt. Col. Harold L. Goss**	10 Jul 36-8 Feb 37	Unknown	ao Apr 40-7 Dec 41

** RAI Commanders: Organized Reserve officers.

87th Evacuation Hospital (Sixth Army)**Organized Reserve Oregon/California****HQ—Not initiated** 1923-25; Portland, OR, 1925-36; Modesto, CA, 1936-37; *Inactive* 1937-41

Constituted in the Organized Reserve 12 September 1923 as Evacuation Hospital No. 87 and assigned to the Sixth Army. Initiated 21 January 1925 at Portland, OR. Redesignated 87th Evacuation Hospital 23 March 1925. Relocated in 1936 to Modesto, CA. Inactivated 18 February 1937 at Modesto by relief of personnel. Location 7 December 1941—*Inactive*.

Status: Disbanded 11 November 1944.**Commanders, 87th Evacuation Hospital**

Col. Herbert M. Greene	21 Jan 25-Aug 30	Unknown	8 Jul 36-18 Feb 37
Lt. Col. Ralph C. Matson	Aug 30-8 Jul 36	<i>Inactive</i>	18 Feb 37-7 Dec 41

88th Evacuation Hospital (Sixth Army)**Organized Reserve California****HQ—Not initiated** 1923-25; San Francisco, CA, 1925-30; *Inactive* 1930-41

Constituted in the Organized Reserve 12 September 1923 as Evacuation Hospital No. 88 and assigned to the Sixth Army. Initiated 21 January 1925 at San Francisco, CA. Redesignated 88th Evacuation Hospital 23 March 1925. Inactivated 15 April 1930 at San Francisco by relief of personnel. Location 7 December 1941—*Inactive*.

Status: Disbanded 30 January 1942.**Commanders, 88th Evacuation Hospital**

Unknown	21 Jan 25-Jul 25	Col. Harry G. Ford	Jul 25-15 Apr 30
	<i>Inactive</i>	15 Apr 30-7 Dec 41	

89th Evacuation Hospital (Sixth Army)**Organized Reserve California/Ohio****HQ—Not initiated** 1923-25; Los Angeles, CA, 1925-30; *Inactive* 1930-41

Constituted in the Organized Reserve 12 September 1923 as Evacuation Hospital No. 89 and assigned to the Sixth Army. Initiated 21 January 1925 at Los Angeles, CA. Redesignated 89th Evacuation Hospital 23 March 1925. Redesignated 89th Evacuation Hospital 23 March 1925. Inactivated 15 April 1930 at Los Angeles by relief of personnel. Withdrawn from the Ninth Corps Area 5 June 1936 and allotted to the Fifth Corps Area. Columbus, OH, designated as headquarters on reorganization, but the unit was never organized at that location. Location 7 December 1941—*Inactive*.

Status: Disbanded 30 January 1942.**Commanders, 89th Evacuation Hospital**

Unknown	21 Jan 25-Dec 25	Col. Henry W. Hoagland	Mar 26-15 Apr 30
Lt. Col. Philip S. Doane	Dec 25-Mar 26	<i>Inactive</i>	15 Apr 30-7 Dec 41

90th Evacuation Hospital (Sixth Army)**Organized Reserve California****HQ—Not initiated** 1923-25; San Diego, CA, 1925-37; *Inactive* 1937-41

Constituted in the Organized Reserve 12 September 1923 as Evacuation Hospital No. 90 and assigned to the Sixth Army. Initiated 25 February 1925 at San Diego, CA. Redesignated 90th Evacuation Hospital 23 March 1925. Inactivated 4 March 1937 at San Diego by relief of personnel. Conducted summer training at Del Monte, CA, or Letterman General Hospital at the Presidio of San Francisco, CA. Location 7 December 1941—*Inactive*.

Status: Disbanded 30 January 1942.**Commanders, 90th Evacuation Hospital**

Col. Alfred E. Banks	25 Feb 25-ao Jun 27	Unknown	Apr 31-Aug 35
Unknown	ao Jun 27-ao Jun 29	Lt. Col. John W. Shuman	Aug 35-25 May 36
Lt. Col. Chester L. Magee	ao Jun 29-Apr 31	Col. Lloyd Thompson	25 May 36-4 Mar 47
	<i>Inactive</i>	4 Mar 37-7 Dec 41	

616th Evacuation Hospital (C.Z.)

Regular Army Inactive

HQ-*Not organized 1927-28*

Constituted in the Regular Army 18 October 1927, assigned to the Communications Zone, and allotted to the Second Corps Area. Withdrawn from the Second Corps Area 5 September 1928.

Status: Demobilized 27 March 1953.

622nd Evacuation Hospital (C.Z.)

Regular Army Inactive

HQ-*Not organized 1927-28*

Constituted in the Regular Army 18 October 1927, assigned to the Communications Zone, and allotted to the Sixth Corps Area. Withdrawn from the Sixth Corps Area 5 September 1928.

Status: Demobilized 27 March 1953.

624th Evacuation Hospital (C.Z.)

Regular Army Inactive

HQ-*Not organized 1927-28*

Constituted in the Regular Army 18 October 1927, assigned to the Communications Zone, and allotted to the Seventh Corps Area. Withdrawn from the Seventh Corps Area 5 September 1928.

Status: Demobilized 27 March 1953.

632nd Evacuation Hospital (C.Z.)

Regular Army Inactive

HQ-*Not organized 1927-28*

Constituted in the Regular Army 18 October 1927, assigned to the Communications Zone, and allotted to the Third Corps Area. Withdrawn from the Third Corps Area 5 September 1928.

Status: Demobilized 27 March 1953.

637th Evacuation Hospital (C.Z.)

Regular Army Inactive

HQ-*Not organized 1927-28*

Constituted in the Regular Army 18 October 1927, assigned to the Communications Zone, and allotted to the Third Corps Area. Withdrawn from the Third Corps Area 5 September 1928.

Status: Demobilized 27 March 1953.

645th Evacuation Hospital (C.Z.)

Regular Army Inactive

HQ-*Not organized 1927-28; Fourth Corps Area 1928*

Constituted in the Regular Army 18 October 1927, assigned to the Communications Zone, and allotted to the Fourth Corps Area. Organized 16 March 1928 with Organized Reserve personnel as a RAI unit in the Fourth Corps Area. Withdrawn from the Fourth Corps Area 5 September 1928. Reserve personnel relieved 12 February 1929.

Status: Demobilized 27 March 1953.

Commanders, 645th Evacuation Hospital

Lt. Col. Ross C. Spier** 16 Mar 28-12 Feb 29
** RAI Commanders: Organized Reserve officers.

647th Evacuation Hospital (C.Z.)

Regular Army Inactive

HQ-*Not organized* 1927-28; Fourth Corps Area 1928

Constituted in the Regular Army 18 October 1927, assigned to the Communications Zone, and allotted to the Fourth Corps Area. Organized 20 September 1928 with Organized Reserve personnel as a RAI unit in the Fourth Corps Area. Withdrawn from the Fourth Corps Area 5 September 1928. Reserve personnel relieved 12 February 1929.

Status: Demobilized 27 March 1953.

Commanders, 647th Evacuation Hospital

1st Lt. Robert D. McFarley** 20 Sep 28-7 Nov 28 Maj. Raymond H. Leu** 7 Nov 28-12 Feb 29
** RAI Commanders: Organized Reserve officers.

654th Evacuation Hospital (C.Z.)

Regular Army Inactive

HQ-*Not organized* 1927-28; Fifth Corps Area 1928

Constituted in the Regular Army 18 October 1927, assigned to the Communications Zone, and allotted to the Fifth Corps Area. Organized 16 March 1928 with Organized Reserve personnel as a RAI unit with headquarters in the Fifth Corps Area. Withdrawn from the Fifth Corps Area 5 September 1928. Reserve personnel relieved 12 February 1929.

Status: Demobilized 27 March 1953.

Commanders, 654th Evacuation Hospital

Maj. James C. Ross** 16 Mar 28-5 Sep 28
** RAI Commanders: Organized Reserve officers.

670th Evacuation Hospital (C.Z.)

Regular Army Inactive

HQ-*Not organized* 1927-28

Constituted in the Regular Army 18 October 1927, assigned to the Communications Zone, and allotted to the Seventh Corps Area. Withdrawn from the Seventh Corps Area 5 September 1928.

Status: Demobilized 27 March 1953.

678th Evacuation Hospital (C.Z.)

Regular Army Inactive

HQ-*Not organized* 1927-28

Constituted in the Regular Army 18 October 1927, assigned to the Communications Zone, and allotted to the Eighth Corps Area. Withdrawn from the Eighth Corps Area 5 September 1928.

Status: Demobilized 27 March 1953.

688th Evacuation Hospital (C.Z.)

Regular Army Inactive

HQ-*Not organized* 1927-28

Constituted in the Regular Army 18 October 1927, assigned to the Communications Zone, and allotted to the Ninth Corps Area. Withdrawn from the Ninth Corps Area 5 September 1928.

Status: Demobilized 27 March 1953.

690th Evacuation Hospital (C.Z.)

Regular Army Inactive

HQ-*Not organized* 1927-28; Ninth Corps Area 1928

Constituted in the Regular Army 18 October 1927, assigned to the Communications Zone, and allotted to the Ninth Corps Area. Organized 16 March 1928 with Organized Reserve personnel as a RAI unit in the Ninth Corps Area. Withdrawn from the Ninth Corps Area 5 September 1928. Reserve personnel relieved 18 March 1929.

Status: Demobilized 27 March 1953.

Commanders, 690th Evacuation Hospital

Maj. Leo W. Chilton** 16 Mar 28-5 Sep 28

** RAI Commanders: Organized Reserve officers.

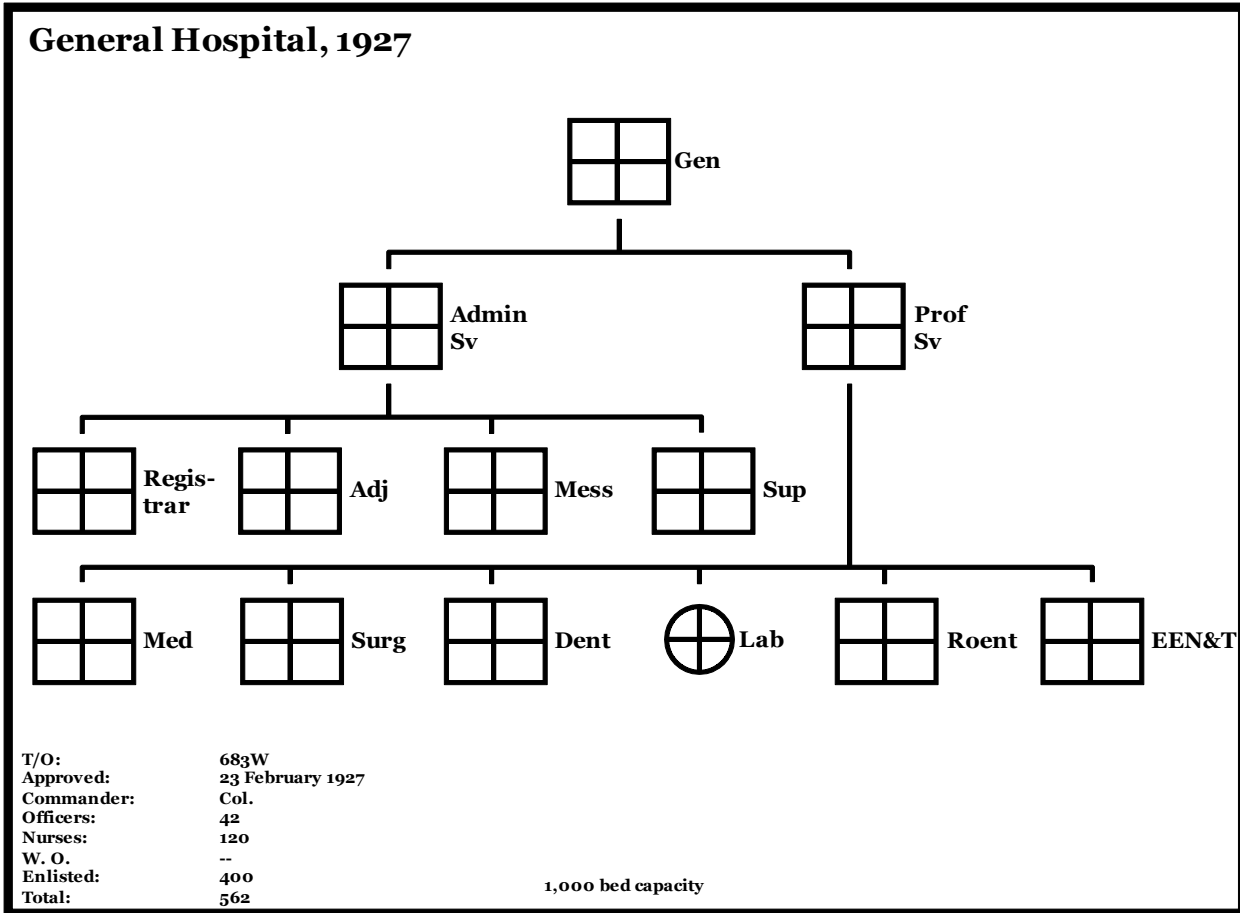

General Hospital TOE.

General Hospital mission: The principal medical hospital in the Communications Zone and the Zone of the Interior. Within the Communications Zone, provide definitive treatment to cases that require long-term or specialized care beyond the capabilities of evacuation and surgical hospitals; evacuate to the Zone of the Interior cases that will require very long-term care or that will be permanently incapacitated; transfer recovering cases to convalescent hospitals and recovered cases to replacement depots or to the control of unit authorities for return to the front. Within the Zone of the Interior, provide definitive treatment to cases that require long-term or specialized care, or that will be permanently incapacitated until such time as they can be released from active service; transfer recovered cases to replacement depots.

Army and Navy General Hospital (Z.I.)

HQ-Hot Springs, AR, 1887-41

Established in the Regular Army 5 July 1882. Opened for operations 17 January 1887 at Hot Springs, AR. Provided the higher general and specialized hospital care for patients in the Fifth, Sixth, and Seventh Corps Areas. Location 7 December 1941—Hot Springs, AR.

Status: Discontinued in 1959; physical plant transferred to the state of Arkansas.

Commanders, Army and Navy General Hospital

Col. Thomas S. Bratton	1 Dec 20-4 Jan 25	Lt. Col. William Denton	ao Dec 31-Jun 32
Col. Robert H. Peck	4 Jan 25-Jul 25	Col. James D. Fife	Jun 32-Sep 35
Col. Thomas S. Bratton	Jul 25-15 Sep 25	Col. William H. Moncrief	Sep 35-1 Apr 39
Col. Robert U. Patterson	15 Sep 25-Aug 30	Col. David W. Harmon	8 May 39-8 Nov 40
Col. William J. Lyster	Aug 30-ao Jun 31	Brig. Gen. Ralph H. Goldthwaite	8 Nov 40-ao Jan 45

Army and Navy General Hospital (Augmentation) (Z.I.)

HQ-Not organized 1928-29; Hot Springs, AR, 1929-41

Constituted in the Regular Army 22 December 1928, assigned to the Seventh Corps Area Service Command, and allotted to the Seventh Corps Area. Organized in 1929 with Organized Reserve personnel as a RAI unit at Hot Springs, AR. Unit mission was to augment the Army and Navy General Hospital on mobilization. Location 7 December 1941—Hot Springs, AR.

Bache General Hospital (Z.I.)

Regular Army Inactive

HQ-Not organized 1928-29; Kansas City, MO, 1929-41

Established in the Regular Army 22 December 1928, assigned to the Seventh Corps Area Service Command, and allotted to the Seventh Corps Area. Named in honor of Col. Dallas Bache, surgeon at the Battle of Wounded Knee, who treated U. S. Army and Indian casualties with the same compassion for both. Organized in July 1929 with Organized Reserve personnel as a RAI unit at Kansas City, MO. Unit mission was to activate Bache General Hospital on mobilization. Location 7 December 1941—Kansas City, MO.

Commanders, Bache General Hospital

Capt. Frederick B. Spencer**	Jul 29-Dec 29	Unknown	ao Jun 30-ao Oct 32
Maj. David A. Morgan**	Dec 29-Mar 30	Lt. Col. Monti Belot**	ao Oct 32-ao Nov 32
Maj. Oliver S. Gilliland**	May 30-ao Jun 30	Unknown	ao Nov 32-7 Dec 41

** RAI Commanders: Organized Reserve officers.

Barnes General Hospital (Z.I.)

Regular Army Inactive

HQ-Seattle, WA, 1930-37; Inactive 1937-41; Vancouver Barracks, WA, 1941

Authorized by the Surgeon General and organized by November 1925 with Organized Reserve personnel as a RAI unit at Seattle, WA. Established in the Regular Army 22 December 1928, assigned to the Ninth Corps Area Service Command, and allotted to the Ninth Corps Area. Named for Brevet Maj. Gen. Joseph K. Barnes, Surgeon General, 1864-1882. Unit mission was to activate Barnes General Hospital at Vancouver Barracks, WA, on mobilization. Inactivated 17 September 1937 at Seattle by relief of personnel. Activated 25 February 1941 at Vancouver Barracks, WA. Location 7 December 1941—Vancouver Barracks, WA.

Status: Discontinued 5 December 1945 at Vancouver, WA.

Commanders, Barnes General Hospital

Maj. Howard J. Knott**	Aug 30-ao Jun 34	Lt. Col. Olive R. Austin**	ao Jun 37-18 Sep 37
Unknown	ao Jun 34-ao Jun 37	<i>Inactive</i>	17 Sep 37-25 Feb 41
	Col. Sidney L. Chappell*	25 Feb 41-ao Dec 41	

* Regular Army active duty commanders

** RAI Commanders: Organized Reserve officers.

Baxter General Hospital (Z.I.)

Regular Army Inactive

HQ-Not organized 1928-29; New Haven, CT, 1929-36; *Inactive* 1936-41

Authorized by the Surgeon General and organized by March 1925 with Organized Reserve personnel as a RAI unit in Texas. Withdrawn from the Eighth Corps Area sometime before 1928. Established in the Regular Army 22 December 1928, assigned to the First Corps Area Service Command, and allotted to the First Corps Area. Named for Brig. Gen. Jedediah H. Baxter, Surgeon General, 1890. Organized by August 1929 with Organized Reserve personnel as a RAI unit at New Haven, CT. Inactivated about September 1937 by transfer of personnel to the 1103rd General Hospital. Location 7 December 1941—*Inactive*.

Status: Discontinued 8 November 1945 at Spokane, WA.

Commanders, Baxter General Hospital

Unknown	ao Aug 29-ao Jun 32	Col. John S. Dye**	5 Nov 36-ao Jun 37
Lt. Col. Charles G. Miles**	ao Jun 32-Sep 36	<i>Inactive</i>	ao Sep 37-7 Dec 41

** RAI Commanders: Organized Reserve officers.

Beal General Hospital (Z.I.)

Regular Army Inactive

HQ-Not organized 1928-29; Boston, MA, 1929-36; *Inactive* 1936-37; Boston, MA, 1937-41

Established in the Regular Army 22 December 1928, assigned to the First Corps Area Service Command, and allotted to the First Corps Area. Organized by August 1929 with Organized Reserve personnel as a RAI unit at Boston, MA. Inactivated about May 1936 by transfer of personnel to the 1102nd General Hospital. Reorganized by June 1937 at Boston. Location 7 December 1941—Boston, MA.

Commanders, Beale General Hospital

Unknown	ao Aug 29-May 36	<i>Inactive</i>	May 36-ao Jun 37
Lt. Col. Elliot C. Cutler**	ao Nov 34-May 36	Lt. Col. Edwin E. Smith**	ao Jun 37-ao Jun 38
	Unknown	ao Jun 38-7 Dec 41	

** RAI Commanders: Organized Reserve officers.

Billings General Hospital (Z.I.)

Regular Army Inactive

HQ-Not organized 1928-34; Cleveland, OH, 1934-41; Fort Benjamin Harrison, IN, 1941

Established in the Regular Army 22 December 1928, assigned to the Fifth Corps Area Service Command, and allotted to the Fifth Corps Area. Named for Lt. Col. John S. Billings, Deputy Surgeon General and organizer of the National Library of Medicine. Organized by June 1934 with Organized Reserve personnel as a RAI unit at Cleveland, OH. Activated 1 March 1941, less Reserve personnel, at Fort Benjamin Harrison, IN. Location 7 December 1941—Fort Benjamin Harrison, IN.

Status: Discontinued 30 September 1947 at Fort Benjamin Harrison, IN.

Commanders, Billings General Hospital

Unknown	ao Jun 34-ao Jan 37	Col. Nathaniel M. Jones**	ao Jan 37-1 Feb 41
	Col. Harry L. Dale*	1 Mar 41-ao Dec 41	

* Regular Army active duty commanders

** RAI Commanders: Organized Reserve officers.

Bradley General Hospital (Z.I.)

Regular Army Inactive

HQ-Not organized 1928-30; Buffalo, NY, 1930-41

Established in the Regular Army 22 December 1928, assigned to the Seventh Corps Area Service Command, and allotted to the Seventh Corps Area. Organized 4 February 1930 with Organized Reserve personnel as a RAI unit at Buffalo, NY. Location 7 December 1941—Buffalo, NY.

Commanders, Bradley General Hospital

Maj. Archibald W. Thompson**	4 Feb 30-3 Mar 34	Unknown	ao Jun 33-31 Jul 36
Maj. Frank E. Fox**	4 Feb 30-ao Jun 33	Lt. Col. Leon S. Kurek**	31 Jul 36-ao Apr 41
	Unknown	ao Apr 41-7 Dec 41	

** RAI Commanders: Organized Reserve officers.

Cochran General Hospital (Z.I.)

Regular Army Inactive

HQ-Not organized 1928-30; Salt Lake City, UT, 1930-37; *Inactive* 1937-41

Established in the Regular Army 22 December 1928, assigned to the Ninth Corps Area Service Command, and allotted to the Ninth Corps Area. Named for Dr. John Cochran, Director General of the Military Hospitals of the Continental Army, 1781-1783. Organized by June 1930 with Organized Reserve personnel as a RAI unit at Salt Lake City, UT. Inactivated 18 September 1937 at Salt Lake City by relief of personnel. Portland, OR, designated as headquarters on reorganization, but the unit was never organized at that location. Location 7 December 1941—*Inactive*.

Commanders, Cochran General Hospital

Maj. Leslie J. Paul**	ao Jun 30-ao Jun 34	Lt. Col. Ralph C. Matson**	8 Jul 36-18 Sep 37
Unknown	ao Jun 34-8 Jul 36	<i>Inactive</i>	18 Sep 37-7 Dec 41

** RAI Commanders: Organized Reserve officers.

Craik General Hospital (Z.I.)

Regular Army Inactive

HQ-Not organized 1928-30; Norfolk, VA, 1930-41

Established in the Regular Army 22 December 1928, assigned to the Third Corps Area Service Command, and allotted to the Third Corps Area. Named for Dr. James Craik, Physician General of the Continental Army, 1798-1800. Organized 2 May 1930 with Organized Reserve personnel as a RAI unit at Norfolk, VA. Location 7 December 1941—Norfolk, VA.

Commanders, Craik General Hospital

Lt. Col. Coursen B. Conklin**	2 May 30-17 Jan 31	Maj. Martillus H. Todd**	22 Oct 34-ao Jan 35
Lt. Col. Floyd K. Foley**	17 Jan 31-22 Oct 34	Unknown	ao Jan 35-7 Dec 41

** RAI Commanders: Organized Reserve officers.

Crane General Hospital (Z.I.)

Regular Army Inactive

HQ-Not organized 1928-29; St. Paul, MN, 1929-41

Established in the Regular Army 22 December 1928, assigned to the Seventh Corps Area Service Command, and allotted to the Seventh Corps Area. Named for Brig. Gen. Charles H. Crane, Surgeon General, 1882-83. Organized by July 1929 with Organized Reserve personnel as a RAI unit at St. Paul, MN. Conducted summer training at the station hospital, Fort Snelling, MN. Location 7 December 1941—St. Paul, MN.

Commanders, Crane General Hospital

1st Lt. Percy A. Mattison**	Jul 29-Dec 29	Col. Edward A. Meyerding**	Dec 29-22 Aug 37
	Unknown	22 Aug 37-7 Dec 41	

** RAI Commanders: Organized Reserve officers.

Finley General Hospital (Z.I.)

Regular Army Inactive

HQ-Not organized 1928-29; Houston, TX, 1929-41

Established in the Regular Army 22 December 1928, assigned to the Eighth Corps Area Service Command, and allotted to the Eighth Corps Area. Named for Brevet Brig. Gen. Clement A. Finley, Surgeon General, 1861-1862. Organized 5 March 1929 with Organized Reserve personnel as a RAI unit at Houston, TX. Conducted summer training at Fort Sam Houston, TX. Location 7 December 1941—Houston, TX.

Commanders, Finley General Hospital

Capt. Ernest J. Reed, Q.M.C.**	5 Mar 29-7 Nov 29	Maj. William C. Spalding**	2 Feb 31-9 Jun 31
Lt. Col. Robert E. B. Bledsoe**	8 Nov 29-2 Feb 31	Lt. Col. Frank G. Sanders**	29 Jun 31-9 Jun 36
	Unknown	9 Jun 36-7 Dec 41	

** RAI Commanders: Organized Reserve officers.

Fitzsimons General Hospital (Z.I.)**HQ**-Aurora, CO, 1917-41

Established in the Regular Army in October 1917. Opened for operations 13 October 1918 at Aurora, CO. Named 26 June 1920 for 1st Lt. William T. Fitzsimons, Medical Reserve Corps, the first American to be killed in France in World War I. Provided the higher general and specialized hospital care for patients in the Eighth and Ninth Corps Areas. Location 7 December 1941—Aurora, CO.

Status: Discontinued 30 June 1996 at Aurora, CO.**Commanders, Fitzsimons General Hospital**

Lt. Col. William H. Moncrief	ao Jun 21-ao Jun 23	Col. Paul S. Halloran	1 Oct 28-27 Apr 31
Col. Paul C. Hutton	ao Dec 23-1 Oct 28	Col. Carroll D. Buck	27 Apr 31-May 40
	Brig. Gen. Omar H. Quade	20 May 40-ao May 45	

Fitzsimons General Hospital (Augmentation) (Z.I.)**HQ**-*Not organized* 1928-29; Aurora, CO, 1929-41

Constituted in the Regular Army 22 December 1928, assigned to the Eighth Corps Area Service Command, and allotted to the Eighth Corps Area. Organized 8 November 1929 with Organized Reserve personnel as a RAI unit at Denver, CO. Unit mission was to augment Fitzsimons General Hospital on mobilization. Location 7 December 1941—Aurora, CO.

Commanders, Fitzsimons General Hospital (Augmentation)

Maj. Louis Huff **	8 Nov 29-ao Feb 32	Unknown	ao Feb 32-7 Dec 41
--------------------	--------------------	---------	--------------------

** RAI Commanders: Organized Reserve officers.

Forwood General Hospital (Z.I.)**Regular Army Inactive****HQ**-*Not organized* 1928-30; Chicago, IL, 1930-32; *Inactive* 1932-41

Established in the Regular Army 22 December 1928, assigned to the Sixth Corps Area Service Command, and allotted to the Sixth Corps Area. Named for Brig. Gen. William H. Forwood, Surgeon General, 1902. Organized by June 1930 with Organized Reserve personnel as a RAI unit at Chicago, IL. Inactivated by June 1932 at Chicago by relief of personnel. Location 7 December 1941—*Inactive*.

Commanders, Forwood General Hospital

Maj. Otis B. Mallow**	ao Jun 30-ao Jul 30	Unknown	ao Jul 30-Jul 32
	<i>Inactive</i>	Jul 32-7 Dec 41	

** RAI Commanders: Organized Reserve officers.

Gorgas General Hospital (Z.I.)**Regular Army Inactive****HQ**-*Not organized* 1928-30; Charleston, SC, 1930-34; *Inactive* 1934-35; Charleston, SC, 1935-41

Established in the Regular Army 22 December 1928, assigned to the Fourth Corps Area Service Command, and allotted to the Fourth Corps Area. Named for Brig. Gen. William C. Gorgas, Surgeon General, 1914-1918. Organized 26 April 1930 with Organized Reserve personnel as a RAI unit at Charleston, SC. Inactivated 9 October 1934 at Charleston by relief of personnel. Reorganized 3 July 1935 at Charleston. Location 7 December 1941—Charleston, SC.

Commanders, Gorgas General Hospital

1st Lt. Fitzhugh L. Smith**	26 Apr 30-ao May 31	Lt. Col. William C. O'Driscoll**	24 Aug 35-20 Dec 36
Unknown	ao May 31-Jun 31	Lt. Col. Henry G. Waddell**	20 Dec 36-ao Jul 39
Lt. Col. Thomas J. Holton**	Jun 31-9 Oct 34	Col. Michael A. Dailey (RA)	ao Oct 39-ao Sep 40
<i>Inactive</i>	9 Oct 34-3 Jul 35	Unknown	ao Sep 40-7 Dec 41

** RAI Commanders: Organized Reserve officers.

Greenleaf General Hospital (Z.I.)**Regular Army Inactive****HQ**-Cincinnati, OH, 1924-34; *Inactive* 1934-35; Cincinnati, OH, 1935-41

Authorized by the Surgeon General and organized 23 December 1924 with Organized Reserve personnel as a RAI unit at Cincinnati, OH. Established in the Regular Army 22 December 1928, assigned to the Fifth Corps Area Service Command, and allotted to the Fifth Corps Area. Named for Col. Charles R. Greenleaf, Chief Surgeon, Army in the Field, during the Spanish-American War. Inactivated by June 1934 at Cincinnati. Reorganized by June 1935 at Cincinnati. Location 7 December 1941—Cincinnati.

Commanders, Greenleaf General Hospital

Lt. Col. Albert E. Harris**	23 Dec 24-Jan 25	<i>Inactive</i>	ao Jun 34-ao Jun 35
Capt. Frederick J. Burt**	Jan 25-17 Mar 25	Unknown	ao Jun 35-7 Dec 41

** RAI Commanders: Organized Reserve officers.

Hammond General Hospital (Z.I.)**Regular Army Inactive****HQ**-*Not organized* 1928-30; Syracuse, NY, 1930-41

Established in the Regular Army 22 December 1928, assigned to the Second Corps Area Service Command, and allotted to the Second Corps Area. Named for Brig. Gen. William A. Hammond, Surgeon General, 1862-64. Organized 4 February 1930 with Organized Reserve personnel as a RAI unit at Syracuse, NY. Location 7 December 1941—Syracuse, NY.

Status: Discontinued 20 December 1945 at Modesto, CA.**Commanders, Hammond General Hospital**

Lt. Col. Edmund P. Fowler**	4 Feb 30-9 Aug 30	Col. Isedor Unger**	9 Aug 30-19 Jan 41
	Lt. Col. Charles E. Maxwell**	19 Jan 41-9 Feb 41	

** RAI Commanders: Organized Reserve officers.

Hoff General Hospital (Z.I.)**Regular Army Inactive****HQ**-*Not organized* 1928-30; Brooklyn, NY, 1930-38; *Inactive* 1938-41; Santa Barbara, CA, 1941

Established in the Regular Army 22 December 1928, assigned to the Second Corps Area Service Command, and allotted to the Second Corps Area. Named for Col. Alexander H. Hoff, Superintendent of Medical Transportation, Army of the Tennessee, 1862-64. Organized 4 February 1930 with Organized Reserve personnel as a RAI unit at Brooklyn, NY. Inactivated 5 June 1938 at Brooklyn by relief of personnel. Concurrently, personnel transferred to the 1203rd Corps Area Service Unit. Activated 25 February 1941 at Santa Barbara, CA. Location 7 December 1941—Santa Barbara, CA.

Commanders, Hoff General Hospital

Lt. Col. Frederick H. Howard**	4 Feb 30-5 Jun 38	<i>Inactive</i>	5 Jun 38-25 Feb 41
	Col. William H. Allen*	25 Feb 41-ao Dec 41	

* Regular Army active duty commanders

** RAI Commanders: Organized Reserve officers.

LaGarde General Hospital (Z.I.)**Regular Army Inactive****HQ**-*Not organized* 1928-30; New Orleans, LA, 1930-34; *Inactive* 1934-35; New Orleans, LA, 1935-41

Established in the Regular Army 22 December 1928, assigned to the Fourth Corps Area Service Command, and allotted to the Fourth Corps Area. Named for Maj. Louis A. LaGarde, organizer of the National Library of Medicine. Organized 26 April 1930 with Organized Reserve personnel as a RAI unit at New Orleans, LA. Inactivated 9 October 1934 at New Orleans by relief of personnel. Reorganized 3 July 1935 at New Orleans. Activated 25 February 1941, less Reserve personnel, at New Orleans. Location 7 December 1941—New Orleans.

Status: Discontinued 28 November 1945 at New Orleans, LA.

Commanders, LaGarde General Hospital

Unknown	26 Apr 30-5 Sep 30	Unknown	3 Jul 35-11 Apr 36
Lt. Col. Francis S. Furman**	5 Sep 30-9 May 33	Lt. Col. John H. Musser, jr.**	11 Apr 36-21 Aug 38
Lt. Col. James S. Hough**	Jul 31-9 Oct 34	Lt. Col. Herbert N. Barnett**	18 Apr 37-ao Jun 37
<i>Inactive</i>	9 Oct 34-3 Jul 35	Unknown	ao Jun 37-25 Feb 41
	Col. William H. Smith*	25 Feb 41-ao Dec 41	

* Regular Army active duty commanders

** RAI Commanders: Organized Reserve officers.

Lawson General Hospital (Z.I.)

Regular Army Inactive

HQ-Not organized 1928-31; Atlanta, GA, 1931-34; *Inactive* 1934-35; Atlanta, GA, 1935-41

Established in the Regular Army 22 December 1928, assigned to the Fourth Corps Area Service Command, and allotted to the Fourth Corps Area. Named for Brevet Brig. Gen. Thomas Lawson, Surgeon General, 1836-1861. Organized by February 1931 with Organized Reserve personnel as a RAI unit at Atlanta, GA. Inactivated 9 October 1934 at Atlanta by relief of personnel. Reorganized 3 July 1935 at Atlanta. Activated 19 January 1941, less Reserve personnel, at Atlanta. Location 7 December 1941—Atlanta, GA.

Status: Discontinued 25 June 1946 at Atlanta, GA.

Commanders, Lawson General Hospital

Lt. Col. John D. Gable**	Feb 31-9 Oct 34	Lt. Col. James F. Arthur**	4 Apr 37-ao Jun 39
<i>Inactive</i>	9 Oct 34-3 Jul 35	Unknown	ao Jun 39-15 Mar 41
Unknown	3 Jul 35-30 Aug 36	Lt. Col. Jesse I. Sloat*	15 Mar 41-1 May 41
Lt. Col. William P. Nicholson**	30 Aug 36-4 Apr 37	Brig. Gen. William L. Sheep*	1 May 41-ao Dec 41

* Regular Army active duty commanders

** RAI Commanders: Organized Reserve officers.

Letterman General Hospital (Z.I.)

HQ-Presidio of San Francisco, CA, 1899-41

Established in the Regular Army in 1898. Opened for operations 27 July 1899 at the Presidio of San Francisco, CA. Named 13 November 1911 for Brig. Gen. Jonathan Letterman, Medical Director, Army of the Potomac, 1862-64. Provided the higher general and specialized hospital care for patients in the Ninth Corps Area. Location 7 December 1941—Presidio of San Francisco, CA.

Status: Discontinued 1 August 1995 at the Presidio of San Francisco, CA.

Commanders, Letterman General Hospital

Lt. Col. Robert M. Thornburg	ao Jan 19-ao Feb 19	Col. Albert E. Truby	Feb 26-1 Feb 27
Col. James M. Kennedy	ao Dec 19-ao Jan 22	Col. Wallace DeWitt	1 Feb 27-16 Jun 31
Col. Albert E. Truby	ao Mar 22-Apr 24	Col. M. Augustus W. Shockley	16 Jun 31-29 Apr 35
Col. James M. Kennedy	Apr 24-Feb 26	Brig. Gen. Roger Brooke	May 35-25 Mar 40
	Col. Wallace DeWitt	25 Mar 40-ao Jan 42	

Letterman General Hospital (Augmentation) (Z.I.)

HQ-Not organized 1928-29; San Francisco, CA, 1929-41

Constituted in the Regular Army 22 December 1928, assigned to the Ninth Corps Area Service Command, and allotted to the Ninth Corps Area. Organized in 1929 with Organized Reserve personnel as a RAI unit at San Francisco, CA. Unit mission was to augment Letterman General Hospital on mobilization. Conducted summer training at Letterman General Hospital. Location 7 December 1941—San Francisco, CA.

Lovell General Hospital (Z.I.)**Regular Army Inactive****HQ**-Springfield, MA, 1925-36; *Inactive* 1936-41; Fort Devens, MA, 1941

Authorized by the Surgeon General and organized by March 1925 with Organized Reserve personnel as a RAI unit at Springfield, MA. Established in the Regular Army 22 December 1928, assigned to the First Corps Area Service Command, and allotted to the First Corps Area. Named for Dr. Joseph Lovell, Surgeon General, United States Army, 1818-1836. Inactivated about June 1936 at Springfield by relief of personnel. Personnel concurrently transferred to the 1101st General Hospital. Activated 3 March 1941 at Fort Devens, MA. Location 7 December 1941—Fort Devens, MA.

Status: Discontinued 30 June 1946 at Ayers, MA.**Commanders, Lovell General Hospital**

Maj. John M. Krase**	ao Mar 25-17 Mar 25	<i>Inactive</i>	Jun 36-3 Mar 41
Unknown	17 Mar 25-Jun 36	Lt. Col. John Wallace*	1 Apr 41-1 May 41
	Brig. Gen. Henry C. Pillsbury**	1 May 41-ao Dec 41	

* Regular Army active duty commanders

** RAI Commanders: Organized Reserve officers.

Moore General Hospital (Z.I.)**Regular Army Inactive****HQ**-*Not organized* 1928-37; Indianapolis, IN, 1937-41

Established in the Regular Army 22 December 1928, assigned to the Fifth Corps Area Service Command, and allotted to the Fifth Corps Area. Named for Brig. Gen. John Moore, Surgeon General, 1886-90. Initiated by August 1937 at Indianapolis. Location 7 December 1941—Indianapolis, IN.

Status: Discontinued 18 July 1942.**Commanders, Moore General Hospital**

Unknown	ao Aug 37-7 Dec 41
---------	--------------------

Morgan General Hospital (Z.I.)**Regular Army Inactive****HQ**-*Not organized* 1928-31; Detroit, MI, 1931-32; *Inactive* 1932-41

Established in the Regular Army 22 December 1928, assigned to the Sixth Corps Area Service Command, and allotted to the Sixth Corps Area. Named for Dr. John Morgan, Director General and Physician in Chief of the American Hospital, 1775-1777. Organized by June 1930 with Organized Reserve personnel as a RAI unit at Detroit, MI. Inactivated by June 1932. Location 7 December 1941—*Inactive*.

Commanders, Morgan General Hospital

Unknown	ao Jun 30-Jun 32	<i>Inactive</i>	Jun 32-7 Dec 41
---------	------------------	-----------------	-----------------

Murray General Hospital (Z.I.)**Regular Army Inactive****HQ**-*Not organized* 1928-29; St. Louis, MO, 1929-41

Established in the Regular Army 22 December 1928, assigned to the Seventh Corps Area Service Command, and allotted to the Seventh Corps Area. Named for Brig. Gen. Robert Murray, Surgeon General, 1883-86. Organized by July 1929 with Organized Reserve personnel as a RAI unit at St. Louis, MO. Conducted C.M.T.C. training in 1936 at Fort Leavenworth, KS. Location 7 December 1941—St. Louis, MO.

Commanders, Murray General Hospital

Capt. Dan Staples**	Jul 29-ao Aug 29	Lt. Col. J. W. Shankland**	Feb 31-ao Jan 32
Maj. Abram C. Leggat**	May 30-Jun 30	Unknown	ao Jan 32-ao Jul 36
Maj. Alfred L. Wessling**	Jul 30-Feb 31	Lt. Col. Frederick L. Nelson**	ao Jul 36-22 Aug 37
	Unknown	22 Aug 37-7 Dec 41	

** RAI Commanders: Organized Reserve officers.

O'Reilly General Hospital (Z.I.)**Regular Army Inactive****HQ-Not organized** 1928-30; Philadelphia, PA, 1925-28; *Inactive* 1928-30; Springfield, MO, 1930-41

Authorized by the Surgeon General and organized 8 January 1925 with Organized Reserve personnel as a RAI unit at Philadelphia, PA. Named for Brig. Gen. Robert M. O'Reilly, Surgeon General, 1902-1909. Withdrawn from the Third Corps Area by 1928. Established in the Regular Army 22 December 1928, assigned to the Seventh Corps Area Service Command, and allotted to the Seventh Corps Area. Initiated in May 1930 at Springfield MO. Activated 1 April 1941 at Springfield, MO. Location 7 December 1941—Springfield, MO.

Status: Discontinued 23 September 1946 at Springfield, MO.**Commanders, O'Reilly General Hospital**

Lt. Col. William H. Herr**	8 Jan 25-ao Feb 25	Unknown	ao Jun 31-1 Apr 41
Unknown	ao Feb 25- 22 Dec 28	1st Lt. W. M. Warner*	1 Apr 41-27 Apr 41
<i>Inactive</i>	22 Dec 28-2 May 30	Maj. Allan B. Ramsay*	27 Apr 41-1 Apr 41
Lt. Col. Walter J. Shidler**	2 May 30-ao Jun 31	Lt. Col. James H. Barbin*	1 Jul 41-
	Col. George B. Foster, Jr.*	ao Aug 41-ao Dec 41	

* Regular Army active duty commanders

** RAI Commanders: Organized Reserve officers.

Shippen General Hospital (Z.I.)**Regular Army Inactive****HQ-Not organized** 1928-30; Baltimore, MD, 1930-41

Established in the Regular Army 22 December 1928, assigned to the Third Corps Area Service Command, and allotted to the Third Corps Area. Named for Dr. William Shippen, Jr., Director General of the Military Hospitals of the Continental Army, 1777-1781. Organized 6 May 1930 with Organized Reserve personnel as a RAI unit at Baltimore, MD. Location 7 December 1941—Baltimore, MD.

Commanders, Shippen General Hospital

1st Carl H. Hoover**	6 May 30-24 Nov 30	Lt. Col. Robert C. Parrish**	24 Nov 30-29 Jan 31
	Unknown	29 Jan 31-7 Dec 41	

** RAI Commanders: Organized Reserve officers.

Smart General Hospital (Z.I.)**Regular Army Inactive****HQ-Not organized** 1928-30; Milwaukee, WI, 1930-32; *Inactive* 1932-41

Established in the Regular Army 22 December 1928, assigned to the Sixth Corps Area Service Command, and allotted to the Sixth Corps Area. Named for Lt. Col. Charles Smart, U. S. Army Medical Department, pioneer in dietary practices and sanitation techniques. Organized by June 1930 with Organized Reserve personnel as a RAI unit at Milwaukee, WI. Inactivated by June 1932 at Milwaukee by relief of personnel. Location 7 December 1941—*Inactive*.

Commanders, Smart General Hospital

Unknown	ao Jun 30-Jun 32	<i>Inactive</i>	Jun 32-7 Dec 41
---------	------------------	-----------------	-----------------

Sternberg General Hospital (Philippine Department)**HQ-Manila, PI, 1898-41**

Established in the Regular Army in 1898 at Manila, PI, as the Department Hospital, Manila, PI. Redesignated 26 June 1920 as Sternberg General Hospital. Named for Brig. Gen. George M. Sternberg, Surgeon General, 1893-1902. Provided the higher general and specialized hospital care for patients in the Philippine Department and the U.S. Army Forces in China. Location 7 December 1941—Manila, PI.

Commanders, Sternberg General Hospital

Col. George F. Juenemann	ao Dec 20-ao Jan 21	Col. Paul S. Halloran	Nov 27-Aug 29
Col. William F. Lewis	ao Jun 21-28 Nov 21	Col. Louis Brechemin, Jr.	Aug 29-Jan 32
Unknown	28 Nov 21-17 Jun 22	Col. Alexander Murray	Jan 32-11 Mar 33
Lt. Col. Alexander Murray	17 Jun 22-1 Dec 23	Col. Frank W. Weed	11 Mar 33-26 Sep 34
Lt. Col. Charles F. Morse	8 Dec 23-15 Nov 24	Col. Mathew A. Reasoner	26 Sep 34-23 Mar 35
Lt. Col. William H. Moncrief	15 Nov 24-4 Oct 25	Unknown	23 Mar 35-ao Jun 37
Lt. Col. Lloyd C. Smith	4 Oct 25-22 Feb 26	Col. William H. Allen	ao Jun 37-ao Sep 38
Col. Christopher C. Collins	22 Feb 26-Nov 27	Col. Adam E. Schlanser	ao Oct 39-Sep 41
	Col. Wibb E. Cooper	Sep 41-26 May 42	

Sternberg General Hospital (Augmentation) (Philippine Department)

HQ-Not organized 1928-29; Manila, PI, 1929-41

Constituted in the Regular Army 22 December 1928 and allotted to the Philippine Department. Unit mission was to augment Sternberg Hospital on mobilization. Organized in 1929 with Organized Reserve personnel as a RAI unit at Manila. Location 7 December 1941—Manila, PI.

Commanders, Sternberg General Hospital (Augmentation)

Unknown	ao Dec 29-7 Dec 41
---------	--------------------

Sutherland General Hospital (Z.I.)

Regular Army Inactive

HQ-Not organized 1928-30; Pittsburgh, PA, 1930-41

Established in the Organized Reserve 22 December 1928, assigned to the Third Corps Area Service Command, and allotted to the Third Corps Area. Named for Brig. Gen. Charles Sutherland, Surgeon General, 1890-93. Organized 2 May 1930 with Organized Reserve personnel as a RAI unit at Pittsburgh, PA. Location 7 December 1941—Pittsburgh, PA.

Commanders, Sutherland General Hospital

1st Lt. Charles L. DePriest**	2 May 30-20 May 30	Lt. Col. George I. Yearick**	22 Dec 32-ao Dec 34
Lt. Col. Allensen F. B. Morris**	2 May 30-22 Dec 32	Unknown	ao Dec 34-7 Dec 41

** RAI Commanders: Organized Reserve officers.

Tilton General Hospital (Z.I.)

Regular Army Inactive

HQ-Not organized 1928-29; Los Angeles, CA, 1929-41; Fort Dix, NJ, 1941



Established in the Regular Army 22 December 1928, assigned to the Ninth Corps Area Service Command, and allotted to the Ninth Corps Area. Named for Dr. James Tilton, Physician and Surgeon General of the United States Army, 1813-1815. Organized by November 1929 with Organized Reserve personnel as a RAI unit at Los Angeles, CA. Conducted summer training at Del Monte, CA, the Presidio of Monterey, CA, OR, Letterman General Hospital, San Francisco, CA. Activated 1 March 1941, less Reserve personnel, at Fort Dix, NJ. Location 7 December 1941—Fort Dix, NJ.

Status: Discontinued 30 June 1949 at Fort Dix, NJ.

Commanders, Tilton General Hospital

Maj. Byron Palmer**	Nov 29-ao Jun 33	Col. George B. Booth**	21 Jul 37-ao Jan 38
Unknown	ao Jun 33-11 Jun 35	Lt. Col. Sydney V. Kirby**	3 Sep 38-ao Jan 39
Col. Charles E. Sisson**	11 Jun 35-10 Jul 37	Unknown	ao Jan 39-1 Mar 41
Lt. Col. William A. Eaton**	10 Jul 37-21 Jul 37	Col. Samuel J. Turnbull*	1 Mar 41-ao Dec 41

* Regular Army active duty commanders

** RAI Commanders: Organized Reserve officers.

Torney General Hospital (Z.I.)**Regular Army Inactive****HQ**-*Not organized* 1928-29; Fort Worth, TX, 1929-37; Dallas, TX, 1937-41

Established in the Regular Army 22 December 1928, assigned to the Eighth Corps Area Service Command, and allotted to the Eighth Corps Area. Named for Brig. Gen. George H. Torney, Surgeon General, 1909-1913. Organized 8 November 1929 with Organized Reserve personnel as a RAI unit at Fort Worth, TX. Conducted summer training at Fort Worth. Relocated 2 February 1937 to Dallas, TX. Location 7 December 1941—Dallas, TX.

Status: Discontinued 22 November 1945 at Palm Springs, CA.**Commanders, Torney General Hospital**

Capt. James Peyton, Q.M.C.	5 Mar 29-7 Nov 29	Lt. Col. Harold L. Warwick**	8 Nov 29-19 Jun 34
	Unknown	19 Jun 34-7 Dec 41	

** RAI Commanders: Organized Reserve officers.

Tripler General Hospital (Z.I.)**HQ**-Fort Shafter, TH, 1907-41

Established in the Regular Army in 1907 at Fort Shafter, TH. Named 26 June 1920 for Brig. Gen. Charles S. Tripler, Medical Director, Army of the Potomac, 1861-62. Provided the higher general and specialized hospital care for patients in Hawaii and the Pacific Ocean areas. Location 7 December 1941—Honolulu, TH.

Commanders, Tripler General Hospital

Lt Col. Eugene G. Northington	Sep 19-Dec 19	Col. James D. Heysinger	Oct 30-Aug 33
Lt Col. John A. Clark	Dec 19-Jul 20	Lt Col. John G. Ingold	Aug 33-Sep 33
Col. William H. Wilson	Jul 20-10 Jul 23	Col. Harold W. Jones	Sep 33-May 36
Lt Col. Charles F. Craig	10 Jul 23-Sep 23	Lt Col. Shelley U. Marietta	May 36-Jun 36
Col. Edward R. Schreiner	Sep 23-7 Oct 27	Col. William H. Smith	1 Jul 36-Jul 39
Col. Raymond F. Metcalfe	7 Oct 27-13 Sep 30	Col. George B. Foster, Jr.	Jul 39-Apr 41
Maj. Harry L. Dale	13 Sep 30-Oct 30	Col. Alvin C. Miller	Apr 41-Sep 42

Tripler General Hospital (Augmentation) (Hawaiian Department)**HQ**-*Not initiated* 1928-29; Honolulu, TH, 1929-41

Constituted in the Regular Army 22 December 1928 and allotted to the Hawaiian Department. Organized in 1929 with Organized Reserve personnel as a RAI unit at Honolulu, TH. Unit mission was to augment Tripler General Hospital on mobilization. Location 7 December 1941—Honolulu, TH.

Walter Reed General Hospital (Z.I.)**HQ**-Washington, DC, 1909-41

Established in the Regular Army in 1905. Opened for operations 1 May 1909 at Washington, DC. Named for Maj. Walter Reed, U.S. Army Medical Department and conqueror of Yellow Fever. Renamed Walter Reed Army Medical Center in 1923. Provided the higher general and specialized hospital care for patients in the First, Second, Third, and Fourth Corps Areas. Location 7 December 1941—Washington, DC.

Status: Active in the Regular Army at Washington, DC.**Commanders, Walter Reed General Hospital**

Col. Edward R. Schreiner	27 Aug 18-15 Mar 19	Brig. Gen. Albert E. Truby	1 Jan 32-31 Jul 35
Brig. Gen. James D. Glennan	19 Mar 19-2 Mar 26	Brig. Gen. Wallace DeWitt	31 Jul 35-28 Dec 39
Brig. Gen. James M. Kennedy	2 Mar 26-5 Dec 29	Brig. Gen. Raymond F. Metcalfe	28 Dec 39-31 Jan 41
Brig. Gen. Carl R Darnall	12 Dec 29-31 Dec 31	Brig. Gen. Shelley U. Marietta	1 Feb 41-9 Feb 46

Walter Reed General Hospital (Augmentation) (Z.I.)

HQ-Not initiated 1928-29; Washington, DC, 1929-41

Constituted in the Regular Army 22 December 1928, assigned to the Third Corps Area Service Command, and allotted to the Third Corps Area. Organized in 1929 with Organized Reserve personnel as a RAI unit at Washington, DC. Unit mission was to augment Walter Reed General Hospital on mobilization. Location 7 December 1941—Washington, DC.

William Beaumont General Hospital (Z.I.)

HQ-El Paso, TX, 1920-41

Established in the Regular Army 20 June 1920. Opened for operations 1 July 1921 at El Paso, TX. Named for Capt. William Beaumont, Surgeon, 6th Infantry, and pioneer in gastrointestinal medicine. Provided the higher general and specialized hospital care for patients in the Fourth, Eighth, and Ninth Corps Areas. Location 7 December 1941—El Paso.

Status: Active in the Regular Army at El Paso, TX.

Commanders, William Beaumont General Hospital

Col. William R. Eastman	Jun 21-Sep 22	Col. William H. Moncrief	Apr 28-1 Jul 31
Col. M. Augustus W. Shockley	Sep 22-Jun 27	Col. Henry F. Pipes	1 Jul 31-15 May 37
Col. Rueben B. Miller	Jun 27-Apr 28	Col. George M. Edwards	15 May 37-Sep 45

William Beaumont General Hospital (Augmentation) (Z.I.)

HQ-Not initiated 1928-29; El Paso, TX, 1929-41

Constituted in the Regular Army 22 December 1928, assigned to the Eighth Corps Area Service Command, and allotted to the Eighth Corps Area. Organized 8 November 1929 with Organized Reserve personnel as a RAI unit at El Paso, TX. Unit mission was to augment William Beaumont General Hospital on mobilization. Location 7 December 1941—El Paso, TX.

Commanders, William Beaumont General Hospital (Augmentation)

Lt Col. Herbert E. Stevenson	8 Nov 29-ao Feb 32	Unknown	ao Feb 32-7 Dec 41
------------------------------	--------------------	---------	--------------------

Woodhull General Hospital (Z.I.)

Regular Army Inactive

HQ-Not organized 1928-30; Seneca Falls, NY, 1930-34; *Inactive* 1934-41

Established in the Regular Army 22 December 1928, assigned to the Second Corps Area Service Command, and allotted to the Second Corps Area. Named for Lt. Col. Alexander A. Woodhull, U. S. Army Medical Department. Organized 4 February 1930 with Organized Reserve personnel as a RAI unit at Seneca Falls, NY. Inactivated 1 July 1934 at Seneca Falls by relief of personnel. Location 7 December 1941—*Inactive*.

Commanders, Woodhull General Hospital

Lt. Col. Fred W. Lester**	4 Feb 30-30 Jun 34	<i>Inactive</i>	30 Jun 34-7 Dec 41
---------------------------	--------------------	-----------------	--------------------

** RAI Commanders: Organized Reserve officers.

1st General Hospital (Z.I.)

Organized Reserve New York

HQ-Not initiated 1923-25; New York City, NY, 1925-41

Authorized 15 March 1923 by the Surgeon General to be organized at, and affiliated with, Bellevue Hospital in New York City, NY. Constituted in the Organized Reserve 2 July 1923 as General Hospital No. 1, assigned to the Zone of the Interior, and allotted to the Second Corps Area. Relieved as Zone of Interior troops 31 March 1924 and assigned to the Communications Zone. Initiated 21 August 1925 at New York City, NY. Redesignated 1st General Hospital 29 March 1929. Consolidated 18 November 1936 with Base Hospital No. 1 (a WWI unit organized in 1916 at New York City, NY; mobilized in November 1917 at New York; demobilized in May 1919 at Camp Upton, NY; reconstituted 18 November 1936). Withdrawn from the Organized Reserve 1 July 1940 and allotted to the Regular Army. Conducted summer training at Carlisle Barracks, PA. Location 7 December 1941—New York City, NY.

Status: Inactive in the U.S. Army Reserve as the 1st General Hospital.

Commanders, 1st General Hospital

Lt. Col. Ranson S. Hooker	21 Aug 25-29 Sep 25	Unknown	ao Jun 33-ao Jun 34
Col. Arthur M. Wright	29 Sep 25-ao Jun 33	Col. George B. Wallace	ao Jun 34-15 Oct 38
	Col. George A. Koenig**	15 Oct 38-ao Dec 41	

** RAI Commanders: Organized Reserve officers.

2nd General Hospital (C.Z.)

Organized Reserve New York

HQ-Not initiated 1923-24; New York City, NY, 1924-41

Constituted in the Organized Reserve 2 July 1923 as General Hospital No. 2, assigned to the Communications Zone, and allotted to the Second Corps Area. Affiliated 18 January 1924 with Presbyterian Hospital in New York City, NY. Initiated 12 March 1925 at New York City. Redesignated 2nd General Hospital 29 March 1929. Consolidated 8 September 1936 with Base Hospital No. 2 (a WWI unit organized in February 1917 at New York City; demobilized 17 February 1919 at Camp George G. Meade, MD; reconstituted 8 September 1936). Withdrawn from the Organized Reserve 1 July 1940 and allotted to the Regular Army. Location 7 December 1941—New York City, NY.

Status: Inactive in the Regular Army as the 2nd General Hospital.

Commanders, 2nd General Hospital

Maj. Robert H. Kennedy	12 Mar 25-7 Oct 25	Unknown	ao Apr 30-18 Apr 35
Col. William Darrach	7 Oct 25-ao Jun 27	Lt. Col. Frank C. Yeomans	18 Apr 35-15 Nov 35
Lt. Col. George J. Lawrence	4 Mar 30-ao Apr 30	Lt. Col. William E. Lippold **	23 Jul 36-ao Jan 41

** RAI Commanders: Organized Reserve officers.

3rd General Hospital (C.Z.)

Organized Reserve New York/New Jersey

HQ-Not initiated 1923-25; New York City, NY, 1925-30; Jersey City, NJ, 1930-41



Constituted in the Organized Reserve 2 July 1923 as General Hospital No. 3, assigned to the Communications Zone, and allotted to the Second Corps Area. Initiated 24 April 1925 at New York City, NY. Affiliated with the Mount Sinai Hospital in New York City. Redesignated 3rd General Hospital 29 March 1929. Relocated 6 February 1930 to Jersey City, NJ. Consolidated 18 September 1936 with Base Hospital No. 3 (a WWI unit organized in 1916 at New York City, NY; mobilized in November 1917 at New York; demobilized in March 1919 at Camp Upton, NY; reconstituted 18 September 1936). Withdrawn from the Organized Reserve 1 July 1940 and allotted to the Regular Army. Location 7 December 1941—Jersey City, NJ.

Status: Inactive in the U.S. Army Reserve as the 3rd General Hospital.

Commanders, 3rd General Hospital

Maj. Ralph P. Hyck	24 Apr 25-29 Sep 25	Lt. Col. James Wall	10 May 30-ao Jun 30
Col. William J. Elser	29 Sep 25-ao Jun 27	Unknown	ao Jun 30-29 Dec 34
Unknown	ao Jun 27-10 May 30	Lt. Col. Robert R. Reed	29 Dec 34-ao May 37
	Unknown	ao May 37-7 Dec 41	

4th General Hospital (C.Z.)**Organized Reserve Ohio****HQ-Not initiated** 1923-25; Cleveland, OH, 1925-41

Authorized 1 March 1923 by the Surgeon General to be organized at, and affiliated with, the Western Reserve University, Lakeside Hospital Unit in Cleveland, OH. Constituted in the Organized Reserve 2 July 1923 as General Hospital No. 4, assigned to the Communications Zone, and allotted to the Fifth Corps Area. Initiated 5 March 1925 at Cleveland, OH. Redesignated 4th General Hospital 29 March 1929. Withdrawn from the Organized Reserve 1 October 1933 and allotted to the Regular Army. Concurrently relieved from the Communications Zone and assigned to the General Headquarters Reserve. Consolidated in 1936 with Base Hospital No. 4 (a WWI unit organized in 1916 at Lakeside Hospital, Cleveland, OH; mobilized in May 1917 at New York; demobilized 16 April 1919 at Camp Sherman, OH; reconstituted in 1936). Location 7 December 1941—Cleveland, OH.

Status: Inactive in the U.S. Army Reserve as the 4th General Hospital.**Commanders, 4th General Hospital**

Maj. Adam B. Denison	5 Mar 25-Oct 30	Col. Frederick C. Herrick	Oct 30-Feb 32
	Unknown	Feb 32-7 Dec 41	

5th General Hospital (C.Z.)**Organized Reserve Massachusetts****HQ-Not initiated** 1923-26; Boston, MA, 1926-41

Constituted in the Organized Reserve 2 July 1923, assigned to the Communications Zone, and allotted to the First Corps Area. Designated 12 September 1923 as General Hospital No. 5. Affiliated with Harvard University Medical School at Cambridge, MA. Initiated by March 1926 at Boston, MA. Redesignated 5th General Hospital 29 March 1929. Withdrawn from the Organized Reserve 1 October 1933 and allotted to the Regular Army. Concurrently relieved from the Communications Zone and assigned to the General Headquarters Reserve. Consolidated 8 August 1936 with Base Hospital No. 5 (a WWI unit organized in February 1918 at Harvard University Medical Center, Cambridge, MA; mobilized in May 1918 at Cambridge; demobilized 2 May 1919 at Camp Devens, MA; reconstituted 8 August 1936). Location 7 December 1941—Boston, MA.

Status: Active in the Regular Army as the 5th General Hospital at Stuttgart, Germany.**Commanders, 5th General Hospital**

Unknown	ao Mar 26-Sep 26	Unknown	ao Feb 30-ao Jun 31
Col. Albert Pfeiffer	Sep 26-Jan 28	Col. Frank W. Snow**	ao Jun 31-ao Jun 39
Lt. Col. George M. Watson	Jan 28-ao Feb 30	Unknown	ao Jun 39-7 Dec 41

** RAI Commanders: Organized Reserve officers.

6th General Hospital (C.Z.)**Organized Reserve Massachusetts/Ohio****HQ-Boston, MA, 1922-36; Inactive** 1936-37; Toledo, OH, 1937-41

Authorized 5 July 1922 by the Surgeon General for organization at, and affiliation with, Massachusetts General Hospital in Boston, MA. Constituted in the Organized Reserve 2 July 1923 as General Hospital No. 6, assigned to the Communications Zone, and allotted to the First Corps Area. Redesignated 6th General Hospital 29 March 1929. Withdrawn from the Organized Reserve 1 October 1933 and allotted to the Regular Army. Concurrently assigned to the General Headquarters Reserve. Withdrawn from the First Corps Area 5 June 1936 and allotted to the Fifth Corps Area. Consolidated 8 August 1936 with Base Hospital No. 6 (a WWI unit organized in March 1916 at Boston, MA; mobilized 24 May 1917 at Boston; demobilized 9 April 1919 at Camp Devens, MA; reconstituted 8 August 1936). Reorganized 6 August 1937 at Toledo, OH. Designated mobilization training station was Fort Devens, MA, 1923-36. Location 7 December 1941—Toledo, OH.

Status: Inactive in the Regular Army as the 6th General Hospital.**Commanders, 6th General Hospital**

Lt. Col. James H. Means	5 Jul 22-ao Jan 30	Unknown	ao Jan 30-7 Dec 41
-------------------------	--------------------	---------	--------------------

7th General Hospital (C.Z.)**Organized Reserve Massachusetts/Ohio****HQ-***Not initiated* 1923-24; Boston, MA, 1924-30; *Inactive* 1930-37; Toledo, OH, 1937-41

Constituted in the Organized Reserve 2 July 1923 as General Hospital No. 7, assigned to the Communications Zone, and allotted to the First Corps Area. Affiliated 12 June 1924 with Boston City Hospital in Boston, MA. Concurrently organized at Boston. Redesignated 7th General Hospital 29 March 1929. Inactivated 11 January 1930 at Boston by relief of personnel. Withdrawn from the Organized Reserve 1 October 1933 and allotted to the Regular Army. Concurrently assigned to the General Headquarters Reserve. Withdrawn from the First Corps Area 5 June 1936 and allotted to the Fifth Corps Area. Consolidated 8 August 1936 with Base Hospital No. 7 (a WWI unit organized in December 1916 at Boston, MA; demobilized 4 April 1919 at Camp Devens, MA; reconstituted 8 August 1936). Reorganized 6 August 1937 at Toledo, OH. Designated mobilization training station was Fort Devens, MA, 1923-36. Location 7 December 1941—Toledo, OH.

Status: Inactive in the U.S. Army Reserve as the 7th General Hospital.**Commanders, 7th General Hospital**

Col. John J. Dowling	12 Jun 24-Aug 29	<i>Inactive</i>	11 Jan 30-6 Aug 37
Lt. Robert C. Cochran	Aug 29-11 Jan 30	Unknown	6 Aug 37-7 Dec 41

8th General Hospital (Z.I.)**Organized Reserve New York****HQ-**Manhattan, NY, 1923-41

Authorized 20 April 1923 by the Surgeon General for organization at, and affiliation with, the New York Post Graduate Medical School and Hospital, Manhattan, NY. Constituted in the Organized Reserve 2 July 1923 as General Hospital No. 8, assigned to the Zone of the Interior, and allotted to the Second Corps Area. Concurrently affiliated with the New York Post Graduate Medical School and Hospital, Manhattan, NY. Relieved as Zone of Interior troops 31 March 1924 and assigned to the Communications Zone. Redesignated 8th General Hospital 29 March 1929. Consolidated 18 September 1936 with Base Hospital No. 8 (a WWI unit organized in November 1916 at the New York Post Graduate Medical School and Hospital, Manhattan, NY; mobilized 15 July 1917 at Fort Jay, NY; demobilized 22 April 1919 at Camp Lee, VA; reconstituted 18 September 1936). Location 7 December 1941—Manhattan, NY.

Status: Inactive in the U.S. Army Reserve as the 320th General Hospital.**Commanders, 8th General Hospital**

Lt. Col. John J. Moorhead	20 Apr 23-3 Feb 25	Col. James F. McKernon	29 Sep 25-20 Mar 29
Maj. John D. Stewart	3 Feb 25-6 Feb 25	Col. Robert H. Halsey	16 Dec 34-20 Jul 37
Lt. Col. Edward W. Peterson	6 Feb 25-29 Sep 25	Capt. J. A. Katzive	20 Jul 37-Jun 39
	Col. Ira Cohen	Jun 39-ao Jun 41	

9th General Hospital (C.Z.)**Organized Reserve New York****HQ-***Not initiated* 1923-25; Manhattan, NY, 1925-41

Constituted in the Organized Reserve 2 July 1923, assigned to the Communications Zone, and allotted to the Second Corps Area. Designated 12 September 1923 as General Hospital No. 9. Initiated 20 March 1925 at, and affiliated with, the Society of the New York Hospital, IN, Manhattan, NY. Redesignated 9th General Hospital 29 March 1929. Consolidated 18 September 1936 with Base Hospital No. 9 (a WWI unit organized in February 1916 at New York City, NY; mobilized 21 July 1917 at Governors Island, NY; demobilized 5 May 1919 at Camp Upton, NY; reconstituted 18 September 1936). Withdrawn from the Organized Reserve 1 July 1940 and allotted to the Regular Army. Affiliation with the Society of the New York Hospital reaffirmed 17 August 1940. Conducted summer training at Carlisle Barracks, PA. Location 7 December 1941—Manhattan, NY.

Status: Inactive in the Regular Army as the 9th General Hospital.

Commanders, 9th General Hospital

Maj. George C. Straub	20 Mar 25-24 Jun 25	Maj. Samuel A. Buchenholz	16 Jan 35-21 Mar 35
Lt. Col. Carter S. Cole	24 Jun 25-7 Sep 26	Lt. Col. Milton I. Strahl	21 Mar 35-ao Jun 36
Col. Harold D. Corbusier	22 Sep 26-Mar 30	Col. Howard W. Barker	ao Jan 37-23 Dec 38
Unknown	Mar 30-16 Jan 35	Col. Milton I. Strahl**	23 Dec 38-ao Jun 41

** RAI Commanders: Organized Reserve officers.

10th General Hospital (C.Z.)

Organized Reserve Pennsylvania

HQ-Philadelphia, PA, 1922-40; *Inactive* 1940-41

Authorized 2 December 1922 by the Surgeon General to be organized at, and affiliated with, the Pennsylvania Hospital in Philadelphia, PA. Constituted in the Organized Reserve 2 July 1923 as General Hospital No. 10, assigned to the Communications Zone, and allotted to the Third Corps Area. Redesignated 10th General Hospital 29 March 1929. Inactivated 15 October 1929 at Philadelphia by relief of personnel. Reorganized 9 April 1930 with headquarters at Philadelphia. Withdrawn from the Organized Reserve 1 October 1933 and allotted to the Regular Army. Consolidated 12 August 1936 with Base Hospital No. 10 (a WWI unit organized in February 1917 at Philadelphia; mobilized in May 1917 at Philadelphia; demobilized 19 April 1919 at Camp Dix, NJ; reconstituted 12 August 1936). Inactivated 10 September 1940 at Philadelphia by relief of personnel. Location 7 December 1941—*Inactive*.

Status: Inactive in the Regular Army as the 10th General Hospital.

Commanders, 10th General Hospital

Col. Charles F. Mitchell	2 Dec 22-26 Jan 28	Lt. Col. Walter J. Shidler	9 Apr 30-10 Oct 32
Lt. Col. Walter E. Lee	26 Jan 28-15 Oct 29	Col. Charles F. Mitchell**	10 Oct 32-1 Jul 40
<i>Inactive</i>	15 Oct 29-9 Apr 30	Unknown	1 Jul 40-10 Sep 40
	<i>Inactive</i>	10 Sep 40-7 Dec 41	

** RAI Commanders: Organized Reserve officers.

11th General Hospital (C.Z.)

Organized Reserve Illinois

HQ-*Not initiated* 1923-24; Chicago, IL, 1924-41



Constituted in the Organized Reserve 2 July 1923, assigned to the Communications Zone, and allotted to the Sixth Corps Area. Designated 12 September 1923 as General Hospital No. 11. Initiated in August 1924 at Chicago, IL. Redesignated 11th General Hospital 29 March 1929. Consolidated 6 August 1931 with Base Hospital No. 11 (a WWI unit organized 4 March 1918 at the St. Mary, St. Joseph, and Augustana Hospitals in Chicago, IL; demobilized in May 1919 at Camp Grant, IL; reconstituted 6 August 1931). Conducted summer training at the station hospitals at Fort Snelling, MN, or Camp Custer, MI. Location 7 December 1941—Chicago, IL.

Status: Inactive in the U.S. Army Reserve as the 329th General Hospital.

Commanders, 11th General Hospital

Unknown	Aug 24-12 Feb 25	Lt. Col. Samuel P. Colehour	ao Jun 34-ao Feb 35
Col. Joseph L. Miller	12 Feb 25-May 29	Unknown	ao Feb 35-ao Oct 35
Lt. Col. G. Thomsen Van Colditz	May 29-ao Jun 33	Lt. Col. G. Thomsen Van Colditz	ao Oct 35-16 Oct 38
Unknown	ao Jun 33-ao Jun 34	Lt. Col. Samuel P. Colehour	16 Oct 38-ao Jan 40
	Unknown	ao Jan 40-7 Dec 41	

12th General Hospital (C.Z.)

Organized Reserve Michigan/Illinois

HQ-*Not initiated* 1923-24; Battle Creek, MI, 1924-38; Kalamazoo, MI, 1938-41; Chicago, IL, 1941

Constituted in the Organized Reserve 2 July 1923, assigned to the Communications Zone, and allotted to the Sixth Corps Area. Designated 12 September 1923 as General Hospital No. 12. Initiated in November 1924 at Battle Creek, MI. Redesignated 12th General Hospital 29 March 1929. Concurrently relieved from the Communications Zone and assigned to the General Headquarters Reserve. Consolidated 18 September 1936 with Base Hospital No. 12 (a WWI

unit organized in July 1916 at the Northwestern University Hospital in Chicago, IL; mobilized 1 May 1917 at Chicago; demobilized 23 April 1919 at Camp Grant, IL; reconstituted 18 September 1936). Relocated by January 1938 to Kalamazoo, MI. Withdrawn from the Organized Reserve 1 July 1940 and allotted to the Regular Army. Relocated 17 May 1941 to Chicago, IL. Concurrently organized at, and affiliated with, Northwestern University in Chicago. Conducted summer training at the station hospital at Camp Custer, MI. Location 7 December 1941—Chicago, IL.

Status: Inactive in the Regular Army as the 12th General Hospital.

Commanders, 12th General Hospital

Unknown	Nov 24-11 Mar 25	Col. Robert B. Harkness	9 Apr 26-ao Jun 39
Maj. Dan H. Eaton	11 Mar 25-9 Apr 26	Unknown	ao Jun 39-7 Dec 41

13th General Hospital (C.Z.)

Organized Reserve Michigan

HQ-Not initiated 1923-25; Detroit, MI, 1925-40; Chicago, IL, 1940-41

Constituted in the Organized Reserve 2 July 1923, assigned to the Communications Zone, and allotted to the Sixth Corps Area. Designated 12 September 1923 as General Hospital No. 13. Initiated 12 February 1925 at Detroit, MI. Redesignated 13th General Hospital 29 March 1929. Consolidated 19 September 1936 with Base Hospital No. 13 (a WWI unit organized in 1916 at Chicago, IL; mobilized 11 January 1918 at Chicago; demobilized 23 April 1919 at Camp Grant, IL; reconstituted 19 September 1936). Withdrawn from the Organized Reserve 1 July 1940 and allotted to the Regular Army. Relocated in 1940 to Chicago, IL, and affiliated with Presbyterian Hospital. Conducted summer training at the station hospital at Camp Custer, MI. Location 7 December 1941—Chicago, IL.

Status: Inactive in the Regular Army as the 13th General Hospital.

Commanders, 13th General Hospital

Maj. Walter G. Darling	12 Feb 25-17 Mar 25	Col. Frederick C. Warnshuis	13 Nov 28-Jun 30
Lt. Col. Cleveland C. MacLane	17 Mar 25-1 Mar 28	Col. Grover C. Penberthy	Jun 30-ao Jan 40
Unknown	1 Mar 28-13 Nov 28	Unknown	ao Jan 40-7 Dec 41

14th General Hospital (C.Z.)

Organized Reserve Illinois

HQ-Not initiated 1923-25; Chicago, IL, 1925-41

Constituted in the Organized Reserve 2 July 1923 as General Hospital No. 14, assigned to the Communications Zone, and allotted to the Sixth Corps Area. Affiliated 23 January 1924 with the Michael Reese Hospital in Chicago, IL. Initiated 11 March 1925 at Chicago. Redesignated 14th General Hospital 29 March 1929. Consolidated 18 September 1936 with Base Hospital No. 14 (a WWI unit organized in July 1916 the St. Luke, St. Michael, and Reese Hospitals in Chicago, IL; mobilized 1 March 1918 at Chicago; demobilized 9 May 1919 at Camp Custer, MI; reconstituted 18 September 1936). Conducted summer training at the station hospitals at Fort Snelling, MN, Camp McCoy, WI, Camp Custer, MI, or Fort Sheridan, IL. Location 7 December 1941—Chicago, IL.

Status: Inactive in the U.S. Army Reserve as the 341st General Hospital.

Commanders, 14th General Hospital

Capt. Alfred E. Jones	11 Mar 25-17 Mar 25	Col. David C. Straus	ao Sep 25-ao Jan 40
Lt. Col. Maurice L. Goodkind	17 Mar 25-ao Apr 25	Unknown	ao Jan 40-7 Dec 41

15th General Hospital (C.Z.)

Organized Reserve New York

HQ-Not initiated 1923-25; Manhattan, NY, 1925-27; *Inactive* 1927-39; Manhattan, NY, 1939-41

Constituted in the Organized Reserve 2 July 1923 as General Hospital No. 15, assigned to the Communications Zone, and allotted to the Second Corps Area. Affiliated with Roosevelt Hospital in Manhattan, NY. Initiated 25 March 1925 at Manhattan. Inactivated 29 March 1927 at Manhattan by relief of personnel. Redesignated 15th General Hospital 29 March 1929. Consolidated 26 October 1936 with Base Hospital No. 15 (a WWI unit organized 12 April 1917 at

the Roosevelt Hospitals in Manhattan, NY; mobilized in June 1917 at New York City; demobilized in April 1919 at Camp Dodge, IA; reconstituted 26 October 1936). Reorganized 1 June 1939 at Manhattan. Location 7 December 1941—Manhattan, NY.

Status: Inactive in the U.S. Army Reserve as the 322nd General Hospital.

Commanders, 15th General Hospital

Maj. Walter F. Jones	20 Mar 25-15 Jun 25	<i>Inactive</i>	29 Mar 27-1 Jun 39
Col. Charles H. Peck	15 Jun 25-29 Mar 27	Lt. Col. Walter V. O. Moore	1 Jun 39-ao Jan 41

16th General Hospital (Z.I.)

Organized Reserve Delaware

HQ-Not initiated 1923-26; Wilmington, DE, 1926-41

Constituted in the Organized Reserve 2 July 1923 as General Hospital No. 16, assigned to the Zone of the Interior, and allotted to the Second Corps Area. Affiliated with Wilmington Hospital in Wilmington, DE,. Initiated about September 1926 at Wilmington. Redesignated 16th General Hospital 29 March 1929. Consolidated 26 October 1936 with Base Hospital No. 16 (a WWI unit organized in January 1918 at Camp Crane, PA; demobilized 5 May 1919 at Camp Sherman, OH; reconstituted 26 October 1936). Location 7 December 1941—Wilmington, DE.

Status: Active in the U.S. Army Reserve as the 325th Field Hospital at Independence, MO.

Commanders, 16th General Hospital

Col. Meredith I. Samuels	Sep 26-ao Apr 39	Unknown	ao Apr 39-ao Nov 40
	Col. Bruce L. Gilfillan	ao Nov 40-Jun 41	

17th General Hospital (Z.I.)

Organized Reserve Michigan

HQ-Not initiated 1923-25; Detroit, MI, 1924-41

Constituted in the Organized Reserve 2 July 1923 as General Hospital No. 17, assigned to the Zone of the Interior, and allotted to the Sixth Corps Area. Affiliated 1 March 1924 with Harper Hospital in Detroit, MI. Initiated 17 March 1925 at Detroit, MI. Redesignated 17th General Hospital 29 March 1929. Consolidated 22 September 1936 with Base Hospital No. 17 (a WWI unit organized in September 1916 at the Harper Hospital in Detroit, MI; mobilized 28 June 1917 in Detroit; demobilized 10 May 1919 at Camp Custer, MI; reconstituted 22 September 1936). Withdrawn from the Organized Reserve 1 July 1940 and allotted to the Regular Army. Affiliation with Harper Hospital reaffirmed 19 November 1940. Conducted summer training at the station hospitals at Fort Snelling, MN, or Camp Custer, MI. Location 7 December 1941—Detroit, MI.

Status: Inactive in the Regular Army as the 17th General Hospital.

Commanders, 17th General Hospital

Maj. Frederick G. Buesser	17 Mar 25-24 Mar 25	Maj. Ward F. Seeley	24 Mar 25-2 Jun 25
	Col. Henry R. Carstens**	2 Jun 25-ao Dec 41	

** RAI Commanders: Organized Reserve officers.

18th General Hospital (C.Z.)

Organized Reserve Maryland

HQ-Not initiated 1923-25; Baltimore, MD, 1925-41

Constituted in the Organized Reserve 2 July 1923 as General Hospital No. 18, assigned to the Communications Zone, and allotted to the Third Corps Area. Initiated 17 January 1925 at, and affiliated with, the Johns Hopkins Hospital in Baltimore, MD. Redesignated 18th General Hospital 29 March 1929. Withdrawn from the Organized Reserve 1 October 1933 and allotted to the Regular Army. Concurrently relieved from the Communications Zone assigned to the General Headquarters Reserve. Consolidated 13 August 1936 with Base Hospital No. 18 (a WWI unit organized in November 1916 at the Johns Hopkins Hospital in Baltimore, MD; mobilized 24 May 1917 in Baltimore; demobilized 21 February 1919 at Camp Upton, NY; reconstituted 13 August 1936). Affiliation with Johns Hopkins Hospital reaffirmed 19 November 1941. Location 7 December 1941—Baltimore, MD.

Status: Inactive in the Regular Army as the 18th General Hospital.

Commanders, 18th General Hospital

Col. Thomas R. Boggs	17 Jan 25-Apr 25	Unknown	ao Jun 26-ao Mar 27
Col. William C. Moore	Apr 25-ao Jun 26	Col. Joseph M. Heller**	ao Mar 27-ao Jun 37
	Unknown	ao Jun 37-7 Dec 41	

** RAI Commanders: Organized Reserve officers.

19th General Hospital (C.Z.)

Organized Reserve New York

HQ-*Not initiated* 1923-25; Rochester, NY, 1925-41

Constituted in the Organized Reserve 2 July 1923 as General Hospital No. 19, assigned to the Communications Zone, and allotted to the Second Corps Area. Affiliated 14 May 1924 with the Rochester General Hospital in Rochester, NY. Initiated 11 February 1925 at Rochester. Redesignated 19th General Hospital 29 March 1929. Consolidated 22 September 1936 with Base Hospital No. 19 (a WWI unit organized in March 1916 at Rochester, NY; mobilized 17 December 1917 in Rochester; demobilized 7 May 1919 at Camp Upton, NY; reconstituted 22 September 1936). Withdrawn from the Organized Reserve 1 July 1940 and allotted to the Regular Army. Affiliation with Rochester General Hospital reaffirmed 8 August 1940. Primary R.O.T.C. feeder school was the Medical College of Syracuse University. Location 7 December 1941—Rochester, NY.

Status: Inactive in the U.S. Army Reserve as the 19th General Hospital.

Commanders, 19th General Hospital

Maj. Joseph P. Henry	11 Feb 25-27 Oct 25	Unknown	18 Nov 29-ao Jan 31
Lt. Col. Ralph R. Fitch	27 Oct 25-ap Jan 26	Col. John M. Swan	ao Jan 31-ao Jun 31
Unknown	ao Jan 26-ao Jun 27	Unknown	ao Jun 31-6 Aug 37
Maj. Joseph P. Henry	ao Jun 27-18 Nov 29	Col. Royden M. Vose**	6 Aug 37-28 Jan 41
	Col. Edward T. Wentworth**	28 Jan 41-ao Dec 41	

** RAI Commanders: Organized Reserve officers.

20th General Hospital (C.Z.)

Organized Reserve Pennsylvania

HQ-*Not initiated* 1923-29; Philadelphia, PA, 1929-41

Constituted in the Organized Reserve 2 July 1923 as General Hospital No. 20, assigned to the Communications Zone, and allotted to the Third Corps Area. Affiliated 12 November 1924 with the Hospital of the University of Pennsylvania in Philadelphia, PA. Redesignated 20th General Hospital 29 March 1929. Initiated 10 September 1929 at Philadelphia. Withdrawn from the Organized Reserve 1 October 1933 and allotted to the Regular Army. Concurrently relieved from the Communications Zone assigned to the General Headquarters Reserve. Consolidated 13 August 1936 with Base Hospital No. 20 (a WWI unit organized in September 1916 at the University of Pennsylvania in Philadelphia; mobilized in November 1917 in Philadelphia; demobilized 4 May 1919 at Camp Dix, NJ; reconstituted 13 August 1936). Affiliation with the University of Pennsylvania School of Medicine reaffirmed 17 August 1940. Location 7 December 1941—Philadelphia, PA.

Status: Inactive in the Regular Army as the 20th General Hospital.

Commanders, 20th General Hospital

Col. William Bates	10 Sep 29-17 Nov 30	Lt. Col. William McKeage**	3 Oct 32-10 Dec 35
Lt. Col. John B. McCreary	17 Nov 30-29 Jan 31	Lt. Col. William H. Thomas**	10 Jan 35-ao Feb 35
Lt. Col. Joseph A. Farrar	29 Jan 32-3 Oct 32	Unknown	ao Feb 35-17 Aug 40
	Lt. Col. Isador S. Ravdin*	17 Aug 40-ao Jan 42	

* Regular Army active duty commanders

** RAI Commanders: Organized Reserve officers.

21st General Hospital (C.Z.)**Organized Reserve Missouri****HQ**-St. Louis, MO, 1922-41

Authorized 30 June 1922 by the Surgeon General to be organized at, and affiliated with, the Washington University Medical School in St. Louis, MO. Constituted in the Organized Reserve 2 July 1923 as General Hospital No. 21, assigned to the Communications Zone, and allotted to the Seventh Corps Area. Redesignated 21st General Hospital 29 March 1929. Withdrawn from the Organized Reserve 1 October 1933 and allotted to the Regular Army. Concurrently relieved from the Communications Zone and assigned to the General Headquarters Reserve. Consolidated 13 August 1936 with Base Hospital No. 21 (a WWI unit organized 1 July 1916 at the Washington University Medical School in St. Louis, MO; mobilized 27 April 1917 in St. Louis; demobilized 3 May 1919 at Camp Funston, KS; reconstituted 13 August 1936). Typically conducted Inactive Training Period meetings at the Medical Society Building in St. Louis. Conducted summer training at the station hospital, Fort Snelling, MN. Location 7 December 1941—St. Louis, MO.

Status: Inactive in the U.S. Army Reserve as the 21st General Hospital.**Commanders, 21st General Hospital**

Col. Malvern B. Clopton**	30 Jun 22-7 Oct 39	Col. Harvey J. Howard**	7 Oct 39-Jun 40
	Lt. Col. Lee D. Cady**	Jun 40-ao Jan 42	

** RAI Commanders: Organized Reserve officers.

22nd General Hospital (C.Z.)**Organized Reserve Wisconsin****HQ**-*Not initiated* 1923-25; Milwaukee, WI, 1925-41

Authorized 24 November 1922 by the Surgeon General to be organized at Milwaukee, WI. Constituted in the Organized Reserve 2 July 1923 as General Hospital No. 22, assigned to the Communications Zone, and allotted to the Sixth Corps Area. Initiated by September 1925 at Milwaukee, Redesignated 22nd General Hospital 29 March 1929. WI. Consolidated 22 September 1936 with Base Hospital No. 22 (a WWI unit organized in July 1916 at Milwaukee, WI; mobilized 7 January 1918; demobilized 16 March 1919 at Camp Grant, IL; reconstituted 22 September 1936). Conducted summer training at the station hospital at Camp Custer, MI, Fort Snelling, MN, or Fort Sheridan, IL. Location 7 December 1941—Milwaukee, WI.

Status: Inactive in the U.S. Army Reserve as the 327th General Hospital.**Commanders, 22nd General Hospital**

Col. Gustavus I. Hogue	ao Sep 25-ao Jun 37	Unknown	ao Jun 37-7 Dec 41
------------------------	---------------------	---------	--------------------

23rd General Hospital (C.Z.)**Organized Reserve New York****HQ**-*Not initiated* 1923-25; Buffalo, NY, 1925-41; *Inactive* 1941

Constituted in the Organized Reserve 2 July 1923 as General Hospital No. 23, assigned to the Communications Zone, and allotted to the Second Corps Area. Initiated 14 March 1925 at Buffalo, NY. Affiliated 7 October 1925 with the Buffalo General Hospital in Buffalo. Redesignated 23rd General Hospital 29 March 1929. Consolidated 22 September 1936 with Base Hospital No. 23 (a WWI unit organized in January 1917 at Buffalo General Hospital in Buffalo, NY; mobilized 21 August 1917 at Buffalo; demobilized 2 May 1919 at Camp Upton, NY; reconstituted 22 September 1936). Affiliation with Buffalo General Hospital reaffirmed 24 September 1940. Inactivated 28 January 1941 at Buffalo by relief of personnel. Conducted summer training at Carlisle Barracks, PA. Primary R.O.T.C. feeder school was the University of Buffalo. Location 7 December 1941—Buffalo, NY.

Status: Inactive in the U.S. Army Reserve as the 23rd General Hospital.**Commanders, 23rd General Hospital**

Maj. Frank H. Tatlock	14 Mar 25-21 Oct 25	Col. Nelson G. Russell	24 May 30-21 Jan 32
Col. William B. Reid	21 Oct 25-ao Sep 28	Col. Francis E. Fronczak	21 Jan 32-13 Feb 39
Unknown	ao Sep 28-24 May 30	Lt. Col. Frank E. Brundage	13 Feb 39-28 Jan 41
	<i>Inactive</i>	28 Jan 41-7 Dec 41	

24th General Hospital (C.Z.)**Organized Reserve Louisiana****HQ-Not initiated** 1923-24; New Orleans, LA, 1924-41

Constituted in the Organized Reserve 2 July 1923 as General Hospital No. 24, assigned to the Communications Zone, and allotted to the Fourth Corps Area. Initiated 27 February 1924 at, and affiliated with, Tulane University of Louisiana School of Medicine in New Orleans, LA. Redesignated 24th General Hospital 29 March 1929. Consolidated 22 September 1936 with Base Hospital No. 24 (a WWI unit organized in January 1917 at Tulane University in New Orleans, LA; mobilized 31 October 1917 at Jackson Barracks, LA; demobilized 3 May 1919 at Camp Shelby, MS; reconstituted 22 September 1936). Withdrawn from the Organized Reserve 1 July 1940 and allotted to the Regular Army. Affiliation with Tulane University of Louisiana School of Medicine reaffirmed 11 September 1940. Location 7 December 1941—New Orleans, LA.

Status: Inactive in the U.S. Army Reserve as the 24th General Hospital.**Commanders, 24th General Hospital**

Unknown	27 Feb 24-ao Jun 27	Lt. Col. Isaac I. Lemann	12 Sep 29-12 Jan 32
Col. Urban Maes	ao Jun 27-ao Jul 27	Col. French H. Craddock	12 Jan 32-6 Sep 36
Unknown	ao Jul 27-12 Sep 29	Col. Adolphus L. Little**	6 Sep 36-21 Oct 40
	Col. Urban Maes**	21 Oct 40-7 Dec 41	

** RAI Commanders: Organized Reserve officers.

25th General Hospital (C.Z.)**Organized Reserve Ohio****HQ-Cincinnati, OH, 1922-41**

Authorized 15 August 1922 by the Surgeon General to be organized at, and affiliated with, the University of Cincinnati College of Medicine and the Cincinnati General Hospital in Cincinnati, OH. Constituted in the Organized Reserve 2 July 1923 as General Hospital No. 25, assigned to the Communications Zone, and allotted to the Fifth Corps Area. Redesignated 25th General Hospital 29 March 1929. Withdrawn from the Organized Reserve 1 October 1933 and allotted to the Regular Army. Concurrently relieved from the Communications Zone and assigned to the General Headquarters Reserve. Location 7 December 1941—Cincinnati, OH.

Status: Inactive in the Regular Army as the 25th General Hospital.**Commanders, 25th General Hospital**

Lt. Col. Arthur C. Bachmeyer	15 Aug 22-ao Jun 27	Unknown	ao Jun 27-7 Dec 41
------------------------------	---------------------	---------	--------------------

26th General Hospital (C.Z.)**Organized Reserve Minnesota****HQ-Not initiated** 1923-25; Minneapolis, MN, 1925-41

Authorized 10 November 1922 by the Surgeon General to be organized at, and affiliated with, the University of Minnesota and University Hospital in Minneapolis, MN. Constituted in the Organized Reserve 2 July 1923 as General Hospital No. 26, assigned to the Communications Zone, and allotted to the Sixth Corps Area. Initiated by October 1925 at Minneapolis, MN. Redesignated 26th General Hospital 29 March 1929. Withdrawn from the Organized Reserve 1 October 1933 and allotted to the Regular Army. Concurrently relieved from the Communications Zone and assigned to the General Headquarters Reserve. Location 7 December 1941—Minneapolis, MN.

Status: Inactive in the Regular Army as the 26th General Hospital.**Commanders, 26th General Hospital**

Unknown	ao Oct 25-Apr 26	Lt. Col. James F. Corbett	Apr 28-ao Aug 29
Col. Louis B. Baldwin	Apr 26-Dec 26	Unknown	ao Aug 29-3 May 36
Lt. Col. Ralph T. Knight	Dec 26-Apr 28	Lt. Col. Harold D. Cohen**	3 May 36-ao Jun 36
	Unknown	ao Jun 36-7 Dec 41	

** RAI Commanders: Organized Reserve officers.

27th General Hospital (C.Z.)**Organized Reserve Pennsylvania****HQ**-Pittsburgh, PA, 1923-41

Authorized 5 April 1923 by the Surgeon General to be organized at, and affiliated with, the University of Pittsburgh School of Medicine in Pittsburgh, PA. Constituted in the Organized Reserve 2 July 1923 as General Hospital No. 27, assigned to the Communications Zone, and allotted to the Third Corps Area. Redesignated 27th General Hospital 29 March 1929. Withdrawn from the Organized Reserve 1 October 1933 and allotted to the Regular Army. Concurrently relieved from the Communications Zone and assigned to the General Headquarters Reserve. Consolidated 13 August 1936 with Base Hospital No. 27 (a WWI unit organized in April 1916 at the University of Pittsburgh School of Medicine in Pittsburgh, PA; mobilized 10 August 1917 at Pittsburgh; demobilized 25 March 1919 at Camp Dix, NJ; reconstituted 13 August 1936). Affiliation with the University of Pittsburgh School of Medicine reaffirmed 26 August 1940. Location 7 December 1941—Pittsburgh, PA.

Status: Inactive in the Regular Army as the 27th General Hospital.**Commanders, 27th General Hospital**

Col. James D. Heard	5 Apr 23-Jun 28	Maj. William D. Hunter**	ao Sep 34-30 Oct 34
Lt. Col. Thomas L. McCullough	Jun 28-9 Sep 29	Unknown	30 Oct 34-ao Aug 38
Col. Frederick A. Hartung	9 Sep 29-ao Jul 30	Lt. Col. Abner A. Bausher**	ao Aug 38-7 Sep 38
Unknown	ao Jul 30-ao Sep 34	Unknown	7 Sep 38-7 Dec 41

** RAI Commanders: Organized Reserve officers.

28th General Hospital (C.Z.)**Organized Reserve Missouri****HQ**-*Not initiated* 1923-25; Kansas City, MO, 1925-41

Authorized 24 May 1923 by the Surgeon General to be organized at, and affiliated with, the Christian Church Hospital in Kansas City, MO. Constituted in the Organized Reserve 2 July 1923 as General Hospital No. 28, assigned to the Communications Zone, and allotted to the Seventh Corps Area. Initiated by October 1925 at Kansas City, MO. Redesignated 28th General Hospital 29 March 1929. Withdrawn from the Organized Reserve 1 October 1933 and allotted to the Regular Army. Concurrently relieved from the Communications Zone and assigned to the General Headquarters Reserve. Consolidated 17 August 1936 with Base Hospital No. 28 (a WWI unit organized in April 1916 at the Christian Church Hospital in Kansas City, MO; mobilized 21 January 1918 in Kansas City; demobilized 2 May 1919 at Camp Dix, NJ; reconstituted 17 August 1936). Conducted summer training at the station hospital, Fort Snelling, MN. Location 7 December 1941—Kansas City, MO.

Status: Inactive in the Regular Army as the 28th General Hospital.**Commanders, 28th General Hospital**

Lt. Col. Frank D. Dickson	ao Oct 25-Feb 29	Col. Alvin L. Jobe**	ao Aug 36-ao Jan 38
Unknown	Feb 29-ao Aug 36	Unknown	ao Jan 38-7 Dec 41

** RAI Commanders: Organized Reserve officers.

29th General Hospital (C.Z.)**Organized Reserve Colorado/Illinois****HQ**-*Not initiated* 1923-25; Denver, CO, 1925-36; *Inactive* 1936-40; Denver, CO, 1940-41

Constituted in the Organized Reserve 2 July 1923 as General Hospital No. 29, assigned to the Communications Zone, and allotted to the Eighth Corps Area. Affiliated with, the University of Colorado Medical School. Initiated 12 April 1925 at Denver, CO. Redesignated 29th General Hospital 29 March 1929. Withdrawn from the Organized Reserve 1 October 1933 and allotted to the Regular Army. Concurrently relieved from the Communications Zone and assigned to the General Headquarters Reserve. Withdrawn from the Eighth Corps Area 5 June 1936 and allotted to the Sixth Corps Area. Chicago, IL, designated as headquarters on reorganization, but the unit was never organized at that location. Withdrawn from the Sixth Corps Area 1 July 1940 and allotted to the Eighth Corps Area. Affiliation reestablished about November 1940 with the University of Colorado Medical School. Reorganized in December 1940 at Denver. Conducted summer training most years at Fitzsimons General Hospital in Denver, CO, and some years at the station hospital, Fort Sam Houston, TX. Designated mobilization training station was Camp Stanley, TX, 1923-36 and Fort Oglethorpe, GA, 1936-40. Location 7 December 1941—Denver, CO.

Status: Inactive in the Regular Army as the 29th General Hospital.

Commanders, 29th General Hospital

Maj. Paul J. Connor	12 Apr 25-4 Feb 26	Col. Thomas J. McCamant**	12 Sep 32-4 Jun 34
Lt. Col. William W. Williams	4 Feb 26-15 Dec 27	Lt. Col. Robert C. Bowie**	4 Jun 34-1 Aug 35
Lt. Col. Harry S. Finney	15 Dec 27-22 Oct 29	Lt. Col. Frederick B. Nather**	1 Aug 35-13 Nov 36
Lt. Col. Herman L. Fowler	22 Oct 29-10 Feb 31	<i>Inactive</i>	13 Nov 36-Dec 40
Lt. Col. Victor B. Ayers**	10 Feb 31-12 Sep 32	Col. Cuthbert Powell**	Dec 40-Dec 41

** RAI Commanders: Organized Reserve officers.

30th General Hospital (C.Z.)

Organized Reserve California/Illinois

HQ-*Not initiated* 1923-25; San Francisco, CA, 1925-36; *Inactive* 1936-41

Constituted in the Organized Reserve 2 July 1923 as General Hospital No. 30, assigned to the Communications Zone, and allotted to the Ninth Corps Area. Affiliated 2 May 1924 with the University of California Medical School in San Francisco, CA. Organized in July 1925 at San Francisco. Redesignated 30th General Hospital 29 March 1929. Withdrawn from the Ninth Corps Area 5 June 1936 and allotted to the Sixth Corps Area. Inactivated 8 July 1936 at San Francisco by relief of personnel. Chicago, IL, designated as headquarters on reorganization, but the unit was never organized at that location. Consolidated in November 1936 with Base Hospital No. 30 (a WWI unit organized 20 November 1917 at Fort Mason, CA, with personnel from the California Medical School in San Francisco; demobilized 15 May 1919 at the Presidio of San Francisco; reconstituted in November 1936). Withdrawn from the Sixth Corps Area 1 July 1940 and allotted to the Ninth Corps Area. Concurrently withdrawn from the Organized Reserve and allotted to the Regular Army. Affiliation reestablished 17 May 1941 with the University of California Medical School in San Francisco. Conducted summer training at the station hospitals at Fort Lewis, WA, or the Presidio of Monterey, CA. Location 7 December 1941—*Inactive*.

Status: Inactive in the Regular Army as the 30th General Hospital.

Commanders, 30th General Hospital

Col. Howard C. Naffziger	Jul 25-24 Apr 30	Unknown	Jun 31-Jun 32
Lt. Col. William J. Kerr	24 Apr 30-Jun 31	Col. William T. Lum	Jun 32-9 Jul 36
	<i>Inactive</i>	9 Jul 36-7 Dec 41	

31st General Hospital (C.Z.)

Organized Reserve Kentucky/Ohio/Colorado

HQ-*Not initiated* 1923-27; Cincinnati, OH, 1927-36; Denver, CO, 1936-41

Constituted in the Organized Reserve 2 July 1923 as General Hospital No. 31, assigned to the Communications Zone, and allotted to the Fifth Corps Area. Fort Thomas, KY, designated as headquarters on organization, but the unit was never organized at that location. Initiated by June 1927 at Cincinnati, OH. Redesignated 31st General Hospital 29 March 1929. Withdrawn from the Organized Reserve 1 October 1933 and allotted to the Regular Army. Concurrently relieved from the Communications Zone and assigned to the General Headquarters Reserve. Withdrawn from the Fifth Corps Area 5 June 1936 and allotted to the Eighth Corps Area. Reorganized at, and affiliated with, the Denver General Hospital in Denver, CO. Location 7 December 1941—Denver, CO.

Commanders, 31st General Hospital

Lt. Col. Elliot C. Cutler	ao Jun 27-ao Jul 27	Col. Eugene F. McCampbell**	ao Jan 29-ao Jun 34
Unknown	ao Jul 27-ao Jan 29	Unknown	ao Jun 34-7 Dec 41

** RAI Commanders: Organized Reserve officers.

32nd General Hospital (C.Z.)

Organized Reserve Indiana

HQ-*Not initiated* 1923-24; Indianapolis, IN, 1924-41

Constituted in the Organized Reserve 2 July 1923 as General Hospital No. 32, assigned to the Communications Zone, and allotted to the Fifth Corps Area. Affiliated 30 August 1923 with the Indiana University School of Medicine in Indianapolis, IN. Initiated about 14 February 1924 at Indianapolis, IN. Redesignated 32nd General Hospital 29 March 1929. Withdrawn from the Organized Reserve 1 October 1933 and allotted to the Regular Army. Concurrently relieved from the Communications Zone and assigned to the General Headquarters Reserve. Consolidated 12 August 1936 with Base Hospital No. 32 (a WWI unit organized in February 1917 at Indianapolis, IN; mobilized 1 September 1917 at Fort Benjamin Harrison, IN; demobilized 7 May 1919 at Camp Zachary Taylor, KY; reconstituted 12 August 1936). Location 7 December 1941—Indianapolis, IN.

Status: Inactive in the Regular Army as the 32nd General Hospital.

Commanders, 32nd General Hospital

Col. Edmund D. Clark	14 Feb 24-ao Jun 27	Lt. Col. Perry C. Traver**	Nov 30-ao Jun 35
Unknown	ao Jun 27-Nov 30	Unknown	ao Jun 35-7 Dec 41

** RAI Commanders: Organized Reserve officers.

33rd General Hospital (C.Z.)

Organized Reserve New York

HQ-Not initiated 1923-25; Manhattan, NY, 1925-30; *Inactive* 1930-39; Albany, NY, 1939-41

Constituted in the Organized Reserve 2 July 1923 as General Hospital No. 33, assigned to the Communications Zone, and allotted to the Second Corps Area. Initiated 29 March 1925 at Manhattan, NY. Redesignated 33rd General Hospital 29 March 1929. Inactivated 6 February 1930 at Manhattan by relief of personnel. Consolidated 22 September 1936 with Base Hospital No. 33 (a WWI unit organized in June 1917 at Albany Hospital in Albany, NY; demobilized 5 March 1919 at Camp Upton, NY; reconstituted 22 September 1936). Reorganized 15 June 1939 at Albany, NY. Withdrawn from the Organized Reserve 1 July 1940 and allotted to the Regular Army. Affiliated 15 July 1940 with Albany Hospital. Primary R.O.T.C. feeder school was the New York Medical College. Location 7 December 1941—Albany, NY.

Status: Inactive in the Regular Army as the 33rd General Hospital.

Commanders, 33rd General Hospital

Maj. John G. Stowe	29 Mar 25-7 Oct 25	<i>Inactive</i>	6 Feb 30-15 Jun 39
Col. William S. Terriberry	7 Oct 25-6 Feb 30	Lt. Col. Willis W. Lasher**	15 Jun 39-ao Jan 41

** RAI Commanders: Organized Reserve officers.

34th General Hospital (C.Z.)

Organized Reserve Pennsylvania

HQ-Not initiated 1923-25; Philadelphia, PA, 1925-40; *Inactive* 1940-41

Constituted in the Organized Reserve 2 July 1923 as General Hospital No. 20, assigned to the Communications Zone, and allotted to the Third Corps Area. Initiated 12 January 1925 at Philadelphia, PA. Redesignated 34th General Hospital 29 March 1929. Withdrawn from the Organized Reserve 1 October 1933 and allotted to the Regular Army. Concurrently relieved from the Communications Zone and assigned to the General Headquarters Reserve. Consolidated 10 August 1936 with Base Hospital No. 34 (a WWI unit organized in April 1917 at the Episcopal Hospital in Philadelphia; mobilized 7 September 1917 at Philadelphia; demobilized 27 April 1919 at Camp Upton, NY; reconstituted 10 August 1936). Inactivated 14 September 1940 at Philadelphia by relief of personnel. Location 7 December 1941—*Inactive*.

Status: Inactive in the Regular Army as the 34th General Hospital.

Commanders, 34th General Hospital

Maj. James R. Wells	12 Jan 25-17 Jan 25	Maj. Henry A. Gorman**	10 Jan 35-22 Mar 38
Lt. Col. John A. Murphy	17 Jan 25-Apr 25	Lt. Col. Charles Cadwalleder**	22 Mar 38-14 Sep 40
Col. Jonathan M. Wainwright**	Apr 25-10 Jan 35	<i>Inactive</i>	14 Sep 40-7 Dec 41

** RAI Commanders: Organized Reserve officers.

35th General Hospital (C.Z.)**Organized Reserve California****HQ-Not initiated** 1923-25; Los Angeles, CA, 1925-41

Constituted in the Organized Reserve 2 July 1923 as General Hospital No. 35, assigned to the Communications Zone, and allotted to the Ninth Corps Area. Initiated 29 June 1925 at Los Angeles, CA. Redesignated 35th General Hospital 29 March 1929. Consolidated 8 October 1936 with Base Hospital No. 35 (a WWI unit organized in April 1917 as the American Red Cross Hospital Unit at Good Samaritan Hospital in Los Angeles, CA; reorganized and redesignated 14 March 1918 as Base Hospital No. 35; demobilized 6 May 1919 at Camp Kearney, CA; reconstituted 8 October 1936). Conducted summer training at Del Monte, CA, the Presidio of Monterey, CA, or at Letterman General Hospital, San Francisco, CA. Location 7 December 1941—Los Angeles, CA.

Status: Active in the U.S. Army Reserve as the 328th Field Hospital at Salt Lake City, UT.**Commanders, 35th General Hospital**

Col. Henry H. Lissner	29 Jun 25-ao Jun 32	Unknown	22 May 34-22 Apr 35
Unknown	ao Jun 32-ao Sep 33	Col. Joseph G. Evans	22 Apr 35-27 Oct 36
Col. Frank C. Wiser	ao Sep 33-27 Oct 33	Lt. Col. John H. Shafer	27 Oct 36-2 Mar 37
Lt. Col. Ralph Hagan	27 Oct 33-22 May 34	Col. Ralph Kayson	2 Mar 37-ao Aug 38
	Unknown	ao Aug 38-7 Dec 41	

36th General Hospital (C.Z.)**Organized Reserve Michigan****HQ-Not initiated** 1923-24; Detroit, MI, 1924-41

Constituted in the Organized Reserve 2 July 1923 as General Hospital No. 36, assigned to the Communications Zone, and allotted to the Sixth Corps Area. Affiliated 8 November 1924 with the Detroit College of Medicine in Detroit, MI. Initiated 23 December 1924 at Detroit. Redesignated 36th General Hospital 29 March 1929. Consolidated 8 October 1936 with Base Hospital No. 36 (a WWI unit organized in April 1917 at Detroit, MI; demobilized in May 1919 at Camp Custer, MI; reconstituted 8 October 1936). Conducted summer training at the station hospitals at Fort Snelling, MN, or Camp Custer, MI. Location 7 December 1941—Detroit, MI.

Status: Inactive in the U.S. Army Reserve as the 36th General Hospital.**Commanders, 36th General Hospital**

Lt. Col. Albert E. Harris	23 Dec 24-ao Jun 30	Unknown	ao Jun 30-7 Dec 41
---------------------------	---------------------	---------	--------------------

37th General Hospital (C.Z.)**Organized Reserve New York****HQ-Not initiated** 1923-25; Brooklyn, NY, 1925-41

Constituted in the Organized Reserve 2 July 1923 as General Hospital No. 37, assigned to the Communications Zone, and allotted to the Second Corps Area. Affiliated with the Kings County Hospital in Brooklyn, NY. Initiated 20 March 1925 at Brooklyn. Redesignated 37th General Hospital 29 March 1929. Consolidated 8 October 1936 with Base Hospital No. 37 (a WWI unit organized in July 1917 at the Kings County Hospital in Brooklyn, NY; mobilized 4 January 1918 at the Kings County Hospital in Brooklyn; demobilized 5 March 1919 at Camp Upton, NY; reconstituted 8 October 1936). Withdrawn from the Organized Reserve 1 July 1940 and allotted to the Regular Army. Affiliation with the Kings County Hospital reaffirmed 17 August 1940. Location 7 December 1941—Brooklyn, NY.

Status: Inactive in the U.S. Army Reserve as the 37th General Hospital.**Commanders, 37th General Hospital**

Maj. Eldorus H. Palmer	20 Mar 25-7 Oct 25	Col. Emil Altman	20 Apr 32-20 Jul 37
Col. Martin J. Synnott	7 Oct 25-6 Feb 30	Lt. Col. Carl Boettiger	20 Jul 37-1 Feb 39
Col. William S. Terriberry	6 Feb 30-ao Jun 30	Lt. Col. Theodore Burstein**	1 Feb 39-3 Aug 40
Unknown	ao Jun 30-20 Apr 32	Lt. Col. Dana F. Downing**	31 Oct 40-30 Oct 41

** RAI Commanders: Organized Reserve officers.

38th General Hospital (C.Z.)**Organized Reserve Pennsylvania****HQ**-Philadelphia, PA, 1922-41

Authorized 5 October 1922 by the Surgeon General to be organized at, and affiliated with, the Jefferson Medical College in Philadelphia, PA. Constituted in the Organized Reserve 2 July 1923 as General Hospital No. 38, assigned to the Communications Zone, and allotted to the Third Corps Area. Redesignated 38th General Hospital 29 March 1929. Withdrawn from the Organized Reserve 1 October 1933 and allotted to the Regular Army. Concurrently assigned to the General Headquarters Reserve. Consolidated 18 August 1936 with Base Hospital No. 38 (a WWI unit organized in April 1917 at the Jefferson Medical College in Philadelphia, PA; mobilized 15 October 1917 at Philadelphia; demobilized 7 May 1919 at Camp Dix, NJ; reconstituted 18 August 1936). Location 7 December 1941—Philadelphia, PA.

Status: Inactive in the U.S. Army Reserve as the 38th General Hospital.**Commanders, 38th General Hospital**

Lt. Col. Henry K. Mohler	5 Oct 22-ao Jun 27	Lt. Col. William G. Turnbull	11 Sep 29-ao Jun 31
Unknown	ao Jun 27-ao Aug 28	Unknown	ao Jun 31-ao Jul 33
Lt. Col. Hubley R. Owen	ao Aug 28-17 Nov 28	Lt. Col. Claude H. Church**	ao Jul 33-ao Jun 34
Unknown	17 Nov 28-11 Sep 29	Unknown	ao Jun 34-ao Jun 35
	Lt. Col. Henry K. Mohler**	ao Jun 35-17 May 41	

** RAI Commanders: Organized Reserve officers.

39th General Hospital (C.Z.)**Organized Reserve Connecticut****HQ**-*Not initiated* 1923-26; New Haven, CT, 1926-41

Constituted in the Organized Reserve 2 July 1923 as General Hospital No. 39, assigned to the Communications Zone, and allotted to the First Corps Area. Affiliated 16 January 1924 with Yale-New Haven Hospital in New Haven, CT. Initiated by March 1926 at New Haven, CT. Redesignated 39th General Hospital 29 March 1929. Withdrawn from the Organized Reserve 1 October 1933 and allotted to the Regular Army. Concurrently assigned to the General Headquarters Reserve. Affiliation changed to the Yale University School of Medicine 12 October 1940. Location 7 December 1941—New Haven, CT.

Status: Inactive in the Regular Army as the 39th General Hospital.**Commanders, 39th General Hospital**

Maj. Samuel C. Clark	ao Mar 26-ao May 26	Maj. Francis G. Blake	ao Jun 27-Dec 29
Unknown	ao May 26-ao Jun 27	Unknown	Dec 29-7 Dec 41

40th General Hospital (C.Z.)**Organized Reserve Kentucky****HQ**-*Not initiated* 1923-25; Camp Knox, KY, 1925-27; Louisville, KY, 1927-33; Hopkinsville, KY, 1933-37; *Inactive* 1937-41

Constituted in the Organized Reserve 2 July 1923 as General Hospital No. 40, assigned to the Communications Zone, and allotted to the Fifth Corps Area. Redesignated 23 March 1925 as the 40th General Hospital. Initiated by June 1925 at Camp Knox, KY. Relocated in 1927 to Louisville, KY. Redesignated 40th General Hospital 29 March 1929. Relocated 22 March 1934 to Hopkinsville, KY. Consolidated 8 October 1936 with Base Hospital No. 40 (a WWI unit organized in June 1917 at the Good Samaritan Hospital in Lexington, KY; mobilized 23 February 1918 at Lexington; demobilized 16 April 1919 at Camp Zachary Taylor, KY; reconstituted 8 October 1936). Inactivated by January 1937 at Hopkinsville by relief of personnel. Location 7 December 1941—*Inactive*.

Status: Inactive in the U.S. Army Reserve as the 340th General Hospital.**Commanders, 40th General Hospital**

Col. Arthur T. McCormack	Jun 25-ao Jul 29	Unknown	ao Jul 29-Jan 37
	<i>Inactive</i>	Jan 37-7 Dec 41	

41st General Hospital (C.Z.)**Organized Reserve Pennsylvania/Virginia****HQ-Not initiated** 1923-25; Philadelphia, PA, 1925-27; Norfolk, VA, 1927-36; Richmond, VA, 1936-41

Constituted in the Organized Reserve 2 July 1923 as General Hospital No. 41, assigned to the Communications Zone, and allotted to the Third Corps Area. Redesignated 41st General Hospital 29 March 1929. Initiated 12 January 1925 at Philadelphia, PA. Relocated by September 1927 to Norfolk, VA. Withdrawn from the Organized Reserve 1 October 1933 and allotted to the Regular Army. Concurrently relieved from the Communications Zone and assigned to the General Headquarters Reserve. Relocated by December 1936 to Richmond, VA. Location 7 December 1941—Richmond, VA.

Status: Inactive in the U.S. Army Reserve as the 359th Station Hospital.**Commanders, 41st General Hospital**

Maj. Rae S. Dorsett	12 Jan 25-23 Jan 25	Col. Burton O. Clark	23 Nov 28-10 Dec 30
Lt. Col. Warren T. Vaughn	23 Jan 25-Apr 25	Lt. Col. William R. Weisiger	10 Dec 30-7 Jul 31
Col. Daniel M. Hoyt	Apr 25-13 Sep 26	Col. Gerald A. Ezekiel**	7 Jul 31-ao Jun 40
Lt. Col. Warren T. Vaughn	13 Sep 26-23 Nov 28	Unknown	ao Jun 40-7 Dec 41

** RAI Commanders: Organized Reserve officers.

42nd General Hospital (C.Z.)**Organized Reserve Maryland****HQ-Not initiated** 1923-25; Baltimore, MD, 1925-29; Salisbury, MD, 1929-41

Constituted in the Organized Reserve 2 July 1923 as General Hospital No. 42, assigned to the Communications Zone, and allotted to the Third Corps Area. Affiliated 14 November 1923 with the University of Maryland School of Medicine in Baltimore, MD. Initiated in April 1925 at Baltimore. Redesignated 42nd General Hospital 29 March 1929. Relocated 9 September 1929 to Salisbury, MD. Withdrawn from the Organized Reserve 1 October 1933 and allotted to the Regular Army. Concurrently relieved from the Communications Zone and assigned to the General Headquarters Reserve. Location 7 December 1941—Salisbury, MD.

Commanders, 42nd General Hospital

Col. Archibald C. Harrison	Apr 25-6 Feb 26	Col. George M. Linthicum**	24 Apr 30-15 Feb 35
Lt. Col. Arthur M. Shipley	6 Feb 26-1 Jul 27	Lt. Col. Firmadge K. Nichols**	15 Feb 35-6 Nov 38
Lt. Co. Howard E. Ashbury	1 Jul 27-9 Sep 29	Col. Willie J. Vinson**	6 Nov 38-ao Mar 39
Lt. Col. Firmadge K. Nichols	9 Sep 29-24 Apr 30	Unknown	ao Mar 39-7 Dec 41

** RAI Commanders: Organized Reserve officers.

43rd General Hospital (C.Z.)**Organized Reserve Georgia****HQ-Atlanta, GA, 1922-41**

Authorized 15 August 1922 by the Surgeon General to be organized at, and affiliated with, the Emory University Medical School in Atlanta, GA. Constituted in the Organized Reserve 2 July 1923 as General Hospital No. 43, assigned to the Communications Zone, and allotted to the Fourth Corps Area. Redesignated 43rd General Hospital 29 March 1929. Consolidated 8 October 1936 with Base Hospital No. 43 (a WWI unit organized in June 1917 at the Emory University Medical School in Atlanta, GA; mobilized 4 March 1918 at Atlanta; demobilized 3 April 1919 at Camp Gordon, GA; reconstituted 8 October 1936). Withdrawn from the Organized Reserve 1 July 1940 and allotted to the Regular Army. Affiliation with the Emory University Medical School reaffirmed 7 August 1940. Location 7 December 1941—Atlanta, GA.

Status: Inactive in the Regular Army as the 43rd General Hospital.**Commanders, 43rd General Hospital**

Lt. Col. Frank K. Bolend	15 Aug 22-14 Nov 33	Col. John D. Smyser	14 Nov 33-24 Aug 35
	Col. Frank K. Bolend**	24 Aug 35-ao Jan 41	

** RAI Commanders: Organized Reserve officers.

44th General Hospital (C.Z.)**Organized Reserve Connecticut/Indiana/Wisconsin****HQ-***Not initiated* 1923-26; Waterbury, CT, 1926-29; *Inactive* 1929-40; Madison, WI, 1940-41

Constituted in the Organized Reserve 2 July 1923 as General Hospital No. 44, assigned to the Communications Zone, and allotted to the First Corps Area. Initiated by May 1926 at Waterbury, CT. Redesignated 44th General Hospital 29 March 1929. Inactivated in December 1929 at Waterbury by relief of personnel. Withdrawn from the Organized Reserve 1 October 1933 and allotted to the Regular Army. Concurrently withdrawn from the First Corps Area and allotted to the Sixth Corps Area. Additionally relieved from the Communications Zone and assigned to the General Headquarters Reserve. Consolidated 17 August 1936 with Base Hospital No. 44 (a WWI unit organized in March 1917 at the Massachusetts Homeopathic Hospital in Boston, MA; mobilized 10 March 1918 at Boston; demobilized 2 May 1919 at Camp Devens, MA; reconstituted 17 August 1936). Reorganized by June 1940 at, and affiliated with, the University of Wisconsin School of Medicine in Madison, WI. Location 7 December 1941—Madison, WI.

Status: Inactive in the U.S. Army Reserve as the 44th General Hospital.**Commanders, 44th General Hospital**

Col. John S. Dye	ao May 26-Dec 29	<i>Inactive</i>	Dec 29-ao Jun 40
	Unknown	ao Jun 40-7 Dec 41	

45th General Hospital (C.Z.)**Organized Reserve Pennsylvania/Maryland/Virginia****HQ-***Not initiated* 1923-25; York, PA, 1925-29; *Inactive* 1929-30; Salisbury, MD, 1930-37; *Inactive* 1937-41; Richmond, VA, 1941

Constituted in the Organized Reserve 2 July 1923 as General Hospital No. 45, assigned to the Communications Zone, and allotted to the Third Corps Area. Affiliated 10 November 1924 with the York Hospital and Dispensary in York, PA. Initiated by September 1925 at York. Redesignated 45th General Hospital 29 March 1929. Inactivated by June 1929 at York by relief of personnel. Reorganized by June 1930 at Salisbury, MD. Withdrawn from the Organized Reserve 1 October 1933 and allotted to the Regular Army. Concurrently relieved from the Communications Zone and assigned to the General Headquarters Reserve. Consolidated 12 October 1936 with Base Hospital No. 45 (a WWI unit organized in July 1917 at the Medical College of Virginia in Richmond, VA; mobilized 1 April 1918 at Camp Lee, VA; demobilized 27 April 1919 at Camp Lee; reconstituted 12 October 1936). Inactivated by June 1937 at Salisbury by relief of personnel. Withdrawn from the Regular Army 1 July 1940 and allotted to the Organized Reserve. Affiliated 28 May 1941 and reorganized at the Medical College of Virginia in Richmond. Location 7 December 1941—Richmond, VA.

Status: Inactive in the Regular Army as the 45th General Hospital.**Commanders, 45th General Hospital**

Unknown	ao Sep 25-ao Mar 27	Unknown	ao Jun 30-15 Jul 31
Maj. Edward A. Looper	ao Mar 27-ao Jun 27	Col. Joseph C. Monmonier**	15 Jul 31-ao Jun 35
Col. James B. Guthrie	ao Dec 27-17 Mar 28	Unknown	ao Jun 35-ao Jun 37
Unknown	17 Mar 28-ao Jun 29	<i>Inactive</i>	ao Jun 37-28 May 41
<i>Inactive</i>	ao Jun 29-ao Jun 30	Unknown	28 May 41-7 Dec 41

** RAI Commanders: Organized Reserve officers.

46th General Hospital (C.Z.)**Organized Reserve Oregon/California****HQ-**Portland, OR, 1922-36; Pasadena, CA, 1936-40; Portland, OR, 1940-41

Authorized 6 November 1922 by the Surgeon General to be organized at, and affiliated with, the University of Oregon Medical School in Portland, OR. Constituted in the Organized Reserve 2 July 1923 as General Hospital No. 46, assigned to the Communications Zone, and allotted to the Ninth Corps Area. Initiated in January 1925 at Portland. Redesignated 46th General Hospital 29 March 1929. Relocated in 1936 to Pasadena, CA. Consolidated 12 October 1936 with Base Hospital No. 46 (a WWI unit organized in May 1917 at the University of Oregon Medical School in Portland, OR; mobilized 20 March 1918 at Camp Lewis, WA; demobilized 31 May 1919 at Camp Lewis; reconstituted

12 October 1936). Affiliation reestablished in June 1940 with the University of Oregon Medical School in Portland. Hospital concurrently organized with local physicians and faculty from the Oregon Medical School. Withdrawn from the Organized Reserve 1 July 1940 and allotted to the Regular Army. Typically conducted Inactive Training Period meetings at the Portland Aeronautics Club Building in Portland. Location 7 December 1941—Portland, OR.

Status: Inactive in the Regular Army as the 46th General Hospital.

Commanders, 46th General Hospital

Maj. Richard B. Dillehunt	6 Nov 22-Oct 30	Col. John G. Strohm	Feb 31-16 Jun 40
Lt. Col. Frederick D. Stricker	Oct 30-Feb 31	Col. Richard B. Dillehunt**	16 Jun 40-ao Dec 41

** RAI Commanders: Organized Reserve officers.

47th General Hospital (C.Z.)

Organized Reserve California

HQ-*Not initiated* 1923-25; Los Angeles, CA, 1925-40; *Inactive* 1940-41



Constituted in the Organized Reserve 1 March 1923 as General Hospital No. 47, assigned to the Communications Zone, and allotted to the Ninth Corps Area. Initiated 21 February 1925 at Los Angeles, CA. Affiliated with the College of Medical Evangelists in Loma Linda, CA. Redesignated 47th General Hospital 29 March 1929. Consolidated 28 September 1936 with Base Hospital No. 47 (a WWI unit organized in July 1917 at the San Francisco Hospital in San Francisco, CA; mobilized 5 December 1917 at Camp Fremont, CA; demobilized 10 May 1919 at the Presidio of San Francisco; reconstituted 28 September 1936). Conducted summer training at Del Monte, CA, the Presidio of Monterey, CA, or at Letterman General Hospital, San Francisco, CA. Inactivated 30 July 1940 at Los Angeles by relief of personnel. Location 7 December 1941—*Inactive*.

Commanders, 47th General Hospital

Lt. Col. Newton G. Evans	21 Feb 25-ao Jun 31	Unknown	15 Apr 35-2 Mar 37
Unknown	ao Jun 31-ao Mar 35	Col. Charles G. Baird	2 Mar 37-30 Jul 40
Lt. Col. Charles C. Wallingsford	ao Mar 35-15 Apr 35	<i>Inactive</i>	30 Jul 40-7 Dec 41

48th General Hospital (C.Z.)

Organized Reserve New York

HQ-*Not initiated* 1923-25; Manhattan, NY, 1925-41

Authorized 5 July 1922 by the Surgeon General to be organized at, and affiliated with, the University of Oregon Medical School in Portland, OR. Constituted in the Organized Reserve 2 July 1923 as General Hospital No. 48, assigned to the Communications Zone, and allotted to the Second Corps Area. Initiated 13 January 1925 at Manhattan, NY. Redesignated 48th General Hospital 29 March 1929. Consolidated 28 September 1936 with Base Hospital No. 48 (a WWI unit organized in November 1917 at the Metropolitan Hospital in New York City, NY; mobilized 6 March 1918 at new York City; demobilized 10 May 1919 at Camp Upton, NY; reconstituted 28 September 1936). Conducted summer training at Carlisle Barracks, PA. Location 7 December 1941—Manhattan, NY.

Status: Active in the U.S. Army Reserve as the 348th General Hospital at Fort Dix, NJ.

Commanders, 48th General Hospital

Maj. Walter S. Mills	13 Jan 25-7 Oct 25	Col. Frederick M. Dearborn	7 Oct 25-7 Jun 41
----------------------	--------------------	----------------------------	-------------------

49th General Hospital (C.Z.)

Organized Reserve Nebraska

HQ-*Not initiated* 1923-25; Omaha, NE, 1925-41

Constituted in the Organized Reserve 2 July 1923 as General Hospital No. 49, assigned to the Communications Zone, and allotted to the Seventh Corps Area. Initiated by October 1925 at Omaha, NE. Redesignated 49th General Hospital 29 March 1929. Withdrawn from the Organized Reserve 1 October 1933 and allotted to the Regular Army. Concurrently relieved from the Communications Zone and assigned to the General Headquarters Reserve. Consolidated 28 August

1936 with Base Hospital No. 49 (a WWI unit organized in September 1917 at Nebraska University in Omaha, NE; mobilized 25 March 1918 at Omaha; demobilized 7 May 1919 at Camp Dodge, IA; reconstituted 28 August 1936). Location 7 December 1941—Omaha, NE.

Status: Inactive in the Regular Army as the 49th General Hospital.

Commanders, 49th General Hospital

Unknown	ao Oct 25-ao Jun 27	Unknown	Dec 31-ao Jul 37
Lt. Col. William W. Duke	ao Jun 27-May 29	Col. Harry C. Parker**	ao Jul 37-22 Aug 37
Unknown	May 29-ao Nov 31	Unknown	22 Aug 37-19 May 38
Col. Alva S. Pinto	ao Nov 31-Dec 31	Col. Czar C. Johnson**	19 May 38-27 Aug 38
	Unknown	27 Aug 38-7 Dec 41	

** RAI Commanders: Organized Reserve officers.

50th General Hospital (C.Z.)

Organized Reserve Washington/Illinois

HQ-Seattle, WA, 1922-36; *Inactive* 1936-41

Authorized 9 November 1922 by the Surgeon General to be organized at, and affiliated with, the University of Washington Medical School in Seattle, WA. Constituted in the Organized Reserve 2 July 1923 as General Hospital No. 50, assigned to the Communications Zone, and allotted to the Ninth Corps Area. Initiated 27 May 1925 at Seattle. Redesignated 50th General Hospital 29 March 1929. Withdrawn from the Ninth Corps Area 5 June 1936 and allotted to the Sixth Corps Area. Chicago, IL, designated as headquarters on reorganization, but the unit was never organized at that location. Consolidated 24 November 1936 with Base Hospital No. 50 (a WWI unit organized in October 1917 at the University of Washington in Seattle, WA; mobilized 27 March 1918 at Fort Lawton, WA; demobilized 5 May 1919 at Camp Lewis, WA; reconstituted 24 November 1936). Typically conducted Inactive Training Period meetings at the Henry Building in Seattle. Location 7 December 1941—*Inactive*.

Status: Inactive in the U.S. Army Reserve as the 50th General Hospital.

Commanders, 50th General Hospital

Col. James B. Eagleson	9 Nov 22-Sep 26	Lt. Col. William E. Joiner	Dec 29-Feb 31
Lt. Col. Copeland Plummer	Sep 26-Feb 27	Col. Frederick T. Harris	Feb 31-5 Jun 36
Lt. Col. Francis M. Carroll	Feb 27-Dec 29	<i>Inactive</i>	5 Jun 36-7 Dec 41

51st General Hospital (C.Z.)

Organized Reserve District of Columbia

HQ-*Not initiated* 1923-25; Washington, DC, 1925-38; *Inactive* 1938-41

Authorized 3 July 1922 by the Surgeon General to be organized at, and affiliated with, the Georgetown University School of Medicine in Washington, DC. Constituted in the Organized Reserve 2 July 1923 as General Hospital No. 51, assigned to the Communications Zone, and allotted to the Third Corps Area. Initiated 23 January 1925 at Washington, DC. Redesignated 51st General Hospital 29 March 1929. Consolidated 6 November 1936 with Base Hospital No. 51 (a WWI unit organized 18 February 1918 at Camp Greenleaf, GA; demobilized 12 June 1919 at Camp Dix, NJ; reconstituted 6 November 1936). Inactivated 7 September 1938 at Washington by relief of personnel. Typically conducted Inactive Training Period meetings at the Ambassador Hotel, the Medical Society Building, 1718 M Street, NW, or the Munitions Building in Washington. Location 7 December 1941—*Inactive*.

Status: Inactive in the U.S. Army Reserve as the 351st General Hospital.

Commanders, 51st General Hospital

Maj. Joseph P. Madigan	23 Jan 25-Apr 25	Unknown	ao Jun 32-ao Dec 34
Col. Roy D. Adams	Apr 25-26 Feb 30	Lt. Col. Clarence T. Obenschain	ao Dec 34-2 Aug 36
Lt. Col. Harry H. Kerr	26 Feb 30-12 Oct 31	Col. Dunlap R. Penhallow	2 Aug 36-23 Feb 37
Unknown	12 Oct 31-12 Jan 32	Unknown	23 Feb 37-7 Sep 38
Col. Adam T. Finch	12 Jan 32-ao Jan 33	<i>Inactive</i>	7 Sep 38-7 Dec 41

52nd General Hospital (C.Z.)**Organized Reserve New York****HQ**-Syracuse, NY, 1922-41

Authorized 6 July 1922 by the Surgeon General to be organized at, and affiliated with, the Syracuse University College of Medicine in Syracuse, NY. Constituted in the Organized Reserve 2 July 1923 as General Hospital No. 52, assigned to the Zone of the Interior, and allotted to the Second Corps Area. Relieved as Zone of Interior troops 31 March 1924 and assigned to the Communications Zone. Redesignated 52nd General Hospital 29 March 1929. Consolidated 10 November 1936 with Base Hospital No. 52 (a WWI unit organized 11 April 1918 at Camp Greenleaf, GA; demobilized 4 May 1919 at Camp Sherman, OH; reconstituted 10 November 1936). Affiliation reaffirmed 5 November 1940 with the Syracuse University College of Medicine. Typically conducted Inactive Training Period meetings at the Syracuse University Hospital. Location 7 December 1941—Syracuse, NY.

Status: Inactive in the U.S. Army Reserve as the 52nd General Hospital.**Commanders, 52nd General Hospital**

Col. Edward S. Van Duyn	6 Jul 22-18 Nov 29	Col. Royden M. Vose	11 May 37-5 Aug 37
Lt. Col. Leonard D. Frescoln	18 Nov 29-14 Feb 31	Col. Hans Hansen	5 Aug 37-11 Jan 38
Unknown	14 Feb 31-1 May 37	Col. Edward T. Wentworth	11 Jan 38-28 Jan 41
	Maj. James H. Van Marter	28 Jan 41-14 Mar 41	

53rd General Hospital (C.Z.)**Organized Reserve Missouri****HQ**-St. Louis, MO, 1922-41; Fort Benning, GA, 1941

Authorized 8 July 1922 by the Surgeon General to be organized at, and affiliated with, the St. Louis University School of Medicine in St. Louis, MO. Constituted in the Organized Reserve 2 July 1923 as General Hospital No. 53, assigned to the Communications Zone, and allotted to the Seventh Corps Area. Redesignated 53rd General Hospital 29 March 1929. Withdrawn from the Organized Reserve 1 October 1933 and allotted to the Regular Army. Concurrently relieved from the Communications Zone and assigned to the General Headquarters Reserve. Consolidated 28 August 1936 with Base Hospital No. 53 (a WWI unit organized 3 June 1918 at Camp Grant, IL; demobilized 5 May 1919 at Camp Dix, NJ; reconstituted 28 August 1936).

Activated 10 February 1941, less Reserve personnel, at Fort Benning, GA, and assigned to the Third Army. Location 7 December 1941—Fort Benning, GA.

Status: Inactive in the U.S. Army Reserve as the 53rd General Hospital.**Commanders, 53rd General Hospital**

Col. Hanau W. Loeb	8 Jul 22-26 Jul 27	Lt. Col. T. B. Ayars	Mar 31-ao Jan 32
Lt. Col. William E. Leighton	26 Jul 27-Apr 28	Unknown	ao Jan 32-ao Jun 37
Unknown	Apr 28-Mar 30	Lt. Col. Thomas E. Gray**	ao Jun 37-26 Sep 37
Lt. Col. Robert E. Owen	Mar 30-Mar 31	Unknown	26 Sep 37-10 Feb 41
	Capt. Charles H. Gingles*	10 Feb 41-10 Jan 42	

* Regular Army active duty commanders

** RAI Commanders: Organized Reserve officers.

54th General Hospital (C.Z.)**Organized Reserve Iowa****HQ**-Iowa City, IA, 1922-41

Authorized 8 July 1922 by the Surgeon General to be organized at, and affiliated with, the State University of Iowa College of Medicine in Iowa City, IA. Constituted in the Organized Reserve 2 July 1923 as General Hospital No. 54, assigned to the Communications Zone, and allotted to the Sixth Corps Area. Redesignated 54th General Hospital 29 March 1929. Withdrawn from the Organized Reserve and allotted to the Regular Army. Consolidated 23 November 1936 with Base Hospital No. 54 (a WWI unit organized in May 1918 at Camp Greenleaf, GA; demobilized 30 May 1919 at Camp Grant, IL; reconstituted 23 November 1936). Conducted summer training at the station hospitals at Fort Snelling, MN, or Fort Des Moines, IA. Location 7 December 1941—Iowa City, IA.

Status: Inactive in the U.S. Army Reserve as the 332nd General Hospital.

Authorized 1 March 1923 by the Surgeon General to be organized at, and affiliated with, Western Reserve University-Cleveland City Hospital in Cleveland, OH. Constituted in the Organized Reserve 2 July 1923 as General Hospital No. 57, assigned to the Zone of the Interior, and allotted to the Fifth Corps Area. Initiated in January 1926 at Cleveland, OH. Redesignated 57th General Hospital 29 March 1929. Consolidated 7 November 1936 with Base Hospital No. 56 (a WWI unit organized in June 1918 at Camp Greenleaf, GA; demobilized in August 1919 in France; reconstituted 7 November 1936). Location 7 December 1941—Cleveland, OH.

Status: Active in the U.S. Army Reserve as the 349th General Hospital at Los Angeles, CA.

Commanders, 57th General Hospital

Lt. Col. Carl A. Hamann	Jan 26-ao Oct 29	Unknown	ao Jun 34-ao Jun 36
Unknown	ao Oct 29-Jun 31	Col. Michael P. Motto	ao Jun 36-11 May 37
Col. Nathaniel M. Jones	Jul 31-ao Jun 34	Lt. Col. Philip P. Close	11 May 37-ao Jun 37
	Unknown	ao Jun 37-7 Dec 41	

58th General Hospital (Z.I.)

Organized Reserve Connecticut/Rhode Island/Pennsylvania

HQ-Not initiated 1923-24; Hartford, CT, 1924-37; Providence, RI, 1937-40; Pittsburgh, PA, 1940-41

Constituted in the Organized Reserve 2 July 1923 as General Hospital No. 58, assigned to the Zone of the Interior, and allotted to the First Corps Area. Initiated 28 May 1924 at, and affiliated with, St. Francis Hospital in Hartford, CT. Redesignated 58th General Hospital 29 March 1929. Withdrawn from the Organized Reserve 1 October 1933 and allotted to the Regular Army. Concurrently relieved from the Zone of the Interior and assigned to the General Headquarters Reserve. Consolidated 28 August 1936 with Base Hospital No. 58 (a WWI unit organized 3 June 1918 at Camp Grant, IL; demobilized 5 May 1919 at Camp Dix, NJ; reconstituted 28 August 1936). Relocated by January 1937 to Providence, RI. Withdrawn from the First Corps Area 1 July 1940 and allotted to the Third Corps Area. Affiliated 10 December 1940 with and organized at Western Pennsylvania Hospital in Pittsburgh, PA. Location 7 December 1941—Pittsburgh, PA.

Status: Inactive in the U.S. Army Reserve as the 58th General Hospital.

Commanders, 58th General Hospital

Maj. John McBirney	28 May 24-May 26	Col. John S. Dye**	Dec 29-5 Nov 36
Lt. Col. Arthur B. Landry	May 26-1 Sep 29	Lt. Col. Edward P. Case**	5 Nov 36-1 Jul 40
Unknown	1 Sep 29-Dec 29	Unknown	1 Jul 40-7 Dec 41

* Regular Army active duty commanders

** RAI Commanders: Organized Reserve officers.

59th General Hospital (Z.I.)

Organized Reserve Kentucky

HQ-Not initiated 1923-25; Louisville, KY, 1925-36; Frankfort, KY, 1936-41

Constituted in the Organized Reserve 2 July 1923 as General Hospital No. 59, assigned to the Zone of the Interior, and allotted to the Fifth Corps Area. Affiliated in April 1924 with University of Louisville School of Medicine in Louisville, KY. Redesignated 59th General Hospital 29 March 1929. Initiated by April 1925 at Louisville. Relocated in 1936 to Frankfort, KY. Consolidated 11 November 1936 with Base Hospital No. 59 (a WWI unit organized in April 1918 at Camp Greenleaf, GA; demobilized 3 July 1919 at Camp Dix, NJ; reconstituted 11 November 1936). Location 7 December 1941—Frankfort, KY.

Status: Inactive in the U.S. Army Reserve as the 457th General Hospital.

Commanders, 59th General Hospital

Col. Irvin Abell	ao Apr 25-ao Jul 29	Unknown	ao Jul 29-7 Dec 41
------------------	---------------------	---------	--------------------

60th General Hospital (Z.I.)**Organized Reserve Iowa/Minnesota****HQ**-Des Moines, IA, 1922-28; Minneapolis, MN, 1928-41

Authorized 18 August 1922 by the Surgeon General to be organized at, and affiliated with, Iowa Methodist Hospital in Des Moines, IA. Constituted in the Organized Reserve 2 July 1923 as General Hospital No. 60, assigned to the Zone of the Interior, and allotted to the Seventh Corps Area. Redesignated 60th General Hospital 29 March 1929. Relocated 3 April 1928 to Minneapolis, MN. Conducted summer training at the station hospital, Fort Des Moines, IA. Location 7 December 1941—Minneapolis, MN.

Commanders, 60th General Hospital

Maj. Charles F. Smith	18 Aug 22-ao Jan 24	Col. James W. Osborne	ao Jun 27-Jan 28
Unknown	ao Jan 24-ao May 26	Unknown	ao Jun 28-ao Nov 40
Lt. Col. Gasparre E. Lentine	ao May 26-ao Sep 26	Lt. Col. Francis L. Love	ao Nov 40-ao Jan 41
Unknown	ao Sep 26-ao Jun 27	Unknown	ao Jan 41-7 Dec 41

61st General Hospital (Z.I.)**Organized Reserve Utah/California****HQ**-*Not initiated* 1923-25; Salt Lake City, UT, 1925-36; San Francisco, CA, 1936-41

Authorized 7 June 1923 by the Surgeon General to be organized at, and affiliated with, the Latter Day Saints Hospital in Salt Lake City, UT. Constituted in the Organized Reserve 2 July 1923 as General Hospital No. 61, assigned to the Zone of the Interior, and allotted to the Ninth Corps Area. Initiated 27 January 1925 at Salt Lake City. Mobilization mission was to supplement Sutherland General Hospital and provide general area medical support. Redesignated 61st General Hospital 29 March 1929. Relocated in 1936 to San Francisco, CA. Consolidated 11 November 1936 with Base Hospital No. 61 (a WWI unit organized 5 June 1918 at Camp Greenleaf, GA; demobilized 27 April 1919 at Camp Dix, NJ; reconstituted 11 November 1936). Conducted summer training at Letterman General Hospital, San Francisco, CA, or at the station hospital, Fort Lewis, WA. Location 7 December 1941—San Francisco, CA.

Status: Inactive in the U.S. Army Reserve as the 321st General Hospital.**Commanders, 61st General Hospital**

Maj. James P. Kerby, jr.	27 Jan 25-Feb 25	Col. Howard P. Kirtley	Mar 26-9 Feb 37
Col. S. C. Baldwin	Feb 25-Mar 26	Lt. Col. Jackson H. Barnett	9 Feb 37-13 Aug 39
	Unknown	13 Aug 39-7 Dec 41	

62nd General Hospital (Z.I.)**Organized Reserve Florida****HQ**-Jacksonville, FL, 1923-41

Authorized 7 June 1923 by the Surgeon General to be organized at, and affiliated with, St. Luke's Hospital in Jacksonville, FL. Constituted in the Organized Reserve 2 July 1923 as General Hospital No. 62, assigned to the Zone of the Interior, and allotted to the Fourth Corps Area. Redesignated 62nd General Hospital 29 March 1929. Consolidated 11 November 1936 with Base Hospital No. 62 (a WWI unit organized in June 1918 at Camp Greenleaf, GA; demobilized 7 June 1919 at Camp Dix, NJ; reconstituted 11 November 1936). Location 7 December 1941—Jacksonville, FL.

Status: Active in the U.S. Army Reserve as the 323rd Combat Support Hospital at Southfield, MI.**Commanders, 62nd General Hospital**

Lt. Col. Stanley Erwin	7 Jun 23-ao Jan 24	Lt. Col. William S. Manning	9 Oct 34-14 Feb 35
Unknown	ao Jan 24-ao Jun 27	Col. Raymond Sanderson	14 Feb 35-13 Aug 39
Col. Hermann H. Harris	ao Jun 27-11 Sep 34	Col. Jackson H. Barnett	13 Aug 39-ao Sep 40
	Unknown	ao Sep 40-7 Dec 41	

63rd General Hospital (Z.I.)**Organized Reserve Massachusetts/Indiana****HQ-Not initiated** 1923-24; Springfield, MA, 1924-36; *Inactive* 1936-38; Richmond, IN, 1938-41

Constituted in the Organized Reserve 2 July 1923 as General Hospital No. 63, assigned to the Zone of the Interior, and allotted to the First Corps Area. Initiated by December 1924 at Springfield, MA. Redesignated 63rd General Hospital 29 March 1929. Withdrawn from the Organized Reserve 1 October 1933 and allotted to the Regular Army. Concurrently relieved from the Zone of the Interior and assigned to the General Headquarters Reserve. Withdrawn from the First Corps Area 5 June 1936 and allotted to the Fifth Corps Area. Reorganized by June 1938 at Richmond, IN. Designated mobilization station was Fort Oglethorpe, GA. Activated 10 February 1941, less Reserve personnel, at Camp Blanding, FL, and assigned to the Third Army. Location 7 December 1941—Camp Blanding, FL,

Status: Disbanded 15 January 1943.**Commanders, 63rd General Hospital**

Unknown	ao Dec 24-ao Apr 26	<i>Inactive</i>	5 Jun 36-ao Jun 38
Maj. William A. R. Chapin	ao Apr 26-1 Sep 29	Lt. Col. Walter M. Stout**	ao Jun 38-ao Aug 38
Maj. Harry R. Wheat	1 Sep 29-ao Feb 30	Unknown	ao Aug 38-10 Feb 41
Unknown	ao Feb 30-ao Nov 34	1st Lt. V. A. Shaw*	10 Feb 41-15 Feb 41
Lt. Col. Edward B. Bigelow**	ao Nov 34-ao Jan 35	1st Lt. William S. Worthy*	15 Feb 41-16 Feb 41
Unknown	ao Jan 35-ao May 36	1st Lt. V. V. Smith*	16 Feb 41-23 Feb 41
Col. David D. Scannell**	ao May 36-5 Jun 36	Maj. William C. Knott*	23 Feb 41-ao Jan 42

* Regular Army active duty commanders

** RAI Commanders: Organized Reserve officers.

64th General Hospital (Z.I.)**Organized Reserve Connecticut/ Rhode Island/Louisiana****HQ-Not initiated** 1923-26; Bridgeport, CT, 1926-33; Hartford, CT, 1933-37; Providence, RI, 1937-40; New Orleans, LA, 1940-41

Constituted in the Organized Reserve 2 July 1923 as General Hospital No. 64, assigned to the Zone of the Interior, and allotted to the First Corps Area. Initiated by April 1926 at Bridgeport, CT. Redesignated 64th General Hospital 29 March 1929. Withdrawn from the Organized Reserve 1 October 1933 and allotted to the Regular Army. Concurrently relieved from the Zone of the Interior and assigned to the General Headquarters Reserve. Relocated by December 1933 to Hartford, CT. Consolidated 31 August 1936 with Base Hospital No. 64 (a WWI unit organized 5 June 1918 at Camp Greenleaf, GA; demobilized 23 June 1919 at Camp Dix, NJ; reconstituted 31 August 1936) . Relocated by January 1937 to Providence, RI. Withdrawn from the First Corps Area 1 July 1940 and allotted to the Fourth Corps Area. Affiliated 26 September 1940 with the Louisiana State University Medical School in New Orleans, LA. Location 7 December 1941—New Orleans, LA.

Status: Inactive in the Regular Army as the 64th General Hospital.**Commanders, 64th General Hospital**

Maj. Harry G. Anderson	ao Apr 26-1 Sep 29	Lt. Col. Robert F. Souther	ao Jun 32-Jul 32
Unknown	1 Sep 29-ao Jun 32	Col. John F. Hackett**	Jul 32-5 Jun 36
	Unknown	5 Jun 36-7 Dec 41	

** RAI Commanders: Organized Reserve officers.

65th General Hospital (Z.I.)**Organized Reserve Rhode Island/Kentucky/North Carolina****HQ-Not initiated** 1923-25; Providence, RI, 1925-36; *Inactive* 1936-40; Durham, NC, 1940-41

Constituted in the Organized Reserve 2 July 1923 as General Hospital No. 65, assigned to the Zone of the Interior, and allotted to the First Corps Area. Initiated by June 1925 at Providence, RI. Redesignated 65th General Hospital 29 March 1929. Withdrawn from the Organized Reserve 1 October 1933 and allotted to the Regular Army. Concurrently relieved from the Zone of the Interior and assigned to the General Headquarters Reserve. Withdrawn from the First Corps Area 5 June 1936 and allotted to the Fifth Corps Area. Lexington, KY, designated as headquarters on reorganization,

but the unit was never organized at that location. Consolidated 27 August 1936 with Base Hospital No. 65 (a WWI unit organized in March 1918 at Fort McPherson, GA; demobilized 16 August 1919 at Camp Lee, VA; reconstituted 27 August 1936). Withdrawn from the Fifth Corps Area 1 July 1940 and allotted to the Fourth Corps Area. Affiliated 26 November 1940 with the Duke University Medical School and organized at Durham, NC. Location 7 December 1941—Durham, NC.

Status: Inactive in the Regular Army as the 65th General Hospital.

Commanders, 65th General Hospital

Col. Joseph F. Hawkins**	ao Jun 25-ao Nov 34	<i>Inactive</i>	5 Jun 36-26 Nov 40
Unknown	ao Nov 34-5 Jun 36	Unknown	26 Nov 40-7 Dec 41

** RAI Commanders: Organized Reserve officers.

66th General Hospital (Z.I.)

Organized Reserve Vermont/Maine/Kentucky

HQ-Not initiated 1923-25; Burlington, VT, 1925-33; Lewiston, ME, 1933-36; *Inactive* 1936-41; Fort Bragg, NC, 1941

Constituted in the Organized Reserve 2 July 1923 as General Hospital No. 66, assigned to the Zone of the Interior, and allotted to the First Corps Area. Initiated by June 1925 at Burlington, VT. Redesignated 66th General Hospital 29 March 1929. Relocated in 1933 to Lewiston, ME. Withdrawn from the Organized Reserve 1 October 1933 and allotted to the Regular Army. Concurrently relieved from the Zone of the Interior and assigned to the General Headquarters Reserve. Withdrawn from the First Corps Area 5 June 1936 and allotted to the Fifth Corps Area. Louisville, KY, designated as headquarters on reorganization, but the unit was never organized at that location. Consolidated 31 August 1936 with Base Hospital No. 66 (a WWI unit organized 6 November 1917 at Camp Merritt, NJ; demobilized 27 February 1919 at Camp Devens, MA; reconstituted 31 August 1936). Activated 10 February 1941 at Fort Bragg, NC, and assigned to the First Army. Location 7 December 1941—Fort Bragg, NC.

Status: Disbanded 15 April 1943.

Commanders, 66th General Hospital

Maj. Oscar V. Hefflon	ao Jun 25-ao Jun 27	Lt. Col. Charles E. Libby**	ao Nov 29-5 Jun 36
Unknown	ao Jun 27-ao Nov 29	<i>Inactive</i>	5 Jun 36-10 Feb 41
	Unknown	10 Feb 41-7 Dec 41	

** RAI Commanders: Organized Reserve officers.

67th General Hospital (Z.I.)

Organized Reserve Maine/Kentucky

HQ-Not initiated 1923-24; Portland, ME, 1924-36; Covington, KY, 1936-40; Portland, ME, 1940-41

Constituted in the Organized Reserve 2 July 1923 as General Hospital No. 67, assigned to the Zone of the Interior, and allotted to the First Corps Area. Affiliated with the Maine General Hospital in Portland, ME. Initiated 8 November 1924 at Portland. Redesignated 67th General Hospital 29 March 1929. Withdrawn from the Organized Reserve 1 October 1933 and allotted to the Regular Army. Concurrently relieved from the Zone of the Interior and assigned to the General Headquarters Reserve. Withdrawn from the First Corps Area 5 June 1936 and allotted to the Fifth Corps Area. Reorganized in 1936 at Covington, KY. Consolidated 17 August 1936 with Base Hospital No. 67 (a WWI unit organized in April 1918 at Camp Crane, PA; demobilized 13 May 1919 at Camp Sherman, OH; reconstituted 17 August 1936). Withdrawn from the Fifth Corps Area 1 July 1940 and allotted to the First Corps Area. Affiliation reestablished 1 January 1940 with the Maine General Hospital and reorganized at Portland. Location 7 December 1941—Portland, ME.

Status: Inactive in the Regular Army as the 67th General Hospital.

Commanders, 67th General Hospital

Col. Thomas J. Burrage	8 Nov 25-Dec 29	Unknown	Dec 29-7 Dec 41
------------------------	-----------------	---------	-----------------

68th General Hospital (Z.I.)**Organized Reserve Massachusetts****HQ**-*Not initiated* 1923-25; Boston, MA, 1925-30; *Inactive* 1930-37; New York City, NY, 1937-41

Constituted in the Organized Reserve 2 July 1923 as General Hospital No. 68, assigned to the Zone of the Interior, and allotted to the First Corps Area. Affiliated 21 November 1924 with Boston City Hospital, IN, Boston, MA. Initiated 25 February 1925 at Boston. Redesignated 68th General Hospital 29 March 1929. Inactivated 15 January 1930 at Boston by relief of personnel. Withdrawn from the Organized Reserve 1 October 1933 and allotted to the Regular Army. Concurrently relieved from the Zone of the Interior and assigned to the General Headquarters Reserve. Withdrawn from the First Corps Area 5 June 1936 and allotted to the Second Corps Area. Consolidated in 1936 with Base Hospital No. 68 (a WWI unit organized in July 1918 at Camp Crane, PA; demobilized 5 May 1919 at Camp Sherman, OH; reconstituted in 1936). Reorganized 9 March 1937 at New York City, NY. Withdrawn from the Regular Army 1 July 1940 and allotted to the Organized Reserve. Conducted summer training at Carlisle Barracks, PA. Location 7 December 1941—New York City, NY.

Status: Active in the U.S. Army Reserve as the 350th Evacuation Hospital at Indianapolis, IN.**Commanders, 68th General Hospital**

Lt. Col. James B. Means	25 Feb 25-ao Mar 25	<i>Inactive</i>	15 Feb 30-9 Mar 37
Col. David D. Scannell	ao Mar 26-15 Feb 30	Col. Conrad Berens**	9 Mar 37-ao Jan 41

** RAI Commanders: Organized Reserve officers.

69th General Hospital (Z.I.)**Organized Reserve Massachusetts/New York****HQ**-*Not initiated* 1923-25; Lynn, MA, 1925-30; *Inactive* 1930-37; New York City, NY, 1937-41

Constituted in the Organized Reserve 2 July 1923, assigned to the Zone of the Interior, and allotted to the First Corps Area. Designated 12 September 1923 as General Hospital No. 69. Initiated in August 1925 at Lynn, MA. Redesignated 69th General Hospital 29 March 1929. Inactivated 15 January 1930 at Lynn by relief of personnel. Withdrawn from the Organized Reserve 1 October 1933 and allotted to the Regular Army. Concurrently relieved from the Zone of the Interior and assigned to the General Headquarters Reserve. Withdrawn from the First Corps Area 5 June 1936 and allotted to the Second Corps Area. Consolidated 10 September 1936 with Base Hospital No. 69 (a WWI unit organized 11 June 1918 at Camp Greenleaf, GA; demobilized 21 July 1919 at Camp Grant, IL; reconstituted 10 September 1936). Reorganized 7 November 1937 at New York City, NY. Withdrawn from the Regular Army 1 July 1940 and allotted to the Organized Reserve. Location 7 December 1941—New York City, NY.

Status: Inactive in the U.S. Army Reserve as the 69th General Hospital.**Commanders, 69th General Hospital**

Lt. Col. Nathaniel P. Reed	Aug 25-15 Jan 30	Maj. Israel Herman**	9 Feb 38-14 May 38
<i>Inactive</i>	15 Jan 30-7 Nov 37	Lt. Col. William J. Young**	14 May 38-16 Feb 39
1st Lt. Kenneth T. Fairfax**	7 Nov 37-9 Feb 38	Col. Louis R. Steibel**	16 Feb 39-ao Dec 41

** RAI Commanders: Organized Reserve officers.

70th General Hospital (Z.I.)**Organized Reserve Massachusetts/Missouri****HQ**-Worcester, MA, 1922-30; *Inactive* 1930-36; St. Louis, MO, 1936-41

Authorized 20 November 1922 by the Surgeon General to be organized at, and affiliated with, the Worcester City Hospital in Worcester, MA. Constituted in the Organized Reserve 2 July 1923, assigned to the Zone of the Interior, and allotted to the First Corps Area. Designated 12 September 1923 as General Hospital No. 70. Redesignated 70th General Hospital 29 March 1929. Inactivated 11 January 1930 at Worcester by relief of personnel. Withdrawn from the Organized Reserve 1 October 1933 and allotted to the Regular Army. Concurrently relieved from the Zone of the Interior and assigned to the General Headquarters Reserve. Withdrawn from the First Corps Area 5 June 1936 and allotted to the Seventh Corps Area. Consolidated 5 September 1936 with Base Hospital No. 70 (a WWI unit organized 29 May 1918 at Fort Riley, KS; demobilized 14 May 1919 at Camp Pike, AR; reconstituted 5 September 1936). Reorganized by December 1936 at St. Louis, MO. Affiliated 6 September 1940 with the St. Louis University School of Medicine in St. Louis. Location 7 December 1941—St. Louis, MO.

Status: Inactive in the U.S. Army Reserve as the 70th General Hospital.

Commanders, 70th General Hospital

Lt. Col. Frank W. George	20 Nov 22-ao Jun 27	Maj. George M. Albee	May 28-11 Jan 30
Unknown	ao Jun 27-ao Apr 28	<i>Inactive</i>	11 Jan 30-ao Dec 36
Lt. Col. Edward B. Bigelow	ao Apr 28-May 28	Unknown	ao Dec 36-7 Dec 41

71st General Hospital (Z.I.)

Organized Reserve Massachusetts/Minnesota

HQ-*Not initiated* 1923-25; Boston, MA, 1925-36; *Inactive* 1936-41

Constituted in the Organized Reserve 2 July 1923, assigned to the Zone of the Interior, and allotted to the First Corps Area. Designated 12 September 1923 as General Hospital No. 71. Initiated 17 April 1925 at Boston, MA. Redesignated 71st General Hospital 29 March 1929. Inactivated 11 January 1930 at Boston by relief of personnel. Withdrawn from the Organized Reserve 1 October 1933 and allotted to the Regular Army. Concurrently relieved from the Zone of the Interior and assigned to the General Headquarters Reserve. Withdrawn from the First Corps Area 5 June 1936 and allotted to the Seventh Corps Area. Rochester, MN, designated as headquarters on reorganization, but the unit was never organized at that location. Affiliated with the Mayo Foundation at the University of Minnesota in Rochester. Location 7 December 1941—*Inactive*.

Status: Inactive in the U.S. Army Reserve as the 71st General Hospital.

Commanders, 71st General Hospital

Col. William H. Robey, jr.	17 Apr 25-11 Jan 30	<i>Inactive</i>	11 Jan 30-7 Dec 41
----------------------------	---------------------	-----------------	--------------------

72nd General Hospital (Z.I.)

Organized Reserve Massachusetts/New York

HQ-*Not initiated* 1923-25; Lowell, MA, 1925-30; *Inactive* 1930-37; Buffalo, NY, 1937-41

Constituted in the Organized Reserve 2 July 1923, assigned to the Zone of the Interior, and allotted to the First Corps Area. Designated 12 September 1923 as General Hospital No. 72. Initiated in August 1925 at Lowell, MA. Redesignated 72nd General Hospital 29 March 1929. Inactivated 15 January 1930 at Lowell by relief of personnel. Withdrawn from the Organized Reserve 1 October 1933 and allotted to the Regular Army. Concurrently relieved from the Zone of the Interior and assigned to the General Headquarters Reserve. Withdrawn from the First Corps Area 5 June 1936 and allotted to the Second Corps Area. Reorganized 12 May 1937 at Buffalo, NY. Primary R.O.T.C. feeder school was the Medical College of Syracuse University. Location 7 December 1941—Buffalo, NY.

Status: Disbanded 11 November 1944.

Commanders, 72nd General Hospital

Unknown	Aug 25-ao Apr 26	<i>Inactive</i>	15 Jan 30-12 May 37
Maj. Ransom A. Greene	ao Apr 26-Jul 28	Lt. Col. Hall G. Van Vlack**	12 May 37-27 May 37
Col. Frank W. Snow	Jul 28-15 Jan 30	Col. Robert L. Crockett**	27 May 37-9 Mar 40
	Unknown	9 Mar 40-7 Dec 41	

** RAI Commanders: Organized Reserve officers.

73rd General Hospital (Z.I.)

Organized Reserve Maryland/ District of Columbia

HQ-*Not initiated* 1923-25; Baltimore, MD, 1925-29; Washington, DC, 1929-38; *Inactive* 1938-40; Washington, DC, 1940-41

Constituted in the Organized Reserve 2 July 1923, assigned to the Zone of the Interior, and allotted to the Third Corps Area. Designated 12 September 1923 as General Hospital No. 73. Affiliated 2 October 1923 with the Franklin Square Hospital in Baltimore, MD. Initiated 12 January 1925 at Baltimore. Redesignated 73rd General Hospital 29 March 1929. Inactivated 7 September 1929 at Baltimore by relief of personnel. Reorganized 11 December 1929 at Washington, DC. Inactivated 7 September 1938 at Washington by relief of personnel. Reorganized by June 1940 at Washington, DC. Location 7 December 1941—Washington, DC.

Status: Disbanded 11 November 1944.

Commanders, 73rd General Hospital

Maj. Stewart C. Bowers	12 Jan 25-23 Jan 25	Unknown	11 Dec 29-7 Sep 38
Lt. Col. Charles W. Hoffman	23 Jan 25-7 Sep 29	<i>Inactive</i>	7 Sep 38-ao Jun 40
<i>Inactive</i>	7 Sep 29-11 Dec 29	Unknown	ao Jun 40-7 Dec 41

74th General Hospital (Z.I.)

Organized Reserve District of Columbia/Maryland

HQ-Not initiated 1923-25; Washington, DC, 1925-29; Hagerstown, MD, 1929-33; Washington, DC, 1933-39; *Inactive* 1939-41

Constituted in the Organized Reserve 2 July 1923, assigned to the Zone of the Interior, and allotted to the Third Corps Area. Designated 12 September 1923 as General Hospital No. 74. Affiliated 26 June 1924 with the Garfield Memorial Hospital in Washington, DC. Initiated 17 January 1925 at Washington. Redesignated 74th General Hospital 29 March 1929. Relocated 11 December 1929 to Hagerstown, MD. Relocated 4 December 1933 to Washington, DC. Inactivated by June 1939 at Washington by relief of personnel. Location 7 December 1941—*Inactive*.

Status: Inactive in the U.S. Army Reserve as the 74th General Hospital.

Commanders, 74th General Hospital

Col. Luther H. Reichelderfer	17 Jan 25-8 Sep 26	Lt. Col. Llewellyn Powell	9 Sep 29-6 Feb 30
Lt. Col. Harry H. Kerr	8 Sep 26-9 Dec 26	Col. Thaddeus S. Troy	6 Feb 30-5 Feb 32
Lt. Col. Frank Leech	9 Dec 26-1 May 29	Lt. Col. Llewellyn Powell	5 Feb 32-ao Jun 34
Maj. William C. Stirling	1 May 29-9 Sep 29	Unknown	ao Jun 34-ao Jun 39
	<i>Inactive</i>	ao Jun 39-7 Dec 41	

75th General Hospital (Z.I.)

Organized Reserve District of Columbia

HQ-Not initiated 1923-25; Washington, DC, 1925-29; Pittsburgh, PA, 1929-39; *Inactive* 1939-40; Pittsburgh, PA, 1940-41

Constituted in the Organized Reserve 2 July 1923, assigned to the Zone of the Interior, and allotted to the Third Corps Area. Designated 12 September 1923 as General Hospital No. 75. Affiliated 29 September 1923 with the George Washington University Hospital in Washington, DC. Initiated 17 January 1925 at Washington. Redesignated 75th General Hospital 29 March 1929. Relocated 11 December 1929 to Pittsburgh, PA. Withdrawn from the Organized Reserve 1 October 1933 and allotted to the Regular Army. Concurrently relieved from the Zone of the Interior and assigned to the General Headquarters Reserve. Inactivated by June 1939 at Pittsburgh by relief of personnel. Reorganized by June 1940 at Pittsburgh. Location 7 December 1941—Pittsburgh, PA.

Status: Inactive in the Regular Army as the 347th Station Hospital.

Commanders, 75th General Hospital

Lt. Col. William J. Mallory	17 Jan 25-1 Jul 29	Unknown	ao Jan 33-ao Jun 34
Lt. Col. Daniel L. Bordon	1 Jul 29-ao Sep 29	Lt. Col. Samuel A. Baltz**	ao Jun 34-ao Jun 38
Unknown	ao Sep 29-ao Jun 30	<i>Inactive</i>	ao Jun 39-ao Jun 40
Col. Thomas W. Grayson	20 Jun 31-ao Jan 33	Unknown	ao Jun 40-7 Dec 41

** RAI Commanders: Organized Reserve officers.

76th General Hospital (Z.I.)

Organized Reserve New York

HQ-Not initiated 1923-25; New York City, NY, 1925-41



Constituted in the Organized Reserve 2 July 1923, assigned to the Zone of the Interior, and allotted to the Second Corps Area. Designated 12 September 1923 as General Hospital No. 76. Affiliated 23 November 1923 with the Lebanon Hospital in New York City, NY. Initiated 7 October 1925 at New York City. Redesignated 76th General Hospital 29 March 1929. Consolidated 23 November 1923 with Base Hospital No. 76 (a WWI unit organized 4 June 1918 at Greenleaf General Hospital, Fort Oglethorpe, GA; demobilized 18 May 1919 at Camp Dix, NJ; reconstituted 23 November 1923). Conducted summer training at Carlisle Barracks, PA. Location 7 December 1941—New York City, NY.

Status: Inactive in the U.S. Army Reserve as the 331st General Hospital.

Commanders, 76th General Hospital

Col. Lipman M. Kahn	7 Oct 25-ao Jun 27	Col. Jerome Kingsbury	15 Aug 31-23 Nov 33
Unknown	ao Jun 27-10 Jun 30	Lt. Col. Philip J. Lipsett	23 Nov 33-18 Oct 35
Lt. Col. Philip J. Lipsett	10 Jun 30-15 Aug 31	Lt. Col. Edgar W. White	5 Dec 35-28 May 38
	Maj. Theodore Rosenthal	28 May 38-ao Jan 41	

77th General Hospital (Z.I.)

Organized Reserve New York

HQ-*Not initiated* 1923-25; Brooklyn, NY, 1925-41

Constituted in the Organized Reserve 2 July 1923, assigned to the Zone of the Interior, and allotted to the Second Corps Area. Designated 12 September 1923 as General Hospital No. 77. Affiliated 23 November 1923 with the Jewish Hospital in Brooklyn, NY. Initiated 24 March 1925 at Brooklyn. Redesignated 77th General Hospital 29 March 1929. Inactivated 13 November 1929 at Brooklyn by relief of personnel. Reorganized 16 June 1939 at Brooklyn. Primary R.O.T.C. feeder school was the Cornell University Medical School. Location 7 December 1941—Brooklyn, NY.

Status: Disbanded 10 June 1943.

Commanders, 77th General Hospital

1st Lt. Abraham H. Salzborg	24 Mar 25-7 Oct 25	<i>Inactive</i>	13 Nov 29-16 Jun 39
Lt. Col. John E. Daugherty	7 Oct 25-13 Nov 29	Col. Robert M. Rogers	16 Jun 39-ao Jun 41

78th General Hospital (Z.I.)

Organized Reserve New Jersey

HQ-*Not initiated* 1923-25; Newark, NJ, 1925-41

Constituted in the Organized Reserve 2 July 1923, assigned to the Zone of the Interior, and allotted to the Second Corps Area. Designated 12 September 1923 as General Hospital No. 78. Affiliated 19 February 1924 with the Newark City Hospital in Newark, NJ. Initiated 13 January 1925 at Newark. Redesignated 78th General Hospital 29 March 1929. Consolidated 11 November 1936 with Base Hospital No. 78 (a WWI unit organized in June 1918 at Greenleaf General Hospital, Fort Oglethorpe, GA; demobilized 6 June 1919 at Camp Dix, NJ; reconstituted 11 November 1936). Conducted summer training at Carlisle Barracks, PA. Location 7 December 1941—Newark, NJ.

Status: Inactive in the U.S. Army Reserve as the 348th Station Hospital.

Commanders, 78th General Hospital

Maj. Philip G. Hood	13 Jan 25-16 Oct 25	Lt. Col. Robert R. Reed	16 Oct 34-29 Dec 34
Col. Harrison S. Hartland	16 Oct 25-16 Oct 34	Unknown	29 Dec 34-7 Dec 41

79th General Hospital (Z.I.)

Organized Reserve New York

HQ-*Not initiated* 1923-25; Brooklyn, NY, 1925-30; *Inactive* 1930-34; Brooklyn, NY, 1934-41

Constituted in the Organized Reserve 2 July 1923, assigned to the Zone of the Interior, and allotted to the Second Corps Area. Designated 12 September 1923 as General Hospital No. 79. Affiliated 2 May 1924 with the Long Island College Hospital in Brooklyn, NY. Initiated by May 1925 at Brooklyn. Redesignated 79th General Hospital 29 March

1929. Inactivated in March 1930 at Brooklyn by relief of personnel. Reorganized 17 December 1934 at Brooklyn. Consolidated 11 November 1936 with Base Hospital No. 79 (a WWI unit organized in June 1918 at Greenleaf General Hospital, Fort Oglethorpe, GA; demobilized 12 July 1919 at Camp Upton, NY; reconstituted 11 November 1936). Location 7 December 1941—Brooklyn, NY.

Status: Inactive in the U.S. Army Reserve as the 79th General Hospital.

Commanders, 79th General Hospital

Col. Sheridan H. Baketel <i>Inactive</i>	May 25-Mar 30 Mar 30-17 Dec 34	Maj. John L. Haskins Lt. Col. Melvin E. Herzfeld	17 Dec 34-11 Dec 36 11 Dec 36-ao Jan 41
---	-----------------------------------	---	--

80th General Hospital (Z.I.)

Organized Reserve New York

HQ-*Not initiated* 1923-27; Brooklyn, NY, 1927; *Inactive* 1927-41

Constituted in the Organized Reserve 2 July 1923, assigned to the Zone of the Interior, and allotted to the Second Corps Area. Designated 12 September 1923 as General Hospital No. 80. Affiliated 6 June 1924 with the Cornell University Medical College in New York City, NY. Initiated 19 May 1927 at Brooklyn, NY. Inactivated in June 1927. Redesignated 80th General Hospital 29 March 1929. Consolidated 11 November 1936 with Base Hospital No. 80 (a WWI unit organized in June 1918 at Greenleaf General Hospital, Fort Oglethorpe, GA; demobilized in May 1919 at Camp Upton, NY; reconstituted 11 November 1936). Location 7 December 1941—*Inactive*.

Status: Inactive in the U.S. Army Reserve as the 336th General Hospital.

Commanders, 80th General Hospital

Col. Junius H. McHenry	19 May 27-Jun 27	<i>Inactive</i>	Jun 27-7 Jun 41
------------------------	------------------	-----------------	-----------------

81st General Hospital (Z.I.)

Organized Reserve New York

HQ-*Not initiated* 1923-26; New York City, NY, 1926-38; *Inactive* 1938-41

Constituted in the Organized Reserve 2 July 1923, assigned to the Zone of the Interior, and allotted to the Second Corps Area. Designated 12 September 1923 as General Hospital No. 81. Affiliated 10 September 1924 with the 5th Avenue Hospital in New York City, NY. Initiated in June 1926 at New York City, NY. Redesignated 81st General Hospital 29 March 1929. Consolidated 11 November 1936 with Base Hospital No. 81 (a WWI unit organized in February 1918 at Fort Riley, KS; demobilized 24 June 1919 at Camp Dodge, IA; reconstituted 11 November 1936). Inactivated by June 1938 at New York City by relief of personnel. Location 7 December 1941—*Inactive*.

Status: Inactive in the U.S. Army Reserve as the 338th General Hospital.

Commanders, 81st General Hospital

Unknown	Jun 26-6 Jan 27	Lt. Col. Will L. Wood	7 Oct 35-ao Nov 36
Col. William F. Honan	6 Jan 27-7 Oct 35 <i>Inactive</i>	Unknown ao Jun 38-7 Dec 41	ao Nov 36-ao Jun 38

82nd General Hospital (Z.I.)

Organized Reserve New York

HQ-*Not initiated* 1923-25; Brooklyn, NY, 1925-41

Constituted in the Organized Reserve 2 July 1923 as General Hospital No. 82, assigned to the Zone of the Interior, and allotted to the Second Corps Area. Initiated 20 March 1925 at Brooklyn, NY. Redesignated 82nd General Hospital 29 March 1929. Consolidated 18 November 1936 with Base Hospital No. 82 (a WWI unit organized in April 1918 at Fort Riley, KS; demobilized 14 June 1919 at Camp Devens, MA; reconstituted 18 November 1936). Conducted summer training at Carlisle Barracks, PA. Location 7 December 1941—Brooklyn, NY.

Status: Inactive in the U.S. Army Reserve as the 343rd General Hospital.

Commanders, 82nd General Hospital

Maj. Frederick P. Hammond	20 Mar 25-11 Apr 25	Col. John M. Swan	16 Oct 25-4 Mar 30
Lt. Col. Walter M. Brickner	11 Apr 25-16 Oct 25	Col. Edward W. Pinkham	4 Mar 30-22 Oct 34
	Col. John L. Kantor	22 Oct 34-ao Jun 41	

83rd General Hospital (Z.I.)

Organized Reserve New York

HQ-*Not initiated* 1923-25; Brooklyn, NY, 1925-38; *Inactive* 1938-41

Constituted in the Organized Reserve 2 July 1923, assigned to the Zone of the Interior, and allotted to the Second Corps Area. Designated 12 September 1923 as General Hospital No. 83. Affiliated 2 April 1925 with the Brooklyn Hospital in Brooklyn, NY. Initiated 9 April 1925 at Brooklyn, NY. Redesignated 83rd General Hospital 29 March 1929. Inactivated 4 March 1930 at Brooklyn by relief of personnel. Consolidated 18 November 1936 with Base Hospital No. 83 (a WWI unit organized in April 1918 at Fort Riley, KS; demobilized 3 May 1919 at Camp Dix, NJ; reconstituted 18 November 1936). Location 7 December 1941—*Inactive*.

Status: Active in the U.S. Army Reserve as the 344th Combat Support Hospital at Flushing, NY.

Commanders, 83rd General Hospital

Col. Walter A. Sherwood	9 Apr 25-4 Mar 30	<i>Inactive</i>	4 Mar 30-7 Dec 41
-------------------------	-------------------	-----------------	-------------------

84th General Hospital (Z.I.)

Organized Reserve New Jersey

HQ-*Not initiated* 1923-25; Elizabeth, NJ, 1925-30; *Inactive* 1930-41

Constituted in the Organized Reserve 2 July 1923, assigned to the Zone of the Interior, and allotted to the Second Corps Area. Designated 12 September 1923 as General Hospital No. 84. Affiliated 22 August 1924 with the Elizabeth General Hospital and Dispensary in Elizabeth, NJ. Initiated 3 February 1925 at Elizabeth, NJ. Redesignated 84th General Hospital 29 March 1929. Consolidated 18 November 1936 with Base Hospital No. 84 (a WWI unit organized in April 1918 at Fort Riley, KS; demobilized 12 July 1919 at Camp Bowie, TX; reconstituted 18 November 1936). Inactivated 18 December 1930 at Elizabeth by relief of personnel. Location 7 December 1941—*Inactive*.

Status: Inactive in the U.S. Army Reserve as the 156th General Hospital.

Commanders, 84th General Hospital

Maj. Rocco M. Nittoll	3 Feb 25-16 Oct 25	Unknown	ao Jun 27-18 Dec 30
Col. Charles H. Schlichter	16 Oct 25-ao Jun 27	<i>Inactive</i>	18 Dec 30-7 Dec 41

85th General Hospital (Z.I.)

Organized Reserve Pennsylvania

HQ-*Not initiated* 1923-25; Pittsburgh, PA, 1925-29; Philadelphia, PA, 1929-38; *Inactive* 1938-40; Philadelphia, PA, 1940-41

Constituted in the Organized Reserve 2 July 1923, assigned to the Zone of the Interior, and allotted to the Third Corps Area. Designated 12 September 1923 as General Hospital No. 85. Initiated 12 January 1925 at Pittsburgh, PA. Redesignated 85th General Hospital 29 March 1929. Relocated 11 December 1929 to Philadelphia, PA. Consolidated 18 November 1936 with Base Hospital No. 85 (a WWI unit organized in April 1918 at Fort Riley, KS; demobilized 25 July 1919 at Camp Upton, NY; reconstituted 18 November 1936). Inactivated 6 June 1938 at Philadelphia by relief of personnel. Reorganized 11 September 1940 at Philadelphia. Location 7 December 1941—Philadelphia, PA.

Status: Inactive in the U.S. Army Reserve as the 356th General Hospital.

Commanders, 85th General Hospital

Maj. Samuel E. Lambert	12 Jan 25-24 Jan 25	Unknown	14 May 31-20 Jun 31
Lt. Col. Howard G. Schleiter	24 Jan 25-ao Sep 25	Col. Roscoe L. Perkins	20 Jun 31-6 Jun 38
Col. John A. Murphy	ao Dec 25-11 Sep 29	<i>Inactive</i>	6 Jun 38-11 Sep 40
Lt. Col. David Reisman	11 Sep 29-14 May 31	Maj. Sidney H. Goldman	11 Sep 40-7 Aug 41

86th General Hospital (Z.I.)**Organized Reserve District of Columbia****HQ-Not initiated** 1923-25; Washington, DC, 1925-38; *Inactive* 1938-40; Washington, DC, 1940-41

Constituted in the Organized Reserve 2 July 1923, assigned to the Zone of the Interior, and allotted to the Third Corps Area. Designated 12 September 1923 as General Hospital No. 86. Initiated 17 January 1925 at Washington, DC. Redesignated 86th General Hospital 29 March 1929. Consolidated 18 November 1936 with Base Hospital No. 86 (a WWI unit organized in April 1918 at Fort Riley, KS; demobilized in May 1919 at Camp Dix, NJ; reconstituted 18 November 1936). Inactivated 7 September 1938 at Washington by relief of personnel. Reorganized by June 1940 at Washington. Location 7 December 1941—Washington, DC.

Status: Disbanded 10 June 1943.**Commanders, 86th General Hospital**

Maj. Roland H. Ford	17 Jan 25-24 Jan 25	Lt. Col. William H. Herr	ao Jun 31-27 Feb 32
Col. Henry C. Maddux	24 Jan 25-10 Jan 29	Maj. William C. Stirling	27 Feb 32-ao Jan 35
Lt. Col. Edgar A. Bocock	10 Jan 29-ao Jun 30	Unknown	ao Jan 35-7 Sep 38
Unknown	ao Jun 30-ao Jun 31	<i>Inactive</i>	7 Sep 38-ao Jun 40
	Unknown	ao Jun 40-7 Dec 41	

87th General Hospital (Z.I.)**Organized Reserve Louisiana****HQ-Not initiated** 1923-26; New Orleans, LA, 1926-41

Constituted in the Organized Reserve 2 July 1923, assigned to the Zone of the Interior, and allotted to the Fourth Corps Area. Designated 12 September 1923 as General Hospital No. 87. Affiliated 27 March 1924 with the Charity Hospital in New Orleans, LA. Initiated by June 1926 at New Orleans. Redesignated 87th General Hospital 29 March 1929. Consolidated 18 November 1936 with Base Hospital No. 87 (a WWI unit organized in April 1918 at Fort Riley, KS; demobilized 23 June 1919 at Camp Funston, KS; reconstituted 18 November 1936). Location 7 December 1941—New Orleans, LA.

Status: Disbanded 1 June 1943.**Commanders, 87th General Hospital**

Maj. Cornelius P. Munday	ao Jun 26-ao Jul 26	Lt. Col. Jacob W. Kennedy	12 Apr 30-16 Feb 32
Col. John B. Elliott	ao Jun 27-ao Jul 27	Col. Duke C. Bradford	16 Feb 32-14 Dec 35
Unknown	ao Jul 27-12 Sep 29	Lt. Col. Orren P. Goodwin	14 Dec 35-6 Sep 36
Lt. Col. William J. Lancaster	12 Sep 29-22 Oct 29	Unknown	6 Sep 36-7 Dec 41

88th General Hospital (Z.I.)**Organized Reserve South Carolina****HQ-Not initiated** 1923-27; Columbia, SC, 1927-41

Constituted in the Organized Reserve 2 July 1923, assigned to the Zone of the Interior, and allotted to the Fourth Corps Area. Designated 12 September 1923 as General Hospital No. 88. Affiliated 22 August 1924 with the Columbia Hospital of Richmond County in Columbia, SC. Initiated by June 1927 at Columbia. Redesignated 88th General Hospital 29 March 1929. Consolidated 18 November 1936 with Base Hospital No. 88 (a WWI unit organized in April 1918 at Fort Riley, KS; demobilized 30 July 1919 at Camp Dodge, IA; reconstituted 18 November 1936). Location 7 December 1941—Columbia, SC.

Commanders, 88th General Hospital

Lt. Col. William Weston	ao Jun 27-Jul 29	Col. Erin E. Epting	Nov 31-6 Sep 36
Lt. Col. Robert E. Seibel	12 Sep 29-5 Nov 29	Col. Floyd D. Rogers	20 Dec 36-ao Sep 40
Lt. Col. William C. O'Driscoll	1 Mar 30-Nov 31	Unknown	ao Sep 40-7 Dec 41

89th General Hospital (Z.I.)**Organized Reserve Tennessee****HQ-Not initiated** 1923-27; Chattanooga, TN, 1927-41

Constituted in the Organized Reserve 2 July 1923, assigned to the Zone of the Interior, and allotted to the Fourth Corps Area. Designated 12 September 1923 as General Hospital No. 89. Initiated by June 1927 at Chattanooga, TN. Redesignated 89th General Hospital 29 March 1929. Consolidated 18 November 1936 with Base Hospital No. 89 (a WWI unit organized in April 1918 at Fort Riley, KS; demobilized 12 July 1919 at Camp Dix, NJ; reconstituted 18 November 1936). Location 7 December 1941—Chattanooga, TN.

Status: Disbanded 11 November 1944.

Commanders, 89th General Hospital

Lt. Col. William A. Carnes	ao Jun 27-Mar 30	Col. Emmett M. Harrison	ao Jun 32-ao Aug 39
Lt. Col. Duncan P. Dixon	Mar 30-10 Dec 30	Unknown	ao Aug 39-ao Sep 40
Lt. Col. Jesse C. Eldridge	10 Dec 30-ao Jan 31	Lt. Col. Jesse C. Eldridge	ao Sep 40-ao Jan 41
Unknown	ao Jan 31-ao Jun 32	Unknown	ao Jan 41-7 Dec 41

90th General Hospital (Z.I.)

Organized Reserve Georgia

HQ-*Not initiated* 1923-25; Atlanta, GA, 1925-41

Constituted in the Organized Reserve 2 July 1923, assigned to the Zone of the Interior, and allotted to the Fourth Corps Area. Designated 12 September 1923 as General Hospital No. 90. Initiated 8 May 1925 at Atlanta, GA. Redesignated 90th General Hospital 29 March 1929. Location 7 December 1941—Atlanta, GA.

Status: Active in the U.S. Army Reserve as the 337th Combat Support Hospital at Indianapolis, IN.

Commanders, 90th General Hospital

Maj. Orion O. Feaster	8 May 25-ao Jun 25	Lt. Col. William C. Thomas	12 Sep 29-Nov 31
Unknown	ao Jun 25-ao Jun 27	Col. Lee W. Wiggins	Nov 31-21 Jun 32
Col. Percy O. Chaudron	ao Jun 27-12 Feb 29	Lt. Col. James W. Crum	21 Jun 32-14 Mar 33
Lt. Col. William B. Crawford	12 Feb 29-Jul 29	Col. Lee W. Wiggins	14 Mar 33-ao Sep 40
	Unknown	ao Sep 40-7 Dec 41	

91st General Hospital (Z.I.)

Organized Reserve Georgia

HQ-*Not initiated* 1923-25; Atlanta, GA, 1925-36; *Inactive* 1936-41

Constituted in the Organized Reserve 2 July 1923, assigned to the Zone of the Interior, and allotted to the Fourth Corps Area. Designated 12 September 1923 as General Hospital No. 91. Initiated 8 May 1925 at Atlanta, GA. Redesignated 91st General Hospital 29 March 1929. Inactivated 20 December 1936 at Omaha by relief of personnel. Location 7 December 1941—*Inactive*.

Status: Inactive in the U.S. Army Reserve as the 355th General Hospital.

Commanders, 91st General Hospital

Lt. Col. William E. Howell	8 May 25-ao Jun 25	Lt. Col. Will L. Wood	8 Nov 30-Nov 31
Unknown	ao Jun 25-ao Jun 27	Col. James E. Daniel	Nov 31-14 Dec 34
Lt. Col. Thomas C. Davison	ao Jun 27-10 Mar 28	Col. James W. Crum	22 Dec 34-6 Sep 36
Unknown	10 Mar 28-12 Sep 29	Lt. Col. Laurie J. Arnold	6 Sep 36-20 Dec 36
Lt. Col. William E. Howell	12 Sep 29-8 Nov 30	<i>Inactive</i>	20 Dec 36-7 Dec 41

92nd General Hospital (Z.I.)

Organized Reserve Alabama

HQ-*Not initiated* 1923-25; Birmingham, AL, 1925-41

Constituted in the Organized Reserve 2 July 1923, assigned to the Zone of the Interior, and allotted to the Fourth Corps Area. Designated 12 September 1923 as General Hospital No. 92. Initiated 8 May 1925 at Birmingham, AL. Redesignated 92nd General Hospital 29 March 1929. Location 7 December 1941—Birmingham, AL.

Status: Disbanded 10 June 1943.

Commanders, 92nd General Hospital

Maj. Jesse M. Barfield	8 May 25-ao Jun 25	Lt. Col. Julius B. Cooper	8 May 34-9 Oct 34
Unknown	ao Jun 25-ao Jun 27	Lt. Col. James S. Hough	9 Oct 34-6 Sep 36
Col. John W. Barksdale	ao Jun 27-ao Nov 33	Unknown	6 Sep 36-7 Dec 41

93rd General Hospital (Z.I.)**Organized Reserve Alabama****HQ-Not initiated** 1923-26; Birmingham, AL, 1926-41

Constituted in the Organized Reserve 2 July 1923, assigned to the Zone of the Interior, and allotted to the Fourth Corps Area. Designated 12 September 1923 as General Hospital No. 93. Initiated by June 1926 at Birmingham, AL. Redesignated 93rd General Hospital 29 March 1929. Consolidated 18 November 1936 with Base Hospital No. 93 (a WWI unit organized 15 July 1918 at Camp Lewis, WA; demobilized 30 June 1919 at Camp Lewis; reconstituted 18 November 1936). Location 7 December 1941—Birmingham, AL.

Status: Active in the U.S. Army Reserve as the 339th Combat Support Hospital at Oakdale, PA.**Commanders, 93rd General Hospital**

Maj. Duncan P. Dixon	ao Jun 26-ao Sep 26	Col. Ross L. Speir	Feb 31-14 Dec 35
Col. Hamilton P. Jones	ao Jun 27-5 Dec 27	Col. Duke C. Bradford	14 Dec 35-ao Sep 40
Lt. Col. Byron S. Bruce	12 Sep 29-Feb 31	Unknown	ao Sep 40-7 Dec 41

94th General Hospital (Z.I.)**Organized Reserve Tennessee****HQ-Not initiated** 1923-24; Memphis, TN, 1924-41

Constituted in the Organized Reserve 2 July 1923, assigned to the Zone of the Interior, and allotted to the Fourth Corps Area. Designated 12 September 1923 as General Hospital No. 94. Initiated in November 1924 at Memphis, TN. Redesignated 94th General Hospital 29 March 1929. Location 7 December 1941—Memphis, TN.

Status: Active in the U.S. Army Reserve as the 94th General Hospital at Mesquite, TX.**Commanders, 94th General Hospital**

Unknown	Nov 24-ao Jun 27	Unknown	ao Jun 32-24 Aug 35
Col. Edward C. Mitchell	ao Jun 27-ao Jun 32	Lt. Col. Harry C. Schmeisser	24 Aug 35-ao Sep 40
	Unknown	ao Sep 40-7 Dec 41	

95th General Hospital (Z.I.)**Organized Reserve South Carolina****HQ-Not initiated** 1923-26; Columbia, SC, 1926-36; *Inactive* 1936-41

Constituted in the Organized Reserve 2 July 1923, assigned to the Zone of the Interior, and allotted to the Fourth Corps Area. Designated 12 September 1923 as General Hospital No. 95. Initiated by February 1926 at Columbia, SC. Redesignated 95th General Hospital 29 March 1929. Inactivated 20 December 1936 at Columbia by relief of personnel. Location 7 December 1941—*Inactive*.

Status: Inactive in the U.S. Army Reserve as the 347th General Hospital.**Commanders, 95th General Hospital**

Col. John W. MacConnell	Feb 26-22 Oct 29	Col. Floyd D. Rogers	Sep 31-20 Dec 36
Lt. Col. James W. Davis	22 Oct 29-Sep 31	<i>Inactive</i>	20 Dec 36-7 Dec 41

96th General Hospital (Z.I.)**Organized Reserve South Carolina****HQ-Not initiated** 1923-27; Greenville, SC, 1927-41

Constituted in the Organized Reserve 2 July 1923, assigned to the Zone of the Interior, and allotted to the Fourth Corps Area. Designated 12 September 1923 as General Hospital No. 96. Initiated by June 1927 at Greenville, SC. Redesignated 96th General Hospital 29 March 1929. Location 7 December 1941—Greenville, SC.

Status: Active in the U.S. Army Reserve as the 324th Combat Support Hospital at Perrine, FL.

Commanders, 96th General Hospital

Col. Curran B. Earle	ao Jun 27-21 Apr 34	Lt. Col. Walter H. Powe	9 Oct 34-24 Aug 35
Lt. Col. Neil E. Funk	21 Apr 34-9 Oct 34	Col. John D. Smyser	24 Aug 35-ao Jan 36
	Unknown	ao Jan 36-7 Dec 41	

97th General Hospital (Z.I.)

Organized Reserve North Carolina/Florida

HQ-Not initiated 1923-27; Greensboro, NC, 1927-35; St. Petersburg, FL, 1935-41

Constituted in the Organized Reserve 2 July 1923, assigned to the Zone of the Interior, and allotted to the Fourth Corps Area. Designated 12 September 1923 as General Hospital No. 97. Initiated by June 1927 at Greensboro, NC. Redesignated 97th General Hospital 29 March 1929. Relocated 24 January 1935 to St. Petersburg, FL. Typically conducted Inactive Training Period meetings at the Power & Light Building in St. Petersburg. Location 7 December 1941—St. Petersburg, FL.

Status: Inactive in the Regular Army as the 97th General Hospital.

Commanders, 97th General Hospital

Lt. Col. Otis H. Johnson	ao Jun 27-ao Sep 27	Col. James W. Davis	9 Oct 34-22 Jan 35
Unknown	ao Sep 27-ao Mar 30	Col. Linwood M. Gable	14 Feb 35-ao Sep 40
Lt. Col. Lyman A. Burnside	Mar 30-9 Oct 34	Unknown	ao Sep 40-7 Dec 41

98th General Hospital (Z.I.)

Organized Reserve Alabama

HQ-Not initiated 1923-25; Birmingham, AL, 1925-40; New Orleans, LA, 1940; Birmingham, AL, 1940-41

Constituted in the Organized Reserve 2 July 1923, assigned to the Zone of the Interior, and allotted to the Fourth Corps Area. Designated 12 September 1923 as General Hospital No. 98. Initiated 20 February 1925 at Birmingham, AL. Redesignated 98th General Hospital 29 March 1929. Relocated 1 April 1940 to New Orleans, LA. Relocated 24 October 1940 to Birmingham. Location 7 December 1941—Birmingham, AL.

Status: Inactive in the Regular Army as the 98th General Hospital.

Commanders, 98th General Hospital

Lt. Col. Bernard H. Booth	20 Feb 25-ao Jun 25	Col. Hardie Hays	8 Nov 30-ao Jul 32
Unknown	ao Jun 25-ao Jun 27	Unknown	ao Jul 32-ao Aug 37
Col. Edward C. Ellett	ao Jun 27-8 Nov 30	Col. Robert F. Ashworth	ao Aug 37-ao Sep 40
	Unknown	ao Sep 40-7 Dec 41	

99th General Hospital (Z.I.)

Organized Reserve Ohio

HQ-Not initiated 1923-27; Columbus, OH, 1927-41

Constituted in the Organized Reserve 2 July 1923, assigned to the Zone of the Interior, and allotted to the Fourth Corps Area. Designated 12 September 1923 as General Hospital No. 99. Affiliated 11 December 1923 with the Ohio State University College of Medicine in Columbus, OH. Initiated by June 1927 at Columbus, OH. Redesignated 99th General Hospital 29 March 1929. Consolidated 18 November 1936 with Base Hospital No. 99 (a WWI unit organized 21 August 1918 at Camp Custer, MI; demobilized 27 June 1919 at Camp Custer; reconstituted 18 November 1936). Location 7 December 1941—Columbus, OH.

Status: Active in the U.S. Army Reserve as the 330th Combat Support Hospital at Millington, TN.

Commanders, 99th General Hospital

Col. James S. Wilson	ao Jun 27-11 May 28	Unknown	Oct 29-Jan 30
Lt. Col. Elijah J. Gordon	11 May 28-Oct 29	Col. Edward D. Sinks	Jan 30-ao Jun 34
	Unknown	ao Jun 34-7 Dec 41	

100th General Hospital (Z.I.)

Organized Reserve Kentucky

HQ-*Not initiated* 1923-25; Louisville, KY, 1925-41

Constituted in the Organized Reserve 2 July 1923, assigned to the Zone of the Interior, and allotted to the Fifth Corps Area. Designated 12 September 1923 as General Hospital No. 100. Affiliated 26 May 1924 with the Saints Mary and Elizabeth Hospital in Louisville, KY. Initiated in April 1925 at Louisville, KY. Redesignated 100th General Hospital 29 March 1929. Consolidated 23 November 1936 with Base Hospital No. 100 (a WWI unit organized in July 1918 at Camp Greenleaf, GA; demobilized in July 1919 at Camp Sherman, OH; reconstituted 23 November 1936). Location 7 December 1941—Louisville, KY.

Status: Inactive in the U.S. Army Reserve as the 100th General Hospital.

Commanders, 100th General Hospital

Col. Joseph G. Sherrill	Apr 25-ao Jul 29	Col. Lurty N. Harris	ao Jun 34-ao Jun 37
Unknown	ao Jul 29-ao Jun 34	Unknown	ao Jun 37-7 Dec 41

101st General Hospital (Z.I.)

Organized Reserve West Virginia

HQ-*Not initiated* 1923-24; Huntington, WV 1924-41

Constituted in the Organized Reserve 2 July 1923, assigned to the Zone of the Interior, and allotted to the Fifth Corps Area. Designated 12 September 1923 as General Hospital No. 101. Initiated 26 May 1924 at Huntington, WV. Redesignated 101st General Hospital 29 March 1929. Consolidated 23 November 1936 with Base Hospital No. 101 (a WWI unit organized 5 July 1917 at St. Nazaire, France; demobilized 14 July 1919 at Camp Dix, NJ; reconstituted 23 November 1936). Location 7 December 1941—Huntington, WV.

Status: Active in the U.S. Army Reserve as the 352nd General Hospital at Oakland, CA.

Commanders, 101st General Hospital

Unknown	26 May 24-Oct 26	Col. Charles A. Neal	Oct 26-ao Jul 35
	Unknown	ao Jun 35-7 Dec 41	

102nd General Hospital (Z.I.)

Organized Reserve Indiana

HQ-*Not initiated* 1923-24; Indianapolis, IN, 1924-34; Vincennes, IN, 1934-41; Indianapolis, IN, 1941

Constituted in the Organized Reserve 2 July 1923, assigned to the Zone of the Interior, and allotted to the Fifth Corps Area. Designated 12 September 1923 as General Hospital No. 102. Initiated in April 1924 at Indianapolis, IN. Redesignated 102nd General Hospital 29 March 1929. Withdrawn from the Organized Reserve 1 October 1933 and allotted to the Regular Army. Concurrently relieved from the Zone of the Interior and assigned to the General Headquarters Reserve. Relocated 22 March 1934 to Vincennes, IN. Consolidated 23 November 1936 with Base Hospital No. 102 (a WWI unit organized in February 1918 at San Juan, PR; demobilized 3 May 1919 at Camp Shelby, MS; reconstituted 23 November 1936). Relocated 6 November 1941 to Indianapolis. Conducted summer training at the station hospital, Fort Knox, KY. Location 7 December 1941—Indianapolis, IN.

Status: Inactive in the U.S. Army Reserve as the 354th General Hospital.

Commanders, 102nd General Hospital

Unknown	Apr 24-ao Apr 26	Lt. Col. John W. Sluss	Mar 31-Sep 31
Col. Dunning S. Wilson	ao Apr 26-ao Jun 27	Unknown	Sep 31-ao Jun 35
Unknown	ao Jun 27-ao Jan 29	Col. Thomas Dobbins**	ao Jun 35-ao Jul 38
Col. William K. Nisbet	ao Jan 29-Mar 31	Unknown	ao Jul 38-7 Dec 41

** RAI Commanders: Organized Reserve officers.

103rd General Hospital (Z.I.)**Organized Reserve Ohio****HQ-Not initiated** 1923-25; Cleveland, OH, 1925-41

Constituted in the Organized Reserve 2 July 1923, assigned to the Zone of the Interior, and allotted to the Fifth Corps Area. Designated 12 September 1923 as General Hospital No. 103. Initiated by September 1925 at Cleveland, OH. Redesignated 103rd General Hospital 29 March 1929. Location 7 December 1941—Cleveland, OH.

Status: Inactive in the U.S. Army Reserve as the 361st General Hospital.**Commanders, 103rd General Hospital**

Col. John C. Darby	Sep 25-Jul 29	Unknown	ao Mar 32-ao Mar 37
Col. Charles H. MacFarland	Jul 29-Jan 32	Maj. A.A. Southwick	ao Mar 37-ao Jul 37
Col. Frederick C. Herrick	Feb 32-ao Mar 32	Unknown	ao Mar 32-7 Dec 41

104th General Hospital (Z.I.)**Organized Reserve Ohio****HQ-Not initiated** 1923-26; Cincinnati, OH, 1926-33; Dayton, OH, 1933-41

Constituted in the Organized Reserve 2 July 1923, assigned to the Zone of the Interior, and allotted to the Fifth Corps Area. Designated 12 September 1923 as General Hospital No. 104. Initiated by March 1926 at, and affiliated with, the Good Samaritan Hospital in Cincinnati, OH. Redesignated 104th General Hospital 29 March 1929. Relocated 21 January 1933 to Dayton, OH. Location 7 December 1941—Dayton, OH.

Status: Inactive in the U.S. Army Reserve as the 451st General Hospital.**Commanders, 104th General Hospital**

Lt. Col. Joseph E. Pirrung	ao Mar 26-Oct 29	Lt. Col. Howard F. Schell	Apr 30-ao May 30
	Unknown	ao May 30-7 Dec 41	

105th General Hospital (Z.I.)**Organized Reserve Indiana****HQ-Not initiated** 1923-26; Fort Benjamin Harrison, IN, 1926-33; Muncie, IN, 1933-41

Constituted in the Organized Reserve 2 July 1923, assigned to the Zone of the Interior, and allotted to the Fifth Corps Area. Designated 12 September 1923 as General Hospital No. 105. Initiated by September 1926 at Fort Benjamin Harrison, IN. Redesignated 105th General Hospital 29 March 1929. Withdrawn from the Organized Reserve 1 October 1933 and allotted to the Regular Army. Concurrently relieved from the Zone of the Interior and assigned to the General Headquarters Reserve. Relocated 21 December 1933 to Muncie, IN. Conducted summer training at the station hospital, Fort Knox, KY. Location 7 December 1941—Muncie, IN.

Status: Inactive in the U.S. Army Reserve as the 105th General Hospital.**Commanders, 105th General Hospital**

Unknown	ao Sep 26-Feb 27	Lt. Col. Walter M. Stout**	ao Jul 37-ao Aug 37
Col. Willard G. Stoner	Feb 27-Mar 27	Unknown	ao Aug 37-ao Mar 38
Lt. Col. William H. Lane	Mar 27-ao Apr 27	Col. Perry C. Travers**	ao Mar 38-ao Apr 38
Unknown	ao Apr 27-ao Jul 37	Unknown	ao Apr 38-7 Dec 41

** RAI Commanders: Organized Reserve officers.

106th General Hospital (Z.I.)**Organized Reserve Kentucky/Ohio****HQ-Not initiated** 1923-27; Cleveland, OH, 1927-41

Constituted in the Organized Reserve 2 July 1923, assigned to the Zone of the Interior, and allotted to the Fifth Corps Area. Designated 12 September 1923 as General Hospital No. 106. Camp Knox, KY, designated as headquarters on organization, but the unit was never organized at that location. Affiliated 29 May 1926 with the Mount Sinai Hospital in Cleveland, OH. Initiated by June 1927 at Cleveland, OH. Redesignated 106th General Hospital 29 March 1929. Location 7 December 1941—Cleveland, OH.

Status: Disbanded 30 January 1942.

Commanders, 106th General Hospital

1st Lt. Frank C. Beck	ao Jun 27-ao Jul 27	Unknown	ao Mar 32-ao Mar 37
Unknown	ao Jul 27-ao Jan 32	Maj. Rudolph S. Reich	ao Mar 37-ao Jul 37
Col. Charles H. MacFarland	Jan 32-ao Feb 32	Unknown	ao Mar 32-7 Dec 41

107th General Hospital (Z.I.)

Organized Reserve Illinois

HQ-*Not initiated* 1923-24; Chicago, IL, 1924-41

Constituted in the Organized Reserve 2 July 1923, assigned to the Zone of the Interior, and allotted to the Sixth Corps Area. Designated 12 September 1923 as General Hospital No. 107. Affiliated 22 January 1924 with Cook County Hospital in Chicago, IL. Initiated about November 1924 at Chicago. Mobilization assignment in 1925 was to reinforce Lovell General Hospital. Redesignated 107th General Hospital 29 March 1929. Conducted summer training at the station hospitals at Fort Snelling, MN, or Fort Sheridan, IL. Location 7 December 1941—Chicago, IL.

Status: Inactive in the U.S. Army Reserve as the 364th General Hospital.

Commanders, 107th General Hospital

Unknown	Nov 24-11 Mar 25	Maj. Raymond W. McNealy	ao May 31-ao Jun 33
Maj. Charles E. Riesling	11 Mar 25-ao Apr 25	Unknown	ao Jun 33-ao Jun 36
Maj. Karl A. Meyer	ao Aug 25-ao Jun 29	Lt. Col. John Favill	ao Jun 36-12 Oct 36
Unknown	ao Jun 29-ao May 31	Col. Henry W. Lang	12 Oct 36-ao Jan 40
	Unknown	ao Jan 40-7 Dec 41	

108th General Hospital (Z.I.)

Organized Reserve Illinois

HQ-*Not initiated* 1923-24; Chicago, IL, 1924-41



Constituted in the Organized Reserve 2 July 1923, assigned to the Zone of the Interior, and allotted to the Sixth Corps Area. Designated 12 September 1923 as General Hospital No. 108. Affiliated 28 January 1924 with Mercy Hospital in Chicago, IL. Initiated by December 1924 at Chicago. Redesignated 108th General Hospital 29 March 1929. Mobilization assignment in 1929 was to reinforce Greenleaf General Hospital. Consolidated 6 August 1931 with Base Hospital No. 108 (a WWI unit organized in August 1918 at Camp Greenleaf, GA; demobilized 10 July 1919 at Camp Dodge, IA; reconstituted 6 August 1931). Affiliation changed in 1938 to Loyola

University Hospital in Chicago. Conducted summer training at the station hospitals at Fort Snelling, MN, Fort Sheridan, IL, or Camp Custer, MI. Location 7 December 1941—Chicago, IL.

Status: Inactive in the U. S. Army Reserve as the 108th General Hospital.

Commanders, 108th General Hospital

Maj. Ellsworth Orton	ao Dec 24-1 Apr 25	Maj. Benjamin B. Beeson	12 May 25-ao Jun 27
Maj. Robert S. Berghoff	1 Apr 25-12 May 25	Unknown	ao Jun 27-ao Jun 28
	Col. George T. Jordan	ao Jun 28-Sep 42	

109th General Hospital (Z.I.)

Organized Reserve Wisconsin

HQ-*Not initiated* 1923-24; Milwaukee, WI, 1924-38; *Inactive* 1938-41

Constituted in the Organized Reserve 2 July 1923, assigned to the Zone of the Interior, and allotted to the Sixth Corps Area. Designated 12 September 1923 as General Hospital No. 109. Affiliated 5 February 1924 with the Marquette University Hospital in Milwaukee, WI. Initiated about November 1924 at Milwaukee. Redesignated 109th General Hospital 29 March 1929. Inactivated 7 March 1938 at Milwaukee by relief of personnel. Conducted summer training at the station hospitals at Fort Snelling, MN, Fort Sheridan, IL, OR, Fort Brady, MI. Location 7 December 1941—*Inactive*.

Status: Inactive in the U.S. Army Reserve as the 109th General Hospital.

Commanders, 109th General Hospital

Capt. William B. Ford	27 Jan 25-12 Feb 25	Maj. Charles J. Baumann	ao Jun 30-ao Jul 30
Maj. Edward F. Barta	12 Feb 25-ao Mar 25	Unknown	ao Jul 30-ao Jun 32
Maj. Bernard F. McGrath	ao Sep 25-ao Jun 27	Col. Harvey E. Webb	ao Jun 32-ao Jun 36
Unknown	ao Jun 27-ao Jun 30	Unknown	ao Jun 36-7 Mar 38
	Inactive	7 Mar 38-7 Dec 41	

110th General Hospital (Z.I.)

Organized Reserve Illinois

HQ-Not initiated 1923-25; Chicago, IL, 1925-41

Constituted in the Organized Reserve 2 July 1923, assigned to the Zone of the Interior, and allotted to the Sixth Corps Area. Designated 12 September 1923 as General Hospital No. 110. Affiliated 7 February 1924 with the Masonic Hospital in Chicago, IL. Initiated 9 January 1925 at Chicago. Redesignated 110th General Hospital 29 March 1929. Mobilization assignment in 1929 was to reinforce Shippen General Hospital. Consolidated 26 December 1930 with Base Hospital No. 110 (a WWI unit organized 14 August 1918 at Camp Greenleaf, GA; demobilized 10 July 1919 at Camp Dix, NJ; reconstituted 26 December 1930). Conducted summer training at the station hospitals at Fort Snelling, MN, Fort Sheridan, IL, or Camp Custer, MI. Location 7 December 1941—Chicago, IL.

Status: Inactive in the U.S. Army Reserve as the 110th General Hospital.

Commanders, 110th General Hospital

Maj. Cleveland C. MacLane	9 Jan 25-ao Feb 25	Lt. Col. Arthur H. Geiger	12 Nov 36-ao Jan 40
Col. Gilbert Fitz-Patrick	ao Sep 25-12 Nov 36	Unknown	ao Jan 40-7 Dec 41

111th General Hospital (Z.I.)

Organized Reserve Michigan

HQ-Not initiated 1923-24; Ann Arbor, MI, 1924-38; Detroit, MI, 1938-41

Constituted in the Organized Reserve 2 July 1923, assigned to the Zone of the Interior, and allotted to the Sixth Corps Area. Designated 12 September 1923 as General Hospital No. 111. Affiliated 14 February 1924 with the University of Michigan Medical School in Ann Arbor, MI. Concurrently organized at Ann Arbor. Redesignated 111th General Hospital 29 March 1929. Relocated by January 1938 to Detroit, MI. Conducted summer training at the station hospitals at Fort Snelling, MN, or Fort Sheridan, IL. Location 7 December 1941—Detroit, MI.

Status: Inactive in the U.S. Army Reserve as the 360th General Hospital.

Commanders, 111th General Hospital

1st Lt. William L. Bettison	2 Jun 25-2 Jul 25	Lt. Col. Frederick A. Coller	Aug 25-ao Jun 29
Maj. Carl W. Eberbach	2 Jul 25-Aug 25	Unknown	ao Jun 29-7 Dec 41

112th General Hospital (Z.I.)

Organized Reserve Illinois

HQ-Not initiated 1923-25; Chicago, IL, 1925-41

Constituted in the Organized Reserve 2 July 1923, assigned to the Zone of the Interior, and allotted to the Sixth Corps Area. Designated 12 September 1923 as General Hospital No. 112. Affiliated 18 February 1924 with the Chicago Polyclinic Hospital in Chicago, IL. Initiated 21 January 1925 at Chicago. Redesignated 112th General Hospital 29 March 1929. Conducted summer training at the station hospitals at Fort Snelling, MN, Fort Sheridan, IL, or Camp Custer, MI. Location 7 December 1941—Chicago, IL.

Status: Active in the U.S. Army Reserve as the 818th Hospital Center at Fort Gillam, GA.

Commanders, 112th General Hospital

Capt. Peter P. O'Connor	21 Jan 25-12 Feb 25	Unknown	ao Dec 26-ao Jun 27
Maj. John A. Graham	12 Feb 25-21 Jul 25	Col. William McI. Thompson	ao Jun 27-ao Jun 32
Maj. Wilson A. Abbott	21 Jul 25-ao Aug 25	Unknown	ao Jun 32 ao Jun 34
Unknown	ao Aug 25-ao Nov 26	Col. Carl B. Hermann	ao Jun 34-ao Jan 40
Lt. Col. Robert P. Hentz	ao Nov 26-ao Dec 26	Unknown	ao Jan 40-7 Dec 41

113th General Hospital (Z.I.)

Organized Reserve Illinois

HQ-Not initiated 1923-24; Chicago, IL, 1924-30; *Inactive* 1929-34; Chicago, IL, 1934-36; *Inactive* 1936-41

Constituted in the Organized Reserve 2 July 1923, assigned to the Zone of the Interior, and allotted to the Sixth Corps Area. Designated 12 September 1923 as General Hospital No. 113. Initiated in November 1924 at Chicago, IL. Redesignated 113th General Hospital 29 March 1929. Inactivated 12 August 1929 at Chicago by relief of personnel. Reorganized by June 1934 at Chicago. Inactivated about August 1936 at Chicago by relief of personnel. Conducted summer training at Fort Sheridan, IL. Location 7 December 1941—*Inactive*.

Status: Disbanded 30 January 1942.

Commanders, 113th General Hospital

Lt. Col. Edward S. Blaine	Nov 24-10 Apr 25	<i>Inactive</i>	12 Aug 29-ao Jun 34
Col. Ernest E. Irons	10 Apr 25-ao Jun 27	Unknown	ao Jun 34-ao Feb 35
Unknown	ao Jun 27 ao Jun 29	Lt. Col. Christian H. Zollar	ao Feb 35-ao Mar 35
Lt. Col. George A. Kelso	ao Jun 29-12 Aug 29	Unknown	ao Mar 35-Aug 36
	<i>Inactive</i>	Aug 36-7 Dec 41	

114th General Hospital (Z.I.)

Organized Reserve Illinois

HQ-Not initiated 1923-24; Chicago, IL, 1924-41

Constituted in the Organized Reserve 2 July 1923, assigned to the Zone of the Interior, and allotted to the Sixth Corps Area. Designated 12 September 1923 as General Hospital No. 114. Affiliated 30 October 1924 with St. Luke's Hospital in Chicago, IL. Concurrently organized at Chicago. Redesignated 114th General Hospital 29 March 1929. Consolidated 24 November 1936 with Base Hospital No. 114 (a WWI unit organized 8 March 1918 at Camp Crane, PA; demobilized 30 May 1919 at Camp George G. Meade, MD; reconstituted 24 November 1936). Typically conducted *Inactive Training Period* meetings at the Post Office Building in Chicago. Conducted summer training at the station hospitals at Fort Snelling, MN, or at Fort Sheridan, IL. Location 7 December 1941—Chicago, IL.

Status: *Inactive* in the U.S. Army Reserve as the 453rd General Hospital.

Commanders, 114th General Hospital

Col. Ernest E. Irons	12 Feb 25-10 Apr 25	Unknown	ao May 31-Jun 36
Lt. Col. Gilbert C. Newell	10 Apr 25-Jul 29	Lt. Col. John W. Turner	Jun 36-Jul 36
Lt. Col. George W. Scupham	Jul 29-ao May 31	Col. John Favill	Jul 36-ao Mar 41

115th General Hospital (Z.I.)

Organized Reserve Michigan/Illinois

HQ-Not initiated 1923-24; Detroit, MI, 1924-30; Chicago, IL, 1930-41

Constituted in the Organized Reserve 2 July 1923, assigned to the Zone of the Interior, and allotted to the Sixth Corps Area. Designated 12 September 1923 as General Hospital No. 115. Initiated 30 October 1924 at Detroit, MI. Redesignated 115th General Hospital 29 March 1929. Relocated 6 December 1930 to Chicago, IL. Consolidated 23 November 1936 with Base Hospital No. 115 (a WWI unit organized in June 1918 at Cape May, NJ; demobilized 10 May 1919 at Camp Dix, NJ; reconstituted 23 November 1936). Conducted summer training at the station hospitals at Fort Snelling, MN, or Camp Custer, MI. Also conducted C.M.T.C. training at Jefferson Barracks, MO, IN, 1934 as an alternate form of summer training. Location 7 December 1941—Chicago, IL.

Status: *Inactive* in the Regular Army as the 386th Station Hospital.

Commanders, 115th General Hospital

Unknown	30 Oct 24-17 Mar 25	Col. Frank Deacon	24 Apr 26-ao Jan 40
Maj. Martin J. Schwanz	17 Mar 25-24 Apr 26	Unknown	ao Jan 40-7 Dec 41

116th General Hospital (Z.I.)

Organized Reserve Michigan/Illinois

HQ-*Not initiated* 1923-24; Detroit, MI, 1924-30; Chicago, IL, 1930-41

Constituted in the Organized Reserve 2 July 1923, assigned to the Zone of the Interior, and allotted to the Sixth Corps Area. Designated 12 September 1923 as General Hospital No. 116. Initiated by November 1924 at Detroit, MI. Redesignated 116th General Hospital 29 March 1929. Relocated 6 December 1930 to Chicago, IL. Consolidated 23 November 1936 with Base Hospital No. 116 (a WWI unit organized 20 December 1917 at the 71st Regiment Armory, New York City, NY; demobilized 31 May 1919 at Camp Upton, NY; reconstituted 23 November 1936). Conducted summer training at the station hospitals at Fort Snelling, MN, Fort Sheridan, IL, or Camp Custer, MI. Location 7 December 1941—Chicago, IL.

Status: Inactive in the U.S. Army Reserve as the 385th Station Hospital.

Commanders, 116th General Hospital

Unknown	ao Nov 24-24 Apr 26	Col. Thomas H. Scott	11 Apr 28-ao Jun 34
Col. Carl L. Barnes	24 Apr 26-5 Apr 27	Unknown	ao Jun 34-ao Feb 35
Unknown	5 Apr 27-11 Apr 28	Col. Gerald R. Allaben	ao Feb 35-ao Jan 40
	Unknown	ao Jan 40-7 Dec 41	

117th General Hospital (Z.I.)

Organized Reserve Wisconsin

HQ-*Not initiated* 1923-25; Milwaukee, WI, 1925-29; *Inactive* 1929-34; Milwaukee, WI, 1934-37; *Inactive* 1937-41

Constituted in the Organized Reserve 2 July 1923, assigned to the Zone of the Interior, and allotted to the Sixth Corps Area. Designated 12 September 1923 as General Hospital No. 117. Initiated by September 1925 at Milwaukee, WI. Redesignated 117th General Hospital 29 March 1929. Inactivated 30 July 1929 at Milwaukee by relief of personnel. Reorganized by June 1934 at Milwaukee. Consolidated 23 November 1936 with Base Hospital No. 117 (a WWI unit organized in March 1918 at Camp Crane, PA; demobilized 12 January 1919 at La Fauche, France; reconstituted 23 November 1936). Inactivated by June 1937 at Milwaukee by relief of personnel. Conducted summer training at the station hospitals at Fort Snelling, MN, or Camp McCoy, WI. Location 7 December 1941—*Inactive*.

Status: Disbanded 30 January 1942.

Commanders, 117th General Hospital

Unknown	ao Sep 25-9 Apr 26	Lt. Col. Frank F. Bowman	18 Mar 29-30 Jul 29
Col. Peter L. Scanlan	9 Apr 26-ao May 26	<i>Inactive</i>	30 Jul 29-ao Jun 33
Unknown	ao May 26-ao Jan 27	Maj. Herbert T. Barnes	ao Jun 34-ao Jan 37
Maj. James T. Degan	ao Jan 27-18 Mar 29	<i>Inactive</i>	ao Jun 37-7 Dec 41

118th General Hospital (Z.I.)

Organized Reserve Michigan

HQ-*Not initiated* 1923-24; Detroit, MI, 1924-41

Constituted in the Organized Reserve 2 July 1923, assigned to the Zone of the Interior, and allotted to the Sixth Corps Area. Designated 12 September 1923 as General Hospital No. 118. Initiated by November 1924 at Detroit, MI. Redesignated 118th General Hospital 29 March 1929. Conducted summer training at the station hospitals at Fort Snelling, MN, or Camp Custer, MI. Location 7 December 1941—Detroit, MI.

Status: Inactive in the U.S. Army Reserve as the 118th General Hospital.

Commanders, 118th General Hospital

Unknown	ao Nov 24-18 Apr 26	Unknown	ao Jun 34-ao Jun 35
Col. John C. Dallenbach	18 Apr 26-May 31	Lt. Col. Edgar E. Poos	ao Jun 35-ao Jun 37
Col. John S. Lambie, Jr.	May 31-ao Jun 34	Unknown	ao Jun 37-7 Dec 41

119th General Hospital (Z.I.)

Organized Reserve Illinois

HQ-*Not initiated* 1923-25; Chicago, IL, 1925-41

Constituted in the Organized Reserve 2 July 1923, assigned to the Zone of the Interior, and allotted to the Sixth Corps Area. Designated 12 September 1923 as General Hospital No. 119. Initiated 17 March 1925 at Chicago, IL. Redesignated 119th General Hospital 29 March 1929. Consolidated 26 December 1930 with Base Hospital No. 119 (a WWI unit organized 28 August 1918 at Camp Greenleaf, GA; demobilized 21 July 1919 at Camp Zachary Taylor, KY; reconstituted 26 December 1930). Conducted summer training at the station hospitals at Fort Snelling, MN, or Fort Sheridan, IL. Location 7 December 1941—Chicago, IL.

Status: Inactive in the U.S. Army Reserve as the 454th General Hospital.

Commanders, 119th General Hospital

Maj. William E. Buehler	17 Mar 25-ao Apr 25	Unknown	Mar 36-7 Oct 37
Unknown	ao Apr 25-ao Sep 25	Lt. Col. Harry M. Hedge	7 Oct 37-Mar 39
Col. John W. H. Pollard	ao Sep 25-Mar 36	Lt. Col. Alonzo B. Middleton	Mar 39-ao Nov 40
	Unknown	ao Nov 40-7 Dec 41	

120th General Hospital (Z.I.)

Organized Reserve Michigan/Wisconsin

HQ-*Not initiated* 1923-24; Detroit, MI, 1924-25; *Inactive* 1925-26; Racine, WI, 1926-30; *Inactive* 1930-41

Constituted in the Organized Reserve 2 July 1923, assigned to the Zone of the Interior, and allotted to the Sixth Corps Area. Designated 12 September 1923 as General Hospital No. 120. Affiliated 8 November 1924 with the Detroit College of Medicine in Detroit, MI. Initiated 23 December 1924 at Detroit. Inactivated 12 May 1925 at Detroit by relief of personnel. Reorganized 17 April 1926 at Racine. Redesignated 120th General Hospital 29 March 1929. Inactivated by December 1930 at Racine by relief of personnel. Relieved from the Zone of the Interior in 1936 and assigned to the General Headquarters Reserve. Conducted summer training at the station hospitals at Fort Snelling, MN, Camp McCoy, WI, or Fort Leavenworth, KS. Location 7 December 1941—*Inactive*.

Status: Disbanded 30 January 1942.

Commanders, 120th General Hospital

Lt. Col. Anfin Egdahl	23 Dec 24-12 May 25	Unknown	ao Jun 27-30 Jul 29
<i>Inactive</i>	12 May 25-17 Apr 26	Lt. Col. Carl C. Vogel	30 Jul 29-ao Aug 29
Col. Edward J. Barrett	17 Apr 26-ao Jun 27	Unknown	ao Aug 29-ao Dec 30
	<i>Inactive</i>	ao Dec 30-7 Dec 41	

121st General Hospital (Z.I.)

Organized Reserve Kansas/Missouri

HQ-*Not initiated* 1923-25; Wichita, KS, 1925-28; St. Louis, MO, 1928-38; *Inactive* 1938-39; Wichita, KS, 1939-41

Constituted in the Organized Reserve 2 July 1923 as General Hospital No. 121, assigned to the Zone of the Interior, and allotted to the Seventh Corps Area. Affiliated 10 November 1923 with St. Francis Hospital in Wichita, KS. Initiated by September 1925 at Wichita. Relocated 3 April 1928 to St. Louis, MO. Redesignated 121st General Hospital 29 March 1929. Relieved from the Zone of the Interior in 1936 and assigned to the General Headquarters Reserve. Inactivated 28 May 1938 at St. Louis by relief of personnel. Reorganized 16 September 1939 at Wichita. Conducted summer training at the station hospitals at Fort Snelling, MN, or Fort Leavenworth, KS. Location 7 December 1941—Wichita, KS.

Commanders, 121st General Hospital

Unknown	ao Sep 25-ao Apr 27	Col. Hugh Wilkinson	Jan 32-15 Aug 34
Col. Frederick W. O'Donnell	ao Apr 27-May 27	Unknown	15 Aug 34-ao Mar 38
Col. Leon Matassarini	May 27-Mar 31	Col. Lyle S. Powell	ao Mar 38-28 May 38
Lt. Col. Joseph E. Rowan	Mar 31-Jan 32	<i>Inactive</i>	28 May 38-16 Sep 39
	Col. Lyle S. Powell	16 Sep 39-ao Aug 41	

122nd General Hospital (Z.I.)

Organized Reserve Missouri

HQ-Not initiated 1923-24; Kansas City, MO, 1924-41

Constituted in the Organized Reserve 2 July 1923, assigned to the Zone of the Interior, and allotted to the Seventh Corps Area. Designated 12 September 1923 as General Hospital No. 122. Affiliated 26 January 1924 with St. Joseph's Hospital in Kansas City, MO. Initiated 26 November 1924 at Kansas City, MO. Initial mobilization mission 1925-28 was to establish and operate Smart General Hospital. Redesignated 122nd General Hospital 29 March 1929. Relieved from the Zone of the Interior in 1936 and assigned to the General Headquarters Reserve. Conducted summer training at the station hospital, Fort Snelling, MN. Location 7 December 1941—Kansas City, MO.

Status: Disbanded 4 April 1953.

Commanders, 122nd General Hospital

Unknown	26 Nov 24-ao Sep 25	Unknown	ao Jan 30-ao Jan 38
Col. Kerwin W. Kinard	ao Sep 25-ao Jan 30	1st Lt. James W. Branch	ao Jan 38-ao Feb 38
	Unknown	ao Feb 38-7 Dec 41	

123rd General Hospital (Z.I.)

Organized Reserve Nebraska

HQ-Not initiated 1923-24; Lincoln, NE, 1924-41

Constituted in the Organized Reserve 2 July 1923, assigned to the Zone of the Interior, and allotted to the Seventh Corps Area. Designated 12 September 1923 as General Hospital No. 123. Affiliated 3 March 1924 with St. Elizabeth's Hospital in Lincoln, NE. Initiated in November 1924 at Lincoln. Redesignated 123rd General Hospital 29 March 1929. Relieved from the Zone of the Interior in 1936 and assigned to the General Headquarters Reserve. Conducted summer training at the station hospital, Fort Snelling, MN. Location 7 December 1941—Lincoln, NE.

Status: Inactive in the U.S. Army Reserve as the 362nd General Hospital.

Commanders, 123rd General Hospital

Col. Czar C. Johnson	Nov 24-ao Jun 27	Lt. Col. Tenney T. Harris	22 Aug 37-ao Sep 37
Maj. Benjamin F. Williams	Jan 28-Dec 31	Unknown	ao Sep 37-ao Apr 38
Col. Erskine M. Barnes	Dec 31-ao Dec 32	Col. Czar C. Johnson	ao Apr 38-19 May 38
Unknown	ao Dec 32-18 Aug 35	Unknown	19 May 38-16 Sep 39
Lt. Col. Alvan M. Fortney	18 Aug 35-22 Aug 37	Col. Leon Mattassarini	16 Sep 39-ao Jan 40
	Unknown	ao Jan 40-7 Dec 41	

124th General Hospital (Z.I.)

Organized Reserve Minnesota

HQ-Not initiated 1923-24; Minneapolis, MN, 1924-41

Constituted in the Organized Reserve 2 July 1923, assigned to the Zone of the Interior, and allotted to the Seventh Corps Area. Designated 12 September 1923 as General Hospital No. 124. Affiliated 10 March 1924 with St. Mary's Hospital in Minneapolis, MN. Initiated in November 1924 at Minneapolis. Redesignated 124th General Hospital 29 March 1929. Conducted summer training at the station hospital, Fort Snelling, MN. Location 7 December 1941—Minneapolis, MN, (Inactivated 22 January 1942).

Status: Inactive in the U.S. Army Reserve as the 124th Station Hospital.

Commanders, 124th General Hospital

Unknown	Nov 24-ao Sep 25	Col. Harry H. Sellers	May 31-ao Jun 31
Lt. Col. James F. Corbett	ao Sep 25-Apr 28	Unknown	ao Jun 31-14 Mar 37
Unknown	Apr 28-Dec 29	Col. John R. Gardner	14 Mar 37-23 Sep 39
Lt. Col. Robert H. Monahan	Dec 29-Feb 30	Unknown	23 Sep 39-ao Jun 41
Unknown	Feb 30-May 31	Lt. Col. Tenney T. Harris	ao Jun 41-ao Nov 41

125th General Hospital (Z.I.)

Organized Reserve Kansas

HQ-Not initiated 1923-24; Kansas City, KS, 1924-41

Constituted in the Organized Reserve 2 July 1923, assigned to the Zone of the Interior, and allotted to the Seventh Corps Area. Designated 12 September 1923 as General Hospital No. 125. Affiliated 19 March 1924 with the Bell Memorial Hospital in Kansas City, KS. Initiated in November 1924 at Kansas City, KS. Redesignated 125th General Hospital 29 March 1929. Relieved from the Zone of the Interior in 1936 and assigned to the General Headquarters Reserve. Conducted summer training at the station hospital, Fort Snelling, MN. Location 7 December 1941—Kansas City, KS.

Status: Disbanded 3 October 1950 in the U.S. Army Reserve at Brooklyn, NY, as the 363rd General Hospital.

Commanders, 125th General Hospital

Unknown	Nov 24-ao Sep 25	Col. Lloyd Thompson	Dec 31-ao Jun 32
Col. Clarence B. Francisco	ao Sep 25-ao Jun 27	Unknown	ao Jun 32-ao Jul 37
Unknown	ao Jun 27-Apr 31	Col. Roscoe T. Nichols	ao Jul 37-22 Aug 37
Lt. Col. David C. Bosserman	Apr 31-Dec 31	Unknown	22 Aug 37-7 Dec 41

126th General Hospital (Z.I.)

Organized Reserve Missouri/Minnesota

HQ-Not initiated 1923-24; Kansas City, MO, 1924-31; Rochester, MN, 1931-41

Constituted in the Organized Reserve 2 July 1923, assigned to the Zone of the Interior, and allotted to the Seventh Corps Area. Designated 12 September 1923 as General Hospital No. 126. Affiliated 3 June 1924 with St. Luke's Hospital in Kansas City, MO. Concurrently organized at Kansas City, MO. Redesignated 126th General Hospital 29 March 1929. Relocated 12 October 1931 to Rochester, MN. Conducted summer training with the station hospital, Fort Snelling, MN. Location 7 December 1941—Rochester, MN.

Status: Inactive in the U.S. Army Reserve as the 126th General Hospital.

Commanders, 126th General Hospital

Unknown	3 Jun 24-11 Jan 25	Unknown	ao Apr 30-ao Aug 32
Col. Don H. Silsby	11 Jan 25-Sep 29	Lt. Col. W. H. Replogle	ao Aug 32-ao Sep 32
Unknown	Sep 29-Mar 30	Unknown	ao Sep 32-ao Jul 38
Lt. Col. Fred W. Rankin	Mar 30-ao Apr 30	Lt. Col. Arthur Steindler	ao Jul 38-ao Sep 38
	Unknown	ao Sep 38-7 Dec 41	

127th General Hospital (Z.I.)

Organized Reserve Texas/Illinois

HQ-Not initiated 1923-25; Galveston, TX, 1925-36; *Inactive* 1936-41

Constituted in the Organized Reserve 2 July 1923, assigned to the Zone of the Interior, and allotted to the Eighth Corps Area. Designated 12 September 1923 as General Hospital No. 127. Affiliated 26 September 1924 with the University of Texas School of Medicine in Galveston, TX. Initiated 12 May 1925 at Galveston. Redesignated 127th General Hospital 29 March 1929. Withdrawn from the Eighth Corps Area 5 June 1936 and allotted to the Sixth Corps Area. Inactivated 12 November 1936 at Galveston by relief of personnel. Chicago, IL, designated 28 July 1937 as headquarters on reorganization, but the unit was never organized at that location. Conducted summer training at the station hospital, Fort Sam Houston, TX. Designated mobilization training station was Camp Stanley, TX. Location 7 December 1941—*Inactive*.

Status: Inactive in the U.S. Army Reserve as the 127th General Hospital.

Commanders, 127th General Hospital

1st Lt. Leroy M. Cochran	12 May 25-30 Jul 25	Lt. Col. Thomas C. Liddell	17 Dec 29-11 Mar 31
Maj. Joseph Kopecky	30 Jul 25-15 Dec 27	Col. John F. Park	11 Mar 31-12 Sep 32
Maj. William B. Sharp	15 Dec 27-8 Dec 28	Col. Frank H. McGregor	12 Sep 32-ao Oct 32
Maj. George P. Acton	8 Dec 28-3 May 29	Unknown	ao Oct 32-ao Oct 36
Lt. Col. William K. Read	3 May 29-17 Dec 29	Lt. Col. Thomas C. Liddell	ao Oct 36-12 Nov 36
	<i>Inactive</i>	12 Nov 36-7 Dec 41	

128th General Hospital (Z.I.)**Organized Reserve Texas/Illinois****HQ**-*Not initiated* 1923-25; Fort Sam Houston, TX, 1925-36; *Inactive* 1936-41

Constituted in the Organized Reserve 2 July 1923, assigned to the Zone of the Interior, and allotted to the Eighth Corps Area. Designated 12 September 1923 as General Hospital No. 128. Affiliated 3 March 1925 with Brooke Army Hospital at Fort Sam Houston, TX. Initiated 20 March 1925 at Fort Sam Houston. Redesignated 128th General Hospital 29 March 1929. Withdrawn from the Eighth Corps Area 5 June 1936 and allotted to the Sixth Corps Area. Inactivated 12 November 1936 at Fort Sam Houston by relief of personnel. Chicago, IL, designated 28 July 1937 as headquarters on reorganization, but the unit was never organized at that location. Conducted summer training at the station hospital, Fort Sam Houston, TX. Designated mobilization training station was Camp Stanley, TX. Location 7 December 1941—*Inactive*.

Status: Inactive in the U.S. Army Reserve as the 394th Station Hospital.**Commanders, 128th General Hospital**

1st Lt. Leroy M. Cochran	20 Mar 25-3 Mar 26	Col. Clarence E. Yount	8 Dec 28-8 Apr 35
Lt. Col. Alfred C. McDaniel	3 Mar 26-5 Apr 26	Lt. Col. Charles D. Dixon	8 Apr 35-20 Sep 35
Lt. Col. Charles F. Venable	12 Apr 27-7 Dec 28	Capt. John T. Wylie	20 Sep 35-12 Nov 36
	<i>Inactive</i>	12 Nov 36-7 Dec 41	

129th General Hospital (Z.I.)**Organized Reserve Colorado/Illinois****HQ**-*Not initiated* 1923-25; Denver, CO, 1925-36; *Inactive* 1936-41

Constituted in the Organized Reserve 2 July 1923, assigned to the Zone of the Interior, and allotted to the Eighth Corps Area. Designated 12 September 1923 as General Hospital No. 129. Initiated 25 April 1925 at Denver, CO. Redesignated 129th General Hospital 29 March 1929. Conducted summer training most years at Fitzsimons General Hospital in Denver, CO. Withdrawn from the Eighth Corps Area 5 June 1936 and allotted to the Sixth Corps Area. Inactivated 12 November 1936 at Denver by relief of personnel. Chicago, IL, designated 28 July 1937 as headquarters on reorganization, but the unit was never organized at that location. Designated mobilization training station was Camp Stanley, TX. Location 7 December 1941—*Inactive*.

Status: Disbanded 30 January 1942.**Commanders, 129th General Hospital**

Lt. Col. Victor B. Ayers	25 Apr 25-4 Feb 26	Lt. Col. Pleasant B. Nesbitt	5 May 31-29 Sep 32
Unknown	ao Mar 25-ao Mar 26	Unknown	29 Sep 32-7 Mar 36
Col. John S. Lambie, Jr.	4 Feb 26-5 May 31	Lt. Col. Louis W. Solend	7 Mar 36-12 Nov 36
	<i>Inactive</i>	12 Nov 36-7 Dec 41	

130th General Hospital (Z.I.)**Organized Reserve New Mexico/Illinois****HQ**-*Not initiated* 1923-25; Albuquerque, NM, 1925-36; *Inactive* 1936-41

Constituted in the Organized Reserve 2 July 1923, assigned to the Zone of the Interior, and allotted to the Eighth Corps Area. Designated 12 September 1923 as General Hospital No. 130. Initiated by March 1925 at Albuquerque, NM. Redesignated 130th General Hospital 29 March 1929. Withdrawn from the Eighth Corps Area 5 June 1936 and allotted

to the Sixth Corps Area. Inactivated 12 November 1936 at Albuquerque by relief of personnel. Chicago, IL, designated 28 July 1937 as headquarters on reorganization, but the unit was never organized at that location. Conducted summer training at the station hospital, Fort Sam Houston, TX. Designated mobilization training station was Camp Stanley, TX. Location 7 December 1941—*Inactive*.

Status: Disbanded 30 January 1942.

Commanders, 130th General Hospital

Maj. George E. Hartshorne	20 Mar 25-5 Feb 26	Col. James H. Gambrell	5 Mar 30-8 Sep 33
Lt. Col. James H. Gambrell	5 Feb 26-8 Dec 28	Col. Jefferson B. Latta	8 Sep 33-24 Jul 34
Lt. Col. William D. McFaul	8 Dec 28-17 Dec 29	Col. James H. Gambrell	24 Jul 34-12 Nov 36
Col. Jacob C. Epler	17 Dec 29-5 Mar 30	<i>Inactive</i>	12 Nov 36-7 Dec 41

131st General Hospital (Z.I.)

Organized Reserve New Mexico/Illinois

HQ—*Not initiated* 1923-25; Fort Bayard, NM, 1925-36; *Inactive* 1936-41

Constituted in the Organized Reserve 2 July 1923, assigned to the Zone of the Interior, and allotted to the Eighth Corps Area. Designated 12 September 1923 as General Hospital No. 131. Initiated 20 March 1925 at Fort Bayard, NM. Redesignated 131st General Hospital 29 March 1929. Withdrawn from the Eighth Corps Area 5 June 1936 and allotted to the Sixth Corps Area. Consolidated 24 November 1936 with Base Hospital No. 131 (a WWI unit organized 23 July 1918 at Jefferson Barracks, MO; demobilized 12 June 1919 at Camp Zachary Taylor, KY; reconstituted 24 November 1936). Inactivated 12 November 1936 at Fort Bayard by relief of personnel. Chicago, IL, designated 28 July 1937 as headquarters on reorganization, but the unit was never organized at that location. Conducted summer training most years at William Beaumont General Hospital at El Paso, TX. Designated mobilization training station was Camp Stanley, TX. Location 7 December 1941—*Inactive*.

Status: Disbanded 30 January 1942.

Commanders, 131st General Hospital

Capt. James T. Nichols	20 Mar 25-30 Sep 25	Unknown	ao Feb 32-ao Jun 33
Maj. Witten B. Russ	30 Sep 25-5 Feb 26	Lt. Col. Samuel E. Getty	ao Jun 33-6 Sep 33
Col. Charles F. Stough	5 Feb 26-3 Aug 29	Unknown	6 Sep 33-7 Mar 36
Lt. Col. Laurence C. Cook	3 Aug 29-ao Feb 32	Lt. Col. Gottlieb A. Lurie	7 Mar 36-12 Nov 36
	<i>Inactive</i>	12 Nov 36-7 Dec 41	

132nd General Hospital (Z.I.)

Organized Reserve Colorado/Illinois

HQ—*Not initiated* 1923-25; Colorado Springs, CO, 1925-28; Tulsa, OK, 1928-36; *Inactive* 1936-41

Constituted in the Organized Reserve 2 July 1923, assigned to the Zone of the Interior, and allotted to the Eighth Corps Area. Designated 12 September 1923 as General Hospital No. 132. Initiated 14 March 1925 at Colorado Springs, CO. Relocated in 1928 to Tulsa, OK. Redesignated 132nd General Hospital 29 March 1929. Withdrawn from the Eighth Corps Area 5 June 1936 and allotted to the Sixth Corps Area. Inactivated 12 November 1936 at Colorado Springs by relief of personnel. Chicago, IL, designated 28 July 1937 as headquarters on reorganization, but the unit was never organized at that location. Conducted summer training most years at Fitzsimons General Hospital in Denver, CO, and some years at the station hospital, Fort Sam Houston, TX. Designated mobilization training station was Camp Stanley, TX. Location 7 December 1941—*Inactive*.

Status: Inactive in the U.S. Army Reserve as the 346th General Hospital.

Commanders, 132nd General Hospital

Lt. Col. Lloyd R. Allen	14 Mar 25-8 Dec 28	Col. Louis H. Webb	ao Sep 33-4 Jun 34
Col. John A. Roddy	8 Dec 28-ao Feb 32	Col. Pleasant P. Nesbitt	4 Jun 34-12 Nov 36
Unknown	ao Feb 32-ao Sep 33	<i>Inactive</i>	12 Nov 36-7 Dec 41

133rd General Hospital (Z.I.)**Organized Reserve Texas/Illinois****HQ-***Not initiated* 1923-25; Fort Worth, TX, 1925-36; *Inactive* 1936-41

Constituted in the Organized Reserve 2 July 1923, assigned to the Zone of the Interior, and allotted to the Eighth Corps Area. Designated 12 September 1923 as General Hospital No. 133. Initiated in March 1925 at Fort Worth, TX. Redesignated 133rd General Hospital 29 March 1929. Withdrawn from the Eighth Corps Area 5 June 1936 and allotted to the Sixth Corps Area. Inactivated 12 November 1936 at Fort Worth by relief of personnel. Chicago, IL, designated 28 July 1937 as headquarters on reorganization, but the unit was never organized at that location. Conducted summer training at the station hospital, Fort Sam Houston, TX. Designated mobilization training station was Camp Stanley, TX. Location 7 December 1941—*Inactive*.

Status: Disbanded 30 January 1942.**Commanders, 133rd General Hospital**

1st Lt. Edwin L. Myrick	26 Mar 25-24 Sep 25	Lt. Col. George H. Stagner	4 Sep 29-ao Feb 32
Lt. Col. George H. Stagner	24 Sep 25-8 Dec 28	Unknown	ao Feb 32-ao Oct 36
Col. John O. McReynolds	8 Dec 28-4 Sep 29	Capt. Asa F. Constable	ao Oct 36-12 Nov 36
	<i>Inactive</i>	12 Nov 36-7 Dec 41	

134th General Hospital (Z.I.)**Organized Reserve Texas/Illinois****HQ-***Not initiated* 1923-25; Houston, TX, 1925-36; *Inactive* 1936-41

Constituted in the Organized Reserve 2 July 1923, assigned to the Zone of the Interior, and allotted to the Eighth Corps Area. Designated 12 September 1923 as General Hospital No. 134. Initiated 20 March 1925 at Houston, TX. Redesignated 134th General Hospital 29 March 1929. Conducted summer training most years at the Fort Sam Houston station hospital. Withdrawn from the Eighth Corps Area 5 June 1936 and allotted to the Sixth Corps Area. Inactivated 12 November 1936 at Houston by relief of personnel. Chicago, IL, designated 28 July 1937 as headquarters on reorganization, but the unit was never organized at that location. Conducted summer training at the station hospital, Fort Sam Houston, TX. Designated mobilization training station was Camp Stanley, TX. Location 7 December 1941—*Inactive*.

Status: Disbanded 30 January 1942.**Commanders, 134th General Hospital**

1st Lt. Karl A. D. Beer	20 Mar 25-11 May 25	Lt. Col. Warren M. Weir	8 Dec 28-ao Jan 29
Maj. Samuel J. Pate	11 May 25-30 Sep 25	Unknown	ao Jan 29-ao Oct 36
Lt. Col. James G. Flynn	30 Sep 25-8 Dec 28	2nd Lt. Neil S. Carlock	ao Oct 36-12 Nov 36
	<i>Inactive</i>	12 Nov 36-7 Dec 41	

135th General Hospital (Z.I.)**Organized Reserve Texas/Illinois****HQ-***Not initiated* 1923-25; Kerrville, TX, 1925-36; *Inactive* 1936-41

Constituted in the Organized Reserve 2 July 1923, assigned to the Zone of the Interior, and allotted to the Eighth Corps Area. Designated 12 September 1923 as General Hospital No. 135. Initiated 20 March 1925 at Kerrville, TX. Redesignated 135th General Hospital 29 March 1929. Withdrawn from the Eighth Corps Area 5 June 1936 and allotted to the Sixth Corps Area. Inactivated 12 November 1936 at Kerrville by relief of personnel. Chicago, IL, designated 28 July 1937 as headquarters on reorganization, but the unit was never organized at that location. Conducted summer training at the station hospital, Fort Sam Houston, TX. Designated mobilization training station was Camp Stanley, TX. Location 7 December 1941—*Inactive*.

Status: Disbanded 30 January 1942.**Commanders, 135th General Hospital**

Maj. Thomas P. Poole	20 Mar 25-8 Dec 28	Lt. Col. William H. Hargis	4 Jun 29-ao Feb 32
Maj. John E. White	26 Apr 27-8 Dec 28	Unknown	ao Feb 32-ao Oct 36
Lt. Col. Ernest H. Stark	8 Dec 28-4 Jun 29	Col. Louis H. Webb	ao Oct 36-12 Nov 36
	<i>Inactive</i>	12 Nov 36-7 Dec 41	

136th General Hospital (Z.I.)**Organized Reserve Texas/Illinois****HQ-Not initiated** 1923-25; Fort Worth, TX, 1925-27; Dallas, TX, 1927-36; *Inactive* 1936-41

Constituted in the Organized Reserve 2 July 1923 as General Hospital No. 136, assigned to the Zone of the Interior, and allotted to the Eighth Corps Area. Affiliated with the All Saints Episcopal Hospital in Fort Worth, TX. Initiated by March 1925 at Fort Worth. Relocated in 1927 to Dallas, TX. Redesignated 136th General Hospital 29 March 1929. Withdrawn from the Eighth Corps Area 5 June 1936 and allotted to the Sixth Corps Area. Inactivated 12 November 1936 at Fort Worth by relief of personnel. Chicago, IL, designated as headquarters on reorganization, but the unit was never organized at that location. Conducted summer training at the station hospital, Fort Sam Houston, TX. Designated mobilization training station was Camp Stanley, TX. Location 7 December 1941—*Inactive*.

Status: Disbanded 30 January 1942.**Commanders, 136th General Hospital**

Maj. Walter H. Moursund	ao Mar 25-15 Dec 27	Lt. Col. George E. Glover	14 Jul 30-ao Feb 32
Maj. Clark A. Wilcox	15 Dec 27-8 Dec 28	Unknown	ao Feb 32-ao Sep 33
Lt. Col. Isaac A. Withers	8 Dec 28-14 Jul 30	Col. Laurence C. Cook	ao Sep 33-12 Nov 36
	<i>Inactive</i>	12 Nov 36-7 Dec 41	

137th General Hospital (Z.I.)**Organized Reserve Texas/Illinois****HQ-Not initiated** 1923-25; Temple, TX, 1925-36; *Inactive* 1936-41

Constituted in the Organized Reserve 2 July 1923 as General Hospital No. 137, assigned to the Zone of the Interior, and allotted to the Eighth Corps Area. Redesignated 23 March 1925 as the 137th General Hospital. Initiated 20 March 1925 at Temple, TX. Redesignated 137th General Hospital 29 March 1929. Withdrawn from the Eighth Corps Area 5 June 1936 and allotted to the Sixth Corps Area. Inactivated 12 November 1936 at Temple by relief of personnel. Chicago, IL, designated as headquarters on reorganization, but the unit was never organized at that location. Conducted summer training at the station hospital, Fort Sam Houston, TX. Designated mobilization training station was Camp Stanley, TX. Location 7 December 1941—*Inactive*.

Commanders, 137th General Hospital

Maj. Samuel W. Wilson	20 Mar 25-1 Oct 25	Unknown	ao Feb 32-ao Sep 36
Maj. Robert C. Cook	1 Oct 25-8 Dec 28	Col. John A. Roddy	ao Sep 36-12 Nov 36
Lt. Col. Robert E. B. Bledsoe	8 Dec 28-ao Feb 32	<i>Inactive</i>	12 Nov 36-7 Dec 41

138th General Hospital (Z.I.)**Organized Reserve California****HQ-Not initiated** 1923-24; San Francisco, CA, 1924-41

Constituted in the Organized Reserve 2 July 1923 as General Hospital No. 138, assigned to the Zone of the Interior, and allotted to the Ninth Corps Area. Initiated 22 August 1924 at, and affiliated with, the Stanford University Medical School in San Francisco, CA. Redesignated 138th General Hospital 29 March 1929. Conducted summer training at Del Monte, CA, the Presidio of Monterey, CA, or at Letterman General Hospital, San Francisco, CA. Location 7 December 1941—San Francisco, CA.

Status: Disbanded 30 January 1942.**Commanders, 138th General Hospital**

Unknown	22 Aug 24-Jul 25	Maj. Sylvan L. Haas	ao Jun 29-Dec 30
Lt. Col. Morton R. Gibbons	Jul 25-ao Jun 27	Unknown	Dec 30-ao Jun 32
Unknown	ao Jun 27-ao Jun 29	Col. Chester S. Harris	ao Jun 32-ao Jun 39
	Unknown	ao Jun 39-7 Dec 41	

139th General Hospital (Z.I.)**Organized Reserve Oregon/California****HQ-Not initiated** 1923-25; Salem, OR, 1925-34; *Inactive* 1934-37; Long Beach, CA, 1937-41

Constituted in the Organized Reserve 2 July 1923 as General Hospital No. 139, assigned to the Zone of the Interior, and allotted to the Ninth Corps Area. Initiated by July 1925 at Salem, OR. Redesignated 139th General Hospital 29 March 1929. Inactivated 27 September 1934 at Salem by relief of personnel. Reorganized 18 September 1937 at Long Beach, CA. Location 7 December 1941—Long Beach, CA.

Status: Disbanded 11 November 1944.

Commanders, 139th General Hospital

Col. Marius B. Marcellus	ao Jul 25-ao Jun 29	<i>Inactive</i>	27 Sep 34-18 Sep 37
Unknown	ao Jun 29-ao Jun 31	Lt. Col. Oliver R. Austin	18 Sep 37-ao Jan 38
Lt. Col. Walter C. Belt	ao Jun 31-27 Sep 34	Unknown	ao Jan 38-ao Feb 40
	Col. Karl J. Swenson	ao Feb 40-ao Dec 41	

140th General Hospital (Z.I.)

Organized Reserve California/Illinois

HQ-*Not initiated* 1923-25; Los Angeles, CA, 1925-30; *Inactive* 1930-41

Constituted in the Organized Reserve 2 July 1923 as General Hospital No. 140, assigned to the Zone of the Interior, and allotted to the Ninth Corps Area. Affiliated 21 August 1924 with the Los Angeles General Hospital in Los Angeles, CA. Initiated in October 1925 at Los Angeles. Redesignated 140th General Hospital 29 March 1929. Inactivated 15 April 1930 at Los Angeles by relief of personnel. Withdrawn from the Ninth Corps Area 5 June 1936 and allotted to the Sixth Corps Area. Chicago, IL, designated as headquarters on reorganization, but the unit was never organized at that location. Location 7 December 1941—*Inactive*.

Status: Disbanded 30 January 1942.

Commanders, 140th General Hospital

Lt. Col. John M. Lacey	Oct 25-15 Apr 30	<i>Inactive</i>	15 Apr 30-7 Dec 41
------------------------	------------------	-----------------	--------------------

141st General Hospital (Z.I.)

Organized Reserve Washington/Illinois

HQ-*Not initiated* 1923-25; Seattle, WA, 1925-36; *Inactive* 1936-41

Constituted in the Organized Reserve 2 July 1923 as General Hospital No. 141, assigned to the Zone of the Interior, and allotted to the Ninth Corps Area. Initiated by October 1925 at Seattle, WA. Redesignated 141st General Hospital 29 March 1929. Withdrawn from the Ninth Corps Area 5 June 1936 and allotted to the Sixth Corps Area. Chicago, IL, designated as headquarters on reorganization, but the unit was never organized at that location. Location 7 December 1941—*Inactive*.

Status: Disbanded 30 January 1942.

Commanders, 141st General Hospital

Col. Edward A. Rich	ao Oct 25-ao Jun 32	Lt. Col. John A. Johnson	ao Jan 34-17 Dec 34
Unknown	ao Jun 32-ao Jan 34	Col. Frank W. Anderson	17 Dec 34-5 Jun 36
	<i>Inactive</i>	5 Jun 36-7 Dec 41	

142nd General Hospital (Z.I.)

Organized Reserve California/Maryland/Illinois

HQ-*Not initiated* 1923-25; Los Angeles, CA, 1925-30; *Inactive* 1930-41

Constituted in the Organized Reserve 2 July 1923 as General Hospital No. 142, assigned to the Zone of the Interior, and allotted to the Ninth Corps Area. Initiated by July 1925 at Los Angeles, CA. Redesignated 142nd General Hospital 29 March 1929. Mobilization mission was to supplement LaGarde General Hospital and provide general area medical support. Inactivated 15 April 1930 at Los Angeles by relief of personnel. Withdrawn from the Ninth Corps Area 1 October 1933 and allotted to the Third Corps Area. Baltimore, MD, designated as headquarters on reorganization, but the unit was never organized at that location. Affiliated with the University of Maryland in Baltimore. Withdrawn from the Third Corps Area 5 June 1936 and allotted to the Sixth Corps Area. Chicago, IL, designated as headquarters on reorganization, but the unit was never organized at that location. Location 7 December 1941—*Inactive*.

Status: Inactive in the U.S. Army Reserve as the 450th General Hospital.

Commanders, 142nd General Hospital

Col. James A. Mattison

ao Jul 25-15 Apr 30

Inactive

15 Apr 30-7 Dec 41

143rd General Hospital (Z.I.)

Organized Reserve Washington

HQ-*Not initiated* 1923-25; Spokane, WA, 1925-37; *Inactive* 1937-41

Constituted in the Organized Reserve 2 July 1923 as General Hospital No. 143, assigned to the Zone of the Interior, and allotted to the Ninth Corps Area. Initiated by September 1925 at Spokane, WA. Redesignated 143rd General Hospital 29 March 1929. Inactivated 17 February 1937 at Spokane by relief of personnel. Location 7 December 1941—*Inactive*.

Status: Disbanded 11 November 1944.

Commanders, 143rd General Hospital

Unknown

ao Sep 25-Apr 26
Inactive

Col. Samuel E. Lambert
17 Feb 37-7 Dec 41

Apr 26-17 Feb 37

144th General Hospital (Z.I.)

Organized Reserve California

HQ-*Not initiated* 1923-25; Los Angeles, CA, 1925-37; *Inactive* 1937-41

Constituted in the Organized Reserve 2 July 1923 as General Hospital No. 144, assigned to the Zone of the Interior, and allotted to the Ninth Corps Area. Redesignated 23 March 1925 as the 144th General Hospital. Initiated by September 1925 at Los Angeles, CA. Redesignated 144th General Hospital 29 March 1929. Inactivated 2 March 1937 at Los Angeles by relief of personnel. Conducted summer training at the station hospital, Presidio of Monterey, CA. Location 7 December 1941—*Inactive*.

Status: Disbanded 11 November 1944.

Commanders, 144th General Hospital

Unknown

ao Sep 25-Oct 25

Col. Elliot P. Smart

11 Jun 35-11 Feb 37

Col. Frank C. Wisser

Oct 25-ao Jun 32

Col. Daniel L. High

11 Feb 37-2 Mar 37

Unknown

ao Jun 32-11 Jun 35

Inactive

2 Mar 37-7 Dec 41

145th General Hospital (Z.I.)

Organized Reserve Montana/California

HQ-*Not initiated* 1923-26; Billings, MT, 1926-36; Oakland, CA, 1936-37; *Inactive* 1937-41

Constituted in the Organized Reserve 2 July 1923 as General Hospital No. 145, assigned to the Zone of the Interior, and allotted to the Ninth Corps Area. Redesignated 23 March 1925 as the 145th General Hospital. Initiated in March 1926 at Billings, MT. Redesignated 145th General Hospital 29 March 1929. Relocated in 1936 to Oakland, CA. Inactivated 31 January 1937 at Oakland by relief of personnel. Typically conducted Inactive Training Period meetings at the Hart-Albin Building in Billings. Conducted summer training at Letterman General Hospital, San Francisco, CA. Location 7 December 1941—*Inactive*.

Status: Disbanded 11 November 1944.

Commanders, 145th General Hospital

Maj. Ferris L. Arnold

Mar 26-Jul 26

Lt. Col. William R. Morrison

Jul 26-31 Jan 37

Inactive

31 Jan 37-7 Dec 41

146th General Hospital (Z.I.)**Organized Reserve Massachusetts****HQ-Not initiated** 1923-26; Boston, MA, 1926-36; *Inactive* 1936-37; Newark, NJ, 1937-41

Constituted in the Organized Reserve 2 July 1923 as General Hospital No. 146, assigned to the Zone of the Interior, and allotted to the First Corps Area. Initiated by April 1926 at Boston, MA. Redesignated 146th General Hospital 29 March 1929. Relieved from the Zone of the Interior 1 October 1933 and assigned to the General Headquarters Reserve. Withdrawn from the First Corps Area 5 June 1936 and allotted to the Second Corps Area. Reorganized 2 October 1937 at Newark, NJ. Location 7 December 1941—Newark, NJ.

Status: Disbanded 11 November 1944.**Commanders, 146th General Hospital**

Maj. Reed B. Bontecou	ao Apr 26-ao Jul 28	<i>Inactive</i>	26 Oct 34-2 Oct 37
Maj. Alpha R. Sawyer	ao Nov 29-11 Jan 30	Capt. Morris D. Berk	2 Oct 37-28 Feb 39
Maj. Thomas Ries	11 Jan 30-26 Oct 34	Col. William C. Davis	28 Feb 39-3 Apr 41
	Col. Earl LeR. Wood	30 Jul 41-ao Dec 41	

147th General Hospital (I) (Z.I.)**Organized Reserve Massachusetts****HQ-Not initiated** 1923-27

Constituted in the Organized Reserve 2 July 1923, assigned to the Zone of the Interior, and allotted to the First Corps Area. Worcester, MA, designated as headquarters on organization, but the unit was never organized at that location. Withdrawn from the First Corps Area 11 January 1927 and demobilized.

147th General Hospital (II) (Z.I.)**Regular Army Inactive****HQ-Not organized** 1927-29; Worcester, MA, 1929-36; *Inactive* 1936-37; Seventh Corps Area 1937-41; Fort Leonard Wood, MO, 1941

Constituted in the Regular Army 21 December 1928, assigned to the Zone of the Interior, and allotted to the First Corps Area. Withdrawn from the First Corps Area 28 November 1928 and allotted to the Seventh Corps Area. Withdrawn from the Seventh Corps Area and allotted to the First Corps Area. Organized by August 1929 with Organized Reserve personnel as a RAI unit with headquarters at Worcester, MA. Relieved from the Zone of the Interior 1 October 1933 and assigned to the General Headquarters Reserve. Withdrawn from the First Corps Area 5 June 1936 and allotted to the Seventh Corps Area. Reorganized 27 May 1937 with Organized Reserve personnel as a RAI unit in the Seventh Corps Area. Activated 1 May 1941 at Fort Leonard Wood, MO, and assigned to the Second Army. Location 7 December 1941—Fort Leonard Wood, MO.

Status: Inactive in the Regular Army as the 147th General Hospital.**Commanders, 147th General Hospital**

Unknown	ao Aug 29-19 May 34	Unknown	ao Sep 34-5 Jun 36
1st Lt. Erin Cook**	19 May 34-ao Sep 34	<i>Inactive</i>	5 Jun 36-27 May 37
	Unknown	27 May 37-7 Dec 41	

** RAI Commanders: Organized Reserve officers.

148th General Hospital (I) (Z.I.)**Organized Reserve Massachusetts****HQ-Not initiated** 1923-26; Fall River, MA, 1926-28

Constituted in the Organized Reserve 2 July 1923, assigned to the Zone of the Interior, and allotted to the First Corps Area. Initiated by April 1926 at Fall River, MA. Withdrawn from the First Corps Area 5 September 1928 and demobilized.

Commanders, 148th General Hospital (I)

Maj. Frank C. Leavitt	ao Apr 26-5 Sep 28
-----------------------	--------------------

148th General Hospital (II) (Z.I.)**Regular Army Inactive****HQ-Not organized** 1928-29; Fall River, MA, 1929-36; *Inactive* 1936-41; Camp Shelby, MS, 1941

Constituted in the Regular Army 21 December 1928, assigned to the Zone of the Interior, and allotted to the First Corps Area. Withdrawn from the First Corps Area 28 November 1928 and allotted to the Seventh Corps Area. Withdrawn from the Organized Reserve 21 December 1928 and allotted to the Regular Army. Concurrently, withdrawn from the Seventh Corps Area and allotted to First Corps Area. Organized by August 1929 with Organized Reserve personnel as a RAI unit with headquarters at Fall River, MA. Relieved from the Zone of the Interior 1 October 1933 and assigned to the General Headquarters Reserve. Withdrawn from the First Corps Area 5 June 1936 and allotted to the Seventh Corps Area. Activated 10 February 1941 at Camp Shelby, MS, and assigned to the Third Army. Location 7 December 1941—Camp Shelby, MS.

Status: Disbanded 15 May 1946.**Commanders, 148th General Hospital (II)**

Unknown	ao Aug 29-ao Jan 34	Lt. Col. George E. Perkins**	ao May 36-5 Jun 36
Capt. Meyer Winer**	ao Jan 34-ao Sep 34	<i>Inactive</i>	5 Jun 36-10 Feb 41
Unknown	ao Sep 34-ao May 36	Unknown	10 Feb 41-7 Dec 41

** RAI Commanders: Organized Reserve officers.

149th General Hospital (I) (Z.I.)**Organized Reserve Connecticut****HQ-Not initiated** 1923-28

Constituted in the Organized Reserve 2 July 1923, assigned to the Zone of the Interior, and allotted to the First Corps Area. Bridgeport, CT, designated as headquarters on organization, but the unit was never organized at that location. Withdrawn from the First Corps Area 5 September 1928 and demobilized.

149th General Hospital (II) (Z.I.)**Regular Army Inactive****HQ-Not organized** 1928-38; Elizabeth, NJ, 1938-41

Constituted in the Regular Army 5 September 1928, assigned to the Zone of the Interior, and allotted to the First Corps Area. Bridgeport, CT, designated as headquarters on organization, but the unit was never organized at that location. Relieved from the Zone of the Interior 1 October 1933 and assigned to the General Headquarters Reserve. Withdrawn from the First Corps Area 5 June 1936 and allotted to Second Corps Area. Organized by June 1938 with Organized Reserve personnel as a RAI unit with headquarters at Elizabeth, NJ. Location 7 December 1941—Elizabeth, NJ.

Status: Disbanded 11 November 1944.**Commanders, 149th General Hospital (II)**

Col. Lancelot Ely**	ao Jun 38-1 Jun 39	Unknown	21 Jun 41-6 Sep 41
Lt. Col. Edgar T. Flint**	1 Jun 39-21 Jun 41	Col. Earl LeR. Wood**	6 Sep 41-ao Dec 41

** RAI Commanders: Organized Reserve officers.

150th General Hospital (Z.I.)**Organized Reserve New York****HQ-Not initiated** 1923-30; Albany, NY, 1930-41

Constituted in the Organized Reserve 5 September 1928, assigned to the Zone of the Interior, and allotted to the First Corps Area. Withdrawn from the Organized Reserve 21 December 1928 and allotted to the Regular Army. Initiated 4 February 1930 with Organized Reserve personnel as a RAI unit with headquarters at Albany, NY. Relieved from the Zone of the Interior 1 October 1933 and assigned to the General Headquarters Reserve. Withdrawn from the Regular Army 1 July 1940 and allotted to the Organized Reserve. Conducted summer training at Carlisle Barracks, PA. Location 7 December 1941—Albany, NY.

Status: Disbanded 11 November 1944.

Commanders, 150th General Hospital

Lt. Col. Robert L. Crockett**	4 Feb 30-29 May 37	Lt. Col. Edward N. Parkard**	3 Nov 37-15 Mar 38
Maj. Ray D. Champlin**	13 Jul 37-3 Nov 37	Col. John W. Turner**	15 Mar 38-9 Aug 39
	Unknown	9 Aug 39-7 Dec 41	

** RAI Commanders: Organized Reserve officers.

151st General Hospital (Z.I.)

Organized Reserve Massachusetts/New York

HQ-Not initiated 1923-29; New York City, NY, 1929-41

Constituted in the Organized Reserve 5 September 1928, assigned to the Zone of the Interior, and allotted to the First Corps Area. Boston, MA, designated as headquarters on organization, but the unit was never organized at that location. Withdrawn from the First Corps Area 28 November 1928 and allotted to the Second Corps Area. Initiated 6 December 1929 at New York City, NY. Location 7 December 1941—New York City, NY.

Status: Disbanded 11 November 1944.

Commanders, 151st General Hospital

Maj. Karl Metz	6 Dec 29-19 Dec 29	Lt. Col. Samuel E. Getty	4 Mar 30-ao Apr 30
Col. John H. Telfair	19 Dec 29-4 Mar 30	Unknown	ao Apr 30-ao Jun 32
	Col. John H. Telfair	ao Jun 32-ao Jun 41	

152nd General Hospital (Z.I.)

Organized Reserve Massachusetts/New York

HQ-Not initiated 1928-30; Utica, NY, 1930-37; *Inactive* 1937-41; New York City, NY, 1937-41

Constituted in the Organized Reserve 5 September 1928, assigned to the Zone of the Interior, and allotted to the First Corps Area. Bedford, MA, designated as headquarters on organization, but the unit was never organized at that location. Withdrawn from the First Corps Area 28 November 1928 and allotted to the Second Corps Area. Initiated 4 February 1930 at Utica, NY. Conducted summer training in 1932 at Fort Niagara, NY. Inactivated 13 May 1937 at Utica by relief of personnel. Reorganized 1 May 1941 at New York City, NY. Occasionally conducted Inactive Training Period meetings at the Syracuse University Hospital. Location 7 December 1941—New York City, NY.

Status: Disbanded 11 November 1944.

Commanders, 152nd General Hospital

Col. Owen H. Kenan	4 Feb 30-30 Mar 30	Unknown	ao Aug 35-ao Jan 37
Lt. Col. James Breslin	10 May 30-7 Nov 33	Lt. Col. James Breslin	ao Jan 37-7 May 37
Lt. Col. Garrett W. Timmers	7 Nov 33-28 Aug 35	<i>Inactive</i>	13 May 37-1 May 41
	Col. Harry A. Steckel	1 May 41-ao Dec 41	

153rd General Hospital (Z.I.)

Organized Reserve New York

HQ-Not initiated 1928-30; Schenectady, NY, 1930-37; *Inactive* 1937-41

Constituted in the Organized Reserve 5 September 1928, assigned to the Zone of the Interior, and allotted to the Second Corps Area. Initiated 4 February 1930 at Schenectady, NY. Inactivated 11 May 1937 at Schenectady by relief of personnel. Location 7 December 1941—Schenectady, NY.

Status: Disbanded 30 January 1942.

Commanders, 153rd General Hospital

1st Lt. Charles R. Marsh	4 Feb 30-6 Mar 30	Lt. Col. Alexander W. Jacobs	25 Apr 32-26 Jul 33
Col. Albert Pfeiffer	6 Mar 30-8 Mar 32	Lt. Col. Charles W. Woodall	26 Jul 33-11 May 37
Lt. Col. Charles W. Woodall	8 Mar 32-25 Apr 32	<i>Inactive</i>	11 May 37-7 Dec 41

154th General Hospital (Z.I.)**Organized Reserve New York****HQ**-*Not initiated* 1928-41

Constituted in the Organized Reserve 5 September 1928, assigned to the Zone of the Interior, and allotted to the Second Corps Area. Troy, NY, designated as headquarters on organization, but the unit was never organized at that location. Location 7 December 1941—*Not initiated*.

Status: Disbanded 30 January 1942.**155th General Hospital (Z.I.)****Organized Reserve New York****HQ**-*Not initiated* 1928-30; Binghamton, NY, 1930-37; *Inactive* 1937-41

Constituted in the Organized Reserve 5 September 1928, assigned to the Zone of the Interior, and allotted to the Second Corps Area. Initiated 4 March 1930 at Binghamton, NY. Conducted summer training at Carlisle Barracks, PA. Inactivated 13 May 1937 at Binghamton by relief of personnel. Location 7 December 1941—*Inactive*.

Status: Disbanded 30 January 1942.**Commanders, 155th General Hospital**

Col. Walter A. Sherwood

4 Mar 30-21 Nov 31
*Inactive*Col. Royden M. Vose
13 May 37-7 Dec 41

20 Jan 32-11 May 37

156th General Hospital (Z.I.)**Organized Reserve New York****HQ**-*Not initiated* 1928-41

Constituted in the Organized Reserve 5 September 1928, assigned to the Zone of the Interior, and allotted to the Second Corps Area. Niagara Falls, NY, designated as headquarters on organization, but the unit was never organized at that location. Location 7 December 1941—*Not initiated*.

Status: Disbanded 30 January 1942.**157th General Hospital (Z.I.)****Organized Reserve New Jersey****HQ**-*Not initiated* 1928-29; Paterson, NJ, 1929-38; *Inactive* 1938-41

Constituted in the Organized Reserve 5 September 1928, assigned to the Zone of the Interior, and allotted to the Second Corps Area. Initiated 6 December 1929 at Paterson, NJ. Inactivated 14 May 1938 at Paterson by relief of personnel. Morristown, NJ, designated as headquarters on reorganization, but the unit was never organized at that location. Location 7 December 1941—*Inactive*.

Status: Inactive in the U.S. Army Reserve as the 457th General Hospital.**Commanders, 157th General Hospital**

Lt. Col. Ira Cohen

6 Dec 29-4 Mar 30
*Inactive*Col. Alvin W. Schoenleber
14 May 38-7 Dec 41

4 Mar 30-14 May 38

158th General Hospital (Z.I.)**Organized Reserve New Jersey****HQ**-*Not initiated* 1928-41

Constituted in the Organized Reserve 5 September 1928, assigned to the Zone of the Interior, and allotted to the Second Corps Area. Trenton, NJ, designated as headquarters on organization, but the unit was never organized at that location. Designated headquarters location changed in 1937 to Paterson, NJ, but the unit was never organized at that location. Location 7 December 1941—*Not initiated*.

Status: Disbanded 30 January 1942.

159th General Hospital (Z.I.)**Organized Reserve New Jersey****HQ-Not initiated** 1928-30; Camden, NJ, 1930-36; *Inactive* 1936-41

Constituted in the Organized Reserve 5 September 1928, assigned to the Zone of the Interior, and allotted to the Second Corps Area. Initiated 4 March 1930 at Camden, NJ. Inactivated 11 December 1936 at Camden by relief of personnel. Montclair, NJ, designated as headquarters on reorganization, but the unit was never organized at that location. Location 7 December 1941—*Inactive*.

Status: Disbanded 30 January 1942.**Commanders, 159th General Hospital**

Col. Sheridan H. Baketel

4 Mar 30-11 Dec 36

Inactive

11 Dec 36-7 Dec 41

160th General Hospital (Z.I.)**Organized Reserve New Jersey****HQ-Not initiated** 1928-41

Constituted in the Organized Reserve 5 September 1928, assigned to the Zone of the Interior, and allotted to the Second Corps Area. Bayonne, NJ, designated as headquarters on organization, but the unit was never organized at that location. Designated headquarters location changed to Orange, NJ, IN, 1937, but the unit was never organized at that location. Location 7 December 1941—*Not initiated*.

Status: Disbanded 30 January 1942.**161st General Hospital (Z.I.)****Organized Reserve New Jersey****HQ-Not initiated** 1928-41

Constituted in the Organized Reserve 5 September 1928, assigned to the Zone of the Interior, and allotted to the Second Corps Area. Hoboken, NJ, designated as headquarters on organization, but the unit was never organized at that location. Designated headquarters location changed in 1937 to Bloomfield, NJ, but the unit was never organized at that location. Location 7 December 1941—*Not initiated*.

Status: Disbanded 30 January 1942.**162nd General Hospital (Z.I.)****Organized Reserve New Jersey****HQ-Not initiated** 1928-41

Constituted in the Organized Reserve 5 September 1928, assigned to the Zone of the Interior, and allotted to the Second Corps Area. Passaic, NJ, designated as headquarters on organization, but the unit was never organized at that location. Designated headquarters location changed in 1937 to Newark, NJ, but the unit was never organized at that location. Location 7 December 1941—*Not initiated*.

Status: Disbanded 30 January 1942.**163rd General Hospital (Z.I.)****Organized Reserve New Jersey****HQ-Not initiated** 1928-30; East Orange, NJ, 1930-37; *Inactive* 1937-41

Constituted in the Organized Reserve 5 September 1928, assigned to the Zone of the Interior, and allotted to the Second Corps Area. Initiated 4 March 1930 at East Orange, NJ. Inactivated 29 November 1937 at East Orange by relief of personnel. Passaic, NJ, designated as headquarters on reorganization, but the unit was never organized at that location. Location 7 December 1941—*Inactive*.

Status: Disbanded 30 January 1942.

Commanders, 163rd General Hospital

Col. William F. Honan	4 Mar 30-22 Nov 30 <i>Inactive</i>	Lt. Col. James S. Knowles 29 Nov 37-7 Dec 41	22 Nov 30-29 Nov 37
-----------------------	---------------------------------------	---	---------------------

164th General Hospital (Z.I.)

Organized Reserve New Jersey

HQ-*Not initiated* 1928-30; Atlantic City, NJ, 1930-34; *Inactive* 1934-41

Constituted in the Organized Reserve 5 September 1928, assigned to the Zone of the Interior, and allotted to the Second Corps Area. Initiated 5 March 1930 at Atlantic City, NJ. Inactivated 17 December 1934 at Atlantic City by relief of personnel. East Orange, NJ, designated as headquarters on reorganization, but the unit was never organized at that location. Location 7 December 1941—*Inactive*.

Status: Disbanded 30 January 1942.

Commanders, 164th General Hospital

Col. William C. Davis	5 Mar 30-17 Dec 34	<i>Inactive</i>	17 Dec 34-7 Dec 41
-----------------------	--------------------	-----------------	--------------------

165th General Hospital (Z.I.)

Organized Reserve New York

HQ-*Not initiated* 1928-30; Elmira, NY, 1930-37; *Inactive* 1937-41

Constituted in the Organized Reserve 5 September 1928, assigned to the Zone of the Interior, and allotted to the Second Corps Area. Initiated 5 March 1930 at Elmira, NY. Primary R.O.T.C. feeder school was the University of Buffalo. Inactivated 21 August 1936 at Elmira by relief of personnel. East Orange, NJ, designated as headquarters on reorganization, but the unit was never organized at that location. Location 7 December 1941—*Inactive*.

Status: Disbanded 30 January 1942.

Commanders, 165th General Hospital

Col. John M. Swan	5 Mar 30-2 Feb 34	Unknown	30 Apr 36-21 Aug 36
Maj. Adrian G. Gould	17 May 34-30 Apr 36	<i>Inactive</i>	21 Aug 36-7 Dec 41

166th General Hospital (Z.I.)

Organized Reserve New York

HQ-*Not initiated* 1928-41

Constituted in the Organized Reserve 5 September 1928, assigned to the Zone of the Interior, and allotted to the Second Corps Area. Mount Vernon, NY, designated as headquarters on organization, but the unit was never organized at that location. Location 7 December 1941—*Inactive*.

Status: Disbanded 30 January 1942.

167th General Hospital (Z.I.)

Organized Reserve New York

HQ-*Not initiated* 1928-30; Jamestown, NY, 1930-37; *Inactive* 1937-39; Jamestown, NY, 1939-41

Constituted in the Organized Reserve 5 September 1928, assigned to the Zone of the Interior, and allotted to the Second Corps Area. Initiated 5 March 1930 at Jamestown, NY. Primary R.O.T.C. feeder school was the University of Buffalo. Inactivated 12 May 1937 at Jamestown by transfer of personnel to the 72nd General Hospital. Reorganized by January 1939 at Jamestown. Location 7 December 1941—Jamestown, NY.

Status: Disbanded 30 January 1942.

Commanders, 167th General Hospital

1st Lt. Donald R. Alvarez	5 Mar 30-ao Jun 30	Lt. Col. Hall G. Van Vlack	3 Mar 34-12 May 37
Unknown	ao Jun 30-29 Oct 31	<i>Inactive</i>	12 May 37-ao Jan 39
Lt. Col. Raymond G. Bell	29 Oct 31-3 Mar 34	Col. James B. Schreiter	ao Jan 39-May 39
	Unknown	May 39-7 Dec 41	

168th General Hospital (Z.I.)

Organized Reserve New York

HQ-*Not initiated* 1928-41

Constituted in the Organized Reserve 5 September 1928, assigned to the Zone of the Interior, and allotted to the Second Corps Area. New Rochelle, NY, designated as headquarters on organization, but the unit was never organized at that location. Location 7 December 1941—*Not initiated*.

Status: Disbanded 30 January 1942.

169th General Hospital (Z.I.)

Organized Reserve New York

HQ-*Not initiated* 1928-30; Auburn, NY, 1930-41

Constituted in the Organized Reserve 5 September 1928, assigned to the Zone of the Interior, and allotted to the Second Corps Area. Initiated 29 January 1930 at Auburn, NY. Conducted summer training at Carlisle Barracks, PA. Location 7 December 1941—Auburn, NY.

Status: Disbanded 30 January 1942.

Commanders, 169th General Hospital

Maj. Joseph P. Henry	29 Jan 30-5 Mar 30	Col. Hans Hansen	19 Jan 39-14 Dec 39
Col. Montgomery E. Leary	5 Mar 30-19 Jul 32	Lt. Col. Ralph E. Brodie	14 Dec 39-28 Jan 41
Lt. Col. Ralph E. Brodie	19 Jul 32-19 Jan 39	Col. Royden M. Vose	28 Jan 41-13 Dec 41

170th General Hospital (Z.I.)

Organized Reserve New Jersey

HQ-*Not initiated* 1928-30; Perth Amboy, NJ, 1930; *Inactive* 1930-41

Constituted in the Organized Reserve 5 September 1928, assigned to the Zone of the Interior, and allotted to the Second Corps Area. Initiated 29 January 1930 at Perth Amboy, NJ. Inactivated by June 1930 at Perth Amboy by relief of personnel. Dover, NJ, designated in 1937 as headquarters on reorganization, but the unit was never organized at that location. Location 7 December 1941—*Not initiated*.

Status: Disbanded 30 January 1942.

Commanders, 170th General Hospital

1st Lt. Ralph E. Brown	19 Mar 30-ao Apr 30	<i>Inactive</i>	ao Jun 30-7 Dec 41
------------------------	---------------------	-----------------	--------------------

171st General Hospital (Z.I.)

Organized Reserve New Jersey

HQ-*Not initiated* 1928-41

Constituted in the Organized Reserve 5 September 1928, assigned to the Zone of the Interior, and allotted to the Second Corps Area. Perth Amboy, NJ, designated as headquarters on organization, but the unit was never organized at that location. Location 7 December 1941—*Not initiated*.

Status: Disbanded 30 January 1942.

172nd General Hospital (Z.I.)**Organized Reserve New Jersey****HQ-Not initiated** 1928-41

Constituted in the Organized Reserve 5 September 1928, assigned to the Zone of the Interior, and allotted to the Second Corps Area. Orange, NJ, designated as headquarters on organization, but the unit was never organized at that location. Designated headquarters location changed in 1937 to Hackensack, NJ, but the unit was never organized at that location. Location 7 December 1941—*Not initiated*.

Status: Inactive in the U.S. Army Reserve as the 455th Field Hospital.**173rd General Hospital (Z.I.)****Organized Reserve New Jersey****HQ-Not initiated** 1928-30; Brunswick, NJ, 1930-38; *Inactive* 1938-41

Constituted in the Organized Reserve 5 September 1928, assigned to the Zone of the Interior, and allotted to the Second Corps Area. Initiated 20 February 1930 at Brunswick, NJ. Inactivated by November 1938 at Brunswick by relief of personnel. Location 7 December 1941—*Inactive*.

Status: Disbanded 30 January 1942.**Commanders, 173rd General Hospital**

Lt. Col. George B. Emory	20 Feb 30-5 Mar 30	Col. Lancelot Ely	29 Dec 34-ao May 37
Col. Arthur W. Slee	5 Mar 30-ao Jun 33	Unknown	ao May 37-ao Nov 38
Unknown	ao Jun 33-29 Dec 34	<i>Inactive</i>	ao Nov 38-7 Dec 41

174th General Hospital (Z.I.)**Organized Reserve New Jersey****HQ-Not initiated** 1928-30; West New York, NJ, 1930-38; *Inactive* 1938-41

Constituted in the Organized Reserve 5 September 1928, assigned to the Zone of the Interior, and allotted to the Second Corps Area. Initiated 5 March 1930 at West New York, NJ. Inactivated by November 1938 at West New York by relief of personnel. Location 7 December 1941—*Inactive*.

Status: Disbanded 30 January 1942.**Commanders, 174th General Hospital**

Col. Joseph C. DeVries	5 Mar 30-23 Sep 35	Unknown	23 Sep 35-ao Jun 38
	<i>Inactive</i>	ao Jun 38-7 Dec 41	

175th General Hospital (Z.I.)**Organized Reserve New York****HQ-Not initiated** 1928-30; Poughkeepsie, NY, 1930-37; New York City, NY, 1937-41

Constituted in the Organized Reserve 5 September 1928, assigned to the Zone of the Interior, and allotted to the Second Corps Area. Initiated 5 March 1930 at Poughkeepsie, NY. Relocated by November 1937 to New York City, NY. Location 7 December 1941—New York City, NY.

Status: Disbanded 30 January 1942.**Commanders, 175th General Hospital**

Col. Raymond P. Sullivan	5 Mar 30-ao Jun 33	Capt. Wilbur J. Bowman	3 Mar 34-13 Dec 39
Unknown	ao Jun 33-3 Mar 34	Col. Hyman I. Teperson	13 Dec 39-ao Jun 41

176th General Hospital (Z.I.)**Organized Reserve New Jersey****HQ-***Not initiated* 1928-29; Montclair, NJ, 1929-37; *Inactive* 1937-41

Constituted in the Organized Reserve 5 September 1928, assigned to the Zone of the Interior, and allotted to the Second Corps Area. Initiated in December 1929 at Montclair, NJ. Inactivated by March 1937 at Montclair by relief of personnel. New Brunswick, NJ, designated as headquarters on reorganization, but the unit was never organized at that location. Location 7 December 1941—*Inactive*.

Status: Disbanded 30 January 1942.**Commanders, 176th General Hospital**

Maj. Roger A. McCullough	Dec 29-5 Mar 30	Lt. Col. George W. Conterno	21 Jul 33-10 Sep 35
Col. Martin J. Synnott	5 Mar 30-21 Jul 33 <i>Inactive</i>	Unknown ao Mar 37-7 Dec 41	10 Sep 35-ao Mar 37

177th General Hospital (Z.I.)**Organized Reserve New York****HQ-***Not initiated* 1928-30; Amsterdam, NY, 1930-34; *Inactive* 1934-41

Constituted in the Organized Reserve 5 September 1928, assigned to the Zone of the Interior, and allotted to the Second Corps Area. Initiated 5 March 1930 at Amsterdam, NY. Inactivated by December 1934 at Amsterdam by relief of personnel. Rochester, NY, designated as headquarters on reorganization, but the unit was never organized at that location. Location 7 December 1941—*Inactive*.

Status: Disbanded 30 January 1942.**Commanders, 177th General Hospital**

Col. Michael M. Lucid	5 Mar 30-21 Apr 33 <i>Inactive</i>	Unknown ao Dec 34-7 Dec 41	21 Apr 33-ao Dec 34
-----------------------	---------------------------------------	-------------------------------	---------------------

178th General Hospital (Z.I.)**Organized Reserve New Jersey****HQ-***Not initiated* 1928-30; Plainfield, NJ, 1930-37; *Inactive* 1937-41

Constituted in the Organized Reserve 5 September 1928, assigned to the Zone of the Interior, and allotted to the Second Corps Area. Initiated 6 March 1930 at Plainfield, NJ. Inactivated 28 January 1937 at Plainfield by relief of personnel. Location 7 December 1941—*Inactive*.

Status: Disbanded 30 January 1942.**Commanders, 178th General Hospital**

Col. Harold D. Corbusier	6 Mar 30-28 Jan 37
--------------------------	--------------------

179th General Hospital (Z.I.)**Organized Reserve New York****HQ-***Not initiated* 1928-30; Watertown, NY, 1930-34; *Inactive* 1934-41

Constituted in the Organized Reserve 5 September 1928, assigned to the Zone of the Interior, and allotted to the Second Corps Area. Initiated 10 May 1930 at Watertown, NY. Inactivated by December 1934 at Watertown by relief of personnel. Syracuse, NY, designated as headquarters on reorganization, but the unit was never organized at that location. Location 7 December 1941—*Inactive*.

Status: Disbanded 30 January 1942.**Commanders, 179th General Hospital**

Maj. Charles A. Krauss	10 May 30-25 Apr 32	Unknown	ao Jun 33-ao Dec 34
Lt. Col. Harry B. Williams	25 Apr 32-ao Jun 33 <i>Inactive</i>		ao Dec 34-7 Dec 41

180th General Hospital (Z.I.)**Organized Reserve New Jersey****HQ-Not initiated** 1928-30; Kearney, NJ, 1930-34; *Inactive* 1934-41

Constituted in the Organized Reserve 5 September 1928, assigned to the Zone of the Interior, and allotted to the Second Corps Area. Initiated 19 March 1930 at Kearney, NJ. Inactivated by December 1934 at Kearney by relief of personnel. Trenton, NJ, designated as headquarters on reorganization, but the unit was never organized at that location. Location 7 December 1941—*Inactive*.

Status: Disbanded 30 January 1942.**Commanders, 180th General Hospital**

Lt. Col. Edward W. Peterson	4 Mar 30-ao Jun 34 <i>Inactive</i>	Unknown ao Dec 34-7 Dec 41	ao Jun 34-ao Dec 34
-----------------------------	---------------------------------------	-------------------------------	---------------------

181st General Hospital (Z.I.)**Organized Reserve Delaware/New Jersey****HQ-Not initiated** 1928-30; Wilmington, DE, 1930-37; *Inactive* 1937-41

Constituted in the Organized Reserve 5 September 1928, assigned to the Zone of the Interior, and allotted to the Second Corps Area. Initiated 6 March 1930 at Wilmington, DE. Inactivated by December 1937 at Wilmington by relief of personnel. Camden, NJ, designated as headquarters on reorganization, but the unit was never organized at that location. Location 7 December 1941—*Inactive*.

Status: Disbanded 30 January 1942.**Commanders, 181st General Hospital**

Maj. William H. Speer	5 Mar 30-8 Aug 30	Unknown	ao Jul 37-ao Dec 37
Col. Meredith I. Samuel	8 Aug 30-ao Jul 37	<i>Inactive</i>	ao Dec 37-7 Dec 41

182nd General Hospital (Z.I.)**Organized Reserve New York****HQ-Not initiated** 1928-29; Buffalo, NY, 1929-37; Rochester, NY, 1937-41

Constituted in the Organized Reserve 5 September 1928, assigned to the Zone of the Interior, and allotted to the Second Corps Area. Withdrawn from the Organized Reserve 21 December 1928 and allotted to the Regular Army. Initiated 5 April 1929 at Buffalo, NY. Relieved from the Zone of the Interior 1 October 1933 and assigned to the General Headquarters Reserve. Relocated by November 1937 to Rochester, NY. Withdrawn from the Regular Army 1 July 1940 and allotted to the Organized Reserve. Location 7 December 1941—Rochester, NY.

Status: Active in the U.S. Army Reserve as the 452nd Combat Support Hospital at Milwaukee, WI.**Commanders, 182nd General Hospital**

Maj. Charles W. Selour**	5 Apr 29-4 Feb 30	Maj. John F. Kellogg**	14 Sep 39-20 Feb 40
Lt. Col. Edwin W. Gates**	4 Feb 30-24 May 30	Lt. Col. John D. Fowler**	20 Feb 40-13 Feb 41
Lt. Col. William W. Schairer**	24 May 30-14 Sep 39	Maj. John F. Kellogg	13 Feb 41-3 Apr 41
	Maj. James H. Van Marter	3 Apr 41-ao Dec 41	

** RAI Commanders: Organized Reserve officers.

183rd General Hospital (Z.I.)**Organized Reserve Pennsylvania****HQ-Not initiated** 1928-30; Philadelphia, PA, 1930-41; Fort Sill, OK, 1941

Constituted in the Organized Reserve 5 September 1928, assigned to the Zone of the Interior, and allotted to the Third Corps Area. Withdrawn from the Organized Reserve 21 December 1928 and allotted to the Regular Army. Concurrently relieved from the Zone of the Interior and assigned to the General Headquarters Reserve. Initiated 18 July 1930 at Philadelphia, PA. Activated 10 February 1941, less Reserve personnel, at Fort Sill, OK. Location 7 December 1941—Fort Sill, OK.

Status: Disbanded 11 November 1944.

Commanders, 183rd General Hospital

Lt. Col. David H. Keller**	18 Jul 30-16 Feb 38	Lt. Col. Sylvanus D. Newton**	16 Feb 38-10 Feb 41
	Unknown	10 Feb 41-7 Dec 41	

** RAI Commanders: Organized Reserve officers.

184th General Hospital (Z.I.)

Organized Reserve Pennsylvania

HQ-Not initiated 1928-41

Constituted in the Organized Reserve 5 September 1928, assigned to the Zone of the Interior, and allotted to the Third Corps Area. Philadelphia, PA, designated as headquarters on organization, but the unit was never organized at that location. Location 7 December 1941—*Not initiated*.

185th General Hospital (Z.I.)

Organized Reserve Pennsylvania

HQ-Not initiated 1928-41

Constituted in the Organized Reserve 5 September 1928, assigned to the Zone of the Interior, and allotted to the Third Corps Area. Philadelphia, PA, designated as headquarters on organization, but the unit was never organized at that location. Location 7 December 1941—*Not initiated*.

186th General Hospital (Z.I.)

Organized Reserve Pennsylvania

HQ-Not initiated 1928-41

Constituted in the Organized Reserve 5 September 1928, assigned to the Zone of the Interior, and allotted to the Third Corps Area. Philadelphia, PA, designated as headquarters on organization, but the unit was never organized at that location. Location 7 December 1941—*Not initiated*.

187th General Hospital (Z.I.)

Organized Reserve Pennsylvania

HQ-Not initiated 1928-37; Philadelphia, PA, 1937-41

Constituted in the Organized Reserve 5 September 1928, assigned to the Zone of the Interior, and allotted to the Third Corps Area. Initiated by October 1937 at Philadelphia, PA. Location 7 December 1941—Philadelphia, PA.

Commanders, 187th General Hospital

Lt. Col. William A. Wood	ao Oct 37-ao Jan 38	Unknown	ao Jan 38-7 Dec 41
--------------------------	---------------------	---------	--------------------

188th General Hospital (Z.I.)

Organized Reserve Maryland

HQ-Not initiated 1928-41

Constituted in the Organized Reserve 5 September 1928, assigned to the Zone of the Interior, and allotted to the Third Corps Area. Baltimore, MD, designated as headquarters on organization, but the unit was never organized at that location. Location 7 December 1941—*Not initiated*.

189th General Hospital (Z.I.)**Organized Reserve Maryland**

HQ-*Not initiated* 1923-28; Baltimore, MD, 1928-29; *Inactive* 1929-41

Constituted in the Organized Reserve 5 September 1928, assigned to the Zone of the Interior, and allotted to the Third Corps Area. Initiated by January 1929 at Baltimore, MD. Inactivated in November 1929 at Baltimore by relief of personnel. Location 7 December 1941—*Inactive*.

Commanders, 189th General Hospital

Lt. Col. Charles G. Baird

Jan 29-Nov 29

Inactive

Nov 29-7 Dec 41

190th General Hospital (Z.I.)**Organized Reserve Maryland**

HQ-*Not initiated* 1928-41

Constituted in the Organized Reserve 5 September 1928, assigned to the Zone of the Interior, and allotted to the Third Corps Area. Baltimore, MD, designated as headquarters on organization, but the unit was never organized at that location. Location 7 December 1941—*Not initiated*.

Status: Disbanded 30 January 1942.

191st General Hospital (Z.I.)**Organized Reserve Maryland**

HQ-*Not initiated* 1928-41

Constituted in the Organized Reserve 5 September 1928, assigned to the Zone of the Interior, and allotted to the Third Corps Area. Baltimore, MD, designated as headquarters on organization, but the unit was never organized at that location. Location 7 December 1941—*Not initiated*.

Status: Disbanded 30 January 1942.

192nd General Hospital (Z.I.)**Organized Reserve Pennsylvania**

HQ-*Not initiated* 1928-41

Constituted in the Organized Reserve 5 September 1928, assigned to the Zone of the Interior, and allotted to the Third Corps Area. Pittsburgh, PA, designated as headquarters on organization, but the unit was never organized at that location. Location 7 December 1941—*Not initiated*.

Status: Disbanded 30 January 1942.

193rd General Hospital (Z.I.)**Organized Reserve Pennsylvania**

HQ-*Not initiated* 1928-41

Constituted in the Organized Reserve 5 September 1928, assigned to the Zone of the Interior, and allotted to the Third Corps Area. Pittsburgh, PA, designated as headquarters on organization, but the unit was never organized at that location. Location 7 December 1941—*Not initiated*.

Status: Disbanded 30 January 1942.

194th General Hospital (Z.I.)**Organized Reserve Pennsylvania****HQ-***Not initiated* 1928-41

Constituted in the Organized Reserve 5 September 1928, assigned to the Zone of the Interior, and allotted to the Third Corps Area. Pittsburgh, PA, designated as headquarters on organization, but the unit was never organized at that location. Location 7 December 1941—*Not initiated*.

Status: Disbanded 30 January 1942.**195th General Hospital (Z.I.)****Organized Reserve District of Columbia****HQ-***Not initiated* 1928-41

Constituted in the Organized Reserve 5 September 1928, assigned to the Zone of the Interior, and allotted to the Third Corps Area. Washington, DC, designated as headquarters on organization, but the unit was never organized at that location. Location 7 December 1941—*Not initiated*.

Status: Disbanded 30 January 1942.**196th General Hospital (Z.I.)****Organized Reserve District of Columbia****HQ-***Not initiated* 1928-41

Constituted in the Organized Reserve 5 September 1928, assigned to the Zone of the Interior, and allotted to the Third Corps Area. Washington, DC, designated as headquarters on organization, but the unit was never organized at that location. Location 7 December 1941—*Not initiated*.

Status: Disbanded 30 January 1942.**198th General Hospital (C.Z.)****Organized Reserve Virginia****HQ-***Not initiated* 1928-41

Constituted in the Organized Reserve 5 September 1928, assigned to the Zone of the Interior, and allotted to the Third Corps Area. Richmond, VA, designated as headquarters on organization, but the unit was never organized at that location. Location 7 December 1941—*Not initiated*.

Status: Disbanded 30 January 1942.**199th General Hospital (Z.I.)****Organized Reserve****HQ-***Not initiated* 1928-41

Constituted in the Organized Reserve 5 September 1928, assigned to the Zone of the Interior, and allotted to the Third Corps Area. Location 7 December 1941—*Not initiated*.

Status: Disbanded 30 January 1942.**200th General Hospital (Z.I.)****Organized Reserve Maryland****HQ-***Not initiated* 1928-29; Baltimore, MD, 1929; *Inactive* 1929-41

Constituted in the Organized Reserve 5 September 1928, assigned to the Zone of the Interior, and allotted to the Third Corps Area. Initiated 14 February 1929 at Baltimore, MD. Inactivated in November 1929 at Baltimore by relief of personnel. Location 7 December 1941—*Inactive*.

Status: Disbanded 30 January 1942.

Commanders, 200th General Hospital

Lt. Col. Charles G. Baird	14 Feb 29-Nov 29	<i>Inactive</i>	Nov 29-7 Dec 41
---------------------------	------------------	-----------------	-----------------

201st General Hospital (Z.I.)

Organized Reserve

HQ-*Not initiated* 1928-41

Constituted in the Organized Reserve 5 September 1928, assigned to the Zone of the Interior, and allotted to the Third Corps Area. Withdrawn from the Organized Reserve 1 October 1933 and allotted to the Regular Army. Location 7 December 1941—*Not initiated*.

Status: Disbanded 30 January 1942.

202nd General Hospital (Z.I.)

Organized Reserve District of Columbia

HQ-*Not initiated* 1928-30; Washington, DC, 1930-41

Constituted in the Organized Reserve 5 September 1928, assigned to the Zone of the Interior, and allotted to the Third Corps Area. Withdrawn from the Organized Reserve 21 December 1928 and allotted to the Regular Army. Concurrently relieved from the Zone of the Interior and assigned to the General Headquarters Reserve. Organized 10 November 1930 at Washington, DC. Consolidated 5 September 1936 with Base Hospital No. 202 (a WWI unit organized 14 June 1918 in France; demobilized 27 April 1919 at Camp Dix, NJ; reconstituted 5 September 1936). Withdrawn from the Organized Reserve 1 July 1940 and allotted to the Regular Army. Location 7 December 1941—Washington, DC.

Status: Disbanded 30 January 1942.

Commanders, 202nd General Hospital

Capt. William F. Murphy**	10 Nov 30-8 Jan 31	Col. Clarence M. Dollman**	16 Feb 38-ao Oct 40
Lt. Col. Edward H. Bedrossian**	8 Jan 31-16 Feb 38	Unknown	ao Oct 40-7 Dec 41

** RAI Commanders: Organized Reserve officers.

203rd General Hospital (Z.I.)

Organized Reserve Florida/Maine

HQ-*Not initiated* 1928-31; Jacksonville, FL, 1931-33; *Inactive* 1933-41; Fort Lewis, WA, 1941

Constituted in the Organized Reserve 5 September 1928, assigned to the Zone of the Interior, and allotted to the Fourth Corps Area. Initiated by June 1931 at Jacksonville, FL. Withdrawn from the Organized Reserve 1 October 1933 and allotted to the Regular Army. Concurrently relieved from the Zone of the Interior and assigned to the General Headquarters Reserve. Additionally, withdrawn from the Fourth Corps Area and allotted to the First Corps Area. Lewiston, ME, designated as headquarters on reorganization, but the unit was never organized at that location. Activated 10 February 1941 at Fort Lewis, WA, and assigned to the Fourth Army. Location 7 December 1941—Fort Lewis, WA.

Status: Inactive in the Regular Army as the 203rd General Hospital.

Commanders, 203rd General Hospital

Unknown	ao Jun 31-1 Oct 33	Lt. Col. R. R. Williams*	10 Feb 41-17 Feb 41
<i>Inactive</i>	1 Oct 33-10 Feb 41	Maj. James E. Graham*	17 Feb 41-5 May 42

* Regular Army active duty commanders

204th General Hospital (Z.I.)**Organized Reserve Florida/Massachusetts****HQ-Not initiated** 1928-29; Tampa, FL, 1929-33; *Inactive* 1933-41; Fort Bliss, TX, 1941

Constituted in the Organized Reserve 5 September 1928, assigned to the Zone of the Interior, and allotted to the Fourth Corps Area. Initiated by June 1929 at Tampa, FL. Withdrawn from the Organized Reserve 1 October 1933 and allotted to the Regular Army. Concurrently relieved from the Zone of the Interior and assigned to the General Headquarters Reserve. Additionally, withdrawn from the Fourth Corps Area and allotted to the First Corps Area. Fort Devens, MA, designated as headquarters on reorganization, but the unit was never organized at that location. Activated 10 February 1941 at Fort Bliss, TX, and assigned to the Third Army. Location 7 December 1941—Fort Bliss, TX.

Status: Inactive in the Regular Army as the 204th General Hospital.**Commanders, 204th General Hospital**

Unknown	ao Jun 29-1 Oct 33	<i>Inactive</i>	1 Oct 33-10 Feb 41
	Capt. Byron A. Nichol*	10 Feb 41-ao Jan 42	

* Regular Army active duty commanders

205th General Hospital (Z.I.)**Organized Reserve Florida/New York****HQ-Not initiated** 1928-33; New York City, NY, 1933-41

Constituted in the Organized Reserve 5 September 1928, assigned to the Zone of the Interior, and allotted to the Fourth Corps Area. Jacksonville, FL, designated as headquarters on organization, but the unit was never organized at that location. Withdrawn from the Organized Reserve 1 October 1933 and allotted to the Regular Army. Concurrently relieved from the Zone of the Interior and assigned to the General Headquarters Reserve. Additionally, withdrawn from the Fourth Corps Area and allotted to the Second Corps Area. Organized 16 November 1933 at New York City, NY. Withdrawn from the Regular Army 1 July 1940 and allotted to the Organized Reserve. Conducted summer training at Carlisle Barracks, PA. Location 7 December 1941—New York City, NY.

Status: Disbanded 11 November 1944.**Commanders, 205th General Hospital**

1st Lt. Lewis F. Foster**	16 Nov 33-2 Nov 34	Col. Samuel A. Cohen**	2 Nov 34-ao Jun 41
---------------------------	--------------------	------------------------	--------------------

** RAI Commanders: Organized Reserve officers.

206th General Hospital (Z.I.)**Organized Reserve Louisiana/New York****HQ-Not initiated** 1928-33; New York City, NY, 1933-41

Constituted in the Organized Reserve 5 September 1928, assigned to the Zone of the Interior, and allotted to the Fourth Corps Area. Shreveport, LA, designated as headquarters on organization, but the unit was never organized at that location. Withdrawn from the Organized Reserve 1 October 1933 and allotted to the Regular Army. Concurrently relieved from the Zone of the Interior and assigned to the General Headquarters Reserve. Additionally, withdrawn from the Fourth Corps Area and allotted to the Second Corps Area. Organized 5 December 1933 at New York City, NY. Withdrawn from the Regular Army 1 July 1940 and allotted to the Organized Reserve. Primary R.O.T.C. feeder school was New York University. Location 7 December 1941—New York City, NY.

Status: Disbanded 11 November 1944.**Commanders, 206th General Hospital**

1st Lt. Bernard B. Budinoff**	5 Dec 33-6 Dec 34	Lt. Col. Harry C. W. S. de Brun**	16 Feb 39-23 Apr 40
Lt. Col. Charles P. Gray**	6 Dec 34-16 Feb 39	Lt. Col. Joseph K. Surles**	23 Apr 40-3 May 40
	Unknown	3 May 40-7 Dec 41	

** RAI Commanders: Organized Reserve officers.

207th General Hospital (Z.I.)**Organized Reserve Tennessee/Pennsylvania****HQ-Not initiated** 1928-33; Pittsburgh, PA, 1933-41; Camp Livingston, LA, 1941

Constituted in the Organized Reserve 5 September 1928, assigned to the Zone of the Interior, and allotted to the Fourth Corps Area. Memphis, TN, designated 22 October 1929 as headquarters on organization, but the unit was never organized at that location. Withdrawn from the Organized Reserve 1 October 1933 and allotted to the Regular Army. Concurrently relieved from the Zone of the Interior and assigned to General Headquarters Reserve. Additionally, withdrawn from the Fourth Corps Area and allotted to the Third Corps Area. Organized 13 December 1933 at Pittsburgh, PA. Functioned as a pool unit for excess medical corps lieutenants. Activated 10 February 1941, less Reserve personnel, at Camp Livingston, LA. Concurrently assigned to the Third Army. Location 7 December 1941—Camp Livingston, LA.

Status: Disbanded 11 November 1944.**Commanders, 207th General Hospital**

Lt. Col. Charles S. Flagler**	18 Dec 33-Apr 34	Maj. Harry Epstein**	30 Sep 39-10 Feb 41
Unknown	Apr 34-30 Sep 39	Unknown	10 Feb 41-7 Dec 41

** RAI Commanders: Organized Reserve officers.

208th General Hospital (Z.I.)**Organized Reserve Florida/Pennsylvania****HQ-Not initiated** 1928-34; Philadelphia, PA, 1934-41; Fort Devens, MA, 1941

Constituted in the Organized Reserve 5 September 1928, assigned to the Zone of the Interior, and allotted to the Fourth Corps Area. Orlando, FL, designated 22 October 1929 as headquarters on organization, but the unit was never organized at that location. Withdrawn from the Organized Reserve 1 October 1933 and allotted to the Regular Army. Concurrently relieved from the Zone of the Interior and assigned to General Headquarters Reserve. Additionally, withdrawn from the Fourth Corps Area and allotted to the Third Corps Area. Organized 18 August 1934 at Philadelphia, PA. Functioned as a pool unit for excess medical corps lieutenants. Activated 1 June 1941, less Reserve personnel, at Fort Devens, MA. Concurrently assigned to the First Army. Location 7 December 1941—Fort Devens, MA.

Status: Inactive in the Regular Army as the 327th Station Hospital.**Commanders, 208th General Hospital**

Unknown	18 Aug 34-25 Jul 41	Maj. Charles H. Beasley*	25 Jul 41-ao Dec 41
---------	---------------------	--------------------------	---------------------

* Regular Army active duty commanders

209th General Hospital (Z.I.)**Organized Reserve Florida/Kentucky****HQ-Not initiated** 1928-34; Bowling Green, KY, 1934-41; Fort George G. Meade, MD, 1941

Constituted in the Organized Reserve 5 September 1928, assigned to the Zone of the Interior, and allotted to the Fourth Corps Area. Miami, FL, designated 22 October 1929 as headquarters on organization, but the unit was never organized at that location. Withdrawn from the Organized Reserve 1 October 1933 and allotted to the Regular Army. Concurrently relieved from the Zone of the Interior and assigned to General Headquarters Reserve. Additionally, withdrawn from the Fourth Corps Area and allotted to the Fifth Corps Area. Organized by June 1934 at Bowling Green, KY. Conducted summer training at the station hospital, Fort Knox, KY. Activated 1 June 1941, less Reserve personnel, at Fort George G. Meade, MD. Concurrently assigned to the First Army. Location 7 December 1941—Fort George G. Meade, MD.

Status: Disbanded 11 November 1944.**Commanders, 209th General Hospital**

Lt. Col. Amplias W. Davis	ao Jun 34-ao Jul 35	Unknown	ao Jul 35-1 Jun 41
	Maj. Louis E. Etter*	1 Jun 41-ao Dec 41	

* Regular Army active duty commanders

210th General Hospital (Z.I.)**Organized Reserve Georgia/West Virginia****HQ-Not initiated** 1928-34; Wheeling, WV 1934-41; Fort Dix, NJ, 1941

Constituted in the Organized Reserve 5 September 1928, assigned to the Zone of the Interior, and allotted to the Fourth Corps Area. Savannah, GA, designated 22 October 1929 as headquarters on organization, but the unit was never organized at that location. Withdrawn from the Organized Reserve 1 October 1933 and allotted to the Regular Army. Concurrently relieved from the Zone of the Interior and assigned to General Headquarters Reserve. Additionally, withdrawn from the Fourth Corps Area and allotted to the Fifth Corps Area. Organized by June 1934 at Wheeling, WV. Conducted summer training at the station hospital, Fort Knox, KY. Activated 1 June 1941, less Reserve personnel, at Fort Dix, NJ. Concurrently assigned to the First Army. Location 7 December 1941—Fort Dix, NJ.

Status: Inactive in the Regular Army as the 368th Station Hospital.**Commanders, 210th General Hospital**

Unknown	ao Jun 34-ao Jul 37	Unknown	ao Jul 38-5 Sep 41
Maj. William B. Hunter**	ao Jul 37-ao Jul 38	Lt. Col. Carlton C. Starkes*	5 Sep 41-ao Dec 41

* Regular Army active duty commanders

** RAI Commanders: Organized Reserve officers.

211th General Hospital (Z.I.)**Organized Reserve North Carolina/Michigan****HQ-Not initiated** 1928-34; Detroit, MI, 1934-41

Constituted in the Organized Reserve 5 September 1928, assigned to the Zone of the Interior, and allotted to the Fourth Corps Area. Raleigh, NC, designated 22 October 1929 as headquarters on organization, but the unit was never organized at that location. Designated mobilization station was Fort Oglethorpe, GA. Withdrawn from the Organized Reserve 1 October 1933 and allotted to the Regular Army. Concurrently withdrawn from the Fourth Corps Area and allotted to the Sixth Corps Area. Additionally relieved from the Communications Zone and assigned to the General Headquarters Reserve. Organized by May 1934 at Detroit, MI. Withdrawn from the Regular Army 1 July 1940 and allotted to the Organized Reserve. Conducted summer training at the station hospital, Camp Custer, MI. Location 7 December 1941—Detroit, MI.

Status: Disbanded 30 January 1942.**Commanders, 211th General Hospital**

Lt. Col. Bror H. Larsson**	ao May 34-ao Aug 39	Unknown	ao Aug 39-7 Dec 41
----------------------------	---------------------	---------	--------------------

** RAI Commanders: Organized Reserve officers.

212th General Hospital (Z.I.)**Organized Reserve Georgia/Michigan****HQ-Not initiated** 1928-34; Battle Creek, MI, 1934-38; Kalamazoo, MI, 1938-41; Camp Claiborne, LA, 1941

Constituted in the Organized Reserve 5 September 1928, assigned to the Zone of the Interior, and allotted to the Fourth Corps Area. Augusta, GA, designated 22 October 1929 as headquarters on organization, but the unit was never organized at that location. Withdrawn from the Organized Reserve 1 October 1933 and allotted to the Regular Army. Concurrently withdrawn from the Fourth Corps Area and allotted to the Sixth Corps Area. Additionally relieved from the Zone of the Interior and assigned to the General Headquarters Reserve. Organized by May 1934 at Battle Creek, MI. Relocated by January 1938 to Kalamazoo, MI. Conducted summer training at the station hospital, Camp Custer, MI. Activated 1 June 1941, less Reserve personnel, at Camp Claiborne, LA. Concurrently assigned to the Third Army. Location 7 December 1941—Camp Claiborne, LA.

Status: Disbanded 11 November 1944.**Commanders, 212th General Hospital**

Lt. Col. Willard N. Putnam	ao Jun 34-ao Jun 35	Lt. Col. William E. Allegar	ao Jul 39-1 Jun 41
Unknown	ao Jun 35-ao Jul 39	Unknown	1 Jun 41-7 Dec 41

** RAI Commanders: Organized Reserve officers.

213th General Hospital (Z.I.)**Organized Reserve Tennessee/Ohio**

HQ-Not initiated 1928-35; Nashville, TN, 1935-36; *Inactive* 1936-37; Akron, OH, 1937-41; Camp Bowie, TX, 1941
 Constituted in the Organized Reserve 5 September 1928, assigned to the Zone of the Interior, and allotted to the Fourth Corps Area. Withdrawn from the Organized Reserve 1 October 1933 and allotted to the Regular Army. Concurrently relieved from the Zone of the Interior and assigned to the General Headquarters Reserve. Organized by April 1935 at Nashville, TN. Withdrawn from the Fourth Corps Area 5 June 1936 and allotted to the Fifth Corps Area. Reorganized 6 August 1937 at Akron, OH. Activated 27 June 1941 at Camp Bowie, TX. Concurrently assigned to the Third Army. Location 7 December 1941—Camp Bowie, TX.

Status: Disbanded 11 November 1944.

Commanders, 213th General Hospital

Unknown	ao Apr 35-5 Jun 36	Unknown	6 Aug 37-27 Jun 41
<i>Inactive</i>	5 Jun 36-6 Aug 37	1st Lt. C. H. Talbot*	27 Jun 41-ao Aug 41
	Unknown	Aug 41-7 Dec 41	

214th General Hospital (Z.I.)**Organized Reserve Georgia/Ohio**

HQ-Not initiated 1928-34; Columbus, GA, 1934-36; *Inactive* 1936-37; Dayton, OH, 1937-41; Camp Joseph T. Robinson, AR, 1941

Constituted in the Organized Reserve 5 September 1928, assigned to the Zone of the Interior, and allotted to the Fourth Corps Area. Withdrawn from the Organized Reserve 1 October 1933 and allotted to the Regular Army. Concurrently relieved from the Zone of the Interior and assigned to the General Headquarters Reserve. Organized 9 October 1934 at Columbus, GA. Withdrawn from the Fourth Corps Area 5 June 1936 and allotted to the Fifth Corps Area. Inactivated 30 August 1936 at Columbus by relief of personnel. Reorganized 6 August 1937 at Dayton, OH. Activated 1 June 1941, less Reserve personnel, at Camp Joseph T. Robinson, AR. Concurrently assigned to the Second Army. Location 7 December 1941—Camp Joseph T. Robinson, AR.

Status: Disbanded 11 November 1944.

Commanders, 214th General Hospital

Lt. Col. John D. Gable**	9 Oct 34-30 Aug 36	Unknown	6 Aug 37-1 Jun 41
<i>Inactive</i>	30 Aug 36-6 Aug 37	1st Lt. Oney Raines*	1 Jun 41-ao Jan 42

* Regular Army active duty commanders

** RAI Commanders: Organized Reserve officers.

215th General Hospital (Z.I.)**Organized Reserve Texas/Georgia**

HQ-Not initiated 1928-34; San Antonio, TX, 1934-36; *Inactive* 1936-41; Fort Custer, MI, 1941

Constituted in the Organized Reserve 5 September 1928, assigned to the Zone of the Interior, and allotted to the Fourth Corps Area. Macon, GA, designated 22 October 1929 as headquarters on organization, but the unit was never organized at that location. Withdrawn from the Organized Reserve 1 October 1933 and allotted to the Regular Army. Concurrently relieved from the Zone of the Interior and assigned to the General Headquarters Reserve. Further, withdrawn from the Fourth Corps Area and allotted to the Eighth Corps Area. Organized 10 August 1934 with Organized Reserve personnel as a RAI unit with headquarters at San Antonio, TX. Withdrawn from the Eighth Corps Area 5 June 1936 and allotted to the Sixth Corps Area. Inactivated 13 November 1936 in the Eighth Corps Area by relief of personnel. Chicago, IL, designated as headquarters on reorganization, but the unit was never organized at that location. Activated 16 May 1941 at Fort Custer, MI. Concurrently assigned to the Second Army. Location 7 December 1941—Fort Custer, MI.

Status: Disbanded 11 November 1944.

Commanders, 215th General Hospital

Lt. Col. Walter A. Ostendorf**	10 Aug 34-13 Nov 36	<i>Inactive</i>	13 Nov 36-16 May 41
	Unknown	16 May 41-7 Dec 41	

** RAI Commanders: Organized Reserve officers.

216th General Hospital (Z.I.)**Organized Reserve Alabama****HQ-Not initiated** 1928-34; Eighth Corps Area 1934-36; *Inactive* 1936-41; Camp Forrest, TN, 1941

Constituted in the Organized Reserve 5 September 1928, assigned to the Zone of the Interior, and allotted to the Fourth Corps Area. Mobile, AL, designated 22 October 1929 as headquarters on organization, but the unit was never organized at that location. Withdrawn from the Organized Reserve 1 October 1933 and allotted to the Regular Army. Concurrently relieved from the Zone of the Interior and assigned to the General Headquarters Reserve. Further, withdrawn from the Fourth Corps Area and allotted to the Eighth Corps Area. Organized 10 August 1934 with Organized Reserve personnel as a RAI unit with headquarters in the Eighth Corps Area. Withdrawn from the Eighth Corps Area 5 June 1936 and allotted to the Sixth Corps Area. Inactivated 13 November 1936 in the Eighth Corps Area by relief of personnel. Chicago, IL, designated as headquarters on reorganization, but the unit was never organized at that location. Activated 1 June 1941 at Camp Forrest, TN. Concurrently assigned to the Second Army. Location 7 December 1941—Camp Forrest, TN.

Status: Inactive in the Regular Army as the 387th Station Hospital.**Commanders, 216th General Hospital**

Lt. Col. Thomas E. Crump**	10 Aug 34-13 Nov 36	<i>Inactive</i>	13 Nov 36-1 Jun 41
	Unknown	1 Jun 41-7 Dec 41	

** RAI Commanders: Organized Reserve officers.

217th General Hospital (Z.I.)**Organized Reserve Florida/Missouri****HQ-Not initiated** 1928-36; Kansas City, MO, 1936-41; Fort Riley, KS, 1941

Constituted in the Organized Reserve 5 September 1928, assigned to the Zone of the Interior, and allotted to the Fourth Corps Area. Pensacola, FL, designated 22 October 1929 as headquarters on organization, but the unit was never organized at that location. Withdrawn from the Organized Reserve 1 October 1933 and allotted to the Regular Army. Concurrently relieved from the Zone of the Interior and assigned to the General Headquarters Reserve. Additionally, withdrawn from the Fourth Corps Area and allotted to the Seventh Corps Area. Organized 11 October 1936 at Kansas City, MO. Activated 1 June 1941, less Reserve personnel, at Fort Riley, KS. Concurrently assigned to the Second Army. Location 7 December 1941—Fort Riley, KS.

Status: Inactive in the Regular Army as the 217th General Hospital.**Commanders, 217th General Hospital**

Lt. Col. Frank W. Shelton**	11 Oct 36-1 Jun 41	Unknown	1 Jun 41-7 Dec 41
-----------------------------	--------------------	---------	-------------------

** RAI Commanders: Organized Reserve officers.

218th General Hospital (Z.I.)**Organized Reserve Louisiana/California****HQ-Not initiated** 1928-36; Bakersfield, CA, 1936-39; *Inactive* 1939-41; Fort Belvoir, VA, 1941

Constituted in the Organized Reserve 5 September 1928, assigned to the Zone of the Interior, and allotted to the Fourth Corps Area. Alexandria, LA, designated 22 October 1929 as headquarters on organization, but the unit was never organized at that location. Withdrawn from the Organized Reserve 1 October 1933 and allotted to the Regular Army. Concurrently relieved from the Zone of the Interior and assigned to the General Headquarters Reserve. Additionally, withdrawn from the Fourth Corps Area and allotted to the Ninth Corps Area. Organized 27 May 1936 at Bakersfield, CA. Inactivated by December 1939 at Bakersfield. Activated 1 June 1941, less Reserve personnel, at Fort Belvoir, VA. Concurrently assigned to the First Army. Location 7 December 1941—Fort Belvoir, VA.

Status: Disbanded 24 April 1953 as the 262nd General Hospital.**Commanders, 218th General Hospital**

Unknown	27 May 36-ao Dec 39	<i>Inactive</i>	ao Dec 39-1 Jun 41
	Unknown	1 Jun 41-7 Dec 41	

219th General Hospital (Z.I.)**Organized Reserve Tennessee****HQ-Not initiated** 1928-41

Constituted in the Organized Reserve 5 September 1928, assigned to the Zone of the Interior, and allotted to the Fourth Corps Area. Memphis, TN, designated 22 October 1929 as headquarters on organization, but the unit was never organized at that location. Withdrawn from the Organized Reserve 1 October 1933 and allotted to the Regular Army. Location 7 December 1941—*Not initiated*.

Status: Disbanded 30 January 1942.**220th General Hospital (Z.I.)****Organized Reserve Alabama****HQ-Not initiated** 1928-41

Constituted in the Organized Reserve 5 September 1928, assigned to the Zone of the Interior, and allotted to the Fourth Corps Area. Montgomery, AL, designated 22 October 1929 as headquarters on organization, but the unit was never organized at that location. Withdrawn from the Organized Reserve 1 October 1933 and allotted to the Regular Army. Location 7 December 1941—*Not initiated*.

Status: Disbanded 30 January 1942.**221st General Hospital (Z.I.)****Organized Reserve Tennessee/Kentucky****HQ-Not initiated** 1928-41

Constituted in the Organized Reserve 5 September 1928, assigned to the Zone of the Interior, and allotted to the Fourth Corps Area. Knoxville, TN, designated 22 October 1929 as headquarters on organization, but the unit was never organized at that location. Withdrawn from the Organized Reserve 1 October 1933 and allotted to the Regular Army. Withdrawn from the Fourth Corps Area 5 June 1936 and allotted to the Fifth Corps Area. Louisville, KY, designated 5 April 1937 as headquarters on organization, but the unit was never organized at that location. Location 7 December 1941—*Not initiated*.

Status: Disbanded 30 January 1942.**222nd General Hospital (Z.I.)****Organized Reserve Georgia/Ohio****HQ-Not initiated** 1928-29; Atlanta, GA, 1929-36; *Inactive* 1936-37; Cleveland, OH, 1937-41; Fort Eustis, VA, 1941

Constituted in the Organized Reserve 5 September 1928, assigned to the Zone of the Interior, and allotted to the Fourth Corps . Withdrawn from the Organized Reserve 21 December 1928 and allotted to the Regular Army. Organized 12 February 1929 at Atlanta, GA. Relieved from the Zone of the Interior 1 October 1933 and assigned to the General Headquarters Reserve. Conducted summer training at the station hospital, Fort McPherson, GA. Withdrawn from the Fourth Corps Area 5 June 1936 and allotted to the Fifth Corps Area. Inactivated 30 August 1936 at Atlanta by relief of personnel. Reorganized 6 August 1937 at Cleveland, OH. Designated mobilization station was Fort Oglethorpe, GA. Activated 16 June 1941 at Fort Eustis, VA, and assigned to the First Army. Location 7 December 1941—Fort Eustis, VA.

Status: Inactive in the Regular Army as the 134th General Hospital.**Commanders, 222nd General Hospital**

Col. Thomas C. Davison**	12 Feb 29-18 Apr 33	<i>Inactive</i>	30 Aug 36-6 Aug 37
Lt. Col. James F. Arthur**	18 Apr 33-30 Aug 36	Lt. Col. Nicolas A. Albanese**	6 Aug 37-ao Jul 38
	Unknown	ao Jul 38-7 Dec 41	

** RAI Commanders: Organized Reserve officers.

223rd General Hospital (Z.I.)**Organized Reserve Georgia/Ohio**

HQ-Not initiated 1928-29; Savannah, GA, 1929-36; *Inactive* 1936-37; Cincinnati, OH, 1937-41; Camp Lee, VA, 1941

Constituted in the Organized Reserve 5 September 1928, assigned to the Zone of the Interior, and allotted to the Fourth Corps Area. Withdrawn from the Organized Reserve 21 December 1928 and allotted to the Regular Army. Organized 12 February 1929 at Savannah, GA. Relieved from the Zone of the Interior 1 October 1933 and assigned to the General Headquarters Reserve. Conducted summer training at the station hospital, Fort McPherson, GA. Withdrawn from the Fourth Corps Area 5 June 1936 and allotted to the Fifth Corps Area. Reorganized 6 August 1937 at Cincinnati, OH. Designated mobilization station was Fort Oglethorpe, GA. Activated 16 June 1941 at Camp Lee, VA, and assigned to the First Army. Location 7 December 1941—Camp Lee, VA.

Status: Disbanded 11 November 1944.

Commanders, 223rd General Hospital

Maj. Lyman A. Burnside**	12 Feb 29-11 Apr 29	Lt. Col. Robert B. Scales**	27 Nov 34-5 Jun 36
Lt. Col. James M. Mason**	11 Apr 29-ao Jun 32	<i>Inactive</i>	5 Jun 36-6 Aug 37
Unknown	ao Jun 32-27 Nov 34	Lt. Col. James A. Gould**	6 Aug 37-16 Jun 41
	Capt. F. W. Regnier*	16 Jun 41-ao Dec 41	

* Regular Army active duty commanders

** RAI Commanders: Organized Reserve officers.

224th General Hospital (Z.I.)**Organized Reserve West Virginia**

HQ-Not initiated 1928-30; Huntington, WV 1930-41

Constituted in the Organized Reserve 5 September 1928, assigned to the Zone of the Interior, and allotted to the Fifth Corps Area. Initiated about March 1930 at Huntington, WV. Location 7 December 1941—Huntington, WV.

Status: Disbanded 30 January 1942.

Commanders, 224th General Hospital

Unknown	Mar 30-9 Jun 31	Col. James A. Duff	9 Jun 31-ao Jun 34
	Unknown	ao Jun 34-7 Dec 41	

225th General Hospital (Z.I.)**Organized Reserve Indiana**

HQ-Not initiated 1928-30; Indianapolis, IN, 1930-33; South Bend, IN, 1933-41

Constituted in the Organized Reserve 5 September 1928, assigned to the Zone of the Interior, and allotted to the Fifth Corps Area. Initiated by February 1930 at Indianapolis, IN. Relieved from the Zone of the Interior 1 October 1933 and assigned to the General Headquarters Reserve. Relocated 21 December 1933 to South Bend, IN. Location 7 December 1941—South Bend, IN.

Status: Disbanded 11 November 1944.

Commanders, 225th General Hospital

Unknown	ao Feb 30-7 Dec 41
---------	--------------------

226th General Hospital (Z.I.)**Organized Reserve Kentucky**

HQ-Not initiated 1928-30; Lexington, KY, 1930-34; Ashland, KY, 1934-41

Constituted in the Organized Reserve 5 September 1928, assigned to the Zone of the Interior, and allotted to the Fifth Corps Area. Initiated by February 1930 at Lexington, KY. Relocated 22 March 1934 to Ashland, KY. Conducted summer training at the station hospital, Fort Knox, KY. Location 7 December 1941—Ashland, KY.

Status: Disbanded 30 January 1942.

Commanders, 226th General Hospital

Col. Scott D. Breckenridge	ao Feb 30-ao Jun 35	Unknown	ao Jun 35-7 Dec 41
----------------------------	---------------------	---------	--------------------

227th General Hospital (Z.I.)**Organized Reserve Indiana****HQ-Not initiated** 1928-41

Constituted in the Organized Reserve 5 September 1928, assigned to the Zone of the Interior, and allotted to the Fifth Corps Area. Vincennes, IN, designated 9 July 1931 as headquarters on organization, but the unit was never organized at that location. Relieved from the Zone of the Interior 1 October 1933 and assigned to the General Headquarters Reserve. Location 7 December 1941—*Not initiated*.

Status: Disbanded 30 January 1942.**228th General Hospital (Z.I.)****Organized Reserve Indiana****HQ-Not initiated** 1928-41

Constituted in the Organized Reserve 5 September 1928, assigned to the Zone of the Interior, and allotted to the Fifth Corps Area. Bloomington, IN, designated 9 July 1931 as headquarters on organization, but the unit was never organized at that location. Relieved from the Zone of the Interior 1 October 1933 and assigned to the General Headquarters Reserve. Location 7 December 1941—*Not initiated*.

Status: Disbanded 30 January 1942.**229th General Hospital (Z.I.)****Organized Reserve Indiana****HQ-Not initiated** 1928-31; Indianapolis, IN, 1931-41

Constituted in the Organized Reserve 5 September 1928, assigned to the Zone of the Interior, and allotted to the Fifth Corps Area. Initiated by June 1931 at Indianapolis, IN. Relieved from the Zone of the Interior 1 October 1933 and assigned to the General Headquarters Reserve. Location 7 December 1941—Indianapolis, IN.

Status: Disbanded 30 January 1942.**Commanders, 229th General Hospital**

Unknown ao Jun 31-7 Dec 41

230th General Hospital (Z.I.)**Organized Reserve Indiana****HQ-Not initiated** 1928-34; Gary, IN, 1934-41

Constituted in the Organized Reserve 5 September 1928, assigned to the Zone of the Interior, and allotted to the Fifth Corps Area. South Bend, IN, designated as headquarters on organization, but the unit was never organized at that location. Relieved from the Zone of the Interior 1 October 1933 and assigned to the General Headquarters Reserve. Designated headquarters location changed 21 December 1933 to Gary, IN. Initiated by June 1934 at Gary. Location 7 December 1941—Gary, IN.

Status: Disbanded 30 January 1942.**Commanders, 230th General Hospital**

Unknown ao Jun 34-7 Dec 41

231st General Hospital (Z.I.)**Organized Reserve Kentucky****HQ-Not initiated** 1928-30; Hopkinsville, KY, 1934-41

Constituted in the Organized Reserve 5 September 1928, assigned to the Zone of the Interior, and allotted to the Fifth Corps Area. Louisville, KY, designated as headquarters on organization, but the unit was never organized at that location. Relieved from the Zone of the Interior 1 October 1933 and assigned to the General Headquarters Reserve. Designated headquarters location changed 21 December 1933 to Hopkinsville, KY. Initiated by June 1934 at Hopkinsville. Location 7 December 1941—Hopkinsville, KY.

Status: Disbanded 30 January 1942.

Commanders, 231st General Hospital

Unknown ao Jun 34-7 Dec 41

232nd General Hospital (Z.I.)

Organized Reserve Kentucky

HQ-*Not initiated* 1928-41

Constituted in the Organized Reserve 5 September 1928, assigned to the Zone of the Interior, and allotted to the Fifth Corps Area. Covington, KY, designated 9 July 1931 as headquarters on organization, but the unit was never organized at that location. Location 7 December 1941—*Not initiated*.

Status: Disbanded 30 January 1942.

233rd General Hospital (Z.I.)

Organized Reserve West Virginia

HQ-*Not initiated* 1928-34; Wheeling, WV 1934-41

Constituted in the Organized Reserve 5 September 1928, assigned to the Zone of the Interior, and allotted to the Fifth Corps Area. Initiated by June 1934 at Wheeling, WV. Location 7 December 1941—Wheeling, WV.

Status: Disbanded 30 January 1942.

Commanders, 233rd General Hospital

Unknown ao Jun 34-7 Dec 41

234th General Hospital (Z.I.)

Organized Reserve West Virginia

HQ-*Not initiated* 1928-41

Constituted in the Organized Reserve 5 September 1928, assigned to the Zone of the Interior, and allotted to the Fifth Corps Area. Huntington, WV, designated 9 July 1931 as headquarters on organization, but the unit was never organized at that location. Location 7 December 1941—*Not initiated*.

Status: Disbanded 30 January 1942.

235th General Hospital (Z.I.)

Organized Reserve Indiana/Ohio

HQ-*Not initiated* 1928-34; Toledo, OH, 1934-41

Constituted in the Organized Reserve 5 September 1928, assigned to the Zone of the Interior, and allotted to the Fifth Corps Area. Indianapolis, IN, designated as headquarters on organization, but the unit was never organized at that location. Designated headquarters location changed 21 December 1933 to Toledo, OH. Initiated by June 1934 at Toledo. Location 7 December 1941—Toledo, OH.

Status: Disbanded 30 January 1942.

Commanders, 235th General Hospital

Unknown ao Jun 34-7 Dec 41

236th General Hospital (Z.I.)**Organized Reserve Ohio****HQ-Not initiated** 1928-34; Lima, OH, 1934-41

Constituted in the Organized Reserve 5 September 1928, assigned to the Zone of the Interior, and allotted to the Fifth Corps Area. Toledo, OH, designated as headquarters on organization, but the unit was never organized at that location. Designated headquarters location changed 21 December 1933 to Lima, OH. Initiated by June 1934 at Lima. Location 7 December 1941—Lima, OH.

Status: Disbanded 30 January 1942.**Commanders, 236th General Hospital**

Unknown ao Jun 34-7 Dec 41

237th General Hospital (Z.I.)**Organized Reserve Ohio****HQ-Not initiated** 1928-34; Canton, OH, 1935-41

Constituted in the Organized Reserve 5 September 1928, assigned to the Zone of the Interior, and allotted to the Fifth Corps Area. Cincinnati, OH, designated as headquarters on organization, but the unit was never organized at that location. Designated headquarters location changed 21 December 1933 to Canton, OH. Initiated by June 1934 at Canton. Location 7 December 1941—Canton, OH.

Status: Disbanded 30 January 1942.**Commanders, 237th General Hospital**

Unknown ao Jun 34-7 Dec 41

238th General Hospital (Z.I.)**Organized Reserve Ohio****HQ-Not initiated** 1928-34; Toledo, OH, 1934-41

Constituted in the Organized Reserve 5 September 1928, assigned to the Zone of the Interior, and allotted to the Fifth Corps Area. Akron, OH, designated as headquarters on organization, but the unit was never organized at that location. Designated headquarters location changed 21 December 1933 to Toledo, OH. Initiated by June 1934 at Toledo. Location 7 December 1941—Toledo, OH.

Status: Disbanded 30 January 1942.**Commanders, 238th General Hospital**

Unknown ao Jun 34-7 Dec 41

239th General Hospital (Z.I.)**Organized Reserve West Virginia****HQ-Not initiated** 1928-41

Constituted in the Organized Reserve 5 September 1928, assigned to the Zone of the Interior, and allotted to the Fifth Corps Area. Charleston, WV, designated 9 July 1931 as headquarters on organization, but the unit was never organized at that location. Location 7 December 1941—*Not initiated*.

Status: Disbanded 30 January 1942.**240th General Hospital (Z.I.)****Organized Reserve Kentucky****HQ-Not initiated** 1928-41

Constituted in the Organized Reserve 5 September 1928, assigned to the Zone of the Interior, and allotted to the Fifth Corps Area. Frankfort, KY, designated 9 July 1931 as headquarters on organization, but the unit was never organized at that location. Designated headquarters location changed 5 April 1937 to Bowling Green, KY. Location 7 December 1941—*Not initiated*.

Status: Disbanded 30 January 1942.

241st General Hospital (Z.I.)

Organized Reserve Indiana

HQ-*Not initiated* 1928-34; Fort Wayne, IN, 1934-41

Constituted in the Organized Reserve 5 September 1928, assigned to the Zone of the Interior, and allotted to the Fifth Corps Area. Relieved from the Zone of the Interior 1 October 1933 and assigned to the General Headquarters Reserve. Initiated by June 1934 at Fort Wayne, IN. Location 7 December 1941—Fort Wayne, IN.

Status: Disbanded 30 January 1942.

Commanders, 241st General Hospital

Unknown ao Jun 34-7 Dec 41

242nd General Hospital (Z.I.)

Organized Reserve Indiana

HQ-*Not initiated* 1928-41

Constituted in the Organized Reserve 5 September 1928, assigned to the Zone of the Interior, and allotted to the Fifth Corps Area. Indianapolis, IN, designated 9 July 1931 as headquarters on organization, but the unit was never organized at that location. Relieved from the Zone of the Interior 1 October 1933 and assigned to the General Headquarters Reserve. Location 7 December 1941—*Not initiated*.

Status: Disbanded 30 January 1942.

243rd General Hospital (Z.I.)

Organized Reserve Ohio

HQ-*Not initiated* 1928-34; Akron, OH, 1934-41

Constituted in the Organized Reserve 5 September 1928, assigned to the Zone of the Interior, and allotted to the Fifth Corps Area. Cleveland, OH, designated 9 July 1931 as headquarters on organization, but the unit was never organized at that location. Designated headquarters location changed 21 December 1933 to Akron, OH. Initiated by June 1934 at Akron. Location 7 December 1941—Akron, OH.

Status: Disbanded 30 January 1942.

Commanders, 243rd General Hospital

Unknown ao Jun 34-7 Dec 41

244th General Hospital (Z.I.)

Organized Reserve Ohio

HQ-*Not initiated* 1928-34; Gallipolis, OH, 1934-41

Constituted in the Organized Reserve 5 September 1928, assigned to the Zone of the Interior, and allotted to the Fifth Corps Area. Toledo, OH, designated 9 July 1931 as headquarters on organization, but the unit was never organized at that location. Designated headquarters location changed 21 December 1933 to Gallipolis, OH. Initiated by June 1934 at Gallipolis. Location 7 December 1941—Gallipolis, OH.

Status: Disbanded 30 January 1942.

Commanders, 244th General Hospital

Unknown ao Jun 34-7 Dec 41

245th General Hospital (Z.I.)

Organized Reserve Ohio

HQ-Not initiated 1928-34; Columbus, OH, 1934-41

Constituted in the Organized Reserve 5 September 1928, assigned to the Zone of the Interior, and allotted to the Fifth Corps Area. Withdrawn from the Organized Reserve 21 December 1928 and allotted to the Regular Army. Affiliated 28 April 1930 with the Ohio State University ROTC. Relieved from the Zone of the Interior 1 October 1933 and assigned to the General Headquarters Reserve. Organized by June 1934 at Columbus, OH. Withdrawn from the Regular Army 1 July 1940 and allotted to the Organized Reserve. Designated mobilization station was Fort Oglethorpe, GA. Location 7 December 1941—Columbus, OH.

Status: Disbanded 11 November 1944.

Commanders, 245th General Hospital

Unknown ao Jun 34-ao Aug 38 Lt. Col. Nelson C. Dysart** ao Aug 38-ao Sep 38
Unknown ao Sep 38-7 Dec 41

** RAI Commanders: Organized Reserve officers.

246th General Hospital (Z.I.)

Organized Reserve Ohio

HQ-Not initiated 1928-34; Cleveland, OH, 1934-41

Constituted in the Organized Reserve 5 September 1928, assigned to the Zone of the Interior, and allotted to the Fifth Corps Area. Withdrawn from the Organized Reserve 21 December 1928 and allotted to the Regular Army Affiliated 28 April 1930 with Western Reserve University ROTC. Relieved from the Zone of the Interior 1 October 1933 and assigned to the General Headquarters Reserve. Organized by June 1934 at Cleveland, OH. Withdrawn from the Regular Army 1 July 1940 and allotted to the Organized Reserve. Location 7 December 1941—Cleveland, OH.

Status: Disbanded 11 November 1944.

Commanders, 246th General Hospital

Unknown ao Jun 34-ao Aug 39 Col. Willard C. Stoner** ao Mar 37-5 Nov 39
Unknown 5 Nov 39-7 Dec 41

* Regular Army active duty commanders

** RAI Commanders: Organized Reserve officers.

247th General Hospital (Z.I.)

Organized Reserve Wisconsin

HQ-Not initiated 1928-34; Madison, WI, 1934-37; *Inactive* 1937-41

Constituted in the Organized Reserve 5 September 1928, assigned to the Zone of the Interior, and allotted to the Sixth Corps Area. Initiated by June 1934 at Madison, WI. Inactivated by June 1937 at Madison by relief of personnel. Location 7 December 1941—*Inactive*.

Status: Disbanded 30 January 1942.

Commanders, 247th General Hospital

Maj. Erwin R. Schmidt ao Jun 34-ao Jun 36 Unknown ao Jun 36-ao Jun 37
Inactive ao Jun 37-7 Dec 41

248th General Hospital (Z.I.)**Organized Reserve Wisconsin****HQ-Not initiated** 1928-34; La Crosse, WI, 1934-37; *Inactive* 1937-41

Constituted in the Organized Reserve 5 September 1928, assigned to the Zone of the Interior, and allotted to the Sixth Corps Area. Initiated by June 1934 at La Crosse, WI. Inactivated by June 1937 at La Crosse by relief of personnel. Location 7 December 1941—*Inactive*.

Status: Disbanded 30 January 1942.**Commanders, 248th General Hospital**

Capt. George W. Griswold	ao Jun 34-ao Jun 36 <i>Inactive</i>	Unknown ao Jun 37-7 Dec 41	ao Jun 36-ao Jun 37
--------------------------	--	-------------------------------	---------------------

249th General Hospital (Z.I.)**Organized Reserve Wisconsin****HQ-Not initiated** 1928-34; Superior, WI, 1934-37; *Inactive* 1937-41

Constituted in the Organized Reserve 5 September 1928, assigned to the Zone of the Interior, and allotted to the Sixth Corps Area. Initiated by June 1934 at Superior, WI. Inactivated 30 March 1937 at Superior by relief of personnel. Wausau, WI, designated 28 July 1937 as headquarters on reorganization, but the unit was never organized at that location. Conducted summer training at the station hospital, Fort Brady, MI. Location 7 December 1941—*Inactive*.

Status: Disbanded 30 January 1942.**Commanders, 249th General Hospital**

Lt. Col. Will G. Merrill	ao Jun 36-Apr 36	Unknown	ao May 36-30 Mar 37
Capt. Allen L. Millard	Apr 36-ao May 36	<i>Inactive</i>	30 Mar 37-7 Dec 41

250th General Hospital (Z.I.)**Organized Reserve Wisconsin****HQ-Not initiated** 1928-30; Oshkosh, WI, 1930-37; *Inactive* 1937-41

Constituted in the Organized Reserve 5 September 1928, assigned to the Zone of the Interior, and allotted to the Sixth Corps Area. Initiated 6 December 1930 at Oshkosh, WI. Inactivated by June 1937 at Oshkosh by relief of personnel. Location 7 December 1941—*Inactive*.

Status: Inactive in the Regular Army as the 250th General Hospital.**Commanders, 250th General Hospital**

Unknown	6 Dec 30-ao Jun 34	Unknown	ao Jun 36-ao Jun 37
1st Lt. Russell D. Settle	ao Jun 34-ao Jun 36	<i>Inactive</i>	ao Jun 37-7 Dec 41

251st General Hospital (Z.I.)**Organized Reserve Wisconsin****HQ-Not initiated** 1928-30; Eau Claire, WI, 1930-36; *Inactive* 1936-41

Constituted in the Organized Reserve 5 September 1928, assigned to the Zone of the Interior, and allotted to the Sixth Corps Area. Initiated 6 December 1930 at Eau Claire, WI. Inactivated 19 November 1936 at Eau Claire by relief of personnel. Location 7 December 1941—*Inactive*.

Status: Disbanded 30 January 1942.**Commanders, 251st General Hospital**

Unknown	6 Dec 30-19 Nov 36	<i>Inactive</i>	19 Nov 36-7 Dec 41
---------	--------------------	-----------------	--------------------

252nd General Hospital (Z.I.)**Organized Reserve Wisconsin****HQ-Not initiated** 1928-34; Manitowoc, WI, 1934-36; *Inactive* 1936-41

Constituted in the Organized Reserve 5 September 1928, assigned to the Zone of the Interior, and allotted to the Sixth Corps Area. Initiated by June 1934 at Manitowoc, WI. Inactivated 19 November 1936 at Manitowoc by relief of personnel. Location 7 December 1941—*Inactive*.

Status: Disbanded 30 January 1942.**Commanders, 252nd General Hospital**

Lt. Col. Ralph T. Gilchrist

ao Jun 34-19 Nov 36

Inactive

19 Nov 36-7 Dec 41

253rd General Hospital (Z.I.)**Organized Reserve Michigan****HQ-Not initiated** 1928-34; Ann Arbor, MI, 1934-37; Detroit, MI, 1937-41

Constituted in the Organized Reserve 5 September 1928, assigned to the Zone of the Interior, and allotted to the Sixth Corps Area. Initiated by June 1934 at Ann Arbor, MI. Relocated 7 April 1937 to Detroit, MI. Location 7 December 1941—Detroit, MI.

Status: Disbanded 30 January 1942.**Commanders, 253rd General Hospital**

Unknown

ao Jun 34-7 Dec 41

254th General Hospital (Z.I.)**Organized Reserve Wisconsin****HQ-Not initiated** 1928-34; Milwaukee, WI, 1934-36; *Inactive* 1936-41

Constituted in the Organized Reserve 5 September 1928, assigned to the Zone of the Interior, and allotted to the Sixth Corps Area. Initiated by June 1934 at Milwaukee, WI. Inactivated 19 November 1936 at Milwaukee by relief of personnel. Location 7 December 1941—*Inactive*.

Status: Disbanded 30 January 1942.**Commanders, 254th General Hospital**

Capt. Herbert W. Powers

ao Jun 34-19 Nov 36

Inactive

19 Nov 36-7 Dec 41

255th General Hospital (Z.I.)**Organized Reserve Michigan****HQ-Not initiated** 1928-34; Muskegon, MI, 1934-38; Grand Rapids, MI, 1938-41

Constituted in the Organized Reserve 5 September 1928, assigned to the Zone of the Interior, and allotted to the Sixth Corps Area. Initiated by June 1934 at Muskegon, MI. Relocated by January 1938 to Grand Rapids, MI. Location 7 December 1941—Grand Rapids, MI.

Status: Disbanded 11 November 1944.**Commanders, 255th General Hospital**

Unknown

ao Jun 34-7 Dec 41

256th General Hospital (Z.I.)**Organized Reserve Michigan****HQ-Not initiated** 1928-34; Detroit, MI, 1934-41

Constituted in the Organized Reserve 5 September 1928, assigned to the Zone of the Interior, and allotted to the Sixth Corps Area. Initiated by June 1934 at Detroit, MI. Location 7 December 1941—Detroit, MI.

Status: Disbanded 11 November 1944.

Commanders, 256th General Hospital

Unknown ao Jun 34-7 Dec 41

257th General Hospital (Z.I.)

Organized Reserve Michigan

HQ-Not initiated 1928-34; Grand Rapids, MI, 1934-38; Detroit, MI, 1938-41

Constituted in the Organized Reserve 5 September 1928, assigned to the Zone of the Interior, and allotted to the Sixth Corps Area. Initiated by June 1934 at Grand Rapids, MI. Relocated by January 1938 to Detroit, MI. Location 7 December 1941—Detroit, MI.

Status: Disbanded 11 November 1944.

Commanders, 257th General Hospital

Maj. Maurice L. Puffer ao Jun 34-ao Jun 35 Unknown ao Jun 35-7 Dec 41

258th General Hospital (Z.I.)

Organized Reserve Michigan

HQ-Not initiated 1928-34; Flint, MI, 1934-38; Saginaw, MI, 1938-41

Constituted in the Organized Reserve 5 September 1928, assigned to the Zone of the Interior, and allotted to the Sixth Corps Area. Initiated by June 1934 at Flint, MI. Relocated by January 1938 to Saginaw, MI. Location 7 December 1941—Saginaw, MI.

Status: Disbanded 11 November 1944.

Commanders, 258th General Hospital

Unknown ao Jun 34-7 Dec 41

259th General Hospital (Z.I.)

Organized Reserve Illinois

HQ-Not initiated 1928-34; Evanston, IL, 1934-37; *Inactive* 1937-41

Constituted in the Organized Reserve 5 September 1928, assigned to the Zone of the Interior, and allotted to the Sixth Corps Area. Initiated by June 1934 at Evanston, IL. Inactivated 2 June 1937 at Evanston by relief of personnel. Chicago, IL, designated 28 July 1937 as headquarters on reorganization, but the unit was never organized at that location. Location 7 December 1941—*Inactive*.

Status: Disbanded 11 November 1944.

Commanders, 259th General Hospital

Unknown ao Jun 34-1 Jun 36 Col. Jesse G. Maxon 1 Jun 36-2 Jun 37
Inactive 2 Jun 37-7 Dec 41

260th General Hospital (Z.I.)

Organized Reserve Illinois

HQ-Not initiated 1928-34; Evanston, IL, 1934-37; Chicago, IL, 1937-41

Constituted in the Organized Reserve 5 September 1928, assigned to the Zone of the Interior, and allotted to the Sixth Corps Area. Initiated by June 1934 at Evanston, IL. Relocated 28 July 1937 to Chicago, IL. Location 7 December 1941—Chicago, IL.

Status: Disbanded 11 November 1944.

268th General Hospital (Z.I.)**Organized Reserve Missouri****HQ-Not initiated** 1928-29; St. Joseph, MO, 1929-41

Constituted in the Organized Reserve 5 September 1928, assigned to the Zone of the Interior, and allotted to the Seventh Corps Area. Initiated 30 November 1929 at St. Joseph, MO. Location 7 December 1941—St. Joseph, MO.

Status: Disbanded 11 November 1944.**Commanders, 268th General Hospital**

Lt. Col. Ernest W. Slusher	30 Nov 29-Feb 30	Unknown	ao Jan 36-ao Aug 37
Lt. Col. Harvey J. Howard	Feb 30-Dec 30	Maj. Ellis E. Raike	ao Aug 37-19 Sep 37
Lt. Col. Norvelle W. Sharpe	Dec 30-ao Jan 36	Unknown	19 Sep 37-7 Dec 41

269th General Hospital (Z.I.)**Organized Reserve Missouri****HQ-Not initiated** 1928-29; Springfield, MO, 1929-41

Constituted in the Organized Reserve 5 September 1928, assigned to the Zone of the Interior, and allotted to the Seventh Corps Area. Initiated in December 1929 at Springfield, MO. Location 7 December 1941—Springfield, MO.

Status: Disbanded 11 November 1944.**Commanders, 269th General Hospital**

Lt. Col. Harvey J. Howard	Dec 29-Feb 30	Maj. Joel W. Hardesty	22 Dec 35-ao Jan 36
Col. Don H. Silsby	Mar 30-ao Apr 30	Unknown	ao Jan 36-22 Aug 37
Unknown	ao Apr 30-22 Dec 35	Maj. Samuel W. Connor	22 Aug 37-ao Sep 37
	Unknown	ao Sep 37-7 Dec 41	

270th General Hospital (Z.I.)**Organized Reserve North Dakota****HQ-Not initiated** 1928-29; Fargo, ND, 1929-41

Constituted in the Organized Reserve 5 September 1928, assigned to the Zone of the Interior, and allotted to the Seventh Corps Area. Initiated in December 1929 at Fargo, ND. Location 7 December 1941—Fargo, ND.

Status: Disbanded 11 November 1944.**Commanders, 270th General Hospital**

Lt. Col. Paul F. Rice	Dec 29-Mar 30	Unknown	ao Jan 32-22 Aug 37
Unknown	Mar 30-Oct 31	Col. Harry C. Parker	22 Aug 37-ao Sep 37
Col. Floyd S. Kidd	Oct 31-ao Jan 32	Unknown	ao Sep 37-7 Dec 41

271st General Hospital (Z.I.)**Organized Reserve Arkansas****HQ-Not initiated** 1928-41Constituted in the Organized Reserve 5 September 1928, assigned to the Zone of the Interior, and allotted to the Seventh Corps Area. Fort Smith, AR, designated as headquarters on organization, but the unit was never organized at that location. Location 7 December 1941—*Not initiated*.**Status:** Disbanded 11 November 1944.**272nd General Hospital (Z.I.)****Organized Reserve Arkansas****HQ-Not initiated** 1928-41

Constituted in the Organized Reserve 5 September 1928, assigned to the Zone of the Interior, and allotted to the Seventh Corps Area. Little Rock, AR, designated as headquarters on organization, but the unit was never organized at that location. Location 7 December 1941—*Not initiated*.

Status: Disbanded 11 November 1944.

273rd General Hospital (Z.I.)

Organized Reserve Iowa

HQ-*Not initiated* 1928-41

Constituted in the Organized Reserve 5 September 1928, assigned to the Zone of the Interior, and allotted to the Seventh Corps Area. Cedar Rapids, IA, designated as headquarters on organization, but the unit was never organized at that location. Location 7 December 1941—*Not initiated*.

Status: Disbanded 11 November 1944.

274th General Hospital (Z.I.)

Organized Reserve Iowa

HQ-*Not initiated* 1928-41

Constituted in the Organized Reserve 5 September 1928, assigned to the Zone of the Interior, and allotted to the Seventh Corps Area. Council Bluffs, IA, designated as headquarters on organization, but the unit was never organized at that location. Location 7 December 1941—*Not initiated*.

Status: Disbanded 11 November 1944.

275th General Hospital (Z.I.)

Organized Reserve Iowa

HQ-*Not initiated* 1928-41

Constituted in the Organized Reserve 5 September 1928, assigned to the Zone of the Interior, and allotted to the Seventh Corps Area. Des Moines, IA, designated as headquarters on organization, but the unit was never organized at that location. Location 7 December 1941—*Not initiated*.

Status: Disbanded 30 January 1942.

276th General Hospital (Z.I.)

Organized Reserve Kansas

HQ-*Not initiated* 1928-41

Constituted in the Organized Reserve 5 September 1928, assigned to the Zone of the Interior, and allotted to the Seventh Corps Area. Kansas City, KS, designated as headquarters on organization, but the unit was never organized at that location. Location 7 December 1941—*Not initiated*.

Status: Disbanded 30 January 1942.

277th General Hospital (Z.I.)

Organized Reserve Kansas

HQ-*Not initiated* 1928-41

Constituted in the Organized Reserve 5 September 1928, assigned to the Zone of the Interior, and allotted to the Seventh Corps Area. Topeka, KS, designated as headquarters on organization, but the unit was never organized at that location. Location 7 December 1941—*Not initiated*.

Status: Disbanded 30 January 1942.

278th General Hospital (Z.I.)

Organized Reserve Kansas

HQ-*Not initiated* 1928-41

Constituted in the Organized Reserve 5 September 1928, assigned to the Zone of the Interior, and allotted to the Seventh Corps Area. Wichita, KS, designated as headquarters on organization, but the unit was never organized at that location. Location 7 December 1941—*Not initiated*.

Status: Disbanded 30 January 1942.

279th General Hospital (Z.I.)

Organized Reserve Minnesota

HQ-*Not initiated* 1928-41

Constituted in the Organized Reserve 5 September 1928, assigned to the Zone of the Interior, and allotted to the Seventh Corps Area. Duluth, MN, designated as headquarters on organization, but the unit was never organized at that location. Location 7 December 1941—*Not initiated*.

Status: Disbanded 30 January 1942.

280th General Hospital (Z.I.)

Organized Reserve Iowa

HQ-*Not initiated* 1928-41

Constituted in the Organized Reserve 5 September 1928, assigned to the Zone of the Interior, and allotted to the Seventh Corps Area. Davenport, IA, designated as headquarters on organization, but the unit was never organized at that location. Location 7 December 1941—*Not initiated*.

Status: Disbanded 30 January 1942.

281st General Hospital (Z.I.)

Organized Reserve Minnesota

HQ-*Not initiated* 1928-41

Constituted in the Organized Reserve 5 September 1928, assigned to the Zone of the Interior, and allotted to the Seventh Corps Area. Rochester, MN, designated as headquarters on organization, but the unit was never organized at that location. Location 7 December 1941—*Not initiated*.

Status: Disbanded 30 January 1942.

282nd General Hospital (Z.I.)

Organized Reserve Minnesota

HQ-*Not initiated* 1928-41

Constituted in the Organized Reserve 5 September 1928, assigned to the Zone of the Interior, and allotted to the Seventh Corps Area. St. Cloud, MN, designated as headquarters on organization, but the unit was never organized at that location. Location 7 December 1941—*Not initiated*.

Status: Disbanded 30 January 1942.

283rd General Hospital (Z.I.)

Organized Reserve Minnesota

HQ-*Not initiated* 1928-41

Constituted in the Organized Reserve 5 September 1928, assigned to the Zone of the Interior, and allotted to the Seventh Corps Area. St. Paul, MN, designated as headquarters on organization, but the unit was never organized at that location. Location 7 December 1941—*Not initiated*.

Status: Disbanded 30 January 1942.

284th General Hospital (Z.I.)

Organized Reserve Minnesota

HQ-*Not initiated* 1928-41

Constituted in the Organized Reserve 5 September 1928, assigned to the Zone of the Interior, and allotted to the Seventh Corps Area. St. Paul, MN, designated as headquarters on organization, but the unit was never organized at that location. Location 7 December 1941—*Not initiated*.

Status: Disbanded 30 January 1942.

285th General Hospital (Z.I.)

Organized Reserve Missouri

HQ-*Not initiated* 1928-41

Constituted in the Organized Reserve 5 September 1928, assigned to the Zone of the Interior, and allotted to the Seventh Corps Area. Joplin, MO, designated as headquarters on organization, but the unit was never organized at that location. Location 7 December 1941—*Not initiated*.

Status: Disbanded 30 January 1942.

286th General Hospital (Z.I.)

Organized Reserve Missouri

HQ-*Not initiated* 1928-41

Constituted in the Organized Reserve 5 September 1928, assigned to the Zone of the Interior, and allotted to the Seventh Corps Area. Kansas City, MO, designated as headquarters on organization, but the unit was never organized at that location. Location 7 December 1941—*Not initiated*.

Status: Disbanded 30 January 1942.

287th General Hospital (Z.I.)

Organized Reserve Missouri

HQ-*Not initiated* 1928-41

Constituted in the Organized Reserve 5 September 1928, assigned to the Zone of the Interior, and allotted to the Seventh Corps Area. Kansas City, MO, designated as headquarters on organization, but the unit was never organized at that location. Location 7 December 1941—*Not initiated*.

Status: Disbanded 30 January 1942.

288th General Hospital (Z.I.)

Organized Reserve Missouri

HQ-*Not initiated* 1928-41

Constituted in the Organized Reserve 5 September 1928, assigned to the Zone of the Interior, and allotted to the Seventh Corps Area. St. Louis, MO, designated as headquarters on organization, but the unit was never organized at that location. Location 7 December 1941—*Not initiated*.

Status: Disbanded 30 January 1942.

289th General Hospital (Z.I.)**Organized Reserve Nebraska****HQ-Not initiated** 1928-41

Constituted in the Organized Reserve 5 September 1928, assigned to the Zone of the Interior, and allotted to the Seventh Corps Area. Hastings, NE, designated as headquarters on organization, but the unit was never organized at that location. Location 7 December 1941—*Not initiated*.

Status: Disbanded 30 January 1942.**290th General Hospital (Z.I.)****Organized Reserve South Dakota****HQ-Not initiated** 1928-41

Constituted in the Organized Reserve 5 September 1928, assigned to the Zone of the Interior, and allotted to the Seventh Corps Area. Sioux Falls, SD, designated as headquarters on organization, but the unit was never organized at that location. Location 7 December 1941—*Not initiated*.

Status: Disbanded 30 January 1942.**291st General Hospital (Z.I.)****Organized Reserve Iowa****HQ-Not initiated** 1928-29; Cedar Rapids, IA, 1929-41

Constituted in the Organized Reserve 5 September 1928, assigned to the Zone of the Interior, and allotted to the Seventh Corps Area. Withdrawn from the Organized Reserve 21 December 1928 and allotted to the Regular Army. Organized in December 1929 at Cedar Rapids, IA. Relieved from the Zone of the Interior 1 October 1933 and assigned to the General Headquarters Reserve. Withdrawn from the Regular Army 1 July 1940 and allotted to the Organized Reserve. Location 7 December 1941—Cedar Rapids, IA.

Status: Disbanded 30 January 1942.**Commanders, 291st General Hospital**

Unknown	Dec 29-May 30	Unknown	ao Oct 32-22 Aug 37
Lt. Col. John R. Gardner**	May 30-ao Oct 32	Maj. Edward J. Wehman**	22 Aug 37-ao Sep 37
	Unknown	ao Sep 37-7 Dec 41	

** RAI Commanders: Organized Reserve officers.

292nd General Hospital (Z.I.)**Organized Reserve Texas/Minnesota/Illinois****HQ-Not initiated** 1928-29; Laredo, TX, 1929-36; *Inactive* 1936-41

Constituted in the Organized Reserve 5 September 1928, assigned to the Zone of the Interior, and allotted to the Eighth Corps Area. Initiated 27 April 1929 at Laredo, TX. Withdrawn from the Eighth Corps Area 5 June 1936 and allotted to the Sixth Corps Area. Inactivated 12 November 1936 at Laredo by relief of personnel. Chicago, IL, designated 28 July 1937 as headquarters on reorganization, but the unit was never organized at that location. Designated mobilization training station was Camp Stanley, TX. Location 7 December 1941—*Inactive*.

Status: Disbanded 30 January 1942.**Commanders, 292nd General Hospital**

Capt. Frank A. DeVerts	27 Apr 29-ao May 29	2nd Lt. Jack S. Love	ao Oct 36-12 Nov 36
Unknown	ao May 29-ao Oct 36	<i>Inactive</i>	12 Nov 36-7 Dec 41

293rd General Hospital (Z.I.)**Organized Reserve New Mexico/Illinois****HQ-Not initiated** 1928-29; Roswell, NM, 1929-36; Chicago, IL, 1936-37; *Inactive* 1937-41

Constituted in the Organized Reserve 5 September 1928, assigned to the Zone of the Interior, and allotted to the Eighth Corps Area. Initiated 27 April 1929 at Roswell, NM. Withdrawn from the Eighth Corps Area 5 June 1936 and allotted to the Sixth Corps Area. Organized by October 1936 at Chicago, IL. Inactivated 12 May 1937 at Chicago by relief of personnel. Designated mobilization training station was Camp Stanley, TX. Location 7 December 1941—*Inactive*.

Status: Disbanded 30 January 1942.**Commanders, 293rd General Hospital**

Unknown	27 Apr 29-3 May 29	<i>Inactive</i>	5 Jun 36-ao Oct 36
Lt. Col. Ben H. Metcalf	3 May 29-ao Jan 30	1st Lt. Wesley O. Connor, jr.	ao Oct 36-12 May 37
Unknown	ao Jan 30-5 Jun 36	<i>Inactive</i>	12 May 37-7 Dec 41

294th General Hospital (Z.I.)**Organized Reserve Missouri****HQ-Not initiated** 1928-30; Kansas City, MO, 1930-39; St. Paul, MO, 1939-41

Constituted in the Organized Reserve 5 September 1928, assigned to the Zone of the Interior, and allotted to the Eighth Corps Area. Withdrawn from the Organized Reserve 21 December 1928 and allotted to the Regular Army. Organized in May 1930 at Kansas City, MO. Relieved from the Zone of the Interior 1 October 1933 and assigned to the General Headquarters Reserve. Relocated by 1939 to St. Paul, MO. Withdrawn from the Regular Army 1 July 1940 and allotted to the Organized Reserve. Location 7 December 1941—St. Paul, MO.

Status: Disbanded 30 January 1942.**Commanders, 294th General Hospital**

Lt. Col. George H. Smith**	May 30-Jan 31	Unknown	ao Oct 32-ao Jul 37
Lt. Col. Harry C. Parker**	Jan 31-ao Oct 32	Lt. Col. Tenney T. Harris**	ao Jul 37-22 Aug 37
	Unknown	22 Aug 37-7 Dec 41	

** RAI Commanders: Organized Reserve officers.

295th General Hospital (Z.I.)**Organized Reserve California****HQ-Not initiated** 1928-30; Oakland, CA, 1930-41

Constituted in the Organized Reserve 5 September 1928, assigned to the Zone of the Interior, and allotted to the Ninth Corps Area. Initiated 6 April 1930 at Oakland, CA. Location 7 December 1941—Oakland, CA.

Status: Disbanded 11 November 1944.**Commanders, 295th General Hospital**

Unknown	6 Apr 30-7 Dec 41
---------	-------------------

296th General Hospital (Z.I.)**Organized Reserve Washington****HQ-Not initiated** 1928-41

Constituted in the Organized Reserve 5 September 1928, assigned to the Zone of the Interior, and allotted to the Ninth Corps Area. Seattle, WA, designated as headquarters on organization, but the unit was never organized at that location. Withdrawn from the Ninth Corps Area 5 June 1936 and allotted to the Sixth Corps Area. Chicago, IL, designated as headquarters on organization, but the unit was never organized at that location. Location 7 December 1941—*Not initiated*.

Status: Disbanded 30 January 1942.

297th General Hospital (Z.I.)**Organized Reserve Texas/Illinois****HQ-Not initiated** 1928-29; Fort Bliss, TX, 1929-36; *Inactive* 1936-41

Constituted in the Organized Reserve 5 September 1928, assigned to the Zone of the Interior, and allotted to the Eighth Corps Area. Withdrawn from the Organized Reserve 21 December 1928 and allotted to the Regular Army. Organized 6 March 1929 with Organized Reserve personnel as a RAI unit with headquarters at Fort Bliss, TX. Relieved from the Zone of the Interior 1 October 1933 and assigned to the General Headquarters Reserve. Withdrawn from the Eighth Corps Area 5 June 1936 and allotted to the Sixth Corps Area. Inactivated 13 November 1936 at Fort Bliss by relief of personnel. Affiliated 17 August 1940 with Cooke County Hospital in Chicago, IL, but the unit was never organized at that location. Conducted summer training at the station hospital, Fort Sam Houston, TX. Designated mobilization station was Fort Bliss 1928-36 and Fort Oglethorpe, GA, 1936-41. Location 7 December 1941—*Inactive*.

Status: Inactive in the U.S. Army Reserve as the 297th General Hospital.**Commanders, 297th General Hospital**

Capt. Charles M. Roland, Q.M.C.**	6 Mar 29-15 Mar 29	Unknown	ao Feb 32-ao Oct 36
Lt. Col. William B. Cantrell**	15 Mar 29-ao Feb 32	Lt. Col. Lloyd R. Allen**	ao Oct 36-13 Nov 36
	<i>Inactive</i>	13 Nov 36-7 Dec 41	

** RAI Commanders: Organized Reserve officers.

298th General Hospital (Z.I.)**Organized Reserve Texas/Michigan/Illinois****HQ-Not initiated** 1928-29; Fort Sam Houston, TX, 1929-36; *Inactive* 1936-41

Constituted in the Organized Reserve 5 September 1928, assigned to the Zone of the Interior, and allotted to the Eighth Corps Area. Withdrawn from the Organized Reserve 21 December 1928 and allotted to the Regular Army. Organized 6 March 1929 with Organized Reserve personnel as a RAI unit with headquarters at Fort Sam Houston, TX. Relieved from the Zone of the Interior 1 October 1933 and assigned to the General Headquarters Reserve. Withdrawn from the Eighth Corps Area 5 June 1936 and allotted to the Sixth Corps Area. Inactivated 13 November 1936 at Fort Sam Houston by relief of personnel. Chicago, IL, designated 28 July 1937 as headquarters on organization, but the unit was never organized at that location. Affiliated 7 August 1940 with the University of Michigan in Ann Arbor, MI, but the unit was never organized at that location. Conducted summer training at the station hospital, Fort Sam Houston, TX, 1929-35. Designated mobilization training station was Fort Sam Houston, TX, 1928-36 and Fort Oglethorpe, GA, 1936-41. Location 7 December 1941—*Inactive*.

Status: Inactive in the U.S. Army Reserve as the 298th General Hospital.**Commanders, 298th General Hospital**

Capt. Lorenz E. Marshall, Q.M.C.**	6 Mar 29-15 Mar 29	Lt. Col. Paul R. Brown**	25 Feb 32-17 Oct 34
Lt. Col. Warren M. Wier**	12 Apr 29-25 Feb 32	Lt. Col. Aaron L. Roberts**	17 Oct 34-13 Nov 36
	<i>Inactive</i>	13 Nov 36-7 Dec 41	

** RAI Commanders: Organized Reserve officers.

299th General Hospital (Z.I.)**Organized Reserve Minnesota****HQ-Not initiated** 1928-31; Seattle, WA, 1931-36; *Inactive* 1936-41

Constituted in the Organized Reserve 5 September 1928, assigned to the Zone of the Interior, and allotted to the Seventh Corps Area. Withdrawn from the Organized Reserve 21 December 1928 and allotted to the Regular Army. Organized in April 1931 at Seattle, WA. Relieved from the Zone of the Interior 1 October 1933 and assigned to the General Headquarters Reserve. Withdrawn from the Ninth Corps Area 5 June 1936 and allotted to the Seventh Corps Area. Withdrawn from the Regular Army 1 July 1940 and allotted to the Organized Reserve. Location 7 December 1941—*Inactive*.

Status: Disbanded 30 January 1942.**Commanders, 299th General Hospital**

Lt. Col. Harold L. Goss**	Apr 31-5 Jun 36	<i>Inactive</i>	5 Jun 36-7 Dec 41
---------------------------	-----------------	-----------------	-------------------

** RAI Commanders: Organized Reserve officers.

300th General Hospital (Z.I.)**Organized Reserve Tennessee/Minnesota****HQ-Not initiated** 1928-31; Seattle, WA, 1931-36; *Inactive* 1936-40; Nashville, TN, 1940-41

Constituted in the Organized Reserve 5 September 1928, assigned to the Zone of the Interior, and allotted to the Ninth Corps Area. Withdrawn from the Organized Reserve 21 December 1928 and allotted to the Regular Army. Organized in April 1931 at Seattle, WA. Relieved from the Zone of the Interior 1 October 1933 and assigned to the General Headquarters Reserve. Withdrawn from the Ninth Corps Area 5 June 1936 and allotted to the Seventh Corps Area. Withdrawn from the Seventh Corps Area 1 July 1940 and allotted to the Fourth Corps Area. Affiliated with and organized 26 August 1940 at the Vanderbilt University School of Medicine, Nashville, TN. Location 7 December 1941—Nashville, TN.

Status: Inactive in the Regular Army as the 300th General Hospital.**Commanders, 300th General Hospital**

Lt. Col. Herbert C. Ostrum**	Apr 31-5 Jun 36	<i>Inactive</i>	5 Jun 36-26 Aug 40
	Lt. Col. Hugh J. Morgan**	26 Aug 40-ao Jun 42	

** RAI Commanders: Organized Reserve officers.

301st General Hospital (Panama Canal Department)**Regular Army Inactive****HQ-Not organized** 1935-41

Constituted in the Regular Army 10 December 1935 and allotted to the Panama Canal Department. Location 7 December 1941—*Inactive*.

Status: Disbanded 11 November 1944.**302nd General Hospital (Panama Canal Department)****Regular Army Inactive****HQ-Not organized** 1936-41

Constituted in the Regular Army 17 June 1936 as the Department Medical Reserve, Panama Canal Department and allotted to the Panama Canal Department. Redesignated 15 June 1937 as the 302nd General Hospital. Location 7 December 1941—*Inactive*.

Status: Disbanded 11 November 1944.**624th General Hospital (C.Z.)****Regular Army Inactive****HQ-Not organized** 1927-28; Fourth Corps Area 1928-29

Constituted in the Regular Army 18 October 1927, assigned to the Communications Zone, and allotted to the Fourth Corps Area. Organized 10 March 1928 with Organized Reserve personnel as a RAI unit with headquarters in the Fourth Corps Area. Withdrawn from the Fourth Corps Area 21 December 1928 and demobilized. Reserve personnel relieved 12 February 1929.

Commanders, 624th General Hospital

Lt. Col. Thomas C. Davison**	10 Mar 28-16 Aug 28	Lt. Col. James F. Arthur**	16 Aug 28-12 Feb 29
------------------------------	---------------------	----------------------------	---------------------

** RAI Commanders: Organized Reserve officers.

629th General Hospital (C.Z.)**Regular Army Inactive****HQ-Not organized** 1927-28

Constituted in the Regular Army 18 October 1927, assigned to the Communications Zone, and allotted to the Eighth Corps Area. Withdrawn from the Eighth Corps Area 21 December 1928 and demobilized.

661st General Hospital (C.Z.)**Regular Army Inactive****HQ-Not organized** 1927-28

Constituted in the Regular Army 18 October 1927, assigned to the Communications Zone, and allotted to the Ninth Corps Area. Withdrawn from the Ninth Corps Area 21 December 1928 and demobilized.

676th General Hospital (C.Z.)**Regular Army Inactive****HQ-Not organized** 1927-28

Constituted in the Regular Army 18 October 1927, assigned to the Communications Zone, and allotted to the Second Corps Area. Withdrawn from the Second Corps Area 21 December 1928 and demobilized.

1101st General Hospital (First C.A.S.C.)**Organized Reserve Massachusetts****HQ-Not initiated** 1929-32; Worcester, MA, 1932-41

Constituted in the Organized Reserve about June 1929, assigned to the First Corps Area Service Command, and allotted to the First Corps Area. Organized by June 1932 at Worcester, MA. Location 7 December 1941—Worcester, MA.

Commanders, 1101st General Hospital

Maj. Edward D. Hartnett

ao Jun 32-ao Nov 34

Unknown

ao Nov 34-7 Dec 41

1102nd General Hospital (First C.A.S.C.)**Organized Reserve Massachusetts****HQ-Not initiated** 1929-38; Boston, MA, 1938-41

Constituted in the Organized Reserve about June 1929, assigned to the First Corps Area Service Command, and allotted to the First Corps Area. Organized about May 1936 at Boston, MA, by transfer of personnel from Beale General Hospital. Location 7 December 1941—Boston, MA.

Commanders, 1102nd General Hospital

Lt. Col. Elliot C. Cutler

May 36-7 Dec 41

1103rd General Hospital (First C.A.S.C.)**Organized Reserve Connecticut****HQ-Not initiated** 1929-36; New Haven, CT, 1936-41

Constituted in the Organized Reserve about June 1929, assigned to the First Corps Area Service Command, and allotted to the First Corps Area. Organized about September 1936 at New Haven, CT, by transfer of personnel from Baxter General Hospital. Served as an augmentation unit for Baxter General Hospital. Location 7 December 1941—New Haven, CT.

Commanders, 1103rd General Hospital

Lt. Col. Charles G. Miles

Sep 36-7 Dec 41

1670th General Hospital (Sixth C.A.S.C.)

Organized Reserve Illinois

HQ-*Not initiated* 1936-38; Chicago, IL, 1938; *Inactive* 1938-41

Constituted in the Organized Reserve in 1936, assigned to the Sixth Corps Area Service Command, and allotted to the Sixth Corps Area. Served as an augmentation unit for Forwood General Hospital. Organized 12 January 1938 at Chicago, IL. Inactivated 12 December 1938 at Chicago by relief of personnel. Location 7 December 1941—*Inactive*.

Commanders, 1670th General Hospital

Lt. Col. Arthur C. Bachmeyer

12 Jan 38-12 Dec 38

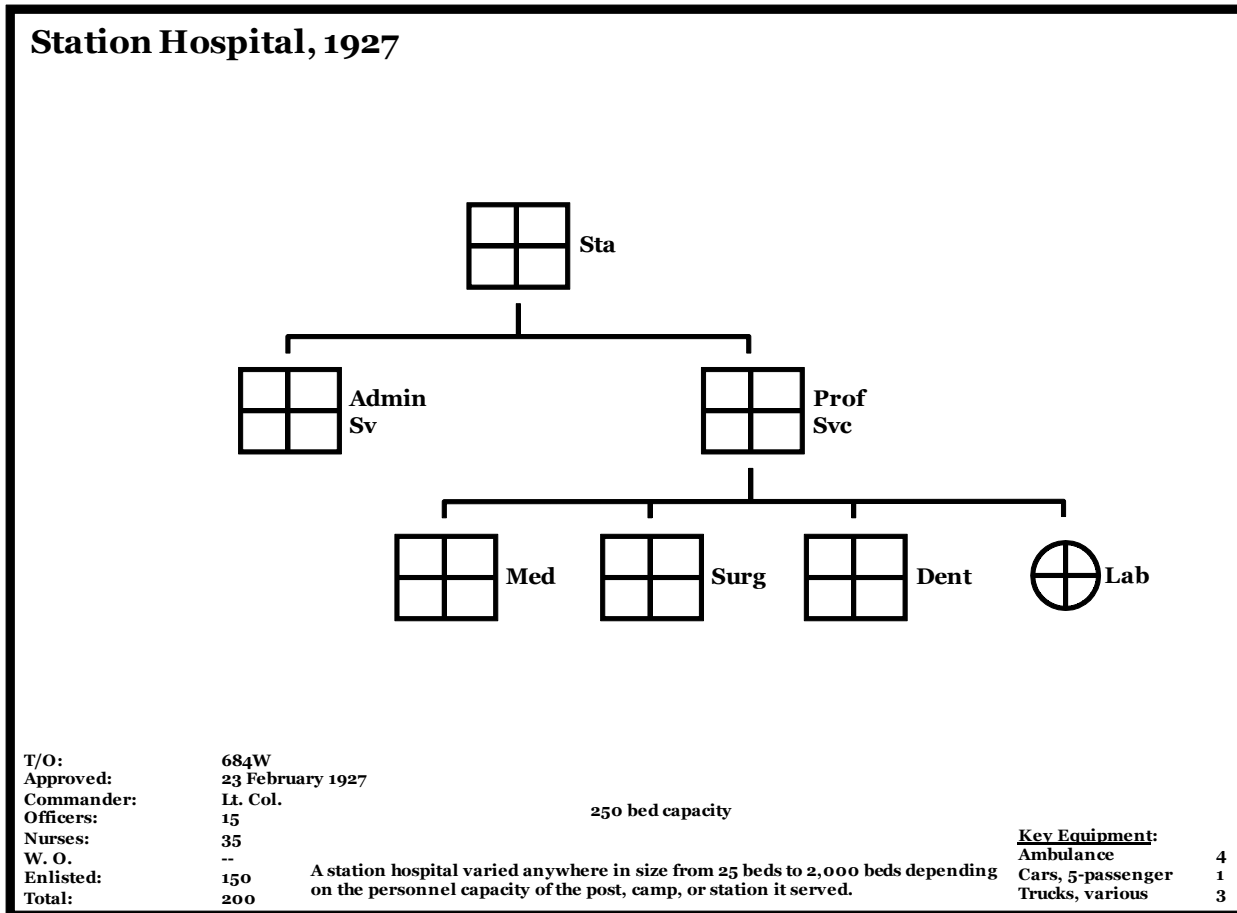

Station Hospital TOE.

Station Hospital mission: Provide definitive medical care for troops at the camp, post, or station at which the hospital is located; transfer to a general hospital cases that require long-term or specialized care not available at the station hospital.

1st Station Hospital (C.Z.)

Organized Reserve Connecticut/Ohio

HQ-Norwich, CT, 1922-36; *Inactive* 1936-37; Cleveland, OH, 1937-41; Fort Ord, CA, 1941

Authorized by the Surgeon General 13 September 1922 for organization in the First Corps Area and concurrently initiated at Norwich, CT. Constituted in the Organized Reserve 2 July 1923, assigned to the Communications Zone, and allotted to the First Corps Area. Designated 12 September 1923 as Station Hospital No. 1. Redesignated 23 March 1925 as the 1st Station Hospital. Withdrawn from the Organized Reserve 1 October 1933 and allotted to the Regular Army. Concurrently relieved from the Communications Zone and assigned to the General Headquarters Reserve. Withdrawn from the First Corps Area 5 June 1936 and allotted to the Fifth Corps Area. Reorganized 6 August 1937 at Cleveland, OH. Activated 10 February 1941, less Reserve personnel, at Fort Ord, CA, and assigned to the Fourth Army. Location 7 December 1941—Fort Ord, CA.

Status: Inactive in the Regular Army as the 1st Station Hospital.

Commanders, 1st Station Hospital

Lt. Col. Louis I. Mason	13 Sep 22-Sep 29	<i>Inactive</i>
Lt. Col. Charles S. Doucet**	Sep 29-5 Jun 36	Unknown
** RAI Commanders: Organized Reserve officers.		

2nd Station Hospital (C.Z.)**Organized Reserve Illinois****HQ**-Chicago, IL, 1922-41

Authorized by the Surgeon General 27 September 1922 for organization in the Sixth Corps Area. Constituted in the Organized Reserve 2 July 1923, assigned to the Communications Zone, and allotted to the Sixth Corps Area. Designated 12 September 1923 as Station Hospital No. 2. Redesignated 23 March 1925 as the 2nd Station Hospital. Conducted summer training at the station hospitals at Fort Snelling, MN, OR, Fort Sheridan, IL, OR, Jefferson Barracks, MO. Location 7 December 1941—Chicago, IL.

Status: Inactive in the Regular Army as the 2nd Station Hospital (Philippine Scouts).**Commanders, 2nd Station Hospital**

Lt. Co. James A. Harvey	27 Sep 22-ao Jan 24	Unknown	ao Jun 32-ao Jun 34
Unknown	ao Jan 24-2 Jun 25	Lt. Col. Eugene J. Chesrow	ao Jun 34-ao Feb 35
Lt. Col. Charles E. Remy	2 Jun 25-6 Feb 30	Unknown	ao Feb 35-oa Oct 38
Lt. Col. Walter G. Bain	6 Feb 30-ao Jun 32	Maj. Vincent Gino	ao Oct 38-ao Jan 40
	Unknown	ao Jan 40-7 Dec 41	

3rd Station Hospital (C.Z.)**Organized Reserve Wisconsin****HQ**-*Not initiated* 1922-24; Milwaukee, WI, 1924-37; LaCrosse, WI, 1937-41

Constituted in the Organized Reserve 2 July 1923, assigned to the Communications Zone, and allotted to the Sixth Corps Area. Designated 12 September 1923 as Station Hospital No. 3. Initiated in November 1924 at Milwaukee, WI. Redesignated 23 March 1925 as the 3rd Station Hospital. Relocated 7 April 1937 to LaCrosse, WI. Conducted summer training at the station hospitals at Fort Snelling, MN, Camp Custer, MI, OR, Fort Brady, MI. Location 7 December 1941—LaCrosse, WI.

Status: Active in the U.S. Army Reserve as the 312th Field Hospital at Greensboro, NC.**Commanders, 3rd Station Hospital**

Lt. Col. James G. Taylor	Nov 24-ao Jun 27	Maj. Jose A. Hernandez	17 Jun 29-ao Jun 30
Unknown	ao Jun 27-ao May 29	Unknown	ao Jun 30-ao Jun 32
Lt. Col. John C. Johnson	ao May 29-17 Jun 29	Lt. Col. John W. Rock	ao Jun 32-ao Jun 36
	Unknown	ao Jun 36-7 Dec 41	

4th Station Hospital (C.Z.)**Organized Reserve Indiana****HQ**-Indianapolis, IN, 1922-41

Authorized by the Surgeon General 15 September 1922 for organization in the Sixth Corps Area. Constituted in the Organized Reserve 2 July 1923 as Station Hospital No. 4, assigned to the Communications Zone, and allotted to the Fifth Corps Area. Redesignated 23 March 1925 as the 4th Station Hospital. Relieved from the Communications Zone and assigned to the General Headquarters Reserve. Location 7 December 1941—Indianapolis, IN.

Status: Disbanded 11 November 1944.**Commanders, 4th Station Hospital**

Maj. Flavius J. Beck	15 Sep 22-ao Jan 24	Lt. Col. Daniel D. Jones	ao Nov 25-ao Sep 28
Unknown	ao Jan 24-ao Nov 25	Unknown	ao Sep 28-7 Dec 41

5th Station Hospital (C.Z.)**Organized Reserve Minnesota****HQ**-St. Paul, MN, 1922-31; Mankato, MN, 1931-41

Authorized by the Surgeon General 27 September 1922 for organization in the Seventh Corps Area. Constituted in the Organized Reserve 2 July 1923 as Station Hospital No. 5, assigned to the Communications Zone, and allotted to the Fifth Corps Area. Redesignated 23 March 1925 as the 5th Station Hospital. Relocated 12 October 1931 to Mankato, MN. Withdrawn from the Organized Reserve 1 October 1933 and allotted to the Regular Army. Relieved from the

Communications Zone in 1936 and assigned to the General Headquarters Reserve. Conducted summer training at the station hospital at Fort Snelling, MN. Activated 7 January 1941 at Camp Stewart, GA, and assigned to the First Army. Location 7 December 1941—Camp Stewart, GA.

Status: Inactive in the Regular Army as the 5th Station Hospital.

Commanders, 5th Station Hospital

Maj. Frederick E. Kraft	27 Sep 22-ao Jun 27	Unknown	ao Jan 30-ao Jun 36
Unknown	ao Jun 27-6 Nov 29	Lt. Col. John J. Catlin**	ao Jun 36-12 Jul 36
Lt. Col. Harry G. Thomas	6 Nov 29-ao Jan 30	Unknown	12 Jul 36-7 Dec 41

** RAI Commanders: Organized Reserve officers.

6th Station Hospital (C.Z.)

Organized Reserve Michigan

HQ-*Not initiated* 1922-24; Detroit, MI, 1924-29; *Inactive* 1929-34; Detroit, MI, 1934-41

Authorized by the Surgeon General 26 September 1922 for organization in the Sixth Corps Area. Constituted in the Organized Reserve 2 July 1923 as Station Hospital No. 6, assigned to the Communications Zone, and allotted to the Sixth Corps Area. Initiated about November 1924 at Detroit, MI. Redesignated 23 March 1925 as the 6th Station Hospital. Inactivated 8 August 1929 at Detroit by relief of personnel. Reorganized by June 1934 at Detroit. Conducted annual summer training at Camp Custer, MI. Location 7 December 1941—Detroit, MI.

Status: Inactive in the Regular Army as the 6th Station Hospital (Philippine Scouts).

Commanders, 6th Station Hospital

Lt. Col. Henry G. Berry	Nov 24-9 Feb 26	<i>Inactive</i>	8 Aug 29-ao Jun 34
Lt. Col. Ralph H. Bookmeyer	9 Feb 26-8 Aug 29	Unknown	ao Jun 34-7 Dec 41

7th Station Hospital (C.Z.)

Organized Reserve Pennsylvania

HQ-Pittsburgh, PA, 1923-41; Camp Edwards, MA, 1941

Constituted in the Organized Reserve 23 February 1923 by the Surgeon General as Station Hospital No. 7, assigned to the Communications Zone, and allotted to the Third Corps Area. Initiated by November 1923 at Pittsburgh, PA. Redesignated 23 March 1925 as the 7th Station Hospital. Withdrawn from the Organized Reserve 1 October 1933 and allotted to the Regular Army. Concurrently relieved from the Communications Zone and assigned to the General Headquarters Reserve. Activated 10 February 1941, less Reserve personnel, at Camp Edwards, MA, and assigned to the First Army. Location 7 December 1941—Camp Edwards, MA.

Status: Inactive in the Regular Army as the 7th Station Hospital.

Events: 323

Commanders, 7th Station Hospital

Lt. Col. Clarence H. Ingram	ao Nov 23-ao Jun 31	Unknown	ao Jun 31-7 Dec 41
-----------------------------	---------------------	---------	--------------------

8th Station Hospital (C.Z.)

Organized Reserve Massachusetts/Ohio

HQ-*Not initiated* 1922-26; Worcester, MA, 1926-36; *Inactive* 1936-37; Columbus, OH, 1937-41; Fort Dix, NJ, 1941

Constituted in the Organized Reserve 2 July 1923, assigned to the Communications Zone, and allotted to the First Corps Area. Designated 12 September 1923 as Station Hospital No. 8. Redesignated 23 March 1925 as the 8th Station Hospital. Initiated by April 1926 at Worcester, MA. Withdrawn from the Organized Reserve 1 October 1933 and allotted to the Regular Army. Concurrently relieved from the Communications Zone and assigned to the General Headquarters Reserve. Withdrawn from the First Corps Area 5 June 1936 and allotted to the Fifth Corps Area. Reorganized 6 August 1937 at Columbus, OH. Conducted summer training at the station hospital at Fort Devens, MA. Designated mobilization training station was Fort Devens, MA, 1923-36. Activated 10 February 1941, less Reserve personnel, at Fort Dix, NJ, and assigned to the First Army. Location 7 December 1941—Fort Dix, NJ.

Status: Inactive in the Regular Army as the 8th Station Hospital.

Commanders, 8th Station Hospital

Maj. Walter F. Robie	ao Apr 26-Apr 27	Maj. George A. McIver**	ao Nov 34-ao Jan 35
Lt. Col. Rob R. McCully	Apr 27-Jul 28	Unknown	ao Jan 35-5 Jun 36
Unknown	Jul 28-ao Jan 30	<i>Inactive</i>	5 Jun 36-6 Aug 37
Capt. Albert H. Prouty	ao Jan 30-ao Feb 30	Unknown	6 Aug 37-10 Feb 41
Unknown	ao Feb 30-ao Nov 34	Lt. Col. Alvin T. Bakley*	10 Feb 41-ao Dec 41

* Regular Army active duty commanders

** RAI Commanders: Organized Reserve officers.

9th Station Hospital (C.Z.)

Organized Reserve Massachusetts/Ohio

HQ-*Not initiated* 1923-25; Holyoke, MA, 1925-36; *Inactive* 1936-37; Cincinnati, OH, 1937-41; Fort McClellan, AL, 1941

Constituted in the Organized Reserve 2 July 1923, assigned to the Communications Zone, and allotted to the First Corps Area. Designated 12 September 1923 as Station Hospital No. 9. Redesignated 23 March 1925 as the 9th Station Hospital. Initiated about March 1925 at Holyoke, MA. Withdrawn from the Organized Reserve 1 October 1933 and allotted to the Regular Army. Concurrently relieved from the Communications Zone and assigned to the General Headquarters Reserve. Withdrawn from the First Corps Area 5 June 1936 and allotted to the Fifth Corps Area. Reorganized 6 August 1937 at Cincinnati, OH. Conducted summer training at the station hospital at Fort Devens, MA. Activated 11 February 1941, less Reserve personnel, at Fort McClellan, AL, and assigned to the Second Army. Location 7 December 1941—Fort McClellan, AL.

Status: Inactive in the Regular Army as the 109th Field Hospital.

Commanders, 9th Station Hospital

Unknown	Mar 25-20 Dec 26	Maj. Arthur H. Ring**	14 Jan 29-5 Jun 36
Maj. James H. Quinn	20 Dec 26-ao Jan 27	<i>Inactive</i>	5 Jun 36-6 Aug 37
Lt. Col. Edward J. Hussey	ao Jun 27-14 Jan 29	Unknown	6 Aug 37-24 Jun 41
	Lt. Col. Frank W. Pinger*	24 Jun 41-ao Dec 41	

* Regular Army active duty commanders

** RAI Commanders: Organized Reserve officers.

10th Station Hospital (C.Z.)

Organized Reserve Massachusetts/Ohio

HQ-*Not initiated* 1923-25; Haverhill, MA, 1925-36; *Inactive* 1936-37; Toledo, OH, 1936-41; Camp Claiborne, LA, 1941

Constituted in the Organized Reserve 2 July 1923, assigned to the Communications Zone, and allotted to the First Corps Area. Designated 12 September 1923 as Station Hospital No. 10. Redesignated 23 March 1925 as the 10th Station Hospital. Initiated in November 1925 at Haverhill, MA. Withdrawn from the Organized Reserve 1 October 1933 and allotted to the Regular Army. Concurrently relieved from the Communications Zone and assigned to the General Headquarters Reserve. Withdrawn from the First Corps Area 5 June 1936 and allotted to the Fifth Corps Area. Reorganized 6 August 1937 at Toledo, OH. Conducted summer training at the station hospital at Fort Devens, MA. Designated mobilization training station was Fort Devens 1923-36. Activated 10 February 1941, less Reserve personnel, at Camp Claiborne, LA, and assigned to the Third Army. Location 7 December 1941—Camp Claiborne, LA.

Status: Inactive in the Regular Army as the 10th Station Hospital.

Events: 323

Commanders, 10th Station Hospital

Lt. Col. Wilbert C. Hardie**	Nov 25-Oct 34	<i>Inactive</i>	5 Jun 36-6 Aug 37
Unknown	Oct 34-5 Jun 36	Unknown	6 Aug 37-5 Jun 41
	Lt. Col. Lester E. Beringer*	5 Jun 41-ao Dec 41	

* Regular Army active duty commanders

** RAI Commanders: Organized Reserve officers.

11th Station Hospital (C.Z.)**Organized Reserve Massachusetts**

HQ-Not initiated 1923-25; Lawrence, MA, 1925-36; *Inactive* 1936-37; Newark, NJ, 1937-1941; Reykjavik, Iceland 1941

Constituted in the Organized Reserve 2 July 1923, assigned to the Communications Zone, and allotted to the First Corps Area. Designated 12 September 1923 as Station Hospital No. 11. Redesignated 23 March 1925 as the 11th Station Hospital. Initiated in August 1925 at Lawrence, MA. Withdrawn from the Organized Reserve 1 October 1933 and allotted to the Regular Army. Concurrently relieved from the Communications Zone and assigned to the General Headquarters Reserve. Withdrawn from the First Corps Area 5 June 1936 and allotted to the Second Corps Area. Reorganized 31 December 1937 at Newark, NJ. Conducted summer training at the station hospital at Fort Devens, MA. Designated mobilization training station was Fort Devens, 1923-36. Activated 25 January 1941, less Reserve personnel, at Fort Custer, MI. Embarked at NYPE 5 September 1941 and sailed for Iceland, where it was assigned to the Iceland Base Command. Arrived 24 September 1941 at Reykjavik. Opened operations 1 December 1941 at Camp Helgafell. Location 7 December 1941—Camp Helgafell, Iceland.

Status: Disbanded 6 December 1943.

Commanders, 11th Station Hospital

Unknown	Aug 25-ao May 26	<i>Inactive</i>	5 Jun 36-31 Dec 37
Maj. Elmer S. Bagnell**	ao May 26-Nov 34	Maj. Julius Sobin	31 Dec 37-25 Jan 41
Maj. Francis A. O'Reilley**	Nov 34-5 Jun 36	Unknown	25 Jan 41-7 Dec 41

* Regular Army active duty commanders

** RAI Commanders: Organized Reserve officers.

12th Station Hospital (C.Z.)**Organized Reserve Massachusetts**

HQ-Not initiated 1923-25; Brockton, MA, 1925-33; Lewiston, ME, 1933-37; Concord, NH, 1937-41; Camp Forrest, TN, 1941

Constituted in the Organized Reserve 2 July 1923, assigned to the Communications Zone, and allotted to the First Corps Area. Designated 12 September 1923 as Station Hospital No. 12. Redesignated 23 March 1925 as the 12th Station Hospital. Initiated in August 1925 at Brockton, MA. Withdrawn from the Organized Reserve 1 October 1933 and allotted to the Regular Army. Concurrently relieved from the Communications Zone and assigned to the General Headquarters Reserve. Relocated by December 1933 to Lewiston, ME. Relocated by January 1937 to Concord, NH. Conducted summer training at the station hospital at Fort Devens, MA. Activated 10 February 1941, less Reserve personnel, at Camp Forrest, TN, and assigned to the Second Army. Location 7 December 1941—Camp Forrest, TN.

Status: Inactive in the Regular Army as the 12th Station Hospital.

Events: 323

Commanders, 12th Station Hospital

Unknown	Aug 25-ao Apr 26	Lt. Col. Charles G. Miles**	ao Dec 29-ao Jun 35
Maj. Joseph B. Sayles	ao Apr 26-ao Jun 27	Unknown	ao Jun 35-Jun 41
Unknown	ao Jul 27-ao Dec 29	Lt. Col. William P. Dingle*	Jun 41-ao Jan 42

* Regular Army active duty commanders

** RAI Commanders: Organized Reserve officers.

13th Station Hospital (C.Z.)**Organized Reserve Maine/Indiana**

HQ-Not initiated 1923-25; Lewiston, ME, 1925-27; *Inactive* 1927-41

Constituted in the Organized Reserve 2 July 1923, assigned to the Communications Zone, and allotted to the First Corps Area. Designated 12 September 1923 as Station Hospital No. 13. Redesignated 23 March 1925 as the 13th Station Hospital. Initiated about November 1925 at Lewiston, ME. Withdrawn from the First Corps Area 11 January 1927 and allotted to the Fifth Corps Area. Inactivated 8 February 1927 at Lewiston by relief of personnel. Bloomington, IN, designated as headquarters on reorganization, but the unit was never organized at that location. Withdrawn from the Organized Reserve 1 October 1933 and allotted to the Regular Army. Concurrently relieved from the Communications Zone and assigned to the General Headquarters Reserve. Designated headquarters location changed 22 March 1934 to Martinsville, IN. Location 7 December 1941—*Inactive*.

Status: Inactive in the U.S. Army Reserve as the 13th Station Hospital.

Commanders, 13th Station Hospital

Lt. Col. William L. Haskell

Nov 25-7 Feb 27

Inactive

7 Feb 27-7 Dec 41

14th Station Hospital (C.Z.)

Organized Reserve Massachusetts/Ohio

HQ-*Not initiated* 1923-25; Fitchburg, MA, 1925-27; *Inactive* 1927-34; Chillicothe, OH, 1934-41

Constituted in the Organized Reserve 2 July 1923, assigned to the Communications Zone, and allotted to the First Corps Area. Designated 12 September 1923 as Station Hospital No. 14. Redesignated 23 March 1925 as the 14th Station Hospital. Initiated in August 1925 at Fitchburg, MA. Withdrawn from the First Corps Area 11 January 1927 and allotted to the Fifth Corps Area. Inactivated 7 February 1927 at Fitchburg by relief of personnel. Columbus, OH, designated as headquarters on reorganization, but the unit was never organized at that location. Withdrawn from the Organized Reserve 1 October 1933 and allotted to the Regular Army. Concurrently relieved from the Communications Zone and assigned to the General Headquarters Reserve. Reorganized by June 1934 at Chillicothe, OH. Location 7 December 1941—Chillicothe, OH.

Status: Disbanded 6 December 1943.

Commanders, 14th Station Hospital

Unknown

Aug 25-ao Apr 26

Inactive

7 Feb 27-ao Jun 34

Maj. Dixi G. Hoyt

ao Apr 26-7 Feb 27

Unknown

ao Jun 34-7 Dec 41

15th Station Hospital (C.Z.)

Organized Reserve Massachusetts

HQ-*Not initiated* 1923-25; Cambridge, MA, 1925-29; *Inactive* 1929-37; Syracuse, NY, 1937-41

Constituted in the Organized Reserve 2 July 1923, assigned to the Communications Zone, and allotted to the First Corps Area. Designated 12 September 1923 as Station Hospital No. 15. Redesignated 23 March 1925 as the 15th Station Hospital. Initiated in August 1925 at Cambridge, MA, Inactivated about June 1929 at Cambridge by relief of personnel. Relieved from the Communications Zone 1 October 1933 and assigned to the General Headquarters Reserve. Withdrawn from the First Corps Area 5 June 1936 and allotted to the Second Corps Area. Reorganized 8 May 1937 at Syracuse, NY. Location 7 December 1941—Syracuse, NY.

Status: Disbanded 6 December 1943.

Commanders, 15th Station Hospital

Unknown

Aug 25-ao Apr 26

Capt. Reneh Juchli

8 May 37-13 May 37

Maj. Arthur H. Ring

ao Apr 26-Jun 29

Maj. Walter S. Pugh

13 May 37-25 Aug 38

Inactive

Jun 29-8 May 37

Lt. Col. Ray D. Champlin

25 Aug 38-11 Dec 40

Maj. Walter S. Pugh

11 Dec 40-ao Jan 41

16th Station Hospital (C.Z.)

Organized Reserve Maine

HQ-*Not initiated* 1923-25; Portland, ME, 1925-27; Augusta, ME, 1928-36; *Inactive* 1936-37; Utica, NY, 1937-41

Constituted in the Organized Reserve 2 July 1923, assigned to the Communications Zone, and allotted to the First Corps Area. Designated 12 September 1923 as Station Hospital No. 16. Redesignated 23 March 1925 as the 16th Station Hospital. Initiated in September 1925 at Portland, ME. Relocated by December 1927 to Augusta, ME. Relieved from the Communications Zone 1 October 1933 and assigned to the General Headquarters Reserve. Withdrawn from the First Corps Area 5 June 1936 and allotted to the Second Corps Area. Reorganized 13 May 1937 at Utica, NY. Location 7 December 1941—Utica, NY.

Status: Inactive in the U.S. Army Reserve as the 311th Station Hospital.

Commanders, 16th Station Hospital

Unknown	Sep 25-16 Feb 26	<i>Inactive</i>	5 Jun 36-13 May 37
Maj. Joseph E. Stephans	16 Feb 26-Apr 26	1st Lt. Dominick Battaglia	13 May 37-19 Mar 38
Lt. Col. Ronald B. Moore	Apr 26-Dec 29	Maj. William Zuckerman	19 Mar 38-9 Nov 40
Unknown	Dec 29-5 Jun 36	Capt. John O. Whitaker	9 Nov 40-ao Jan 41
	Unknown	ao Jan 41-7 Dec 41	

17th Station Hospital (C.Z.)

Organized Reserve New Hampshire/Maine/New York

HQ-Not initiated 1923-25; Portsmouth, NH, 1925-27; Lewiston, ME, 1927-36; *Inactive* 1936-37; Rochester, NY, 1937-41

Constituted in the Organized Reserve 2 July 1923, assigned to the Communications Zone, and allotted to the First Corps Area. Designated 12 September 1923 as Station Hospital No. 17. Redesignated 23 March 1925 as the 17th Station Hospital. Initiated by September 1925 at Portsmouth, NH. Inactivated 28 February 1927 at Portsmouth by relief of personnel. Reorganized 25 May 1927 at Lewiston, ME. Relieved from the Communications Zone 1 October 1933 and assigned to the General Headquarters Reserve. Withdrawn from the First Corps Area 5 June 1936 and allotted to the Second Corps Area. Reorganized 13 May 1937 at Rochester, NY. Location 7 December 1941—Rochester, NY.

Status: Inactive in the U.S. Army Reserve as the 17th Station Hospital.

Commanders, 17th Station Hospital

Unknown	Sep 25-6 Mar 26	Maj. R. B. McGee	Feb 29-Dec 29
Lt. Col. Robert O. Blood	6 Mar 26-28 Feb 27	Unknown	Dec 29-5 Jun 36
<i>Inactive</i>	28 Feb 27-25 May 27	<i>Inactive</i>	5 Jun 36-13 May 37
Lt. Col. William L. Haskell	25 May 27-Feb 29	Capt. Stephen J. Karpenski	13 May 37-ao Apr 41

18th Station Hospital (C.Z.)

Organized Reserve Vermont/New York

HQ-Not initiated 1923-25; Montpelier, VT, 1925-36; *Inactive* 1936-37; Buffalo, NY, 1937-41

Constituted in the Organized Reserve 2 July 1923, assigned to the Communications Zone, and allotted to the First Corps Area. Designated 12 September 1923 as Station Hospital No. 18. Redesignated 23 March 1925 as the 18th Station Hospital. Initiated in August 1925 at Montpelier, VT. Relieved from the Communications Zone 1 October 1933 and assigned to the General Headquarters Reserve. Withdrawn from the First Corps Area 5 June 1936 and allotted to the Second Corps Area. Reorganized 9 June 1937 at Buffalo, NY. Location 7 December 1941—Buffalo, NY.

Status: Inactive in the U.S. Army Reserve as the 810th Station Hospital.

Commanders, 18th Station Hospital

Unknown	Aug 25-ao Apr 26	1st Lt. John F. Argue	9 Jun 37-6 Aug 37
Maj. Henry C. Jackson	ao Apr 26-ao Jun 27	Capt. Raymond J. Germain	6 Aug 37-19 Jul 39
Unknown	ao Jun 27-5 Jun 36	Maj. Charles H. Edel	19 Jul 39-16 Jan 40
<i>Inactive</i>	5 Jun 36-9 Jun 37	Capt. Raymond J. Germain	16 Jan 40-ao Apr 41

19th Station Hospital (C.Z.)

Organized Reserve Vermont/New York

HQ-Not initiated 1923-26; Brattleboro, VT, 1926-36; *Inactive* 1936-37; Buffalo, NY, 1937-41

Constituted in the Organized Reserve 2 July 1923, assigned to the Communications Zone, and allotted to the First Corps Area. Designated 12 September 1923 as Station Hospital No. 19. Redesignated 23 March 1925 as the 19th Station Hospital. Initiated by April 1926 at Brattleboro, VT. Relieved from the Communications Zone 1 October 1933 and assigned to the General Headquarters Reserve. Withdrawn from the First Corps Area 5 June 1936 and allotted to the Second Corps Area. Reorganized 9 June 1937 at Buffalo, NY. Location 7 December 1941—Buffalo, NY.

Status: Inactive in the U.S. Army Reserve as the 806th Station Hospital.

Commanders, 19th Station Hospital

Maj. George X. Roberts	ao Apr 26-Dec 29	1st Lt. Solomon Rosokoff	9 Jun 37-17 Nov 37
Unknown	ao Dec 29-5 Jun 36	Lt. Col. Walter H. Vosberg	17 Nov 37-1 Dec 38
<i>Inactive</i>	5 Jun 36-9 Jun 37	Capt. Solomon Rosokoff	1 Dec 39-ao Jan 41

20th Station Hospital (C.Z.)

Organized Reserve New Hampshire/New York

HQ-*Not initiated* 1923-25; Nashua, NH, 1925-36; *Inactive* 1936-41

Constituted in the Organized Reserve 2 July 1923, assigned to the Communications Zone, and allotted to the First Corps Area. Designated 12 September 1923 as Station Hospital No. 20. Redesignated 23 March 1925 as the 20th Station Hospital. Initiated in August 1925 at Nashua, NH. Relieved from the Communications Zone 1 October 1933 and assigned to the General Headquarters Reserve. Withdrawn from the First Corps Area 5 June 1936 and allotted to the Second Corps Area. New York City, NY, designated as headquarters on reorganization, but the unit was never organized at that location. Location 7 December 1941—*Inactive*.

Status: Inactive in the Regular Army as the 20th Station Hospital.

Commanders, 20th Station Hospital

Unknown	Aug 25-ao Apr 26	Unknown	Dec 29-5 Jun 36
Lt. Col. Charles E. Congdon	ao Apr 26-Dec 29	<i>Inactive</i>	5 Jun 36-7 Dec 41

21st Station Hospital (C.Z.)

Organized Reserve Vermont

HQ-*Not initiated* 1923-25; Rutland, VT, 1925-36; *Inactive* 1936-41

Constituted in the Organized Reserve 2 July 1923, assigned to the Communications Zone, and allotted to the First Corps Area. Designated 12 September 1923 as Station Hospital No. 21. Redesignated 23 March 1925 as the 21st Station Hospital. Initiated in November 1925 at Rutland, VT. Relieved from the Communications Zone 1 October 1933 and assigned to the General Headquarters Reserve. Withdrawn from the First Corps Area 5 June 1936 and allotted to the Second Corps Area. Buffalo, NY, designated as headquarters on reorganization, but the unit was never organized at that location. Location 7 December 1941—*Inactive*.

Status: Disbanded 13 October 1945.

Commanders, 21st Station Hospital

Unknown	Nov 25-ao May 26	Unknown	ao Jul 28-5 Jun 36
Maj. George A. Russell	ao May 26-ao Jul 28	<i>Inactive</i>	5 Jun 36-7 Dec 41

22nd Station Hospital (C.Z.)

Organized Reserve Massachusetts

HQ-*Not initiated* 1923-25; Pittsfield, MA, 1925-36; *Inactive* 1936-38; New York City, NY, 1938-41; Camp Hulen, TX, 1941

Constituted in the Organized Reserve 2 July 1923, assigned to the Communications Zone, and allotted to the First Corps Area. Designated 12 September 1923 as Station Hospital No. 22. Redesignated 23 March 1925 as the 22nd Station Hospital. Initiated in August 1925 at Pittsfield, MA. Withdrawn from the Organized Reserve 1 October 1933 and allotted to the Regular Army. Concurrently relieved from the Communications Zone and assigned to the General Headquarters Reserve. Withdrawn from the First Corps Area 5 June 1936 and allotted to the Second Corps Area. Reorganized 14 May 1938 at New York City, NY. Conducted summer training at the station hospital at Fort Devens, MA. Designated mobilization training station was Fort Devens, MA, 1923-36. Activated 10 February 1941, less Reserve personnel, at Camp Hulen, TX, and assigned to the Third Army. Reserve personnel relieved 5 June 1941. Location 7 December 1941—Camp Hulen, TX.

Status: Inactive in the Regular Army as the 22nd General Hospital.

Commanders, 22nd Station Hospital

Unknown	Aug 25-ao May 26	Maj. Charles H. Griswold**	ao Feb 35-ao Jun 35
Lt. Col. Frederick H. Howard	ao May 26-ao Sep 27	Unknown	ao Jun 35-14 May 38
Unknown	ao Sep 27-ao Feb 30	Capt. Albert L. Eisner**	14 May 38-Jan 41
Maj. George C. Parcher **	ao Feb 30-ao Nov 34	1st Lt. Joseph M. Covelle**	Jan 41-10 Feb 41
Unknown	ao Nov 34-ao Feb 35	Unknown	10 Feb 41-7 Dec 41

** RAI Commanders: Organized Reserve officers.

23rd Station Hospital (C.Z.)

Organized Reserve Connecticut/Massachusetts/New York

HQ-Not initiated 1923-25; New Britain, CT, 1925-1927; Fitchburg, MA, 1927-28; *Inactive* 1928-41

Constituted in the Organized Reserve 2 July 1923, assigned to the Communications Zone, and allotted to the First Corps Area. Designated 12 September 1923 as Station Hospital No. 23. Redesignated 23 March 1925 as the 23rd Station Hospital. Initiated by June 1925 at New Britain, CT. Relocated about 1 June 1927 to Fitchburg, MA. Inactivated 1 June 1928 at Fitchburg by relief of personnel. Relieved from the Communications Zone 1 October 1933 and assigned to the General Headquarters Reserve. Withdrawn from the First Corps Area 5 June 1936 and allotted to the Second Corps Area. New York City, NY, designated as headquarters on reorganization, but the unit was never organized at that location. Location 7 December 1941—*Inactive*.

Status: Inactive in the U.S. Army Reserve as the 802nd Station Hospital.

Commanders, 23rd Station Hospital

Maj. William C. Deming	ao Jun 25-14 Sep 26	Maj. Dixi G. Hoyt	28 Feb 27-1 Jun 28
Capt. Albert A. Ankenbrandt	14 Sep 26-28 Feb 27	<i>Inactive</i>	1 Jun 28-7 Dec 41

24th Station Hospital (C.Z.)

Organized Reserve Rhode Island/New York

HQ-Not initiated 1923-24; Providence, RI, 1925-29; *Inactive* 1929-41

Constituted in the Organized Reserve 2 July 1923, assigned to the Communications Zone, and allotted to the First Corps Area. Designated 12 September 1923 as Station Hospital No. 24. Redesignated 23 March 1925 as the 24th Station Hospital. Initiated in December 1924 at Providence, RI. Inactivated in December 1929 at Providence by relief of personnel. Relieved from the Communications Zone 1 October 1933 and assigned to the General Headquarters Reserve. Withdrawn from the First Corps Area 5 June 1936 and allotted to the Second Corps Area. Rochester, NY, designated as headquarters on reorganization, but the unit was never organized at that location. Location 7 December 1941—*Inactive*.

Status: Inactive in the U.S. Army Reserve as the 807th Station Hospital.

Commanders, 24th Station Hospital

Unknown	Dec 24-22 May 25	Lt. Col. John Champlin, Sr.	22 May 25-Dec 29
	<i>Inactive</i>	Dec 29-7 Dec 41	

25th Station Hospital (C.Z.)

Organized Reserve Maine/New York

HQ-Not initiated 1923-24; Bangor, ME, 1925-36; *Inactive* 1936-41

Constituted in the Organized Reserve 2 July 1923, assigned to the Communications Zone, and allotted to the First Corps Area. Designated 12 September 1923 as Station Hospital No. 25. Redesignated 23 March 1925 as the 25th Station Hospital. Initiated by May 1925 at, and affiliated with, Eastern Maine General Hospital in Bangor, ME. Relieved from the Communications Zone 1 October 1933 and assigned to the General Headquarters Reserve. Withdrawn from the First Corps Area 5 June 1936 and allotted to the Second Corps Area. Rochester, NY, designated as headquarters on reorganization, but the unit was never organized at that location. Location 7 December 1941—*Inactive*.

Status: Disbanded 30 January 1942.

Commanders, 25th Station Hospital

Unknown	ao May 25-20 Mar 26	Unknown	Dec 29-ao Jul 35
Maj. Leonard H. Ford	20 Mar 26-ao Jun 27	Maj. Frank S. Adams	ao Jul 35-5 Jun 36
Maj. George H. Stone	ao Jun 28-Dec 29	<i>Inactive</i>	5 Jun 36-7 Dec 41

26th Station Hospital (C.Z.)

Organized Reserve New Hampshire/Vermont

HQ-Not initiated 1923-25; Keene, NH, 1925-27; White River Junction, VT, 1927-36; Concord, NH, 1936-41; Camp San Luis Obispo, CA, 1941

Constituted in the Organized Reserve 2 July 1923, assigned to the Communications Zone, and allotted to the First Corps Area. Designated 12 September 1923 as Station Hospital No. 26. Redesignated 23 March 1925 as the 26th Station Hospital. Initiated in June 1925 at Keene, NH. Inactivated about March 1927 at Keene by relief of personnel. Reorganized 14 April 1927 at White River Junction, VT. Withdrawn from the Organized Reserve 1 October 1933 and allotted to the Regular Army. Concurrently relieved from the Communications Zone and assigned to the General Headquarters Reserve. Relocated by December 1936 to Concord, NH. Activated 10 February 1941, less Reserve personnel, at Camp San Luis Obispo, CA. Concurrently assigned to the Fourth Army. Location 7 December 1941—Camp San Luis Obispo, CA.

Status: Inactive in the Regular Army as the 26th Station Hospital.

Commanders, 26th Station Hospital

Maj. William P. Burke	Jun 25-14 Apr 27	Maj. Edward R. B. McGee**	ao Jun 39-ao Jan 40
Lt. Col. Robert O. Blood **	14 Apr 27-ao Jun 34	Unknown	ao Jan 40-10 Feb 41
Unknown	ao Jun 34-ao Jun 39	1st Lt. Robert S. Hamilton*	10 Feb 41-ao Jan 42

* Regular Army active duty commanders

** RAI Commanders: Organized Reserve officers.

27th Station Hospital (C.Z.)

Organized Reserve New York/New Jersey

HQ-Not initiated 1923-25; Albany, NY, 1925-37; East Orange, NJ, 1937-41

Constituted in the Organized Reserve 2 July 1923, assigned to the Communications Zone, and allotted to the Second Corps Area. Designated 12 September 1923 as Station Hospital No. 27. Redesignated 23 March 1925 as the 27th Station Hospital. Initiated in August 1925 at Albany, NY. Relocated 5 May 1937 to East Orange, NJ. Location 7 December 1941—East Orange, NJ.

Status: Inactive in the U.S. Army Reserve as the 310th Station Hospital.

Commanders, 27th Station Hospital

Unknown	Aug 25-9 Oct 25	Unknown	ao Jun 32-ao Apr 39
Lt. Col. William Swanton	9 Oct 25-ao Jun 32	Maj. W. A. McCullough	ao Apr 39-ao May 39
	Unknown	ao May 39-7 Dec 41	

28th Station Hospital (C.Z.)

Organized Reserve New York

HQ-Not initiated 1923-25; Clifton Springs, NY, 1925-37; Buffalo, NY, 1937-41

Constituted in the Organized Reserve 2 July 1923, assigned to the Communications Zone, and allotted to the Second Corps Area. Designated 12 September 1923 as Station Hospital No. 28. Redesignated 23 March 1925 as the 28th Station Hospital. Initiated 15 March 1925 at Clifton Springs, NY. Relocated 20 November 1937 to Buffalo, NY. Location 7 December 1941—Buffalo, NY.

Status: Active in the U.S. Army Reserve as the 801st General Hospital at Chicago, IL.

Commanders, 28th Station Hospital

Capt. Clarence P. Thomas	12 Mar 25-9 Oct 25	Unknown	ao Jun 27-27 May 37
Lt. Col. Charles O. Boswell	9 Oct 25-ao Jun 27	Lt. Col. Cyrus W. Field	27 May 37-ao Jun 37
	Unknown	ao Jun 37-7 Dec 41	

29th Station Hospital (C.Z.)**Organized Reserve New York/Puerto Rico****HQ-Not initiated** 1923-25; New York City, NY, 1925-30; *Inactive* 1930-41

Constituted in the Organized Reserve 2 July 1923, assigned to the Communications Zone, and allotted to the Second Corps Area. Designated 12 September 1923 as Station Hospital No. 29. Redesignated 23 March 1925 as the 29th Station Hospital. Initiated 9 October 1925 at New York City, NY. Inactivated about October 1930 at New York City by relief of personnel. San Juan, PR, designated 29 June 1938 as headquarters on reorganization, but the unit was never organized at that location. Location 7 December 1941—*Inactive*.

Status: Disbanded 30 January 1942.**Commanders, 29th Station Hospital**

Maj. Albert V. Rockwell	9 Oct 25-15 Oct 25 <i>Inactive</i>	Lt. Col. Joseph E. Hurley Oct 30-7 Dec 41	15 Oct 25-Oct 30
-------------------------	---------------------------------------	--	------------------

30th Station Hospital (C.Z.)**Organized Reserve New York****HQ-Not initiated** 1923-25; Mineola, LI, NY, 1925-41

Constituted in the Organized Reserve 2 July 1923, assigned to the Communications Zone, and allotted to the Second Corps Area. Designated 12 September 1923 as Station Hospital No. 30. Redesignated 23 March 1925 as the 30th Station Hospital. Initiated 7 October 1925 at Mineola, LI, NY. Location 7 December 1941—Mineola, LI, NY.

Status: Inactive in the U.S. Army Reserve as the 808th Station Hospital.**Commanders, 30th Station Hospital**

1st Lt. Clarence T. Lugar	7 Oct 25-16 Oct 25	Capt. Irving Madoff	3 Jan 39-16 Oct 39
Lt. Col. Frank N. Greene	16 Oct 25-Sep 26	Capt. Samuel E. DiFiglia	8 Dec 39-ao Jun 40
Lt. Col. William N. Barnhardt	Sep 26-25 Sep 30	Unknown	ao Jun 40-ao Jan 41
Unknown	25 Sep 30-ao Jun 34	1st Lt. David Levine	ao Jan 41-ao Feb 41
1st Lt. S. G. Chasko	ao Jun 34-3 Jan 39	Unknown	ao Feb 41-7 Dec 41

31st Station Hospital (C.Z.)**Organized Reserve New Jersey****HQ-Not initiated** 1923-25; Elizabeth, NJ, 1925-37; Trenton, NJ, 1937-1941

Constituted in the Organized Reserve 2 July 1923, assigned to the Communications Zone, and allotted to the Second Corps Area. Designated 12 September 1923 as Station Hospital No. 31. Redesignated 23 March 1925 as the 31st Station Hospital. Initiated 16 October 1925 at Elizabeth, NJ. Relocated 4 May 1937 to Trenton, NJ. Typically held Inactive Training Period meetings at the Post Office Building in Trenton. Location 7 December 1941—Trenton, NJ.

Status: Inactive in the U.S. Army Reserve as the 818th Station Hospital.**Commanders, 31st Station Hospital**

Maj. John L. Meehan	16 Oct 25-7 Sep 26	Lt. Col. James Breslin	11 Feb 27-18 Nov 29
Lt. Col. Carter S. Cole	7 Sep 26-15 Dec 26	Lt. Col. Stephen T. Quinn	4 Mar 30-ao Jun 33
	Unknown	ao Jun 33-7 Dec 41	

32nd Station Hospital (C.Z.)**Organized Reserve New York****HQ-Not initiated** 1923-25; Glen Falls, NY, 1925-30; *Inactive* 1930-41

Constituted in the Organized Reserve 2 July 1923, assigned to the Communications Zone, and allotted to the Second Corps Area. Designated 12 September 1923 as Station Hospital No. 32. Redesignated 23 March 1925 as the 32nd Station Hospital. Initiated 16 October 1925 at Glen Falls, NY. Inactivated 4 March 1930 at Glen Falls by relief of personnel. Location 7 December 1941—*Inactive*.

Status: Disbanded 30 January 1942.

Commanders, 32nd Station Hospital

Lt. Col. Michael M. Lucid 16 Oct 25-4 Mar 30 *Inactive* 4 Mar 30-7 Dec 41

33rd Station Hospital (C.Z.)

Organized Reserve New Jersey

HQ-*Not initiated* 1923-25; Brooklyn, NY, 1925-34; *Inactive* 1934-41

Constituted in the Organized Reserve 2 July 1923, assigned to the Communications Zone, and allotted to the Second Corps Area. Designated 12 September 1923 as Station Hospital No. 33. Redesignated 23 March 1925 as the 33rd Station Hospital. Initiated 25 March 1925 at Brooklyn, NY. Inactivated 2 March 1934 at Brooklyn by relief of personnel. Location 7 December 1941—*Inactive*.

Status: Disbanded 30 January 1942.

Commanders, 33rd Station Hospital

Capt. Frederick C. Smith 20 Mar 25-16 Oct 25 Unknown ao Nov 25-ao Jun 27
Capt. Charles L. Crane 16 Oct 25-ao Nov 25 Lt. Col. Frederick A. Hunt ao Jun 27-2 Mar 34
Inactive 2 Mar 34-7 Dec 41

34th Station Hospital (C.Z.)

Organized Reserve New York

HQ-*Not initiated* 1923-25; New Rochelle, NY, 1925-29; *Inactive* 1929-41

Constituted in the Organized Reserve 2 July 1923, assigned to the Communications Zone, and allotted to the Second Corps Area. Designated 12 September 1923 as Station Hospital No. 34. Redesignated 23 March 1925 as the 34th Station Hospital. Initiated 16 October 1925 at New Rochelle, NY. Inactivated 28 March 1929 at New Rochelle by relief of personnel. Location 7 December 1941—*Inactive*.

Status: Disbanded 30 January 1942.

Commanders, 34th Station Hospital

Capt. Clarence H. Harrington 16 Oct 25-9 Apr 26 Lt. Col. Albert Vander Veer, jr. 9 Apr 26-28 Mar 29
Inactive 28 Mar 29-7 Dec 41

35th Station Hospital (C.Z.)

Organized Reserve New York

HQ-*Not initiated* 1923-25; Niagara Falls, NY, 1925-30; *Inactive* 1930-41

Constituted in the Organized Reserve 2 July 1923, assigned to the Communications Zone, and allotted to the Second Corps Area. Designated 12 September 1923 as Station Hospital No. 35. Redesignated 23 March 1925 as the 35th Station Hospital. Initiated 20 March 1925 at Niagara Falls, NY. Inactivated 27 February 1930 at Niagara Falls by relief of personnel. Location 7 December 1941—*Inactive*.

Status: Disbanded 30 January 1942.

Commanders, 35th Station Hospital

Maj. Augustus W. Hengerer 20 Mar 25-9 Oct 25 Lt. Col. Francis E. Fronczak 9 Oct 25-27 Feb 30
Inactive 27 Feb 30-7 Dec 41

36th Station Hospital (C.Z.)

Organized Reserve New York

HQ-*Not initiated* 1923-25; Manhattan, NY, 1925-30; *Inactive* 1930-41

Constituted in the Organized Reserve 2 July 1923, assigned to the Communications Zone, and allotted to the Second Corps Area. Designated 12 September 1923 as Station Hospital No. 36. Redesignated 23 March 1925 as the 36th Station Hospital. Initiated 21 April 1925 at Manhattan, NY. Inactivated by June 1930 at Manhattan by relief of personnel. Location 7 December 1941—*Inactive*.

Status: Disbanded 30 January 1942.

Commanders, 36th Station Hospital

Lt. Col. Dean O. Thompson	21 Apr 25-ao Jun 27 <i>Inactive</i>	Unknown ao Jun 30-7 Dec 41	ao Jun 27-ao Jun 30
---------------------------	--	-------------------------------	---------------------

37th Station Hospital (C.Z.)

Organized Reserve New York

HQ-*Not initiated* 1923-25; Rochester, NY, 1925-37; *Inactive* 1937-41

Constituted in the Organized Reserve 2 July 1923, assigned to the Communications Zone, and allotted to the Second Corps Area. Designated 12 September 1923 as Station Hospital No. 37. Redesignated 23 March 1925 as the 37th Station Hospital. Initiated 9 October 1925 at Rochester, NY. Inactivated 13 May 1937 at Rochester by relief of personnel. Location 7 December 1941—*Inactive*.

Status: Disbanded 30 January 1942.

Commanders, 37th Station Hospital

Lt. Col. Martin B. Tinker	9 Oct 25-4 Mar 30	Lt. Col. Murray F. Mudge	1 Nov 32-27 Feb 34
Lt. Col. Joseph E. Hurley	4 Mar 30-22 Oct 30	Maj. John C. Hoeffler	27 Feb 34-12 May 37
Maj. John D. Fowler	22 Oct 30-1 Nov 32	<i>Inactive</i>	12 May 37-7 Dec 41

38th Station Hospital (C.Z.)

Organized Reserve New York/New Jersey

HQ-*Not initiated* 1923-25; Rome, NY, 1925-37; *Inactive* 1937-41

Constituted in the Organized Reserve 2 July 1923, assigned to the Communications Zone, and allotted to the Second Corps Area. Designated 12 September 1923 as Station Hospital No. 38. Redesignated 23 March 1925 as the 38th Station Hospital. Initiated 9 October 1925 at Rome, NY. Inactivated 29 December 1937 at Rome by relief of personnel. Princeton, NJ, designated as headquarters on reorganization, but the unit was never organized at that location. Location 7 December 1941—*Inactive*.

Status: Disbanded 30 January 1942.

Commanders, 38th Station Hospital

Lt. Col. Montgomery E. Leary	9 Oct 25-ao Jun 27	Lt. Col. Edward J. Cringle	12 Apr 30-18 Dec 31
Unknown	ao Jun 27-4 Mar 30	Unknown	18 Dec 31-29 Dec 37
Maj. Albert E. Davenport	4 Mar 30-12 Apr 30	<i>Inactive</i>	29 Dec 37-7 Dec 41

39th Station Hospital (C.Z.)

Organized Reserve New Jersey

HQ-*Not initiated* 1923-25; Trenton, NJ, 1925-38; *Inactive* 1938-41

Constituted in the Organized Reserve 2 July 1923, assigned to the Communications Zone, and allotted to the Second Corps Area. Designated 12 September 1923 as Station Hospital No. 39. Redesignated 23 March 1925 as the 39th Station Hospital. Initiated 7 October 1925 at Trenton, NJ. Inactivated about October 1937 at Trenton by relief of personnel. Location 7 December 1941—*Inactive*.

Status: Disbanded 30 January 1942.

Commanders, 39th Station Hospital

1st Lt. Carl H. Gans	7 Oct 25-9 Oct 25	Unknown	ao Jun 34-ao Mar 37
Col. Thomas J. Harris	9 Oct 25-24 May 30	Capt. Edward Kuch	ao Mar 37-Oct 37
Lt. Col. Lancelot Ely	24 May 30-ao Jun 34	<i>Inactive</i>	Oct 37-7 Dec 41

40th Station Hospital (C.Z.)**Organized Reserve New York/New Jersey****HQ-Not initiated** 1923-25; Yonkers, NY, 1925-37; Jersey City, NJ, 1937-38; *Inactive* 1938-41

Constituted in the Organized Reserve 2 July 1923, assigned to the Communications Zone, and allotted to the Second Corps Area. Designated 12 September 1923 as Station Hospital No. 40. Redesignated 23 March 1925 as the 40th Station Hospital. Initiated 9 October 1925 at Yonkers, NY. Relocated by March 1937 to Jersey City, NJ. Inactivated by November 1938 at Jersey City by relief of personnel. Atlantic City, NJ, designated as headquarters on reorganization, but the unit was never organized at that location. Location 7 December 1941—*Inactive*.

Status: Disbanded 30 January 1942.**Commanders, 40th Station Hospital**

Lt. Col. Samuel E. Getty	9 Oct 25-Mar 30	Lt. Col. Edward Adams	ao Mar 37-ao May 37
Lt. Col. George W. Beatty	11 Jun 30-12 Nov 35	Unknown	ao May 37-ao Nov 38
Unknown	12 Nov 35-ao Mar 37	<i>Inactive</i>	ao Nov 38-7 Dec 41

41st Station Hospital (C.Z.)**Organized Reserve New York/New Jersey**

HQ-Not initiated 1923-25; Schenectady, NY, 1925-30; Jersey City, NJ, 1930-36; *Inactive* 1936-41 Constituted in the Organized Reserve 2 July 1923, assigned to the Communications Zone, and allotted to the Second Corps Area. Designated 12 September 1923 as Station Hospital No. 41. Redesignated 23 March 1925 as the 41st Station Hospital. Initiated 4 September 1925 at Schenectady, NY. Relocated by March 1930 to Jersey City, NJ. Inactivated by June 1936 at Jersey City by relief of personnel. Camden, NJ, designated as headquarters on reorganization, but the unit was never organized at that location. Location 7 December 1941—*Inactive*.

Status: Disbanded 30 January 1942.**Commanders, 41st Station Hospital**

1st Lt. Charles H. Harbinson	4 Sep 25-16 Oct 25	Lt. Col. Frank Overton	21 Apr 30-7 Jan 32
Lt. Col. John D. Howland	16 Oct 25-ao Jun 27	Unknown	7 Jan 32-ao Jun 36
Unknown	ao Jun 27-21 Apr 30	<i>Inactive</i>	ao Jun 36-7 Dec 41

42nd Station Hospital (C.Z.)**Organized Reserve New York****HQ-Not initiated** 1923-25; New York City, NY, 1925-30; *Inactive* 1930-41

Constituted in the Organized Reserve 2 July 1923, assigned to the Communications Zone, and allotted to the Second Corps Area. Designated 12 September 1923 as Station Hospital No. 42. Redesignated 23 March 1925 as the 42nd Station Hospital. Initiated 20 March 1925 at New York City, NY. Inactivated 27 February 1930 at New York City by relief of personnel. Location 7 December 1941—*Inactive*.

Status: Disbanded 30 January 1942.**Commanders, 42nd Station Hospital**

Lt. Col. Albert K. Detwiller	20 Mar 25-27 Feb 30	<i>Inactive</i>	27 Feb 30-7 Dec 41
------------------------------	---------------------	-----------------	--------------------

43rd Station Hospital (C.Z.)**Organized Reserve New Jersey/New York****HQ-Not initiated** 1923-25; Bayonne, NJ, 1925-29; *Inactive* 1929-41

Constituted in the Organized Reserve 2 July 1923, assigned to the Communications Zone, and allotted to the Second Corps Area. Designated 12 September 1923 as Station Hospital No. 43. Redesignated 23 March 1925 as the 43rd Station Hospital. Initiated 15 October 1925 at Bayonne, NJ. Inactivated 18 November 1929 at Bayonne by relief of personnel. New York City, NY, designated as headquarters on reorganization, but the unit was never organized at that location. Location 7 December 1941—*Inactive*.

Status: Disbanded 30 January 1942.

Commanders, 43rd Station Hospital

1st Lt. Edward Klein	15 Oct 25-16 Oct 25 <i>Inactive</i>	Lt. Col. William H. Haskin 18 Nov 29-7 Dec 41	16 Oct 25-18 Nov 29
----------------------	--	--	---------------------

44th Station Hospital (C.Z.)

Organized Reserve New Jersey/New York

HQ-*Not initiated* 1923-25; Englewood, NJ, 1925-30; *Inactive* 1930-41

Constituted in the Organized Reserve 2 July 1923, assigned to the Communications Zone, and allotted to the Second Corps Area. Designated 12 September 1923 as Station Hospital No. 44. Redesignated 23 March 1925 as the 44th Station Hospital. Initiated 7 October 1925 at Englewood, NJ. Inactivated 4 March 1930 at Englewood by relief of personnel. New York City, NY, designated as headquarters on reorganization, but the unit was never organized at that location. Location 7 December 1941—*Inactive*.

Status: Disbanded 30 January 1942.

Commanders, 44th Station Hospital

1st Lt. Charles F. A. Rupp	7 Oct 25-16 Oct 25	Lt. Col. Stephen T. Quinn	2 Dec 25-4 Mar 30
Capt. Harry E. Matthews	16 Oct 25-2 Dec 25	<i>Inactive</i>	4 Mar 30-7 Dec 41

45th Station Hospital (C.Z.)

Organized Reserve New Jersey/Delaware

HQ-*Not initiated* 1923-25; Atlantic City, NJ, 1925-29; *Inactive* 1929-41

Constituted in the Organized Reserve 2 July 1923, assigned to the Communications Zone, and allotted to the Second Corps Area. Designated 12 September 1923 as Station Hospital No. 45. Redesignated 23 March 1925 as the 45th Station Hospital. Initiated 24 March 1925 at Atlantic City, NJ. Inactivated 6 November 1929 at Atlantic City by relief of personnel. Wilmington, DE, designated as headquarters on reorganization, but the unit was never organized at that location. Location 7 December 1941—*Inactive*.

Status: Inactive in the U.S. Army Reserve as the 45th Station Hospital.

Commanders, 45th Station Hospital

Capt. Michael T. Cawley	24 Mar 25-16 Oct 25	Unknown	ao Jun 27-ao Jun 29
Maj. Harry G. Thomas	16 Oct 25-11 Feb 27	Lt. Col. Harry G. Thomas	ao Jun 29-6 Nov 29
Lt. Col. Edward B. Rogers	11 Feb 27-ao Jun 27	<i>Inactive</i>	6 Nov 29-7 Dec 41

46th Station Hospital (C.Z.)

Organized Reserve New Jersey/Delaware

HQ-*Not initiated* 1923-25; Camden, NJ, 1925-30; *Inactive* 1930-41

Constituted in the Organized Reserve 2 July 1923, assigned to the Communications Zone, and allotted to the Second Corps Area. Designated 12 September 1923 as Station Hospital No. 46. Redesignated 23 March 1925 as the 46th Station Hospital. Initiated in August 1925 at Camden, NJ. Inactivated by June 1930 at Camden by relief of personnel. Dover, DE, designated as headquarters on reorganization, but the unit was never organized at that location. Location 7 December 1941—*Inactive*.

Status: Disbanded 30 January 1942.

Commanders, 46th Station Hospital

1st Lt. Jesse B. Eppleman	7 Oct 25-9 Oct 25	Unknown	ao Jun 27-ao Jun 30
Lt. Col. John N. Teeter	9 Oct 25-ao Jun 27	<i>Inactive</i>	ao Jun 30-7 Dec 41

47th Station Hospital (C.Z.)**Organized Reserve Pennsylvania**

HQ-Not initiated 1923-25; Carlisle Barracks, PA, 1925-32; Harrisburg, PA, 1932-36; Pittsburgh, PA, 1936-41; Camp Lee, VA, 1941

Constituted in the Organized Reserve 2 July 1923, assigned to the Communications Zone, and allotted to the Third Corps Area. Designated 12 September 1923 as Station Hospital No. 47. Initiated 13 January 1925 at Carlisle Barracks, PA. Redesignated 23 March 1925 as the 47th Station Hospital. Relocated 15 December 1932 to Harrisburg, PA. Withdrawn from the Organized Reserve 1 October 1933 and allotted to the Regular Army. Concurrently relieved from the Communications Zone and assigned to the General Headquarters Reserve. Relocated by December 1936 to Pittsburgh, PA. Activated 18 February 1941, less Reserve personnel, at Camp Lee, VA, and assigned to the First Army. Location 7 December 1941—Camp Lee, VA.

Status: Disbanded 15 November 1944.

Commanders, 47th Station Hospital

Capt. Ulysses G. Bickell	13 Jan 25-17 Jan 25	Maj. Roy E. Sleppy	11 Sep 29-18 Sep 29
Maj. William T. Phillipy	17 Jan 25-ao Sep 25	Unknown	18 Sep 29-ao Dec 37
Lt. Col. Percy E. Deckard	ao Dec 25-18 Jun 29	Maj. Charles W. Dixon**	ao Dec 37-7 Mar 38
Unknown	18 Jun 29-11 Sep 29	Unknown	18 Sep 29-18 Feb 41
	Capt. Milton A. Honigman*	18 Feb 41-ao Dec 41	

* Regular Army active duty commanders

** RAI Commanders: Organized Reserve officers.

48th Station Hospital (C.Z.)**Organized Reserve Pennsylvania**

HQ-Not initiated 1923-25; Carlisle Barracks, PA, 1925-32; Carlisle, PA, 1932-38; *Inactive* 1938-40; Philadelphia, PA, 1940-41

Constituted in the Organized Reserve 2 July 1923, assigned to the Communications Zone, and allotted to the Third Corps Area. Designated 12 September 1923 as Station Hospital No. 48. Initiated 13 January 1925 at Carlisle Barracks, PA. Redesignated 23 March 1925 as the 48th Station Hospital. Relocated 14 December 1932 to Carlisle, PA. Inactivated 8 June 1938 at Carlisle by relief of personnel. Reorganized 11 September 1940 at Philadelphia, PA. Location 7 December 1941—Philadelphia, PA.

Status: Inactive in the U.S. Army Reserve as the 811th Station Hospital.

Commanders, 48th Station Hospital

Capt. Charles Becker	13 Jan 25-17 Jan 25	Unknown	ao Jun 34-8 Jun 38
Lt. Col. Louis J. C. Bailey	17 Jan 25-18 Nov 29	<i>Inactive</i>	8 Jun 38-11 Sep 40
Lt. Col. Raymond R. Decker	18 Nov 29-ao Jun 34	Unknown	11 Sep 40-7 Dec 41

49th Station Hospital (C.Z.)**Organized Reserve Pennsylvania**

HQ-Not initiated 1923-25; Carlisle Barracks, PA, 1925-32; Wilkes-Barre, PA, 1932-38; *Inactive* 1938-40; Philadelphia, PA, 1940-41

Constituted in the Organized Reserve 2 July 1923, assigned to the Communications Zone, and allotted to the Third Corps Area. Designated 12 September 1923 as Station Hospital No. 49. Initiated 12 January 1925 at Carlisle Barracks, PA. Redesignated 23 March 1925 as the 49th Station Hospital. Relocated 14 December 1932 to Wilkes-Barre, PA. Inactivated about June 1938 at Wilkes-Barre by relief of personnel. Reorganized 12 September 1940 at Philadelphia, PA. Location 7 December 1941—Philadelphia, PA.

Status: Inactive in the U.S. Army Reserve as the 809th Station Hospital.

Commanders, 49th Station Hospital

Capt. Joseph C. Boggs	12 Jan 25-20 Jan 25	Lt. Col. Daniel H. Keller	Dec 25-Jun 38
Maj. Charles J. Smyser	20 Jan 25-Dec 25	<i>Inactive</i>	Jun 38-12 Sep 40
	Lt. Col. Daniel H. Keller	12 Sep 40-7 Aug 41	

50th Station Hospital (C.Z.)**Organized Reserve Pennsylvania****HQ-***Not initiated* 1923-25; Carlisle Barracks, PA, 1925-32; Williamsport, PA, 1932-38; *Inactive* 1938-41

Constituted in the Organized Reserve 2 July 1923, assigned to the Communications Zone, and allotted to the Third Corps Area. Designated 12 September 1923 as Station Hospital No. 50. Initiated 12 January 1925 at Carlisle Barracks, PA. Redesignated 23 March 1925 as the 50th Station Hospital. Relocated 15 December 1932 to Williamsport, PA. Inactivated 8 June 1938 at Williamsport by relief of personnel. Location 7 December 1941—*Inactive*.

Status: Inactive in the U.S. Army Reserve as the 300th Field Hospital.**Commanders, 50th Station Hospital**

Capt. Alfred L. Rhodes	12 Jan 25-13 Jan 25	Lt. Col. Thomas W. Grayson	6 Sep 29-20 Jun 31
Lt. Col. John E. Medley	13 Jan 25-29 Aug 27	Unknown	20 Jun 31-23 May 32
Unknown	27 Aug 27-Sep 29	Lt. Col. Harold F. Baker	23 May 32-8 Jun 38
	<i>Inactive</i>	8 Jun 38-7 Dec 41	

51st Station Hospital (C.Z.)**Organized Reserve Virginia/Maryland****HQ-***Not initiated* 1923-25; Fort Eustis, VA, 1925-30; *Inactive* 1930-41

Constituted in the Organized Reserve 2 July 1923, assigned to the Communications Zone, and allotted to the Third Corps Area. Designated 12 September 1923 as Station Hospital No. 51. Initiated 17 January 1925 at Fort Eustis, VA. Redesignated 23 March 1925 as the 51st Station Hospital. Inactivated by June 1930 at Fort Eustis by relief of personnel. Cumberland, MD, designated as headquarters on organization, but the unit was never organized at that location. Location 7 December 1941—*Inactive*.

Status: Inactive in the U.S. Army Reserve as the 51st Station Hospital.**Commanders, 51st Station Hospital**

Maj. Edward H. Pershing	17 Jan 25-24 Jan 25	Unknown	29 Aug 27-ao Jun 30
Lt. Col. Giles B. Cook	24 Jan 25-29 Aug 27	<i>Inactive</i>	ao Jun 30-7 Dec 41

52nd Station Hospital (C.Z.)**Organized Reserve Virginia****HQ-***Not initiated* 1923-25; Fort Monroe, VA, 1925-32; Richmond, VA, 1932-38; *Inactive* 1938-41

Constituted in the Organized Reserve 2 July 1923, assigned to the Communications Zone, and allotted to the Third Corps Area. Designated 12 September 1923 as Station Hospital No. 52. Initiated 13 January 1925 at Fort Monroe, VA. Redesignated 23 March 1925 as the 52nd Station Hospital. Relocated 5 December 1932 to Richmond, VA. Inactivated 8 August 1938 at Richmond by relief of personnel. Location 7 December 1941—*Inactive*.

Location 7 December 1941—Richmond, VA.

Status: Inactive in the U.S. Army Reserve as the 832nd Station Hospital.**Commanders, 52nd Station Hospital**

Maj. James H. Arnett	13 Jan 25-17 Jan 25	Lt. Col. Leonard D. Frescoln	9 Sep 29-22 Aug 31
Lt. Col. George A. Renn	17 Jan 25-21 Nov 28	Lt. Col. Nelson Mercer	22 Aug 31-20 Jul 32
Maj. William J. Lally	21 Nov 28-9 Sep 29	Maj. Alvah L. Herring	20 Jul 32-8 Aug 38
	<i>Inactive</i>	8 Aug 38-7 Dec 41	

53rd Station Hospital (C.Z.)**Organized Reserve Virginia****HQ-***Not initiated* 1923-25; Fort Myer, VA, 1925-32; Alexandria, VA, 1932-37; *Inactive* 1937-41

Constituted in the Organized Reserve 2 July 1923, assigned to the Communications Zone, and allotted to the Third Corps Area. Designated 12 September 1923 as Station Hospital No. 53. Initiated 13 January 1925 at Fort Myer, VA. Redesignated 23 March 1925 as the 53rd Station Hospital. Relocated 5 December 1932 to Alexandria, VA. Inactivated 15 November 1937 at Alexandria by relief of personnel. Location 7 December 1941—*Inactive*.

Status: Disbanded 30 January 1942.

Commanders, 53rd Station Hospital

Lt. Col. Henry D. Jump	13 Jan 25-20 May 27	Lt. Col. Walter A. Frankland	6 Sep 29-7 Jan 32
Lt. Col. Horace C. Dodge	20 May 27-21 Jun 29	Unknown	7 Jan 32-15 Nov 37
Maj. Charles S. Robbins	21 Jun 29-6 Sep 29	<i>Inactive</i>	15 Nov 37-7 Dec 41

54th Station Hospital (C.Z.)

Organized Reserve Maryland

HQ-*Not initiated* 1923-25; Camp George G. Meade, MD, 1925-28; *Inactive* 1928-41

Constituted in the Organized Reserve 2 July 1923, assigned to the Communications Zone, and allotted to the Third Corps Area. Designated 12 September 1923 as Station Hospital No. 54. Initiated 17 January 1925 at Camp George G. Meade, MD. Redesignated 23 March 1925 as the 54th Station Hospital. Inactivated by June 1928 at Camp George G. Meade by relief of personnel. Location 7 December 1941—*Inactive*.

Status: Inactive in the U.S. Army Reserve as the 171st Evacuation Hospital.

Commanders, 54th Station Hospital

Col. Abraham B. Hooe	17 Jan 25-ao Feb 25	Unknown	20 May 27-ao Jun 28
Lt. Col. Horace C. Dodge	ao Sep 25-20 May 27	<i>Inactive</i>	ao Jun 28-7 Dec 41

55th Station Hospital (C.Z.)

Organized Reserve Maryland

HQ-*Not initiated* 1923-25; Camp George G. Meade, MD, 1925-29; *Inactive* 1929-41

Constituted in the Organized Reserve 2 July 1923, assigned to the Communications Zone, and allotted to the Third Corps Area. Designated 12 September 1923 as Station Hospital No. 55. Initiated 12 January 1925 at Camp George G. Meade, MD. Redesignated 23 March 1925 as the 55th Station Hospital. Inactivated 29 August 1929 at Camp George G. Meade by relief of personnel. Location 7 December 1941—*Inactive*.

Status: Disbanded 30 January 1942.

Commanders, 55th Station Hospital

Maj. Allison F. B. Morris	12 Jan 25-13 Jan 25	Maj. Allensen F. B. Morris	1 May 25-ao Jun 25
Col. Daniel M. Hoyt	13 Jan 25-1 May 25	Lt. Col. George E. Lewis	ao Jan 26-29 Aug 29
	<i>Inactive</i>	29 Aug 29-7 Dec 41	

56th Station Hospital (C.Z.)

Organized Reserve District of Columbia/Maryland/Delaware

HQ-*Not initiated* 1923-25; Washington, DC 1925-27; Fort George G. Meade, MD, 1927-29; *Inactive* 1929-41

Constituted in the Organized Reserve 2 July 1923, assigned to the Communications Zone, and allotted to the Third Corps Area. Designated 12 September 1923 as Station Hospital No. 56. Initiated 26 January 1925 at Washington, DC. Redesignated 23 March 1925 as the 56th Station Hospital. Relocated in 1927 to Camp George G. Meade, MD. Inactivated 10 September 1929 at Camp George G. Meade by relief of personnel. Withdrawn from the Third Corps Area 5 June 1936 and allotted to the Second Corps Area. Wilmington, DE, designated as headquarters on reorganization, but the unit was never organized at that location. Location 7 December 1941—*Inactive*.

Commanders, 56th Station Hospital

Maj. Augustus C. Gray	26 Jan 25-ao Aug 25	Maj. Compton Wilson	6 Sep 29-10 Sep 29
Lt. Col. Walter A. Frankland	ao Dec 25-6 Sep 29	<i>Inactive</i>	10 Sep 29-7 Dec 41

57th Station Hospital (C.Z.)

Organized Reserve Maryland

HQ-*Not initiated* 1923-25; Holabird Q.M. Depot, MD, 1925-29; *Inactive* 1929-41

Constituted in the Organized Reserve 2 July 1923, assigned to the Communications Zone, and allotted to the Third Corps Area. Designated 12 September 1923 as Station Hospital No. 57. Initiated 13 January 1925 at Holabird Q.M. Depot, MD. Redesignated 23 March 1925 as the 57th Station Hospital. Inactivated about June 1929 at Holabird Q.M. Depot by relief of personnel. Location 7 December 1941—*Inactive*.

Commanders, 57th Station Hospital

Maj. Francis J. Kelly	13 Jan 25-Jun 26 <i>Inactive</i>	Lt. Col. Robert C. Kirkwood Jun 29-7 Dec 41	Jun 26-19 Apr 29
-----------------------	-------------------------------------	--	------------------

58th Station Hospital (C.Z.)

Organized Reserve Virginia

HQ—*Not initiated* 1923-25; Petersburg, VA, 1925-29; *Inactive* 1929-41

Constituted in the Organized Reserve 2 July 1923, assigned to the Communications Zone, and allotted to the Third Corps Area. Designated 12 September 1923 as Station Hospital No. 58. Initiated 17 January 1925 at Petersburg, VA. Redesignated 23 March 1925 as the 58th Station Hospital. Inactivated 29 August 1929 at Petersburg by relief of personnel. Location 7 December 1941—*Inactive*.

Status: Disbanded 30 January 1942.

Commanders, 58th Station Hospital

Capt. James A. Rice	17 Jan 25-20 Jan 25	Lt. Col. Joseph N. Barney	24 Jan 25-29 Aug 29
Maj. Vancleft Decker	20 Jan 25-24 Jan 25	<i>Inactive</i>	29 Aug 29-7 Dec 41

59th Station Hospital (C.Z.)

Organized Reserve District of Columbia/Maryland

HQ—*Not initiated* 1923-25; Washington, DC 1925-27; *Inactive* 1927-41

Constituted in the Organized Reserve 2 July 1923, assigned to the Communications Zone, and allotted to the Third Corps Area. Designated 12 September 1923 as Station Hospital No. 59. Initiated 24 January 1925 at Washington, DC. Redesignated 23 March 1925 as the 59th Station Hospital. Inactivated 29 August 1927 at Washington, DC, by relief of personnel. Fort Howard, MD, designated as headquarters on reorganization, but the unit was never organized at that location. Location 7 December 1941—*Inactive*.

Status: Disbanded 30 January 1942.

Commanders, 59th Station Hospital

Maj. Charles B. Ensor	24 Jan 25-ao Sep 25	Lt. Col. Elmer E. Keiser	5 Mar 26-29 Aug 27
Lt. Col. Robert W. Brace	ao Dec 25-5 Mar 26	<i>Inactive</i>	29 Aug 27-7 Dec 41

60th Station Hospital (C.Z.)

Organized Reserve Pennsylvania

HQ—*Not initiated* 1923-25; Harrisburg, PA, 1925-29; *Inactive* 1929-41

Constituted in the Organized Reserve 2 July 1923, assigned to the Communications Zone, and allotted to the Third Corps Area. Designated 12 September 1923 as Station Hospital No. 60. Initiated 12 January 1925 at Harrisburg, PA. Redesignated 23 March 1925 as the 60th Station Hospital. Inactivated 6 September 1929 at Harrisburg by relief of personnel. Location 7 December 1941—*Inactive*.

Commanders, 60th Station Hospital

Lt. Col. Thomas W. Grayson	12 Jan 25-6 Sep 29	<i>Inactive</i>	6 Sep 29-7 Dec 41
----------------------------	--------------------	-----------------	-------------------

61st Station Hospital (C.Z.)**Organized Reserve Alabama****HQ-Not initiated** 1923-26; Selma, AL, 1926-41

Constituted in the Organized Reserve 2 July 1923, assigned to the Communications Zone, and allotted to the Fourth Corps Area. Designated 12 September 1923 as Station Hospital No. 61. Redesignated 23 March 1925 as the 61st Station Hospital. Initiated 8 May 1925 at Selma, AL. Location 7 December 1941—Selma, AL.

Commanders, 61st Station Hospital

Capt. Frank D. Knox	8 May 25-ao Jun 25	Lt. Col. James C. Ballard	ao Dec 26-12 Sep 29
Unknown	ao Jun 25-ao Dec 26	Lt. Col. French H. Craddock	12 Sep 29-Jan 32
	Unknown	Jan 32-7 Dec 41	

62nd Station Hospital (C.Z.)**Organized Reserve Florida****HQ-Not initiated** 1923-25; Miami, FL, 1925-41

Constituted in the Organized Reserve 2 July 1923, assigned to the Communications Zone, and allotted to the Fourth Corps Area. Designated 12 September 1923 as Station Hospital No. 62. Redesignated 23 March 1925 as the 62nd Station Hospital. Initiated 8 May 1925 at Miami, FL. Location 7 December 1941—Miami, FL.

Status: Inactive in the U.S. Army Reserve as the 819th Station Hospital.**Commanders, 62nd Station Hospital**

Unknown	8 May 25-ao Dec 26	Lt. Col. Aldo V. Sibert	1 Jul 30-24 Aug 35
Lt. Col. Lester J. Williams	ao Dec 26-18 Mar 30	Lt. Col. Willie J. Vinson	24 Aug 35-6 Nov 38
Maj. Samuel C. Hollingsworth	18 Mar 30-1 Jul 30	Unknown	6 Nov 38-7 Dec 41

63rd Station Hospital (C.Z.)**Organized Reserve Georgia****HQ-Not initiated** 1923-25; Decatur, GA, 1925-41

Constituted in the Organized Reserve 2 July 1923, assigned to the Communications Zone, and allotted to the Fourth Corps Area. Designated 12 September 1923 as Station Hospital No. 63. Redesignated 23 March 1925 as the 63rd Station Hospital. Initiated 8 May 1925 at Decatur, GA. Inactivated 29 December 1936 at Decatur by relief of personnel. Reorganized 18 July 1937 at Decatur. Location 7 December 1941—Decatur, GA.

Status: Disbanded 15 October 1944.**Commanders, 63rd Station Hospital**

Maj. Robert P. Oppenheimer	8 May 25-2 Jun 25	Unknown	1 Mar 30-21 Jun 36
Lt. Col. Frederick A. Hunt	2 Jun 25-ao Jul 25	Lt. Col. Gordon T. Crozier	21 Jun 36-20 Dec 36
Unknown	ao Jul 25-ao Jun 27	<i>Inactive</i>	20 Dec 36-18 Jul 37
Lt. Col. Horace Vandebert	ao Jun 27-1 Mar 30	Lt. Col. Gordon T. Crozier	18 Jul 37-ao Jan 40
	Unknown	ao Jan 40-7 Dec 41	

64th Station Hospital (C.Z.).**Organized Reserve Georgia****HQ-Not initiated** 1923-25; Savannah, GA, 1925-41

Constituted in the Organized Reserve 2 July 1923, assigned to the Communications Zone, and allotted to the Fourth Corps Area. Designated 12 September 1923 as Station Hospital No. 64. Redesignated 23 March 1925 as the 64th Station Hospital. Initiated by December 1925 at Savannah, GA. Location 7 December 1941—Savannah, GA.

Status: Disbanded 11 November 1944.**Commanders, 64th Station Hospital**

Lt. Col. Linwood M. Gable	ao Dec 25-28 Mar 33	Lt. Col. Clinton R. Riner	14 Dec 34-21 Jun 36
Unknown	28 Mar 33-14 Dec 34	Lt. Col. Walter A. Norton	21 Jun 36-ao Sep 40
	Unknown	ao Jan 40-7 Dec 41	

65th Station Hospital (C.Z.)**Organized Reserve North Carolina****HQ-***Not initiated* 1923-25; Salisbury 1925-41

Constituted in the Organized Reserve 2 July 1923, assigned to the Communications Zone, and allotted to the Fourth Corps Area. Designated 12 September 1923 as Station Hospital No. 65. Redesignated 23 March 1925 as the 65th Station Hospital. Initiated by June 1925 at Salisbury, NC. Location 7 December 1941—Salisbury, NC.

Status: Inactive in the U.S. Army Reserve as the 65th Station Hospital.**Commanders, 65th Station Hospital**

Lt. Col. William E. Park	ao Jun 25-10 May 30	Lt. Col. Joseph B. Stone	Oct 31-14 Dec 34
Unknown	10 May 30-Oct 31	Maj. Walter A. Norton	14 Dec 34-28 Dec 36
	Unknown	28 Dec 36-7 Dec 41	

66th Station Hospital (C.Z.)**Organized Reserve South Carolina****HQ-***Not initiated* 1923-26; Charleston, SC, 1926-36; *Inactive* 1936-41

Constituted in the Organized Reserve 2 July 1923, assigned to the Communications Zone, and allotted to the Fourth Corps Area. Designated 12 September 1923 as Station Hospital No. 66. Redesignated 23 March 1925 as the 66th Station Hospital. Initiated by December 1926 at Charleston, SC. Inactivated 28 December 1936 at Omaha by relief of personnel. Location 7 December 1941—*Inactive*.

Status: Disbanded 30 January 1942.**Commanders, 66th Station Hospital**

Maj. John H. Johnson	ao Dec 26-12 Sep 29	Unknown	1 Feb 30-ao Jun 32
Lt. Col. Henry W. Shaw	12 Sep 29-1 Feb 30	Lt. Col. Rufus E. Graham	ao Jun 32-28 Dec 36
	<i>Inactive</i>	28 Dec 36-7 Dec 41	

67th Station Hospital (C.Z.)**Organized Reserve Tennessee****HQ-***Not initiated* 1923-26; Dyersburg, TN, 1926-41

Constituted in the Organized Reserve 2 July 1923, assigned to the Communications Zone, and allotted to the Fourth Corps Area. Designated 12 September 1923 as Station Hospital No. 67. Redesignated 23 March 1925 as the 67th Station Hospital. Initiated by December 1926 at Dyersburg, TN. Location 7 December 1941—Dyersburg, TN.

Status: Disbanded 31 July 1945.**Commanders, 67th Station Hospital**

Maj. Thomas M. Harper	ao Dec 26-12 Sep 29	Lt. Col. Leslie T. Bolton	10 Dec 30-10 Apr 35
Lt. Col. Herbert H. Forcheimer	12 Sep 29-10 Dec 30	Lt. Col. Joseph B. Stone	10 Apr 35-ao May 35
	Unknown	ao May 35-7 Dec 41	

68th Station Hospital (C.Z.)**Organized Reserve North Carolina****HQ-***Not initiated* 1923-25; Winston-Salem, NC, 1925-41

Constituted in the Organized Reserve 2 July 1923, assigned to the Communications Zone, and allotted to the Fourth Corps Area. Designated 12 September 1923 as Station Hospital No. 68. Redesignated 23 March 1925 as the 68th Station Hospital. Initiated by May 1925 at Winston-Salem, NC. Location 7 December 1941—Winston-Salem, NC.

Status: Disbanded 30 January 1942.**Commanders, 68th Station Hospital**

Lt. Col. James B. Bullitt	ao May 25-1 Mar 30	Maj. Frank A. Thomitz	ao Oct 35-ao Jun 36
Unknown	1 Mar 30-ao Oct 35	Unknown	ao Jun 36-7 Dec 41

69th Station Hospital (C.Z.)**Organized Reserve South Carolina****HQ-Not initiated** 1923-25; Anderson, SC, 1926-41

Constituted in the Organized Reserve 2 July 1923, assigned to the Communications Zone, and allotted to the Fourth Corps Area. Designated 12 September 1923 as Station Hospital No. 69. Redesignated 23 March 1925 as the 69th Station Hospital. Initiated by December 1926 at Anderson, SC. Location 7 December 1941—Anderson, SC.

Status: Disbanded 30 January 1942.**Commanders, 69th Station Hospital**

Lt. Col. Francis L. Parker	ao Jun 27-22 Jan 29	Unknown	22 Jan 29-7 Dec 41
----------------------------	---------------------	---------	--------------------

70th Station Hospital (C.Z.)**Organized Reserve Louisiana****HQ-Not initiated** 1923-25; Monroe, LA, 1925-29; *Inactive* 1929-41

Constituted in the Organized Reserve 2 July 1923, assigned to the Communications Zone, and allotted to the Fourth Corps Area. Designated 12 September 1923 as Station Hospital No. 70. Redesignated 23 March 1925 as the 70th Station Hospital. Initiated 8 May 1925 at Monroe, LA. Inactivated 11 September 1929 at Monroe by relief of personnel. Location 7 December 1941—*Inactive*.

Status: Disbanded 30 January 1942.**Commanders, 70th Station Hospital**

Lt. Col. Herbert H. Forcheimer	8 May 25-11 Sep 29	<i>Inactive</i>	11 Sep 29-7 Dec 41
--------------------------------	--------------------	-----------------	--------------------

71st Station Hospital (C.Z.)**Organized Reserve North Carolina/Ohio****HQ-Not initiated** 1923-26; Rocky Mount, NC, 1926-36; *Inactive* 1936-41

Constituted in the Organized Reserve 2 July 1923, assigned to the Communications Zone, and allotted to the Fourth Corps Area. Designated 12 September 1923 as Station Hospital No. 71. Redesignated 23 March 1925 as the 71st Station Hospital. Initiated 5 June 1925 at Rocky Mount, NC. Withdrawn from the Fourth Corps Area 5 June 1936 and allotted to the Fifth Corps Area. Dayton, OH, designated as headquarters on reorganization, but the unit was never organized at that location. Location 7 December 1941—*Inactive*.

Status: Disbanded 25 January 1949.**Commanders, 71st Station Hospital**

Lt. Col. Ross C. Speir	5 Jun 25-17 Mar 28	Unknown	ao May 28-5 Jun 36
Maj. Philip S. Easley	17 Mar 28-ao May 28	<i>Inactive</i>	5 Jun 36-7 Dec 41

72nd Station Hospital (C.Z.)**Organized Reserve Tennessee/Ohio****HQ-Not initiated** 1923-25; Memphis, TN, 1925-36; *Inactive* 1936-41

Constituted in the Organized Reserve 2 July 1923, assigned to the Communications Zone, and allotted to the Fourth Corps Area. Designated 12 September 1923 as Station Hospital No. 72. Redesignated 23 March 1925 as the 72nd Station Hospital. Initiated 8 May 1925 at Memphis, TN. Withdrawn from the Fourth Corps Area 5 June 1936 and allotted to the Fifth Corps Area. Akron, OH, designated as headquarters on reorganization, but the unit was never organized at that location. Location 7 December 1941—*Inactive*.

Status: Disbanded 6 December 1943.**Commanders, 72nd Station Hospital**

Maj. Leon L. Meyer	8 May 25-ao Jun 25	Lt. Col. Chester D. Allen	ao Dec 26-ao May 30
Unknown	ao Jun 25-ao Dec 26	Unknown	ao May 30-5 Jun 36
	<i>Inactive</i>	5 Jun 36-7 Dec 41	

73rd Station Hospital (C.Z.)**Organized Reserve Georgia/Ohio****HQ-Not initiated** 1923-26; Atlanta, GA, 1926-36; *Inactive* 1936-41

Constituted in the Organized Reserve 2 July 1923, assigned to the Communications Zone, and allotted to the Fourth Corps Area. Designated 12 September 1923 as Station Hospital No. 73. Redesignated 23 March 1925 as the 73rd Station Hospital. Initiated by December 1926 at Atlanta, GA. Withdrawn from the Fourth Corps Area 5 June 1936 and allotted to the Fifth Corps Area. Cleveland, OH, designated as headquarters on reorganization, but the unit was never organized at that location. Location 7 December 1941—*Inactive*.

Status: Disbanded 30 January 1942.**Commanders, 73rd Station Hospital**

Lt. Col. Byron S. Bruce	ao Dec 26-12 Sep 29	Lt. Col. Byron S. Bruce	Feb 31-3 Jan 33
Maj. Jacob J. Kennedy	12 Sep 29-Feb 31	Unknown	3 Jan 33-5 Jun 36
	<i>Inactive</i>	5 Jun 36-7 Dec 41	

74th Station Hospital (C.Z.)**Organized Reserve Georgia/Indiana****HQ-Not initiated** 1923-26; Gainesville, GA, 1926-28; Griffin, GA, 1928-29; *Inactive* 1929-41

Constituted in the Organized Reserve 2 July 1923, assigned to the Communications Zone, and allotted to the Fourth Corps Area. Designated 12 September 1923 as Station Hospital No. 74. Redesignated 23 March 1925 as the 74th Station Hospital. Initiated by December 1926 at Gainesville, GA. Relocated in 1928 to Griffin, GA. Inactivated 14 September 1929 at Griffin by relief of personnel. Withdrawn from the Fourth Corps Area 5 June 1936 and allotted to the Fifth Corps Area. Lafayette, IN, designated as headquarters on reorganization, but the unit was never organized at that location. Location 7 December 1941—*Inactive*.

Status: Disbanded 30 January 1942.**Commanders, 74th Station Hospital**

Lt. Col. William P. Herbert	ao Dec 26-14 Sep 29	<i>Inactive</i>	14 Sep 29-7 Dec 41
-----------------------------	---------------------	-----------------	--------------------

75th Station Hospital (C.Z.)**Organized Reserve North Carolina/Kentucky****HQ-Not initiated** 1923-26; Rutherfordton, NC, 1926-29; *Inactive* 1929-41

Constituted in the Organized Reserve 2 July 1923, assigned to the Communications Zone, and allotted to the Fourth Corps Area. Designated 12 September 1923 as Station Hospital No. 75. Redesignated 23 March 1925 as the 75th Station Hospital. Initiated by December 1926 at, and affiliated with, Rutherford College Medical School in Rutherfordton, NC. Inactivated 14 September 1929 at Rutherfordton by relief of personnel. Withdrawn from the Fourth Corps Area 5 June 1936 and allotted to the Fifth Corps Area. Ashland, KY, designated as headquarters on reorganization, but the unit was never organized at that location. Location 7 December 1941—*Inactive*.

Commanders, 75th Station Hospital

Lt. Col. Robert F. Leinbach	ao Dec 26-14 Sep 29	<i>Inactive</i>	14 Sep 29-7 Dec 41
-----------------------------	---------------------	-----------------	--------------------

76th Station Hospital (C.Z.)**Organized Reserve West Virginia****HQ-Not initiated** 1923-25; Wheeling, WV 1925-27; Bluefield, WV 1927-41

Constituted in the Organized Reserve 2 July 1923, assigned to the Communications Zone, and allotted to the Fifth Corps Area. Designated 12 September 1923 as Station Hospital No. 76. Redesignated 23 March 1925 as the 76th Station Hospital. Initiated by July 1925 at Wheeling, WV. Relocated in 1927 to Bluefield, WV. Location 7 December 1941—Bluefield, WV.

Status: Disbanded 30 January 1942.

Commanders, 76th Station Hospital

Lt. Col. Henry D. Hatfield Jul 25-14 Sep 29 Unknown 14 Sep 29-7 Dec 41

77th Station Hospital (C.Z.)

Organized Reserve Ohio

HQ-*Not initiated* 1923-25; Cleveland, OH, 1925-37; *Inactive* 1937-41

Constituted in the Organized Reserve 2 July 1923, assigned to the Communications Zone, and allotted to the Fifth Corps Area. Designated 12 September 1923 as Station Hospital No. 77. Redesignated 23 March 1925 as the 77th Station Hospital. Initiated by July 1925 at Cleveland, OH. Inactivated by June 1937 at Cleveland by relief of personnel. Location 7 December 1941—*Inactive*.

Status: Disbanded 30 January 1942.

Commanders, 77th Station Hospital

Lt. Col. Charles T. Hunt Jul 25-ao Jun 27 1st Lt. R. E. Hopkins ao Jan 37-Jun 37
Unknown ao Jun 27-ao Jan 37 *Inactive* Jun 37-7 Dec 41

78th Station Hospital (C.Z.)

Organized Reserve Ohio

HQ-*Not initiated* 1923-26; Fort Hayes, OH, 1926-27; Columbus, OH, 1927-37; *Inactive* 1937-41

Constituted in the Organized Reserve 2 July 1923, assigned to the Communications Zone, and allotted to the Fifth Corps Area. Designated 12 September 1923 as Station Hospital No. 78. Redesignated 23 March 1925 as the 78th Station Hospital. Initiated by October 1926 at Fort Hayes, OH. Relocated in 1927 to Columbus, OH. Inactivated by June 1937 at Columbus by relief of personnel. Location 7 December 1941—*Inactive*.

Status: Disbanded 30 January 1942.

Commanders, 78th Station Hospital

Lt. Col. Lee E. Casey ao Oct 26-Dec 28 Unknown Dec 28-ao Jun 37
Inactive ao Jun 37-7 Dec 41

79th Station Hospital (C.Z.)

Organized Reserve Ohio

HQ-*Not initiated* 1923-26; Fort Hayes, OH, 1926-27; Columbus, OH, 1927-37; *Inactive* 1937-41

Constituted in the Organized Reserve 2 July 1923, assigned to the Communications Zone, and allotted to the Fifth Corps Area. Designated 12 September 1923 as Station Hospital No. 79. Redesignated 23 March 1925 as the 79th Station Hospital. Initiated by October 1926 at Fort Hayes, OH. Relocated in 1927 to Columbus, OH. Inactivated by June 1937 at Columbus by relief of personnel. Location 7 December 1941—*Inactive*.

Status: Disbanded 30 January 1942.

Commanders, 79th Station Hospital

Lt. Col. Benjamin C. Bernard Oct 26-Mar 30 Unknown ao Feb 35-ao Jun 37
Col. Gerald P. Lawrence Mar 30-ao Feb 35 *Inactive* ao Jun 37-7 Dec 41

80th Station Hospital (C.Z.)

Organized Reserve Kentucky/Ohio

HQ-*Not initiated* 1923-25; Fort Thomas, KY, 1925-27; Dayton, OH, 1927-37; *Inactive* 1937-41

Constituted in the Organized Reserve 2 July 1923, assigned to the Communications Zone, and allotted to the Fifth Corps Area. Designated 12 September 1923 as Station Hospital No. 80. Redesignated 23 March 1925 as the 80th Station Hospital. Initiated by June 1925 at Fort Thomas, KY. Relocated in 1927 to Dayton, OH. Inactivated by June 1937 at Dayton by relief of personnel. Location 7 December 1941—*Inactive*.

Status: Disbanded 30 January 1942.

Commanders, 80th Station Hospital

Lt. Col. Philip H. Stewart	ao Jun 25-Feb 29	Lt. Col. Sydney J. Anderson	May 31-ao Jun 31
Unknown	Feb 29-May 31	Unknown	ao Jun 31-ao Jun 37
	<i>Inactive</i>	ao Jun 37-7 Dec 41	

81st Station Hospital (C.Z.)

Organized Reserve West Virginia

HQ-*Not initiated* 1923-26; Clarksburg, WV 1926-30; *Inactive* 1930-34; Clarksburg, WV 1934-41

Constituted in the Organized Reserve 2 July 1923, assigned to the Communications Zone, and allotted to the Fifth Corps Area. Designated 12 September 1923 as Station Hospital No. 81. Redesignated 23 March 1925 as the 81st Station Hospital. Initiated by December 1926 at Clarksburg, WV. Inactivated about February 1930 at Clarksburg by relief of personnel. Reorganized by June 1934 at Clarksburg. Location 7 December 1941—Clarksburg, WV.

Status: Disbanded 30 January 1942.

Commanders, 81st Station Hospital

Maj. Louis M. Cusher	ao Dec 26-Oct 27	<i>Inactive</i>	Feb 30-ao Jun 34
Lt. Col. John H. Blackburn	Oct 27-Feb 30	Unknown	ao Jun 34-7 Dec 41

82nd Station Hospital (C.Z.)

Organized Reserve Indiana

HQ-*Not initiated* 1923-25; Fort Benjamin Harrison, IN, 1925-27; Fort Wayne, IN, 1927-30; *Inactive* 1930-34; Fort Wayne, IN, 1934-41

Constituted in the Organized Reserve 2 July 1923, assigned to the Communications Zone, and allotted to the Fifth Corps Area. Designated 12 September 1923 as Station Hospital No. 82. Redesignated 23 March 1925 as the 82nd Station Hospital. Initiated by June 1925 at Fort Benjamin Harrison, IN. Relocated in 1927 to Fort Wayne, IN. Inactivated by March 1930 at Fort Wayne by relief of personnel. Relieved from the Communications Zone 1 October 1933 and assigned to the General Headquarters Reserve. Reorganized by June 1934 at Fort Wayne. Location 7 December 1941—Fort Wayne, IN.

Status: Disbanded 30 January 1942.

Commanders, 82nd Station Hospital

Lt. Col. John C. Boone	Jun 25-ao Jun 27	<i>Inactive</i>	ao Mar 30-ao Jun 34
Unknown	ao Jun 27-ao Mar 30	Unknown	ao Jun 34-7 Dec 41

83rd Station Hospital (C.Z.)

Organized Reserve Indiana

HQ-*Not initiated* 1923-26; Fort Benjamin Harrison, IN, 1926-27; Gary, IN, 1927-30; *Inactive* 1930-34; South Bend, IN, 1934-41

Constituted in the Organized Reserve 2 July 1923, assigned to the Communications Zone, and allotted to the Fifth Corps Area. Designated 12 September 1923 as Station Hospital No. 83. Redesignated 23 March 1925 as the 83rd Station Hospital. Initiated by December 1926 at Fort Benjamin Harrison, IN. Relocated in 1927 to Gary, IN. Inactivated by March 1930 at Gary by relief of personnel. Relieved from the Communications Zone 1 October 1933 and assigned to the General Headquarters Reserve. Reorganized 22 March 1934 at South Bend, IN. Location 7 December 1941—South Bend, IN.

Status: Disbanded 30 January 1942.

Commanders, 83rd Station Hospital

Maj. George B. Breedlove	ao Dec 26-ao Jul 27	Unknown	ao Jun 29-Mar 30
Unknown	ao Jul 27-ao May 29	<i>Inactive</i>	Mar 30-22 Mar 34
Lt. Col. Harrison A. Coleman	ao May 29-Jun 29	Unknown	22 Mar 34-7 Dec 41

84th Station Hospital (C.Z.)**Organized Reserve Kentucky**

HQ-Not initiated 1923-25; Camp Knox, KY, 1925-27; Louisville, KY, 1927-34; Frankfort, KY, 1934-36; Louisville, KY, 1936-41

Constituted in the Organized Reserve 2 July 1923, assigned to the Communications Zone, and allotted to the Fifth Corps Area. Designated 12 September 1923 as Station Hospital No. 84. Redesignated 23 March 1925 as the 84th Station Hospital. Initiated by May 1925 at Camp Knox, KY. Relocated in 1927 to Louisville, KY. Relocated 22 March 1934 to Frankfort, KY. Relocated in 1936 to Louisville, KY. Location 7 December 1941—Louisville, KY.

Status: Disbanded 30 January 1942.

Commanders, 84th Station Hospital

Lt. Col. Charles G. Lucas	May 25-ao Jul 29	Unknown	ao Jul 29-7 Dec 41
---------------------------	------------------	---------	--------------------

85th Station Hospital (C.Z.)**Organized Reserve Kentucky**

HQ-Not initiated 1923-26; Camp Knox, KY, 1926-27; Louisville, KY, 1927-29; *Inactive* 1929-41

Constituted in the Organized Reserve 2 July 1923, assigned to the Communications Zone, and allotted to the Fifth Corps Area. Designated 12 September 1923 as Station Hospital No. 85. Redesignated 23 March 1925 as the 85th Station Hospital. Initiated by December 1926 at Camp Knox, KY. Relocated in 1927 to Louisville, KY. Inactivated by December 1929 at Louisville by relief of personnel. Frankfort, KY, designated 22 March 1934 as headquarters on reorganization, but the unit was never organized at that location. Location 7 December 1941—*Inactive*.

Status: Disbanded 30 January 1942.

Commanders, 85th Station Hospital

Lt. Col. Raymond M. Evans	ao Dec 26-a Sep 28 <i>Inactive</i>	Unknown ao Dec 29-7 Dec 41	ao Sep 28-ao Dec 29
---------------------------	---------------------------------------	-------------------------------	---------------------

86th Station Hospital (C.Z.)**Organized Reserve Kentucky**

HQ-Not initiated 1923-26; Camp Knox, KY, 1926-27; Paducah, KY, 1927-29; *Inactive* 1929-41 Constituted in the Organized Reserve 2 July 1923, assigned to the Communications Zone, and allotted to the Fifth Corps Area. Designated 12 September 1923 as Station Hospital No. 86. Redesignated 23 March 1925 as the 86th Station Hospital. Initiated by December 1926 at Camp Knox, KY. Relocated in 1927 to Paducah, KY. Inactivated by December 1929 at Paducah by relief of personnel. Frankfort, KY, designated 22 March 1934 as headquarters on reorganization, but the unit was never organized at that location. Location 7 December 1941—*Inactive*.

Status: Disbanded 30 January 1942.

Commanders, 86th Station Hospital

Maj. Charles A. Lester	ao Dec 26-ao Jun 27 <i>Inactive</i>	Unknown ao Dec 29-7 Dec 41	ao Jun 27-ao Dec 29
------------------------	--	-------------------------------	---------------------

87th Station Hospital (C.Z.)**Organized Reserve Kentucky/West Virginia**

HQ-Not initiated 1923-26; Camp Knox, KY, 1926-27; Morgantown, WV 1927-29; *Inactive* 1929-41

Constituted in the Organized Reserve 2 July 1923, assigned to the Communications Zone, and allotted to the Fifth Corps Area. Designated 12 September 1923 as Station Hospital No. 87. Redesignated 23 March 1925 as the 87th Station Hospital. Initiated by May 1926 at Camp Knox, KY. Relocated in 1927 to Morgantown, WV. Inactivated about October 1929 at Morgantown by relief of personnel. Location 7 December 1941—*Inactive*.

Status: Disbanded 30 January 1942.

Commanders, 87th Station Hospital

Lt. Col. Gerald P. Lawrence	ao May 26-Jul 28	Lt. Col. Harry S. Osborne	14 Jan 29-Oct 29
Unknown	Jul 28-14 Jan 29	<i>Inactive</i>	Oct 29-7 Dec 41

88th Station Hospital (C.Z.)

Organized Reserve Ohio

HQ-*Not initiated* 1923-25; Chillicothe, OH, 1925-27; Dayton, OH, 1927-30; *Inactive* 1930-34; Springfield, OH, 1934-37; *Inactive* 1937-41

Constituted in the Organized Reserve 2 July 1923, assigned to the Communications Zone, and allotted to the Fifth Corps Area. Designated 12 September 1923 as Station Hospital No. 88. Redesignated 23 March 1925 as the 88th Station Hospital. Initiated by November 1925 at Chillicothe, OH. Relocated in 1927 to Dayton, OH. Inactivated in June 1930 at Dayton by relief of personnel. Reorganized 22 March 1934 at Springfield, OH. Inactivated by June 1937 at Springfield by relief of personnel. Location 7 December 1941—*Inactive*.

Status: Disbanded 30 January 1942.

Commanders, 88th Station Hospital

Lt. Col. Burton O. Clark	ao Nov 25-Mar 28	Lt. Col. Raymond M. Evans	22 Mar 34-ao Jun 34
Lt. Col. Raymond M. Evans	Mar 28-Jun 30	Unknown	ao Jun 34- ao Jun 37
<i>Inactive</i>	Jun 30-22 Mar 34	<i>Inactive</i>	ao Jun 37-7 Dec 41

89th Station Hospital (C.Z.)

Organized Reserve Ohio

HQ-*Not initiated* 1923-25; Camp Sherman, OH, 1925-27; Youngstown, OH, 1927-37; *Inactive* 1937-41

Constituted in the Organized Reserve 2 July 1923, assigned to the Communications Zone, and allotted to the Fifth Corps Area. Designated 12 September 1923 as Station Hospital No. 89. Redesignated 23 March 1925 as the 89th Station Hospital. Initiated by July 1925 at Camp Sherman, OH. Relocated in 1927 to Youngstown, OH. Inactivated by March 1930 at Youngstown by relief of personnel. Reorganized 22 March 1934 at Youngstown. Inactivated by June 1937 at Dayton by relief of personnel. Location 7 December 1941—*Inactive*.

Status: Disbanded 30 January 1942.

Commanders, 89th Station Hospital

Lt. Col. Raymond M. Evans	ao Jul 25-ao Aug 25	Unknown	ao Jun 27-Mar 30
Unknown	ao Aug 25-ao Jun 27	<i>Inactive</i>	Mar 30-22 Mar 34
Maj. Robert L. Collins	ao Jun 27-ao Jul 27	Unknown	22 Mar 34- ao Jun 37
	<i>Inactive</i>	ao Jun 37-7 Dec 41	

90th Station Hospital (C.Z.)

Organized Reserve Illinois

HQ-*Not initiated* 1923-25; Chicago, IL, 1925-30; *Inactive* 1930-34; Chicago, IL, 1934-37; *Inactive* 1937-41

Constituted in the Organized Reserve 2 July 1923, assigned to the Communications Zone, and allotted to the Sixth Corps Area. Designated 12 September 1923 as Station Hospital No. 90. Redesignated 23 March 1925 as the 90th Station Hospital. Affiliated with the Norwegian-American Hospital in Chicago, IL. Initiated by September 1925 in Chicago. Inactivated by December 1930 at Chicago by relief of personnel. Reorganized by June 1934 at Chicago. Inactivated 7 October 1937 at Chicago by relief of personnel. Location 7 December 1941—*Inactive*.

Status: Inactive in the U.S. Army Reserve as the 820th Station Hospital.

Commanders, 90th Station Hospital

Maj. Charles F. Goetzinger	ao Sep 25-ao Aug 29	Unknown	ao Jun 34-ao May 36
Unknown	ao Aug 29-ao Dec 30	Lt. Col. Harry M. Hedge	ao May 36-7 Oct 37
<i>Inactive</i>	ao Dec 30-ao Jun 34	<i>Inactive</i>	7 Oct 37-7 Dec 41

91st Station Hospital (C.Z.)**Organized Reserve Illinois****HQ-Not initiated** 1923-25; Bloomington, IL, 1925-38; Decatur, IL, 1938-41

Constituted in the Organized Reserve 2 July 1923, assigned to the Communications Zone, and allotted to the Sixth Corps Area. Designated 12 September 1923 as Station Hospital No. 91. Redesignated 23 March 1925 as the 91st Station Hospital. Initiated by September 1925 at Bloomington, IL. Relocated by January 1938 to Decatur, IL. Conducted summer training at the station hospital at Jefferson Barracks, MO. Location 7 December 1941—Decatur, IL.

Status: Disbanded 1 December 1944.**Commanders, 91st Station Hospital**

Unknown	ao Sep 25-17 Apr 26	Lt. Col. Walter A. Dew	17 Apr 26-ao Jan 40
	Unknown	ao Jan 40-7 Dec 41	

92nd Station Hospital (C.Z.)**Organized Reserve Illinois****HQ-Not initiated** 1923-25; Champaign, IL, 1925-30; *Inactive* 1930-34; Chicago, IL, 1934-38; *Inactive* 1938-41

Constituted in the Organized Reserve 2 July 1923, assigned to the Communications Zone, and allotted to the Sixth Corps Area. Designated 12 September 1923 as Station Hospital No. 92. Redesignated 23 March 1925 as the 92nd Station Hospital. Initiated by September 1925 at Champaign, IL. Inactivated by December 1930 at Champaign by relief of personnel. Reorganized at Chicago by January 1934. Inactivated by December 1938 at Chicago by relief of personnel. Conducted summer training at the station hospital at Jefferson Barracks, MO. Location 7 December 1941—*Inactive*.

Status: Inactive in the U.S. Army Reserve as the 92nd Station Hospital.**Commanders, 92nd Station Hospital**

Unknown	ao Sep 25-9 Feb 26	<i>Inactive</i>	ao Dec 30-ao Jan 34
Lt. Col. Leonard S. Hughes	9 Feb 26-13 Nov 28	Unknown	ao Jan 34-ao Nov 36
Lt. Col. Paul R. Allyn	13 Nov 28-ao Jun 29	Lt. Col. Alonzo B. Middleton	ao Nov 36-ao Aug 38
Unknown	ao Jun 29-ao Dec 30	<i>Inactive</i>	ao Dec 38-7 Dec 41

93rd Station Hospital (C.Z.)**Organized Reserve Illinois****HQ-Not initiated** 1923-25; Alton, IL, 1925-38; Marion, IL, 1938-41

Constituted in the Organized Reserve 2 July 1923, assigned to the Communications Zone, and allotted to the Sixth Corps Area. Designated 12 September 1923 as Station Hospital No. 93. Redesignated 23 March 1925 as the 93rd Station Hospital. Initiated by September 1925 at Alton, IL. Relocated by January 1938 to Marion, IL. Conducted summer training at the station hospital at Jefferson Barracks, MO. Location 7 December 1941—Marion, IL.

Status: Inactive in the U.S. Army Reserve as the 821st Station Hospital.**Commanders, 93rd Station Hospital**

Unknown	ao Sep 25-9 Feb 26	Lt. Col. F. C. Murrah	Nov 39-ao Jan 40
Lt. Col. Clyde S. Wilson	9 Feb 26-Nov 39	Unknown	ao Jan 40-7 Dec 41

94th Station Hospital (C.Z.)**Organized Reserve Illinois****HQ-Not initiated** 1923-25; Chicago, IL, 1925-41

Constituted in the Organized Reserve 2 July 1923, assigned to the Communications Zone, and allotted to the Sixth Corps Area. Designated 12 September 1923 as Station Hospital No. 94. Redesignated 23 March 1925 as the 94th Station Hospital. Initiated by June 1925 at Chicago, IL. Conducted summer training at the station hospitals at Fort Sheridan, IL, OR, Camp Custer, MI. Location 7 December 1941—Chicago, IL.

Status: Inactive in the U.S. Army Reserve as the 826th Station Hospital.

Commanders, 94th Station Hospital

Maj. Gideon Benson	ao Jun 25-ao Jul 25	Unknown	ao Jun 30-ao Mar 31
Unknown	ao Jul 25-ao Sep 25	Maj. Frank J. Novak, jr.	ao Mar 31-ao Jun 33
Lt. Col. Samuel R. Slaymaker	ao Sep 25-ao Jun 27	Unknown	ao Jun 33-ao Feb 35
Unknown	ao Jun 27-ao Jun 29	Maj. Walter C. Burket	ao Feb 35-20 Nov 37
Maj. Gideon Benson	ao Jun 29-ao Jun 30	Lt. Col. John W. Green	20 Nov 37-ao Jul 39
	Unknown	ao Jul 39-7 Dec 41	

95th Station Hospital (C.Z.)**Organized Reserve Illinois**

HQ-Not initiated 1923-25; Chicago, IL, 1925-30; *Inactive* 1930-34; Chicago, IL, 1934-41

Constituted in the Organized Reserve 2 July 1923, assigned to the Communications Zone, and allotted to the Sixth Corps Area. Designated 12 September 1923 as Station Hospital No. 95. Redesignated 23 March 1925 as the 95th Station Hospital. Initiated by September 1925 at Chicago, IL. Inactivated by December 1930 at Chicago by relief of personnel. Reorganized by June 1934 at Chicago. Location 7 December 1941—Chicago, IL.

Status: Inactive in the U.S. Army Reserve as the 827th Station Hospital.

Commanders, 95th Station Hospital

Lt. Col. Charles L. Mix	ao Sep 25-8 May 29	<i>Inactive</i>	ao Dec 30-ao Jun 34
Unknown	8 May 29-ao Dec 30	Unknown	ao Jun 34-7 Dec 41

96th Station Hospital (C.Z.)**Organized Reserve Illinois**

HQ-Not initiated 1923-25; Chicago, IL, 1925-30; *Inactive* 1930-34; Chicago, IL, 1934-41

Constituted in the Organized Reserve 2 July 1923, assigned to the Communications Zone, and allotted to the Sixth Corps Area. Designated 12 September 1923 as Station Hospital No. 96. Redesignated 23 March 1925 as the 96th Station Hospital. Initiated by September 1925 at Chicago, IL. Inactivated by December 1930 at Chicago by relief of personnel. Reorganized by June 1934 at Chicago. Location 7 December 1941—Chicago, IL.

Status: Disbanded 30 January 1942.

Commanders, 96th Station Hospital

Lt. Col. Henry F. Lewis	ao Sep 25-8 May 29	Unknown	ao Jun 29-ao Dec 30
Lt. Col. William H. Walsh	8 May 29-ao Jun 29	<i>Inactive</i>	ao Dec 30-ao Jun 34
	Unknown	ao Jun 34-7 Dec 41	

97th Station Hospital (C.Z.)**Organized Reserve Michigan**

HQ-Not initiated 1923-24; Detroit, MI, 1924-41

Constituted in the Organized Reserve 2 July 1923, assigned to the Communications Zone, and allotted to the Sixth Corps Area. Designated 12 September 1923 as Station Hospital No. 97. Initiated in November 1924 at Detroit, MI. Redesignated 23 March 1925 as the 97th Station Hospital. Conducted summer training at the station hospital at Camp Custer, MI. Location 7 December 1941—Detroit, MI.

Status: Active in the U.S. Army Reserve as the 828th Evacuation Hospital at Fresno, CA.

Commanders, 97th Station Hospital

Capt. Arthur W. Erskitz	Nov 24-17 Mar 25	Lt. Col. Martin B. Robinson	7 Dec 31-ao Jan 32
Lt. Col. Max Ballin	17 Mar 25-7 Dec 31	Unknown	ao Jan 32-7 Dec 41

98th Station Hospital (C.Z.)**Organized Reserve Illinois**

HQ-Not initiated 1923-25; East St. Louis, IL, 1925-38; Belleville, IL, 1938-41

Constituted in the Organized Reserve 2 July 1923, assigned to the Communications Zone, and allotted to the Sixth Corps Area. Designated 12 September 1923 as Station Hospital No. 98. Redesignated 23 March 1925 as the 98th Station Hospital. Initiated 10 April 1925 at East St. Louis, IL. Relocated by January 1938 to Belleville, IL. Conducted summer training at the station hospital at Jefferson Barracks, MO. Location 7 December 1941—Belleville, IL.

Status: Inactive in the U.S. Army Reserve as the 98th Station Hospital.

Commanders, 98th Station Hospital

Maj. Wilmer P. Frazier	10 Apr 25-9 Feb 26	Unknown	ao May 29-ao Jun 36
Lt. Col. Tullie Van Boyd	9 Feb 26-3 Apr 29	Lt. Col. William L. Hanson	ao Jun 36-ao Jan 40
Lt. Col. Orvel A. Suttle	3 Apr 29-ao May 29	Unknown	ao Jan 40-7 Dec 41

99th Station Hospital (C.Z.)

Organized Reserve Michigan

HQ-Not initiated 1923-25; Flint, MI, 1925-30; *Inactive* 1930-34; Saginaw, MI, 1934-41

Constituted in the Organized Reserve 2 July 1923, assigned to the Communications Zone, and allotted to the Sixth Corps Area. Designated 12 September 1923 as Station Hospital No. 99. Redesignated 23 March 1925 as the 99th Station Hospital. Initiated in September 1925 at Flint, MI. Inactivated by December 1930 at Flint by relief of personnel. Reorganized by June 1934 at Saginaw, MI. Conducted summer training at the station hospital at Camp Custer, MI. Location 7 December 1941—Saginaw, MI.

Status: Inactive in the U.S. Army Reserve as the 99th Field Hospital.

Commanders, 99th Station Hospital

Unknown	ao Sep 25-ao Jun 27	<i>Inactive</i>	ao Dec 30-ao Jun 34
Lt. Col. James G. Matthews	ao Jun 27-ao Jul 27	Maj. Jacob R. Rupp	ao Jun 34-ao Jul 39
Unknown	ao Jul 27-ao Dec 30	Unknown	ao Jul 39-7 Dec 41

100th Station Hospital (C.Z.)

Organized Reserve Michigan

HQ-Not initiated 1923-24; Kalamazoo, MI, 1924-29; *Inactive* 1929-34; Kalamazoo, MI, 1934-41

Constituted in the Organized Reserve 2 July 1923 as Station Hospital No. 100, assigned to the Communications Zone, and allotted to the Sixth Corps Area. Designated 12 September 1923 as Station Hospital No. 100. Initiated in November 1924 at Kalamazoo, MI. Redesignated 23 March 1925 as the 100th Station Hospital. Inactivated 30 July 1929 at Kalamazoo by relief of personnel. Reorganized by June 1934 at Kalamazoo. Conducted summer training at the station hospital at Camp Custer, MI. Location 7 December 1941—Kalamazoo, MI.

Status: Inactive in the U.S. Army Reserve as the 100th Station Hospital.

Commanders, 100th Station Hospital

Unknown	Nov 24-9 Feb 26	<i>Inactive</i>	30 Jul 29-ao Jun 34
Lt. Col. James J. Haviland	9 Feb 26-30 Jul 29	Maj. Thomas Van Urk	ao Jun 34-ao Jun 35
	Unknown	ao Jun 35-7 Dec 41	

101st Station Hospital (C.Z.)

Organized Reserve Illinois

HQ-Not initiated 1923-25; Rockford, IL, 1925-30; *Inactive* 1930-34; Rockford, IL, 1934-37; *Inactive* 1937-41

Constituted in the Organized Reserve 2 July 1923, assigned to the Communications Zone, and allotted to the Sixth Corps Area. Designated 12 September 1923 as Station Hospital No. 101. Initiated by September 1925 at Rockford, IL. Redesignated 23 March 1925 as the 101st Station Hospital. Inactivated 13 August 1929 at Rockford by relief of personnel. Reorganized by June 1934 at Rockford. Inactivated 18 February 1937 at Rockford by relief of personnel. Location 7 December 1941—*Inactive*.

Status: Disbanded 30 January 1942.

Commanders, 101st Station Hospital

Unknown	ao Sep 25-16 Jun 26	Lt. Col. Ulysses S. Boyer	ao Jun 34-15 Oct 36
Maj. Gerald R. Allaben	16 Jun 26-13 Aug 29	Col. Joseph B. Schreiter	15 Oct 36-18 Feb 37
<i>Inactive</i>	13 Aug 29-ao Jun 34	<i>Inactive</i>	18 Feb 37-7 Dec 41

102nd Station Hospital (C.Z.)

Organized Reserve Illinois

HQ-*Not initiated* 1923-25; Rock Island, IL, 1925-30; *Inactive* 1929-34; Quincy, IL, 1934-41

Constituted in the Organized Reserve 2 July 1923, assigned to the Communications Zone, and allotted to the Sixth Corps Area. Designated 12 September 1923 as Station Hospital No. 102. Initiated by March 1925 at Rock Island, IL. Redesignated 23 March 1925 as the 102nd Station Hospital. Inactivated 17 December 1929 at Rock Island by relief of personnel. Reorganized by June 1934 at Quincy, IL. Inactivated by June 1939 at Quincy by relief of personnel. Location 7 December 1941—Quincy, IL.

Status: Disbanded 30 January 1942.

Commanders, 102nd Station Hospital

Maj. Wilmer P. Frazier	ao Mar 25-10 Apr 25	Unknown	ao Jun 34-1 Sep 36
Unknown	10 Apr 25-8 Jan 26	Lt. Col. Emery B. Neff	1 Sep 36-Mar 38
Lt. Col. Louis Ostrom	8 Jan 26-17 Dec 29	Unknown	Mar 38-ao Jun 39
<i>Inactive</i>	17 Dec 29-ao Jun 34	<i>Inactive</i>	ao Jun 39-7 Dec 41

103rd Station Hospital (C.Z.)

Organized Reserve Illinois

HQ-*Not initiated* 1923-25; Springfield, IL, 1925-29; *Inactive* 1929-35; Decatur, IL, 1935-37; *Inactive* 1937-41

Constituted in the Organized Reserve 2 July 1923, assigned to the Communications Zone, and allotted to the Sixth Corps Area. Designated 12 September 1923 as Station Hospital No. 103. Redesignated 23 March 1925 as the 103rd Station Hospital. Initiated by June 1925 at Springfield, IL. Inactivated 23 August 1929 at Springfield by relief of personnel. Reorganized by February 1935 at Decatur, IL. Inactivated 18 February 1937 at Decatur by relief of personnel. Conducted summer training at the station hospital at Jefferson Barracks, MO. Location 7 December 1941—*Inactive*.

Commanders, 103rd Station Hospital

Unknown	ao Jun 25-17 Apr 26	Unknown	ao Feb 35-ao Jun 36
Lt. Col. Robert H. Gibson	17 Apr 26-23 Aug 29	Maj. Roy O. Hawthorne	ao Jun 36-1 Sep 36
<i>Inactive</i>	23 Aug 29-ao Feb 35	Lt. Col. John M. Hays	1 Sep 36-18 Feb 37
	<i>Inactive</i>	18 Feb 37-7 Dec 41	

104th Station Hospital (C.Z.)

Organized Reserve Michigan

HQ-*Not initiated* 1923-25; Grand Rapids, MI, 1925-30; *Inactive* 1930-34; Grand Rapids, MI, 1934-37; *Inactive* 1937-41

Constituted in the Organized Reserve 2 July 1923, assigned to the Communications Zone, and allotted to the Sixth Corps Area. Designated 12 September 1923 as Station Hospital No. 104. Initiated by September 1925 at Grand Rapids, MI. Redesignated 23 March 1925 as the 104th Station Hospital. Inactivated by December 1930 at Grand Rapids by relief of personnel. Reorganized by June 1934 at Grand Rapids. Inactivated by June 1937 at Grand Rapids by relief of personnel. Location 7 December 1941—*Inactive*.

Status: Disbanded 31 August 1945.

Commanders, 104th Station Hospital

Unknown	ao Sep 25-9 Apr 26	Unknown	ao Jun 29-ao Dec 30
Lt. Col. Charles V. Crane	9 Apr 26-ao Jun 29	<i>Inactive</i>	ao Dec 30-ao Jun 34
	Unknown	ao Jun 34-7 Dec 41	

105th Station Hospital (C.Z.)**Organized Reserve Illinois****HQ**-*Not initiated* 1923-25; Chicago, IL, 1925-29; *Inactive* 1929-35; Chicago, IL, 1935-39; *Inactive* 1939-41

Constituted in the Organized Reserve 2 July 1923, assigned to the Communications Zone, and allotted to the Sixth Corps Area. Designated 12 September 1923 as Station Hospital No. 105. Redesignated 23 March 1925 as the 105th Station Hospital. Initiated by September 1925 at Chicago, IL. Inactivated 17 December 1929 at Chicago by relief of personnel. Reorganized by June 1934 at Chicago. Inactivated by June 1939 at Chicago by relief of personnel. Location 7 December 1941—*Inactive*.

Status: Disbanded 30 January 1942.**Commanders, 105th Station Hospital**

Lt. Col. Albert B. Keyes	ao Sep 25-ao Jun 27	<i>Inactive</i>	17 Dec 29-ao Jun 34
Unknown	ao Jun 27-ao Jun 29	Unknown	ao Jun 34-ao Jun 39
Lt. Col. John W. Turner	ao Jun 29-17 Dec 29	<i>Inactive</i>	ao Jun 39-7 Dec 41

106th Station Hospital (C.Z.)**Organized Reserve Wisconsin****HQ**-*Not initiated* 1923-25; Superior, WI, 1925-38; Eau Claire, WI, 1938-39; *Inactive* 1939-41

Constituted in the Organized Reserve 2 July 1923, assigned to the Communications Zone, and allotted to the Sixth Corps Area. Designated 12 September 1923 as Station Hospital No. 106. Redesignated 23 March 1925 as the 106th Station Hospital. Initiated by May 1925 at Superior, WI. Relocated by January 1938 to Eau Claire, WI. Inactivated by June 1939 at Eau Claire by relief of personnel. Conducted summer training at the station hospital at Camp Custer, MI. Location 7 December 1941—*Inactive*.

Commanders, 106th Station Hospital

Maj William D. Harvie	ao May 25-2 Jun 25	Lt. Col. Jonas R. Longley	ao Jun 30-ao Jun 34
Unknown	2 Jun 25-17 Nov 26	Unknown	ao Jun 34-ao Jun 36
Lt. Col. Harry M. Hedge	17 Nov 26-ao Jun 29	Lt. Col. Richard S. Wilson	ao Jun 36-ao Jun 37
Unknown	ao Jun 29-ao Jun 30	Unknown	ao Jun 37-ao Jun 39
	<i>Inactive</i>	ao Jun 39-7 Dec 41	

107th Station Hospital (C.Z.)**Organized Reserve Arkansas****HQ**-*Not initiated* 1923-25; Hot Springs, AR, 1925-41

Constituted in the Organized Reserve 2 July 1923, assigned to the Communications Zone, and allotted to the Seventh Corps Area. Designated 12 September 1923 as Station Hospital No. 107. Redesignated 23 March 1925 as the 107th Station Hospital. Initiated by October 1925 at Hot Springs, AR. Location 7 December 1941—Hot Springs, AR.

Status: Inactive in the U.S. Army Reserve as the 803rd Station Hospital.**Commanders, 107th Station Hospital**

Lt. Col. Frederick E. Woodruff	ao Oct 25-Aug 29	Unknown	Aug 29-7 Dec 41
--------------------------------	------------------	---------	-----------------

108th Station Hospital (C.Z.)**Organized Reserve Arkansas****HQ**-*Not initiated* 1923-25; Hot Springs, AR, 1925-41

Constituted in the Organized Reserve 2 July 1923, assigned to the Communications Zone, and allotted to the Seventh Corps Area. Designated 12 September 1923 as Station Hospital No. 108. Redesignated 23 March 1925 as the 108th Station Hospital. Initiated by September 1925 at Hot Springs, AR. Location 7 December 1941—Hot Springs, AR.

Status: Inactive in the U.S. Army Reserve as the 804th Station Hospital.**Commanders, 108th Station Hospital**

Unknown	ao Sep 25-ao Jun 27	Col. Lloyd Thompson	ao Jun 27-Jul 29
	Unknown	Jul 29-7 Dec 41	

109th Station Hospital (C.Z.)**Organized Reserve Nebraska/Iowa****HQ-Not initiated** 1923-25; Fort Crook, NE, 1925-29; Des Moines, IA, 1929-41; Boston, MA, 1941

Constituted in the Organized Reserve 2 July 1923, assigned to the Communications Zone, and allotted to the Seventh Corps Area. Designated 12 September 1923 as Station Hospital No. 109. Redesignated 23 March 1925 as the 109th Station Hospital. Initiated by September 1925 at Fort Crook, NE. Relocated in December 1929 to Des Moines, IA. Withdrawn from the Organized Reserve 1 October 1933 and allotted to the Regular Army. Concurrently relieved from the Communications Zone and assigned to the General Headquarters Reserve. Activated 1 June 1941, less Reserve personnel, at Boston, MA, and attached to the Harbor Defenses of Boston. Location 7 December 1941—Boston, MA.

Status: Disbanded 25 June 1945.**Commanders, 109th Station Hospital**

Unknown	ao Sep 25-Oct 26	Unknown	ao Jan 30-10 Nov 35
Lt. Col. Charles G. Baird	Oct 26-Jan 28	Maj. John T. Harna**	10 Nov 35-ao Jan 36
Unknown	Jan 28-Dec 29	Unknown	ao Jan 36-22 Aug 37
Capt. Joseph B. Schrock	Dec 29-ao Jan 30	Maj. Ralph J. Selman**	22 Aug 37-ao Jan 38
	Unknown	ao Jan 38-7 Dec 41	

** RAI Commanders: Organized Reserve officers.

110th Station Hospital (C.Z.)**Organized Reserve Nebraska****HQ-Not initiated** 1923-25; Fort Crook, NE, 1925-28; Omaha, NE, 1928-41

Constituted in the Organized Reserve 2 July 1923, assigned to the Communications Zone, and allotted to the Seventh Corps Area. Designated 12 September 1923 as Station Hospital No. 110. Redesignated 23 March 1925 as the 110th Station Hospital. Initiated by September 1925 at Fort Crook, NE. Relocated 3 April 1928 to Omaha, NE. Location 7 December 1941—Omaha, NE.

Status: Inactive in the U.S. Army Reserve as the 110th Station Hospital.**Commanders, 110th Station Hospital**

Unknown	ao Sep 25-Oct 26	Lt. Col. Frederick J. Swift	Oct 26-Mar 30
	Unknown	Mar 30-7 Dec 41	

111th Station Hospital (C.Z.)**Organized Reserve Kansas****HQ-Not initiated** 1923-25; Junction City, KS, 1925-41

Constituted in the Organized Reserve 2 July 1923, assigned to the Communications Zone, and allotted to the Seventh Corps Area. Designated 12 September 1923 as Station Hospital No. 111. Redesignated 23 March 1925 as the 111th Station Hospital. Initiated by September 1925 at Junction City, KS. Location 7 December 1941—Junction City, KS.

Status: Disbanded 30 January 1942.**Commanders, 111th Station Hospital**

Lt. Col. Charles W. Jones	ao Sep 25-Jun 29	Unknown	Jun 29-7 Dec 41
---------------------------	------------------	---------	-----------------

112th Station Hospital (C.Z.)**Organized Reserve Kansas/North Dakota****HQ-Not initiated** 1923-24; Junction City, KS, 1924-26; Bismarck, ND, 1926-31; Minot, ND, 1931-41

Constituted in the Organized Reserve 2 July 1923, assigned to the Communications Zone, and allotted to the Seventh Corps Area. Designated 12 September 1923 as Station Hospital No. 112. Initiated in November 1924 at Junction City, KS. Redesignated 23 March 1925 as the 112th Station Hospital. Relocated 26 May 1926 to Bismarck, ND. Relocated 12 October 1931 to Minot, ND. Location 7 December 1941—Minot, ND, (inactivated 22 January 1942).

Status: Disbanded 18 January 1945.

Commanders, 112th Station Hospital

Lt. Col. Clifford L. Hooper	ao Sep 25-May 29	Lt. Col. Samuel J. Hillis	Mar 30-ao Jun 30
Unknown	May 29-Dec 29	Unknown	Jun 30-ao Jul 37
Maj. J. T. Ince	Dec 29-Mar 30	Maj. Edward J. Wehman	ao Jul 37-22 Aug 37
	Unknown	22 Aug 37-7 Dec 41	

113th Station Hospital (C.Z.)

Organized Reserve Kansas/North Dakota/Arkansas

HQ-Not initiated 1923-24; Junction City, KS, 1924-26; Fargo, ND, 1926-31; North Little Rock, AR, 1931-41

Constituted in the Organized Reserve 2 July 1923, assigned to the Communications Zone, and allotted to the Seventh Corps Area. Designated 12 September 1923 as Station Hospital No. 113. Initiated in November 1924 at Junction City, KS. Redesignated 23 March 1925 as the 113th Station Hospital. Relocated 26 May 1926 to Fargo, ND. Relocated 12 October 1931 to North Little Rock, AR. Relieved from the Communications Zone in 1936 and assigned to the General Headquarters Reserve. Conducted summer training at the station hospital at Camp Pike, AR. Location 7 December 1941—North Little Rock, AR.

Status: Disbanded 21 August 1945.

Commanders, 113th Station Hospital

Lt. Col. Walter H. Bruce	ao Sep 25-May 29	Lt. Col. Dewell Gann, jr.	ao Oct 32-ao Jan 33
Lt. Col. Horace E. Ruff	Dec 29-Feb 30	Unknown	ao Jan 33-ao Dec 36
Unknown	Feb 30-ao Oct 32	Maj. William V. Pruett	ao Dec 36-10 Jan 37
	Unknown	10 Jan 37-7 Dec 41	

114th Station Hospital (C.Z.)

Organized Reserve Nebraska/North Dakota

HQ-Not initiated 1923-25; Fort Crook, NE, 1925-26; Grand Forks, ND, 1926-41

Constituted in the Organized Reserve 2 July 1923, assigned to the Communications Zone, and allotted to the Seventh Corps Area. Designated 12 September 1923 as Station Hospital No. 114. Redesignated 23 March 1925 as the 114th Station Hospital. Initiated by September 1925 at Fort Crook, NE. Relocated 26 May 1926 to Grand Forks, ND. Location 7 December 1941—Grand Forks, ND.

Status: Disbanded 30 January 1942.

Commanders, 114th Station Hospital

Lt. Col. John B. Brickell	ao Sep 25-1 Oct 27	Unknown	1 Oct 27-7 Dec 41
---------------------------	--------------------	---------	-------------------

115th Station Hospital (C.Z.)

Organized Reserve Iowa/South Dakota

HQ-Not initiated 1923-25; Fort Des Moines, IA, 1925-28; Sioux Falls, SD, 1928-31; Mason City, IA, 1931-41

Constituted in the Organized Reserve 2 July 1923, assigned to the Communications Zone, and allotted to the Seventh Corps Area. Designated 12 September 1923 as Station Hospital No. 115. Redesignated 23 March 1925 as the 115th Station Hospital. Initiated 29 August 1924 at Fort Des Moines, IA. Relocated 3 April 1928 to Sioux Falls, SD. Relocated 12 October 1931 to Mason City, IA. Location 7 December 1941—Mason City, IA.

Status: Active in the U.S. Army Reserve as the 829th Station Hospital at St. Petersburg, FL.

Commanders, 115th Station Hospital

Unknown	29 Aug 24-Oct 26	Unknown	ao Jul 27-22 Aug 37
Lt. Col. Thomas V. Golden	Oct 26-ao Jan 27	Capt. Loira C. Pumphrey	22 Aug 37-ao Jan 38
Lt. Col. Frederick E. Woodruff	ao Jun 27-ao Jul 27	Unknown	ao Jan 38-7 Dec 41

116th Station Hospital (C.Z.)**Organized Reserve Iowa****HQ-Not initiated** 1923-25; Fort Des Moines, IA, 1925-41

Constituted in the Organized Reserve 2 July 1923, assigned to the Communications Zone, and allotted to the Seventh Corps Area. Designated 12 September 1923 as Station Hospital No. 116. Redesignated 23 March 1925 as the 116th Station Hospital. Initiated by September 1925 at Fort Des Moines, IA. Location 7 December 1941—Fort Des Moines, IA.

Status: Disbanded 30 January 1942.**Commanders, 116th Station Hospital**

Lt. Col. Edward L. Rohlf	ao Sep 25-Aug 29	Unknown	Aug 29-7 Dec 41
--------------------------	------------------	---------	-----------------

117th Station Hospital (C.Z.)**Organized Reserve Minnesota/Missouri****HQ-Not initiated** 1923-25; Fort Snelling, MN, 1925-28; St. Louis, MO, 1928-41

Constituted in the Organized Reserve 2 July 1923, assigned to the Communications Zone, and allotted to the Seventh Corps Area. Designated 12 September 1923 as Station Hospital No. 117. Redesignated 23 March 1925 as the 117th Station Hospital. Initiated by September 1925 at Fort Snelling, MN. Relocated 3 April 1928 to St. Louis, MO. Location 7 December 1941—St. Louis, MO.

Status: Disbanded 30 January 1942.**Commanders, 117th Station Hospital**

Lt. Col. Charles L. Marston	ao Sep 25-Aug 29	Unknown	Aug 29-7 Dec 41
-----------------------------	------------------	---------	-----------------

118th Station Hospital (C.Z.)**Organized Reserve Minnesota****HQ-Not initiated** 1923-25; Fort Snelling, MN, 1925-41

Constituted in the Organized Reserve 2 July 1923, assigned to the Communications Zone, and allotted to the Seventh Corps Area. Designated 12 September 1923 as Station Hospital No. 118. Redesignated 23 March 1925 as the 118th Station Hospital. Initiated by September 1925 at Fort Snelling, MN. Location 7 December 1941—Fort Snelling, MN.

Status: Disbanded 30 January 1942.**Commanders, 118th Station Hospital**

Lt. Col. Ralph S. Perry	ao Sep 25-ao Jun 27	Unknown	ao Jun 27-7 Dec 41
-------------------------	---------------------	---------	--------------------

119th Station Hospital (C.Z.)**Organized Reserve Kansas****HQ-Not initiated** 1923-25; Junction City, KS, 1925-31; Emporia, KS, 1931-41

Constituted in the Organized Reserve 2 July 1923, assigned to the Communications Zone, and allotted to the Seventh Corps Area. Designated 12 September 1923 as Station Hospital No. 119. Redesignated 23 March 1925 as the 119th Station Hospital. Initiated by September 1925 at Junction City, KS. Relocated 12 October 1931 to Emporia, KS. Location 7 December 1941—Emporia, KS.

Status: Disbanded 30 January 1942.**Commanders, 119th Station Hospital**

Lt. Col. John DeWitt	ao Sep 25-4 Jan 26	Lt. Col. Arthur B. Cullum	4 Jan 26-ao Jun 27
	Unknown	ao Jun 27-7 Dec 41	

120th Station Hospital (C.Z.)**Organized Reserve Kansas****HQ-Not initiated** 1923-24; Fort Leavenworth, KS, 1924-26; Wichita, KS, 1926-31; Independence, KS, 1931-41

Constituted in the Organized Reserve 2 July 1923, assigned to the Communications Zone, and allotted to the Seventh Corps Area. Designated 12 September 1923 as Station Hospital No. 120. Initiated in November 1924 at Fort Leavenworth, KS. Redesignated 23 March 1925 as the 120th Station Hospital. Relocated 26 May 1926 to Wichita, KS. Relocated 12 October 1931 to Independence, KS. Location 7 December 1941—Independence, KS.

Status: Inactive in the U.S. Army Reserve as the 120th Station Hospital.**Commanders, 120th Station Hospital**

Lt. Col. Harry L. Chambers	Nov 24-Oct 28	Unknown	Jan 30-ao Jun 35
Unknown	Oct 28-Jul 29	Maj. Samuel W. Connor	ao Jun 35-10 Nov 35
Lt. Col. George H. Smith	Jul 29-Jan 30	Unknown	10 Nov 35-7 Dec 41

121st Station Hospital (C.Z.)**Organized Reserve Colorado/Nebraska/Missouri****HQ-Not initiated** 1923-26; Colorado Springs, CO, 1926-27; *Inactive* 1927-28; Omaha, NE, 1928-31; Hannibal, MO, 1931-41

Constituted in the Organized Reserve 2 July 1923, assigned to the Communications Zone, and allotted to the Eighth Corps Area. Designated 12 September 1923 as Station Hospital No. 121. Redesignated 23 March 1925 as the 121st Station Hospital. Initiated February 1926 at Colorado Springs, CO. Withdrawn from the Eighth Corps Area 11 January 1927 and allotted to the Seventh Corps Area. Inactivated 4 April 1927 at Colorado Springs by relief of personnel. Reorganized in January 1928 at Omaha, NE. Relocated 12 October 1931 to Hannibal, MO. Withdrawn from the Organized Reserve in 1936 and allotted to the Regular Army. Conducted summer training at the station hospital at Fort Snelling, MN. Location 7 December 1941—Hannibal, MO.

Status: Inactive in the U.S. Army Reserve as the 824th Station Hospital.**Commanders, 121st Station Hospital**

Maj. Arnold S. Taussig	5 Feb 26-4 Apr 27	Maj. Frederick L. Nelson	Feb 28-Feb 30
<i>Inactive</i>	4 Apr 27-Jan 28	Lt. Col. Edward L. Stewart	Feb 30-ao May 32
Lt. Col. Charles G. Baird	Jan 28-Feb 28	Unknown	ao May 32-7 Dec 41

122nd Station Hospital (C.Z.)**Organized Reserve Colorado/Kansas****HQ-Not initiated** 1923-26; Denver, CO, 1926-27; *Inactive* 1927-28; Hutchinson, KS, 1928-41

Constituted in the Organized Reserve 2 July 1923, assigned to the Communications Zone, and allotted to the Eighth Corps Area. Designated 12 September 1923 as Station Hospital No. 122. Redesignated 23 March 1925 as the 122nd Station Hospital. Initiated 5 February 1926 at Denver, CO. Withdrawn from the Eighth Corps Area 11 January 1927 and allotted to the Seventh Corps Area. Inactivated 4 April 1927 at Denver by relief of personnel. Reorganized by February 1928 at Hutchinson, KS. Withdrawn from the Organized Reserve in 1936 and allotted to the Regular Army. Location 7 December 1941—Hutchinson, KS.

Status: Disbanded 30 January 1942.**Commanders, 122nd Station Hospital**

Maj. George H. Cattermole	5 Feb 26-4 Apr 27	Maj. Francis D. Kennedy	Feb 28-Aug 29
<i>Inactive</i>	4 Apr 27-Feb 28	Unknown	Aug 29-7 Dec 41

123rd Station Hospital (C.Z.)**Organized Reserve Colorado/Kansas****HQ-Not initiated** 1923-26; Pueblo, CO, 1926-27; *Inactive* 1927-28; Atchison, KS, 1928-41

Constituted in the Organized Reserve 2 July 1923, assigned to the Communications Zone, and allotted to the Eighth Corps Area. Designated 12 September 1923 as Station Hospital No. 123. Redesignated 23 March 1925 as the 123rd Station Hospital. Initiated 6 February 1926 at Pueblo, CO. Withdrawn from the Eighth Corps Area 11 January 1927 and allotted to the Seventh Corps Area. Inactivated 4 April 1927 at Pueblo by relief of personnel. Reorganized by February 1928 at Atchison, KS. Withdrawn from the Organized Reserve 5 June 1936 and allotted to the Regular Army. Location 7 December 1941—Atchison, KS.

Status: Disbanded 30 January 1942.

Commanders, 123rd Station Hospital

Maj. William McConnell <i>Inactive</i>	6 Feb 26-4 Apr 27 4 Apr 27-Feb 28 Unknown	Unknown Lt. Col. Gordon I. Thacher Aug 29-7 Dec 41	Feb 28-Nov 28 Nov 28-Aug 29
---	---	--	--------------------------------

124th Station Hospital (C.Z.)

Organized Reserve New Mexico/Missouri

HQ-Not initiated 1923-25; Las Cruces, NM, 1925-27; *Inactive* 1927-28; St. Joseph, MO, 1928-41

Constituted in the Organized Reserve 2 July 1923, assigned to the Communications Zone, and allotted to the Eighth Corps Area. Designated 12 September 1923 as Station Hospital No. 124. Redesignated 23 March 1925 as the 124th Station Hospital. Initiated 20 March 1925 at Las Cruces, NM. Withdrawn from the Eighth Corps Area 11 January 1927 and allotted to the Seventh Corps Area. Inactivated 4 April 1927 at Las Cruces by relief of personnel. Reorganized by November 1928 at St. Joseph, MO. Location 7 December 1941—St. Joseph, MO.

Status: Disbanded 30 January 1942.

Commanders, 124th Station Hospital

Lt. Col. Scurry L. Terrell <i>Inactive</i>	20 Mar 25-4 Apr 27 4 Apr 27-Nov 28	Maj. Charles Greenberg Unknown	Nov 28-ao Jan 29 ao Jan 29-7 Dec 41
---	---------------------------------------	-----------------------------------	--

125th Station Hospital (C.Z.)

Organized Reserve New Mexico/Minnesota/Kansas

HQ-Not initiated 1923-26; Santa Fe, NM, 1926-27; Pipestone, MN, 1927-31; Lawrence, KS, 1931-41

Constituted in the Organized Reserve 2 July 1923, assigned to the Communications Zone, and allotted to the Eighth Corps Area. Designated 12 September 1923 as Station Hospital No. 125. Redesignated 23 March 1925 as the 125th Station Hospital. Initiated 6 February 1926 at Santa Fe, NM. Withdrawn from the Eighth Corps Area 11 January 1927 and allotted to the Seventh Corps Area. Inactivated 4 April 1927 at Santa Fe by relief of personnel. Reorganized by August 1927 at Pipestone, MN. Relocated 12 October 1931 to Lawrence, KS. Location 7 December 1941—Lawrence, KS.

Status: Disbanded 30 January 1942.

Commanders, 125th Station Hospital

Lt. Col. William D. McFaul <i>Inactive</i> Unknown	6 Feb 26-4 Apr 27 4 Apr 27-Aug 27 Aug 27-Nov 28	Lt. Col. Arthur L. Ludwig Col. Don H. Silsby Unknown	Nov 28-Aug 29 Sep 29-Feb 30 Feb 30-7 Dec 41
--	---	--	---

126th Station Hospital (C.Z.)

Organized Reserve Oklahoma/Minnesota/Kansas

HQ-Not initiated 1923-25; McAlester, OK, 1925-27; *Inactive* 1927-28; Duluth 1928-31; Parsons, KS, 1931-41

Constituted in the Organized Reserve 2 July 1923, assigned to the Communications Zone, and allotted to the Eighth Corps Area. Designated 12 September 1923 as Station Hospital No. 126. Redesignated 23 March 1925 as the 126th Station Hospital. Initiated 22 May 1925 at McAlester, OK. Conducted summer training at William Beaumont General Hospital at El Paso, TX. Withdrawn from the Eighth Corps Area 11 January 1927 and allotted to the Seventh Corps Area. Inactivated 4 April 1927 at McAlester by relief of personnel. Reorganized by April 1928 at Duluth, MN. Relocated 12 October 1931 to Parsons, KS. Location 7 December 1941—Parsons, KS.

Status: Disbanded 30 January 1942.

Commanders, 126th Station Hospital

Capt. John C. Kitchen	22 May 25-8 Feb 26	<i>Inactive</i>	4 Apr 27-Apr 28
Maj. William P. Mills	8 Feb 26-4 Apr 27	Unknown	Apr 28-7 Dec 41

127th Station Hospital (C.Z.)

Organized Reserve Oklahoma/Iowa/Missouri

HQ-Not initiated 1923-24; Tulsa, OK, 1924-27; *Inactive* 1927-28; Sioux City, IA, 1928-31; Columbia, MO, 1931-36; *Inactive* 1936-41

Constituted in the Organized Reserve 2 July 1923, assigned to the Communications Zone, and allotted to the Eighth Corps Area. Designated 12 September 1923 as Station Hospital No. 127. Redesignated 23 March 1925 as the 127th Station Hospital. Initiated in November 1924 at Tulsa, OK. Conducted summer training at the station hospital at Fort Sam Houston, TX. Withdrawn from the Eighth Corps Area 11 January 1927 and allotted to the Seventh Corps Area. Inactivated 4 April 1927 at Tulsa by relief of personnel. Reorganized by November 1928 at Sioux City, IA. Relocated 12 October 1931 to Columbia, MO. Withdrawn from the Seventh Corps Area 5 June 1936 and allotted to the Sixth Corps Area. Location 7 December 1941—*Inactive*.

Status: Disbanded 30 January 1942.

Commanders, 127th Station Hospital

Unknown	Nov 24-20 Mar 25	<i>Inactive</i>	4 Apr 27-Nov 28
2nd Lt. George M. Thompson	20 Mar 25-8 Feb 26	Lt. Col. Walter F. Fry	Nov 28-Oct 29
Maj. George R. Osborn	8 Feb 26-4 Apr 27	Unknown	Oct 29-5 Jun 36
	<i>Inactive</i>	5 Jun 36-7 Dec 41	

128th Station Hospital (C.Z.)

Organized Reserve Texas/Arkansas

HQ-Not initiated 1923-25; Amarillo, TX, 1925-27; *Inactive* 1927-28; Fort Smith AR 1928-31; Texarkana, AR, 1931-36; *Inactive* 1936-41

Constituted in the Organized Reserve 2 July 1923, assigned to the Communications Zone, and allotted to the Eighth Corps Area. Designated 12 September 1923 as Station Hospital No. 128. Redesignated 23 March 1925 as the 128th Station Hospital. Initiated in July 1925 at Amarillo, TX. Conducted summer training at William Beaumont General Hospital at El Paso, TX. Withdrawn from the Eighth Corps Area 11 January 1927 and allotted to the Seventh Corps Area. Inactivated 4 April 1927 at Amarillo by relief of personnel. Reorganized by November 1928 at Fort Smith AR. Relocated 12 October 1931 to Texarkana, AR. Withdrawn from the Seventh Corps Area 5 June 1936 and allotted to the Sixth Corps Area. Location 7 December 1941—*Inactive*.

Status: Disbanded 30 January 1942.

Commanders, 128th Station Hospital

Maj. David C. Dodds	28 Jul 25-4 Apr 27	Lt. Col. William G. Baird	Nov 28-Jul 29
<i>Inactive</i>	4 Apr 27-Nov 28	Unknown	Jul 29-5 Jun 36
	<i>Inactive</i>	5 Jun 36-7 Dec 41	

129th Station Hospital (C.Z.)

Organized Reserve Texas/North Dakota

HQ-Not initiated 1923-25; Fort Worth, TX, 1925-27; *Inactive* 1927-28; Jamestown, ND, 1928-36; *Inactive* 1936-41

Constituted in the Organized Reserve 2 July 1923, assigned to the Communications Zone, and allotted to the Eighth Corps Area. Designated 12 September 1923 as Station Hospital No. 129. Redesignated 23 March 1925 as the 129th Station Hospital. Initiated 29 September 1925 at Fort Worth, TX. Withdrawn from the Eighth Corps Area 7 January 1927 and allotted to the Seventh Corps Area. Reorganized by November 1928 at Jamestown, ND. Withdrawn from the Seventh Corps Area 5 June 1936 and allotted to the Sixth Corps Area. Location 7 December 1941—*Inactive*.

Status: Disbanded 30 January 1942.

Commanders, 129th Station Hospital

Lt. Col. Alfred C. McDaniel
Inactive

29 Sep 25-11 Jan 27
11 Jan 27-Nov 28
Inactive

Lt. Col. Paul F. Rice
Unknown
5 Jun 36-7 Dec 41

Nov 28-Aug 29
Aug 29-5 Jun 36

130th Station Hospital (C.Z.)

Organized Reserve Texas/Missouri

HQ-*Not initiated* 1923-25; Galveston, TX, 1925-27; *Inactive* 1927-28; Kansas City, MO, 1928-31; Independence, MO, 1931-36; *Inactive* 1936-41

Constituted in the Organized Reserve 2 July 1923, assigned to the Communications Zone, and allotted to the Eighth Corps Area. Designated 12 September 1923 as Station Hospital No. 130. Redesignated 23 March 1925 as the 130th Station Hospital. Initiated 30 July 1925 at Galveston, TX. Withdrawn from the Eighth Corps Area 11 January 1927 and allotted to the Seventh Corps Area. Inactivated 4 April 1927 at Galveston by relief of personnel. Reorganized in November 1928 at Kansas City, MO. Relocated 12 October 1931 to Independence, MO. Withdrawn from the Seventh Corps Area 5 June 1936 and allotted to the Sixth Corps Area. Location 7 December 1941—*Inactive*.

Status: Inactive in the Regular Army as the 130th Field Hospital.

Commanders, 130th Station Hospital

Maj. George A. McBride
Inactive

30 Jul 25-4 Apr 27
4 Apr 27-Nov 28
Inactive

Lt. Col. Ernest W. Slusher
Unknown
5 Jun 36-7 Dec 41

Nov 28-Jul 29
Jul 29-5 Jun 36

131st Station Hospital (C.Z.)

Organized Reserve Texas/Iowa

HQ-*Not initiated* 1923-26; Houston, TX, 1926-27; *Inactive* 1927-28; Storm Lake, IA, 1928-31; Clinton, IA, 1931-36; *Inactive* 1936-41

Constituted in the Organized Reserve 2 July 1923, assigned to the Communications Zone, and allotted to the Eighth Corps Area. Designated 12 September 1923 as Station Hospital No. 131. Redesignated 23 March 1925 as the 131st Station Hospital. Initiated 16 March 1926 at Houston, TX. Withdrawn from the Eighth Corps Area 7 January 1927 and allotted to the Seventh Corps Area. Inactivated 4 April 1927 at Houston by relief of personnel. Reorganized in November 1928 at Storm Lake, IA. Relocated 12 October 1931 to Clinton, IA. Withdrawn from the Seventh Corps Area 5 June 1936 and allotted to the Sixth Corps Area. Location 7 December 1941—*Inactive*.

Status: Disbanded 30 January 1942.

Commanders, 131st Station Hospital

Maj. Witten B. Russ
Inactive

16 Mar 26-4 Apr 27
4 Apr 27-Nov 28
Inactive

Maj. Kurt Jaenicke
Unknown
5 Jun 36-7 Dec 41

Nov 28-Aug 29
Aug 29-5 Jun 36

132nd Station Hospital (C.Z.)

Organized Reserve Oklahoma/Illinois

HQ-*Not initiated* 1923-25; Oklahoma City, OK, 1925-27; *Inactive* 1927-29; Oklahoma City, OK, 1929-36; *Inactive* 1936-41

Constituted in the Organized Reserve 2 July 1923, assigned to the Communications Zone, and allotted to the Eighth Corps Area. Designated 12 September 1923 as Station Hospital No. 132. Redesignated 23 March 1925 as the 132nd Station Hospital. Initiated 20 March 1925 at Oklahoma City, OK. Inactivated 4 April 1927 at Oklahoma City by relief of personnel. Reorganized 3 May 1927 at Oklahoma City, OK. Withdrawn from the Eighth Corps Area 5 June 1936 and allotted to the Sixth Corps Area. Inactivated 12 November 1936 at Oklahoma City by relief of personnel. Chicago, IL, designated as headquarters on reorganization, but the unit was never organized at that location. Conducted summer training at the station hospital at Fort Sam Houston, TX. Designated mobilization training station was Camp Stanley, TX. Location 7 December 1941—*Inactive*.

Status: Disbanded 30 January 1942.

Commanders, 132nd Station Hospital

Maj. Albert M. Chambers <i>Inactive</i>	20 Mar 25-4 Apr 27 4 Apr 27-3 May 29 <i>Inactive</i>	Lt. Col. Charles B. Palmer Lt. Col. George A. Nyland 12 Nov 36-7 Dec 41	3 May 29-15 Nov 29 15 Nov 29-12 Nov 36
--	--	---	---

133rd Station Hospital (C.Z.)**Organized Reserve Arizona/New Mexico/Illinois****HQ-Not initiated** 1923-26; Phoenix, AZ, 1926-27; Santa Fe, NM, 1927-36; *Inactive* 1936-41

Constituted in the Organized Reserve 2 July 1923, assigned to the Communications Zone, and allotted to the Eighth Corps Area. Designated 12 September 1923 as Station Hospital No. 133. Redesignated 23 March 1925 as the 133rd Station Hospital. Initiated 20 March 1925 at Phoenix, AZ. Relocated 5 December 1927 to Santa Fe, NM. Withdrawn from the Eighth Corps Area 5 June 1936 and allotted to the Sixth Corps Area. Inactivated 12 November 1936 at Santa Fe by relief of personnel. Chicago, IL, designated as headquarters on reorganization, but the unit was never organized at that location. Conducted summer training at the station hospital at Fort Sam Houston, TX. Designated mobilization training station was Camp Stanley, TX. Location 7 December 1941—*Inactive*.

Status: Disbanded 30 January 1942.**Commanders, 133rd Station Hospital**

Unknown	20 Mar 25-ao Jun 27	Unknown	14 Apr 30-ao Sep 31
Maj. Ernest L. Hicks	ao Jun 27-15 Dec 27	Lt. Col. Edwin B. Godfrey	ao Sep 31-6 Oct 31
Maj. Christian H. Koentz	15 Dec 27-ao Jan 28	Lt. Col. Irl Thomas	22 Dec 31-21 Feb 33
Unknown	ao Jan 28-3 May 29	Lt. Col. Edwin G. Condit	7 Apr 33-12 Nov 36
Lt. Col. Ernest L. Hicks	3 May 29-14 Apr 30	<i>Inactive</i>	12 Nov 36-7 Dec 41

134th Station Hospital (C.Z.)**Organized Reserve Texas/Illinois****HQ-Not initiated** 1923-25; Dallas, TX, 1925-36; *Inactive* 1936-41

Constituted in the Organized Reserve 2 July 1923, assigned to the Communications Zone, and allotted to the Eighth Corps Area. Designated 12 September 1923 as Station Hospital No. 134. Redesignated 23 March 1925 as the 134th Station Hospital. Initiated 27 July 1925 at Dallas, TX. Withdrawn from the Eighth Corps Area 5 June 1936 and allotted to the Sixth Corps Area. Inactivated 12 November 1936 at Dallas by relief of personnel. Chicago, IL, designated as headquarters on reorganization, but the unit was never organized at that location. Conducted summer training at the station hospital at Fort Sam Houston, TX. Designated mobilization training station was Camp Stanley, TX. Location 7 December 1941—*Inactive*.

Status: Disbanded 30 January 1942.**Commanders, 134th Station Hospital**

Maj. Marcus P. Smartt	27 Jul 25-ao Jun 27	Lt. Col. David H. Lawrence	6 Feb 30-29 Sep 32
Unknown	ao Jun 27-3 May 29	Maj. Roland E. Toms	29 Sep 32-ao Jan 33
1st Lt. George G. Harvey	3 May 29-ao May 29	Unknown	ao Jan 33-ao Oct 36
Unknown	ao May 29-6 Feb 30	Capt. William M. Reppeto	ao Oct 36-12 Nov 36
	<i>Inactive</i>	12 Nov 36-7 Dec 41	

135th Station Hospital (C.Z.)**Organized Reserve Texas/Illinois****HQ-Not initiated** 1923-25; Waco, TX, 1925-36; *Inactive* 1936-37; Chicago, IL, 1937-41

Constituted in the Organized Reserve 2 July 1923, assigned to the Communications Zone, and allotted to the Eighth Corps Area. Designated 12 September 1923 as Station Hospital No. 135. Redesignated 23 March 1925 as the 135th Station Hospital. Initiated 20 March 1925 at Waco, TX. Withdrawn from the Eighth Corps Area 5 June 1936 and allotted to the Sixth Corps Area. Inactivated 12 November 1936 at Waco by relief of personnel. Reorganized 9 February 1937 at Chicago, IL. Conducted summer training at the station hospital at Fort Sam Houston, TX. Designated mobilization training station was Camp Stanley, TX. Location 7 December 1941—Chicago, IL.

Status: Disbanded 30 January 1942.

Commanders, 135th Station Hospital

Capt. Charles E. Durham	20 Mar 25-ao Jun 27	Lt. Col. Thomas E. Crump	11 Mar 31-7 Sep 32
Unknown	ao Jun 27-3 May 29	Lt. Col. Walter R. Russell	7 Sep 32-20 Sep 35
1st Lt. Howard G. Malitz	3 May 29-ao May 29	1st Lt. Marcellus A. Walker, jr.	20 Sep 35-12 Nov 36
Unknown	ao May 29-ao Dec 30	<i>Inactive</i>	12 Nov 36-9 Feb 37
Lt. Col. Edward F. Cooke	ao Dec 30-11 Mar 31	Capt. Ernest Q. King	9 Feb 37-ao Jun 37
	Unknown	ao Jan 37-7 Dec 41	

136th Station Hospital (C.Z.)

Organized Reserve Utah/California

HQ-Not initiated 1923-25; Salt Lake City, UT, 1925-37; Sacramento, CA, 1937-41

Constituted in the Organized Reserve 2 July 1923, assigned to the Communications Zone, and allotted to the Ninth Corps Area. Designated 12 September 1923 as Station Hospital No. 136. Redesignated 23 March 1925 as the 136th Station Hospital. Initiated by September 1925 at Salt Lake City, UT. Relocated 14 May 1937 to Sacramento, CA. Conducted summer training at Letterman General Hospital at San Francisco, CA. Location 7 December 1941—Sacramento, CA.

Status: Inactive in the U.S. Army Reserve as the 822nd Station Hospital.

Commanders, 136th Station Hospital

Lt. Col. Chauncey M. Benedict	ao Sep 25-ao Jun 29	Lt. Col. John U. Geisy	9 Feb 37-ao Jun 37
Unknown	ao Jun 29-9 Feb 37	Unknown	ao Jun 37-7 Dec 41

137th Station Hospital (C.Z.)

Organized Reserve Washington/New Jersey

HQ-Not initiated 1923-25; Seattle, WA, 1925-36; *Inactive* 1936-38; Hoboken, NJ, 1938-41

Constituted in the Organized Reserve 2 July 1923, assigned to the Communications Zone, and allotted to the Ninth Corps Area. Designated 12 September 1923 as Station Hospital No. 137. Redesignated 23 March 1925 as the 137th Station Hospital. Initiated by September 1925 at Seattle, WA. Withdrawn from the Ninth Corps Area 5 June 1936 and allotted to the Second Corps Area. Reorganized 4 July 1938 at Hoboken, NJ. Typically conducted Inactive Training Period meetings at the Henry Building in Seattle. Location 7 December 1941—Hoboken, NJ.

Status: Inactive in the U.S. Army Reserve as the 823rd Station Hospital.

Commanders, 137th Station Hospital

Lt. Col. Frederick T. Harris	Oct 25-Feb 30	<i>Inactive</i>	5 Jun 36-23 Dec 38
Maj. Frederick T. Hyde	Feb 30-Nov 30	1st Lt. Robert G. Nevins	4 Jul 38-23 Dec 38
Unknown	Nov 30-Mar 31	Capt. Alexander Friedman	23 Dec 38-19 Mar 40
Lt. Col. Jacob S. Smith	Mar 31-5 Jun 36	Capt. William Feller	19 Mar 40-ao Dec 41

138th Station Hospital (C.Z.)

Organized Reserve Oregon/New Jersey

HQ-Not initiated 1923-25; Portland, OR, 1925-36; *Inactive* 1936-41

Constituted in the Organized Reserve 2 July 1923, assigned to the Communications Zone, and allotted to the Ninth Corps Area. Designated 12 September 1923 as Station Hospital No. 138. Redesignated 23 March 1925 as the 138th Station Hospital. Initiated by September 1925 at Portland, OR. Withdrawn from the Ninth Corps Area 5 June 1936 and allotted to the Second Corps Area. Atlantic City, NJ, designated as headquarters on reorganization, but the unit was never organized at that location. Location 7 December 1941—*Inactive*.

Status: Disbanded 30 January 1942.

Commanders, 138th Station Hospital

Maj. Calvin S. White	Nov 25-Jul 26	Lt. Col. Robert T. Legge	Apr 31-ao May 31
Lt. Col. Oliver R. Austin	Jul 26-Apr 31	Unknown	ao May 31-5 Jun 36
	<i>Inactive</i>	5 Jun 36-7 Dec 41	

139th Station Hospital (C.Z.)**Organized Reserve California****HQ-Not initiated** 1923-25; San Francisco, CA, 1925-37; *Inactive* 1937-41

Constituted in the Organized Reserve 2 July 1923, assigned to the Communications Zone, and allotted to the Ninth Corps Area. Designated 12 September 1923 as Station Hospital No. 139. Redesignated 23 March 1925 as the 139th Station Hospital. Initiated by July 1925 at San Francisco, CA. Conducted summer training at the station hospital at Presidio of Monterey, CA. Inactivated 4 March 1937 at San Francisco by relief of personnel.

Location 7 December 1941—*Inactive*.**Status:** Disbanded 15 October 1944.**Commanders, 139th Station Hospital**

Lt. Col. Charles L. Garvin	ao Jul 25-ao Jun 29	Lt. Col. John D. Morgan, Jr.	9 Feb 35-24 Feb 37
Unknown	ao Jun 29-9 Feb 35	<i>Inactive</i>	4 Mar 37-7 Dec 41

140th Station Hospital (C.Z.)**Organized Reserve Washington/New York****HQ-Not initiated** 1923-25; Spokane, WA, 1925-36; *Inactive* 1936-41

Constituted in the Organized Reserve 2 July 1923, assigned to the Communications Zone, and allotted to the Ninth Corps Area. Designated 12 September 1923 as Station Hospital No. 140. Redesignated 23 March 1925 as the 140th Station Hospital. Initiated by September 1925 at Spokane, WA. Withdrawn from the Ninth Corps Area 5 June 1936 and allotted to the Second Corps Area. New York City, NY, designated as headquarters on reorganization, but the unit was never organized at that location. Location 7 December 1941—*Inactive*.

Status: Disbanded 30 January 1942.**Commanders, 140th Station Hospital**

Unknown	ao Sep 25-Mar 26	Lt. Col. William L. McClure	ao Nov 34-7 Dec 34
Lt. Col. Ralph Hendricks	Mar 26-ao Jun 29	Unknown	7 Dec 34-5 Jun 36
Unknown	ao Jun 29-ao Nov 34	<i>Inactive</i>	5 Jun 36-7 Dec 41

141st Station Hospital (C.Z.)**Organized Reserve Wyoming/California****HQ-Not initiated** 1923-25; Cheyenne, WY, 1925-37; *Inactive* 1937-41

Constituted in the Organized Reserve 2 July 1923, assigned to the Communications Zone, and allotted to the Ninth Corps Area. Designated 12 September 1923 as Station Hospital No. 141. Redesignated 23 March 1925 as the 141st Station Hospital. Initiated in November 1925 at Cheyenne, WY. Inactivated 9 February 1937 at Cheyenne by relief of personnel. Fresno, CA, designated as headquarters on reorganization, but the unit was never organized at that location. Conducted summer training at Letterman General Hospital at San Francisco, CA. Location 7 December 1941—*Inactive*.

Status: Disbanded 15 October 1944.**Commanders, 141st Station Hospital**

Unknown	Nov 25-Mar 26	Maj. John E. Garberson	29 Nov 29-ao Jul 31
Lt. Col. John Hynds	Mar 26-Feb 27	Unknown	ao Jul 31-ao Jun 36
Lt. Col. Tomas J. Riach	Feb 27-29 Nov 29	Lt. Col. Hathaway J. Denman	ao Jun 36-31 Jan 37
	<i>Inactive</i>	9 Feb 37-7 Dec 41	

142nd Station Hospital (C.Z.)**Organized Reserve California****HQ-Not initiated** 1923-25; San Francisco, CA, 1925-37; *Inactive* 1937-41

Constituted in the Organized Reserve 2 July 1923, assigned to the Communications Zone, and allotted to the Ninth Corps Area. Designated 12 September 1923 as Station Hospital No. 142. Redesignated 23 March 1925 as the 142nd Station Hospital. Initiated in November 1925 at San Francisco, CA. Inactivated 4 March 1937 at San Francisco by relief of personnel. Location 7 December 1941—*Inactive*.

Status: Disbanded 15 December 1943.

Commanders, 142nd Station Hospital

Maj. Emil O. Jellineck	Nov 25-Mar 26	Lt. Col. Herbert J. Cohn	ao Dec 34-4 Mar 37
Col. Charles E. Mordoff	Mar 26-ao Jun 34	<i>Inactive</i>	4 Mar 37-7 Dec 41

143rd Station Hospital (C.Z.)

Organized Reserve Oregon/New York

HQ-*Not initiated* 1923-25; Portland, OR, 1925-36; *Inactive* 1936-41

Constituted in the Organized Reserve 2 July 1923, assigned to the Communications Zone, and allotted to the Ninth Corps Area. Designated 12 September 1923 as Station Hospital No. 143. Redesignated 23 March 1925 as the 143rd Station Hospital. Initiated by September 1925 at Portland, OR. Withdrawn from the Ninth Corps Area 5 June 1936 and allotted to the Second Corps Area. New York City, NY, designated as headquarters on reorganization, but the unit was never organized at that location. Location 7 December 1941—*Inactive*.

Status: Disbanded 30 January 1942.

Commanders, 143rd Station Hospital

Lt. Col. Ivan C. Burch	ao Sep 25-Mar 26	Unknown	ao Jun 29-ao Apr 34
Lt. Col. Vestal R. Abraham	Mar 26-Sep 26	Maj. Clyde T. Hockett	ao Apr 34-21 May 34
Lt. Col. Thomas M. Joyce	Sep 26-ao Jun 29	Unknown	21 May 34-5 Jun 36
	<i>Inactive</i>	5 Jun 36-7 Dec 41	

144th Station Hospital (C.Z.)

Organized Reserve California

HQ-*Not initiated* 1923-25; Los Angeles, CA, 1925-37; *Inactive* 1937-41

Constituted in the Organized Reserve 2 July 1923, assigned to the Communications Zone, and allotted to the Ninth Corps Area. Designated 12 September 1923 as Station Hospital No. 144. Redesignated 23 March 1925 as the 144th Station Hospital. Initiated by July 1925 at Los Angeles, CA. Inactivated 4 March 1937 at Los Angeles by relief of personnel. Location 7 December 1941—*Inactive*.

Status: Inactive in the U.S. Army Reserve as the 805th Station Hospital.

Commanders, 144th Station Hospital

Lt. Col. Neal N. Wood	ao Jul 25-Apr 26	Unknown	Feb 31-ao May 34
Lt. Col. Frank H. Paterson	Apr 26-ao Jun 29	Lt. Col. William H. Eaton	ao May 34-21 Sep 36
Unknown	ao Jun 29-ao Jan 31	Lt. Col. John W. Shuman	21 Sep 36-25 Feb 37
Lt. Col. Ray H. Davies	ao Jan 31-Feb 31	<i>Inactive</i>	4 Mar 37-7 Dec 41

145th Station Hospital (C.Z.)

Organized Reserve California

HQ-*Not initiated* 1923-25; Los Angeles, CA, 1925-37; *Inactive* 1937-41

Constituted in the Organized Reserve 2 July 1923, assigned to the Communications Zone, and allotted to the Ninth Corps Area. Designated 12 September 1923 as Station Hospital No. 145. Redesignated 23 March 1925 as the 145th Station Hospital. Initiated by September 1925 at Los Angeles, CA. Inactivated 4 March 1937 at Los Angeles by relief of personnel. Location 7 December 1941—*Inactive*.

Status: Disbanded 1 June 1944.

Commanders, 145th Station Hospital

Unknown	ao Sep 25-Mar 26	Maj. Ralph Van Vranken	ao Aug 36-21 Sep 36
Lt. Col. Fred D. Fairchild	Mar 26-ao Jun 33	Maj. Donald C. Collins	21 Sep 36-25 Feb 37
Unknown	ao Jun 33-ao Aug 36	<i>Inactive</i>	4 Mar 37-7 Dec 41

146th Station Hospital (C.Z.)

Organized Reserve California

HQ-*Not initiated* 1923-25; San Diego, CA, 1925-30; *Inactive* 1930-41

Constituted in the Organized Reserve 2 July 1923, assigned to the Communications Zone, and allotted to the Ninth Corps Area. Designated 12 September 1923 as Station Hospital No. 146. Redesignated 23 March 1925 as the 146th Station Hospital. Initiated 25 February 1925 at San Diego, CA. Inactivated 15 April 1930 at San Diego by relief of personnel. Location 7 December 1941—*Inactive*.

Status: Disbanded 30 January 1942.

Commanders, 146th Station Hospital

Unknown	25 Feb 25-Nov 25	Unknown	ao Mar 26-ao Jun 27
Maj. William Ruoff	Nov 25-ao Mar 26	Lt. Col. Bryant R. Simpson	ao Jun 27-15 Apr 30
	<i>Inactive</i>	15 Apr 30-7 Dec 41	

147th Station Hospital (C.Z.)

Organized Reserve Washington

HQ-*Not initiated* 1923-25; Seattle, WA, 1925-37; *Inactive* 1937-41

Constituted in the Organized Reserve 2 July 1923, assigned to the Communications Zone, and allotted to the Ninth Corps Area. Designated 12 September 1923 as Station Hospital No. 147. Redesignated 23 March 1925 as the 147th Station Hospital. Initiated 21 February 1925 at Seattle, WA. Inactivated 18 February 1937 at Seattle by relief of personnel. Typically conducted Inactive Training Period meetings at the Henry Building in Seattle. Location 7 December 1941—*Inactive*.

Status: Disbanded 30 January 1942.

Commanders, 147th Station Hospital

Unknown	21 Feb 25-Jun 25	Lt. Col. Albert H. Roler	17 Aug 34-ao Jun 35
Lt. Col. Frank P. Gardner	Jul 25-Oct 30	Unknown	ao Jun 35-ao Jun 36
Lt. Col. Edward R. Perry	Oct 30-4 Dec 33	Capt. Jesse L. Norris	ao Jun 36-18 Feb 37
Unknown	ao Jun 33-17 Aug 34	<i>Inactive</i>	18 Feb 37-7 Dec 41

148th Station Hospital (C.Z.)

Organized Reserve Oregon/California

HQ-*Not initiated* 1923-25; Portland, OR, 1925-37; *Inactive* 1937-41

Constituted in the Organized Reserve 2 July 1923, assigned to the Communications Zone, and allotted to the Ninth Corps Area. Designated 12 September 1923 as Station Hospital No. 148. Redesignated 23 March 1925 as the 148th Station Hospital. Initiated by September 1925 at Portland, OR. Inactivated 18 February 1937 at Portland by relief of personnel. San Jose, CA, designated as headquarters on reorganization, but the unit was never organized at that location. Location 7 December 1941—*Inactive*.

Status: Disbanded 30 January 1942.

Commanders, 148th Station Hospital

Unknown	ao Sep 25-Mar 26	Unknown	ao Jun 32-18 Feb 37
Lt. Col. Karl J. Swenson	Mar 26-ao Jun 32	<i>Inactive</i>	18 Feb 37-7 Dec 41

149th Station Hospital (C.Z.)**Organized Reserve California****HQ-Not initiated** 1923-25; San Francisco, CA, 1925-30; *Inactive* 1930-41

Constituted in the Organized Reserve 2 July 1923, assigned to the Communications Zone, and allotted to the Ninth Corps Area. Designated 12 September 1923 as Station Hospital No. 149. Redesignated 23 March 1925 as the 149th Station Hospital. Initiated in November 1925 at San Francisco, CA. Inactivated 15 April 1930 at San Francisco by relief of personnel. Location 7 December 1941—*Inactive*.

Status: Disbanded 30 January 1942.**Commanders, 149th Station Hospital**

Maj. Philip K. Brown	Nov 25-Mar 26 <i>Inactive</i>	Lt. Col. Justus M. Wheate 15 Apr 30-7 Dec 41	Mar 26-15 Apr 30
----------------------	----------------------------------	---	------------------

150th Station Hospital (C.Z.)**Organized Reserve California****HQ-Not initiated** 1923-25; Los Angeles, CA, 1925-30; *Inactive* 1930-32; Los Angeles, CA, 1932-41

Constituted in the Organized Reserve 2 July 1923, assigned to the Communications Zone, and allotted to the Ninth Corps Area. Designated 12 September 1923 as Station Hospital No. 150. Redesignated 23 March 1925 as the 150th Station Hospital. Initiated by July 1925 at Los Angeles, CA. Inactivated 15 April 1930 at Los Angeles by relief of personnel. Reorganized by June 1932 at Los Angeles. Location 7 December 1941—Los Angeles, CA.

Status: Disbanded 30 January 1942.**Commanders, 150th Station Hospital**

Lt. Col. Fred C. Shurtleff	ao Jul 25-Mar 26	<i>Inactive</i>	15 Apr 30-ao Jun 32
Lt. Col. Raymond L. Akin	Mar 26-15 Apr 30	Unknown	ao Jun 32-7 Dec 41

151st Station Hospital (Z.I.)**Organized Reserve Massachusetts/New York****HQ-Not initiated** 1928-31; Boston, MA, 1931-36; *Inactive* 1936-37; New York City, NY, 1937-41; Fort Hancock, NJ, 1941

Constituted in the Organized Reserve 5 September 1928, assigned to the Zone of the Interior, and allotted to the First Corps Area. Withdrawn from the First Corps Area 28 November 1928 and allotted to the Second Corps Area. Withdrawn from the Second Corps Area 21 December 1928 and allotted to the First Corps Area. Concurrently, withdrawn from the Organized Reserve and allotted to the Regular Army. Organized by April 1931 with Organized Reserve personnel as a RAI unit with headquarters at Boston, MA. Relieved from the Zone of the Interior 1 October 1933 and assigned to the General Headquarters Reserve. Withdrawn from the First Corps Area 5 June 1936 and allotted to the Second Corps Area. Reorganized 10 December 1937 at New York City, NY. Activated 1 June 1941 at Fort Hancock, NJ, and attached to the Harbor Defenses of Sandy Hook. Organized Reserve personnel relieved 5 June 1941. Location 7 December 1941—Fort Hancock, NJ.

Commanders, 151st Station Hospital

1st Lt. Saul L. Fox**	ao Apr 31-ao Jan 34	1st Lt. Leon L. Cohen**	10 Dec 37-15 Dec 37
Unknown	ao Jan 34-ao Jun 34	Capt. M. Martyn Kafka**	15 Dec 37-24 Apr 39
Capt. Morton B. Brown**	ao Jun 34-5 Jun 36	1st Lt. Harry Fabricant**	24 Apr 39-5 Jun 41

** RAI Commanders: Organized Reserve officers.

152nd Station Hospital (Z.I.)**Organized Reserve Massachusetts****HQ-Not initiated** 1928-30; New Bedford, MA, 1930-36; New York City, NY, 1936-41; Fort Barrancas, FL, 1941

Constituted in the Organized Reserve 5 September 1928, assigned to the Zone of the Interior, and allotted to the First Corps Area. Withdrawn from the First Corps Area 28 November 1928 and allotted to the Second Corps Area. Withdrawn from the Second Corps Area 21 December 1928 and allotted to the First Corps Area. Concurrently, withdrawn from the Organized Reserve and allotted to the Regular Army. Organized in March 1930 with Organized Reserve personnel

as a RAI unit with headquarters at New Bedford, MA. Relieved the Zone of the Interior 1 October 1933 and assigned to the General Headquarters Reserve. Withdrawn from the First Corps Area 5 June 1936 and allotted to the Second Corps Area. Reorganized in June 1936 at New York City, NY. Activated 1 June 1941, less Reserve personnel, at Fort Barrancas, FL, assigned to the Third Army, and attached to the Harbor Defenses of Pensacola. Organized Reserve personnel relieved 5 June 1941. Location 7 December 1941—Fort Barrancas, FL.

Status: Inactive in the Regular Army as the 152nd Station Hospital.

Commanders, 152nd Station Hospital

Lt. Col. James Breslin**	Mar 30-May 30	Capt. Theodore D. Reed**	ao Jun 36-5 Jun 41
Unknown	May 30-ao Jun 36	Unknown	1 Jun 41-7 Dec 41

** RAI Commanders: Organized Reserve officers.

153rd Station Hospital (Z.I.)

Organized Reserve New York

HQ-Not initiated 1928-30; Buffalo, NY, 1930-41; Camp Roberts, CA, 1941

Constituted in the Organized Reserve 5 September 1928, assigned to the Zone of the Interior, and allotted to the Second Corps Area. Withdrawn from the Organized Reserve 21 December 1928 and allotted to the Regular Army. Organized 4 February 1930 with Organized Reserve personnel as a RAI unit with headquarters in Buffalo, NY. Relieved the Zone of the Interior 1 October 1933 and assigned to the General Headquarters Reserve. Primary R.O.T.C. feeder school was the University of Buffalo. Inactivated 15 May 1941 at Buffalo by relief of personnel. Activated 1 June 1941 at Camp Roberts, CA, and assigned to the Fourth Army. Location 7 December 1941—Camp Roberts, CA.

Status: Inactive in the Regular Army as the 153rd Station Hospital.

Commanders, 153rd Station Hospital

1st Lt. Charles R. Marsh**	4 Feb 30-22 May 35	Maj. Joseph J. Walker **	ao Apr 41-15 May 41
Maj. Leon H. Smith **	22 May 35-28 Jul 38	<i>Inactive</i>	15 May 41-23 Aug 41
Unknown	28 Jul 38-ao Apr 41	Lt. Col. Roy F. Brown *	23 Aug 41-ao Dec 41

* Regular Army active duty commanders

** RAI Commanders: Organized Reserve officers.

154th Station Hospital (Z.I.)

Organized Reserve New Jersey

HQ-Not initiated 1928-30; Paterson, NJ, 1930-36; Hoboken, NJ, 1936-38; *Inactive* 1938-41; Camp Wheeler, GA, 1941

Constituted in the Organized Reserve 5 September 1928, assigned to the Zone of the Interior, and allotted to the Second Corps Area. Withdrawn from the Organized Reserve 21 December 1928 and allotted to the Regular Army. Organized 4 February 1930 with Organized Reserve personnel as a RAI unit with headquarters at Paterson, NJ. Relieved the Zone of the Interior 1 October 1933 and assigned to the General Headquarters Reserve. Relocated in 1936 to Hoboken, NJ. Inactivated by November 1938 at Hoboken by relief of personnel. Activated 1 June 1941, less Reserve personnel, at Camp Wheeler, GA, and assigned to the Third Army. Location 7 December 1941—Camp Wheeler, GA.

Status: Inactive in the Regular Army as the 154th Station Hospital.

Events: 330

Commanders, 154th Station Hospital

Maj. Morris H. Leaver**	6 Feb 30-ao Jun 34	<i>Inactive</i>	ao Jun 38-1 Jun 41
Unknown	ao Jun 34-ao Jun 38	1st Lt. F. G. Miller*	1 Jun 41-Aug 41
	Maj. John E. Wyttenbach**	Aug 41-ao Oct 41	

* Regular Army active duty commanders

** RAI Commanders: Organized Reserve officers.

155th Station Hospital (C.Z.)**Organized Reserve Pennsylvania****HQ-Not initiated** 1928-34; Philadelphia, PA, 1934-41

Constituted in the Organized Reserve 5 September 1928, assigned to the Communications Zone, and allotted to the Third Corps Area. Withdrawn from the Organized Reserve 21 December 1928 and allotted to the Regular Army. Relieved from the Zone of the Interior 1 October 1933 and assigned to the General Headquarters Reserve. Organized 18 August 1934 with Organized Reserve personnel as a RAI unit with headquarters at Philadelphia, PA. Functioned as a pool unit for excess medical corps lieutenants. Activated 1 June 1941, less Reserve personnel, at Camp Roberts, CA, and assigned to the Fourth Army. Location 7 December 1941—Camp Roberts, CA.

Commanders, 155th Station Hospital

Unknown	18 Aug 34-7 Mar 38	Capt. Thomas R. Evans**	7 Mar 38-ao Jun 40
	Unknown	ao Jun 40-7 Dec 41	

** RAI Commanders: Organized Reserve officers.

156th Station Hospital (C.Z.)**Organized Reserve Pennsylvania****HQ-Not initiated** 1928-35; Philadelphia, PA, 1935-41; Camp Wolters, TX, 1941

Constituted in the Organized Reserve 5 September 1928, assigned to the Communications Zone, and allotted to the Third Corps Area. Withdrawn from the Organized Reserve 21 December 1928 and allotted to the Regular Army. Relieved from the Zone of the Interior 1 October 1933 and assigned to the General Headquarters Reserve. Organized 28 January 1935 with Organized Reserve personnel as a RAI unit with headquarters at Philadelphia, PA. Functioned as a pool unit for excess medical corps lieutenants. Activated 1 June 1941, less Reserve personnel, at Camp Wolters, TX, and assigned to the Third Army. Location 7 December 1941—Camp Wolters, TX.

Status: Inactive in the Regular Army as the 156th Station Hospital.**Commanders, 156th Station Hospital**

1st Lt. Israel Z. Fischer**	28 Jan 32-7 Mar 38	Maj. Henry P. Ash**	7 Mar 38-ao Jun 38
	Unknown	ao Jun 38-7 Dec 41	

** RAI Commanders: Organized Reserve officers.

157th Station Hospital (C.Z.)**Organized Reserve Pennsylvania****HQ-Not initiated** 1928-41

Constituted in the Organized Reserve 5 September 1928, assigned to the Communications Zone, and allotted to the Third Corps Area. Scranton, PA, designated 11 December 1929 as headquarters on organization, but the unit was never organized at that location. Location 7 December 1941—*Not initiated*.

Status: Disbanded 30 January 1942.**158th Station Hospital (C.Z.)****Organized Reserve Maryland****HQ-Not initiated** 1928-41

Constituted in the Organized Reserve 5 September 1928, assigned to the Communications Zone, and allotted to the Third Corps Area. Cumberland, MD, designated 11 December 1929 as headquarters on organization, but the unit was never organized at that location. Location 7 December 1941—*Not initiated*.

Status: Disbanded 30 January 1942.

159th Station Hospital (C.Z.)**Organized Reserve Alabama/Ohio****HQ-Not initiated** 1928-29; Anniston, AL, 1929-36; *Inactive* 1936-41; Fort Monroe, VA, 1940-41

Constituted in the Organized Reserve 5 September 1928, assigned to the Communications Zone, and allotted to the Fourth Corps Area. Withdrawn from the Organized Reserve 21 December 1928 and allotted to the Regular Army. Organized 12 February 1929 with Organized Reserve personnel as a RAI unit with headquarters at Anniston, AL. Relieved from the Communications Zone 1 October 1933 and assigned to the General Headquarters Reserve. Withdrawn from the Fourth Corps Area 5 June 1936 and allotted to the Fifth Corps Area. Inactivated 1 September 1936 at Anniston by relief of personnel. Cincinnati, OH, designated 6 August 1937 as headquarters on reorganization, but the unit was never organized at that location. Designated mobilization station was Fort Oglethorpe, GA. Activated 1 June 1941 at Fort Monroe, VA, assigned to the First Army, and attached to the Harbor Defenses of Chesapeake Bay. Location 7 December 1941—Fort Monroe, VA.

Status: Disbanded 11 November 1944.**Commanders, 159th Station Hospital**

Maj. Crawford H. Cleveland**	12 Feb 29-14 Sep 29	Unknown	Apr 31-ao Aug 36
Lt. Col. Fred S. Gay**	14 Sep 29-Apr 31	Maj. James E. Carson**	ao Mar 36-1 Sep 36
	Unknown	1 Sep 36-7 Dec 41	

** RAI Commanders: Organized Reserve officers.

160th Station Hospital (C.Z.)**Organized Reserve Louisiana****HQ-Not initiated** 1928-29; Alexandria, LA, 1929-40; *Inactive* 1940-41; Fort Story, VA, 1941

Constituted in the Organized Reserve 5 September 1928, assigned to the Communications Zone, and allotted to the Fourth Corps Area. Withdrawn from the Organized Reserve 21 December 1928 and allotted to the Regular Army. Organized in March 1929 with Organized Reserve personnel as a RAI unit with headquarters at Alexandria, LA. Relieved the Zone of the Interior 1 October 1933 and assigned to the General Headquarters Reserve. Inactivated 24 September 1940 at Alexandria by relief of personnel. Activated 1 June 1941 at Fort Story, VA, assigned to the First Army, and attached to the Harbor Defenses of Chesapeake Bay. Location 7 December 1941—Fort Story, VA.

Status: Inactive in the Regular Army as the 160th Station Hospital.**Commanders, 160th Station Hospital**

Maj. Jack T. Cappel**	12 Feb 29-14 Sep 29	Unknown	1 Mar 30-20 Sep 40
Maj. Francis O. Darby**	14 Sep 29-1 Mar 30	<i>Inactive</i>	20 Sep 40-1 Jun 41
	Capt. George R. Gallagher*	1 Jun 41-ao Dec 41	

* Regular Army active duty commanders

** RAI Commanders: Organized Reserve officers.

161st Station Hospital (Z.I.)**Organized Reserve Georgia****HQ-Not initiated** 1928-41

Constituted in the Organized Reserve 5 September 1928, assigned to the Zone of the Interior, and allotted to the Fourth Corps Area. Gainesville, GA, designated 22 October 1929 as headquarters on organization, but the unit was never organized at that location. Location 7 December 1941—*Not initiated*.

Status: Disbanded 30 January 1942.**162nd Station Hospital (Z.I.)****Organized Reserve North Carolina****HQ-Not initiated** 1928-41

Constituted in the Organized Reserve 5 September 1928, assigned to the Zone of the Interior, and allotted to the Fourth Corps Area. Hendersonville, NC, designated 22 October 1929 as headquarters on organization, but the unit was never organized at that location. Location 7 December 1941—*Not initiated*.

Status: Disbanded 30 January 1942.

163rd Station Hospital (C.Z.)

Organized Reserve North Carolina

HQ-*Not initiated* 1928-41

Constituted in the Organized Reserve 5 September 1928, assigned to the Communications Zone, and allotted to the Fourth Corps Area. Raleigh, NC, designated 22 October 1929 as headquarters on organization, but the unit was never organized at that location. Location 7 December 1941—*Not initiated*.

Status: Disbanded 30 January 1942.

164th Station Hospital (C.Z.)

Organized Reserve South Carolina

HQ-*Not initiated* 1928-41

Constituted in the Organized Reserve 5 September 1928, assigned to the Communications Zone, and allotted to the Fourth Corps Area. Anderson, SC, designated 22 October 1929 as headquarters on organization, but the unit was never organized at that location. Withdrawn from the Organized Reserve 1 October 1933 and allotted to the Regular Army. Location 7 December 1941—*Not initiated*.

Status: Disbanded 30 January 1942.

165th Station Hospital (C.Z.)

Organized Reserve Indiana

HQ-*Not initiated* 1928-33; Indianapolis, IN, 1933-41; Fort Crockett, TX, 1941

Constituted in the Organized Reserve 5 September 1928, assigned to the Communications Zone, and allotted to the Fifth Corps Area. Withdrawn from the Organized Reserve 21 December 1928 and allotted to the Regular Army. Organized 24 January 1933 with Organized Reserve personnel as a RAI unit with headquarters at Indianapolis, IN. Relieved from the Communications Zone 1 October 1933 and assigned to the General Headquarters Reserve. Activated 1 June 1941, less Reserve personnel, at Fort Crockett, TX, assigned to the Third Army, and attached to the Harbor Defenses of Galveston. Location 7 December 1941—Fort Crockett, TX.

Status: Inactive in the Regular Army as the 165th Station Hospital.

Commanders, 165th Station Hospital

Maj. Horace E. Auringer**	24 Jan 33-ao Feb 33	Unknown	ao Feb 33-1 Jun 41
	Maj. Malcolm Jones**	1 Jun 41-ao Dec 41	

* Regular Army active duty commanders

** RAI Commanders: Organized Reserve officers.

166th Station Hospital (C.Z.)

Organized Reserve Ohio

HQ-*Not initiated* 1928-33; Lima, OH, 1933-41; Camp Callan, CA, 1941

Constituted in the Organized Reserve 5 September 1928, assigned to the Communications Zone, and allotted to the Fifth Corps Area. Withdrawn from the Organized Reserve 21 December 1928 and allotted to the Regular Army. Organized about January 1933 with Organized Reserve personnel as a RAI unit with headquarters at Lima, OH. Relieved the Zone of the Interior 1 October 1933 and assigned to the General Headquarters Reserve. Activated 1 June 1941, less Reserve personnel, at Camp Callan, CA, and assigned to the First Army. Location 7 December 1941—Camp Callan, CA.

Status: Disbanded 15 November 1944.

Commanders, 166th Station Hospital

Unknown Jan 33-7 Dec 41

167th Station Hospital (C.Z.)

Organized Reserve Illinois

HQ-Not initiated 1928-29; Chicago, IL, 1929-40; Rockford, IL, 1940-41; Fort Dix, NJ, 1941; Reykjavik, Iceland 1941

Constituted in the Organized Reserve 5 September 1928, assigned to the Communications Zone, and allotted to the Sixth Corps Area. Withdrawn from the Organized Reserve 21 December 1928 and allotted to the Regular Army. Organized 8 May 1929 with Organized Reserve personnel as a RAI unit with headquarters at Chicago, IL. Attached 3 November 1930 to the 86th Division for organization, administration, and training. Relieved from the Communications Zone 1 October 1933 and assigned to the General Headquarters Reserve. Relocated 2 January 1940 to Rockford, IL. Conducted summer training at the station hospitals at Fort Snelling, MN, OR, Camp Custer, MI. Activated 12 July 1941 at Fort Dix, NJ. Embarked at NYPE 5 September 1941 and sailed for Iceland where it was assigned to the Iceland Base Command. Location 7 December 1941—Reykjavik, Iceland.

Status: Disbanded 6 December 1943.

Commanders, 167th Station Hospital

Unknown	8 May 29-8 Aug 29	Unknown	ao Jun 34-18 Feb 37
Maj. James C. Tyvand**	8 Aug 29-ao Jun 34	Col. Joseph B. Schreiter**	18 Feb 37-ao Jan 40
	Unknown	ao Jan 39-7 Dec 41	

** RAI Commanders: Organized Reserve officers.

168th Station Hospital (C.Z.)

Organized Reserve Illinois

HQ-Not initiated 1928-29; Chicago, IL, 1929-33; Fort Sheridan, IL, 1933-37; Decatur, IL, 1937-41; Reykjavik, Iceland 1941

Constituted in the Organized Reserve 5 September 1928, assigned to the Communications Zone, and allotted to the Sixth Corps Area. Withdrawn from the Organized Reserve 21 December 1928 and allotted to the Regular Army. Organized 8 May 1929 with Organized Reserve personnel as a RAI unit with headquarters at Chicago, IL. Attached 3 November 1930 to the 86th Division for organization, administration, and training. Relieved the Zone of the Interior 1 October 1933 and assigned to the General Headquarters Reserve. Relocated 7 October 1933 to Fort Sheridan, IL. Relocated 7 April 1937 to Decatur, IL. Conducted summer training at the station hospitals at Fort Snelling, MN, OR, Camp Custer, MI. Activated 12 July 1941, less Reserve personnel, at Fort Dix, NJ. Embarked at NYPE 5 September 1941 and sailed for Iceland, where it was assigned to the Iceland base Command. Location 7 December 1941—Reykjavik, Iceland.

Status: Inactive in the Regular Army as the 168th Station Hospital.

Commanders, 168th Station Hospital

Maj. George A. McBride**	8 May 29-23 Aug 29	Lt. Col. John M. Hayes**	18 Feb 37-ao Jan 40
Maj. Frank T. Thometz**	23 Aug 29-18 Feb 37	Unknown	ao Jan 40-7 Dec 41

** RAI Commanders: Organized Reserve officers.

169th Station Hospital (C.Z.)

Organized Reserve Michigan

HQ-Not initiated 1928-34; Escanaba, MI, 1934-41

Constituted in the Organized Reserve 5 September 1928, assigned to the Communications Zone, and allotted to the Sixth Corps Area. Sault St. Marie, designated 6 December 1930 as headquarters on organization, but the unit was never organized at that location. Initiated about May 1934 at Escanaba, MI. Location 7 December 1941—Escanaba, MI.

Status: Disbanded 1 June 1944.

Commanders, 169th Station Hospital

Unknown ao May 34-7 Dec 41

170th Station Hospital (C.Z.)

Organized Reserve Michigan

HQ-Not initiated 1928-29; Sault St. Marie, MI, 1929-30; Sheboygan, MI, 1930-41

Constituted in the Organized Reserve 5 September 1928, assigned to the Communications Zone, and allotted to the Sixth Corps Area. Initiated by December 1929 at Sault St. Marie, MI. Inactivated 1 December 1930 at Sault St. Marie by relief of personnel. Reorganized 6 December 1930 at Sheboygan, MI. Location 7 December 1941—Sheboygan, MI.

Status: Inactive in the U.S. Army Reserve as the 346th General Hospital.

Commanders, 170th Station Hospital

Unknown ao Dec 29-1 Dec 30 Maj. William E. Alleger 6 Dec 30-ao Jun 35
Inactive 1 Dec 30-6 Dec 30 Unknown ao Jun 35-7 Dec 41

171st Station Hospital (C.Z.)

Organized Reserve Nebraska

HQ-Not initiated 1928-36; Omaha, NE, 1936-41

Constituted in the Organized Reserve 5 September 1928, assigned to the Communications Zone, and allotted to the Seventh Corps Area. Withdrawn from the Organized Reserve 21 December 1928 and allotted to the Regular Army. Relieved from the Communications Zone 1 October 1933 and assigned to the General Headquarters Reserve. Organized by May 1936 with Organized Reserve personnel as a RAI unit with headquarters at Omaha, NE. Location 7 December 1941—Omaha, NE.

Commanders, 171st Station Hospital

Unknown ao May 36-ao May 39 Maj. Lothar F. Egan** ao May 39-27 Jul 39
Unknown 27 Jul 39-7 Dec 41

** RAI Commanders: Organized Reserve officers.

172nd Station Hospital (C.Z.)

Organized Reserve Nebraska

HQ-Not initiated 1928-36; Omaha, NE, 1936-41

Constituted in the Organized Reserve 5 September 1928, assigned to the Communications Zone, and allotted to the Seventh Corps Area. Withdrawn from the Organized Reserve 21 December 1928 and allotted to the Regular Army. Relieved from the Communications Zone 1 October 1933 and assigned to the General Headquarters Reserve. Organized by November 1936 with Organized Reserve personnel as a RAI unit with headquarters at Omaha, NE. Location 7 December 1941—Omaha, NE.

Status: Inactive in the Regular Army as the 172nd Station Hospital.

Commanders, 172nd Station Hospital

Maj. Ralph J. Selman** ao Nov 36-22 Aug 37 Maj. John K. Muldoon** 19 May 38-ao Jun 38
Unknown 22 Aug 37-19 May 38 Unknown ao Jun 38-7 Dec 41

** RAI Commanders: Organized Reserve officers.

173rd Station Hospital (C.Z.)

Organized Reserve South Dakota

HQ-Not initiated 1928-41

Constituted in the Organized Reserve 5 September 1928, assigned to the Communications Zone, and allotted to the Seventh Corps Area. Huron, SD, designated 12 December 1931 as headquarters on organization, but the unit was never organized at that location. Location 7 December 1941—*Not initiated*.

Status: Disbanded 30 January 1942.

174th Station Hospital (C.Z.)

Organized Reserve Oklahoma/Illinois

HQ-*Not initiated* 1928-29; Fort Sill, OK, 1929-36; *Inactive* 1936-41

Constituted in the Organized Reserve 5 September 1928, assigned to the Communications Zone, and allotted to the Eighth Corps Area. Withdrawn from the Organized Reserve 21 December 1928 and allotted to the Regular Army. Organized 12 April 1929 with Organized Reserve personnel as a RAI unit with headquarters at Fort Sill, OK. Relieved from the Communications Zone 1 October 1933 and assigned to the General Headquarters Reserve. Withdrawn from the Eighth Corps Area 5 June 1936 and allotted to the Sixth Corps Area. Inactivated 13 November 1936 at Fort Sill by relief of personnel. Chicago, IL, designated 28 July 1937 as headquarters on reorganization, but the unit was never organized at that location. Conducted summer training at the station hospitals at Fort Sill, OK, OR, Fort Sam Houston, TX, 1929-35. Location 7 December 1941—*Inactive*.

Status: Inactive in the Regular Army as the 174th Station Hospital.

Commanders, 174th Station Hospital

Maj. Arthur L. Mobley**	12 Apr 29-ao Feb 32	Maj. Albert N. Ernest**	ao Oct 36-13 Nov 36
Unknown	ao Feb 32-ao Oct 36	<i>Inactive</i>	13 Nov 36-7 Dec 41

** RAI Commanders: Organized Reserve officers.

175th Station Hospital (C.Z.)

Organized Reserve Texas

HQ-*Not initiated* 1928-29; Fort Sam Houston, TX, 1929-36; *Inactive* 1936-41

Constituted in the Organized Reserve 5 September 1928, assigned to the Communications Zone, and allotted to the Eighth Corps Area. Withdrawn from the Organized Reserve 21 December 1928 and allotted to the Regular Army. Organized 12 April 1929 with Organized Reserve personnel as a RAI unit with headquarters at Fort Sam Houston, TX. Relieved the Zone of the Interior 1 October 1933 and assigned to the General Headquarters Reserve. Withdrawn from the Eighth Corps Area 5 June 1936 and allotted to the Sixth Corps Area. Inactivated 12 November 1936 at Fort Sam Houston by relief of personnel. Chicago, IL, designated 28 July 1937 as headquarters on reorganization, but the unit was never organized at that location. Conducted summer training at the station hospital at Fort Sam Houston, TX, 1929-35. Designated mobilization training station was Fort Sam Houston, TX, 1928-36. Location 7 December 1941—*Inactive*.

Status: Inactive in the Regular Army as the 175th Station Hospital.

Commanders, 175th Station Hospital

Maj. Gilbert A. Rhodes**	12 Apr 29-23 Jan 30	Maj. David W. Griffin**	23 Jan 30-12 Nov 36
	<i>Inactive</i>	12 Nov 36-7 Dec 41	

** RAI Commanders: Organized Reserve officers.

176th Station Hospital (C.Z.)

Organized Reserve Texas/Illinois

HQ-*Not initiated* 1928-29; Wichita Falls, TX, 1929-36; *Inactive* 1936-41

Constituted in the Organized Reserve 5 September 1928, assigned to the Communications Zone, and allotted to the Eighth Corps Area. Initiated 3 May 1929 at Wichita Falls, TX. Withdrawn from the Eighth Corps Area 5 June 1936 and allotted to the Sixth Corps Area. Inactivated 12 November 1936 at Wichita Falls by relief of personnel. Chicago, IL, designated 28 July 1937 as headquarters on reorganization, but the unit was never organized at that location. Designated mobilization training station was Camp Stanley, TX. Location 7 December 1941—*Inactive*.

Status: Disbanded 30 January 1942.

Commanders, 176th Station Hospital

1st Lt. Alton P. Shirey	3 May 29-ao May 29	Lt. Col. George W. Contero	ao Dec 32-24 Jan 33
Unknown	ao May 29-ao Dec 32	Lt. Col. Clarence E. Lee	24 Jan 33-12 Nov 36
	<i>Inactive</i>	12 Nov 36-7 Dec 41	

177th Station Hospital (C.Z.)

Organized Reserve Texas/Illinois

HQ-*Not initiated* 1928-29; Beaumont, TX, 1929-36; *Inactive* 1936-41

Constituted in the Organized Reserve 5 September 1928, assigned to the Communications Zone, and allotted to the Eighth Corps Area. Initiated 3 May 1929 at Beaumont, TX. Withdrawn from the Eighth Corps Area 5 June 1936 and allotted to the Sixth Corps Area. Inactivated 12 November 1936 at Beaumont by relief of personnel. Chicago, IL, designated 28 July 1937 as headquarters on reorganization, but the unit was never organized at that location. Conducted summer training at the station hospital at Fort Sam Houston, TX. Designated mobilization training station was Camp Stanley, TX. Location 7 December 1941—*Inactive*.

Status: Disbanded 30 January 1942.

Commanders, 177th Station Hospital

1st Lt. Freeman W. Rowell	3 May 29-ao May 29	Lt. Col. William B. Harned	ao Sep 36-12 Nov 36
Unknown	ao May 29-ao Sep 36	<i>Inactive</i>	12 Nov 36-7 Dec 41

178th Station Hospital (C.Z.)

Organized Reserve Texas/Illinois

HQ-*Not initiated* 1928-29; Amarillo, TX, 1929-36; *Inactive* 1936-41

Constituted in the Organized Reserve 5 September 1928, assigned to the Communications Zone, and allotted to the Eighth Corps Area. Initiated 3 May 1929 at Amarillo, TX. Withdrawn from the Eighth Corps Area 5 June 1936 and allotted to the Sixth Corps Area. Inactivated 12 November 1936 at Amarillo by relief of personnel. Chicago, IL, designated 28 July 1937 as headquarters on reorganization, but the unit was never organized at that location. Designated mobilization training station was Camp Stanley, TX. Location 7 December 1941—*Inactive*.

Status: Disbanded 30 January 1942.

Commanders, 178th Station Hospital

1st Lt. William M. Reppeto	3 May 29-8 Oct 29	Unknown	ao Feb 32-12 Nov 36
Maj. Raymond H. Fox	8 Oct 29-ao Feb 32	<i>Inactive</i>	12 Nov 36-7 Dec 41

179th Station Hospital (C.Z.)

Organized Reserve Texas/California

HQ-*Not initiated* 1928-29; San Francisco, CA, 1929-41; *Inactive* 1941

Constituted in the Organized Reserve 5 September 1928, assigned to the Communications Zone, and allotted to the Eighth Corps Area. Withdrawn from the Eighth Corps Area 21 December 1928 and allotted to the Ninth Corps Area. Concurrently, withdrawn from the Organized Reserve and allotted to the Regular Army. Organized 3 May 1929 with Organized Reserve personnel as a RAI unit with headquarters at San Francisco, CA. Conducted summer training at the station hospitals at Fort Lewis, WA, Del Monte, CA, the Presidio of Monterey, CA, OR, Letterman General Hospital at San Francisco, CA. Inactivated 20 January 1941 at San Francisco by relief of personnel. Location 7 December 1941—*Inactive*.

Commanders, 179th Station Hospital

Maj. Louis H. Fales**	3 May 29-Dec 30	Capt. Robert B. Irving**	1 Aug 36-ao Sep 36
Maj. Melvin A. Shade**	Dec 30-ao Jun 31	Unknown	ao Sep 36-20 Jan 41
Unknown	ao Jun 31-1 Aug 36	<i>Inactive</i>	20 Jan 41-7 Dec 41

** RAI Commanders: Organized Reserve officers.

180th Station Hospital (C.Z.)**Organized Reserve Washington/Missouri****HQ-***Not initiated* 1928-29; Tacoma, WA, 1929-36; *Inactive* 1936-41

Constituted in the Organized Reserve 5 September 1928, assigned to the Communications Zone, and allotted to the Ninth Corps Area. Withdrawn from the Organized Reserve 21 December 1928 and allotted to the Regular Army. Organized 13 March 1929 with Organized Reserve personnel as a RAI unit with headquarters at Tacoma, WA. Relieved the Communications Zone 1 October 1933 and assigned to the General Headquarters Reserve. Withdrawn from the Ninth Corps Area 5 June 1936 and allotted to the Seventh Corps Area. Conducted summer training at the station hospital at Fort Lewis, WA. Location 7 December 1941—*Inactive*.

Status: Inactive in the Regular Army as the 180th Station Hospital.**Commanders, 180th Station Hospital**

Maj. Frank T. Witt**	13 Mar 29-ao Jun 34	Unknown	ao Jun 34-5 Jun 36
	<i>Inactive</i>	5 Jun 36-7 Dec 41	

** RAI Commanders: Organized Reserve officers.

678th Station Hospital (C.Z.)**Regular Army Inactive****HQ-***Not organized* 1927-28; Fifth Corps Area 1928

Constituted in the Regular Army 18 October 1927, assigned to the Communications Zone, and allotted to the Fifth Corps Area. Organized 6 March 1928 with Organized Reserve personnel as a RAI unit with headquarters in the Fifth Corps Area. Withdrawn from the Fifth Corps Area 21 December 1928 and demobilized.

Commanders, 678th Station Hospital

Maj. Howard C. Lisle** 6 Mar 28-21 Dec 28

** RAI Commanders: Organized Reserve officers.

1101st Station Hospital (First C.A.S.C.)**Organized Reserve Massachusetts****HQ-***Not initiated* 1929-32; Fort Devens, MA, 1932-36; *Inactive* 1936-41

Constituted in the Organized Reserve in June 1929, assigned to the First Corps Area Service Command, and allotted to the First Corps Area. Initiated 9 January 1930 at Camp Devens, MA. Inactivated 1 April 1936 at Fort Devens by relief of personnel. Location 7 December 1941—*Inactive*.

Commanders, 1101st Station Hospital

Maj. Arthur B. Courtemache	9 Jan 30-1 Apr 36	<i>Inactive</i>	1 Apr 36-7 Dec 41
----------------------------	-------------------	-----------------	-------------------

1102nd Station Hospital (First C.A.S.C.)**Organized Reserve New Hampshire****HQ-***Not initiated* 1929-31; Portsmouth, NH, 1931-36; *Inactive* 1936-41

Constituted in the Organized Reserve in June 1929, assigned to the First Corps Area Service Command, and allotted to the First Corps Area. Initiated by June 1931 at Portsmouth, NH. Inactivated 1 April 1936 at Portsmouth by relief of personnel. Location 7 December 1941—Portsmouth, NH.

Commanders, 1102nd Station Hospital

Unknown	ao Jun 31-1 Apr 36	<i>Inactive</i>	1 Apr 36-7 Dec 41
---------	--------------------	-----------------	-------------------

1103rd Station Hospital (First C.A.S.C.)**Organized Reserve Connecticut****HQ-**Willimantic, CT, 1929-41

Constituted in the Organized Reserve in June 1929, assigned to the First Corps Area Service Command, and allotted to the First Corps Area. Initiated 1 November 1929 at Willimantic, CT. Location 7 December 1941—Willimantic, CT.

Commanders, 1103rd Station Hospital

Unknown	1 Nov 29-ao Jun 38	Unknown	ao Jul 38-ao Jul 39
Lt. Col. Charles G. Miles	ao Jun 38-ao Jul 38	Col. Hollis G. Batchelder	ao Jul 39-ao Jan 40
	Unknown	ao Jan 40-7 Dec 41	

1104th Station Hospital (First C.A.S.C.)

Organized Reserve Massachusetts

HQ-Not initiated 1929-30; Amherst, MA, 1930-41

Constituted in the Organized Reserve in June 1929, assigned to the First Corps Area Service Command, and allotted to the First Corps Area. Initiated 1 November 1929 at Amherst, MA. Location 7 December 1941—Amherst, MA.

Commanders, 1104th Station Hospital

Lt. Col. Herbert B. Priest	1 Nov 29-ao Jun 35	Unknown	ao Jun 35-7 Dec 41
----------------------------	--------------------	---------	--------------------

1105th Station Hospital (First C.A.S.C.)

Organized Reserve Rhode Island

HQ-Not initiated 1929-31; Arctic Center, RI, 1931-41

Constituted in the Organized Reserve in June 1929, assigned to the First Corps Area Service Command, and allotted to the First Corps Area. Initiated by June 1931 at Arctic Center, RI. Location 7 December 1941—Arctic Center, RI.

Commanders, 1105th Station Hospital

Maj. John M. O'Connell	ao Jun 31-ao Nov 34	Unknown	ao Nov 34-7 Dec 41
------------------------	---------------------	---------	--------------------

1106th Station Hospital (First C.A.S.C.)

Organized Reserve Massachusetts

HQ-Not initiated 1929-30; Andover, MA, 1930-41

Constituted in the Organized Reserve in June 1929, assigned to the First Corps Area Service Command, and allotted to the First Corps Area. Initiated by June 1930 at Andover, MA. Location 7 December 1941—Andover, MA.

Commanders, 1106th Station Hospital

Lt. Col. Frank L. Morse	ao Jun 30-Oct 33	Maj. Frank E. Lewis	Oct 33-ao Jan 35
	Unknown	ao Jan 35-7 Dec 41	

1107th Station Hospital (First C.A.S.C.)

Organized Reserve Maine

HQ-Not initiated 1929-30; Portland, ME, 1930-41

Constituted in the Organized Reserve in June 1929, assigned to the First Corps Area Service Command, and allotted to the First Corps Area. Initiated by July 1930 Portland, ME. Location 7 December 1941—Portland, ME.

Commanders, 1107th Station Hospital

Unknown	ao Jun 30-7 Dec 41
---------	--------------------

1108th Station Hospital (First C.A.S.C.)

Organized Reserve Vermont

HQ-Not initiated 1929-30; First Corps Area 1930-41

Constituted in the Organized Reserve in June 1929, assigned to the First Corps Area Service Command, and allotted to the First Corps Area. Initiated 1 November 1929 in Vermont. Location 7 December 1941—Vermont.

Commanders, 1108th Station Hospital

Maj. Harry W. Sampson

1 Nov 29-ao Jun 34

Unknown

ao Jun 34-7 Dec 41

1109th Station Hospital (First C.A.S.C.)

Organized Reserve Rhode Island

HQ-*Not initiated* 1929-36; Providence, RI, 1936-41

Constituted in the Organized Reserve in June 1929, assigned to the First Corps Area Service Command, and allotted to the First Corps Area. Initiated by June 1936 at Providence, RI. Location 7 December 1941—Providence, RI.

Commanders, 1109th Station Hospital

Unknown

ao Jun 36-5 Nov 36

Col. John F. Hackett

5 Nov 36-7 Dec 41

1110th Station Hospital (First C.A.S.C.)

Organized Reserve Connecticut

HQ-*Not initiated* 1929-38; Connecticut 1938-41

Constituted in the Organized Reserve in 1936, assigned to the First Corps Area Service Command, and allotted to the First Corps Area. Initiated by June 1936 in Connecticut. Location 7 December 1941—Connecticut.

Commanders, 1110th Station Hospital

Unknown

ao Jun 36-7 Dec 41

1111th Station Hospital (First C.A.S.C.)

Organized Reserve Connecticut

HQ-*Not initiated* 1929-38; Connecticut 1938-41

Constituted in the Organized Reserve in 1936, assigned to the First Corps Area Service Command, and allotted to the First Corps Area. Initiated by June 1936 in Connecticut. Location 7 December 1941—Connecticut.

Commanders, 1111th Station Hospital

Unknown

ao Jun 36-7 Dec 41

1501st Station Hospital (Fifth C.A.S.C.)

Organized Reserve Ohio

HQ-*Not initiated* 1929-41

Constituted in the Organized Reserve in June 1929, assigned to the Fifth Corps Area Service Command, and allotted to the Fifth Corps Area. Location 7 December 1941—*Not initiated*.

1502nd Station Hospital (Fifth C.A.S.C.)

Organized Reserve Ohio

HQ-*Not initiated* 1929-41

Constituted in the Organized Reserve in June 1929, assigned to the Fifth Corps Area Service Command, and allotted to the Fifth Corps Area. Location 7 December 1941—*Not initiated*.

1503rd Station Hospital (Fifth C.A.S.C.)

Organized Reserve Ohio

HQ-*Not initiated* 1929-41

Constituted in the Organized Reserve in June 1929, assigned to the Fifth Corps Area Service Command, and allotted to the Fifth Corps Area. Location 7 December 1941—*Not initiated*.

1504th Station Hospital (Fifth C.A.S.C.)

Organized Reserve Ohio

HQ-*Not initiated* 1929-41

Constituted in the Organized Reserve in June 1929, assigned to the Fifth Corps Area Service Command, and allotted to the Fifth Corps Area. Location 7 December 1941—*Not initiated*.

1505th Station Hospital (Fifth C.A.S.C.)

Organized Reserve Ohio

HQ-*Not initiated* 1929-41

Constituted in the Organized Reserve in June 1929, assigned to the Fifth Corps Area Service Command, and allotted to the Fifth Corps Area. Location 7 December 1941—*Not initiated*.

1506th Station Hospital (Fifth C.A.S.C.)

Organized Reserve Ohio

HQ-*Not initiated* 1929-34; Fifth Corps Area 1934-41

Constituted in the Organized Reserve in June 1929, assigned to the Fifth Corps Area Service Command, and allotted to the Fifth Corps Area. Initiated by June 1934 in the Fifth Corps Area. Location 7 December 1941—Fifth Corps Area. Location 7 December 1941—Fifth Corps Area.

Commanders, 1506th Station Hospital

Unknown ao Jun 34-7 Dec 41

1507th Station Hospital (Fifth C.A.S.C.)

Organized Reserve Ohio

HQ-*Not initiated* 1929-34; Fifth Corps Area 1934-41

Constituted in the Organized Reserve in June 1929, assigned to the Fifth Corps Area Service Command, and allotted to the Fifth Corps Area. Initiated by June 1934 in the Fifth Corps Area. Location 7 December 1941—Fifth Corps Area. Location 7 December 1941—Fifth Corps Area.

Commanders, 1507th Station Hospital

Unknown ao Jun 34-7 Dec 41

1508th Station Hospital (Fifth C.A.S.C.)

Organized Reserve Ohio

HQ-*Not initiated* 1929-34; Fifth Corps Area 1934-41

Constituted in the Organized Reserve in June 1929, assigned to the Fifth Corps Area Service Command, and allotted to the Fifth Corps Area. Initiated by June 1934 in the Fifth Corps Area. Location 7 December 1941—Fifth Corps Area. Location 7 December 1941—Fifth Corps Area.

Commanders, 1508th Station Hospital

Unknown ao Jun 34-7 Dec 41

1509th Station Hospital (Fifth C.A.S.C.)

Organized Reserve Ohio

HQ-Not initiated 1929-34; Fifth Corps Area 1934-41

Constituted in the Organized Reserve in June 1929, assigned to the Fifth Corps Area Service Command, and allotted to the Fifth Corps Area. Initiated by June 1934 in the Fifth Corps Area. Location 7 December 1941—Fifth Corps Area. Location 7 December 1941—Fifth Corps Area.

Commanders, 1509th Station Hospital

Unknown ao Jun 34-7 Dec 41

1510th Station Hospital (Fifth C.A.S.C.)

Organized Reserve Ohio

HQ-Not initiated 1929-34; Fifth Corps Area 1934-41

Constituted in the Organized Reserve in June 1929, assigned to the Fifth Corps Area Service Command, and allotted to the Fifth Corps Area. Initiated by June 1934 in the Fifth Corps Area. Location 7 December 1941—Fifth Corps Area. Location 7 December 1941—Fifth Corps Area.

Commanders, 1510th Station Hospital

Unknown ao Jun 34-7 Dec 41

1511th Station Hospital (Fifth C.A.S.C.)

Organized Reserve Ohio

HQ-Not initiated 1929-34; Columbus, OH, 1934-41

Constituted in the Organized Reserve in June 1929, assigned to the Fifth Corps Area Service Command, and allotted to the Fifth Corps Area. Initiated by June 1934 at Columbus, OH. Location 7 December 1941—Columbus, OH.

Commanders, 1511th Station Hospital

Unknown ao Jun 34-7 Dec 41

1512th Station Hospital (Fifth C.A.S.C.)

Organized Reserve Ohio

HQ-Not initiated 1929-34; Cleveland, OH, 1934-41

Constituted in the Organized Reserve in June 1929, assigned to the Fifth Corps Area Service Command, and allotted to the Fifth Corps Area. Initiated by June 1934 at Cleveland, OH. Location 7 December 1941—Cleveland, OH.

Commanders, 1512th Station Hospital

Unknown ao Jun 34-ao May 38 Col. Gerald P. Lawrence ao May 38-ao Jun 38
Unknown ao Jun 38-7 Dec 41

1513th Station Hospital (Fifth C.A.S.C.)

Organized Reserve Ohio

HQ-Not initiated 1929-34; Akron, OH, 1934-41

Constituted in the Organized Reserve in June 1929, assigned to the Fifth Corps Area Service Command, and allotted to the Fifth Corps Area. Initiated by June 1934 at Akron, OH. Location 7 December 1941—Akron, OH.

Commanders, 1513th Station Hospital

Unknown ao Jun 34-7 Dec 41

1514th Station Hospital (Fifth C.A.S.C.)

Organized Reserve Ohio

HQ-Not initiated 1929-35; Cincinnati, OH, 1935-41

Constituted in the Organized Reserve in June 1929, assigned to the Fifth Corps Area Service Command, and allotted to the Fifth Corps Area. Initiated by July 1935 at Cincinnati, OH. Location 7 December 1941—Cincinnati, OH.

Commanders, 1514th Station Hospital

Unknown ao Jul 35-7 Dec 41

1515th Station Hospital (Fifth C.A.S.C.)

Organized Reserve Ohio

HQ-Not initiated 1929-34; Dayton, OH, 1934-41

Constituted in the Organized Reserve in June 1929, assigned to the Fifth Corps Area Service Command, and allotted to the Fifth Corps Area. Initiated by June 1934 at Dayton, OH. Location 7 December 1941—Dayton, OH.

Commanders, 1515th Station Hospital

Unknown ao Jun 34-7 Dec 41

1516th Station Hospital (Fifth C.A.S.C.)

Organized Reserve Ohio

HQ-Not initiated 1929-34; Toledo, OH, 1934-41

Constituted in the Organized Reserve in June 1929, assigned to the Fifth Corps Area Service Command, and allotted to the Fifth Corps Area. Initiated by June 1934 at Toledo, OH. Location 7 December 1941—Toledo, OH.

Commanders, 1516th Station Hospital

Unknown ao Jun 34-22 Sep 35 Maj. Oliver H. Griffith 22 Sep 35-ao Jun 36
Unknown ao Jun 36-7 Dec 41

1517th Station Hospital (Fifth C.A.S.C.)

Organized Reserve Ohio

HQ-Not initiated 1929-34; Fifth Corps Area 1934-41

Constituted in the Organized Reserve in June 1929, assigned to the Fifth Corps Area Service Command, and allotted to the Fifth Corps Area. Initiated by June 1934 in the Fifth Corps Area. Location 7 December 1941—Fifth Corps Area.

Commanders, 1517th Station Hospital

Unknown ao Jun 34-7 Dec 41

1518th Station Hospital (Fifth C.A.S.C.)

Organized Reserve Ohio

HQ-Not initiated 1929-34; Fifth Corps Area 1934-41

Constituted in the Organized Reserve in June 1929, assigned to the Fifth Corps Area Service Command, and allotted to the Fifth Corps Area. Initiated by June 1934 in the Fifth Corps Area. Location 7 December 1941—Fifth Corps Area.

Commanders, 1518th Station Hospital

Unknown ao Jun 34-ao Jul 35 Maj. Dorsey McN. Ryan ao Jul 35-ao Jul 37
Unknown ao Jul 37-7 Dec 41

1519th Station Hospital (Fifth C.A.S.C.)

Organized Reserve Ohio

HQ-Not initiated 1929-34; Fifth Corps Area 1934-41

Constituted in the Organized Reserve in June 1929, assigned to the Fifth Corps Area Service Command, and allotted to the Fifth Corps Area. Initiated by June 1934 in the Fifth Corps Area. Location 7 December 1941—Fifth Corps Area.

Commanders, 1519th Station Hospital

Unknown ao Jun 34-7 Dec 41

1702nd Station Hospital (Seventh C.A.S.C.)

Organized Reserve Nebraska

HQ-Not initiated 1929-39; Fort Omaha, NE, 1939-41

Constituted in the Organized Reserve in June 1929, assigned to the Seventh Corps Area Service Command, and allotted to the Seventh Corps Area. Initiated by September 1939 at Fort Omaha, NE. Mobilization mission was to establish the station hospital at Fort Omaha. Location 7 December 1941—Fort Omaha, NE.

Commanders, 1702nd Station Hospital

Maj. Lynn T. Hall 11 Sep 39-8 Nov 39 Unknown 8 Nov-7 Dec 41

1714th Station Hospital (Seventh C.A.S.C.)

Organized Reserve Minnesota

HQ-Not initiated 1929-41

Constituted in the Organized Reserve in June 1929, assigned to the Seventh Corps Area Service Command, and allotted to the Seventh Corps Area. Fort Snelling, MN, designated as headquarters on organization, but the unit was never organized at that location. Mobilization mission was to augment the station hospital at Fort Snelling. Location 7 December 1941—*Not initiated*.

1722nd Station Hospital (Seventh C.A.S.C.)

Organized Reserve Iowa

HQ-Not initiated 1929-41

Constituted in the Organized Reserve in June 1929, assigned to the Seventh Corps Area Service Command, and allotted to the Seventh Corps Area. Fort Des Moines, IA, designated as headquarters on organization, but the unit was never organized at that location. Mobilization mission was to augment the station hospital at Fort Des Moines. Location 7 December 1941—*Not initiated*.

1733rd Station Hospital (Seventh C.A.S.C.)

Organized Reserve North Dakota

HQ-Not initiated 1929-41

Constituted in the Organized Reserve in June 1929, assigned to the Seventh Corps Area Service Command, and allotted to the Seventh Corps Area. Fort Lincoln, ND, designated as headquarters on organization, but the unit was never organized at that location. Mobilization mission was to augment the station hospital at Fort Lincoln. Location 7 December 1941—*Not initiated*.

1744th Station Hospital (Seventh C.A.S.C.)**Organized Reserve Kansas****HQ-Not initiated** 1929-39; Fort Leavenworth, KS, 1939-41

Constituted in the Organized Reserve in June 1929, assigned to the Seventh Corps Area Service Command, and allotted to the Seventh Corps Area. Initiated by August 1939 at Fort Leavenworth, KS. Mobilization mission was to augment the station hospital at Fort Leavenworth. Location 7 December 1941—Fort Leavenworth, KS.

Commanders, 1744th Station Hospital

Maj. Alonzo R. Adams	2 Aug 39-ao Nov 39	Unknown	ao Nov 39-7 Dec 41
----------------------	--------------------	---------	--------------------

1749th Station Hospital (Seventh C.A.S.C.)**Organized Reserve South Dakota****HQ-Not initiated** 1929-39; Fort Meade, SD, 1939-41

Constituted in the Organized Reserve in June 1929, assigned to the Seventh Corps Area Service Command, and allotted to the Seventh Corps Area. Initiated 11 September 1939 at Fort Meade, SD. Mobilization mission was to augment the station hospital at Fort Meade. Location 7 December 1941—Fort Meade, SD.

Commanders, 1744th Station Hospital

Maj. Frank A. Neisius	11 Sep 39-ao Nov 39	Unknown	ao Nov 39-7 Dec 41
-----------------------	---------------------	---------	--------------------

1751st Station Hospital (Seventh C.A.S.C.)**Organized Reserve Nebraska****HQ-Not initiated** 1929-41

Constituted in the Organized Reserve in June 1929, assigned to the Seventh Corps Area Service Command, and allotted to the Seventh Corps Area. Initiated 11 September 1939 at Fort Crook, NE. Mobilization mission was to augment the station hospital at Fort Crook. Location 7 December 1941—*Not initiated*.

Commanders, 1751st Station Hospital

Capt. Hiram H. Avey	11 Sep 39-ao Nov 39	Unknown	ao Nov 39-7 Dec 41
---------------------	---------------------	---------	--------------------

1764th Station Hospital (Seventh C.A.S.C.)**Organized Reserve Missouri****HQ-Not initiated** 1929-41

Constituted in the Organized Reserve in June 1929, assigned to the Seventh Corps Area Service Command, and allotted to the Seventh Corps Area. Jefferson Barracks, MO, designated as headquarters on organization, but the unit was never organized at that location. Mobilization mission was to augment the station hospital at Jefferson Barracks. Location 7 December 1941—*Not initiated*.

1781st Station Hospital (Seventh C.A.S.C.)**Organized Reserve Arkansas****HQ-Not initiated** 1929-41

Constituted in the Organized Reserve in June 1929, assigned to the Seventh Corps Area Service Command, and allotted to the Seventh Corps Area. Camp Robinson, AR, designated as headquarters on organization, but the unit was never organized at that location. Mobilization mission was to augment the station hospital at Camp Robinson. Location 7 December 1941—*Not initiated*.

1786th Station Hospital (Seventh C.A.S.C.)**Organized Reserve Missouri****HQ**-*Not initiated* 1929-41

Constituted in the Organized Reserve in June 1929, assigned to the Seventh Corps Area Service Command, and allotted to the Seventh Corps Area. Camp Clark, MO, designated as headquarters on organization, but the unit was never organized at that location. Mobilization mission was to establish the station hospital at Camp Clark. Location 7 December 1941—*Not initiated*.

1901st Station Hospital (Ninth C.A.S.C.)**Organized Reserve Montana****HQ**-Dillon, MT, 1929-41

Constituted in the Organized Reserve in June 1929, assigned to the Ninth Corps Area Service Command, and allotted to the Ninth Corps Area. Initiated 30 November 1929 at Dillon, MT. Conducted summer training at Fort Lewis, WA. Location 7 December 1941—Dillon, MT.

Commanders, 1901st Station Hospital

Maj. Frederick M. Poindexter	30 Nov 29-ao Jun 34	Unknown	ao Jun 34-7 Dec 41
------------------------------	---------------------	---------	--------------------

1902nd Station Hospital (Ninth C.A.S.C.)**Organized Reserve****HQ**-*Not initiated* 1929-33; Ninth Corps Area 1933-41

Constituted in the Organized Reserve in June 1929, assigned to the Ninth Corps Area Service Command, and allotted to the Ninth Corps Area. Initiated by June 1934 in the Ninth Corps Area. Conducted summer training at Fort Lewis, WA. Location 7 December 1941—Ninth Corps Area.

Commanders, 1902nd Station Hospital

Unknown	ao Jun 33-7 Dec 41
---------	--------------------

1903rd Station Hospital (Ninth C.A.S.C.)**Organized Reserve Montana****HQ**-Missoula, MT, 1929-41

Constituted in the Organized Reserve in June 1929, assigned to the Ninth Corps Area Service Command, and allotted to the Ninth Corps Area. Initiated 30 November 1929 at Missoula, MT. Conducted summer training at Fort Lewis, WA. Location 7 December 1941—Missoula, MT.

Commanders, 1903rd Station Hospital

Maj. William J. Marshall	30 Nov 29-ao Jun 34	Unknown	ao Jun 34-7 Dec 41
--------------------------	---------------------	---------	--------------------

1904th Station Hospital (Ninth C.A.S.C.)**Organized Reserve****HQ**-*Not initiated* 1929-31; Ninth Corps Area 1931-41

Constituted in the Organized Reserve in June 1929, assigned to the Ninth Corps Area Service Command, and allotted to the Ninth Corps Area. Initiated by June 1931 in the Ninth Corps Area. Location 7 December 1941—Ninth Corps Area.

Commanders, 1904th Station Hospital

Lt. Col. William E. Joiner	ao Jun 31-29 Jan 34	Maj. Rueben H. Fields	18 Mar 34-ao Jan 35
	Unknown	ao Jan 35-7 Dec 41	

1905th Station Hospital (Ninth C.A.S.C.)**Organized Reserve Washington****HQ**-*Not initiated* 1929-31; Ninth Corps Area 1931-41

Constituted in the Organized Reserve in June 1929, assigned to the Ninth Corps Area Service Command, and allotted to the Ninth Corps Area. Initiated by June 1931 in the Ninth Corps Area. Location 7 December 1941—Ninth Corps Area.

Commanders, 1905th Station Hospital

Unknown	ao Jun 31-ao Jun 33	Maj. Henry H. Slater	ao Jun 33-14 Dec 33
	Unknown	13 Dec 33-7 Dec 41	

1906th Station Hospital (Ninth C.A.S.C.)**Organized Reserve California****HQ**-San Diego, CA, 1931-41

Constituted in the Organized Reserve in June 1929, assigned to the Ninth Corps Area Service Command, and allotted to the Ninth Corps Area. Initiated by June 1931 at San Diego, CA. Location 7 December 1941—San Diego, CA.

Commanders, 1906th Station Hospital

Unknown	ao Jun 31-7 Jan 35	Lt. Col. Clarence P. Baxter	7 Jan 35-25 Jan 35
	Unknown	25 Jan 35-7 Dec 41	

1907th Station Hospital (Ninth C.A.S.C.)**Organized Reserve California****HQ**-San Francisco, CA, 1931-41

Constituted in the Organized Reserve in June 1929, assigned to the Ninth Corps Area Service Command, and allotted to the Ninth Corps Area. Initiated by June 1931 at San Francisco, CA. Location 7 December 1941—San Francisco, CA.

Commanders, 1907th Station Hospital

Unknown	ao Jun 31-ao Dec 33	Lt. Col. William B. Haggerty	ao Dec 33-24 Jun 34
	Unknown	24 Jun 34-7 Dec 41	

1908th Station Hospital (Ninth C.A.S.C.)**Organized Reserve California****HQ**-Los Angeles, CA, 1931-41

Constituted in the Organized Reserve 29 October 1929, assigned to the Ninth Corps Area Service Command, and allotted to the Ninth Corps Area. Initiated by June 1931 at Los Angeles, CA. Location 7 December 1941—Los Angeles, CA.

Commanders, 1908th Station Hospital

Unknown	ao Jun 31-7 Dec 41
---------	--------------------

1909th Station Hospital (Ninth C.A.S.C.)**Organized Reserve****HQ**-*Not initiated* 1929-31; Ninth Corps Area 1931-41

Constituted in the Organized Reserve in June 1929, assigned to the Ninth Corps Area Service Command, and allotted to the Ninth Corps Area. Initiated by June 1931 in the Ninth Corps Area. Location 7 December 1941—Ninth Corps Area.

Commanders, 1909th Station Hospital

Unknown	ao Jun 31-7 Dec 41
---------	--------------------

1910th Station Hospital (Ninth C.A.S.C.)

Organized Reserve California

HQ-San Francisco, CA, 1931-41

Constituted in the Organized Reserve in June 1929, assigned to the Ninth Corps Area Service Command, and allotted to the Ninth Corps Area. Initiated by June 1931 at San Francisco, CA. Location 7 December 1941—San Francisco, CA.

Commanders, 1910th Station Hospital

Unknown ao Jun 31-7 Dec 41

1911th Station Hospital (Ninth C.A.S.C.)

Organized Reserve Montana

HQ-Great Falls, MT, 1931-41

Constituted in the Organized Reserve in June 1929, assigned to the Ninth Corps Area Service Command, and allotted to the Ninth Corps Area. Initiated 30 November 1929 at Great Falls, MT. Conducted summer training at Fort Lewis, WA. Location 7 December 1941—Great Falls, MT.

Commanders, 1911th Station Hospital

Maj. Harry J. MacGregor 30 Nov 29-ao Jan 30 Unknown ao Jan 30-7 Dec 41

1912th Station Hospital (Ninth C.A.S.C.)

Organized Reserve California

HQ-Presidio of Monterey, CA, 1931-41

Constituted in the Organized Reserve in June 1929, assigned to the Ninth Corps Area Service Command, and allotted to the Ninth Corps Area. Initiated by June 1931 at Presidio of Monterey, CA. Location 7 December 1941—Presidio of Monterey, CA.

Commanders, 1912th Station Hospital

Unknown ao Jun 31-7 Dec 41

1913th Station Hospital (Ninth C.A.S.C.)

Organized Reserve California

HQ-Sacramento, CA, 1931-41

Constituted in the Organized Reserve in June 1929, assigned to the Ninth Corps Area Service Command, and allotted to the Ninth Corps Area. Initiated by June 1931 at Sacramento, CA. Location 7 December 1941—Sacramento, CA.

Commanders, 1913th Station Hospital

Unknown ao Jun 31-7 Dec 41

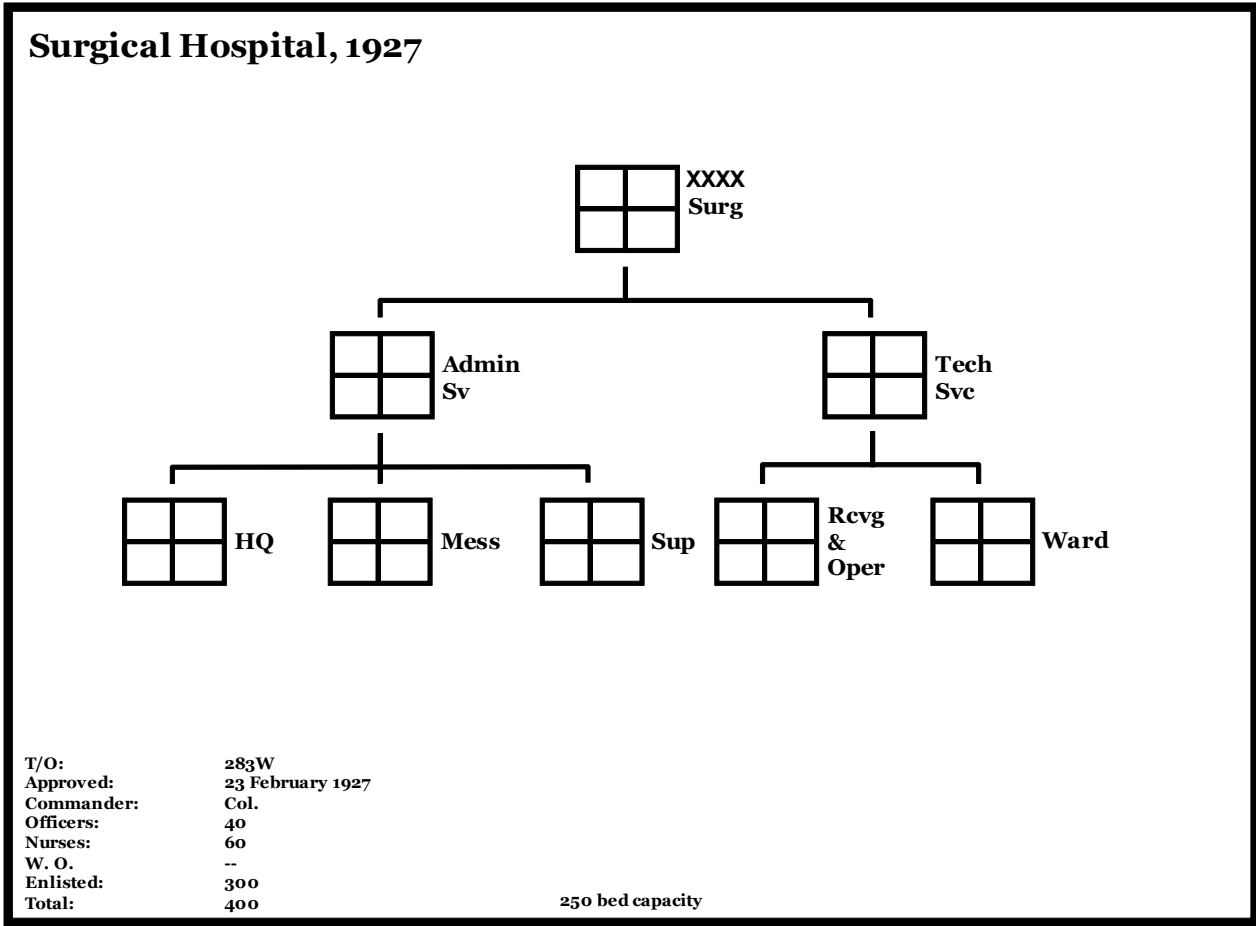

Surgical Hospital TOE.

Surgical Hospital mission: As near the front line as possible, provide facilities for major medical and surgical procedures for a limited number of severe battle casualties; and relieve division clearing stations of non-transportable casualties. Reserve hospital capacities for cases in which immediate major surgical procedures are necessary to save life and limb and cases in which immediate movement to an evacuation hospital would gravely endanger life or limb.

1st Surgical Hospital (Second Army)

Organized Reserve New Hampshire/New York

HQ-*Not initiated* 1923-25; Manchester, NH, 1925-28; *Inactive* 1928-41

Constituted in the Organized Reserve 2 July 1923 as Surgical Hospital No. 1, assigned to the Second Army, and allotted to the First Corps Area. Initiated by August 1925 at Manchester, NH. Redesignated 23 March 1925 as the 1st Surgical Hospital. Withdrawn from the Organized Reserve 27 December 1928 and allotted to the Regular Army. Concurrently withdrawn from the First Corps Area and allotted to the Second Corps Area. New York City, NY, designated as headquarters on reorganization, but the unit was never organized at that location. Consolidated in November 1936 with Mobile Hospital No. 1 (a WWI unit organized in February 1918 at Paris, France; demobilized 5 May 1919 at Camp Dodge, IA; reconstituted in November 1936). Location 7 December 1941—*Inactive*.

Commanders, 1st Surgical Hospital

Unknown	ao Aug 25-ao Mar 26	Unknown
Lt. Col. George C. Wilkins	ao Mar 26-ao Sep 27	<i>Inactive</i>
		ao Jun 27-27 Dec 28
		27 Dec 28-7 Dec 41

2nd Surgical Hospital (First Army)**Organized Reserve New York****HQ-Not initiated** 1923-25; New York City, NY, 1925-41

Constituted in the Organized Reserve 2 July 1923 as Surgical Hospital No. 2, assigned to the First Army, and allotted to the Second Corps Area. Affiliated 12 February 1924 with the College of Physicians and Surgeons, Columbia University in New York City, NY. Initiated 13 January 1925 at New York City. Redesignated 23 March 1925 as the 2nd Surgical Hospital. Withdrawn from the Organized Reserve 1 October 1933 and allotted to the Regular Army. Consolidated in November 1936 with Mobile Hospital No. 2 (a WWI unit organized in May 1918 at Paris, France; demobilized in December 1918 at Paris, France; reconstituted in November 1936). Location 7 December 1941—New York City, NY.

Status: Active in the Regular Army as the 502nd Combat Support Hospital at Landstuhl, Germany.**Commanders, 2nd Surgical Hospital**

Capt. Angus McDonald	13 Jan 25-Apr 25	Maj. Charles H. Wilson**	ao May 36-4 Jun 36
Lt. Col. Fordyce B. St. John	Apr 25-15 Aug 29	Unknown	4 Jun 36-8 May 37
Unknown	15 Aug 29-ao May 36	Lt. Col. James Breslin**	8 May 37-28 Apr 39
	Unknown	28 Apr 39-7 Dec 41	

** RAI Commanders: Organized Reserve officers.

3rd Surgical Hospital (First Army)**Organized Reserve New Jersey****HQ-Not initiated** 1923-25; Atlantic City, NJ, 1925-40; Jersey City, NJ, 1940-41

Authorized 23 March 1923 by the Surgeon General for affiliation with the Atlantic City Hospital in Atlantic City, NJ. Constituted in the Organized Reserve 2 July 1923 as Surgical Hospital No. 3, assigned to the First Army, and allotted to the Second Corps Area. Initiated 13 January 1925 at Atlantic City. Redesignated 23 March 1925 as the 3rd Surgical Hospital. Withdrawn from the Organized Reserve 1 October 1933 and allotted to the Regular Army. Consolidated in November 1936 with Mobile Hospital No. 3 (a WWI unit organized in July 1918 at Paris, France; demobilized 30 June 1919 at Camp Zachary Taylor, KY; reconstituted in November 1936). Relocated about October 1940 to Jersey City, NJ. Conducted summer training at Carlisle Barracks, PA. Location 7 December 1941—Jersey City, NJ.

Status: Inactive in the Regular Army as the 3rd Combat Support Hospital.**Commanders, 3rd Surgical Hospital**

Unknown	13 Jan 25-ao Jun 27	Col. William C. Davis**	17 Dec 34-23 Jul 36
Lt. Col. Richard Bew	ao Jun 27-5 Sep 27	Maj. Clarence W. Way**	23 Jul 36-2 Dec 38
Unknown	5 Sep 27-17 Dec 34	Maj. Robert Stewart**	2 Dec 38-6 Oct 40
	Unknown	6 Oct 40-7 Dec 41	

* Regular Army active duty commanders

** RAI Commanders: Organized Reserve officers.

4th Surgical Hospital (Sixth Army)**Organized Reserve Missouri****HQ-Not initiated** 1923-25; St. Louis, MO, 1924-41

Constituted in the Organized Reserve 2 July 1923 as Surgical Hospital No. 4, assigned to the Sixth Army, and allotted to the Seventh Corps Area. Affiliated 23 March 1923 with Washington University Medical School in St. Louis, MO. Initiated by April 1925 at St. Louis. Redesignated 4th Surgical Hospital 23 March 1925. Withdrawn from the Organized Reserve 1 October 1933 and allotted to the Regular Army. Concurrently, relieved from the Sixth Army and assigned to the Fourth Army. Consolidated in November 1936 with Mobile Hospital No. 4 (a WWI unit organized 13 August 1918 at Paris, France; demobilized in January 1919 in France; reconstituted in November 1936). Conducted C.M.T.C. training at Fort Des Moines, IA, in 1936. Designated mobilization station was Camp Dodge, IA. Location 7 December 1941—St. Louis, MO.

Status: Inactive in the Regular Army as the 4th Combat Support Hospital.

Commanders, 4th Surgical Hospital

Maj. Barney Brooks	ao Apr 25-11 Jan 26	Unknown	Jan 31-ao Jun 40
1st Lt. Leon Bromberg	ao Jun 27-Jan 28	Lt. Col. M. F. Arbuckle**	ao Jun 40-ao Jul 40
Lt. Col. Warren R. Rainey	Jan 28-Jan 31	Unknown	ao Jul 40-7 Dec 41

** RAI Commanders: Organized Reserve officers.

5th Surgical Hospital (Second Army)

Organized Reserve Ohio/Indiana

HQ—*Not initiated* 1923-25; Cleveland, OH, 1923-27; Bloomington, IN, 1927-30; *Inactive* 1930-34; Lafayette, IN, 1934-41

Authorized 1 March 1923 by the Surgeon General for affiliation with the Western Reserve University—St. Vincent's Charity Hospital Unit in Cleveland, OH. Constituted in the Organized Reserve 2 July 1923 as Surgical Hospital No. 5, assigned to the Second Army, and allotted to the Fifth Corps Area. Initiated by April 1925 at Cleveland. Redesignated 5th Surgical Hospital 23 March 1925. Relocated in 1927 to Bloomington, IN. Inactivated by March 1930 at Bloomington by relief of personnel. Withdrawn from the Organized Reserve 1 October 1933 and allotted to the Regular Army. Reorganized 22 March 1934 at Lafayette, IN. Consolidated 4 November 1936 with Mobile Hospital No. 5 (a WWI unit organized in August 1918 at Paris, France; demobilized 18 January 1919 at Joinville, France; reconstituted 4 November 1936). Designated mobilization station was Fort Oglethorpe, GA. Location 7 December 1941—Lafayette, IN.

Status: Inactive in the Regular Army as the 5th Surgical Hospital.

Commanders, 5th Surgical Hospital

Maj. Ursus V. Portmann	ao Apr 25-ao Jun 27	<i>Inactive</i>	ao Mar 30-22 Mar 34
Unknown	ao Jun 27-ao Mar 30	Unknown	22 Mar 34-7 Dec 41

6th Surgical Hospital (Second Army)

Organized Reserve Massachusetts/New Jersey

HQ—Boston, MA 1922-30; Fort Devens, MA 1930-36; *Inactive* 1936-38; Englewood, NJ, 1938-40; Fort Knox, KY, 1940-41



Authorized 9 November 1922 by the Surgeon General for affiliation with the Peter Bent Brigham Organization in Boston, MA. Concurrently initiated at Boston. Constituted in the Organized Reserve 2 July 1923 as Surgical Hospital No. 6, assigned to the Second Army, and allotted to the First Corps Area. Redesignated 6th Surgical Hospital 23 March 1925. Inactivated in September 1929 at Boston by relief of personnel. Fort Devens, MA, designated as headquarters on reorganization, but the unit was never organized at that location. Withdrawn from the Organized Reserve 1 October 1933 and allotted to the Regular Army. Concurrently relieved from the Second Army and assigned to the First Army. Withdrawn from the First Corps Area 5 June 1936 and allotted to the Second Corps Area. Consolidated 4 November 1936 with Mobile Hospital No. 6 (a WWI unit organized 4 September

1918 at Paris, France; demobilized 4 June 1919 at Varennes, France; reconstituted 4 November 1936). Reorganized 5 September 1938 at Englewood, NJ. Activated 1 August 1940, less Reserve personnel, at Fort Knox, KY. Location 7 December 1941—Fort Knox, KY.

Status: Inactive in the Regular Army as the 91st Evacuation Hospital.

Commanders, 6th Surgical Hospital

Maj. Elliot E. Cutler	9 Nov 22-ao Jun 24	<i>Inactive</i>	Sep 29-24 Sep 38
Unknown	ao Jun 24-ao Jun 25	Capt. David B. Simpson**	24 Sep 38-10 Aug 40
Lt. Col. William C. Quinby	ao Jun 25-Sep 29	Capt. Thomas A. Wildman*	10 Aug 40-ao Jan 41
	Unknown	ao Jan 41-7 Dec 41	

* Regular Army active duty commanders

** RAI Commanders: Organized Reserve officers.

7th Surgical Hospital (First Army)**Organized Reserve Pennsylvania****HQ-Not initiated** 1923-25; Scranton, PA, 1925-39; *Inactive* 1929-40; Fort Ord, CA, 1940-41

Constituted in the Organized Reserve 2 July 1923 as Surgical Hospital No. 7, assigned to the First Army, and allotted to the Third Corps Area. Affiliated 29 October 1923 with Hahnemann Hospital in Scranton, PA. Initiated 15 January 1925 at Scranton. Redesignated 7th Surgical Hospital 23 March 1925. Inactivated 20 November 1929 at Scranton by relief of personnel. Withdrawn from the Organized Reserve 1 October 1933 and allotted to the Regular Army. Philadelphia, PA, designated by July 1939 as headquarters on reorganization, but the unit was never organized at that location. Designated mobilization station was Carlisle Barracks, PA. Activated 1 August 1940, less Reserve personnel, at Fort Ord, CA, and assigned to the Fourth Army. Reserve personnel relieved 12 September 1940 at Philadelphia. Location 7 December 1941—Fort Ord, CA.

Status: Inactive in the Regular Army as the 92nd General Hospital.**Commanders, 7th Surgical Hospital**

Maj. Robert V. White	15 Jan 25-ao Sep 25	<i>Inactive</i>	20 Nov 29-1 Aug 40
Lt. Col. Roscoe L. Perkins	ao Dec 25-20 Nov 29	Capt. Jonathan M. Rigdon*	10 Aug 40-ao Jan 41
	Unknown	ao Jan 41-7 Dec 41	

* Regular Army active duty commanders

** RAI Commanders: Organized Reserve officers.

8th Surgical Hospital (First Army)**Organized Reserve Pennsylvania****HQ-Not initiated** 1923-25; McKeesport, PA, 1925-38; *Inactive* 1938-41

Constituted in the Organized Reserve 2 July 1923 as Surgical Hospital No. 8, assigned to the First Army, and allotted to the Third Corps Area. Affiliated 28 August 1924 with McKeesport Hospital, in McKeesport, PA. Redesignated 8th Surgical Hospital 23 March 1925. Initiated in April 1925 at McKeesport. Consolidated 11 November 1936 with Mobile Hospital No. 8 (a WWI unit organized in September 1918 at Paris, France; demobilized 11 January 1919 in France; reconstituted 11 November 1936). Inactivated 7 January 1938 at McKeesport by relief of personnel. Location 7 December 1941—*Inactive*.

Status: Active in the U.S. Army Reserve as the 350th Surgical Hospital at Greenville, NC.**Commanders, 8th Surgical Hospital**

Maj. William C. Heisey	Apr 25-20 Nov 29	Lt. Col. William M. Caffey	20 Jun 31-7 Jan 38
Lt. Col. Roscoe L. Perkins	20 Nov 29-20 Jun 31	<i>Inactive</i>	7 Jan 38-7 Dec 41

9th Surgical Hospital (First Army)**Organized Reserve Pennsylvania****HQ-Not initiated** 1923-27; Philadelphia, PA, 1927-28; *Inactive* 1928-41

Constituted in the Organized Reserve 2 July 1923 as Surgical Hospital No. 9, assigned to the First Army, and allotted to the Third Corps Area. Affiliated 24 September 1924 with Mount Sinai Hospital, in Philadelphia, PA. Redesignated 9th Surgical Hospital 23 March 1925. Initiated by March 1927 at Philadelphia. Inactivated by June 1928 at Philadelphia by relief of personnel. Consolidated in November 1936 with Mobile Hospital No. 9 (a WWI unit organized in September 1918 at Paris, France; demobilized in April 1919 in France; reconstituted in November 1936). Location 7 December 1941—*Inactive*.

Status: Inactive in the U.S. Army Reserve as the 97th Evacuation Hospital.**Commanders, 9th Surgical Hospital**

Unknown	ao Mar 27-ao Jun 28	<i>Inactive</i>	ao Jun 28-7 Dec 41
---------	---------------------	-----------------	--------------------

10th Surgical Hospital (First Army)**Organized Reserve New York****HQ-Not initiated** 1923-25; New York City, NY, 1925-41

Reconstituted in the Organized Reserve 2 July 1923 as Surgical Hospital No. 10, assigned to the First Army, and allotted to the Second Corps Area. Affiliated 17 January 1924 with the New York Post Graduate Medical School and Hospital in New York City, NY. Initiated 6 February 1925 at New York City. Redesignated 23 March 1925 as the 10th Surgical Hospital. Consolidated in November 1936 with Mobile Hospital No. 10 (a WWI unit organized in September 1918 at Paris, France; demobilized in 1919 at Paris; reconstituted in November 1936). Location 7 December 1941—New York City, NY.

Commanders, 10th Surgical Hospital

Capt. Charles W. Stevens	6 Feb 25-ao Mar 25	Col. John J. Moorhead	30 Jan 35-5 Aug 35
Unknown	ao Mar 25-ao Jan 27	Lt. Col. Edward W. Peterson	5 Aug 35-21 Aug 37
Maj. Thomas H. Cherry	ao Jan 27-ao Jan 28	Lt. Col. Charles A. Smith	21 Aug 37-ao Jul 39
Unknown	ao Jan 28-30 Jan 35	Unknown	ao Jul 39-7 Dec 41

11th Surgical Hospital (First Army)**Organized Reserve New York****HQ-Not initiated** 1923-25; Long Island City, NY, 1925-41

Constituted in the Organized Reserve 2 July 1923 as Surgical Hospital No. 11, assigned to the First Army, and allotted to the Second Corps Area. Affiliated 1 October 1924 with St. John's Long Island City Hospital in Long Island City, NY. Initiated 23 January 1925 at Long Island City. Conducted summer training most years at Carlisle Barracks, PA. Location 7 December 1941—Long Island City, NY.

Status: Active in the U.S. Army Reserve as the 99th Combat Support Hospital at Lancaster, PA.**Commanders, 11th Surgical Hospital**

Maj. Melvin G. Herzfeld	23 Jan 25-16 Oct 25	Unknown	ao Aug 34-ao Jun 38
Maj. Carl Boettiger	16 Oct 25-9 Nov 29	<i>Inactive</i>	ao Jun 38-28 Apr 39
Lt. Col. Albert K. Detwiller	27 Feb 30-2 Nov 31	Lt. Col. Hyman I. Teperson	28 Apr 39-13 Dec 39
Maj. John L. Haskins	19 Dec 31-ao Aug 34	Lt. Col. Leopold M. Rohr	13 Dec 39-ao Aug 40
	Unknown	ao Aug 40-7 Dec 41	

12th Surgical Hospital (Fourth Army)**Organized Reserve New York/Vermont****HQ-Not initiated** 1923-27; Yonkers, NY, 1927-28; *Inactive* 1928-31; Manchester, VT, 1931-33; White River Junction, VT, 1933-36; *Inactive* 1936-39; New York City, NY, 1939-41

Constituted in the Organized Reserve 2 July 1923 as Surgical Hospital No. 12, assigned to the Fourth Army, and allotted to the Second Corps Area. Affiliated 1 October 1924 with St. John's Riverside Hospital in Yonkers, NY. Redesignated 23 March 1925 as the 12th Surgical Hospital. Initiated by June 1927 at Yonkers, NY. Withdrawn from the Organized Reserve 6 October 1928 and allotted to the Regular Army. Concurrently withdrawn from the Second Corps Area and allotted to the First Corps Area. Reorganized by June 1931 at Manchester, VT. Relocated in 1933 to White River Junction, VT. Relieved from the Fourth Army 1 October 1933 and assigned to the First Army. Withdrawn from the First Corps Area 5 June 1936 and allotted to the Second Corps Area. Reorganized 15 February 1939 at New York City, NY. Location 7 December 1941—New York City, NY.

Commanders, 12th Surgical Hospital

Unknown	ao Jun 27-6 Oct 28	1st George W. R. Bowie**	19 May 34-5 Jun 36
<i>Inactive</i>	6 Oct 28-ao Jun 31	<i>Inactive</i>	5 Jun 36-15 Feb 39
Unknown	ao Jun 31-19 May 34	Capt. Lewis E. Scharf **	15 Feb 39-ao Jan 41
	Unknown	ao Jan 41-7 Dec 41	

** RAI Commanders: Organized Reserve officers.

13th Surgical Hospital (Fourth Army)**Organized Reserve New York****HQ-Not initiated** 1923-25; Manhattan, NY, 1925-38; *Inactive* 1938-41

Constituted in the Organized Reserve 2 July 1923 as Surgical Hospital No. 13, assigned to the Fourth Army, and allotted to the Second Corps Area. Redesignated 23 March 1925 as the 13th Surgical Hospital. Initiated 24 March 1925 at Manhattan, NY. Inactivated by June 1938 at Manhattan by relief of personnel. Location 7 December 1941—*Inactive*.

Commanders, 13th Surgical Hospital

1st Lt. Samuel P. Wainwright	24 Mar 25-11 Apr 25	Unknown	12 Jan 29-ao Jun 38
Lt. Col. Grover C. Sherrard	11 Apr 25-12 Jan 29	<i>Inactive</i>	ao Jun 38-7 Dec 41

14th Surgical Hospital (Fourth Army)**Organized Reserve New York****HQ-Not initiated** 1923-25; Binghamton, NY, 1925-30; *Inactive* 1930-41

Constituted in the Organized Reserve 2 July 1923 as Surgical Hospital No. 14, assigned to the Fourth Army, and allotted to the First Corps Area. Withdrawn from the First Corps Area 11 January 1927 and allotted to the Second Corps Area. Affiliated with Binghamton City Hospital in Binghamton, NY. Initiated 20 March 1925 at Binghamton. Redesignated 23 March 1925 as the 14th Surgical Hospital. Withdrawn from the Organized Reserve 27 December 1928 and allotted to the Regular Army. Inactivated 6 February 1930 at Binghamton by relief of personnel. Location 7 December 1941—*Inactive*.

Commanders, 14th Surgical Hospital

Maj. Louis Carp	20 Mar 25-29 May 25	1st Lt. Thomas H. Argue**	2 Sep 26-6 Feb 30
	<i>Inactive</i>	6 Feb 30-7 Dec 41	

** RAI Commanders: Organized Reserve officers.

15th Surgical Hospital (Fourth Army)**Organized Reserve New Jersey/Connecticut/New York****HQ-Not initiated** 1923-25; Trenton, NJ, 1925-28; *Inactive* 1928-31; Stamford, CT, 1931-33; Hartford, CT, 1933-36; *Inactive* 1936-41

Authorized 8 July 1922 by the Surgeon General for organization at, and affiliation with, the Mercer Hospital in Trenton, NJ. Constituted in the Organized Reserve 2 July 1923 as Surgical Hospital No. 15, assigned to the Fourth Army, and allotted to the Second Corps Area. Redesignated 23 March 1925 as the 15th Surgical Hospital. Initiated by December 1925 at Trenton, NJ. Withdrawn from the Organized Reserve 27 December 1928 and allotted to the Regular Army. Concurrently withdrawn from the Second Corps Area and allotted to the First Corps Area. Additionally, relieved from the Fourth Army and assigned to the First Army. Reorganized by May 1931 at Stamford, CT. Relocated in 1933 to Hartford, CT. Withdrawn from the First Corps Area 5 June 1936 and allotted to the Second Corps Area. New York City, NY, designated as headquarters on reorganization, but the unit was never organized at that location. Location 7 December 1941—*Inactive*.

Status: *Inactive* in the Regular Army as the 15th Portable Surgical Hospital.**Commanders, 15th Surgical Hospital**

Unknown	ao Dec 25-27 Dec 28	1st Lt. Edward Burgin**	ao May 31-ao Jun 34
<i>Inactive</i>	27 Dec 28-ao May 31	Unknown	ao Jun 34-5 Jun 36
	<i>Inactive</i>	ao Jun 34-7 Dec 41	

** RAI Commanders: Organized Reserve officers.

16th Surgical Hospital (Sixth Army)**Organized Reserve Texas****HQ-Not initiated** 1923-25; El Paso, TX, 1925-36; Fort Sam Houston, TX, 1936-41

Authorized 5 December 1922 by the Surgeon General for organization at, and affiliation with, the Southern Pacific Hospital in El Paso, TX. Constituted in the Organized Reserve 2 July 1923 as Surgical Hospital No. 16, assigned to the Sixth Army, and allotted to the Eighth Corps Area. Initiated 10 March 1925 at El Paso, TX. Redesignated 16th Surgical Hospital 23 March 1925. Withdrawn from the Organized Reserve 1 October 1933 and allotted to the Regular Army. Relocated in 1936 to Fort Sam Houston, TX. Conducted summer training at the station hospital at Fort Sam Houston or Fitzsimons General Hospital. Designated mobilization training station was Camp Stanley, TX. Location 7 December 1941—Fort Sam Houston, TX.

Status: Active in the Regular Army as the 16th Surgical Hospital at Fort Riley, KS.

Commanders, 16th Surgical Hospital

Lt. Col. William R. Jamieson	10 Mar 25-18 Jan 28	Maj. William F. Spiller**	26 Feb 35-ao Mar 35
Maj. Francis O. Barrett	18 Jan 28-ao Feb 32	Unknown	ao Mar 35-25 Nov 36
Unknown	ao Feb 32-26 Feb 35	Capt. Theodore L. Hyde**	25 Nov 36-ao Jan 37
	Unknown	ao Jan 37-7 Dec 41	

** RAI Commanders: Organized Reserve officers.

17th Surgical Hospital (First Army)

Organized Reserve Pennsylvania

HQ-Not initiated 1923-25; Philadelphia, PA, 1925-41

Constituted in the Organized Reserve 2 July 1923 as Surgical Hospital No. 17, assigned to the First Army, and allotted to the Third Corps Area. Affiliated 9 January 1924 with the Frankford Hospital in Philadelphia, PA. Initiated 13 January 1925 at Philadelphia, PA. Redesignated 17th Surgical Hospital 23 March 1925. Location 7 December 1941—Philadelphia, PA.

Commanders, 17th Surgical Hospital

Lt. Col. Charles F. Nassau	13 Jan 25-2 Apr 29	Lt. Col. Edmund B. Piper	14 Jun 30-ao Jun 34
Maj. Lewis D. Englerth	2 Apr 29-14 Jun 30	Unknown	ao Jun 34-7 Dec 41

18th Surgical Hospital (Fourth Army)

Organized Reserve Maryland/New York

HQ-Not initiated 1923-25; Baltimore, MD, 1925-28; *Inactive* 1928-29; Brooklyn, NY, 1929-41

Constituted in the Organized Reserve 2 July 1923 as Surgical Hospital No. 18, assigned to the Fourth Army, and allotted to the Third Corps Area. Redesignated 18th Surgical Hospital 23 March 1925. Initiated 17 January 1925 at Baltimore, MD. Withdrawn from the Organized Reserve 6 October 1928 and allotted to the Regular Army. Concurrently, withdrawn from the Third Corps Area and allotted to the Second Corps Area. Reorganized 1 March 1929 at Brooklyn, NY. Relieved from the Fourth Army 1 October 1933 and assigned to the First Army. Typically conducted Inactive Training Period meetings at the 101st Cavalry Regiment armory in Brooklyn, NY. Conducted summer training at Carlisle Barracks, PA. Location 7 December 1941—New York City, NY.

Status: Active in the Regular Army as the 18th Surgical Hospital at Fort Lewis, WA.

Commanders, 18th Surgical Hospital

Maj. Hovhanness K. Peltskin	17 Jan 25-ao Sep 25	Maj. Ethan F. Butler	1 Mar 29-24 May 30
Lt. Col. William H. Littlepage	ao Jan 26-14 Sep 27	Maj. Robert F. Barber	4 Feb 30-ao Jun 31
Unknown	14 Sep 27-6 Oct 28	Unknown	ao Jun 31-31 Jan 34
<i>Inactive</i>	6 Oct 28-1 Mar 29	Col. Llewellyn E. Hetrick**	31 Jan 34-4 Jan 40
	Lt. Col. John F. Schafmeister	28 Feb 40-ao Jan 41	

** RAI Commanders: Organized Reserve officers.

19th Surgical Hospital (Fourth Army)

Organized Reserve Pennsylvania/New Jersey

HQ-Not initiated 1923-25; Scranton, PA, 1925-28; *Inactive* 1928-30; Trenton, NJ, 1930-40; *Inactive* 1940-41

Constituted in the Organized Reserve 2 July 1923 as Surgical Hospital No. 19, assigned to the Fourth Army, and allotted to the Third Corps Area. Redesignated 19th Surgical Hospital 23 March 1925. Initiated 12 January 1925 at Scranton, PA. Withdrawn from the Organized Reserve 6 October 1928 and allotted to the Regular Army. Concurrently, withdrawn from the Third Corps Area and allotted to the Second Corps Area. Reorganized 4 February 1930 at Trenton, NJ. Relieved from the Fourth Army 1 October 1933 and assigned to the First Army. Typically conducted Inactive Training Period meetings at the 112th Field Artillery Regiment armory or the Post Office Building in Trenton. Inactivated about June 1940. Location 7 December 1941—*Inactive*.

Commanders, 19th Surgical Hospital

Maj. Ethan F. Butler	12 Jan 25-17 Jan 25	Maj. Abijah O. Buck**	15 Mar 30-15 Feb 32
Lt. Col. Jonathan M. Wainwright	17 Jan 25-Apr 25	Maj. Robert Stewart**	1 Feb 32-21 Jul 34
Lt. Col. William S. Watson	Apr 25-6 Oct 28	Unknown	21 Jul 34-10 May 35
<i>Inactive</i>	6 Oct 28-4 Feb 30	Maj. Robert R. Sellers**	10 May 35-13 Mar 39
Maj. Carl Boettiger**	4 Feb 30-15 Mar 30	Maj. Clarence W. Way **	1 Apr 39-Jun 40
	<i>Inactive</i>	Jun 40-7 Dec 41	

** RAI Commanders: Organized Reserve officers.

20th Surgical Hospital (Fourth Army)

Organized Reserve Pennsylvania/Maryland

HQ—*Not initiated* 1923-25; Pittsburgh, PA, 1925-29; *Inactive* 1929-41

Constituted in the Organized Reserve 2 July 1923 as Surgical Hospital No. 20, assigned to the Fourth Army, and allotted to the Third Corps Area. Redesignated 20th Surgical Hospital 23 March 1925. Initiated 12 January 1925 at Pittsburgh, PA. Inactivated 6 September 1929 at Pittsburgh by relief of personnel. Affiliated with the University of Maryland Medical School in May 1940. Location 7 December 1941—*Inactive*.

Commanders, 20th Surgical Hospital

Maj. Walter B. Harvey	12 Jan 25-13 Jan 25	Lt. Col. William S. Watson	5 Jul 27-6 Sep 29
Lt. Col. Edmund B. Piper	13 Jan 25-5 Jul 27	<i>Inactive</i>	6 Sep 29-7 Dec 41

21st Surgical Hospital (I) (Fourth Army)

Organized Reserve Pennsylvania

HQ—*Not initiated* 1923-25; Reading, PA, 1925-28

Constituted in the Organized Reserve 2 July 1923 as Surgical Hospital No. 21, assigned to the Fourth Army, and allotted to the Third Corps Area. Affiliated 16 October 1924 with the Reading Hospital in Reading, PA. Redesignated 21st Surgical Hospital 23 March 1925. Initiated by October 1925 at Reading, PA. Demobilized 6 October 1928.

Commanders, 21st Surgical Hospital (I)

Maj. Wellington A. Lebkicher	ao Oct 25-6 Oct 28
------------------------------	--------------------

21st Surgical Hospital (II) (Fourth Army)

Regular Army Inactive

HQ—Reading, PA, 1928-29; *Inactive* 1929-41; Philadelphia, PA, 1941

Constituted in the Regular Army 21 December 1928, assigned to the Fourth Army, and allotted to the Third Corps Area. Concurrently organized with Organized Reserve personnel as a RAI unit with headquarters at Reading, PA. Inactivated 29 August 1929 at Reading by relief of personnel. Reorganized by January 1941 at Philadelphia, PA. Location 7 December 1941—Philadelphia, PA.

Commanders, 21st Surgical Hospital (II)

Maj. Wellington A. Lebkicher**	21 Dec 28-29 Aug 29	<i>Inactive</i>	29 Aug 29-ao Jan 41
	Capt. Robert E. Klein**	ao Jan 41-7 Aug 41	

** RAI Commanders: Organized Reserve officers.

22nd Surgical Hospital (First Army)**Organized Reserve North Carolina****HQ-Not initiated** 1923-27; Durham, NC, 1927-29; *Inactive* 1929-41; Camp Hulen, TX, 1941

Constituted in the Organized Reserve 2 July 1923 as Surgical Hospital No. 22, assigned to the First Army, and allotted to the Fourth Corps Area. Redesignated 22nd Surgical Hospital 23 March 1925. Initiated by June 1927 at Durham, NC. Inactivated 14 September 1929 at Reading. Withdrawn from the Organized Reserve 1 October 1933 and allotted to the Regular Army. Concurrently, relieved from the First Army and assigned to the Third Army. Withdrawn from the Fourth Corps Area 5 June 1936 and allotted to the Second Corps Area. Activated 10 February 1941, less Reserve personnel, at Camp Hulen, TX. Location 7 December 1941—Camp Hulen, TX.

Status: Inactive in the Regular Army as the 22nd Surgical Hospital.**Commanders, 22nd Surgical Hospital**

Lt. Col. Robert T. Ferguson	ao Jun 27-14 Sep 29	<i>Inactive</i>	14 Sep 29-10 Feb 41
	Unknown	10 Feb 41-7 Dec 41	

23rd Surgical Hospital (First Army)**Organized Reserve Louisiana****HQ-Not initiated** 1923-27; New Orleans, LA, 1927-41

Constituted in the Organized Reserve 2 July 1923 as Surgical Hospital No. 23, assigned to the First Army, and allotted to the Fourth Corps Area. Redesignated 23rd Surgical Hospital 23 March 1925. Initiated by June 1927 at New Orleans, LA. Withdrawn from the Organized Reserve 1 October 1933 and allotted to the Regular Army. Concurrently, relieved from the First Army and assigned to the Third Army. Location 7 December 1941—New Orleans, LA.

Commanders, 23rd Surgical Hospital

Maj. Muir Bradburn	ao Jun 27-ao Jul 27	Unknown	ao Jul 27-7 Dec 41
--------------------	---------------------	---------	--------------------

24th Surgical Hospital (First Army)**Organized Reserve Alabama****HQ-Not initiated** 1923-27; Birmingham, AL, 1927-41

Constituted in the Organized Reserve 2 July 1923 as Surgical Hospital No. 24, assigned to the First Army, and allotted to the Fourth Corps Area. Redesignated 24th Surgical Hospital 23 March 1925. Initiated by June 1927 at Birmingham, AL. Relieved from the First Army 1 October 1933 and assigned to the Third Army. Location 7 December 1941—Birmingham, AL.

Status: Active in the U.S. Army Reserve as the 403rd Combat Support Hospital at Phoenix, AZ.**Commanders, 24th Surgical Hospital**

Lt. Col. James M. Mason	ao Jun 27-22 Jan 29	Unknown	22 Jan 29-7 Dec 41
-------------------------	---------------------	---------	--------------------

25th Surgical Hospital (First Army)**Organized Reserve Florida****HQ-Not initiated** 1923-25; Jacksonville, FL, 1925-29; *Inactive* 1929-41

Constituted in the Organized Reserve 2 July 1923 as Surgical Hospital No. 25, assigned to the First Army, and allotted to the Fourth Corps Area. Redesignated 25th Surgical Hospital 23 March 1925. Initiated 27 May 1925 at Jacksonville, FL. Inactivated 14 September 1929 at Jacksonville. Assigned to the Third Army 1 October 1933. Location 7 December 1941—*Inactive*.

Status: Inactive in the U.S. Army Reserve as the 102nd Evacuation Hospital.**Commanders, 25th Surgical Hospital**

Maj. John H. Woolsey	27 May 25-ao Jun 25	Lt. Col. William J. Lancaster	ao Jun 27-14 Sep 29
Unknown	ao Jun 25-ao Jun 27	<i>Inactive</i>	14 Sep 29-7 Dec 41

26th Surgical Hospital (Third Army)**Organized Reserve Alabama****HQ-Not initiated** 1923-27; Birmingham, AL, 1927-28

Constituted in the Organized Reserve 2 July 1923 as Surgical Hospital No. 26, assigned to the Third Army, and allotted to the Fourth Corps Area. Redesignated 26th Surgical Hospital 23 March 1925. Initiated by June 1927 at Birmingham, AL. Withdrawn from the Fourth Corps Area 27 December 1928 and demobilized.

Commanders, 26th Surgical Hospital

Maj. Julian B. Cooper	ao Jun 27-ao Jul 27	Unknown	ao Jul 27-27 Dec 28
-----------------------	---------------------	---------	---------------------

27th Surgical Hospital (Third Army)**Organized Reserve Florida****HQ-Not initiated** 1923-27; Tampa, FL, 1927-29

Constituted in the Organized Reserve 2 July 1923 as Surgical Hospital No. 27, assigned to the Third Army, and allotted to the Fourth Corps Area. Redesignated 27th Surgical Hospital 23 March 1925. Initiated by June 1927 at Tampa, FL. Withdrawn from the Fourth Corps Area 27 December 1928 and demobilized.

Commanders, 27th Surgical Hospital

Lt. Col. Robert B. Scales	ao Jun 27-27 Dec 28
---------------------------	---------------------

28th Surgical Hospital (Third Army)**Organized Reserve Tennessee/District of Columbia****HQ-Not initiated** 1923-27; Chattanooga, TN, 1927-28; Washington, DC 1928-29; *Inactive* 1929-34; Washington, DC 1934-41; Fort George G. Meade, MD, 1941

Constituted in the Organized Reserve 2 July 1923 as Surgical Hospital No. 28, assigned to the Third Army, and allotted to the Fourth Corps Area. Redesignated 28th Surgical Hospital 23 March 1925. Initiated by June 1927 at Chattanooga, TN. Withdrawn from the Organized Reserve 6 October 1928 and allotted to the Regular Army. Concurrently, withdrawn from the Fourth Corps Area and allotted to the Third Corps Area. Reorganized 25 October 1928 at Washington, DC. Inactivated 14 September 1929 at Washington, DC, by relief of personnel. Relieved from the Third Army 1 October 1933 and assigned to the First Army. Reorganized 4 March 1934 at Washington, DC. Designated mobilization station was Carlisle Barracks, PA. Activated 10 February 1941, less Reserve personnel, at Fort George G. Meade, MD. Location 7 December 1941—Fort George G. Meade, MD.

Status: Active in the U.S. Army Reserve as the 830th Station Hospital at Des Moines, IA.**Commanders, 28th Surgical Hospital**

Lt. Col. Walter J. Bristow	ao Jun 27-6 Oct 28	<i>Inactive</i>	14 Sep 29-4 Mar 34
<i>Inactive</i>	6 Oct 28-25 Oct 28	Maj. Ivy A. Pelzman**	10 Feb 34-ao Jun 40
Lt. Col. Ralph W. Chaney**	25 Oct 28-14 Sep 29	Unknown	ao Jun 40-15 Sep 41
	Capt. H. C. Welling*	15 Sep 41-ao Dec 41	

* Regular Army active duty commanders

** RAI Commanders: Organized Reserve officers.

29th Surgical Hospital (Third Army)**Organized Reserve North Carolina****HQ-Not initiated** 1923-27; Wilmington, NC, 1927-28; *Inactive* 1928-34; Pittsburgh, PA, 1934-41

Constituted in the Organized Reserve 2 July 1923 as Surgical Hospital No. 29, assigned to the Third Army, and allotted to the Fourth Corps Area. Redesignated 29th Surgical Hospital 23 March 1925. Initiated by June 1927 at Wilmington, NC. Withdrawn from the Organized Reserve 6 October 1928 and allotted to the Regular Army. Concurrently, withdrawn from the Fourth Corps Area and allotted to the Third Corps Area. Reorganized by June 1935 at Pittsburgh, PA. Relieved from the Third Army 1 October 1933 and assigned to the First Army. Functioned as a pool unit for excess medical corps lieutenants. Designated mobilization station was Carlisle Barracks, PA. Location 7 December 1941—Pittsburgh, PA.

Status: Inactive in the Regular Army as the 29th Evacuation Hospital.

Commanders, 29th Surgical Hospital

1st Lt. Julian K. Quattlebaum	ao Jun 27-ao Jul 27	Unknown	ao Jun 34-28 Sep 39
Unknown	ao Jul 27-6 Oct 28	Lt. Col. William C. Browne**	28 Sep 39-ao Jan 40
<i>Inactive</i>	6 Oct 28-ao Jun 34	Unknown	ao Jan 40-7 Dec 41

** RAI Commanders: Organized Reserve officers.

30th Surgical Hospital (Second Army)

Organized Reserve Indiana

HQ-*Not initiated* 1923-27; Fort Wayne, IN, 1927-41

Constituted in the Organized Reserve 2 July 1923 as Surgical Hospital No. 30, assigned to the Second Army, and allotted to the Fifth Corps Area. Affiliated with Fort Wayne Lutheran Hospital in Fort Wayne, IN. Redesignated 30th Surgical Hospital 23 March 1925. Initiated by June 1927 at Fort Wayne. Withdrawn from the Organized Reserve 1 October 1933 and allotted to the Regular Army. Designated mobilization station was Fort Oglethorpe, GA. Location 7 December 1941—Fort Wayne, IN.

Status: Active in the U.S. Army Reserve at Fort Sam Houston, TX, as the 228th Combat Support Hospital.

Commanders, 30th Surgical Hospital

Maj. Charles G. Deall	ao Jun 27-Jan 30	Lt. Col. George B. Booth**	Jan 30-ao Aug 38
	Unknown	ao Aug 38-7 Dec 41	

** RAI Commanders: Organized Reserve officers.

31st Surgical Hospital (Second Army)

Organized Reserve Kentucky/Ohio

HQ-*Not initiated* 1923-26; Fort Thomas, KY, 1926-27; Cincinnati, OH, 1927-37; *Inactive* 1937-41

Constituted in the Organized Reserve 2 July 1923 as Surgical Hospital No. 31, assigned to the Second Army, and allotted to the Fifth Corps Area. Redesignated 31st Surgical Hospital 23 March 1925. Initiated by April 1926 at Fort Thomas, KY. Relocated in 1927 to Cincinnati, OH. Inactivated by June 1937 at Cincinnati by relief of personnel. Withdrawn from the Organized Reserve 1 January 1938 and allotted to the Regular Army. Designated mobilization station was Fort Oglethorpe, GA. Location 7 December 1941—*Inactive*.

Status: Active in the Regular Army as the 31st Combat Support Hospital at Fort Bliss, TX.

Commanders, 31st Surgical Hospital

Lt. Col. Joseph E. Pirrung	Apr 26-ao Jun 27	Unknown	ao Jun 27-ao Jun 37
	<i>Inactive</i>	ao Jun 37-7 Dec 41	

32nd Surgical Hospital (Second Army)

Organized Reserve Ohio

HQ-*Not initiated* 1923-27; Fort Hayes, OH, 1927; Columbus, OH, 1927-30; *Inactive* 1930-33; Columbus, OH, 1934-37; *Inactive* 1937-41

Constituted in the Organized Reserve 2 July 1923 as Surgical Hospital No. 32, assigned to the Second Army, and allotted to the Fifth Corps Area. Redesignated 32nd Surgical Hospital 23 March 1925. Initiated by June 1927 at Fort Hayes, OH. Inactivated by March 1930 at Columbus by relief of personnel. Reorganized 22 March 1934 at Columbus. Inactivated by June 1937 at Columbus by relief of personnel. Toledo, OH, designated as headquarters on reorganization, but the unit was never organized at that location. Withdrawn from the Organized Reserve 1 January 1938 and allotted to the Regular Army. Designated mobilization station was Fort Oglethorpe, GA. Location 7 December 1941—*Inactive*.

Status: Inactive in the Regular Army as the 32nd Combat Support Hospital.

Commanders, 32nd Surgical Hospital

Lt. Col. Joseph A. Link	ao Jun 27-ao Sep 28	<i>Inactive</i>	Mar 30-22 Mar 34
Unknown	ao Sep 28-ao Mar 30	Unknown	22 Mar 34-ao Jun 37
	<i>Inactive</i>	ao Jun 37-7 Dec 41	

33rd Surgical Hospital (Second Army)

Organized Reserve Kentucky

HQ-Not initiated 1923-25; Camp Knox, KY, 1925-28; *Inactive* 1928-29; Columbia, TN, 1929-36; Birmingham, AL, 1936-1941; Fort Oglethorpe, GA, 1941

Constituted in the Organized Reserve 2 July 1923 as Surgical Hospital No. 33, assigned to the Second Army, and allotted to the Fifth Corps Area. Initiated by June 1925 at Camp Knox, KY. Redesignated 33rd Surgical Hospital 23 March 1925. Withdrawn from the Organized Reserve 6 October 1928 and allotted to the Regular Army. Concurrently, withdrawn from the Fifth Corps Area and allotted to the Fourth Corps Area. Reorganized in March 1929 at Columbia, TN. Relieved from the Second Army 1 October 1933 and assigned to the Third Army. Relocated by December 1936 to Birmingham, AL. Activated 25 January 1941, less Reserve personnel, at Fort Oglethorpe, GA, and assigned to the Third Army. Location 7 December 1941—Fort Oglethorpe, GA.

Status: Inactive in the Regular Army as the 361st Station Hospital.

Commanders, 33rd Surgical Hospital

Lt. Col. William R. Davidson	Jun 25-6 Oct 28	Lt. Col. Jacob W. Kennedy**	22 Oct 29-12 Apr 30
<i>Inactive</i>	6 Oct 28-Mar 29	Unknown	12 Apr 30-ao May 38
1st Lt. Ben H. Nicholson**	Mar 29-14 Sep 29	Lt. Col. Charles D. Mason**	ao May 38-ao Jan 39
Maj. Milton W. Robertson**	14 Sep 29-22 Oct 29	Unknown	ao Jan 39-15 Sep 41
	Lt. Col. James H. Blackwell*	15 Sep 41-ao Dec 41	

* Regular Army active duty commanders

** RAI Commanders: Organized Reserve officers.

34th Surgical Hospital (Second Army)

Organized Reserve Kentucky

HQ-Not initiated 1923-26; Camp Knox, KY, 1926-29; Tampa, FL, 1929-41; Fort Oglethorpe, GA, 1941

Constituted in the Organized Reserve 2 July 1923 as Surgical Hospital No. 34, assigned to the Second Army, and allotted to the Fifth Corps Area. Redesignated 34th Surgical Hospital 23 March 1925. Initiated by October 1926 at Camp Knox, KY. Withdrawn from the Organized Reserve 6 October 1928 and allotted to the Regular Army. Concurrently, withdrawn from the Fifth Corps Area and allotted to the Fourth Corps Area. Inactivated 14 January 1929 at Camp Knox. Organized 12 February 1929 at Tampa, FL. Relieved from the Second Army 1 October 1933 and assigned to the Third Army. Activated 25 January 1941, less Reserve personnel, at Fort Oglethorpe, GA, and assigned to the Third Army. Location 7 December 1941—Fort Oglethorpe, GA.

Commanders, 34th Surgical Hospital

Lt. Col. Harry S. Osborne**	ao Oct 26-14 Jan 29	Maj. Harold O. Brown**	ao Nov 37-ao Jan 38
Maj. Velpeau H. Ragsdale**	12 Feb 29-ao Jun 32	Unknown	ao Jan 38-ao Sep 38
Unknown	ao Jun 32-ao Nov 37	Lt. Col. Frank S. Adams**	ao Sep 38-ao Oct 38
	Unknown	ao Oct 38-7 Dec 41	

** RAI Commanders: Organized Reserve officers.

35th Surgical Hospital (Second Army)

Organized Reserve Ohio

HQ-Not initiated 1923-27; Youngstown, OH, 1927-30; *Inactive* 1930-34; Youngstown, OH, 1934-37; *Inactive* 1937-41

Constituted in the Organized Reserve 2 July 1923 as Surgical Hospital No. 35, assigned to the Second Army, and allotted to the Fifth Corps Area. Redesignated 35th Surgical Hospital 23 March 1925. Initiated by March 1926 at Cleveland, OH. Inactivated by March 1930 at Cleveland by relief of personnel. Reorganized 22 March 1934 at Youngstown. Inactivated by June 1937 at Youngstown by relief of personnel. Location 7 December 1941—*Inactive*.

Commanders, 35th Surgical Hospital

Lt. Col. William R. Barney	ao Mar 26-ao Jul 27	<i>Inactive</i>	ao Mar 30-22 Mar 34
Unknown	ao Jul 27-ao Mar 30	Unknown	22 Mar 34-ao Jun 37
	<i>Inactive</i>	ao Jun 37-7 Dec 41	

36th Surgical Hospital (Second Army)

Organized Reserve Indiana

HQ—*Not initiated* 1923-25; Fort Benjamin Harrison, IN, 1925-29; South Bend, IN, 1929-30; *Inactive* 1930-34; Gary, IN, 1934-41

Constituted in the Organized Reserve 2 July 1923 as Surgical Hospital No. 36, assigned to the Second Army, and allotted to the Fifth Corps Area. Redesignated 36th Surgical Hospital 23 March 1925. Initiated by June 1925 at Fort Benjamin Harrison, IN. Relocated by 1929 to South Bend, IN, and affiliated with, St. Joseph's Hospital. Inactivated about February 1930 at South Bend by relief of personnel. Reorganized 22 March 1934 at Gary, IN. Location 7 December 1941—Gary, IN.

Status: Disbanded 30 January 1942.

Commanders, 36th Surgical Hospital

Lt. Col. Harry S. Osborne	ao Jun 25-Oct 26	<i>Inactive</i>	Feb 30-22 Mar 34
Lt. Col. Perry C. Traver	Oct 26-Feb 30	Unknown	22 Mar 34-7 Dec 41

37th Surgical Hospital (Second Army)

Organized Reserve Connecticut/New York

HQ—*Not initiated* 1923-26; New Haven, CT, 1926-36; *Inactive* 1936-41

Constituted in the Organized Reserve 2 July 1923 as Surgical Hospital No. 37, assigned to the Second Army, and allotted to the Fifth Corps Area. Affiliated 30 April 1924 with Grace Hospital in New Haven, CT. Redesignated 36th Surgical Hospital 23 March 1925. Initiated by April 1926 at New Haven. Relieved from the Second Army 1 October 1933 and assigned to the First Army. Withdrawn from the First Corps Area 5 June 1936 and allotted to the Second Corps Area. New York City, NY, designated as headquarters on reorganization, but the unit was never organized at that location. Location 7 December 1941—*Inactive*.

Status: Disbanded 30 January 1942.

Commanders, 37th Surgical Hospital

Capt. Charles H. Dabbs	ao Apr 26-May 26	Unknown	Dec 29-5 Jun 36
Maj. Charles S. Smith	May 26-Dec 29	<i>Inactive</i>	5 Jun 36-7 Dec 41

38th Surgical Hospital (I) (Second Army)

Organized Reserve Connecticut

HQ—*Not initiated* 1923-24; Stamford, CT, 1924-28

Constituted in the Organized Reserve 2 July 1923 as Surgical Hospital No. 38, assigned to the Fourth Army, and allotted to the First Corps Area. Initiated at, and affiliated with, the Stamford Hospital in Stamford, CT, 26 May 1924. Redesignated 38th Surgical Hospital 23 March 1925. Withdrawn from the First Corps Area 21 October 1928 and demobilized.

Commanders, 38th Surgical Hospital (I)

Capt. Edmund J. O'Shaughnessy	ao Jun 25-Apr 26	Maj. Oliver L. Stringfield	Apr 26-27 Dec 28
-------------------------------	------------------	----------------------------	------------------

38th Surgical Hospital (II) (Second Army)

Regular Army Inactive

HQ—Stamford, CT, 1928-34; *Inactive* 1934-40; Second Corps Area 1940-41

Constituted in the Regular Army 21 December 1928, assigned to the Second Army, and allotted to the First Corps Area. Concurrently organized with Organized Reserve personnel as a RAI unit with headquarters at Stamford, CT. Inactivated in October 1934 at Stamford by relief of personnel. Withdrawn from the First Corps Area 5 June 1936 and allotted to the Second Corps Area. Reorganized 2 September 1940 in the Second Corps Area. Location 7 December 1941—Second Corps Area.

Commanders, 38th Surgical Hospital (II)

Maj. Edmund J. O'Shaughnessy**	27 Dec 28-Oct 34	Capt. Stephen G. Chesko**	2 Sep 40-ao Jun 41
<i>Inactive</i>	Oct 34-2 Sep 40	Unknown	ao Jun 41-7 Dec 41

** RAI Commanders: Organized Reserve officers.

39th Surgical Hospital (Fourth Army)

Organized Reserve Massachusetts/Ohio

HQ-Not initiated 1923-24; Boston, MA 1924-28; *Inactive* 1928-35; Columbus, OH, 1935-37; *Inactive* 1937-41

Constituted in the Organized Reserve 2 July 1923 as Surgical Hospital No. 39, assigned to the Fourth Army, and allotted to the First Corps Area. Initiated by December 1924 at Boston, MA. Redesignated 39th Surgical Hospital 23 March 1925. Withdrawn from the Organized Reserve 6 October 1928 and allotted to the Regular Army. Concurrently, withdrawn from the First Corps Area and allotted to the Fifth Corps Area. Relieved from the Fourth Army 1 October 1933 and assigned to the Second Army. Reorganized by June 1935 at Columbus, OH. Inactivated by June 1937 at Columbus by relief of personnel. Designated mobilization station was Fort Oglethorpe, GA. Location 7 December 1941—*Inactive*.

Commanders, 39th Surgical Hospital

Maj. Hollis G. Batchelder	ao Apr 26-Mar 28	Lt. Col. Nicolas A. Albanese**	ao Jun 35-ao Jan 36
Maj. Donald Munro**	Mar 28-6 Oct 28	Unknown	ao Jan 36-ao Jun 37
<i>Inactive</i>	6 Oct 28-ao Jun 35	<i>Inactive</i>	ao Jun 37-7 Dec 41

** RAI Commanders: Organized Reserve officers.

40th Surgical Hospital (Fourth Army)

Organized Reserve Connecticut/New Jersey

HQ-Not initiated 1923-25; Waterbury, CT, 1925-36; *Inactive* 1936-41

Constituted in the Organized Reserve 2 July 1923 as Surgical Hospital No. 40, assigned to the Fourth Army, and allotted to the First Corps Area. Affiliated 15 December 1923 with Waterbury Hospital in Waterbury, CT. Redesignated 40th Surgical Hospital 23 March 1925. Initiated by June 1925 at Waterbury, CT. Relieved from the Fourth Army 1 October 1933 and assigned to First Army. Withdrawn from the First Corps Area 5 June 1936 and allotted to the Second Corps Area. Jersey City, NJ, designated as headquarters on reorganization, but the unit was never organized at that location. Location 7 December 1941—*Inactive*.

Status: Disbanded 30 January 1942.

Commanders, 40th Surgical Hospital

Maj. George M. Smith	ao Jun 25-ao Jul 28	Unknown	ao Jul 28-5 Jun 36
	<i>Inactive</i>	5 Jun 36-7 Dec 41	

41st Surgical Hospital (Fourth Army)

Organized Reserve Massachusetts/Ohio

HQ-Not initiated 1923-26; Worcester, MA 1926-28; *Inactive* 1928-30; Cleveland, OH, 1930-41

Constituted in the Organized Reserve 2 July 1923 as Surgical Hospital No. 41, assigned to the Fourth Army, and allotted to the First Corps Area. Redesignated 41st Surgical Hospital 23 March 1925. Initiated by March 1926 at Worcester, MA. Withdrawn from the Organized Reserve 6 October 1928 and allotted to the Regular Army. Concurrently withdrawn from the First Corps Area and allotted to the Fifth Corps Area. Reorganized 28 April 1930 at, and affiliated with, Western Reserve University in Cleveland, OH. Relieved from the Fourth Army 1 October 1933 and assigned to the Second Army. Designated mobilization station was Fort Oglethorpe, GA. Location 7 December 1941—Cleveland, OH.

Status: Active in the Regular Army as the 41st Combat Support Hospital at Fort Hood, TX.

Commanders, 41st Surgical Hospital

Lt. Col. Donald S. Adams <i>Inactive</i>	ao Mar 26-6 Oct 28 6 Oct 28-28 Apr 30 Unknown	Unknown Lt. Col. Walter B. Rogers ao Jun 37-7 Dec 41	28 Apr 30-ao Mar 37 ao Mar 37-ao Jun 37
---	---	--	--

42nd Surgical Hospital (Fourth Army)

Organized Reserve Massachusetts/Illinois

HQ-Not initiated 1923-25; New Bedford, MA 1925-28; *Inactive* 1928-29; Chicago, IL, 1929-41

Constituted in the Organized Reserve 2 July 1923 as Surgical Hospital No. 42, assigned to the Fourth Army, and allotted to the First Corps Area. Initiated by March 1926 at New Bedford, MA. Redesignated 42nd Surgical Hospital 23 March 1925. Withdrawn from the Organized Reserve 6 October 1928 and allotted to the Regular Army. Concurrently, withdrawn from the First Corps Area and allotted to the Fifth Corps Area. Reorganized 12 January 1929 at Chicago, IL. Relieved from the Fourth Army 1 October 1933 and assigned to Second Army. Conducted summer training at the station hospitals at Fort Snelling, MN, or Jefferson Barracks, MO. Designated mobilization station was Fort Oglethorpe, GA. Location 7 December 1941—Chicago, IL.

Commanders, 42nd Surgical Hospital

Maj. Louis B. Hayden <i>Inactive</i>	ao Mar 26-6 Oct 28 6 Oct 28-12 Jan 29	Unknown Lt. Col. Samuel M. Robin**	ao Jun 29-20 Nov 37 20 Nov 37-ao Jan 40
Maj. Oliver B. Stewart**	12 Jan 29-ao Jun 29	Unknown	ao Jan 40-7 Dec 41

** RAI Commanders: Organized Reserve officers.

43rd Surgical Hospital (Fifth Army)

Organized Reserve Illinois/Wisconsin

HQ-Not initiated 1923-25; Chicago, IL, 1925-26; Wauwatosa, WI, 1926-34; Milwaukee, WI, 1934-41

Constituted in the Organized Reserve 2 July 1923 as Surgical Hospital No. 43, assigned to the Fifth Army, and allotted to the Sixth Corps Area. Redesignated 43rd Surgical Hospital 23 March 1925. Initiated 1 April 1925 at Chicago, IL. Relocated 23 December 1926 to Wauwatosa, WI. Reorganized at, and affiliated with, the Milwaukee County Hospital in Wauwatosa. Withdrawn from the Organized Reserve 1 October 1933 and allotted to the Regular Army. Concurrently relieved from the Fifth Army and assigned to Second Army. Relocated 22 March 1934 to Milwaukee, WI. Conducted annual summer training at the station hospitals at Camp Custer, MI, Camp McCoy, WI, or Fort Sheridan, IL. Designated mobilization station was Fort Oglethorpe, GA. Location 7 December 1941—Milwaukee, WI.

Commanders, 43rd Surgical Hospital

1st Lt. James F. Wilkinson Unknown	1 Apr 25-ao May 25 ao May 25-ao Jan 27	1st Lt. Robert J. Brooks Unknown	ao Jun 29-ao Jun 30 ao Jun 30-ao Jun 34
1st Lt. Franklin T. O'Connell Unknown	ao Jan 27-ao Jun 27 ao Jun 27-ao Jun 29	Col. Edward J. Barrett** Unknown	ao Jun 34-ao Jun 37 ao Jun 37-7 Dec 41

** RAI Commanders: Organized Reserve officers.

44th Surgical Hospital (Fifth Army)

Organized Reserve Michigan

HQ-Not initiated 1923-25; Grand Rapids, MI, 1925-30; *Inactive* 1930-34; Grand Rapids, MI, 1934-41

Constituted in the Organized Reserve 2 July 1923 as Surgical Hospital No. 44, assigned to the Fifth Army, and allotted to the Sixth Corps Area. Initiated by September 1925 at Grand Rapids, MI. Redesignated 44th Surgical Hospital 23 March 1925. Inactivated by December 1930 at Grand Rapids by relief of personnel. Relieved from the Fifth Army 1 October 1933 and assigned to Second Army. Reorganized by June 1934 at Grand Rapids. Designated mobilization station was Fort Oglethorpe, GA. Location 7 December 1941—Grand Rapids, MI.

Commanders, 44th Surgical Hospital

Lt. Col. Wilfred Haughey	ao Sep 25-Jun 29	<i>Inactive</i>	ao Dec 30-ao Jul 34
Maj. Erwin R. Schmidt	Jun 29-ao Jul 29	Maj. Garnett S. Felt	ao Jul 34-ao Jun 39
Unknown	ao Jul 29-ao Dec 30	Unknown	ao Jun 39-7 Dec 41

45th Surgical Hospital (Fifth Army)

Organized Reserve Illinois

HQ-Not initiated 1923-26; Springfield, IL, 1926-41

Constituted in the Organized Reserve 2 July 1923 as Surgical Hospital No. 45, assigned to the Fifth Army, and allotted to the Sixth Corps Area. Redesignated 45th Surgical Hospital 23 March 1925. Initiated 16 June 1926 at Springfield, IL. Relieved from the Fifth Army 1 October 1933 and assigned to Second Army. Conducted annual summer training at the station hospital at Jefferson Barracks, MO. Location 7 December 1941—Springfield, IL.

Commanders, 45th Surgical Hospital

Lt. Col. Joseph B. Schreiter	16 Jun 26-ao Jun 36	Unknown	ao Jun 36-7 Dec 41
------------------------------	---------------------	---------	--------------------

46th Surgical Hospital (Fifth Army)

Organized Reserve Illinois/Michigan

HQ-Not initiated 1923-25; Ann Arbor, MI, 1925-26; Highland Park, MI, 1926-30; *Inactive* 1930-34; Detroit, MI, 1934-41

Constituted in the Organized Reserve 2 July 1923 as Surgical Hospital No. 46, assigned to the Fifth Army, and allotted to the Sixth Corps Area. Redesignated 46th Surgical Hospital 23 March 1925. Initiated by September 1925 at Ann Arbor, MI. Relocated 23 December 1926 to Highland Park, MI. Inactivated by December 1930 at Highland Park by relief of personnel. Relieved from the Fifth Army 1 October 1933 and assigned to Second Army. Reorganized by June 1934 at Detroit, MI. Conducted annual summer training at the station hospital at Camp Custer, MI. Location 7 December 1941—Detroit, MI.

Commanders, 46th Surgical Hospital

Lt. Col. Frank C. Kinsey	ao Sep 25-ao Jul 28	<i>Inactive</i>	ao Dec 30-ao Jun 34
Unknown	ao Jul 28-ao Dec 30	Unknown	ao Jun 34-7 Dec 41

47th Surgical Hospital (Fifth Army)

Organized Reserve Michigan/Illinois

HQ-Not initiated 1923-26; Detroit, MI, 1926-28; Chicago, IL, 1928-41



Constituted in the Organized Reserve 2 July 1923 as Surgical Hospital No. 47, assigned to the Fifth Army, and allotted to the Sixth Corps Area. Redesignated 47th Surgical Hospital 23 March 1925. Initiated 17 November 1926 at Detroit, MI. Withdrawn from the Organized Reserve 6 October 1928 and allotted to the Regular Army. Relocated by December 1928 to Chicago, IL. Relieved from the Fifth Army 1 October 1933 and assigned to the Second Army. Conducted summer training at the station hospitals at Fort Snelling, MN, Jefferson Barracks, MO, or Camp Custer, MI. Designated mobilization station was Fort Oglethorpe, GA. Location 7 December 1941—Chicago, IL.

Status: Active in the Regular Army as the 47th Combat Support Hospital at Fort Lewis, WA.

Commanders, 47th Surgical Hospital

Lt. Col. William H. Walsh**	17 Nov 26-8 Mar 29	Lt. Col. Edmund G. Brust**	ao Jun 32-ao Aug 39
Unknown	8 Mar 29-ao Jun 32	Unknown	ao Aug 39-7 Dec 41

** RAI Commanders: Organized Reserve officers.

48th Surgical Hospital (Fifth Army)**Organized Reserve Illinois****HQ-Not initiated** 1923-25; Chicago, IL, 1925-41

Constituted in the Organized Reserve 2 July 1923 as Surgical Hospital No. 48, assigned to the Fifth Army, and allotted to the Sixth Corps Area. Initiated by March 1925 at Chicago, IL. Redesignated 48th Surgical Hospital 23 March 1925. Withdrawn from Organized Reserve 1 October 1933 and allotted to the Regular Army. Concurrently, relieved from the Fifth Army and assigned to the Second Army. Conducted summer training at the station hospitals at Fort Snelling, MN, Fort Sheridan, IL, or Camp Custer, MI. Activated 10 February 1941, less Reserve personnel, at Fort Francis E. Warren, WY, and assigned to the Fourth Army. Location 7 December 1941—Fort Francis E. Warren, WY.

Status: Inactive in the Regular Army as the 128th Combat Support Hospital.**Commanders, 48th Surgical Hospital**

Unknown	ao Mar 25-Jul 26	Unknown	ao Feb 35-ao Oct 35
Lt. Col. Robert J. Hathaway	Jul 26-Aug 29	Lt. Col. Otto L. Kahn**	ao Oct 35-ao Jul 39
Maj. Carl B. Herrmann**	Aug 29-ao Feb 35	Unknown	ao Jul 39-5 Sep 41
	Maj. Merritt G. Ringer*	5 Sep 41-ao Dec 41	

* Regular Army active duty commanders

** RAI Commanders: Organized Reserve officers.

49th Surgical Hospital (Fifth Army)**Organized Reserve Michigan****HQ-Not initiated** 1923-28; Highland Park, MI, 1928-28

Constituted in the Organized Reserve 2 July 1923 as Surgical Hospital No. 49, assigned to the Fifth Army, and allotted to the Sixth Corps Area. Redesignated 49th Surgical Hospital 23 March 1925. Initiated 11 April 1928 at Highland Park, MI. Withdrawn from the Sixth Corps Area 27 December 1928 and demobilized.

Commanders, 49th Surgical Hospital

Lt. Col. Martin H. Deffenbaugh	11 Apr 28-27 Dec 28
--------------------------------	---------------------

50th Surgical Hospital (Fifth Army)**Organized Reserve Wisconsin****HQ-Not initiated** 1923-25; Milwaukee, WI, 1925-37; Wausau, WI, 1937-41

Constituted in the Organized Reserve 2 July 1923 as Surgical Hospital No. 50, assigned to the Fifth Army, and allotted to the Sixth Corps Area. Redesignated 50th Surgical Hospital 23 March 1925. Initiated 24 March 1925 at Milwaukee, WI. Relieved from the Fifth Army 1 October 1933 and assigned to the General Headquarters Reserve. Relocated 7 April 1937 to Wausau, WI. Conducted summer training at the station hospitals at Fort Snelling, MN, Fort Sheridan, IL, or Camp McCoy, WI. Location 7 December 1941—Wausau, WI.

Commanders, 50th Surgical Hospital

Capt. Hjorleifur T. Kristjanson	24 Mar 25-ao Apr 25	Lt. Col. Frank F. Bowman	30 Jul 29-ao Aug 29
Lt. Col. Emery B. Neff	ao Sep 25-ao Jun 27	Unknown	ao Aug 29-ao Jul 32
Unknown	ao Jun 27-ao Jun 29	Col. Walter A. Ford	ao Jul 32-ao Jan 40
Maj. Allen L. Millard	ao Jun 29-30 Jul 29	Unknown	ao Jan 40-7 Dec 41

51st Surgical Hospital (Sixth Army)**Organized Reserve Missouri/Minnesota****HQ-Not initiated** 1923-27; St. Louis, MO, 1927-31; Minneapolis, MN, 1931-41

Constituted in the Organized Reserve 2 July 1923 as Surgical Hospital No. 51, assigned to the Sixth Army, and allotted to the Seventh Corps Area. Affiliated 5 July 1924 with St. Luke's Hospital in St. Louis, MO. Redesignated 51st Surgical Hospital 23 March 1925. Initiated by June 1927 at St. Louis. Relocated 12 October 1931 to Minneapolis, MN. Withdrawn from the Organized Reserve 1 October 1933 and allotted to the Regular Army. Concurrently, relieved from the Sixth Army and assigned to the Fourth Army. Designated mobilization station was Camp Dodge, IA. Location 7 December 1941—Minneapolis, MN, (Inactivated 22 January 1942).

Status: Disbanded 11 November 1944.

Commanders, 51st Surgical Hospital

1st Lt. Chester L. Carson	ao Jun 27-ao Jul 27	Maj. Maurice W. Quigley**	17 Nov 35-8 Dec 36
Unknown	ao Jul 27-17 Nov 35	Maj. Charles K. Holmes**	8 Dec 36-ao Jan 37
	Unknown	ao Jan 37-7 Dec 41	

** RAI Commanders: Organized Reserve officers.

52nd Surgical Hospital (Third Army)

Organized Reserve Kansas/Minnesota

HQ-Not initiated 1923-25; Fort Riley, KS, 1925-28; St. Paul, MN, 1928-41

Constituted in the Organized Reserve 2 July 1923 as Surgical Hospital No. 52, assigned to the Third Army, and allotted to the Seventh Corps Area. Initiated by September 1925 at Fort Riley, KS. Redesignated 52nd Surgical Hospital 23 March 1925. Relocated 3 April 1928 to St. Paul, MN. Designated mobilization station was Camp Dodge, IA. Location 7 December 1941—St. Paul, MN.

Commanders, 52nd Surgical Hospital

Lt. Col. John N. Sherman	ao Sep 25-Nov 28	Lt. Col. George H. Smith	Nov 28-Jul 29
	Unknown	Jul 29-7 Dec 41	

53rd Surgical Hospital (Third Army)

Organized Reserve Nebraska

HQ-Not initiated 1923-25; Omaha, NE, 1925-41

Constituted in the Organized Reserve 2 July 1923 as Surgical Hospital No. 53, assigned to the Third Army, and allotted to the Seventh Corps Area. Initiated by October 1925 at Omaha, NE. Redesignated 53rd Surgical Hospital 23 March 1925. Relieved from the Third Army 1 October 1933 and assigned to the Fourth Army. Conducted summer training at the station hospital at Fort Sam Houston, TX. Designated mobilization station was Camp Dodge, IA. Location 7 December 1941—Omaha.

Commanders, 53rd Surgical Hospital

Lt. Col. Alfred J. Brown	ao Oct 25-May 29	Maj. Francis E. Bouza	Dec 30-Feb 31
Lt. Col. Ole Olson	Dec 29-Mar 30	Lt. Col. Louis H. Webb	Feb 31-ao Mar 31
	Unknown	ao Mar 31-7 Dec 41	

54th Surgical Hospital (Sixth Army)

Organized Reserve Iowa

HQ-Not initiated 1923-25; Fort Des Moines, IA, 1925-31; Ottumwa, IA, 1931-41

Constituted in the Organized Reserve 2 July 1923 as Surgical Hospital No. 54, assigned to the Sixth Army, and allotted to the Seventh Corps Area. Redesignated 54th Surgical Hospital 23 March 1925. Initiated by September 1925 at Fort Des Moines, IA. Relocated 12 October 1931 to Ottumwa, IA. Designated mobilization station was Camp Dodge, IA. Location 7 December 1941—Ottumwa, IA.

Commanders, 54th Surgical Hospital

Lt. Col. Harold A. Spilman	ao Sep 25-Apr 29	Unknown	Apr 29-7 Dec 41
----------------------------	------------------	---------	-----------------

55th Surgical Hospital (Third Army)

Organized Reserve Minnesota/North Carolina

HQ-Not initiated 1923-25; Fort Snelling, MN, 1925-33; *Inactive* 1933-35; Durham, NC, 1935-41

Constituted in the Organized Reserve 2 July 1923 as Surgical Hospital No. 55, assigned to the Third Army, and allotted to the Seventh Corps Area. Redesignated 55th Surgical Hospital 23 March 1925. Initiated by September 1925 at Fort Snelling, MN. Withdrawn from the Seventh Corps Area 1 October 1933 and allotted to the Fourth Corps Area. Reorganized 29 January 1935 at Durham, NC. Location 7 December 1941—Durham, NC.

Commanders, 55th Surgical Hospital

Unknown	ao Sep 25-ao Jun 27	Unknown	Feb 30-1 Oct 33
Col. Gilbert G. Cottam	ao Jun 27-Feb 30	<i>Inactive</i>	1 Oct 33-29 Jan 35
	Unknown	29 Jan 35-7 Dec 41	

56th Surgical Hospital (Third Army)

Organized Reserve Minnesota

HQ-*Not initiated* 1923-25; Minneapolis, MN, 1925-27; *Inactive* 1927-28

Constituted in the Organized Reserve 2 July 1923 as Surgical Hospital No. 55, assigned to the Third Army, and allotted to the Seventh Corps Area. Redesignated 56th Surgical Hospital 23 March 1925. Initiated by September 1925 at Minneapolis, MN. Inactivated by June 1927 at Minneapolis by relief of personnel. Withdrawn from the Organized Reserve 27 December 1928 and demobilized.

Commanders, 56th Surgical Hospital

Unknown	ao Sep 25-ao Jun 27	<i>Inactive</i>	ao Jun 27-27 Dec 28
---------	---------------------	-----------------	---------------------

57th Surgical Hospital (Sixth Army)

Organized Reserve Kansas

HQ-*Not initiated* 1923-25; Fort Leavenworth, KS, 1924-33; *Inactive* 1933-41

Constituted in the Organized Reserve 2 July 1923 as Surgical Hospital No. 57, assigned to the Sixth Army, and allotted to the Seventh Corps Area. Redesignated 57th Surgical Hospital 23 March 1925. Initiated by September 1925 at Fort Leavenworth, KS. Withdrawn from the Seventh Corps Area 1 October 1933 and allotted to the Eighth Corps Area. Concurrently relieved from the Sixth Army and assigned to the Third Army. Location 7 December 1941—*Inactive*.

Commanders, 57th Surgical Hospital

Col. Hugh Wilkinson	ao Sep 25-Jan 32	Unknown	Jan 32-1 Oct 33
	<i>Inactive</i>	1 Oct 33-7 Dec 41	

58th Surgical Hospital (Sixth Army)

Organized Reserve Texas

HQ-*Not initiated* 1923-25; Galveston, TX, 1925-41

Reconstituted in the Organized Reserve 2 July 1923 as Surgical Hospital No. 58, assigned to the Sixth Army, and allotted to the Eighth Corps Area. Redesignated 58th Surgical Hospital 23 March 1925. Initiated 27 July 1925 at Galveston, TX. Relieved from the Sixth Army 1 October 1933 and assigned to the Third Army. Conducted summer training at the station hospital at Fort Sam Houston, TX. Designated mobilization training station was Camp Stanley, TX. Location 7 December 1941—Galveston, TX.

Commanders, 58th Surgical Hospital

Maj. Harry K. Loew	27 Jul 25-ao Feb 32	Lt. Col. Walter A. Ford	ao Jul 35-ao Jan 41
Unknown	ao Feb 32-ao Jul 35	Unknown	ao Jan 41-7 Dec 41

59th Surgical Hospital (Sixth Army)

Organized Reserve Texas

HQ-*Not initiated* 1923-25; Austin, TX, 1925-29; *Inactive* 1929-41

Reconstituted in the Organized Reserve 2 July 1923 as Surgical Hospital No. 59, assigned to the Sixth Army, and allotted to the Eighth Corps Area. Initiated 25 February 1925 at Austin, TX. Redesignated 59th Surgical Hospital 23 March 1925. Withdrawn from the Organized Reserve 27 December 1928 and allotted to the Regular Army. Relieved from the Sixth Army 1 October 1933 and assigned to the Third Army. Inactivated 14 February 1929 at Austin by relief of personnel. Conducted summer training at the station hospital at Fort Sam Houston, TX. Designated mobilization training station was Camp Stanley, TX. Location 7 December 1941—*Inactive*.

Commanders, 59th Surgical Hospital

Lt. Col. Richard L. Cook	25 Feb 25-ao Aug 26	Maj. Jackson S. Cooper**	ao Mar 26-14 Feb 29
Unknown	ao Aug 25-ao Mar 26	<i>Inactive</i>	14 Feb 29-7 Feb 41

** RAI Commanders: Organized Reserve officers.

60th Surgical Hospital (Sixth Army)

Organized Reserve Oklahoma

HQ-Not initiated 1923-26; Tulsa, OK, 1923-41

Reconstituted in the Organized Reserve 2 July 1923 as Surgical Hospital No. 60, assigned to the Sixth Army, and allotted to the Eighth Corps Area. Redesignated 60th Surgical Hospital 23 March 1925. Initiated 8 February 1926 at Tulsa, OK. Relieved from the Sixth Army 1 October 1933 and assigned to the Third Army. Conducted summer training most years at Fitzsimons General Hospital in Denver, CO, or at the station hospital at Fort Sam Houston, TX. Designated mobilization training station was Camp Stanley, TX. Location 7 December 1941—Tulsa, OK.

Commanders, 60th Surgical Hospital

Lt. Col. Floyd E. Waterfield	8 Feb 26-28 Jun 29	Lt. Col. Jasper Grimes	7 Sep 32-25 Sep 32
Maj. George E. Hartshorne	28 Jun 29-15 Nov 29	Maj. Albert N. Earnest	25 Sep 32-19 Jan 33
Lt. Col. Pleasant P. Nesbitt	15 Nov 29-6 Jun 31	Unknown	19 Jan 33-ao Dec 40
Maj. Albert N. Earnest	6 Jun 31-22 Dec 31	Lt. Col. E. Albert Eisenstadt	ao Dec 40-ao Mar 41
Lt. Col. Walter A. Ostendorf	22 Dec 31-7 Sep 32	Unknown	ao Mar 41-ao Dec 41

61st Surgical Hospital (Third Army)

Organized Reserve Oklahoma

HQ-Not initiated 1923-26; Tulsa, OK, 1926-41; Fort George G. Meade, MD, 1941



Constituted in the Organized Reserve 2 July 1923 as Surgical Hospital No. 61, assigned to the Third Army, and allotted to the Eighth Corps Area. Redesignated 61st Surgical Hospital 23 March 1925. Initiated 8 February 1926 at Tulsa, OK. Withdrawn from the Organized Reserve 1 January 1938 and allotted to the Regular Army. Conducted summer training at the station hospital at Fort Sam Houston, TX. Designated mobilization training station was Camp Stanley, TX. Activated 1 June 1941, less Reserve personnel, at Fort George G. Meade, MD, and assigned to the First Army. Location 7 December 1941—Fort George G. Meade, MD.

Status: Inactive in the Regular Army as the 93rd Evacuation Hospital.

Commanders, 61st Surgical Hospital

Maj. Richard S. Wilson	8 Feb 26-21 Apr 26	Maj. James G. Harris	15 Dec 27-8 Dec 32
Maj. James G. Harris	21 Apr 26-31 Sep 27	Maj. John C. Jacobs	31 Dec 27-26 Sep 32
Capt. Ralph E. Jones	31 Sep 27-15 Dec 27	Maj. George P. Acton	26 Sep 32-ao Jan 33
	Unknown	ao Jan 33-7 Dec 41	

62nd Surgical Hospital (Third Army)

Organized Reserve Colorado/Nebraska

HQ-Not initiated 1923-25; Denver, CO, 1925-28; *Inactive* 1928-29; Denver, CO, 1929-33; *Inactive* 1933-35; Omaha, NE, 1935-41

Constituted in the Organized Reserve 2 July 1923 as Surgical Hospital No. 62, assigned to the Third Army, and allotted to the Eighth Corps Area. Redesignated 62nd Surgical Hospital 23 March 1925. Initiated 8 February 1926 at Denver, CO. Withdrawn from the Organized Reserve 6 October 1928 and allotted to the Regular Army. Inactivated 5 November 1928 at Denver by relief of personnel. Reorganized in December 1929 at Denver. Withdrawn from the Eighth Corps Area 1 October 1933 and allotted to the Seventh Corps Area. Concurrently relieved from the Third Army and assigned to the Fourth Army. Reorganized 10 November 1935 at Omaha, NE. Conducted summer training at the station hospital at Fort Sam Houston, TX, 1925-33. Designated mobilization station was Camp Dodge, IA, 1933-41. Location 7 December 1941—Omaha, NE.

Status: Disbanded 11 November 1944.

Commanders, 62nd Surgical Hospital

Lt. Col. Lee H. Winemiller	8 Feb 25-14 Feb 28	Unknown	ao Jan 30-1 Oct 33
Maj. Ray L. Drinkwater**	14 Feb 28-5 Nov 28	<i>Inactive</i>	1 Oct 33-10 Nov 35
<i>Inactive</i>	5 Nov 28-Dec 29	Maj. John H. Murphy**	10 Nov 35-26 Apr 38
Maj. Lothar F. Egan**	Dec 29-ao Jan 30	Maj. Charles H. Arnold**	19 May 38-ao Jan 39
	Unknown	ao Jan 39-7 Dec 41	

** RAI Commanders: Organized Reserve officers.

63rd Surgical Hospital (Third Army)

Organized Reserve Colorado/Nebraska

HQ-Not initiated 1923-25; Denver, CO, 1925-29; *Inactive* 1929-35; Omaha, NE, 1935-41; Fort Oglethorpe, GA, 1941
 Constituted in the Organized Reserve 2 July 1923 as Surgical Hospital No. 63, assigned to the Third Army, and allotted to the Eighth Corps Area. Redesignated 63rd Surgical Hospital 23 March 1925. Initiated by March 1925 at Denver, CO. Withdrawn from the Organized Reserve 6 October 1928 and allotted to the Regular Army. Inactivated 23 January 1929 at Denver by relief of personnel. Withdrawn from the Eighth Corps Area 1 October 1933 and allotted to the Seventh Corps Area. Concurrently relieved from the Third Army and assigned to the Fourth Army. Reorganized by November 1935 at Omaha, NE. Conducted summer training at the station hospital at Fort Leavenworth, KS. Designated mobilization station was Camp Dodge, IA, 1933-41. Activated 1 June 1941, less Reserve personnel, at Fort Oglethorpe, GA. Relieved from the Fourth Army 7 November 1941 and assigned to the Third Army. Location 7 December 1941—Fort Oglethorpe, GA.

Status: *Inactive* in the Regular Army as the 94th Evacuation Hospital.

Commanders, 63rd Surgical Hospital

Maj. Leon Block	ao Mar 25-23 Jan 28	Maj. Samuel W. Connor**	ao Jul 37-22 Aug 37
Lt. Col. Joseph H. Stolper**	23 Jan 28-23 Jan 29	Lt. Col. Walter M. Stout**	22 Aug 37-16 Sep 39
<i>Inactive</i>	23 Jan 29-ao Nov 35	Lt. Col. Frank Schaeffer**	16 Sep 39-ao Jan 40
Unknown	ao Nov 35-ao Jul 37	Unknown	ao Jan 40-1 Jun 41
	1st Lt. J. H. Smith*	1 Jun 41-ao Dec 41	

* Regular Army active duty commanders

** RAI Commanders: Organized Reserve officers.

64th Surgical Hospital (Third Army)

Organized Reserve Texas

HQ-Not initiated 1923-25; Austin, TX, 1925-29; Fort Clark, TX, 1929-1933; Houston, TX, 1933-40; Pueblo, CO, 1940-41

Constituted in the Organized Reserve 2 July 1923 as Surgical Hospital No. 64, assigned to the Third Army, and allotted to the Eighth Corps Area. Redesignated 64th Surgical Hospital 23 March 1925. Initiated 15 April 1925 at Austin, TX. Withdrawn from the Organized Reserve 6 October 1928 and allotted to the Regular Army. Relocated 19 February 1929 to Fort Clark, TX. Relocated about 1933 to Houston, TX. Relocated 25 September 1940 to Pueblo, CO. Concurrently affiliated with St. Mary's Hospital in Pueblo. Conducted summer training at the station hospitals at Fort Sam Houston, TX, or Fort Clark, TX. Designated mobilization training station was Fort Clark. Location 7 December 1941—Pueblo, CO.

Status: Disbanded 20 December 1943.

Commanders, 64th Surgical Hospital

Lt. Col. Joseph M. Greer	15 Apr 25-17 Oct 28	Maj. William F. McAnally**	20 Mar 30-6 Jun 30
Unknown	17 Oct 28-12 Apr 29	Unknown	6 Jun 30-ao Dec 34
Maj. George H. Spivey**	12 Apr 29-20 Mar 30	Maj. Oscar H. Peterson**	ao Dec 34-1 Feb 35
	Unknown	1 Feb 35-7 Dec 41	

** RAI Commanders: Organized Reserve officers.

65th Surgical Hospital (Third Army)**Organized Reserve California****HQ-Not initiated** 1923-25; San Francisco, CA, 1924-40; *Inactive* 1940-41

Constituted in the Organized Reserve 2 July 1923 as Surgical Hospital No. 65, assigned to the Third Army, and allotted to the Ninth Corps Area. Affiliated 2 May 1924 with the University of California Medical School in San Francisco, CA. Redesignated 65th Surgical Hospital 23 March 1925. Initiated in July 1925 at San Francisco, CA. Withdrawn from the Organized Reserve 1 October 1933 and allotted to the Regular Army. Concurrently relieved from the Third Army and assigned to the Fourth Army. Conducted summer training at the station hospitals at Presidio of Monterey, CA, or at Letterman General Hospital, San Francisco, CA. Inactivated 31 December 1940 at San Francisco by relief of personnel. Location 7 December 1941—*Inactive*.

Status: Disbanded 20 December 1943.**Commanders, 65th Surgical Hospital**

Maj. John H. Woolsey	Jul 25-ao Jun 27	Lt. Col. Earle V. Shaefe**	22 Apr 35-ao Jul 36
Unknown	ao Jun 27-Dec 30	Unknown	ao Jul 36-31 Dec 40
Lt. Col. Benjamin W. Black**	Dec 30-22 Apr 35	<i>Inactive</i>	31 Dec 40-7 Dec 41

** RAI Commanders: Organized Reserve officers.

66th Surgical Hospital (Third Army)**Organized Reserve Montana/California****HQ-Not initiated** 1923-25; Butte, MT, 1925-36; San Francisco, CA, 1936-37; *Inactive* 1937-41

Constituted in the Organized Reserve 2 July 1923 as Surgical Hospital No. 66, assigned to the Third Army, and allotted to the Ninth Corps Area. Redesignated 66th Surgical Hospital 23 March 1925. Affiliated with Murray Hospital in Butte, MT. Initiated in July 1925 at Butte, MT. Relieved from the Third Army 1 October 1933 and assigned to the Fourth Army. Relocated in 1936 to San Francisco, CA. Inactivated 31 January 1937 at San Francisco by relief of personnel. Conducted summer training at the station hospital at Fort Lewis, WA. Designated mobilization station was Fort Missoula, MT, 1923-36. Location 7 December 1941—*Inactive*.

Commanders, 66th Surgical Hospital

Lt. Col. Thomas C. Witherspoon	Jul 25-ao Jun 27	Lt. Col. Lawrence Stevens	ao Jun 29-31 Jan 37
Unknown	ao Jun 27-ao Jun 29	<i>Inactive</i>	31 Jan 37-7 Dec 41

67th Surgical Hospital (Third Army)**Organized Reserve California****HQ-Not initiated** 1923-25; Los Angeles, CA, 1925-41

Constituted in the Organized Reserve 2 July 1923 as Surgical Hospital No. 67, assigned to the Third Army, and allotted to the Ninth Corps Area. Redesignated 67th Surgical Hospital 23 March 1925. Affiliated with the Los Angeles General Hospital in Los Angeles, CA. Initiated in July 1925 at Los Angeles, CA. Relieved from the Third Army 1 October 1933 and assigned to the Fourth Army. Conducted summer training at the station hospital at Presidio of Monterey, CA. Location 7 December 1941—Los Angeles, CA.

Commanders, 67th Surgical Hospital

Maj. Walter A. Bayley	Jul 25-ao Jun 27	Maj. Clarence A. Johnson	ao Jun 29-Jan 31
Unknown	ao Jun 27-ao Jun 29	Unknown	Jan 31-7 Dec 41

68th Surgical Hospital (Third Army)**Organized Reserve California/Texas****HQ-Not initiated** 1923-25; San Francisco, CA, 1925-28; Fort Sam Houston, TX, 1928-36; *Inactive* 1936-41

Constituted in the Organized Reserve 2 July 1923 as Surgical Hospital No. 68, assigned to the Third Army, and allotted to the Ninth Corps Area. Redesignated 68th Surgical Hospital 23 March 1925. Affiliated with Hahnemann Hospital in San Francisco, CA. Initiated in July 1925 at San Francisco. Withdrawn from the Ninth Corps Area 1 September 1928 and allotted to the Eighth Corps Area. Withdrawn from the Organized Reserve 6 October 1928 and allotted to the Regular Army. Reorganized 12 April 1929 with Organized Reserve personnel as a RAI unit with headquarters at Fort Sam Houston, TX. Withdrawn from the Regular Army 5 June 1936 and allotted to the Organized Reserve. Concurrently withdrawn from the Eighth Corps Area and allotted to the Ninth Corps Area. Los Angeles, CA, designated as headquarters on reorganization, but the unit was never organized at that location. Conducted summer training at the station hospital at Fort Sam Houston, TX, 1929-35. Designated mobilization training station was Fort Sam Houston, TX, 1928-36. Location 7 December 1941—*Inactive*.

Status: Disbanded 20 December 1943.

Commanders, 68th Surgical Hospital

Lt. Col. Fred A. Pittenger	Jul 25-1 Sep 28	Maj. Enoch S. Fulton**	12 Apr 29-19 Jan 33
<i>Inactive</i>	1 Sep 28-12 Apr 29	Unknown	19 Jan 33-5 Jun 36
	<i>Inactive</i>	5 Jun 36-7 Dec 41	

** RAI Commanders: Organized Reserve officers.

69th Surgical Hospital (Sixth Army)

Organized Reserve Washington/California

HQ-*Not initiated* 1923-25; Seattle, WA, 1925-36; Los Angeles, CA, 1936-41

Constituted in the Organized Reserve 2 July 1923 as Surgical Hospital No. 69, assigned to the Sixth Army, and allotted to the Ninth Corps Area. Redesignated 69th Surgical Hospital 23 March 1925. Initiated in October 1925 at Seattle, WA. Withdrawn from the Organized Reserve 6 October 1928 and allotted to the Regular Army. Relieved from the Third Army 1 October 1933 and assigned to the Fourth Army. Relocated in 1936 to Los Angeles, CA. Typically conducted Inactive Training Period meetings at the Henry Building in Seattle. Location 7 December 1941—Los Angeles, CA.

Commanders, 69th Surgical Hospital

Lt. Col. William D. Kirkpatrick**	Oct 25-ao Mar 32	Unknown	ao Mar 32-7 Dec 41
-----------------------------------	------------------	---------	--------------------

** RAI Commanders: Organized Reserve officers.

70th Surgical Hospital (Sixth Army)

Organized Reserve Oregon/California

HQ-*Not initiated* 1923-25; Portland, OR, 1925-36; Los Angeles, CA, 1936-37; *Inactive* 1937-41

Constituted in the Organized Reserve 2 July 1923 as Surgical Hospital No. 70, assigned to the Sixth Army, and allotted to the Ninth Corps Area. Redesignated 70th Surgical Hospital 23 March 1925. Initiated by October 1925 at Portland, OR. Relieved from the Third Army 1 October 1933 and assigned to the Fourth Army. Relocated in 1936 to Los Angeles, CA. Inactivated 17 February 1937 at Los Angeles, CA, by relief of personnel. Typically conducted Inactive Training Period meetings at the Portland Aeronautics Club Building in Portland. Location 7 December 1941—*Inactive*.

Commanders, 70th Surgical Hospital

Lt. Col. William J. Pennock	Mar 26-Oct 26	Unknown	ao Jun 31-ao Jun 32
Lt. Col. John J. Sellwood	Oct 26-Jan 30	Maj. Harry F. Reidel	ao Jun 32-ao Jul 32
Lt. Col. Ferdinand H. Dammasch	Jan 30-ao Jun 31	Lt. Col. Charles G. Sabin	ao Jul 33-17 Feb 37
	<i>Inactive</i>	17 Feb 37-7 Dec 41	

71st Surgical Hospital (Sixth Army)

Organized Reserve California

HQ-*Not initiated* 1923-25; San Francisco, CA, 1925-30; *Inactive* 1930-34; San Francisco, CA, 1934-40; *Inactive* 1940-41

Constituted in the Organized Reserve 2 July 1923 as Surgical Hospital No. 71 assigned to the Sixth Army, and allotted to the Ninth Corps Area. Redesignated 71st Surgical Hospital 23 March 1925. Initiated by September 1925 at San Francisco, CA. Inactivated 15 April 1930 at San Francisco by relief of personnel. Withdrawn from the Organized Reserve 1 October 1933 and allotted to the Regular Army. Concurrently relieved from the Sixth Army and assigned to the General Headquarters Reserve. Reorganized by June 1934 at San Francisco. Conducted summer training at Letterman General Hospital, San Francisco. Inactivated 31 December 1940 at San Francisco by relief of personnel. Location 7 December 1941—*Inactive*.

Status: Disbanded 11 November 1944.

Commanders, 71st Surgical Hospital

Lt. Col. Charles D. Lockwood <i>Inactive</i>	ao Sep 25-15 Apr 30 15 Apr 30-ao Jun 34	Unknown <i>Inactive</i>	ao Jun 34-31 Dec 40 31 Dec 40-7 Dec 41
---	--	----------------------------	---

72nd Surgical Hospital (Sixth Army)

Organized Reserve California

HQ-Not initiated 1923-25; Los Angeles, CA, 1925-30; *Inactive* 1930-36; Los Angeles, CA, 1936-41

Constituted in the Organized Reserve 2 July 1923 as Surgical Hospital No. 72 assigned to the Sixth Army, and allotted to the Ninth Corps Area. Redesignated 72nd Surgical Hospital 23 March 1925. Initiated by July 1925 at Los Angeles, CA. Inactivated 15 April 1930 at Los Angeles by relief of personnel. Reorganized 27 January 1936 at Los Angeles. Location 7 December 1941—Los Angeles, CA.

Commanders, 72nd Surgical Hospital

Lt. Col. Levi L. Riggin <i>Inactive</i>	ao Jul 25-15 Apr 30 15 Apr 30-27 Jan 36	Lt. Col. Philip J. Lipsett Unknown	27 Jan 36-2 Jul 37 2 Jul 37-7 Dec 41
--	--	---------------------------------------	---

73rd Surgical Hospital (Fourth Army)

Organized Reserve California/Oregon

HQ-Not initiated 1923-29; Los Angeles, CA, 1929-31; Portland, OR, 1931-41

Constituted in the Organized Reserve 2 July 1923 as Surgical Hospital No. 73 assigned to the Sixth Army, and allotted to the Ninth Corps Area. Redesignated 73rd Surgical Hospital 23 March 1925. Withdrawn from the Organized Reserve 21 December 1928 and allotted to the Regular Army. Organized 17 March 1929 at Los Angeles, CA. Relocated by December 1931 to Portland, OR. Typically conducted Inactive Training Period meetings at the Portland Aeronautics Club Building in Portland. Conducted summer training at the station hospital at Fort Lewis, WA. Location 7 December 1941—Portland, OR.

Status: Disbanded 11 November 1944.

Commanders, 73rd Surgical Hospital

Maj. Leo W. Chilton**	17 Mar 29-ao Jun 29	Unknown	ao Jun 35-ao May 36
Unknown	ao Jun 29-7 Mar 35	Maj. Vernon E. Ruedy**	ao May 36-14 Jan 37
Maj. Dean P. Crowell**	7 Mar 35-ao Jun 35	Maj. William Levin**	14 Jan 37-ao Mar 40
	Unknown	ao Mar 40-7 Dec 41	

** RAI Commanders: Organized Reserve officers.

74th Surgical Hospital (I) (Fourth Army)

Organized Reserve California/Washington

HQ-Not initiated 1923-27; San Francisco, CA, 1927-28

Constituted in the Organized Reserve 2 July 1923 as Surgical Hospital No. 74 assigned to the Sixth Army, and allotted to the Ninth Corps Area. Redesignated 74th Surgical Hospital 23 March 1925. Initiated by June 1927 at San Francisco, CA. Withdrawn from the Organized Reserve 21 December 1928 and demobilized.

Commanders, 74th Surgical Hospital (I)

Unknown ao Jun 27-21 Dec 28

74th Surgical Hospital (II) (Fourth Army)

Regular Army Inactive

HQ-Not organized 1928-32; Seattle, WA, 1932-41; Fort Francis E. Warren, WY, 1941

Constituted in the Regular Army 21 December 1928, assigned to the Fourth Army, and allotted to the Ninth Corps Area. Organized by June 1932 organized with Organized Reserve personnel as a RAI unit with headquarters at Seattle, WA. Activated 1 June 1941, less Reserve personnel, at Fort Francis E. Warren, WY, and assigned to the Fourth Army. Location 7 December 1941—Fort Francis E. Warren, WY.

Status: Active in the Regular Army as the 95th Combat Support Hospital at Heidelberg, Germany.

Commanders, 74th Surgical Hospital (II)

Unknown	ao Jun 32-18 Mar 37	Unknown	ao Jun 39-1 Jun 41
Maj. Herbert M. Knudtsen**	18 Mar 37-ao Jun 39	1st Lt. G. H. Talbot*	1 Jun 41-ao Dec 41

* Regular Army active duty commanders

** RAI Commanders: Organized Reserve officers.

602nd Surgical Hospital (C.Z.)

Regular Army Inactive

HQ-Not organized 1927-28

Constituted in the Regular Army 18 October 1927, assigned to the Communications Zone, and allotted to the Second Corps Area. Withdrawn from the Second Corps Area 5 September 1928. Demobilized 21 December 1928.

605th Surgical Hospital (C.Z.)

Regular Army Inactive

HQ-Not organized 1927-28; Fifth Corps Area 1928

Constituted in the Regular Army 18 October 1927, assigned to the Communications Zone, and allotted to the Fifth Corps Area. Organized 2 August 1928 with Organized Reserve personnel as a RAI unit in the Fifth Corps Area. Withdrawn from the Fifth Corps Area 5 September 1928. Demobilized 21 December 1928.

Commanders, 605th Surgical Hospital

Unknown 2 Aug 28-5 Sep 28

608th Surgical Hospital (C.Z.)

Regular Army Inactive

HQ-Not organized 1927-28

Constituted in the Regular Army 18 October 1927, assigned to the Communications Zone, and allotted to the Third Corps Area. Withdrawn from the Third Corps Area 5 September 1928. Demobilized 21 December 1928.

617th Surgical Hospital (C.Z.)

Regular Army Inactive

HQ-Not organized 1927-28

Constituted in the Regular Army 18 October 1927, assigned to the Communications Zone, and allotted to the Third Corps Area. Withdrawn from the Third Corps Area 5 September 1928. Demobilized 21 December 1928.

632nd Surgical Hospital (C.Z.)**Regular Army Inactive****HQ-Not organized** 1927-28; Fifth Corps Area 1928

Constituted in the Regular Army 18 October 1927, assigned to the Communications Zone, and allotted to the Fifth Corps Area. Organized 2 August 1928 with Organized Reserve personnel as a RAI unit with headquarters in the Fifth Corps Area. Withdrawn from the Fifth Corps Area 5 September 1928 and demobilized.

Commanders, 632nd Surgical Hospital

Unknown	2 Aug 28-5 Sep 28
---------	-------------------

648th Surgical Hospital (C.Z.)**Regular Army Inactive****HQ-Not organized** 1927-28; Sixth Corps Area 1928

Constituted in the Regular Army 18 October 1927, assigned to the Communications Zone, and allotted to the Sixth Corps Area. Organized 24 April 1928 with Organized Reserve personnel as a RAI unit with headquarters in the Sixth Corps Area. Withdrawn from the Sixth Corps Area 5 September 1928. Demobilized 21 December 1928.

Commanders, 648th Surgical Hospital

1st Lt. Will P. Gleason**	24 Apr 28-25 Jul 28	Maj. Oliver E. Stewart**	25 Jul 28-5 Sep 28
---------------------------	---------------------	--------------------------	--------------------

** RAI Commanders: Organized Reserve officers.

655th Surgical Hospital (C.Z.)**Regular Army Inactive****HQ-Not organized** 1927-28

Constituted in the Regular Army 18 October 1927, assigned to the Communications Zone, and allotted to the Seventh Corps Area. Withdrawn from the Seventh Corps Area 5 September 1928. Demobilized 21 December 1928.

660th Surgical Hospital (C.Z.)**Regular Army Inactive****HQ-Not organized** 1927-28

Constituted in the Regular Army 18 October 1927, assigned to the Communications Zone, and allotted to the Eighth Corps Area. Withdrawn from the Eighth Corps Area 5 September 1928. Demobilized 21 December 1928.

665th Surgical Hospital (C.Z.)**Regular Army Inactive****HQ-Not organized** 1927-28; Portland, OR, 1928

Constituted in the Regular Army 18 October 1927, assigned to the Communications Zone, and allotted to the Ninth Corps Area. Organized about March 1928 with Organized Reserve personnel as a RAI unit with headquarters at t Portland, OR. Withdrawn from the Ninth Corps Area 5 September 1928. Demobilized 21 December 1928.

Commanders, 665th Surgical Hospital

Maj. Edward F. Ziegelman	ao Mar 28-5 Sep 28
--------------------------	--------------------

667th Surgical Hospital (C.Z.)**Regular Army Inactive****HQ-Not organized** 1927-28

Constituted in the Regular Army 18 October 1927, assigned to the Communications Zone, and allotted to the Ninth Corps Area. Withdrawn from the Ninth Corps Area 5 September 1928. Demobilized 21 December 1928.

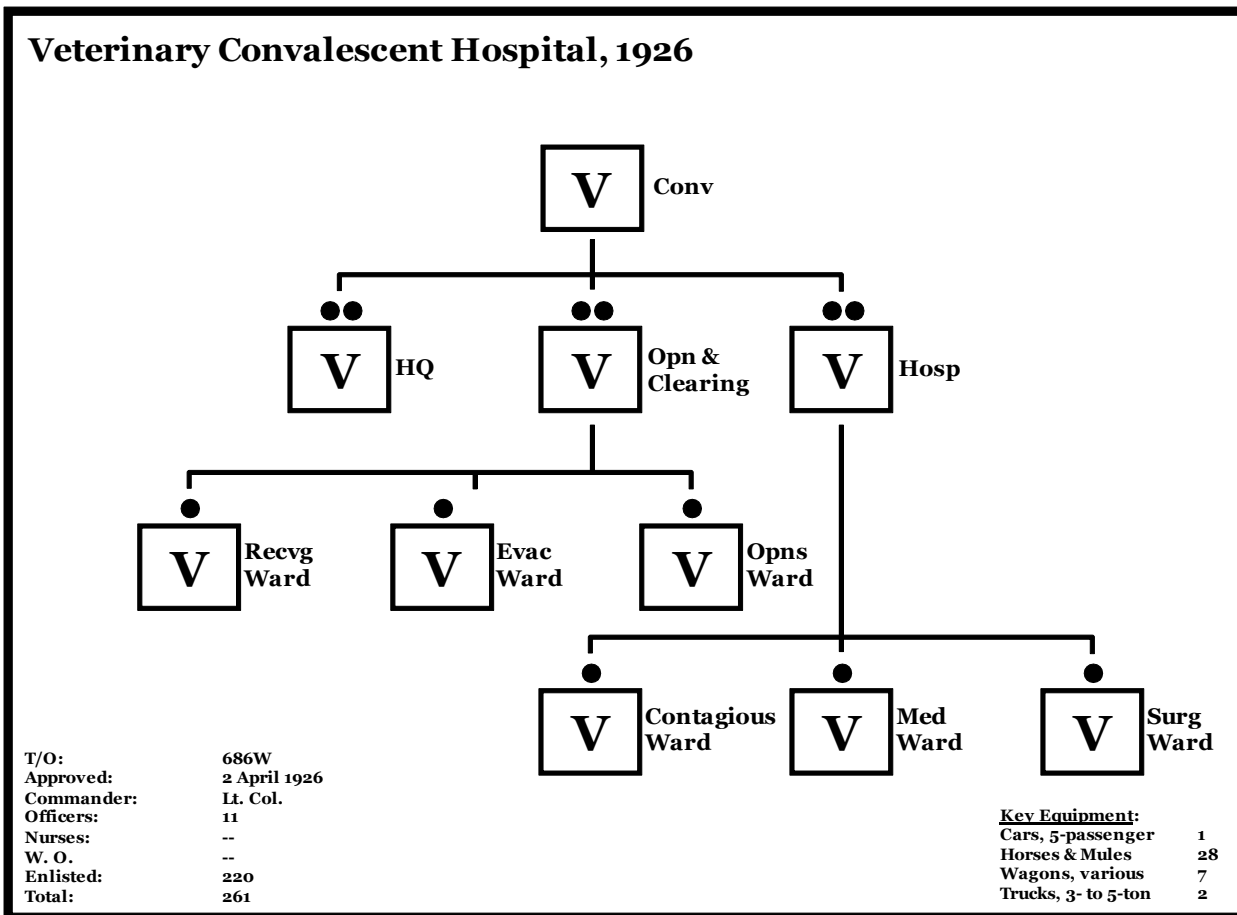

Veterinary Convalescent Hospital TOE.

Veterinary Convalescent Hospital mission: Furnish care for salvageable animals that require no further treatment by a veterinary evacuation hospital and are not yet ready for return to duty; furnish definitive treatment to short-duration cases received from lower echelon veterinary services located in the army rear area; return medically recovered animals to the army remount depot.

1st Veterinary Convalescent Hospital (First Army)

Organized Reserve New Jersey/New York

HQ-*Not initiated* 1923-25; Brooklyn, NY, 1925-41

Authorized 28 February 1923 by the Surgeon General for organization at Trenton, NJ. Constituted in the Organized Reserve 2 July 1923, assigned to the First Army, and allotted to the Second Corps Area. Designated 12 September 1923 as Veterinary Convalescent Hospital No.1. Redesignated 23 March 1925 as the 1st Veterinary Convalescent Hospital. Trenton designated as headquarters on organization, but the unit was never organized at that location. Initiated in April 1925 at Brooklyn, NY. Location 7 December 1941—Brooklyn, NY.

Status: Disbanded 11 November 1944.

Commanders, 1st Veterinary Convalescent Hospital

Unknown	Apr 25-16 Oct 25	Unknown	ao Jun 28-ao Jan 37
Maj. Edwin B. Ackerman	16 Oct 25-ao Jun 28	1st Lt. Donald V. Hughes	ao Jan 37-8 May 41

2nd Veterinary Convalescent Hospital (Second Army)**Organized Reserve Kentucky/Ohio****HQ-Not initiated** 1923-27; Camp Sherman, OH, 1927-30; *Inactive* 1930-41

Authorized 27 April 1923 by the Surgeon General for organization at Fort Thomas, KY. Constituted in the Organized Reserve 2 July 1923, assigned to the Second Army, and allotted to the Fifth Corps Area. Designated 12 September 1923 as Veterinary Convalescent Hospital No.2. Redesignated 23 March 1925 as the 2nd Veterinary Convalescent Hospital. Fort Thomas designated as headquarters on organization, but the unit was never organized at that location. Initiated by June 1927 at Camp Sherman, OH. Inactivated by March 1930 at Camp Sherman by relief of personnel. Springfield, OH, designated 9 July 1931 as headquarters on reorganization, but the unit was never organized at that location. Designated headquarters changed 5 April 1937 to Chillicothe, OH. Location 7 December 1941— *Inactive*.

Commanders, 2nd Veterinary Convalescent Hospital

Capt. Walter R. Hobbs	ao Jun 27-ao Jul 27	Unknown	ao Jul 27-Mar 30
	<i>Inactive</i>	Mar 30-7 Dec 41	

3rd Veterinary Convalescent Hospital (Fifth Army)**Organized Reserve Wisconsin****HQ-Not initiated** 1923-25; Neillsville, WI, 1925-33

Authorized 15 December 1922 by the Surgeon General for organization at Madison, WI. Constituted in the Organized Reserve 2 July 1923, assigned to the Fifth Army, and allotted to the Sixth Corps Area. Designated 12 September 1923 as Veterinary Convalescent Hospital No.3. Redesignated 23 March 1925 as the 3rd Veterinary Convalescent Hospital. Madison designated as headquarters on organization, but the unit was never organized at that location. Initiated 17 March 1925 at Neillsville, WI. Conducted summer training at the veterinary hospital at Fort Snelling, MN, or Jefferson Barracks, MO. Demobilized 1 October 1933.

Commanders, 3rd Veterinary Convalescent Hospital

Capt. J. Roy Fawver	17 Mar 25-ao Apr 25	Unknown	ao Jun 28-ao Jun 29
Maj. Hays A. Raffensperger	ao Sep 25-ao Jun 28	Capt. Joseph R. McIlree	ao Jun 29-ao Jun 31
	Unknown	ao Jun 31-1 Oct 33	

4th Veterinary Convalescent Hospital (Fourth Army)**Organized Reserve Tennessee****HQ-Not initiated** 1923-27; Columbia, SC, 1927-29; Chattanooga, TN, 1929-41

Constituted in the Organized Reserve 2 July 1923, assigned to the Fourth Army, and allotted to the First Corps Area. Designated 12 September 1923 as Veterinary Convalescent Hospital No. 4. Concurrently withdrawn from the First Corps Area and allotted to the Fourth Corps Area. Redesignated 23 March 1925 as the 4th Veterinary Convalescent Hospital. Initiated by June 1927 at Columbia, SC. Relocated 22 October 1929 to Chattanooga, TN. Relieved from the Fourth Army 1 October 1933 and assigned to the Third Army. Withdrawn from the Organized Reserve 1 January 1938 and allotted to the Regular Army. Location 7 December 1941—Chattanooga, TN.

Status: Disbanded 13 December 1952.**Commanders, 4th Veterinary Convalescent Hospital**

Unknown	ao Jun 27-7 Dec 41
---------	--------------------

5th Veterinary Convalescent Hospital (Third Army)**Organized Reserve Texas****HQ-Not initiated** 1923-25; Fort Sam Houston, TX, 1925-41

Constituted in the Organized Reserve 2 July 1923, assigned to the Third Army, and allotted to the Third Corps Area. Designated 12 September 1923 as Veterinary Convalescent Hospital No. 5. Concurrently withdrawn from the Third Corps Area and allotted to the Eighth Corps Area. Redesignated 23 March 1925 as the 5th Veterinary Convalescent

Hospital. Initiated 30 September 1925 at Fort Sam Houston, TX. Withdrawn from the Organized Reserve 6 October 1928 and allotted to the Regular Army. Conducted summer training at the veterinary hospital at Fort Sam Houston. Designated mobilization training station was Fort Sam Houston. Location 7 December 1941—Fort Sam Houston.

Commanders, 5th Veterinary Convalescent Hospital

Maj. Nicholas E. Dutro	30 Sep 25-ao Jan 28	Maj. Elmer E. Black**	ao Jun 30-14 Jul 30
Unknown	ao Jan 28-ao Jun 30	Unknown	14 Jun 30-7 Dec 41

** RAI Commanders: Organized Reserve officers.

6th Veterinary Convalescent Hospital (Sixth Army)

Organized Reserve California

HQ-*Not initiated* 1923-25; San Francisco, CA, 1925-30; *Inactive* 1930-41

Constituted in the Organized Reserve 2 July 1923, assigned to the Sixth Army, and allotted to the Ninth Corps Area. Designated 12 September 1923 as Veterinary Convalescent Hospital No. 6. Redesignated 23 March 1925 as the 6th Veterinary Convalescent Hospital. Initiated about September 1925 at San Francisco, CA. Inactivated 15 April 1930 at San Francisco by relief of personnel. Relieved from the Sixth Army 1 October 1933 and assigned to the Fourth Army. Location 7 December 1941—*Inactive*.

Status: Disbanded 11 November 1944.

Commanders, 6th Veterinary Convalescent Hospital

Maj. William H. Boynton	ao Sep 25-Mar 30	Maj. Norwood B. Giles	Mar 30-15 Apr 30
	<i>Inactive</i>	15 Apr 30-7 Dec 41	

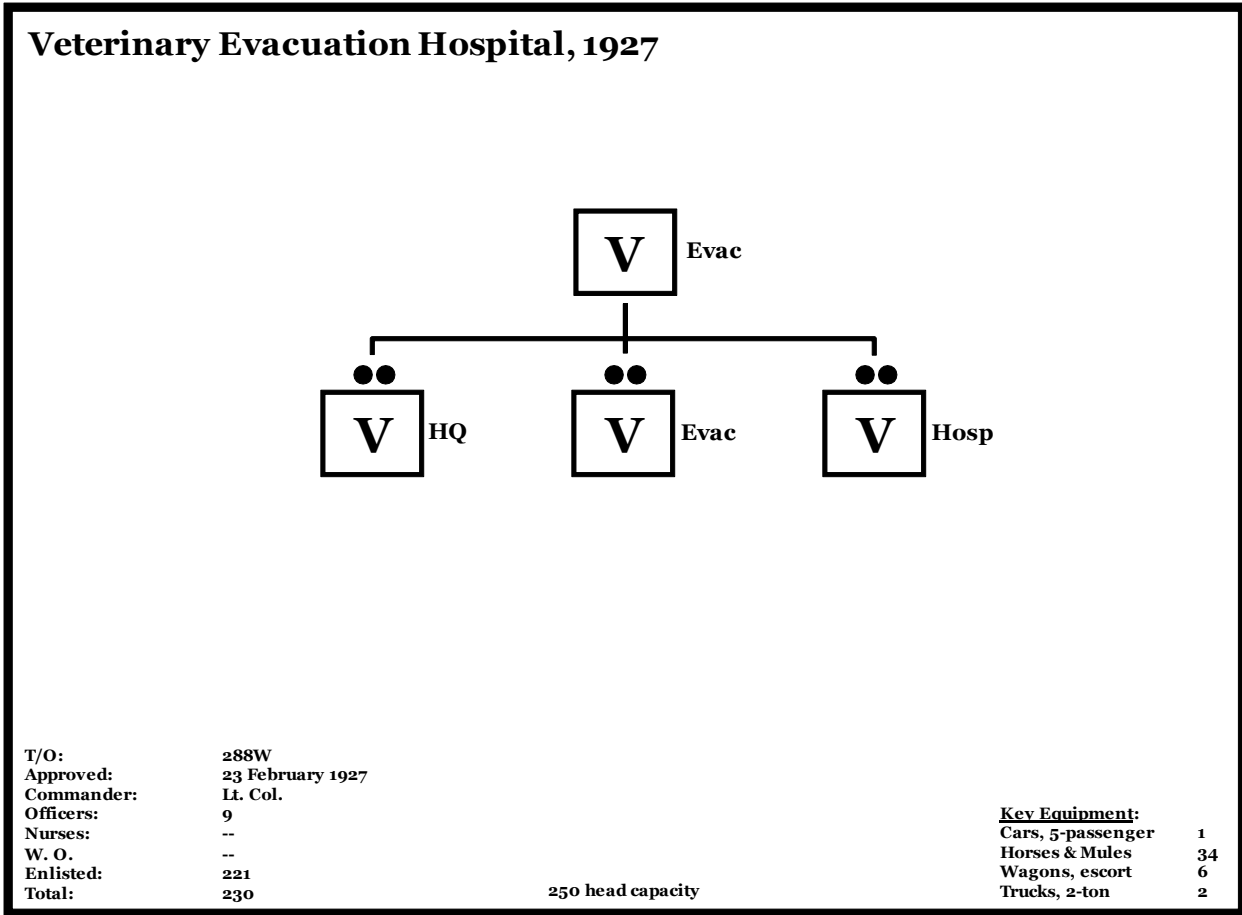

Veterinary Evacuation Hospital TOE.

Veterinary Evacuation Hospital mission: Relieve lower veterinary service echelons of animal casualties within the army area; furnish definitive treatment to short-duration cases; sort animal casualties and return medically recovered animals to the army remount depot; evacuate long-duration animal casualties to veterinary convalescent or general hospitals; destroy non-salvageable or uneconomically treatable cases.

1st Veterinary Evacuation Hospital (Third Army)

Organized Reserve Idaho

HQ-Not initiated 1923-24; Boise, ID, 1924-33

Authorized 12 December 1922 by the Surgeon General for organization at Boise, ID. Constituted in the Organized Reserve 2 July 1923, assigned to the Third Army, and allotted to the Ninth Corps Area. Designated 12 September 1923 as Veterinary Evacuation Hospital No. 1. Initiated by March 1924 at Boise. Redesignated 23 March 1925 as the 1st Veterinary Evacuation Hospital. Demobilized 1 October 1933.

Commanders, 1st Veterinary Evacuation Hospital

Capt. John McBirney	ao Mar 24-ao Jan 25 Unknown	1st Lt. John D. Adams ao Jun 29-1 Oct 33	ao Sep 25-ao Jun 29
---------------------	--------------------------------	---	---------------------

2nd Veterinary Evacuation Hospital (Third Army)

Organized Reserve California

HQ-Not initiated 1923-25; San Francisco, CA, 1925-28; Inactive 1928-41

Authorized 12 December 1922 by the Surgeon General for organization at San Francisco, CA. Constituted in the Organized Reserve 2 July 1923, assigned to the Third Army, and allotted to the Ninth Corps Area. Designated 12 September 1923 as Veterinary Evacuation Hospital No. 2. Redesignated 23 March 1925 as the 2nd Veterinary Evacuation Hospital. Initiated by September 1925 at San Francisco. Inactivated about August 1928 at San Francisco by relief of personnel. Withdrawn from the Organized Reserve 27 December 1928 and allotted to the Regular Army. Location 7 December 1941—*Inactive*.

Commanders, 2nd Veterinary Evacuation Hospital

Lt. Col. Henry E. Torgerson	ao Sep 25-Aug 28	<i>Inactive</i>	Aug 28-7 Dec 41
-----------------------------	------------------	-----------------	-----------------

3rd Veterinary Evacuation Hospital (Second Army)

Organized Reserve Massachusetts

HQ-*Not initiated* 1923-27; Boston, MA, 1927-33

Constituted in the Organized Reserve 2 July 1923, assigned to the Second Army, and allotted to the First Corps Area. Designated 12 September 1923 as Veterinary Evacuation Hospital No. 3. Redesignated 23 March 1925 as the 3rd Veterinary Evacuation Hospital. Initiated by June 1927 at Boston, MA. Demobilized 1 October 1933.

Commanders, 3rd Veterinary Evacuation Hospital

2nd Lt. Robert Globus	ao Jun 27-Sep 27	Unknown	Sep 27-ao Jan 30
	1st Lt. Einer W. Johnson	ao Jan 30-1 Oct 33	

4th Veterinary Evacuation Hospital (Second Army)

Organized Reserve Kentucky

HQ-*Not initiated* 1923-30; Lexington, KY, 1930-41

Constituted in the Organized Reserve 2 July 1923, assigned to the Second Army, and allotted to the Fifth Corps Area. Designated 12 September 1923 as Veterinary Evacuation Hospital No. 4. Redesignated 23 March 1925 as the 4th Veterinary Evacuation Hospital. Withdrawn from the Organized Reserve 27 December 1928 and allotted to the Regular Army. Organized 3 January 1930 at Lexington, KY. Location 7 December 1941—Lexington, KY.

Commanders, 4th Veterinary Evacuation Hospital

Maj. Lester W. Thiele	3 Jan 30-ao Jun 32	Unknown	ao Jun 32-7 Dec 41
-----------------------	--------------------	---------	--------------------

5th Veterinary Evacuation Hospital (Second Army)

Organized Reserve Ohio

HQ-*Not initiated* 1923-25; Fort Hayes, OH, 1925-27; Springfield, OH, 1927-41

Authorized 26 December 1922 by the Surgeon General for organization at Fort Hayes, OH. Constituted in the Organized Reserve 2 July 1923, assigned to the Second Army, and allotted to the Fifth Corps Area. Designated 12 September 1923 as Veterinary Evacuation Hospital No. 5. Redesignated 23 March 1925 as the 5th Veterinary Evacuation Hospital. Initiated in May 1925 at Fort Hayes. Relocated in 1927 to Springfield, OH. Location 7 December 1941—Springfield, OH.

Status: Disbanded 11 November 1944.

Commanders, 5th Veterinary Evacuation Hospital

Capt. Philip H. Fulstow	May 25-ao Jun 27	Unknown	ao Jun 27-7 Dec 41
-------------------------	------------------	---------	--------------------

6th Veterinary Evacuation Hospital (Fifth Army)

Organized Reserve Wisconsin

HQ-*Not initiated* 1923-24; LaCross, WI, 1924-41

Authorized 26 December 1922 by the Surgeon General for organization at LaCross, WI. Constituted in the Organized Reserve 2 July 1923, assigned to the Second Army, and allotted to the Fifth Corps Area. Designated 12 September 1923 as Veterinary Evacuation Hospital No. 6. Initiated in December 1924 at LaCross, WI. Redesignated 23 March 1925 as the 6th Veterinary Evacuation Hospital. Withdrawn from the Organized Reserve 27 December 1928 and allotted to the Regular Army. Conducted summer training at the veterinary hospital at Fort Snelling, MN. Location 7 December 1941—LaCross, WI.

Commanders, 6th Veterinary Evacuation Hospital

Unknown	Dec 24-ao Jan 27	Unknown	ao Jan 28-ao Apr 38
Maj. Willis A. Myers	ao Jan 27-ao Jun 28	Capt. Melvin L. Deitrich**	ao Apr 38-31 May 38
	Unknown	31 May 38-7 Dec 41	

** RAI Commanders: Organized Reserve officers.

7th Veterinary Evacuation Hospital (Sixth Army) Organized Reserve Idaho/California

HQ-Not initiated 1923-27; Pocatello, ID, 1927-1936; Sacramento, CA, 1936-41

Authorized 6 January 1923 by the Surgeon General for organization at Pocatello, ID. Constituted in the Organized Reserve 2 July 1923, assigned to the Sixth Army, and allotted to the Ninth Corps Area. Designated 12 September 1923 as Veterinary Evacuation Hospital No. 7. Redesignated 23 March 1925 as the 7th Veterinary Evacuation Hospital. Initiated by January 1927 at Pocatello, ID. Relocated by December 1936 to Sacramento, CA. Location 7 December 1941—Sacramento, CA.

Status: Disbanded 11 November 1944.

Commanders, 7th Veterinary Evacuation Hospital

1st Lt. Simpson M. Turner	ao Jan 27-29 Nov 29	Maj. Wendell Cotton	29 Nov 29-ao Jul 31
	Unknown	ao Jul 31-7 Dec 41	

8th Veterinary Evacuation Hospital (Fifth Army) Organized Reserve Michigan

HQ-Not initiated 1923-24; Ann Arbor, MI, 1924-32; Manchester, MI, 1932-37; Ann Arbor, MI, 1937-38; Detroit, MI, 1938-41

Constituted in the Organized Reserve 2 July 1923, assigned to the Second Army, and allotted to the Fifth Corps Area. Designated 12 September 1923 as Veterinary Evacuation Hospital No. 8. Initiated in December 1924 at Ann Arbor, MI. Redesignated 23 March 1925 as the 8th Veterinary Evacuation Hospital. Relocated 27 September 1932 to Manchester, MI. Relieved from the Fifth Army 1 October 1933 and assigned to the General Headquarters Reserve. Relocated 7 April 1937 to Ann Arbor, MI. Relocated by January 1938 to Detroit, MI. Conducted summer training at the veterinary hospital at Jefferson Barracks, MO, or Camp Custer, MI. Location 7 December 1941—Detroit, MI.

Status: Disbanded 11 November 1944.

Commanders, 8th Veterinary Evacuation Hospital

Unknown	Dec 24-ao Sep 25	Unknown	ao Sep 29-ao Jun 30
Capt. Earle M. Hough	ao Sep 25-13 Aug 29	Maj. Lee Davisson	ao Jun 30-ao Jul 32
Maj. Daniel C. Martin	13 Aug 29-ao Sep 29	Unknown	ao Jul 32-7 Dec 41

9th Veterinary Evacuation Hospital (Third Army) Organized Reserve Kansas

HQ-Not initiated 1923-24; Camp Funston, KS, 1924-26; Parsons, KS, 1926-31; Kansas City, KS, 1931-41

Constituted in the Organized Reserve 2 July 1923, assigned to the Third Army, and allotted to the Seventh Corps Area. Designated 12 September 1923 as Veterinary Evacuation Hospital No. 9. Initiated in November 1924 at Camp Funston, KS. Redesignated 23 March 1925 as the 9th Veterinary Evacuation Hospital. Relocated 26 May 1926 to Parsons, KS.

Relocated 12 October 1931 to Kansas City, KS. Relieved from the Third Army 1 October 1933 and assigned to the Fourth Army. Relieved from the Fourth Army in 1936 and assigned to the General Headquarters Reserve. Designated mobilization station was Camp Dodge, IA. Location 7 December 1941—Kansas City, KS.

Status: Disbanded 11 November 1944.

Commanders, 9th Veterinary Evacuation Hospital

Unknown	Dec 24-ao Sep 25	Unknown	ao Aug 35-27 Jun 37
Lt. Col. Ralph R. Dykstra	ao Sep 25-ao Jun 27	Maj. Edward H. Lenheim	27 Jun 37-8 Apr 38
Unknown	ao Jun 27-21 Jul 35	Unknown	8 Apr 38-29 Sep 39
Capt. Frank B. Jones	21 Jul 35-ao Aug 35	Lt. Col. Ralph R. Dykstra	29 Sep 39-ao Jan 40
	Unknown	ao Jan 40-7 Dec 41	

10th Veterinary Evacuation Hospital (Sixth Army)

Organized Reserve Iowa/Texas

HQ-*Not initiated* 1923-24; Fort Des Moines, IA, 1924-26; Mason City, IA, 1926-33; *Inactive* 1933-35; Waco, TX, 1935-41

Constituted in the Organized Reserve 2 July 1923, assigned to the Sixth Army, and allotted to the Seventh Corps Area. Designated 12 September 1923 as Veterinary Evacuation Hospital No. 10. Initiated in November 1924 at Fort Des Moines, IA. Redesignated 23 March 1925 as the 10th Veterinary Evacuation Hospital. Relocated 26 May 1926 to Mason City, IA. Withdrawn from the Seventh Corps Area 1 October 1933 and allotted to the Eighth Corps Area. Concurrently relieved from the Sixth Army 1 October 1933 and assigned to the Third Army. Organized 19 April 1935 at Waco, TX. Location 7 December 1941—Waco, TX.

Status: Disbanded 11 November 1944.

Commanders, 10th Veterinary Evacuation Hospital

Unknown	Nov 24-ao Sep 25	<i>Inactive</i>	1 Oct 33-19 Apr 35
Maj. Willard F. Guard	ao Sep 25-ao Jun 27	Maj. Elmer E. Black	19 Apr 35-ao May 35
Unknown	ao Jun 27-1 Oct 33	Unknown	ao May 35-7 Dec 41

11th Veterinary Evacuation Hospital (Fourth Army)

Organized Reserve Massachusetts

HQ-*Not initiated* 1923-25; Springfield, MA, 1925-33

Constituted in the Organized Reserve 2 July 1923, assigned to the Fourth Army, and allotted to the First Corps Area. Designated 12 September 1923 as Veterinary Evacuation Hospital No. 11. Redesignated 23 March 1925 as the 11th Veterinary Evacuation Hospital. Initiated in November 1925 at Springfield, MA. Demobilized 1 October 1933.

Commanders, 11th Veterinary Evacuation Hospital

Lt. Col. John B. Lentz	Nov 25-1 Oct 33
------------------------	-----------------

12th Veterinary Evacuation Hospital

Organized Reserve New York

HQ-*Not initiated* 1923-25; Plattsburg, NY, 1925-37; Syracuse, NY, 1937-41

Constituted in the Organized Reserve 2 July 1923, assigned to the Fourth Army, and allotted to the First Corps Area. Designated 12 September 1923 as Veterinary Evacuation Hospital No. 12. Redesignated 23 March 1925 as the 12th Veterinary Evacuation Hospital. Initiated 16 October 1925 at Plattsburg, NY. Relocated 20 November 1937 to Syracuse, NY. Location 7 December 1941—Syracuse, NY.

Status: Disbanded 11 November 1944.

Commanders, 12th Veterinary Evacuation Hospital

Capt. Frank F. Finney	16 Oct 25-5 Feb 30	Maj. Dallas W. Shaffer	3 Mar 34-ao Jun 34
	Unknown	ao Jun 34-7 Dec 41	

13th Veterinary Evacuation Hospital (Fourth Army)**Organized Reserve New Jersey****HQ-Not initiated** 1923-25; Newark, NJ, 1925-33

Constituted in the Organized Reserve 2 July 1923, assigned to the Fourth Army, and allotted to the Second Corps Area. Designated 12 September 1923 as Veterinary Evacuation Hospital No. 13. Redesignated 23 March 1925 as the 13th Veterinary Evacuation Hospital. Initiated 16 October 1925 at Newark, NJ. Demobilized 1 October 1933.

Commanders, 13th Veterinary Evacuation Hospital

Lt. Col. Adolph Eichhorn	16 Oct 25-1 Oct 33
--------------------------	--------------------

14th Veterinary Evacuation Hospital (First Army)**Organized Reserve Pennsylvania****HQ-Not initiated** 1923-25; Philadelphia, PA, 1925-28; *Inactive* 1928-30; Philadelphia 1930-33

Constituted in the Organized Reserve 2 July 1923, assigned to the First Army, and allotted to the Third Corps Area. Designated 12 September 1923 as Veterinary Evacuation Hospital No. 14. Initiated 28 January 1925 at Philadelphia, PA. Redesignated 23 March 1925 as the 14th Veterinary Evacuation Hospital. Inactivated 23 November 1928 at Philadelphia by relief of personnel. Reorganized by August 1930 at Philadelphia. Demobilized 1 October 1933.

Commanders, 14th Veterinary Evacuation Hospital

Lt. Col. Edward M. Ranck	28 Jan 25-20 Oct 28	<i>Inactive</i>	23 Nov 28-ao Aug 30
2nd Lt. Constantine M. Christy	20 Oct 28-23 Nov 28	Lt. Col. Delwin M. Campbell	ao Aug 30-1 Oct 33

15th Veterinary Evacuation Hospital**Organized Reserve Pennsylvania****HQ-Not initiated** 1923-25; Philadelphia, PA, 1925-27; *Inactive* 1927-33

Constituted in the Organized Reserve 2 July 1923, assigned to the Fourth Army, and allotted to the Third Corps Area. Designated 12 September 1923 as Veterinary Evacuation Hospital No. 15. Initiated 28 January 1925 at Philadelphia, PA. Redesignated 23 March 1925 as the 15th Veterinary Evacuation Hospital. Inactivated 2 September 1927 at Philadelphia by relief of personnel. Demobilized 1 October 1933.

Commanders, 15th Veterinary Evacuation Hospital

Lt. Col. John A. Kiernan	28 Jan 25-29 Aug 27	Maj. John J. Connelly	29 Aug 27-2 Sep 27
	<i>Inactive</i>	2 Sep 27-1 Oct 33	

16th Veterinary Evacuation Hospital (I) (First Army)**Organized Reserve Georgia/
Massachusetts/New York****HQ-Not initiated** 1923-27; Augusta, GA, 1927-33

Constituted in the Organized Reserve 2 July 1923, assigned to the First Army, and allotted to the Fourth Corps Area. Designated 12 September 1923 as Veterinary Evacuation Hospital No. 16. Redesignated 23 March 1925 as the 16th Veterinary Evacuation Hospital. Initiated by June 1927 at Augusta, GA. Demobilized 1 October 1933.

Commanders, 16th Veterinary Evacuation Hospital (I)

Capt. Billy E. Carlisle	ao Jun 27-ao Jan 28	Unknown	ao Jan 28-1 Oct 33
-------------------------	---------------------	---------	--------------------

16th Veterinary Evacuation Hospital (II) (GHQR)**Regular Army Inactive****HQ-Not organized** 1933-37; Fort Devens, MA, 1933-36; *Inactive* 1936-37; Syracuse, NY, 1937-40; Fort Bliss, TX, 1940-41

Constituted in the Regular Army 1 October 1933, assigned to the General Headquarters Reserve, and allotted to the First Corps Area. Fort Devens, MA, designated as headquarters on reorganization, but the unit was never organized at that location. Withdrawn from the First Corps Area 5 June 1936 and allotted to the Second Corps Area. Reorganized 13 May 1937 at Syracuse, NY. Activated 1 June 1941, less Reserve personnel, at Fort Bliss, TX, and assigned to the Third Army. Location 7 December 1941—Fort Bliss, TX.

Status: Inactive in the Regular Army as the 16th Veterinary Evacuation Hospital.

Events: 315, 328

Commanders, 16th Veterinary Evacuation Hospital (II)

1st Lt. Clark A. Metz**	13 May 37-24 Nov 39	1st Lt. Glen J. Weaver**	24 Nov 39-14 May 41
	Lt. Col. Charles C. Wright*	1 Jun 41-4 Feb 42	

* Regular Army active duty commanders

** RAI Commanders: Organized Reserve officers.

17th Veterinary Evacuation Hospital (I) (Fifth Army)

Organized Reserve Alabama

HQ-*Not initiated* 1923-26; Montgomery, AL, 1926-33

Constituted in the Organized Reserve 2 July 1923, assigned to the Fifth Army, and allotted to the Fourth Corps Area. Designated 12 September 1923 as Veterinary Evacuation Hospital No. 17. Redesignated 23 March 1925 as the 17th Veterinary Evacuation Hospital. Initiated by December 1926 at Montgomery, AL. Demobilized 1 October 1933.

Commanders, 17th Veterinary Evacuation Hospital

Maj. Daniel J. Meador	ao Dec 26-ao Jun 27	Unknown	ao Jun 27-1 Oct 33
-----------------------	---------------------	---------	--------------------

17th Veterinary Evacuation Hospital (II) (Fourth Army)

Regular Army Inactive

HQ-*Not organized* 1933-41; Fort Bliss, TX, 1941

Constituted in the Regular Army 1 October 1933, assigned to the Fourth Army, and allotted to the Ninth Corps Area. Bakersfield, CA, designated as headquarters on reorganization, but the unit was never organized at that location. Activated 1 June 1941, less Reserve personnel, at Fort Bliss, TX, and assigned to the Third Army. Location 7 December 1941—Fort Bliss, TX.

Status: Inactive in the Regular Army as the 17th Veterinary Evacuation Hospital.

Events: 315

Commanders, 17th Veterinary Evacuation Hospital

Unknown	1 Jun 41-7 Dec 41
---------	-------------------

18th Veterinary Evacuation Hospital (I) (Fifth Army)

Organized Reserve Mississippi/Georgia

HQ-*Not initiated* 1923-27; Jackson, MS, 1927-30; Atlanta, GA, 1930-33

Constituted in the Organized Reserve 2 July 1923, assigned to the Fifth Army, and allotted to the Fourth Corps Area. Designated 12 September 1923 as Veterinary Evacuation Hospital No. 18. Redesignated 23 March 1925 as the 18th Veterinary Evacuation Hospital. Initiated by September 1927 at Jackson, MS. Relocated by December 1930 to Atlanta, GA. Demobilized 1 October 1933.

Commanders, 18th Veterinary Evacuation Hospital (I)

Unknown	ao Sep 27-1 Oct 33
---------	--------------------

18th Veterinary Evacuation Hospital (II) (Z.I.)**Regular Army Inactive****HQ-Not initiated** 1933-35; El Paso, TX, 1935-36; *Inactive* 1936-38; Chicago, IL, 1937-41

Constituted in the Regular Army 1 October 1933, assigned to the Zone of the Interior, and allotted to the Eighth Corps Area. Organized by December 1935 with Organized Reserve personnel as a RAI unit at El Paso, TX. Withdrawn from the Eighth Corps Area 5 June 1936 and allotted to the Sixth Corps Area. Inactivated 12 November 1936 at El Paso by relief of personnel. Chicago, IL, designated as headquarters on reorganization, but the unit was never organized at that location. Location 7 December 1941—*Inactive*.

Status: Inactive in the Regular Army as the 18th Veterinary Evacuation Hospital.**Commanders, 18th Veterinary Evacuation Hospital (II)**

Capt. Howard C. Gale**	ao Dec 35-12 Nov 36	<i>Inactive</i>	12 Nov 36-7 Dec 41
------------------------	---------------------	-----------------	--------------------

** RAI Commanders: Organized Reserve officers.

19th Veterinary Evacuation Hospital (I) (Z.I.)**Organized Reserve Maine****HQ-Not initiated** 1923-28

Constituted in the Organized Reserve 2 July 1923, assigned to the Zone of the Interior, and allotted to the First Corps Area. Designated 12 September 1923 as Veterinary Evacuation Hospital No. 19. Redesignated 23 March 1925 as the 19th Veterinary Evacuation Hospital. Bangor, ME, designated as headquarters on organization, but the unit was never organized at that location. Withdrawn from the Organized Reserve 21 December 1928 and demobilized.

19th Veterinary Evacuation Hospital (II) (Z.I.)**Regular Army Inactive****HQ-Not initiated** 1928-29; Lewiston, ME, 1929-36; *Inactive* 1936-37; Albany, NY, 1937-41

Constituted in the Regular Army 21 December 1928, assigned to the Zone of the Interior, and allotted to the First Corps Area. Organized by August 1929 with Organized Reserve personnel as a RAI unit at Lewiston, ME. Relieved from the Zone of the Interior 1 October 1933 and assigned to the First Army. Withdrawn from the First Corps Area 5 June 1936 and allotted to the Second Corps Area. Reorganized 13 May 1937 at Albany, NY. Location 7 December 1941—Albany, NY.

Status: Disbanded 25 July 1944.**Commanders, 19th Veterinary Evacuation Hospital**

Unknown	ao Aug 29-ao Jun 34	<i>Inactive</i>	5 Jun 36-13 May 37
1st Lt. Anthony T. Scutakes**	ao Jun 34-5 Jun 36	1st Lt. Robert F. Brown**	13 May 37-6 Jun 41

** RAI Commanders: Organized Reserve officers.

20th Veterinary Evacuation Hospital (I) (Z.I.)**Organized Reserve New Jersey****HQ-Not initiated** 1923-28

Constituted in the Organized Reserve 2 July 1923, assigned to the Zone of the Interior, and allotted to the Second Corps Area. Designated 12 September 1923 as Veterinary Evacuation Hospital No. 20. Redesignated 23 March 1925 as the 20th Veterinary Evacuation Hospital. Passaic, NJ, designated as headquarters on organization, but the unit was never organized at that location. Withdrawn from the Organized Reserve 21 December 1928 and demobilized.

20th Veterinary Evacuation Hospital (II) (Z.I.)**Regular Army Inactive****HQ-Not initiated** 1928-30; Passaic, NJ, 1930-37; New York City, NY, 1937-41

Constituted in the Regular Army 21 December 1928, assigned to the Zone of the Interior, and allotted to the Second Corps Area. Organized 4 February 1930 with Organized Reserve personnel as a RAI unit at Passaic, NJ. Relieved from the Zone of the Interior 1 October 1933 and assigned to the First Army. Relocated by May 1937 to New York City, NY. Location 7 December 1941—New York City, NY.

Status: Disbanded 11 November 1944.

Commanders, 20th Veterinary Evacuation Hospital (II)

1st Lt. Herman H. Hollingsworth **	4 Feb 30-7 Feb 30	1st Lt. Irving H. Schwab**	10 May 35-1 May 36
Maj. Ernest L. Volgenau**	7 Feb 30-2 Jan 30	Maj. William W. Yard**	1 May 36-ao Jun 40
Capt. George Smith**	2 Jan 30-10 May 35	Unknown	ao Jun 40-7 Dec 41

** RAI Commanders: Organized Reserve officers.

21st Veterinary Evacuation Hospital (I) (Z.I.)

Organized Reserve Maryland

HQ-Not initiated 1923-28

Constituted in the Organized Reserve 2 July 1923, assigned to the Zone of the Interior, and allotted to the Third Corps Area. Designated 12 September 1923 as Veterinary Evacuation Hospital No. 21. Redesignated 23 March 1925 as the 21st Veterinary Evacuation Hospital. Baltimore, MD, designated as headquarters on organization, but the unit was never organized at that location. Withdrawn from the Organized Reserve 21 December 1928 and demobilized.

21st Veterinary Evacuation Hospital (II) (Z.I.)

Regular Army Inactive

HQ-Not initiated 1928-30; Baltimore, MD, 1930-41

Constituted in the Regular Army 21 December 1928, assigned to the Zone of the Interior, and allotted to the Third Corps Area. Relieved from the Zone of the Interior 1 October 1933 and assigned to the First Army. Designated mobilization station was Carlisle Barracks, PA. Organized 30 July 1930 with Organized Reserve personnel as a RAI unit at Baltimore, MD. Location 7 December 1941—Baltimore, MD.

Status: Disbanded 11 November 1944.

Commanders, 21st Veterinary Evacuation Hospital

2nd Lt. Chauncey E. Moorman**	30 Jul 30-22 Sep 32	Capt. Harry C. Kutz**	ao May 34-11 Sep 34
2nd Lt. Harry E. Skoog**	10 Oct 32-ao Jan 33	1st Lt. Lee K. Bailey**	11 Sep 34-ao Jun 37
Unknown	ao Jan 33-ao May 34	Unknown	ao Jun 37-7 Dec 41

** RAI Commanders: Organized Reserve officers.

22nd Veterinary Evacuation Hospital (I) (Z.I.)

Organized Reserve Kentucky

HQ-Not initiated 1923-28

Constituted in the Organized Reserve 2 July 1923, assigned to the Zone of the Interior, and allotted to the Fifth Corps Area. Designated 12 September 1923 as Veterinary Evacuation Hospital No. 22. Redesignated 23 March 1925 as the 22nd Veterinary Evacuation Hospital. Lexington, KY, designated as headquarters on organization, but the unit was never organized at that location. Withdrawn from the Organized Reserve 21 December 1928 and demobilized.

22nd Veterinary Evacuation Hospital (II) (Z.I.)

Regular Army Inactive

HQ-Not initiated 1928-29; Fort Oglethorpe, GA, 1929-41

Constituted in the Regular Army 21 December 1928, assigned to the Zone of the Interior, and allotted to the Fourth Corps Area. Organized 12 February 1929 with Organized Reserve personnel as a RAI unit at Fort Oglethorpe, GA.

Relieved from the Zone of the Interior 1 October 1933 and assigned to the Third Army. Location 7 December 1941—Fort Oglethorpe, GA.

Status: Disbanded 11 November 1944.

Commanders, 22nd Veterinary Evacuation Hospital

Maj. Oliver A. Barber **	12 Feb 29-ao Aug 31	Unknown	ao Jan 33-13 Aug 39
Unknown	ao Aug 31-25 Oct 32	1st Lt. Raymond T. Hander**	13 Aug 39-ao Jan 40
1st Lt. John R. Wells**	25 Oct 32-ao Jan 33	Unknown	ao Jan 40-7 Dec 41

** RAI Commanders: Organized Reserve officers.

23rd Veterinary Evacuation Hospital (I) (Z.I.)

Organized Reserve Kentucky

HQ-*Not initiated* 1923-28

Constituted in the Organized Reserve 2 July 1923, assigned to the Zone of the Interior, and allotted to the Fifth Corps Area. Designated 12 September 1923 as Veterinary Evacuation Hospital No. 23. Redesignated 23 March 1925 as the 23rd Veterinary Evacuation Hospital. Lexington, KY, designated as headquarters on organization, but the unit was never organized at that location. Withdrawn from the Organized Reserve 21 December 1928 and demobilized.

23rd Veterinary Evacuation Hospital (II) (Z.I.)

Regular Army Inactive

HQ-*Not initiated* 1928-34; Lexington, KY, 1934-41

Constituted in the Regular Army 21 December 1928, assigned to the Zone of the Interior, and allotted to the Fifth Corps Area. Relieved from the Zone of the Interior 1 October 1933 and assigned to the Second Army. Organized by June 1934 with Organized Reserve personnel as a RAI unit at Lexington, KY. Designated mobilization station was Fort Oglethorpe, GA. Location 7 December 1941—Lexington, KY.

Status: Disbanded 11 November 1944.

Commanders, 23rd Veterinary Evacuation Hospital

Unknown	ao Jun 34-7 Dec 41
---------	--------------------

24th Veterinary Evacuation Hospital (I) (Z.I.)

Organized Reserve Illinois

HQ-*Not initiated* 1923-28

Constituted in the Organized Reserve 2 July 1923, assigned to the Zone of the Interior, and allotted to the Sixth Corps Area. Designated 12 September 1923 as Veterinary Evacuation Hospital No. 24. Redesignated 23 March 1925 as the 24th Veterinary Evacuation Hospital. Withdrawn from the Organized Reserve 21 December 1928 and demobilized.

24th Veterinary Evacuation Hospital (II) (Z.I.)

Regular Army Inactive

HQ-*Not initiated* 1928-29; Chicago, IL, 1929-41

Constituted in the Regular Army 21 December 1928, assigned to the Zone of the Interior, and allotted to the Sixth Corps Area. Organized 8 August 1929 with Organized Reserve personnel as a RAI unit at Chicago, IL. Attached 3 November 1930 to the 86th Division for organization, administration, and training. Relieved from the Zone of the Interior 1 October 1933 and assigned to the Second Army. Conducted summer training at the veterinary hospital at Jefferson Barracks, MO, or Camp Custer, MI. Designated mobilization station was Fort Oglethorpe, GA. Location 7 December 1941—Chicago, IL.

Status: Disbanded 11 November 1944.

Commanders, 24th Veterinary Evacuation Hospital

Maj. David A. Lynch**	8 Aug 29-Jun 30	Unknown	ao Jul 37-ao Oct 38
Maj. Lester W. Thiele**	Jun 30-ao Jul 37	Maj. J. S. Stotchik**	ao Oct 38-ao Mar 39
	Unknown	ao Mar 39-7 Dec 41	

** RAI Commanders: Organized Reserve officers.

25th Veterinary Evacuation Hospital (Z.I.)

Regular Army Inactive

HQ-Not initiated 1928-29; St. Louis, MO, 1929-41

Constituted in the Regular Army 21 December 1928, assigned to the Zone of the Interior, and allotted to the Seventh Corps Area. Organized by July 1929 with Organized Reserve personnel as a RAI unit with headquarters at St. Louis, MO. Relieved from the Zone of the Interior 1 October 1933 and assigned to the Fourth Army. Conducted summer training at the veterinary hospital at Fort Snelling, MN. Designated mobilization station was Camp Dodge, IA. Location 7 December 1941—St. Louis, MO.

Status: Disbanded 11 November 1944.

Commanders, 25th Veterinary Evacuation Hospital

Unknown	ao Jul 29-7 Mar 36	1st Lt. Thomas J. Leasure**	ao Jul 37-22 Aug 37
2nd Lt. Bernard E. Foote**	7 Mar 36-ao Apr 36	1st Lt. Wayne A. Anderson**	22 Aug 37-ao Sep 37
Unknown	ao Apr 36-ao Jul 37	Unknown	ao Sep 37-7 Dec 41

** RAI Commanders: Organized Reserve officers.

26th Veterinary Evacuation Hospital (Z.I.)

Regular Army Inactive

HQ-Not initiated 1928-29; Fort Sam Houston, TX, 1929-41

Constituted in the Regular Army 21 December 1928, assigned to the Zone of the Interior, and allotted to the Eighth Corps Area. Organized 12 April 1929 with Organized Reserve personnel as a RAI unit with headquarters at Fort Sam Houston, TX. Relieved from the Zone of the Interior 1 October 1933 and assigned to the Third Army. Conducted summer training at the veterinary hospital at Fort Sam Houston, TX. Designated mobilization training station was Fort Sam Houston, TX. Location 7 December 1941—Fort Sam Houston, TX.

Status: Disbanded 11 November 1944.

Commanders, 26th Veterinary Evacuation Hospital

Maj William L. Endsley**	12 Apr 29-26 Sep 32	Maj. James T. Traylor**	27 Nov 36-ao Jan 37
Unknown	26 Sep 32-27 Nov 36	Unknown	ao Jan 37-7 Dec 41

** RAI Commanders: Organized Reserve officers.

27th Veterinary Evacuation Hospital (Z.I.)

Regular Army Inactive

HQ-Not initiated 1928-29; Boise, ID, 1929-33; Sacramento, CA, 1933-41; *Inactive* 1941

Constituted in the Regular Army 21 December 1928, assigned to the Zone of the Interior, and allotted to the Ninth Corps Area. Organized by June 1929 with Organized Reserve personnel as a RAI unit with headquarters at Boise, ID. Relieved from the Zone of the Interior 1 October 1933 and assigned to the Fourth Army. Conducted summer training at the veterinary hospital at Fort Lewis, WA. Inactivated in January 1941 at Sacramento, CA, by relief of personnel. Location 7 December 1941—*Inactive*.

Status: Disbanded 11 November 1944.

Commanders, 27th Veterinary Evacuation Hospital

Unknown	ao Jun 29-7 Dec 41	Unknown	ao Jun 39-Jan 41
Maj. Hadleigh Marsh**	9 Feb 37-ao Jun 39	<i>Inactive</i>	Jan 41-7 Dec 41

** RAI Commanders: Organized Reserve officers.

Veterinary General Hospital, 1926

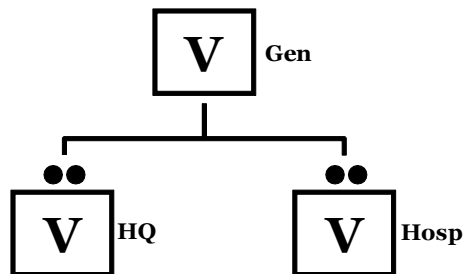

T/O: 686W
Approved: 2 April 1926
Commander: Lt. Col.
Officers: 11
Nurses: --
W. O.: --
Enlisted: 220
Total: 261

500 head capacity

Key Equipment:
Cars, 5-passenger 1
Horses & Mules 28
Wagons, various 7
Trucks, 3- to 5-ton 2

Veterinary General Hospital TOE.

Veterinary General Hospital mission: The principal veterinary hospital. Provide the final stage of animal hospitalization within a theater of operation; furnish definitive treatment to salvageable animals that require no further treatment by a veterinary evacuation or convalescent hospital and are not yet ready for return to duty; furnish definitive treatment to cases received from lower echelon veterinary services located in the Communications Zone.

1st Veterinary General Hospital (C.Z.)

Organized Reserve Pennsylvania

HQ—*Not initiated* 1923-25; Philadelphia, PA, 1925-38; *Inactive* 1938-41

Authorized 9 November 1922 by the Surgeon General for organization at Philadelphia, PA. Constituted in the Organized Reserve 2 July 1923, assigned to the Communications Zone, and allotted to the Third Corps Area. Designated 12 September 1923 as Veterinary General Hospital No. 1. Initiated 28 January 1925 at, and affiliated with, the University of Pennsylvania School of Veterinary Medicine at Philadelphia, PA. Redesignated 23 March 1925 as the 1st Veterinary General Hospital. Inactivated 1 June 1938 at Philadelphia by relief of personnel. Location 7 December 1941—*Inactive*.

Status: Disbanded 30 January 1942.

Commanders, 1st Veterinary General Hospital

Lt. Col. Louis A. Klein	28 Jan 25-1 Oct 28	Capt. Charles T. Bishop	21 Jan 32-10 Oct 34
Capt. Benjamin Fritz	1 Oct 28-1 Sep 29	Maj. Herbert L. Armstrong	10 Oct 34-ao Jan 35
Lt. Col. John P. Turner	1 Sep 29-17 Nov 30	Unknown	ao Jan 35-1 Jun 38
Maj. Jesse P. Porch	17 Nov 30-21 Jan 32	<i>Inactive</i>	1 Jun 38-7 Dec 41

2nd Veterinary General Hospital (C.Z.)**Organized Reserve Ohio****HQ-Not initiated** 1923-27; Dayton, OH, 1927-31; Bucyrus, OH, 1931-33; Steubenville, OH, 1933-41

Authorized 28 December 1922 by the Surgeon General for organization at Dayton, OH. Constituted in the Organized Reserve 2 July 1923, assigned to the Communications Zone, and allotted to the Fifth Corps Area. Designated 12 September 1923 as Veterinary General Hospital No. 2. Redesignated 23 March 1925 as the 2nd Veterinary General Hospital. Initiated by June 1927 at Dayton. Relocated 9 July 1931 to Bucyrus, OH. Relocated 21 December 1933 to Steubenville, OH. Location 7 December 1941—Steubenville, OH.

Status: Disbanded 11 November 1944.**Commanders, 2nd Veterinary General Hospital**

Maj. Frederick G. Kneup

ao Jun 27-ao Aug 29

Unknown

ao Aug 29-7 Dec 41

3rd Veterinary General Hospital (C.Z.)**Organized Reserve Michigan****HQ-Not initiated** 1923-24; Battle Creek, MI, 1924-25; Detroit, MI, 1925-29; Battle Creek, MI, 1929-38; Kalamazoo, MI, 1938-41

Constituted in the Organized Reserve 2 July 1923, assigned to the Communications Zone, and allotted to the Sixth Corps Area. Designated 12 September 1923 as Veterinary General Hospital No. 3. Redesignated 23 March 1925 as the 3rd Veterinary General Hospital. Initiated about November 1924 at Battle Creek, MI. Relocated by December 1925 to Detroit, MI. Relocated 29 March 1929 to Battle Creek, MI. Relocated by January 1938 to Kalamazoo, MI. Conducted summer training at the veterinary hospital at Camp McCoy, WI. Location 7 December 1941—Kalamazoo, MI.

Status: Disbanded 11 November 1944.**Commanders, 3rd Veterinary General Hospital**

Unknown

Nov 24-9 Jan 26
UnknownMaj. David J. Lynch
8 Aug 29-7 Dec 41

9 Jan 26-8 Aug 29

4th Veterinary General Hospital (Z.I.)**Organized Reserve Illinois****HQ-Not initiated** 1923-24; Chicago, IL, 1924-41

Authorized 29 December 1922 by the Surgeon General for organization at Chicago, IL. Constituted in the Organized Reserve 2 July 1923, assigned to the Zone of the Interior, and allotted to the Sixth Corps Area. Designated 12 September 1923 as Veterinary General Hospital No. 4. Initiated about November 1924 at Chicago, IL. Redesignated 23 March 1925 as the 4th Veterinary General Hospital. Conducted summer training at the veterinary hospital at Fort Snelling, MN, or Jefferson Barracks, MO. Location 7 December 1941—Chicago, IL.

Status: Disbanded 11 November 1944.**Commanders, 4th Veterinary General Hospital**

Lt. Col. Louis A. Merillat

Nov 24-ao Jun 27

Unknown

ao Jun 33-ao Jun 34

Unknown

ao Jun 27-ao Jun 29

Lt. Col. Warren J. Embree

ao Jun 34-ao Jun 36

Maj. Robert J. Robertson

ao Jun 29-4 Dec 29

Unknown

ao Jun 36-ao Jun 37

Lt. Col. Delwin M. Campbell

4 Dec 29-ao Jun 33

Capt. Buell S. Law

ao Jun 37-ao Jun 39

Unknown

ao Jun 39-7 Dec 41

5th Veterinary General Hospital (C.Z.)**Organized Reserve Nebraska/Iowa****HQ-Not initiated** 1923-25; Omaha, NE, 1925-31; Sioux City, IA, 1931-41

Constituted in the Organized Reserve 2 July 1923, assigned to the Communications Zone, and allotted to the Seventh Corps Area. Designated 12 September 1923 as Veterinary General Hospital No. 5. Redesignated 23 March 1925 as the 5th Veterinary General Hospital. Initiated by September 1925 at Omaha, NE. Relocated 12 October 1931 to Sioux City, IA. Conducted summer training at the veterinary hospital at Fort Snelling, MN. Location 7 December 1941—Sioux City, IA, (Inactivated 22 January 1942).

Status: Disbanded 11 November 1944.

Commanders, 5th Veterinary General Hospital

1st Lt. Richard C. Gilmore	ao Sep 25-1 Oct 27	Capt. Guy H. Todd	ao Jul 37-22 Aug 37
Lt. Col. Lester R. Smith	1 Oct 27-ao Jan 28	Capt. Anthony J. Matter	22 Aug 37-ao Sep 37
Unknown	ao Jan 28-ao Jul 37	Unknown	ao Sep 37-7 Dec 41
	1st Lt. Donald K. Theophilus	9 Oct 39-ao Aug 41	

6th Veterinary General Hospital (C.Z.)

Organized Reserve Missouri/Arkansas

HQ-Not initiated 1923-24; St. Louis, MO, 1924-31; Little Rock, AR, 1931-41

Constituted in the Organized Reserve 2 July 1923, assigned to the Communications Zone, and allotted to the Seventh Corps Area. Redesignated 23 March 1925 as the 6th Veterinary General Hospital. Designated 12 September 1923 as Veterinary General Hospital No. 6. Initiated in November 1924 at St. Louis, MO. Relocated 12 October 1931 to Little Rock, AR. Relieved from the Communications Zone 1 October 1933 and assigned to the General Headquarters Reserve. Location 7 December 1941—Little Rock, AR.

Status: Disbanded 11 November 1944.

Commanders, 6th Veterinary General Hospital

Lt. Col. Harry G. Beauman	Nov 24-ao Jul 30	Maj. Edward H. Lenheim	11 Aug 35-27 Jun 37
Unknown	ao Jul 30-11 Aug 35	Capt. Guy H. Todd	22 Aug 37-ao Sep 37
	Unknown	ao Sep 37-7 Dec 41	

7th Veterinary General Hospital (Z.I.)

Organized Reserve Pennsylvania

HQ-Not initiated 1923-25; Pittsburgh, PA, 1925-29; *Inactive* 1929-34; Pittsburgh, PA, 1934-41

Constituted in the Organized Reserve 2 July 1923, assigned to the Zone of the Interior, and allotted to the Third Corps Area. Designated 12 September 1923 as Veterinary General Hospital No. 7. Initiated 12 January 1925 at Pittsburgh, PA. Redesignated 23 March 1925 as the 7th Veterinary General Hospital. Inactivated 25 June 1928 at Pittsburgh by relief of personnel. Reorganized 10 October 1934 at Pittsburgh. Location 7 December 1941—Pittsburgh, PA.

Status: Disbanded 30 January 1942.

Commanders, 7th Veterinary General Hospital

Capt. Hirsh R. Yosh	12 Jan 25-25 Jun 28	Maj. Jacob A. Jones	10 Oct 34-ao Jun 35
<i>Inactive</i>	25 Jun 28-10 Oct 34	Unknown	ao Jun 35-7 Dec 41

8th Veterinary General Hospital (Z.I.)

Organized Reserve Pennsylvania

HQ-Not initiated 1923-25; Philadelphia, PA, 1925-30; *Inactive* 1930-34; Philadelphia, PA, 1934-38; *Inactive* 1938-41

Constituted in the Organized Reserve 2 July 1923, assigned to the Zone of the Interior, and allotted to the Third Corps Area. Designated 12 September 1923 as Veterinary General Hospital No. 8. Initiated 28 January 1925 at Philadelphia, PA. Redesignated 23 March 1925 as the 8th Veterinary General Hospital. Inactivated 1 January 1930 at Philadelphia by relief of personnel. Reorganized by June 1934 at Philadelphia. Inactivated 29 March 1938 at Philadelphia by relief of personnel. Location 7 December 1941—*Inactive*.

Status: Disbanded 30 January 1942.

Commanders, 8th Veterinary General Hospital

Lt. Col. Ramon M. Staley	28 Jan 25-25 Jun 28	Capt. William A. Bennett	1 Jan 30-9 Apr 30
Capt. Hirsh B. Yosh	25 Jun 28-31 Jan 29	<i>Inactive</i>	9 Apr 30-ao Jun 34
Capt. Charles B. Shore	31 Jan 29-1 Jan 30	Maj. Elmer Lash	ao Jun 34-29 Mar 38
	<i>Inactive</i>	29 Mar 38-7 Dec 41	

9th Veterinary General Hospital (Z.I.)

Organized Reserve Kansas/Arkansas/Missouri

HQ-*Not initiated* 1923-24; Junction City, KS, 1924-26; Prescott, AR, 1926-31; Kansas City, MO, 1923-41

Constituted in the Organized Reserve 2 July 1923, assigned to the Zone of the Interior, and allotted to the Third Corps Area. Designated 12 September 1923 as Veterinary General Hospital No. 9. Initiated in November 1924 at Junction City, KS. Redesignated 23 March 1925 as the 9th Veterinary General Hospital. Relocated 26 May 1926 to Prescott, AR. Relocated 12 October 1931 to Kansas City, MO. Location 7 December 1941—Kansas City, MO.

Status: Disbanded 30 January 1942.

Commanders, 9th Veterinary General Hospital

Capt. Andrew S. Pyles	Nov 24-ao Jun 27	Unknown	ao Jun 27-7 Dec 41
-----------------------	------------------	---------	--------------------

10th Veterinary General Hospital (C.Z.)

Organized Reserve Maine/Indiana

HQ-*Not initiated* 1923-26; Augusta, ME, 1926-27; *Inactive* 1930-34; Fort Wayne, IN, 1934-41

Constituted in the Organized Reserve 2 July 1923, assigned to the Communications Zone, and allotted to the First Corps Area. Designated 12 September 1923 as Veterinary General Hospital No. 10. Redesignated 23 March 1925 as the 10th Veterinary General Hospital. Initiated by April 1926 at Augusta, ME. Withdrawn from the First Corps Area 11 January 1927 and allotted to the Fifth Corps Area. Inactivated 7 February 1927 at Augusta by relief of personnel. Evansville, IN, designated as headquarters on reorganization, but the unit was never organized at that location. Relieved from the Communications Zone 1 October 1933 and assigned to the General Headquarters Reserve. Reorganized 22 March 1934 at Fort Wayne, IN. Location 7 December 1941—Fort Wayne, IN.

Status: Disbanded 11 November 1944.

Commanders, 10th Veterinary General Hospital

1st Lt. Harland S. Irish	ao Apr 26-7 Feb 27	<i>Inactive</i>	7 Feb 27-22 Mar 34
	Unknown	22 Mar 34-7 Dec 41	

11th Veterinary General Hospital (Z.I.)

Organized Reserve New Hampshire/New York

HQ-*Not initiated* 1923-25; Concord, NH, 1925-36; *Inactive* 1936-37; Syracuse, NY, 1937-41

Constituted in the Organized Reserve 2 July 1923, assigned to the Zone of the Interior, and allotted to the First Corps Area. Designated 12 September 1923 as Veterinary General Hospital No. 11. Redesignated 23 March 1925 as the 11th Veterinary General Hospital. Initiated 13 May 1925 at Concord, NH. Relieved from the Zone of the Interior 1 October 1933 and assigned to the General Headquarters Reserve. Withdrawn from the First Corps Area 5 June 1936 and allotted to the Second Corps Area. Reorganized 22 May 1937 at Syracuse, NY. Location 7 December 1941—Syracuse, NY.

Status: Disbanded 11 November 1944.

Commanders, 11th Veterinary General Hospital

2nd Lt. Haven T. Paul	13 May 25-ao Jul 28	<i>Inactive</i>	5 Jun 36-22 May 37
Unknown	ao Jul 28-5 Jun 36	1st Lt. Philip C. Close	22 May 37-ao Jun 37
	Unknown	ao Jun 37-7 Dec 41	

12th Veterinary General Hospital (Z.I.)**Organized Reserve Connecticut****HQ-Not initiated** 1923-28

Constituted in the Organized Reserve 2 July 1923, assigned to the Zone of the Interior, and allotted to the First Corps Area. Designated 12 September 1923 as Veterinary General Hospital No. 12. Redesignated 23 March 1925 as the 12th Veterinary General Hospital. Hartford, CT, designated as headquarters on organization, but the unit was never organized at that location. Withdrawn from the First Corps Area 27 December 1928 and demobilized.

13th Veterinary General Hospital (Z.I.)**Organized Reserve Connecticut/Rhode Island/New York****HQ-Not initiated** 1923-25; Hartford, CT, 1925-28; *Inactive* 1928-41

Constituted in the Organized Reserve 2 July 1923, assigned to the Zone of the Interior, and allotted to the First Corps Area. Designated 12 September 1923 as Veterinary General Hospital No. 13. Redesignated 23 March 1925 as the 13th Veterinary General Hospital. Initiated 27 November 1925 at Hartford, CT. Inactivated by July 1928 at Hartford by relief of personnel. Providence, RI, designated as headquarters on reorganization, but the unit was never organized at that location. Relieved from the Zone of the Interior 1 October 1933 and assigned to the General Headquarters Reserve. Withdrawn from the First Corps Area 5 June 1936 and allotted to the Second Corps Area. New York City, NY, designated as headquarters on reorganization, but the unit was never organized at that location. Location 7 December 1941—*Inactive*.

Status: Disbanded 30 January 1942.**Commanders, 13th Veterinary General Hospital**

Unknown	27 Nov 25-ao Apr 26	Unknown	ao Jun 27-ao Jul 28
1st Lt. Edward J. Welch	ao Apr 26-ao Jun 27	<i>Inactive</i>	ao Jul 28-7 Dec 41

14th Veterinary General Hospital (Z.I.)**Organized Reserve Connecticut/Ohio****HQ-Not initiated** 1923-33; Akron, OH, 1934-37; *Inactive* 1937-41

Constituted in the Organized Reserve 2 July 1923, assigned to the Zone of the Interior, and allotted to the First Corps Area. Designated 12 September 1923 as Veterinary General Hospital No. 14. Redesignated 23 March 1925 as the 14th Veterinary General Hospital. Waterbury, CT, designated as headquarters on organization, but the unit was never organized at that location. Withdrawn from the First Corps Area 11 January 1927 and allotted to the Fifth Corps Area. Marietta, OH, designated as headquarters on organization, but the unit was never organized at that location. Designated headquarters location changed 21 December 1933 to Akron, OH. Initiated by June 1934 at Akron. Inactivated by June 1937 at Akron by relief of personnel. Location 7 December 1941—*Inactive*.

Status: Disbanded 30 January 1942.**Commanders, 14th Veterinary General Hospital**

Unknown	ao Jun 34-ao Jun 37	<i>Inactive</i>	ao Jun 37-7 Dec 41
---------	---------------------	-----------------	--------------------

15th Veterinary General Hospital (Z.I.)**Organized Reserve Massachusetts/New York****HQ-Not initiated** 1923-26; Boston, MA, 1926-36; *Inactive* 1936-41

Constituted in the Organized Reserve 2 July 1923, assigned to the Zone of the Interior, and allotted to the First Corps Area. Designated 12 September 1923 as Veterinary General Hospital No. 15. Redesignated 23 March 1925 as the 15th Veterinary General Hospital. Initiated by April 1926 at Boston, MA. Relieved from the Zone of the Interior 1 October 1933 and assigned to the General Headquarters Reserve. Withdrawn from the First Corps Area 5 June 1936 and allotted to the Second Corps Area. New York City, NY, designated as headquarters on reorganization, but the unit was never organized at that location. Location 7 December 1941—*Inactive*.

Status: Disbanded 30 January 1942.

Commanders, 15th Veterinary General Hospital

Capt. Robert H. Sewell	ao Apr 26-ao Jul 28 <i>Inactive</i>	Unknown 5 Jun 36-7 Dec 41	ao Jul 28-5 Jun 36
------------------------	--	------------------------------	--------------------

16th Veterinary General Hospital (Z.I.)

Organized Reserve New York

HQ-Not initiated 1923-25; Ithaca, NY, 1925-41

Constituted in the Organized Reserve 2 July 1923, assigned to the Zone of the Interior, and allotted to the Second Corps Area. Designated 12 September 1923 as Veterinary General Hospital No. 16. Redesignated 23 March 1925 as the 16th Veterinary General Hospital. Initiated 9 October 1925 at Ithaca, NY. Location 7 December 1941—Ithaca, NY.

Status: Disbanded 11 November 1944.

Commanders, 16th Veterinary General Hospital

Capt. William A. Hagan	9 Oct 25-ao Jun 27	Maj. Harry E. Barker	3 Mar 34-23 Nov 39
Unknown	ao Jun 27-3 Mar 34	Capt. Fred E. Cleaver	23 Nov 39-25 Apr 40
	Lt. Col. Harry E. Barker	25 Apr 40-21 May 41	

17th Veterinary General Hospital (Z.I.)

Organized Reserve New York

HQ-Not initiated 1923-25; Buffalo, NY, 1925-37; Syracuse, NY, 1937-41

Constituted in the Organized Reserve 2 July 1923, assigned to the Zone of the Interior, and allotted to the Second Corps Area. Designated 12 September 1923 as Veterinary General Hospital No. 17. Redesignated 23 March 1925 as the 17th Veterinary General Hospital. Initiated 9 October 1925 at Buffalo, NY. Relocated 5 April 1937 to Syracuse, NY. Location 7 December 1941—Syracuse, NY.

Status: Disbanded 11 November 1944.

Commanders, 17th Veterinary General Hospital

Maj. Ernest L. Volgenau	9 Oct 25-4 Feb 30	1st Lt. Burt W. Larson	13 Dec 38-1 Mar 39
Unknown	4 Feb 30-16 Jan 36	Unknown	1 Mar 39-30 Nov 39
1st Lt. Walter O. Bauer	16 Jan 36-13 Dec 38	Capt. Trevor H. Hughes	30 Nov 39-ao Jun 41

18th Veterinary General Hospital (Z.I.)

Organized Reserve New York

HQ-Not initiated 1923-25; Brooklyn, NY, 1925-28; *Inactive* 1928-41

Constituted in the Organized Reserve 2 July 1923, assigned to the Zone of the Interior, and allotted to the Second Corps Area. Designated 12 September 1923 as Veterinary General Hospital No. 18. Redesignated 23 March 1925 as the 18th Veterinary General Hospital. Initiated 9 October 1925 at Brooklyn, NY. Inactivated 13 November 1928 at Brooklyn by relief of personnel. Location 7 December 1941—*Inactive*.

Status: Disbanded 30 January 1942.

Commanders, 18th Veterinary General Hospital

Maj. John G. Wills	9 Oct 25-13 Nov 28	<i>Inactive</i>	13 Nov 28-7 Dec 41
--------------------	--------------------	-----------------	--------------------

19th Veterinary General Hospital (Z.I.)

Organized Reserve New York

HQ-Not initiated 1923-25; Manhattan, NY, 1925-41

Constituted in the Organized Reserve 2 July 1923, assigned to the Zone of the Interior, and allotted to the Second Corps Area. Designated 12 September 1923 as Veterinary General Hospital No. 19. Redesignated 23 March 1925 as the 19th Veterinary General Hospital. Initiated 9 October 1925 at Manhattan, NY. Conducted summer training at the veterinary hospital at Carlisle Barracks, PA. Location 7 December 1941—Manhattan, NY.

Status: Disbanded 11 November 1944.

Commanders, 19th Veterinary General Hospital

Col. William R. Blair	9 Oct 25-19 Nov 26	Capt. Fred W. Graves	Jun 30-1 Sep 33
Lt. Col. Cassius Way	19 Nov 26-28 Mar 28	Maj. Norman J. Pyle	1 Sep 33-7 Nov 34
Maj. Edwin B. Ackerman	19 Mar 30-Jun 30	Lt. Col. Orville E. McKim	7 Nov 34-ao Jan 41

20th Veterinary General Hospital (Z.I.)

Organized Reserve New York

HQ-*Not initiated* 1923-28

Constituted in the Organized Reserve 2 July 1923, assigned to the Zone of the Interior, and allotted to the Second Corps Area. Designated 12 September 1923 as Veterinary General Hospital No. 20. Redesignated 23 March 1925 as the 20th Veterinary General Hospital. Brooklyn, NY, designated as headquarters on organization, but the unit was never organized at that location. Withdrawn from the Organized Reserve 27 December 1928.

21st Veterinary General Hospital (Z.I.)

Organized Reserve New York

HQ-*Not initiated* 1923-25; Brooklyn, NY, 1925-30; *Inactive* 1930-39; Brooklyn, NY, 1939-41

Constituted in the Organized Reserve 2 July 1923, assigned to the Zone of the Interior, and allotted to the Second Corps Area. Designated 12 September 1923 as Veterinary General Hospital No. 21. Redesignated 23 March 1925 as the 21st Veterinary General Hospital. Initiated 9 October 1925 at Brooklyn, NY. Inactivated by June 1930 at Brooklyn by relief of personnel. Reorganized 17 June 1939 at Brooklyn. Location 7 December 1941—Brooklyn, NY.

Status: Disbanded 11 November 1944.

Commanders, 21st Veterinary General Hospital

Maj. John B. Hopper	9 Oct 25-ao Jun 27	<i>Inactive</i>	ao Jun 30-17 Jun 39
Unknown	ao Jun 37-ao Jun 30	1st Lt. Harry A. Lutvack	17 Jun 39-16 Aug 41

22nd Veterinary General Hospital (Z.I.)

Organized Reserve Pennsylvania

HQ-*Not initiated* 1923-25; Philadelphia, PA, 1925-29; *Inactive* 1929-41

Constituted in the Organized Reserve 2 July 1923, assigned to the Zone of the Interior, and allotted to the Third Corps Area. Designated 12 September 1923 as Veterinary General Hospital No. 22. Redesignated 23 March 1925 as the 22nd Veterinary General Hospital. Initiated 28 January 1925 at Philadelphia, PA. Withdrawn from the Organized Reserve 6 October 1928 and allotted to the Regular Army. Inactivated about June 1929 at Philadelphia by relief of personnel. Location 7 December 1941—*Inactive*.

Status: Disbanded 30 January 1942.

Commanders, 22nd Veterinary General Hospital

1st Lt. William R. Andress**	28 Jan 25-14 Jan 29	Maj. Oliver A. Barber**	14 Jan 29-ao Jun 29
	<i>Inactive</i>	ao Jun 29-7 Dec 41	

** RAI Commanders: Organized Reserve officers.

23rd Veterinary General Hospital (Z.I.)

Organized Reserve Virginia/Iowa

HQ-*Not initiated* 1923-25; Front Royal, VA, 1925-28; *Inactive* 1928-41

Constituted in the Organized Reserve 2 July 1923, assigned to the Zone of the Interior, and allotted to the Third Corps Area. Designated 12 September 1923 as Veterinary General Hospital No. 23. Redesignated 23 March 1925 as the 23rd Veterinary General Hospital. Initiated 28 January 1925 at Front Royal, VA. Withdrawn from the Organized Reserve 6 October 1928 and allotted to the Regular Army. Concurrently withdrawn from the Third Corps Area and allotted to the Seventh Corps Area. Council Bluffs, IA, designated as headquarters on reorganization, but the unit was never organized at that location. Location 7 December 1941—*Inactive*.

Status: Disbanded 30 January 1942.

Commanders, 23rd Veterinary General Hospital

1st Lt. William S. Trigg	28 Jan 25-12 Feb 26	2nd Lt. Roy A. Gregory	2 Sep 27-6 Oct 28
Capt. Julius H. Hurst	12 Feb 26-2 Sep 27	<i>Inactive</i>	6 Oct 28-7 Dec 41

24th Veterinary General Hospital (Z.I.)

Organized Reserve Virginia/Pennsylvania

HQ—*Not initiated* 1923-25; Richmond, VA, 1925-27; *Inactive* 1927-41

Constituted in the Organized Reserve 2 July 1923, assigned to the Zone of the Interior, and allotted to the Third Corps Area. Designated 12 September 1923 as Veterinary General Hospital No. 24. Initiated 28 January 1925 at Richmond, VA. Redesignated 23 March 1925 as the 24th Veterinary General Hospital. Inactivated by June 1927 at Richmond by relief of personnel. Philadelphia, PA, designated as headquarters on reorganization, but the unit was never organized at that location. Location 7 December 1941—*Inactive*.

Status: Disbanded 30 January 1942.

Commanders, 24th Veterinary General Hospital

1st Lt. Thomas Fraser	28 Jan 25-May 27	<i>Inactive</i>	ao Jun 27-7 Dec 41
-----------------------	------------------	-----------------	--------------------

25th Veterinary General Hospital (Z.I.)

Organized Reserve Virginia

HQ—*Not initiated* 1923-25; Norfolk, VA, 1925-29; Newport News, VA, 1929-41

Constituted in the Organized Reserve 2 July 1923, assigned to the Zone of the Interior, and allotted to the Third Corps Area. Designated 12 September 1923 as Veterinary General Hospital No. 25. Initiated 28 January 1925 at Norfolk, VA. Redesignated 23 March 1925 as the 25th Veterinary General Hospital. Inactivated 10 September 1929 at Norfolk by relief of personnel. Newport News, VA, designated 11 December 1929 as headquarters on reorganization, but the unit was never organized at that location. Location 7 December 1941—Newport News, VA.

Status: Disbanded 30 January 1942.

Commanders, 25th Veterinary General Hospital

Maj. Jesse T. Porch	28 Jan 25-ao Apr 25	Lt. Col. John P. Turner	ao Sep 25-10 Sep 29
	<i>Inactive</i>	10 Sep 29-7 Dec 41	

26th Veterinary General Hospital (C.Z.)

Organized Reserve Louisiana

HQ—*Not initiated* 1923-25; New Orleans, LA, 1926-41

Constituted in the Organized Reserve 2 July 1923, assigned to the Zone of the Interior, and allotted to the Fourth Corps Area. Designated 12 September 1923 as Veterinary General Hospital No. 26. Redesignated 23 March 1925 as the 26th Veterinary General Hospital. Initiated by December 1926 at New Orleans, LA. Location 7 December 1941—New Orleans, LA.

Status: Disbanded 11 November 1944.

Commanders, 26th Veterinary General Hospital

1st Lt. Albert W. Vornheder	ao Jun 27-ao Aug 27	1st Lt. Gilbert T. Jackson	2 Nov 35-8 Aug 37
Unknown	ao Aug 27-Nov 30	1st Lt. Charles E. Kennedy	8 Aug 37-ao Sep 40
Lt. Col. Louis E. Beckham	Nov 30-2 Nov 35	Unknown	ao Sep 40-7 Dec 41

27th Veterinary General Hospital (Z.I.)**Organized Reserve South Carolina****HQ-Not initiated** 1923-26; Columbia, SC, 1926-41

Constituted in the Organized Reserve 2 July 1923, assigned to the Zone of the Interior, and allotted to the Fourth Corps Area. Designated 12 September 1923 as Veterinary General Hospital No. 27. Redesignated 23 March 1925 as the 27th Veterinary General Hospital. Initiated by December 1926 at Columbia, SC. Location 7 December 1941—Columbia, SC.

Status: Disbanded 30 January 1942.**Commanders, 27th Veterinary General Hospital**

Capt. Herbert C. Nichols

ao Dec 26-ao Jul 27

Unknown

ao Jul 27-7 Dec 41

28th Veterinary General Hospital (Z.I.)**Organized Reserve Louisiana****HQ-Not initiated** 1923-27; New Orleans, LA, 1927-37; *Inactive* 1937-41

Constituted in the Organized Reserve 2 July 1923, assigned to the Zone of the Interior, and allotted to the Fourth Corps Area. Designated 12 September 1923 as Veterinary General Hospital No. 28. Redesignated 23 March 1925 as the 28th Veterinary General Hospital. Initiated by June 1927 at New Orleans, LA. Inactivated 12 May 1937 at New Orleans by relief of personnel. Location 7 December 1941—*Inactive*.

Status: Disbanded 30 January 1942.**Commanders, 28th Veterinary General Hospital**

Unknown

ao Jun 27-12 May 37

Inactive

12 May 37-7 Dec 41

29th Veterinary General Hospital (Z.I.)**Organized Reserve Tennessee****HQ-Not initiated** 1923-27; Memphis, TN, 1927-28

Constituted in the Organized Reserve 2 July 1923, assigned to the Zone of the Interior, and allotted to the Fourth Corps Area. Designated 12 September 1923 as Veterinary General Hospital No. 29. Redesignated 23 March 1925 as the 29th Veterinary General Hospital. Initiated by June 1927 at Memphis, TN. Withdrawn from the Fourth Corps Area 27 December 1928.

Status: Disbanded 30 January 1942.**Commanders, 29th Veterinary General Hospital**

Capt. Leo C. Woods

ao Jun 27-27 Dec 28

30th Veterinary General Hospital (Z.I.)**Organized Reserve Mississippi/Connecticut/New York****HQ-Not initiated** 1923-26; Vicksburg, MS, 1926-28; *Inactive* 1928-30; New York City, NY, 1930-33; Hartford, CT, 1934-36; *Inactive* 1936-37; New York City, NY, 1937-41; Fort Bliss, TX, 1941

Constituted in the Organized Reserve 2 July 1923, assigned to the Zone of the Interior, and allotted to the Fourth Corps Area. Designated 12 September 1923 as Veterinary General Hospital No. 30. Redesignated 23 March 1925 as the 30th Veterinary General Hospital. Initiated by December 1926 at Vicksburg, MS. Withdrawn from the Organized Reserve and allotted to the Regular Army. Concurrently withdrawn from the Fourth Corps Area 27 December 1928 and allotted to the Second Corps Area. Reorganized 4 February 1930 at New York City, NY. Withdrawn from the Second Corps Area 1 October 1933 and allotted to the First Corps Area. Concurrently relieved from the Zone of the Interior and assigned to the General Headquarters Reserve. Reorganized 17 May 1933 at Hartford, CT. Withdrawn from the First Corps Area 5 June 1936 and allotted to the Second Corps Area. Reorganized 15 December 1937 at New York City, NY. Activated 1 June 1941 at Fort Bliss, TX, and assigned to the Third Army. Reserve personnel relieved 5 June 1941. Location 7 December 1941—Fort Bliss, TX.

Commanders, 30th Veterinary General Hospital

Unknown	ao Dec 26-27 Dec 28	<i>Inactive</i>	1 Oct 33-17 May 33
<i>Inactive</i>	27 Dec 28-4 Feb 30	2nd Lt. Percival G. Barbor**	17 May 33-5 Jun 36
1st Lt. William Lancellotti**	4 Feb 30-ao Jun 30	<i>Inactive</i>	5 Jun 36-15 Dec 37
Unknown	ao Jun 30-1 Oct 33	1st Lt. Arnold Elder**	15 Dec 37-1 Jun 41
	Lt. Col. Delwin M. Campbell*	1 Jun 41-4 Feb 42	

* Regular Army active duty commanders

** RAI Commanders: Organized Reserve officers.

31st Veterinary General Hospital (Z.I.)

Organized Reserve North Carolina

HQ-Not initiated 1923-30; New York City, NY, 1930-41

Constituted in the Organized Reserve 2 July 1923, assigned to the Zone of the Interior, and allotted to the Fourth Corps Area. Designated 12 September 1923 as Veterinary General Hospital No. 31. Redesignated 23 March 1925 as the 31st Veterinary General Hospital. Charlotte, NC, designated as headquarters on organization, but the unit was never organized at that location. Withdrawn from the Organized Reserve 6 October 1928 and allotted to the Regular Army. Concurrently withdrawn from the Fourth Corps Area and allotted to the Second Corps Area. Organized 7 February 1930 at New York City, NY. Relieved from the Zone of the Interior 1 October 1933 and assigned to the General Headquarters Reserve. Conducted summer training at the veterinary hospital at Carlisle Barracks, PA. Location 7 December 1941—New York City, NY.

Status: Disbanded 11 November 1944.

Commanders, 31st Veterinary General Hospital

Maj. Louis Griessman**	7 Feb 30-16 Feb 39	1st Lt. Samuel Hutt**	16 Feb 39-19 Jun 41
	Capt. Joseph J. Merenda**	19 Jun 41-ao Dec 41	

** RAI Commanders: Organized Reserve officers.

32nd Veterinary General Hospital (Z.I.)

Organized Reserve Ohio

HQ-Not initiated 1923-26; Cleveland, OH, 1926-31; Springfield, OH, 1931-33; Cincinnati, OH, 1933-41

Constituted in the Organized Reserve 2 July 1923, assigned to the Zone of the Interior, and allotted to the Fifth Corps Area. Designated 12 September 1923 as Veterinary General Hospital No. 32. Redesignated 23 March 1925 as the 32nd Veterinary General Hospital. Initiated by December 1926 at Cleveland, OH. Relocated 9 July 1931 to Springfield, OH. Relocated 21 December 1933 to Cincinnati, OH. Location 7 December 1941—Cincinnati, OH.

Status: Disbanded 11 November 1944.

Commanders, 32nd Veterinary General Hospital

Capt. Charles J. Griffin	ao Dec 26-ao Jan 28	Lt. Col. Frederick G. Kneup	ao Jun 34-ao Feb 38
Unknown	ao Jan 28-ao Jun 34	Unknown	ao Feb 38-7 Dec 41

33rd Veterinary General Hospital (Z.I.)

Organized Reserve Ohio/Kentucky

HQ-Not initiated 1923-25; Chillicothe, OH, 1925-27; Lexington, KY, 1927-30; *Inactive* 1930-41

Constituted in the Organized Reserve 2 July 1923, assigned to the Zone of the Interior, and allotted to the Fifth Corps Area. Designated 12 September 1923 as Veterinary General Hospital No. 33. Redesignated 23 March 1925 as the 33rd Veterinary General Hospital. Initiated 8 August 1925 at Chillicothe, OH. Relocated by December 1927 to Lexington, KY. Inactivated by March 1930 at Lexington. Location 7 December 1941—*Inactive*.

Status: Disbanded 30 January 1942.

Commanders, 33rd Veterinary General Hospital

Unknown	8 Aug 25-ao Jun 27	Unknown	ao Jul 27-ao Jun 30
2nd Lt. Charles L. Sanders	ao Jun 27-ao Jul 27	<i>Inactive</i>	ao Jun 30-15 Dec 37

34th Veterinary General Hospital (Z.I.)**Organized Reserve Indiana****HQ-Not initiated** 1923-25; Fort Benjamin Harrison, IN, 1925-30; *Inactive* 1930-34; Columbus, IN, 1934-41

Constituted in the Organized Reserve 2 July 1923, assigned to the Zone of the Interior, and allotted to the Fifth Corps Area. Designated 12 September 1923 as Veterinary General Hospital No. 34. Redesignated 23 March 1925 as the 34th Veterinary General Hospital. Initiated 8 August 1925 at Fort Benjamin Harrison, IN. Inactivated by March 1930 at Fort Benjamin Harrison by relief of personnel. Withdrawn from the Organized Reserve 1 October 1933 and allotted to the Regular Army. Concurrently relieved from the Zone of the Interior and assigned to the General Headquarters Reserve. Reorganized 22 March 1934 at Columbus, IN. Location 7 December 1941—Columbus, IN.

Status: Disbanded 11 November 1944.**Commanders, 34th Veterinary General Hospital**

Unknown	8 Aug 25-ao Jun 27	Unknown	ao Jul 27-Mar 30
2nd Lt. James C. Conway	ao Jun 27-ao Jul 27	<i>Inactive</i>	Mar 30-22 Mar 34
	Unknown	22 Mar 24-7 Dec 41	

35th Veterinary General Hospital (Z.I.)**Organized Reserve Kentucky****HQ-Not initiated** 1923-41

Constituted in the Organized Reserve 2 July 1923, assigned to the Zone of the Interior, and allotted to the Fifth Corps Area. Designated 12 September 1923 as Veterinary General Hospital No. 35. Redesignated 23 March 1925 as the 35th Veterinary General Hospital. Camp Knox, KY, designated as headquarters on organization, but the unit was never organized at that location. Withdrawn from the Organized Reserve 27 December 1928 and allotted to the Regular Army. Location 7 December 1941—*Not initiated*.

36th Veterinary General Hospital (Z.I.)**Organized Reserve Ohio/West Virginia****HQ-Not initiated** 1923-26; Camp Sherman, OH, 1926-27; Huntington, WV 1927-34; *Inactive* 1934-41

Constituted in the Organized Reserve 2 July 1923, assigned to the Zone of the Interior, and allotted to the Fifth Corps Area. Designated 12 September 1923 as Veterinary General Hospital No. 36. Redesignated 23 March 1925 as the 36th Veterinary General Hospital. Initiated by December 1926 at Camp Sherman, OH. Relocated by December 1927 to Huntington, WV. Inactivated by June 1934 at Huntington by relief of personnel. Location 7 December 1941—*Inactive*.

Status: Disbanded 30 January 1942.**Commanders, 36th Veterinary General Hospital**

2nd Lt. Festus L. Rogers	ao Dec 26-ao Jan 28	Unknown	ao Jan 28-ao Jun 34
	<i>Inactive</i>	ao Jun 34-7 Dec 41	

37th Veterinary General Hospital (Z.I.)**Organized Reserve Indiana/Ohio****HQ-Not initiated** 1923-26; Indianapolis, IN, 1926-27; Lancaster, OH, 1927-30; *Inactive* 1930-34; Toledo, OH, 1934-41

Constituted in the Organized Reserve 2 July 1923, assigned to the Zone of the Interior, and allotted to the Fifth Corps Area. Designated 12 September 1923 as Veterinary General Hospital No. 37. Redesignated 23 March 1925 as the 37th Veterinary General Hospital. Initiated by December 1926 at Indianapolis, IN. Relocated by December 1927 to Lancaster, OH. Inactivated by March 1930 at Lancaster by relief of personnel. Reorganized 22 March 1934 at Toledo, OH. Location 7 December 1941—Toledo.

Status: Disbanded 11 November 1944.

Commanders, 37th Veterinary General Hospital

2nd Lt. Harry W. Brown	ao Dec 26-ao Jan 28	<i>Inactive</i>	ao Mar 30-22 Mar 34
Unknown	ao Jan 28-ao Mar 30	Maj. Lester W. Thiele	22 Mar 34-ao Dec 41

38th Veterinary General Hospital (Z.I.)

Organized Reserve Wisconsin

HQ-Not initiated 1923-24; Phillips, WI, 1924-29; *Inactive* 1929-34; Phillips, WI, 1934-37; LaCrosse, WI, 1937-41

Constituted in the Organized Reserve 2 July 1923, assigned to the Zone of the Interior, and allotted to the Sixth Corps Area. Designated 12 September 1923 as Veterinary General Hospital No. 38. Redesignated 23 March 1925 as the 38th Veterinary General Hospital. Initiated in November 1924 at Phillips, WI. Inactivated about August 1929 at Phillips by relief of personnel. Reorganized by June 1934 at Phillips. Inactivated 30 March 1937 at Phillips. Reorganized 7 April 1937 at LaCrosse, WI. Conducted summer training at the veterinary hospital at Camp McCoy, WI. Location 7 December 1941—LaCrosse, WI.

Status: Disbanded 11 November 1944.

Commanders, 38th Veterinary General Hospital

Unknown	Nov 24-ao Sep 25	Maj. Frank J. Younglove	ao Jun 34-30 Mar 37
Maj. James A. Weigen	ao Sep 25-Aug 29	<i>Inactive</i>	30 Mar 37-7 Apr 37
Unknown	Aug 29-ao Jun 34	Unknown	7 Apr 37-7 Dec 41

39th Veterinary General Hospital (Z.I.)

Organized Reserve Michigan

HQ-Not initiated 1923-25; Grand Rapids, MI, 1925-37; Detroit, MI, 1937-41

Constituted in the Organized Reserve 2 July 1923, assigned to the Zone of the Interior, and allotted to the Sixth Corps Area. Designated 12 September 1923 as Veterinary General Hospital No. 39. Redesignated 23 March 1925 as the 39th Veterinary General Hospital. Initiated by September 1925 at Grand Rapids, MI. Relocated 7 April 1937 to Detroit, MI. Location 7 December 1941—Detroit, MI.

Status: Disbanded 11 November 1944.

Commanders, 39th Veterinary General Hospital

Maj. Daniel C. Martin	ao Sep 25-13 Aug 29	2nd Lt. Xenophon B. Shaffer	ao Jun 34-ao Dec 34
Unknown	13 Aug 29-ao Jun 34	Unknown	ao Dec 24-7 Dec 41

40th Veterinary General Hospital (Z.I.)

Organized Reserve Wisconsin

HQ-Not initiated 1923-24; Sturgeon Bay, WI, 1924-41

Constituted in the Organized Reserve 2 July 1923, assigned to the Zone of the Interior, and allotted to the Sixth Corps Area. Designated 12 September 1923 as Veterinary General Hospital No. 40. Redesignated 23 March 1925 as the 40th Veterinary General Hospital. Initiated in November 1924 at Sturgeon Bay, WI. Withdrawn from the Organized Reserve 27 December 1928 and allotted to the Regular Army. Location 7 December 1941—Sturgeon Bay, WI.

Commanders, 40th Veterinary General Hospital

Unknown	Nov 24-ao Sep 25	1st Lt. Russell C. Evans	ao Sep 25-ao Jun 27
	Unknown	ao Jun 27-7 Dec 41	

41st Veterinary General Hospital (Z.I.)

Organized Reserve Illinois

HQ-Not initiated 1923-24; Vandalia, IL, 1924-36; Belleville, IL, 1936-41

Constituted in the Organized Reserve 2 July 1923, assigned to the Zone of the Interior, and allotted to the Sixth Corps Area. Designated 12 September 1923 as Veterinary General Hospital No. 41. Initiated in November 1924 at Vandalia, IL. Redesignated 23 March 1925 as the 41st Veterinary General Hospital. Relocated about November 1936 to Belleville, IL. Conducted summer training at the veterinary hospital at Jefferson Barracks, MO, or Camp Custer, MI. Location 7 December 1941—Belleville, IL.

Status: Disbanded 11 November 1944.

Commanders, 41st Veterinary General Hospital

Unknown	Nov 24-17 Mar 25	Maj. Albert R. Kincaid	24 Sep 29-1 Sep 36
Maj. Warren J. Embree	17 Mar 25-ao Jan 26	Unknown	1 Sep 36-11 Nov 36
Capt. Basil Bennett	ao Jan 27-24 Sep 29	1st Lt. Vit J. Novy	11 Nov 36-ao Jan 38
	Unknown	ao Jan 38-7 Dec 41	

42nd Veterinary General Hospital (Z.I.)

Organized Reserve Illinois

HQ-Not initiated 1923-24; Chicago, IL, 1924-41

Constituted in the Organized Reserve 2 July 1923, assigned to the Zone of the Interior, and allotted to the Sixth Corps Area. Designated 12 September 1923 as Veterinary General Hospital No. 42. Initiated in November 1924 at Chicago, IL. Redesignated 23 March 1925 as the 42nd Veterinary General Hospital. Conducted summer training at the veterinary hospital at Jefferson Barracks, MO. Location 7 December 1941—Chicago, IL.

Status: Disbanded 11 November 1944.

Commanders, 42nd Veterinary General Hospital

Unknown	Nov 24-ao Sep 25	Lt. Col. Ora L. Campbell	ao Sep 25-ao Aug 38
	Unknown	ao Aug 38-7 Dec 41	

43rd Veterinary General Hospital (Z.I.)

Organized Reserve Iowa/North Dakota/Minnesota

HQ-Not initiated 1923-24; Fort Des Moines, IA, 1924-26; Dickinson, ND, 1926-31; Minneapolis, MN, 1931-41

Constituted in the Organized Reserve 2 July 1923, assigned to the Zone of the Interior, and allotted to the Seventh Corps Area. Designated 12 September 1923 as Veterinary General Hospital No. 43. Initiated in November 1924 at Fort Des Moines, IA. Redesignated 23 March 1925 as the 43rd Veterinary General Hospital. Relocated 26 May 1926 to Dickinson, ND. Relocated 12 October 1931 to Minneapolis, MN. Location 7 December 1941—Minneapolis, MN, (inactivated 22 January 1942).

Status: Disbanded 11 November 1944.

Commanders, 43rd Veterinary General Hospital

Unknown	Nov 24-ao Sep 25	Maj. Roy M. Morton	Jul 30-Mar 31
Lt. Col. Charles E. Cotton	ao Sep 25-ao Jun 27	Unknown	Mar 31-27 Jun 37
Unknown	ao Jun 27-Feb 30	Maj. Horace L. Anderson	27 Jun 37-ao Jan 38
Lt. Col. Donald B. Palmer	Feb 30-Jul 30	Unknown	ao Jan 38-7 Dec 41

44th Veterinary General Hospital (Z.I.)

Organized Reserve Minnesota/Missouri

HQ-Not initiated 1923-24; Minneapolis, MN, 1924-26; Kansas City, MO, 1926-31; St. Paul, MN, 1931-41

Constituted in the Organized Reserve 2 July 1923, assigned to the Zone of the Interior, and allotted to the Seventh Corps Area. Designated 12 September 1923 as Veterinary General Hospital No. 44. Initiated in November 1924 at Minneapolis, MN. Redesignated 23 March 1925 as the 44th Veterinary General Hospital. Relocated 26 May 1926 to Kansas City, MO. Relocated 12 October 1931 to St. Paul, MN. Location 7 December 1941—St. Paul, MN, (inactivated 22 January 1942).

Status: Disbanded 30 January 1942.

Commanders, 44th Veterinary General Hospital

Unknown	Nov 24-ao Sep 25 Unknown	Lt. Col. Donald B. Palmer Feb 30-7 Dec 41	ao Sep 25-Feb 30
---------	-----------------------------	--	------------------

45th Veterinary General Hospital (Z.I.)

Organized Reserve Nebraska

HQ-Not initiated 1923-24; Fort Omaha, NE, 1924-41

Constituted in the Organized Reserve 2 July 1923, assigned to the Zone of the Interior, and allotted to the Seventh Corps Area. Designated 12 September 1923 as Veterinary General Hospital No. 45. Initiated in November 1924 at Fort Omaha, NE. Redesignated 23 March 1925 as the 45th Veterinary General Hospital. Location 7 December 1941—Fort Omaha, NE.

Status: Disbanded 30 January 1942.

Commanders, 45th Veterinary General Hospital

Unknown	Nov 24-ao Sep 25 Unknown	Capt. Norris L. Townsend ao Jun 27-7 Dec 41	ao Sep 25-ao Jun 27
---------	-----------------------------	--	---------------------

46th Veterinary General Hospital (Z.I.)

Organized Reserve Iowa/Missouri

HQ-Not initiated 1923-24; Sioux City, IA, 1924-26; Council Bluffs, IA, 1926-31; St. Louis, MO, 1931-41

Constituted in the Organized Reserve 2 July 1923, assigned to the Zone of the Interior, and allotted to the Seventh Corps Area. Designated 12 September 1923 as Veterinary General Hospital No. 46. Initiated in November 1924 at Sioux City, IA. Redesignated 23 March 1925 as the 46th Veterinary General Hospital. Relocated 26 May 1926 to Council Bluffs, IA. Relocated 12 October 1931 to St. Louis, MO. Location 7 December 1941—St. Louis, MO.

Status: Disbanded 30 January 1942.

Commanders, 46th Veterinary General Hospital

Unknown	Nov 24-ao Sep 25 Unknown	Maj. Clifford M. Cline ao Jun 27-7 Dec 41	ao Sep 25-ao Jun 27
---------	-----------------------------	--	---------------------

47th Veterinary General Hospital (C.Z.)

Organized Reserve Oklahoma/Missouri

HQ-Not initiated 1923-25; Fort Reno, OK, 1925-27; *Inactive* 1927-36; St. Joseph, MO, 1936-41

Constituted in the Organized Reserve 2 July 1923, assigned to the Communications Zone, and allotted to the Eighth Corps Area. Designated 12 September 1923 as Veterinary General Hospital No. 47. Redesignated 23 March 1925 as the 47th Veterinary General Hospital. Initiated 26 March 1925 at Fort Reno, OK. Conducted summer training at the veterinary hospital at Fort Bliss, TX. Designated mobilization training station was Camp Stanley, TX. Withdrawn from the Eighth Corps Area 7 January 1927 and allotted to the Seventh Corps Area. Inactivated 4 April 1927 at Fort Reno by relief of personnel. Mankato, MN, designated as headquarters on reorganization, but the unit was never organized at that location. Relieved from the Communications Zone 1 October 1933 and assigned to the General Headquarters Reserve. Reorganized by December 1936 at St. Joseph, MO. Location 7 December 1941—St. Joseph, MO.

Status: Disbanded 11 November 1944.

Commanders, 47th Veterinary General Hospital

Capt. Charles H. Hart	26 Mar 25-21 Dec 25	<i>Inactive</i>	4 Apr 27-ao Dec 36
Maj. Thomas O. Booth	Jan 26-4 Apr 27 Unknown	1st Lt. Charles D. Pickett 22 Aug 37-7 Dec 41	ao Dec 36-22 Aug 37

48th Veterinary General Hospital (C.Z.)**Organized Reserve Texas/New Jersey****HQ-Not initiated** 1923-26; San Antonio, TX, 1926-36; *Inactive* 1936-41

Constituted in the Organized Reserve 2 July 1923, assigned to the Communications Zone, and allotted to the Eighth Corps Area. Designated 12 September 1923 as Veterinary General Hospital No. 48. Redesignated 23 March 1925 as the 48th Veterinary General Hospital. Initiated 28 July 1925 at San Antonio, TX. Conducted summer training most years at Fort Sam Houston, TX, and some years at Fort Bliss, TX. Designated mobilization training station was Camp Stanley, TX. Withdrawn from the Eighth Corps Area 5 June 1936 and allotted to the Second Corps Area. Inactivated 12 November 1936 at San Antonio by relief of personnel. Trenton, NJ, designated as headquarters on reorganization, but the unit was never organized at that location.

Location 7 December 1941—*Inactive*.**Status:** Disbanded 30 January 1942.**Commanders, 48th Veterinary General Hospital**

Maj. Walter J. Crocker	28 Jul 25-ao Jun 27	Unknown	1 Nov 29-3 Dec 30
Capt. Judge E. Richardson	ao Dec 27-11 Jun 29	Lt. Col. Nicolas E. Dutro	3 Dec 30-12 Nov 36
1st. Lt. Fred I. Hamman	11 Jun 29-1 Nov 29	<i>Inactive</i>	12 Nov 36-7 Dec 41

49th Veterinary General Hospital (Z.I.)**Organized Reserve Texas/New York****HQ-Not initiated** 1923-25; Fort Bliss, TX, 1925-36; New York City, NY, 1936-37; *Inactive* 1937-39; New York City, 1939-41

Constituted in the Organized Reserve 2 July 1923, assigned to the Zone of the Interior, and allotted to the Eighth Corps Area. Designated 12 September 1923 as Veterinary General Hospital No. 49. Redesignated 23 March 1925 as the 49th Veterinary General Hospital. Initiated 26 March 1925 at Fort Bliss, TX. Conducted summer training at the veterinary hospital at Fort Sam Houston, TX. Designated mobilization training station was Camp Stanley, TX. Withdrawn from the Eighth Corps Area 5 June 1936 and allotted to the Second Corps Area. Reorganized 8 June 1936 at New York City, NY. Inactivated 12 May 1937 at New York City by relief of personnel. Reorganized about September 1939 at New York City. Location 7 December 1941—New York City, NY.

Status: Disbanded 11 November 1944.**Commanders, 49th Veterinary General Hospital**

1st Lt. Michael Shipley	26 Mar 25-30 Jul 25	Maj. Edward H. Lenheim	8 Jun 36-9 Nov 36
Capt. Samuel B. Norris	30 Jul 25-ao Feb 32	Unknown	9 Nov 36-12 May 37
Unknown	ao Feb 32-5 Jun 36	<i>Inactive</i>	12 May 37-ao Sep 39
<i>Inactive</i>	5 Jun 36-8 Jun 36	1st Lt. Ralph Povar	ao Oct 39-30 Mar 40
	Maj. Norman J. Pyle	30 Mar 40-4 Mar 41	

50th Veterinary General Hospital (Z.I.)**Organized Reserve Texas/New York****HQ-Not organized** 1923-25; Fort Bliss, TX, 1925-36; New York City, NY, 1936-37; *Inactive* 1937-41

Constituted in the Organized Reserve 2 July 1923, assigned to the Zone of the Interior, and allotted to the Eighth Corps Area. Designated 12 September 1923 as Veterinary General Hospital No. 50. Redesignated 23 March 1925 as the 50th Veterinary General Hospital. Initiated 30 July 1925 at Fort Bliss, TX. Conducted summer training most years at Fort Bliss, TX, and some years at Fort Sam Houston, TX. Designated mobilization training station was Camp Stanley, TX. Withdrawn from the Eighth Corps Area 5 June 1936 and allotted to the Second Corps Area. Reorganized about June 1936 at New York City, NY. Inactivated 12 May 1937 at New York City by relief of personnel. Location 7 December 1941—*Inactive*.

Status: Disbanded 30 January 1942.**Commanders, 50th Veterinary General Hospital**

Unknown	30 Jul 25-12 May 37	<i>Inactive</i>	12 May 37-7 Dec 41
---------	---------------------	-----------------	--------------------

51st Veterinary General Hospital (Z.I.)**Organized Reserve Colorado/New York****HQ-Not initiated** 1923-25; Colorado Springs, CO, 1925-36; *Inactive* 1936-41

Constituted in the Organized Reserve 2 July 1923, assigned to the Zone of the Interior, and allotted to the Eighth Corps Area. Designated 12 September 1923 as Veterinary General Hospital No. 51. Redesignated 23 March 1925 as the 51st Veterinary General Hospital. Initiated 25 April 1925 at Fort Bliss, TX. Conducted summer training most years at Fort Sam Houston, TX. Designated mobilization training station was Camp Stanley, TX. Withdrawn from the Eighth Corps Area 5 June 1936 and allotted to the Second Corps Area. New York City, NY, designated as headquarters on reorganization, but the unit was never organized at that location. Location 7 December 1941—*Inactive*.

Status: Disbanded 30 January 1942.**Commanders, 51st Veterinary General Hospital**

Maj. Harry E. Kingman	25 Apr 25-17 Aug 27	Unknown	ao Feb 32-5 Jun 36
Lt. Col. George E. Miller	17 Aug 27-ao Feb 32	<i>Inactive</i>	5 Jun 36-7 Dec 41

52nd Veterinary General Hospital (Z.I.)**Organized Reserve Texas****HQ-Not initiated** 1923-34; Philadelphia, PA, 1934-40; *Inactive* 1940-41

Constituted in the Organized Reserve 2 July 1923, assigned to the Zone of the Interior, and allotted to the Eighth Corps Area. Designated 12 September 1923 as Veterinary General Hospital No. 52. Redesignated 23 March 1925 as the 52nd Veterinary General Hospital. Del Rio, TX, designated as headquarters on organization, but the unit was never organized at that location. Designated mobilization training station was Camp Stanley, TX. Withdrawn from the Organized Reserve 6 October 1928 and allotted to the Regular Army. Concurrently withdrawn from the Eighth Corps Area and allotted to the Third Corps Area Relieved from the Zone of the Interior 1 October 1933 and assigned to the General Headquarters Reserve. Organized 15 September 1934 at Philadelphia, PA. Inactivated 14 September 1940 at Philadelphia by relief of personnel. Location 7 December 1941—*Inactive*.

Status: Disbanded 11 November 1944.**Commanders, 52nd Veterinary General Hospital**

2nd Lt. Edward E. Thompson**	15 Sep 34-ao Jun 35	1st Lt. S. J. Michael**	ao Mar 36-11 Sep 40
Unknown	ao Jun 35-ao Mar 36	<i>Inactive</i>	11 Sep 40-7 Dec 41

** RAI Commanders: Organized Reserve officers.

53rd Veterinary General Hospital (Z.I.)**Organized Reserve Texas/New Jersey****HQ-Not initiated** 1923-25; Fort Worth, TX, 1925-36; *Inactive* 1936-41

Constituted in the Organized Reserve 2 July 1923, assigned to the Zone of the Interior, and allotted to the Eighth Corps Area. Designated 12 September 1923 as Veterinary General Hospital No. 53. Redesignated 23 March 1925 as the 53rd Veterinary General Hospital. Initiated 30 July 1925 at Fort Worth, TX. Conducted summer training at the veterinary hospital at Fort Sam Houston, TX. Designated mobilization training station was Camp Stanley, TX. Withdrawn from the Eighth Corps Area 5 June 1936 and allotted to the Second Corps Area. Inactivated 12 November 1936 at Fort Worth by relief of personnel. Trenton, NJ, designated 12 May 1937 as headquarters on reorganization, but the unit was never organized at that location. Location 7 December 1941—*Inactive*.

Status: Disbanded 30 January 1942.**Commanders, 53rd Veterinary General Hospital**

Maj. Herbert L. Blackburn	30 Jul 25-23 Oct 29	Maj. James T. Traylor	23 Apr 34-12 Nov 36
Lt. Col. George G. Miller	23 Oct 29-23 Apr 34	<i>Inactive</i>	5 Jun 36-7 Dec 41

54th Veterinary General Hospital (Z.I.)**Organized Reserve Utah/New York****HQ-Not initiated** 1923-25; Salt Lake City, UT, 1925-36; *Inactive* 1936-41

Constituted in the Organized Reserve 2 July 1923, assigned to the Zone of the Interior, and allotted to the Ninth Corps Area. Designated 12 September 1923 as Veterinary General Hospital No. 54. Redesignated 23 March 1925 as the 54th Veterinary General Hospital. Initiated in December 1925 at Salt Lake City, UT. Withdrawn from the Ninth Corps Area 5 June 1936 and allotted to the Second Corps Area. Inactivated 23 August 1936 at Salt Lake City by relief of personnel. New York City, NY, designated as headquarters on reorganization, but the unit was never organized at that location. Conducted summer training at the veterinary hospital at Fort Lewis, WA, or the Presidio of San Francisco, CA. Location 7 December 1941—*Inactive*.

Status: Disbanded 30 January 1942.**Commanders, 54th Veterinary General Hospital**

Capt. John M. Twitchell	Dec 25-ao Jun 27 <i>Inactive</i>	Unknown 23 Aug 36-7 Dec 41	ao Jun 27-23 Aug 36
-------------------------	-------------------------------------	-------------------------------	---------------------

55th Veterinary General Hospital (Z.I.)**Organized Reserve California/Tennessee****HQ-Not initiated** 1923-26; San Francisco, CA, 1926-28; *Inactive* 1928-29; Memphis, TN, 1929-41

Constituted in the Organized Reserve 2 July 1923, assigned to the Zone of the Interior, and allotted to the Ninth Corps Area. Designated 12 September 1923 as Veterinary General Hospital No. 55. Redesignated 23 March 1925 as the 55th Veterinary General Hospital. Initiated by December 1926 at San Francisco, CA. Withdrawn from the Organized Reserve 6 October 1928 and allotted to the Regular Army. Concurrently withdrawn from the Ninth Corps Area and allotted to the Fourth Corps Area. Reorganized 12 February 1929 at Memphis, TN. Relieved from the Zone of the Interior 1 October 1933 and assigned to the General Headquarters Reserve. Location 7 December 1941—Memphis, TN.

Status: Disbanded 11 November 1944.**Commanders, 55th Veterinary General Hospital**

1st Lt. Emile D. Torre	ao Dec 26-ao Jun 27	Unknown	ao Mar 29-9 Oct 34
Unknown	ao Jun 27-12 Feb 29	2nd Lt. Gordon C. Kendall**	9 Oct 34-ao Jan 35
1st Lt. Charles E. O'Neal**	12 Feb 29-ao Mar 29	Unknown	ao Jan 35-7 Dec 41

** RAI Commanders: Organized Reserve officers.

56th Veterinary General Hospital (Z.I.)**Organized Reserve Oregon/New Jersey****HQ-Not initiated** 1923-25; Corvallis, OR, 1925-36; *Inactive* 1936-41

Constituted in the Organized Reserve 2 July 1923, assigned to the Zone of the Interior, and allotted to the Ninth Corps Area. Designated 12 September 1923 as Veterinary General Hospital No. 56. Redesignated 23 March 1925 as the 56th Veterinary General Hospital. Initiated in December 1925 at Corvallis, OR. Withdrawn from the Ninth Corps Area 5 June 1936 and allotted to the Second Corps Area. Camden, NJ, designated as headquarters on reorganization, but the unit was never organized at that location. Conducted summer training at the veterinary hospital at the Presidio of San Francisco, CA. Location 7 December 1941—*Inactive*.

Status: Disbanded 30 January 1942.**Commanders, 56th Veterinary General Hospital**

Unknown	Dec 25-ao Jan 27	Unknown	ao Jun 27-5 Jun 36
Maj. Bennett T. Simms	ao Jan 27-ao Jun 27	<i>Inactive</i>	5 Jun 36-7 Dec 41

57th Veterinary General Hospital (Z.I.)**Organized Reserve Washington/New York****HQ-Not initiated** 1923-26; Pullman, WA, 1926-36; *Inactive* 1936-41

Constituted in the Organized Reserve 2 July 1923, assigned to the Zone of the Interior, and allotted to the Ninth Corps Area. Designated 12 September 1923 as Veterinary General Hospital No. 57. Redesignated 23 March 1925 as the 57th Veterinary General Hospital. Initiated by December 1926 at Pullman, WA. Withdrawn from the Ninth Corps Area 5 June 1936 and allotted to the Second Corps Area. Albany, NY, designated as headquarters on reorganization, but the unit was never organized at that location. Location 7 December 1941—*Inactive*.

Status: Disbanded 30 January 1942.**Commanders, 57th Veterinary General Hospital**

1st Lt. Rueben A. Button	ao Dec 26-ao Jun 27 <i>Inactive</i>	Unknown 5 Jun 36-7 Dec 41	ao Jun 27-5 Jun 36
--------------------------	--	------------------------------	--------------------

58th Veterinary General Hospital (Z.I.)**Organized Reserve California/New York****HQ-Not initiated** 1923-25; Los Angeles, CA, 1925-37; *Inactive* 1937-41

Constituted in the Organized Reserve 2 July 1923, assigned to the Zone of the Interior, and allotted to the Ninth Corps Area. Designated 12 September 1923 as Veterinary General Hospital No. 58. Redesignated 23 March 1925 as the 58th Veterinary General Hospital. Initiated in December 1925 at Los Angeles, CA. Withdrawn from the Ninth Corps Area 5 June 1936 and allotted to the Second Corps Area. Inactivated 22 May 1937 at Los Angeles by relief of personnel. New York City, NY, designated as headquarters on reorganization, but the unit was never organized at that location. Location 7 December 1941—*Inactive*.

Status: Disbanded 30 January 1942.**Commanders, 58th Veterinary General Hospital**

Unknown	Dec 25-ao Jun 27	Lt. Col. Robert J. Robertson	ao Dec 34-13 Jul 36
Maj. John McBirney	ao Jun 27-ao Jun 34	Maj. J. G. Townsend	13 Jul 36-22 May 37
Unknown	ao Jun 27-13 Jul 36	<i>Inactive</i>	13 Jul 36-7 Dec 41

59th Veterinary General Hospital (Z.I.)**Organized Reserve California****HQ-Not initiated** 1923-25; San Francisco, CA, 1925-29; *Inactive* 1929-41

Constituted in the Organized Reserve 2 July 1923, assigned to the Zone of the Interior, and allotted to the Ninth Corps Area. Designated 12 September 1923 as Veterinary General Hospital No. 59. Redesignated 23 March 1925 as the 59th Veterinary General Hospital. Initiated in November 1925 at San Francisco, CA. Inactivated 2 October 1929 at San Francisco by relief of personnel. Location 7 December 1941—*Inactive*.

Status: Disbanded 30 January 1942.**Commanders, 59th Veterinary General Hospital**

Unknown	Nov 25-ao Jun 27 <i>Inactive</i>	Lt. Col. George W. Constable 2 Oct 29-7 Dec 41	ao Jun 27-2 Oct 29
---------	-------------------------------------	---	--------------------

60th Veterinary General Hospital (Z.I.)**Organized Reserve Montana/California****HQ-Not initiated** 1923-25; Miles City, MT, 1925-37; Sacramento, CA, 1937-41

Constituted in the Organized Reserve 2 July 1923, assigned to the Zone of the Interior, and allotted to the Ninth Corps Area. Designated 12 September 1923 as Veterinary General Hospital No. 60. Redesignated 23 March 1925 as the 60th Veterinary General Hospital. Initiated in December 1925 at Miles City, MT. Relocated 14 May 1937 to Sacramento, CA. Location 7 December 1941—Sacramento, CA.

Status: Disbanded 30 January 1942.

Commanders, 60th Veterinary General Hospital

Unknown	Dec 25-ao Jun 27 Unknown	Maj. Albert C. Morrow ao Jun 29-7 Dec 41	ao Jun 27-ao Jun 29
---------	-----------------------------	---	---------------------

61st Veterinary General Hospital (GHQR)

Organized Reserve Ohio

HQ-Not initiated 1928-30; Columbus, OH, 1930-41

Constituted in the Organized Reserve 21 December 1928, assigned to the General Headquarters Reserve, and allotted to the Fifth Corps Area. Initiated 28 April 1930 at, and affiliated with, the Ohio State University Medical School in Columbus, OH. Location 7 December 1941—Columbus, OH.

Status: Disbanded 11 November 1944.

Commanders, 61st Veterinary General Hospital

Unknown	28 Apr 30-7 Dec 41
---------	--------------------

62nd Veterinary General Hospital (GHQR)

Organized Reserve Illinois

HQ-Not initiated 1928-29; Chicago, IL, 1929-41

Constituted in the Organized Reserve 21 December 1928, assigned to the General Headquarters Reserve, and allotted to the Sixth Corps Area. Initiated 8 August 1929 at Chicago, IL. Conducted summer training at the veterinary hospital at Jefferson Barracks, MO, or Camp Custer, MI. Location 7 December 1941—Chicago, IL.

Status: Disbanded 11 November 1944.

Commanders, 62nd Veterinary General Hospital

Capt. Robert S. Marshall	8 Aug 29-Jun 30	Capt. David E. Sisk	ao Jun 34-14 Nov 36
Capt. Albert Sanders, jr.	Jun 30-ao Dec 30	Maj. James H. Allen	14 Nov 36-24 Mar 39
Unknown	ao Dec 30-ao Jun 34	Unknown	24 Mar 39-7 Dec 41

63rd Veterinary General Hospital (GHQR)

Organized Reserve Nebraska

HQ-Not initiated 1928-38; Omaha, NE, 1938-41

Constituted in the Organized Reserve 21 December 1928, assigned to the General Headquarters Reserve, and allotted to the Seventh Corps Area. Initiated 23 February 1938 at Omaha, NE. Location 7 December 1941—Omaha, NE.

Status: Disbanded 11 November 1944.

Commanders, 63rd Veterinary General Hospital

Capt. Richard E. Geisler	24 Feb 38-23 Mar 39	Capt. Virgil H. Clark	16 Sep 39-ao Jan 40
1st Lt. Harold P. Hartsell	23 Mar 39-16 Sep 39	Unknown	ao Jan 40-7 Dec 41

64th Veterinary General Hospital (GHQR)

Organized Reserve Texas/Illinois

HQ-Not initiated 1928-29; Fort Clark, TX, 1929-36; *Inactive* 1936-41

Constituted in the Organized Reserve 21 December 1928, assigned to the General Headquarters Reserve, and allotted to the Eighth Corps Area. Initiated by July 1929 at Fort Clark, TX. Designated mobilization training station was Fort Clark, TX. Conducted summer training at the veterinary hospital at Fort Clark, TX. Withdrawn from the Eighth Corps Area 5 June 1936 and allotted to the Sixth Corps Area. Inactivated 12 November 1936 at Fort Clark, TX, by relief of personnel. Chicago, IL, designated as headquarters on reorganization, but the unit was never organized at that location. Location 7 December 1941—*Inactive*.

Status: Disbanded 11 November 1944.

Commanders, 64th Veterinary General Hospital

Unknown

ao Jul 29-ao Oct 36
Inactive

1st Lt. Carl Tryggvi
12 Nov 36-7 Dec 41

ao Oct 36-12 Nov 36

65th Veterinary General Hospital (GHQR)

Organized Reserve Oregon

HQ-*Not initiated* 1928-29; Corvallis, OR, 1929-36; *Inactive* 1936-41

Constituted in the Organized Reserve 21 December 1928, assigned to the General Headquarters Reserve, and allotted to the Eighth Corps Area. Initiated by June 1929 at Corvallis, OR. Withdrawn from the Ninth Corps Area 5 June 1936 and allotted to the Seventh Corps Area. Conducted summer training at the veterinary hospital at the station hospital, Fort Lewis, WA. Location 7 December 1941—*Inactive*.

Status: Disbanded 11 November 1944.

Commanders, 65th Veterinary General Hospital

Unknown

ao Jun 29-5 Jun 36

Inactive

5 Jun 36-7 Dec 41

Veterinary Station Hospital, 1926

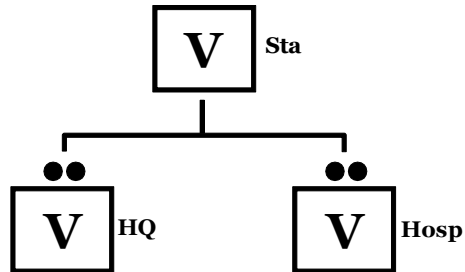

T/O: 687W
Approved: 2 April 1926
Commander: Capt.
Officers: 4
Nurses: --
W. O.: --
Enlisted: 72
Total: 76

150 head capacity

Key Equipment:
 Cars, 5-passenger 1
 Mules 16
 Wagons, escort 3
 Trucks, 3- to 5-ton 1

Veterinary Station Hospital TOE.

Veterinary Station Hospital mission: The principal veterinary hospital within the Zone of the Interior. Provide the final stage of animal hospitalization within the Zone of the Interior; furnish definitive treatment to salvageable animals that require no further treatment by lower echelon veterinary services but are not yet ready for return to duty; furnish definitive treatment to cases received from lower echelon veterinary services located in the Zone of the Interior.

1st Veterinary Station Hospital

Organized Reserve Alabama

HQ-*Not initiated* 1923-25; Auburn, AL, 1924-41

Constituted in the Organized Reserve 2 July 1923, assigned to the Communications Zone, and allotted to the Third Corps Area. Designated 12 September 1923 as Veterinary Station Hospital No. 1. Initiated 2 June 1924 at Auburn, AL. Redesignated 23 March 1925 as the 1st Veterinary Station Hospital. Location 7 December 1941—Auburn, AL.

Status: Disbanded 11 November 1944.

Commanders, 1st Veterinary Station Hospital

Unknown
2nd Lt. Frederick D. Patterson, jr.

2 Jun 24-ao Jun 27
ao Jun 27-ao Jan 28
Unknown

Unknown
Capt. Houston Odom
ao Feb 38-7 Dec 41

ao Jan 28-9 Oct 35
9 Oct 35-ao Feb 38

2nd Veterinary Station Hospital (C.Z.)**Organized Reserve Kansas****HQ-Not initiated** 1923-24; Fort Leavenworth, KS, 1924-31; Wichita, KS, 1931-41

Authorized 16 April 1923 by the Surgeon General for organization at Fort Leavenworth, KS. Constituted in the Organized Reserve 2 July 1923, assigned to the Communications Zone, and allotted to the Seventh Corps Area. Designated 12 September 1923 as Veterinary Station Hospital No. 2. Initiated in November 1924 at Fort Leavenworth, KS. Redesignated 23 March 1925 as the 2nd Veterinary Station Hospital. Relocated 12 October 1931 to Wichita, KS. Location 7 December 1941—Wichita, KS.

Status: Disbanded 30 January 1942.**Commanders, 2nd Veterinary Station Hospital**

Unknown	Nov 24-ao Sep 25 Unknown	Capt. William G. Keehn 6 Dec 27-7 Dec 41	ao Sep 25-6 Dec 27
---------	-----------------------------	---	--------------------

3rd Veterinary Station Hospital (C.Z.)**Organized Reserve Texas/Missouri/Nebraska****HQ-Not initiated** 1923-26; Fort Sam Houston, TX, 1926-27; Springfield, MO, 1927-31; Lincoln, NE, 1931-41

Constituted in the Organized Reserve 2 July 1923, assigned to the Communications Zone, and allotted to the Eighth Corps Area. Designated 12 September 1923 as Veterinary Station Hospital No. 3. Redesignated 23 March 1925 as the 3rd Veterinary Station Hospital. Initiated by December 1926 at Fort Sam Houston, TX. Withdrawn from the Eighth Corps Area 13 January 1927 and allotted to the Seventh Corps Area. Reorganized by June 1927 at Springfield, MO. Relocated 12 October 1931 to Lincoln, NE. Location 7 December 1941—Lincoln, NE.

Status: Disbanded 30 January 1942.**Commanders, 3rd Veterinary Station Hospital**

Maj. David J. Lynch	ao Dec 26-12 Jan 27	Unknown	ao Jun 27-7 Dec 41
---------------------	---------------------	---------	--------------------

4th Veterinary Station Hospital (C.Z.)**Organized Reserve Minnesota/South Dakota****HQ-Not initiated** 1923-24; Fort Snelling, MN, 1924-28; Sioux Falls, SD, 1928-41

Authorized 27 December 1922 by the Surgeon General for organization at Fort Snelling, MN. Constituted in the Organized Reserve 2 July 1923, assigned to the Communications Zone, and allotted to the Seventh Corps Area. Designated 12 September 1923 as Veterinary Station Hospital No. 4. Initiated in November 1924 at Fort Snelling, MN. Redesignated 23 March 1925 as the 4th Veterinary Station Hospital. Relocated 3 April 1928 to Sioux Falls, SD. Location 7 December 1941—Sioux Falls, SD.

Status: Disbanded 30 January 1942.**Commanders, 4th Veterinary Station Hospital**

Unknown	Nov 24-ao Sep 25 Unknown	Maj. Orval C. Selby ao Jun 27-7 Dec 41	ao Sep 25-ao Jun 27
---------	-----------------------------	---	---------------------

5th Veterinary Station Hospital (C.Z.)**Organized Reserve Iowa****HQ-Not initiated** 1923-24; Fort Des Moines, IA, 1924-31; Cedar Rapids, IA, 1931-41

Authorized 26 December 1922 by the Surgeon General for organization at Fort Des Moines, IA. Constituted in the Organized Reserve 2 July 1923, assigned to the Communications Zone, and allotted to the Seventh Corps Area. Designated 12 September 1923 as Veterinary Station Hospital No. 5. Initiated in November 1924 at Fort Des Moines, IA. Redesignated 23 March 1925 as the 5th Veterinary Station Hospital. Location 7 December 1941—Cedar Rapids, IA.

Status: Disbanded 30 January 1942.

Commanders, 5th Veterinary Station Hospital

Unknown	Nov 24-ao Sep 25 Unknown	Capt. Gordon Schultz ao Jun 27-7 Dec 41	ao Sep 25-ao Jun 27
---------	-----------------------------	--	---------------------

6th Veterinary Station Hospital (C.Z.)

Organized Reserve Minnesota/Nebraska

HQ-Not initiated 1923-25; Fort Snelling, MN, 1925-28; Omaha, NE, 1928-31; Grand Island, NE, 1931-41

Authorized 6 January 1923 by the Surgeon General for organization at Fort Snelling, MN. Constituted in the Organized Reserve 2 July 1923, assigned to the Communications Zone, and allotted to the Seventh Corps Area. Designated 12 September 1923 as Veterinary Station Hospital No. 6. Redesignated 23 March 1925 as the 6th Veterinary Station Hospital. Initiated by September 1925 at Fort Snelling, MN. Relocated 3 April 1928 to Omaha, NE. Relocated 12 October 1931 to Grand Island, NE. Relieved from assignment to the Communications Zone 1 October 1933 and assigned to the General Headquarters Reserve. Location 7 December 1941—Grand Island, NE.

Status: Disbanded 11 November 1944.

Commanders, 6th Veterinary Station Hospital

Capt. Merrill L. Steele	ao Sep 25-ao Jun 27	1st Lt. William G. Sullivan	8 Dec 35-20 Mar 39
Unknown	ao Jun 27-8 Dec 35 Unknown	1st Lt. Marvin J. Twiehaus, Jr. ao Apr 39-7 Dec 41	20 Mar 39-ao Apr 39

7th Veterinary Station Hospital (C.Z.)

Organized Reserve Vermont/New York

HQ-Not initiated 1923-27; Burlington, VT, 1927-30; *Inactive* 1930-32; White River Junction, VT, 1932-36; *Inactive* 1936-37; Syracuse, NY, 1936-41

Constituted in the Organized Reserve 2 July 1923, assigned to the Communications Zone, and allotted to the First Corps Area. Designated 12 September 1923 as Veterinary Station Hospital No. 7. Initiated 17 February 1927 at Burlington, VT. Redesignated 23 March 1925 as the 7th Veterinary Station Hospital. Withdrawn from the Organized Reserve 6 October 1928 and allotted to the Regular Army. Inactivated by June 1930 at Burlington by relief of personnel. Reorganized by June 1932 at White River Junction, VT. Relieved from assignment to the Communications Zone 1 October 1933 and assigned to the General Headquarters Reserve. Withdrawn from the First Corps Area 5 June 1936 and allotted to the Second Corps Area. Reorganized 13 May 1937 at Syracuse, NY. Location 7 December 1941—Syracuse, NY.

Status: Disbanded 11 November 1944.

Commanders, 7th Veterinary Station Hospital

2nd Lt. Lawrence H. Conlon	17 Feb 27-ao Jul 28	Unknown	ao Dec 34-5 Jun 36
<i>Inactive</i>	ao Jun 30-ao Jun 32	<i>Inactive</i>	5 Jun 36-13 May 37
Unknown	ao Jun 32-17 May 33	1st Lt. John P. McCarthy**	13 May 37-3 Nov 37
2nd Lt. Fred F. Bushnell, Jr.**	17 May 33-ao Dec 34	1st Lt. Donald J. Pressler**	3 Nov 37-27 Mar 41
	1st Lt. Frederick J. Hoyt**	27 Mar 41-ao Dec 41	

** RAI Commanders: Organized Reserve officers.

8th Veterinary Station Hospital (C.Z.)

Organized Reserve Massachusetts/New York

HQ-Not initiated 1923-25; Amherst, MA, 1925-36; *Inactive* 1936-37; Albany, NY, 1937-41

Constituted in the Organized Reserve 2 July 1923, assigned to the Communications Zone, and allotted to the First Corps Area. Designated 12 September 1923 as Veterinary Station Hospital No. 8. Initiated by October 1925 at Amherst, MA. Redesignated 23 March 1925 as the 8th Veterinary Station Hospital. Relieved from assignment to the Communications Zone 1 October 1933 and assigned to the General Headquarters Reserve. Withdrawn from the First Corps Area 5 June 1936 and allotted to the Second Corps Area. Reorganized 25 May 1937 at Albany, NY. Location 7 December 1941—Albany, NY.

Status: Disbanded 11 November 1944.

Commanders, 8th Veterinary Station Hospital

Unknown	ao Oct 25-ao Jun 27	<i>Inactive</i>	5 Jun 36-24 May 37
Capt. Norman J. Pyle	ao Jun 27-9 Nov 29	1st Lt. Frederick C. Cairns	24 May 37-26 Oct 38
Unknown	9 Nov 29-5 Jun 36	1st Lt. William S. Houk	26 Oct 38-16 Jan 40
	1st Lt. David Jacobsen	6 Mar 40-ao Dec 41	

9th Veterinary Station Hospital (C.Z.)

Organized Reserve Maine

HQ-Not initiated 1923-27; Bangor, MA, 1927-28

Constituted in the Organized Reserve 2 July 1923, assigned to the Communications Zone, and allotted to the First Corps Area. Designated 12 September 1923 as Veterinary Station Hospital No. 9. Redesignated 23 March 1925 as the 9th Veterinary Station Hospital. Initiated 28 March 1927 at Bangor, MA. Withdrawn from the First Corps Area 27 December 1928 and demobilized.

Commanders, 9th Veterinary Station Hospital

Unknown	28 Mar 27-27 Dec 28
---------	---------------------

10th Veterinary Station Hospital (C.Z.)

Organized Reserve New York

HQ-Not initiated 1923-41

Constituted in the Organized Reserve 2 July 1923, assigned to the Communications Zone, and allotted to the Second Corps Area. Designated 12 September 1923 as Veterinary Station Hospital No. 10. Redesignated 23 March 1925 as the 10th Veterinary Station Hospital. Jamaica, NY, designated as headquarters on organization, but the unit was never organized at that location. Location 7 December 1941—*Not initiated*.

Status: Disbanded 30 January 1942.

11th Veterinary Station Hospital (C.Z.)

Organized Reserve New York

HQ-Not initiated 1923-41

Constituted in the Organized Reserve 2 July 1923, assigned to the Communications Zone, and allotted to the Second Corps Area. Designated 12 September 1923 as Veterinary Station Hospital No. 11. Redesignated 23 March 1925 as the 11th Veterinary Station Hospital. Manhattan, NY, designated as headquarters on organization, but the unit was never organized at that location. Location 7 December 1941—*Not initiated*.

Status: Disbanded 30 January 1942.

12th Veterinary Station Hospital (C.Z.)

Organized Reserve New York

HQ-Not initiated 1923-41

Constituted in the Organized Reserve 2 July 1923, assigned to the Communications Zone, and allotted to the Second Corps Area. Designated 12 September 1923 as Veterinary Station Hospital No. 12. Redesignated 23 March 1925 as the 11th Veterinary Station Hospital. Withdrawn from the Organized Reserve 27 December 1928 and allotted to the Regular Army. Rochester, NY, designated as headquarters on organization, but the unit was never organized at that location. Location 7 December 1941—*Not initiated*.

13th Veterinary Station Hospital (C.Z.)

Organized Reserve Maryland

HQ-*Not initiated* 1923-39; Frederick, MD, 1939-41

Constituted in the Organized Reserve 2 July 1923, assigned to the Communications Zone, and allotted to the Third Corps Area. Designated 12 September 1923 as Veterinary Station Hospital No. 13. Redesignated 23 March 1925 as the 13th Veterinary Station Hospital. Camp George G. Meade, MD, designated as headquarters on organization, but the unit was never organized at that location. Designated headquarters changed 20 January 1933 to Frederick, MD. Initiated 1 December 1939 at Frederick. Location 7 December 1941—Frederick, MD.

Status: Disbanded 30 January 1942.

Commanders, 13th Veterinary Station Hospital

Capt. Merrill L. Steele 1 Dec 39-30 Jan 42

14th Veterinary Station Hospital (C.Z.)

Organized Reserve Virginia

HQ-*Not initiated* 1923-41

Constituted in the Organized Reserve 2 July 1923, assigned to the Communications Zone, and allotted to the Third Corps Area. Designated 12 September 1923 as Veterinary Station Hospital No. 14. Redesignated 23 March 1925 as the 14th Veterinary Station Hospital. Fort Myer, VA, designated as headquarters on organization, but the unit was never organized at that location. Designated headquarters changed 20 January 1933 to Alexandria, VA. Location 7 December 1941—*Not initiated*.

Status: Disbanded 30 January 1942.

15th Veterinary Station Hospital (C.Z.)

Organized Reserve Virginia

HQ-*Not initiated* 1923-41

Constituted in the Organized Reserve 2 July 1923, assigned to the Communications Zone, and allotted to the Third Corps Area. Designated 12 September 1923 as Veterinary Station Hospital No. 15. Redesignated 23 March 1925 as the 15th Veterinary Station Hospital. Norfolk, VA, designated as headquarters on organization, but the unit was never organized at that location. Withdrawn from the Organized Reserve 27 December 1928 and allotted to the Regular Army. Location 7 December 1941—*Not initiated*.

16th Veterinary Station Hospital (C.Z.)

Organized Reserve Maryland

HQ-*Not initiated* 1923-25; Baltimore, MD, 1925-30; *Inactive* 1930-41

Constituted in the Organized Reserve 2 July 1923, assigned to the Communications Zone, and allotted to the Third Corps Area. Designated 12 September 1923 as Veterinary Station Hospital No. 16. Initiated 28 January 1925 at Baltimore, MD. Redesignated 23 March 1925 as the 16th Veterinary Station Hospital. Inactivated by June 1930 at Baltimore by relief of personnel. Location 7 December 1941—*Inactive*.

Status: Disbanded 30 January 1942.

Commanders, 16th Veterinary Station Hospital

1st Lt. Robert W. McKibben	28 Jan 25-11 Jun 25	Unknown	ao Jun 26-ao Jun 30
Capt. Walter C. Reeder	11 Jan 25-ao Jun 26	<i>Inactive</i>	ao Jun 30-7 Dec 41

17th Veterinary Station Hospital (C.Z.)**Organized Reserve Louisiana/Alabama/Ohio****HQ-Not initiated** 1923-41

Constituted in the Organized Reserve 2 July 1923, assigned to the Communications Zone, and allotted to the Third Corps Area. Designated 12 September 1923 as Veterinary Station Hospital No. 17. Redesignated 23 March 1925 as the 17th Veterinary Station Hospital. Alexandria, LA, designated as headquarters on organization, but the unit was never organized at that location. Designated headquarters changed 22 October 1929 to Montgomery, AL. Withdrawn from the Fourth Corps Area 5 June 1936 and allotted to the Fifth Corps Area. Columbus, OH, designated as headquarters on organization, but the unit was never organized at that location. Location 7 December 1941—*Not initiated*.

Status: Disbanded 24 May 1949.**18th Veterinary Station Hospital (C.Z.)****Organized Reserve Alabama****HQ-Not initiated** 1923-38; Fourth Corps Area 1938-41

Constituted in the Organized Reserve 2 July 1923, assigned to the Communications Zone, and allotted to the Third Corps Area. Designated 12 September 1923 as Veterinary Station Hospital No. 18. Redesignated 23 March 1925 as the 18th Veterinary Station Hospital. Mobile, AL, designated as headquarters on organization, but the unit was never organized at that location. Withdrawn from the Organized Reserve 27 December 1928 and allotted to the Regular Army. Organized by December 1938 in the Fourth Corps Area. Location 7 December 1941—Fourth Corps Area.

Commanders, 18th Veterinary Station Hospital

1st Lt. Alan W. Wright**	ao Dec 38-29 May 39	Unknown	29 May 39-7 Dec 41
--------------------------	---------------------	---------	--------------------

** RAI Commanders: Organized Reserve officers.

19th Veterinary Station Hospital (C.Z.)**Organized Reserve Kentucky/Ohio****HQ-Not initiated** 1923-25; Camp Knox, KY, 1925-31; Bellefontaine, OH, 1931-33; Dayton, OH, 1933-41

Constituted in the Organized Reserve 2 July 1923, assigned to the Communications Zone, and allotted to the Fifth Corps Area. Designated 12 September 1923 as Veterinary Station Hospital No. 19. Redesignated 23 March 1925 as the 19th Veterinary Station Hospital. Initiated in October 1925 at Camp Knox, KY. Relocated 9 July 1931 to Bellefontaine, OH. Relocated 21 December 1933 to Dayton, OH. Location 7 December 1941—Dayton, OH.

Status: Disbanded 11 November 1944.**Commanders, 19th Veterinary Station Hospital**

Unknown	Oct 25-ao Jun 27	2nd Lt. Gerald S. Harshfield	ao Jun 27-ao Jan 28
	Unknown	ao Jan 28-7 Dec 41	

20th Veterinary Station Hospital (C.Z.)**Organized Reserve Kentucky****HQ-Not initiated** 1923-26; Camp Knox, KY, 1926-30; *Inactive* 1930-41

Constituted in the Organized Reserve 2 July 1923, assigned to the Communications Zone, and allotted to the Fifth Corps Area. Designated 12 September 1923 as Veterinary Station Hospital No. 20. Redesignated 23 March 1925 as the 21st Veterinary Station Hospital. Initiated by December 1926 at Camp Knox, KY. Inactivated by March 1930 at Camp Knox by relief of personnel. Louisville, KY, designated 9 July 1931 as headquarters on reorganization, but the unit was never organized at that location. Designated headquarters changed 21 December 1933 to Lexington, KY. Location 7 December 1941—*Inactive*.

Status: Disbanded 30 January 1942.

Commanders, 20th Veterinary Station Hospital

2nd Lt. Charles W. Anson

ao Dec 26-ao Jun 27
Inactive

Unknown
Mar 30-7 Dec 41

ao Jun 27-Mar 30

21st Veterinary Station Hospital (C.Z.)

Organized Reserve Kentucky/Indiana

HQ-*Not initiated* 1923-26; Camp Knox, KY, 1926-30; *Inactive* 1930-41

Constituted in the Organized Reserve 2 July 1923, assigned to the Communications Zone, and allotted to the Fifth Corps Area. Designated 12 September 1923 as Veterinary Station Hospital No. 21. Redesignated 23 March 1925 as the 21st Veterinary Station Hospital. Initiated by December 1926 at Camp Knox, KY. Inactivated by March 1930 at Camp Knox by relief of personnel. Jeffersonville, IN, designated 9 July 1931 as headquarters on reorganization, but the unit was never organized at that location. Relieved from assignment to the Communications Zone 1 October 1933 and assigned to the General Headquarters Reserve. Location 7 December 1941—*Inactive*.

Status: Disbanded 11 November 1944.

Commanders, 21st Veterinary Station Hospital

Unknown

ao Dec 26-Mar 30

Inactive

Mar 30-7 Dec 41

22nd Veterinary Station Hospital (C.Z.)

Organized Reserve Kentucky

HQ-*Not initiated* 1923-41

Constituted in the Organized Reserve 2 July 1923, assigned to the Communications Zone, and allotted to the Fifth Corps Area. Designated 12 September 1923 as Veterinary Station Hospital No. 22. Redesignated 23 March 1925 as the 22nd Veterinary Station Hospital. Fort Thomas, KY, designated as headquarters on organization, but the unit was never organized at that location. Withdrawn from the Organized Reserve 27 December 1928 and allotted to the Regular Army. Location 7 December 1941—*Not initiated*.

23rd Veterinary Station Hospital (C.Z.)

Organized Reserve Illinois

HQ-*Not initiated* 1923-24; Decatur, IL, 1924-30; *Inactive* 1930-34; Chicago, IL, 1934-41

Constituted in the Organized Reserve 2 July 1923, assigned to the Communications Zone, and allotted to the Fifth Corps Area. Designated 12 September 1923 as Veterinary Station Hospital No. 23. Initiated in December 1924 at Decatur, IL. Redesignated 23 March 1925 as the 23rd Veterinary Station Hospital. Inactivated by December 1930 at Decatur by relief of personnel. Reorganized by June 1934 at Chicago, IL. Conducted summer training at the veterinary hospital at Camp McCoy, WI. Location 7 December 1941—Chicago, IL.

Status: Disbanded 23 October 1944.

Commanders, 23rd Veterinary Station Hospital

Unknown

2nd Lt. Ross J. Hinkle

Dec 24-ao Sep 25

ao Sep 25-ao Jun 29

Unknown

Unknown

Inactive

ao Jun 34-7 Dec 41

ao Jun 29-ao Dec 30

ao Dec 30-ao Jun 34

24th Veterinary Station Hospital (C.Z.)

Organized Reserve Michigan

HQ-*Not initiated* 1923-24; Alma, MI, 1924-32; Marshall, MI, 1932-37; Battle Creek, MI, 1937-38; Kalamazoo, MI, 1938-41

Constituted in the Organized Reserve 2 July 1923, assigned to the Communications Zone, and allotted to the Fifth Corps Area. Designated 12 September 1923 as Veterinary Station Hospital No. 24. Redesignated 23 March 1925 as the 24th Veterinary Station Hospital. Initiated in November 1924 at Alma, MI. Relocated successively as follows: 27 March 1932 to Marshall, MI; 28 July 1937 to Battle Creek, MI; by January 1938 to Kalamazoo, MI. Conducted summer training at the veterinary hospital at Camp McCoy, WI, or Jefferson Barracks, MO. Location 7 December 1941—Kalamazoo, MI.

Status: Disbanded 23 October 1944.

Commanders, 24th Veterinary Station Hospital

Unknown	Nov 24-ao Sep 25 Unknown	Capt. Benjamin H. Dunkley ao Jun 27-7 Dec 41	ao Sep 25-ao Jun 27
---------	-----------------------------	---	---------------------

25th Veterinary Station Hospital (C.Z.)

Organized Reserve Illinois

HQ-*Not initiated* 1923-26; East St. Louis, IL, 1926-41

Constituted in the Organized Reserve 2 July 1923, assigned to the Communications Zone, and allotted to the Fifth Corps Area. Designated 12 September 1923 as Veterinary Station Hospital No. 25. Redesignated 23 March 1925 as the 25th Veterinary Station Hospital. Initiated 17 April 1926 at East St. Louis, IL. Conducted summer training at the veterinary hospital at Jefferson Barracks, MO. Withdrawn from the Organized Reserve 27 December 1928 and allotted to the Regular Army. Location 7 December 1941—East St. Louis, IL.

Commanders, 25th Veterinary Station Hospital

2nd Lt. Robert W. Merriman Unknown	17 Apr 26-ao Jun 27 ao Jun 27-ao Aug 37	Maj. William G. Keehn** Unknown	ao Aug 37-19 Sep 37 19 Sep 37-7 Dec 41
---------------------------------------	--	------------------------------------	---

** RAI Commanders: Organized Reserve officers.

26th Veterinary Station Hospital

Organized Reserve Oklahoma/North Dakota

HQ-*Not initiated* 1923-41

Constituted in the Organized Reserve 2 July 1923, assigned to the Communications Zone, and allotted to the Eighth Corps Area. Designated 12 September 1923 as Veterinary Station Hospital No. 26. Oklahoma City, OK, designated as headquarters on organization, but the unit was never organized at that location. Redesignated 23 March 1925 as the 26th Veterinary Station Hospital. Withdrawn from the Eighth Corps Area 7 January 1927 and allotted to the Seventh Corps Area. Fargo, ND, designated as headquarters on organization, but the unit was never organized at that location. Location 7 December 1941—*Not initiated*.

Status: Disbanded 30 January 1942.

27th Veterinary Station Hospital

Organized Reserve Texas/South Dakota

HQ-*Not initiated* 1923-36; Vermillion, SD, 1936-41

Constituted in the Organized Reserve 2 July 1923, assigned to the Communications Zone, and allotted to the Eighth Corps Area. Designated 12 September 1923 as Veterinary Station Hospital No. 27. Redesignated 23 March 1925 as the 27th Veterinary Station Hospital. Fort Bliss, TX, designated as headquarters on organization, but the unit was never organized at that location. Withdrawn from the Eighth Corps Area 7 January 1927 and allotted to the Seventh Corps Area. Conducted summer training in 1927 at the Fort Sam Houston station hospital. Organized Reserve 27 December 1928 and allotted to the Regular Army. Concurrently withdrawn from the Eighth Corps Area and allotted to the Seventh Corps Area. Organized 3 August 1936 at Vermillion, SD. Location 7 December 1941—Vermillion, SD.

Status: Disbanded 11 November 1944.

Commanders, 27th Veterinary Station Hospital

Unknown 3 Aug 36-7 Dec 41

28th Veterinary Station Hospital

Organized Reserve Colorado/New York

HQ-Not initiated 1923-36; Syracuse, NY, 1936-41

Constituted in the Organized Reserve 2 July 1923, assigned to the Communications Zone, and allotted to the Fifth Corps Area. Designated 12 September 1923 as Veterinary Station Hospital No. 28. Redesignated 23 March 1925 as the 28th Veterinary Station Hospital. Denver, CO, designated as headquarters on organization, but the unit was never organized at that location. Withdrawn from the Eighth Corps Area 5 June 1936 and allotted to the Second Corps Area. Initiated 3 August 1936 at Syracuse, NY. Designated mobilization training station was Camp Stanley, TX, 1923-36. Location 7 December 1941—Syracuse, NY.

Status: Disbanded 11 November 1944.

Commanders, 28th Veterinary Station Hospital

1st Lt. Russel J. Stewart	3 Aug 36-12 Nov 36	1st Lt. Wilbur C. H. Hirschey	18 Jun 38-7 Oct 38
Unknown	12 Nov 36-17 May 37	Unknown	7 Oct 38-22 Jan 39
1st Lt. George Wohnseidler	17 May 37-18 Jun 38	1st Lt. James J. McCarthy	22 Jun 39-ao Dec 41

29th Veterinary Station Hospital (C.Z.)

Organized Reserve Oregon/California

HQ-Not initiated 1923-25; Corvallis, OR, 1925-36; Sacramento, CA, 1936-41

Constituted in the Organized Reserve 2 July 1923, assigned to the Communications Zone, and allotted to the Ninth Corps Area. Designated 12 September 1923 as Veterinary Station Hospital No. 29. Redesignated 23 March 1925 as the 29th Veterinary Station Hospital. Initiated by September 1925 at Corvallis, OR. Relocated in 1936 to Sacramento, CA. Location 7 December 1941—Sacramento, CA, (inactivated 30 January 1942).

Status: Disbanded 11 November 1944.

Commanders, 29th Veterinary Station Hospital

Unknown	ao Sep 25-28 Sep 33	Capt. Thomas B. Carter	28 Sep 33-7 Jun 37
	1st Lt. Wallace V. Glayser	7 Jun 37-ao Jan 41	

30th Veterinary Station Hospital (C.Z.)

Organized Reserve California

HQ-Not initiated 1923-25; Los Angeles, CA, 1925-41

Constituted in the Organized Reserve 2 July 1923, assigned to the Communications Zone, and allotted to the Ninth Corps Area. Designated 12 September 1923 as Veterinary Station Hospital No. 30. Redesignated 23 March 1925 as the 29th Veterinary Station Hospital. Initiated by September 1925 at Los Angeles, CA. Withdrawn from the Organized Reserve 27 December 1928 and allotted to the Regular Army. Location 7 December 1941—Los Angeles, CA.

Commanders, 30th Veterinary Station Hospital

Unknown	ao Sep 25-ao Jan 37	1st Lt. Roger F. Rolnbaker**	ao Jan 37-ao Jan 41
---------	---------------------	------------------------------	---------------------

** RAI Commanders: Organized Reserve officers.

31st Veterinary Station Hospital (C.Z.)

Organized Reserve

HQ-Not initiated 1923-32; Fourth Corps Area 1932-33; Brooklyn, NY, 1933-41

Constituted in the Organized Reserve 5 September 1928, assigned to the Communications Zone, and allotted to the Eighth Corps Area. Withdrawn from the Eighth Corps Area 28 November 1928 and allotted to the Fourth Corps Area. Initiated by June 1932 in the Fourth Corps Area. Demobilized 1 October 1933. Concurrently reconstituted in the Regular Army and allotted to the Second Corps Area. Reorganized 7 November 1933 at Brooklyn, NY. Location 7 December 1941—Brooklyn, NY.

Status: Disbanded 11 November 1944.

Commanders, 31st Veterinary Station Hospital

Unknown	ao Jun 32-1 Oct 33	1st Lt. Frederick C. Cairns**	7 Nov 33-24 May 37
<i>Inactive</i>	1 Oct 33-7 Nov 33	Capt. Joseph J. Merenda**	24 May 37-ao Dec 41

** RAI Commanders: Organized Reserve officers.

32nd Veterinary Station Hospital (I) (C.Z.)

Regular Army Inactive

HQ-*Not initiated* 1928-32; Unknown 1932-33

Constituted in the Organized Reserve 5 September 1928 and assigned to the Communications Zone. Withdrawn from the Organized Reserve 21 December 1928 and allotted to the Regular Army. Organized about September 1932. Demobilized 1 October 1933.

Commanders, 32nd Veterinary Station Hospital (I)

Unknown	ao Sep 32-1 Oct 33
---------	--------------------

32nd Veterinary Station Hospital (II) (C.Z.)

Organized Reserve

HQ-*Not initiated* 1933-34; Third Corps Area 1934-41

Constituted in the Organized Reserve 1 October 1933, assigned to the Communications Zone, and allotted to the Third Corps Area. Initiated 18 October 1934 in the Third Corps Area. Location 7 December 1941—Third Corps Area.

Status: Disbanded 30 January 1942.

Commanders, 32nd Veterinary Station Hospital (II)

2nd Lt. Clair L. Butler	18 Oct 34-ao Jan 35	Unknown	ao Jan 35-7 Dec 41
-------------------------	---------------------	---------	--------------------

33rd Veterinary Station Hospital (I) (C.Z.)

Regular Army Inactive

HQ-*Not initiated* 1928-30; Auburn, AL, 1930-33

Constituted in the Organized Reserve 5 September 1928, assigned to the Communications Zone, and allotted to the Fourth Corps Area. Withdrawn from the Organized Reserve 21 December 1928 and allotted to the Regular Army. Organized by March 1930 at Auburn, AL. Demobilized 1 October 1933.

Commanders, 33rd Veterinary Station Hospital

1st Lt. Gilbert T. Jackson**	ao Mar 30-14 Jun 30	Capt. Don B. Strickler**	14 Jun 30-8 Jul 32
	2nd Lt. Houston Odom**	8 Jul 32-1 Oct 33	

** RAI Commanders: Organized Reserve officers.

33rd Veterinary Station Hospital (II) (C.Z.)

Organized Reserve

HQ-*Not initiated* 1933-41

Constituted in the Organized Reserve 1 October 1933, assigned to the Communications Zone, and allotted to the Fourth Corps Area. Location 7 December 1941—*Not initiated*.

Status: Disbanded 30 January 1942.

34th Veterinary Station Hospital (I) (C.Z.)**Regular Army Inactive****HQ-Not initiated** 1928-33

Constituted in the Organized Reserve 5 September 1928, assigned to the Communications Zone, and allotted to the Fifth Corps Area. Withdrawn from the Organized Reserve 21 December 1928 and allotted to the Regular Army. Huntington, WV, designated as headquarters on organization, but the unit was never organized at that location. Demobilized 1 October 1933.

34th Veterinary Station Hospital (II) (C.Z.)**Organized Reserve West Virginia****HQ-Not initiated** 1933-41

Constituted in the Organized Reserve 1 October 1933, assigned to the Communications Zone, allotted to the Fifth Corps Area. Clarksburg, WV, designated as headquarters on organization, but the unit was never organized at that location. Location 7 December 1941—*Not initiated*.

Status: Disbanded 30 January 1942.**35th Veterinary Station Hospital (I) (C.Z.)****Regular Army Inactive****HQ-Not initiated** 1928-30; Chicago, IL, 1930-33

Constituted in the Organized Reserve 5 September 1928, assigned to the Communications Zone, and allotted to the Sixth Corps Area. Withdrawn from the Organized Reserve 21 December 1928 and allotted to the Regular Army. Organized by March 1930 at Chicago, IL. Demobilized 1 October 1933.

Commanders, 35th Veterinary Station Hospital (I)

Unknown ao Mar 30-1 Oct 33

35th Veterinary Station Hospital (II) (C.Z.)**Organized Reserve Illinois****HQ-Chicago, IL, 1933-37; Inactive** 1937-41

Constituted in the Organized Reserve 1 October 1933, assigned to the Communications Zone, allotted to the Sixth Corps Area. Concurrently organized at Chicago, IL. Inactivated by June 1937 at Chicago relief of personnel. Conducted summer training at the veterinary hospital at Jefferson Barracks, MO, or Camp Custer, MI. Location 7 December 1941—*Inactive*.

Status: Disbanded 30 January 1942.**Commanders, 35th Veterinary Station Hospital (II)**

Unknown	1 Oct 33-26 Mar 35	Unknown	ao Jun 35-ao Jun 37
2nd Lt. Percy A. Aldrich	26 Mar 35-ao Jun 35	<i>Inactive</i>	ao Jun 37-7 Dec 41

36th Veterinary Station Hospital (I) (C.Z.)**Organized Reserve Kansas****HQ-Not initiated** 1928-30; Manhattan, KS, 1930-33

Constituted in the Organized Reserve 5 September 1928, assigned to the Communications Zone, and allotted to the Seventh Corps Area. Withdrawn from the Organized Reserve 21 December 1928 and allotted to the Regular Army. Organized by January 1930 at Manhattan, KS. Demobilized 1 October 1933.

Commanders, 36th Veterinary Station Hospital (I)

Unknown ao Jan 30-1 Oct 33

36th Veterinary Station Hospital (II) (C.Z.)**Organized Reserve New York****HQ-Not initiated** 1933-41

Constituted in the Regular Army 1 October 1933, assigned to the Communications Zone, and allotted to the Eighth Corps Area. Withdrawn from the Eighth Corps Area 5 June 1936 and allotted to the Second Corps Area. New York City, NY, designated as headquarters on organization, but the unit was never organized at that location. Location 7 December 1941—*Not initiated*.

Status: Disbanded 30 January 1942.**37th Veterinary Station Hospital (Z.I.)****Organized Reserve Texas/Illinois****HQ-Not initiated** 1928-29; Fort Bliss, TX, 1929-36; *Inactive* 1936-41

Constituted in the Organized Reserve 5 September 1928, assigned to the Zone of the Interior, and allotted to the Eighth Corps Area. Withdrawn from the Organized Reserve 21 December 1928 and allotted to the Regular Army. Organized by December 1929 at Fort Bliss, TX. Relieved from the Zone of the Interior 1 October 1933 and assigned to the General Headquarters Reserve. Conducted summer training at the veterinary hospital at Fort Sam Houston, TX. Withdrawn from the Eighth Corps Area 5 June 1936 and allotted to the Sixth Corps Area. Chicago, IL, designated as headquarters on reorganization, but the unit was never organized at that location. Location 7 December 1941—*Inactive*.

Commanders, 37th Veterinary Station Hospital

Unknown

ao Dec 29-5 Jun 36

Inactive

5 Jun 36-7 Dec 41

38th Veterinary Station Hospital (Z.I.)**Organized Reserve Oregon****HQ-Not initiated** 1928-32; Portland, OR, 1932-36; *Inactive* 1936-41

Constituted in the Organized Reserve 5 September 1928, assigned to the Zone of the Interior, and allotted to the Ninth Corps Area. Initiated by June 1932 at Portland, OR. Withdrawn from the Organized Reserve 21 December 1928 and allotted to the Regular Army. Relieved from the Zone of the Interior 1 October 1933 and assigned to the General Headquarters Reserve. Withdrawn from the Ninth Corps Area 5 June 1936 and allotted to the Seventh Corps Area. Location 7 December 1941—*Not initiated*.

Commanders, 38th Veterinary Station Hospital

Unknown

ao Jun 32-5 Jun 36

Inactive

5 Jun 36-7 Dec 41

39th Veterinary Station Hospital (Z.I.)**Organized Reserve Michigan****HQ-Not initiated** 1933-38; Grand Rapids, MI, 1938-41

Constituted in the Organized Reserve 1 October 1933, assigned to the Zone of the Interior, and allotted to the Ninth Corps Area. Initiated by January 1938 at Grand Rapids, MI. Location 7 December 1941—Grand Rapids, MI.

Commanders, 39th Veterinary Station Hospital

Unknown

ao Jan 38-7 Dec 41

601st Veterinary Evacuation Hospital**Regular Army Inactive****HQ-Not organized** 1927-28

Constituted in the Regular Army 18 October 1927 and allotted to the Ninth Corps Area. Withdrawn 5 September 1928 from the Ninth Corps Area. Demobilized 21 December 1928.

601st Veterinary General Hospital

Regular Army Inactive

HQ-Not organized 1927-28

Constituted in the Regular Army 18 October 1927 and allotted to the Third Corps Area. Withdrawn 5 September 1928 from the Third Corps Area. Demobilized 21 December 1928.

603rd Veterinary Convalescent Hospital

Regular Army Inactive

HQ-Not organized 1927-28

Constituted in the Regular Army 18 October 1927 and allotted to the Ninth Corps Area. Withdrawn 5 September 1928 from the Ninth Corps Area. Demobilized 21 December 1928.

606th Veterinary Evacuation Hospital

Regular Army Inactive

HQ-Not organized 1927-28

Constituted in the Regular Army 18 October 1927 and allotted to the Sixth Corps Area. Chicago, IL, designated as headquarters on organization, but the unit was never organized at that location. Withdrawn 5 September 1928 from the Sixth Corps Area. Demobilized 21 December 1928.

606th Veterinary General Hospital

Regular Army Inactive

HQ-Not organized 1927-28

Constituted in the Regular Army 18 October 1927 and allotted to the Seventh Corps Area. Withdrawn 5 September 1928 from the Seventh Corps Area. Demobilized 21 December 1928.

607th Veterinary General Hospital

Regular Army Inactive

HQ-Not organized 1927-28

Constituted in the Regular Army 18 October 1927 and allotted to the Seventh Corps Area. Withdrawn 5 September 1928 from the Seventh Corps Area. Demobilized 21 December 1928.

608th Veterinary General Hospital

Regular Army Inactive

HQ-Not organized 1927-28

Constituted in the Regular Army 18 October 1927 and allotted to the Third Corps Area. Withdrawn 5 September 1928 from the Third Corps Area. Demobilized 21 December 1928.

609th Veterinary Evacuation Hospital

Regular Army Inactive

HQ-Not organized 1927-28

Constituted in the Regular Army 18 October 1927 and allotted to the Seventh Corps Area. Withdrawn 5 September 1928 from the Seventh Corps Area. Demobilized 21 December 1928.

610th Veterinary Evacuation Hospital**Regular Army Inactive****HQ-Not organized 1927-28**

Constituted in the Regular Army 18 October 1927 and allotted to the Seventh Corps Area. Withdrawn 5 September 1928 from the Seventh Corps Area. Demobilized 21 December 1928.

615th Veterinary Evacuation Hospital**Regular Army Inactive****HQ-Not organized 1927-28**

Constituted in the Regular Army 18 October 1927 and allotted to the Third Corps Area. Withdrawn 5 September 1928 from the Third Corps Area. Demobilized 21 December 1928.

616th Veterinary Evacuation Hospital**Regular Army Inactive****HQ-Not organized 1927-28; Fort Oglethorpe, GA, 1928-29**

Constituted in the Regular Army 18 October 1927 and allotted to the Fourth Corps Area. Organized 16 March 1928 with Organized Reserve personnel as a RAI unit with headquarters at Fort Oglethorpe, GA. Withdrawn 5 September 1928 from the Fourth Corps Area. Demobilized 21 December 1928. Inactivated 12 February 1929 at Fort Oglethorpe by relief of personnel.

Commanders, 616th Veterinary Evacuation Hospital

Maj. Oliver A. Barber** 16 Mar 28-12 Feb 29

** RAI Commanders: Organized Reserve officers.

647th Veterinary General Hospital**Regular Army Inactive****HQ-Not organized 1927-28**

Constituted in the Regular Army 18 October 1927 and allotted to the Eighth Corps Area. Fort Bliss, TX, designated as headquarters on organization, but the unit was never organized at that location. Withdrawn 5 September 1928 from the Eighth Corps Area. Demobilized 21 December 1928.

648th Veterinary General Hospital**Regular Army Inactive****HQ-Not organized 1927-28**

Constituted in the Regular Army 18 October 1927 and allotted to the Eighth Corps Area. Withdrawn 5 September 1928 from the Eighth Corps Area. Demobilized 21 December 1928.

658th Veterinary General Hospital**Regular Army Inactive****HQ-Not organized 1927-28**

Constituted in the Regular Army 18 October 1927 and allotted to the Ninth Corps Area. Withdrawn 5 September 1928 from the Ninth Corps Area. Demobilized 21 December 1928.

Part XI

Military Police Organizations

1919-41

Chapter 49

Military Police Battalions



National Archives II

Fort Wood, NY, home of the 1st MP Company in the 1920s and 30s.

The military police battalion provided circulation control, order, and security in the army and corps rear areas. In the interwar period, they were considered infantry organizations and were therefore commanded by infantry officers.

Organization

Between 1921 and 1940, forty-five military police battalions were constituted and added to the rolls of the Army. Of these, four were in the Regular Army, eleven were in the National Guard, and the remainder were in the Organized Reserve. None of the four Regular Army battalions served on active duty, but all were organized as RAI units. Only one National Guard unit, the 101st Military Police Battalion, was organized. Most of the Reserve battalions were organized at various times in the 1920s and 1930s.

There were two types of MP battalions; one assigned to the field army and the other assigned to the corps. The primary difference between the two was that the army battalion was authorized one additional MP company for a total of five.

Training

A handful of the Reserve and RAI MP battalions were concentrated enough geographically to function as units during the Inactive Training period. The personnel for most, however, were too geographically dispersed to assemble for training meetings. These battalions were simply pool units and only functioned as cohesive commands when the battalion was ordered to assemble at a summer training camp.

Military Police Battalion, Army, 1921

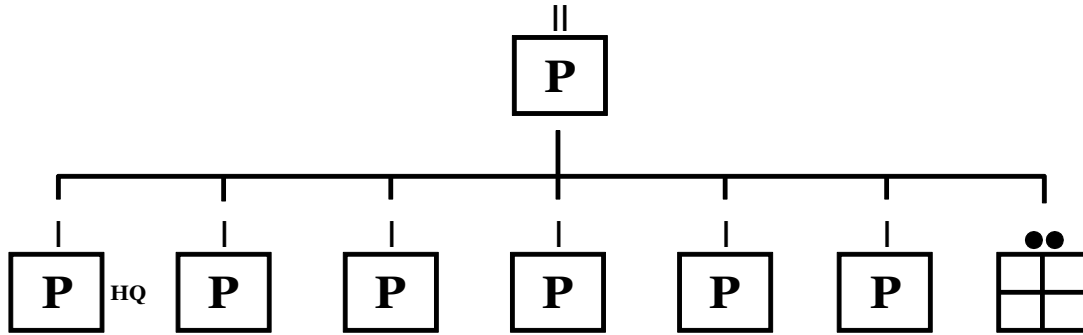

T/O: 205W
 Approved: 30 April 1921
 Commander: Maj.
 Officers: 30
 W. O. --
 Enlisted: 775
 Total: 805

Key Equipment:
 Cars, 5-passenger 6
 Trucks, various 7
 Horses & Mules 167
 Wagons, various 5
 Motorcycles w/sidecar 52

Military Police Battalion, Corps, 1930

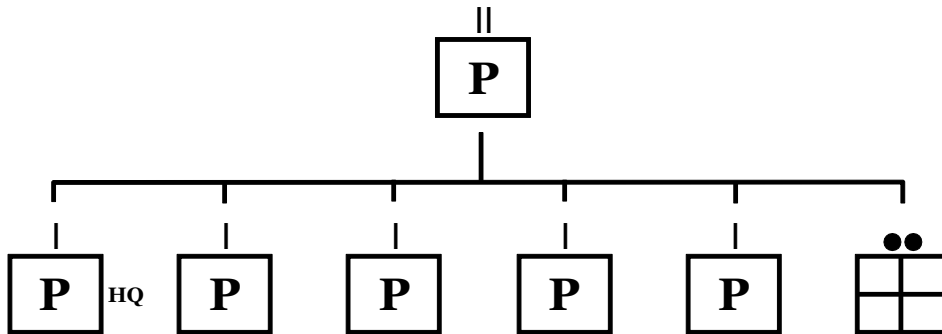

T/O: 105W
 Effective: 1 July 1930
 Commander: Maj.
 Officers: 25
 W. O. --
 Enlisted: 623
 Total: 648

Key Equipment:
 Cars, various 5
 Trucks, various 9
 Horses 102
 Motorcycles w/sidecar 44

MP Battalion TOEs.

14th Military Police Battalion (Army)**Regular Army Inactive**

HQ-*Not organized* 1927-29; St. Louis, MO, 1929-33; *Inactive* 1933-35; Tucson, AZ, 1935-36; *Inactive* 1936-38; Eighth Corps Area 1938-40

Constituted in the Regular Army 18 October 1927 and allotted to the Seventh Corps Area. Organized by May 1929 as a RAI unit with Organized Reserve personnel at St. Louis, MO. Withdrawn from the Seventh Corps Area 1 October 1933 and allotted to the Eighth Corps Area. Organized 11 January 1935 at Tucson, AZ. Withdrawn from the Eighth Corps Area 5 June 1936 and allotted to the Sixth Corps Area. Withdrawn from the Sixth Corps Area 1 January 1938 and allotted to the Eighth Corps Area. Organized by December 1938 as a RAI unit with Organized Reserve personnel in the Eighth Corps Area. Conducted annual summer training at Jefferson Barracks, MO, in 1939. Redesignated 1 June 1940 as the 518th Military Police Battalion.

Status: Inactive in the Regular Army as the 518th Military Police Battalion.

15th Military Police Battalion (V Corps)**Regular Army Inactive**

HQ-*Not organized* 1927-28; Bloomington, IN, 1928-40

Constituted in the Regular Army 18 October 1927, assigned to the V Corps, and allotted to the Fifth Corps Area. Affiliated with the University of Indiana, Bloomington, IN and organized 13 March 1928 as a RAI unit with personnel from the R.O.T.C. detachment and Organized Reserve personnel commissioned from the program. Relieved from assignment to the V Corps 1 October 1933 and assigned to the General Headquarters Reserve. Conducted annual summer training at Fort Thomas, KY, or Fort Benjamin Harrison, IN. Redesignated 1 June 1940 as the 519th Military Police Battalion.

Status: Active in the Regular Army at Fort Polk, LA, as the 519th Military Police Battalion.

16th Military Police Battalion (VI Corps)**Regular Army Inactive**

HQ-*Not organized* 1927-28; Chicago, IL, 1928-33; New York City, NY, 1934-40

Constituted in the Regular Army 18 October 1927, assigned to the VI Corps, and allotted to the Sixth Corps Area. Organized 5 November 1928 as a RAI unit with Organized Reserve personnel at Chicago, IL. Typically conducted Inactive Training Period meetings at the Post Office Building in Chicago. Withdrawn from the Sixth Corps Area 1 October 1933 and allotted to the Second Corps Area. Attached to the 61st Cavalry Division 23 November 1933 for administration and training. Organized 1 May 1934 as a RAI unit with Organized Reserve personnel at New York City, NY. Conducted annual summer training in 1930 at Fort Sheridan, IL, and at Plattsburg Barracks, NY, 1934-38. Designated mobilization station was Camp Dix, NJ. Redesignated 1 June 1940 as the 520th Military Police Battalion.

Status: Disbanded 11 November 1944.

17th Military Police Battalion (IX Corps)**Regular Army Inactive**

HQ-*Not organized* 1927-28; San Francisco, CA, 1928-38; Des Moines, IA, 1938-40

Constituted in the Regular Army 18 October 1927, assigned to the IX Corps, and allotted to the Ninth Corps Area. Organized 25 June 1928 as a RAI unit with Organized Reserve personnel at San Francisco, CA. Relieved from assignment to the IX Corps 1 October 1933 and assigned to the General Headquarters Reserve. Withdrawn from the Ninth Corps Area 1 January 1938 and allotted to the Seventh Corps Area. Organized in late 1938 as a RAI unit with Organized Reserve personnel at Des Moines, IA. Conducted annual summer training at various locations to include the Presidio of San Francisco, Del Monte, CA, Fort MacArthur, CA, and Fort Ord, CA, 1929-37. Conducted summer training in 1940 at Fort Snelling, MN. Redesignated 1 June 1940 as the 527th Military Police Battalion.

101st Military Police Battalion (I) (I Corps)**New Hampshire National Guard****HQ**-*Not organized* 1921-27

Constituted in the National Guard in 1921, assigned to the I Corps, and allotted to the state of New Hampshire. Placed on the deferred list 2 July 1923, unit requirement transferred to the Organized Reserve as a Deferred National Guard unit, and redesignated as the 311th Military Police Battalion. Withdrawn as a Deferred National Guard unit and allotted permanently to the Organized Reserve 11 January 1927 as the 311th Military Police Battalion. Concurrently withdrawn from the First Corps Area and allotted to the Fifth Corps Area.

101st Military Police Battalion (II)**New York National Guard****HQ**-Brooklyn, NY, 1940-41; Fort Dix, NJ, 1941

Constituted in the National Guard 1 September 1940, and allotted to the state of New York. Organized in September 1940 at Brooklyn, NY, from the 3rd Battalion, 106th Infantry. Assigned 30 December 1940 to the First Army. Inducted into federal service at Brooklyn 3 March 1941, transferred to Fort Dix, NJ, and assigned to the First Army. Location 7 December 1941—Fort Dix, NJ.

Events: 330**102nd Military Police Battalion (III Corps)****Pennsylvania and Virginia National Guard****HQ**-*Not organized* 1921-27

Constituted in the National Guard in 1921, assigned to the III Corps, and allotted to the states of Pennsylvania and Virginia. Placed on the deferred list 2 July 1923, unit requirement transferred to the Organized Reserve as a Deferred National Guard unit, and redesignated as the 312th Military Police Battalion. Withdrawn as a Deferred National Guard unit and demobilized 17 September 1927.

103rd Military Police Battalion (IV Corps)**Tennessee, Florida, and Louisiana National Guard****HQ**-*Not organized* 1921-27

Constituted in the National Guard in 1921 as the 103rd Military Police Battalion, assigned to the IV Corps, and allotted to the states of Tennessee, Florida, and Louisiana. HHD allotted to the state of Tennessee, Company A allotted to the state of Florida, and Company B allotted to the state of Louisiana. Chattanooga, TN, designated as headquarters on organization, but the unit was never organized at that location. Placed on the deferred list 2 July 1923, unit requirement transferred to the Organized Reserve as a Deferred National Guard unit, and redesignated as the 313th Military Police Battalion. Concurrently relieved from the IV Corps and assigned to the XIV Corps. Company B withdrawn from the state of Louisiana 2 September 1925 and allotted to the state of Alabama. Withdrawn as a Deferred National Guard unit and demobilized 5 September 1928.

104th Military Police Battalion (V Corps)**West Virginia National Guard****HQ**-*Not organized* 1921-27

Constituted in the National Guard in 1921 as the 104th Military Police Battalion, assigned to the V Corps, and allotted to the state of West Virginia. Company A organized 9 December 1921 at Parsons, WV. Conducted annual summer training at Camp Knox, KY, 1922-24. Battalion placed on the deferred list 2 July 1923, unit requirement transferred to the Organized Reserve as a Deferred National Guard unit, and redesignated as the 314th Military Police Battalion. Federal recognition withdrawn from Company A on 1 December 1924 and unit inactivated at Parsons. Battalion concurrently relieved from the V Corps and assigned to the XV Corps. Withdrawn as a Deferred National Guard unit and demobilized 17 September 1927.

105th Military Police Battalion (VI Corps)**Michigan National Guard**

HQ-Not organized 1921-27

Constituted in the National Guard in 1921 as the 105th Military Police Battalion, assigned to the VI Corps, and allotted to the state of Michigan. Placed on the deferred list 2 July 1923, unit requirement transferred to the Organized Reserve as a Deferred National Guard unit, and redesignated as the 315th Military Police Battalion. Concurrently relieved from the VI Corps and assigned to the XVI Corps. Withdrawn as a Deferred National Guard unit and demobilized 17 September 1927.

106th Military Police Battalion (VII Corps)**Minnesota National Guard**

HQ-Not organized 1921-27

Constituted in the National Guard in 1921 as the 106th Military Police Battalion, assigned to the VII Corps, and allotted to the state of Minnesota. Placed on the deferred list 2 July 1923, unit requirement transferred to the Organized Reserve as a Deferred National Guard unit, and redesignated as the 316th Military Police Battalion. Withdrawn as a Deferred National Guard unit and demobilized 17 September 1927.

107th Military Police Battalion (VIII Corps)**Oklahoma National Guard**

HQ-Not organized 1921-27

Constituted in the National Guard in 1921 as the 107th Military Police Battalion and assigned to the VIII Corps. Allotted 29 August 1921 to the Oklahoma National Guard. Oklahoma City, OK, designated as headquarters on organization, but the unit was never organized at that location. Placed on the deferred list 2 July 1923, unit requirement transferred to the Organized Reserve as a Deferred National Guard unit, and redesignated as the 317th Military Police Battalion. Relieved from the VIII Corps 13 January 1927, withdrawn from the Eighth Corps Area, and allotted to the Seventh Corps Area. Withdrawn as a Deferred National Guard unit 17 September 1927 and allotted permanently to the Organized Reserve as the 317th Military Police Battalion.

108th Military Police Battalion (IX Corps)**Idaho and Montana National Guard**

HQ-Not organized 1921-27

Constituted in the National Guard in 1921 as the 108th Military Police Battalion, assigned to the IX Corps, and allotted to the states of Idaho and Montana. HHD and Company A allotted to the state of Idaho and Company B allotted to the state of Montana. Placed on the deferred list 2 July 1923, unit requirement transferred to the Organized Reserve as a Deferred National Guard unit, and redesignated as the 318th Military Police Battalion. Concurrently relieved from the IX Corps and assigned to the XIX Corps. Withdrawn as a Deferred National Guard unit and demobilized 17 September 1927.

111th Military Police Battalion (Second Army)**Pennsylvania and Virginia National Guard**

HQ-Not organized 1921-27

Constituted in the National Guard in 1921, assigned as Second Army troops, and allotted to the states of Pennsylvania and Virginia. Company A allotted to the state of Pennsylvania and Company B allotted to the state of Virginia. No battalion headquarters and headquarters detachment was authorized in the National Guard as the two companies were intended to be assigned to the 325th Military Police Battalion (Organized Reserve; see below) on mobilization. All elements withdrawn from their state of allotment in March 1926. Withdrawn from the National Guard and demobilized 17 September 1927.

112th Military Police Battalion (Third Army)

Iowa National Guard

HQ-*Not organized* 1921-27

Constituted in the National Guard in 1921 as the 112th Military Police Battalion, assigned to the Third Army, and allotted to the state of Iowa. Placed on the deferred list 2 July 1923, unit requirement transferred to the Organized Reserve as a Deferred National Guard unit, and redesignated as the 319th Military Police Battalion. Withdrawn as a Deferred National Guard unit and demobilized 17 September 1927.

301st Military Police Battalion (XI Corps)

Organized Reserve Massachusetts

HQ-Boston, MA 1921-40

Constituted in the Organized Reserve 29 July 1921, assigned to the XI Corps, and allotted to the First Corps Area. Initiated 14 December 1921 at Boston, MA. Attached to the 94th Division for administration and training. Relieved from assignment to the XI Corps 1 October 1933 and assigned to the I Corps. Withdrawn from the Organized Reserve 1 January 1938 and allotted to the Regular Army as an RAI unit. Redesignated 1 June 1940 as the 501st Military Police Battalion.

302nd Military Police Battalion (XII Corps)

Organized Reserve New Jersey/New York

HQ-Plainfield, NJ, 1921-29; Brooklyn, NY, 1929-40

Constituted in the Organized Reserve 29 July 1921, assigned to the XII Corps, and allotted to the Second Corps Area. Initiated 2 November 1921 at Plainfield, NJ. Attached to the 78th Division 17 September 1925 for administration and training. Relocated 2 July 1929 to Brooklyn, NY. Relieved from attachment to the 78th Division 14 October 1929 and attached to the 61st Cavalry Division for administration and training. Relieved from assignment to the XII Corps 1 October 1933 and assigned to the II Corps. Withdrawn from the Organized Reserve 1 January 1938 and allotted to the Regular Army as an RAI unit. Typically conducted annual summer training with the 26th Infantry at Plattsburg Barracks, NY. Designated mobilization station was Camp Dix, NJ, 1921-33 and Fort George G. Meade, MD, 1933-40. Maj. Richard E. Enright, New York City Police Commissioner, was the battalion commander in the 1930s. Redesignated 1 June 1940 as the 502nd Military Police Battalion.

Status: Inactive in the Regular Army as the 502nd Military Police Battalion.

303rd Military Police Battalion (XIII Corps)

Organized Reserve Pennsylvania

HQ-Columbia, PA, 1922-29; *Inactive* 1929-40

Constituted in the Organized Reserve 29 July 1921, assigned to the XIII Corps, and allotted to the Third Corps Area. Initiated 27 February 1922 at Columbia, PA. Inactivated 8 August 1929 at Omaha by relief of personnel. Withdrawn from the Organized Reserve 1 January 1938 and allotted to the Regular Army as an RAI unit. Designated mobilization station was Fort George G. Meade, MD, 1921-40. Redesignated 1 June 1940 as the 503rd Military Police Battalion.

Status: Active in the Regular Army at Fort Bragg, NC, as the 503rd Military Police Battalion.

304th Military Police Battalion (XIV Corps)**Organized Reserve Tennessee****HQ**-Pittsburg Landing, TN, 1922-40

Constituted in the Organized Reserve 29 July 1921, assigned to the XIV Corps, and allotted to the Fourth Corps Area. Initiated 1 April 1922 at Pittsburg Landing, TN. Relieved from assignment to the XIV Corps 5 September 1928 and assigned to the IV Corps. Withdrawn from the Organized Reserve 1 January 1938 and allotted to the Regular Army as an RAI unit. Conducted annual summer training at various locations to include Fort Screven, GA, Camp McClellan, AL, and Fort Benning, GA, 1929-40. Designated mobilization station was Camp McClellan, AL, 1922-30 and Camp Beauregard, LA, 1930-40. Redesignated 1 June 1940 as the 504th Military Police Battalion.

Status: Active in the Regular Army at Fort Lewis, WA, as the 504th Military Police Battalion.

305th Military Police Battalion (XV Corps)**Organized Reserve West Virginia/Ohio****HQ**-*Not initiated* 1921-23; Charleston, WV, 1923-30; *Inactive* 1930-35; Cincinnati, OH, 1935-40

Constituted in the Organized Reserve 29 July 1921, assigned to the XV Corps, and allotted to the Fifth Corps Area. Initiated in 1923 at Charleston, WV. Relieved from assignment to the XV Corps 5 September 1928 and assigned to the V Corps. Inactivated by March 1930 at Charleston by relief of personnel. Cincinnati, OH, designated 21 December 1933 as headquarters on reorganization. Reorganized by July 1935 at Cincinnati. Typically conducted annual summer training with the 10th Infantry at Camp Knox, KY. Designated mobilization station was Camp Beauregard, LA. Withdrawn from the Organized Reserve 1 January 1938 and allotted to the Regular Army as an RAI unit. Redesignated 1 June 1940 as the 505th Military Police Battalion.

306th Military Police Battalion (XVI Corps)**Organized Reserve Wisconsin****HQ**-*Not initiated* 1921-23; Milwaukee, WI, 1923-30; *Inactive* 1930-34; Sheboygan, WI, 1934-40

Constituted in the Organized Reserve 29 July 1921, assigned to the XVI Corps, and allotted to the Sixth Corps Area. Initiated in July 1923 at Milwaukee, WI. Relieved from assignment to the XVI Corps 2 July 1923 and assigned to the VI Corps. Attached to the 65th Cavalry Division 19 October 1925 for organization, administration, and training. Relieved from attachment to the 65th Cavalry Division 31 January 1927. Inactivated by December 1930 at Milwaukee by relief of personnel. Reorganized by May 1934 at Sheboygan. Withdrawn from the Organized Reserve 1 January 1938 and allotted to the Regular Army as an RAI unit. Conducted annual summer training at Fort Sheridan, IL. Conducted infantry C.M.T.C. training in 1928 at Camp McCoy, WI, as an alternate form of summer training. Designated mobilization station was Jefferson Barracks, MO, 1938-40. Redesignated 1 June 1940 as the 506th Military Police Battalion.

307th Military Police Battalion (XVII Corps)**Organized Reserve Arkansas****HQ**-Little Rock, AR, 1922-40

Constituted in the Organized Reserve 29 July 1921, assigned to the XVII Corps, and allotted to the Seventh Corps Area. Initiated in April 1922 at Little Rock, AR. Relieved from assignment to the XVII Corps 17 September 1927 and assigned to the VII Corps. Withdrawn from the Organized Reserve 1 January 1938 and allotted to the Regular Army as an RAI unit. Conducted annual summer training most years with the 17th Infantry at Fort Leavenworth, KS, and at Fort Crook, NE, in 1940. Redesignated 1 June 1940 as the 507th Military Police Battalion.

308th Military Police Battalion (XVIII Corps)**Organized Reserve Texas/Nebraska/California**

HQ-Hillsboro, TX, 1922-25; Waco, TX, 1925-27; Lincoln, NE, 1927-33; *Inactive* 1933-37; Fresno, CA, 1937-40



Constituted in the Organized Reserve 29 July 1921, assigned to the XVIII Corps, and allotted to the Eighth Corps Area. Initiated 27 July 1922 at Hillsboro, TX. Relieved from assignment to the XVIII Corps 2 July 1923 and assigned to the VIII Corps. Relocated 15 April 1925 to Waco, TX. Conducted annual summer training in 1926 at Fort Sam Houston, TX. Withdrawn from the Eighth Corps Area 13 January 1927 and allotted to the Seventh Corps Area. Inactivated 4 April 1927 at Waco by relief of personnel. Organized in July 1927 at Lincoln, NE. Withdrawn from the Seventh Corps Area 1 October 1933 and allotted to the Ninth Corps Area. Concurrently relieved from the VIII Corps and assigned to the IX Corps. Reorganized 17 December 1937 at Fresno, CA. Typically conducted Inactive Training Period meetings at the Brix Building in Fresno.

Withdrawn from the Organized Reserve 1 January 1938 and allotted to the Regular Army as an RAI unit. Redesignated 1 June 1940 as the 508th Military Police Battalion.

Status: Inactive in the Regular Army as the 508th Military Police Battalion.

309th Military Police Battalion (XIX Corps)**Organized Reserve California**

HQ-Los Angeles, CA, 1922-40



Constituted in the Organized Reserve 29 July 1921, assigned to the XIX Corps, and allotted to the Ninth Corps Area. Initiated 21 July 1922 at Los Angeles, CA. Relieved from assignment to the XIX Corps 2 July 1923 and assigned to the IX Corps. Relieved from assignment to the IX Corps 18 October 1927 and assigned to the XIX Corps. Conducted annual summer training most years at Fort MacArthur, CA, and some years at Fort Ord, CA. Redesignated 1 June 1940 as the 509th Military Police Battalion.

310th Military Police Battalion (II Corps)**Organized Reserve New York**

HQ-New York City, NY, 1921-40

Constituted in the Organized Reserve 29 July 1921, assigned to the II Corps, and allotted to the Second Corps Area. Initiated 23 December 1921 at New York City, NY. Attached to the 77th Division 17 September 1925 for administration and training. Relieved from attachment to the 77th Division 14 October 1929 and attached to the 61st Cavalry Division. Relieved from assignment to the II Corps 1 October 1933 and assigned to the XII Corps. Typically conducted annual summer training with the 26th Infantry at Plattsburg Barracks, NY, or with the 16th Infantry at Camp Dix, NJ. Designated mobilization station was Camp Dix, NJ. Redesignated 1 June 1940 as the 510th Military Police Battalion.

Status: Active in the U. S. Army Reserve at Hempstead, NY.

311th Military Police Battalion (I Corps)**Organized Reserve Indiana**

HQ-*Not initiated* 1923-27; Fort Wayne, IN, 1927-30; *Inactive* 1930-34; Fort Wayne, IN, 1934-40

Constituted in the National Guard in 1921 as the 101st Military Police Battalion, assigned to the I Corps, and allotted to the First Corps Area. Placed on the deferred list 2 July 1923, unit requirement transferred to the Organized Reserve as a Deferred National Guard unit, and redesignated as the 311th Military Police Battalion. Withdrawn as a Deferred National Guard unit 17 September 1927 and allotted permanently to the Organized Reserve. Concurrently withdrawn from the First Corps Area, allotted to the Fifth Corps Area, and assigned to the XV Corps. Initiated by December 1927 at Fort Wayne, IN. Inactivated by March 1930 at Fort Wayne by relief of personnel. Reorganized by July 1934 at Fort Wayne. Redesignated 1 June 1940 as the 511th Military Police Battalion.

312th Military Police Battalion (I) (III Corps)

Organized Reserve

HQ-Not initiated 1923-27

Constituted in the National Guard in 1921 as the 102nd Military Police Battalion, assigned to the III Corps, and allotted to the Third Corps Area. Placed on the deferred list 2 July 1923, unit requirement transferred to the Organized Reserve as a Deferred National Guard unit, and redesignated as the 312th Military Police Battalion. Withdrawn as a Deferred National Guard unit and demobilized 17 September 1927.

312th Military Police Battalion (II) (XIV Corps)

Organized Reserve Alabama

HQ-Not initiated 1928-37; Sheffield, AL, 1937-41

Constituted in the Organized Reserve 5 September 1928, assigned to the XIV Corps, and allotted to the Fourth Corps Area. Initiated 2 May 1937 at Sheffield, AL. Conducted annual summer training at Fort McClellan, AL. Redesignated 1 June 1940 as the 512th Military Police Battalion.

Status: Inactive in the Army Reserve as the 512th Military Police Battalion.

313th Military Police Battalion (I) (XIV Corps)

Organized Reserve Mississippi

HQ-Not initiated 1923-28

Constituted in the National Guard in 1921 as the 103rd Military Police Battalion, assigned to the IV Corps, and allotted to the states of Tennessee, Florida, and Louisiana. HHD allotted to the state of Tennessee, Company A allotted to the state of Florida, and Company B allotted to the state of Louisiana. Placed on the deferred list 2 July 1923, unit requirement transferred to the Organized Reserve as a Deferred National Guard unit, and redesignated as the 313th Military Police Battalion. Concurrently relieved from the IV Corps and assigned to the XIV Corps. Columbia, MS, designated as headquarters on organization, but the unit was never organized at that location. Withdrawn as a Deferred National Guard unit and demobilized 5 September 1928.

313th Military Police Battalion (II) (XVI Corps)

Organized Reserve Illinois/Michigan

HQ-Not initiated 1928-34; Detroit, MI, 1934-37; Chicago, IL, 1937-40

Constituted in the Organized Reserve 5 September 1928, assigned to the XVI Corps, and allotted to the Sixth Corps Area. Initiated by June 1934 at Detroit, MI. Relocated 28 July 1937 to Chicago, IL. Typically conducted Inactive Training Period meetings at the Post Office Building in Chicago. Conducted annual summer training at Jefferson Barracks, MO. Redesignated 1 June 1940 as the 513th Military Police Battalion.

314th Military Police Battalion (I) (V Corps)

Organized Reserve

HQ-Not initiated 1923-27

Constituted in the National Guard in 1921 as the 104th Military Police Battalion, assigned to the V Corps, and allotted to the state of West Virginia. Placed on the deferred list 2 July 1923, unit requirement transferred to the Organized Reserve as a Deferred National Guard unit, and redesignated as the 314th Military Police Battalion. Assigned to the V Corps 2 July 1923. Withdrawn as a Deferred National Guard unit and demobilized 17 September 1927.

314th Military Police Battalion (II) (XI Corps)

Organized Reserve New York/Connecticut

HQ-New York City, NY, 1928-33; Hartford, CT, 1934-41

Constituted in the Organized Reserve 5 September 1928, assigned to the XI Corps, and allotted to the Second Corps Area. Initiated in late 1928 at New York City, NY. Attached to the 61st Cavalry Division 17 September 1925 for administration and training. Conducted annual summer training with the 26th Infantry at Plattsburg Barracks, NY. Withdrawn from the Second Corps Area 1 October 1933 and allotted to the First Corps Area. Reorganized in 1934 at Hartford, CT. Redesignated 1 June 1940 as the 514th Military Police Battalion.

315th Military Police Battalion (I) (XVI Corps)

Organized Reserve

HQ-*Not initiated* 1923-27

Constituted in the National Guard in 1921 as the 105th Military Police Battalion, assigned to the VI Corps, and allotted to the Sixth Corps Area. Placed on the deferred list 2 July 1923, unit requirement transferred to the Organized Reserve as a Deferred National Guard unit, and redesignated as the 315th Military Police Battalion. Concurrently relieved from the VI Corps and assigned to the XVI Corps. Designated mobilization station was Camp Custer, MI. Withdrawn as a Deferred National Guard unit and demobilized 17 September 1927.

315th Military Police Battalion (II) (XVIII Corps)

Organized Reserve Texas

HQ-*Not initiated* 1928-35; Dallas, TX, 1935-40

Constituted in the Organized Reserve 5 September 1928, assigned to the XVIII Corps, and allotted to the Eighth Corps Area. Initiated 25 February 1935 at Dallas, TX. Typically conducted annual summer training with the 9th Infantry at Fort Sam Houston, TX. Redesignated 1 June 1940 as the 515th Military Police Battalion and concurrently relocated to Austin, TX.

316th Military Police Battalion (I) (VII Corps)

Organized Reserve North Dakota

HQ-*Not initiated* 1923-24; Crosby, ND, 1924-27

Constituted in the National Guard in 1921 as the 106th Military Police Battalion, assigned to the VII Corps, and allotted to the Seventh Corps Area. Placed on the deferred list 2 July 1923, unit requirement transferred to the Organized Reserve as a Deferred National Guard unit, and redesignated as the 316th Military Police Battalion. Initiated in 1924 at Crosby, ND. Withdrawn as a Deferred National Guard unit and demobilized 17 September 1927.

316th Military Police Battalion (II) (VIII Corps)

Organized Reserve Arizona

HQ-*Not initiated* 1933-35; Tucson, AZ, 1935-40

Constituted in the Organized Reserve 1 October 1933, assigned to the VIII Corps, and allotted to the Eighth Corps Area. Initiated 13 May 1935 at Tucson, AZ. Conducted annual summer training at Fort Huachuca, AZ. Redesignated 1 June 1940 as the 526th Military Police Battalion.

317th Military Police Battalion (VIII Corps)**Organized Reserve North Dakota****HQ-***Not initiated* 1923-31; Bismarck, ND, 1931-40

Constituted in the National Guard in 1921 as the 107th Military Police Battalion and assigned to the VIII Corps. Allotted 29 August 1921 to the Oklahoma National Guard. Oklahoma City, OK, designated as headquarters on organization, but the unit was never organized at that location. Placed on the deferred list 2 July 1923, unit requirement transferred to the Organized Reserve as a Deferred National Guard unit, and redesignated as the 317th Military Police Battalion. Relieved from the VIII Corps 13 January 1927, withdrawn from the Eighth Corps Area, and allotted to the Seventh Corps Area. Withdrawn as a Deferred National Guard unit 17 September 1927 and allotted permanently to the Organized Reserve as the 317th Military Police Battalion. Concurrently assigned to the XVII Corps. Initiated by March 1931 at Bismarck, ND. Typically conducted annual summer training with the 3rd Infantry at Fort Snelling, MN. Redesignated 1 June 1940 as the 517th Military Police Battalion.

318th Military Police Battalion (XIX Corps)**Organized Reserve California****HQ-**San Francisco, CA, 1923-27

Constituted in the National Guard in 1921 as the 108th Military Police Battalion, assigned to the IX Corps, and allotted to the state of Idaho. Placed on the deferred list 2 July 1923, unit requirement transferred to the Organized Reserve as a Deferred National Guard unit, and redesignated as the 318th Military Police Battalion. Concurrently relieved from the IX Corps and assigned to the XIX Corps. Initiated in 1923 at San Francisco, CA. Withdrawn as a Deferred National Guard unit and demobilized 17 September 1927.

319th Military Police Battalion (Third Army)**Organized Reserve North Dakota/Arkansas****HQ-***Not initiated* 1923-24; Ellendale, ND, 1924-26; Fort Smith, AR, 1926-27

Constituted in the National Guard in 1921 as the 112th Military Police Battalion, assigned to the Third Army, and allotted to the state of Iowa. Placed on the deferred list 2 July 1923, unit requirement transferred to the Organized Reserve as a Deferred National Guard unit, and redesignated as the 319th Military Police Battalion. Initiated 29 August 1924 at Ellendale, ND. Relocated 26 May 1926 to Fort Smith, AR. Withdrawn as a Deferred National Guard unit and demobilized 17 September 1927.

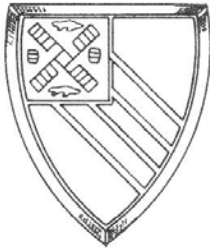
321st Military Police Battalion (Fourth Army)**Organized Reserve New York****HQ-**New York City, NY, 1922-40

Constituted in the Organized Reserve 15 October 1921 assigned to the Fourth Army, and allotted to the Second Corps Area. Initiated in January 1922 at New York City, NY. Attached to the 61st Cavalry Division 17 September 1925 for administration and training. Designated mobilization station was Camp Dix, NJ. Relieved from assignment to the Fourth Army 1 October 1933 and assigned to the First Army. Conducted annual summer training at Blauvelt, NY, in 1925, Fort Wadsworth, NY, in 1927, and with the 26th Infantry at Plattsburg Barracks, NY, during 1930-38. Redesignated 1 June 1940 as the 521st Military Police Battalion.

322nd Military Police Battalion (I) (Fifth Army)

Organized Reserve Illinois

HQ-Chicago, IL, 1922-30; *Inactive* 1930-33

Constituted in the Organized Reserve 15 October 1921 assigned to the Fifth Army, and allotted to the Sixth Corps Area. Initiated 23 January 1922 at Chicago, IL. Attached to the 65th Cavalry Division 19 October 1925 for organization, administration, and training. Relieved from attachment to the 65th Cavalry Division 31 January 1927. Inactivated by December 1930 at Chicago by relief of personnel. Typically conducted Inactive Training Period meetings at the Post Office Building in Chicago. Conducted annual summer training at Camp Custer, MI, or Fort Sheridan, IL. Demobilized 1 October 1933.

322nd Military Police Battalion (II) (Corps)

Organized Reserve

HQ-*Not initiated* 1933-40

Constituted in the Organized Reserve 1 October 1933. Redesignated 1 June 1940 as the 522nd Military Police Battalion.

323rd Military Police Battalion (Sixth Army)

Organized Reserve Missouri

HQ-Moberly, MO, 1922-40

Constituted in the Organized Reserve 15 October 1921 assigned to the Sixth Army, and allotted to the Seventh Corps Area. Initiated in March 1922 at Moberly, MO. Relieved from assignment to the Sixth Army 1 October 1933 and assigned to the Fourth Army. Conducted annual summer training most years with the 17th Infantry at Fort Leavenworth, KS, and at Fort Crook, NE. Redesignated 1 June 1940 as the 523rd Military Police Battalion.

324th Military Police Battalion (First Army)

Organized Reserve Pennsylvania/Ohio/North Carolina

HQ-Pittsburgh, PA, 1922-27; Toledo, OH, 1927-30; *Inactive* 1930-34; Winston-Salem, NC, 1934-41

Constituted in the Organized Reserve 15 October 1921 assigned to the First Army, and allotted to the Third Corps Area. Initiated in July 1922 at Pittsburgh, PA. Withdrawn from the Third Corps Area 11 January 1927 and allotted to the Fifth Corps Area. Reorganized in 1927 at Toledo, OH. Inactivated by March 1930 at Toledo by relief of personnel. Withdrawn from the Fifth Corps Area 1 October 1933, allotted to the Fourth Corps Area, and assigned to the Third Army. Reorganized 4 May 1934 at Winston-Salem, NC. Withdrawn from the Organized Reserve 1 January 1938 and allotted to the Regular Army as an RAI unit. Conducted annual summer training at Fort McClellan, AL in 1939. Designated mobilization station was Camp Beauregard, LA 1933-40. Redesignated 1 June 1940 as the 524th Military Police Battalion.

325th Military Police Battalion (Second Army)

Organized Reserve Illinois

HQ-Chicago, IL, 1922-41

Constituted in the Organized Reserve 15 October 1921 (less Companies A and B), assigned to the Second Army, and allotted to the Sixth Corps Area. Initiated 17 April 1922 at Chicago, IL. Attached to Headquarters, Artillery Group, Sixth Corps Area on 19 October 1925 for organization, administration, and training. Companies A and B (of the 111th Military Police Battalion) were allotted to the National Guard and further allotted to the states of Pennsylvania and Virginia, respectively. The two companies were intended to be assigned to the 325th Military Police Battalion to bring it up to strength on mobilization. Neither of the two National Guard companies were ever organized and when demobilized in 1927, Companies A and B of the 325th were apparently concurrently constituted. Typically conducted Inactive Training Period meetings at the Post Office Building in Chicago. Conducted annual summer training at Camp Custer, MI, Jefferson Barracks, MO, or Fort Sheridan, IL. Designated mobilization station was Jefferson Barracks 1938-40. Redesignated 1 June 1940 as the 525th Military Police Battalion.

Part XII

Signal Corps Organizations

1919-41

Chapter 50

Signal Corps Organizations



National Archives II

US Army signaleers operate the signal station at Camp Hoover, during the 1931 Nicaragua canal survey.

Signal corps organizations performed a variety of missions to include, radio, telephone, telegraph, and carrier pigeon operations. These units enabled commanders to command and control widely dispersed units and direct them in coordinated efforts to close with and defeat the enemy.

Organization

Between 1921 and 1940, there were a variety of signal corps units assigned to various echelons of command. These echelons included units as large as the General Headquarters Signal Service, which was designed to command and control the signal operations of an army group, down to the small communications section assigned to each division's air service.

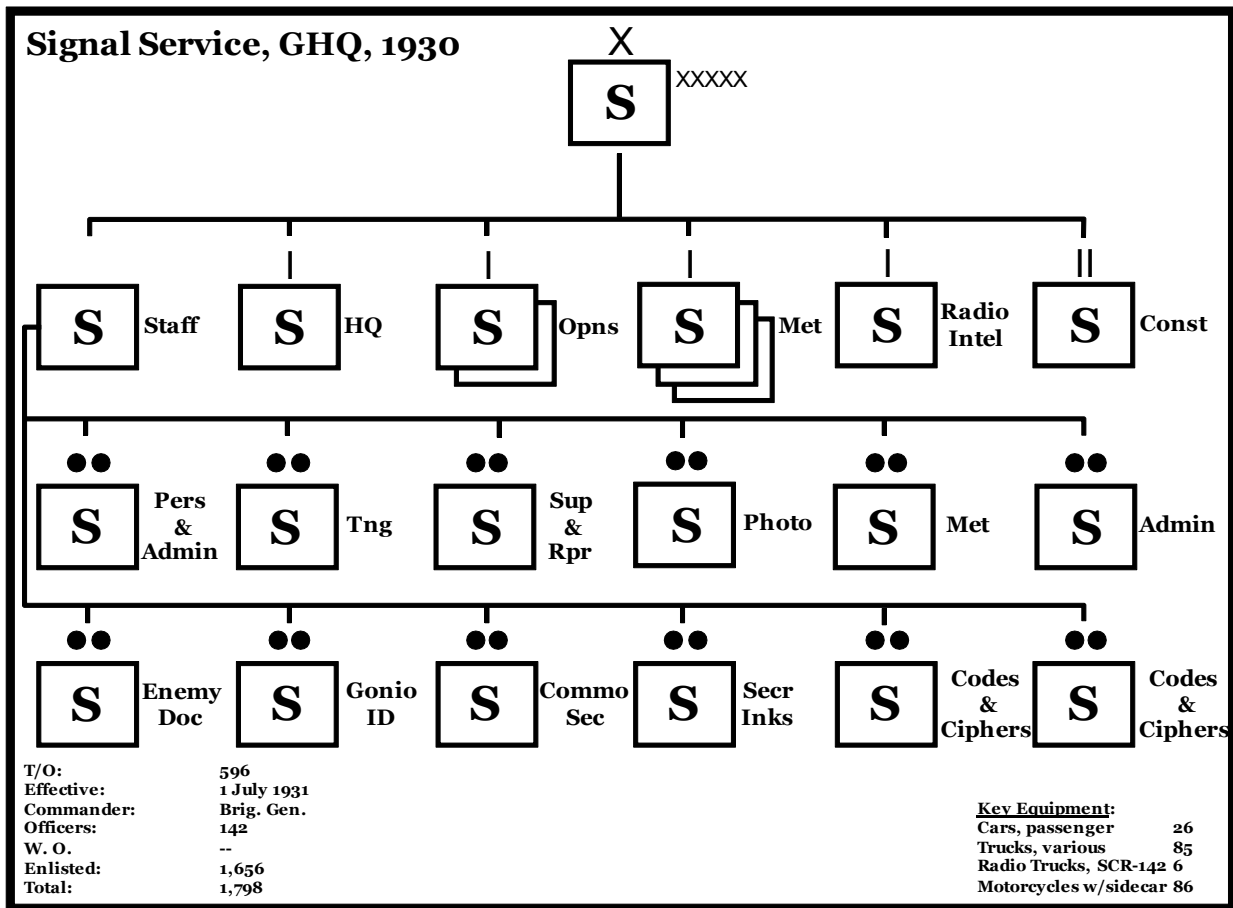

GHQ Signal Service TOE.

As its named implied, the General Headquarters Signal Service was constituted to provide command and control capability for the General Headquarters. The command included the service headquarters, but no assigned units. Those units would be attached from the General Headquarters Reserve as needed to support the signal operations of the GHQ and provide communications support down to subordinate field armies.

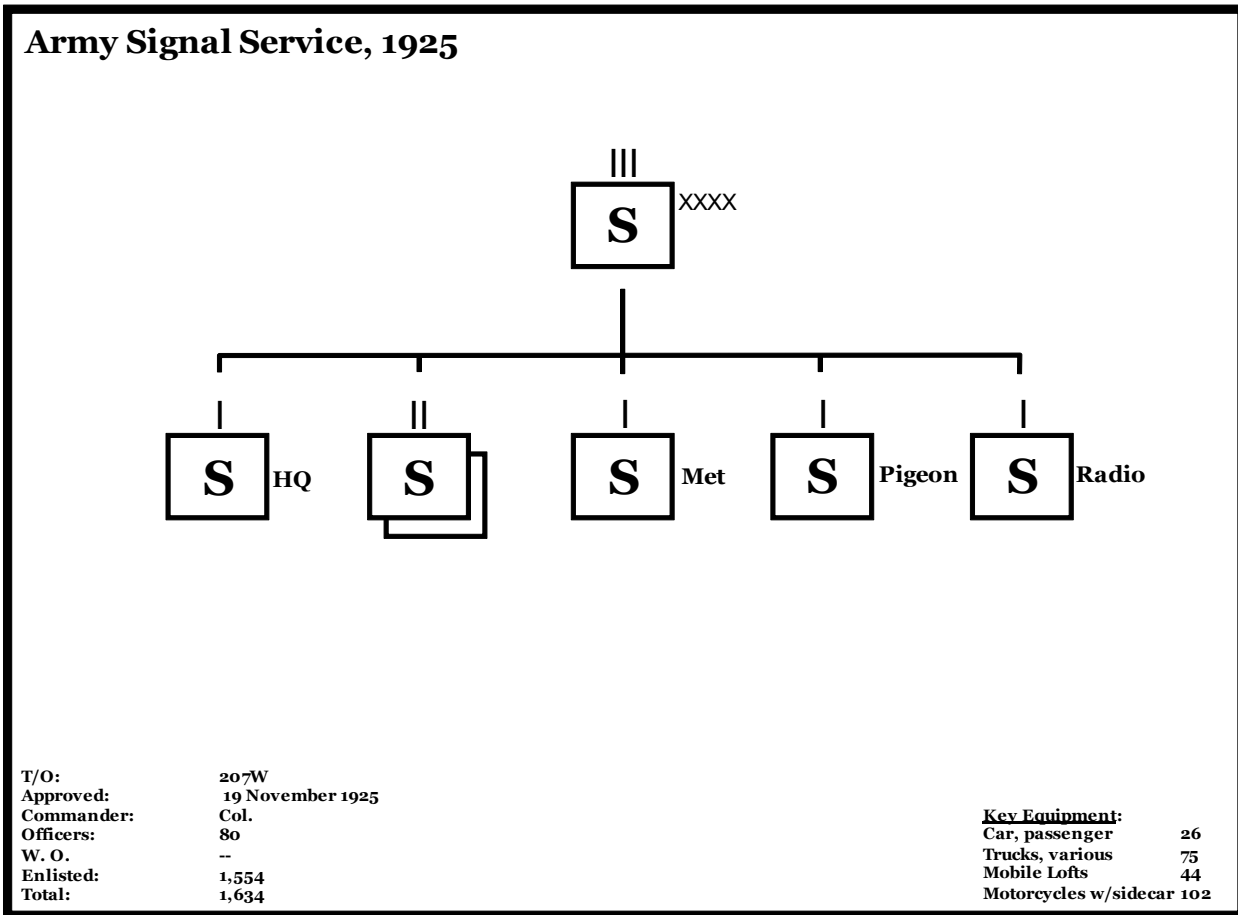

Army Signal Service TOE.

There were six signal service headquarters constituted in the Organized Reserve, one each to support the six field armies. Apparently, only three of those headquarters were ever organized and all were withdrawn from the Organized Reserve in 1928. The army signal service consisted of the following elements:

Headquarters, Army Signal Service

- 2 Signal Battalions
- 1 Meteorological Company
- 1 Pigeon Company
- 1 Radio Company

Signal Battalion, 1930

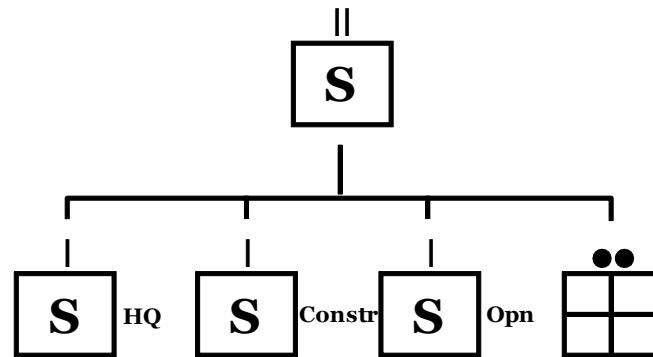

T/O: 107W
 Effective: 1 July 1930
 Commander: Maj.
 Officers: 19
 W. O.: --
 Enlisted: 480
 Total: 499

Key Equipment:
 Cars, motor, medium 5
 Trucks, various 33
 Motorcycles w/sidecar 23

Signal Battalion TOE.

The signal organizations supporting the field armies were largely Organized Reserve units. The three lower numbered armies, however, each had two National Guard signal battalions assigned to their orders of battle. The Fifth Army also possessed one Guard signal battalion. The remaining units were Reserve formations. The corps signal service consisted of a single signal battalion. All of the corps signal organizations were Organized Reserve units until 1933 when many were replaced by RAI formations.

Signal Construction Battalion, 1925

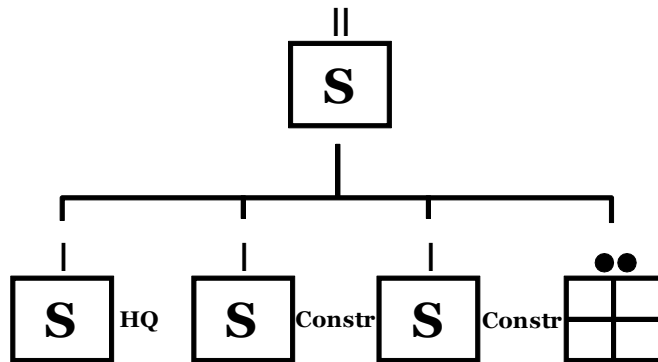

T/O: 507W
 Approved: 20 November 1925
 Commander: Maj.
 Officers: 19
 W. O. --
 Enlisted: 478
 Total: 497

Key Equipment:
 Cars, various 3
 Trucks, various 32
 Motorcycles w/sidecar 21

Signal Construction Battalion TOE.

In addition to the battalions supporting the armies and corps, there were about 19 signal construction battalions constituted and assigned to the communications zone and the General Headquarters Reserve. These units were responsible for building, repairing, maintaining, and operating permanent and semi-permanent communications systems in the communications zone and the rear areas of the combat zone.

There were a total of nineteen RA signal battalions constituted between 1919 and 1940. Most of these were assigned to armies and corps to replace OR units in the order of battle in the reorganization of 1933. Only one these units, however, the 51st Signal Battalion, was active for any length of time during this period. Most of the others were organized as RAI units and were activated for service during 1940-41. Similarly, only one of the thirteen constituted National Guard signal battalions was organized during this period, and that was the New York National Guard's 101st Signal Battalion. None of the others were ever organized as Guard units, though some were initiated as DNG/OR units. Most of the forty-one OR signal battalions were initiated at some point during the interwar period. Most of those that were not were either DNG units or were specialized signal construction and maintenance battalions.

Shortly before World War II, about thirteen OR signal battalions were affiliated with the various Bell Telephone companies located around the United States. A few of those Reserve battalions were activated for service during the war.

Training

A handful of the Reserve and RAI Signal Corps battalions were concentrated enough geographically to function as units during the Inactive Training period. The personnel for most, however, were too

geographically dispersed to assemble for training meetings. These battalions were simply pool units and only functioned as cohesive commands when the battalion was ordered to assemble at a summer training camp. Many signal personnel assigned to these pool units generally attended branch specific training organized and conducted to reach reservists in a certain geographical area. This training was often performed as contact camps or with nearby RA and NG units. Many signal reservists, particularly those in the western states where they tended to be more geographically dispersed, usually attended non-branch specific troop schools and correspondence schools during the Inactive Training period.

Headquarters, GHQ, Signal Service

HQ-Not organized 1933-41

Constituted in the Regular Army 1 October 1933, assigned to the General Headquarters Reserve, and allotted to the Third Corps Area. Washington, DC, designated as headquarters on organization, but the unit was never organized at that location. Mobilization responsibility for this command was assigned to the Adjutant General. Location 7 December 1941—*Not organized*.

First Army Signal Service Headquarters

Organized Reserve New York

HQ-Not initiated 1921-22; Fort Jay, NY, 1922-28

Constituted in the Organized Reserve 15 October 1921, assigned to the First Army, and allotted to the Second Corps Area. Initiated by December 1922 at Fort Jay, NY. Withdrawn from the Organized Reserve and Second Corps Area 5 September 1928.

Commanders, First Army Signal Service Headquarters

Lt. Col. Winfred S. Soloman

ao Dec 22-ao Feb 24

Unknown

ao Feb 24-5 Sep 28

Second Army Signal Service Headquarters

Organized Reserve Illinois

HQ-Not initiated 1921-28

Constituted in the Organized Reserve 15 October 1921, assigned to the Second Army, and allotted to the Sixth Corps Area. Chicago, IL, designated as headquarters on organization, but the unit was never organized at that location. Withdrawn from the Organized Reserve and Sixth Corps Area 5 September 1928.

Third Army Signal Service Headquarters

Organized Reserve Missouri

HQ-Not initiated 1921-28

Constituted in the Organized Reserve 15 October 1921, assigned to the Third Army, and allotted to the Seventh Corps Area. St. Louis, MO, designated as headquarters on organization, but the unit was never organized at that location. Withdrawn from the Organized Reserve and Seventh Corps Area 5 September 1928.

Fourth Army Signal Service Headquarters

Organized Reserve New York

HQ-Not initiated 1921-23; Manhattan, NY, 1923-28

Constituted in the Organized Reserve 15 October 1921, assigned to the Fourth Army, and allotted to the Second Corps Area. Initiated by May 1923 at Manhattan, NY. Withdrawn from the Organized Reserve and Second Corps Area 5 September 1928.

Commanders, Fourth Army Signal Service Headquarters

Maj. Philip Hamlin

ao May 23-2 Nov 23

Lt. Col. Sidney L. Davis

4 Sep 26-9 Sep 26

Maj. Herbert J. Slinge

2 Nov 23-4 Sep 26

Lt. Col. Carroll H. Gardner

7 Sep 26-5 Sep 28

Fifth Army Signal Service Headquarters

Organized Reserve Ohio

HQ-Not initiated 1921-28

Constituted in the Organized Reserve 15 October 1921, assigned to the Fifth Army, and allotted to the Fifth Corps Area. Withdrawn from the Organized Reserve and Fifth Corps Area 5 September 1928.

Sixth Army Signal Service Headquarters**Organized Reserve California****HQ-Not initiated** 1921-22; San Francisco, CA, 1922-28

Constituted in the Organized Reserve 15 October 1921, assigned to the Sixth Army, and allotted to the Ninth Corps Area. Initiated 28 April 1922 at San Francisco, CA. Withdrawn from the Organized Reserve and Ninth Corps Area 5 September 1928.

Commanders, Sixth Army Signal Service Headquarters

Lt. Col. Robert Loughry

28 Apr 22-ao Jan 23

Unknown

ao Jan 23-ao Aug 27

Lt. Col. William H. Fairbanks

ao Aug 27-5 Sep 28

1st Signal Construction Battalion (GHQR)**Regular Army Inactive****HQ-Not organized** 1927-30; Philadelphia, PA, 1930-34; *Inactive* 1934-41

Constituted in the Regular Army 18 October 1927, assigned to the General Headquarters Reserve, and allotted to the Third Corps Area. Organized 27 January 1930 with Organized Reserve personnel as a RAI unit at Philadelphia, PA. Inactivated 15 February 1934 at Philadelphia by relief of personnel. Location 7 December 1941—*Inactive*.

2nd Signal Construction Battalion (GHQR)**Regular Army Inactive****HQ-Not organized** 1927-28; Cincinnati, OH, 1928-41

Constituted in the Regular Army 18 October 1927, assigned to the General Headquarters Reserve, and allotted to the Fifth Corps Area. Organized 18 August 1928 with Organized Reserve personnel as a RAI unit at Cincinnati, OH. Location 7 December 1941—Cincinnati, OH.

3rd Signal Construction Battalion (GHQR)**Regular Army Inactive****HQ-Not organized** 1927-29; Chicago, IL, 1929-31; *Inactive* 1931-33

Constituted in the Regular Army 18 October 1927, assigned to the General Headquarters Reserve, and allotted to the Sixth Corps Area. Organized 17 May 1929 with Organized Reserve personnel as a RAI unit at Chicago, IL. Attached 3 November 1930 to the 65th Cavalry Division for organization, administration, and training. Inactivated 21 April 1931 at Chicago by relief of personnel. Conducted summer training at Fort Sheridan, IL. Demobilized 1 October 1933.

4th Signal Construction Battalion (GHQR)**Regular Army Inactive****HQ-Not organized** 1927-28; Chicago, IL, 1928-31; *Inactive* 1931-33

Constituted in the Regular Army 18 October 1927, assigned to the General Headquarters Reserve, and allotted to the Sixth Corps Area. Organized 1 August 1928 with Organized Reserve personnel as a RAI unit at Chicago, IL. Attached 3 November 1930 to the 65th Cavalry Division for organization, administration, and training. Inactivated 21 April 1931 at Chicago by relief of personnel. Conducted summer training at Fort Sheridan, IL. Demobilized 1 October 1933.

5th Signal Construction Battalion (GHQR)**Regular Army Inactive****HQ-Not organized** 1927-31; Hartford, CT, 1931-36; San Antonio, TX, 1936-41; Camp Claiborne, LA, 1941

Constituted in the Regular Army 13 July 1931, assigned to the General Headquarters Reserve, and allotted to the First Corps Area. Organized by 1931 with Organized Reserve personnel as a RAI unit at Hartford, CT. Designated mobilization training station was Camp Dix, NJ. Withdrawn from the First Corps Area in 5 June 1936 and allotted to the Eighth Corps Area. Reorganized in 1936 as a RAI unit with Organized Reserve personnel at San Antonio, TX. Activated 10 February 1941, less Reserve personnel, at Camp Claiborne, LA. Location 7 December 1941—Camp Claiborne, LA.

20th Signal Battalion (Panama Canal Department)

Regular Army Inactive

HQ—*Not organized* 1921-41

Constituted in the Regular Army in 1936 and allotted to the Panama Canal Department. Location 7 December 1941—*Not organized*.

50th Signal Battalion (VI Corps)

Regular Army Inactive

HQ—Fort Sam Houston, TX, 1919-21; *Inactive* 1921-26; Fort Monmouth, NJ, 1926-33; *Inactive* 1933-35; Baltimore, MD, 1935-40; Fort Sheridan, IL, 1940-41

Arrived at the port of Hoboken, NJ, in August 1919 as the 51st Telegraph Battalion after occupation duty in France and Germany. Shortly thereafter transferred to Fort Sam Houston, TX. Consolidated with the 52nd Telegraph Battalion 8 March 1921 and redesignated as the 50th Signal Battalion. Inactivated 24 September 1921 at Fort Sam Houston. Assigned to the VI Corps in October 1921 and allotted to the Second Corps Area. The 51st Signal Battalion designated in 1921 as Active Associate. Designated mobilization training station was Fort Monmouth, NJ. Relieved from the VI Corps 2 July 1923 and assigned to the General Headquarters Reserve. Organized 6 October 1926 with Organized Reserve personnel as a RAI unit at Fort Monmouth, NJ. Withdrawn from the Second Corps Area 1 October 1933, allotted to the Third Corps Area, and assigned to the III Corps. Reorganized 10 January 1935 with Organized Reserve personnel as a RAI unit at Baltimore, MD. Conducted summer training at Fort Monmouth, NJ. Also conducted C.M.T.C. training some years at Fort George G. Meade, MD, or Camp Dix, NJ, as an alternate form of summer training. Activated 1 July 1940, less Reserve personnel, at Fort Sheridan, IL, and assigned to the Second Army. Location 7 December 1941—Fort Sheridan, IL.

Status: Active in the Regular Army as the 50th Signal Battalion at Fort Bragg, NC.

Events: 324

51st Signal Battalion (I Corps)

HQ—Fort Monmouth, NJ, 1921-41



Arrived at the port of New York in June 1919 as the 55th Telegraph Battalion after occupation duty in France and Germany. Shortly thereafter transferred to Camp Alfred Vail (later redesignated Fort Monmouth), NJ. Redesignated as the 51st Signal Battalion 8 March 1921. Assigned to the I Corps about October 1921. Relieved from the I Corps 18 October 1927 and assigned to the General Headquarters Reserve. Assigned to the First Army 1 October 1933. Provided soldiers to guard the crash site at the Hindenburg disaster at Lakehurst, NJ, in May 1937. Relieved from the First Army 26 October 1939 and assigned to the II Corps. Location 7 December 1941—Fort Monmouth, NJ.

Organization Day: 15 April. Chosen to commemorate the battalion's arrival in France on 15 April 1918.

Status: Active in the Regular Army as the 51st Signal Battalion in the Republic of Korea.

Events: 91, 168, 190, 214, 242, 255, 258, 268, 280, 282, 283, 293, 296, 301, 302, 330

52nd Signal Battalion (III Corps)**Regular Army Inactive****HQ—Not organized** 1927-29; Brooklyn, NY, 1929-33; Eighth Corps Area 1933-41; Fort Sam Houston, TX, 1941

Constituted in the Regular Army 18 October 1927, assigned to the III Corps, and allotted to the Second Corps Area. Organized 7 February 1929 with Organized Reserve personnel as a RAI unit at Brooklyn, NY. Withdrawn from the Second Corps Area 1 October 1933 and allotted to the Eighth Corps Area. Concurrently, relieved from the III Corps and assigned to the Third Army. Reorganized in late 1933 as a RAI unit with Organized Reserve personnel in the Eighth Corps Area. Conducted summer training at Fort Sam Houston, TX. Activated 10 February 1941, less Reserve personnel, at Fort Sam Houston, TX. Location 7 December 1941—Fort Sam Houston, TX.

Status: Active in the Regular Army as the 52nd Signal Battalion in Germany.**Events:** 317, 328**53rd Signal Battalion (I Corps)****Regular Army Inactive****HQ—Not organized** 1927-28; Cambridge, MA, 1928-33; Boston, MA, 1933-41; Camp Bowie, TX, 1941

Constituted in the Regular Army 18 October 1927, assigned to the I Corps, and allotted to the First Corps Area. Organized by June 1928 with Organized Reserve personnel as a RAI unit at Cambridge, MA. Affiliated with the Massachusetts Institute of Technology 30 April 1930 and organized as a RAI unit with personnel from the R.O.T.C. detachment and Organized Reserve personnel commissioned from the program. Relocated by 1933 to Boston, MA. Conducted summer training at Fort Monmouth, NJ, or Fort Devens, MA. Designated mobilization training station was Fort Devens. Activated 1 June 1941, less Reserve personnel, at Camp Bowie, TX, and assigned to the VIII Corps. Location 7 December 1941—Camp Bowie, TX.

Status: Active in the Regular Army as the 53rd Signal Battalion at Peterson Air Force Base, CO.**54th Signal Battalion (III Corps)****Regular Army Inactive****HQ—Not organized** 1927-30; Third Corps Area at large 1930-33; San Bernardino, CA, 1933-36; *Inactive* 1936-41; Fort Ord, CA, 1941

Constituted in the Regular Army 18 October 1927, assigned to the III Corps, and allotted to the Third Corps Area. Organized 10 November 1930 with Organized Reserve personnel as a RAI unit in the Third Corps Area. Withdrawn from the Third Corps Area 1 October 1933 and allotted to the Ninth Corps Area. Concurrently, relieved from the III Corps and assigned to the Fourth Army. Reorganized in late 1933 with Organized Reserve personnel as a RAI unit at San Bernardino, CA. Inactivated 8 July 1936 at San Bernardino by relief of personnel. Relieved from the Fourth Army 24 January 1941 and assigned to the III Corps. Activated 10 February 1941 at Fort Ord, CA. Location 7 December 1941—Fort Ord, CA.

Status: Active in the Regular Army as HHD, 54th Signal Battalion in Saudi Arabia.**55th Signal Battalion (VII Corps)****Regular Army Inactive****HQ—Not organized** 1927-29; Minneapolis, MN, 1929-41

Constituted in the Regular Army 18 October 1927, assigned to the VII Corps, and allotted to the Seventh Corps Area. Organized by 1929 with Organized Reserve personnel as a RAI unit at Minneapolis, MN. Conducted summer training at Fort Crook, NE. Relieved from the VII Corps 24 January 1941 and assigned to the General Headquarters Reserve. Location 7 December 1941—Minneapolis, MN.

56th Signal Battalion (Third Army)

Regular Army Inactive

HQ-*Not organized* 1927-28; Augusta, GA, 1928-41; Fort Jackson, SC, 1941

Constituted in the Regular Army 18 October 1927, assigned to the Third Army, and allotted to the Fourth Corps Area. Organized 10 May 1928 with Organized Reserve personnel as a RAI unit at Augusta, GA. Relieved from the Third Army by October 1932. Assigned to the I Corps 24 January 1941. Activated 1 February 1941, less Reserve personnel, at Fort Jackson, SC. Location 7 December 1941—Fort Jackson, SC.

Status: Active in the Regular Army as HHD, 56th Signal Battalion at Corozal, Panama.

Events: 330

57th Signal Battalion (V Corps)

Regular Army Inactive

HQ-*Not organized* 1927-28; Columbus, OH, 1928-41; Camp Edwards, MA, 1941



Constituted in the Regular Army 18 October 1927, assigned to the V Corps, and allotted to the Fifth Corps Area. Organized 12 January 1928 with Organized Reserve personnel as a RAI unit at Columbus, OH. Affiliated with the Ohio State University 28 April 1930 and organized as a RAI unit with personnel from the R.O.T.C. detachment and Organized Reserve personnel commissioned from the program. Conducted summer training at Camp Knox, KY. Designated mobilization training station was Camp Joseph T. Robinson, AR. Relieved from the V Corps 23 January 1941 and assigned to the VI Corps. Activated 10 February 1941, less Reserve personnel, at Camp Edwards, MA. Location 7 December 1941—Camp Edwards, MA.

Status: Active in the Regular Army as the 57th Signal Battalion at Fort Hood, TX.

Events: 330

58th Signal Battalion (VI Corps)

Regular Army Inactive

HQ-*Not organized* 1927-28; Chicago, IL, 1928-41; Camp Forrest, TN, 1941



Constituted in the Regular Army 18 October 1927, assigned to the VI Corps, and allotted to the Sixth Corps Area. Organized 5 November 1928 with Organized Reserve personnel as a RAI unit at Chicago, IL. Conducted summer training at Fort Sheridan, IL. Designated mobilization training station was Camp Joseph T. Robinson, AR. Relieved from the VI Corps 23 January 1941 and assigned to the VII Corps. Activated 10 February 1941, less Reserve personnel, at Camp Peay, TN. Location 7 December 1941—Camp Forrest, TN.

Status: Active in the Regular Army as HHD, 58th Signal Battalion at Fort Buckner, Okinawa, Japan.

Events: 324

59th Signal Battalion (IX Corps)

Regular Army Inactive

HQ-*Not organized* 1927-30; Presidio of San Francisco, CA, 1930-41; Fort Knox, KY, 1941

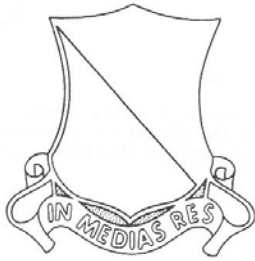

Constituted in the Regular Army 18 October 1927, assigned to the IX Corps, and allotted to the Ninth Corps Area. Organized by 1930 with Organized Reserve personnel as a RAI unit at the Presidio of San Francisco, CA. Conducted summer training at Del Monte, CA, or the Presidio of Monterey, CA. Relieved from the IX Corps 24 January 1941 and assigned to the General Headquarters Reserve. Activated 1 February 1941, less Reserve personnel, at Fort Knox, KY. Location 7 December 1941—Fort Knox, KY.

Status: Inactive in the Regular Army as the 1st Signal Battalion.

60th Signal Battalion (Second Army)

Regular Army Inactive

HQ-*Not organized* 1933-34; Fort Wayne, IN, 1934-41; Fort Lewis, WA, 1940-41



Constituted in the Regular Army 1 October 1933, assigned to the Second Army, and allotted to the Fifth Corps Area. Organized by 1934 with Organized Reserve personnel as a RAI unit at Fort Wayne, IN. Conducted summer training at Fort Knox, KY. Designated mobilization training station was Camp Joseph T. Robinson, AR. Activated 1 June 1940, less Reserve personnel, at Fort Lewis, WA, and assigned to the IX Corps. Location 7 December 1941—Fort Lewis, WA.

Status: Inactive in the Regular Army as HHD, 60th Signal Battalion.

Events: 304

61st Signal Battalion (Third Army)

Regular Army Inactive

HQ-*Not organized* 1933-35; Montgomery, AL, 1935-41; Camp Blanding, FL, 1941

Constituted in the Regular Army 1 October 1933, assigned to the Third Army, and allotted to the Fourth Corps Area. Organized 7 December 1935 with Organized Reserve personnel as a RAI unit at Montgomery, AL. Activated in 1941, less Reserve personnel, at Camp Blanding, FL, and assigned to the IV Corps. Location 7 December 1941—Camp Blanding, FL.

Status: Inactive in the Regular Army as the 61st Signal Battalion.

62nd Signal Battalion (Fourth Army)

Regular Army Inactive

HQ-*Not organized* 1933-37; Seventh Corps Area at large 1937-39; Fort Sam Houston, TX, 1939-41



Constituted in the Regular Army 1 October 1933, assigned to the Fourth Army, and allotted to the Seventh Corps Area. Organized 15 May 1937 with Organized Reserve personnel as a RAI unit in the Seventh Corps Area at large. Designated mobilization training station was Camp Joseph T. Robinson, AR. Withdrawn from the Seventh Corps Area 27 September 1939 and allotted to the Eighth Corps Area. Activated 13 October 1939, less Reserve personnel, at Fort Sam Houston, TX, and assigned to the Third Army. Location 7 December 1941—Fort Sam Houston, TX.

Status: Inactive in the Regular Army as the 62nd Signal Battalion.

Events: 295, 296, 300, 309, 330

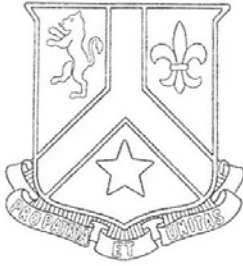
101st Signal Battalion (First Army)**New York National Guard****HQ**-Manhattan, NY, 1921-41; Camp Shelby, MS, 1941

Arrived at the port of New York 15 March 1919 on the S.S. *Hollandia* as the 102nd Field Signal Battalion, an element of the 27th Division. Shortly thereafter transferred to Camp Upton, NY. Demobilized 31 March 1919 at Camp Upton Reconstituted and organized 2 May 1921 as the 1st Battalion, Signal Corps, New York National Guard. Headquarters federally recognized 3 May 1921 at Manhattan, NY. Redesignated as the 101st Signal Battalion 1 June 1921 and assigned to the II Corps. Laid 125 miles of wire to support the II Corps Headquarters during the 1929 Second Corps Area CPX at Camp Dix, NJ. Relieved from the II Corps in 1936 and assigned to the First Army. Conducted summer training at Pine Camp, NY, Camp Smith, NY, or Camp Dix, NJ. Relieved from the First Army 30 December 1940 and assigned to the V Corps. Inducted into federal service 13 January 1941 at Manhattan, NY, and transferred to Camp Shelby, MS. Location 7 December 1941—Camp Shelby, MS.

Events: 91, 190, 280, 286, 301**102nd Signal Battalion** (III Corps)**Pennsylvania National Guard****HQ**-*Not organized* 1921-27

Constituted in the National Guard 29 July 1921, assigned to the III Corps, and allotted to the Pennsylvania National Guard. Placed on the deferred list 2 July 1923, unit requirement transferred to the Organized Reserve as a Deferred National Guard unit, and redesignated as the 310th Signal Battalion. Withdrawn as a Deferred National Guard unit 17 September 1927 and demobilized.

103rd Signal Battalion (IV Corps)**Georgia and Tennessee National Guard****HQ**-*Not organized* 1921-27

Constituted in the National Guard 29 July 1921, assigned to the IV Corps, and allotted to the states of Georgia and Tennessee. Headquarters and Company B allotted to the state of Georgia and Company A allotted to the state of Tennessee. Atlanta, GA, designated as headquarters on organization, but the unit was never organized at that location. Placed on the deferred list 2 July 1923 and unit requirement transferred to the Organized Reserve as a Deferred National Guard unit. Concurrently redesignated as the 311th Signal Battalion and assigned to the XIV Corps. Withdrawn as a Deferred National Guard unit 17 September 1927 and demobilized.

104th Signal Battalion (V Corps)**Kentucky National Guard****HQ**-*Not organized* 1921-27

Constituted in the National Guard 29 July 1921, assigned to the V Corps, and allotted to the state of Kentucky. Placed on the deferred list 2 July 1923 and unit requirement transferred to the Organized Reserve as a Deferred National Guard unit. Concurrently redesignated as the 312th Signal Battalion and assigned to the XV Corps. Withdrawn as a Deferred National Guard unit 17 September 1927 and demobilized.

106th Signal Battalion (VIII Corps)**Colorado National Guard****HQ**-*Not organized* 1921-40

Constituted in the National Guard 29 July 1921, assigned to the VIII Corps, and allotted to the state of Colorado. Placed on the deferred list 2 July 1923 and unit requirement transferred to the Organized Reserve as a Deferred National Guard unit. Concurrently redesignated as the 314th Signal Battalion. Organized by June 1924 at Dallas, TX, as the 314th Signal Battalion. Designated mobilization training station was Camp Joseph T. Robinson, AR, 1923-27. Withdrawn as a Deferred National Guard unit 17 September 1927, redesignated as the 106th Signal Battalion, and reallocated to the state of Colorado. Concurrently, personnel from the 314th transferred to the 308th Signal Battalion. Designated mobilization training station was changed to the Waco Concentration Camp at Waco, TX, 1928-40. Disbanded in May 1940.

107th Signal Battalion (IX Corps)

Idaho and Montana National Guard

HQ-Not organized 1921-27

Constituted in the National Guard 29 July 1921, assigned to the IX Corps, and allotted to the states of Idaho and Montana. HHD and Company B allotted to the state of Idaho and Company A allotted to the state of Montana. Placed on the deferred list 2 July 1923 and unit requirement transferred to the Organized Reserve as a Deferred National Guard unit. Concurrently redesignated as the 315th Signal Battalion. Withdrawn as a Deferred National Guard unit 17 September 1927 and demobilized.

111th Signal Battalion (First Army)

New Hampshire National Guard

HQ-Not organized 1921-27

Constituted in the National Guard 29 July 1921, assigned to the First Army, and allotted to the state of New Hampshire. Placed on the deferred list 2 July 1923 and unit requirement transferred to the Organized Reserve as a Deferred National Guard unit. Concurrently redesignated as the 316th Signal Battalion. Withdrawn as a Deferred National Guard unit 11 January 1927 and allotted permanently to the Organized Reserve as the 316th Signal Battalion.

112th Signal Battalion (First Army)

New Jersey National Guard

HQ-Not organized 1921-40

Constituted in the National Guard 29 July 1921, assigned to the First Army, and allotted to the state of New Jersey. Placed on the deferred list 2 July 1923 and unit requirement transferred to the Organized Reserve as a Deferred National Guard unit. Concurrently redesignated as the 317th Signal Battalion. Withdrawn as a Deferred National Guard unit 17 September 1927, redesignated as the 112th Signal Battalion, and allotted to the Second Corps Area. Reallotted in February 1928 to the state of New Jersey. Designated mobilization training station was Camp Dix, NJ. Assigned to the II Corps by 1940. Disbanded in May 1940.

113th Signal Battalion (Fifth Army)

Wisconsin National Guard

HQ-Not organized 1921-27

Constituted in the National Guard 29 July 1921, assigned to the Second Army and allotted to the state of Wisconsin. Placed on the deferred list 2 July 1923 and unit requirement transferred to the Organized Reserve as a Deferred National Guard unit. Concurrently redesignated as the 318th Signal Battalion. Additionally, relieved from the Second Army and assigned to the Fifth Army. Designated mobilization training station was Camp McCoy, WI. Withdrawn as a Deferred National Guard unit 17 September 1927 and demobilized.

114th Signal Battalion (Second Army)**Michigan National Guard****HQ-Not organized 1921-40**

Constituted in the National Guard 29 July 1921, assigned to the Second Army and allotted to the state of Michigan. Placed on the deferred list 2 July 1923 and unit requirement transferred to the Organized Reserve as a Deferred National Guard unit. Concurrently redesignated as the 319th Signal Battalion. Additionally, relieved from the Second Army and assigned to the Fifth Army. Withdrawn as a Deferred National Guard 17 September 1927, redesignated as the 114th Signal Battalion, and allotted to the Sixth Corps Area. Reallotted in February 1928 to the state of Michigan. Ypsilanti, MI, designated as headquarters on organization, but the unit was never organized at that location. Disbanded in May 1940.

115th Signal Battalion (Third Army)**South Dakota National Guard****HQ-Not organized 1921-27**

Constituted in the National Guard 29 July 1921, assigned to the Third Army and allotted to the state of South Dakota. Placed on the deferred list 2 July 1923 and unit requirement transferred to the Organized Reserve as a Deferred National Guard unit. Concurrently redesignated as the 320th Signal Battalion. Designated mobilization training station was Camp Custer, MI, 1923-29 and Camp Joseph T. Robinson, AR, 1929-41. Withdrawn as a Deferred National Guard unit 17 September 1927 and demobilized.

116th Signal Battalion**New Mexico National Guard****HQ-Not organized 1921-27**

Constituted in the National Guard 29 July 1921, assigned to the Third Army and allotted to the state of New Mexico. Placed on the deferred list 2 July 1923 and unit requirement transferred to the Organized Reserve as a Deferred National Guard unit. Concurrently redesignated as the 327th Signal Battalion. Withdrawn as a Deferred National Guard unit, allotted permanently to the Organized Reserve 13 January 1927 as the 327th Signal Battalion.

117th Signal Battalion (VII Corps)**Nebraska and Missouri National Guard****HQ-Not organized 1921-27**

Constituted in the National Guard 29 July 1921, assigned to the VII Corps, and allotted to the states of Nebraska and Missouri. HHD and Company B allotted to the state of Nebraska and Company A allotted to the state of Missouri. Placed on the deferred list 2 July 1923 and unit requirement transferred to the Organized Reserve as a Deferred National Guard unit. Concurrently redesignated as the 313th Signal Battalion. Withdrawn as a Deferred National Guard unit 17 September 1927 and demobilized.

301st Signal Battalion (XI Corps)**Organized Reserve Massachusetts****HQ-Boston, MA, 1921-41**

Constituted in the Organized Reserve 29 July 1921, assigned to the XI Corps, and allotted to the First Corps Area. Initiated 17 December 1921 at Boston, MA. Conducted summer training most years with the 51st Signal Battalion at Fort Monmouth, NJ, and some years at Camp Devens, MA. Also conducted C.M.T.C. training in 1929 at Fort Monmouth as an alternate form of summer training. Affiliated 3 November 1941 with the New England Telephone and Telegraph Company. Location 7 December 1941—Boston, MA.

302nd Signal Battalion (XII Corps)**Organized Reserve New York****HQ**-*Not initiated* 1921-22; Manhattan, NY, 1922-41

Constituted in the Organized Reserve 29 July 1921, assigned to the XII Corps, and allotted to the Second Corps Area. Initiated 25 January 1922 at Manhattan, NY. Designated mobilization training station was Fort Monmouth, NJ. Conducted summer training most years with the 51st Signal Battalion at Fort Monmouth, NJ, and some years at Camp Dix, NJ. Also conducted C.M.T.C. training some years at Fort Monmouth and Fort Niagara, NY, as an alternate form of annual training. Withdrawn from the Second Corps Area 3 November 1941 and allotted to the Office of the Chief Signal Officer for mobilization purposes. Concurrently affiliated with the New York Bell Telephone Company. Primary R.O.T.C. feeder school was Cornell University. Location 7 December 1941—Manhattan, NY.

Status: Active in the Regular Army as HHD, 302nd Signal Battalion at Fort Detrick, MD.**Events:** 190**303rd Signal Battalion (Fourth Army)****Organized Reserve Pennsylvania/New York****HQ**-Philadelphia, PA, 1921-23; Manhattan, NY, 1923-41

Constituted in the Organized Reserve 29 July 1921, assigned to the XIII Corps, and allotted to the Third Corps Area. Initiated 27 October 1921 at Philadelphia, PA. Withdrawn from the Third Corps Area 2 July 1923, allotted to the Second Corps Area, and organized at Manhattan, NY. Concurrently relieved from the XIII Corps and assigned to the Fourth Army. Relieved from the Fourth Army 1 October 1933 and assigned to the General Headquarters Reserve. Conducted summer training most years with the 51st Signal Battalion at Camp Alfred Vail/Fort Monmouth, NJ, and some years at Pine Camp, NY, and Camp Dix, NJ. Also conducted infantry C.M.T.C. training some years at Camp Alfred Vail/Fort Monmouth as an alternate form of annual training. Designated mobilization training station was Fort Monmouth. Primary R.O.T.C. feeder school was Cornell University. Withdrawn from the Second Corps Area 3 November 1941 and allotted to the Office of the Chief Signal Officer for mobilization purposes. Concurrently affiliated with New York Bell Telephone Company. Location 7 December 1941—Manhattan, NY.

Events: 190**304th Signal Battalion (XIV Corps)****Organized Reserve Georgia****HQ**-*Not initiated* 1921-22; Atlanta, GA, 1922-41

Constituted in the Organized Reserve 29 July 1921, assigned to the XIV Corps, and allotted to the Fourth Corps Area. Initiated 29 March 1922 at Atlanta, GA. Relieved from the XIV Corps 2 July 1923 and assigned to the IV Corps. Relieved from the IV Corps in September 1927 and assigned to the XIV Corps. Conducted summer training at Fort Oglethorpe, GA, or Fort Benning, GA. Withdrawn from the Fourth Corps Area 3 November 1941 and allotted to the Office of the Chief Signal Officer for mobilization purposes. Concurrently affiliated with the Southern Bell Telephone Company. Designated mobilization station was Camp Jackson, SC. Location 7 December 1941—Atlanta, GA.

Status: Active in the Regular Army as the 304th Signal Battalion at Camp Colbern, Republic of Korea.**305th Signal Battalion (XV Corps)****Organized Reserve Ohio****HQ**-*Not initiated* 1921-22; Cleveland, OH, 1922-41

Constituted in the Organized Reserve 29 July 1921, assigned to the XV Corps, and allotted to the Fifth Corps Area. Initiated in March 1922 at Cleveland, OH. Relieved from the XV Corps 2 July 1923 and assigned to the V Corps. Relieved from the V Corps 18 October 1927 and assigned to the XV Corps. Conducted summer training at Camp Knox, KY. Withdrawn from the Second Corps Area 3 November 1941 and allotted to the Office of the Chief Signal Officer

for mobilization purposes. Concurrently affiliated with the Ohio Bell Telephone Company. Location 7 December 1941—Cleveland, OH.

Events: 213

306th Signal Battalion (XVI Corps)

Organized Reserve Michigan

HQ-Jackson, MI, 1921-25; Lansing, MI, 1925-32; Detroit, MI, 1932-41

Constituted in the Organized Reserve 29 July 1921, assigned to the XVI Corps, and allotted to the Sixth Corps Area. Initiated 25 October 1921 at Jackson, MI. Relieved from the XVI Corps 2 July 1923 and assigned to VI Corps. Relocated 2 June 1925 to Lansing, MI. Relieved from the VI Corps 18 October 1927 and assigned to XVI Corps. Relocated 27 September 1932 to Detroit, MI. Conducted summer training most years at Fort Sheridan, IL, and some years at Camp Custer, MI. Location 7 December 1941—Detroit, MI.

307th Signal Battalion (XVII Corps)

Organized Reserve Missouri

HQ-*Not initiated* 1921-22; St. Louis, MO, 1922-41

Constituted in the Organized Reserve 29 July 1921, assigned to the XVII Corps, and allotted to the Seventh Corps Area. Initiated in March 1922 at St. Louis, MO. Conducted summer training most years at Fort Crook, NE, and some years at Fort Leavenworth, KS. Location 7 December 1941—St. Louis, MO.

308th Signal Battalion (XVIII Corps)

Organized Reserve Texas

HQ-*Not initiated* 1921-22; Dallas, TX, 1922-41

Constituted in the Organized Reserve 29 July 1921, assigned to the XVIII Corps, and allotted to the Eighth Corps Area. Initiated 23 August 1922 at Dallas, TX. Conducted summer training with the 2nd Signal Company at Fort Sam Houston, TX. Withdrawn from the Eighth Corps Area 3 November 1941 and allotted to the Office of the Chief Signal Officer for mobilization purposes. Concurrently affiliated with the Southwestern Bell Telephone Company. Location 7 December 1941—Dallas, TX.

309th Signal Battalion (XIX Corps)

Organized Reserve Washington

HQ-*Not initiated* 1921-22; Seattle, WA, 1922-41

Constituted in the Organized Reserve 29 July 1921, assigned to the XIX Corps, and allotted to the Ninth Corps Area. Initiated 22 April 1922 at Seattle, WA. Conducted summer training at Fort Lewis, WA. Withdrawn from the Ninth Corps Area 3 November 1941 and allotted to the Office of the Chief Signal Officer for mobilization purposes. Concurrently affiliated with the Pacific Telephone and Telegraph Company. Location 7 December 1941—Seattle, WA.

310th Signal Battalion (III Corps)

Organized Reserve

HQ-*Not initiated* 1921-27

Constituted in the National Guard 29 July 1921 as the 102nd Signal Battalion, assigned to the III Corps, and allotted to the Third Corps Area. Placed on the deferred list 2 July 1923, unit requirement transferred to the Organized Reserve as a Deferred National Guard unit, and redesignated as the 310th Signal Battalion. Withdrawn as a Deferred National Guard unit 17 September 1927 and demobilized.

311th Signal Battalion (IV Corps)**Organized Reserve Tennessee****HQ-Not initiated** 1921-27

Constituted in the National Guard 29 July 1921 as the 103rd Signal Battalion, assigned to the IV Corps, and allotted to the Fourth Corps Area. Placed on the deferred list 2 July 1923, unit requirement transferred to the Organized Reserve as a Deferred National Guard unit, and redesignated as the 311th Signal Battalion and assigned to the XIV Corps. Jackson, TN, designated as headquarters on organization, but the unit was never organized at that location. Designated mobilization training station was Fort Bragg, NC. Withdrawn as a Deferred National Guard unit 17 September 1927 and demobilized.

312th Signal Battalion (XV Corps)**Organized Reserve****HQ-Not initiated** 1921-27

Constituted in the National Guard 29 July 1921 as the 104th Signal Battalion, assigned to the V Corps, and allotted to the state of West Virginia. Placed on the deferred list 2 July 1923, unit requirement transferred to the Organized Reserve as a Deferred National Guard unit, and redesignated as the 312th Signal Battalion and assigned to the XV Corps. Withdrawn as a Deferred National Guard unit 17 September 1927 and demobilized.

313th Signal Battalion (VII Corps)**Organized Reserve Missouri/Minnesota****HQ-Not initiated** 1921-24; Fulton, MO, 1924-26; Minneapolis, MN, 1926-27

Constituted in the National Guard 29 July 1921 as the 117th Signal Battalion, assigned to the VII Corps, and allotted to the state of Missouri. Placed on the deferred list 2 July 1923, unit requirement transferred to the Organized Reserve as a Deferred National Guard unit, and redesignated as the 313th Signal Battalion. Initiated 29 August 1924 at Fulton, MO. Relocated 26 May 1926 to Minneapolis, MN. Withdrawn as a Deferred National Guard unit 17 September 1927 and demobilized.

314th Signal Battalion (VIII Corps)**Organized Reserve Texas****HQ-Not initiated** 1921-24; Dallas, TX, 1924-27

Constituted in the National Guard 29 July 1921 as the 106th Signal Battalion, assigned to the VIII Corps, and allotted to the state of Colorado. Placed on the deferred list 2 July 1923, unit requirement transferred to the Organized Reserve as a Deferred National Guard unit, and redesignated as the 314th Signal Battalion. Initiated in 1924 at Dallas, TX. Conducted summer training with the 2nd Signal Company at Fort Sam Houston, TX. Designated mobilization training station was Camp Joseph T. Robinson, AR. Withdrawn as a Deferred National Guard unit 17 September 1927, redesignated as 106th Signal Battalion, and reallocated to the state of Colorado. Concurrently, personnel transferred to the 308th Signal Battalion.

315th Signal Battalion (IX Corps)**Organized Reserve California****HQ-Not initiated** 1921-27

Constituted in the National Guard 29 July 1921 as the 107th Signal Battalion, assigned to the IX Corps, and allotted to the state of Idaho. Placed on the deferred list 2 July 1923, unit requirement transferred to the Organized Reserve as a Deferred National Guard unit, and redesignated as the 315th Signal Battalion. Los Angeles, CA, designated as headquarters on organization, but the unit was never organized at that location.. Withdrawn as a Deferred National Guard unit 17 September 1927 and demobilized.

316th Signal Battalion (First Army)

Organized Reserve Ohio/Indiana

HQ—*Not initiated* 1921-27; Ohio 1927-30; *Inactive* 1930-34; South Bend, IN, 1934-41

Constituted in the National Guard 29 July 1921 as the 111th Signal Battalion, assigned to the First Army, and allotted to the state of New Hampshire. Placed on the deferred list 2 July 1923, unit requirement transferred to the Organized Reserve as a Deferred National Guard unit, and redesignated as the 316th Signal Battalion. Withdrawn as a Deferred National Guard unit 11 January 1927 and allotted permanently to the Organized Reserve as the 316th Signal Battalion. Concurrently withdrawn from the First Corps Area and allotted to the Fifth Corps Area. Initiated in 1927 in Ohio. Inactivated by March 1930 by relief of personnel. Reorganized by June 1934 at South Bend, IN. Location 7 December 1941—South Bend, IN.

317th Signal Battalion (First Army)

Organized Reserve New Jersey

HQ—*Not initiated* 1921-27

Constituted in the National Guard 29 July 1921 as the 112th Signal Battalion, assigned to the First Army, and allotted to the state of New Jersey. Placed on the deferred list 2 July 1923, unit requirement transferred to the Organized Reserve as a Deferred National Guard unit, and redesignated as the 317th Signal Battalion. Withdrawn as a Deferred National Guard unit 17 September 1927, redesignated as the 112th Signal Battalion, and allotted to the state of New Jersey.

318th Signal Battalion (Fifth Army)

Organized Reserve Wisconsin

HQ—*Not initiated* 1921-27

Constituted in the National Guard 29 July 1921 as the 113th Signal Battalion, assigned to the Second Army and allotted to the state of Wisconsin. Placed on the deferred list 2 July 1923, unit requirement transferred to the Organized Reserve as a Deferred National Guard unit, and redesignated as the 318th Signal Battalion. Concurrently relieved from the Second Army and assigned to the Fifth Army. Designated mobilization training station was Camp McCoy, WI. Withdrawn as a Deferred National Guard unit 17 September 1927 and demobilized.

319th Signal Battalion (Fifth Army)

Organized Reserve

HQ—*Not initiated* 1921-41

Constituted in the National Guard 29 July 1921 as the 114th Signal Battalion, assigned to the Second Army and allotted to the state of Michigan. Placed on the deferred list 2 July 1923, unit requirement transferred to the Organized Reserve as a Deferred National Guard unit, and redesignated as the 319th Signal Battalion. Concurrently relieved from the Second Army and assigned to the Fifth Army. Withdrawn as a Deferred National Guard unit and allotted permanently to the Organized Reserve 17 September 1927 as the 319th Signal Battalion. Designated mobilization training station was Camp Custer, MI, 1923-29 and Camp Joseph T. Robinson, AR, 1929-41. Location 7 December 1941—*Not initiated*.

320th Signal Battalion (Third Army)

Organized Reserve Nebraska

HQ—*Not initiated* 1921-24; Omaha, NE, 1924-27

Constituted in the National Guard 29 July 1921, assigned to the Third Army and allotted to the state of Nebraska. Placed on the deferred list 2 July 1923, unit requirement transferred to the Organized Reserve as a Deferred National Guard unit, and redesignated as the 320th Signal Battalion. Initiated 29 August 1924 with headquarters at Omaha, NE. Withdrawn as a Deferred National Guard unit 17 September 1927 and demobilized.

321st Signal Battalion (Fourth Army)**Organized Reserve Connecticut/New York**

HQ-*Not initiated* 1921-23; Hartford, CT, 1923-33; *Inactive* 1933-37; Buffalo, NY, 1937-41

Constituted in the Organized Reserve 15 October 1921, assigned to the Fourth Army, and allotted to the First Corps Area. Initiated in March 1923 at Hartford, CT. Designated mobilization training station was Camp Alfred Vail/Fort Monmouth, NJ, 1923-41. Conducted summer training with the 51st Signal Battalion at Camp Alfred Vail/Fort Monmouth, NJ. Withdrawn from the First Corps Area 1 October 1933 and allotted to the Second Corps Area. Concurrently relieved from the Fourth Army and assigned to the General Headquarters Reserve. Reorganized 5 April 1937 at Buffalo, NY. Withdrawn from the Second Corps Area 3 November 1941 and allotted to the Office of the Chief Signal Officer for mobilization purposes. Concurrently affiliated with the New York Bell Telephone Company. Location 7 December 1941—Buffalo, NY.

322nd Signal Battalion (Fourth Army)**Organized Reserve New York/Pennsylvania**

HQ-*Not initiated* 1921-22; Ephrata, PA, 1922-23; Philadelphia, PA, 1923-37; *Inactive* 1937-41

Constituted in the Organized Reserve 15 October 1921, assigned to the Fourth Army, and allotted to the Second Corps Area. Withdrawn from the Second Corps Area by February 1922 and allotted to the Third Corps Area. Concurrently relieved from the Fourth Army and assigned to the XIII Corps. Initiated 28 February 1922 at Ephrata, PA. Relocated by December 1923 to Philadelphia, PA. Conducted summer training most years with the 51st Signal Battalion at Camp Alfred Vail/Fort Monmouth, NJ, and some years at Fort George G. Meade, MD. Also conducted C.M.T.C. training some years at Fort George G. Meade or Fort Monmouth as an alternate form of summer training. Designated mobilization training station was Camp Alfred Vail/Fort Monmouth, NJ, 1923-41. Inactivated 12 January 1937 at Philadelphia, PA, by relief of personnel. Location 7 December 1941—*Inactive*.

323rd Signal Battalion (Second Army)**Organized Reserve Indiana/Ohio**

HQ-*Not initiated* 1921-22; Indianapolis, IN, 1922-30; *Inactive* 1930-33

Constituted in the Organized Reserve 15 October 1921, assigned to the Second Army, and allotted to the Fifth Corps Area. Initiated in July 1922 at Indianapolis, IN. Inactivated by March 1930 at Indianapolis by relief of personnel. Lorain, OH, designated 9 July 1931 as headquarters on reorganization, but the unit was never organized at that location. Demobilized 1 October 1933.

324th Signal Battalion (Fifth Army)**Organized Reserve Illinois**

HQ-*Not initiated* 1921-22; Chicago, IL, 1922-41

Constituted in the Organized Reserve 15 October 1921, assigned to the Fifth Army, and allotted to the Sixth Corps Area. Initiated 23 January 1922 at Chicago, IL. Conducted summer training most years at Fort Sheridan, IL, and some years at Camp Custer, MI. Location 7 December 1941—Chicago, IL.

325th Signal Battalion (Sixth Army)**Organized Reserve Minnesota/South Dakota**

HQ-*Not initiated* 1921-22; St. Paul, MN, 1922-26; Sioux Falls, SD, 1926-28

Constituted in the Organized Reserve 15 October 1921, assigned to the Sixth Army, and allotted to the Seventh Corps Area. Initiated in July 1922 at St. Paul, MN. Relocated 26 May 1926 to Sioux Falls, SD. Conducted summer training most years at Fort Crook, NE, and some years at Fort Leavenworth, KS, or Fort Snelling, MN. Demobilized 6 October 1928.

326th Signal Battalion (Sixth Army)**Organized Reserve Oregon/California/New Jersey**

HQ—*Not initiated* 1921-22; Portland, OR, 1922-28; San Francisco, CA, 1928-36; *Inactive* 1936-41

Constituted in the Organized Reserve 15 October 1921, assigned to the Sixth Army, and allotted to the Ninth Corps Area. Initiated 22 April 1922 at Portland, OR. Relieved from assignment to the Sixth Army 2 July 1923 and assigned to the Third Army. Relocated 1 January 1928 to San Francisco, CA. Conducted summer training most years at the Presidio of Monterey, CA, and some years at Del Monte, CA, or the Presidio of San Francisco, CA. Withdrawn from the Ninth Corps Area 5 June 1936 and allotted to the Second Corps Area. Inactivated 13 June 1936 at San Francisco by relief of personnel. Newark, NJ, designated 5 April 1937 as headquarters on organization, but the unit was never organized at that location. Designated headquarters location changed 11 April 1940 to East Orange, NJ. Location 7 December 1941—*Inactive*.

Status: Disbanded 11 November 1944.

327th Signal Battalion (Third Army)**Organized Reserve Colorado/Iowa/South Dakota**

HQ—*Not initiated* 1921-25; Denver, CO, 1925-27; Cedar Rapids, IA, 1927-31; Mitchell, SD, 1931-41

Constituted in the National Guard 29 July 1921 as the 116th Signal Battalion, assigned to the Third Army, and allotted to the state of New Mexico. Placed on the deferred list 2 July 1923, unit requirement transferred to the Organized Reserve as a Deferred National Guard unit, and redesignated as the 327th Signal Battalion. Assigned to the Third Army and allotted to the Eighth Corps Area. Initiated 27 February 1925 at Denver, CO. Withdrawn as a Deferred National Guard unit 13 January 1927 and allotted permanently to the Organized Reserve as the 327th Signal Battalion. Concurrently withdrawn from the Eighth Corps Area and allotted to the Seventh Corps Area. Reorganized 3 August 1927 at Cedar Rapids, IA. Relocated 12 October 1931 to Mitchell, SD. Withdrawn from the Second Corps Area 3 November 1941 and allotted to the Office of the Chief Signal Officer for mobilization purposes. Concurrently affiliated with Northwestern Bell Telephone Company. Location 7 December 1941—Mitchell, SD.

331st Signal Construction Battalion (C.Z.)**Organized Reserve Illinois/Michigan**

HQ—*Not initiated* 1923-25; East St. Louis, IL, 1925-27; Detroit, MI, 1927-28

Constituted in the Organized Reserve 2 July 1923, assigned to the Communications Zone, allotted to the Sixth Corps Area. Initiated 10 December 1925 at East St. Louis, IL. Relocated 7 January 1927 to Detroit, MI. Conducted summer training at Fort Sheridan, IL. Demobilized 6 October 1928.

332nd Signal Construction Battalion (C.Z.)**Organized Reserve Michigan**

HQ—*Not initiated* 1923-25; Detroit, MI, 1925-41

Constituted in the Organized Reserve 2 July 1923, assigned to the Communications Zone, allotted to the Sixth Corps Area. Initiated 10 December 1925 at Detroit, MI. Conducted summer training at Fort Sheridan, IL, or Camp Custer, MI. Withdrawn from the Sixth Corps Area 3 November 1941 and allotted to the Office of the Chief Signal Officer for mobilization purposes. Concurrently affiliated with Wisconsin Telephone Company. Location 7 December 1941—Detroit, MI.

333rd Signal Construction Battalion (C.Z.)

Organized Reserve Pennsylvania

HQ-*Not initiated* 1923-25; Pittsburgh, PA, 1925-35; Baltimore, MD, 1935-41

Constituted in the Organized Reserve 2 July 1923, assigned to the Communications Zone, allotted to the Sixth Corps Area. Initiated 19 February 1925 at Pittsburgh, PA. Relocated 10 January 1935 to Baltimore, MD. Conducted summer training at Fort Monmouth, NJ. Conducted C.M.T.C. training most years at Fort George G. Meade, MD, and some years at Fort Monmouth as an alternate form of annual training. Withdrawn from the Third Corps Area 3 November 1941 and allotted to the Office of the Chief Signal Officer for mobilization purposes. Concurrently affiliated with Bell Telephone Company of Pennsylvania. Location 7 December 1941—Pittsburgh, PA.

334th Signal Construction Battalion (C.Z.)

Organized Reserve Pennsylvania

HQ-*Not initiated* 1923-25; Harrisburg, PA, 1925-27; *Inactive* 1927-28

Constituted in the Organized Reserve 2 July 1923, assigned to the Communications Zone, allotted to the Sixth Corps Area. Initiated in February 1925 at Harrisburg, PA. Withdrawn from the Third Corps Area 11 January 1927 and allotted to the Fifth Corps Area. Demobilized 6 October 1928.

335th Signal Construction Battalion (C.Z.)

Organized Reserve West Virginia

HQ-*Not initiated* 1923-26; Huntington, WV, 1926-30; *Inactive* 1930-41

Constituted in the Organized Reserve 2 July 1923, assigned to the Communications Zone, allotted to the Fifth Corps Area. Initiated 20 April 1926 at Huntington, WV. Inactivated by March 1930 at Huntington by relief of personnel. Location 7 December 1941—*Inactive*.

336th Signal Construction Battalion (C.Z.)

Organized Reserve Ohio

HQ-*Not initiated* 1923-31; Cleveland, OH, 1931-33; Cincinnati, OH, 1933-41

Constituted in the Organized Reserve 2 July 1923, assigned to the Communications Zone, allotted to the Fifth Corps Area. Initiated 9 July 1931 at Cleveland, OH. Relocated 21 December 1933 to Cincinnati, OH. Designated mobilization training station was Camp Sherman, OH, 1923-41. Location 7 December 1941—Cincinnati, OH.

337th Signal Operation and Maintenance Battalion (C.Z.)

Organized Reserve Wisconsin

HQ-*Not initiated* 1923-24; Milwaukee, WI, 1924

Constituted in the Organized Reserve 2 July 1923, assigned to the Communications Zone, allotted to the Sixth Corps Area. Initiated 18 April 1924 at Milwaukee, WI. Withdrawn from the Sixth Corps Area 13 June 1924 and demobilized.

337th Signal Construction Battalion (GHQR)

Organized Reserve

HQ-*Not initiated* 1933-41

Constituted in the Organized Reserve 1 October 1933, assigned to the General Headquarters Reserve, and allotted to the Seventh Corps Area. Location 7 December 1941—*Not initiated*.

338th Signal Operation and Maintenance Battalion (C.Z.)

Organized Reserve Illinois

HQ-East St. Louis, IL, 1924

Constituted in the Organized Reserve 2 July 1923, assigned to the Communications Zone, allotted to the Sixth Corps Area. Initiated April 1924 at East St. Louis, IL. Withdrawn from the Sixth Corps Area 13 June 1924 and demobilized.

338th Signal Construction Battalion (GHQR)

Organized Reserve New York

HQ-*Not initiated* 1933-36; Manhattan, NY, 1936-37; *Inactive* 1937-40; Manhattan, NY, 1940-41

Constituted in the Organized Reserve 1 October 1933, assigned to the General Headquarters Reserve, and allotted to the Eighth Corps Area. Conducted summer training at Fort Sam Houston, TX. Withdrawn from the Eighth Corps Area 5 June 1936 and allotted to the Second Corps Area. Designated mobilization training station was Fort Brown, TX, 1933-36 and Fort Monmouth, NJ, 1936-41. Initiated in 1936 at Manhattan, NY. Inactivated 12 May 1937 at Manhattan by relief of personnel. Reorganized 1 October 1940 at Manhattan. Location 7 December 1941—Manhattan, NY.

339th Signal Operation and Maintenance Battalion (C.Z.)

Organized Reserve

HQ-*Not initiated* 1923-24

Constituted in the Organized Reserve 2 July 1923 and assigned to the Communications Zone. Not allotted a Corps Area. Withdrawn from the Organized Reserve 13 June 1924 and demobilized.

340th Signal Operation and Maintenance Battalion (C.Z.)

Organized Reserve

HQ-*Not initiated* 1923-24

Constituted in the Organized Reserve 2 July 1923 and assigned to the Communications Zone. Not allotted a Corps Area. Withdrawn from the Organized Reserve 13 June 1924 and demobilized.

341st Signal Operation and Maintenance Battalion (C.Z.)

Organized Reserve

HQ-*Not initiated* 1923-24

Constituted in the Organized Reserve 2 July 1923 and assigned to the Communications Zone. Not allotted a Corps Area. Withdrawn from the Organized Reserve 13 June 1924 and demobilized.

342nd Signal Operation and Maintenance Battalion (C.Z.)

Organized Reserve

HQ-*Not initiated* 1923-24

Constituted in the Organized Reserve 2 July 1923 and assigned to the Communications Zone. Not allotted a Corps Area. Withdrawn from the Organized Reserve 13 June 1924 and demobilized.

Part XIII

Chemical Warfare Service Organizations

1919-41

Chapter 51

Chemical Warfare Service Organizations



Coast Artillery Journal

A chemical mortar crew from the 1st Chemical Regiment practices crew drills at Edgewood Arsenal, MD, circa 1936.

There were a variety of Chemical Warfare Service organizations in the interwar period. These units performed an assortment of missions to include chemical protection, maintenance, smoke generation, and chemical attack.

Organization

Other than the General Headquarters Reserve, chemical units were habitually assigned only at the field army level where three companies—a chemical laboratory, a depot and a maintenance company—provided that command with specialized chemical warfare support. The primary means for chemical and smoke attack was the service's various chemical regiments and separate battalions.

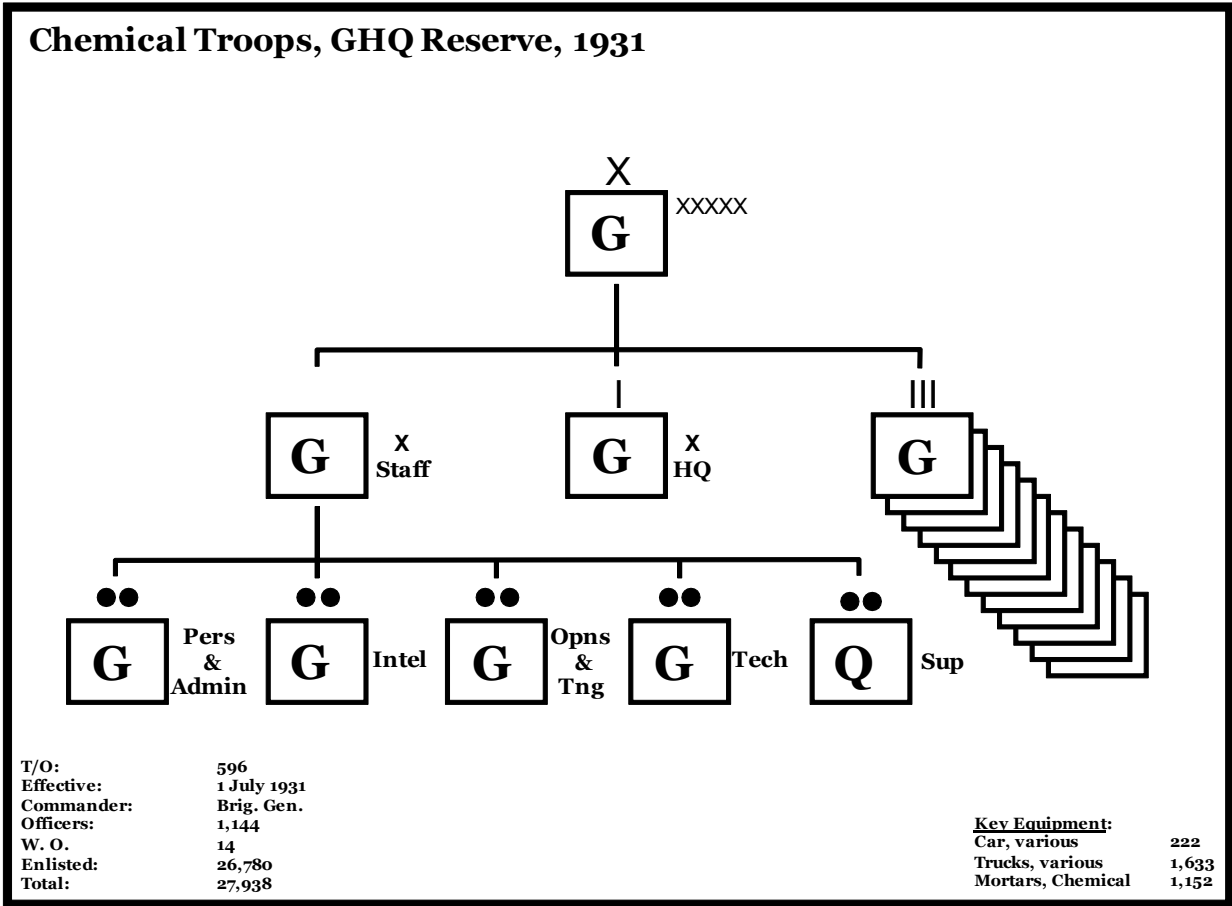

Chemical Service GHQR TOE.

As its named implied, the Headquarters, Chemical Troops, GHQR, was constituted to provide command and control capability for the chemical units assigned or attached to the General Headquarters. This command controlled most chemical units in the theater of operations and attached them to the various armies and/or corps based on requirements for current and future operations.

Chemical Regiment (Motorized), 1931

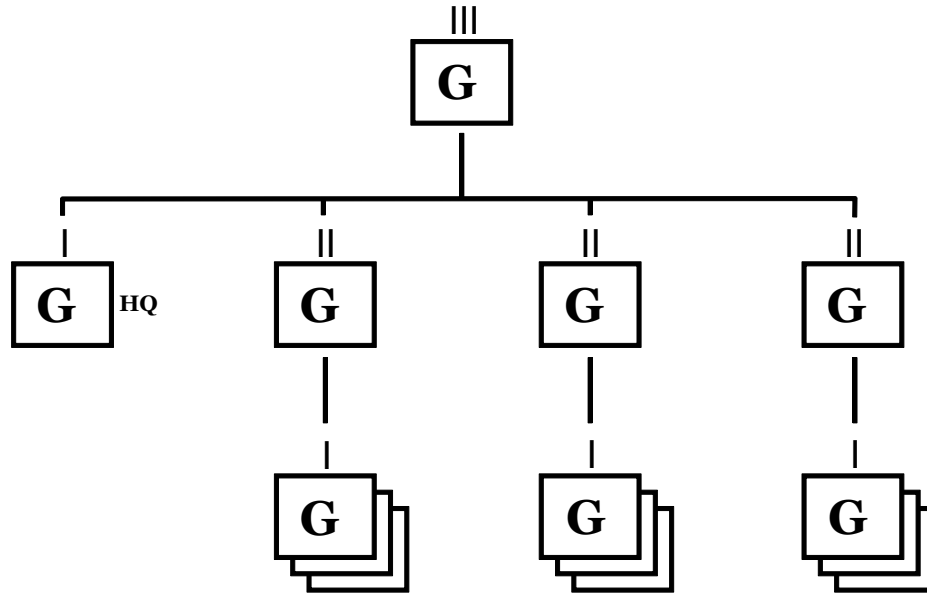

T/O: 597
 Effective: 1 July 1931
 Commander: Col.
 Officers: 94
 W. O.: 1
 Enlisted: 2226
 Total: 2321

Key Equipment:
 Car, various 18
 Trucks, various 136
 Mortars, Chemical 96

Chemical Regiment TOE.

There were at least eighteen chemical regiments in the Army's inventory in the interwar period. Two, one of which was venerable 1st Gas Regiment of World War I, were allotted to the Regular Army and both of these regiments had a number of active battalions or companies during this period.

Separate Chemical Battalion (Motorized), 1931

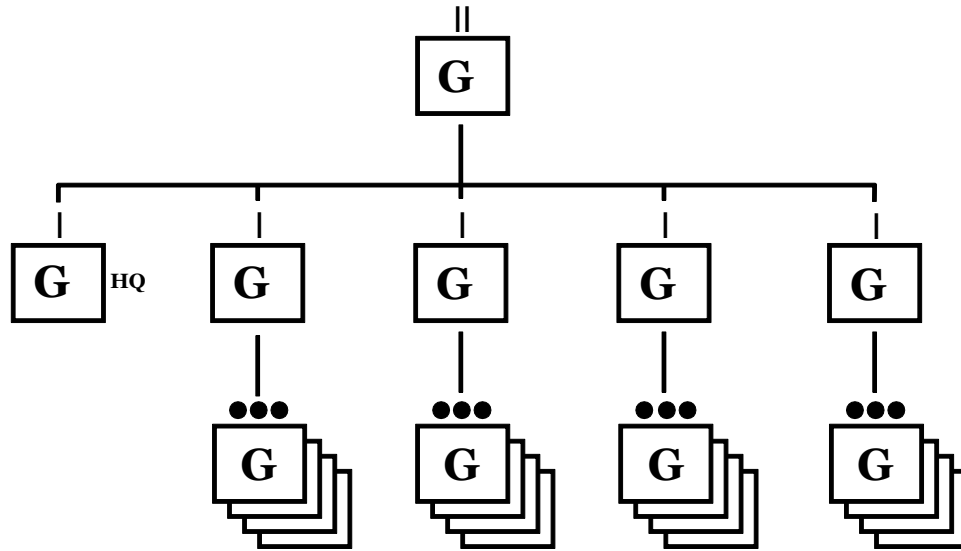

T/O: 597-3
 Effective: 1 July 1931
 Commander: Maj.
 Officers: 23
 W. O.: -
 Enlisted: 660
 Total: 883

Key Equipment:
 Car, passenger 5
 Trucks, various 34
 Mortars, Chemical 32

Separate Chemical Battalion (Animal-Drawn), 1931

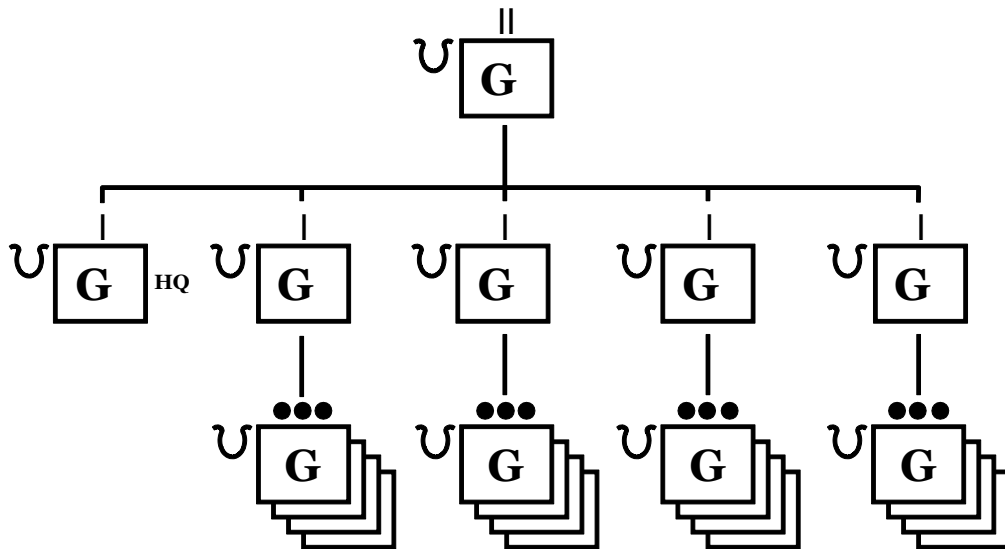

T/O: 599
 Effective: 1 July 1931
 Commander: Maj.
 Officers: 28
 W. O.: -
 Enlisted: 832
 Total: 860

Key Equipment:
 Car, passenger 2
 Horses & Mules 326
 Wagons, various 28
 Mortars, Chemical 32

Chemical Battalion TOEs.

There were also two separate chemical battalions in the Regular Army, one animal-drawn and one motorized. The animal-drawn 1st Chemical Battalion was located in Hawaii due to the mountainous terrain located there. The 2nd Chemical Battalion was located at Edgewood Arsenal and performed duties as the support unit for the C.W.S. school.

Four regiments were allotted to the National Guard in 1931, but these were withdrawn in 1934 and allotted to the Organized Reserve. Including the four regiments transferred from the National Guard, there were at least twelve OR chemical regiments (there may have been a 901st Chemical Regiment as well). Ten were standard chemical mortar regiments. The remaining two were intended to perform duties as C.W.S. training regiments.

Training

The few active Regular Army chemical units were fairly lively organizations in the interwar period. Given the experiences with chemical warfare during World War I, chemical warfare protection and defense was frequently integrated into training exercises, though generally on a small scale. The various OR chemical regiments were also some of the most active reserve units of the period. This was particularly true of the 302nd and 303rd Chemical Regiments. In the 1930s, the latter regiment held a number of chemical warfare training exercises with Regular Army and National Guard units in the Second Corps Area that may have been more frequent than Appendix C indicates. The OR regiments tended to be concentrated in a single city as a complete regiment, or by battalions in a single city, which allowed for frequent and well-attended training assemblies during the Inactive Training Period.

Headquarters, Chemical Troops, GHQ

HQ-*Not organized* 1931-41

Constituted in the Regular Army 4 March 1931 and allotted to the Third Corps Area. Unit mission on activation was to be the command and control headquarters for Zone of the Interior chemical units and for GHQR chemical units in a theater of operations. Location 7 December 1941—*Not organized*.

Status: Disbanded 18 October 1943.

1st Gas Regiment (1919-29) (Z.I.)

1st Chemical Regiment (1929-41) (Zone of the Interior)

HQ-Edgewood Arsenal, MD, 1920-35; *Inactive* 1935-36; Philadelphia, PA, 1936-40; *Inactive* 1940-41



Arrived at the Port of Hoboken on the S.S. *Celtic* 24 January 1919 as the 1st Gas Regiment after eleven months of wartime duty in France. Transferred to Camp Kendrick, Lakehurst, NJ, where the regiment was demobilized on 28 February 1919. Reconstituted 24 February 1920 in the Regular Army as the 1st Gas Regiment and assigned to the Zone of the Interior. Regiment organized 24 February-2 March 1920 with Regimental Headquarters, 1st Battalion, and 2nd Battalion at Edgewood Arsenal, MD. The 3rd Battalion concurrently organized at Lakehurst Proving Grounds, NJ. The 3rd Battalion was inactivated 1 July 1921 at Lakehurst. Companies G and H transferred in January 1922 to the Hawaiian Department. Company F transferred 15 July 1922 to Fort Benning, GA. Headquarters and headquarters detachments for 1st and 2nd Battalions, and Companies E and H inactivated 29 September 1922. Regimental Headquarters, Headquarters and Service Company, and Companies A, B, C, D, F, and G remained active. Company C transferred 21 January 1926 to the Panama Canal Zone. Companies C, G, and H redesignated 13 July 1927 as the 1st, 2nd, and 3rd Separate Chemical Companies, respectively. Concurrently, new Company C constituted and organized at Edgewood Arsenal. New Companies G and H constituted as inactive units. The Provisional Mechanized Platoon, 1st Gas Regiment was organized 23 April 1928 at Fort Holabird, MD, to support the tests and training of the Experimental Mechanized Force 30 April-1 October 1928. Redesignated 5 February 1929 as the 1st Chemical Regiment. Company C inactivated 1 April 1931 at Edgewood Arsenal. The 1st and 2nd Battalion reorganized 7 November 1932 with Organized Reserve personnel as a RAI units at Philadelphia, PA. Regiment inactivated 15 April 1935 and concurrently reorganized entirely with Organized Reserve personnel as a RAI unit as follows: Headquarters and 2nd Battalion at Philadelphia, 1st Battalion at Pittsburgh, PA, and the 3rd Battalion at Richmond, VA. Conducted chemical warfare training for the Pennsylvania National Guard and Fleet Marine Corps Reserve units in the eastern Pennsylvania area 1937-38. Participated in an amphibious training exercise at Tuckerton, NJ, 25-26 June 1938. Inactivated 9 October 1940 at Philadelphia by transfer of personnel to the 902nd Chemical Regiment. As a RAI unit, conducted summer training most years at Edgewood Arsenal, MD, or some years at Camp Dix, NJ, with the 1st Division Chemical Warfare Service Detachment. Location 7 December 1941—*Inactive*.

Organization Day: 4 June. Chosen to commemorate the establishment of the Chemical Warfare Service as a branch separate from the Engineer Corps on 4 June 1920.

Status: Disbanded 12 March 1942. Reconstituted and consolidated 7 November 1951 with the 2nd Chemical Weapons Battalion. Currently active at Fort Hood, TX, as the 2nd Chemical Battalion.

Events: 54, 155, 176, 254

Commanders, 1st Gas Regiment

Col. Amos A. Fries	Oct 17-9 Mar 18	Maj. Earl J. Atkisson	12 May 20-20 Jun 23
Col. Earl J. Atkisson	10 Mar 18-12 Jan 19	Maj. Oscar A. Eastwald	20 Jun 23-16 Aug 23
<i>Demobilized/Inactive</i>	28 Feb 19-23 Feb 20	Maj. William A. Copthorne	16 Aug 23-25 May 25
Maj. Stephen J. Delanoy	24 Feb 20-12 May 20	Maj. Paul X. English	25 May 25-2 Jul 28
	Capt. Eugene P. H. Gempel	2 Jul 28-4 Feb 29	

Commanders, 1st Chemical Regiment

Capt. Eugene P. H. Gempel	5 Sep 29-18 Aug 30	Maj. Harry L. Gilchrist	17 Aug 31-20 Sep 32
Maj. Edward C. Wallington	19 Aug 30-16 Aug 31	Maj. Leigh F. J. Zerbee	21 Sep 32-15 Apr 35
	Lt. Col. Herbert K. Bear**	15 Apr 35-9 Oct 40	

** RAI Commanders: Organized Reserve officers.

1st Separate Chemical Battalion (Motorized)

HQ-Not organized 1931-41



Constituted in the Regular Army 4 March 1931 as the 1st Separate Chemical Battalion (Motorized) and allotted to the Hawaiian Department. Company A, the only active unit, was organized 4 March 1931 at Schofield Barracks, TH, from the 2nd Separate Chemical Company. Location 7 December 1941—*Not organized*.

Status: Disbanded 12 March 1942.

Events: 248, 276, 297, 312

2nd Chemical Regiment (Z.I.)

Regular Army Inactive

HQ-Not organized 1931-32; Columbus, GA, 1932-40; *Inactive* 1940-41

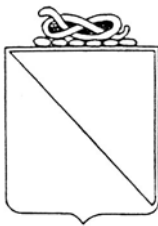

Constituted in the Regular Army 1 April 1931 as the 2nd Chemical Regiment, assigned to the Zone of the Interior, and allotted to the Fourth Corps Area. Company C, the only active unit, was organized 1 April 1931 at Fort Benning, GA, from D Company, 1st Chemical Regiment. Remainder of the regiment was organized in June 1932 with Organized Reserve personnel as a RAI unit at Columbus, GA. Conducted summer training at Fort Benning, GA, or Fort McPherson, GA. Conducted C.M.T.C. training at Fort McPherson in 1936 as an alternate form of annual training. Designated mobilization training station was Fort Benning, GA. Inactivated 25 August 1940 at Columbus by relief of personnel. Attached 24 January 1941 to the Third Army. Location 7 December 1941—*Inactive*.

Status: Disbanded 12 March 1942.

Events: 143, 209, 293, 295, 296, 301

Commanders, 2nd Chemical Regiment

Unknown	1 Jun 32-23 Aug 32	Lt. Col. Edward A. Vaughn**	30 Jun 34-ao Jul 34
Lt. Col. George W. Wanamaker**	23 Aug 32-9 Oct 32	Unknown	ao Jul 34-ao Jul 37
Lt. Col. Andrew J. Bethea**	9 Oct 32-9 Feb 33	Lt. Col. George W. Wanamaker**	ao Jul 37-25 Aug 40
Lt. Col. James C. Akers**	9 Feb 33-30 Jun 34	<i>Inactive</i>	25 Aug 40-7 Dec 41

** RAI Commanders: Organized Reserve officers.

2nd Separate Chemical Battalion (Motorized)

HQ-Edgewood Arsenal, MD, 1935-41

Constituted in the Regular Army 16 April 1935 as the 2nd Separate Chemical Battalion (Motorized), and activated, less B and C Companies, at Edgewood Arsenal, MD. Companies B and C allotted to the Third Corps Area as inactive units. Organized Reserve officers assigned to the battalion were predominantly from Virginia and trained with the battalion during summer camp at Edgewood Arsenal. Location 7 December 1941—Edgewood Arsenal, MD.

Status: Consolidated 7 November 1951 with the 1st Chemical Regiment. Currently active in the Regular Army at Fort Hood, TX, as the 2nd Chemical Battalion.

Events: 219, 240, 266, 330

101st Chemical Regiment (Z.I.)

National Guard

HQ-Not organized 1931-34

Constituted in the National Guard 4 March 1931 as the 101st Chemical Regiment, assigned to the Zone of the Interior, and allotted to the First and Second Corps Areas. Withdrawn from the National Guard 2 November 1934, allotted to the Organized Reserve, and redesignated as the 307th Chemical Regiment.

102nd Chemical Regiment (Z.I.)

National Guard

HQ-Not organized 1931-34

Constituted in the National Guard 4 March 1931 as the 102nd Chemical Regiment and assigned to the Zone of the Interior. Withdrawn from the National Guard 2 November 1934, allotted to the Organized Reserve, and redesignated as the 308th Chemical Regiment.

103rd Chemical Regiment (Z.I.)

National Guard

HQ-Not organized 1931-34

Constituted in the National Guard 4 March 1931 as the 103rd Chemical Regiment, assigned to the Zone of the Interior, and allotted to the Sixth Corps Area. Withdrawn from the National Guard 17 November 1934, allotted to the Organized Reserve, and redesignated as the 309th Chemical Regiment.

104th Chemical Regiment (Z.I.)

National Guard

HQ-Not organized 1931-34

Constituted in the National Guard 4 March 1931 as the 104th Chemical Regiment, assigned to the Zone of the Interior, and allotted to the Ninth Corps Area. Withdrawn from the National Guard 2 November 1934, allotted to the Organized Reserve, and redesignated as the 310th Chemical Regiment.

301st Gas Regiment (1923-29) (Z.I.)

Organized Reserve Georgia and South Carolina

301st Chemical Regiment (1929-41)

HQ-Not initiated 1923-24; Augusta, GA, 1924-29; Atlanta, GA, 1929-41



Constituted in the Organized Reserve 2 July 1923 as the 301st Gas Regiment, assigned to the Zone of the Interior, and allotted to the Fourth Corps Area. Initiated 17 March 1924 with headquarters at Augusta, GA. Redesignated 1 February 1929 as the 301st Chemical Regiment. Headquarters relocated 22 October 1929 to Atlanta, GA. Typically conducted Inactive Training Period meetings at the Atlantic Athletic Club in Atlanta. Conducted summer training at Fort Benning, GA, or Fort McPherson, GA. Conducted summer training with the 30th Division in July 1928 at Camp Jackson, SC. Conducted C.M.T.C. training at Fort McPherson in 1936 as an alternate form of annual training. Designated mobilization station was Fort Benning. Location 7 December 1941—Atlanta, GA.

Status: Disbanded 18 October 1943.

Commanders, 301st Chemical Regiment

Lt. Col. Edwin E. Corry	17 Mar 24-17 Sep 26	Lt. Col. Edward A. Vaughn	9 Feb 33-30 Jun 34
Lt. Col. Thomas H. McHatton	17 Sep 26-8 Nov 30	Col. Andrew J. Bethea	ao Dec 34-23 Jan 38
Lt. Col. James C. Akers	8 Nov 30-9 Feb 33	Col. Thomas H. McHatton	23 Jan 38-Jul 41

302nd Gas Regiment (1923-29) (Z.I.)

Organized Reserve California

302nd Chemical Regiment (1929-41)

HQ-*Not initiated* 1923-25; San Francisco, CA, 1925-41



Constituted in the Organized Reserve 2 July 1923 as the 302nd Gas Regiment, assigned to the Zone of the Interior, and allotted to the Ninth Corps Area. Initiated in March 1925 with headquarters at San Francisco, CA. Redesignated 1 February 1929 as the 302nd Chemical Regiment. Many unit members participated in earthquake relief operations 14-22 March 1933 in the Los Angeles area. Typically conducted Inactive Training Period meetings at the Fairmont Hotel in San Francisco. Conducted summer training at the Presidio of Monterey, CA, or Del Monte, CA. Location 7 December 1941—San Francisco, CA.

Status: Disbanded 18 October 1943.

Commanders, 302nd Chemical Regiment

Col. George A. Hunt Mar 25-Jul 41

303rd Chemical Regiment (GHQR)

Organized Reserve New York, New Jersey, and Delaware

HQ-New York City, NY, 1931-41



Constituted in the Organized Reserve 4 March 1931 as the 303rd Chemical Regiment, assigned to the General Headquarters Reserve, and allotted to the Second Corps Area. Initiated 1 April 1931 with regimental headquarters and 1st Battalion at New York City, NY; 2nd Battalion at East Orange, NJ; and 3rd Battalion at Wilmington, DE. Typically conducted Inactive Training Period meetings, less the 3rd Battalion, at the Federal Building, Washington St., in New York City; 3rd Battalion held its meetings at the Post Office Building in Wilmington, DE. Conducted summer training with the 1st Division Chemical Warfare Service Detachment at Camp Dix, NJ. Designated mobilization training station was the Syracuse Concentration Area, NY. Location 7 December

1941—New York City, NY.

Status: Disbanded 18 October 1943.

Events: 210, 229, 244, 254

Commanders, 303rd Chemical Regiment

Col. Joseph D. Sears 1 Apr 31-Jul 41

304th Chemical Regiment (GHQR)

Organized Reserve Illinois and Wisconsin

HQ-Chicago, IL, 1931-41



Constituted in the Organized Reserve 4 March 1931 as the 304th Chemical Regiment, assigned to the General Headquarters Reserve, and allotted to the Sixth Corps Area. Initiated in 1931 with regimental headquarters at Chicago, IL. Subordinate battalion headquarters concurrently organized as follows: 1st Battalion at Appleton, WI; 2nd Battalion at Chicago, IL; and 3rd Battalion at Joliet, IL. Entire regiment, less the 1st Battalion, relocated 7 April 1937 to Chicago. Concurrently, the 1st Battalion relocated to Milwaukee, WI. Typically conducted Inactive Training Period meetings at the US Court House in Chicago. Location 7 December 1941—Chicago, IL.

Status: Disbanded 18 October 1943.

Commanders, 304th Chemical Regiment

Lt. Col. Frederick U. Conard

ao Dec 31-ao May 33

Col. Benjamin B. Freud

ao Sep 33-ao Dec 41

305th Chemical Regiment (Z.I.)**Organized Reserve Massachusetts, Connecticut,
New Hampshire, Maine, and Rhode Island**

HQ-Boston, MA, 1931-41

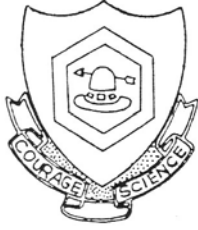

Constituted in the Organized Reserve 4 March 1931 as the 305th Chemical Regiment, assigned to the Zone of the Interior, and allotted to the First Corps Area. Initiated 28 April 1931 with headquarters at Boston, MA. The 1st Battalion was allotted to the area of Massachusetts and organized with headquarters at Boston; 2nd Battalion was allotted to the area of Connecticut and Rhode Island and organized with headquarters at Hartford, CT; and 3rd Battalion was allotted to the area of New Hampshire and Maine and organized with headquarters at Berlin, NH. Concurrently attached to the 94th Division for organization, administration, and training. Conducted summer training at Fort Devens, MA. Location 7 December 1941—Boston, MA.

Status: Disbanded 18 October 1943.**Commanders, 305th Chemical Regiment**

Lt. Col. Earl C. Popp
Lt. Col. Franklin H. Springer

Apr 31-ao Jul 37
ao Jul 38-11 Jan 39

Lt. Col. Edwin E. Corry
Unknown

11 Jan 39-ao Jan 40
ao Jan 40-7 Dec 41

306th Chemical Regiment (Z.I.)**Organized Reserve Texas, Oklahoma, and Colorado**

HQ-San Antonio, TX, 1931-37; Beaumont, TX, 1937-41



Constituted in the Organized Reserve 4 March 1931 as the 306th Chemical Regiment, assigned to the Zone of the Interior, and allotted to the Eighth Corps Area. Initiated 14 October 1931 with headquarters at San Antonio, TX. Subordinate battalion headquarters concurrently organized as follows: 1st Battalion at Beaumont, TX, 2nd Battalion at Oklahoma City, OK, and 3rd Battalion at Denver, CO. Headquarters relocated 21 June 1937 to Beaumont, TX. Conducted summer training with the 2nd Division Chemical Warfare Service Detachment at Fort Sam Houston, TX. Location 7 December 1941—Beaumont, TX.

Status: Disbanded 18 October 1943.**Commanders, 306th Chemical Regiment**

Lt. Col. John G. Barry

14 Oct 31-2 Jan 36

Col. Charles F. Williams

2 Jan 36-1 Feb 42

307th Chemical Regiment (Z.I.)**Organized Reserve New York**HQ-*Not initiated* 1931-37; Syracuse, NY, 1937-41

Constituted in the National Guard 4 March 1931 as the 101st Chemical Regiment, assigned to the Zone of the Interior, and allotted to the First and Second Corps Areas. Withdrawn from the National Guard 2 November 1934, allotted to the Organized Reserve, and redesignated as the 307th Chemical Regiment. Entire regiment allotted to the Corps Area 5 June 1936. Initiated 16 April 1937 at Syracuse, NY. Location 7 December 1941—Syracuse, NY.

Status: Disbanded 18 October 1943.**Commanders, 307th Chemical Regiment**

Lt. Col. Joaquin E. Zanetti

16 Apr 37-Jul 41

308th Chemical Regiment (Z.I.)**Organized Reserve Michigan**HQ-*Not initiated* 1931-37; Detroit, MI, 1937-41

Constituted in the National Guard 4 March 1931 as the 102nd Chemical Regiment and assigned to the Zone of the Interior. Withdrawn from the National Guard 2 November 1934, allotted to the Organized Reserve, and redesignated as the 308th Chemical Regiment. Allotted to the Sixth Corps Area 5 June 1936. Initiated in July 1937 at Detroit, MI. Location 7 December 1941—Detroit, MI.

309th Chemical Regiment (GHQR)

Organized Reserve New Jersey and Delaware

HQ—*Not initiated* 1931-41

Constituted in the National Guard 4 March 1931 as the 103rd Chemical Regiment, assigned to the General Headquarters Reserve, and allotted to the Sixth Corps Area. Withdrawn from the National Guard 2 November 1934, allotted to the Organized Reserve, and redesignated as the 309th Chemical Regiment. Concurrently withdrawn from the Sixth Corps Area and allotted to the Eighth Corps Area. Withdrawn from the Eighth Corps Area 5 June 1936 and allotted to the Second Corps Area. Headquarters locations designated 5 April 1937 as follows: regimental headquarters at Englewood, NJ; 1st Battalion at Newark, NJ; 2nd Battalion at Elizabeth, NJ; and 3rd Battalion at Wilmington, DE. Units were never organized at those locations. Location 7 December 1941—*Not initiated*.

310th Chemical Regiment (GHQR)

Organized Reserve California

HQ—*Not initiated* 1931-37; Los Angeles, CA, 1937-41

Constituted in the National Guard 4 March 1931 as the 104th Chemical Regiment, assigned to the General Headquarters Reserve, and allotted to the Ninth Corps Area. Withdrawn from the National Guard 2 November 1934, allotted to the Organized Reserve, and redesignated as the 310th Chemical Regiment. Allotted to the Ninth Corps Area 5 June 1936. Initiated by December 1937 at Los Angeles, CA. Location 7 December 1941—Los Angeles, CA.

Commanders, 310th Chemical Regiment

Unknown Dec 37-7 Dec 41

902nd Chemical Regiment (Z.I.)

Organized Reserve Pennsylvania

HQ—Philadelphia, PA, 1940-41; *Inactive* 1941

Constituted in the Organized Reserve in 1940, assigned to the Zone of the Interior, and allotted to the Third Corps Area. Initiated 10 September 1940 at Philadelphia, PA. Organized with personnel transferred from the inactivated 1st Chemical Regiment. Mobilization mission was to function as a training regiment for the Chemical Warfare School at Aberdeen Proving Grounds. Inactivated 7 August 1941 at Philadelphia by relief of personnel. Location 7 December 1941—*Inactive*.

Commanders, 902nd Chemical Regiment

Lt. Col. Herbert K. Bear 9 Oct 40-7 Aug 41

904th Chemical Regiment (Z.I.)

Organized Reserve Virginia

HQ—*Not initiated* 190-41; Richmond, VA, 1941; *Inactive* 1941

Constituted in the Organized Reserve in 1940, assigned to the Zone of the Interior, and allotted to the Third Corps Area. Initiated 24 January 1941 at Richmond, VA. Mobilization mission was to function as a training regiment for the Chemical Warfare School at Aberdeen Proving Grounds. Inactivated 7 August 1941 at Richmond by relief of personnel. Location 7 December 1941—*Inactive*.

Commanders, 904th Chemical Regiment

Maj. Harold C. James 24 Jan 41-7 Aug 41

Part XIV

Miscellaneous Organizations

1919-41

Chapter 52

Border Commands

The border commands were created as the result of long-standing problems along the border with Mexico. The command system was in place well before World War I and underwent several reorganizations during that conflict. As of 1 January 1919, the organization of the Mexican Border Patrol consisted of seven districts—four entirely in Texas, one partly in Texas and partly New Mexico, one in Arizona, and one in California. On 1 September 1920, the nine corps areas were established to supercede the old department system. At that point, all border districts, less the Southern California District, came under control of the Eighth Corps Area. The Southern California District became the Ninth Corps Area's responsibility. Due to continuing problems with banditry and other border violations along the Mexican border with Texas, New Mexico, and Arizona significant numbers of troops were maintained in those border posts conducting regular patrolling activities. Conversely, in the Southern California District, only one troop of the 11th Cavalry remained at Camp Lawrence J. Hearn to perform border patrol duties. On 18 January 1922, the Headquarters, Eighth Corps Area issued General Order #2 which reorganized the Mexican border patrol in that corps area into "border commands" as outlined in the command list below. Subsequent changes in the border commands are detailed in the individual command entries. The border commands were discontinued by Eighth Corps Area General Order #10, dated 25 March 1927, probably as a result of the public statements by Mexican President Plutarco Elias Calles indicating that he had evidence that the United States was preparing to invade Mexico. Thus the border commands were ostensibly eliminated as one of a number of measures implemented by the U.S. government designed to improve diplomatic relations with Mexico.

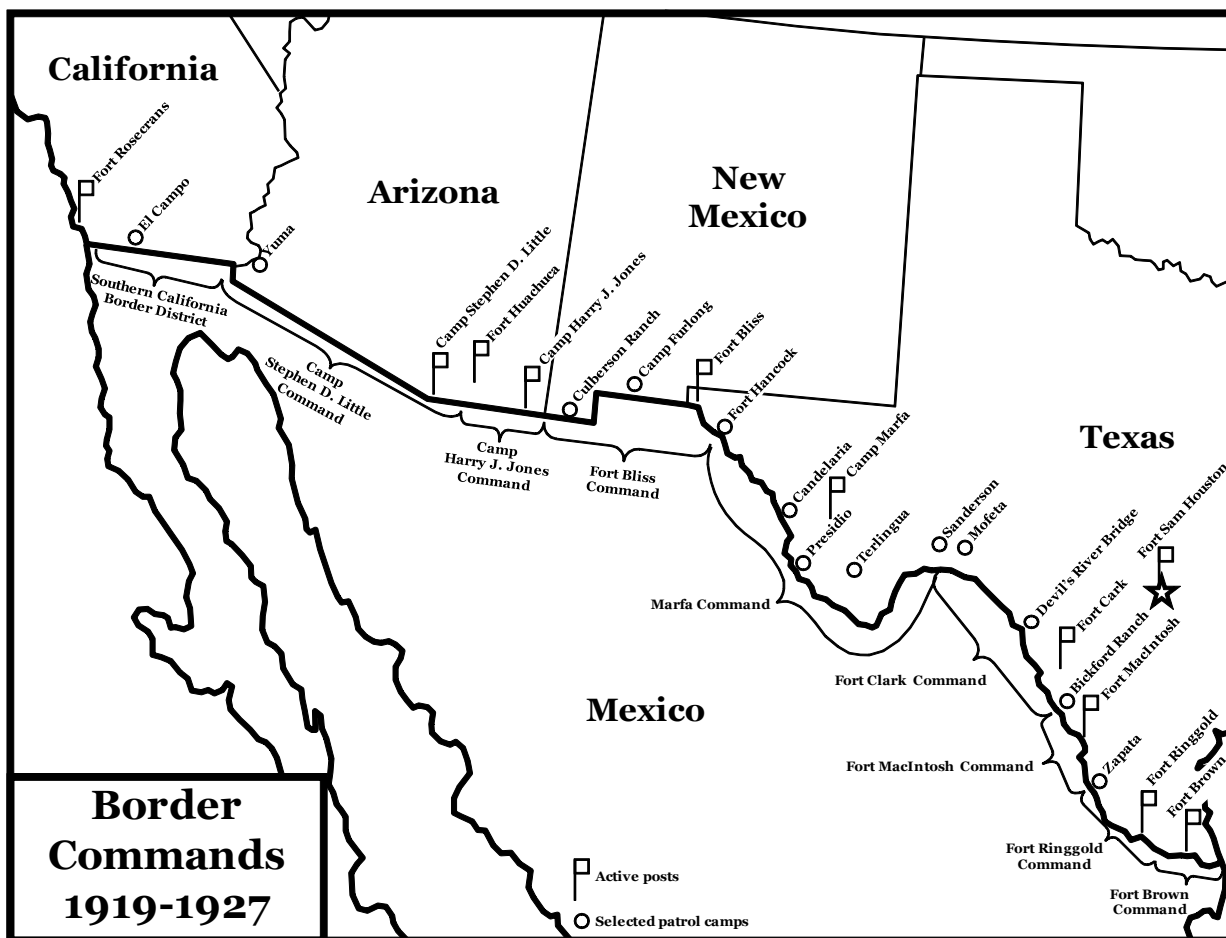

Border Commands, 1919-1927.

Fort Brown Command

Headquarters-Fort Brown, TX, 1919-27

Subordinate units: HHT, 1st Cavalry Brigade 1919 (Fort Brown); 16th Cavalry 1919-20 (Fort Brown); 4th Cavalry (-) 1920-21 (Fort Brown); 2nd Sq., 4th Cavalry 1920 (Camp San Bonito); 3rd Sq., 4th Cavalry 1920 (Camp Mercedes); 12th Cavalry 1921-27 (Fort Brown); 1st Sq., 12th Cavalry 1921-22 (Fort Ringgold)

Known as the Brownsville District as of 1 January 1919. The district patrol sector extended from the mouth of the Rio Grande River on the Gulf of Mexico to Zapata, TX, exclusive. The district included Fort Ringgold, TX, and the patrol camps of Camp Sam Fordyce, Camp Mercedes, Camp San Bonito, and Camp McAllen. Reorganized and redesignated 18 January 1922 as the Fort Brown Command. Concurrently Fort Ringgold, Camp Sam Fordyce, and Camp McAllen were withdrawn and placed under a separate border command. The command's revised patrol sector extended from the Gulf of Mexico to Donna, TX, inclusive. Discontinued 25 March 1927.

Commanders, Brownsville District/Fort Brown Command

Col. Frank Keller, 16th Cav.	1 Feb 19-28 Feb 19	Col. Howard R. Hickok, 4th Cav.	23 Sep 20-12 Nov 21
Col. George O. Cress, 16th Cav.	3 Mar 19-May 19	Col. Sedgwick Rice, 12th Cav.	12 Nov 21-1 Oct 23
Col. Farrand Sayre, 16th Cav.	May 19-30 Apr 20	Col. John M. Morgan, 12th Cav.	1 Oct 23-28 Sep 25
Col. De Rosey C. Cabell, 4th Cav.	30 Apr 20-23 Sep 20	Lt. Col. Edmund A. Buchanan, 12th Cav.	28 Sep 25-2 Oct 25
	Col. William T. Johnston, 12th Cav.		2 Oct 25-25 Mar 27

Fort Ringgold Command

Headquarters-Fort Ringgold, TX, 1922-27

Subordinate units: 2nd Sq., 12th Cavalry 1922-27

Established 18 January 1922 at Fort Ringgold. The Fort Ringgold patrol sector extended from Donna, TX, exclusive, to Arroyo del Tigre, inclusive. This command included the patrol camps of Camp Sam Fordyce and Camp McAllen. Discontinued 25 March 1927.

Commanders, Fort Ringgold Command

Lt. Col. William M. Cooley, 12th Cav.	18 Jan 22-10 Jan 23	Capt. Raymond C. Blatt, 12th Cav.	22 Apr 24-8 Jul 24
Lt. Col. Otto M. Rethorst, 12th Cav.	10 Jan 23-22 Mar 24	Maj. Edward Bowditch, jr., 12th Cav.	8 Jul 24-15 Sep 24
Lt. Col. William M. Cooley, 12th Cav.	22 Mar 24-22 Apr 24	Lt. Col. Charles O. Thomas, jr. 12th Cav.	15 Sep 24-25 Mar 27

Fort McIntosh Command

Headquarters-Fort McIntosh, TX, 1919-27

Subordinate units: 17th Infantry 1920-21; 37th Infantry 1919-20; 4th Cavalry 1921-24; 4th Field Artillery 1924-27

Known as the Laredo District as of 1 January 1919. The district patrol sector extended from Zapata, TX, inclusive, to Bickford Ranch, TX, inclusive. Reorganized and redesignated 18 January 1922 as the Fort McIntosh Command. The revised command patrol sector extended from Arroyo del Tigre, exclusive, to Bickford Ranch, TX. Discontinued 25 March 1927.

Commanders, Laredo District/Fort McIntosh Command

Col. Edward A. Roche, 37th Inf.	1 Jan 19-4 Jul 19	Maj. Harry L. King, 4th Cav.	10 Jan 24-9 Feb 24
Unknown	4 Jul 19-22 Sep 19	Lt. Col. Edward A. Keyes, 4th Cav.	9 Feb 24-22 Apr 24
Col. Frank L. Winn, 37th Inf.	22 Sep 19-31 Aug 20	Col. Edwin E. Booth, 4th Cav.	22 Apr 24-21 Jul 24
Lt. Col. Lucius C. Bennett, 37th Inf.	31 Aug 20-7 Oct 20	Col. Thomas Q. Donaldson, 4th Cav.	22 Jul 24-1 Oct 24
Col. John S. Switzer, 17th Inf.	8 Oct 20-4 Oct 20	Col. Pierce A. Murphy, 4th F.A.	1 Oct 24-10 Apr 26
Col. William B. Cochran, 17th Inf.	4 Oct 20-25 Oct 21	Maj. Joseph A. Rogers, 4th F.A.	10 Apr 26-12 Oct 26
Col. Howard R. Hickok, 4th Cav.	25 Oct 21-10 Jan 24	Col. Robert C. Foy, 4th F.A.	12 Oct 26-25 Mar 27

Fort Clark Command

Headquarters-Camp Eagle Pass, TX, 1919-22; Fort Clark, TX, 1922-27

Subordinate units: HHT, 1st Cavalry Brigade 1923-27 (Fort Clark); 3rd Infantry 1919-20 (Camp Eagle Pass); 1st Bn, 3rd Infantry 1919-20 (Camp Robert L. Michie); 46th Infantry 1920-21 (Camp Eagle Pass); 5th Cavalry 1921-27 (Fort Clark); 1st Sq., 5th Cavalry 1921-22 (Camp Robert L. Michie); 7th Cavalry 1921-27 (Fort Clark); 12th Cavalry 1920-21 (Camp Robert L. Michie); 13th Cavalry 1919-20 (Fort Clark); 1st M.G. Sq. 1923-27 (Fort Clark)

Known as the Eagle Pass District as of 1 January 1919. The district patrol sector extended from Bickford Ranch, TX, exclusive, to Sanderson, TX, exclusive. The district included Fort Clark, TX, and Camp Robert L. Michie, TX, (temporary camp). In accordance with Southern Department General Order #32 the Eagle Pass District was discontinued 17 May 20. Reorganized and redesignated 18 January 1922 as the Fort Clark Command and headquarters concurrently transferred to Fort Clark. The Fort Clark Command was divided into two sectors. The Eagle Pass Sector (Camp Eagle Pass) extended from Bickford Ranch, TX, exclusive to Tequesquite Creek, inclusive. The Del Rio Sector (Camp Robert L. Michie) extended from Tequesquite Creek, exclusive, to Mofeta, TX, exclusive. In accordance with Eighth Corps Area General Order #4, dated 26 January 1924, these two sectors were discontinued and all patrol activities came under the direct control of the Fort Clark Command. Discontinued 25 March 1927.

Commanders, Eagle Pass District/Fort Clark Command

Col. Gustave A. Weiser, 3rd Inf.	1 Jan 19-Jan 20	Col. James H. Bradford, Jr., 46th Inf.	15 Aug 20-16 Nov 21
Col. Paul Giddings, 3rd Inf.	Jan 20-17 May 20	Col. William D. Forsyth, 5th Cav.	17 Nov 21-28 Oct 23
Maj. Samuel A. Price, 46th Inf.	20 May 20-15 Aug 20	Lt. Col. John T. Sayles, 5th Cav.	28 Oct 23-17 Feb 24
Col. Wallace B. Scales, 5th Cav.			17 Feb 24-25 Mar 27

Marfa Command

Headquarters-Camp Marfa, TX, 1919-27

Subordinate units: 8th Cavalry 1919; 5th Cavalry 1919-21; 1st Cavalry 1923-27; 2nd Bn, 17th Infantry 1920

Known as the Big Bend District as of 1 January 1919. The district patrol sector extended from Sanderson, TX, inclusive, to Perez Ranch, TX, inclusive. Reorganized and redesignated 18 January 1922 as the Marfa Command. The revised command patrol sector extended from Mofeta, TX, inclusive, to Arroyo Macho, TX, exclusive. Discontinued 25 March 1927.

Commanders, Big Bend District/Marfa Command

Col. James J. Hornbrook, 5th Cav.	10 Mar 19-26 May 20	Col. Alvord V. P. Anderson, 1st Cav.	23 Jan 23-12 Aug 23
Col. Oren B. Meyer, 5th Cav.	26 May 20-10 Feb 21	Col. LeRoy Eltinge, 1st Cav.	12 Aug 23-29 May 24
Col. James J. Hornbrook, 5th Cav.	10 Feb 21-15 Aug 21	Lt. Col. Arthur Poillon, 1st Cav.	29 May 24-11 Sep 24
Col. William D. Forsyth, 5th Cav.	15 Aug 21-4 Oct 21	Col. Charles E. Stodter, 1st Cav.	11 Sep 24-10 Mar 26
Unknown	5 Oct 21-22 Jan 23	Lt. Col. Arthur Poillon, 1st Cav.	10 Mar 26-6 Aug 26
	Col. Conrad S. Babcock, 1st Cav.	6 Aug 26-25 Mar 27	

Fort Bliss Command

Headquarters-Fort Bliss, TX, 1919-27

Subordinate units: HHT, 1st Cavalry Division 1921-27; HHT, 2nd Cavalry Brigade 1921-27; 5th Cavalry 1919; 7th Cavalry 1919-27; 8th Cavalry 1919-27; 12th Cavalry (-) (Camp Furlong) 1919-20; 2nd Sq., 12th Cavalry (Camp Shannon) 1919-20; 24th Infantry (-) 1919-22 (Camp Furlong); 2nd Bn, 24th Infantry 1920-22 (Camp Shannon); 2nd Bn, 25th Infantry 1920-22 (Camp Shannon); 2nd M.G. Sq 1921-27

Known as the El Paso District as of 1 January 1919. The district patrol sector extended from Fort Hancock, TX, inclusive, to the New Mexico-Arizona border. The district included Fort Hancock, TX, (general camp), Camp Deming, NM, (army cantonment), Camp Shannon, NM, and Camp Furlong, NM. Reorganized and redesignated 18 January 1922 as the Fort Bliss Command. Concurrently Camp Furlong withdrawn and designated as a separate border command. The revised command patrol sector extended from Arroyo Macho, inclusive, to Mount Riley, NM, exclusive. This command included Camp Shannon, NM. In accordance with Eighth Corps Area General Order #79, the Camp Furlong Command was discontinued 28 December 1922 and the responsibility for the Camp Furlong patrol sector was returned to the Fort Bliss Command. The Fort Bliss Command was directed not to permanently station troops at Camp Furlong, but to maintain the patrol sector by periodically rotating units positioned there. The revised patrol sector extended from Arroyo Macho, inclusive, to the Arizona-New Mexico border. Discontinued 25 March 1927.

Commanders, El Paso District/Fort Bliss Command

Col. Selah R. H. Tompkins, 7th Cav.	1 Jan 19-25 Mar 19	Maj. Gen. Robert L. Howze	1 Sep 19-7 Jun 25
Brig. Gen James B. Erwin	25 Mar 19-1 Sep 19	Brig. Gen. Joseph C. Castner	8 Jun 25-29 Mar 26
	Brig. Gen. Edwin B. Winans	3 Apr 26-25 Mar 27	

Camp Furlong Command

Headquarters-Camp Furlong, Columbus, NM, 1922

Subordinate units: 24th Infantry 1922; 2nd Bn, 25th Infantry 1922

Established 18 January 1922 at Camp Furlong, NM. The Camp Furlong patrol sector extended from Mount Riley, NM, inclusive, to the Arizona-New Mexico border. This command was discontinued 28 December 1922 in accordance with Eighth Corps Area General Order #79 in anticipation of the camp's abandonment as a permanent post in 1923. The responsibility for the Camp Furlong patrol sector was transferred to the Fort Bliss Command.

Commanders, Camp Furlong Command

Col. John B. Schoeffel, 24th Inf.	18 Jan 22-1 Oct 22	Lt. Col. Robert H. Wescott, 24th Inf.	1 Oct 22-23 Dec 22
	Maj. Harry J. Castles, 24th Inf.	23 Dec 22-28 Dec 22	

Camp Harry J. Jones Command

Headquarters-Camp Harry J. Jones, Douglas, AZ, 1919-27

Subordinate units: HHT, 1st Cavalry Brigade 1921-23 (Camp Harry J. Jones); 1st Cavalry 1919-22 (Camp Harry J. Jones); 24th Infantry 1922 (Camp Harry J. Jones); 10th Cavalry 1919-27 (Fort Huachuca); 19th Infantry 1920-21 (Camp Harry J. Jones); 48th Infantry 1920-21 (Camp Harry J. Jones); 1st M.G. Sq 1921-22; 1st Bn, 25th Infantry 1922-27

Known as the Arizona District as of 1 January 1919. The district patrol sector extended from Hudspeth's Ranch on the New Mexico-Arizona border to Gadsden, AZ, on the California-Arizona border. The district included Fort Huachuca, AZ, and Camp Stephen D. Little, AZ. Reorganized and redesignated 18 January 1922 as the Camp Harry J. Jones Command. Concurrently Camp Stephen D. Little withdrawn and designated as a separate border command. The revised command patrol sector extended from the Arizona-New Mexico border to Monument 102, inclusive. This command included the patrol camp at Naco, AZ. Discontinued 25 March 1927.

Commanders, Camp Harry J. Jones Command

Col. Julien E. Gaujot, 1st Cav.	25 Jan 19-21 May 19	Brig. Gen. William H. Hay, 1st Cav Brig.	18 Aug 22-18 Nov 22
Col. Hamilton S. Hawkins, 1st Cav.	22 May 19-31 Jul 19	Col. Alvord A. P. Anderson, 1st Cav.	18 Nov 22-26 Dec 22
Col. Guy H. Preston, 1st Cav.	15 Dec 19-7 Sep 20	Capt. John R. Hermann, 25th Inf.	26 Dec 22-5 Apr 23
Brig. Gen. Malin Craig	21 Sep 20-14 Aug 21	Maj. Harry J. Castles, 25th Inf.	5 Apr 23-1 Jul 23
Col. Alvord A. P. Anderson, 1st Cav.	14 Aug 21-20 Jan 22	Capt. Thomas S. Arms, 25th Inf.	1 Jul 23-10 Sep 23
Lt. Col. Julien E. Gaujot, 1st Cav.	20 Jan 22-1 Jul 22	Capt. Ralph E. Bower, 25th Inf.	10 Sep 23-1 Oct 23
Col. Alvord A. P. Anderson, 1st Cav.	1 Jul 22-18 Aug 22	Maj. Charles B. Townsend, 25th Inf.	1 Oct 23-1 Nov 26
	Capt. James Wheelin, 25th Inf.		1 Nov 26-25 Mar 27

Camp Stephen D. Little Command

Headquarters-Camp Stephen D. Little, Nogales, AZ, 1922-27

Subordinate units: 25th Infantry (-) 1922-27

Known as the Nogales Sub-District, Arizona District as of 1 January 1919. Reorganized and redesignated 18 January 1922 as Camp Stephen D. Little Command. The Camp Stephen D. Little patrol sector extended from Monument 102, exclusive, to the 114th meridian. This command included the patrol camps at Arivaca, AZ, Ruby, AZ, and Lochiel, AZ. Discontinued 25 March 1927.

Commanders, Camp Harry J. Jones Command

Col. Alexander J. McNab, Jr., 25th Inf.	18 Jan 22-14 Oct 23	Lt. Col. William S. Faulkner, 25th Inf.	11 Sep 25-12 Oct 25
Col. Woodson Hocker, 25th Inf.	15 Oct 23-11 Sep 25	Col. Andrew J. Dougherty, 25th Inf.	12 Oct 25-25 Mar 27

Southern California Border District

Headquarters-Camp Lawrence J. Hearn, Imperial Beach, CA, 1919-21; Fort Rosecrans, CA, 1921-23; Camp Lawrence J. Hearn, Imperial Beach, CA, 1923-27

Subordinate units: Tps H, I, M, K, 11th Cavalry 1920 (Camp Lawrence J. Hearn); Tp D, 11th Cavalry 1920-21 (Camp Lawrence J. Hearn); Tp F, 11th Cavalry 1921-23 (Camp Lawrence J. Hearn); Tp G, 11th Cavalry 1923-25 (Camp Lawrence J. Hearn); Tp B, 11th Cavalry 1925-27 (Camp Lawrence J. Hearn); Tps A, D, E, 11th Cavalry 1920 (El Campo, CA); MG Tp, 11th Cavalry 1919 (Camp John H. Beacom); Tps, A, C, F, 11th Cavalry 1920-21 (Camp John H. Beacom)

Known as the Southern California District as of 1 January 1919. The district patrol sector extended from the California-Arizona border to the Pacific Ocean. The district included Camp John H. Beacom, CA, and Camp Walter R. Taliaferro, CA. In accordance with Ninth Corps Area General Order #34, dated 1 December 1921, the district was redesignated as the Southern California Border District and the commanding officer of the Coast Defenses of San Diego was directed to assume command. The headquarters of the district was transferred to Fort Rosecrans, CA, headquarters for the

Coast Defenses of San Diego, on 15 December 1921. The district's patrol sector was revised to extend from the 114th meridian (in Arizona) to the Pacific Ocean. In accordance with Ninth Corps Area General Order #3, dated 5 February 1923, the headquarters of the Southern California Border District was transferred back from Fort Rosecrans to Camp Lawrence J. Hearn effective 15 February 1923. Discontinued about April 1927.

Commanders, Southern California Border District

Lt. Col. Enos Copley, 11th Cav.	29 Nov 20-1 Dec 21	Capt. John P. O'Neill, C.A.C.	10 Jul 22-14 Aug 22
Col. Edwin Landon, C.A.C.	1 Dec 21-10 Jul 22	Maj. Edgar B. Colladay, C.A.C.	14 Aug 22-5 Feb 23
	Unknown	6 Feb 23-Apr 27	

Chapter 53

Reserve Officers Training Corps Units

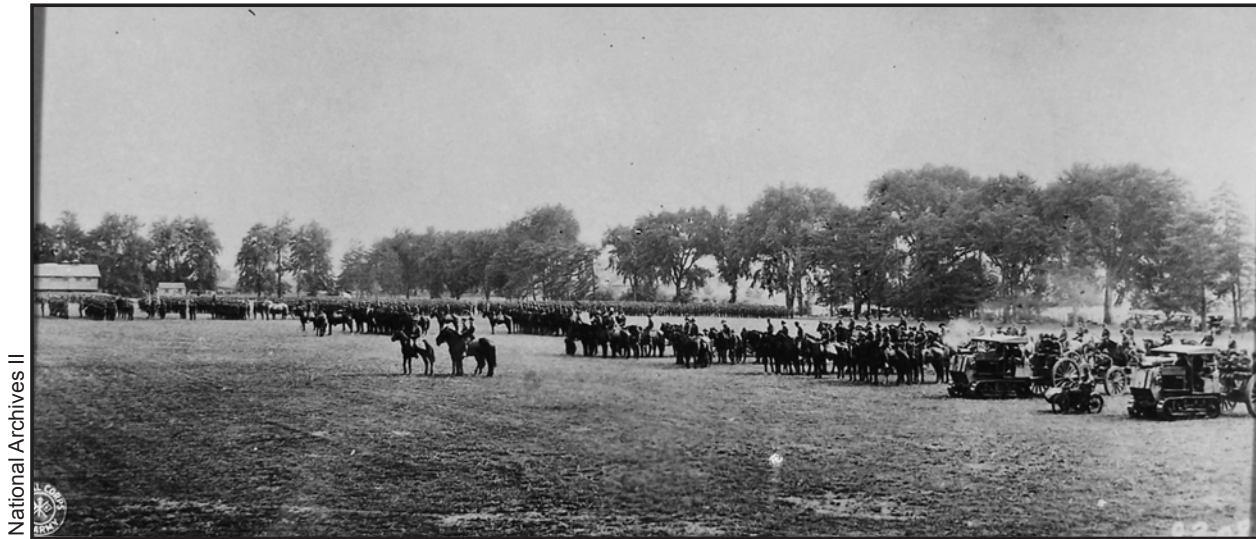

The cadets, animals, and equipment of the University of Illinois ROTC Brigade drawn up for a parade.

The mission of R.O.T.C. units was to produce Reserve officers for units of the Organized Reserve.

Organization

The establishment of R.O.T.C. programs began with a rush in 1916, but many of those units were inactivated during World War I. Beginning in 1919, the vast majority of the inactive programs were reestablished along with many new programs. By the end of 1921, there were almost 180 R.O.T.C. programs across the United States. In 1936, another seventeen programs were established or reestablished giving R.O.T.C. a presence on colleges and universities in all 48 states, Puerto Rico, Alaska, and Hawaii, and included four historically black colleges or universities. R.O.T.C. programs were established based on the various branches of the Army. Those programs then educated and trained cadets to prepare them for a commission directly into a given branch. Most programs were infantry branch material, but every branch in the Army was represented including the Air Service. The field artillery, medical, and quartermaster branches offered specialized training. Schools with field artillery units offered either horsed-drawn or truck-drawn training. Medical programs were differentiated based on the type of education offered by a given school. These specialized areas could include medical, dental, medical administration, and veterinary training. The Quartermaster Corps offered general quartermaster training. At a few schools in the 1920s, however, it also offered more specialized programs in motor repair and motor transport. Most schools only offered one or two branch material units through which a cadet could earn a commission. A few colleges, at all of which R.O.T.C. was a mandatory course, offered multiple branches for a cadet to consider.

The actual R.O.T.C. organization varied from school to school based on enrollment numbers and branches offered. Where possible, units conformed to the standard tables of organization for a given type of organization. Some schools had programs large enough to form brigades and many were organized as regiments due to the mandatory nature of the program at many land grant and military schools. Branch specific units were generally organized into battalions with a battalion staff, a headquarters company, and two or more line companies. Specialized organizations, such as service companies, machine gun companies, and medical detachments were omitted. For training purposes, units were often equipped with much of the same equipment that an active unit possessed. Thus it was not unusual for an R.O.T.C. unit to have a battery

of 75mm horse drawn guns and a stable of draft horses that pulled the weapons. Almost all programs kept an arms room full of M-1903 Springfield or M-1917 Remington rifles for training, marksmanship, drill, and ceremonies. Some even kept machine guns and mortars. The availability of such equipment often made R.O.T.C. units popular locations for local Organized Reserve units to train.

By 1919, when many of these programs were being formed, R.O.T.C. was still new to the Army. What seemed like feasible options in 1919 turned out to be unworkable or unsupportable. In the case of the specialized motor repair and transportation programs of the Quartermaster Corps, the Army decided that the broad exposure to logistics functions provided by most quartermaster programs better provided for the needs of the Organized Reserve units in which these officers would serve. Additionally, with the budget reductions imposed on the Army, such units were too expensive to maintain and so by 1926, the motor repair and transportation programs were converted to standard quartermaster units.

Medical programs were affected by several problems. One of the most significant was the amount of time R.O.T.C. took out of a busy medical student's already overtaxed schedule. However, the biggest problem came in 1935 when Congress, in a cost saving measure, cut funding for all medical programs from the defense budget. Cooler heads prevailed the following year when Congress restored funding for the medical programs. Most of the programs were reestablished in the summer of 1936.

Only six Air Service programs were ever established in the R.O.T.C. in the interwar era and typically produced only a combined total of fifty or so lieutenants a year. Most of these commissionees had little or no flight experience due to the impracticality of conducting such training at, or near the college. The service, however, required about 2,000 new lieutenants a year to keep the active and reserve component units at full strength. Throughout the 1920s and early 30s, Air Service, and later Air Corps, leaders pressed for additional programs and funding to address this shortfall but it was all for naught. In 1936, at about the same time Congress restored the medical programs, the Army was forced to eliminate all Air Corps R.O.T.C. programs. The Army then replaced the lost Air Corps units with less expensive types of units, mostly infantry, at other schools.

As its name implied, the purpose of the R.O.T.C. was to produce Reserve officers for Organized Reserve units. Therefore, for the most part, the location and allotment of branch material programs was based on the kinds of Organized Reserve units in the state or geographical area in which a school was located. The influx of large numbers of officers from a single school in a given unit often led to informal relationships between the R.O.T.C. unit and one or more Reserve units. The schools that provided significant numbers of commissionees to a Reserve unit became known as "feeder" schools and in a number of instances, both units attempted to build and retain strong relationships. A more formal effort to establish such ties was made through the affiliation program. Almost all of the Regular Army Inactive (RAI) infantry regiments and many other types of RAI units were formally affiliated with R.O.T.C. programs. These units were intended to absorb lieutenants from the R.O.T.C. program and, in theory, provided them a more structured unit with Regular Army leaders and a higher level of training provided by those leaders. Typically the P.M.S. & T. or the senior officer assigned to the R.O.T.C. program that was of the RAI unit's branch was designated as the regimental commander. Other Regular Army personnel assigned to the program were also assigned to key posts within the regiment. RAI units were among the organizations given the highest priority for mobilization, thus the intent of the R.O.T.C. affiliation program (as well as all other affiliation programs) was to provide a means for rapid organization in an emergency. The system proved to be unworkable, probably due to the inability for the Regular Army personnel to devote sufficient attention to both the R.O.T.C. program and the RAI unit. By 1 October 1933, command of all RAI units had been turned over to Reserve officers. Additionally, a number of the affiliations between these units had become defunct by 1940, though the RAI units themselves remained among the most active in the Reserves.

Training

The R.O.T.C course of instruction consisted of a four-year program consisting of a basic course and an advanced course. The first two years were the basic course, and as the title implied, consisted of basic knowledge and skills instruction common to all soldiers. The advanced course consisted of training in branch-specific knowledge and skills training. In many schools of this period, but primarily land-grant and military colleges and universities, all four years were mandatory for male students. In some schools only the first two years were mandatory. Even if a student completed all four years, he was not required to take a commission, nor did completion of the four-year program guarantee a commission in the Organized Reserve.

R.O.T.C. cadets pursuing a commission typically attended a summer camp some time during the summer after their junior or senior year in college. The cadets from a given school would attend the camp en masse at a Regular Army installation and go through training conducted by a Regular Army unit of the same branch as that of the branch material R.O.T.C. unit. Most often, R.O.T.C. units of the same branch from several different schools would attend at the same time. The camps lasted four weeks and served as a training, orientation, and leadership evaluation opportunity for the cadets. Once a cadet completed the four-year course and the summer camp, he was offered a commission as a second lieutenant in the Organized Reserve, if the P.M.S. & T. considered the young man of sufficient character and ability to serve as an officer in the Army of the United States.

Agricultural and Mechanical College of Texas (MC)

Location-College Station, TX

Established 21 October 1916 at the Agricultural and Mechanical College of Texas. The program provided Infantry, Cavalry, Field Artillery, Coast Artillery, Engineer, Air Service, Signal Corps, and Chemical Warfare Service branch material training. Sub-programs of Texas A&M consisted of those at John Tarleton College (effective 23 April 1923), North Texas Agricultural College (effective 23 April 1923), and Prairie View A&M. Branch units were established on the following dates: Infantry unit 21 October 1916; Field Artillery and Signal Corps units 29 December 1919; Air Corps unit 2 November 1920; Cavalry unit 31 December 1921; Engineer unit in August 1928; Coast Artillery unit 23 September 1931; and Chemical Warfare Service unit September 1935. The Air Corps unit was discontinued in June 1928. The Texas A&M cadet corps was organized into a brigade of two regiments. The 1st Regiment was composed of cadets in the Infantry program. The 2nd Regiment was a composite regiment of the cadets enrolled in the remaining branch material programs. The Cavalry unit consisted of two troops and 60 horses. The Field Artillery unit initially consisted of one cadet battalion of two batteries. In July 1936, the battalion expanded to three batteries and was reorganized as a truck-drawn unit. Annual summer camps for advanced course cadets were held as follows: Infantry, Field Artillery, and Signal Corps cadets trained with units of the 2nd Division at Camp Bullis, TX; Cavalry cadets trained with the 11th Cavalry at the Presidio of Monterey, CA, in 1921, thereafter with the 5th Cavalry at Fort Clark, TX; Engineer cadets trained with the 8th Engineers at Fort McIntosh, TX; Air Corps cadets trained at Brooks and Hensley Fields, TX; Chemical Warfare Service cadets trained at Edgewood Arsenal, MD. Newly commissioned officers from Texas A&M were assigned predominantly to the units of the 90th Division, 156th Cavalry Brigade, and XVIII Corps units. Newly commissioned officers from Prairie View A & M were assigned predominantly to the "colored" Organized Reserve units of the Eighth Corps Area. Some units of the 90th Division held annual contact camps at Texas A&M with assistance from the ROTC detachment. Designated as a "Distinguished College" 1910-27.

Agricultural College of Utah (CC)

Location-Logan, UT

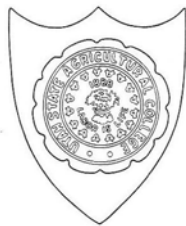

Established 21 December 1916 at the Agricultural College of Utah. Discontinued during World War I and reestablished 7 November 1919. Renamed Utah State Agricultural College in February 1929. The program provided Infantry, Coast Artillery, and Motor Transport Corps branch material training. Branch units were established on the following dates: Infantry unit 21 December 1916; and Coast Artillery and Motor Transport Corps units 29 December 1919. The Infantry unit was discontinued 27 July 1921. The Motor Transport Corps unit was discontinued 7 August 1924. Newly commissioned officers were assigned predominantly to the 104th Division and XIX Corps units.

Alabama Polytechnic Institute (CC)

Location-Auburn, AL

Established 18 November 1916 at Alabama Polytechnic Institute. The program provided Infantry, Field Artillery, and Engineer branch material training. Branch units were established on the following dates: Infantry unit 18 November 1916; and Field Artillery and Engineer units 29 December 1919. The Infantry unit was discontinued 28 July 1927. The Field Artillery unit was organized as a regiment that consisted of three cadet battalions of three batteries each and a single gun battery of eight 75mm guns and seventy horses. By 1936, it was reorganized into a single cadet battalion of three batteries. Regular Army Inactive affiliate units were the 85th Field Artillery Regiment and 4th Engineer Regiment (less 2nd Battalion). Both regiments were organized 28 May 1929 with the program's Regular Army personnel and Reserve officers commissioned from the program. Annual summer camps for advanced course cadets were held as follows: Infantry cadets trained with units of the 8th Infantry Brigade at Camp McClellan, AL; Field Artillery cadets trained with units of the 13th Field Artillery Brigade at Fort Bragg, NC; Engineer cadets trained with the 4th Engineers at Fort Benning, GA. Newly commissioned officers were assigned predominantly to the 87th Division, Fifth Army, and XIV Corps units. Designated as a "Distinguished College" 1920-27.

Albany Medical School (CC)**Location**-Albany, NY

Established 31 October 1921 at Albany Medical School. The program provided Medical Corps branch material training only. The Medical Corps unit was established 31 October 1921. Regular Army Inactive affiliate unit was the 8th Medical Regiment. The 8th Medical Regiment was organized 15 August 1927 with the program's Regular Army personnel and Reserve officers commissioned from the program. Annual summer camp for advanced course cadets was held at Carlisle Barracks, PA, with the 1st Medical Regiment. Newly commissioned officers were assigned predominantly to Organized Reserve medical units in the Second Corps Area. The ROTC program was discontinued 30 June 1935.

Arkansas State College (CC)**Location**-Jonesboro, AR

Established in August 1936 at Arkansas State College. The program provided Field Artillery branch material training only. The Field Artillery unit consisted of a single cadet battalion of two motorized batteries. Annual summer camp for advanced course cadets was held at Fort Knox, KY, with the 3rd Field Artillery. Newly commissioned officers were assigned predominantly to the 102nd Division.

Baldwin-Wallace College (CC)**Location**-Berea, OH

Established 27 January 1919 at Baldwin-Wallace College. The program provided Infantry branch material training only. The Infantry unit was established 27 January 1919. The ROTC program was discontinued 13 April 1920.

Baylor University, College of Medicine (CC)**Location**-Dallas, TX

Established 9 August 1921 at Baylor University. The program provided Medical Corps branch material training only. The Medical Corps unit was established 9 August 1921. Annual summer camp for advanced course cadets was held at Fort Sam Houston, TX, with the 2nd Medical Regiment. Newly commissioned officers were assigned predominantly to Organized Reserve medical units in the Eighth Corps Area. The ROTC program was discontinued in June 1935.

Boston University (CC)**Location**-Chestnut Hill, MA

Established 27 January 1919 at Boston University. The program originally provided Infantry branch material training only. The Infantry unit was established 27 January 1919. The Medical Corps unit was established in August 1936. Annual summer camps for advanced course cadets were held as follows: Infantry cadets trained with units of the 18th Infantry Brigade at Camp Devens, MA; Medical Corps cadets trained with the 1st Medical Regiment at Carlisle Barracks, PA. Newly commissioned officers were assigned predominantly to the 76th and 94th Divisions, and to the First Army and XI Corps medical units.

Bowdoin College (CC)

Location-Brunswick, ME

Established 27 January 1919 at Bowdoin College. The program provided Infantry branch material training only. The Infantry unit was established 27 January 1919. The ROTC program was discontinued 13 April 1920.

Brown University (CC)

Location-Providence, RI

Established 27 September 1917 at Brown University. The program provided Infantry branch material training only. The ROTC program was discontinued 29 December 1919.

Bucknell College (CC)

Location-Lewisburg, PA

Established 27 January 1919 at Bucknell College. The program provided Infantry branch material training only. The Infantry unit was established 27 January 1919. The ROTC program was discontinued 13 April 1920.

California Institute of Technology (CC)

Location-Pasadena, CA

Established 8 January 1917 at the Throop College of Technology. Renamed the California Institute of Technology in 1920. The program provided Engineer branch material training only. Annual summer camp for advanced course cadets was held at Del Monte, CA with the 2nd Battalion, 6th Engineers. Newly commissioned officers were assigned predominantly to the 91st Division, XIX Corps, and Sixth Army units. The ROTC program was discontinued 1 August 1929.

Campion College (CC)

Location-Prairie du Chien, WI

Established 27 January 1919 at Campion College. The program provided Infantry branch material training only. The Infantry unit was established 27 January 1919. The ROTC program was discontinued 31 December 1921.

Carnegie Institute of Technology (CC)

Location-Pittsburgh, PA



Established 30 March 1918 at Carnegie Institute of Technology. The program provided Infantry, Field Artillery, Engineer, Signal Corps, and Quartermaster branch material training. The Infantry unit was discontinued 29 December 1919; concurrently, the Field Artillery, Engineer, Signal Corps, and Motor Transport Corps units were established. The Field Artillery unit was discontinued 7 August 1920. The Motor Transport Corps unit was discontinued 30 June 1924. Annual summer camps for advanced course cadets were held as follows: Engineer cadets trained with the 13th Engineers at Fort A. A. Humphreys, VA; Signal Corps cadets trained with the 1st Signal Company at Camp Vail (Fort Monmouth), NJ. The cadet rifle team won the William

Randolph Hearst Trophy for rifle marksmanship in 1931. Newly commissioned officers were assigned predominantly to the 79th and 99th Divisions, and XIII Corps units.

Case School of Applied Science (CC)**Location**-Hudson, OH

Established 29 December 1919 at the Case School of Applied Science. The program provided Coast Artillery branch material training only. The ROTC program was discontinued 24 June 1920.

The Citadel (MC)**Location**-Charleston, SC

Established 21 October 1916 at The Citadel. Discontinued during World War I and reestablished in September 1919. The program provided Infantry and Coast Artillery branch material training. The Infantry unit was established 21 October 1916. The Coast Artillery unit was established 29 December 1919. Regular Army Inactive affiliate units were the 3rd Battalion, 39th Infantry and the machine gun battalion, 67th Coast Artillery. Both battalions were organized 21 April 1930 with the program's Regular Army personnel and Reserve officers commissioned from the program. Annual summer camps for advanced course cadets were held as follows: Infantry cadets trained with units of the 8th Infantry Brigade at Fort Benning, GA; Coast Artillery cadets trained at Fort Monroe, VA. Newly commissioned officers were assigned predominantly to the 82nd Division and XIV Corps units and to the Organized Reserve units assigned to the Harbor Defenses of Charleston. Designated as a "Distinguished College" 1904-05, 1908-25, and 1927.

Clarkson College of Technology (CC)**Location**-Potsdam, NY

Established in August 1936 at Clarkson College of Technology. The program provided Engineer branch material training only. Annual summer camp for advanced course cadets was held at Fort A. A. Humphreys (later renamed Fort Belvoir), VA, with the 13th Engineers. Newly commissioned officers were assigned predominantly to the 98th Division, XII Corps, and First Army units.

Clemson Agricultural College (CC)**Location**-Clemson, SC

Established 17 April 1917 at Clemson Agricultural College. The program provided Infantry branch material training only. Regular Army Inactive affiliate unit was the 39th Infantry Regiment (less 3rd Battalion). The 39th Infantry was organized 21 April 1930 with the program's Regular Army personnel and Reserve officers commissioned from the program. Annual summer camp for advanced course cadets was held at Fort Benning, GA, with the 29th Infantry. Newly commissioned officers were assigned predominantly to the 82nd Division and XIV Corps units. Designated as a "Distinguished College" 1921-27.

Coe College (CC)**Location**-Cedar Rapids, IA

Established 27 January 1919 at Coe College. The program provided Infantry branch material training only. The Infantry unit was established 27 January 1919. Annual summer camp for advanced course cadets was held at Fort Snelling, MN, with the 3rd Infantry. Newly commissioned officers were assigned predominantly to the 88th Division and XVII Corps units.

College of Agricultural and Mechanic Arts (CC)

Location-Mayaguez, PR

Established 29 December 1919 at the College of Agricultural and Mechanic Arts. The program provided Infantry branch material training only. The Infantry unit was established 29 December 1919. The ROTC program at College of Agricultural and Mechanic Arts was made a sub-program of the University of Puerto Rico 14 July 1924. Annual summer camp for advanced course cadets was held at San Juan, PR, with the 65th Infantry. Newly commissioned officers were assigned predominantly to the units of the 211th Infantry Brigade and later to the 42nd Infantry (RAI).

College of the City of New York (CC)

Location-New York City, NY

Established in 1918 at the College of the City of New York. The program provided Infantry branch material training only. The Infantry unit was established 29 December 1919. Annual summer camp for advanced course cadets was held at Plattsburg Barracks, NY, with the 26th Infantry. Newly commissioned officers were assigned predominantly to the 77th Division and XII Corps units.

Colorado Agricultural College (CC)

Location-Fort Collins, CO



Established 22 January 1917 at Colorado Agricultural College. Renamed Colorado State College of Agricultural and Mechanic Arts in 1935. The program provided Infantry and Field Artillery branch material training. The Infantry unit was discontinued 29 December 1919; concurrently the Field Artillery unit was established. The Field Artillery unit consisted of two horse-drawn battalions of three batteries each. Annual summer camp for advanced course cadets was held some years at Fort Bliss, TX with the 82nd Field Artillery, Fort Francis E. Warren, WY with the 76th Field Artillery, or at Fort Sill, OK with the 1st Field Artillery. Newly commissioned officers were assigned predominantly to the 103rd Division and XVIII Corps units. Designated as a "Distinguished College" 1921-22, 1924-25, and 1927.

Colorado College (CC)

Location-Colorado Springs, CO

Established 11 June 1918 at Colorado College. The program provided Infantry branch material training only. The Infantry unit was established 11 April 1918. The ROTC program was discontinued by 1921.

Colorado State School of Mines (CC)

Location-Golden, CO

Established 27 January 1919 at Colorado State School of Mines. The program provided Infantry and Engineer branch material training. The Infantry unit was established 27 January 1919. The Infantry unit was discontinued 29 December 1919; concurrently, the Engineer unit was established. Regular Army Inactive affiliate unit was the 9th Engineer Squadron, less Troop A. The 9th Engineer Squadron was organized in 1927 with the program's Regular Army personnel and Reserve officers commissioned from the program. Affiliation was ended 1 October 1933 when the squadron was withdrawn from the Eighth Corps Area and allotted to the Seventh Corps Area. Annual summer camp for advanced course cadets was held at Fort Logan, CO, with the 2nd Engineers. Newly commissioned officers were assigned predominantly to the 103rd Division and XVIII Corps units.

Columbia University (CC)

Location-New York City, NY

Established 23 April 1918 at Columbia University. The program provided Infantry and Coast Artillery branch material training. The Infantry unit was established 23 April 1918. The Coast Artillery unit was established 31 December 1921. Annual summer camps for advanced course cadets were held as follows: Infantry cadets trained with the 26th Infantry at Plattsburg Barracks, NY; Coast Artillery cadets trained at Fort Hancock, NJ, with the 7th Coast Artillery. Newly commissioned officers were assigned predominantly to the 77th Division and Second Corps Area Organized Reserve Coast Artillery units. The ROTC program was discontinued 26 August 1920.

Connecticut Agricultural College (CC)

Location-Storrs, CT



Established 18 November 1916 at Connecticut Agricultural College. Renamed Connecticut State College in January 1933. Renamed University of Connecticut in 1939. The program provided Infantry branch material training only. Annual summer camp for advanced course cadets was held at Camp Devens, MA, with Infantry units of the 18th Infantry Brigade. Newly commissioned officers were assigned predominantly to the 76th Division. The ROTC detachment and university played host to the "Special Officers Camp" for the 76th and 94th Divisions for several summers in the 1920s. The camp consisted of training for unassigned officers, officers who could not attend unit training with their assigned units, and basic training for recent ROTC and CMTC commissionees.

Cornell University (CC)

Location-Ithaca, NY

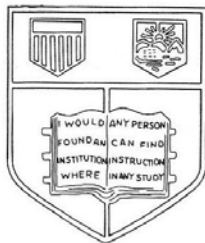

Established 15 February 1917 at Cornell University. The program provided Infantry, Field Artillery, Signal Corps, Ordnance Corps, and Veterinary Corps branch material training. Branch units were established on the following dates: Infantry unit 27 January 1919; Field Artillery unit 29 December 1919; Veterinary Corps unit 9 August 1921; Ordnance Corps and Signal Corps units 31 December 1921. The Infantry unit was discontinued 26 October 1920. The Veterinary Corps unit was discontinued in June 1935. The Field Artillery unit was originally organized as a horse-drawn unit, but was reorganized in July 1936 as a mixed horse-drawn and motorized unit. Regular Army Inactive affiliate units were the 40th Infantry Regiment and 9th Medical Regiment. Both regiments were organized 18 April 1930 with the program's Regular Army personnel and Reserve officers commissioned from the program. Annual summer camps for advanced course cadets were held as follows: Infantry cadets trained with the 26th Infantry at Plattsburg Barracks, NY; Field Artillery cadets trained with the 2nd Battalion, 7th Field Artillery at Madison Barracks, NY; Signal Corps cadets trained with the 1st Signal Company at Camp Vail (Fort Monmouth), NJ; Ordnance Corps cadets trained at Aberdeen Proving Ground, MD; Veterinary Corps cadets trained at Carlisle Barracks, PA. Newly commissioned officers were assigned predominantly to the 98th Division, XII Corps, and Fourth Army units. Designated as a "Distinguished College" 1914-25.

Cornell University Medical College (CC)

Location-New York City, NY

Established 15 February 1917 at Cornell University. The program provided Medical Corps branch material training only. Annual summer camp for advanced course cadets was held at Carlisle Barracks, PA with the 1st Medical Regiment. Newly commissioned officers were assigned predominantly to Organized Reserve medical units in the Second Corps Area. The ROTC program was discontinued in June 1935. The Medical Corps unit was reestablished 16 August 1937.

Creighton University (CC)

Location-Omaha, NE

Established 27 January 1919 at Creighton University. The program provided Infantry and Dental Corps branch material training. The Infantry unit was established 27 January 1919. The Dental Corps unit was discontinued in June 1935. The Regular Army Inactive affiliate unit was the 54th Infantry Regiment. The 54th Infantry was organized by April 1930 with the program's Regular Army personnel and Reserve officers commissioned from the program. Annual summer camps for advanced course cadets were held as follows: Infantry cadets trained with the 17th Infantry at Fort Leavenworth, KS; Dental Corps cadets trained at Fort Snelling, MN. Newly commissioned officers were assigned predominantly to the units of the 89th Division and XVII Corps units.

Culver Military Academy (MI)

Location-Culver, IN



Established 18 November 1916 at Culver Military Academy. The program provided Infantry, Cavalry, and Field Artillery branch material training. The Infantry, Cavalry, and Field Artillery units were established 18 November 1916. The Field Artillery unit consisted of one battery of horse-drawn 75mm guns. Annual summer camps for advanced course cadets were held at Fort Knox, KY for Infantry, Cavalry, and Field Artillery cadets. Newly commissioned officers were assigned predominantly to the 84th Division, 64th Cavalry Division, and XV Corps units.

Brig. Gen. Leigh Gignilliet, CG, 168th Infantry Brigade, was school superintendent 1920-1941. Col. Fitzhugh Lee assigned as PMS&T 1920-24. Units of the 84th Division held frequent contact camps at Culver. Some years the 168th Infantry Brigade, 335th and 336th Infantry Regiments and 313th Cavalry Regiment held their summer training at the campus. Designated "Honor Military School" 1906-31.

Davidson College (CC)

Location-Davidson, NC

Established 27 January 1919 at Davidson College. The program provided Infantry branch material training only. The Infantry unit was established 27 January 1919. Annual summer camp for advanced course cadets was held at Fort Benning, GA, with the 29th Infantry. Newly commissioned officers were assigned predominantly to the 81st Division and XIV Corps units. Designated as a "Distinguished College" 1926-27.

Denison University (CC)

Location-Granville, OH

Established 29 December 1919 at Denison College. Renamed Denison University in 1927. The program provided Infantry branch material training only. The Infantry unit was established 29 December 1919. Annual summer camp for advanced course cadets was held at Fort Knox, KY, with units of the 10th Infantry Brigade. Newly commissioned officers were assigned predominantly to the 83rd Division and XV Corps units. The ROTC program was discontinued 30 June 1928.

DePauw University (CC)

Location-Greencastle, IN

Established 27 January 1919 at DePauw University. The program provided Infantry branch material training only. The Infantry unit was established 27 January 1919. Annual summer camp for advanced course cadets was held at Fort Knox, KY, with units of the 10th Infantry Brigade. Newly commissioned officers were assigned predominantly to the 84th Division and XV Corps units. Designated as a "Distinguished College" 1922 and 1927. The ROTC program was discontinued 1 June 1934.

Drexel Institute (CC)

Location-Philadelphia, PA



Established in 1918 at Drexel Institute. The program provided Infantry branch material training only. The Infantry unit was established 29 December 1919. Annual summer camp for advanced course cadets was held at Camp George G. Meade, MD with units of the 16th Infantry Brigade. Newly commissioned officers were assigned predominantly to the 79th Division and XIII Corps units.

Dubuque College (CC)

Location-Dubuque, IA

Established 29 January 1917 at Columbia College. Renamed Dubuque College in 1920. The program provided Infantry branch material training only. The ROTC program was discontinued 26 August 1920.

Duquesne University (CC)

Location-Pittsburgh, PA



Established 27 January 1919 at Duquesne University. The program provided Infantry and Field Artillery branch material training. The Infantry unit was established 27 January 1919. The ROTC program was discontinued 21 July 1920. The program was reestablished in August 1936, this time providing Field Artillery branch material training. The Field Artillery unit consisted of one truck-drawn battery of six 75mm guns. Annual summer camp for advanced course cadets was held at Camp George G. Meade, MD with the 1st Battalion, 16th Artillery. Newly commissioned officers were assigned predominantly to the 99th Division and XIII Corps units.

Eastern Kentucky State Teacher's College (CC)

Location-Richmond, KY



Established in August 1936 at Eastern Kentucky State Teacher's College. The program provided Field Artillery branch material training only. The Field Artillery unit consisted of one truck-drawn battery of six 75mm guns. Annual summer camp for advanced course cadets was held at Fort Knox, KY with the 3rd Field Artillery. Newly commissioned officers were assigned predominantly to the 100th Division and V Corps units.

Emory and Henry College (CC)

Location-Emory, VA

Established 29 December 1919 at Emory and Henry College. The program provided Infantry branch material training only. The ROTC program was discontinued 24 June 1920.

Emory University (CC)

Location-Macon, GA

Established in 1918 at Emory University. The program provided Infantry branch material training only. The Infantry unit was established 29 December 1919. Annual summer camp for advanced course cadets was held at Fort Benning, GA with the 29th Infantry. Newly commissioned officers were assigned predominantly to the 82nd Division and XIV Corps units. The ROTC program was discontinued 1 June 1930.

Fairmont College (CC)

Location-Wichita, KS

Established 27 January 1919 at Fairmont College. Renamed Municipal University of Wichita on 30 April 1926. The program provided Infantry branch material training only. The Infantry unit was established 27 January 1919. Annual summer camp for advanced course cadets was held at Fort Leavenworth, KS, with the 17th Infantry. Newly commissioned officers were assigned predominantly to the 89th Division.

Fordham University (CC)

Location-Fordham, NY

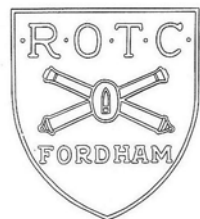

Established 14 July 1926 at Fordham University. The program provided Coast Artillery branch material training only. Annual summer camp for advanced course cadets was held at Fort Hancock, NJ with the 7th Coast Artillery. Newly commissioned officers were assigned predominantly to the Coast Artillery units of the XII Corps, First Army, and Fourth Army.

Georgetown University (CC)

Location-Washington, DC



Established 18 February 1918 at Georgetown University. The program provided Infantry and Medical Corps branch material training. The Infantry unit was established 18 February 1918. The Medical Corps unit was established 27 July 1921. The Medical Corps unit was discontinued in June 1935 and reestablished 19 August 1936. Annual summer camps for advanced course cadets were held as follows: Infantry cadets trained with units of the 16th Infantry Brigade at Camp George G. Meade, MD; Medical Corps cadets trained with the 1st Medical Regiment at Carlisle Barracks, PA. Newly commissioned officers were assigned predominantly to the 80th Division and XIII Corps units. Designated as a "Distinguished College" 1921 and 1926-27.

George Washington University (CC)

Location-Washington, DC

Established in 1918 at George Washington University. The program provided Medical Corps branch material training only. The Medical Corps unit was established 21 March 1921. The ROTC program was discontinued 30 June 1935. Annual summer camp for advanced course cadets was held at Carlisle Barracks, PA with the 1st Medical Regiment. Newly commissioned officers were assigned predominantly to the 80th Division, XIII Corps, and medical units in the Third Corps Area.

Georgia School of Technology (CC)

Location-Atlanta, GA

Established 30 March 1918 at the Georgia School of Technology. Discontinued during World War I and reestablished 27 January 1919. The program provided Infantry, Coast Artillery, Air Service, Signal Corps, Quartermaster, and Ordnance Corps branch material training. Branch units were established on the following dates: Infantry unit 29 December 1919; Air Service unit 2 November 1920; Quartermaster Corps and Medical Corps units 1 March 1921. The Quartermaster Corps unit was discontinued 7 August 1924. The Air Corps unit was discontinued 1 May 1928. Annual summer camps for advanced course cadets were held as follows: Infantry cadets trained with the 29th Infantry at Fort Benning, GA; Coast Artillery cadets trained with the 13th Coast Artillery at Fort Barrancas, FL; Signal Corps cadets trained with the 51st Signal Battalion at Camp Vail (Fort Monmouth), NJ; Air Corps trained at Maxwell Field, AL; Ordnance Corps cadets trained at Aberdeen Proving Grounds, MD. Regular Army Inactive affiliate unit was the 67th Coast Artillery Regiment. The 67th Coast Artillery was organized 17 June 1927 with the program's Regular Army personnel and Reserve officers commissioned from the program. Newly commissioned officers were assigned predominantly to the 67th Coast Artillery, 82nd Division, XIV Corps, and Fifth Army units. Designated as a "Distinguished College" 1921-26.

Gettysburg College (CC)

Location-Gettysburg, PA



Established 8 January 1917 at Gettysburg College. The program provided Infantry branch material training only. Annual summer camp for advanced course cadets was held at Camp George G. Meade, MD, with units of the 16th Infantry Brigade. Newly commissioned officers were assigned predominantly to the 79th Division and XIII Corps units.

Grove City College (CC)**Location**-Grove City, PA

Established 27 January 1919 at Grove City College. The program provided Infantry branch material training only. The Infantry unit was established 27 January 1919. The ROTC program was discontinued 13 April 1920.

Gustavus Adolphus College (CC)**Location**-St. Peter, MN

Established 27 January 1919 at Gustavus Adolphus College. The program provided Infantry branch material training only. The Infantry unit was established 27 January 1919. The ROTC program was discontinued 15 September 1920.

Hampton Institute (CC)**Location**-Hampton, VA

Established 27 January 1919 at Hampton Institute. The program provided Infantry branch material training only. The Infantry unit was established 27 January 1919. The ROTC program was discontinued 2 November 1920.

Harvard University (CC)**Location**-Cambridge, MA

Established 15 February 1917 at Harvard University. The program provided Infantry, Field Artillery, and Medical Corps branch material training. The Infantry unit was established 15 February 1917. The Infantry unit was discontinued 29 December 1919; concurrently, the Field Artillery unit was established. The Medical Corps unit was established in January 1922 at the Harvard Medical School. Medical Corps branch training was discontinued in June 1932. Regular Army Inactive affiliate units were the 19th Field Artillery Regiment, the 14th Medical Regiment, and the 57th Signal Battalion. All three units were organized 28 April 1930 with the program's Regular Army personnel and Reserve officers commissioned from the program. Annual summer camps for advanced course cadets were held as follows: Field Artillery cadets trained with the 7th Field Artillery at Fort Ethan

Allen, VT, and some years at Fort Devens, MA; Medical Corps cadets trained with the 1st Medical Regiment at Carlisle Barracks, PA. Newly commissioned officers were assigned predominantly to the 94th Division, and XI Corps units. Designated as a "Distinguished College" 1917-18.

Henderson State Teacher's College (CC)**Location**-Arkadelphia, AR

Established in August 1936 at Henderson State Teacher's College. The program provided Infantry branch material training only. Annual summer camp for advanced course cadets was held at Fort Leavenworth, KS, with the 17th Infantry. Newly commissioned officers were assigned predominantly to the 102nd Division.

Howard University (CC)**Location**-Washington, DC

Established 27 January 1918 at Howard University. The program provided Infantry branch material training only. The Infantry unit was established 27 January 1918. The Infantry unit was discontinued 27 July 1921. Annual summer camp for advanced course cadets was held at Camp George G. Meade, MD, with units of the 16th Infantry Brigade. Newly commissioned officers were assigned predominantly to the “colored” Organized Reserve and National Guard units of the Third Corps Area.

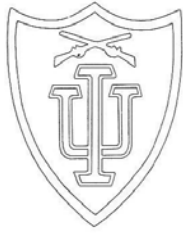
Indiana University (CC)**Location**-Bloomington, IN

Established 17 April 1917 at Indiana University. The program originally provided only Infantry branch material training. Medical Corps unit was established in July 1936. Regular Army Inactive affiliate unit was the 15th Military Police Battalion. The battalion was organized 13 March 1928 with the program’s Regular Army personnel and Reserve officers commissioned from the program. The Medical Corps unit was discontinued in June 1935. Annual summer camps for advanced course cadets were held as follows: Infantry cadets trained with units of the 10th Infantry Brigade at Camp Knox, KY; Medical Corps cadets trained at Fort Snelling, MN. Newly commissioned officers were assigned predominantly to the 84th Division and XV Corps units.

Indiana University Medical School (CC)**Location**-Indianapolis, IN

Established in 1919 at Indiana University Medical School. The program provided Medical Corps branch material training only. Annual summer camp for advanced course cadets was held at Fort Snelling, MN. Newly commissioned officers were assigned predominantly to the 84th Division, XV Corps units, and Medical units in the Fifth Corps Area. Designated as a “Distinguished College” 1920-23. The ROTC program was discontinued in June 1935.

Iowa State College of Agriculture and Mechanic Arts (CC)**Location**-Ames, IA

Established 10 October 1917 at Iowa State College of Agriculture and Mechanic Arts. The program provided Infantry, Field Artillery, Engineer, and Veterinary Corps branch material training. Branch units were established on the following dates: Infantry unit 10 October 1917; Field Artillery and Engineer units 29 December 1919; Veterinary Corps unit 30 November 1921. The Infantry unit was discontinued 15 June 1925. The Veterinary Corps unit discontinued in June 1935. Annual summer camps for advanced course cadets were held as follows: Infantry cadets trained with the 3rd Infantry at Fort Snelling, MN; Field Artillery cadets trained with the 3rd Field Artillery at Camp Knox, KY; Engineer cadets trained at Fort Leavenworth, KS; Veterinary Corps cadets trained at Fort Snelling, MN. Newly commissioned officers were assigned predominantly to the 88th Division, XVII Corps, and Medical units of the Seventh Corps Area. Designated as a “Distinguished College” 1925-27.

Jefferson Medical College (CC)

Location-Philadelphia, PA

Established in 1918 at Jefferson Medical College. The program provided Medical Corps branch material training only. The Medical Corps unit was established 3 November 1920. Annual summer camp for advanced course cadets was held at Carlisle Barracks, PA with the 1st Medical Regiment. Newly commissioned officers were assigned predominantly to Organized Reserve medical units in the Third Corps Area. The ROTC program was discontinued in June 1935.

The Johns Hopkins University (CC)

Location-Baltimore, MD



Established 18 November 1916 at Johns Hopkins University. The program provided Infantry, Engineer, and Medical Corps branch material training. Medical Corps branch training was discontinued June 1935. Annual summer camps for advanced course cadets were held as follows: Infantry cadets trained with units of the 16th Infantry Brigade at Camp George G. Meade, MD; Engineer cadets trained with the 13th Engineers at Fort A. A. Humphreys, VA; Medical Corps cadets trained with the 1st Medical Regiment at Carlisle Barracks, PA. The Medical Corps unit was discontinued in June 1935. Newly commissioned officers were assigned predominantly to the 80th Division, and XIII Corps units. Designated as a "Distinguished College" 1920-21, 1923-24, and 1926-27.

Kansas State Agricultural College (CC)

Location-Manhattan, KS

Established in 1863 at Kansas State Agricultural College. Officially recognized as an ROTC program in 1916. Renamed Kansas State College of Agricultural and Applied Science in 1931. The program provided Infantry, Coast Artillery, and Veterinary Corps branch material training. Branch units were established on the following dates: Infantry unit 29 December 1919; Coast Artillery and Veterinary Corps units 8 October 1920. The Veterinary Corps unit was discontinued in June 1935. The cadet corps was organized into a regiment consisting of six Coast Artillery batteries and six Infantry companies. Annual summer camps for advanced course cadets were held as follows: Infantry cadets trained with the 17th Infantry at Fort Leavenworth, KS; Coast Artillery cadets trained at Fort Leavenworth, KS; Veterinary Corps cadets trained at Fort Snelling, MN. Newly commissioned officers were assigned predominantly to the 89th Division, XVII Corps, Sixth Army, and Seventh Corps Area Medical units. Maj. James A. Van Fleet assigned as the PMS&T July 1920-February 1921. Designated as a "Distinguished College" 1914-16 and 1927.

Kemper Military School (MI)

Location-Booneville, MO

Established 4 December 1916 at the Kemper Military School. The program provided Infantry branch material training only. The Infantry unit was established 4 December 1916. The ROTC program was discontinued by 1921.

Knox College (CC)

Location-Galesburg, IL

Established 29 December 1919 at Knox College. The program provided Infantry branch material training only. The Infantry unit was established 29 December 1919. Annual summer camp for advanced course cadets was held at Fort Sheridan, IL, with the 1st Battalion, 2nd Infantry. Newly commissioned officers were assigned predominantly to the 86th Division and XVI Corps units.

Lafayette College (CC)**Location**-Easton, PA

Established in 1918 at Lafayette College. The program provided Infantry branch material training only. The Infantry unit was established 27 January 1919. Annual summer camp for advanced course cadets was held at Camp George G. Meade, MD, with units of the 16th Infantry Brigade. Newly commissioned officers were assigned predominantly to the 79th Division and XIII Corps units.

Lehigh University (CC)**Location**-Bethlehem, PA

Established 29 December 1919 at Lehigh University. The program originally provided only Infantry branch material training. The Infantry unit was established 29 December 1919. The Ordnance Corps unit was established 5 December 1925. Annual summer camps for advanced course cadets were held as follows: Infantry cadets trained with units of the 16th Infantry Brigade at Camp George G. Meade, MD; Ordnance Corps cadets trained at Aberdeen Proving Grounds, MD. Newly commissioned officers were assigned predominantly to the 79th Division and XIII Corps units. Designated as a “Distinguished College” 1922-24 1926-27.

Louisiana Industrial Institute (CC)**Location**-Ruston, LA

Established 29 December 1919 at the Louisiana Industrial Institute. The program provided Infantry branch material training only. The ROTC program was discontinued 21 July 1920.

Little Rock College (CC)**Location**-Little Rock, AR

Established in 1918 at Little Rock College. The program provided Infantry branch material training only. The Infantry unit was established 27 January 1919. Annual summer camp for advanced course cadets was held at Fort Leavenworth, KS with the 17th Infantry. Newly commissioned officers were assigned predominantly to the 102nd Division. The ROTC program was discontinued 31 March 1926.

Louisiana State University and Agricultural and Mechanical College (CC)**Location**-Baton Rouge, LA

Established 18 November 1916 at Louisiana State University. The program provided Infantry, Field Artillery, Engineer, and Motor Transport Corps branch material training. The Infantry unit was established 18 November 1916. The Motor Transport Corps unit was established 31 December 1921. The Motor Transport Corps unit was discontinued in October 1922. The Field Artillery and Engineer units were established in August 1936. The Field Artillery unit consisted of two truck-drawn gun batteries of six 75mm guns each. Regular Army Inactive affiliate unit was the 3rd Battalion, 47th Infantry. The battalion was organized in 1930 with the program’s Regular Army personnel and Reserve officers commissioned from the program. Annual summer camps for advanced course cadets were held as follows: Infantry cadets trained with the 29th Infantry at Fort Benning, GA; Field Artillery cadets trained with units of the 13th Field Artillery Brigade at Fort Bragg, NC; Engineer cadets trained with Company A, 4th Engineers at Fort Benning, GA. Newly commissioned officers were assigned predominantly to the 87th Division and XIV Corps units. Col. Troy Middleton assigned as PMS&T in the 1930s. Designated as a “Distinguished College” 1922, 1924, and 1926.

Marion Institute (MI)**Location-**Marion, AL

Established 18 November 1916 at Marion Institute. The program provided Infantry branch material training only. The Infantry unit was established 29 December 1919. Annual summer camp for advanced course cadets was held at Camp McClellan, AL, with units of the 8th Infantry Brigade. Newly commissioned officers were assigned predominantly to the 87th Division. Designated "Honor Military School" 1920. The Senior ROTC program was discontinued 19 May 1925.

Massachusetts Agricultural College (CC)**Location-**Amherst, MA

Established 29 January 1917 at Massachusetts Agricultural College. Renamed Massachusetts State College 13 March 1931. The program provided Infantry and Cavalry branch material training. The Infantry unit was discontinued 2 November 1920. The Cavalry unit was established 31 December 1921. Annual summer camp for advanced course cadets was held at Fort Ethan Allen, VT, with the 1st Squadron, 3rd Cavalry. Newly commissioned officers were assigned predominantly to the units of the 158th Cavalry Brigade.

Massachusetts Institute of Technology (CC)**Location-**Cambridge, MA

Established 19 December 1917 at the Massachusetts Institute of Technology. Branch units were established on the following dates: Coast Artillery and Signal Corps 19 December 1917; Ordnance Corps 4 October 1919; Engineer 6 November 1919; Air Service 4 November 1920; and Chemical Warfare Service 7 August 1924. The Chemical Warfare Service unit was discontinued in June 1928. The Air Corps unit was discontinued 9 December 1935. Regular Army Inactive affiliate unit was the 68th Coast Artillery (AA). The 68th Coast Artillery was organized in 1930 with the program's Regular Army personnel and Reserve officers commissioned from the program. Annual summer camps for advanced course cadets were held as follows: Coast Artillery cadets trained with the 11th Coast Artillery at Fort H. G. Wright; Engineer cadets trained with the 13th Engineers at Fort A. A. Humphreys, VA; Air Corps trained at Langley Field, VA; Ordnance Corps cadets trained at Aberdeen Proving Ground, MD. Newly commissioned officers were assigned predominantly to the 94th Division and XI Corps units.

Medical College of Virginia (CC)**Location-**Richmond, VA

Established in October 1922 at the Medical College of Virginia. The program provided Medical Corps branch material training only. Annual summer camp for advanced course cadets was held at Carlisle Barracks, PA, with the 1st Medical Regiment. Newly commissioned officers were assigned predominantly to Organized Reserve medical units in the Third Corps Area. The ROTC program was discontinued in June 1935.

Michigan Agricultural College (CC)**Location-**Lansing, MI

Established 14 November 1917 at Michigan Agricultural College. Renamed Michigan State College of Agriculture and Applied Science 13 May 1925. The program provided Infantry, Cavalry, Coast Artillery, and Field Artillery branch

material training. Branch units were established on the following dates: Infantry unit 14 November 1917; Coast Artillery unit 29 December 1919; and Field Artillery unit in August 1936. The Field Artillery unit consisted of two truck-drawn gun batteries of six 75mm guns each. Annual summer camps for advanced course cadets were held as follows: Infantry cadets trained with the 1st Battalion, 2nd Infantry at Fort Sheridan, IL; Field Artillery cadets trained with battalions of the 3rd and 14th Field Artillery at Fort Sheridan, IL; Cavalry cadets trained with the 3rd Cavalry at Fort Ethan Allen, VT in 1921 and thereafter with the 14th Cavalry at Fort Sheridan, IL. Newly commissioned officers were assigned predominantly to the 85th Division, 65th Cavalry Division, and XVI Corps units. Designated as a "Distinguished College" 1919 and 1924-27.

Michigan College of Mining and Technology (CC)

Location-Houghton, MI

Established 30 August 1928 at Michigan College of Mining and Technology. The program provided Engineer branch material training only. The Engineer unit was established 10 October 1928. Annual summer camp for advanced course cadets was held at Camp Custer, MI. Newly commissioned officers were assigned predominantly to the 85th Division and XVI Corps units.

Middlebury College (CC)

Location-Middlebury, VT

Established 27 January 1919 at Middlebury College. The program provided Infantry branch material training only. The Infantry unit was established 27 January 1919. The ROTC program was discontinued by 1921.

Milwaukee School of Engineering (CC)

Location-Milwaukee, WI

Established 29 December 1919 at the Milwaukee School of Engineering. The program provided Infantry branch material training only. The ROTC program was discontinued 16 June 1920.

Mississippi Agricultural and Mechanical College (CC)

Location-Starkville, MS

Established 31 October 1916 at Mississippi A & M College. Discontinued during World War I and reestablished 8 October 1919. Renamed Mississippi State College 18 February 1932. The program provided Infantry and Coast Artillery branch material training. The Infantry unit was established 31 October 1916. The Coast Artillery unit was established 29 December 1919. Regular Army Inactive affiliate unit was the 47th Infantry Regiment (less 3rd Battalion). The 47th Infantry Regiment was organized 21 April 1930 with the program's Regular Army personnel and Reserve officers commissioned from the program. Annual summer camps for advanced course cadets were held as follows: Infantry cadets trained with units of the 8th Infantry Brigade at Fort McClellan, AL; Coast Artillery cadets trained with the 13th Coast Artillery at Fort Barrancas, FL. Newly commissioned officers were assigned predominantly to the 87th Division and XIV Corps units. Designated as a "Distinguished College" 1923-25 and 1927.

Missouri School of Mines (CC)

Location-Rolla, MO

Established 27 January 1919 at the Missouri School of Mines. The program provided Infantry and Engineer branch material training. The Infantry unit was established 27 January 1919. The Engineer unit was established 29 December 1919. Annual summer camp for advanced course cadets was held at Fort Leavenworth, KS, with Troop A, 9th Engineers. Newly commissioned officers were assigned predominantly to the 102nd Division and Seventh Corps Area Engineer units.

Montana State College of Agricultural and Mechanical Arts (CC)

Location-Bozeman, MT



Established 29 January 1917 at Montana State College of Agricultural and Mechanical Arts. The program provided Infantry branch material training only. Newly commissioned officers were assigned predominantly to the 104th Division.

Morningside College (CC)

Location-Sioux City, IA

Established 27 January 1919 at Morningside College. The program provided Infantry branch material training only. The ROTC program was discontinued by 1921.

Mount St. Mary's College (CC)

Location-Emmitsburg, MD

Established 27 January 1919 at Mount St. Mary's College. The program provided Infantry branch material training only. The ROTC program was discontinued 26 October 1920.

Muhlenburg College (CC)

Location-Allentown, PA

Established 27 January 1919 at Muhlenburg College. The program provided Infantry branch material training only. The Infantry unit was established 27 January 1919. The ROTC program was discontinued 25 May 1920.

Municipal University of Akron (CC)

Location-Akron, OH

Established 29 December 1919 at the Municipal University of Akron. Renamed the University of Akron in 1930. The program provided Infantry branch material training only. The Infantry unit was established 29 December 1919. Annual summer camp for advanced course cadets was held at Fort Knox, KY, with units of the 10th Infantry Brigade. Newly commissioned officers were assigned predominantly to the 83rd Division and XV Corps units.

New Hampshire College of Agricultural and Mechanical Arts (CC)

Location-Durham, NH



Established 21 December 1916 at New Hampshire College. Renamed University of New Hampshire 1924. The program provided Infantry and Coast Artillery branch material training. The Infantry unit was established 21 December 1916. The Coast Artillery unit was established 29 December 1919. Annual summer camps for advanced course cadets were held as follows: Infantry cadets trained with units of the 18th Infantry Brigade at Camp Devens, MA; Coast Artillery cadets trained with the 11th Coast Artillery at Fort H. G. Wright, NY. Newly commissioned officers were assigned predominantly to the 97th Division, Fourth Army Coast Artillery regiments, and XI Corps units.

New Mexico College of Agricultural and Mechanical Arts (CC)

Location-State College, NM



Established 4 December 1916 at the New Mexico College of Agricultural and Mechanical Arts. The program provided Infantry branch material training only. The Infantry unit was discontinued 27 July 1921 and reestablished 30 November 1921. Annual summer camp for advanced course cadets was held at Camp Bullis, TX, with units of the 2nd Division. Newly commissioned officers were assigned predominantly to the units of the 103rd Division.

New Mexico Military Institute (MI)

Location-Roswell, NM

Established 21 December 1916 at the New Mexico Military Institute. The program provided Infantry and Cavalry branch material training. The Infantry unit was established 21 December 1916. The Infantry unit was discontinued 13 December 1920; concurrently, a Cavalry unit was established. Annual summer camp for advanced course cadets was held with the 11th Cavalry at the Presidio of Monterey, CA in 1921, thereafter at Fort Bliss, TX, with units of the 2nd Cavalry Brigade. Newly commissioned officers were assigned predominantly to units of the 156th Cavalry Brigade and 103rd Division. Designated as a "Distinguished Honor Military School" in 1909-31.

New York University (CC)

Location-New York City, NY

Established 27 January 1918 at New York University. The program provided Infantry, Air Corps, Engineer, and Medical Corps branch material training. The Infantry unit was established 27 January 1919. The Air Corps unit was established 2 October 1926 and discontinued in June 1932. The Engineer unit was established in June 1932. The Medical Corps unit was discontinued in June 1935. Annual summer camps for advanced course cadets were held as follows: Infantry cadets trained with the 26th Infantry at Plattsburg Barracks, NY; Engineer cadets trained with the 1st Engineers at Fort Du Pont, DE; Air Corps cadets trained at Langley Field, VA; Medical Corps cadets trained with the 1st Medical Regiment at Carlisle Barracks, PA. Newly commissioned officers were assigned predominantly to the 77th Division and XII Corps units.

Niagara University (CC)

Location-Niagara, NY

Established in August 1936 at Niagara University. The program provided Infantry branch material training only. Annual summer camp for advanced course cadets was held at Plattsburg Barracks, NY, with the 26th Infantry. Newly commissioned officers were assigned predominantly to the 98th Division and XII Corps units.

North Carolina State College of Agriculture and Engineering (CC)

Location-West Raleigh, NC

Established 21 December 1916 at North Carolina State College of Agriculture and Engineering. The program provided Infantry branch material training only. Annual summer camp for advanced course cadets was held at Fort Benning, GA with the 29th Infantry. Newly commissioned officers were assigned predominantly to the 81st Division and XIV Corps units.

North Dakota Agricultural College (CC)

Location-Fargo, ND



Established 15 February 1917 at the North Dakota Agricultural College. The program provided Infantry branch material training only. Annual summer camp for advanced course cadets was held at Fort Snelling, MN with the 3rd Infantry. Newly commissioned officers were assigned predominantly to the units of the 88th Division and XVII Corps units. The cadet rifle team won the National Collegiate Rifle Marksmanship Match in 1928 and 1929. Designated as a "Distinguished College" 1923-25.

North Georgia Agricultural College (MC)

Location-Dahlonega, GA



Established 4 December 1916 at North Georgia Agricultural College. Renamed North Georgia College in July 1929. The program provided Infantry branch material training only. Annual summer camp for advanced course cadets was held at Fort Benning, GA, with the 29th Infantry. Newly commissioned officers were assigned predominantly to the 82nd Division and XIV Corps units.

North Pacific College (CC)

Location-Portland, OR

Established 18 December 1920 at North Pacific College. The program provided Dental Corps branch material training only. The ROTC program was discontinued in June 1935.

Northwestern College (CC)**Location**-Naperville, IL

Established 27 January 1919 at Northwestern College. The program provided Infantry branch material training only. The Infantry unit was established 27 January 1919. Annual summer camp for advanced course cadets was held at Fort Sheridan, IL, with the 1st Battalion, 2nd Infantry. Newly commissioned officers were assigned predominantly to the 86th Division and XVI Corps units. The ROTC program was discontinued 30 June 1925.

Northwestern University (CC)**Location**-Evanston, IL

Established 26 February 1918 at Northwestern University. The program provided Infantry branch material training only. The Infantry unit was established 27 January 1919. Annual summer camp for advanced course cadets was held at Fort Sheridan, IL, with the 1st Battalion, 2nd Infantry. Newly commissioned officers were assigned predominantly to the 86th Division and XVI Corps units. The ROTC program was discontinued 30 June 1930.

Northwestern University Dental School (CC)**Location**-Chicago, IL

Established 20 January 1921 at Northwestern University Dental School. The program provided Dental Corps branch material training only. Annual summer camp for advanced course cadets was held at Fort Snelling, MN. Newly commissioned officers were assigned predominantly to the Organized Reserve medical units in the Sixth Corps Area. The ROTC program was discontinued in June 1935.

Norwich University (MC)**Location**-Northfield, VT

Established in 1819 at Norwich University. Officially recognized as an ROTC program 18 November 1916. The program provided Cavalry branch material training only. The Cavalry unit was established 18 November 1916. Annual summer camp for advanced course cadets was held at Fort Ethan Allen, VT with the 1st Squadron, 3rd Cavalry. Newly commissioned officers were assigned predominantly to the units of the 158th Cavalry Brigade. The Headquarters Company, 2nd Battalion, 172nd Infantry was organized in December 1922 entirely with faculty of the university and cadets of the ROTC program. The unit remained organized as such until the eve of World War II. Cadets were called out to assist with flood relief and guard duties associated with the flooding of the Third Branch in November 1927. Designated as a "Distinguished College" 1904-27.

Occidental College (CC)**Location**-Los Angeles, CA

Established 27 January 1919 at Occidental College. The program provided Infantry branch material training only. The Infantry unit was established 27 January 1919. The ROTC program was discontinued by 1921.

Ohio Northern University (CC)

Location-Ada, OH

Established 29 December 1919 at Ohio Northern University. The program provided Infantry branch material training only. The Infantry unit was established 29 December 1919. The ROTC program was discontinued 27 July 1921.

Ohio State University (CC)

Location-Columbus, OH

Established 18 November 1916 at Ohio State University. The program provided Infantry, Field Artillery, Signal Corps, Medical Corps, Dental Corps, and Veterinary Corps branch material training. Branch units were established on the following dates: Infantry unit 18 November 1916; Field Artillery unit 29 December 1919; Veterinary Corps unit 20 January 1921; Signal Corps unit 1 October 1921; and Medical Corps unit 16 July 1921; and Dental Corps units 31 August 1921. Infantry unit was discontinued in June 1936; concurrently, the Engineer unit was established. The Medical Corps, Dental Corps, and Veterinary Corps units were discontinued in June 1935. The Field Artillery unit originally consisted of four horse-drawn gun batteries of six 75mm guns each. The unit was reorganized as a truck-drawn unit in June 1936. Regular Army Inactive affiliate units were the 60th Infantry Regiment, 19th Field Artillery Regiment, 57th Signal Battalion, 245th General Hospital, 41st Surgical Hospital, 61st Veterinary General Hospital, and 52nd Evacuation Hospital. The units were organized 28 April 1930 with the program's Regular Army personnel and Reserve officers commissioned from the program. Annual summer camps for advanced course cadets were held as follows: Infantry cadets trained with the units of the 10th Infantry Brigade at Camp Knox, KY; Field Artillery cadets trained with the 3rd Field Artillery at Camp Knox, KY; Medical Corps cadets trained at Fort Snelling, MN. Newly commissioned officers were assigned predominantly to the Regular Army Inactive affiliate units, 83rd Division, XV Corps, and Fifth Army units. Designated as a "Distinguished College" 1916, 1918, 1920-22, and 1924-27.

Ohio University (CC)

Location-Athens, OH

Established in 1936 at Ohio University. The program provided Infantry branch material training only. Annual summer camp for advanced course cadets was held at Fort Knox, KY, with units of the 10th Infantry Brigade. Newly commissioned officers were assigned predominantly to the 83rd Division, XV Corps, and Fifth Army units.

Ohio Wesleyan College (CC)

Location-Delaware, OH

Established 27 January 1919 at Ohio Wesleyan College. The program provided Infantry branch material training only. The Infantry unit was established 27 January 1919. The ROTC program was discontinued 24 April 1920.

Oklahoma Agricultural and Mechanical College (CC)

Location-Stillwater, OK



Established 31 October 1916 at the Oklahoma Agricultural and Mechanical College. The program originally provided only Infantry branch material training. The Engineer unit was established in July 1936. Annual summer camps for advanced course cadets were held as follows: Infantry cadets trained with the 1st Battalion, 38th Infantry and later the 3rd Battalion, 29th Infantry at Fort Sill, OK; Engineer cadets trained with the 2nd Engineers at Fort Sam Houston, TX 1919-26 and at Fort Logan, CO 1927-41. Newly commissioned officers were assigned predominantly to the units of the 95th Division.

Oklahoma Military Academy (MI)

Location-Claremore, OK



Established 20 September 1930 at the Oklahoma Military Academy. The program provided Infantry and Cavalry branch material training. Annual summer camps for advanced course cadets were held as follows: Infantry cadets trained with the 1st Battalion, 38th Infantry and later the 3rd Battalion, 29th Infantry at Fort Sill, OK; Cavalry cadets trained with the 5th Cavalry at Fort Clark, TX. Newly commissioned officers were assigned predominantly to the units of the 312th Cavalry and 95th Division.

Oregon Agricultural College (CC)

Location-Corvallis, OR

Established 29 January 1917 at the Oregon Agricultural College. Renamed Oregon State Agricultural College 1927. The program provided Infantry, Cavalry, Field Artillery, Engineer, Quartermaster Corps, and Motor Transport Corps branch material training. Branch units were established on the following dates: Infantry unit 29 January 1917; Field Artillery, Engineer, and Motor Transport Corps units 29 December 1919; Cavalry unit was 31 December 1921. The Motor Transport Corps unit was discontinued 7 August 1924. The Cavalry unit was discontinued in June 1929. The Quartermaster Corps unit was discontinued in May 1930. The Field Artillery unit originally consisted of one cadet battalion of three horse-drawn batteries. In September 1928, it was reorganized into a regiment of six batteries. The Field Artillery unit was reorganized once again in June 1936 as a truck-drawn regiment. Regular Army Inactive affiliate unit was the 32nd Field Artillery Regiment. The 32nd Field Artillery was organized 24 April 1930 with the program's Regular Army personnel and Reserve officers commissioned from the program. Field artillery unit motorized 1936. Annual summer camps for advanced course cadets were held as follows: Infantry cadets trained with the 1st Battalion, 7th Infantry at Fort Lewis, WA; Cavalry cadets trained with the 11th Cavalry at Del Monte, CA; Field Artillery cadets trained with the 10th Field Artillery at Fort Lewis, WA; Engineer cadets trained with the 6th Engineers at Fort Lewis, WA. Newly commissioned officers were assigned predominantly to the units of the 96th Division, 162nd Cavalry Brigade, and XIX Corps units. Designated as a "Distinguished College" 1917, 1919-24, and 1926-27.

Ouachita College (CC)

Location-Arkadelphia, AR

Established 29 December 1919 at Ouachita College. The program provided Infantry branch material training only. The Infantry unit was established 29 December 1919. Annual summer camp for advanced course cadets was held at Fort Leavenworth, KS, with the 17th Infantry. Newly commissioned officers were assigned predominantly to the 102nd Division. Designated as a "Distinguished College" 1925.

Pennsylvania Military College (MC)

Location-Chester, PA



Established 8 January 1917 at Pennsylvania Military College. The program provided Infantry branch material training only. Annual summer camp for advanced course cadets was held at Camp George G. Meade, MD with units of the 16th Infantry Brigade. Newly commissioned officers were assigned predominantly to the 99th Division and XIII Corps units. Designated as a "Distinguished College" 1904-13, 1918-21, and 1924-27.

Pennsylvania State College (CC)

Location-State College, PA

Established 27 September 1917 at Pennsylvania State College. The program originally provided only Infantry branch material training. The Engineer unit was established 7 August 1924. Annual summer camps for advanced course cadets were held as follows: Infantry cadets trained with units of the 16th Infantry Brigade at Camp George G. Meade, MD; Engineer cadets trained with the 13th Engineers at Fort A. A. Humphreys (later renamed Fort Belvoir), VA. Newly commissioned officers were assigned predominantly to the 99th Division and XIII Corps units.

Pomona College (CC)

Location-Claremont, CA

Established 26 February 1918 at Pomona College. The program provided Infantry branch material training only. Annual summer camp for advanced course cadets was held at Del Monte, CA, with the 30th Infantry. Newly commissioned officers were assigned predominantly to the units of the 91st Division and XIX Corps units. Col. William H. Simpson (commanding general, Ninth Army in WWII) assigned as PMS&T 1931-35.

Presbyterian College (CC)

Location-Clinton, SC

Established 29 December 1919 at Presbyterian College. The program provided Infantry branch material training only. The Infantry unit was established 29 December 1919. Annual summer camp for advanced course cadets was held at Fort Benning, GA, with the 29th Infantry. Newly commissioned officers were assigned predominantly to the 82nd Division and XIV Corps units.

Princeton University (CC)

Location-Princeton, NJ



Established 17 April 1917 at Princeton University. The program provided Infantry and Field Artillery branch material training. The Infantry unit was established 17 April 1917. The Field Artillery unit was established 29 December 1919. The Infantry unit was discontinued 31 December 1921. The Field Artillery unit originally consisted of two cadet battalions of three batteries each and a single gun horse-drawn battery of six 75mm guns and ninety horses. The unit was reorganized as a truck-drawn unit in June 1936. Annual summer camp for advanced course cadets was held at Madison Barracks, NY, with the 7th Field Artillery. Newly commissioned officers were assigned predominantly to the 77th and 78th Divisions, and XII Corps Artillery units.

Purdue University (CC)

Location-Lafayette, IN



Established 18 November 1919 at Purdue University. The program provided Infantry and Field Artillery branch material training. The Infantry unit was established 18 November 1919. The Field Artillery unit was established 29 December 1919. The Infantry unit was discontinued 26 October 1920. Originally, Purdue had the only truck-drawn ROTC Field Artillery unit when it was established. The Field Artillery unit consisted of one cadet brigade of two 10 battery regiments. Regular Army Inactive affiliate units were the 21st and 27th Field Artillery Regiments. The regiments were organized in April 1930 with the program's Regular Army personnel and Reserve

officers commissioned from the program. Annual summer camp for advanced course cadets was held at Fort Knox, KY with the 14th Field Artillery and later the 3rd Field Artillery. Newly commissioned officers were assigned predominantly to the 84th Division and Artillery units of the Fifth Corps Area. Maj. Leslie J. McNair (commanding general, HQ, U.S. Army Ground Forces in WWII) assigned as PMS&T 1924-26. Lt. Col. Carlos Brewer (commanding general, 12th Armored Division in WWII) assigned as PMS&T 1933-37. Designated as a “Distinguished College” 1917, 1920-22, and 1924-27.

Rhode Island State College (CC)

Location-Kingston, RI



Established 21 December 1916 at Rhode Island State College. The program provided Infantry branch material training only. Annual summer camp for advanced course cadets was held at Camp Devens, MA with units of the 18th Infantry Brigade. Newly commissioned officers were assigned predominantly to the 97th Division. Designated as a “Distinguished College” 1925-27.

Rice Institute (CC)

Location-Houston, TX

Established 10 October 1917 at the Rice Institute. The program provided Infantry branch material training only. The Infantry unit was established 10 October 1917. The ROTC program was discontinued by 1921.

Ripon College (CC)

Location-Ripon, WI

Established 27 January 1919 at Ripon College. The program provided Infantry branch material training only. The Infantry unit was established 27 January 1919. Annual summer camp for advanced course cadets was held at Fort Sheridan, IL, with the 1st Battalion, 2nd Infantry. Newly commissioned officers were assigned predominantly to the 101st Division.

Rose Polytechnic Institute (CC)

Location-Terre Haute, IN

Established in August 1919 at Rose Polytechnic Institute. The program provided Engineer branch material training only. The Engineer unit was established 29 December 1919. Annual summer camp for advanced course cadets was held at Camp Custer, MI. Newly commissioned officers were assigned predominantly to the 84th Division and Engineer units of the Fifth Corps Area.

Rush Medical College (CC)

Location-Chicago, IL

Established 13 December 1920 at Rush Medical College, University of Chicago. The program provided Medical Corps branch material training only. The Medical Corps unit was established 13 December 1920. The ROTC program was discontinued by 1922.

Rutgers College (CC)

Location-Rutgers, NJ

Established 31 October 1916 at Rutgers College. The program provided Infantry branch material training only. Annual summer camp for advanced course cadets was held at Plattsburg Barracks, NY with the 26th Infantry. Newly commissioned officers were assigned predominantly to the 77th and 78th Divisions. Designated as a “Distinguished College” 1925-26.

St. Bonaventure College (CC)

Location-Allegheny, NY



Established in August 1936 at St. Bonaventure College. The program provided Field Artillery branch material training only. Annual summer camp for advanced course cadets was held at Madison Barracks, NY, with the 7th Field Artillery. Newly commissioned officers were assigned predominantly to the units of the 98th Division and XII Corps units.

St. John's College (CC)

Location-Annapolis, MD

Established 26 October 1916 at St. John's College. The program provided Infantry branch material training only. Annual summer camp for advanced course cadets was held at Camp George G. Meade, MD, with units of the 16th Infantry Brigade. Newly commissioned officers were assigned predominantly to the units of the 80th Division and XIII Corps units. The ROTC program was discontinued 31 March 1926.

St. John's Military Academy (MI)

Location-Delafield, IL

Established 10 March 1917 at St. John's Military Academy. The program provided Infantry branch material training only. The Infantry unit was established 10 March 1917. The senior ROTC program was discontinued 2 September 1920.

St. John's School (MI)

Location-Manlius, NY

Established 22 January 1917 at St. John's School. The program provided Infantry and Cavalry branch material training. The Infantry unit was established 22 January 1917. The Cavalry unit was established 10 March 1917. The senior ROTC program was discontinued 4 September 1920.

St. Louis University (CC)

Location-St. Louis, MO

Established 27 January 1919 at St. Louis University. The program provided Infantry branch material training only. The Infantry unit was established 27 January 1919. The ROTC program was discontinued 4 September 1920.

St. Louis University School of Medicine (CC)

Location-St. Louis, MO

Established 27 January 1919 at the St. Louis University School of Medicine. The program provided Medical Corps and Dental Corps branch material training. The Dental Corps unit was established 13 December 1920. The Medical Corps unit was established 1 March 1921. Annual summer camp for advanced course cadets was held at Fort Snelling, MN. Newly commissioned officers were assigned predominantly to the Seventh Corps Area Medical units. The ROTC program was discontinued in June 1935.

St. Mary's College (CC)

Location-Dayton, OH

Established 29 December 1919 at St. Mary's College. The program provided Infantry branch material training only. The Infantry unit was established 29 December 1919. The ROTC program was discontinued by 1921.

St. Norbert College (CC)

Location-West De Pere, WI

Established 17 January 1936 at St. Norbert College. The program provided Infantry branch material training only. The unit initially consisted of one cadet battalion of three line companies. Company D was added in 1940. Annual summer camp for advanced course cadets was held at Fort Sheridan, IL, with the 1st Battalion, 2nd Infantry. Newly commissioned officers were assigned predominantly to the units of the 101st Division and XVI Corps units.

College of St. Thomas (CC)

Location-St. Paul, MN

Established 27 September 1917 at the College of St. Thomas. The program provided Infantry branch material training only. The Infantry unit was established 27 September 1917. The ROTC program was discontinued 4 September 1920.

South Carolina Agricultural and Mechanical College (CC)

Location-Orangeburg, SC

Established 27 January 1919 at South Carolina Agricultural and Mechanical College. The program provided Infantry branch material training only. The Infantry unit was established 27 January 1919. The ROTC program was discontinued 31 December 1921.

South Dakota State College of Agriculture and Mechanic Arts (CC)

Location-Brookings, SD

Established 18 November 1916 at the South Dakota State College of Agriculture and Mechanic Arts. Discontinued during World War I and reestablished 31 December 1921. The program provided Infantry branch material training only. Annual summer camp for advanced course cadets was held at Fort Snelling, MN, with the 3rd Infantry. Newly commissioned officers were assigned predominantly to the 89th Division and XVII Corps units.

Maj. James A. Van Fleet PMS&T February 1921-August 1921

Southwestern College (CC)

Location-Winfield, KS

Established 27 January 1919 at Southwestern College. The program provided Infantry branch material training only. The Infantry unit was established 27 January 1919. The ROTC program was discontinued by 1921.

Spring Hill College (CC)

Location-Spring Hill, AL

Established 27 January 1919 at Spring Hill College. The program provided Infantry branch material training only. The Infantry unit was established 27 January 1919. The ROTC program was discontinued 2 November 1920.

Leland Stanford Jr. University (CC)

Location-Stanford, CA



Established 4 December 1916 at Stanford University. The program originally provided Infantry branch material training. The program was discontinued during World War I, and when it was reestablished in August 1919, Field Artillery branch material training was offered in lieu of Infantry training. The Field Artillery unit was established 29 December 1919. The Infantry unit was reestablished 20 January 1921. The Ordnance Corps unit was established 19 June 1925. The Field Artillery unit consisted of five batteries of cadets and a single horse-drawn gun battery of six 75mm guns. Annual summer camps for advanced course cadets were held as follows: Field Artillery cadets trained with the 76th Field Artillery at the Presidio of Monterrey, CA and some years at Fort Lewis, WA with the 10th Field Artillery; Ordnance Corps cadets trained at Aberdeen Proving Grounds, MD.

Newly commissioned officers were assigned predominantly to the 91st Division and XIX Corps units. Designated as a "Distinguished College" 1917-18.

The State College of Washington (CC)

Location-Pullman, WA

Established 31 October 1916 at the State College of Washington. The program provided Infantry and Engineer branch material training. Annual summer camps for advanced course cadets were held as follows: Infantry cadets trained with the 1st Battalion, 7th Infantry at Fort Lewis, WA; Engineer cadets trained with the 6th Engineers at Fort Lewis, WA. Newly commissioned officers were assigned predominantly to the units of the 96th Division and XIX Corps units. Designated as a "Distinguished College" 1916 and 1922-23.

State Manual Training Normal School (CC)

Location-Pittsburg, KS

Established 27 January 1919 at the State Manual Training Normal School. The program provided Infantry branch material training only. The Infantry unit was established 27 January 1919. The ROTC program was discontinued 1921.

The State University of Iowa (CC)

Location-Iowa City, IA



Established in 1864 at the State University of Iowa. Officially recognized as an ROTC program 10 March 1917. The program provided Infantry, Engineer, Motor Transport Corps, Medical Corps, and Dental Corps branch material training. Branch units were established on the following dates: Infantry unit 10 March 1917; Medical Corps and Dental Corps units 9 August 1921; and Engineer and Motor Transport Corps units 31 December 1921. The Motor Transport Corps unit was discontinued 30 June 1924. The Medical Corps and Dental Corps units were discontinued in June 1935. The Medical Corps unit was reestablished in August 1936. Annual summer camps for advanced course cadets were held as follows: Infantry cadets trained with the 3rd Infantry at Fort Snelling, MN; Engineer cadets trained with the 9th Engineers at Fort Leavenworth, KS; Medical and Dental Corps cadets trained at Fort

Snelling, MN. Newly commissioned officers were assigned predominantly to the units of the 88th Division, XVII Corps units, and Seventh Corps Area Medical units.

Syracuse University (CC)

Location-Syracuse, NY



Established in 1918 at Syracuse University. The program originally provided Infantry branch material training only. The Infantry unit was established 29 December 1919. A Medical Corps unit was established in August 1936. Regular Army Inactive affiliate unit was the 41st Infantry Regiment. The 41st Infantry was organized 18 April 1930 with the program's Regular Army personnel and Reserve officers commissioned from the program. Annual summer camp for advanced course cadets was held at Plattsburg Barracks, NY, with the 26th Infantry. Newly commissioned officers were assigned predominantly to the 98th Division and XII Corps units.

Texas Technological College (CC)

Location-Lubbock, TX

Established in August 1936 at the Texas Technological College. The program provided Engineer branch material training only. Annual summer camp for advanced course cadets was held at Fort Bliss, TX, and later Fort McIntosh, TX, with the 8th Engineers. Newly commissioned officers were assigned predominantly to the units of the 90th Division and XVIII Corps units.

Temple University (CC)

Location-Philadelphia, PA

Established 27 January 1919 at Temple University. The program provided Infantry branch material training only. The Infantry unit was established 27 January 1919.

Trinity College (CC)

Location-Durham, NC

Established 27 January 1919 at Trinity College. The program provided Infantry branch material training only. The Infantry unit was established 27 January 1919. The ROTC program was discontinued 15 September 1920.

Tuskegee Institute (CC)

Location-Tuskegee, AL

Senior program established in August 1936 at Tuskegee Institute. The program provided Infantry branch material training only. Newly commissioned officers were assigned predominantly to the "colored" units of the Third Corps Area. Lt. Col. Benjamin O. Davis assigned as PMS&T when Tuskegee was a JROTC unit 1920-24. His son, 1st Lt. Benjamin O. Davis, Jr. assigned as PMS&T 1938-41.

Union College (CC)

Location-Schenectady, NY

Established 7 December 1917 at Union College. The program provided Infantry branch material training only. The Infantry unit was established 7 December 1917. The ROTC program was discontinued by 1921.

Union University (CC)

Location-Jackson, TN

Established 29 December 1919 at Union University. The program provided Infantry branch material training only. The ROTC program was discontinued 1 March 1921.

University of Southern California (CC)

Location-Los Angeles, CA

Established 23 April 1918 at the University of Southern California. The program provided Infantry branch material training only. The ROTC program was discontinued 16 June 1920.

University of Alabama (CC)

Location-Tuscaloosa, AL

Established 4 December 1916 at the University of Alabama. Discontinued during World War I and reestablished 27 January 1919. The unit originally provided only Infantry branch material training. The Infantry unit was established 27 January 1919. The Coast Artillery and Engineer units were established 29 December 1919. The cadet corps was organized as a brigade of three regiments: 1st Regiment was Infantry; 2nd Regiment was Coast Artillery, and 3rd Regiment was Engineers. Regular Army Inactive affiliate unit was the 2nd Battalion, 4th Engineer Regiment, organized 28 May 1929 with the program's Regular Army personnel and Reserve officers commissioned from the program. Newly commissioned officers were assigned predominantly to the 87th Division, XIV Corps, and Fifth Army units.

University of Alaska (CC)

Location-Fairbanks, TA

Established in August 1936 at the University of Alaska. The program provided Infantry branch material training only. Newly commissioned officers were assigned predominantly to the 516th Infantry Battalion and units of the Alaska Territorial Militia (later redesignated Alaska National Guard).

University of Arkansas (CC)

Location-Fayetteville, AR



Established 26 October 1916 at University of Arkansas. The program provided Infantry branch material training only. The Infantry unit was established 26 October 1916. Annual summer camps for advanced course cadets were held with the 17th Infantry at Fort Leavenworth, KS. Newly commissioned officers were assigned predominantly to the 102nd Division.

University of Arizona (CC)

Location-Tucson, AZ

Established 17 April 1917 at University of Arizona. The program provided Infantry and Cavalry branch material training. The Infantry unit was established 17 January 1917. The Infantry unit was discontinued 29 December 1919; concurrently, the Cavalry unit was established. Annual summer camps for advanced course cadets were held with the 11th Cavalry at the Presidio of Monterey, CA. Newly commissioned officers were assigned predominantly to the 312th Cavalry and 103rd Division. Designated as a "Distinguished College" 1923-27.

University of Buffalo (CC)

Location-Buffalo, NY

Established in 1918 at the University of Buffalo. The program provided Medical Corps branch material training only. Newly commissioned officers were assigned predominantly to Organized Reserve medical units in the Fifth Corps Area. The ROTC program was discontinued in June 1935.

University of California (CC)

Location-Berkeley, CA



Established 17 April 1917 at the University of California. The program provided Infantry, Coast Artillery, Engineer, Air Service, Ordnance Corps, Signal Corps, and Medical Corps branch material training. Branch units were established on the following dates: Infantry unit 27 January 1919; Air Service unit 2 November 1920; Medical Corps unit 1 March 1921; Coast Artillery unit 31 December 1921; and the Ordnance Corps unit in May 1922. The Air Corps unit was discontinued in August 1932. The Signal Corps unit was established in January 1935. The Medical Corps unit was discontinued in June 1935. The Engineer unit was established in August 1938. Newly commissioned officers were assigned predominantly to the 91st Division, XIX Corps, and Sixth Army units. Designated as a “Distinguished College” 1914-27.

University of California Medical School (CC)

Location-San Francisco, CA

Established in 1918 at the University of California Medical School. The program provided Medical Corps branch material training only. Newly commissioned officers were assigned predominantly to the Organized Reserve medical units in the Ninth Corps Area. The ROTC program was discontinued in June 1935.

University of California, Los Angeles (CC)

Location-Los Angeles, CA

Established 31 December 1921 at the University of California, Los Angeles. The program provided Infantry and Engineer branch material training. The Infantry unit was established 31 December 1921. Regular Army Inactive affiliate unit was the 32nd Infantry Regiment. The 32nd Infantry was organized 29 April 1930 with the program’s Regular Army personnel and Reserve officers commissioned from the program. The Coast Artillery unit was established in April 1936. Newly commissioned officers were assigned predominantly to the 91st Division, XIX Corps, and Sixth Army units. Designated as a “Distinguished College” 1926-27.

University of Chicago (CC)

Location-Chicago, IL



Established 29 January 1917 at the University of Chicago. The program provided Infantry, Field Artillery, and Medical Corps branch material training. The Infantry unit was established 29 January 1917. The Infantry unit was discontinued 29 December 1919; concurrently the Field Artillery unit was established. The Medical Corps unit was established 13 December 1920. The Medical Corps unit was discontinued in June 1935. Newly commissioned officers were assigned predominantly to the 86th Division and to artillery and medical units of the Sixth Corps Area.

University of Cincinnati (CC)

Location-Cincinnati, OH



Established in March 1919 at the University of Cincinnati. The program provided Engineer, Coast Artillery, and Ordnance Corps branch material training. The Coast Artillery and Engineer units were established 29 December 1919. Newly commissioned officers were assigned predominantly to the 83rd Division, XV Corps, and Fifth Army units.

University of Colorado (CC)

Location-Boulder, CO

Established 19 December 1917 at the University of Colorado. The program provided Infantry branch material training only. The Infantry unit was established 19 December 1917. The ROTC program was discontinued by 1921.

University of Dayton (CC)

Location-Dayton, OH

Established 4 January 1919 at the University of Dayton. The program provided Infantry branch material training only. Newly commissioned officers were assigned predominantly to the 83rd Division and XV Corps units, especially the 329th Infantry.

University of Delaware (CC)

Location-Newark, DE



Established 21 December 1916 at the University of Delaware. The program originally provided only Infantry branch material training only. The Infantry unit was discontinued 20 August 1927 and concurrently a Coast Artillery unit was established. Newly commissioned officers were assigned predominantly to the 621st Coast Artillery, 77th and 78th Divisions, and XII Corps units. Designated as a "Distinguished College" 1923-25.

University of Florida (CC)

Location-Gainesville, FL



Established 18 November 1916 at the University of Florida. The program originally provided only Infantry branch material training. The Infantry unit was established 18 November 1916. The Field Artillery unit was established in August 1928. The Field Artillery unit consisted of two cadet battalions of three horse-drawn batteries each. The Field Artillery unit was reorganized as a truck-drawn unit in July 1936. Regular Army Inactive affiliate unit was the 86th Field Artillery Regiment. The 86th Field Artillery was organized 21 April 1930 with the program's Regular Army personnel and Reserve officers commissioned from the program. The 86th Field Artillery Regiment relieved from affiliation with the university 21 October 1933 and replaced by the 36th Field Artillery. Newly commissioned officers were assigned predominantly to the 82nd Division and XIV Corps units. Designated as a "Distinguished College" 1919-20 and 1925-27. Maj. James A. Van Fleet PMS&T August 1921-August 1924 and July 1929-June 1933

University of Georgia (CC)

Location-Athens, GA



Established 21 December 1916 at the University of Georgia. The program provided Infantry, Cavalry, and Motor Transport Corps branch material training. The Infantry unit was established 21 December 1916. The Cavalry and Motor Transport Corps units were established 31 December 1921. The Motor Transport Corps unit was discontinued 7 May 1924. Advanced course cadets trained with the 3rd Cavalry at Fort Ethan Allen, VT, in 1921, thereafter with the 6th Cavalry at Fort Oglethorpe, GA. Newly commissioned officers were assigned predominantly to the units of the 82nd Division and 63rd Cavalry Division. Designated as a “Distinguished College” 1917 and 1924-25.

University of Hawaii (CC)

Location-Honolulu, TH



Established 13 September 1921 at the University of Hawaii. The program provided Infantry branch material training only. Newly commissioned officers were assigned predominantly to the Organized Reserve and National Guard units of the Hawaiian Department.

University of Idaho (CC)

Location-Moscow, ID

Established 8 January 1917 at the University of Idaho. The program provided Infantry branch material training only. Newly commissioned officers were assigned predominantly to the 104th Division. Designated as a “Distinguished College” 1926-27.

University of Illinois (CC)

Location-Urbana, IL

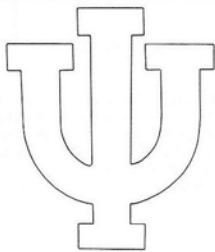

Established 8 January 1917 at the University of Illinois. The program provided Infantry, Cavalry, Field Artillery, Engineer, Air Service, and Signal Corps branch material training. Branch units were established on the following dates: Infantry unit 8 January 1917; Field Artillery unit 29 December 1919; Air Service unit 2 November 1920; Cavalry unit 31 December 1921; and Coast Artillery unit 30 September 1930. The Air Corps unit was discontinued in June 1931. The Field Artillery unit was reorganized as a truck-drawn unit in June 1936. Annual summer camps for advanced course cadets were held as follows: Infantry cadets trained with units of the 10th Infantry Brigade and Cavalry cadets trained with the 1st and 6th Cavalry Regiments at Camp Knox, KY; Field Artillery cadets trained with the 14th Field Artillery at Camp Sparta (Camp McCoy), WI, and some years at Fort Knox; Engineer cadets trained at Camp Custer MI; and Air Corps cadets trained at Chanute Field, IL. Newly commissioned officers were assigned predominantly to the 86th Division, 65th Cavalry Division, XVI Corps, and Fifth Army units. Designated as a “Distinguished College” 1914-18 and 1920-26.

University of Kansas (CC)**Location**-Lawrence, KS

Established 2 July 1918 at the University of Kansas. The program provided Infantry, Coast Artillery, and Engineer branch material training. The Infantry unit was established 2 July 1918. The Infantry unit was discontinued 2 November 1920. The Coast Artillery and Engineer units were established 31 December 1921. The Infantry unit was reestablished in August 1935. The Engineer unit was discontinued in June 1936. The cadet corps was originally organized in 1921 as a regiment with one Coast Artillery and one Engineer battalion each. Advanced course cadets trained with the 9th Engineers and 17th Infantry at Fort Leavenworth, KS. Newly commissioned officers were assigned predominantly to the 89th Division, XVII Corps, and Sixth Army units.

University of Kentucky (CC)**Location**-Lexington, KY

Established 17 April 1917 at the University of Kentucky. The program provided Infantry branch material training only. Regular Army Inactive affiliate unit was the 61st Infantry Regiment. The 61st Infantry was organized about June 1927 with the program's Regular Army personnel and Reserve officers commissioned from the program. Newly commissioned officers were assigned predominantly to the units of the 100th Division and XV Corps units. Designated as a "Distinguished College" 1926-27.

University of Maine (CC)**Location**-Orono, ME

Established 21 October 1916 at the University of Maine. The program originally provided Infantry branch material training only. The Coast Artillery unit was established in April 1936. Newly commissioned officers were assigned predominantly to the units of the 97th Division and XI Corps units.

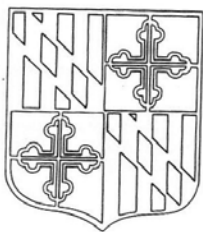
University of Maryland (CC)**Location**-College Park, MD

Established 27 September 1917 at the Maryland State College of Agriculture. Renamed the University of Maryland in 1918. The program provided Infantry branch material training only. Newly commissioned officers were assigned predominantly to the units of the 80th Division and XIII Corps units. Designated as a "Distinguished College" 1910-11 and 1922-27.

University of Michigan (CC)**Location**-Ann Arbor, MI

Established 8 September 1917 at the University of Michigan. The program originally provided only Infantry, branch material training. The Infantry unit was established 8 September 1917. The Infantry unit was discontinued 29 December 1919; concurrently, Coast Artillery, Ordnance Corps, and Signal Corps units were established. The Coast Artillery unit was discontinued 28 July 1928. The Engineer and Medical Corps units were established in August 1936. Newly commissioned officers were assigned predominantly to the 85th Division, XVI Corps, and Fifth Army units.

University of Minnesota (CC)

Location-Minneapolis, MN



Established 21 December 1916 at the University of Minnesota. Discontinued during World War I and reestablished 24 January 1919. The program originally provided Infantry, Coast Artillery, Signal Corps, Medical Corps, and Dental Corps branch material training. Branch units were established on the following dates: Infantry unit 21 December 1916; Coast Artillery and Signal Corps units 22 April 1919; and Medical Corps and Dental Corps units 20 January 1921. Regular Army Inactive affiliate unit was the 53rd Infantry Regiment. The 53rd Infantry was organized 21 April 1930 with the program's Regular Army personnel and Reserve officers commissioned from the program. The Infantry and Dental Corps units were discontinued 6 October 1934. Affiliation with the 53rd Infantry concurrently withdrawn. The Medical Corps unit was discontinued in June 1935. Newly commissioned officers were assigned predominantly to the 88th Division, XVII Corps, Fifth Army, and Seventh Corps Area Medical units. The cadet rifle team won the William Randolph Hearst Trophy for rifle marksmanship in 1926. Designated as a "Distinguished College" 1914-18 and 1920-21.

University of Mississippi (CC)

Location-Oxford, MS

Established in 1936 at the University of Mississippi. The program provided Infantry branch material training only. Newly commissioned officers were assigned predominantly to the units of the 87th Division and XIV Corps units.

University of Missouri (CC)

Location-Columbia, MO

Established 8 September 1917 at the University of Missouri. The program provided Infantry and Field Artillery branch material training. The Infantry unit was established 8 September 1917. The Field Artillery unit was established 29 December 1919. The Infantry unit was discontinued in June 1938. Infantry advanced course cadets trained with the 17th Infantry at Fort Leavenworth, KS, and the Field Artillery cadets trained with the 14th Field Artillery at Fort Knox, KY. Newly commissioned officers were assigned predominantly to the units of the 102nd Division and XVII Corps units. Designated as a "Distinguished College" 1914-16 and 1920-27.

University of Montana (CC)

Location-Missoula, MT

Established 27 January 1919 at the University of Montana. The program provided Infantry branch material training only. The Infantry unit was established 27 January 1919. Newly commissioned officers were assigned predominantly to the units of the 96th Division and XIX Corps units. Maj. Frank Milburn (commanding general, 83rd Infantry Division in WWII) assigned as PMS&T 1926-31.

University of Nebraska (CC)

Location-Lincoln, NE



Established 8 January 1917 at the University of Nebraska. The program provided Infantry, Field Artillery, Engineer and Motor Transport Corps branch material training. The Infantry unit was established 8 January 1917. The Field Artillery and Motor Transport Corps units were established 29 December 1919. The Field Artillery and Motor Transport Corps units were discontinued in June 1922. The Field Artillery unit was reestablished as a truck-drawn unit in August 1936. An Engineer unit was concurrently established. The Field Artillery unit consisted of one cadet battalion of three batteries and a horse-drawn battery of six 75mm guns. The Regular Army Inactive affiliate unit was the 54th Infantry Regiment. The 54th Infantry was organized by April 1930 with the program's Regular Army personnel and Reserve officers commissioned from the program. Newly commissioned officers were assigned predominantly to the 89th Division and XVII Corps units. Designated as a "Distinguished College" 1924-25 and 1927.

University of Nevada (CC)

Location-Reno, NV

Established 31 October 1916 at the University of Nevada. The program provided Infantry branch material training only. Newly commissioned officers were assigned predominantly to the 96th Division, especially the 2nd Battalion, 413th Infantry.

University of North Carolina (CC)

Location-Chapel Hill, NC

Established 29 December 1919 at the University of North Carolina. The program provided Infantry branch material training only. The Infantry unit was established 29 December 1919. The ROTC program was discontinued 19 August 1921.

University of North Dakota (CC)

Location-Grand Forks, ND

Established 29 December 1919 at the University of North Dakota. The program provided Infantry branch material training only. The Infantry unit was established 29 December 1919. Newly commissioned officers were assigned predominantly to the units of the 88th Division and XVII Corps.

University of Oklahoma (CC)

Location-Norman, OK



Established 29 December 1919 at the University of Oklahoma. The program provided Infantry, Field Artillery, and Ordnance Corps branch material training. The Infantry and Field Artillery units were established 29 December 1919. Infantry branch training was discontinued 28 July 1927. The Ordnance Corps unit was established 6 October 1934. The Field Artillery unit consisted of a cadet battalion of four horse-drawn gun batteries of six 75mm guns. The Field Artillery unit was reorganized as a truck-drawn unit in July 1936. Newly commissioned officers were assigned predominantly to the 95th Division and XVIII Corps. Designated as a "Distinguished College" 1923-27.

University of Oregon (CC)

Location-Eugene, OR



Established 27 January 1919 at the University of Oregon. The program provided Infantry branch material training only. The Infantry unit was established 27 January 1919. Newly commissioned officers were assigned predominantly to the 96th Division and XIX Corps.

University of Oregon Medical School (CC)

Location-Portland, OR

Established 21 April 1921 at the University of Oregon Medical School. The program provided Medical Corps branch material training only. Newly commissioned officers were assigned predominantly to Organized Reserve medical units in the Ninth Corps Area. The ROTC program was discontinued in June 1935.

University of Pennsylvania (CC)

Location-Philadelphia, PA

Established 26 February 1918 at the University of Pennsylvania. The program provided Infantry, Medical Corps, and Dental Corps branch material training. The Infantry unit was established 26 February 1918. The Dental Corps unit was established 20 January 1921. The Medical Corps unit was established in June 1922. The Medical Corps and Dental Corps units were discontinued in June 1935. Newly commissioned officers were assigned predominantly to the 79th Division, XIII Corps, Fourth Army, and Third Corps Area Medical units. The U.S. Army Field Artillery Sound and Flash Course was taught at the University of Pennsylvania in the 1930s and early 1940s.

University of Pittsburgh (CC)

Location-Pittsburgh, PA

Established 1 March 1918 at the University of Pittsburgh. Discontinued during World War I and reestablished in September 1919. The program provided Infantry, Coast Artillery, Medical Corps, and Quartermaster branch material training. Branch units were established on the following dates: Infantry unit 1 March 1918; Coast Artillery and Motor Transport Corps units 29 December 1919; and Medical Corps unit 9 August 1921. The Infantry unit was discontinued 27 July 1921. The Motor Transport Corps unit was discontinued 30 June 1924. The Medical Corps unit was discontinued in June 1935. Newly commissioned officers were assigned predominantly to the units of Fourth Army and XIII Corps units.

University of Puerto Rico (CC)

Location-Rio Piedras, PR

Established 29 December 1919 at the University of Puerto Rico. The program provided Infantry branch material training only. The Infantry unit was established 29 December 1919. The ROTC program at College of Agricultural and Mechanic Arts at Mayaguez, PR, was made a sub-program of the University of Puerto Rico 14 July 1924. The Regular Army Inactive affiliate unit was the 42nd Infantry Regiment. The 42nd Infantry was organized 28 May 1929 with

the program's Regular Army personnel and Reserve officers commissioned from the program. Newly commissioned officers were assigned predominantly to the units of the 211th Infantry Brigade until 1927; thereafter to the 42nd Infantry (RAI), 373rd Infantry, and 516th Infantry Battalion.

University of San Francisco (CC)

Location-San Francisco, CA

Established in 1936 at the University of San Francisco. The program provided Coast Artillery branch material training only. Newly commissioned officers were assigned predominantly to the 91st Division, XIX Corps, and Fourth Army units.

University of Santa Clara (CC)

Location-Santa Clara, CA

Established 7 December 1917 at the University of Santa Clara. The program provided Infantry branch material training only. The program was discontinued by 1921. Reestablished in August 1936, this time providing Field Artillery branch material training only. Newly commissioned officers were assigned predominantly to the 91st Division and XIX Corps.

University of South Carolina (CC)

Location-Columbia, SC

Established 24 October 1917 at the University of South Carolina. The program provided Infantry branch material training only. The ROTC program was discontinued 27 July 1921.

University of South Dakota (CC)

Location-Vermillion, SD

Established 29 December 1919 at the University of South Dakota. The program provided Infantry branch material training only. The Infantry unit was established 29 December 1919. Newly commissioned officers were assigned predominantly to the units of the 89th Division and XVII Corps units. Designated as a "Distinguished College" 1924-27.

University of Tennessee (CC)

Location-Knoxville, TN

Established 15 February 1917 at the University of Tennessee. The program provided Infantry, Engineer, and Quartermaster Corps branch material training. The Infantry unit was established 15 February 1917. The Engineer and Motor Transport Corps units were established 31 December 1921. The Motor Transport Corps unit was discontinued 7 August 1924. Newly commissioned officers were assigned predominantly to the units of the 82nd Division and XIV Corps units.

University of Utah (CC)

Location-Salt Lake City, UT



Established in September 1919 at the University of Utah. The program provided Field Artillery branch material training only. The Field Artillery unit was established 29 December 1919. The Field Artillery unit consisted of three battalions of three batteries each and a two horse-drawn gun batteries of six 75mm guns each and seventy-six horses. The unit was reorganized as a truck-drawn unit in July 1936. Newly commissioned officers were assigned predominantly to the 104th Division and XIX Corps units. Designated as a “Distinguished College” 1925-27.

University of Vermont and State Agricultural College (CC)

Location-Burlingame, VT



Established 31 October 1916 at the University of Vermont. The program provided Infantry and Medical Corps branch material training. The Infantry unit was established 31 October 1916. The Medical Corps unit was established in June 1922. Medical Corps unit was discontinued in June 1935. Newly commissioned officers were assigned predominantly to the units of the 97th Division and XI Corps units. Designated as a “Distinguished College” 1915-18, 1921-22, 1924-25, and 1927.

University of Virginia (CC)

Location-Charlottesville, VA

Established 8 September 1917 at the University of Virginia. The program provided Infantry branch material training only. The ROTC program was discontinued 31 December 1921.

University of Washington (CC)

Location-Seattle, WA



Established 18 November 1916 at the University of Washington. The program provided Infantry, Coast Artillery, Air Service, and Ordnance Corps branch material training. Branch units were established on the following dates: Infantry unit 18 November 1916; Coast Artillery unit 29 December 1919; Air Service unit 2 November 1920; and Ordnance Corps unit 10 October 1928. The Air Corps unit was discontinued 10 October 1928. The Ordnance Corps unit was discontinued 6 October 1934. Newly commissioned officers were assigned predominantly to the units of the 96th Division and XIX Corps units. Designated as a “Distinguished College” 1921-24.

University of Wisconsin (CC)

Location-Madison, WI

Established 8 September 1917 at the University of Wisconsin. The program provided Infantry, Field Artillery, Ordnance Corps, and Signal Corps branch material training. Branch units were established on the following dates: Infantry unit 8 September 1917; Field Artillery and Signal Corps units 29 December 1919; Ordnance Corps unit 31 December 1921; and Engineer unit 10 June 1928. The Ordnance Corps unit was discontinued 5 December 1925. The

Field Artillery unit was discontinued in June 1928. Newly commissioned officers were assigned predominantly to the 101st Division, XVI Corps, and Fifth Army units. Maj. Orlando P. Ward PMS&T. Designated as a "Distinguished College" 1916-17 and 1920-23.

University of Wyoming (CC)

Location-Laramie, WY

Established 31 October 1916 at the University of Wyoming. The program provided Infantry branch material training only. Newly commissioned officers were assigned predominantly to the 96th Division and XIX Corps.

Valley Forge Military Academy (MI)

Location-Wayne, PA

Established 23 September 1931 at Valley Forge Military Academy. The program provided Infantry branch material training only. Advanced course cadets trained with units of the 16th Infantry Brigade at Camp George G. Meade, MD. Newly commissioned officers were assigned predominantly to the 79th Division and XIII Corps units. The 315th Infantry and the 308th Cavalry often held contact camps and training at VFMA. Designated "Honor Military School" 1931.

Vanderbilt University (CC)

Location-Nashville, TN

Established 27 January 1919 at Vanderbilt University. The program provided Infantry, Coast Artillery, and Medical Corps branch material training. The Infantry unit was established 27 January 1919. The Infantry unit was discontinued 29 December 1919; concurrently, the Coast Artillery unit was established. The Coast Artillery unit was discontinued 26 October 1920. The Medical Corps unit was established 31 December 1921. Newly commissioned officers were assigned predominantly to Organized Reserve medical units in the Fourth Corps Area. The ROTC program was discontinued in June 1935.

Virginia Agricultural and Mechanical College and Polytechnic Institute (MC)

Location-Blacksburg, VA

Established 21 December 1916 at Virginia Polytechnic Institute. The program provided Infantry, Engineer, and Coast Artillery branch material training. The Infantry unit was established 21 December 1916. The Coast Artillery and Engineer units were established 29 December 1919. Newly commissioned officers were assigned predominantly to the 80th Division, Fourth Army Coast Artillery regiments, and XIII Corps units. Designated as a "Distinguished College" 1919-22 and 1924-27.

Virginia Military Institute (MC)

Location-Lexington, VA

Established 21 December 1916 at the Virginia Military Institute. The program provided Infantry, Cavalry, Field Artillery, and Engineer branch material training. The Infantry, Cavalry, and Field Artillery units were established 21 December 1916. The Engineer unit was established 31 December 1921. The Engineer unit was discontinued in June 1929. The cadet corps was organized as a regiment of two cadet battalions of three companies each. The 1st Battalion

consisted of one Infantry company and two Cavalry troops. The Cavalry troops were assigned eighty horses. The 2nd Battalion consisted of three batteries of cadets and two gun batteries of six 75mm guns each. The batteries were also assigned seventy horses. Annual summer camp for advanced course cadets was held at Camp George G. Meade, MD, with the 16th Field Artillery for Field Artillery cadets, and at Fort Myer, VA, with the 3rd Cavalry for Cavalry cadets. Newly commissioned officers were assigned predominantly to the 80th Division, 62nd Cavalry Division, Fourth Army Coast Artillery regiments, and XIII Corps units. Designated as a "Distinguished College" 1904-27.

Wabash College (CC)

Location-Crawfordsville, IN

Established 27 January 1919 at Wabash College. The program provided Infantry branch material training only. The Infantry unit was established 27 January 1919. The ROTC program was discontinued by 1921.

Washington and Lee College (CC)

Location-Lexington, VA

Established 11 April 1918 at Washington and Lee College. The program provided Infantry branch material training only. The Infantry unit was established 11 April 1918. The ROTC program was discontinued by 1921.

Washington University (CC)

Location-St. Louis, MO

Established 27 January 1919 at Washington University. The program provided Infantry, Field Artillery, Coast Artillery, and Medical Corps branch material training. Branch units were established on the following dates: Infantry unit 27 January 1919; Field Artillery unit in October 1919; Coast Artillery unit 29 December 1919 and Medical Corps unit 2 November 1920. The Infantry unit was discontinued 13 December 1920. The Medical Corps unit was discontinued in June 1935. Newly commissioned officers were assigned predominantly to the units of the 102nd Division and XVII Corps units.

Wentworth Military Academy (MI)

Location-Lexington, MO

Established 29 January 1917 at the Wentworth Military Academy. The program provided Infantry branch material training only. The Infantry unit was established 22 January 1917. The senior ROTC program was discontinued by 1921.

Wesleyan College (CC)

Location-Middletown, CT

Established 3 April 1917 at Wesleyan College. The program provided Infantry branch material training only. The Infantry unit was established 27 January 1919. The ROTC program was discontinued 24 April 1920.

Western Kentucky State Teacher's College (CC)

Location-Bowling Green, KY

Established in September 1935 at Western Kentucky State Teacher's College. The program provided Infantry branch material training only. Newly commissioned officers were assigned predominantly to the 100th Division and V Corps units.

Western Maryland College (CC)

Location-Westminster, MD



Established 29 December 1919 at the Western Maryland College. The program provided Infantry branch material training only. The Infantry unit was established 29 December 1919. Newly commissioned officers were assigned predominantly to the units of the 80th Division and XIII Corps units.

Western Reserve University (CC)

Location-Cleveland, OH

Established in 1918 at Western Reserve University. The program provided Medical Corps branch material training only. The Medical Corps unit was established 27 July 1921. Regular Army Inactive affiliate units were the 50th Evacuation Hospital, 41st Surgical Hospital, and 245th General Hospital. All three units were organized by 1930 with the program's Regular Army personnel and Reserve officers commissioned from the program. Newly commissioned officers were assigned predominantly to Organized Reserve medical units in the Fifth Corps Area. The unit often hosted the Fifth Corps Area Medico-Military Refresher Course for Reserve officers in the early 1930s. The ROTC program was discontinued in June 1935.

West Virginia University (CC)

Location-Morgantown, WV



Established 21 December 1916 at West Virginia University. The program provided Infantry and Engineer branch material training. The Infantry unit was established 21 December 1916. The Engineer unit was established 31 December 1921. Regular Army Inactive affiliate unit was the 10th Engineer Regiment. The 10th Engineer Regiment was organized 28 April 1930 with the program's Regular Army personnel and Reserve officers commissioned from the program. Newly commissioned officers were assigned predominantly to the units of the 100th Division and XV Corps units.

Whitman College (CC)

Location-Walla Walla, WA

Established 19 December 1917 at Whitman College. The program provided Infantry branch material training only. The ROTC program was discontinued 16 June 1920.

Wilberforce University (CC)**Location**-Wilberforce, OH

Established 24 January 1919 at Wilberforce University. The program provided Infantry branch material training only. The Infantry unit was established 27 January 1919. Newly commissioned officers were assigned predominantly to the “colored” Organized Reserve and National Guard units of the Fifth Corps Area.

William Jewel College (CC)**Location**-Liberty, MO

Established 27 January 1919 at William Jewel College. The program provided Infantry branch material training only. The Infantry unit was established 27 January 1919. The ROTC program was discontinued by 1921.

Williams College (CC)**Location**-Williamstown, MA

Established 17 January 1917 at Williams College. The program provided Infantry branch material training only. The Infantry unit was established 17 January 1917. The ROTC program was discontinued by 1921.

Wofford College (CC)**Location**-Spartanburg, SC

Established 29 December 1919 at Wofford College. The program provided Infantry branch material training only. The Infantry unit was established 29 December 1919. Newly commissioned officers were assigned predominantly to the 82nd Division and XIV Corps units.

Xavier University (CC)**Location**-Cincinnati, OH

Established in August 1936 at Xavier University. The program provided Field Artillery branch material training only. Newly commissioned officers were assigned predominantly to the 83rd Division and XV Corps units.

Yale University (CC)**Location**-New Haven, CT

Established 29 January 1917 at Yale University. Branch units were established on the following dates: Field Artillery unit 29 January 1917; Signal Corps unit 2 July 1918; and Engineer and Ordnance Corps units 31 December 1921. The Signal Corps and Ordnance Corps units were discontinued by 17 September 1924. Engineer branch training was discontinued in June 1937. Annual summer camps for advanced course cadets were held as follows: Field Artillery cadets trained with the 7th Field Artillery at Fort Ethan Allen VT and some years at Fort Devens, MA; Engineer cadets trained with the 13th Engineers at Camp A. A. Humphreys (later renamed Fort Belvoir), VA; Signal Corps cadets trained with the 1st Signal Company at Camp Alfred Vail (later renamed Fort Monmouth), NJ; and Ordnance Corps cadets trained at Aberdeen Proving Grounds, MD. Newly commissioned officers were assigned predominantly to the 76th Division. Designated as a “Distinguished College” in 1918.

Bibliography

Contrary to popular belief, there is actually a great deal of information available on U.S. Army organizations in the interwar period. Many historians interested in this era who I have talked to about this project have expressed their frustration, like I once did, at not being able to find much on these organizations, especially those of the Organized Reserve. Their frustrations stem mostly from the fact that if one means that there is very little published on them, that is true. However, even then, locating at least an outline of a unit's history is very often possible in publications like the Center of Military History's (CMH) official Army Lineage Series, James Sawicki's series of books covering Army unit lineages, or even looking on the internet for articles prepared by veterans' groups or others who have gone to the trouble of researching and producing a unit's history (though the latter source must always be carefully scrutinized for accuracy). If one wishes to delve further on a specific unit, there are other publications from which he can locate additional information. Most of these are individual unit histories that include at least snippets of the unit's activities in the 1920s and 30s leading to Pearl Harbor. Beyond these few sources, there existed a significant void in the published record about this topic.

The information in this work was intended to largely fill that void. To that end, the material herein has been gleaned from myriad sources, both official and unofficial, primarily because available official records are very incomplete. The bulk of the lineage information for Regular Army and Organized Reserve (OR) units in these volumes was acquired from the very fine, but limited Army Lineage Series. Also heavily utilized were the official unit data cards for Regular Army and Organized Reserve units held by CMH at Fort McNair, Washington, DC. The primary sources used for National Guard units included the Army Lineage Series, but also included the various National Guard Registers published between 1922 and 1939, as well as unit records held by the respective state National Guard command historians in their own archives. In addition to these sources, I also scoured three key Record Groups (RG) in the National Archives at College Park, MD, for additional unit information related to the period. In order of value, these groups were RG 394: Records of United States Army Continental Commands, 1920-1942; RG 407: Records of the Adjutant General; RG 391: U.S. Regular Army Mobile Units, 1821-1942. In those holdings I was able to locate much of the information I included on subjects such as participation in major Army maneuvers and other operational or training events, summer training attendance by Guard and Reserve units, relocation of units, unit commanders for OR units, Civilian Conservation Corps activities, the Mexican Border Patrol, and so forth.

Provided below is a listing of most of the sources used in compiling this record. Of course, the information in these volumes was drawn from a huge number of locations, literally from around the world. There were those times I would find a bit of information in a publication or document at an obscure library or archive somewhere. Those items usually had nothing else of interest to an organizational historian so I did not bother to record the bibliographical information. I would estimate, however, that 95 percent or more of the information I provide this order of battle will be found in the sources I cite here.

Official Sources:

The vast majority of lineage information in this order of battle was drawn from the Official Sources section.

Center of Military History, Fort McNair, DC

Lineage Books:

Mahon, John K. and Romana Danysh. *Army Lineage Series, Infantry Part I: Regular Army*. Washington, DC:

Government Printing Office, 1972.

McKenney, Janice E. *Army Lineage Series, Air Defense Artillery*. Washington, DC: Government Printing Office, 1985.

———. *Army Lineage Series, Field Artillery, Part I*. Washington, DC: Government Printing Office, 2010.

———. *Army Lineage Series, Field Artillery, Part 2*. Washington, DC: Government Printing Office, 2010.

———. *Army Lineage Series, The Organizational History of Field Artillery, 1775-2003*. Washington, DC: Government Printing Office, 2007.

Office of the Chief of Military History. *The Army Lineage Book, Volume II: Infantry*. Washington, DC: Government Printing Office, 1953.

Raines, Rebecca R. *Army Lineage Series, Signal Corps*. Washington, DC: Government Printing Office, 2005.

Stubbs, Mary Lee and Stanley Russell Connor. *Army Lineage Series, Armor-Cavalry, Part I: Regular Army and Army Reserve*. Washington, DC: Government Printing Office, 1984.

———. *Army Lineage Series, Armor-Cavalry, Part II: National Guard*. Washington, DC: Government Printing Office, 1984.

Wilson John B. *Army Lineage Series, Armies, Corps, Divisions, and Separate Brigades*. Washington, DC: Government Printing Office, 1987.

———. *Army Lineage Series, Maneuver and Firepower: The Evolution of Divisions and Separate Brigades*. Washington, DC: Government Printing Office, 1987.

Wright, Robert K. *Army Lineage Series, Military Police*. Washington, DC: Government Printing Office, 2002.

Other Books:

Center of Military History. *Order of Battle of the United States Land Forces in the World War, Volumes 1-5*. Washington, DC: Government Printing Office, 1988.

Documents:

Unit Data Cards.

These items were the official record of Regular Army organizations during the 1919-1941 period (and later). They include information on unit organization, activations, inactivations, T/O changes, transfers, assignments, and other important events that affected the unit.

Active Unit Files.

These files contain the unit data cards and a host of other material on currently, or sometimes recently, active units of the Regular Army and Army Reserve.

“Old” Organized Reserve Cards.

These items were the official record of Organized Reserve organizations during the 1921-1942 period. They include information on unit initiation, inactivations, transfers, assignments, and other important events that affected the unit, though far more limited in scope than the RA unit data cards. These were literally 3” x 5” cards and so contained much less information than that available for RA units.

National Archives II, College Park, MD

Record Group 92: Office of the Quartermaster General.

This RG has much useful information on the U.S. Army Transport Service and the Harbor Boat Service. It includes data and historical information on vessels of those two services and the Army Mine Planter Service as well.

Record Group 391: U.S. Regular Army Mobile Units, 1821-1942.

This RG has much useful information on the mobile units of the army and is particularly good for combat arms regiments. There are gaps in the regimental and battalion offerings of all branches.

Record Group 392: U.S. Army Coast Artillery Districts and Defenses, 1901-1942.

This RG is very good for information on coast artillery districts and most of the harbor defense commands. Records are spotty or nonexistent for about half of the commands, however, and most of the records are at various regional branches of the National Archives.

Record Group 394: Records of United States Army Continental Commands, 1920-1942.

This RG is essentially the administrative records for the nine corps area headquarters. It is a superb source of information on mobilization plans and orders of battle, OR units, unit commanders, and officer assignments. Particularly useful are the special and general orders for each of the corps areas.

Record Group 395: U.S. Army Overseas Operations and Commands, 1898-1942.

This RG covers the administrative records of the three overseas departments and includes a few unit records, special and general orders, and other documents covering activities of mobile units overseas.

Record Group 407: Adjutant General’s Office, 1917-.

This RG has useful information on OR and NG units.

Army National Guard (various locations)

Books:

Secretary of War, Militia Bureau. *Official National Guard Register*. Washington, D.C.: Government Printing Office.

Volumes were printed for the following years: 1922-31, 1936, 1939. These are excellent sources of military biographical information and assignments on National Guard officers. They also provide the dates of Federal recognition for every company-level organization and above, as well as the city

or town where the unit was located. In addition, they provide an order of battle for each Guard division and unit mobilization assignments for corps and army-level organizations. Finally, the 1939 register also contains a very useful historical sketch of every regiment and separate battalion in the National Guard at that time.

Documents:

Annual or Biennial Reports of the Adjutant General to the Governor 1918-1942 (for each state).

These items are superb sources of information on National Guard unit organization, activation, inactivation, transfer, conversion, Federalization, active duty for state emergencies, etc. Frequently they include information on unit summer training activities and locations, as well as information on commander assignments. Most state Adjutants General prepared these reports, but not all. A large number of these records are located at the Army Heritage Education Center at Carlisle Barracks, PA. Typically, copies can also be found in the state National Guard archives, state and Federal repository libraries, and state historical societies.

Army Heritage Education Center/Military History Institute, Carlisle Barracks, PA

Maneuver and Command Post Exercise Reports:

War Department. U.S. Army War College. *Report of the First Army Command Post Exercise, 1937.*

———. *Reports of the First Army Maneuvers in New York, 1938 and 1940.*

———. *Final Report of the First Army Maneuvers 1939 and 1941.*

———. *Report of the Second Army Command Post Exercise, 1936.*

———. *Report of the Second Army Command Post Exercise, 1938.*

———. *Report of the Mobilization Phase, Second Army Command Post Exercise, 1939.*

———. *Reports of the Second Army Maneuvers in Illinois in 1938, 1939, and 1940.*

———. *Reports of the Second Army Maneuver, 1940.*

———. *Reports of the Third Army Maneuvers in Georgia, Texas, Wyoming in 1938 and 1940.*

———. *Report of the Fourth Army Maneuver 1937.*

———. *Reports of the Fourth Army Maneuvers in Minnesota, Washington, and California in 1940 and 1941.*

———. *Reports on Department Maneuvers, Hawaiian Department, May 1941.*

———. *Reports on Sixth and Seventh Corps Area Maneuvers, Camp McCoy, WI, and Vicinity 1939, 1940, 1941.*

———. *Report of the VII Corps Maneuver, Arkansas-Louisiana, 1941*.

General Headquarters, U.S. Army. *Report of the Second versus Third Army Maneuvers, 1941*. Camp Polk, LA, 1941.

Combined Arms Research Library, Fort Leavenworth, KS

War Department. *Annual Reports of the Secretary of War*. Washington, D.C.: Government Printing Office, (years 1919-1941).

These multivolume sets also include reports from Army and Bureau chiefs such as the Chief of Engineers, the Surgeon General, Quartermaster General, Chief Signal officer, etc. Typically, copies can also be found in the state archives, state and Federal repository libraries, and state historical societies.

War Department. *War Department General Orders*. Washington, D.C.: Government Printing Office, (years 1919-1941).

Issued periodically throughout each fiscal year and collected in annual volumes. Each has useful information on War Department directed or Army-wide unit changes including assignments, designations, inactivations, etc. Also includes key assignments of general officers.

War Department, Adjutant General's Office. *Army List and Directory*, Washington, DC: Government Printing Office, (years 1919-1940).

This publication, which was issued at various intervals between 1 March 1919-20 October 1940, lists Regular Army officers by relative rank, by branch, assignments to National Guard, Organized Reserve, and Reserve Officers' Training Corps units, military attaches, and general officers. Each issue gives a mailing address and general assignment for each officer at the time of publication. They were published at the following intervals: monthly, March 1919-April 1922; bimonthly, June 1922-May 1930; quarterly, July 1930-July 1933; semiannual, December 1933-October 1940. No directories were ever issued for January, March, April, June, and August 1921; December 1922; and April 1933. There are a number of locations around the country that have at least partial collections of this publication.

War Department, Adjutant General's Office, *Unit Officer Rosters*, microfilm.

This resource is located at two locations: the National Personnel Records Center at 9700 Page Blvd, St. Louis MO, and the Combined Arms Research Library at Fort Leavenworth, KS. These monthly rosters detail officer assignments and changes to all Regular Army mobile (T/O) and Table of Distribution (i.e. garrison, schools, CCC, etc.) organizations from January 1920 to October 1939. This was the primary source of Regular Army unit commander information 1920-1939.

US Army Tables of Organization 1919-1941.

An (almost) complete set of the Tables of Organization for U.S. Army organizations 1919 to 1941, including Air Service/Air Corps, are held by the Combined Arms Research Library at Fort Leavenworth, KS.

Air Force Historical Research Agency, Maxwell Air Force Base, AL

“Old” Organized Reserve Cards.

These 3” x 5” cards, formerly retained by the Office of Military History, CMH's predecessor, were transferred to Air Force control sometime after 1947. They, like their ground forces counterparts, were the official record of Air Service/Air Corps Organized Reserve organizations during the 1921-1942 period. They include information on unit initiation, inactivations, transfers, assignments, and other important events that affected the unit.

Unofficial Sources:

Unofficial Lineage Sources:

Sawicki, James A. *Infantry Regiments of the U.S. Army*. Dumfries, VA: Wyvern Publications, 1981.

———. *Cavalry Regiments of the U.S. Army*. Dumfries, VA: Wyvern Publications, 1985.

———. *Field Artillery Battalions of the U.S. Army*, Volumes I and II. Dumfries, VA: Centaur Publications, 1978.

———. *Antiaircraft Artillery Battalions of the U.S. Army*, Volumes I and II. Dumfries, VA: Centaur Publications, 1991.

———. *Tank Battalions of the U.S. Army*. Dumfries, VA: Wyvern Publications, 1983.

General Histories:

Crossland, Richard B. and James T. Currie. *Twice the Citizen: A History of the United States Army Reserve, 1908-1983*. Washington, DC: Office of the Chief of the Army Reserve, 1984.

Army and Navy Publishing Annuals and Pictorial Reviews:

This series of "unit annuals" published by the Army and Navy Publishing Company are superb sources for unit histories from division-level down to the company-, troop-, and battery-level. They usually include biographies of regimental commanders and above. Unfortunately none exist for New York, Pennsylvania, California, Kansas, Minnesota, Mississippi, Utah, Nevada, Puerto Rico, Alaska, or Hawaii for the state series. A handful of divisions and other commands opted to have similar annuals created as well.

State National Guard Annuals and Pictorial Reviews:

Historical Annual, National Guard of the State of Alabama. Baton Rouge, LA: Army and Navy Publishing Co., 1938

Historical and Pictorial Review, National Guard of the State of Arizona. Baton Rouge, LA: Army and Navy Publishing Co., 1939

Historical Annual, National Guard of the State of Arkansas. Baton Rouge, LA: Army and Navy Publishing Co., 1938.

Historical and Pictorial Review, National Guard of the State of Colorado. Baton Rouge, LA: Army and Navy Publishing Co., 1939.

Historical and Pictorial Review, National Guard, Naval Militia, and Governor's Guard of the State of Connecticut. Baton Rouge, LA: Army and Navy Publishing Co., 1939.

Historical and Pictorial Review, National Guard of the State of Delaware. Baton Rouge, LA: Army and Navy Publishing Co., 1940.

Historical and Pictorial Review, National Guard of the District of Columbia. Baton Rouge, LA: Army and Navy Publishing Co., 1940.

Historical Annual, National Guard of the State of Florida. Baton Rouge, LA: Army and Navy Publishing Co., 1939.

Historical and Pictorial Review, National Guard of the State of Georgia. Baton Rouge, LA: Army and Navy Publishing Co., 1939.

Historical Annual, National Guard of the State of Idaho. Baton Rouge, LA: Army and Navy Publishing Co., 1938.

Historical and Pictorial Review, National Guard and Naval Militia of the State of Illinois. Baton Rouge, LA: Army and Navy Publishing Co., 1940.

Historical Annual, National Guard of the State of Indiana. Baton Rouge, LA: Army and Navy Publishing Co., 1938.

Historical Annual, National Guard of the State of Iowa. Baton Rouge, LA: Army and Navy Publishing Co., 1938.

Historical Annual, National Guard of the Commonwealth of Kentucky. Baton Rouge, LA: Army and Navy Publishing Co., 1938.

Historical Annual, National Guard of the State of Louisiana. Baton Rouge, LA: Army and Navy Publishing Co., 1938.

Historical and Pictorial Review, National Guard of the State of Maine. Baton Rouge, LA: Army and Navy Publishing Co., 1939.

Historical and Pictorial Review, National Guard and Naval Militia of the United States, State of Maryland. Baton Rouge, LA: Army and Navy Publishing Co., 1940.

Historical and Pictorial Review, National Guard and Naval Militia of the Commonwealth of Massachusetts. Baton Rouge, LA: Army and Navy Publishing Co., 1939.

Historical and Pictorial Review, National Guard of the State of Michigan. Baton Rouge, LA: Army and Navy Publishing Co., 1940.

Historical Annual, National Guard and Naval Militia of the State of Missouri. Baton Rouge, LA: Army and Navy Publishing Co., 1939.

Historical and Pictorial Review, National Guard of the State of Montana. Baton Rouge, LA: Army and Navy Publishing Co., 1940.

Historical Annual, National Guard of the State of Nebraska. Baton Rouge, LA: Army and Navy Publishing Co., 1938.

Historical and Pictorial Review, National Guard of the State of New Hampshire. Baton Rouge, LA: Army and Navy Publishing Co., 1939.

Historical and Pictorial Review, National Guard of the State of New Jersey. Baton Rouge, LA: Army and Navy Publishing Co., 1940.

Historical and Pictorial Review, National Guard of the State of New Mexico. Baton Rouge, LA: Army and Navy Publishing Co., 1940.

Historical Annual, National Guard of the State of North Carolina. Baton Rouge, LA: Army and Navy Publishing Co., 1938.

Historical and Pictorial Review, National Guard of the State of North Dakota. Baton Rouge, LA: Army and Navy Publishing Co., 1940.

Historical and Pictorial Review, National Guard and Naval Militia of the State of Ohio. Baton Rouge, LA: Army and Navy Publishing Co., 1938.

Historical Annual, National Guard of the State of Oklahoma. Baton Rouge, LA: Army and Navy Publishing Co., 1938.

Historical Annual, National Guard of the State of Oregon. Baton Rouge, LA: Army and Navy Publishing Co., Army and Navy Publishing Co., 1938.

Historical and Pictorial Review, National Guard of the State of Rhode Island. Baton Rouge, LA: Army and Navy Publishing Co., 1940.

Historical Annual, National Guard of the State of South Carolina. Baton Rouge, LA: Army and Navy Publishing Co., 1938.

Historical Annual, National Guard of the State of South Dakota. Baton Rouge, LA: Army and Navy Publishing Co., 1938.

Historical and Pictorial Review, National Guard of the State of Tennessee. Baton Rouge, LA: Army and Navy Publishing Co., 1939.

Historical and Pictorial Review, National Guard of the State of Texas. Baton Rouge, LA: Army and Navy Publishing Co., 1939.

Historical and Pictorial Review, National Guard of the State of Vermont. Baton Rouge, LA: Army and Navy Publishing Co., 1939.

Historical and Pictorial Review, National Guard of the Commonwealth of Virginia. Baton Rouge, LA: Army and Navy Publishing Co., 1940.

Historical Annual, National Guard of the State of West Virginia. Baton Rouge, LA: Army and Navy Publishing Co., 1938.

Historical and Pictorial Review, National Guard and Naval Militia, State of Wisconsin. Baton Rouge, LA: Army and Navy Publishing Co., 1939.

Historical and Pictorial Review, National Guard of the State of Washington. Baton Rouge, LA: Army and Navy Publishing Co., 1939.

Historical and Pictorial Review, National Guard of the State of Wyoming. Baton Rouge, LA: Army and Navy Publishing Co., 1940.

Unit Historical and Pictorial Reviews:

This series of "unit annuals" published by the Army and Navy Publishing Company are similar in format and appearance as those list in the State National Guard series above.

Historical and Pictorial Review, Eighth Motorized Division. Baton Rouge, LA: Army and Navy Publishing Co., 1942.

Historical and Pictorial Review, 6th Infantry Division. Baton Rouge, LA: Army and Navy Publishing Co., 1942.

Historical and Pictorial Review, 27th Division. Baton Rouge, LA: Army and Navy Publishing Co., 1942.

Historical and Pictorial Review, 33d Division. Baton Rouge, LA: Army and Navy Publishing Co., 1942.

Historical and Pictorial Review, 37th Division. Baton Rouge, LA: Army and Navy Publishing Co., 1942.

Historical and Pictorial Review, 38th Division. Baton Rouge, LA: Army and Navy Publishing Co., 1942.

Historical and Pictorial Review, 43d Division. Baton Rouge, LA: Army and Navy Publishing Co., 1942.

Historical and Pictorial Review, 514th Coast Artillery. Baton Rouge, LA: Army and Navy Publishing Co., 1942.

Historical and Pictorial Review, Harbor Defenses of Los Angeles. Baton Rouge, LA: Army and Navy Publishing Co., 1941.

Historical and Pictorial Review, Harbor Defenses of San Francisco. Baton Rouge, LA: Army and Navy Publishing Co., 1941.

State National Guard Histories-General by State:

Balkoski, Joseph M. *The Maryland National Guard: A History of Maryland's Military Forces, 1634-1991*. Baltimore, MD: Maryland National Guard, 1991.

Bauer, Richard E. *The Spirit of the Guard: The Iowa National Guard in Two Wars*. Sheldon, IA: 1980

Casso, Evans J. *Louisiana Legacy: A History of the State National Guard*. Gretna, LA: Pelican Publishing Co., 1976.

Hawk, Robert. *Florida's Army: Militia/State Troops/National Guard 1565-1985*. Englewood, FL: Pineapple press, 1986.

Krenek, Harry L. "A History of the Texas National Guard Between World War I and World War II." Unpublished Ph.D. dissertation Texas Tech University, Lubbock, TX, 1970.

Nankivell, John H. *History of the Military Organizations of the State of Colorado 1860-1935*. Denver, CO: W. H. Kistler Stationery Co., 1935.

Unit Histories-General:

Barry, Herbert. *Squadron A: A History of Its First Fifty Years 1889-1939*. New York: Association of Ex-Members of Squadron A, 1939.

Brewer, James H. F. *History of the 175th Infantry (Fifth Maryland)*. Baltimore, MD: War Records Division, Maryland Historical Society, 1955.

Clay, Steven E. *Blood and Sacrifice: The History of the 16th Infantry Regiment from the Civil War to the Gulf War*. Chicago, IL: Cantigny First Division Foundation, 2001.

———. "The Texas Cavalry: The History of the 56th Cavalry Brigade." Master's degree thesis, Texas State University, San Marcos, TX, 1990.

Crist, Robert G. *The First Century: A History of the 28th Infantry Division*. Harrisburg, PA: 28th Infantry Division, 1979.

Davies, Kenneth M. *To the Last Man: The Chronicle of the 135th Infantry Regiment of Minnesota*. St. Paul, MN: Ramsey County Historical Society, 1982.

Lisle, Clifton H. *Regimental History of the 316th Infantry, Volume II*. Philadelphia, PA: Tracy Press, 1938.

———. *Regimental History of the 316th Infantry, Volume III*. Philadelphia, PA: Tracy Press, 1951.

Nelson, Guy. *Thunderbird: A History of the 45th Infantry Division*. Oklahoma City, OK: 45th Infantry Division Association, 1970.

Solvick, Stanley D. *Let The Drum Beat: A History of the Detroit Light Guard*. Detroit, MI: Wayne State University Press, 1988.

Young, Ford E. *To the Regiment: The History of the 306th Cavalry and the 306th Armored Cavalry Group*. Washington DC: National Capitol Publishing Co., 1970.

Orders of Battle:

Directory of the U.S. Army 1941, Troop Unit Basis.

Call # UA 26.A4 (1941) located the Infantry School Library, Fort Benning Georgia.

Niehorster, Leo W. G. *Order of Battle, 7 December 1941, Volume I: Corps Areas, Continental Commands, and Overseas Commands*. Buckinghamshire, UK: The Military Press, 2005.

———. *Order of Battle, 7 December 1941, Volume II: Air Force Combat Command and Chief of Air Corps*. Buckinghamshire, UK: The Military Press, 2005.

Stanton, Shelby L. *Order of Battle, U.S. Army, World War II*. Novato, CA: Presidio Press, 1984.

Army Maneuvers and Command Post Exercises:

Gabel, Christopher R. *The U.S. Army GHQ Maneuvers of 1941*. Washington, DC: Government Printing Office, 1991.

Fourth Army Maneuvers, Minnesota Area, August 1940. Baton Rouge, LA: Army & Navy Publishing Co. 1940

Fourth Army Maneuvers, Fort Lewis-Chehalis, State of Washington, August 1940. Baton Rouge, LA: Army & Navy Publishing Co. 1940

Moenk, Jean. *A History of Large-Scale Maneuvers in the United States 1935-1964*. Fort Monroe, VA: US Continental Army Command, 1969.

Second Army Maneuvers, Wisconsin Area, August 1940. Baton Rouge, LA: Army & Navy Publishing Co. 1940

Distinctive Unit Insignia:

This items are useful for determining the distinctive unit insignia associated with army organizations. James Sawicki's books listed in the "Unofficial Lineage Sources" section are also excellent sources for this kind of information.

Massaro, Joseph M. *Distinctive Insignia of the U.S. Army Air Forces 1924-1947*. Austin, TX: International Publishing Co., 1987.

Distinctive Unit Insignia Catalogs of the American Society of Military Insignia Collectors:

Air Forces Catalog, undated.

Armor-Cavalry Catalog, December 1973.

Artillery Catalog, Part 1, December 1979; Part 2, April 1980; and Part 3, August 1980; Part 4, August 1981.

Coast Artillery, Antiaircraft Artillery, and Air Defense Artillery Catalog, December 1999.

Engineer Catalog, Volume 1, December 1996, Volume 2, September 1998.

Infantry Catalog, Part 1, January 1986; Part 2, April 1987; and Part 3, December 1987.

Maintenance Catalog, March 1976.

Medical Corps Catalog, March 1967

Military Police Corps, September 1966.

ROTC Catalog, parts 1-8, various dates.

Signal Corps Catalog, December 1985.

Supply Catalog, undated.

Transportation Catalog, May 1972.

Other Unit Commander Resources:

Compiling the unit commander lists was the most difficult aspect of creating this order of battle. The *Unit Officer Rosters* listed above were the primary source for RA officers, but the *Army List and Directory* and the sources listed below were very helpful as well. OR commander lists were compiled from myriad sources, but the primary source was the corps area special orders in RG 394. The primary sources for NG officers were the various *National Guard Registers* listed above as well.

Army Medical Bulletin. Medical Field Service School, Carlisle Barracks, PA: 1927.

Bulletin No. 21, 1927 has a complete listing of commanders for OR medical units across the United States.

Robinson, Wirt, Ed. *Biographical Register of the Officers and Graduates of the United States Military Academy, Volumes VI A and VI B, Supplement 1910-1920*. Saginaw, MI: Seeman and Peters, 1920.

All four volumes of the Biographical Register, commonly known as "Cullum's" are excellent sources of information on Regular Army officers and their assignments.

Donaldson, William H., Ed. *Biographical Register of the Officers and Graduates of the United States Military Academy, Volume VII, Supplement 1920-1930*. Chicago, IL: Lakeside Press, 1931.

Farman, Elbert E., Ed. *Biographical Register of the Officers and Graduates of the United States Military Academy, Volume VIII, Supplement 1930-1940*. Chicago, IL: Lakeside Press, 1941.

Branham, Charles N., Ed. *Biographical Register of the Officers and Graduates of the United States Military Academy, Volume IX, Supplement 1940-1950*. Unknown Publisher, 1955.

Roster of Officers, 61st Cavalry Division. New York City, NY: HQ, 61st Cavalry Division.

Copy in author's collection.

Roster of Officers, 81st Division. Knoxville, TN: HQ, 81st Division.

Copy in author's collection.

Roster of Officers, 88th Division. Minneapolis, MN: HQ, 88th Division.

Military Professional and Branch Magazine and Journal Sources:

These professional journals and periodicals are excellent for random information of units and commanders of all three Army components.

Aero Digest: The Magazine of the Air. New York City, NY: Aeronautical Digest Publishing Corporation, (years 1919-1941).

Air Service News Letter (later *Air Corps News Letter*). Washington, DC: War Department Aeronautical Information Branch, (years 1919-1935).

Titles of this item varied: *Air Service News Letter*, 5 April 1919-12 November 1926; *U.S. Army Air Corps News Letter*, 13 December 1926-January 1927; *Air Corps News Letter*, February 1927-15 December 1935.

Army and Navy Journal: The Gazette of the Land, Sea, and Air. Washington, DC: Army and Navy Publishing Co., (years 1919-1941).

Artillery Journal. Fort Monroe, VA: Coast Artillery School, (years 1919-1922).

Cavalry Journal: Journal of the U.S. Cavalry Association. Washington, DC: U.S. Infantry Association (years 1919-1941).

Coast Artillery Journal. Fort Monroe, VA: Coast Artillery School, (years 1922-1941).

Field Artillery Journal. Washington, DC: Monumental Printing Co., (years 1922-1941).

Infantry Journal. Washington, DC: U.S. Infantry Association (years 1919-1941).

Military Engineer: Journal of the Society of American Military Engineers. Washington, DC: Society of American Military Engineers (years 1919-1941).

The Military Surgeon. Washington, DC: Association of Military Surgeons of the United States (years 1919-1941).

Quartermaster Review. Washington, DC: U.S. Army Quartermaster Association (years 1919-1941).

The Reserve Officer: Journal of the Reserve Officers Association. Washington, DC: Reserve Officers Association, (years 1919-1941).

U.S. Air Services: Journal of the Army and Navy Air Service Association. Washington, DC: Air Service Publishing Co., (years 1919-1941).

U.S. Army Recruiting News. Governors Island, NY: Recruiting Publicity Bureau, (years 1919-1941).

Veterinary Bulletin. Carlisle Barracks, PA: Medical Field Service School.

Organized Reserve and National Guard Bulletins and Newsletters

These items are superb records covering Organized Reserve unit activities, changes of command and other events affecting OR organizations, when they can be located. Information has been added to indicate where at least some issues of these valuable items may be found ("several issues" = 2-4; "partial collection" = 5 or more issues).

The Spirit of 76: Bulletin of the 76th Division. Hartford, CT: HQ, 76th Division.

A partial collection exists at the Sterling Memorial Library, Yale University, New Haven, CT.

78th Division Gazette: Bulletin of the 78th Division. Newark, NJ: HQ, 78th Division.

Only known copy is in RG 394, National Archive II, College Park, MD.

Bulletin 79th Division. Philadelphia, PA: HQ, 79th Division.

Several issues are available at the Pennsylvania Historical Society, Harrisburg, PA. One issue in the author's collection.

Bulletin, 80th Division. Richmond, VA: HQ, 80th Division.

Only known copy is in RG 394, National Archive II, College Park, MD.

The Wildcat: Bulletin of the 81st Division. Knoxville, TN: HQ, 81st Division.

All American: Bulletin of the 82d Division. Columbia, SC: HQ, 82d Division.

The Ohioan: Bulletin of the 83d Division. Columbus, OH: HQ, 83d Division.

85th Division Bulletin. Detroit, MI: HQ, 85th Division.

Blackhawk Bulletin: Bulletin of the 86th Division. Chicago, IL: HQ, 86th Division.

The Acorn: Bulletin of the 87th Division. New Orleans, LA: HQ, 87th Division.

Only known copy is in RG 394, National Archive II, College Park, MD.

The Cloverleaf: Bulletin of the 88th Division. Minneapolis, MN: HQ, 88th Division.

A complete set of *The Cloverleaf* can be found at the Minnesota Historical Society, St. Paul, MN. A partial set can be found at the State Historical Society at the North Dakota State Archives, Bismarck, ND.

The Mid-West: Bulletin of the 89th Division. Omaha, NE: HQ, 89th Division.

Bulletin 90th Division: San Antonio, TX: HQ, 90th Division.

Several issues are available at the Barker History Center, University of Texas at Austin. Copies in the author's collection.

The Bulletin of the 91st Division: San Francisco, CA: HQ, 91st Division.

Several issues are available at the California State Historical Society, San Francisco, CA. Copies in the author's collection.

Bulletin of the 94th Division, United States Army and Organized Reserves in Massachusetts: Boston, MA: HQ, 94th Division.

At least one issue is available at the Army History Education Center, Carlisle Barracks, PA. One copy in the author's collection.

The Observation Post: Bulletin of the 95th Division and Organized Reserve Units in the State of Oklahoma. Oklahoma City, OK: HQ, 95th Division.

Several issues are available at the Oklahoma Historical Society, Oklahoma City, OK. Copies in the author's collection.

The Columbian: Bulletin of the 96th Division. Portland, OR: HQ, 96th Division.

Several issues are available at the Holland and Terrell Libraries, Washington State University, Pullman, WA. Copies in the author's collection.

The 97th Division Bulletin. Manchester, NH: HQ, 97th Division.

The Century, Bulletin of the 100th Division. Charleston and Huntington WV: HQ, 100th Division.

The Iron Division: Bulletin of the 101st Division. Milwaukee, WI: HQ, 101st Division.

Several issues are available at the Wisconsin Veterans Museum Research Center and others at the Wisconsin Historical Society, both in Madison Wisconsin. Copies in the author's collection.

The Ozark: A Bulletin of the 102d Division. St. Louis, MO: HQ, 102d Division.

Several issues are available at the University of Missouri at Kansas City, Kansas City, MO. Copies in the author's collection.

The Cactus: Bulletin of the 103d Division and a Catalog of Organized Reserve Activities. Denver, CO: HQ, 103d Division.

A partial collection is available at the Denver Public Library, Denver, CO. Copies of several issues in the author's collection.

The Forager: Bulletin of the 61st Cavalry Division. New York City, NY: HQ, 61st Cavalry Division.

A partial collection is available at the Cavalry Museum, Fort Riley, KS.

Bulletin of the 62d Cavalry Division. Hagerstown and Towson, MD: HQ, 62d Cavalry Division.

A partial collection is available at the Cavalry Museum, Fort Riley, KS.

The Arrowhead: Bulletin of the 64th Cavalry Division. Louisville, KY: HQ, 64th Cavalry Division.

A partial collection is available at the Cavalry Museum, Fort Riley, KS.

The Chevaliers: Bulletin of the 65th Cavalry Division. Chicago, IL: HQ, 65th Cavalry Division.

A partial collection is available at the Cavalry Museum, Fort Riley, KS.

Pennsylvania Guardsman. Harrisburg, PA: Pennsylvania National Guard.

Sabers: Bulletin of the 56th Cavalry Brigade. Austin, TX: HQ, 56th Cavalry Brigade.

A partial collection is available at the Cavalry Museum, Fort Riley, KS.

The Artillerist: Organized Reserve Bulletin of the First Coast Artillery District. Boston, MA: HQ, First Coast Artillery District.

One issue in author's collection.

Coast Artillery

Besides some of the items listed below, the Coast Defense Study group has a plethora of material available on coast artillery units and other subjects. It can be found on-line at: <http://www.cdsg.org/>

Berhow, Mark A. *Modern American Seacoast Defenses: A List of Military Reservations and Concrete Gun Batteries, 1890-1950.* Coast Defense Study Group, 1994.

This article is an online reference available at <http://www.cdsg.org/reprint%20PDFs/CDList11.pdf>

The article is an extract from: Berhow Mark A., ed. *American Seacoast Defenses, a Reference Guide.* Bel Air, MD: CDSG Press, 2004.

Berhow, Mark A. and David Gustafson. *The Guardian at Angels Gate: Fort MacArthur, Defender of Los Angeles.* San Pedro, CA: Fort MacArthur Military Press, 2001.

Chin, Brian B. *Artillery at the Golden Gate: The Harbor Defenses of San Francisco in World War II.* Missoula, MT: Pictorial Histories Publishing Co., 1994.

Gaines, William C. "Coast Artillery Organizational History, 1917-1950, Part I, Coast Artillery Regiments 1-196." *The Coast Defense Journal*, Volume 23, Issue 2, 4-51.

Gaines, William C. "Coast Artillery Organizational History, 1917-1950, Part II, Coast Artillery Regiments, OR and AUS." *The Coast Defense Journal*, Volume 23, Issue 3, 70-92.

Small, Charles S. *California's Railway Guns*. Canton, OH: Railhead Productions, 1983.

Air Service/Air Corps

Arakaki, Leatrice R. and John R. Kuborn. *7 December 1941, The Air Force Story*. Hickam AFB, HI: Office of History, Pacific Air Forces, 1991.

Cameron, Rebecca H. *Training to Fly: Military Flight Training, 1907-1945*. Washington, DC: Government Printing Office, 1999.

Cantwell, Gerald T. *Citizen Airmen: A History of the Air Force Reserve 1946-1994*. Washington, DC: Government Printing Office, 1997.

Mauer, Mauer. *Aviation in the U.S. Army, 1919-1939*. Washington, DC: Office of Air Force History, 1987.

Mauer, Mauer, ed. *Combat Squadrons of the Air Force in World War II*. Washington, DC: Office of Air Force History, 1986.

Maurer, Maurer, ed. *Air Force Combat Units of World War II*. Washington, DC: Office of Air Force History, 1986.

Shock, James R. *U.S. Army Airships 1908-1942*. Edgewater FL: Atlantis Productions, 2002.

Other On-Line Resources

Newspaper Archive, <http://newspaperarchive.com/>

Newspaper Archive was a great source of information on units from all three components and especially for OR commanders.

ProQuest, [http://proquest.com./](http://proquest.com/)

ProQuest was an excellent source of information of National Guard and Organized Reserve units and personnel assignments in the Second Corps Area via the *New York Times*. This source, however is far more limited than either Newspaper Archive or NewsBank in terms of the number of newspapers available.

NewsBank, "America's GenealogyBank," [http://newsbank.com./](http://newsbank.com/)

While better than ProQuest in terms of available newspapers, NewsBank is more limited than Newspaper Archive in terms of unit information. Still, it was a very useful source of information on units from all three components because it covers a different set of papers than Newspaper Archive.

Appendix A

Glossary

These terms are used throughout this order of battle. They reflect the common usage and definition in use during the period 1919-1941. There are, however, several terms used in this reference that were not contemporary to the period. The non-contemporary terms are identified at the end of their respective definitions.

In most cases, the definitions used for detailing unit lineages for this period are no different than those used by the U.S. Army today. There are some differences, however, and those differences must be taken into account when comparing the official lineages prepared by the Center of Military History with those provided in this order of battle.

Many of the terms included here will be useful for understanding information provided in the unit entries. Others are terms that were commonly used by the U.S. Army during this period and were included primarily to provide the reader a broader understanding of the U.S. Army's organization, administration, training, and functions in the 1919-1941 period.

Activate. To assign personnel to a unit Regular Army unit previously organized and since inactivated, thereby returning that unit to an active duty status. For Organized Reserve units it meant to bring a unit into an active duty status, with or without its assigned Reserve personnel. It was possible for a unit to remain in an active status without personnel assigned though this method was rarely used. The method was used a few times in the 1919-1921 period and accomplished by transferring the unit's colors and records to a new duty station where, upon arrival of the flags and documents, the unit would, shortly thereafter, be reorganized with personnel and equipment (usually from an inactivating unit). For OR units, this term does not apply to units being organized or reorganized in an active Reserve status. For National Guard units see **Reorganize**. See also **Organize** and **Initiate**.

Active Associate (A.A.). This program was established and outlined by War Department General Order Number 32, dated 19 July 1921. Initial assignment of active associate units was outlined in War Department General Order Number 33, dated 27 July 21 and revised by War Department General Order Number 10, dated 24 March 1923. The program provided for the association of Regular Army Inactive (RAI) units with active units. The active unit was designated the "Active Associate." As such, the active unit maintained the records, colors, trophies and other paraphernalia of the RAI unit. In case of a national emergency requiring the expansion of the army, the Active Associate was responsible for providing a cadre to activate its associated RAI unit. Generally, the associated units belonged to the same division or corps. Some RAI units were associated directly with the various department chiefs such as the Surgeon General and Quartermaster General for mobilization responsibility. This program was superseded on 28 February 1927 by War Department General Order Number 3 which directed the assignment of RAI units directly to corps areas and departments for mobilization responsibility. Under the revised program, many, though not all, RAI units were organized similarly to standard Organized Reserve units. Certain RAI units were also affiliated with certain civilian agencies for mobilization purposes as well. See **Affiliate**.

Active Federal Service. Active duty by a National Guard unit when under the control of the United States government rather than under the control of its state government.

Active Training (also referred to as Active Duty Training, Annual Training, Summer Training, Summer Camp). Active training generally consisted of the annual fourteen-day training period conducted by National Guard, Organized Reserve, and Regular Army Inactive units, usually conducted sometime between May and August, although it could be conducted virtually anytime during the year. For National Guard units, active training generally consisted of maneuver or live-fire training at one of the state's training camps or, in some cases, Federal military installations. For Organized Reserve units, the active training consisted of several types of training camps. These camps included General Unit Training Camps, Citizens Military Training

Camps, Local Unit Training Camps, Regular Army Training Camps and unit training with a National Guard unit. Annual training also refers to training performed by individual Guardsmen and Reservists with units or agencies other than that to which they were assigned or attendance at a specialized camp for that officer's branch or specialty. Generally, the specialized camps were for the more technical branches, such as medical corps, ordnance corps, and signal corps. Additional types of camps, such as 76th Division camp conducted at the Connecticut Agricultural College at Storrs, were conducted for various reasons. One such reason was to provide a sort of basic training as for newly commissioned second lieutenants who were not yet assigned to divisional units. Others included the School of Arms, School of Tactics, and major maneuvers (see Appendix B, Abbreviations, for a complete list of camps).

Affiliate. To place a Regular Army Inactive (RAI) or Organized Reserve unit under the sponsorship of a civilian or government organization by mutual agreement between the War Department and the sponsoring agency. In the interwar period, typical affiliated units included the following: selected Regular Army Inactive organizations (mostly combat arms) that were affiliated with college/university ROTC programs; Organized Reserve signal corps units that were affiliated with regional communications corporations; Organized Reserve general, surgical, and station hospitals that were affiliated with community, college/university, or specialized (e.g. burn, surgical, physical therapy) hospitals; and Organized Reserve engineer railway battalions affiliated with regional railroad companies. Typically, the agreement provided that the sponsoring agency would organize the OR or RAI unit with its company/ institution personnel. In these type of units it was not unusual for hospital directors, key railroad executives, and telecommunications company presidents to join as the unit's commander.

Allocation Board. The War Department had the responsibility to allot National Guard and Organized units to a state area. For the allotment of units in 1920 and 1921, as far as possible historical geographical ties were considered when allotting units to state areas in accordance with the directives of the 1920 National Defense Act. Once a unit was allotted, a board of officers, approved by the state governor, was detailed to assigned subordinate units to a specified geographical area within the state. Boards for allotting Organized Reserve units, as originally constituted in 1921, consisted of at least one Regular Army officer, one National Guard officer, one or more Organized Reserve officer, and a board secretary. A board allocating National Guard units consisted of the same composition except that it would have no Reservist and at least two or more Guard officers. The Regular Army officer on a Guard allocation board, usually the state's senior instructor, was present for advice only and held no veto over the stationing of Guard units. Initially, subordinate Reserve units were allotted by congressional districts or counties. The designated region was the area from which the enlisted personnel for the unit were to be recruited for mobilization purposes. The board additionally designated a town or city as the unit's headquarters. This headquarters was also the designated Rendezvous Point at which the officers and men recruited from the region for the unit would assemble for movement to the designated mobilization training station. This practice gradually fell away in the late 1920s and 1930s as geographically dispersed units were consolidated by subsequent boards into larger towns and cities. Concurrently, the concept of local recruiting was dropped in favor of relying solely on the draft for enlisted personnel not already in the ERC and assigned to the unit upon the receipt of mobilization orders.

Allot. To assign a unit to one of the three components of the United States Army. In the interwar period, the components consisted of the Regular Army, National Guard, and Organized Reserve. Allotment also refers to assignment to a geographical area for organization and mobilization purposes. For example, National Guard units were allotted to the various states and territories, and the Commonwealth of Puerto Rico. Regular Army Inactive units were allotted to one of the nine corps areas or one of the three overseas departments. Organized Reserve units were allotted to one of the nine corps areas only.

Arm and Service Assignment Group (A&SAG). See **Branch Assignment Group.**

Army of the United States. A term created by the National Defense Act of 1920 to identify the three components of the Army (Regular Army, National Guard, and Organized Reserve) as parts of one, harmonious, and effective army—the Army of the United States. The Regular Army, National Guard, and Organized Reserve composed the first, second, and third echelons of the land forces of the United States. In an emergency that required maximum mobilization, each component was responsible for furnish enough troops for six complete field armies, plus certain harbor defense, Zone of the Interior, and Communications Zone units. The War Department’s vision for such a mobilization required the Regular Army to oppose an invasion of the United States long enough to give the National Guard time to mobilize, prepare, and come to the assistance of the Regular Army. These two components would likewise bear the brunt of the fighting until the Organized Reserves could mobilize, assemble, train, and join the fight.

Artillery Group (or “Artillery Assignment Group”). Organized Reserve (and later RAI) field artillery and coast artillery personnel in each corps area not assigned to artillery units in infantry or cavalry divisions, were managed by the Artillery Group. The exception to this was coast artillery units in the First, Second, Third, Fourth, and Ninth Corps Areas. Those units and their personnel were managed by the Coast Artillery District headquarters of their respective corps areas. The various artillery group headquarters were organized in 1925 upon the inactivation of the various corps headquarters and establishment of the Non-Divisional and Artillery Groups. The Artillery Group had a Regular Army chief of staff and unit instructors who performed this duty for non-divisional artillery units of the corps area. Their duties included assistance in developing training schedules, enrollment in extension courses, and conducting instruction at meetings. The Artillery Group also managed the preparation and selection of non-divisional artillery officers and units that were ordered to camp each year.

Assign. To designate a unit, on orders at War Department level, as a permanent subordinate unit of a higher headquarters (e.g. the 16th Infantry Regiment is assigned to the 1st Division) for operational, administrative, and logistical command, control, and support.

Attach. To designate a unit, usually on orders at Corps Area level, as a temporary subordinate unit of a higher headquarters (e.g. the 501st Infantry Battalion is attached to the 94th Division) for operational, administrative, and logistical control and support.

Authorize. To place the designation of a new unit (i.e., never previously constituted) on the official rolls of the U. S. Army. This term has the same meaning as the term, “constitute,” but was apparently used only in reference to certain Air Service units in the 1919-1922 period. It was used in lieu of constitute in a relatively few instances and there seems to be no pattern or discernible difference in the term. The term was not used for any new Air Service (or Air Corps) units after 1922.

Auxiliary Reserve. Established by Circular #60, War Department, 15 September 1924. Redesignated 1 October 1935 as the “Inactive Reserve.” The Auxiliary Reserve was a personnel management category primarily for Reserve officers who had reached sixty-four years of age. It was equivalent to the Regular Army retired list. Reserve officers who did not earn enough points during the year to remain qualified for camp attendance or promotion were also involuntarily transferred to the Auxiliary Reserve. Additionally, Reservists in good standing who had not reached sixty-four years of age could also request to be transferred to the Auxiliary Reserve. Officers in the latter two categories were not authorized to be slotted against mobilization assignments and were not eligible for promotion, mobilization, or active duty for training until they earned enough points during the current fiscal year to transfer back into an active reserve status.

Branch Assignment Group (B.A.G.). Organized Reserve personnel assigned to an office, staff section, or non-TOE organizations directly under the administration of the War Department or a chief of arm, service, or corps such as Ordnance, Engineer, or Quartermaster, were assigned to, and managed by the Branch Assignment Group. The Reserve officers managed by the Branch Assignment Group were largely assigned to the office or staff of their respective chiefs of branch for mobilization purposes. In some cases, officers

were also assigned to installations managed by their chief of branch, such as arsenals and ammunition, ordnance, or quartermaster depots. These officers were, in most cases, specialists in a specific occupational field. Many were very well-known experts in various fields of medicine, engineering, and business. They were located all over the United States and did not necessarily reside near the location of their mobilization assignments. Therefore, these officers would usually attend Inactive Training Period meetings with nearby mobile units of their branch. Typically, Branch Assignment Group officers attended summer training at their mobilization assignment location. The Branch Assignment Group was redesignated the Arm and Service Assignment Group (A&SAG) in May 1932.

Call. To bring a National Guard unit into active state service. These duty periods were typically performed for disaster relief, protection of life and property, or other state emergencies. Numerous National Guard units were called to duty in the 1920s and 1930s for riot control during labor disputes, natural disaster relief, to preserve order during elections, to perform martial law in areas that a governor determined that local law enforcement officials could not or would not enforce the laws, or were unable to preserve law and order with local resources. These periods of active duty were paid for by the state, not the Federal government.

Caretaker Status. This term was most typically applied to those coast artillery installations and fixed batteries that were not ready for immediate active service. This generally meant that the weapons, ammunition, and power machinery, less that required for the life support of the caretaker detachment at the post, were placed and maintained in a state of storage. A caretaker detachment, usually one battery of one officer and about thirty enlisted men though it could be as small as five to ten men, was assigned to provide the maintenance and preservation services required to prevent damage and deterioration of the weapons, ammunition, and infrastructure.

Citizens Military Training Camps (CMTC). Established by the National Defense Act of 1920, the Citizens Military Training Camps were the progeny of the pre-World War I "Plattsburg Camps" and the Student Army Training Camps of the Great War. Along with the Reserve Officers Training Corps, the CMTC program was designed to provide military and citizenship training to young men and provide the Officers Reserve Corps with new lieutenants. The program was divided into three four-week courses designated "Red," "White," and "Blue." The Red Course consisted of preliminary and practical military training (school of the soldier). Completion of this course made a candidate eligible to enlist in the Organized Reserve and for attendance at the White Course. The White Course consisted of intermediate military training (small unit tactics, marksmanship, basic aspects of the arm or service of the camp). Completion of this course made a candidate eligible for promotion to non-commissioned officer rank in the Organized Reserve and for attendance at the Blue Course. The Blue Course consisted of advanced military training (leadership, officership, advanced aspects of the arm or service of the camp). Completion of this course made a candidate eligible for commissioning as a second lieutenant in the arm or service in which he was qualified at the three camps. Ideally, a CMTC candidate attended one of these courses each summer over a three-year period. Upon conclusion of the third course, and after the candidate had taken the required pre-commissioning examinations, he would be offered a commission as a second lieutenant in the Organized Reserve. The CMTC program's contribution of new lieutenants to the Organized Reserve in the interwar years was relatively small (ultimately it would produce less than 6,000 lieutenants between 1920 and 1940), but its overall contribution to national defense was much larger. In December 1928, Secretary of War Dwight F. Davis directed that Organized Reserve units (rather than random Reserve personnel) be used in the actual running of CMTC camps and the conduct of training for CMTC cadets. These camps gave Organized Reserve and RAI units one of their few chances to operate like fully functional organizations. Unlike Regular Army or National Guard units, Organized Reserve and RAI units possessed few enlisted men and were essentially officer cadres. Therefore, the Citizens Military Training Camps provided superb opportunities for these units' officers, to conduct the training of organizations and exercise effective command from the squad- to regimental-level. These camps also gave the units' staffs a chance to wrestle with realistic personnel,

training and planning challenges as well. In this way, the CMTC also substantially contributed to preparing tens of thousands of Organized Reserve officers for the leadership demands of military command and staffs. Additionally, the military training provided by the Reservists and their Regular Army counterparts, introduced hundreds of thousands of young men to military discipline, order, and training. Many of these men would later serve in World War II as volunteers, draftees, and, for a substantial number, as officers. In at least these two ways, the CMTC was partially responsible for the U.S. Army's ability to rapidly mobilize for, and fight in, World War II.

Civilian Conservation Corps (CCC). Established by President Franklin D. Roosevelt on 31 March 1933 for the purposes of providing relief to up to 500,000 unemployed, unmarried men between the ages of 18 and 25 years of age. On 12 May 33, Roosevelt directed the War Department to mobilize the CCC and move the enrollees to work camps. By 1 July, almost 250,000 men and boys were equipped, transported, and billeted in 73 camps throughout the United States. The enrollees were given the mission to conduct conservation work in America's forests, national and state parks, and other public lands. Eventually, some 3,465,000 Americans were enrolled in this program and included veterans, minorities, and women. They were billeted at 4,500 different camps in the forty-eight states, Alaska, Hawaii, Puerto Rico, and the Virgin Islands. Administering these camps from April 1933 to about April 1934 required over 3,000 Regular Army officers, 556 Navy and Marine officers and about 300 civilian administrators and physicians. The military significance of the CCC was two-fold. First, the Regular Army contribution to this program required about one-quarter of the officer corps, mostly lieutenants and captains, in full-time administration of the camps. This loss of junior leadership, albeit temporary, affected all branches of the army across the United States. The loss was exacerbated by the fact that none of the overseas garrisons were affected. Additionally, the program was essentially a U.S. Army mission. The CCC was administered at the national level by a government bureau. Below that, however, the CCC was run by the nine corps area commanders. Each corps area was further subdivided into essentially state districts which were in turn run by various division, brigade, and in many cases, regimental commanders. Each of these commanders spent a significant amount of time inspecting and managing their respective districts. This meant that these leaders had less time available to train, and otherwise prepare, their units for war. When one considers the substantial contributions in personnel, time, and resources that the army made to ensure the success of the CCC, it is easy to see why Gen. Douglas MacArthur, the U.S. Army's Chief of Staff at the time, was so concerned about the further degradation of the army's capabilities to defend America in time of war. The second significance of the CCC program to national defense was the call to active duty of thousands of Organized Reserve officers in April 1934 to take over the governance of the camps. For officers who possessed few opportunities to exercise effective leadership of men, the CCC camps provided an intangible, but nevertheless substantial, contribution to preparing thousands of junior officers of the Officers Reserve Corps for the leadership demands of military command. Additionally, the semi-military methods used to manage the enrollees and run the camps introduced hundreds of thousands, perhaps millions, of men who would enlist or be drafted for World War II, to a form of military order and discipline. In at least these two ways, the CCC was partially responsible for the U.S. Army's ability to mobilize for World War II.

Edwin Howard Clark Machine Gun Trophy. Established in 1927 at the bequest of Capt. Edwin Howard Clark, Infantry. Captain Clark, upon his death on 29 July 1923, left money in his will to establish the trophy and competition. A graduate of West Point, Clark served with the 1st Machine Gun Battalion, 1st Division during World War I. He suffered shell shock during the Meuse-Argonne Campaign and was medically retired in 1920. The Clark Trophy was awarded annually to the infantry machine gun company that achieved the highest score per gunner in the regular season's target practice. In addition to the rotating trophy, the unit received a permanently retained bronze plaque and \$300.00 for the unit's soldiers' fund. The 1933 competition was cancelled due to the Great Depression and the requirement for personnel run the newly established CCC camps. The competition resumed in 1934 and lasted until the beginning of World War II.

Columbian Trophy. Awarded annually to the Air Corps flying group that had the lowest accident rate per 1,000 hours of flying time.

Combat Arms. The ground combat branches of the U.S. Army: infantry, cavalry, field artillery, coast artillery, and engineers.

Combat Zone. The combat zone comprised that part of the theater of operations required for the operations of the combatant forces in contact with the enemy. It was defined as the area between the line of contact with the enemy (i.e. the front line) to the rear boundary of the field armies in contact where the communications zone began. It was divided into army areas, sub-divided into corps areas and so forth, all the way down to squads.

Command Post Exercise (CPX). A form of training typically used by the interwar army to train its field army, corps, division, and regimental staffs and exercise each of these headquarters' command and control procedures and communications systems. No subordinate units or soldiers below regimental-level typically participated in these exercises unless they were support units such as signal companies. CPXs were held at various levels, but were used most extensively by the various corps area commanders to train those major commands in their area of responsibility. Corps area CPXs were generally held those years when money was not available to assemble the Regular Army mobile units in that corps area for a maneuver. The first army-level CPX was held by the Second Army in Chicago in 1933 and was followed by the massive GHQ CPX (First Army, Second Army, and GHQ Air Force) in 1934 at Camp Dix and Fort Monmouth, NJ. Beginning in 1936, annual army-level CPXs were planned, hosted, and conducted by the headquarters of the field army that would be assembled the following year for maneuvers. This system continued until 1940 when all four field armies were assembled at various locations across the country for maneuvers in preparation for mobilization that September. The CPX was a valuable method of training staff officers for the major mobilization, logistics, and unit movement problems they would encounter in wartime. Though it is difficult to judge to what degree, surely the U.S. Army's ability to rapidly mobilize, arm, train, and deploy overseas in World War II was due in part by these training events.

Command and Communication Exercise (CCX). A form of Command Post Exercise. This term was used primarily in the Second Corps Area.

Communications Zone (C.Z.). Within a theater of operations (for theoretical purposes generally defined to be overseas), the communications zone (C.Z.) was the area between the rear of the front line field armies and the rear of the theater command's rear areas. In World War I, the C.Z. was operated by a command called the Services of Supply which controlled virtually all logistical operations (supply, construction, transportation, engineering, procurement, and etc.) in the rear areas that supported the front line corps and divisions in the combat zone. Hospitalization and medical support was performed by the Army Medical Department in coordination with the Services of Supply. When constituting new units and developing mobilization plans in 1921 for the event of another major conflict, the WPD assigned numerous organizations to support the communications zone logistical and medical operations. The vast majority of these units were allotted to the Organized Reserve.

Consolidate. To merge or combine two or more units into one unit. The unit may retain the designation of one of the original units or it may be assigned a new designation (see **Redesignate**). The consolidated unit received the history, lineage, and honors of all units affected by the merger. The units affected by the consolidation may have been in either an active or inactive status when the action occurred, although generally, only one of the units was active.

Constitute. To place the designation of a new unit (i.e., never previously constituted) on the official rolls of the U. S. Army.

Contact Camp. Contact camps were training camps designed to specifically train Organized Reserve personnel. The camps generally were of three types. The first and most common camps were weekend

events. These were often held at, and sometimes hosted by, a ROTC program at a college or university. In the Second Corps Area, contact camps were held at locations that were specially procured or provided for each of the three Organized Reserve divisions in that corps area. The second type of contact camp was one to two weeks long and generally held to meet the requirements of the Reserve officers' summer training. This type of camp could also be held in lieu of the summer camp for those officers not selected for active duty training. In those instances, as well as for the weekend camps, the officers were not paid for their attendance. The training activities at a contact camp were of a wide variety, but the camp was often, though not always, developed and conducted with the idea in mind that the Reserve officers attended as individuals, not as part of a unit. Thus, it was not unusual to see officers of many different branches attending the camp. Many regiments, especially those scattered over a large geographical area such as many of those in the western United States, would hold an annual contact camp during the Inactive Training Period with the primary purpose of allowing the unit's officers to get to know each other and their commanders in addition to the training provided at the event. Otherwise, some officers might interact with the other members of the unit only once every three or four years at summer camp. When attending as a unit, the training usually consisted of acquainting the unit with mobilization plans and procedures and aspects of unit administration and training. This was especially true if the unit held the contact camp at its designated mobilization training station. When officers attended as individuals, the training generally consisted of conferences, lectures, and "tactical walks." The training was usually conducted by Regular Army unit instructors assigned to Organized Reserve units or Reserve unit commanders and officers with some form of specialized skill or knowledge, especially in the cases of medical and engineer units. Contact camps were conducted in all corps areas, but they appear to have been most widely used in the First, Second, Fifth, and Eighth Corps Areas.

Convert. To change a unit from one branch of the Army to another (e.g. from cavalry to field artillery). Such a change also includes a redesignation with the unit adopting a name commensurate with those types of units controlled by the branch (e.g. Machine Gun Squadron), therefore the redesignation may not necessarily include the branch name. The unit retains its history, lineage, and honors.

Corps Area. Until September 1920, the United States was organized into geographical units known as "departments" (see **Department**). The National Defense Act of 1920 reorganized the continental United States into nine "corps areas" for the purposes of allotting, mobilizing, administering, and training units, as well as for tactical operations for defense. Overseas territories, namely the Hawaiian Islands, the Philippines, and the Panama Canal retained the title of "Departments." In peacetime, corps area commanders were responsible for the development, organization, training, supply, and inspection of the Regular Army, National Guard, Organized Reserve, Officers' Reserve Corps, Enlisted Reserve Corps, and ROTC units located within the limits of their corps area. In the event of war, each corps area was responsible for mobilizing and training two corps—one composed of largely of Regular Army and National Guard units and the other composed entirely of Organized Reserve units. The corps area would also mobilize its share of army, Communications Zone, and Zone of the Interior organizations. During wartime, the tactical control of corps, corps support units, army support units, divisions, and harbor defense units would be turned over to the headquarters of field armies, or to the headquarters of coast defense commands in the case of the harbor defense organizations. The corps area at that point would function as a corps area support command for Zone of the Interior units and for the field armies located within the corps area limits. Corps Areas were redesignated as "corps area service commands" in May 1941 (see **Corps Area Service Command**).

Corps Area Service Command (CASC). An installation support command consisting of a headquarters unit and a series of administrative and housekeeping units to operate the various installations in the corps area that would support the mobilization activities of the Zone of the Interior in wartime. Corps area service commands were authorized for establishment in each corps area by the War Department General Mobilization Plan (WDGMP) on 20 July 1928. Subordinate units in the CASC were usually, though not always, designated as numbered Corps Area Service Units (CASU). As originally envisioned in the 1928

WDGMP the headquarters of each corps area would also function as the CASC headquarters. The corps areas were in fact redesignated as corps area service commands in May 1941 and were further redesignated simply as “service commands” on 22 July 1942 to reflect their wartime functions.

Corps Area Service Unit (CASU). A subordinate unit of the corps area service command. These units were not T/O units, but were organized based on the installation they were to provide services for in wartime. The organizations were generally numbered in the one thousand series of numbers with the second number identifying the corps area to which the unit belonged. For example a unit such as the 1205th CASU belonged to the Second Corps Area Service Command. A unit such as the 1508th Special Training Battalion belonged to the Fifth Corps Area Service Command and so forth. Most corps areas adopted this numbering system for CASUs in the late 1920s or early 1930s. All corps areas adopted it by 1940.

Deferred National Guard (DNG). The National Defense Act of 1920 provided for a National Guard of 435,800 men. The authorization of those personnel spaces and the various mobile units allotted to the several states and territories, became what was known as the “final allotment” to the National Guard. By late 1922, the various National Guard adjutants general realized that they would not be able to raise and sustain the number of men and units authorized in the final allotment given the existing recruiting realities, availability of existing armories, and budgets. Therefore, a report by the War Department General Staff committee, dated 13 January 1923, amended the plan to provide for the division of the final allotment into two phases. Phase one was designated the “Modified Manpower Program” which limited the number of men to be recruited and sustained by the various state National Guards to 250,000 men. Phase one units were those that were jointly identified by the War Department and individual states to be given priority for organization and which could actually be raised and maintained. Phase two consisted of the “Deferred National Guard” which was often referred to as the “deferred list.” The deferred list was the difference between 435,000 and 250,000 men (185,000 men) and those units that would not be, or could not be, immediately organized. The deferred list units would not be organized in the National Guard until such time that Federal funds and recruiting were sufficient to enable the various states to raise them. Those units were designated as Deferred National Guard units. A DNG unit was temporarily allotted to the Organized Reserve under a different designation and remained so until such time that the state to which the unit was originally allotted indicated that it could organize the unit. At that time, the Organized Reserve unit was to be inactivated (if active) and withdrawn and the original unit requirement and designation reassigned to the National Guard. The deferred list remained in effect until 15 September 1927 when it, and all DNG units, less a few specialized units, were withdrawn from allotment to the National Guard and demobilized. Those few DNG units not withdrawn were then redesignated “National Guard Inactive” units and the unit allotment was returned to the original state for future organization. Few of these units were ever actually organized.

Demobilize. To relieve all personnel from a unit (if active) and remove the designation of the unit from the official rolls of the U.S. Army. If the unit was already inactive, demobilization was then simply a matter of removing the designation of the unit from the official rolls of the U.S. Army. This term is used only for the period of World War I and up to 1938, after which the army began to use the term “disband.” See **Disband.**

Detached Enlisted Men’s List (D.E.M.L.). The Detached Enlisted Men List was a management tool used by the War Department’s Adjutant General section for tracking enlisted personnel who were not assigned to field/mobile units of the Regular Army. Generally speaking, enlisted men placed on the D.E.M.L. were assigned to duties with the National Guard, Organized Reserve, ROTC, the Recruiting Service, the War Department General Staff, and instructor duties at various army service schools and the U. S. Military Academy.

Detached Officers List (D.O.L.). The Detached Officers List was a management tool used by the War Department’s Adjutant General section for tracking officers who were not assigned to field/mobile units of the Regular Army. Generally speaking, officers placed on the D.O.L. were assigned to duties with the

National Guard, Organized Reserve, ROTC, the Recruiting Service, the War Department General Staff, and instructor duties at various army service schools and the U. S. Military Academy.

Department. Until September 1920, the United States was organized into geographical units known as “departments.” The National Defense Act of 1920 reorganized the continental United States into nine “corps areas” for the purposes of allotting, mobilizing, and training units (see **Corps Area**). The three overseas departments—Hawaiian, Philippine, and Panama Canal—remained designated as such after 1920 and into World War II. Departments shared many of the same functions as corps areas, but not all. For example, only the Hawaiian Department bore any responsibility for the management, administration or training of reserve component units. That department had some training and mobilization responsibilities for the Hawaii National Guard. All three directly managed the handful of Reserve officers within each department, but managed no Organized Reserve units. On the other hand, the three departments were burdened with a much higher level of responsibility for actual wartime defense planning and coordination with the U.S. Navy for area and regional defense. The corps areas also shared such responsibilities, but given the much greater likelihood that a department might suffer attack by an enemy in wartime, the level of planning and coordination was much greater within those headquarters.

Disband. To relieve all personnel from a unit, if active, and remove the designation of the unit from the official rolls of the U.S. Army. If the unit was already inactive, disbanding was then simply a matter of removing the designation of the unit from the official rolls of the U.S. Army. This term is used for the period of 1938 to the present. See **Demobilize**.

Discontinue. To relieve all personnel from a non-TOE or provisional unit. Such units are not demobilized or disbanded as they were never “constituted.”

Drill Period. National Guard unit training periods were called the Drill Period which ran roughly August to June. National Guard members who participated in these drills were paid for attending the training. The drills were usually held one four-hour period in the evening every week, one eight-hour period every other weekend, or one weekend a month, depending on the unit commander, the type of unit, or the type of training to be conducted. Evening drill periods usually consisted of one of three kinds of Unit Schools: schools conducting work on correspondence courses; group schools conducting lecture courses, or group schools conducting conference courses. The training was often held on Saturdays and/or Sundays for marksmanship, maneuver, or equestrian training.

Enlisted Reserve Corps (ERC). One of the three components of the Organized Reserves. Though Organized Reserve units were authorized to be maintained at 100% war strength in officers, the units were only authorized to be maintained at 33% war strength in reserve enlisted personnel. This limitation in enlisted strength was a political provision included in the 1920 National Defense Act to assure the National Guard that it would remain the U. S. Army’s second line of defense and to preclude active recruiting competition between the two reserve components, especially in areas of the country where potential manpower was scarce. Unlike the Regular Army and National Guard, there was no recruiting mechanism specifically dedicated to the ERC (though each corps area commander was responsible for determining the recruiting mechanisms for such men). Thus the ERC never consisted of more than 6,000 men nationwide during the interwar period. Enlistments in the ERC were for a three-year period. The members of the ERC were generally prior service Regular Army soldiers, some ex-National Guard enlisted soldiers, ROTC cadets, young men who had attended at least one CMTC camp, and bandsmen of the many Organized Reserve bands organized in the 1920s. Former enlisted men of the Regular Army or National Guard were reenlisted at the rank at which they served in those components, and usually promoted almost immediately to a higher rank to fill critical enlisted leadership positions. Senior ROTC program cadets who dropped out of college, or did not receive a commission, could be promoted to corporal or sergeant in the ERC depending on the number of years completed in ROTC. CMTC candidates were eligible for NCO ranks on the same basis. Unlike Reserve officers, enlisted Reservists were assigned only to Organized Reserve units. They

could not be assigned to Regular Army Inactive or National Guard units until those units were called into Federal service. In a period of national emergency, the President, with the consent of the Congress, could call enlisted Reservists and their units to active duty at any time. Under other circumstances, Reservists could only be ordered to active duty for a period of fifteen days, and then only with the soldier's consent. A substantial number of enlisted personnel in the Organized Reserves during this period were actually bandmen. Each Organized Reserve division was authorized to raise one regimental band. There were also several non-divisional bands as well. Almost all of these bands were organized in the early to mid-1920s. With an authorized strength of 28 enlisted men per band, the ERC boasted over one thousand bandmen by the mid- to late-1920s. Given that the ERC never consisted of more than 6,000 men, OR bands were clearly a significant part of the enlisted manpower of the Organized Reserves in the interwar period until 1931. That year the ERC experienced a loss in strength when the War Department issued a directive on 10 August to cease organized bands due to lack of funds and band equipment. The ERC experienced another dip in strength in the late 1930s when it lost members to the Regular Army Reserve which paid its members a small stipend. See **Regular Army Reserve**.

Establish. To assign personnel to a new (i.e., never previously existing) non-TOE unit, thereby bringing that organization to an active status for the first time. Once established, such a unit is also considered active. Typically this term is used for organizations such as Corps Area headquarters, ROTC programs, and etc. When removing these types of units from the official rolls of the army, the organization was "discontinued," rather than demobilized or disbanded. See **Activate**.

Executive Officer. See **Unit Instructor**.

Federally Recognize. Acceptance of a National Guard unit by the Federal government for funding purposes. Federal recognition occurs only when the unit has been adequately manned, housed, equipped, and organized in accordance with U.S. Army requirements and standards as verified by Regular Army inspectors. Federal recognition was withdrawn from units that failed to maintain the required standards. Federal recognition was also occasionally withdrawn from some units that were no longer required for Army mobilization plans. In those cases, the state had to convert or reorganize the unit into a type needed to fill shortages in the mobilization plans or lose Federal funding for the organization.

Feeder School. Those colleges, universities, and military institutes that commissioned officers from ROTC programs into the units of a specific Organized Reserve or RAI unit. This was not a formal program for most Reserve units (see **Affiliate**). By virtue of the branch training provided by the ROTC units, the proximity of the schools to the Reserve units (generally in the same state), and the fact that most of the commissionees tended to be from the state where they went school made the likelihood that a lieutenant from a given school would end up in the nearest unit of that branch very high. Some Reserve units had a very close relationship with nearby ROTC programs; the 311th Cavalry with the A&M College of Texas and the New Mexico Military Institute, the 621st Coast Artillery with the University of Delaware, and the 385th Infantry with Rhode Island State College were among the most notable. Most units, however, did not foster a close relationship with the feeder school(s) that provided their new lieutenants.

Functional Unit. Organized Reserve and Regular Army Inactive units were largely officer cadres in the interwar period. OR regiments and separate battalions were allotted to a state or multi-state area by allocation boards for the purposes of organization in a similar fashion to the National Guard. Some units were allotted by these boards to be organized in a single large city. Other units were spread out across the state by company. In the latter instance, the commanders of the regiment or battalion found it extremely difficult to assemble their units for any kind of unit activity or training during the Inactive Training Period. As the 1920s wore on, allocation boards, through the urging of Reserve commanders and their Regular Army instructors, reallocated many of the companies and battalion headquarters that had been allotted to small towns to larger regional towns and cities. By 1930, most regiments had been consolidated in one major city or distributed by battalions in two or three smaller cities. The consolidation enabled the units

to function somewhat closer to an actual regiment or battalion and conduct meaningful training during the Inactive Training Period. As a result, commanders could exercise effective command, unit staff officers could perform staff functions, and the regiment, or battalion, could build the cohesion that is important in any military organization. These regiments and battalions were considered functional units. Note: this is not a term contemporary to the interwar period. See **Pool Unit**.

General Headquarters (GHQ). The General Headquarters was the headquarters of the commanding general of U.S. Army field forces. Upon mobilization, the U. S. Army Chief of Staff was to assume that position. The War Plans Division of the War Department General Staff would in turn become the nucleus of the headquarters staff of GHQ. In addition to the commanding general and staff, the GHQ consisted of the following organizations: Headquarters, Special Troops, General Headquarters; Headquarters, General Headquarters Air Service (later Redesignated as Headquarters and Headquarters Squadron, General Headquarters Air Force); and the General Headquarters Reserve. Under this concept, the commanding general of the General Headquarters would become the commander of the theater of operations, exercising command and control over all army groups, field armies, corps, etc., in the theater of operations.

General Headquarters Reserve (GHQR). The General Headquarters Reserve (GHQR) consisted of those units not required in the troop lists of field armies and their subordinate corps, divisions, etc. GHQR units were under the command and control of the General Headquarters which attached them to commands in the theater of operations as needed.

General Unit Training Camp (GUTC). The General Unit Training Camps consisted of several Organized Reserve and/or Regular Army Inactive units brought together for training under one commander, usually the Regular Army chief of staff for an Organized Reserve division. Unit integrity and identity were maintained as far as practicable and units trained under separate schedules coordinated by the camp commander. When units of more than one combat arm were present, priority was given to combined arms training. General Unit Training Camps were generally conducted on Federal military installations and were usually, though not always, assisted by a Regular Army unit specifically assigned for the purpose.

Goodrich Trophy. Established in 1926 by Lt. Col. Louis E. Goodrich, Cavalry Reserve, to “promote enthusiasm in training throughout the cavalry regiments by means of competition among rifle troops.” The Goodrich Trophy was awarded annually to the cavalry infantry troop that achieved the highest score in a four part test consisting of the following categories: mobility, firepower, shock, and interior economy. In addition to the rotating trophy, the unit received . The 1933 competition was cancelled due to the Great Depression and the requirement for personnel run the newly established CCC camps. The competition resumed in 1934 and lasted until the beginning of World War II.

Headquarters. The element of a military unit that contained the commander and selected other personnel required for the command and control of the unit. For a company, for example, this included the commander, executive officer, first sergeant, supply sergeant, and two or three other personnel. For battalions and above, it normally consisted of the commander, executive officer, sergeant major, and the primary and personal staff officers. Enlisted personnel of the staff, less the sergeant major, were assigned to the headquarters company or headquarters detachment. In the pre-World War II era, a headquarters and the headquarters company were considered two distinctly different organizations. The term “headquarters” could also refer to the physical location where the commander and his staff normally performed their duties, though strictly speaking, the headquarters, as a location, was any place where the commander was located. For National Guard units during this period, the custom was to locate regimental headquarters and above in the city where the current commander resided. When a unit changed command, the National Guard Bureau would typically enquire of the new commander where he desired his headquarters to be located. In most cases, the officer would request that it be relocated to the town or city of his home residence. This accounts for the frequency of headquarters relocations in some National Guard regiments and brigades during this period. Some commanders located their headquarters in the town or city where they were employed and

others maintained them where the bulk of the headquarters' staff officers resided. For Organized Reserve units, the actual location of a unit's headquarters sometimes could be confusing. In all cases, the official headquarters was at least nominally located in the town or city designated by Corps Area allocation board reports. However, for a few units, the actual place where the unit headquarters' business was conducted (the business address) was where the Regular Army executive officer (later "unit instructor") was located. Since many of these officers were responsible for multiple units, the need for them to be centrally located to the bulk of the units in their charge sometimes required their office to be located in cities different from that where the unit headquarters was nominally located. Thus frequently, the business address was in a different town or city than that officially designated for the headquarters. In some instances, the regimental commanders did not live in that town or city either. If he was a particularly active Reserve commander who wished to attend to much of his unit's business personally, between the XO and the commander, the unit could end up conducting a great deal of business, but none of it transpiring in the town or city designated for the headquarters. These instances were uncommon, but did occur.

Home station. Local armory or drill period location for National Guard units.

Inactivate. To relieve personnel from an active unit thereby placing that unit in an inactive status. The unit designation was maintained on the rolls of the army in an inactive status until activated, initiated, or it was removed if the unit was demobilized or disbanded.

Inactive Reserve. See **Auxiliary Reserve.**

Inactive Training Period. Organized Reserve unit drill periods were called the Inactive Training Period which ran roughly September to June. Unlike with the National Guard, the Organized Reserve members who participated in the Inactive Training Period drills were not paid for attending the training. The drills were usually held one evening every week or every other week, depending on the unit commander and preferences of the unit members. A training period usually consisted of one of three kinds of Unit Schools: schools conducting work on correspondence courses; group schools conducting lecture/demonstration courses (often by branch, unit position or specialties), or group schools conducting conference or special training courses. The training was often held on a Saturday or Sunday for training such as marksmanship, maneuver, or equestrian training. Depending on the facilities available nearby, Reserve units often drilled at local U.S. Army posts and National Guard armories, but often used schools, post office buildings, Federal buildings, or other local buildings that could support the requirements of the training period. Attendance was voluntary, but a Reservist who desired to attend the Active Training period during the summer had to have been an active participant during the Inactive Training Period and/or complete a certain number of hours in correspondence course work. A Contact Camp was occasionally substituted for the Inactive Training Periods for the month the camp was held. The non-paid, voluntary nature of this training makes it a true indication of the patriotism and dedication of the men who were regular participants in these meetings throughout the 1920s and 30s.

Induct. To bring a National Guard unit into Active Federal Service.

Initiate. To assign personnel to an Organized Reserve unit which was never previously active, thereby bringing that unit to an active reserve status for the first time. This includes those units previously allotted to the National Army, withdrawn, and allotted to the Organized Reserve in 1921. Once initiated, a unit was also considered organized and active in the Organized Reserve, though not on active duty. This word was apparently not an official term but it was used extensively in official "reports of initiation" rendered to the War Department Adjutant General in the 1920s to report the assignment of personnel to Organized Reserve units. It has the same meaning as Organize for Regular Army and National Guard units. See **Organize** and **Activate**.

Knox Trophies. The annual Knox Trophy competition was established in 1924 by Maj. Gen. William J. Snow, Chief of Field Artillery. The Knox Trophies were donated by the Massachusetts Society of the Sons of the American Revolution. Named in honor of Brigadier General Henry Knox, Revolutionary War

artilleryman and first U.S. Secretary of War. Awarded annually to the top Regular Army coast artillery and field artillery batteries for gunnery excellence, the competition consisted of a grading system that included evaluation of battery-sized units in live-fire efficiency, mobility, communications, and administration. In the coast artillery competition, searchlight and mine batteries were also eligible using different tables of grading. There were also separate Knox trophies for a battleship gunnery competition in the U. S. Navy and for coast artillery batteries of the Massachusetts National Guard. There was no Knox trophy competition for 1933 due to the temporary elimination of the gunnery program brought about by budget cuts due to the depression and the army's support of the Civilian Conservation Corps. The competition resumed in 1934 until 1940. The competition was then suspended for the duration of World War II.

Local Unit Training Camp (LUTC). The Local Unit Training Camps consisted of one or more Organized Reserve or Regular Army Inactive units brought together for training under their own respective reserve commanders, though the camp itself was administered by the OR division chief of staff or the Regular Army executive officer. Each commander was assisted by the unit's Regular Army executive officer (later designated "unit instructors") in setting up and conducting the camp. These camps were usually conducted at the unit's mobilization station so that the unit members became familiar with that station's advantages, disadvantages, and geography. These camps also gave the Reservists an excellent opportunity to survey the installation's facilities and allow them to fine-tune their mobilization plans. The camps could also be focused on post-mobilization training as well. The LUTCs could be held at other Federal or state military installations and some were held at state colleges or universities, private military schools, privately owned land, and even tourist areas.

Mobilize. To bring active or inactive units up to Wartime Strength in personnel and equipment.

Mobilization Assignment. Assignment of RA officers (and some NCOs) to mobilization positions in RAI units. The practice of assigning RA commanders to RAI units was ended 1 October 1933 (in some cases earlier). All other RA personnel were relieved from mobilization assignments to RAI units by 1 July 1939. With the exception of the period of 1927 to 1933, there was no obligation on the part of these personnel to participate in the activities of the RAI unit unless they did so voluntarily. RA personnel assigned to ROTC programs with mobilization assignments to an affiliated unit were the most active RA participants in RAI unit activities.

Mobilization Plans. The provisions of the National Defense Act of 1920 made all pre-World War I mobilization plans obsolete, but also provided the basis for the next generation on plans that would govern the organization of the U.S. Army during the interwar period. Soon after the passage of the act, the WDGS assembled the Special Committee on Organization that went to work on setting up the new structure of the Army. Using the provisions of the act as a guideline, results from the various post-war AEF boards appointed by General Pershing to study improvements to various organizations, and input from wartime commanders, the Committee developed the framework upon which the details of organization would be developed. The planning assumption was a field force of just over 2.3 million men concentrated in six field armies, a General Headquarters Reserve, and a Communications Zone. The planners soon added a fourth major category of units, the "Zone of the Interior" to provide for the expansion and creation of wartime support installations in the continental United States. From this framework, WPD planners developed the number of organizations by component to be allotted to each corps area in 1921. The initial allotments were as follows:

Regular Army:	9 infantry and 2 cavalry divisions; certain corps, field army, harbor defense, and GHQ Reserve units; and a proportion of the Communications Zone and Zone of the Interior units.
National Guard:	18 infantry and 4 cavalry divisions; certain corps, field army, harbor defense, and GHQ Reserve units.
Organized Reserve:	27 infantry and 6 cavalry divisions; certain corps, field army, harbor defense,

and GHQ Reserve units; and the majority of Communications Zone and Zone of the Interior units.

From these numbers, the WPD began developing the myriad details for a general mobilization plan upon which subordinate commands could begin developing their own plans and organizations. Though bits and pieces of this plan were made available to the rest of the Army in the early 1920s, it was not until 1923 that a complete, more or less comprehensive plan was actually issued to the corps areas for detailed planning. This plan was the first of a series of mobilization plans issued during the interwar period. As planning assumptions changed based on new calculations regarding manpower acquisition and industrial production capabilities and clearer thinking developed on how to make the plans flexible for varying mobilization scenarios, the plans themselves evolved and new versions were issued to the field. Each had some impact on the organization of the Army and help explain the constitution and demobilization of many of the RAI and OR units of this period. The following is a brief synopsis of those various plans.

War Department Mobilization Plan 1923 (WDMP 1923). Approved 16 April 1923. In addition to the provisions above, the WDMP 1923 now contemplated an initial force of 1,500,000 men organized into six field armies; eighteen corps; GHQ reserve, Communications Zone, and Zone of the Interior units; and reinforcements for overseas garrisons, all mobilized by M+4 (four months from the announced date of mobilization). By M+10 the force was to have expanded to about 3,500,000 men. The WDMP 1923 was a two-phased plan that called for phase one to be completed by M+4 and phase two sometime between M+18 and M+24. In phase one, corps- and division-level field units, certain harbor defense, and Zone of the Interior units needed to support the mobilization would be organized. In phase two, field army headquarters, special troops, and communications zone units needed to provide support in the intended theater of operations would be mobilized. The guiding spirit behind this plan was the idea that when war came, it would not be fought in the United States, but in some theater of war overseas, or at least at a considerable distance from the lower forty-eight states. This concept was a common thread through all mobilization plans leading up to World War II. The 1923 plan called for the mobilization concentration of units using the cantonments used in World War I. However, General Pershing conducted an inspection of many of these locations after the issuance of the plan, and he found that many of these installations had already deteriorated so badly that mobilization planners had to make many modifications and provisions for local mobilization of units in the next plan.

War Department General Mobilization Plan 1924 (WDGMP 1924). Approved 26 April 1924. The 1924 plan was essentially a modification of the 1923 plan. The primary changes were the inclusion of selective service or draft provisions in the planning and more realistic planning regarding mobilization concentration installations. Both the 1923 and 1924 plans suffered from unrealistic assumptions about logistic support for a major mobilization.

War Department General Mobilization Plan 1928 (WDGMP 1928). Approved 20 July 1928. This plan essentially maintained the 1923/24 plan troop basis but substituted four “periods” for the two “phases” of the 1923/24 plan:

- First Period: M day to M+2 (months) (RA, RAI, and selected OR units)
- Second Period: M +2 to M+3 (NG, DNG, and selected OR units)
- Third Period: M +3 to M+4 (OR corps, selected divisions and non-divisional units)
- Fourth Period: M +4 to M+5 (all others)

This plan still contemplated the mobilization of 3,500,000 men, but now that number was to be realized by M+5. Additionally, it provided for the goal of having some 2,800,000 of those troops in the theater of operations by M+10. This plan also provided for the constitution of corps area “service commands,” essentially administrative headquarters for managing the various housekeeping and Zone of the Interior installation support units in the continental United States. Like its predecessor plans,

the 1928 plan ignored the integration of manpower mobilization, industrial mobilization, raw material resources, and the national economy.

War Department General Mobilization Plan 1931 (WDGMP 1931). This plan was never adopted, but was essentially the 1928 plan revised to provide more realistic appraisal of the M-day start point. The 1928 plan used the figure of 700,000 enlisted personnel on M-day. This figure was the total number for the Regular Army and National Guard as authorized by the National Defense Act of 1920. The 1931 plan used the figure of 280,000 which was close to the actual enlisted strength of the two components in 1931. Additionally, replacement training centers and officer candidate schools were provided for in this plan.

War Department Mobilization Plan 1933 (WDMP 1933). Approved 7 August 1933. Implementation effective 1 October 33. The 1920 National Defense Act authorized the Army to organize field army and corps headquarters in peacetime. The 1920 War Department General Order #50 provided for the creation of three "army areas" to be used as the basis for organizing and mobilizing the post-World War I Army. However, other than the six field army headquarters organized with Reservists in the early 1920s, no other actions were taken toward the realization of this framework. When General Douglas MacArthur assumed the position of the Army's Chief of Staff in 1931, he recognized that the six Organized Reserve field armies, as controlling headquarters, would be useless for much of the initial mobilization period as they would be too busy organizing themselves to pay attention to directing the mobilization of the myriad subordinate units in the throes of organization at the same time. In August 1932 therefore, MacArthur directed the constitution or reconstitution of three field army headquarters in the Regular Army (the First Army Headquarters was constituted in 1927) and which were concurrently, or shortly thereafter, activated. At the same time, the organization of the continental United States was reorganized into four army areas, vice the three previously existing areas. These field armies would now form the basis for the next generation of mobilization plans.

The 1933 mobilization plan was built to be a flexible plan under which only the units and manpower needed for a given emergency would be mobilized. This initial force, composed of Regular Army and, if required, National Guard units, would become the "Immediate Readiness Force." This force was to form the basis for immediate basis for the defense of the continental United States and its territories and possessions. It would also be the covering force behind which the Organized Reserve would mobilize if more units were required by a greater emergency. All Organized Reserve units were therefore eliminated from the initial mobilization period and many units were demobilized as a result (including the six Organized Reserve field army headquarters). In their place in the initial mobilization period were many newly constituted RAI units to replace them.

Initial Mobilization:

First Objective: M day to M+2 (months) (Existing RA, NG, and selected RAI units)

Second Objective: M +2 to M+3 (RAI and NGI units)

Subsequent Mobilization:

Third Period: M +3 to M+6 (All OR units)

The 1933 plan contemplated the mobilization of 4,500,000 troops in the event of full mobilization.

Protective Mobilization Plan 1937 (PMP-37). In 1937, the title of the War Department general mobilization plan was changed to the Protective Mobilization Plan 1937 (PMP-37). The title was directed by Secretary of War Harry H. Woodring who intended it to reflect a non-aggressive posture by the United States Army. The primary difference of this plan was that it attempted to provide a more realistic timetable and goals for a major mobilization. It was based in the belief that America, essentially in an isolationist mood in the late 1930s, would not be able to rapidly assemble the large forces contemplated by previous plans. The plan envisaged an initial protective force (IPF) of 400,000

troops (165,000 Regular Army; 235,000 National Guard) by M +30 days and took into account the mobilization of the Regular Army, selected Regular Army Inactive, and existing National Guard units only. The nation thus protected, the army could then begin the mobilization of additional Organized Reserve units as needed.

Protective Mobilization Plan 1939 (PMP-39). Approved 14 December 1938. Changes effective 10 April 1939. This plan envisaged an initial protective force of about 260,000 troops (80,000 Regular Army and 180,000 National Guard) that would be available on M-Day. The plan also anticipated that another 300,000 to 400,000 men would volunteer in the first 30 days (M+1) which would bring a total of about 20,000 officers and 400,000 enlisted men actually assigned to a two-field army, four-corps (4 Regular Army and 18 National Guard divisions) initial protective force. The remaining troops would be assigned to GHQR, harbor defense, and corps area service command units. As with the 1933 and 1937 plans, additional mobilization beyond the IPF would depend on the requirements of the emergency.

Mobilization station. The location where Regular Army Inactive, National Guard, and Organized Reserve units were brought up to Wartime Strength in personnel and equipment. For National Guard units this could be, and usually was, the unit's **Home Station**. For Regular Army units this was generally the unit's peacetime duty station and was also usually the unit's **Mobilization Training Station**.

Mobilization training station. The location where Regular Army, National Guard, and Organized Reserve units were trained for war once the organizations were mobilized. For Regular Army units this was generally the unit's peacetime duty station, but could be another location. For National Guard units this was almost never the unit's **Home Station**, but usually a state encampment or training area, or a Federal installation. For Organized Reserve units, this was generally the same location as the unit's mobilization station though not in all instances. Designated mobilization training stations shown in this order of battle reflect those that were designated by various mobilization plans and documents, thus they do not necessarily reflect where the units were actually mobilized for World War II service.

Modified Manpower Program. See Deferred National Guard.

National Defense Act of 1920. Actually a misnomer; what is commonly referred to as the "National Defense Act of 1920" is actually an amendment to the National Defense Act of 1916 and is more properly titled the "Act of June 4, 1920, an Amendment to National Defense Act of 1916." By this act, the United States Congress spelled out how the post-war military establishment would be organized. In the case of the United States Army, the act stipulated that the service would consist of an "organized peace establishment" of three components, the Regular Army, National Guard, and the Organized Reserve. Additionally, this establishment would include the military organizations necessary to form the basis for the complete and immediate mobilization for the national defense in the event of a national emergency. This was defined to be 54 infantry divisions and those corps, army, zone of the interior, communications zone, and General Headquarters Reserve units necessary to support the mobilization, training and deployment of those divisions. The act also provided for the following:

Regular Army. The Act provided for a Regular Army of 298,000 officers and enlisted men at Peace Strength. The Act also defined the mission of the Regular Army as five specific requirements: (1) Provide garrisons for overseas possessions; (2) Provide garrisons for coast defenses in the continental United States; (3) Provide personnel for the development and training of the National Guard and Organized Reserve; (4) Provide overhead personnel for the Army of the United States (military professional schools, recruiting, ROTC, War Department General Staff, etc.); (5) Provide an adequately organized, balanced, and effective expeditionary force . . . which will serve as a model for the organization, discipline, and training of the National Guard and Organized Reserve. Additional missions not specified in the act but which the War Department enunciated as Army requirements were to: (1) act as a covering force for the mobilization of the two reserve components; (2) serve as a national police force as needed; (3) serve as an organization for the administration and supply of the peacetime establishment.

National Guard. The Act provided for a National Guard of 435,800 men at Peace Strength (based of 800 enlisted men per senator and representative). The National Defense Act contemplated that the National Guard would reach this strength by 30 June 1924. The provision of this part of the act was amended by the War Department General Staff committee report dated 13 January 1923, which modified the plan to provide for the division of the final allotment into two phases: the Modified Manpower Program and the Deferred National Guard. The act defined the mission of the National Guard as two specific requirements: (1) In time of peace, provide an adequately organized and effective force, available in minor emergencies for employment within the limits of the United States, by the states, or by the United States; (2) In time of war or other emergencies when Congress has authorized troops in excess of the Regular Army, to provide an adequately balanced and effective component of the Army of the United States for employment by the United States without restriction. The National Guard was considered to be the second line component of the Army of the United States in peace and war.

Organized Reserve. The Act provided for an Organized Reserve of theoretically unlimited size and defined the mission of the Organized Reserve as a single requirement: Provide a trained, organized, and balanced force which may be readily expanded into an adequate war component of the Army of the United States to meet any major emergency requiring the use of troops in excess of those of the Regular Army and National Guard. The Organized Reserve was considered to be the third line component of the Army of the United States in war.

National Guard (NG). The second component of the Army of the United States in the interwar period. It consisted of units allotted to the forty-eight states, the territories of Alaska and Hawaii, and the Commonwealth of Puerto Rico. The National Guard consisted of an active force (that is, those units and personnel which attended regular drill periods) and a reserve force (the National Guard Reserve). During peacetime, the headquarters to which the National Guard units were assigned generally exercised no command or control over National Guard units. National Guard units, as always in peacetime, were under the command and control of their respective state governors. Except during maneuvers or command post exercises when the units did work for those headquarters, these units communicated directly with their respective state adjutants general for reporting, coordination, and administrative purposes with the corps area headquarters.

National Guard Inactive (NGI). Refers to those Deferred National Guard units from the deferred list that were not withdrawn from allotment to the National Guard on 15 September 1927. Those few DNG units not withdrawn and demobilized were designated "National Guard Inactive" units. The unit was returned to the original state of allotment for future organization. Few of these units were ever organized and most were eventually disbanded in a "not organized" status.

National Guard Reserve (NGR). The NGR was a reserve pool of men who were retained by National Guard units for mobilization to rapidly expand those units in a national emergency. To be eligible for enrollment in the National Guard Reserve, a man had to be a National Guard officer or enlisted man, or a Regular Army enlisted man honorably discharged from active service and reenlisted into the National Guard. Each National Guard unit was responsible for maintaining the records and status of its NGR members. A unit could enroll NGR members in numbers up to the limit of its authorized War Strength, less the number of those personnel already assigned to the unit as active members. A NGR member did not have to attend drills and did not get paid, however, he could be made active at any time upon his request, as long as there was a vacancy in the unit under its Peace Strength limit. The National Guard Reserve was eliminated by War Department General Order #3, dated 4 April 1934.

Non-Divisional Group. Initially, at least eight of the nine corps areas activated one corps headquarters with Regular Army personnel to administer, train, and manage Organized Reserve non-divisional units and personnel assigned to each of the corps area's two tactical corps, less the corps' field artillery units (corps field artillery units and personnel in each corps area were managed by the Artillery Group). Each corps had a

Regular Army chief of staff and a number of other officers and enlisted personnel assigned to fill staff officer positions for the corps and as unit instructors. In 1925, all of the active corps headquarters were relieved from active duty and the Regular Army personnel were relieved and reassigned to the new Non-Divisional Group which assumed the administrative, training, and management functions formerly performed by the corps headquarters. Duties included assistance in developing training schedules, enrollment in extension courses, and conducting instruction at meetings. The Non-Divisional Group also managed the preparation and selection of non-divisional units and officers that were ordered to camp each year.

Not Initiated. A constituted Organized Reserve unit which has never had personnel assigned was considered “not initiated.” In the interwar period, many Organized Reserve Inactive units were never initiated and were demobilized or disbanded in a “not initiated” status. Once an Organized Reserve unit had personnel assigned to it for the first time, it was considered “initiated.” Note: this is not a term contemporary to the interwar period.

Not Organized. A constituted unit which has never had personnel assigned was considered “not organized.” In the interwar period, many Regular Army Inactive, National Guard Inactive, and Deferred National Guard units were never organized and were demobilized or disbanded in a “not organized” status. Once a unit had personnel assigned to it for the first time, it was considered “organized.” Note: this is not a term contemporary to the interwar period.

Officers Reserve Corps (ORC). One of the three components of the Organized Reserves. The creation of the Officers Reserve Corps was originally provided for in the National Defense Act of 1916. Unfortunately, due to its late start in finding and commissioning qualified men, only 3,150 Reserve officers were immediately available for mobilization for World War I service in April 1917. Still the provision was carried over in the 1920 amendment to the National Defense Act. The Officers Reserve Corps was composed of men who qualified for, and who voluntarily accepted, commissions in the Organized Reserve. The original sources for these officers were primarily World War I veterans, ROTC graduates, and CMTC graduates. The ORC was largely composed of World War I veterans between 1919 and about 1929. By the latter year, the number of ROTC graduates commissioned into the corps exceeded the number of veterans, most of whom had let their appointments expire with without requesting reappointment. Appointments in the ORC were for a five-year period. In order to be eligible for reappointment, an officer had to attend at least one summer training camp, attend a number of Inactive Training Periods, and/or complete a number of correspondence courses. Reserve officers were initially assigned only to Organized Reserve units, Corps Area Headquarters, offices of branch chiefs (e.g., Chief of Ordnance, Chief Signal Officer, etc.), arsenals, and depots. The army began assigning Reserve officers to active Regular Army units in April 1924 and to Regular Army Inactive (RAI) units on 10 March 1926. Reserve officers who did not concurrently hold commissions in the National Guard could not be assigned to National Guard units until those units were called into Federal service. In a period of national emergency, the President, with the consent of the Congress, could call Reserve officers and units to active duty at any time. Under other circumstances, Reserve officers could only be ordered to active duty for a period of fifteen days, and then only with the officer’s consent.

Organization Day. The War Department’s General Order #24, dated 10 June 1922 established the concept of “Organization Day” for U.S. Army units. The general order directed each unit to select a date in its history as “Organization Day.” The selected date was to have some special significance in the unit’s history such as its day of original organization, baptism of fire, or some key action or achievement in battle. The concept called for this day to be celebrated annually by the unit in an appropriate manner. Typically, this included a formal parade or review, public reading of the unit’s history, sports competitions, and a formal dinner for officers and men.

Organize. To assign personnel to a Regular Army or National Guard unit never previously active or previously demobilized/dismanded unit (but not inactivated units), thereby bringing that unit to an active status for the first time. Once organized, a unit is also considered active (but not necessarily on active duty

in the case of National Guard and Regular Army Inactive units). A unit may be organized even though it was never previously constituted. In this regard, the term generally applies only to provisional and National Guard units. See **Activate** and **Reorganize**.

Organized Reserves (OR). The third component of the Army of the United States in the interwar period. It consisted of the Officer's Reserve Corps (ORC), the Enlisted Reserve Corps (ERC), and Organized Reserve units allotted to the nine corps areas and to the Territory of Alaska and the Commonwealth of Puerto Rico. No Organized Reserve units were allotted to the three overseas departments. Reserve officers in those departments were given mobilization assignments within existing Regular Army units in the department. By design, Organized Reserve units were authorized to be manned at 100% of War Strength in officers and up to 33% in enlisted personnel. This limitation in enlisted strength was a political provision included in the 1920 National Defense Act to assure the National Guard that it would remain the U. S. Army's second line of defense and to preclude active recruiting competition between the two reserve components, especially in areas of the country where potential manpower was scarce.

Organized Reserve Inactive (ORI). Those units allotted to the Organized Reserve but not organized. These units were usually (though not always) allotted to a corps area but may or may not have been further assigned to a state or other geographical area for organization or mobilization purposes.

Peace Strength (sometimes referred to as "Maintenance Strength"). The strength in personnel and equipment required for the unit to perform its peacetime training mission. The peace strength was indicated in the unit's table of organization and was usually about fifty percent of the wartime strength.

Philippine Scouts (PS). Authorized by act of Congress 2 February 1901. This act authorized the organization of units in the Philippines composed of Filipino soldiers and American officers. If they received the appropriate training, Filipinos could serve in the Philippine Scouts as commissioned officers as well. Prior to World War I, the Philippine Scouts consisted of fourteen battalions of infantry. During the war, the Scouts were reorganized and several regiments of infantry, and one each regiment of artillery and engineers were organized for Philippine defense. After the war, the regimental structure was retained and integrated into the newly constituted and organized Philippine Division. Initially, all elements of the Philippine Division except the 24th Infantry Brigade were Philippine Scout organizations. In 1931, the 24th Brigade was inactivated and the brigade and its subordinate regiments, the 43rd and 44th Infantry Regiments, were also redesignated as Philippine Scout units. None of these units were active until the eve of World War II when the 1st Battalion, 43rd Infantry was activated in April 1941.

Pool Unit. Pool units were Organized Reserve and Regular Army Inactive organizations that were too spread out geographically to function as units in the Inactive Training Period. Field army, corps, and division headquarters and corps area service units were typically pool units. Regiments, separate battalions, special troops, and separate companies were often pool units as well. Generally, each state area would have at least one or more pool units for each branch (infantry, artillery, quartermaster, etc.) to which those officers and enlisted Reservists who lived out in the hinterlands could be assigned for mobilization and promotion purposes. Note: this is not a term contemporary to the interwar period. See **Functional Unit**.

Provisional. A unit organized, usually under an existing table of organization, using personnel on temporary duty from other organizations. Provisional units were not Constituted, so were Discontinued when no longer needed rather than being Demobilized/Disbanded.

Reconstitute. To restore to the official rolls of the U.S. Army the designation of a previously constituted, but since demobilized or disbanded, unit.

Redesignate. To change a unit's official number or name, or both. Redesignation was a change of name only. The unit's history, lineage, honors, and organization remained the same.

Regular Army (RA). The first component of the Army of the United States in the interwar period. The Regular Army was originally supposed to be the initial force upon which the country relied for protection

and around which the remainder of the Army of the United States would mobilize. The 1920 Act provided for a Regular Army of 298,000 officers and enlisted men, but its average strength was only about 136,000 between 1921 and 1939. Much of the Army's strength was to be concentrated in a mobile force of nine infantry divisions and two cavalry divisions in the continental United States and three infantry divisions in the overseas departments. Cuts in the Army's budget by a parsimonious Congress forced the Army to reduce this planned force to three greatly reduced infantry divisions, six brigades, and a single cavalry division on the continent, and two of the three overseas divisions were also forced to inactivate a number of their assigned units. Nevertheless, the Regular Army was able to ably train hundreds of thousands of Reserve and National Guard soldiers, R.O.T.C. cadets, and C.M.T.C. candidates between 1919 to 1941. It also successfully mobilized, supported, and administered hundreds of thousands of young men for the C.C.C. many of whom would turn their "tree army" experiences into a foundation for military service in the next great war. Ultimately, the officers and men of the interwar Regular Army would mobilize, train, and lead the massive Army of the United States to victory in World War II.

Regular Army Inactive (RAI). Units allotted to the Regular Army but not on active duty. Beginning in 1921 mobilization responsibility of RAI units in the event of an emergency was vested in the active Regular Army unit that had been designated by the War Department as the RAI unit's Active Associate. Under this plan, an active unit would essentially split in two to create the cadre for two like organizations, which would then be filled to strength with volunteers and drafted men. Realizing that this plan would not provide the officers needed to rapidly reform inactive units, the War Department somewhat modified the Active Associate program in July 1925 when it also began assigning Regular Army officers and enlisted men serving in non-TOE organizations (such as ROTC cadre, Recruiting Service personnel, and National Guard and Organized Reserve unit instructors) to RAI units for mobilization purposes. The War Department further authorized the assignment of Organized Reserve officers to Regular Army Inactive units on 10 March 1926 to help bring those units to War Strength in the event of mobilization. War Department General Order Number 3 in 1927 effectively eliminated the Active Associate program. This general order further specified the allotment of RAI units to corps areas for mobilization responsibility, a step which also relieved the Active Associate unit of that responsibility. This new program specified the maximum numbers and grades of Reserve officers to be assigned. For example, a RAI infantry regiment was authorized 1 major, 10 captains, 50 first lieutenants, and 25 second lieutenants. Organized Reserve field grade officers assigned to RAI combat arms units had to have had combat service in World War I. Later, the tables were modified and by the mid-1930s, a few RAI units had Reserve commanders in the grade of full colonel, though the vast majority were commanded by Reserve majors and lieutenant colonels, and some even by officers of lower grades. In October 1933 all Regular Army personnel in non-TOE units assigned to RAI units were relieved from their mobilization assignments, and RAI units essentially became Organized Reserve organizations. With the exception of those RAI units affiliated with ROTC programs, RAI units functioned essentially like an Organized Reserve unit. The primary difference was that all Regular Army units (active and RAI) were all "first period" units, meaning they were among the first to be mobilized. However, Organized Reserve personnel could not be ordered to active duty for more than 15 days a year without their consent unless war or other national emergency was declared. Since there were numerous instances where RAI units would be needed for mobilization short of a national emergency, the Judge Advocate General determined that Reserve officers could not be assigned to active Regular Army or RAI units unless they volunteered to be so assigned. The Reservists also had to agree, by documentation, that they would be willing to serve for more than 15 days if called by the President. By 1933, War Department mobilization planners discovered that there were not enough RAI units in the mobilization plans to meet the needs of the new four-army plan. Therefore, on 1 October 1933, certain Organized Reserve organizations were withdrawn from the Organized Reserve and allotted to the Regular Army as RAI units to flesh out the first nine corps (I through IX Corps). Numerous others were so reallocated in 1936 and 1938. Once allotted, RAI units were assigned by the corps area headquarters (rather than by an Allocation Board) to a city or town for home station. That city then became the unit's headquarters location upon organization (i.e., assignment of Reserve officers). The

method of assignment seems to have varied between corps areas. Most Reserve officers assigned to a RAI unit came from the same general geographic area such as a city or region of a state. This allowed the RAI organization to perform as a Functional Unit during the Inactive Training Period. Other corps areas used many of their RAI organizations as Pool Units. The most cohesive RAI units tended to be those that were affiliated with ROTC units or a civilian agency. The officers were almost all exclusively located in or near a single city and could conduct regular unit meetings. This program, while the best that war planners could concoct for a rapid emergency, was ultimately a failure. When the army began to mobilize for World War II, Reserve officers from these units were ordered to active duty as individuals and dispersed throughout the Army rather than being activated with the unit.

Regular Army Reserve (RAR). Established by Congress in April 1938. Enlistments authorized to begin 1 July 1938. The RAR was a reserve pool of prior service enlisted men who were retained for mobilization to rapidly expand the Regular Army in a national emergency. These men could not be assigned to, or drill with, OR or RAI units. To be eligible for enrollment in the Regular Army Reserve, a man had to meet certain requirements. He had to be a former Regular Army enlisted man honorably discharged from active service, less than 36 years of age, unmarried, and pass a physical examination. Enlistees would receive \$24.00 a year paid in quarterly increments of \$8.00. As an additional incentive, upon reporting for duty in the event of a national emergency, the soldier would receive \$3.00 for each month in which he was enrolled in the RAR, for up to \$150.00. The army's goal was to enroll 75,000 prior service enlisted men by 30 June 1942. That plan was modified on 14 January 1939 to change the goal of achieving 75,000 enlistments to be reached as soon as possible. All RAR soldiers were mobilized into active service on 15 February 1941. That mobilization, the declared national emergency, and the implementation of the Selective Service Program, caused the War Department to suspend all enlistments in the RAR on 28 March 1941.

Regular Army Training Camps. The Regular Army Training Camps consisted of one Organized Reserve or Regular Army Inactive unit brought together for training under its own commander, who was assisted by the Regular Army executive officer (later designated "unit instructor"). These camps were conducted at Federal military installations. The significance of this type of training was that the unit would be trained for a week, usually in some form of maneuver training, using lecture and demonstration methods without soldiers. The following week, the unit's officers would be superimposed as the leadership for a Regular Army unit and would conduct the maneuver tasks with actual soldiers and equipment.

Relieve. To remove a subordinate unit on orders from permanent assignment to a higher headquarters (e.g. the 10th Cavalry Regiment is relieved from assignment to the 1st Cavalry Division).

Relocate. To move an Organized Reserve unit headquarters from one location within a given corps area to another. The relocation may be within the same state or to another state in the corps area. For National Guard units, the relocation of the unit headquarters was made from one city to another within the unit's state of allotment. See **Transfer**.

Reorganize. To change the structure of a unit in accordance with a new table of organization within the same arm or service. For units changing tables of organization involving a new branch (e.g., from cavalry to field artillery) see **Convert**. This term is also applied to National Guard units which have been previously organized and demobilized and are reorganized by assignment of personnel. This may or may not involve reconstitution of the unit. It may also simply involve the assignment of the previously demobilized unit's history, lineage, and honors to an already existing unit. The assignment may or may not include the assignment of the previous unit's name. This term is additionally applied to Regular Army Inactive and Organized Reserve units which have been previously organized and inactivated by relief of personnel (but not demobilized) and are reorganized by assignment of personnel. For previously organized and inactivated Regular Army units, see **Activate**.

Reserve Officer Training Corps (ROTC). Established by the National Defense Act of 1916. Comprised of units established at schools colleges, and universities throughout the country as feeder

programs for the Organized Reserve. The ROTC consisted of two components: the Junior Division and Senior Division. Junior Division ROTC units were primarily organized at selected civilian high schools (Class CS) and military high schools (Class MS) and academies that provided only a secondary level of education. There was also a category of "Government Aided" schools that maintained a military cadet corps and offered the junior ROTC program of instruction, but were not official ROTC programs. Junior units could not offer reserve commissions to students who completed the course of instruction. Senior division units were organized at colleges and universities. These included civilian institutions (Class CC), military colleges (Class MC) and military institutes (Class MI). The primary mission of the Reserve Officer Training Corps was the procurement of Reserve officers for the Officer's Reserve Corps in order to adequately man Organized Reserve units. The Senior Division ROTC programs were organized to provide branch-specific training. Most schools offered only one branch, usually infantry, however, many offered two and some of the largest offered up to five or six. The original branch material training programs included infantry, cavalry, field artillery, coast artillery, engineer, air corps, ordnance, signal corps, chemical warfare, medical (including specialized veterinary and dental programs), and quartermaster (including specialized supply and motor transportation corps programs).

Rendezvous Point. A location designated in some corps area mobilization plans where Organized Reserve units would recruit and assemble personnel for mobilization purposes. From the rendezvous point, the unit would travel to the unit's Mobilization Training Station for mobilization and training. This term usually applied primarily to company and smaller units. By about 1926, the term fell from usage as it became apparent that the actual assembly of unit personnel, especially enlisted men who would volunteer at recruiting stations or be drafted, would take place at the unit's Mobilization Training Station.

Special Troops. Special Troops were certain special or auxiliary units that were assigned to a specific level of command. These levels included the General Headquarters, field armies, corps, divisions, and, in at least one case, an overseas department. The Special Troops headquarters generally exercised command over a collection of smaller, diverse, and specialized units that had no headquarters of like branch or capability to which they could report. The units were typically attached to other commands for operations in wartime. The Special Troops commander was also the headquarters commandant and provost marshal for his level of command (corps, division, etc.). As such, he and his staff were primarily concerned with planning and executing rear area security, traffic control, and terrain management in wartime.

Tables of Organization (T/O). A document that describes the mission of a given unit and provides tables that outline in detail the organization, personnel manning, and equipment of the unit. This type of document generally only applied to mobile units of the army such as combat arms and service units that would take to the field in time of war. Typical non-T/O units were corps area headquarters, corps area training centers, ROTC units, harbor defense commands, and Air Corps station complements.

Territorial Assignment Group (T.A.G.). Personnel of services or corps, such as Ordnance or Quartermaster, assigned to corps, army, Communications Zone, and Zone of the Interior units within a given corps area, were assigned to, and managed by, the Territorial Assignment Group of that corps area. Certain Regular Army officers of the various services and corps assigned to the corps area headquarters and the Territorial Assignment Group were responsible to perform the duties of unit instructor for the units/officers of their branch. The group chief of staff, assisted by the unit instructors, managed the Inactive Training Period for these branches. This duty included assistance in developing training schedules, enrollment in extension courses, and conducting instruction at meetings. The Territorial Assignment Group also managed the preparation and selection of corps, army, Communications Zone, and Zone of the Interior units, or individual Reserve officers of the group, which were ordered to camp each year.

Theater of Operations. A theater of operations covers the part of the theater of war that is organized for combat. The Zone of the Interior ends at the rear boundary of a theater of operations. The theater of operations is divided into a combat zone and a communications zone.

Thomason Act. Passed into law by the 74th Congress in 1935, this act provided the president the option to call to active duty for a period of one year 1,000 second lieutenants from the Organized Reserve. The lieutenants had to voluntarily apply for this opportunity and were selected by a board of officers in the War Department. To be eligible, these lieutenants had to have been commissioned in the combat arms or the Chemical Warfare Service. Additionally, beginning 1 July 1936, the act provided that the Secretary of War could select fifty cadets of the Reserve Officers Training Corps, who had completed their ROTC training and earned their baccalaureate degree, for a commission in the Regular Army.

Toulmin Trophy. Established by Colonel Harry A. Toulmin, Jr., in 1927 to be awarded to the Organized Reserve coast artillery or field artillery unit (regiment or separate battalion) in the Fifth Corps Area that achieved the best record of attendance during the Inactive Training Period each year. Oddly, Colonel Toulmin was an infantry officer.

Transfer. To move a unit headquarters from one location to another. For Regular Army units the locations were generally active military posts. For multistate National Guard units, the transfer of the unit headquarters was made from one state to another within the unit's states of allotment. For Organized Reserve and Regular Army Inactive units the transfer of the unit headquarters was made from one corps area to another. This transfer also usually entailed the withdrawal of the entire unit from the original corps area and the allotment of the unit to the new corps area. See **Relocate** and **Withdraw**.

United States Coast Artillery Association (USCAA) Trophy. Established in 1932. Awarded annually to the top Regular Army, National Guard and Organized Reserve coast artillery regiments for gunnery performance, armory and field inspections, and drill attendance.

Unit Instructor. The National Defense Act authorized the assignment of Regular Army officers and NCOs directly to each regimental and separate battalion in the National Guard and Organized Reserve. These soldiers were responsible for mentoring their reserve component units and assisting them with planning and conducting drills and Inactive Training Periods, as well as assisting them to prepare for their summer training periods. At times, the instructors also conducted professional development classes for the officers and NCOs in their units. In the National Guard, these personnel were always designated "unit instructors." The highest ranking officer in a division- or brigade-size unit were titled "Senior Instructor" and NCOs were titled "Sergeant Instructor." In Organized Reserve units, the Regular Army officers who held similar positions were initially titled "Executive Officers" and they functioned as such in the early to mid-1920s. By 1926, Organized Reserve units were functioning well enough to allow Reserve officers to perform routine duties normally assigned to unit executive officers and the Regular Army officers were retitled as "Unit Instructors."

Unit School. Unit schools were conducted during an Organized Reserve unit's Inactive Training Period and were generally conducted two ways: correspondence; and group schools. Of the latter, there were two types. The first was an actual course of instruction that mirrored, as far as possible, the equivalent formal course offered by an Army school, such as the Cavalry School's Troop Officer's Course or the Command and General Staff School. These schools were usually conducted by a combination of Regular Army unit instructors, guest instructors (usually local Regular Army officers invited in to teach a block of instruction), and unit officers who had already completed the course. These schools were generally conducted by conference methods. The second type of unit school was also a formal course of instruction, usually designed to teach some sort of technical skill, such as map-reading, setting up aiming circles, or communications training. These were generally conducted by lectures, demonstrations, and practical exercises.

War Strength. The strength in personnel and equipment required for the unit to perform its wartime tasks. The war strength was indicated in the unit's table of organization. A unit was brought up to war strength once it was mobilized at its mobilization station.

Withdraw. To remove a unit on orders from allotment to a corps area and/or from a component of the Army of the United States (Regular Army, National Guard, or Organized Reserve).

Zone of the Interior (Z.I.). The Zone of the Interior (Z.I.) was defined as those areas of the continental United States that were not included within a theater of operations. The Z.I. was not a command, but rather a geographical area. The Z.I. included, collectively, those U.S. Army stateside commands, agencies, and organizations that were responsible for developing and providing the means with which the organizations within a theater of operations would be able to prosecute the war. This included developing and manufacturing war materiel, construction of wartime support facilities to include new hospitals, posts, airfields and training areas, and training the personnel and units that were destined for deployment overseas. The War Department mobilization planners clearly planned for and assigned certain organizations to the Z.I. to support the Z.I.'s logistical and training operations. The vast majority of these units were allotted to the Organized Reserve. See **Corps Area Service Command**.

Appendix B

Major Events Of The U.S. Army 1919-1941

Some popular images of the U.S. Army between the wars consist of soldiers on parade, painting rocks, or pulling weeds. Many think that soldiers spent almost all of their time in garrison and only occasionally went for a long road march or to the rifle range to complete the annual weapons qualification tables. The perception is not reality. Though those things did occur, particularly in the 1920s, the reality is that army leaders, though starved for funds by a parsimonious Congress, squeezed every penny to enable their units to conduct field training to ready their commands for combat. Granted, the training was not always as realistic, or as frequent, as commanders wished, but it contributed to the army's ability to keep a fighting edge that, while not razor sharp, was not entirely dull.

Between 1919 and 1923 there were few, if any, large scale (i.e. brigade or larger) maneuvers held by U.S. Army units, except for those of the American Forces in Germany (A.F.G.). Beginning with a major joint exercise held by the Panama Canal Department in February 1923, large-scale exercises were held by the three overseas departments on an almost annual basis every year thereafter. These maneuvers were almost always joint exercises that included portions of the U.S. Navy battle fleet and occasionally marines playing the role of the invading enemy. Some even included actual amphibious operations. The exercises were essential in helping the department staffs to develop realistic plans for defending the outlying U.S. possessions from enemy attack. They also allowed army, navy, and air corps staffs to develop procedures and demark lines of responsibility between coast defense commands and naval district headquarters, as well as between on and off shore naval air units and the Army Air Corps. Those areas of responsibility were exercised and refined each time a maneuver was held.

The responsibility for large-scale training events for army units in the continental United States was vested in the corps area commanders. Unlike the overseas departments which were provided money by Congress specifically for their exercises, the corps area commanders had to look for ingenious ways to provide their commands with enough money to hold a corps area maneuver. They were often not successful, especially in the 1920s. However, by the 1930s, most corps area commanders were sufficiently budgeted to hold an annual or biennial maneuver at the corps area, division, or at least, reinforced brigade-level. These exercises usually included Air Corps participation and occasionally involved National Guard units and Reserve officers as well.

The first large-scale maneuver held for state-side units was that of the 1st Cavalry Division near Marfa, Texas in September 1923. This was followed by several other division-level exercises in the 1920s. These maneuvers were mostly in the Eighth Corps Area and primarily conducted by the 1st Cavalry Division and the 2nd Division, both of which had responsibilities for securing the troublesome border with Mexico. Throughout the 1920s there were only a few reinforced brigade maneuvers in other corps areas. In the 1930s, division and reinforced brigade maneuvers became more frequent in all corps areas, and were conducted on an almost annual basis.

In October 1933, the army Chief of Staff, General Douglas MacArthur, restructured the U.S. Army's mobilization plans from a six-field army force to one of only four field armies. He concurrently ordered the activation of the field army headquarters and gave those commanders responsibility for developing and conducting major unit-level training exercises. He also secured money from Congress that allowed one field army per year to conduct an army-level maneuver for the purposes of providing commanders at all levels the opportunity to practice the actual mobilization of their units and exercise their command and staffs under somewhat more realistic conditions. Additionally funds were acquired to allow the field army that was next in line for the annual maneuver to conduct an army-level command post exercise the year prior so that commanders and staffs at brigade level and above were familiar with plans and procedures of the field army headquarters. Unfortunately, the armies were usually forced to hold split maneuvers, largely,

though not entirely, on existing army reservations or other Federal properties, because funds were not available to assemble the entire army in one location. Nor was there enough to rent enough territory over which to maneuver a field army and pay the resulting costs of maneuver damage to the civilian property owners. The initial field army maneuver was that of the First Army held in upstate New York in 1935. That maneuver was followed each year thereafter by another army-level maneuver until 1940 when all four field armies were exercised in major maneuvers at various locations throughout the United States. These exercises included National Guard units and thousands of Organized Reserve officers who typically filled out Regular Army and National Guard units to authorized war strength in officers, functioned as umpires, or as brigade, division, corps, and field army staff officers. Some reserve officers were also assigned to leadership positions in ad hoc corps and army support units.

There were other kinds of maneuvers conducted by stateside army units between the wars as well. In recognition of the increased value of airpower, the Army Air Corps began to hold an annual large-scale air maneuver beginning in 1929. The largest of these was the huge 1st Provisional Air Division maneuver in May 1931 held in the eastern United States. It included virtually every stateside Army Air Corps unit in the Regular Army and almost all of the existing National Guard squadrons as well. In addition to air maneuvers the army held a number of other specialized training events including joint exercises between air corps and coast artillery antiaircraft units, joint Army-Navy coast defense exercises, camouflage exercises, command post exercises, and others.

The army was involved in more than just training in the interwar period. It also participated in a number “real-world” missions in the 1920s and 30s. These included units on various stints providing riot control at labor strikes, the evacuation of the Czech Legion from Siberia, the Nicaraguan Canal survey, and the reinforcement of American forces in China in 1932 due to the ongoing civil war there. Army units also participated in numerous disaster relief operations to include a major earthquake in Japan, a hurricane strike in Puerto Rico, various flood relief operations in Vermont and along the Ohio and Mississippi Rivers, and others. On two occasions, significant numbers of units were sent to the Mexican border to counter the possibility of fighting between revolutionaries and Federalists from spilling over into the United States. During the first, the Battle of Juarez in 1919, U.S. Army units actually entered Mexico and drove both sides out of that Mexican city. Two American soldiers were killed in that action.

The events list provided below reflect the major events in which U.S. Army units participated between 1 January 1919 and 7 December 1941. It is a comprehensive inventory of events in which large numbers, typically defined as at least a brigade or more, of army troops were involved. In a few instances, affairs involving smaller levels of troops are included due to the unusual nature of the event or its value to U.S. Army history. Generally, National Guard participation in periods of disaster relief or martial law are not included in the list, but are included in the individual unit service narratives. The numbers in individual unit entries at the “**Events:**” line can be cross-referenced with the events numbers listed here.

Keep in mind that this is an imperfect list. There is no one location that provides information on which units participated in a given event. The information in this appendix has been gleaned from hundreds of sources. It is highly likely that there will be an event or two in which a given unit might have participated but which is not reflected here. Also, note that where possible, the specific element of a unit that participated in the event is given (i.e. “1-2 F.A.” for the 1st Battalion, 2nd Field Artillery; “A/48 QM Regt” for A Company, 48th Quartermaster Regiment; or “elmts 3rd Div QM Tn” for unspecified elements of the 3rd Division Quartermaster Train). It is possible that in some instances where a unit designation is provided, the entire unit was not present for the event.

EVENT #	DATE	EVENT	LOCATION
1 Units: (1,500 troops)	6-11 Feb 19	Street Car Workers Strike HQ 26th Inf Brig., HQ 13 F.A. Brig, 1 Inf, elmts 44 Inf	Seattle & Tacoma, WA
2 Units: 44 Inf (-)	9-17 Feb 19	Coal Miner Strike	Butte, MT
3 Units: (3,600 troops)	15-16 Jun 19	Battle of Juarez HQ 2 Cav Brig, 19 Inf, 24 Inf, 7 Cav, 8 Cav, 82 F.A.	vicinity El Paso, TX—Juarez, Mexico
4 Units: (1,200 troops)	21-24 Jul 19	Race Riots 63 Inf, 3 Cav	Washington, DC
5 Units: (1,300 troops)	28 Sep 19-15 Nov 19	Race Riots 14 Inf, 20 Inf, 9 Bln Co, 17 Bln Co, 27 Bln Co	Omaha, NE
6 Units: (580 troops)	30 Sep 19-15 Oct 19	Race Riots 4th Inf	Helena—Elaine, AR
7 Units: (1,550 troops)	6 Oct 19-1 Jan 20	Labor Strikes units of 4 & 6 Divs, 47 Inf	Gary, IN
8 Units: (550 troops)	28 Oct 19-16 Nov 19	Street Car Workers' Strike 11 Inf	Knoxville, TN
9 Units: (100 troops)	30 Oct-Nov 19	Coal Miner Strike 21 Inf	Helper, UT
10 Units: (2,500 troops)	31 Oct-18 Nov 19	Coal Miner Strike 16 Inf, 18 Inf, 26 Inf	Charleston, WV
11 Units: 24 Inf, 8 Cav, 12 Cav	1 Nov 19-Jan 20	Coal Miner Strike	Gallup—Raton, NM
12 Units: 1 Inf	20-28 Nov 19	Coal Miner Strike	Bayne, WA
13 Units: 13 Cav	Dec 19	Coal Miner Strike	McAlester, OK
14 Units: (400 troops)	6-22 Dec 19	Coal Miner Strike 1 Inf, 35 Inf	Sand Coulee—Bearcreek, MT
15 Units: (700 troops)	31 Dec 19-Jan 20	Coal Miner Strike (from 7 Div)	Pittsburg, KS
16 Units: HQ Army Transport Service, U.S.A.T. <i>America</i> , U.S.A.T. <i>Edellyn</i> , U.S.A.T. <i>Logan</i> , U.S.A.T. <i>Madawaska</i> , U.S.A.T. <i>Mount Vernon</i> , U.S.A.T. <i>President Grant</i> , U.S.A.T. <i>Sheridan</i> , U.S.A.T. <i>Sherman</i> , U.S.A.T. <i>South Bend</i> , U.S.A.T. <i>Thomas</i>	Jan-Aug 20	Evacuation of the Czech Legion	Vladivostock, Russia—Trieste, Italy
17 Units: 13 F.A.	6-20 Feb 20	Labor Strike	Seattle, WA
18 Units: (1,000 troops)	10-17 Feb 20	Race Riots HQ 1 Inf Brig, HQ 2 Inf Brig, 16 Inf, 18 Inf, 26 Inf, 28 Inf, 3 MG Bn	Lexington, KY
19 Units: HQ 1 Brig A.F.G., 8 Inf, 7 MG Bn, 2-6 F.A., HQ 2 Brig A.F.G. 5 Inf, 50 Inf	Mar 20	American Forces Germany Maneuver	vicinity Ransbach, Germany
20 Units: 1 Inf, 21 Inf, 35 Inf	22 Apr 20-8 Jan 21	Coal Miner Strike	Butte, MT
21 Units: (250 troops)	1 Aug-9 Sep 20	Labor Strike	Denver, CO

- 22** **28 Aug 20-3 Dec 21** **Coal Miner Strike** Logan and Mingo Counties, WV
Units: (2,950 troops) HQ 1 Brig, HQ 2 Brig, 2 Inf, 10 Inf, 16 Inf, 18 Inf, 19 Inf, 26 Inf, 40 Inf, HQ 1 Prov Air Brig, 88 Aero Sq
- 23** **10 Jun-20 Sep 21** **Surface Ship Bombing Tests** Virginia Coast and Chesapeake Bay, VA **Units:** HQ 1 Prov Air Brig, HQ 2 Bomb Gp, 49 Bomb Sq, 50 Obsn Sq, 88 Obsn Sq, 96 Bomb Sq, 258 Heavy Bomb Sq, 19 Bln Sq, U.S.S. *Alabama*, U.S.S. *Iowa*, S.M.S. *Ostfriesland*, S.M.S. *Frankfurt*, U-117
- 24** **16-21 Sep 21** **American Forces Germany Maneuver** Coblenz, Germany
Units: HQ 1 Brig A.F.G., 8 Inf, 7 MG Bn, 2-6 F.A., HQ 2 Brig A.F.G., 5 Inf, 50 Inf
- 25** **1-4 Nov 22** **Coast Defense Exercise** Cape Charles—Cape Henry, VA
Units: HD of Chesapeake Bay, 61 C.A., C.A.C. Batteries, U.S.A.M.P. *Schofield*
- 26** **Jan-Feb 23** **Panama Canal Department Maneuver** Canal Zone, Pacific Side
Units: HQ Panama Canal Dept, HQ PC Div, 19 Inf Brig, 20 Inf Brig, 14 Inf, 33 Inf, 42 Inf, 4 F.A., 11 Engr, PC Div Sp Tps, PC Div Q.M. Tn, Panama C.A. Dist., HD of Balboa, HD of Cristobal, HQ 6 Comp Gp, 7 Obsn Sq, 24 Purs Sq, 25 Bomb Sq, 63 Serv Sq, Consolidated Fleet Marine Force, 5 Marine Regt, U.S.S. *California*, U.S.S. *New York*, U.S.S. *Oklahoma*, U.S.S. *Maryland*, U.S.S. *Henderson*
- 27** **Jan-Feb 23** **Philippine Division Maneuver** Camp Stotsenberg, PI
Units: HQ Ph Div, HHC 23 Inf Brig, HHC 24 Inf Brig, 1-15 Inf, 31 Inf, 45 Inf, 57 Inf, 24 F.A., 1-14 Engr, 12 Med Regt, Ph Div Sp Tps, Ph Div Q.M. Tn, 26 Cav
- 28** **5-30 Sep 23** **Japan Earthquake Relief Operation** Yokohama, Japan
Units: HQ Army Transport Service, U.S.A.T. *Cambrai*, U.S.A.T. *Logan*, U.S.A.T. *Somme*, U.S.A.T. *Thomas*
- 29** **5 Sep 23** **Surface Ship Bombing Tests** Cape Hatteras, NC
Units: HQ 2 Bomb Gp, 17 Bomb Sq, 27 Bomb Sq, 94 Bomb Sq, 95 Bomb Sq, 59 Serv Sq, U.S.S. *New Jersey*, U.S.S. *Virginia*
- 30** **10 Sep-22 Oct 23** **1st Cavalry Division Maneuver** Marfa—Shafter—Alamita, TX
Units: HHT 1 Cav Div, HHT 1 Cav Brig, HHT 2 Cav Brig, 1 Cav, 5 Cav, 7 Cav, 8 Cav, 1 MG Sq, 2 MG Sq, 82 F.A. Bn, 1 Cav Div Sp Tps, 8 Engr Bn, 1 Cav Div Q. M. Tn
- 31** **17-30 Jan 24** **Panama Canal Department Maneuver** vicinity Fort Randolph, CZ
Units: HQ Panama Canal Dept, HQ PC Div, HHC 19 Inf Brig, HHC 20 Inf Brig, 14 Inf, 33 Inf, 42 Inf, 4 F.A., 11 Engr, PC Div Sp Tps, PC Div Q.M. Tn, Panama C.A. Dist., HD of Balboa, HD of Cristobal, HQ 6 Comp Gp, 7 Obsn Sq, 24 Purs Sq, 25 Bomb Sq, 63 Serv Sq, 5 Marines, 6 Marines, 10th Marines, U.S.S. *California*, U.S.S. *Langley*, U.S.S. *Richmond*
- 32** **20-26 Jun 24** **12th Infantry Brigade Maneuver** Camp Custer, MI
Units: HHC 12 Inf Brig, 2 Inf, 6 Inf, 6 Tank Co, 1-14 Cav, 1-14 F.A., 15 Obsn Sq
- 33** **Oct 24** **Hawaiian Department Maneuver** Oahu, TH
Units: HQ Haw Dept, HQ Haw Div, HHC 21 Inf Brig, HHC 22 Inf Brig, HHB 11 F.A. Brig, 19 Inf, 21 Inf, 27 Inf, 35 Inf, 8 F.A., 11 F.A., 13 F.A., 11 Am Tn, 3 Engr, 4 Obsn Sq, 11 Med Regt, Haw Div Sp Tps, Haw Div Q.M. Tn, HD of Pearl Harbor, HD of Honolulu, 15 C.A., 16 C.A., 41 C.A., 55 C.A., 64 C.A., HQ 5 Comp Gp, 6 Purs Sq, 23 Bomb Sq, 65 Serv Sq
- 34** **Oct 24** **Coast Defense Maneuver** Del Monte, CA
Units: 30 Inf, 361 Inf, 362 Inf, 3 Div A.S., 6 C.A., 63 C.A., 91 Obsn Sq
- 35** **21 Jan-8 Feb 25** **Philippine Division Maneuver** vicinity Fort McKinley, PI
Units: HQ Ph Div, HHC 23 Inf Brig, HHC 24 Inf Brig, 1-15 Inf, 31 Inf, 45 Inf, 57 Inf, 24 F.A., 1-14 Engr, 12 Med Regt, Ph Div Sp Tps, Ph Div Q.M. Tn, 26 Cav, 91 C.A., 92 C.A., 2 Obsn Sq
- 36** **6-12 Apr 25** **Panama Canal Department Maneuver** vicinity Fort Randolph, CZ
Units: HQ Panama Canal Dept, HQ PC Div, HHC 19 Inf Brig, HHC 20 Inf Brig, 14 Inf, 33 Inf, 42 Inf, 4 F.A., 11 Engr, PC Div Sp Tps, PC Div Q.M. Tn, Panama C.A. Dist., HD of Balboa, HD of Cristobal, 1 C.A., 2 C.A., 4 C.A., 65 C.A., HQ 6 Comp Gp, 7 Obsn Sq, 24 Purs Sq, 25 Bomb Sq, 63 Serv Sq
- 37** **15 Apr-2 May 25** **Grand Joint Exercise No. 3** Molokai and Lanai Islands, TH
Units: (50,000 troops incl navy personnel) HQ Haw Div, HHC 21 Inf Brig, HHC 22 Inf Brig, HHB 11 F.A. Brig, 19 Inf, 21 Inf, 27 Inf, 35 Inf, 298 Inf, 299 Inf, 8 F.A., 11 F.A., 13 F.A., 11 Am Tn, 3 Engr, 4 Obsn Sq, 11 Med Regt, Haw Div Sp Tps, Haw Div Q.M. Tn, HD of Pearl Harbor, HD of Honolulu, 15 C.A., 16 C.A., 41 C.A., 55 C.A., 64 C.A., 14th Naval Dist, 1st Prov Marine Brig, 4th Marines, 10th Marines, U.S.S. *Idaho*; U.S.S. *Mississippi*; U.S.S. *Oklahoma*; U.S.S. *Pennsylvania*; U.S.S. *Tennessee*; U.S.S. *West Virginia*; U.S.S. *Langley*; U.S.S. *Richmond*
- 38** **Aug 25** **16th Infantry Brigade Maneuver** Camp George G. Meade, MD
Units: HHC 16 Inf Brig, 12 Inf, 34 Inf, 1 F.A. Brig, 6 F.A., 1-16 F.A

39 **8-17 Oct 25** **Air Service Maneuver** Mitchel Field, NY and
Langley Field, VA
Units: (45 aircraft) HQ 1 Purs Gp, 17 Purs Sq, 27 Purs Sq, 94 Purs Sq, 95 Purs Sq, 57 Serv Sq, HQ 2 Bomb Gp, 11 Bomb Sq, 20 Bomb Sq, 49 Bomb Sq, 96 Bomb Sq, 59 Serv Sq, HQ 3 Atk Gp, 8 Atk Sq, 13 Atk Sq, 26 Atk Sq, 90 Atk Sq, 60 Serv Sq

40 **14 Jan-14 Mar 26** **Panama Canal Department Maneuver** Tocumen, Canal Zone
Units: HQ Panama Canal Dept, HQ PC Div, HHC 19 Inf Brig, HHC 20 Inf Brig, 14 Inf, 33 Inf, 42 Inf, 4 F.A., 11 Engr, PC Div Sp Tps, PC Div Q.M. Tn, Panama C.A. Dist., HD of Balboa, HD of Cristobal, 1 C.A., 2 C.A., 4 C.A., 65 C.A., HQ 6 Comp Gp, 7 Obsn Sq, 24 Purs Sq, 25 Bomb Sq, 63 Serv Sq; elmts U.S. Navy

41 **18-27 Jan 26** **Philippine Division Maneuver** Fort McKinley—Alabang, PI
Units: HQ Ph Div, HHC 23 Inf Brig, HHC 24 Inf Brig, 1-15 Inf, 31 Inf, 45 Inf, 57 Inf, 24 F.A., 1-14 Engr, 12 Med Regt, Ph Div Sp Tps, Ph Div Q.M. Tn, 26 Cav, 91 C.A., 92 C.A., 2 Obsn Sq

42 **Jan 26** **1st Cavalry Brigade Maneuver** Fort Clark, TX
Units: HHT 1 Cav Brig, 5 Cav, 1 MG Sq, 12 Obsn Sq

43 **1-28 Feb 26** **Joint Army-Navy Maneuver** vicinity Fort Sherman, CZ
Units: HQ Panama Canal Dept, HQ PC Div, HHC 19 Inf Brig, HHC 20 Inf Brig, 14 Inf, 33 Inf, 42 Inf, 4 F.A., 11 Engr, PC Div Sp Tps, PC Div Q.M. Tn, Panama C.A. Dist., HD of Balboa, HD of Cristobal, 1 C.A., 2 C.A., 4 C.A., 65 C.A., HQ 6 Comp Gp, 7 Obsn Sq, 24 Purs Sq, 25 Bomb Sq, 63 Serv Sq

44 **12-19 Feb 26** **Joint Army-Navy Maneuver** vicinity Manila Bay, PI
Units: HQ Philippine Department, HD of Manila and Subic Bays, 59 C.A., 60 C.A., 91 C.A., 92 C.A., HQ 4 Comp Gp, 2 Obsn Sq, 3 Purs Sq, 28 Bomb Sq, 66 Serv Sq, elmts, U.S. Navy

45 **16 Mar-1 Apr 26** **2nd Division Maneuver** Camp Bullis, TX
Units: HQ 2 Div, HHC 3 Inf Brig, HHC 4 Inf Brig, HHB 2 F.A. Brig, 1 Inf, 9 Inf, 20 Inf, 23 Inf, 12 F.A., 15 F.A., 2 Am Tn, 2 Engr, 2 Med Regt, 2 Div Sp Tps, 2 Div Q.M. Tn, 12 Obsn Sq

46 **06-27 Apr 26** **Air Service Maneuver** Fairfield Depot, OH
Units: (44 aircraft) HQ 1 Purs Gp, 17 Purs Sq, 27 Purs Sq, 94 Purs Sq, 95 Purs Sq, 57 Serv Sq, HQ 2 Bomb Gp, 11 Bomb Sq, 20 Bomb Sq, 49 Bomb Sq, 96 Bomb Sq, 59 Serv Sq, HQ 3 Atk Gp, 8 Atk Sq, 13 Atk Sq, 26 Atk Sq, 90 Atk Sq, 60 Serv Sq

47 **12-29 May 26** **2nd Division Distance March** Fort Sam Houston—Kerrville, TX
Units: HQ 2 Div, HHC 3 Inf Brig, HHC 4 Inf Brig, 2 F.A. Brig, 1 Inf, 9 Inf, 20 Inf, 23 Inf, 12 F.A., 15 F.A., 2 Am Tn, 2 Engr, 2 Med Regt, 2 Div Sp Tps, 2 Div Q.M. Tn

48 **2 May-30 Jun 26** **11th Field Artillery Brigade Maneuver** Waimanalo Training Area, TH
Units: (2,000 troops) HHB 11 F.A. Brig, 8 F.A., 11 F.A., 13 F.A., 11 Am Tn, elmts 11 Med Regt & Haw Div Q.M. Tn

49 **1-14 Aug 26** **Anti-aircraft Exercise** Camp Upton, NY
Units: 62 C.A., 5 Obsn Sq

50 **Oct 26** **12th Infantry Brigade Maneuver** Camp Custer, MI
Units: HHC 12 Inf Brig, 2 Inf, 6 Inf, 6 Tank Co, 1-14 Cav, 1-14 F.A., 15 Obsn Sq

51 **1-8 Jan 27** **Joint Army-Navy Maneuver** vicinity Manila Bay, PI
Units: HQ Philippine Department, HD of Manila and Subic Bays, 59 C.A., 60 C.A., 91 C.A., 92 C.A., HQ 4 Comp Gp, 2 Obsn Sq, 3 Purs Sq, 28 Bomb Sq, 66 Serv Sq, elmts, U.S. Navy

52 **9-27 Jan 27** **Philippine Division Maneuver** Fort McKinley, Santa Tomas, Alabang, PI
Units: HQ Ph Div, HHC 23 Inf Brig, 1-15 Inf, 31 Inf, 45 Inf, 57 Inf, 24 F.A., 1-14 Engr, 12 Med Regt, Ph Div Sp Tps, Ph Div Q.M. Tn, 26 Cav

53 **13 Feb-14 Mar 27** **Panama Canal Division Maneuver** La Chorrera, RP
Units: HQ PC Div, HHC 19 Inf Brig, HHC 20 Inf Brig, 14 Inf, 33 Inf, 42 Inf, 2 F.A. Bn, 11 Engr, PC Div Sp Tps, PC Div Q.M. Tn

54 **2-8 Mar 27** **Joint Army-Air Corps Maneuver** Fort Benning, GA
Units: 24 Inf, 29 Inf, 1-83 F.A., A/4 Engr, 22 Obsn Sq, F/1 Chem Regt

55 **16 Apr -23 May 27** **Joint 2nd Division
and Air Corps Maneuver** Camps Stanley and Bullis, TX
Units: (12,000 troops; 108 aircraft) HQ 2 Div, HHC 3 Inf Brig, HHC 4 Inf Brig, HHB 2 F.A. Brig, HHT 1 Cav Brig, 1 Inf, 9 Inf, 20 Inf, 23 Inf, 5 Cav, 12 Cav, 4 F.A. (-), 12 F.A., 15 F.A., 2 Am Tn, 2 Engr, 2 Med Regt, 2 Div Sp Tps, 2 Div Q.M. Tn, HQ 1 Purs Gp, 17 Purs Sq, 27 Purs Sq, 94 Purs Sq, 95 Purs Sq, 57 Serv Sq, HQ 2 Bomb Gp, 11 Bomb Sq, 20 Bomb Sq, 49 Bomb Sq, 96 Bomb Sq, 59 Serv Sq, HQ 3 Atk Gp, 8 Atk Sq, 13 Atk Sq, 26 Atk Sq, 90 Atk Sq, 60 Serv Sq, 12 Obsn Sq, 16 Obsn Sq

56 **23 Apr-12 Jun 27** **Mississippi River Flood Relief** Louisiana—Mississippi—Arkansas
Border Areas
Units: HQ 31 Div, HHC 61 Inf Brig, HHB 56 F.A. Brig, 153 Inf, 155 Inf, 156 Inf, 114 F.A., 106 Am Tn, 206 C.A., 1-106 Engr, 31 Div Sp Tps, 31 Div Q.M. Tn

57 **Apr 27** **3rd Division Maneuver** Camp Lewis, WA
Units: HQ 3 Div, HHC 5 Inf Brig, HHC 6 Inf Brig, HHB 3 F.A. Brig, 4 Inf, 7 Inf, 30 Inf, 38 Inf, 10 F.A., 76 F.A., 3 Am Tn, 6 Engr, 3 Med Regt, 3 Div Sp Tps, 3 Div Q.M. Tn, 91 Obsn Sq

58 **3-6 May 27** **Joint Army-Navy Maneuver** Panama Canal Zone, Pacific Side
Units: HQ Panama Canal Dept, HQ PC Div, HHC 19 Inf Brig, HHC 20 Inf Brig, 14 Inf, 33 Inf, 42 Inf, 2 F.A. Bn, 11 Engr, PC Div Sp Tps, PC Div Q.M. Tn, Panama C.A. Dist., HD of Balboa, HD of Cristobal, 1 C.A., 4 C.A., HQ 6 Comp Gp, 7 Obsn Sq, 24 Purs Sq, 25 Bomb Sq, 63 Serv Sq, U.S.S. *California*, U.S.S. *Omaha*

59 **21-28 May 27** **Joint Army-Navy Maneuver** Fort Adams, RI—Narragansett Bay—
Fort H. G. Wright, NY—New York Harbor
Units: HD of Narragansett Bay, HD of Long Island Sound, HD of New Bedford, HQ XI Corps, HQ 26 Div, HQ 43 Div, HQ 44 Div, HQ 76 Div, HQ 94 Div, HQ 97 Div, HHC 18 Inf Brig, 5 Inf, 13 Inf (less 2d Bn), 8 C.A., 9 C.A., 10 C.A., 11 C.A., 61 C.A., 241 C.A., 242 C.A., 243 C.A., U.S.A.M.P. *Gen. Robert Anderson*; U.S.S. *Texas*; U.S.S. *Arizona*; U.S.S. *California*; U.S.S. *Idaho*; U.S.S. *Maryland*; U.S.S. *Mississippi*; U.S.S. *Nevada*; U.S.S. *Oklahoma*; U.S.S. *Pennsylvania*; U.S.S. *West Virginia*; U.S.S. *Langley*; U.S.S. *Camden*; U.S.S. *Concord*; U.S.S. *Omaha*; U.S.S. *Seattle*; U.S.S. *Antares*; U.S.S. *Procyon*; U.S.S. *Shawmut*; U.S.S. *Melville*; U.S.S. *Bridge*; Destroyer Division 14; Submarine Division 4

60 **24 May-3 Jun 27** **1st Division Command
and Communication Exercise** Camp Dix, NJ
Units: HQ 1 Div, HHC 1 Inf Brig, HHC 2 Inf Brig, HHB 1 F.A. Brig, 16 Inf, 18 Inf, 26 Inf, 28 Inf, 6 F.A., 7 F.A., 1 Engr, 1 Med Regt, 1 Div Sp Tps, 1 Div Q.M. Tn, 1 Div A.S.

61 **14 Jun 27** **Lindbergh Homecoming Parade** New York Cty, NY
Units: HHC 87 Inf Brig, HHC 93 Inf Brig, NY CA Brig, 14 Inf (NY NG), 71 Inf, 106 Inf, 107 Inf, 165 Inf, 369 Inf, elmts 104 F.A., elmts 105 F.A., 212 C.A., 244 C.A., 245 C.A., 27 Q.M. Tn, reserve officers from HQ Co II Corps, XII Corps, 77, 78 Divs, & 61 Cav Div units.

62 **28 Aug-15 Sep 27** **First Corps Area Maneuver** vicinity Fort Ethan Allen, VT
Units: HHC 18 Inf Brig, 5 Inf, 13 Inf, 1-3 Cav, 1-7 F.A., 9 Tank Co

63 **28 Aug-30 Oct 27** **1st Division Maneuver** Camp Dix, NJ
Units: HQ 1 Div, HHC 1 Inf Brig, HHC 2 Inf Brig, 1 F.A. Brig, 16 Inf, 18 Inf, 26 Inf, 28 Inf, 6 F.A., 7 F.A., 1 Am Tn, 1 Engr, 1 Med Regt, 1 Div Sp Tps, 1 Div Q.M. Tn, 5 Obsn Sq

64 **1-16 Sep 27** **18th Infantry Brigade Maneuver** Fort Ethan Allen—Rutland, VT
Units: HHC 18 Inf Brig, 5 Inf, 13 Inf, 1-3 Cav, 1-7 F.A., 9 Tank Co

65 **18-29 Sep 27** **1st Cavalry Division Maneuver** Marfa, TX
Units: HHT 1 Cav Div, HHT 1 Cav Brig, HHT 2 Cav Brig, 1 Cav, 5 Cav, 7 Cav, 8 Cav, 12 Cav, 1 MG Sq, 2 MG Sq, 82 F.A. Bn, A/1 F.A., 1 Cav Div Sp Tps, 8 Engr Bn, 1 Med Sq, 1 Cav Div Q. M. Tn, 2 Tank Co, 12 Obsn Sq

66 **25-27 Oct 27** **Third Corps Area Maneuver** Camp George G. Meade, MD
Units: HHC 16 Inf Brig, 12 Inf, 34 Inf, 1 F.A. Brig, 6 F.A., 1-16 F.A., 3 Cav (-), 51 C.A.

67 **5 Nov-3 Dec 27** **Vermont Flood Relief** Waterbury—Winooski—Montpelier, VT
Units: 172 Inf, 1-3 Cav, 7 F.A., D/1 Engr, 1 Obsn Sq

68 **12-27 Jan 28** **Philippine Department Maneuver** Orani—Bataan, PI
Units: HQ Philippine Department, HQ Ph Div, HHC 23 Inf Brig, 1-15 Inf, 31 Inf, 45 Inf, 57 Inf, 24 F.A., 1-14 Engr, 12 Med Regt, Ph Div Sp Tps, Ph Div Q.M. Tn, 26 Cav, HD of Manila and Subic Bays, 59 C.A., 60 C.A., 91 C.A., 92 C.A., HQ 4 Comp Gp, 2 Obsn Sq, 3 Purs Sq, 28 Bomb Sq, 66 Serv Sq

69 **16-28 Mar 28** **Panama Canal Department Maneuver** Balboa—Miraflores Locks, CZ
Units: HQ Panama Canal Dept, HQ PC Div, HHC 19 Inf Brig, 14 Inf, 33 Inf, 2 F.A. Bn, 11 Engr, PC Div Sp Tps, PC Div Q.M. Tn, Panama C.A. Dist., HD of Balboa, HD of Cristobal, 1 C.A., 4 C.A., HQ 6 Comp Gp, 7 Obsn Sq, 24 Purs Sq, 25 Bomb Sq, 63 Serv Sq

70 **6-28 Apr 28** **2nd Division Maneuver** Lewis & Alta Vista Ranches, TX
Units: HQ 2 Div, HHC 3 Inf Brig, HHB 2 F.A. Brig, 9 Inf, 23 Inf, 12 F.A., 15 F.A., 2 Am Tn, 2 Med Regt, 2 Div Sp Tps, 2 Div Q.M. Tn, 12 Obsn Sq

71 **1-5 May 28** **Air Corps Maneuver** Langley Field, VA
Units: HQ 2 Wing, HQ 1 Purs Gp, HQ 2 Bomb Gp, 17 Purs Sq, 20 Bomb Sq, 27 Purs Sq, 94 Purs Sq, 95 Purs Sq, 96 Bomb Sq, 56 Serv Sq

72	1-22 May 28	1st Division Command and Communication Exercise	Camp Dix, NJ
Units: HQ 1 Div, HHC 1 Inf Brig, HHC 2 Inf Brig, HHB 1 F.A. Brig, 16 Inf, 18 Inf, 26 Inf, 28 Inf, 6 F.A., 7 F.A., 1 Engr, 1 Med Regt, 1 Div Sp Tps, 1 Div Q.M. Tn, 1 Div Avn			
73	8-23 May 28	Coast Defense Exercise	Fort Story, VA
Units: HD of Chesapeake Bay, 12 C.A., 52 C.A., 61 C.A., U.S.A.M.P. <i>Schofield</i>			
74	12-17 May 28	2nd Division Maneuver	Camp Stanley, TX
Units: HQ 2 Div, HHC 3 Inf Brig, HHB 2 F.A. Brig, 9 Inf, 23 Inf, 12 F.A., 15 F.A., 2 Am Tn, 2 Engr, 2 Med Regt, 2 Div Sp Tps, 2 Div Q.M. Tn, 12 Obsn Sq			
75	10-16 May 28	Joint Army-Navy Maneuver	Oahu, TH
Units: HQ Haw Dept, HQ Haw Div, HHC 21 Inf Brig, HHC 22 Inf Brig, HHB 11 F.A. Brig, 19 Inf, 21 Inf, 27 Inf, 35 Inf, 8 F.A., 11 F.A., 13 F.A., 11 Am Tn, 3 Engr, 11 Med Regt, Haw Div Sp Tps, Haw Div Q.M. Tn, HHB Haw Sep C.A. Brig, 15 C.A., 16 C.A., 41 C.A., 55 C.A., 64 C.A., HQ 5 Comp Gp, 4 Obsn Sq, 6 Purs Sq, 23 Bomb Sq, 65 Serv Sq, U.S.S. <i>Arizona</i> (& Pac Fleet -)			
76	May 28	Joint Army-Navy Maneuver	Fort Winfield Scott, CA
Units: HD of San Francisco, 6 C.A., 63 C.A., U.S.A.M.P. <i>Col. George Armistead</i>			
77	1-15 Jun 28	Joint Army-Navy Maneuver	Long Island Sound—Narragansett Bay— Boston Harbor—Sandy Hook
Units: (1,000 troops) HQ 1 CA Dist, HD of Long Island Sound, HD of Boston, HD of Narragansett Bay, HD of Sandy Hook, 7 C.A., 9 C.A., 10 C.A., 11 C.A., U.S.A.M.P. <i>Gen. Absalom Baird</i> , U.S.A.M.P. <i>Gen.E.O.C. Ord</i> , U.S.S. <i>Arkansas</i> , U.S.S. <i>Florida</i> , U.S.S. <i>Utah</i>			
78	5 Aug-15 Sep 28	First Corps Area Maneuver	vicinity St. Albans, VT
Units: HHC 18 Inf Brig, 5 Inf, 13 Inf, 1-3 Cav, 1-7 F.A., 5 Tank Co, 1 Obsn Sq			
79	17-27 Aug 28	4th Infantry Brigade Maneuver	Pole Mountain, WY
Units: HHC 4 Inf Brig, 1 Inf, 20 Inf, 13 Cav, 76 F.A.			
80	22-26 Oct 28	Eighth Corps Area CPX	Fort Sam Houston—Camp Bullis, TX
Units: (450 officers) HQ Eighth Corps Area, HHC VIII Corps (Prov), HHT 1 Cav Div, HQ 2 Div, HQ 36 Div, HQ 45 Div, HQ 90 Div, HQ 95 Div, HQ 103 Div, HHC 3 Inf Brig, HHT 1 Cav Brig, HHT 2 Cav Brig, HQ 56 Cav Brig, HHB 2 F.A. Brig, 12 F.A., 111 Obsn Sq, 120 Obsn Sq			
81	1 Jan-21 Feb 29	Panama Canal Department Maneuver	Chorrera, Republic of Panama
Units: HQ Panama Canal Dept, HQ PC Div, HHC 19 Inf Brig, 14 Inf, 33 Inf, 2 F.A. Bn, 11 Engr, PC Div Sp Tps, PC Div Q.M. Tn, Panama C.A. Dist., HD of Balboa, HD of Cristobal, 1 C.A., 4 C.A., HQ 6 Comp Gp, 7 Obsn Sq, 24 Purs Sq, 25 Bomb Sq, 63 Serv Sq, U.S.S. <i>Arizona</i> , U.S.S. <i>Langley</i> , U.S.S. <i>Saratoga</i> , U.S.S. <i>Lexington</i> , U.S.S. <i>Omaha</i>			
82	13-18 Feb 29	Philippine Division Maneuver	Dagupan—Pangasinan, PI
Units: HQ Ph Div, HHC 23 Inf Brig, 1-15 Inf, 31 Inf, 45 Inf, 57 Inf, 24 F.A., 1-14 Engr, 12 Med Regt, Ph Div Sp Tps, Ph Div Q.M. Tn, 26 Cav			
83	3 Mar-1 May 29	Escobar-Topete Revolution	Mexican Border, Arizona- New Mexico District
Units: HHT 1 Cav Div, HHC 4 Inf Brig, HHT 1 Cav Brig, HHT 2 Cav Brig, 20 Inf, 25 Inf, 1 Cav, 5 Cav, 7 Cav, 8 Cav, 12 Cav, 10 Cav, 82 F.A. Bn, 8 Engr Sq, A/1 Arm Car Sq, 1 Med Sq, 1 Cav Div Sp Tps, 1 Cav Div Q. M. Tn, 12 Obsn Sq, 90 Atk Sq			
84	17-21 Mar 29	Joint Army-Navy Aerial Exercise	Fort Rosecrans, CA—Rockwell Field, CA
Units: HD of San Diego, 2-3 C.A., 3 Div A.S., 3 Obsn Sq, 91 Obsn Sq, HQ 11th Naval Dist			
85	16-26 May 29	Fifth Corps Area CPX and Air Corps Maneuver	Camp Knox, KY—Fairfield, OH
Units: (200 aircraft) HQ, Fifth Corps Area, HQ 37 Div, HQ 38 Div, HQ 64 Cav Div, HQ 83 Div, HQ 84 Div, HQ 100 Div, HHC 10 Inf Brig (5 Div Prov), HQ 1 Purs Gp, 17 Purs Sq, 27 Purs Sq, 94 Purs Sq, 95 Purs Sq, 57 Serv Sq, HQ 2 Bomb Gp, 20 Bomb Sq, 49 Bomb Sq, 96 Bomb Sq, 59 Serv Sq, HQ 3 Atk Gp, 8 Atk Sq, 13 Atk Sq, 26 Atk Sq, 90 Atk Sq, 60 Serv Sq, HQ 7 Bomb Gp, 9 Bomb Sq, 11 Bomb Sq, 31 Bomb Sq, 63 Serv Sq, HQ 9 Obsn Gp, 1 Obsn Sq, 5 Obsn Sq, 99 Obsn Sq, 61 Serv Sq, 9 Obsn Sq, 15 Obsn Sq, 16 Obsn Sq			
86	16-19 May 29	Joint Army-Navy Exercise	Fort Monroe—Fort Story, VA
Units: HD of Chesapeake Bay, 12 C.A., 51 C.A., 52 C.A., 61 C.A.			
87	1-15 Jun 29	Second Coast Artillery District Coast Defense Exercise	Fort Hancock, NJ and Fort Tilden, NY
Units: (1,000 troops) HQ Second C.A. Dist, HD of Southern New York, HD of Eastern New York, HD of Sandy Hook, HD of the Delaware, 1-16 Inf, 5 C.A., 7 C.A., 62 C.A., 245 C.A., 513 C.A., 619 C.A., 620 C.A., 621 C.A., 5 Obsn Sq, U.S.A.M.P. <i>Edward O.C. Ord</i> , U.S.A.M.P. <i>Joseph Henry</i> , U.S.S. <i>Wyoming</i> , U.S.S. <i>New York</i> , U.S.S. <i>Cincinnati</i> , U.S.S. <i>Milwaukee</i> , U.S.S. <i>Richmond</i> , 12 Destroyers			

88 **10-24 Jun 29** **Hawaiian Department Maneuver** Oahu, TH
Units: HQ Haw Dept, HQ Haw Div, HHC 21 Inf Brig, HHC 22 Inf Brig, HHB 11 F.A. Brig, 19 Inf, 21 Inf, 27 Inf, 35 Inf, 8 F.A., 11 F.A., 13 F.A., 11 Am Tn, 3 Engr, 11 Med Regt, Haw Div Sp Tps, Haw Div Q.M. Tn, HHB Haw Sep C.A. Brig, 15 C.A., 16 C.A., 41 C.A., 55 C.A., 64 C.A., HQ 5 Comp Gp, 4 Obsn Sq, 6 Purs Sq, 23 Bomb Sq, 65 Serv Sq

89 **16-29 Jun 29** **1st Division Command and Communication Exercise** Camp Dix, NJ
Units: HQ 1 Div, HHC 1 Inf Brig, HHC 2 Inf Brig, HHC 1 F.A. Brig, 16 Inf, 18 Inf, 26 Inf, 28 Inf, 6 F.A., 7 F.A., 1 Engr, 1 Sig Co, 1 Med Regt, 1 Div Sp Tps, 1 Div Q.M. Tn

90 **Jul 29** **Joint Army-Navy Coast Defense Maneuver** Port Angeles, WA--Fort Worden, WA
Units: HD of Puget Sound, 14 C. A., U.S.A.M.P. *Gen. J. Franklin Bell*; U.S. Navy elements

91 **7-21 Jul 29** **Second Corps Area CPX** Camp Dix, NJ
Units: (6,000 troops) HQ Second Corps Area, HQ II Corps (Prov), XI Corps (Prov), XII Corps (Prov), HQ 1 Div, HQ 1 Inf Brig, HQ 2 Inf Brig, HHC 27 Div, HHC 53 Inf Brig, HHC 54 Inf Brig, HHC 93 Inf Brig, HHB 52 F.A. Brig, 27 Div Sp Tps, HHD 44 Div, HHC 57 Inf Brig, HHC 87 Inf Brig, HHB 69 F.A. Brig, 44 Div Sp Tps, HQ 61 Cav Div, HQ 151 Cav Brig, HQ 152 Cav Brig, HQ 77 Div, HQ 153 Inf Brig, HQ 154 Inf Brig, HQ 78 Div, HQ 155 Inf Brig, HQ 156 Inf Brig, HQ 98 Div, HQ 195 Inf Brig, HQ 196 Inf Brig, HQ 51 Cav Brig, 51 Sig Bn, 101 Sig Bn, 102 Obsn Sq, U.S.S. *New York*, U.S.S. *Wyoming*, U.S.S. *Richmond*, U.S.S. *Cincinnati*, U.S.S. *Milwaukee*, 12 destroyers, U.S.S. *S-2*, U.S.S. *S-4*

92 **10-25 Jul 29** **Joint Army-Navy Exercise** Fort Rosecrans, CA—Rockwell Field, CA
Units: HD of San Diego, 2-3 C.A., U.S.A.M.P. *Col. George Armistead*, 11th Naval Dist

93 **16-29 Jul 29** **Joint Army-Navy Exercise** Fort Hancock, NJ—Fort H. G. Wright, NY
Units: (1,000 troops) HD of Sandy Hook, 7 C.A., 9 C.A., 11 C.A., 62 C.A., 245 C.A., 519 C.A., 520 C.A., 619 C.A., 620 C.A., 621 C.A., U.S.A.M.P. *Gen. Absalom Baird*, U.S.S. *New York*, U.S.S. *Wyoming*, U.S.S. *Richmond*, U.S.S. *Cincinnati*, U.S.S. *Milwaukee*, 12 destroyers, U.S. Navy Atlantic Scouting Fleet

94 **1-21 Aug 29** **Fourth Corps Area Maneuver** Camp Jackson, SC
Units: HHC 8 Inf Brig, 8 Inf, 22 Inf, 6 Cav, 2-16 F.A., 17 F.A., A/1 Obsn Bn, A/4 Engr, 4 Tank Co, 22 Obsn Sq

95 **25 Aug-20 Sep 29** **First Corps Area Maneuver** Windsor, VT—E. Lebanon, NH
Units: HQ First Corps Area, HQ I Corps (Prov), HHC 18 Inf Brig, 5 Inf, 13 Inf, 1-3 Cav, 9 Tank Co., 8 C.A., 9 C.A., 10 C.A., 11 C.A.

96 **1-21 Oct 29** **Fourth Corps Area Maneuver** Camp Jackson, SC
Units: HHC 8 Inf Brig, 8 Inf, 22 Inf, 6 Cav, 2-16 F.A., 17 F.A., A/1 Obsn Bn, A/4 Engr, 4 Tank Co, 22 Obsn Sq

97 **9-19 Oct 29** **1st Cavalry Division Maneuver** Fillmore Pass, NM
Units: HHT 1 Cav Div, HHT 1 Cav Brig, HHT 2 Cav Brig, 1 Cav, 5 Cav, 7 Cav, 8 Cav, 12 Cav, 82 F.A. Bn, 8 Engr Bn, 1 Med Sq, 1 Cav Div Sp Tps, 1 Cav Div Q. M. Tn

98 **12-29 Oct 29** **Third Corps Area Maneuver** Fort George G. Meade, MD
Units: HHC 16 Inf Brig, HHB 1 F.A. Brig, 12 Inf, 34 Inf, 3 Cav, 6 F.A., 1-16 F.A., 1 Am Tn, 4 Tank Co, A/2 Armd Car Sq, 15 Ord Co

99 **15 Oct 29-25 Jul 31** **Nicaraguan Canal Survey** Brito (Pacific side) to San Juan Del Norte (Atlantic side), Nicaragua
Units: HHSC & A/29 Engr Bn (Topo), A/1 Engr, F/11 Engr

100 **9-16 Jan 30** **Philippine Division Maneuver** Batangas Bay, PI
Units: HQ Ph Div, HHC 23 Inf Brig, 1-15 Inf, 31 Inf, 45 Inf, 57 Inf, 24 F.A., 1-14 Engr, 12 Med Regt, Ph Div Sp Tps, Ph Div Q.M. Tn, 26 Cav

101 **1-14 Feb 30** **Panama Canal Department Maneuver** Fort Amador and Fort Clayton, CZ
Units: (200 aircraft) HQ Panama Canal Dept, HQ PC Div, HHC 19 Inf Brig, 14 Inf, 33 Inf, 2 F.A. Bn, 11 Engr, PC Div Sp Tps, PC Div Q.M. Tn, Panama C.A. Dist., HD of Balboa, HD of Cristobal, 1 C.A., 4 C.A., HQ 6 Comp Gp, 7 Obsn Sq, 24 Purs Sq, 25 Bomb Sq, 63 Serv Sq

102 **25 Feb-10 Mar 30** **Joint Army-Navy Coast Defense Maneuver** Fort Amador and Fort Grant, CZ
Units: (350 aircraft) HQ Panama Canal Dept, Panama C.A. Dist., HD of Balboa, 1 C.A., 2 C.A., 4 C.A., 65 C. A., HQ 6 Comp Gp, 7 Obsn Sq, 24 Purs Sq, 25 Bomb Sq, 63 Serv Sq, U.S.A.M.P. *Gen. William M. Graham*; U.S. Navy Battle Fleet

103 **26 Apr-22 May 30** **Joint Air Corps/Anti-aircraft Exercise** Aberdeen—Baltimore—Washington, DC
Units: 62 C.A., 69 C.A., 1 Sig Co, HQ 9 Obsn Gp, 1 Obsn Sq, 5 Obsn Sq, 99 Obsn Sq, 61 Serv Sq

104 **1-28 Apr 30** **Air Corps Maneuver** Mather Field, CA
Units: (475 troops; 135 aircraft) HQ 1 Prov Wing, HQ 1 Purs Gp, 17 Purs Sq, 27 Purs Sq, 94 Purs Sq, 95 Purs Sq, 57 Serv Sq, HQ 2 Bomb Gp, 20 Bomb Sq, 49 Bomb Sq, 96 Bomb Sq, 59 Serv Sq, HQ 3 Atk Gp, 8 Atk Sq, 13 Atk Sq, 90 Atk Sq, 60 Serv Sq, HQ 7 Bomb Gp, 11 Bomb Sq, 91 Obsn Sq

105 **5-29 May 30** **2nd Division Maneuver** Cotulla—Zella, TX
Units: HQ 2 Div, HHC 3 Inf Brig, HHT 1 Cav Brig, 9 Inf, 23 Inf, 5 Cav, 12 Cav, A/1 AC Sq, 12 F.A., 2-15 F.A., 2 Am Tn, 8 Engr Sq, 2 Med Regt, 2 Div Sp Tps, 2 Div Q.M. Tn, HQ 3 Atk Gp, 8 Atk Sq, 13 Atk Sq, 90 Atk Sq, 60 Serv Sq, 12 Obsn Sq, HQ Air Corps Advanced Flying School

106 **5 May-6 Jun 30** **1st Division Command and Communication Exercise** Camp Dix, NJ
Units: HQ 1 Div, HHC 1 Inf Brig, HHC 2 Inf Brig, HHB 1 F.A. Brig, 16 Inf, 18 Inf, 26 Inf, 28 Inf, 6 F.A., 7 F.A., 1 Am Tn, 1 Engr, 1 Med Regt, 1 Div Sp Tps, 1 Div Q.M. Tn, 1 Sig Co

107 **23-29 May 30** **Joint Army-Navy Coast Defense Exercise** Groton, CT
Units: (500 troops, 45 aircraft) HD of Long Island Sound, HD of Narragansett Bay, HQ 1 Purs Gp, 17 Purs Sq, 27 Purs Sq, 94 Purs Sq, 95 Purs Sq, 57 Serv Sq, HQ 2 Bomb Gp, 20 Bomb Sq, 49 Bomb Sq, 96 Bomb Sq, 59 Serv Sq; HQ 9 Obsn Gp, 1 Obsn Sq, 5 Obsn Sq, 99 Obsn Sq, 61 Serv Sq, U.S.S. *Trenton*, U.S.S. *Detroit*, U.S.S. *Richmond*, U.S.S. *Memphis*, U.S.S. *Milwaukee*, U.S.S. *Cincinnati*, U.S.S. *Raleigh*, U.S.S. *Marblehead*, Destroyer Squadron 14.

108 **14-23 Jun 30** **Joint Army-Navy Coast Defense Exercise** San Francisco, CA
Units: (39 aircraft) HQ Ninth C.A. Dist., HD of San Francisco, 30 Inf, 6 C.A., 517 C.A., 604 C.A., 608 C.A., 627 C.A., 628 C.A., HQ 7 Bomb Gp, 9 Bomb Sq, 11 Bomb Sq, 63 Serv Sq, 91 Obsn Sq, U.S.A.M.P. *Col. George Armistead*, HQ 12th Naval Dist., U.S.S. *Texas*, U.S.S. *Oklahoma*, U.S.S. *Idaho*, U.S.S. *New Mexico*, U.S.S. *Nevada*, U.S.S. *New York*, U.S.S. *Tennessee*, U.S.S. *Saratoga*, U.S.S. *Lexington*, U.S.S. *Langley*, U.S.S. *Omaha*, 24 destroyers, 5 submarines, 4 U.S.C.G vessels

109 **6-19 Jul 30** **Third Corps Area CPX** Fort George G. Meade, MD
Units: (2,440 troops) HQ Third Corps Area, HQ III Corps (Prov), HQ 28 Div, HQ 29 Div, HQ 79 Div, HQ 80 Div, HQ 99 Div, HQ 62 CD, HQ 52 Cav Brig, HQ 16 Inf Brig, HQ 55 Inf Brig, HQ 56 Inf Brig, HQ 58 Inf Brig, HQ 91 Inf Brig, HQ 1 F.A. Brig

110 **Aug 30** **Annual Maneuver** Fort Huachuca, AZ
Units: 25 Inf, 10 Cav

111 **14-16 Aug 30** **Minor Joint Army-Navy Coast Defense Exercise** San Francisco, CA
Units: HD of San Francisco, 30 Inf, 6 C.A., 91 Obsn Sq, U.S.A.M.P. *Col. George Armistead*, HQ 12th Naval Dist.

112 **24-29 Aug 30** **6th Infantry Brigade Maneuver** Gigling Military Reservation, CA
Units: HHC 6 Inf Brig, 30 Inf, 11 Cav, 2-76 F.A., elmts 3 Div Q.M. Tn, 91 Obsn Sq

113 **1-27 Sep 30** **Joint Anti-Aircraft Exercise** Fort Worden, WA
Units: HD of Puget Sound, 14 C.A., 91 Obsn Sq

114 **6-26 Sep 30** **3rd Division Maneuver** Fort Lewis, WA
Units: HQ 3 Div, HHC 5 Inf Brig, 4 Inf, 7 Inf, 10 F.A., 76 F.A., 3 Am Tn, 3 Div Sp Tps, 6 Engr, 3 Med Regt, 3 Div Q.M. Tn

115 **8-10 Sep 30** **Joint Army-Navy Communications Exercise** Sandy Hook, NJ
Units: HD of Sandy Hook, 7 C.A., HQ 9 Obsn Gp, U.S.A.M.P. *Gen.E.O.C. Ord*, HQ 13th Naval Dist

116 **13-15 Oct 30** **Joint Air Defense Exercise** Los Angeles—Burbank, CA
Units: (400 troops, 20 aircraft) HD of Los Angeles, 6 C.A. (-), 63 C.A., HQ 7 Bomb Gp, 11 Bomb Sq, 63 Serv Sq, 91 Obsn Sq, 95 Purs Sq

117 **2-10 Jan 31** **Panamanian Revolution** Panama City, RP
Units: 33 Inf

118 **5-18 Jan 31** **Philippine Division Maneuver** Lingayen—Bataan, PI
Units: HQ Ph Div, HHC 23 Inf Brig, 31 Inf, 45 Inf, 57 Inf, 24 F.A., 1-14 Engr, 12 Med Regt, Ph Div Sp Tps, Ph Div Q.M. Tn, 26 Cav

119 **27 Jan-17 Feb 31** **Panama Canal Department Maneuver** Chorerra, Republic of Panama
Units: HQ Panama Canal Dept, HQ PC Div, HHC 19 Inf Brig, 14 Inf, 33 Inf, 1-2 F.A., 11 Engr, PC Div Sp Tps, PC Div Q.M. Tn, Panama C.A. Dist., HD of Balboa, HD of Cristobal, 1 C.A., 4 C.A., HQ 6 Comp Gp, 7 Obsn Sq, 24 Purs Sq, 25 Bomb Sq, 44 Obsn Sq, 63 Serv Sq

120 **28 Feb-31 Mar 31** **Joint Army-Navy Maneuver** Oahu, TH
Units: HQ Haw Dept, HQ Haw Div, HHC 21 Inf Brig, HHC 22 Inf Brig, HHB 11 F.A. Brig, 19 Inf, 21 Inf, 35 Inf, 8 F.A., 11 F.A., 13 F.A., 11 Am Tn, 3 Engr, 11 Med Regt, Haw Div Sp Tps, Haw Div Q.M. Tn, HHB Haw Sep C.A. Brig, 15 C.A., 16 C.A., 41 C.A., 55 C.A., 64 C.A., HQ 5 Comp Gp, 4 Obsn Sq, 6 Purs Sq, 23 Bomb Sq, 65 Serv Sq

121 **4-30 Apr 31** **Fourth Corps Area Maneuver** Fort Benning, GA
Units: (7,000 troops) HHC 8 Inf Brig, HHB 13 F.A. Brig, 8 Inf, 22 Inf, 24 Inf, 29 Inf, 2-1 Tank Regt, 6 Cav, 2-16 F.A., 17 F.A., 83 F.A., 69 C.A., A/1 Obsn Bn, A/4 Engr, 4 Tank Co, 22 Obsn Sq, 2 Bln Co

122 **6-7 Apr 31** **Coast Defense Exercise** Manila Bay—Corregidor, PI
Units: HD of Manila and Subic Bays, 59 C.A., 60 C.A., 91 C.A., 92 C.A., U.S. Navy Asiatic Fleet

123 **2-6 May 31** **12th Infantry Brigade Maneuver** Harvard, IL
Units: HHC 12 Inf Brig, 2 Inf, 6 Inf, 14 Cav, 3 F.A.

124 **4-9 May 31** **Sixth Corps Area CPX** Camp Custer, MI—Woodstock, IL
Units: HQ Sixth Corps Area, HQ 32 Div, HQ 33 Div, HQ 85 Div, HQ 86 Div, HQ 101 Div, HQ 65 Cav Div, HHC 12 Inf Brig

125 **10-20 May 31** **2nd Division Maneuver** Camp Bullis—Oppenhiemer Ranch, TX
Units: HQ 2 Div, HHC 3 Inf Brig, HHT 1 Cav Brig, 9 Inf, 23 Inf, 5 Cav, A/1 AC Sq, 12 F.A., 2-15 F.A., 2 Am Tn, 2 Div Sp Tps, 8 Engr Sq, 2 Med Regt, 2 Div Q.M. Tn, HQ 3 Atk Gp, 8 Atk Sq, 13 Atk Sq, 90 Atk Sq, 60 Serv Sq, 12 Obsn Sq

126 **16-30 May 31** **1st Air Division (Prov) Maneuver and Demonstration** Dayton—Chicago—New York—Boston—Atlantic City—Philadelphia—Washington
Units: (1,400 troops; 663 aircraft) HQ 1 Air Div (Prov), HQ 1 Purs Gp, HQ 2 Bomb Gp, HQ 3 Atk Gp, HQ 7 Bomb Gp, 11 Bomb Sq, 95 Purs Sq, 152 Obsn Gp (Prov), 153 Obsn Gp (Prov), 101 Obsn Sq, 102 Obsn Sq, 103 Obsn Sq, 104 Obsn Sq, 105 Obsn Sq, 106 Obsn Sq, 107 Obsn Sq, 108 Obsn Sq, 109 Obsn Sq, 110 Obsn Sq, 111 Obsn Sq, 112 Obsn Sq, 113 Obsn Sq, 115 Obsn Sq, 116 Obsn Sq, 118 Obsn Sq, 119 Obsn Sq, 120 Obsn Sq, 154 Obsn Sq, 306 Obsn Sq, 442 Purs Sq, 443 Purs Sq

127 **22 May-1 Jun 31** **1st Cavalry Division Maneuver** Hueco Tanks, TX—Oro Grande Mountains, NM
Units: HHT 1 Cav Div, HHT 2 Cav Brig, 7 Cav, 8 Cav, A/1 Armd Car Sq, 82 F.A. Bn, 1 Cav Div Sp Tps, 8 Engr Sq, 1 Cav Div Q. M. Tn, 1 Med Sq

128 **26-29 May 31** **Third Coast Artillery District Coast Defense Exercise** Fort Monroe and Chesapeake Bay, VA
Units: (1,300 troops) HQ Third C.A. Dist, HD of Chesapeake Bay, 34 Inf, 12 C.A., 1-51 C.A., 61 C.A., A/2 Armd Car Sq, 5 Obsn Sq, 19 Ash Co, HQ Fifth Naval Dist, U.S.S. *Omaha*, U.S.S. *Cincinnati*, U.S.S. *Milwaukee*, Destroyer Divs 3 & 7, 8 USCG Cutters

129 **26 May-6 Jun 31** **10th Infantry Brigade Maneuver** Camp Knox, KY
Units: HHC 10 Inf Brig, 10 Inf, 11 Inf, 5 Tank Co, 1-3 F.A.

130 **8-21 Aug 31** **4th Infantry Brigade Maneuver** Fort Laramie—Pole Mountain, WY
Units: HHC 4 Inf Brig, 1 Inf, 20 Inf, 13 Cav, 76 F.A., 2 Engr

131 **11 Aug 31** **Surface Ship Bombing Test** Off Chesapeake Bay, VA
Units: HQ 2 Bomb Gp, 17 Bomb Sq, 27 Bomb Sq, 94 Bomb Sq, 95 Bomb Sq, 59 Serv Sq, S.S. *Mount Shasta*

132 **16 Aug-14 Sep 31** **18th Infantry Brigade Maneuver** Fort Ethan Allen, VT
Units: (2,600 troops) HHC 18 Inf Brig, 5 Inf, 13 Inf, 1-7 F.A.

133 **24 Aug-19 Sep 31** **2nd Infantry Brigade Maneuver** Pine Camp, NY
Units: HHC 2 Inf Brig, 26 Inf, 28 Inf, 2-7 F.A.

134 **25-28 Aug 31** **6th Infantry Brigade Maneuver** Gigling Military Reservation, CA
Units: HHC 6 Inf Brig, 30 Inf, 38 Inf, 11 Cav, 76 F.A., 91 Obsn Sq

135 **11-20 Sep 31** **3rd Division Maneuver** Camp Lewis, WA
Units: HQ 3 Div, HHC 5 Inf Brig, HHB 3 F.A. Brig, 4 Inf, 7 Inf, 10 F.A., 3 Div Sp Tps, 6 Engr, 3 Div Q.M. Tn, 91 Obsn Sq

136 **16 Aug-14 Sep 31** **14th Infantry Brigade Maneuver** Faribault—Fort Snelling, MN
Units: HHC 14 Inf Brig, 3 Inf, 17 Inf, F/18 F.A., 6 Tank Co, 19 Reserve Officers

137 **16-19 Oct 31** **Yorktown Sesquicentennial Celebration** Yorktown, VA
Units: 34 Inf, 112 Inf, 3 Cav, B/102 Cav, 16 F.A., 12 C.A., 51 C.A., 52 C.A., C/13 Engr, U.S.S. *Arkansas*

138 **24 Oct-7 Nov 31** **Hawaiian Department Maneuver** Oahu, TH
Units: HQ Haw Dept, HQ Haw Div, HHC 21 Inf Brig, HHC 22 Inf Brig, HHB 11 F.A. Brig, 19 Inf, 21 Inf, 27 Inf, 35 Inf, 8 F.A., 11 F.A., 13 F.A., 3 Engr, 11 Med Regt, Haw Div Sp Tps, Haw Div Q.M. Tn, HHB Haw Sep C.A. Brig, 15 C.A., 16 C.A., 41 C.A., 55 C.A., 64 C.A., HQ 5 Comp Gp, 4 Obsn Sq, 6 Purs Sq, 23 Bomb Sq, 65 Serv Sq, U.S.S. *Oglala*, U.S.S. *Itasca*

139 **8-21 Jan 32** **Philippine Division Maneuver** Capas—Manibaug—Fort Stotsenburg, PI
Units: HQ Ph Div, HHC 23 Inf Brig, 31 Inf, 45 Inf, 57 Inf, 24 F.A., 1-14 Engr, 12 Med Regt, Ph Div Sp Tps, Ph Div Q.M. Tn, 26 Cav, HQ 4 Comp Gp, 2 Obsn Sq, 3 Purs Sq, 28 Bomb Sq, 66 Serv Sq

140 **28 Jan-5 Feb 32** **Panama Canal Department Maneuver** Pacora, CZ
Units: HQ Panama Canal Dept, HQ PC Div, HHC 19 Inf Brig, 14 Inf, 33 Inf, 1-2 F.A., 4 F.A., 11 Engr, PC Div Sp Tps, elmts PC Div Q.M. Tn, Panama C.A. Dist., HD of Balboa, HD of Cristobal, 1 C.A., 4 C.A., HQ 6 Comp Gp, 7 Obsn Sq, 24 Purs Sq, 25 Bomb Sq, 44 Obsn Sq, 63 Serv Sq

141 **6-16 Feb 32** **Joint Army-Navy Maneuver** Makua, Oahu, TH
(Grand Joint Exercise No. 4)
Units: (42,000 troops, 300 aircraft, 150 ships) HQ Haw Dept, HQ Haw Div, HHC 21 Inf Brig, HHC 22 Inf Brig, HHB 11 F.A. Brig, HHB Haw Sep C.A. Brig, 19 Inf, 21 Inf, 27 Inf, 35 Inf, 30 Inf, 298 Inf, 299 Inf, 8 F.A., 11 F.A., 13 F.A., C/76 F.A., 15 C.A., 16 C.A., 41 C.A., 55 C.A., 64 C.A., 3 Engr, 11 Med Regt, Haw Div Sp Tps, Haw Div Q.M. Tn, HQ 18 Comp Wing, HQ 5 Comp Gp, HQ 18 Purs Gp, 4 Obsn Sq, 6 Purs Sq, 19 Purs Sq, 23 Bomb Sq, 26 Atk Sq, 36 Purs Sq, 50 Obsn Sq, 72 Bomb Sq, 77 Purs Sq, 65 Serv Sq, 75 Serv Sq, 80 Serv Sq, U.S.A.T. *St. Mihiel*, U.S.S. *Saratoga*, U.S.S. *Lexington*, U.S.S. *Arizona*, U.S.S. *Pennsylvania*, U.S.S. *Maryland*, U.S.S. *West Virginia*, U.S.S. *California*, U.S.S. *Tennessee*, U.S.S. *Nevada*, U.S.S. *Oklahoma*, U.S.S. *New York*, U.S.S. *Colorado*, U.S.S. *Concord*, U.S.S. *Cincinnati*, U.S.S. *Omaha*, U.S.S. *Detroit*, U.S.S. *Anderson*, U.S.S. *Henderson*, 1 Marine Div (Construction)

142 **1-15 Apr 32** **Joint Army-Navy Maneuver** Fort MacArthur, CA
(Grand Joint Exercise No. 5)
Units: HQ Ninth C.A. Dist, HD of Los Angeles, 3 C.A., 63 C.A., HQ 1 Bomb Wing, HQ 7 Bomb Gp, 9 Bomb Sq, 11 Bomb Sq, 31 Bomb Sq, 70 Serv Sq, HQ 17 Purs Gp, 34 Purs Sq, 73 Purs Sq, 95 Purs Sq, 64 Serv Sq, U.S.S. *Saratoga*, U.S.S. *Lexington*, U.S.S. *Maryland*, U.S.S. *West Virginia*, U.S.S. *California*, U.S.S. *Nevada*, U.S.S. *Concord*, U.S.S. *Cincinnati*, U.S.S. *Omaha*

143 **19 Apr-15 May 32** **Fourth Corps Area Maneuver** Fort Benning, GA
Units: (2,000 troops) HHC 8 Inf Brig, 8 Inf, 22 Inf, 24 Inf, 29 Inf, 2-1 Tank Regt, 4 Tank Co, 6 Cav, 1-83 F.A., 69 C.A., A/7 Engr, C/2 Chem Regt, 16 Obsn Sq

144 **May 32** **6th Infantry Brigade Maneuver** Gigling Military Reservation, CA
Units: HHC 6 Inf Brig, 30 Inf, 38 Inf, 11 Cav, 76 F.A., 91 Obsn Sq

145 **5-16 May 32** **3rd Division Maneuver** Camp Lewis, WA
Units: HQ 3 Div, HHC 5 Inf Brig, HHB 3 F.A. Brig, 7 Inf, 1-9 F.A., 10 F.A., 2-6 Engr, 3 Div Sp Tps, elmts 3 Div Q.M. Tn

146 **7-21 May 32** **1st Cavalry Division Maneuver** Hueco Tanks and Rio Grande River Valley, TX
Units: HHT 1 Cav Div, HHT 2 Cav Brig, 7 Cav, 8 Cav, A/1 AC Sq, 82 F.A. Bn, 1 Cav Div Sp Tps, 1 Cav Div Q. M. Tn, 1 Med Sq, 1 Obsn Sq, HQ 3 Atk Gp, 84 reserve officers from 156 Cav Brig, 90 Div, 103 Div

147 **10 May-2 Jun 32** **2nd Division Maneuver** Christine—Tilden, TX
Units: (4,100 troops) HQ 2 Div, HHC 3 Inf Brig, HHB 2 F.A. Brig, HHT 1 Cav Brig, 9 Inf, 23 Inf, 5 Cav, 12 Cav, A/1 AC Sq, 12 F.A., 2-15 F.A., 2 Am Tn, 2 Div Sp Tps, 8 Engr Sq, 2 Med Regt, 2 Div Q.M. Tn, 12 Obsn Sq, 72 reserve officers from HHC 90 Div, Sp Tps 90 Div, 90 Div Q.M. Tn, 315 Med Regt

148 **15-28 May 32** **Sixth Corps Area CPX** Camp Custer, MI
Units: (400 troops) HQ Sixth Corps Area, HHT 1 Cav Corps (Prov), HQ 32 Div, HQ 33 Div, HQ 22 Cav Div (Prov), HHC 12 Inf Brig (6 Div Prov), HQ 53 Cav Brig, 125 reserve officers from HQ 85 Div, HQ 86 Div, HQ 101 Div, HQ 65 Cav Div, 1 Sig Co

149 **23 May 32** **Camouflage and Antiaircraft Exercise** vicinity Great Neck, LI, NY
Units: 62 CA, 40 Engr Bn (Camo), 5 Obsn Sq

150 **26-30 Jun 32** **Seventh Corps Area Maneuver** Camp Ripley, MN
Units: HHC 14 Inf Brig, 3 Inf, 17 Inf, 14 Cav (-), 2-18 F.A., 6 Tank Co

151 **28-29 Jul 32** **Bonus March Incident** Washington, DC
Units: HHC 16 Inf Brig, 12 Inf (-2d Bn), elmts 34 Inf, 3 Cav (-), 13 Engr, 1-260 C.A., B/1 Tank Regt

152 **13-27 Aug 32** **4th Infantry Brigade Maneuver** Pole Mountain Military Reservation, WY
Units: HHC 4 Inf Brig, 1 Inf, 20 Inf, 13 Cav, 76 F.A., 2 Engr, 328 Med Regt, 101 reserve officers from 103 Div

153 **12-24 Sep 32** **1st Division Command** Camp Dix, NJ
and Communication Exercise
Units: (1,255 troops) HQ 1 Div, HHC 1 Inf Brig, HHC 2 Inf Brig, HHB 1 F.A. Brig, 16 Inf, 18 Inf, 26 Inf, 28 Inf, 5 F.A., 6 F.A., 7 F.A., 1 Engr, Sp Tps, 1 Sig Co, 1 Med Regt, 1 Div Sp Tps, elmts 1 Div Q.M. Tn, HQ 77 Div, HQ 153 Inf Brig, HQ 154 Inf Brig, HQ 152 F.A. Brig, 99 Obsn Sq

154 **Oct 32** **Antiaircraft Exercise** San Pedro—Long Beach, CA
Units: 160 Inf, 63 C.A., 975 C.A., 977 C.A.

155 **1-8 Oct 32** **Third Corps Area Maneuver** Fort George G. Meade, MD
Units: (3,000 troops) HHC 16 Inf Brig, 12 Inf, 34 Inf, 3 Cav (-), HHB 1 F.A. Brig, 6 F.A., 1-16 F.A., 1 Chem Regt, HQ 2 Bomb Gp, 20 Bomb Sq, 49 Bomb Sq, 96 Bomb Sq, 59 Serv Sq

156 **10-17 Nov 32** **Cavalry Corps CPX** Chicago, IL
Units: HQ I Cav Corps (Prov), HHT 65 Cav Div, HHT 159 Cav Brig, 2 Cav, 317 Cav, 318 Cav, 65 Sig Tp

157 **1-10 Dec 32** **23rd Brigade River Crossing Exercise** Pasig & Maraquina Rivers near
Fort McKinley, PI
Units: HHC 23 Brig, 45 Inf, 57 Inf, 14 Engr

158 **27 Jan-10 Feb 33** **Joint Army-Navy Maneuver** Oahu, TH
Units: HQ Haw Dept, HQ Haw Div, HHC 21 Inf Brig, HHC 22 Inf Brig, HHB 11 F.A. Brig, 19 Inf, 21 Inf, 27 Inf, 35 Inf, 8 F.A., 11 F.A., 13 F.A., HHB Haw Sep C.A. Brig, 15 C.A., 16 C.A., 41 C.A., 55 C.A., 64 C.A., 3 Engr, 11 Med Regt, Haw Div Sp Tps, Haw Div Q.M. Tn, HQ 18 Comp Wing, HQ 5 Comp Gp, HQ 18 Purs Gp, 4 Obsn Sq, 6 Purs Sq, 19 Purs Sq, 23 Bomb Sq, 26 Atk Sq, 36 Purs Sq, 50 Obsn Sq, 72 Bomb Sq, 77 Purs Sq, 65 Serv Sq, 75 Serv Sq, 80 Serv Sq, U.S.S. *Saratoga*, U.S.S. *Lexington*

159 **6-10 Apr 33** **Second Army CPX** Chicago QM Depot, IL
Units: HQ Second Army, HQ VI Corps, HQ XVI Corps, II Cav Corps (Prov), HQ 32 Div, HQ 33 Div, HQ 85 Div, HQ 86 Div, HQ 101 Div, HQ 22 Cav Div (Prov), HQ 65 Cav Div, HHT 53 Cav Brig, 420 Inf (LT), 423 Inf (LT)

160 **1-16 May 33** **Hawaiian Coast Defense Exercise** Oahu, TH
Units: HD of Pearl Harbor, HD of Honolulu, HHB Haw Sep C.A. Brig, 15 C.A., 16 C.A., 41 C.A., 55 C.A., 64 C.A., HQ 5 Comp Gp, HQ 18 Purs Gp, 4 Obsn Sq, 19 Purs Sq, 50 Obsn Sq, 65 Serv Sq,

161 **1-19 May 33** **3rd Division Maneuver** Camp Lewis, WA
Units: HQ 3 Div, HHC 5 Inf Brig, HHB 3 F.A. Brig, 4 Inf, 7 Inf, 1-9 F.A., 10 F.A., 6 Engr, 3 Div Sp Tps, elmts 3 Div Q.M. Tn

162 **27 May 33** **Century of Progress Parade** Chicago, IL
Units: HQ 6 Div (RAI), HQ 86 Div, HQ 65 Cav Div, HHC 11 Inf Brig (RAI), HHC 12 Inf Brig, HHC 171 Inf Brig, HHT 159 Cav Brig, HHB 6 F.A. Brig, HHB 161 F.A. Brig, 1-2 Inf, 1-4 Cav, 317 Cav, 22 F.A. (RAI), 78 F.A. (RAI), 331 F.A., 332 F.A., 404 F.A., 10 Engr (RAI), 311 Engr

163 **1-18 May 33** **2nd Division Maneuver** Camp Bullis, TX
Units: HQ 2 Div, HHC 3 Inf Brig, HHB 2 F.A. Brig, 9 Inf, 23 Inf, 12 F.A., 15 F.A., 2 Med Regt, 2 Div Sp Tps, elmts 2 Div Q.M. Tn, 12 Obsn Sq, 65 reserve officers from HHC 90 Div, 344 F.A., Sp Tps 90 Div, 90 Div Q.M. Tn, 315 Med Regt

164 **3-26 May 33** **GHQ Air Force Maneuver** March Field—Los Angeles—Riverside—
San Diego, CA
Units: (880 troops; 330 aircraft) HQ 1 Air Div (Prov), HQ 1 Bomb Wing, HQ 2 Bomb Wing, HQ 1 Purs Gp, 17 Purs Sq, 27 Purs Sq, 94 Purs Sq, 95 Purs Sq, 57 Serv Sq, HQ 2 Bomb Gp, 20 Bomb Sq, 49 Bomb Sq, 96 Bomb Sq, 59 Serv Sq, HQ 3 Atk Gp, 8 Atk Sq, 13 Atk Sq, 90 Atk Sq, 60 Serv Sq, HQ 9 Obsn Gp, 1 Obsn Sq, 5 Obsn Sq, 99 Obsn Sq, 61 Serv Sq, HQ 12 Obsn Gp, 12 Obsn Sq, 22 Obsn Sq, 88 Obsn Sq, 62 Serv Sq, HQ 1 Trans Gp (Prov)

165 **15-26 May 33** **Joint Ground-Air Maneuver** Fort Knox, KY—Cincinnati, OH
Units: (113 aircraft) HQ Fifth Corps Area, HHC 10 Inf Brig, 10 Inf, 11 Inf, 1-28 Inf, 1 Cav (Mczd), 3 F.A., 61 C.A., 62 C.A., 69 C.A., 1 Sig Co, HQ 1 Purs Gp, 17 Purs Sq, 27 Purs Sq, 94 Purs Sq, 95 Purs Sq, 57 Serv Sq, HQ 2 Bomb Gp, 20 Bomb Sq, 49 Bomb Sq, 96 Bomb Sq, 59 Serv Sq, HQ 3 Atk Gp, 8 Atk Sq, 13 Atk Sq, 90 Atk Sq, 60 Serv Sq, HQ 7 Bomb Gp, 9 Bomb Sq, 11 Bomb Sq, 31 Bomb Sq, 70 Serv Sq, 325 Obsn Sq

166 **5-18 Jul 33** **4th Infantry Brigade Maneuver** Pole Mountain Military Reservation, WY
Units: HHC 4 Inf Brig, 1 Inf, 20 Inf, 13 Cav, 2-76 F.A., 2 Engr, 108 reserve officers from HQ 103 Div, HHC 206 Inf Brig, 411 Inf, 412 Inf, Sp Tps 103 Div, 328 Med Regt, 103 Div Q.M. Tn, Eighth Corps Area Service Command

167 **3-21 Aug 33** **Panama Canal Department Maneuver** Corozal—Fort Clayton, CZ
Units: HQ Panama Canal Department, HQ Pacific Sector, HQ Atlantic Sector, 14 Inf, 33 Inf, 1-2 F.A., 11 Engr, Panama C.A. Dist., HD of Balboa, HD of Cristobal, 1 C.A., 4 C.A., HQ 6 Comp Gp, 7 Obsn Sq, 24 Purs Sq, 25 Bomb Sq, 44 Obsn Sq, 63 Serv Sq

168 **21-25 Aug 33** **Second Corps Area CPX** Camp Dix, NJ
Units: HQ Second Corps Area, HQ II Corps (Prov), HQ 1 Div, HQ 77 Div, HQ 78 Div, HQ 98 Div, HHC 1 Inf Brig, HHC 2 Inf Brig, HHC 153 Inf Brig, HHC 154 Inf Brig, HHC 155 Inf Brig, HHC 156 Inf Brig, HHC 195 Inf Brig, HHC 196 Inf Brig, HHB 1 F.A. Brig, HHB 152 F.A. Brig, HHB 153 F.A. Brig, HHB 173 F.A. Brig, 16 Inf, 18 Inf, 26 Inf, 28 Inf, 305 Inf, 306 Inf, 307 Inf, 308 Inf, 309 Inf, 310 Inf, 311 Inf, 312 Inf, 389 Inf, 390 Inf, 391 Inf, 392 Inf, HQ 9 Obsn Gp, 1 Sig Co, 51 Sig Bn

169 **9-18 Jan 34** **Philippine Division Maneuver** Bataan Peninsula, vicinity Hermosa and Mariveles Mountain, PI
Units: HQ Ph Div, HHC 23 Inf Brig, 31 Inf, 45 Inf, 57 Inf, 24 F.A., 1-14 Engr, 12 Med Regt, Ph Div Sp Tps, elmts Ph Div Q.M. Tn, 26 Cav

170 **14-29 Mar 34** **Joint Army-Navy Maneuver** Panama Canal Zone
Units: (4,000 troops) HQ Panama Canal Department, HQ Pacific Sector, HQ Atlantic Sector, 14 Inf, 33 Inf, 1-2 F.A., 11 Engr, Panama C.A. Dist., HD of Balboa, HD of Cristobal, 1 C.A., 4 C.A., HHS 6 Comp Gp, 7 Obsn Sq, 24 Purs Sq, 25 Bomb Sq, 44 Obsn Sq, 63 Serv Sq

171 **May 34** **Cavalry School Maneuver** Fort Riley, KS
Units: HHT Cav Brig (Prov), HHT 7 Cav Brig (Mczd), 1 Cav (Mczd), 2 Cav, 9 Cav, 13 Cav, 2-18 F.A., A/9 Engr Sq, A/1 F.A., 16 Obsn Sq

172 **8 Aug-17 Sep 34** **Sixth Corps Area Maneuver** Camp Custer, MI
Units: HHC 12 Inf Brig, 2 Inf, 6 Inf, 1-14 Cav, 2-3 F.A.

173 **10 Aug 34** **Mechanized Maneuver** Richmond, SI, NY
Units: G/18 Inf, 424 Inf (LT), 461 Arm Car Sq, 1 Tank Co, 102 Obsn Sq

174 **26 Aug-7 Sep 34** **General Headquarters CPX** Camp Dix—Raritan Arsenal—Fort Monmouth, NJ
Units: (1,000 troops) HQ GHQ (Prov), HQ First Army, HQ Second Army, GHQ Air Force, HQ I Corps (Prov), HQ II Corps (Prov), HQ III Corps (Prov), HQ V Corps (Prov), HQ VI Corps (Prov), HQ I Cav Corps (Prov), HQ 1 Div, HQ 26 Div, HQ 27 Div, HQ 28 Div, HQ 29 Div, HQ 32 Div, HQ 33 Div, HQ 37 Div, HQ 38 Div, HQ 43 Div, HQ 44 Div, HQ 21 Cav Div, HQ 22 Cav Div, HHC 10 Brig, HHC 12 Brig, HHC 16 Brig, HHC 18 Brig, HHT 7 Cav Brig, HD of Boston, HD of the Delaware, HD of Long Island Sound, HD of Narragansett Bay, HD of Portland, HD of Sandy Hook, HD of Southern New York, 5 C.A., 7 C.A., 8 C.A., 9 C.A., 10 C.A., 11 C.A., HQ 1 Purs Wing, HQ 2 Bomb Wing, HQ 3 Atk Wing, HQ 1 Purs Gp, HQ 2 Bomb Gp, HQ 3 Atk Gp, HQ 8 Purs Gp, HQ 9 Obsn Gp, HQ 12 Obsn Gp

175 **10-18 Sep 34** **General Headquarters CPX (Cavalry Corps)** Fort Knox, KY
Units: HQ I Cav Corps (Prov), HQ 1 Cav Div, HQ 51 Cav Brig (as 21 Cav Div), HQ 54 Cav Brig (as 22 CD), HQ 7 Cav Brig (Mczd), 1 Cav, 4 Cav, 15 Obsn Sq

176 **27 Sep-13 Oct 34** **Third Corps Area Maneuver** Fort Meade, MD
Units: HHC 16 Inf Brig, 12 Inf, 34 Inf, 3 Cav (-), 6 F.A., 1-16 F.A., A/1 Chem Regt, 1-13 Engr, I/66 Inf (LT), HHS 2 Bomb Gp, 8 Purs Gp, 15 Ord Co, 30 Ord Co

177 **10-13 Oct 34** **Cavalry School Maneuver** Fort Riley, KS
Units: HHT Cav Brig (Prov), 2 Cav, 9 Cav, 13 Cav, 2-18 F.A., A/9 Engr Sq

178 **9 Jan-3 Feb 35** **2nd Wing Maneuver** Miami, FL—Mobile, AL—New Orleans, LA—Montgomery, AL—Columbus, GA
Units: (81 aircraft) HHS 2 Wing, HHS 2 Bomb Gp, HHS 8 Purs Gp, 20 Bomb Sq, 49 Bomb Sq, 96 Bomb Sq, 59 Serv Sq, 33 Purs Sq, 35 Purs Sq, 36 Purs Sq, 58 Serv Sq, 19 Ashp Sq

179 **Feb 35** **Philippine Division Maneuver** Bataan Peninsula, vicinity Mariveles Mountain, PI
Units: HQ Ph Div, HHC 23 Inf Brig, 31 Inf, 45 Inf, 57 Inf, 24 F.A., 1-14 Engr, 12 Med Regt, Ph Div Sp Tps, elmts Ph Div Q.M. Tn, 26 Cav

180 **11-16 Feb 35** **Pacific Sector Maneuver** Fort Amador—Pacific Side, CZ
Units: HQ Pacific Sector, HD of Balboa, 14 Inf, 1 C.A., 4 C.A.

181 **12-30 Mar 35** **Panama Canal Department Maneuver** Corundu Military Reservation, CZ
Units: HQ Panama Canal Department, HQ Pacific Sector, HQ Atlantic Sector, 14 Inf, 33 Inf, 1-2 F.A., 11 Engr, Panama C.A. Dist., HD of Balboa, HD of Cristobal, 1 C.A., 4 C.A., HHS 6 Comp Gp, 7 Obsn Sq, 24 Purs Sq, 25 Bomb Sq, 44 Obsn Sq, 63 Serv Sq

182 **22 Mar-14 Apr 35** **1st Wing Maneuver** Hamilton Field, CA—March Field, CA
Units: (90 aircraft) HHS 1 Wing, HHS 7 Bomb Gp, 9 Bomb Sq, 11 Bomb Sq, 31 Bomb Sq, 70 Serv Sq, HHS 19 Bomb Gp, 30 Bomb Sq, 32 Bomb Sq, 72 Bomb Sq, 76 Serv Sq

183 **Apr 35** **1st Cavalry Brigade Maneuver** Del Rio—Devil's River—Eagle Paso, TX
Units: HHT 1 Cav Brig, 5 Cav, 12 Cav, 8 Engr Sq

184 **6-18 May 35** **8th Infantry Brigade Maneuver** Fort Benning, GA
Units: HHC 8 Inf Brig, 8 Inf, 22 Inf, 6 Cav, 1-80 F.A., 22 Obsn Sq

185 **8-19 May 35** **Fifth Corps Area Maneuver** Fort Knox, KY
Units: HHC 10 Inf Brig, HHT 7 Cav Brig (Mczd), 10 Inf, 11 Inf, 5 Tank Co, 1 Cav (Mczd), 19 F.A., 1-68 F.A., 19 Ord Co

186 **22 May-14 Jun 35** **Joint Anti-aircraft/Air Corps Exercise** Fort Sheridan, IL—Moran, MI
Units: (400 troops, 12 aircraft) 61 C.A., 15 Obsn Sq, 30 Reserve officers

187 **May-Jun 35** **Camouflage and Antiaircraft Exercise** vicinity Great Neck, LI, NY
Units: 62 CA, 40 Engr Bn (Camo), 5 Obsn Sq

188 **6-21 Jun 35** **Cavalry School Maneuver** Fort Riley, KS
Units: HHT Cav Brig (Prov), 2 Cav, 9 Cav, 13 Cav, 1-14 F.A., A/9 Engr Sq, 16 Obsn Sq, 2 Med Sq, 17 Q.M. Sq

189 **21-28 Jun 35** **Hawaiian Department Maneuver** Oahu, TH
Units: HQ Haw Dept, HQ Haw Div, HHC 21 Inf Brig, HHC 22 Inf Brig, HHB 11 F.A. Brig, 19 Inf, 21 Inf, 27 Inf, 35 Inf, 8 F.A., 11 F.A., 13 F.A., 3 Engr, 11 Med Regt, Haw Div Sp Tps, elmts Haw Div Q.M. Tn, HHB Haw Sep C.A. Brig, 15 C.A., 16 C.A., 41 C.A., 55 C.A., 64 C.A., HHS 5 Comp Gp, 4 Obsn Sq, 6 Purs Sq, 23 Bomb Sq, 65 Serv Sq

190 **6 Aug-3 Sep 35** **First Army Maneuver,** Pine Camp, NY
First and Second Corps Area Concentration
Units: (36,000 troops) HQ First Army, HQ I Corps (Prov), HQ II Corps (Prov), HQ 1 Div, HHC 1 Inf Brig, HHC 2 Inf Brig, 16 Inf, 18 Inf, 26 Inf, 28 Inf, 7 F.A., 1 Engr, 1 Sig Co, 1 Med Regt, 1 Div Sp Tps, elmts 1 Div Q.M. Tn, HQ 26 Div, HHC 51 Inf Brig, HHC 52 Inf Brig, HHB 51 F.A. Brig, 101 Inf, 104 Inf, 181 Inf, 182 Inf, 101 Am Tn, 101 F.A., 102 F.A., 172 F.A., 101 Engr, 101 Med Regt, 26 Div Sp Tps, 26 Div Q.M. Tn, HQ 27 Div, HHC 53 Inf Brig, HHC 54 Inf Brig, HHB 52 F.A. Brig, 105 Inf, 106 Inf, 107 Inf, 108 Inf, 104 F.A., 105 F.A., 106 F.A., 102 Engr, 102 Med Regt, 27 Div Sp Tps, 27 Div Q.M. Tn, HQ 43 Div, HHC 85 Inf Brig, HHC 86 Inf Brig, HHB 68 F.A. Brig, 102 Inf, 103 Inf, 169 Inf, 172 Inf, 103 F.A., 152 F.A., 192 F.A., 118 Engr, 118 Med Regt, 43 Div Q.M. Tn, 43 Div Sp Tps, HQ 44 Div, HHC 57 Inf Brig, HHC 87 Inf Brig, HHB 69 F.A. Brig, 71 Inf, 113 Inf, 114 Inf, 174 Inf, 112 F.A., 156 F.A., 104 Engr, 119 Med Regt, 44 Div Sp Tps, 44 Div Q.M. Tn, 7 Cav Brig (Mczd), 1 Cav (Mczd), 1-3 Cav, F/67 Inf (MT), 2-25 F.A., 62 C.A., 97 Obsn Sq, 101 Obsn Sq, 102 Obsn Sq, 118 Obsn Sq, 119 Obsn Sq, 51 Sig Bn, 101 Sig Bn, 302 Sig Bn, 303 Sig Bn, 98 Sig Co, 4 Rad Intel Co, 328 Rad Intel Co, 40 Ord Co

191 **10 Aug-3 Sep 35** **First Army Maneuver,** Indiantown Gap—Mt. Gretna, PA
Third Corps Area Concentration
Units: (20,000 troops) HQ III Corps (Prov), HQ 28 Div, HHC 55 Inf Brig, HHC 56 Inf Brig, HHB 53 F.A. Brig, 109 Inf, 110 Inf, 111 Inf, 112 Inf, 107 F.A., 108 F.A., 109 F.A., 103 Engr, 103 Med Regt, 28 Div Sp Tps, 28 Div Q.M. Tn, HQ 29 Div, HHC 58 Inf Brig, HHB 54 F.A. Brig, 1 Inf (MD NG), 5 Inf (MD NG), 111 F.A., 176 F.A., 103 Am Tn, 104 Med Regt, 29 Div Sp Tps, 29 Div Q.M. Tn, 16 Inf Brig, 12 Inf, 34 Inf, 1 F.A. Brig, 6 F.A., 103 Obsn Sq

192 **5 Sep-3 Oct 35** **18th Infantry Brigade Maneuver** Camp Devens, MA
Units: (1,600 troops) HHC 18 Inf Brig, 5 Inf, 13 Inf

193 **16-28 Sep 35** **Fourth Army CPX** Presidio of SF—Omaha, NE—Fort Lewis, WA
Units: (300 officers) HQ Fourth Army, HQ VII Corps (Prov), HQ IX Corps (Prov), HQ XVII Corps (Prov), HQ XIX Corps (Prov), HQ 3 Div, HQ 34 Div, HQ 35 Div, HQ 40 Div, HQ 41 Div, HQ 88 Div, HQ 89 Div, HQ 91 Div, HQ 96 Div, HQ 102 Div, HQ 104 Div, HQ 3 Wing

194 **20-24 Oct 35** **3rd Wing Maneuver** New Orleans, LA—Pensacola, FL
Units: HHS 3 Wing, HHS 3 Atk Gp, HHS 20 Purs Gp, 8 Atk Sq, 13 Atk Sq, 55 Purs Sq, 77 Purs Sq, 79 Purs Sq, 87 Purs Sq, 90 Atk Sq, 60 Serv Sq, 71 Serv Sq

195 **3-17 Nov 35** **1st Wing Maneuver** March Field, CA
Units: HHS 1 Wing, HHS 17 Atk Gp, HHS 19 Bomb Gp, 30 Bomb Sq, 32 Bomb Sq, 34 Atk Sq, 39 Recon Sq, 73 Atk Sq, 88 Recon Sq, 95 Atk Sq, 63 C.A.

196 **12-15 Dec 35** **2nd Wing Maneuver** Chapman Field—Miami, FL
Units: HHS 2 Wing, HHS 2 Bomb Gp, HHS 8 Purs Gp, 20 Bomb Sq, 49 Bomb Sq, 96 Bomb Sq, 59 Serv Sq, 33 Purs Sq, 35 Purs Sq, 36 Purs Sq, 58 Serv Sq

197 **25 Nov-10 Dec 35** **GHQ Air Force Maneuver** Jacksonville—Miami, FL
Units: (800 troops; 125 aircraft) HQ GHQAF, HHS 1 Wing, HHS 2 Wing, HHS 3 Wing, HHS 1 Purs Gp, HHS 3 Atk Gp, HHS 7 Bomb Gp, HHS 20 Purs Gp, 17 Purs Sq, 27 Purs Sq, 94 Purs Sq, 57 Serv Sq, 20 Bomb Sq, 49 Bomb Sq, 96 Bomb Sq, 59 Serv Sq, 8 Atk Sq, 13 Atk Sq, 90 Atk Sq, 60 Serv Sq, 9 Bomb Sq, 11 Bomb Sq, 31 Bomb Sq, 70 Serv Sq, 33 Purs Sq, 35 Purs Sq, 36 Purs Sq, 58 Serv Sq, 34 Purs Sq, 73 Purs Sq, 95 Purs Sq, 64 Serv Sq, 55 Purs Sq, 77 Purs Sq, 79 Purs Sq, 71 Serv Sq, 88 Obsn Sq

198 **Jan 36** **Philippine Division Maneuver** Lingayen Gulf—Bataan Peninsula, PI
Units: HQ Ph Div, HHC 23 Inf Brig, 31 Inf, 45 Inf, 57 Inf, 24 F.A., 1-14 Engr, 12 Med Regt, Ph Div Sp Tps, elmts Ph Div Q.M. Tn, 26 Cav

199 **Jan 36** **3rd Division CPX** Puget Sound Area—Fort Casey—
Fort Worden, WA
Units: HQ 3 Div, HD of Puget Sound, 14 C.A.

200 **30 Jan-8 Feb 36** **GHQ Air Force Winter Maneuver** Burlington, VT—Concord, NH—
Mitchel Field, NY

Units: (216 troops; 62 aircraft) HQ GHQAF, HHS 1 Wing, HHS 2 Wing, HHS 3 Wing, HHS 2 Bomb Gp, HHS 3 Atk Gp, HHS 8 Purs Gp, HHS 20 Purs Gp, 20 Bomb Sq, 49 Bomb Sq, 96 Bomb Sq, 59 Serv Sq, 8 Atk Sq, 13 Atk Sq, 90 Atk Sq, 60 Serv Sq, 9 Bomb Sq, 33 Purs Sq, 35 Purs Sq, 36 Purs Sq, 58 Serv Sq, 55 Purs Sq, 77 Purs Sq, 79 Purs Sq, 71 Serv Sq

201 **10-20 Mar 36** **1st Wing Maneuver** Muroc Dry Lake, CA
Units: HHS 1 Wing, HHS 17 Atk Gp, HHS 7 Bomb Gp, 9 Bomb Sq, 11 Bomb Sq, 31 Bomb Sq, 34 Atk Sq, 73 Atk Sq, 95 Atk Sq, 64 Serv Sq, 70 Serv Sq, 19 Ashp Sq

202 **11 Mar-2 Apr 36** **Pacific Sector Maneuver** Fort Amador—Pacific Side, CZ
Units: HQ Pacific Sector, HD of Balboa, 14 Inf, 1 C.A., 4 C.A., HHS 19 Wing

203 **17 Mar-9 Apr 36** **Pennsylvania Flood Relief** Western Pennsylvania
Units: HQ 28 Div, HHC 55 Inf Brig, HHC 56 Inf Brig, HHB 53 F.A. Brig, 109 Inf, 110 Inf, 111 Inf, 112 Inf, 107 F.A., 108 F.A., 109 F.A., 103 Am Tn, 103 Engr, 103 Med Regt, 28 Div Sp Tps, 28 Div Q.M. Tn, HHT 52 Cav Brig, 103 Cav, 104 Cav, 213 C.A., 103 Obsn Sq

204 **20-27 Mar 36** **Coast Defense Exercise** Puget Sound—Bremerton, WA
Units: (2,500 troops) HD of Puget Sound, HQ 3 Div, 9 F.A., 10 F.A., 14 C.A., 2-6 Engr, 3 Div Sp Tps, 3 Tank Co, 3 Ord Co, 3 Sig Co, U.S.A.M.P. *Gen. J. Franklin Bell*, U.S.C.G.C *Chelan*, HQ, 13th Naval Dist., Marine elements

205 **6-9 Apr 36** **3rd Infantry Brigade Maneuver** Camp Bullis, TX
Units: HHC 3 Inf Brig, 9 Inf, 23 Inf, elmts 3 Q.M. Regt

206 **1 Apr-29 May 36** **1st Cavalry Division Maneuver** Marfa, TX
Units: HHT 1 Cav Div, HHT 1 Cav Brig, HHT 2 Cav Brig, 5 Cav, 7 Cav, 8 Cav, 12 Cav, 1-82 F.A., 8 Engr Sq, 1 Cav Div Sp Tps, 1 Cav Div Q.M. Tn, 1 Med Sq

207 **Apr-May 36** **Sixth Corps Area CPX** Chicago, IL
Units: HHC 12 Inf Brig, 2 Inf, 6 Inf, 1-14 Cav

208 **9-29 May 36** **3rd Division Maneuver** Fort Lewis, WA
Units: HQ 3 Div, HHC 5 Inf Brig, HHB 3 F.A. Brig, 4 Inf, 7 Inf, 1-9 F.A., 10 F.A., 3 Div Sp Tps, 6 Engr, 3 Sig Co, 3 Med Regt, 3 Q.M. Regt

209 **25 May-20 Jun 36** **Infantry School Maneuver** Fort Benning, GA
Units: HHC 8 Inf Brig, 8 Inf, 22 Inf, 29 Inf, 2-66 Inf (LT), F-67 Inf (MT), 6 Cav, A/4 Engr, 1-83 F.A., C/2 Chem Regt

210 **7 Jun 36** **Chemical Warfare Exercise** Camp Dix—Tranquility, NJ
Units: 113 Inf, 303 Chem Regt

211 **16-30 Jun 36** **Joint Army-Navy Maneuver** Oahu, TH
Units: HQ Haw Dept, HQ Haw Div, HHC 21 Inf Brig, HHC 22 Inf Brig, HHB 11 F.A. Brig, 19 Inf, 21 Inf, 27 Inf, 35 Inf, 8 F.A., 11 F.A., 13 F.A., 3 Engr, 11 Med Regt, 11 Q.M. Regt, Haw Div Sp Tps, HHB Haw Sep C.A. Brig, 15 C.A., 16 C.A., 41 C.A., 55 C.A., 64 C.A., HHS 5 Comp Gp, 4 Obsn Sq, 6 Purs Sq, 23 Bomb Sq, 65 Serv Sq, U.S.S. *Pennsylvania*, U.S.S. *Tennessee*, U.S.S. *New Mexico*, U.S.S. *Holland*, U.S.S. *Medusa*

212 **27 Jul-14 Aug 36** **4th Infantry Brigade Maneuver** Pole Mountain, WY
Units: HHC 4 Inf Brig, 1 Inf, 20 Inf, 76 F.A.

213 **1-15 Aug 36** **Second Army Maneuver,** Fort Knox, KY
Fifth Corps Area Concentration
Units: (20,000 troops) HQ Fifth Corps Area, HQ V Corps (Prov), HQ 37 Div, HHC 73 Inf Brig, HHC 74 Inf Brig, HHB 62 F.A. Brig, 145 Inf, 147 Inf, 148 Inf, 166 Inf, 134 F.A., 135 F.A., 112 Engr, 112 Med Regt, 112 Q.M. Regt, 37 Div Sp Tps, HQ 38 Div, HHC 75 Inf Brig, HHC 76 Inf Brig, HHB 63 F.A. Brig, 149 Inf, 150 Inf, 151 Inf, 152 Inf, 138 F.A., 139 F.A., 150 F.A., 113 Engr, 113 Med Regt, 113 Q.M. Regt, 38 Div Sp Tps, HHC 10 Inf Brig, 10 Inf, 11 Inf, 201 Inf, HHT 7 Cav Brig (Mczd), HHT 54 Cav Brig, 1 Cav (Mczd) 107 Cav, 123 Cav, 1-19 F.A., 1-68 F.A., 61 C.A., D/5 Engr, 1 Sig Co, B&E/5 Q.M. Regt, A/55 Q.M. Regt, 56 Q.M. Regt, HHS 2 Wing, HHS 1 Purs Gp, HHS 2 Bomb Gp, HHS 3 Atk Gp, 2 Bln Sq, 17 Purs Sq, 27 Purs Sq, 94 Purs Sq, 95 Purs Sq, 57 Serv Sq, 20 Bomb Sq, 49 Bomb Sq, 96 Bomb Sq, 59 Serv Sq, 8 Atk Sq, 13 Atk Sq, 90 Atk Sq, 60 Serv Sq, 15 Obsn Sq, 112 Obsn Sq, 113 Obsn Sq; 325 Obsn Sq; 305 Sig Bn; 83 Sig Co

214 **8-22 Aug 36** **Second Army Maneuver,** Camp Custer—Allegan, MI
Sixth Corps Area Concentration
Units: (24,000 troops) HQ Sixth Corps Area, HQ VI Corps (Prov), HQ 32 Div, HHC 63 Inf Brig, HHC 64 Inf Brig, HHB 57 F.A. Brig, 125 Inf, 126 Inf, 127 Inf, 128 Inf, 119 F.A., 120 F.A., 121 F.A., 107 Med Regt, 107 Q.M. Regt, 32 Div Sp Tps, HQ 33 Div, HHC 65 Inf Brig, HHC 66 Inf Brig, HHB 58 F.A. Brig, 129 Inf, 130 Inf, 131 Inf, 132 Inf, 122 F.A., 123 F.A., 124 F.A., 108 Engr, 108 Med Regt, 108 Q.M. Regt, 33 Div Sp Tps, HHC 12 Inf Brig, 2 Inf, 6 Inf, 8 Inf (IL NG), 404 Inf, 5 Tank Co, 6 Tank Co, HHT 7 Cav Brig (Mczd), HHT 53 Cav Brig, 1 Cav (Mczd), 1-14 Cav, 105 Cav, 106 Cav, HHB 6 F.A. Brig, 2-3 F.A., 1-19 F.A., 1-68 F.A., 90 F.A. (RAI); 182 F.A., 61 C.A., 328 F.A., 202 C.A., E/5 Engr, 311 Engr, A, B&E/5 Q.M. Regt, Det/6 Q.M. Regt, E/23 Q.M. Regt, A/34 Q.M. Regt, A/55 Q.M. Regt, A/56 Q.M. Regt, 51 Sig Bn, 19 Ord Co, HHS 1 Purs Gp, HHS 2 Bomb Gp, HHS 3 Atk Gp, 17 Purs Sq, 27 Purs Sq, 94 Purs Sq, 95 Purs Sq, 57 Serv Sq, 20 Bomb Sq, 49 Bomb Sq, 96 Bomb Sq, 59 Serv Sq, 8 Atk Sq, 13 Atk Sq, 90 Atk Sq, 60 Serv Sq, 1 Bln Sq, 2 Bln Sq, 9 Ash Sq, 15 Obsn Sq, 107 Obsn Sq, 108 Obsn Sq, 135 Med Regt; 317 reserve officers from XVI Corps, 85 Div, 86 Div, 101 Div, and 65 Cav Div units

231 **1-14 Aug 37** **Fourth Army Maneuver,** San Luis Obispo, CA
Ninth Corps Area Concentration
Units: (10,000 troops) HQ 40 Div, HHC 79 Inf Brig, HHC 80 Inf Brig, HHB 65 F.A. Brig, 159 Inf, 160 Inf, 184 Inf, 185 Inf, 143 F.A., 2-144 F.A., 145 F.A., 222 F.A., 115 Engr, 115 Med Regt, 115 Q.M. Regt, 40 Div Sp Tps, 6 Inf Brig, 30 Inf, 38 Inf, 11 Cav, 2-76 F.A., 6 C.A., 63 C.A., 250 C.A., 251 C.A., A & E/3 Q.M. Regt, HHS 1 Wing, HHS 17 Atk Gp, 34 Atk Sq, 73 Atk Sq, 95 Atk Sq, 115 Obsn Sq, 367 Obsn Sq, 400 Reserve officers from 91 Div, 162 Cav Brig, & XIX Corps units

232 **3-26 Aug 37** **4th Infantry Brigade Maneuver** Pole Mountain, WY
Units: HHC 4 Inf Brig, 1 Inf, 20 Inf, 76 F.A. (-), 185 reserve officers from HQ 103 Div, HHC 206 Inf Brig, 411 Inf, HHB 178 F.A. Brig, 383 F.A., 328 Am Tn, 428 Q.M. Regt, 328 Med Regt, 348 Med Regt

233 **8-22 Aug 37** **Fourth Army Maneuver,** Camp Ripley, MN
Seventh Corps Area Concentration
Units: (15,000 troops) HQ 34 Div, HHC 67 Inf Brig, HHC 68 Inf Brig, HHB 59 F.A. Brig, 133 Inf, 135 Inf, 164 Inf, 168 Inf, 125 F.A., 151 F.A., 185 F.A., 109 Engr, 136 Med Regt, 109 Q.M. Regt, 34 Div Sp Tps, HQ 7 Div (Prov) (played by HHC 14 Inf Brig), 92 Inf Brig, 3 Inf, 3-4 Inf, 205 Inf, 206 Inf, 7 Tank Co, F/14 F.A., 3-80 F.A., 147 F.A., 4 Cav, 14 Cav, 109 Obsn Sq, 314 Obsn Sq, 1 Sig Co, 345 Reserve officers from 88 Div, 89 Div, 66 Cav Div, & XVII Corps units

234 **11 Aug-4 Sep 37** **First Army CPX** Fort Devens, MA
Units: (250 officers) HQ First Army, HQ Sp Tps First Army, HQ First Corps Area, HQ Second Corps Area, HQ Third Corps Area, HQ I Cav Corps (Prov), HQ 1 Div, HQ 26 Div, HQ 27 Div, HQ 28 Div, HQ 29 Div, HQ 43 Div, HQ 44 Div, HHC 18 Inf Brig, HHT 7 Cav Brig (Mezd), HHT 51 Cav Brig, HQ 2 Wing, HQ 10 Trans Gp, HQ 43 Q.M. Regt, HQ 47 Q.M. Regt, HQ 68 Q.M. Bn, HQ 350 Med Regt; 25 reserve officers from the First Corps area

235 **1-14 Aug 37** **Coastal Frontier Defense** San Francisco, CA
Joint Exercise #4
Units: (44 aircraft) HQ Ninth C.A. Dist., HD of San Francisco, 6 C.A., HHS 1 Wing, HHS 7 Bomb Gp, 9 Bomb Sq, 11 Bomb Sq, 31 Bomb Sq, 70 Serv Sq, HHS 19 Bomb Gp, 23 Bomb Sq, 30 Bomb Sq, 32 Bomb Sq, 72 Bomb Sq, 76 Serv Sq, U.S.A.M.P. *Col. Ellery W. Niles*, U.S.S. *Utah*

236 **15-29 Aug 37** **Fourth Army Maneuver,** Fort Riley, KS
Seventh Corps Area Concentration
Units: (16,000 troops) HQ 35 Div, HHC 69 Inf Brig, HHC 70 Inf Brig, HHB 60 F.A. Brig, 134 Inf, 137 Inf, 138 Inf, 140 Inf, 130 F.A., 142 F.A., 161 F.A., 110 Engr, 110 Med Regt, 110 Q.M. Regt, 35 Div Sp Tps, Prov Cav Div, 17 Inf, 153 Inf, 2 Cav, 4 Cav, 114 Cav, 1-84 F.A., 128 F.A., 203 C.A., A/9 Engr Sq, F/18 Q.M. Sq, 1 Obsn Sq, 110 Obsn Sq, 154 Obsn Sq, 1 Sig Co, 451 Reserve officers from 89 Div, 102 Div, 66 Cav Div, & XVII Corps units

237 **16 Aug-9 Sep 37** **Sixth Corps Area Maneuver** Camp McCoy, WI
Units: HHC 12 Inf Brig, 2 Inf, 6 Inf, 1-14 Cav, 2-3 F.A., 75 reserve officers

238 **17-31 Aug 37** **Fourth Army Maneuver,** Centralia—Fort Lewis, WA
Ninth Corps Area Concentration
Units: (15,000 troops) HQ 3 Div, HHC 5 Inf Brig, HHB 3 F.A. Brig, 4 Inf, 7 Inf, 1-9 F.A., 10 F.A., 76 F.A.(-), HQ Tp 24 Cav Div, 14 C.A., 63 C.A., 6 Engr Regt, 3 Q.M. Regt, 3 Med Regt, 3 Div Sp Tps, 91 Obsn Sq, 116 Obsn Sq, HQ 41 Div, HHC 81 Inf Brig, HHC 82 Inf Brig, HHB 66 F.A. Brig, 161 Inf, 162 Inf, 163 Inf, 186 Inf, 146 F.A., 148 F.A., 218 F.A., 116 Engr, 116 Med Regt, 116 Q.M. Regt, 41 Div Sp Tps, 500 Reserve officers from 96 Div, 104 Div, 66 Cav Div, & XIX Corps units

239 **11-25 Sep 37** **18th Infantry Brigade Maneuver** Fort Devens, MA
Units: HHC 18 Inf Brig, 5 Inf, 13 Inf

240 **2 Sep-4 Oct 37** **Third Corps Area Maneuver** Indiantown Gap—Pottsville—
Minersville, PA
Units: (5,000 troops) HQ III Corps (Prov), HHC 1 Div, HHC 1 Inf Brig, HHC 16 Inf Brig, HHB 1 F.A. Brig, 12 Inf, 16 Inf, 18 Inf, 34 Inf, 66 Inf, 3 Cav(-), MG Tp 10 Cav, 6 F.A., 1-16 F.A., 5 Engr(-), 1 Med Regt, A & E/8 Q.M. Regt, A/2 Chem Bn

241 **18-28 Sep 37** **2nd Infantry Brigade Maneuver** Pine Camp, NY
Units: HHC 2 Inf Brig, 26 Inf, 28 Inf, 5 F.A., 2-25 F.A., E/1 Engr, 97 Obsn Sq

242 **1 Oct-13 Nov 37** **Proposed Infantry Division (PID) Tests** Camp Bullis, TX
Units: (13,500 troops) HQ 2 Div, HHC 3 Inf Brig, HHT 1 Cav Brig, HHB 2 F.A. Brig, 6 Inf, 1-8 Inf, 9 Inf, 23 Inf, 12 F.A., 15 F.A., 2-77 F.A., 1-82 F.A., 1-51 C.A., 69 C.A., 2 Engr, 8 Engr Sq, 2 Sig Co, 51 Sig Bn, 2 Med Regt, 2 Q.M. Regt, 22 Obsn Sq

243 **11-29 Oct 37** **3rd Wing Maneuver** East Texas
Units: HHS 3 Wing, HHS 3 Atk Gp, HHS 20 Purs Gp, 8 Atk Sq, 13 Atk Sq, 55 Purs Sq, 77 Purs Sq, 79 Purs Sq, 87 Purs Sq, 90 Atk Sq, 60 Serv Sq, 71 Serv Sq

244 **23 Oct 37** **Chemical and Camouflage Exercise** Camp Dix, NJ
Units: 114 Inf, 303 Chem Regt, 40 Engr Bn (Camo)

- 245** **10-24 Jan 38** **Philippine Department Maneuver** Pampanga and Tarlac Provinces
Units: HQ Philippine Department, HQ Ph Div, HHC 23 Inf Brig, 31 Inf, 45 Inf, 57 Inf, 24 F.A., 1-14 Engr, 12 Med Regt, 12 Q.M. Regt, Ph Div Sp Tps, 26 Cav, HD of Manila and Subic Bays, 59 C.A., 60 C.A., 91 C.A., 92 C.A., HHS 19 Wing, HHS 4 Comp Gp, 2 Obsn Sq, 3 Purs Sq, 28 Bomb Sq, 66 Serv Sq, Philippine Army units
- 246** **18 Jan-12 Mar 38** **Joint Army-Navy Landing Exercise No. 4** Culebra Island, PR
Units: (2,000 troops) HQ 1 Div, 1 Div Sp Tps, 1-18 Inf, 2-18 Inf, 65 Inf, 295 Inf, 296 Inf, 1 Marine Brig, U.S.A.T. *Chateau Thierry*, U.S.A.T. *Hunter Liggett*; U.S.S. *Arkansas*, USCGC *Bibb*,
- 247** **Feb 38** **Third Corps Area CPX** Fort George G. Meade, MD
Units: HQ Third Corps Area, HQ III Corps (Prov), HQ XIII Corps (Prov), HQ 28 Div, HQ 29 Div, HQ 79 Div, HQ 80 Div, HQ 99 Div, HQ 62 Cav Div, HQ Washington Prov Brig, HQ 16 Inf Brig
- 248** **17-30 Mar 38** **Hawaiian Department Maneuver** Oahu, TH
Units: (60,000 troops incl USN, USMC; 150 ships; 300 aircraft) HQ Haw Dept, HQ Haw Div, HHC 21 Inf Brig, HHC 22 Inf Brig, HHB 11 F.A. Brig, 19 Inf, 21 Inf, 27 Inf, 35 Inf, 8 F.A., 11 F.A., 13 F.A., 3 Engr, 11 Med Regt, 11 Q.M. Regt, Haw Div Sp Tps, 90 Q.M. Bn, A/1 Chem Bn, HHB Haw Sep C.A. Brig, 15 C.A., 16 C.A., 41 C.A., 55 C.A., 64 C.A., HHS 18 Wing, HHS 5 Comp Gp, HHS 18 Purs Gp, 4 Obsn Sq, 6 Purs Sq, 19 Purs Sq, 23 Bomb Sq, 26 Atk Sq, 50 Obsn Sq, 72 Bomb Sq, 65 Serv Sq, 75 Serv Sq
- 249** **14-31 Mar 38** **GHQ Air Force Maneuver** McDill Field—Orlando—Tarpon Springs, FL
Units: HQ GHQAF, HHS 1 Wing, HHS 2 Wing, HHS 3 Wing, HHS 1 Purs Gp, HHS 2 Bomb Gp, HHS 3 Atk Gp, HHS 7 Bomb Gp, HHS 9 Bomb Gp, HHS 8 Purs Gp, HHS 17 Purs Gp, HHS 20 Purs Gp, 17 Purs Sq, 27 Purs Sq, 94 Purs Sq, 20 Bomb Sq, 49 Bomb Sq, 96 Bomb Sq, 8 Atk Sq, 13 Atk Sq, 90 Atk Sq, 1 Bomb Sq, 5 Bomb Sq, 99 Bomb Sq, 9 Bomb Sq, 11 Bomb Sq, 31 Bomb Sq, 33 Purs Sq, 35 Purs Sq, 36 Purs Sq, 34 Atk Sq, 73 Atk Sq, 95 Atk Sq, 64 Serv Sq, 55 Purs Sq, 77 Purs Sq, 79 Purs Sq
- 250** **20 Apr-16 May 38** **1st Cavalry Division Maneuver and Provisional Cavalry Division Test** Balmorhea, TX
Units: HHT 1 Cav Div, HHT 1 Cav Brig, HHT 2 Cav Brig, 5 Cav, 7 Cav, 8 Cav, 12 Cav, 1-82 F.A., 1 Cav Div Sp Tps, 8 Engr Sq, 16 Q.M. Sq, 1 Med Sq, 22 Obsn Sq
- 251** **5-13 May 38** **3rd Division Maneuver** Fort Lewis, CA
Units: HHC 3 Div, HHC 5 Inf Brig, HHB 3 F.A. Brig, 7 Inf, 15 Inf, 10 F.A., 6 Engr, Sp Tps 3 Div, elmts 3 Med Regt, elmts 3 Div Q.M. Regt, A/48 Q.M., B/58 Q.M.
- 252** **12-17 May 38** **GHQ Air Force CPX and Maneuver** Mitchel Field, NY—Boston, MA—
Providence, RI—Norfolk, VA
Units: (3,150 troops; 187 aircraft) HQ GHQAF, HHS 1 Wing, HHS 2 Wing, HHS 3 Wing, HHS 2 Bomb Gp, HHS 7 Bomb Gp, HHS 19 Bomb Gp, HHS 3 Atk Gp, HHS 17 Atk Gp, HHS 1 Purs Gp, HHS 8 Purs Gp, HHS 20 Purs Gp, 9 Bomb Sq, 30 Bomb Sq, 49 Bomb Sq, 95 Bomb Sq, 8 Atk Sq, 13 Atk Sq, 27 Purs Sq, 36 Purs Sq, 55 Purs Sq, 18 Rcn Sq, 62 C.A.
- 253** **25-28 May 38** **Fifth Corps Area Maneuver** Fort Knox, KY
Units: (3,100 troops) HHC 10 Inf Brig, HHT 7 Cav Brig (Mczd), 10 Inf, 11 Inf, 1 Cav (Mczd), 13 Cav (Mczd), 1-68 F.A.
- 254** **25-26 Jun 38** **Amphibious Landing Exercise** Tuckerton, NJ
Units: (100 troops) 1 Chem Regt, 303 Chem Regt, 6th Bn Fleet Marine Corps Reserve, elmts U.S.C.G.
- 255** **1-14 Aug 38** **Third Army Maneuver, Fourth Corps Area Concentration** DeSoto National Forest, MS
Units: (23,400 troops) HQ IV Corps (Prov), HQ 4 Div (Prov) (played by HHC 8 Inf Brig) 8 Inf, 22 Inf, 122 Inf, HQ 30 Div, HHC 59 Inf Brig, HHC 60 Inf Brig, HHB 55 F.A. Brig, 117 Inf, 118 Inf, 120 Inf, 121 Inf, 113 F.A., 115 F.A., 118 F.A., 105 Engr, 105 Med Regt, 105 Q.M. Regt, 30 Div Sp Tps, HQ 31 Div, HHC 61 Inf Brig, HHC 62 Inf Brig, HHB 56 F.A. Brig, 124 Inf, 155 Inf, 156 Inf, 167 Inf, 114 F.A., 116 F.A., 117 F.A., 106 Am Tn, 106 Engr, 106 Med Regt, 106 Q.M. Regt, 31 Div Sp Tps, HHT 55 Cav Brig, HHB 13 F.A. Brig, 6 Cav, 108 Cav, 109 Cav, 17 F.A., 141 F.A. Bn, 2-178 F.A., 1 F.A. Obsn Bn, 61 C.A., 62 C.A., 127 Engr Sq, A/164 Engr, 51 Sig Bn, 16 Obsn Sq, 105 Obsn Sq, 106 Obsn Sq, 1,500 reserve officers from XIV Corps, 63 Cav Div, 81 Div, 82 Div, & 87 Div units
- 256** **28 Aug-11 Sep 38** **14th Infantry Brigade Maneuver** Camp McCoy, WI
Units: HHC 14 Inf Brig, 3 Inf, 17 Inf, 14 Cav, F/14 F.A., 3-80 F.A., 7 Tank Co, F/18 Q.M. Sq, 1 Obsn Sq
- 257** **8-16 Aug 38** **1st Wing Air Maneuver** Tacoma Field and Gray Field, WA
Units: (560 troops, 66 aircraft) HHS 1 Wing, HHS 17 Atk Gp, HHS 19 Bomb Gp, 23 Bomb Sq, 30 Bomb Sq, 32 Bomb Sq, 34 Atk Sq, 38 Recon Sq, 73 Atk Sq, 88 Recon Sq, 95 Atk Sq
- 258** **6-30 Aug 38** **Third Army Maneuver, Eighth Corps Area Concentration** Camp Bullis—San Antonio, TX
Units: (23,300 troops) HQ Eighth Corps Area, HQ VIII Corps (Prov) (as "Brown" Corps), HQ 2 Div, HQ 36 Div, HQ 45 Div, HHC 3 Inf Brig, HHC 71 Inf Brig, HHC 72 Inf Brig, HHC 90 Inf Brig, HHT 1 Cav Brig, HHT 56 Cav Brig, HHB 2 F.A. Brig, HHB 61 F.A. Brig, HHB 70 F.A.

Brig, 9 Inf, 23 Inf, 141 Inf, 142 Inf, 143 Inf, 144 Inf, 179 Inf, 180 Inf, 12 F.A., 15 F.A., 77 F.A. (-), 1-82 F.A., 131 F.A., 132 F.A., 133 F.A., 158 F.A., 160 F.A., 189 F.A., 61 C.A., 69 C.A. (-), 8 Engr Sq, 111 Engr, 1-120 Engr, 2 Div Sp Tps, 36 Div Sp Tps, 45 Div Sp Tps, Co/51 Sig Bn, 2 Med Regt, 111 Med Regt, 120 Med Regt, 2 Q.M. Regt, 39 Q.M. Regt (-), 55 Q.M. Regt (-), 111 Q.M. Regt, 120 Q.M. Regt, 22 Obsn Sq, 315 Obsn Sq, 1,504 reserve officers from VIII Corps, XVIII Corps, 90 & 95 Divs, & 156 Cav Brig units

- 259** **13-27 Aug 38** **Third Army Maneuver,** Fort Bliss, TX
Eighth Corps Area Concentration
Units: (4,500 troops) HHT 1 Cav Div, HHT 2 Cav Brig, 7 Cav, 8 Cav, 111 Cav, 1-82 F.A., 1 Cav Div Sp Tps, 120 Engr Regt (-), 16 Q.M. Sq, 1 Med Sq, 208 reserve officers from XVIII Corps, 90, 95, 103 Divs, 156 Cav Brig units
- 260** **1-18 Aug 38** **Third Army Maneuver,** Fort Francis E. Warren WY
Eighth Corps Area Concentration
Units: (5,500 troops) HHC 4 Inf Brig, 1 Inf, 20 Inf, 76 F.A. (-), 157 Inf, 4 Cav, 2 Engr Regt, 279 reserve officers from XVIII Corps, 103 Div units
- 261** **13-27 Aug 38** **Third Army Maneuver,** Fort Huachuca, AZ
Eighth Corps Area Concentration
Units: (2,200 troops) HHC 89 Inf Brig, 158 Inf, 25 Inf, elmts 120 Q.M. Regt, 132 reserve officers from XVIII Corps, 103 Div, 156 Cav Brig units
- 262** **15 Aug-3 Sep 38** **First Corps Area Maneuver** Fort Devens, MA
Units: HHC 18 Inf Brig, 5 Inf, 13 Inf, 3-66 Inf, 7 F.A.
- 263** **Sep 38** **Third Corps Area Maneuver** Fort George G. Meade, MD
Units: HHC 16 Inf Brig, 12 Inf, 34 Inf, 66 Inf, 6 F.A., MG Tp 10 Cav
- 264** **5-26 Sep 38** **Second Army CPX** Fort Knox, KY
Units: (500 officers) HQ Second Army, V Corps (Prov), VI Corps (Prov), I Cav Corps (Prov), 5 Div (Prov) (played by HQ 10 Inf Brig), 6 Div (Prov) (played by HQ 12 Inf Brig), 14 Inf Brig, HQ 32 Div, HQ 33 Div, HQ 37 Div, HQ 38 Div, HQ 83 Div, HQ 84 Div, HQ 85 Div, HQ 86 Div, HQ 100 Div, HQ 101 Div, HQ 2 Cav Div (Prov), HQ 64 Cav Div, HQ 65 Cav Div, HQ 7 Cav Brig (Mczd), HQ 53 Cav Brig, HQ 54 Cav Brig, HHB 6 F.A. Brig, 182 F.A., 61 C.A., 202 C.A., elmts/6 Q.M. Regt, HQ 3 Wing, HHS 33 Obsn Gp, HHS 46 Obsn Gp, 135 Med Regt
- 265** **9-21 Sep 38** **2nd Infantry Brigade Maneuver** Pine Camp, NY
Units: (3,000 troops) HHC 2 Inf Brig, 26 Inf, 28 Inf, 5 F.A., 2-25 F.A., 1 Ord Co
- 266** **26 Sep-8 Oct 38** **1st Infantry Brigade Maneuver** Camp Dix, NJ
Units: (4,000 troops) HHC 1 Inf Brig, 16 Inf, 18 Inf, 7 F.A., 1 Engr, 1 Div Sp Tps, A/2 Chem Bn, 97 Obsn Sq
- 267** **Oct 38** **Field Artillery Group CPX** New York City, NY
Units: (246 troops) 352 F.A., 391 F.A., 432 F.A., 441 F.A., 442 F.A., 566 F.A., 570 F.A., 577 F.A., 861 F.A.
- 268** **3-17 Oct 38** **Joint Anti-aircraft/Air Corps Exercise** Fort Bragg, NC
Units: (2,100 troops) GHQ Air Force, HQ Prov C.A. Brig, 61 C.A., 62 C.A., 69 C.A., Btrys A & C/2 C.A., Co/51 Sig Bn, HHS 2 Wing, HHS 2 Bomb Gp, HHS 8 Purs Gp, HHS 9 Bomb Gp, 1 Bomb Sq, 9 Bomb Sq, 13 Atk Sq, 18 Rcn Sq, 21 Rcn Sq, 27 Purs Sq, 30 Bomb Sq, 33 Purs Sq, 36 Purs Sq, 99 Bomb Sq
- 269** **11-28 Oct 38** **Cavalry School Maneuver** Fort Riley, KS
Units: HHT Cav Brig (Prov), HHT 7 Cav Brig (Mczd), 1 Cav (Mczd), 2 Cav, 9 Cav, 13 Cav (Mczd), 1-68 F.A., elmts/80 F.A., elmts/84 F.A., A/ 9 Engr Sq
- 270** **9 Jan-7 Feb 39** **Philippine Department Maneuver** Luzon, PI
Units: HQ Philippine Department, HQ Ph Div, HHC 23 Inf Brig, 31 Inf, 45 Inf, 57 Inf, 24 F.A., 1-14 Engr, 12 Med Regt, 12 Q.M. Regt, Ph Div Sp Tps, 26 Cav, HD of Manila and Subic Bays, 59 C.A., 60 C.A., 91 C.A., 92 C.A., HHS 19 Wing, HHS 4 Comp Gp, 2 Obsn Sq, 3 Purs Sq, 28 Bomb Sq
- 271** **6-15 Mar 39** **Panama Canal Department Maneuver** Canal Zone
Units: HQ Panama Canal Department, HQ Pacific Sector, HQ Atlantic Sector, 14 Inf, 33 Inf, 1-2 F.A., 11 Engr, Panama C.A. Dist., HD of Balboa, HD of Cristobal, 1 C.A., 4 C.A., HQ 6 Comp Gp, 7 Obsn Sq, 24 Purs Sq, 25 Bomb Sq, 44 Obsn Sq
- 272** **12-22 Apr 39** **Joint Army-Navy Maneuver** Fort Adams, RI—Narragansett Bay
Units: HD of Narragansett Bay, 2d Bn 13 Inf, 10 C.A., elmts of U.S. Navy
- 273** **29 Apr-27 May 39** **3rd Division Maneuver** Fort Lewis, WA
Units: HQ 3 Div, HHC 5 Inf Brig, HHC 6 Inf Brig, HHB 3 F.A. Brig, 4 Inf, 7 Inf, 30 Inf, 38 Inf, 1-9 F.A., 10 F.A., 76 F.A., 6 Engr, 3 Div Sp Tps, 3 Med Regt, 3 Q.M. Regt, 91 Obsn Sq
- 274** **4 May-3 Jun 39** **Sixth and Seventh Corps Area** Camp McCoy—Camp Douglas, WI
Combined Maneuver
Units: (7,000 troops) HQ, Sixth Corps Area, HQ Seventh Corps Area, HHC 12 Inf Brig, HHC 14 Inf Brig, 2 Inf, 3 Inf, 6 Inf, 17 Inf, 6 Tank Co, 7

Tank Co, 14 Cav, 2-3 F.A., 3-80 F.A., 61 C.A., elmts 6 Q.M. Regt, elmts 7 Q.M. Regt, F/18 Q.M. Sq, 1 Obsn Sq, 15 Obsn Sq, 7 A.B. Sq

- 275** **12-29 May 39** **8th Infantry Brigade Maneuver** Fort Benning, GA
Units: HHC 8 Inf Brig, 8 Inf, 22 Inf
- 276** **15-27 May 39** **Hawaiian Department Maneuver** Oahu, TH
Units: HQ Haw Dept, HQ Haw Div, HHC 21 Inf Brig, HHC 22 Inf Brig, HHB 11 F.A. Brig, 19 Inf, 21 Inf, 27 Inf, 35 Inf, 8 F.A., 11 F.A., 13 F.A., 3 Engr, 11 Med Regt, 11 Q.M. Regt, Haw Div Sp Tps, Haw Div Pack Tn, 90 Q.M. Bn, A/1 Chem Bn, HHB Haw Sep C.A. Brig, 15 C.A., 16 C.A., 41 C.A., 55 C.A., 64 C.A., HHS 18 Wing, HHS 5 Comp Gp, HHS 18 Purs Gp, 4 Obsn Sq, 6 Purs Sq, 19 Purs Sq, 23 Bomb Sq, 26 Atk Sq, 50 Obsn Sq, 72 Bomb Sq
- 277** **25-30 May 39** **Fifth Corps Area Maneuver** Fort Knox, KY
Units: (6,000 troops) HHC 10 Inf Brig, HHT 7 Cav Brig (Mczd), 10 Inf, 11 Inf, 1 Cav (Mczd), 13 Cav (Mczd), 1-68 F.A.
- 278** **3-4 Jun 39** **River Crossing Exercise** King's Mill, OH
Units: 147 Inf, 308 Engr, B/112th QM Regt, 359 Obsn Sq, Xavier Univ F.A. unit
- 279** **5-19 Aug 39** **Fourth Army CPX** Presidio of San Francisco, CA
Units: (700 officers) HQ Fourth Army, HQ, VII Corps (Prov), IX Corps (Prov), XVII Corps (Prov), XIX Corps (Prov), HQ 3 Div, HQ 34 Div, HQ 35 Div, HQ 40 Div, HQ 41 Div, HQ 88 Div, HQ 89 Div, HQ 91 Div, HQ 96 Div, HQ 102 Div, HQ 104 Div, HQ 1 Wing, HQ 7 Cav Brig (Mczd)
- 280** **13-27 Aug 39** **First Army Maneuver,**
First and Second Corps Area Concentration Plattsburg, NY
Units: (51,200 troops) HQ First Army, HQ I Corps (Prov), HQ II Corps (Prov), HQ 1 Div, HHC 1 Inf Brig, HHC 2 Inf Brig, HHB 1 F.A. Brig, 16 Inf, 18 Inf, 26 Inf, 28 Inf, 5 F.A., 7 F.A., 1 Engr, 1 Med Regt, 1 Q.M. Regt, 1 Div Sp Tps, HQ 26 Div, HHC 51 Inf Brig, HHC 52 Inf Brig, HHB 51 F.A. Brig, 101 Inf, 104 Inf, 181 Inf, 182 Inf, 101 Am Tn, 101 F.A., 102 F.A., 172 F.A., 101 Engr, 101 Med Regt, 101 Q.M. Regt, 26 Div Sp Tps, HQ 27 Div, HHC 53 Inf Brig, HHC 93 Inf Brig, HHB 52 F.A. Brig, 14 Inf (NY NG), 105 Inf, 107 Inf, 165 Inf, 104 F.A., 105 F.A., 106 F.A., 102 Engr, 102 Med Regt, 102 Q.M. Regt, 27 Div Sp Tps, HQ 43 Div, HHC 85 Inf Brig, HHC 86 Inf Brig, HHB 68 F.A. Brig, 102 Inf, 103 Inf, 169 Inf, 172 Inf, 103 F.A., 152 F.A., 192 F.A., 118 Engr, 118 Med Regt, 118 Q.M. Regt, 43 Div Sp Tps, HQ 44 Div, HHC 57 Inf Brig, HHC 87 Inf Brig, HHB 69 F.A. Brig, 71 Inf, 113 Inf, 114 Inf, 174 Inf, 112 F.A., 156 F.A., 157 F.A., 104 Engr, 119 Med Regt, 119 Q.M. Regt, 44 Div Sp Tps, HHC 18 Inf Brig, 5 Inf, 13 Inf, 3-66 Inf (LT), HHT 7 Cav Brig (Mczd), HHT 51 Cav Brig, 1 Cav (Mczd), 1-3 Cav, 13 Cav (Mczd), 101 Cav, 2-25 F.A., 1-68 F.A., 258 F.A., 10 C.A., 11 C.A., 62 C.A., 197 C.A., 212 C.A., 5 Engr Co (LP), 51 Sig Bn, 101 Sig Bn, A & E/9 Q.M. Regt, E/23 Q.M. Regt, 29 Ord Co, 58 Ord Co, 12 Obsn Sq, 97 Obsn Sq, 101 Obsn Sq, 102 Obsn Sq, 118 Obsn Sq, 119 Obsn Sq, 1,150 reserve officers from HQ Co II Corps, XII Corps, 76, 77, 78, 94, 98, 97 Divs, & 61 Cav Div units
- 281** **5-19 Aug 39** **First Army Maneuver,**
Third Corps Area Concentration Manassas, VA
Units: (24,700 troops) HQ III Corps (Prov), HQ 28 Div, HHC 55 Inf Brig, HHC 56 Inf Brig, HHB 53 F.A. Brig, 109 Inf, 110 Inf, 111 Inf, 112 Inf, 107 F.A., 108 F.A., 109 F.A., 103 Am Tn, 103 Engr, 103 Med Regt, 28 Div Sp Tps, 103 Q.M. Regt, HQ 29 Div, HHC 58 Inf Brig, HHC 91 Inf Brig, HHB 54 F.A. Brig, 1 Inf (MD NG), 1 Inf (VA NG), 5 Inf (MD NG), 116 Inf, 110 F.A., 111 F.A., 176 F.A., 104 Med Regt, 104 Q.M. Regt, 29 Div Sp Tps, HHC 16 Inf Brig, 12 Inf, 34 Inf, 66 Inf (LT), 3 Cav, MG Tp 10 Cav, 1-16 F.A., 1 F.A. Obsn Bn, 213 C.A., 260 C.A., 5 Engr, Prov Obsn Gp, 3 Obsn Sq, 103 Obsn Sq, 104 Obsn Sq, 56 Ord Co, 873 reserve officers from XIII Corps, 79 Div, 80 Div, 99 Div, and 62 Cav Div units
- 282** **9 Aug-24 Sep 39** **Provisional 2nd Division (P2D) Tests** Camp Bullis, TX
Units: HQ 2 Div, HHC 3 Inf Brig, HHT 1 Cav Brig, HHB 2 F.A. Brig, 9 Inf, 20 Inf, 23 Inf, 12 F.A., 15 F.A., 2-77 F.A., 82 F.A., 69 C.A., 2 Engr, 8 Engr Sq, 2 Sig Co, 51 Sig Bn, 2 Med Regt, 2 Q.M. Regt
- 283** **25 Sep-7 Oct 39** **Joint Anti-aircraft/Air Corps Exercise** Carlisle—Lancaster—Reading, PA
Units: Btrys A & C/2 C.A., 61 C.A., 62 C.A., 69 C.A., 51 Sig Bn, 1 Sig Co, HHS 2 Wing, HHS 2 Bomb Gp, HHS 8 Purs Gp, HHS 9 Bomb Gp, 1 Atk Sq, 1 Bomb Sq, 2 Bomb Sq, 9 Bomb Sq, 13 Atk Sq, 90 Atk, 18 Rcn Sq, 21 Rcn Sq, 27 Purs Sq, 30 Bomb Sq, 33 Purs Sq, 36 Purs Sq, 99 Bomb Sq
- 284** **2 Oct-2 Nov 39** **1st Cavalry Division Maneuver** Balmorhea—Toyavale, TX
Units: (7,000 troops) HHT 1 Cav Div, HHT 1 Cav Brig, HHT 2 Cav Brig, 9 Inf, 5 Cav, 7 Cav, 8 Cav, 12 Cav, 1-15 F.A., 82 F.A., 1 Cav Div Sp Tps, 8 Engr Sq, 16 Q.M. Sq, 1 Med Sq, 22 Obsn Sq
- 285** **1 Nov 39-9 Feb 40** **Seventh Corps Area Winter Exercises** Camp Joseph T. Robinson, AR
Units: (4,000 troops) HHC 14 Inf Brig, 3 Inf, 6 Inf, 17 Inf, 4 Cav, 14 Cav, 1-3 FA, 2-3 FA, A/9 Engr Sq, F/18 Q.M. Sq, 6 Tank Co
- 286** **16-22 Dec 39** **New York National Guard**
CPX/Winter Exercises Camp Smith, NY
Units: HHC 27 Div, HHC 87 Inf Brig, HHC 93 Inf Brig, HHT 51 Cav Brig, HHB 52 F.A. Brig, 101 Sig Bn
- 287** **2 Jan-28 Mar 40** **1st Division Maneuvers** Fort Benning, GA
Units: HQ 1 Div, 16 Inf, 18 Inf, 26 Inf, HHB 1 Div Arty, 5 F.A. Bn, 7 F.A. Bn, 32 F.A. Bn, 33 F.A. Bn, 1 Engr, 1 Sig Co, 1 Med Bn, 1 Q.M. Bn

- 288** **3-27 Jan 40** **2nd Division Maneuver** Christine, TX—Tilden, TX
Units: HQ 2 Div, HHT 1 Cav Brig, 9 Inf, 23 Inf, 38 Inf, 5 Cav, 12 Cav, HHB 2 Div Arty, 12 F.A., 15 F.A., 2-77 F.A., 2 Engr, 8 Engr Sq, 2 Sig Co, 2 Med Bn, 2 Q.M. Bn, 22 Obsn Sq, HQ 36 Div
- 289** **12-23 Jan 40** **Joint Army-Navy Landing Exercise** Fort Ord-Monterey, CA
Units: (14,000 troops; 300 aircraft) HQ Fourth Army, HQ Ninth C.A. Dist, HQ 3 Div, HQ 40 Div, HQ 41 Div, HHB 3 Div Arty, 4 Inf, 7 Inf, 15 Inf, 11 Cav, 9 F.A., 10 F.A., 76 F.A., 63 C.A., 65 C.A., 250 C.A., 251 C.A., 6 Engr, 3 Sig Co, 3 Med Bn, 3 Q.M. Bn, HHS 1 Wing, HHS 7 Bomb Gp, 9 Bomb Sq, 11 Bomb Sq, 31 Bomb Sq, HHS 17 Bomb Gp, 34 Bomb Sq, 37 Bomb Sq, 73 Bomb Sq, 95 Bomb Sq, HHS 19 Bomb Gp, 23 Bomb Sq, 30 Bomb Sq, 32 Bomb Sq, 72 Bomb Sq, HHS 20 Purs Gp, 55 Purs Sq, 77 Purs Sq, 79 Purs Sq, 87 Purs Sq, 38 Rcn Sq, 88 Rcn Sq, 91 Rcn Sq, U.S.A.T. *Chateau Thierry*, U.S.A.T. *Hunter Liggett*, U.S.A.T. *Republic*, U.S.A.T. *St. Mihiel*, U.S.A.T. *Leonard Wood*, HQ, 12th Naval Dist.
- 290** **14-26 Jan 40** **Joint Army-Navy Air Defense Maneuver** Fresno—March Field—Hamilton Field, CA
Units: HHS 17 Bomb Gp, HHS 19 Bomb Gp, 34 Bomb Sq, 73 Bomb Sq, 95 Bomb Sq
- 291** **29 Jan-2 Feb 40** **Joint Army-Navy Air Defense Maneuver** Oahu, TH
Units: HQ Haw Dept, HHB Haw Sep C.A. Brig, 15 C.A., 16 C.A., 41 C.A., 55 C.A., 64 C.A., HHS 18 Wing, HQ, 14th Naval Dist.
- 292** **10-20 Mar 40** **Panama Canal Department Maneuver** Campana Mtns—Panama Canal Zone
Units: HHC Panama Canal Department, HHC Panama Mobile Force, 5 Inf, 14 Inf, 33 Inf, 1-2 F.A., 1-87 F.A., Panama Sep C.A. Brig, 1 C.A., 4 C.A., 72 C.A., 73 C.A., 11 Engr, 61 Ord Bn, 1 Sep Chem Co, HHS Panama Canal Air Force, HHS 12 Purs Wing, HHS 19 Bomb Wing, HHS 6 Bomb Gp, HHS 37 Purs Gp, 15 A.B. Gp, 16 A.B. Gp, 3 Bomb Sq, 7 Rcn Sq, 24 Purs Sq, 25 Bomb Sq, 28 Purs Sq, 29 Purs Sq, 30 Purs Sq, 31 Purs Sq, 39 Obsn Sq, 43 Purs Sq, 44 Rcn Sq, 74 Bomb Sq, U.S.A.M.P. *Gen. J. Franklin Bell*, U.S.A.M.P. *Gen. William H. Graham*
- 293** **12-25 Apr 40** **IV Corps Maneuver** Fort Benning, GA
Units: (41,000 troops) HQ IV Corps, HQ 1 Div, 16 Inf, 18 Inf, 26 Inf, HHB 1 Div Arty, 6 F.A. Bn, 7 F.A. Bn, 32 F.A. Bn, 33 F.A. Bn, 1 Engr Bn, 1 Sig Co, 1 Med Bn, 1 Q.M. Bn, HQ 5 Div, 2 Inf, 10 Inf, 11 Inf, HHB 5 Div Arty, 19 F.A. Bn, 21 F.A. Bn, 46 F.A. Bn, 50 F.A. Bn, 7 Engr Bn, 5 Sig Co, 5 Med Bn, 5 Q.M. Bn, HQ 6 Div, 1 Inf, 3 Inf, 20 Inf, HHB 6 Div Arty, 1 F.A. Bn, 51 F.A. Bn, 53 F.A. Bn, 80 F.A. Bn, 6 Engr Bn, 6 Sig Co, 6 Med Bn, 6 Q.M. Bn, HHC 8 Inf Brig, HHB 13 F.A. Brig, 8 Inf, 22 Inf, 24 Inf, 29 Inf, 34 Inf, 2-66 Inf, 2-67 Inf, 6 Cav, 2-4 F.A., 17 F.A., 36 F.A., 2-83 F.A., 4 A.T. Bn, 62 C.A., 1 F.A. Obsn Bn, A/4 Engr, 18 Engr, 21 Engr, 64 Engr Co, 70 Engr Co, 51 Sig Bn, C/2 Chem Regt, B/34 Q.M. Regt, 16 Med Regt, 1 Ord Co, 15 Ord Co, 34 Ord Co, 51 Ord Co, 3 Obsn Sq, 15 Obsn Sq, 16 Obsn Sq, 97 Obsn Sq, 2 Bln Sq
- 294** **12 Apr-8 May 40** **3rd Division Maneuver** Fort Ord, CA
Units: HQ 3 Div, 4 Inf, 7 Inf, 15 Inf, 30 Inf, HHB 3 Div Arty, 9 F.A. Bn, 10 F.A. Bn, 39 F.A. Bn, 41 F.A. Bn, 10 Engr Bn, 3 Sig Co, 3 Med Bn, 3 Q.M. Bn, HQ 40 Div
- 295** **23 Apr-3 May 40** **IX Corps (Provisional) Maneuver** East Texas—Sabine River
Units: (35,000 troops) HQ IX Corps (Prov), HQ 2 Div, 9 Inf, 23 Inf, 38 Inf, HHB 2 Div Arty, 12 F.A. Bn, 15 F.A. Bn, 37 F.A. Bn, 38 F.A. Bn, 2 Engr Bn, 2 Sig Co, 2 Med Bn, 2 Q.M. Bn, HHT 1 Cav Div, HHT 1 Cav Brig, HHT 2 Cav Brig, 5 Cav, 7 Cav, 8 Cav, 12 Cav, 1-82 F.A., 1 Cav Div Sp Tps, 8 Engr Sq, 16 Q.M. Sq, 1 Med Sq, HHT 7 Cav Brig (Mczd), 1 Cav (Mczd), 4 Cav, 13 Cav (Mczd), 7 Rcn & Spt Sq, 68 F.A., 77 F.A., 61 C.A., 69 C.A., 5 Engr, 62 Sig Bn, 1 Rcn Sq, 1 Bln Sq, C/39 Q.M. Regt, K/48 Q.M. Regt, 1 Med Regt, A/2 Chem Regt, 2 Ord Co, 9 Ord Co, 52 Ord Co
- 296** **9-31 May 40** **Third Army Maneuver** Louisiana Maneuver Area
Units: (76,000 troops) HQ Third Army, HQ IV Corps, HQ IX Corps (Prov), HQ 1 Div, 16 Inf, 18 Inf, 26 Inf, HHB 1 Div Arty, 6 F.A. Bn, 7 F.A. Bn, 32 F.A. Bn, 33 F.A. Bn, 1 Engr Bn, 1 Sig Co, 1 Med Bn, 1 Q.M. Bn, HQ 2 Div, 9 Inf, 23 Inf, 38 Inf, HHB 2 Div Arty, 12 F.A. Bn, 15 F.A. Bn, 37 F.A. Bn, 38 F.A. Bn, 2 Engr Bn, 2 Sig Co, 2 Med Bn, 2 Q.M. Bn, HQ 5 Div, 2 Inf, 10 Inf, 11 Inf, HHB 5 Div Arty, 19 F.A. Bn, 21 F.A. Bn, 46 F.A. Bn, 50 F.A. Bn, 7 Engr Bn, 5 Sig Co, 5 Med Bn, 5 Q.M. Bn, HQ 6 Div, 1 Inf, 3 Inf, 20 Inf, HHB 6 Div Arty, 1 F.A., 51 F.A. Bn, 53 F.A. Bn, 80 F.A. Bn, 6 Engr Bn, 6 Sig Co, 6 Med Bn, 6 Q.M. Bn, HHT 1 Cav Div, HHT 1 Cav Brig, HHT 2 Cav Brig, 5 Cav, 7 Cav, 8 Cav, 12 Cav, 1-82 F.A., 1 Cav Div Sp Tps, 8 Engr Sq, 16 Q.M. Sq, 1 Med Sq, HHC 8 Inf Brig, HHT 7 Cav Brig (Mczd), HHB 13 F.A. Brig, 6 Inf, 8 Inf, 22 Inf, 24 Inf, 29 Inf, 34 Inf, 66 Inf, 2-67 Inf, 1-68 Inf, 1 Cav (Mczd), 4 Cav, 6 Cav, 13 Cav (Mczd), 7 Rcn & Spt Sq, 2-4 F.A., 17 F.A., 36 F.A., 68 F.A., 77 F.A., 2-83 F.A., 1 F.A. Obsn Bn, 4 A.T. Bn, 61 C.A., 62 C.A., A/4 Engr, 18 Engr, 1-5 Engr, 21 Engr, 47 Engr Tp, 64 Engr Co, 70 Engr Co, 3 Rad Intel Co, 51 Sig Bn, 62 Sig Bn, A & C/2 Chem Regt, 4 Q.M. Bn, E/9 Q.M. Regt, A,B,C/34 Q.M. Regt, C/39 Q.M. Regt, E,F,G,H,I/48 Q.M. Regt, A/54 Q.M. Regt, B/55 Q.M. Regt, 1 Med Regt, 16 Med Regt, 1 Ord Co, 2 Ord Co, 9 Ord Co, 15 Ord Co, 17 Ord Co, 30 Ord Co, 34 Ord Co, 51 Ord Co, 52 Ord Co, 1 Obsn Sq, 3 Obsn Sq, 15 Obsn Sq, 16 Obsn Sq, 22 Obsn Sq, 97 Obsn Sq, 2 Bln Sq
- 297** **13 May-5 Jun 40** **Hawaiian Department Maneuver** Oahu, TH
Units: (25,000 troops) HQ Haw Dept, HQ Haw Div, HHC 21 Inf Brig, HHC 22 Inf Brig, HHB 11 F.A. Brig, 19 Inf, 21 Inf, 27 Inf, 35 Inf, 8 F.A., 11 F.A., 13 F.A., 3 Engr, 11 Med Regt, 11 Q.M. Regt, Haw Div Sp Tps, Haw Div Pack Tn, HHB Haw Sep C.A. Brig, 15 C.A., 16 C.A., 41 C.A., 55 C.A., 64 C.A., 60 Ord Bn, 90 Q.M. Bn, A/1 Chem Bn, HHS Haw Air Force, HHS 14 Purs Wing, HHS 18 Bomb Wing, HHS 5 Bomb Gp, HHS 11 Bomb Gp, HHS 18 Purs Gp, 17 A.B. Gp, 18 A.B. Gp, 4 Rcn Sq, 6 Purs Sq, 14 Bomb Sq, 19 Purs Sq, 23 Bomb Sq, 26 Bomb Sq, 31 Bomb Sq, 42 Bomb Sq, 50 Rcn Sq, 72 Bomb Sq, 78 Purs Sq, 86 Obsn Sq
- 298** **10-16 Jul 40** **Obstacle Reduction Exercise** Fort DuPont, DE
Units: 1 Engr Bn, 303 Engr Regt, 323 Engr Regt, 360 Engr Regt, 372 Engr Regt, 61 Engr Bn, 438 Engr Bn, 515 Engr Bn; 16 Engr Co (DT); 392 Engr Co (Depot)

299 **16-19 Jul 40** **Eighth Corps Area Maneuver** Camp Bowie, TX
Units: HQ Eighth Corps Area, HQ 2 Div, 9 Inf, 23 Inf, 38 Inf, HHB 2 Div Arty, 12 F.A. Bn, 15 F.A. Bn, 37 F.A. Bn, 38 F.A. Bn, 2 Engr Bn, 2 Sig Co, 2 Med Bn, 2 Q.M. Bn, HQ 90 Div, 22 Obsn Sq

300 **3-23 Aug 40** **Third Army Maneuver** Kisatchie National Forest, LA
Units: (70,000 troops) HQ Third Army, HHC IV Corps, HQ VIII Corps (Prov), HQ 2 Div, 9 Inf, 23 Inf, 38 Inf, HHB 2 Div Arty, 12 F.A. Bn, 15 F.A. Bn, 37 F.A. Bn, 38 F.A. Bn, 2 Engr Bn, 2 Sig Co, 2 Med Bn, 2 Q.M. Bn, HQ 30 Div, HHC 59 Inf Brig, HHC 60 Inf Brig, HHB 55 F.A. Brig, 117 Inf, 118 Inf, 120 Inf, 121 Inf, 113 F.A., 115 F.A., 118 F.A., 105 Engr, 105 Med Regt, 105 Q.M. Regt, 30 Div Sp Tps, HQ 31 Div, HHC 61 Inf Brig, HHC 62 Inf Brig, HHB 56 F.A. Brig, 124 Inf, 155 Inf, 156 Inf, 167 Inf, 114 F.A., 116 F.A., 117 F.A., 106 Engr, 106 Med Regt, 106 Q.M. Regt, 31 Div Sp Tps, HQ 36 Div, HHC 71 Inf Brig, HHC 72 Inf Brig, HHB 61 F.A. Brig, 141 Inf, 142 Inf, 143 Inf, 144 Inf, 131 F.A., 132 F.A., 133 F.A., 111 Engr, 111 Med Regt, 111 Q.M. Regt, 36 Div Sp Tps, HQ 45 Div, HHC 89 Inf Brig, HHC 90 Inf Brig, HHB 70 F.A. Brig, 157 Inf, 158 Inf, 179 Inf, 180 Inf, 158 F.A., 160 F.A., 189 F.A., 120 Engr, 120 Med Regt, 120 Q.M. Regt, 45 Div Sp Tps, HHT 1 Cav Div, HHT 1 Cav Brig, HHT 2 Cav Brig, 5 Cav, 7 Cav, 8 Cav, 12 Cav, 1-82 F.A., 1 Cav Div Sp Tps, 8 Engr Sq, 16 Q.M. Sq, 1 Med Sq, HHT 23 Cav Div, HHT 55 Cav Brig, HHT 56 Cav Brig, 6 Cav, 108 Cav, 109 Cav, 112 Cav, 124 Cav, 141 F.A., 127 Engr Sq, 8 Inf, 22 Inf, 25 Inf, HHB 13 F.A. Brig, 17 F.A., 36 F.A., 77 F.A., 168 F.A., 178 F.A., 179 F.A., 1 F.A. Obsn Bn, 69 C.A., A/4 Engr, 2-20 Engr, 47 Engr Tp, 64 Engr Co (Topo), 101 Engr Co, 102 Engr Co, 16 Obsn Sq, 22 Obsn Sq, 105 Obsn Sq, 106 Obsn Sq, 111 Obsn Sq, 120 Obsn Sq, 153 Obsn Sq, 1 Bln Sq, 2 Bln Sq, 62 Sig Bn, 39 Q.M. Regt (-), H/47 Q.M. Regt, E,F,G,H,I/48 Q.M. Regt, 55 Q.M. Regt (-), B,C/67 Q.M. Bn, C/68 Q.M. Bn, 97 Q.M. Bn (-), 2 Ord Co, 15 Ord Co, 59 Ord Co, 73 Ord Co, reserve officers from XIV Corps 81 Div, 82 Div, 87 Div, 90 Div, 95 Div, 103 Div, and 63 Cav Div units

301 **4-25 Aug 40** **First Army Maneuver** Plattsburg—Watertown—Canton—Ogden, NY
Units: (81,000 troops) HQ First Army, HQ I Corps (Prov), II Corps (Prov), III Corps (Prov), HQ 1 Div, 16 Inf, 18 Inf, 26 Inf, HHB 1 Div Arty, 6 F.A. Bn, 7 F.A. Bn, 32 F.A. Bn, 33 F.A. Bn, 1 Engr, 1 Sig Co, 1 Med Bn, 1 Q.M. Bn, HQ 26 Div, HHC 51 Inf Brig, HHC 52 Inf Brig, HHB 51 F.A. Brig, 101 Inf, 104 Inf, 181 Inf, 182 Inf, 101 F.A., 102 F.A., 172 F.A., 101 Engr, 101 Med Regt, 101 Q.M. Regt, 26 Div Sp Tps, HQ 27 Div, HHC 53 Inf Brig, HHC 54 Inf Brig, HHB 52 F.A. Brig, 105 Inf, 106 Inf, 107 Inf, 108 Inf, 104 F.A., 105 F.A., 106 F.A., 102 Engr, 102 Med Regt, 102 Q.M. Regt, 27 Div Sp Tps, HQ 28 Div, HHC 55 Inf Brig, HHC 56 Inf Brig, HHB 53 F.A. Brig, 109 Inf, 110 Inf, 111 Inf, 112 Inf, 107 F.A., 108 F.A., 109 F.A., 103 Engr, 103 Med Regt, 103 Q.M. Regt, 28 Div Sp Tps, HQ 29 Div, HHC 58 Inf Brig, HHC 91 Inf Brig, HHB 54 F.A. Brig, 1 Inf (MD NG), 1 Inf (VA NG), 5 Inf (MD NG), 116 Inf, 110 F.A., 111 F.A., 176 F.A., 121 Engr, 104 Med Regt, 104 Q.M. Regt, 29 Div Sp Tps, HQ 43 Div, HHC 85 Inf Brig, HHC 86 Inf Brig, HHB 68 F.A. Brig, 102 Inf, 103 Inf, 169 Inf, 172 Inf, 103 F.A., 152 F.A., 192 F.A., 118 Engr, 118 Med Regt, 118 Q.M. Regt, 43 Div Sp Tps, HQ 44 Div, HHC 57 Inf Brig, HHC 87 Inf Brig, HHB 69 F.A. Brig, 71 Inf, 113 Inf, 114 Inf, 174 Inf, 156 F.A., 157 F.A., 165 F.A., 104 Engr, 119 Med Regt, 119 Q.M. Regt, 44 Div Sp Tps, HHT 22 Cav Div, HHT 52 Cav Div, 103 Cav, 104 Cav, 110 Cav, 308 Cav, 21 Recon Sq, 73 F.A. Brig, 166 F.A., 122 Q.M. Sq, 28 Inf, 3 Cav, 1-16 F.A., 112 F.A., NY C.A. Brig, 1-11 C.A., 62 C.A., 68 C.A., 197 C.A., 198 C.A., 211 C.A., 212 C.A., 213 C.A., 244 C.A., 260 C.A., 2-5 Engr, 30 Engr (Topo), 70 Engr Co (LP), 126 Engr Sq, 51 Sig Bn, 101 Sig Bn, 16 Med Regt, 2 Chem Bn, 8 Q.M. Bn, 9 Q.M. Bn, 53 Q.M. Regt, 67 Q.M. Bn, HHS 8 Purs Gp, HHS 23 Comp Gp, 1 Purs Sq, 33 Purs Sq, 35 Purs Sq, 36 Purs Sq, 39 Purs Sq, 54 Bomb Sq, 3 Obsn Sq, 97 Obsn Sq, 101 Obsn Sq, 102 Obsn Sq, 103 Obsn Sq, 118 Obsn Sq, 119 Obsn Sq, 152 Obsn Sq, 1 Evac Hosp

302 **4-27 Aug 40** **Second Army Maneuver** Shamrock—Camp McCoy, WI
Units: (65,000 troops) HQ Second Army, HQ V Corps (Prov), HQ VI Corps (Prov), HQ 5 Div, 2 Inf, 10 Inf, 11 Inf, HHB 5 Div Arty, 19 F.A. Bn, 21 F.A. Bn, 46 F.A. Bn, 50 F.A. Bn, 7 Engr Bn, 5 Sig Co, 5 Med Bn, 5 Q.M. Bn, HQ 32 Div, HHC 63 Inf Brig, HHC 64 Inf Brig, HHB 57 F.A. Brig, 125 Inf, 126 Inf, 127 Inf, 128 Inf, 119 F.A., 120 F.A., 121 F.A., 107 Engr, 107 Med Regt, 107 Q.M. Regt, 32 Div Sp Tps, HQ 33 Div, HHC 65 Inf Brig, HHC 66 Inf Brig, HHB 58 F.A. Brig, 129 Inf, 130 Inf, 131 Inf, 132 Inf, 122 F.A., 123 F.A., 124 F.A., 108 Engr, 108 Med Regt, 108 Q.M. Regt, 33 Div Sp Tps, HQ 37 Div, HHC 73 Inf Brig, HHC 74 Inf Brig, HHB 62 F.A. Brig, 145 Inf, 147 Inf, 148 Inf, 166 Inf, 134 F.A., 135 F.A., 136 F.A., 112 Engr, 112 Med Regt, 112 Q.M. Regt, 37 Div Sp Tps, HQ 38 Div, HHC 75 Inf Brig, HHC 76 Inf Brig, HHB 63 F.A. Brig, 149 Inf, 150 Inf, 151 Inf, 152 Inf, 138 F.A., 139 F.A., 150 F.A., 113 Engr, 113 Med Regt, 113 Q.M. Regt, 38 Div Sp Tps, HHT 7 Cav Brig (Mczd), HHT 53 Cav Brig, HHT 54 Cav Brig, 6 Inf, 8 Inf (IL NG), 201 Inf, 2-372 Inf, 1 Cav (Mczd), 13 Cav (Mczd), 1-14 Cav, 105 Cav, 106 Cav, 107 Cav, 123 Cav, 7 Rcn & Spt Sq, 22 Rcn Sq, 23 Rcn Sq, 68 F.A., 182 F.A., 61 C.A., 202 C.A., 2-18 Engr, 30 Engr Bn (Topo), 47 Engr Tp, Tp/122 Q.M. Sq, K&M/48 Q.M. Regt, B/66 Q.M. Regt, B/81 Q.M. Bn, 4 Med Sq, 32 Med Bn, Tp/122 Med Sq, 135 Med Regt, 7 Sig Tp, 51 Sig Bn, 19 Ord Co, 20 Ord Co, 42 Ord Co, 52 Ord Co, HHS 29 Bomb Gp, 6 Bomb Sq, 29 Bomb Sq, 52 Bomb Sq, 12 Obsn Sq, 15 Obsn Sq, 107 Obsn Sq, 108 Obsn Sq, 112 Obsn Sq, 113 Obsn Sq, 792 reserve officers from 85 Div, 86 Div, 101 Div, VI Corps, and XVI Corps units

303 **4-25 Aug 40** **Fourth Army Maneuver,** Camp Ripley, MN
Seventh Corps Area Concentration
Units: (45,000 troops) HQ VII Corps (Prov), HQ 6 Div, 1 Inf, 3 Inf, 20 Inf, HHB 6 Div Arty, 1 F.A. Bn, 51 F.A. Bn, 53 F.A. Bn, 80 F.A. Bn, 6 Engr Bn, 6 Sig Co, 6 Med Bn, 6 Q.M. Bn, HQ 34 Div, HHC 67 Inf Brig, HHC 68 Inf Brig, HHB 59 F.A. Brig, 133 Inf, 135 Inf, 164 Inf, 168 Inf, 125 F.A., 151 F.A., 185 F.A., 109 Engr, 136 Med Regt, 109 Q.M. Regt, 34 Div Sp Tps, HQ 35 Div, HHC 69 Inf Brig, HHC 70 Inf Brig, HHB 60 F.A. Brig, 134 Inf, 137 Inf, 138 Inf, 140 Inf, 130 F.A., 142 F.A., 161 F.A., 110 Engr, 110 Med Regt, 110 Q.M. Regt, 35 Div Sp Tps, HHT 57 Cav Brig, 17 Inf, 153 Inf, 2 Cav, 4 Cav, 14 Cav, 113 Cav, 114 Cav, 1-3 F.A., 128 F.A., 147 F.A., 203 C.A., 206 C.A., A/9 Engr Sq, A/67 Q.M. Bn, D/69 Q.M. Bn, 24 Sig Tp, 1 Rcn Sq, 109 Obsn Sq, 110 Obsn Sq, 154 Obsn Sq, 411 reserve officers from 88 Div, 89 Div, 102 Div, VII Corps, and XVII Corps units

304 **4-24 Aug 40** **Fourth Army Maneuver,** Centralia—Fort Lewis, WA
Ninth Corps Area Concentration
Units: (42,000 troops) HQ IX Corps (Prov), HQ 3 Div, HHC 5 Inf Brig, HHC 6 Inf Brig, HHB 3 Div Arty, 4 Inf, 7 Inf, 15 Inf, 30 Inf, 1-9 F.A., 10 F.A., 10 Engr Bn, 3 Sig Co, 3 Med Bn, 3 Q.M. Bn, HQ 40 Div, HHC 67 Inf Brig, HHC 68 Inf Brig, HHB 59 F.A. Brig, 159 Inf, 160 Inf, 184 Inf, 185 Inf, 143 F.A., 145 F.A., 222 F.A., 115 Engr, 115 Med Regt, 115 Q.M. Regt, 40 Div Sp Tps, HQ 41 Div, HHC 81 Inf Brig, HHC 82 Inf Brig, HHB 66 F.A. Brig, 161 Inf, 162 Inf, 163 Inf, 186 Inf, 146 F.A., 148 F.A., 218 F.A., 116 Engr, 116 Med Regt, 116 Q.M. Regt, 41 Div Sp Tps, HHT

24 Cav Div, HHT 58 Cav Brig, 115 Cav, 116 Cav, 24 Rcn Sq, 68 Inf, 11 Cav, 65 C.A., 75 C.A., 205 C.A., 251 C.A., 19 Engr, 29 Engr Bn (Topo), 60 Sig Bn, 1 Med Regt, 20 Purs Gp, 3 Bln Sq, 9 Bomb Sq, 82 Obsn Sq, 91 Obsn Sq, 115 Obsn Sq, 116 Obsn Sq; 1,200 reserve officers from 91 Div, 96 Div, 104 Div, IX Corps, and XIX Corps units

- 305** **Sep 40** **River Crossing Exercise** Hannawa Falls Crossing, NY
Units: 105 Inf, 102 Engr Regt, 70 Engr Co (LP)
- 306** **Oct 40** **3rd Division Amphibious Exercise** Monterey, CA
Units: HQ 3 Div, 7 Inf, 15 Inf, 30 Inf, HHB 3 Div Arty, 9 F.A. Bn, 10 F.A. Bn, 39 F.A. Bn, 41 F.A. Bn, 10 Engr Bn, 3 Sig Co, 3 Med Bn, 3 Q.M. Bn
- 307** **14 Jan –14 Mar 41** **Joint Army-Navy Maneuver** Culebra Island, PR
(Joint Exercise No. 7)
Units: HQ 1 Div, 3-16 Inf, 3-18 Inf, 99 F.A. Bn, A/1 Engr, 1 Sig Co, U.S.A.T. *Chateau Thierry* U.S.S. *Arkansas*, U.S.S. *New York*, U.S.S. *Wyoming*, U.S.S. *Antares*; U.S.C.G.C. *Bibb*
- 308** **6-20 Mar 41** **Panama Mobile Force Maneuver** Pacora, CZ
Units: HHC Panama Mobile Force, 5 Inf, 14 Inf, 33 Inf, 2 F.A. Bn, 87 F.A. Bn, 10 Sig Co, 70 Med Bn, 61 Q.M. Tp (Pack), 62 Q.M. Tp (Pack), 1 Sep Chem Co, HHB Panama Sep C.A. Brig, 1 C.A., 4 C.A., 72 C.A., 73 C.A., HHS 19 Wing, HHS 6 Bomb Gp, HHS 16 Purs Gp, 7 Rcn Sq, 24 Purs Sq, 25 Bomb Sq, 29 Purs Sq, 44 Rcn Sq, 74 Purs Sq
- 309** **14 Apr-24 May 41** **IX Corps Maneuver** Fort Lewis, WA
Units: HHC IX Corps, HQ 3 Div, 7 Inf, 15 Inf, 30 Inf, HHB 3 Div Arty, 9 F.A. Bn, 10 F.A. Bn, 39 F.A. Bn, 41 F.A. Bn, 10 Engr Bn, 3 Sig Co, 3 Med Bn, 3 Q.M. Bn, HQ 41 Div, HHC 81 Inf Brig, HHC 82 Inf Brig, HHB 66 F.A. Brig, 161 Inf, 162 Inf, 163 Inf, 186 Inf, 146 F.A., 148 F.A., 218 F.A., 116 Engr, 116 Med Regt, 116 Q.M. Regt, 41 Div Sp Tps, 115 Cav, 3 Bln Sq, 91 Obsn Sq, 116 Obsn Sq, 62 Sig Bn
- 310** **Apr-May 41** **IV Corps Maneuver** Fort Benning, GA
Units: HHC IV Corps, HHC 4 Div, 8 Inf, 22 Inf, 29 Inf, HHB 4 Div Arty, 20 F.A. Bn, 29 F.A. Bn, 42 F.A. Bn, 44 F.A. Bn, 4 Engr Bn, 4 Sig Co, 4 Med Bn, 4 Q.M. Bn, HHC 2 Armd Div, HHC 2 Armd Brig, 66 Armd Regt (L), 67 Armd Regt (L), 68 Armd Regt (M), 41 Inf, 78 F.A. Bn, 14 Q.M. Bn, 48 Med Bn, HHS 17 Bomb Wing, HHS 3 Bomb Gp, HHS 27 Bomb Gp
- 311** **22-29 Apr 41** **Coast Defense Exercise** San Diego Harbor, CA
Units: HD of San Diego, 2-3 C.A., 19 C.A.
- 312** **15-24 May 41** **Hawaiian Department Maneuver** Oahu, TH
Units: (40,000 troops) HQ Haw Dept, HQ Haw Div, HHC 21 Inf Brig, HHC 22 Inf Brig, HHB 11 F.A. Brig, 19 Inf, 21 Inf, 27 Inf, 35 Inf, 8 F.A., 11 F.A., 13 F.A., 3 Engr, 11 Med Regt, 11 Q.M. Regt, Haw Div Sp Tps, Haw Div Pack Tn, 298 Inf, 299 Inf, Haw Sep C.A. Brig, 15 C.A., 16 C.A., 41 C.A., 55 C.A., 64 C.A., 251 C.A., 60 Ord Bn, 90 Q.M. Bn, A/1 Chem Bn, HHS Haw Air Force, HHS 14 Purs Wing, HHS 18 Bomb Wing, HHS 5 Bomb Gp, HHS 11 Bomb Gp, HHS 18 Purs Gp, 17 A.B. Gp, 18 A.B. Gp, 4 Rcn Sq, 6 Purs Sq, 14 Bomb Sq, 19 Purs Sq, 23 Bomb Sq, 26 Bomb Sq, 31 Bomb Sq, 42 Bomb Sq, 50 Rcn Sq, 72 Bomb Sq, 78 Purs Sq, 86 Obsn Sq
- 313** **17-21 May 41** **First Coast Artillery District** Narragansett Bay—Long Island Sound
Coast Defense Exercise
Units: HQ First C.A. Dist, HD of Narragansett Bay, HD of Long Island Sound, HD of New Bedford, 8 C.A., 9 C.A., 10 C.A., 11 C.A., 22 C.A., 23 C.A., 240 C.A., 241 C.A., 242 C.A., 243 C.A.
- 314** **22 May-6 Jul 41** **Fourth Army Maneuver** Hunter-Liggett, CA
Units: (60,000 troops) HQ Fourth Army, HHC III Corps, HHC IX Corps, HQ 3 Div, 7 Inf, 15 Inf, 30 Inf, HHB 3 Div Arty, 9 F.A. Bn, 10 F.A. Bn, 39 F.A. Bn, 41 F.A. Bn, 10 Engr Bn, 3 Sig Co, 3 Med Bn, 3 Q.M. Bn, HQ 7 Div, 17 Inf, 32 Inf, 53 Inf, HHB 7 Div Arty, 31 F.A. Bn, 76 F.A. Bn, 13 Engr Bn, 7 Sig Co, 7 Med Bn, 7 Q.M. Bn, HQ 40 Div, HHC 79 Inf Brig, HHC 80 Inf Brig, HHB 65 F.A. Brig, 159 Inf, 160 Inf, 184 Inf, 185 Inf, 143 F.A., 145 F.A., 222 F.A., 115 Engr, 115 Med Regt, 115 Q.M. Regt, 40 Div Sp Tps, HQ 41 Div, HHC 81 Inf Brig, HHC 82 Inf Brig, HHB 66 F.A. Brig, 161 Inf, 162 Inf, 163 Inf, 186 Inf, 146 F.A., 148 F.A., 218 F.A., 116 Engr, 116 Med Regt, 116 Q.M. Regt, 41 Div Sp Tps, 115 Cav, 98 F.A. Bn, 18 Engr Regt, 69 Engr Co, 58 Q.M. Bn, 73 Q.M. Bn, 97 Q.M. Bn, 1 Med Regt, 56 Med Bn, 3 Bln Sq, 91 Obsn Sq, 116 Obsn Sq
- 315** **25 Jun-3 Jul 41** **1st Cavalry Division Maneuver** Fort Bliss, TX—Oro Grande Mountains, NM
Units: HHT 1 Cav Div, HHT 1 Cav Brig, HHT 2 Cav Brig, 5 Cav, 7 Cav, 8 Cav, 12 Cav, 1-82 F.A., 1 Cav Div Sp Tps, 8 Engr Sq, 16 Q.M. Sq, 1 Med Sq, HHT 56 Cav Brig, 112 Cav, 124 Cav, 61 F.A. Bn, 206 C.A., 16th Vet Evac Hosp
- 316** **2-28 Jun 41** **Second Army/VII Corps Maneuver** Tennessee Maneuver Area—
Murfreesboro—Chattanooga, TN
Units: (77,000 troops) HHC Second Army, HHC VII Corps, HQ 5 Div, 2 Inf, 10 Inf, 11 Inf, HHB 5 Div Arty, 19 F.A. Bn, 21 F.A. Bn, 46 F.A. Bn, 50 F.A. Bn, 7 Engr Bn, 5 Sig Co, 5 Med Bn, 5 Q.M. Bn, HQ 6 Div, 1 Inf, 3 Inf, 20 Inf, HHB 6 Div Arty, 1 F.A. Bn, 51 F.A. Bn, 53 F.A. Bn, 80 F.A. Bn, 6 Engr Bn, 6 Sig Co, 6 Med Bn, 6 Q.M. Bn, HQ 27 Div, HHC 53 Inf Brig, HHC 54 Inf Brig, HHB 52 F.A. Brig, 105 Inf, 106 Inf, 108 Inf, 165 Inf, 104 F.A., 105 F.A., 106 F.A., 102 Engr, 102 Med Regt, 102 Q.M. Regt, 27 Div Sp Tps, HQ 30 Div, HHC 59 Inf Brig, HHC 60 Inf Brig, HHB 55 F.A. Brig, 117 Inf, 118 Inf, 120 Inf, 121 Inf, 113 F.A., 115 F.A., 118 F.A., 105 Engr, 105 Med Regt, 105 Q.M. Regt, 30 Div Sp Tps, HQ 33 Div, HHC 65 Inf Brig, HHC 66 Inf Brig, HHB 58 F.A. Brig, 129 Inf, 130 Inf, 131 Inf, 132 Inf, 122 F.A., 123 F.A., 124 F.A., 108 Engr, 108 Med Regt, 108 Q.M. Regt, 33 Div Sp Tps, HQ 35 Div, HHC 69 Inf Brig, HHC 70 Inf Brig, HHB 60 F.A. Brig, 134 Inf, 137 Inf, 138 Inf, 140 Inf, 127 F.A., 130 F.A., 161 F.A., 110 Engr, 110 Med Regt, 110 Q.M. Regt, 35 Div Sp Tps, 61 C.A., 43 Engr Regt, 87 Engr Bn, 94 Engr Bn, 151 Med Bn

317 **1-18 Jun 41** **VIII Corps Maneuver** Brownwood—Camp Bowie, TX
Units: (70,000 troops) HHC VIII Corps, HQ 2 Div, 9 Inf, 23 Inf, 38 Inf, HHB 2 Div Arty, 12 F.A. Bn, 15 F.A. Bn, 37 F.A. Bn, 38 F.A. Bn, 2 Engr Bn, 2 Sig Co, 2 Med Bn, 2 Q.M. Bn, HQ 36 Div, HHC 71 Inf Brig, HHC 72 Inf Brig, HHB 61 F.A. Brig, 141 Inf, 142 Inf, 143 Inf, 144 Inf, 131 F.A., 132 F.A., 133 F.A., 111 Engr, 111 Med Regt, 111 Q.M. Regt, 36 Div Sp Tps, HQ 45 Div, HHC 89 Inf Brig, HHC 90 Inf Brig, HHB 70 F.A. Brig, 157 Inf, 158 Inf, 179 Inf, 180 Inf, 158 F.A., 160 F.A., 189 F.A., 120 Engr, 120 Med Regt, 120 Q.M. Regt, 45 Div Sp Tps, 113 Cav, HHB 18 F.A. Brig, 77 F.A., 142 F.A., 349 F.A., 2 F.A. Obsn Bn, 52 Sig Bn

318 **9-17 Jun 41** **North American Aviation Labor Strike** Inglewood, CA
Units: (2,500 troops) 15 Inf, 3 C.A., elmts 11 Cav, 115 Q.M. Regt

319 **5-11 Jul 41** **Coast Defense Exercise** Los Angeles Harbor, CA
Units: HD of Los Angeles, 3 C.A. (-), 63 C.A.

320 **16-27 Jun 41** **V Corps Maneuver** Louisiana Maneuver Area—
Camp Beauregard, LA
Units: HHC V Corps, HQ 32 Div, HHC 63 Inf Brig, HHC 64 Inf Brig, HHB 57 F.A. Brig, 125 Inf, 126 Inf, 127 Inf, 128 Inf, 120 F.A., 121 F.A., 126 F.A., 107 Engr, 107 Med Regt, 107 Q.M. Regt, 32 Div Sp Tps, HQ 34 Div, HHC 67 Inf Brig, HHC 68 Inf Brig, HHB 59 F.A. Brig, 133 Inf, 135 Inf, 164 Inf, 168 Inf, 125 F.A., 151 F.A., 185 F.A., 109 Engr, 136 Med Regt, 109 Q.M. Regt, 34 Div Sp Tps, HQ 37 Div, HHC 73 Inf Brig, HHC 74 Inf Brig, HHB 62 F.A. Brig, 145 Inf, 147 Inf, 148 Inf, 166 Inf, 134 F.A., 135 F.A., 136 F.A., 112 Engr, 112 Med Regt, 112 Q.M. Regt, 37 Div Sp Tps, HQ 38 Div, HHC 75 Inf Brig, HHC 76 Inf Brig, HHB 63 F.A. Brig, 149 Inf, 150 Inf, 151 Inf, 152 Inf, 138 F.A., 139 F.A., 150 F.A., 113 Engr, 113 Med Regt, 113 Q.M. Regt, 38 Div Sp Tps, 106 Cav, 107 Cav

321 **18-25 Jun 41** **Second Coast Artillery District** Fort Hamilton—Sandy Hook—
Coast Defense Exercise New York Harbor
Units: (5,000 troops) HQ Second C.A. Dist, HD of Southern New York, HD of Sandy Hook, 5 C.A., 7 C.A., 52 C.A., U.S.A.M.P. *E.O.C. Ord*; HQ 3 Naval Dist

322 **8-18 Jul 41** **Antiaircraft Exercise** Bastrop, TX
Units: 204 C.A., 105 C.A. Bn; 106 C.A. Bn

323 **24 Jul-15 Aug 41** **Army-Marine Amphibious Exercise** New River Inlet, NC
Units: HQ I Amphibious Corps, HQ 1 Div, 16 Inf, 18 Inf, 26 Inf, HHB 1 Div Arty, 6 F.A. Bn, 7 F.A. Bn, 32 F.A. Bn, 33 F.A. Bn, 1 Engr, 1 Sig Co, 1 Med Bn, 1 Q.M. Bn, 4 F.A. Bn, 97 F.A. Bn, 99 F.A. Bn, E/61 C.A., elmts/68 C.A., elmts/77 C.A., 70 Tank Bn, 87 Engr Bn, 67 Q.M. Bn, 99 Q.M. Bn, 29 Ord Co, 7 Sta Hosp, 10 Sta Hosp, 12 Sta Hosp, 1 Marine Div

324 **11-30 Aug 41** **Second Army/VII Corps Maneuver** Camp Robinson—Arkadelphia, AR
Units: (110,000 troops) HHC Second Army, HHC VII Corps, HQ 27 Div, HHC 53 Inf Brig, HHC 54 Inf Brig, HHB 52 F.A. Brig, 105 Inf, 106 Inf, 108 Inf, 165 Inf, 104 F.A., 105 F.A., 106 F.A., 102 Engr, 102 Med Regt, 102 Q.M. Regt, 27 Div Sp Tps, HQ 33 Div, HHC 65 Inf Brig, HHC 66 Inf Brig, HHB 58 F.A. Brig, 129 Inf, 130 Inf, 131 Inf, 132 Inf, 122 F.A., 123 F.A., 124 F.A., 108 Engr, 108 Med Regt, 108 Q.M. Regt, 33 Div Sp Tps, HQ 35 Div, HHC 69 Inf Brig, HHC 70 Inf Brig, HHB 60 F.A. Brig, 134 Inf, 137 Inf, 138 Inf, 140 Inf, 127 F.A., 130 F.A., 161 F.A., 110 Engr, 110 Med Regt, 110 Q.M. Regt, 35 Div Sp Tps, 153 Inf, HHB 72 F.A. Brig, HHB 75 F.A. Brig, 20 Inf, 9 Cav, 107 Cav, 119 F.A., 168 F.A., 177 F.A., 181 F.A., 182 F.A., 191 F.A., 61 C.A., 43 Engr, 86 Engr Bn, 92 Engr Bn, 94 Engr Bn, 50 Sig Bn, 58 Sig Bn, 68 Med Regt, 151 Med Bn, elmts 17 Q.M. Sq, elmts 22 Q.M. Regt, elmts 28 Q.M. Regt, elmts 48 Q.M. Regt, elmts 56 Q.M. Regt, 1 Obsn Sq, 102 Obsn Sq, 108 Obsn Sq, 110 Obsn Sq

325 **11-30 Aug 41** **IV Corps Maneuver** Louisiana Maneuver Area—
Camp Beauregard, LA
Units: HHC IV Corps, HQ 31 Div, HHC 61 Inf Brig, HHC 62 Inf Brig, HHB 56 F.A. Brig, 124 Inf, 155 Inf, 156 Inf, 167 Inf, 114 F.A., 116 F.A., 117 F.A., 106 Engr, 106 Med Regt, 106 Q.M. Regt, 31 Div Sp Tps, HQ 43 Div, HHC 85 Inf Brig, HHC 86 Inf Brig, HHB 68 F.A. Brig, HHB 33 C.A. Brig, 102 Inf, 103 Inf, 169 Inf, 172 Inf, 103 F.A., 152 F.A., 192 F.A., 69 C.A., 197 C.A., 203 C.A., 204 C.A., 211 C.A., 105 C.A. Bn, 106 C.A. Bn, 118 Engr, 118 Med Regt, 118 Q.M. Regt, 43 Div Sp Tps, 24 Inf, 6 Cav, 65 Med Regt

326 **15 Aug-5 Sep 41** **Fourth Army Maneuver** Fort Lewis—Chehalis, WA
Units: HHC Fourth Army, HHC III Corps, HHC IX Corps, HQ 3 Div, 7 Inf, 15 Inf, 30 Inf, HHB 3 Div Arty, 9 F.A. Bn, 10 F.A. Bn, 39 F.A. Bn, 41 F.A. Bn, 10 Engr Bn, 3 Sig Co, 3 Med Bn, 3 Q.M. Bn, HQ 7 Div, 17 Inf, 32 Inf, 53 Inf, HHB 7 Div Arty, 31 F.A. Bn, 76 F.A. Bn, 13 Engr Bn, 7 Sig Co, 7 Med Bn, 7 Q.M. Bn, HQ 40 Div, HHC 79 Inf Brig, HHC 80 Inf Brig, HHB 65 F.A. Brig, 159 Inf, 160 Inf, 184 Inf, 185 Inf, 143 F.A., 145 F.A., 222 F.A., 115 Engr, 115 Med Regt, 115 Q.M. Regt, 40 Div Sp Tps, HQ 41 Div, HHC 81 Inf Brig, HHC 82 Inf Brig, HHB 66 F.A. Brig, 161 Inf, 162 Inf, 163 Inf, 186 Inf, 146 F.A., 148 F.A., 218 F.A., 116 Engr, 116 Med Regt, 116 Q.M. Regt, 41 Div Sp Tps, 115 Cav, 98 F.A. Bn, 18 Engr Regt, 69 Engr Bn, 91 Obsn Sq, 58 Q.M. Bn, 73 Q.M. Bn, 97 Q.M. Bn, 1 Med Regt, 56 Med Bn

327a **26 Aug-3 Sep 41** **VI Corps Maneuver** Pepperill—Fort Devens, MA
Units: HQ VI Corps, HQ 26 Div, HHC 51 Inf Brig, HHC 52 Inf Brig, HHB 51 F.A. Brig, 101 Inf, 104 Inf, 181 Inf, 182 Inf, 101 F.A., 102 F.A., 180 F.A., 101 Engr, 101 Med Regt, 101 Q.M. Regt, 26 Div Sp Tps, 366 Inf, 101 Cav, HHB 71 F.A. Brig, 186 F.A., 258 F.A., 68th C.A., 102 C.A. Bn, 36th Engr, C/22 Q. M, Regt, C/54 Q. M. Regt, HHD & B/84 Q. M. Bn, 16th Med Regt, 4th Evac Hosp, 54th Med Bn, 57th Sig Bn, 5th Ord Co, 29th Ord Co, 101 Obsn Sqdn, 152 Obsn Sqdn

327b **27-29 Aug 41** **Antiaircraft Exercise**
Units: HHB 34 C. A. Brig, 67 C.A., 76 C.A., 77 C.A., 101 C.A. Bn

Fort Bragg, NC

328 **15-28 Sep 41** **Second Army-Third Army**
GHQ Maneuver

Louisiana Maneuver Area

Units: (342,000 troops) General Headquarters, HHC Second Army, HHC Third Army, HQ Sp Tps Third Army, HHC IV Corps, HHC V Corps, HHC VII Corps, HHC VIII Corps, HHC I Armd Corps, HQ 2 Div, 9 Inf, 23 Inf, 38 Inf, HHB 2 Div Arty, 12 F.A. Bn, 15 F.A. Bn, 37 F.A. Bn, 38 F.A. Bn, 2 Engr Bn, 2 Sig Co, 2 Med Bn, 2 Q.M. Bn, HQ 5 Div, 2 Inf, 10 Inf, 11 Inf, HHB 5 Div Arty, 19 F.A. Bn, 21 F.A. Bn, 46 F.A. Bn, 50 F.A. Bn, 7 Engr Bn, 5 Sig Co, 5 Med Bn, 5 Q.M. Bn, HQ 6 Div, 1 Inf, 20 Inf, HHB 6 Div Arty, 1 F.A. Bn, 51 F.A. Bn, 53 F.A. Bn, 80 F.A. Bn, 6 Engr Bn, 6 Sig Co, 6 Med Bn, 6 Q.M. Bn, HQ 27 Div, HHC 53 Inf Brig, HHC 54 Inf Brig, HHB 52 F.A. Brig, 105 Inf, 106 Inf, 108 Inf, 165 Inf, 104 F.A., 105 F.A., 106 F.A., 102 Engr, 102 Med Regt, 102 Q.M. Regt, 27 Div Sp Tps, HQ 31 Div, HHC 61 Inf Brig, HHC 62 Inf Brig, HHB 56 F.A. Brig, 124 Inf, 155 Inf, 156 Inf, 167 Inf, 114 F.A., 116 F.A., 117 F.A., 106 Engr, 106 Med Regt, 106 Q.M. Regt, 31 Div Sp Tps, HQ 32 Div, HHC 63 Inf Brig, HHC 64 Inf Brig, HHB 57 F.A. Brig, 125 Inf, 126 Inf, 127 Inf, 128 Inf, 120 F.A., 121 F.A., 126 F.A., 107 Engr, 107 Med Regt, 107 Q.M. Regt, 32 Div Sp Tps, HQ 33 Div, HHC 65 Inf Brig, HHC 66 Inf Brig, HHB 58 F.A. Brig, 129 Inf, 130 Inf, 131 Inf, 132 Inf, 122 F.A., 123 F.A., 124 F.A., 108 Engr, 108 Med Regt, 108 Q.M. Regt, 33 Div Sp Tps, HQ 34 Div, HHC 67 Inf Brig, HHC 68 Inf Brig, HHB 59 F.A. Brig, 133 Inf, 135 Inf, 164 Inf, 168 Inf, 125 F.A., 151 F.A., 185 F.A., 109 Engr, 136 Med Regt, 109 Q.M. Regt, 34 Div Sp Tps, HQ 35 Div, HHC 69 Inf Brig, HHC 70 Inf Brig, HHB 60 F.A. Brig, 134 Inf, 137 Inf, 138 Inf, 140 Inf, 127 F.A., 130 F.A., 161 F.A., 110 Engr, 110 Med Regt, 110 Q.M. Regt, 35 Div Sp Tps, HQ 36 Div, HHC 71 Inf Brig, HHC 72 Inf Brig, HHB 61 F.A. Brig, 141 Inf, 142 Inf, 143 Inf, 144 Inf, 131 F.A., 132 F.A., 133 F.A., 111 Engr, 111 Med Regt, 111 Q.M. Regt, 36 Div Sp Tps, HQ 37 Div, HHC 73 Inf Brig, HHC 74 Inf Brig, HHB 62 F.A. Brig, 145 Inf, 147 Inf, 148 Inf, 166 Inf, 134 F.A., 135 F.A., 136 F.A., 112 Engr, 112 Med Regt, 112 Q.M. Regt, 37 Div Sp Tps, HQ 38 Div, HHC 75 Inf Brig, HHC 76 Inf Brig, HHB 63 F.A. Brig, 149 Inf, 150 Inf, 151 Inf, 152 Inf, 138 F.A., 139 F.A., 150 F.A., 113 Engr, 113 Med Regt, 113 Q.M. Regt, 38 Div Sp Tps, HQ 43 Div, HHC 85 Inf Brig, HHC 86 Inf Brig, HHB 68 F.A. Brig, 102 Inf, 103 Inf, 169 Inf, 172 Inf, 103 F.A., 152 F.A., 192 F.A., 118 Engr, 118 Med Regt, 118 Q.M. Regt, 43 Div Sp Tps, HQ 45 Div, HHC 89 Inf Brig, HHC 90 Inf Brig, HHB 70 F.A. Brig, 157 Inf, 158 Inf, 179 Inf, 180 Inf, 158 F.A., 160 F.A., 189 F.A., 120 Engr, 120 Med Regt, 120 Q.M. Regt, 45 Div Sp Tps, HHC 1 Armd Div, HHC 1 Armd Brig, 1 Armd Regt (L), 13 Armd Regt (L), 69 Armd Regt (M), 6 Inf, 27 F.A. Bn, 13 Q.M. Bn, 47 Med Bn, HHC 2 Armd Div, HHC 2 Armd Brig, 66 Armd Regt (L), 67 Armd Regt (L), 68 Armd Regt (M), 41 Inf, 78 F.A. Bn, 14 Q.M. Bn, 48 Med Bn, HHT 1 Cav Div, HHT 1 Cav Brig, HHT 2 Cav Brig, 5 Cav, 7 Cav, 8 Cav, 12 Cav, 82 F.A., 1 Cav Div Sp Tps, 8 Engr Sq, 16 Q.M. Sq, 1 Med Sq, HHT 2 Cav Div, HHT 3 Cav Brig, HHT 4 Cav Brig, 2 Cav, 9 Cav, 10 Cav, 14 Cav, 3 F.A., 9 Engr Sq, 17 Q.M. Sq, 2 Med Sq, 24 Inf, HHT 56 Cav Brig, 4 Cav, 6 Cav, 106 Cav, 107 Cav, 112 Cav, 113 Cav, 124 Cav, HHB 18 F.A. Brig, 77 F.A., 142 F.A., 349 F.A., 2 F.A. Obsn Bn, HHB 76 F.A. Brig, 144 F.A., 183 F.A., 188 F.A., HHB 33 C.A. Brig, 14 C.A., 69 C.A., 197 C.A., 203 C.A., 204 C.A., 210 C.A., 211 C.A., 105 C.A. Bn, 106 C.A. Bn, 20 Engr Regt, 37 Engr Regt, 42 Engr Regt, 43 Engr Regt, 46 Engr Regt, 151 Engr Regt, 30 Engr Bn (Topo), 80 Engr Bn (WS), 85 Engr Bn (HP), 86 Engr Bn (HP), 87 Engr Bn (HP), 88 Engr Bn (HP), 91 Engr Bn (Sep), 94 Engr Bn (Sep), 95 Engr Bn (Sep), 67 Engr Co (Topo), 71 Engr Co (LP), 75 Engr Co (LP), 77 Engr Co (LP), 392 Engr Co (Depot), 52 Sig Bn, elmts/48 Q.M. Regt, 65 Med Regt, 68 Med Regt, 151 Med Bn, HHS 2 Bomb Wing, HHS 6 Purs Wing, HHS 10 Purs Wing, HHS 17 Bomb Wing, 1 Bln Sq

329 **25 Sep-10 Oct 41** **Puerto Rican Department Maneuver** vicinity Caguas, PR

Units: HQ Puerto Rican Department, HHC 92 Inf Brig, 65 Inf, 295 Inf, 296 Inf, 2-25 F.A., 1-162 F.A., 1-51 C.A., 1-66 C.A., 1-201 C.A., 1-253 C.A., 27 Engr Bn, 1-130 Engr, HHS 25 Bomb Gp, 10 Bomb Sq, 12 Bomb Sq, 27 Rcn Sq, 32 Purs Sq

330 **6 Oct-1 Nov 41** **First Army GHQ Maneuver** Carolina Maneuver Area

Units: (295,000 troops) HHC First Army, HQ Sp Tps First Army, HHC I Corps, HHC II Corps, HHC IV Corps, HHC VI Corps, HHC I Armd Corps, HQ 1 Div, 16 Inf, 18 Inf, 26 Inf, HHB 1 Div Arty, 6 F.A. Bn, 7 F.A. Bn, 32 F.A. Bn, 33 F.A. Bn, 1 Engr, 1 Sig Co, 1 Med Bn, 1 Q.M. Bn, HQ 4 Div, 8 Inf, 22 Inf, 29 Inf, HHB 4 Div Arty, 20 F.A. Bn, 29 F.A. Bn, 42 F.A. Bn, 44 F.A. Bn, 4 Engr Bn, 4 Sig Co, 4 Med Bn, 4 Q.M. Bn, HQ 8 Div, 13 Inf, 28 Inf, 34 Inf, HHB 8 Div Arty, 28 F.A. Bn, 83 F.A. Bn, 12 Engr, 8 Sig Co, 8 Med Bn, 8 Q.M. Bn, HQ 9 Div, 39 Inf, 47 Inf, 60 Inf, HHB 9 Div Arty, 26 F.A. Bn, 34 F.A. Bn, 60 F.A. Bn, 84 F.A. Bn, 15 Engr Bn, 9 Med Bn, 9 Sig Co, 9 Med Bn, 9 Q.M. Bn, HQ 26 Div, HHC 51 Inf Brig, HHC 52 Inf Brig, HHB 51 F.A. Brig, 101 Inf, 104 Inf, 181 Inf, 182 Inf, 101 F.A., 102 F.A., 180 F.A., 101 Engr, 101 Med Regt, 101 Q.M. Regt, 26 Div Sp Tps, HQ 28 Div, HHC 55 Inf Brig, HHC 56 Inf Brig, HHB 53 F.A. Brig, 109 Inf, 110 Inf, 111 Inf, 112 Inf, 107 F.A., 108 F.A., 109 F.A., 103 Engr, 103 Med Regt, 103 Q.M. Regt, 28 Div Sp Tps, HQ 29 Div, HHC 58 Inf Brig, HHC 88 Inf Brig, HHB 54 F.A. Brig, 115 Inf, 116 Inf, 175 Inf, 176 Inf, 110 F.A., 111 F.A., 176 F.A., 104 Med Regt, 104 Q.M. Regt, 29 Div Sp Tps, HQ 30 Div, HHC 59 Inf Brig, HHC 60 Inf Brig, HHB 55 F.A. Brig, 117 Inf, 118 Inf, 120 Inf, 121 Inf, 113 F.A., 115 F.A., 118 F.A., 105 Engr, 105 Med Regt, 105 Q.M. Regt, 30 Div Sp Tps, HQ 31 Div, HHC 61 Inf Brig, HHC 62 Inf Brig, HHB 56 F.A. Brig, 124 Inf, 155 Inf, 156 Inf, 167 Inf, 114 F.A., 116 F.A., 117 F.A., 106 Engr, 106 Med Regt, 106 Q.M. Regt, 31 Div Sp Tps, HQ 43 Div, HHC 85 Inf Brig, HHC 86 Inf Brig, HHB 68 F.A. Brig, 102 Inf, 103 Inf, 169 Inf, 172 Inf, 103 F.A., 152 F.A., 192 F.A., 118 Engr, 118 Med Regt, 118 Q.M. Regt, 43 Div Sp Tps, HQ 44 Div, HHC 57 Inf Brig, HHC 87 Inf Brig, HHB 69 F.A. Brig, 71 Inf, 113 Inf, 114 Inf, 174 Inf, 156 F.A., 157 F.A., 165 F.A., 104 Engr, 119 Med Regt, 119 Q.M. Regt, HHC 1 Armd Div, HHC 1 Armd Brig, 1 Armd Regt (L), 13 Armd Regt (L), 69 Armd Regt (M), 6 Inf, 27 F.A. Bn, 13 Q.M. Bn, 47 Med Bn, HHC 2 Armd Div, HHC 2 Armd Brig, 66 Armd Regt (L), 67 Armd Regt (L), 68 Armd Regt (M), 41 Inf, 78 F.A. Bn, 14 Q.M. Bn, 48 Med Bn, 24 Inf, HHB 13 F.A. Brig, HHB 71 F.A. Brig, HHB 74 F.A. Brig, HHB Fort Bragg Prov F.A. Brig, HHB 33 C.A. Brig, HHB 34 C.A. Brig, HHB 38 C.A. Brig, HHB 102 C.A. Brig, 3 Cav, 6 Cav, 101 Cav, 102 Cav, 104 Cav, 107 Cav, 70 Tank Bn, 191 Tank Bn, 192 Tank Bn, 1 F.A. Obsn Bn, 3 F.A. Obsn Bn, 7 F.A. Obsn Bn, 4 F.A. Bn, 17 F.A., 36 F.A., 47 F.A., 72 F.A., 79 F.A., 97 F.A. Bn, 99 F.A. Bn, 112 F.A., 128 F.A., 172 F.A., 178 F.A., 179 F.A., 186 F.A., 187 F.A., 258 F.A., E/8 C.A., 57 C.A., 62 C.A., 67 C.A., 68 C.A., 70 C.A., 71 C.A., G/74 C.A., 76 C.A., 77 C.A., 102 C.A. Bn, 207 C.A., 209 C.A., 212 C.A., 213 C.A., 214 C.A., 244 C.A., 101 C.A. Bn, 104 C.A. Bn, 107 C.A. Bn, 5 Engr Regt, 21 Engr Regt, 36 Engr Regt, 38 Engr Regt, 41 Engr Regt, 44 Engr Regt, 45 Engr Regt, 30 Engr Bn (Topo), 80 Engr Bn, 84 Engr Bn, 85 Engr Bn, 95 Engr Bn, 96 Engr Bn, 101 M.P. Bn, 510 M.P. Bn, 51 Sig Bn, 56 Sig Bn, 57 Sig Bn, 62 Sig Bn, 64 Sig Bn, 1 Ord Bn, 2 Ord Bn, 6 Ord Bn, 41 Ord Bn, 2/22 Q.M. Regt, elmts/23 Q.M. Regt, 2/28 Q.M. Regt, elmts/47 Q.M. Regt, 2/48 Q.M. Regt, 1/53 Q.M. Regt, 66 Q.M. Bn, 67 Q.M. Bn, 74 Q.M. Bn, 80 Q.M. Bn, 86 Q.M. Bn, 94 Q.M. Bn, 95 Q.M. Bn, 99 Q.M. Bn, 201 Q.M. Bn, 203 Q.M. Bn, 205 Q.M. Bn, 207 Q.M. Bn, 240 Q.M. Bn, 16 Med Regt, 65 Med Regt, 134 Med Regt, 51 Med Bn, 52 Med Bn, 1 Evac Hosp, 154 Sta Hosp, 2 Chem Bn, HHS 2 Bomb Wing, HHS 6 Purs Wing, HHS 10 Purs Wing, HHS 3 Bomb Gp, HHS 8 Purs Gp, HHS 17 Bomb Gp, HHS 31 Purs Gp, 103 Obsn Sq, 104 Obsn Sq, 105 Obsn Sq, 112 Obsn Sq, 119 Obsn Sq, 121 Obsn Sq, 126

Obsn Sq, 152 Obsn Sq, 2 Bln Sq

331 **20-24 Oct 41** **Coast Defense Exercise** Fort Winfield Scott—Fort Baker, CA
Units: HD of San Francisco, 30 Inf, 6 C.A., 18 C.A., 56 C.A., 1-147 F.A., 13 Engr Bn; 7 Med. Bn.; 41 Bomb. Sq., 115 Obsn. Sq, U.S.A.M.P. *Col. Ellery W. Niles*, U.S.A.M.P. *Gen. J. Franklin Bell*

332 **27-31 Oct 41** **Coast Defense Exercise** Fort Rosecrans, CA
Units: (2,000 troops) HD of San Diego, 19 C.A.

333 **1-15 Nov 41** **Panama Mobile Force Maneuver** vicinity Cano Saddle—Estobal, CZ
Units: HHC Panama Mobile Force, 5 Inf, 14 Inf, 33 Inf, 2 F.A. Bn, 87 F.A. Bn, 10 Sig Co, 70 Med Bn, 61 Q.M. Tp (Pack), 62 Q.M. Tp (Pack), 1 Chem Co, HHS Panama Canal Air Force, HHS 12 Purs Wing, HHS 19 Bomb Wing, HHS 6 Bomb Gp, HHS 37 Purs Gp, 15 A.B. Gp, 16 A.B. Gp, 3 Bomb Sq, 7 Rcn Sq, 25 Bomb Sq, 24 Purs Sq, 28 Purs Sq, 29 Purs Sq, 30 Purs Sq, 31 Purs Sq, 39 Obsn Sq, 43 Purs Sq, 44 Rcn Sq, 74 Bomb Sq

334 **Nov 41** **Antiaircraft Exercise** Columbia—Spartanburg—Camden, SC
Units: HD of Charleston, HHB 34 C. A. Brig, D/13 C.A., 67 C.A., 76 C.A., 77 C.A., 263 C.A., 101 C.A. Bn

335 **30 Nov-8 Dec 41** **Antiaircraft Exercise** San Francisco—Los Angeles, CA
Units: (2,500 troops) HQ 9 C.A. District, HD of San Francisco, HD of Los Angeles, HHB 37 C. A. Brig, 101 C.A. Brig, 3 C.A., 6 C.A., 18 C.A., 56 C.A., 63 C.A., 65 C.A., 78 C.A., 216 C.A., 217 C.A.

Appendix C
U.S. Army Statistics
1919-41

Regular Army Reserve (RAR)

Authorized by Congress April 1938. Established July 1938. Goal was to enroll 75,000 prior service enlisted men by 30 June 1942. To be eligible, a man had to be prior service Regular Army, honorably discharged, and single. All eligible RAR soldiers were mobilized for active service on 15 February 1941.

Date	Enrolled
31 Aug 39	24,972
1 Mar 40	30,903
1 Sep 40	36,024
1 Dec 40	37,037

Organized Reserve (OR)

Authorized by the 1920 Amendment to the 1916 National Defense Act. Composed of two corps: The Officers Reserve Corps (ORC) and the Enlisted Reserve Corps (ERC).

Date	ORC	ERC	Total OR Strength
30 Jun 1920	68,232	0	68,232
30 Jun 1921	66,905	1	66,906
30 Jun 1922	67,390	480	67,870
30 Jun 1923	76,923	1,557	78,480
30 Jun 1924	81,706	3,400	85,106
30 Jun 1925	95,154	5,116	100,270
30 Jun 1926	103,829	5,775	109,604
30 Jun 1927	110,014	5,735	115,749
30 Jun 1928	114,824	5,464	120,288
30 Jun 1929	112,757	5,192	117,949
30 Jun 1930	113,523	4,721	118,244
30 Jun 1931	120,550	4,837	125,387
30 Jun 1932	128,003	4,872	132,875
30 Jun 1933	133,485	5,028	138,513
30 Jun 1934	114,357	4,646	119,003
30 Jun 1935	112,590	4,323	116,913
30 Jun 1936	115,169	3,897	119,066
30 Jun 1937	111,169	3,189	114,358
30 Jun 1938	113,177	2,998	116,175

30 Jun 1939	116,719	3,054	119,773
30 Jun 1940	116,636	3,233	119,869

National Guard (NG)

Date	Officers	Enlisted	Total Strength
30 Jun 1919	1,198	36,012	37,210
30 Jun 1920	2,073	54,017	56,090
30 Jun 1921	5,843	107,797	113,640
30 Jun 1922	8,744	150,914	159,658
30 Jun 1923	9,675	150,923	160,598
30 Jun 1924	10,997	165,325	176,322
30 Jun 1925	11,595	165,930	177,525
30 Jun 1926	11,435	163,534	174,969
30 Jun 1927	12,192	168,950	181,142
30 Jun 1928	12,428	168,793	181,221
30 Jun 1929	12,347	164,453	176,988
30 Jun 1930	12,930	169,785	182,715
30 Jun 1931	13,249	174,137	187,386
30 Jun 1932	13,550	173,863	187,413
30 Jun 1933	13,569	172,356	185,925
30 Jun 1934	13,507	171,284	184,791
30 Jun 1935	13,571	172,244	185,915
30 Jun 1936	13,721	175,452	189,173
30 Jun 1937	14,110	178,051	192,161
30 Jun 1938	14,443	182,745	197,188
30 Jun 1939	14,666	184,825	199,491
30 Jun 1940	14,775	226,837	241,612

Regular Army (RA)

Date	Officer	Enlisted	Strength
30 Jun 1919	91,975	759,649	851,624
30 Jun 1920	18,999	185,293	204,292
30 Jun 1921	16,501	214,224	230,725
30 Jun 1922	15,667	133,096	148,763

30 Jun 1923	14,021	119,222	133,243
30 Jun 1924	11,655	129,288	140,943
30 Jun 1925	12,462	122,792	135,254
30 Jun 1926	12,143	121,200	133,343
30 Jun 1927	12,076	121,192	133,668
30 Jun 1928	13,320	121,185	134,505
30 Jun 1929	13,313	124,216	137,529
30 Jun 1930	13,344	124,301	137,645
30 Jun 1931	13,350	125,467	138,817
30 Jun 1932	13,287	119,913	133,200
30 Jun 1933	13,227	121,788	135,015
30 Jun 1934	13,152	123,823	136,975
30 Jun 1935	12,868	125,098	137,966
30 Jun 1936	12,909	153,212	166,121
30 Jun 1937	13,115	164,993	178,108
30 Jun 1938	13,304	170,151	183,455
30 Jun 1939	13,814	174,079	187,893
30 Jun 1940	14,677	249,441	264,118
30 Jun 1941	99,536	1,362,779	1,462,315

Reserve Officers Training Corps (ROTC)

Date	Total Enrollment	Commissions
30 Jun 1920	NA	NA
30 Jun 1921	90,811	NA
30 Jun 1922	88,901	2,031
30 Jun 1923	57,505	2,874
30 Jun 1924	63,570	3,317
30 Jun 1925	69,368	4,135
30 Jun 1926	68,553	4,842
30 Jun 1927	70,809	5,018
30 Jun 1928	72,731	5,142
30 Jun 1929	71,903	5,752
30 Jun 1930	73,030	5,082

30 Jun 1931	75,786	5,151
30 Jun 1932	73,989	5,490
30 Jun 1933	66,729	5,846
30 Jun 1934	65,419	5,640
30 Jun 1935	71,955	5,543
30 Jun 1936	79,953	4,831
30 Jun 1937	87,796	4,923
30 Jun 1938	93,308	5,393
30 Jun 1939	97,549	5,376
30 Jun 1940	103,818	6,709

Citizens Military Training Camps (CMTC)

Date	Total Enrollment	Commissions
30 Jun 1921	11,202	None
30 Jun 1922	NA	270
30 Jun 1923	NA	525
30 Jun 1924	24,483	509
30 Jun 1925	32,647	265
30 Jun 1926	33,914	299
30 Jun 1927	34,194	23
30 Jun 1928*	38,597*	NA
30 Jun 1929	34,514	113
30 Jun 1930	36,533	46
30 Jun 1931	39,061	114
30 Jun 1932	38,546	325
30 Jun 1933	38,588	270
30 Jun 1934	15,797	168
30 Jun 1935	14,853	179
30 Jun 1936	31,362	142
30 Jun 1937	31,480	144
30 Jun 1938	32,522	168
30 Jun 1939	36,783	139
30 Jun 1940	35,579	166

*Figures from 1921 to 1927 for enrollment include those who attended but did not complete training. From 1928 on, the enrollment figures include only those who completed the training.

Appendix D
Civilian Conservation Corps
Organization 1933-41



US Forestry Service (from the book *Twice the Citizen*)

Civilian Conservation Corps. Reserve officers issue instructions to men of a CCC company.

The US Army and the CCC

With the United States in the grip of the Great Depression and almost an third of American workers unemployed, President Franklin D. Roosevelt introduced the Emergency Conservation Work Act (ECWA) on March 21, 1933 to the United States Congress to help relieve some of the misery. The act was signed into law ten days later and the Civilian Conservation Corps (CCC) was created. The purpose of the CCC was to take young unemployed men and put them to work on a host of conservation and infrastructure projects for the Department of the Interior. This, in turn, would help remove hundreds of thousands of workers from the rolls of the unemployed and, in theory, help get the economy on the mend.

Various government agencies were involved in this venture. The Department of Labor was responsible for selecting and enrolling the participants. The Departments of the Interior and Agriculture were responsible for identifying and selecting the various forestry, agriculture, and infrastructure projects on which that the CCC enrollees would work. The War Department responsible for managing the health, welfare, and housing of these thousands of men and boys. Due to its ability to induct, mobilize, and maintain large bodies of men, Roosevelt logically selected the U.S. Army to perform the mobilization and personnel management aspects of the CCC program. This included receiving the enrollees upon induction, providing them food, clothing, shelter, preparing them for service at the project site, providing health care and wages, and transporting the enrollees to wherever their services were needed.

In performing these various tasks, virtually every department, branch, and unit of the Army was involved in supporting the CCC on some level, especially in the beginning. The Army's Quartermaster Department managed the funds and managed the contracts to construct the work camps and supply the enrollees with food, equipment, and other necessities. The Finance Corps managed the funds and paid the enrollees as well as the Reservists called up to support the effort. The Adjutant General's Corps

performed the personnel management aspects of the operation. The Medical Corps performed the initial physical exams and supervised the health maintenance of the enrollees. The Veterinary Corps inspected the subsistence and commissary supplies and provided medical care for the horses and mules purchased to support the work effort. Army chaplains attended to the spiritual needs of the enrollees. Leaders and support personnel for the CCC's organizational infrastructure—the district and sub-district headquarters and 1,600 CCC companies—were drawn from the Army at large.

CCC Enrollees

Enrollment of the 250,000 men authorized for the program during 1933 began on 6 April, only one week after the ECWA was created. Enrollment increased each year until 1935 when it peaked at 500,000 men, then averaged about 245,000 per year thereafter until 1939 when it began a further decline due to an increasingly better economy and expansion of the armed services for World War II.

Initially, the CCC was limited to men aged 18 to 25, who were unmarried, unemployed, and whose families were on relief (Congress expanded the age limits from 17 to 28 years old and dropped the unemployment requirements in 1937). The enrollees signed up for a six month "enlistment," with an option to stay in the program for up to two years. In return, the participants received \$30 per month, \$25 of which was sent to their families.

Despite the racial norms of the time, the CCC was not limited to Caucasians. It was open to blacks and Indians, and even a few women were enrolled. Each of these groups was organized into segregated CCC companies (although blacks were initially integrated with whites in the early years). Additionally, veterans were organized into separate companies as well.

From 1933 to 1942, about 250,000 African-American enrollees served in the CCC. Initially, blacks served in racially integrated companies and received equal pay and housing. In 1935 however, Robert Fechner, the CCC Director, ordered blacks to be placed in segregated units due to pressures from southern political leaders and even the Army itself. At its peak, there were about 150 all-black CCC companies. In the early stages of the program, these companies were employed like any others. Soon, however, complaints from local leaders from communities near the black camps forced the Army to move the African-American companies to other areas. In southern states, there were no other options other than, perhaps, moving the companies to locations in northern or western states. The Army largely solved the problem by housing the companies on military installations and using them to perform projects on the posts or at nearby federal and state parks and other properties. By 1937, seventy-seven of the companies were housed and primarily employed on military installations.

Enrollment of Native-Americans was not initially authorized as part of the CCC. However, soon after the program started authority was granted to enroll 14,000 Indians between the ages of 18 and 35 years, who, like many people, were in dire economic straits. This program was for members of federally recognized Indian tribes only, and was designated as the Indian Emergency Conservation Work or "CCC-Indian Division." The CCC-ID was the only source of employment for some reservations. The program focused on projects such as construction of roads, bridges, schools, and other public works on, or near, the reservations. CCC-ID differed from other CCC activities in that it explicitly trained men to be carpenters, truck drivers, radio operators, mechanics, surveyors, and technicians. A total of 85,000 Indians enrolled in the CCC-ID and 24,000 of them later served in the armed forces in World War II.

Like Native-Americans, women were initially excluded from the CCC. Due to the insistence of Eleanor Roosevelt, however, the act was amended to allow enrollment of women. Before long, several companies were organized and sent to camps in the First and Second Corps Areas. By 1937, some 8,500 women had served in the CCC but the program was eliminated that year.

The enrollment of about 25,000 veterans per year was authorized under the original provisions of the ECWA. These men were to be Spanish-American War and World War I veterans. Unlike other categories of

enrollees, these men faced no age or marital restrictions. During the existence of the CCC program, about 250,000 veterans served in Roosevelt's "Tree Army."

CCC Camps

Once the enrollees were signed up for a six-month stint with the CCC they were sent to a conditioning camp at a military installation. There they were issued military clothing, organized into 200-man companies, and put through a regimen of exercise, instruction, and healthy meals. From there the companies were sent to a CCC district where they would be assigned to a work camp. Because the greatest concentration of camps was in the Ninth Corps Area, the Army organized the rail movement of tens of thousands of young men from the other eight corps areas to camps in the western United States. This effort was required not only for the movement out there, but also to return these men to their home communities.

The first of what would become thousands of CCC camps was established by the 12th Infantry on 18 April 1933 near Luray, Virginia, in the Shenandoah National Forest. The camp was named Camp Roosevelt in honor of the president. Initially, there were about 1,600 camps authorized by the program that were to be built across the lower 48 states, Alaska, Hawaii, and Puerto Rico. By 1935, the number of camps had expanded to 2,500 as the number of enrollees increased. That number would then continue to decrease as World War II approached and as projects were completed.

Most CCC camps were initially "tent cities." These usually consisted of the Army's pyramidal squad tents, headquarters, kitchen and maintenance tents. The camps, at least those associated with areas of the country that required manpower for long-term projects, soon evolved into what the Army termed "temporary facilities." These were not unlike the World War II-era wooden barracks, but were almost always built as smaller, one-story structures. Some of the camps were built of pre-fabricated structures that could be disassembled, moved, and rebuilt in another location. These buildings were often used in the mountainous areas of the west where frequent movement of companies was required for short-term projects. The design for these camps, not surprisingly, was based on a military layout that included barracks, a kitchen and mess hall, recreation hall, company offices for the company commander and staff, latrines, and supply, equipment, and storage facilities.

About 20 to 50 work camps were constructed in each CCC district. Sub-districts usually contained 10 to 20 camps each. The camps were normally built to hold one CCC company, but at a few larger work projects, some were built for two companies. At any given project, camps could, and occasionally were temporarily expanded to hold an additional company by the erection of tents.

CCC Projects and Work Environment

The companies were assigned work projects of varying types, the vast majority of which were performed in wilderness areas. Most were associated with the needs of the Department of the Interior (especially the US Forest Service) and the Department of Agriculture. Thus, the tasks usually involved forestry projects, state and national park improvements, and improvements to agricultural areas. Projects included planting and cutting trees, building roads and bridges, and constructing shelters, pavilions, firewatch towers, ranger headquarters, and other facilities, and constructing drainage and irrigation canals around crop lands. Other projects included clearing and maintenance of waterways and wildlife habitats. A sizable number of jobs, however, took place on military installations. These usually involved similar assignments to those described above, but could also include the construction of small structures such as guard posts and rifle ranges.

In addition to the projects described above, some of the lesser known CCC projects were related to natural disasters. CCC Companies were often employed in fighting forest fires and flood control and relief operations. Most notably, from February through May 1937 tens of thousands of CCC men were used to combat flooding and perform rescue and recovery operations in the many states along the Ohio and Mississippi Rivers.

Of course, life in the CCC was not easy. The work was hard and, at times, dangerous. More than a few enrollees lost life and limb. The year 1937 is a case in point. That year, 652 CCC men and boys lost their lives in various ways. Of these deaths, about half were from disease and illness. Another 243 deaths were from accidents, mostly at work sites. Seventeen enrollees were murdered either by other enrollees or by local thugs. Another twenty CCC members committed suicide and forty-one were drowned.

CCC Organization

The Army Chief of Staff, General Douglas MacArthur, placed the management of CCC personnel operations into the hands of the commanding generals of the nine corps areas and the Hawaiian Department, and the Commander, U.S. Troops in Puerto Rico. In the case of the corps areas, each created a number of subordinate organizations to assist in the implementation, management, and administration of the CCC. These included district and sub-district headquarters, supply depots, and the aforementioned conditioning camps.

Each corps area developed a unique method for dividing up its corps area into districts and sub-districts. None were exactly the same. Most underwent numerous, and at times confusing, revisions to their CCC organization between 1933 and 1941. Only in the First and Fourth Corps Areas did the CCC district organization remain relatively constant from beginning to end.

Each CCC district headquarters consisted of a district commander, an executive officer, two inspectors, adjutant, district surgeon, veterinarian, chaplain and quartermaster, all of whom were initially Regular Army officers. The districts also included a small enlisted staff. In a few instances a number of Reserve officers were ordered to active duty to fill out holes in the district staff. These reservists usually manned specialized skill positions such as the district surgeon, veterinarian, or chaplain. By the spring of 1934, reservists held most, if not all, of the district and sub-district positions that required specialized skills. Generally speaking, by 1936, all of the district positions, less those of district commander and executive officer, were filled by reservists and in some cases, by civilians as well. A small percentage of the medical positions were also filled by civilian contract surgeons.

The district boundaries were frequently based on state lines, but about as often were simply geographical areas within a state as well. Some districts were later expanded to consist of up to two entire states. This was least true in the Ninth Corps Area where large geographical areas and the number and location of the camps managed by the districts made state boundaries almost irrelevant. Most districts were reorganized, in terms of geographical boundaries, several times between 1933 and 1941, and many earlier districts were reorganized out of existence by consolidation with other districts over the years. District headquarters and support facilities were usually located on an Army post. The Ninth Corps Area was again the major exception to this rule, though it did apply even there in some districts. As World War II drew near and the Army grew in size, post commanders found that they required the office space, warehouses, barracks, and other facilities assigned to the district headquarters for CCC support. Between 1938 and 1941, many of the district headquarters and facilities were moved off Army posts and replaced by rented properties in nearby civilian communities.

The sub-district headquarters was a much less robust organization than that of the districts and usually consisted only of a commander and adjutant. Like most district positions, these jobs were rapidly taken over by reservists beginning the summer of 1933. Not all CCC districts used the sub-district organization. The First and Second Corps Areas appear to have used few if any. Geographically, sub-districts were defined by the counties that were assigned to its area. Few, sub-district boundaries crossed state lines, but there were some instances where this occurred.

The company was the primary CCC organization. Each CCC company had at least one captain or first lieutenant as the company commander, who was assisted by one first or second lieutenant who managed a small number of enlisted men (two or three) who performed personnel and logistics functions. The company commanders were originally Regular Army officers, but were gradually replaced through the fall of 1933

and spring of 1934 by Reserve Officers. Beginning in May 1935, President Roosevelt authorized the use of marine and navy reserve officers to fill some of the company positions as well.

Generally speaking, the CCC company officers had authority over the enrollees from 5 p.m. until 8 a.m. In other words, the military was responsible for taking care of the enrollees when they were in camp. This included their feeding, billeting, general health care, spiritual care, and administration. The Army issued clothing and personal items such as soap and tooth brushes, and cleaning supplies to maintain a healthy environment in the camps. The camps were run in a loose military fashion in terms of accountability formations, sanitation, meal times, and lights out (i.e., sleep times), but included no military training or drills.

During work hours, which were typically 8 a.m. to 5 p.m., the responsible work agency had authority over CCC men. This meant that project managers from the Department of the Interior or the Department of Agriculture determined when, where, and on what projects the CCC companies would work. Of course, for those companies residing on military installations, the projects were determined by the post commander.

The Army's Personnel Contributions to the CCC

Initially, just over 3,800 of the Regular Army's 13,000 officers and 4,600 of its 120,000 enlisted personnel were mobilized to support the C.C.C. program in the spring of 1933. The Regulars were pulled from just about every source possible. These men were usually drawn from the Army's combat regiments and battalions, and Army instructors from ROTC, Organized Reserve, and National Guard organizations. In at least one case each, district personnel were drawn from an engineer regiment and an air corps group. In July, however, only three months after the beginning of the program, the War Department sent orders out to corps area commanders to begin relieving from CCC duty Regular Army officers assigned as instructors with R.O.T.C. detachments and Organized Reserve units and return them to their places of duty. By June 1934, just over 400 RA officers remained on CCC duty and this number continued to dwindle. Effective 1 January 1938, the War Department limited the number of Regular Army officers assigned to CCC duty to just 117 for the nine corps areas. The intent was to stabilize the turnover of Regular Army officers assigned to CCC duty. In addition, given the relatively few regiments and battalions in the diminutive interwar Army, this directive made assignment to command of a CCC district equivalent to command duty with troops. Regular Army officers remained in charge of all districts until after the beginning of World War II.

When the Army was directed to mobilize the CCC in April 1933, only 575 Reserve officers were initially ordered to active duty. In August, however, the War Department ordered corps area commanders to begin replacing the Regulars with Reserve officers who wished to volunteer for a tour of duty with the CCC. By the end of September, the number of Regular Army officers on CCC duty had dropped to about 2,000 and the number of Reservists had increased to 2,200. By October, Reserve officers had assumed command of almost all CCC companies and sub-districts.

As the number of Regulars decreased, of course there was a corresponding increase of Reservists. By 1937, the composition of officers assigned to CCC duty consisted of the following:

Regular Army	120
Organized Reserve	3,341 (not including the next four categories below)
Reserve Medical Officers	702
Reserve Dental Officers	146
Reserve Veterinarians	93
Reserve Chaplains	165
Marine Corps Reserve	25

Navy Reserve	111
Navy Medical Reserve	2
Navy Chaplains	2

These 5,500 or so officers were also supplemented by about 4,800 enlisted personnel, most of whom were Regular Army NCOs.

The tour of duty for Reserve officers assigned was initially six months in length, but was later lengthened to one year. Given the opportunity to actually lead men, and for some the dire economic conditions, many reservists voluntarily extended for additional tours. Due to a ruling by the courts that reserve officers on CCC duty must be provided the same housing and subsistence benefits as Regular Army officers, President Roosevelt directed that all reservists be relieved from CCC duty effective 1 July 1939. The changeover was complete by September 1939, but it was a change largely in name only because many of the Reservists merely took off their uniform and continued their jobs with the CCC as civilians, albeit with lower pay.

Legacy of the CCC in America

The CCC program enjoyed great public support in its time. When the first camps were established in the spring of 1933, however, many communities were resistant to having these large groups of formerly unemployed men in their area. Once the CCC's mission became better known, and the enrollees began to make noticeably positive improvements to the local parks and wildlife areas, the camps became accepted and even sought after by many communities. The CCC camps also stimulated regional economies and provided communities with improvements in forest activity, flood control, fire protection, and overall community safety.

The record of the program is impressive. During its lifespan, CCC enrollees completed the following projects:

- erected 3,470 fire towers
- built 97,000 miles of fire roads
- 4,235,000 man-days devoted to fighting fires
- planted more than 3 billion trees
- 7,153,000 man days expended on protecting the natural habitats of wildlife
- 46 camps were assigned to work under the direction of the U.S. Bureau of Agriculture Engineering; more than 84,400,000 acres of agricultural land were improved by manmade drainage systems
- 1,240,000 man-days of emergency work were completed during floods of the Ohio and Mississippi valleys

In addition, CCC enrollees made incalculable improvements to: local disease and insect control; forestry management (inventories of timber stands, surveying, and reforestation); forest recreation development (construction of campgrounds, picnic shelters, swimming pools, fireplaces, and restrooms). As a result of their work, today the CCC is considered the most successful of the many "alphabet" programs instituted by the Roosevelt administration.

Impact of the CCC on the US Army

The CCC program also had significant effects on the US Army. Initially, many, if not most, of the leaders in the US Army were opposed to the CCC mission. Their opposition was mostly over a concern about the impact of the mission on the Army's readiness. Many of the Army's leaders later revised their opinions on the experience, most notably future General of the Army George C. Marshall. Marshall actually enjoyed his time with the CCC and saw it as a very positive experience personally, for the Army, and for the

many young Americans who participated. Between 1933 and 1942, over 3 million men enrolled in the CCC. It is estimated that about seventy-five percent of them later served in the US armed forces during World War II. Many of former enrollees later stated that their CCC experience made the transition to soldiering a much easier process. Even though there was only a passing similarity to military structure and lifestyle in the CCC, it was enough to make their integration into the real military less drastic than for other civilians-turned-soldier.

Another positive effect of the CCC on the Army was the opportunity to mobilize hundreds of thousands of men per year, move them to conditioning camps, clothe, feed, and train them, and then move them, sometimes thousands of miles to their assigned camps. Though the experience was not exactly like mobilizing for war, it was close enough that it revealed weaknesses in the Army's existing mobilization plans. It gave Army planners a chance to correct some of the problems and gain real experience in the process prior to having to do it for real beginning in 1940.

Perhaps the CCC's greatest contribution to the Army was the opportunity for tens of thousands of Reserve officers to practice their leadership skills. As members of military organizations that were almost entirely composed of officers, the chance for many of these leaders to actually lead men in any capacity was very limited. Though many occasionally worked with CMTC candidates for two weeks at summer training camps, they were lucky if they served at a CMTC camp more than once every three or four years. There is, of course, no way to measure the effect of the CCC on these leaders, but one must believe that the experience gained by these officers was crucial in developing their abilities to efficiently perform their duties when they were called to the colors in World War II. It was the officers of the Organized Reserve that provided the bulk of the leadership for the huge wartime army. Without the leadership experience provided to them by the CCC, it is arguable whether the Reservists could have helped build the US Army so rapidly and efficiently during that conflict.

First Corps Area

In April 1933, the First Corps Area was allotted 18,000 enrollees and 90 camps. The initial organization of the CCC in the First Corps Area consisted of six districts. Each district consisted of a state geographical area which made it a very tidy system compared to some corps areas. Two of the districts were discontinued in 1937 when they were consolidated with the 3rd CCC District of Massachusetts but otherwise, the CCC district system in the First Corps Area remained relatively stable.

1st CCC District (Maine)

HQ-Fort Williams, ME 1933-41

Established in June 1933 with headquarters at Fort Williams, ME. The support unit for this district was the 5th Infantry Regiment. The district consisted of the state of Maine and was originally allotted 15 camps. Location 7 December 1941—Fort Williams, ME.

Commanders, 1st CCC District

Col. Joseph W. Beacham, Jr.*	1 Jun 33-1 Aug 34	Lt. Col. Robert J. Halpin*	19 Jan 38-17 May 38
Col. Frederick F. Black*	8 Sep 34-4 Jul 36	Col. Charles A. Hunt*	17 May 38-6 Dec 39
Col. Wilson B. Burt*	4 Jul 36-19 Jan 38	Col. Louis P. Ford*	7 Dec 39-28 May 41
	Col. Benjamin F. Delamater, Jr.*	29 May 41-20 Jan 42	

*Commanders, 5th Infantry Regiment.

2nd CCC District (New Hampshire)

HQ-Fort Ethan Allen, VT 1933-41

Established in June 1933 with headquarters at Fort Ethan Allen, VT. The support unit for this district was the 7th Field Artillery. The district consisted of the state of Vermont and was originally allotted 13 camps. Location 7 December 1941—Fort Ethan Allen, VT.

Commanders, 2nd CCC District

Col. Joseph F. Barnes*	1 Jun 33-1 Jul 35	Col. Benjamin F. Miller*	9 Sep 36-13 Oct 38
Col. Ned B. Rehkopf*	2 Jul 35-31 Mar 36	Lt. Col. Raymond W. Barker*	13 Oct 38-5 Sep 39
Lt. Col. Cortlandt Parker*	31 May 36-8 Sep 36	Col. Edmund L. Gruber*	5 Sep 39-20 Oct 39
	Unknown	20 Oct 39-7 Dec 41	

*Commanders, 7th Field Artillery Regiment.

3rd CCC District (Massachusetts)

HQ-Fort Devens, MA 1933-41

Established in June 1933 with headquarters at Fort Devens, MA. The support unit for this district was the 13th Infantry. The district consisted of the state of Massachusetts and was originally allotted 32 camps. Location 7 December 1941—Fort Devens, MA.

Commanders, 3rd CCC District

Col. Albert W. Foreman*	1 Jun 33-1 Nov 34	Lt. Col. George L. Smith*	15 Apr 39-30 Jun 39
Col. Converse R. Lewis*	1 Nov 34-15 Jun 36	Col. John H. Stutesman*	30 Jun 39-8 Jul 40
Col. Eugene Santschi*	16 Jun 36-6 Oct 36	Lt. Col. Eustis L. Poland*	18 Jul 40-12 Sep 40
Col. Matthew J. Thomlinson*	7 Oct 36-14 Apr 39	Col. Sumner Waite*	12 Sep 40-ao Dec 41

*Commanders, 13th Infantry Regiment.

4th CCC District (Rhode Island)

HQ-Fort Adams, RI 1933-37

Established in May 1933 with headquarters at Fort Adams, RI. The support unit for this district was the 13th Infantry. The district consisted of the state of Rhode Island and was originally allotted 3 camps. Discontinued 15 May 37.

Commanders, 4th CCC District

Lt. Col. Edward E. McCammon, 13th Inf.	May 33-1 Jul 34	Col. Eugene Santschi, Jr., 13th Inf.	9 Mar 36-23 Oct 36
Lt. Col. Frederick C. Test, 13th Inf.	1 Jul 34-9 Mar 36	Lt. Col. Paul H. Herman, 10th C.A.	23 Oct 36-15 May 37

5th CCC District (Connecticut)

HQ-Fort H. G. Wright, NY 1933-37

Established in June 1933 with headquarters at Fort H. G. Wright, NY. The support unit for this district was the 11th Coast Artillery. The district consisted of the state of Connecticut and was originally allotted 14 camps. Consolidated with the 3rd CCC District and discontinued 30 June 1937.

Commanders, 5th CCC District

Col. George A. Nugent*	May 33-20 May 33	Lt. Col. Monte J. Hickok*	10 Jun 35-1 Aug 35
Maj. Hollis LeR. Muller*	20 May 33-10 Jun 33	Col. Edward J. Cullen*	1 Aug 35-5 May 36
Col. William H. Wilson*	10 Jun 33-10 Jun 35	Lt. Col. Monte J. Hickok*	5 May 36-12 Jun 36
	Col. Robert W. Collins*	12 Jun 36-30 Jun 37	

Commanders, 11th Coast Artillery Regiment.

6th CCC District (Vermont)

HQ-Montpelier, VT 1933-35; Army Base Boston, MA 1935-37; Waterbury, VT 1937; Army Base Boston, MA 1937-41

Established in May 1933 with headquarters at 103rd State Street, Montpelier, VT. The support unit for this district was the 7th Field Artillery. The district consisted of the state of Vermont and was originally allotted 13 camps. Organized into three sub-districts: Waterbury, Barry, and Montpelier. Relocated 31 October 1935 to the Army Base, Boston, MA.

Relocated by August 1937 at Camp Charles M. Smith, Waterbury, VT. Relocated 25 October 1937 to the Army Base, Boston, MA. Location 7 Dec 41—Army Base Boston, MA.

Commanders, 6th CCC District

Col. Clement A. Trott , Inf., D.O.L.	May 33-10 Aug 34	Maj. Edwin H. Johnson, 13th Inf.	30 Jan 37-5 Feb 37
Lt. Col. Raymond E. Lee, F.A., D.O.L.	10 Aug 34-6 Mar 35	Lt. Col. Charles A. French, C.A., D.O.L.	5 Feb 37-Apr 39
Lt. Col. Henry C. McLean, 18th Inf. Brig.	6 Mar 35-30 Jan 37	Unknown	Apr 39-7 Dec 41

Second Corps Area

In April 1933, the Second Corps Area was allotted 8,000 enrollees and 42 camps. The organization of the CCC in the Second Corps Area went through numerous organizational changes in the first two years of the program. As originally organized the corps areas consisted of two zones—the Northern Zone and the Southern Zone—and one separate district. The Northern Zone consisted of the state of New York, less New York City, Long Island, and New York CCC District No. 3. The Southern Zone consisted of those portions of the state of New York not allotted to the Northern Zone, and the states of New Jersey and Delaware. In October 1933 the zones underwent a reorganization that moved responsibility for District No. 3 to the Northern Zone and created two new districts (Nos. 5 and 6) in New York that covered Long Island and Manhattan Island respectively, in the Southern Zone. These two new districts were consolidated into one in March 1934. The next major reorganization of the corps area CCC came in June 1935 when the Zone system was abandoned and the numbered districts in New York were consolidated and reorganized into two named districts (Binghamton and Schenectady). The numbered districts in New Jersey and Delaware followed suit the next year when the Trenton CCC District was created to absorb the camps in those two states and the New York City area. The one separate district in the corps area consisted of the island of Puerto Rico. One additional organization related to the CCC in this corps area was the creation on 26 December 1933 of the Second Corps Area CCC Service Company at Fort Jay, NY, with personnel and assets of the 1st Motor Transport Company. Other elements of the company were established at Fort Wadsworth and Fort Ontario. The company was created to provide transportation, administration, and limited supply support to CCC organizations in the corps area.

Northern CCC Zone

HQ-Fort Ontario, NY, 1933-35

Established 30 May 1933 with headquarters at Fort Ontario, NY. The supporting headquarters for this zone was the 2nd Infantry Brigade. After October 1933, the zone consisted of New York CCC Districts 1-4. This zone included all of New York state except several southeastern counties, Manhattan, Staten Island, and Long Island. The zone was discontinued 30 June 1935 and its duties and responsibilities were absorbed by the new Schenectady and Binghamton CCC Districts.

Commanders, Northern CCC Zone

Brig. Gen. Charles D. Roberts* 30 May 33-30 Jun 35

*Commanders, 2nd Infantry Brigade.

CCC District No. 1 (Northern New York)

HQ-Tupper Lake Junction, NY, 1933; Plattsburgh Barracks, NY, 1933-35

Established 30 May 1933 with headquarters Tupper Lake Junction, NY, and assigned to the Northern CCC Zone. Headquarters transferred 6 October 1933 to Plattsburgh Barracks, NY. The support unit for this district was the 26th Infantry. The district consisted of the northeastern areas of the state of New York. Discontinued on 1 June 1935 and the area of responsibility transferred to the Schenectady CCC District.

Commanders, CCC District No. 1

Col. Harry E. Knight*	May 33-17 Apr 34	Lt. Col. Harry H. Pritchett*	17 Apr 34-20 May 34
	Col. William B. Wallace*	20 May 34-1 Jun 35	

*Commanders, 26th Infantry Regiment.

CCC District No. 2 (Central New York)

HQ-Gloversville, NY, 1933; Albany, NY, 1933-34; Madison Barracks, NY, 1934-36

Established 30 May 1933 with headquarters at Gloversville, NY, and assigned to the Northern CCC Zone. Headquarters transferred 6 October 1933 to 100 State Street, Albany, NY. The support unit for this district was the 5th Field Artillery. The district consisted of the east-central areas of the state of New York. Headquarters transferred 1 June 1934 to Madison Barracks, NY. Discontinued 30 June 1936 and the area of responsibility transferred to the Schenectady CCC District.

Commanders, CCC District No. 2

Col. Alexander J. MacNab, Jr., Inf., D.O.L.	30 May 33-23 Oct 33	Col. Raymond W. Briggs, 5th F.A.	1 Jun 34-30 Apr 36
Maj. Frederick W. Whitney, Cav. D.O.L.	23 Oct 33-31 May 34	Col. Harold W. Huntley, 5th F. A.	1 May 36-30 Jun 36

CCC District No. 3 (Northern New York)

HQ- New York City, NY, 1933; Syracuse, NY, 1933-34; Fort Ontario, NY, 1934-35

Established 30 May 1933 with headquarters at the Army Building, New York City, NY, and assigned to the Southern CCC Zone. Headquarters transferred 6 October 1933 to the Northern CCC Zone. Headquarters transferred 23 October 1933 to the Federal Building, Syracuse, NY. The support unit for this district was the 28th Infantry. The district consisted of the central and north-central areas of the state of New York. Headquarters transferred 1 June 1934 to Fort Ontario, NY. Discontinued on 1 June 1935 and the area of responsibility transferred to the Schenectady CCC District.

Commanders, CCC District No. 3

Col. Walter D. McCaskey, Inf., D.O.L.	30 May 33-23 Oct 33	Col. Conrad H. Lanza, F.A. D.O.L.	23 Oct 33-31 May 34
	Col. Charles H. Morrow*	1 Jun 34-1 Jun 35	

*Commanders, 28th Infantry Regiment.

CCC District No. 4 (Western New York)

HQ-Ithaca, NY, 1933; Buffalo, NY, 1933-34; Fort Niagara, NY, 1934-41

Established 30 May 1933 with headquarters at Ithaca, NY, and assigned to the Northern CCC Zone. Headquarters transferred 6 October 1933 to Room 417, Old Customs House, Buffalo, NY. The support unit for this district was the 28th Infantry. The district consisted of the western areas of the state of New York. Headquarters transferred 1 June 1934 to Fort Niagara, NY. Discontinued on 1 June 1935 and the area of responsibility transferred to the Binghamton CCC District.

Commanders, CCC District No. 4

Col. Allen J. Greer, F.A. D.O.L.	1 Jun 33-31 May 34	Col. Charles H. Morrow*	1 Jun 34-21 Dec 35
----------------------------------	--------------------	-------------------------	--------------------

*Commanders, 28th Infantry Regiment.

Southern CCC Zone

HQ-New York City, NY, 1933-41

Established 30 May 1933 with headquarters at 641 Washington Street, New York City, NY. The supporting headquarters for this zone was the Second Coast Artillery District. This zone consisted of New York CCC Districts No. 5 and 6, New Jersey CCC Districts No. 1 and 2, and Delaware CCC District No. 1. The zone was discontinued 30 June 1935.

Commanders, Southern CCC Zone

Brig. Gen. William E. Cole*	1 Jun 33-30 Jun 35
-----------------------------	--------------------

*Commanders, Second Coast Artillery District.

CCC District No. 5 (Southern New York)

HQ-New York City, NY, 1933-34; Fort Totten, NY, 1934-35

Established 6 October 1933 with headquarters at 641 Washington Street in New York City, and assigned to the Southern CCC Zone. The support unit for this district was the 62nd Coast Artillery. Headquarters transferred 1 March 1934 to Fort Totten, NY. Discontinued 30 June 1935 and the area of responsibility transferred to the Binghamton CCC District.

Commanders, CCC District No. 5

Col. Conrad S. Babcock*	Jun 33-28 Feb 34	Lt. Col. Clair W. Baird*	22 Aug 34-1 Sep 34
Col. Arthur S. Conklin*	1 Mar 34-22 Aug 34	Col. Frank K. Fergusson*	1 Sep 34-30 Jun 35

*Commanders, 62nd Coast Artillery Regiment.

CCC District No. 6 (Southern New York)

HQ-New York City, NY, 1933-34

Established 6 October 1933 with headquarters at 641 Washington Street, New York City, NY, and assigned to the Southern CCC Zone. The district consisted of Manhattan and Staten Islands, New York. The district was consolidated 3 March 1934 with District No. 5.

Commanders, CCC District No. 6

Unknown 6 Oct 33-3 Mar 34

CCC District No. 7 (Southern New York)

HQ-Wawayanda, NY, 1933-36

Established 30 June 1935 with headquarters at Wawayanda, NY. This temporary district consisted of several counties in southeastern New York state. Discontinued in 1936 and consolidated with the Schenectady CCC District.

Commanders, CCC District No. 7

Lt. Col. Griffin S. Stewart, 62nd C.A. ao Dec 35-ao Jun 36

CCC District No. 8 (Southern New York)

HQ-Fort Totten, NY, 1935-36

Established 30 June 1935 with headquarters at Fort Totten, NY. Personnel were transferred from CCC District No. 5. This temporary district consisted of the geographical area of Long Island, New York. Discontinued 30 June 1936 and consolidated with the Schenectady CCC District.

Commanders, CCC District No. 8

Col. Frank K. Fergusson, 62nd C.A. 30 Jun 35-30 Jun 36

CCC District No. 1 (North New Jersey)

HQ-Newark, NJ, 1933; Fort Jay, NY, 1933-35

Established 1 May 1933 with headquarters at Newark, NJ. Assigned 30 May 1933 to the Southern CCC Zone. Headquarters transferred 6 October 1933 to Fort Jay, NY. The support unit for this district was the 16th Infantry. The district consisted of the geographical area of northeastern New Jersey. Discontinued 30 June 1935 and consolidated with New Jersey District No. 2.

Commanders, CCC District No. 1

Col. Oliver J. Dockery, Inf., D.O.L.	30 May 33-6 Oct 33	Maj. Joseph J. O' Hare*	26 Jul 34-31 Aug 34
Col. Joseph A. Marmon*	6 Oct 33-26 Jul 34	Col. Albert S. Williams*	31 Aug 34-30 Jun 35

*Commanders, 16th Infantry Regiment.

CCC District No. 2 (South New Jersey)

HQ-Atlantic City, NJ, 1933; Camp Dix, NJ, 1933-36

Established 8 April 1933 with headquarters at Atlantic City, NJ. Assigned 30 May 1933 to the Southern CCC Zone. Headquarters transferred 6 October 1933 to Camp Dix, NJ. The support unit for this district was HQ, 1st Infantry Brigade. The district consisted of the geographical area of southwestern New Jersey. Consolidated 30 June 1935 with New Jersey District No. 1 and retained designation as CCC District No. 2. Discontinued 30 June 1936 and consolidated with the Trenton CCC District.

Commanders, CCC District No. 2

Col. Frederick W. Stopford	8 Apr 33-23 Oct 33	Maj. Donald C. Hawley, Cav.	15 May 34-25 Oct 34
Lt. Col. Torrey Maghee, Inf.	23 Oct 33-15 May 34	Lt. Col. Ford Richardson, 18th Inf.	25 Oct 34-30 Jun 36

CCC District No. 1 (Delaware)

HQ-Fort DuPont, DE, 1933-36

Established 30 May 1933 with headquarters at Fort DuPont, DE. The support unit for this district was the 1st Engineer Regiment. The district consisted of the geographical area of the state of Delaware. Discontinued 30 June 1936 and consolidated with the Trenton CCC District.

Commanders, CCC District No. 1

Lt. Col. Lewis H. Watkins*	Jun 33-14 May 34	Col. Ulysses S. Grant, III*	28 Jun 34-26 Aug 36
Maj. Tatnall D. Simkins*	14 May 34-28 Jun 34	Maj. Clinton W. Ball*	26 Aug 36-30 Jun 36

*Commanders, 1st Engineer Regiment.

Binghamton CCC District

HQ-Binghamton, NY, 1935-37

Established 30 June 1935 with headquarters at Binghamton, NY. The district consisted of the geographical area of the western half of New York state west of a north-south line through the cities of Canton—Oneonta, NY. The district consisted of 49 camps and was organized into three sub-districts as follows:

Sub-district #1	Whitney Point, NY
Sub-district #2	Fayetteville, NY
Sub-district #3	Castille, NY

Discontinued 1 December 1937 and area of responsibility transferred to the Schenectady CCC District.

Commanders, CCC District No. 5/Binghamton CCC District

Lt. Col. Emer Yeager, F. A.	30 Jun 35-16 May 37	Maj. Elbert A. Nostrand, Inf.	16 May 37-30 Nov 37
-----------------------------	---------------------	-------------------------------	---------------------

Schenectady CCC District

HQ-Schenectady, NY, 1935-41

Established 1 June 1935 with headquarters at Schenectady, NY. The district consisted of the geographical area of the eastern half of New York state, less New York City and Long Island, east of a north-south line through the cities of Canton—Oneonta, NY. The district consisted of about 40 camps and was organized into five sub-districts. Absorbed the Binghamton CCC District 1 December 1937 and assumed responsibility of the entire state of New York except New York City and Long Island. Location 7 December 1941—Schenectady, NY.

Commanders, Schenectady CCC District

Maj. Harry R. Simmons, 26th Inf.	1 Jun 35-30 Jun 36	Maj. John A. Steere, 25th F. A.	1 Jan 38-Apr 39
Maj. Samuel L. Dunlap, 26th Inf.	30 Jun 36-16 Jul 37	Lt. Col. Edward B. Dennis, 7th C.A.	Apr 39-1 Jul 39
Maj. John A. Steere, 25th F. A.	16 Jul 37-14 Aug 37	Maj. Elbert A. Nostrand, Inf.	1 Jul 39-ao Apr 40
Lt. Col. Edward B. Dennis, 7th C.A.	14 Aug 37-1 Jan 38	Maj. Jerome D. Cambre, Inf.	ao Aug 40-11 Sep 40
	Unknown	11 Sep 40-7 Dec 41	

Trenton CCC District

HQ-Trenton, NJ, 1936-41

Established 1 July 1936 with headquarters at the Ajax Rubber Company at North Olden and Bruenig Avenues, Trenton, NJ. The district consisted of the geographical area of the states of New Jersey and Delaware. Location 7 December 1941—Trenton, NJ.

Commanders, Trenton CCC District

Maj. Donald C. Hawley, Cav.	1 Jul 36-1 Jan 38	Lt. Col. Claude E. Stadtman, Inf.	1 Jul 39-31 Dec 39
Maj. Elbert A. Nostrand, Inf.	1 Jan 38-1 Jul 39	Unknown	31 Dec 39-7 Dec 41

Puerto Rico CCC District

HQ-San Juan, PR, 1933-41

Established in June 1933 with headquarters at San Juan, PR. The district consisted of the geographical area of the island of Puerto Rico. Location 7 December 1941—San Juan, PR.

Commanders, Puerto Rico CCC District

Col. George L. Byroade*	Jun 33-6 Jul 34	Col. John W. Wright*	18 May 36-17 Aug 39
Col. Otis R. Cole*	6 Jul 34-18 May 36	Col. Russel P. Hartle*	17 Aug 39-31 Dec 39

*Commanders, 65th Infantry Regiment.

Third Corps Area

In April 1933, the Second Corps Area was allotted 31,000 enrollees and 156 camps. The organization of the CCC in the Third Corps Area initially consisted of four CCC Districts and apparently one special military district. There were two districts in Pennsylvania consisting of one in the eastern half and one in the western half with the border being the Susquehanna River. There was also one district each comprising the geographical areas of the states of Maryland and Virginia. Originally the districts were divided into 14 sub-districts. The Third Corps Area was later further subdivided into 25 sub-districts in 1935. In November 1937, the state of Pennsylvania was combined into one district and redesignated as the Northern CCC District. Maryland, formerly CCC District #3, became the Central CCC District, and Virginia, formerly CCC District #4, became the Southern CCC District. About April 1938, the Northern and Central Districts were combined to make one Northern District now consisting of the states of Pennsylvania and Maryland. The geographical area of the Southern District remained unchanged. The Northern CCC District was reestablished in Pennsylvania in 1940 and the corps area organization remained constant from that point until the end of the CCC. The special military district was that of the Aberdeen Proving Grounds.

The Third Corps Area, affording work for 31,000 men, will have 156 camps--eleven in Maryland, ninety-seven in Pennsylvania, and forty-eight in Virginia.

CCC District #1

HQ-New Cumberland, PA 1933-37

Established in May 1933 with headquarters at New Cumberland Army Depot, PA. The district consisted of the eastern half of the state of Pennsylvania and was originally allotted 34 camps. Originally organized into two sub-districts as follows:

- Sub-district #1 Canadensis, PA
- Sub-district #2 Waterville, PA

The district was reorganized 1 May 37 into five sub-districts as follows:

- Sub-district #1 Reading, PA
- Sub-district #2 Williamsport, PA
- Sub-district #3 Lock Haven, PA
- Sub-district #4 Mifflin, PA
- Sub-district #5 Gettysburg, PA.

The district was discontinued 1 November 1937 and integrated into the new Northern CCC District.

Commanders, CCC District No. 1

Col. Clarence R. Day, Inf, D.O.L.	May 33-16 Jan 36	Lt. Col. Newton N. Polk, 6th F.A.	9 Mar 36-17 Nov 36
Maj. Leslie W. Brown , 12th Inf.	16 Jan 36-9 Mar 36	Lt. Col. Benjamin G. Ferris, 66th Inf.	17 Nov 36-31 Oct 37

CCC District #2 (1933-37)

Northern CCC District (1937-41)

HQ-Pittsburgh, PA 1933-37; Indiana, PA 1937-38; *Discontinued* 1938-40; Williamsport, PA 1940-41

Established in April 1933 with headquarters at Room, 310 Westinghouse Building, Pittsburgh, PA. The district consisted of the half of the state of Pennsylvania west of the Susquehanna River. The district was originally responsible for 63 Camps organized into seven sub-districts as follows:

- Sub-district #3 Sizerville, PA
- Sub-district #4 Tyler, PA
- Sub-district #5 Dunkle Corner, PA
- Sub-district #6 Greenwood Furnace, PA
- Sub-district #7 Loganton, PA
- Sub-district #8 Pine Grove Furnace, PA
- Sub-district #9 Old Forge, PA

The district grew to as many as 107 camps, but by May 1936 it was reduced to 55. The district headquarters was relocated in October 1936 to the Wabash Building in Pittsburgh and on 14 July 1937 to the Community Building at Indiana, PA. It was reorganized 1 November 1937 to consist of the entire state of Pennsylvania and concurrently redesignated as the Northern CCC District. The Northern CCC District was combined 31 January 1938 with the Central District and temporarily discontinued. Concurrently, the Central CCC District was redesignated as the new Northern CCC District. The original Northern CCC District headquarters was reestablished 31 May 1940 at Williamsport, PA, to once again consist of the state of Pennsylvania. Location 7 December 41—Williamsport, PA.

Commanders, CCC District No. 2/Northern CCC District

Col. Howard L. Landers,* F.A., D.O.L.	Apr 33-16 Dec 33	Lt. Col. Lawrence B. Weeks, 2nd C.A.	14 Jul 37-31 Jan 38
Lt. Col. Frederick A. Prince,* F.A., D.O.L.	16 Dec 33-6 Jul 36	Lt. Col. Clifford B. King, F.A.	Feb 38-May 39
Lt. Col. Frank E. Bonney,* Inf., D.O.L.	6 Jul 36-31 Aug 36	Unknown	May 39-31 May 40
Col. Ephraim G. Peyton,* Inf., D.O.L.	1 Sep 36-3 Nov 36	Lt. Col. David S. Rumbough, F.A.	31 May 40-7 Nov 40
Lt. Col. F. S. Clark, 2nd C.A.	4 Nov 36-4 Jul 37	Lt. Col. Thomas R. Gibson, Inf.	7 Nov 40-May 41
	Lt. Col. William R. Hazelrigg, Inf., D.O.L.	May 41-ao Dec 41	

* Chiefs of Staff, 99th Division

CCC District #3 (1933-37)

Central CCC District (1937-38)

Northern CCC District (1938-40)

Central CCC District (1940-41)

HQ-Towson, MD 1933-41

Established in May 1933 with headquarters at York Road and Baltimore Avenue in Towson, MD. The district consisted of the state of Maryland. The district was originally responsible for 11 camps and possessed only one sub-district (#10) at Hancock, MD. By 1935 it had grown to consist of 31 camps and was reorganized into three sub-districts as follows:

- Sub-district #14 Goldsboro, MD
- Sub-district #15 Beltsville, MD
- Sub-district #16 Grantsville, MD

It was consolidated 31 January 1938 with the Northern CCC District and concurrently redesignated as the new Northern CCC District to consist of the states of Maryland and Pennsylvania. It was once again redesignated 31 May 1940 as the Central CCC District, to consist of the state of Maryland. Concurrently, the state of Pennsylvania was reorganized into the Northern CCC District. Location 7 December 1941—Towson, MD.

Commanders, CCC District No. 3/Central CCC District

Col. George T. Bowman, Cav., D.O.L.*	May 33-30 Jun 33	Lt. Col. Thompson Lawrence, Inf.	10 Aug 37-30 Jun 39
Col. Charles R. Mayo, Cav., D.O.L.*	Jun 33-Jul 33	Lt. Col. Henry M. Pendleton, Cavv.	30 Jun 39-11 Apr 40
Col. John D. Long, Cav., D.O.L.*	1 Jul 33-17 May 37	Unknown	11 Apr 40-15 Jun 40
Col. Osmun Latrobe, Cav., D.O.L.*	17 May 37-10 Aug 37	Lt. Col. Lewis C. Davidson, Inf.	15 Jun 40-Jan 41
	Lt. Col. George R. Hedge, Inf.	Jan 41-Mar 41	

* Chiefs of Staff, 62nd Cavalry Division.

CCC District #4 (1933-37)

Southern CCC District (1937-41)

HQ-Richmond, VA 1933-41

Established in May 1933 with headquarters at 8th and Main streets in Richmond, VA. The support unit for this district was the 2nd Coast Artillery Regiment. The district consisted of the state of Virginia. The district was originally responsible for 48 camps organized into four sub-districts as follows:

- Sub-district #11 Big Meadow, VA
- Sub-district #12 Natural Bridge, VA
- Sub-district #13 Sugar Grove, VA
- Sub-district #14 Yorktown, VA

By 1935 it had grown to 93 camps and was reorganized into nine sub-districts as follows:

- Sub-district #17 Washington, DC
- Sub-district #18 Front Royal, VA
- Sub-district #19 Moorman's River, VA
- Sub-district #20 Richmond, VA
- Sub-district #21 Yorktown, VA
- Sub-district #22 Clifton Forge, VA
- Sub-district #23 Marion, VA
- Sub-district #24 Salem, VA
- Sub-district #25 Petersburg, VA

It was redesignated 1 November 1937 as the Southern CCC District. Location 7 Dec 41— Richmond, VA.

Commanders, CCC District No. 4/Southern CCC District

Col. Kerwin T. Smith, Inf., D.O.L.*	May 33-3 Feb 35	Col. Ellery Farmer, Inf., D.O.L.*	19 Jul 38-3 Apr 39
Col. William E. Persons, Inf. D.O.L.*	3 Feb 35-1 Jun 36	Lt. Col. Isaac Gill, Inf.	3 Apr 39-1 Jun 40
Col. Louis C. Brinton, Jr. C.A.C., D.O.L.*	1 Jun 36-19 Jul 38	Lt. Col. Harold P. Gibson, Inf.	1 Jun 40-ao Dec 41

* Chiefs of Staff, 80th Division.

Aberdeen Proving Ground CCC District

HQ-Aberdeen Proving Ground, MD 1935-38

Established 1 August 1935 with headquarters at Aberdeen Proving Ground, MD. This district apparently consisted only of Fort Hoyle and the Aberdeen Proving Grounds. It was discontinued 31 March 1938.

Commanders, Aberdeen Proving Ground CCC District

Col. Charles M. Wesson*	1 Aug 35-31 Mar 38
-------------------------	--------------------

*Commandant, Chemical Warfare School.

Fourth Corps Area

In April 1933, the Fourth Corps Area was allotted 40,000 enrollees and 198 camps. The organization of the CCC in the Fourth Corps Area consisted of nine lettered CCC Districts, each with an Army installation responsible for providing personnel and support to each district. Unlike most corps areas, the organization of the CCC in the Fourth Corps Area remained relatively constant at the district level from 1933 to 1941, though three of the districts were discontinued in 1937.

District A

HQ-Fort Bragg, NC 1933-41

Established 1 May 1933 with headquarters at Fort Bragg, NC. The support unit for this district was the 13th Field Artillery Brigade. The district consisted of the geographical area of the state of North Carolina and was originally allotted 30 camps. Location 7 December 1941—Fort Bragg, NC.

Commanders, District A

Brig. Gen. Manus McCloskey*	1 May 33-31 Dec 37	Col. John R. Starkey*	23 May 40-13 Sep 40
Col. Joseph A. Rogers*	1 Apr 38-11 May 38	Brig. Gen. Francis W. Honeycutt*	13 Sep 40-21 Sep 40
Brig. Gen. William Bryden*	11 May 38-23 May 40	Col. George R. Allin*	21 Sep 40-13 Nov 40
	Brig. Gen. John A. Crane*	13 Nov 40-Aug 41	

*Commanders, 13th Field Artillery Brigade.

District B

HQ-Fort McPherson, GA 1933-40; East Point, GA 1940-41

Established 1 May 1933 with headquarters at Fort Bragg, NC. The support unit for this district was the 8th Infantry Brigade. The district consisted of a geographical area that included western parts of the state of Georgia and eastern parts of the state of Alabama. It was originally was allotted about 17 camps. District headquarters was relocated in November 1940 to East Point, GA. Location 7 December 1941—East Point, GA.

Commanders, District B

Brig. Gen. George H. Estes*	1 May 33-25 Aug 33	Brig. Gen. Robert O. Van Horn*	12 Jan 34-1 Jul 40
Col. Thomas S. Moorman*	25 Aug 33-12 Jan 34	Unknown	1 Jul 40-7 Dec 41

*Commanders, 8th Infantry Brigade.

District C

HQ-Fort Oglethorpe, GA 1933-41

Established 1 May 1933 with headquarters at Fort Oglethorpe, GA. The support unit for this district was the 6th Cavalry Regiment. The district consisted of a geographical area that included northern parts of the state of Georgia, northern parts of the state of Alabama, and the state of Tennessee. It was originally was allotted about 40 camps. Location 7 December 1941—Fort Oglethorpe, GA.

Commanders, District C

Col. Gordon Johnston*	1 May 33-15 Nov 33	Col. Charles Burnett*	1 Dec 36-4 May 37
Lt. Col. Walton Goodwin, Jr.*	15 Nov 33-3 Jan 34	Col. George Dillman*	4 May 37-16 Aug 39
Col. Walter S. Grant*	3 Jan 34-27 Mar 35	Lt. Col. John A. Weeks*	16 Aug 39-16 Sep 39
Lt. Col. Kinzie B. Edmunds*	27 Mar 35-15 Jun 35	Col. John Millikin*	16 Sep 39-6 Oct 40
Col. Llewellyn B. Oliver*	16 Jun 35-1 Dec 36	Lt. Col. John A. Considine*	7 Oct 40-19 Jul 42

*Commanders, 6th Cavalry Regiment

District D

HQ-Fort McClellan, AL 1933-40; Anniston, AL 1940-41

Established 1 May 1933 with headquarters at Fort McClellan, AL. The support unit for this district was the 22nd Infantry Regiment. The district consisted of a geographical area that included central and southern parts of the state of Alabama. It was originally was allotted about 17 camps. The district was organized into sub-district as follows:

Sub-District #1	Fort McClellan, AL
Sub-District #2	Ashland, AL
Sub-District #3	York, AL
Sub-District #4	Oxford, MS
Sub-District #5	Holly Springs, MS
Sub-District #6	Sheffield, AL
Sub-District #7	Huntsville, AL

District headquarters was relocated in November 1940 to Anniston, AL. Location 7 December 1941—Anniston, AL.

Commanders, District D

Col. Thomas S. Moorman*	1 May 33-8 Aug 34	Col. John W. Lang*	3 May 37-1 Aug 38
Lt. Col. Cary I. Crockett*	8 Aug 34-6 May 35	Col. Simon B. Buckner*	1 Sep 38-16 Oct 39
Col. George F. Baltzell*	6 May 35-3 May 37	Col. Albert S. Peake*	16 Oct 39-11 Nov 41
	Col. George H. Weems*	12 Nov 41-17 Feb 42	

*Commanders, 22nd Infantry Regiment.

District E

HQ-Camp Beauregard, LA 1933-40; Alexandria, LA 1940-41

Established 19 May 1933 with headquarters at Camp Beauregard, LA. The district consisted of a geographical area that included the states of Louisiana and Mississippi. It was originally was allotted 39 camps. District headquarters was relocated in November 1940 to Alexandria, LA. Location 7 December 1941—Alexandria, LA.

Commanders, District E

Maj. Gooding Packard, C.A.C.	19 May 33-4 Sep 34	Col. Thomas D. Osborne, F.A.	6 Mar 35-14 May 36
Lt. Col. Leslie J. McNair, 83rd F.A.	4 Sep 34-6 Mar 35	Col. Harold E. Marr, F.A.	14 May 36-31 Jan 38
	Unknown	31 Jan 38-7 Dec 41	

District F

HQ-Fort Screven, GA 1933-37

Established 1 May 1933 with headquarters at Fort Screven, GA. The support unit for this district was the 8th Infantry Regiment. The district consisted of a geographical area that included eastern parts of the state of Georgia. It was originally was allotted about 15 camps. Discontinued 31 May 1937.

Commanders, District F

Lt. Col. Clyde R. Abraham, 8th Inf.	1 Jul 33-ao Apr 34	Lt. Col. Jesse C. Drain, 8th Inf.	ao Oct 34-27 Jun 36
Unknown	ao Apr 34-ao Oct 34	Maj. Elmer F. Wallender, Q.M.C.	27 Jun 36-19 Sep 36
	Col. William A. Ganoe, 8th Inf.	19 Sep 36-31 May 37	

District G

HQ-Fort Barrancas, FL 1933-37

Established 1 May 1933 with headquarters at Fort Barrancas, FL. The support unit for this district was the 13th Coast Artillery Regiment. The district consisted of a geographical area that consisted of the state of Florida and was originally allotted 22 camps. The district was divided into Eastern and Western Sub-Districts by March 1934. Discontinued 15 October 1937.

Commanders, District G

Col. Francis H. Lincoln*	1 May 33-24 Jun 33	Col. Arthur L. Fuller*	27 Dec 33-12 Oct 35
Lt. Col. Clifford R. Jones*	25 Jun 33-27 Dec 33	Col. Robert Arthur*	12 Oct 35-28 Feb 37
	Lt. Col. George F. Humbert*	1 Mar 37-15 Oct 37	

*Commanders, 13th Coast Artillery Regiment.

District H

HQ-Fort Benning, GA 1933-37

Established 1 May 1933 with headquarters at Fort Benning, GA. The support unit for this district was the 24th Infantry Regiment. The district consisted of a geographical area that included western and southern parts of the state of Georgia. It was originally was allotted about 10 camps. Discontinued 31 December 1937.

Commanders, District H

Brig. Gen. George H. Estes*	1 May 33-29 Apr 36	Col. Wiley J. Noble, D.O.L.	29 Apr 36-1 Oct 36
	Brig. Gen. Asa L. Singleton*	1 Oct 36-31 Dec 37	

*Commandant, Infantry School

District I

HQ-Fort Moultrie, SC 1933-40; Charleston, SC 1940-41

Established in May 1933 with headquarters at Fort Moultrie, SC. The support unit for this district was the 8th Infantry Regiment. The district consisted of a geographical area that consisted of the state of South Carolina and was originally allotted 18 camps. District headquarters relocated in November 1940 to Charleston, SC. Location 7 December 1941—Charleston, SC.

Commanders, District I

Col. George C. Marshall*	May 33-21 Oct 33	Lt. Col. Frederick C. Rogers, 8th Inf.	18 May 37-6 Jun 37
Lt Col. Clyde R. Abraham*	21 Oct 33-16 Nov 33	Col. Charles A. Dravo*	6 Jun 37-18 Sep 37
Col. Frank F. Jewett*	16 Nov 33-7 Aug 35	Col. William A. Ganoe*	18 Sep 37-3 Dec 37
Lt. Col. Jesse C. Drain*	7 Aug 35-5 Sep 35	Col. John J. Fulmer*	3 Dec 37-30 Aug 39
Col. Charles A. Dravo*	5 Sep 35-18 May 37	Col. Philip S. Gage, C.A.	11 Sep 39-26 Jun 40

*Commanders, 8th Infantry Regiment.

Fifth Corps Area

In April 1933, the Fifth Corps Area was allotted 15,000 enrollees and 74 camps. The organization of the CCC in the Fifth Corps Area initially consisted of four CCC districts which did not follow state lines. Each of the district headquarters was located on one of the four main Army posts in the corps area, and initially designated as "CCC Work Camps" rather than as districts. In 1935, the work camp titles were dropped in favor of the term "district" and the districts were named for the Army post on which the headquarters resided. The district titles were again redesignated on 9 December 1937 this time by state names. The district boundaries changed several times over the years as one district was eliminated and another created, then discontinued and consolidated several years later.

CCC Work Camps, State of Indiana (1933-35)

Fort Benjamin Harrison CCC District (1935-37)

Indiana CCC District (1937-40)

Indiana-Kentucky CCC District (1940-41)

HQ-Fort Benjamin Harrison, IN 1933-41

Established 31 May 1933 with headquarters at Fort Benjamin Harrison, IN. The support unit for this district was the 10th Infantry Brigade. The district consisted of the geographical area of the state of Indiana and was originally allotted 21 camps. Redesignated 1 April 1935 as the Fort Benjamin Harrison CCC District. Redesignated 10 December 1937 as the Indiana CCC District. Consolidated with the Kentucky CCC District 1 June 1940 and redesignated as the Indiana-Kentucky CCC District with headquarters at Fort Benjamin Harrison. Location 7 December 1941—Fort Benjamin Harrison, IN.

Commanders, Fort Benjamin Harrison/Indiana CCC District

Brig. Gen. George H. Jamerson*	31 May 33-25 Oct 33	Brig. Gen. Dana T. Merrill*	30 Nov 38-1 Jun 40
Col. Dana T. Merrill*	25 Oct 33-10 Dec 33	Lt. Col. Clarence C. Benson, Cav.	1 Jun 40-10 Aug 40
Brig. Gen. William K. Naylor*	10 Dec 33-30 Nov 38	Lt. Col. Frederick W. Huntington, Inf.	10 Aug 40-Apr 41
	Unknown	Apr 41-7 Dec 41	

*Commanders, 10th Infantry Brigade.

CCC Work Camps, Western Kentucky (1933-35)

Fort Knox CCC District (1935-37)

Kentucky CCC District (1937-40)

HQ-Fort Knox, KY 1933-40

Established 31 May 1933 with headquarters at Fort Knox, KY. The support unit for this district was the 7th Cavalry Brigade. The district originally consisted of the geographical area of the state of Kentucky west of a north-south line through the city of Frankfort, KY. It was originally allotted about 8 camps. Redesignated 1 April 1935 as the Fort Knox CCC District. Redesignated 10 December 1937 as the Kentucky CCC District. Concurrently, the Fort Thomas CCC District, less Butler and Brown counties in Ohio, consolidated with the Kentucky CCC District. Consolidated with the Indiana CCC District 1 June 1940 and redesignated as the Indiana-Kentucky CCC District with headquarters at Fort Benjamin Harrison. Concurrently, CCC headquarters at Fort Knox was discontinued. Commanders, Fort Knox/Kentucky CCC District

Commanders, Fort Knox CCC District

Brig. Gen. Julian R. Lindsey*	31 May 33-31 May 34	Col. Bruce Palmer*	10 Sep 35-27 Jun 36
Brig. Gen. Guy V. Henry*	31 May 34-24 Jul 35	Brig. Gen. Daniel Van Voorhis*	27 Jun 36-8 Oct 38
Col. James P. Barney*	24 Jul 35-10 Sep 35	Col. Charles L. Scott*	8 Oct 38-1 Nov 38
	Brig. Gen. Adna R. Chaffee*	1 Nov 38-15 Jun 40	

*Commanders, 7th Cavalry Brigade.

Ohio-West Virginia CCC District (1933-35)

Fort Hayes CCC District (1935-37)

Ohio CCC District (1937-40)

Ohio-West Virginia CCC District (1940-41)

HQ-Fort Hayes, OH 1933-41

Established 31 May 1933 with headquarters at Fort Hayes, OH. The support unit for this district was the 10th Infantry Regiment. The district originally consisted of the geographical area of the state of Ohio, less Butler and Brown counties, and the state of West Virginia. It was originally allotted 36 camps. The district was organized into sub-districts as follows:

Northern Sub-District (OH)	Coshcocton, OH
Southern Sub-District (OH)	Chillicothe, OH
Eastern Sub-District (WV)	Charleston, WV (redesignated Charleston District 1 Apr 35)

Redesignated as the Fort Hayes CCC District 1 April 1935 and reorganized into sub-districts as follows:

Chillicothe Sub-District	Chillicothe, OH
Cleveland Sub-District	Cleveland, OH
Findlay Sub-District	Findlay, OH
Jackson Sub-District	Jackson, OH
Newark Sub-District	Newark, OH
Portsmouth Sub-District	Portsmouth, OH
Wooster Sub-District	Wooster, OH
Zanesville Sub-District	Zanesville, OH

Sub-districts were discontinued 30 June 1936. Redesignated 10 December 1937 as the Ohio CCC District. Concurrently, assumed control of Butler and Brown counties and released the geographical area of West Virginia to the newly established West Virginia CCC District. Consolidated with the West Virginia CCC District 1 July 1940 and redesignated as the Ohio-West Virginia CCC District. Location 7 December 1941—Fort Hayes, OH.

Commanders, Fort Hayes/Ohio CCC District

Lt. Col. Clement H. Wright, 11th Inf.	1 Jul 33-1 Sep 34	Col. Benjamin E. Grey, Inf., D.O.L.	13 Jun 35-1 Nov 36
Maj. Robert H. Barrett, 10th Inf.	1 Sep 34-1 Oct 34	Maj. Elmer J. Armstrong, 10th Inf.	1 Nov 36-16 Jul 37
Lt. Col. James Blyth, 10th Inf.	1 Oct 34-11 Feb 35	Col. Thomas N. Gimperling, Inf., D.O.L.	16 Jul 37-15 Apr 39
Maj. Robert H. Barrett, 10th Inf.	11 Feb 35-14 Apr 35	Maj. Harry D. Scheibla, D.O.L.	15 Apr 39-2 Jun 39
Col. William H. Waldron, Inf., D.O.L.	14 Apr 35-22 Apr 35	Lt. Col. Frederick J. de Rohan, Inf., D.O.L.	2 Jun 39-Apr 40
Col. Charles, R. Pettis, C.E., D.O.L.	22 Apr 35-13 Jun 35	Unknown	Apr 40-7 Dec 41

Eastern Kentucky CCC District, (1933-35)

Fort Thomas CCC District (1935-37)

HQ-Fort Thomas, KY 1933-37

Established 31 May 1933 with headquarters at Fort Thomas, KY. The support unit for this district was the 10th Infantry Regiment. The district originally consisted of the geographical area of the state of Kentucky east of a north-south line through the city of Frankfort, KY, as well as Butler and Brown counties in southern Ohio. It was originally allotted about 9 camps. Redesignated 1 April 1935 as the Fort Thomas CCC District. The Fort Thomas CCC District was discontinued 10 December 1937. Concurrently, Butler and Brown counties were consolidated with the Ohio CCC District and eastern Kentucky was consolidated with the new Kentucky CCC District with headquarters at Fort Knox.

Commanders, Fort Thomas CCC District

Lt. Col. Samuel J. Sutherland*	31 May 33-28 Jul 33	Lt. Col. John P. Bubb*	31 Jan 35-15 Feb 35
Col. Dana T. Merrill*	28 Jul 33-31 Jan 35	Col. Charles L. Mitchell*	15 Feb 35-15 Feb 37
	Col. Rowan P. Lemly*	15 Feb 37-10 Dec 37	

*Commanders, 10th Infantry Regiment.

Charleston CCC District (1935-37)

West Virginia CCC District (1937-40)

HQ-Charleston, WV 1935-40

Established 31 May 1933 as the Eastern Sub-District, Ohio-West Virginia CCC District, with headquarters at Charleston, WV. The sub-district originally consisted of the geographical area of the state of West Virginia. The district was redesignated Charleston District 1 April 1935 with no change to the geographical area. It was further redesignated 10 December 1937 as the West Virginia CCC District. The district was organized into sub-district as follows:

Clarksburg Sub-District	Clarksburg, WV
Elkins Sub-District	Elkins, WV
Lewisburg Sub-District	Lewisburg, WV
Logan Sub-District	Logan, WV
Marlinton Sub-District	Marlinton, WV
Petersburg Sub-District	Petersburg, WV
Williamson Sub-District	Williamson, WV

The West Virginia CCC District was discontinued 1 July 1940 and consolidated with the Ohio-West Virginia CCC District. Concurrently, the district headquarters at Charleston was discontinued.

Commanders, West Virginia CCC District

Col. William H. Waldron, Inf., D.O.L.	1 May 35-10 Dec 37	Maj. John W. Thomas, Jr., 11th Inf.	10 Dec 37-31 Mar 38
	Unknown	31 Mar 38-1 Jul 40	

Sixth Corps Area

In April 1933, the Sixth Corps Area was allotted 27,000 enrollees and 139 camps. The organization of the CCC in the Sixth Corps Area initially consisted of five "forestry districts" created in May 1933. In less than a month, those five districts were discontinued and twenty-two new districts were created and established. On 17 November 1933, one additional district was established and inexplicably, one (the 20th Forestry District) was discontinued. The 20th District was reorganized in Jan 35 bringing the total number of districts up to twenty-three. The corps area CCC organization was reconfigured into five large CCC districts on 31 March 1935 which included two in Michigan, two in Illinois, and one in Wisconsin. This system more closely aligned with the standard geographical organization seen in most other corps areas.

Forestry District No. 1

HQ-East Tawas, MI 1933

Established 24 May 1933 with headquarters at East Tawas, MI. The district consisted the geographical area of the Huron National Forest in Michigan. Discontinued 14 June 1933.

Forestry District No. 2

HQ-Fort Brady, MI 1933

Established 24 May 1933 with headquarters at Fort Brady, MI. The district consisted the geographical area of the Marquette and Hiawatha National Forests in Michigan. Discontinued 14 June 1933.

Forestry District No. 3**HQ**-Three Lakes, WI 1933

Established 24 May 1933 with headquarters at Three Lakes, WI. The district consisted the geographical area of the Ottawa National Forest in Michigan and the Argonne National Forest in Wisconsin. Discontinued 14 June 1933.

Forestry District No. 4**HQ**-Fifield, WI 1933

Established 24 May 1933 with headquarters at Fifield, WI. The district consisted the geographical area of the Flambeau National Forest in Wisconsin. Discontinued 14 June 1933.

Forestry District No. 5**HQ**-Washburn, WI 1933

Established 24 May 1933 with headquarters at Washburn, WI. The district consisted the geographical area of the Moquah National Forest in Wisconsin. Discontinued 14 June 1933.

1st CCC Forestry District**HQ**-Houghton Lake, MI 1933-34; Fort Wayne, MI 1934-35

Established 14 June 1933 with headquarters at Houghton Lake, MI. The district consisted the geographical area of the following counties in Michigan: Roscommon, Ogemaw, Clare, Gladwin, Isabella, Midland, Arenac, Bay and Huron. Discontinued 31 March 1935.

2nd CCC Forestry District**HQ**-Traverse City, MI 1933; Camp Ludington, Ludington, MI 1933-35

Established 14 June 1933 with headquarters at Traverse City, MI. The district consisted the geographical area of the following counties in Michigan: Leelanau, Benzie, Grand Traverse, Manistee, Wexford, Mason, Lake, Osceola, and Mecosta. Headquarters transferred 19 November 1933 to Ludington, MI. Discontinued 31 March 1935.

3rd CCC Forestry District**HQ**-East Tawas, MI 1933-34; Camp Bay City, Bay City, MI 1934-35

Established 14 June 1933 with headquarters at East Tawas, MI. The district consisted the geographical area of the following counties in Michigan: Alpena, Oscoda, Alcona, Osco, and parts of Crawford and Montmorency. Discontinued 31 March 1935.

4th CCC Forestry District**HQ**-Alba, MI 1933-34; Camp Higgins Lake, Rosecommon, MI 1934-35

Established 14 June 1933 with headquarters at Alba, MI. The district consisted the geographical area of the following counties in Michigan: Antrim, Otsego, Kalaska, Crawford, Missaukee and part of Grand Traverse. Discontinued 31 March 1935.

5th CCC Forestry District

HQ-Camp Wolverine, Clarion, MI 1933-35

Established 14 June 1933 with headquarters at Clarion, MI. The district consisted the geographical area of the following counties in Michigan: Emmet, Charlevoix, Cheboygan, Presque Isle and Montmorency. Discontinued 31 March 1935.

6th CCC Forestry District

HQ-Fort Brady, MI 1933-35

Established 14 June 1933 with headquarters at Fort Brady, MI. The district consisted the geographical area of the following counties in Michigan: Luce, Mackinac, Chippewa, and part of Schoolcraft. Discontinued 31 March 1935.

7th CCC Forestry District

HQ-Steuben, MI 1933-34; Camp Steuben, Manistique, MI 1934-35

Established 14 June 1933 with headquarters at Steuben, MI. The district consisted the geographical area of the following counties in Michigan: Alger, Schoolcraft, Delta, and Menominee. Discontinued 31 March 1935.

8th CCC Forestry District

HQ-Forsyth, MI 1933-34; Camp Big Bay, Big Bay, MI 1934-35

Established 14 June 1933 with headquarters at Forsyth, MI. The district consisted the geographical area of the following counties in Michigan: Baraga, Marquette, Dickinso, and part of Iron. Discontinued 31 March 1935.

9th CCC Forestry District

HQ-Kenton, MI 1933-34; Watersmeet 1934-35

Established 14 June 1933 with headquarters at Kenton, MI. The district consisted the geographical area of the following counties in Wisconsin: Houghton, Ontonagon, Gogebic, and part of Iron. Discontinued 31 March 1935.

10th CCC Forestry District

HQ-Elcho, WI 1933-35

Established 14 June 1933 with headquarters at Elcho, WI. The district consisted the geographical area of the following counties in Wisconsin: Langlade, Marinette, Oconto, and part of Forest. Discontinued 31 March 1935 and consolidated with the new Sparta CCC District.

11th CCC Forestry District

HQ-Three Lakes, WI 1933-35

Established 14 June 1933 with headquarters at Camp Nine Mile, Three Lakes, WI. The district consisted the geographical area of the following counties in Wisconsin: Iron, Vilas, Oneida, and part of Forest. Discontinued 31 March 1935.

12th CCC Forestry District

HQ-Camp Riley Creek, Fifield, WI 1933-35

Established 14 June 1933 with headquarters at Fifield, WI. The district consisted the geographical area of the following counties in Wisconsin: Price, Rusk, Sawyer, and Taylor. Discontinued 31 March 1935 and consolidated with the new Sparta CCC District.

13th CCC Forestry District

HQ-Camp Cable, Cable, WI 1933-35

Established 14 June 1933 with headquarters at Cable, WI. The district consisted the geographical area of the following counties in Wisconsin: Douglas, Bayfield, Ashland, Burnett, Washburn, and Sawyer. Discontinued 31 March 1935 and consolidated with the new Sparta CCC District.

14th CCC Forestry District

HQ-Merillan, WI 1933; Bangor, WI 1933-35; Camp McCoy, WI 1935

Established 14 June 1933 with headquarters at Merillan, WI. The district consisted the geographical area of the following counties in Wisconsin: Pepin, Eau Claire, Clark, Buffalo, Trempealeau, Jackson, La Crosse, Monroe, Juneau, Adams, Vernon, and Crawford. Discontinued 31 March 1935 and consolidated with the new Sparta CCC District.

15th CCC Forestry District

HQ-Milwaukee, WI 1933; West Allis, WI 1933-34; Camp Whitehall Park, Hales Corner, WI 1934-35

Established 14 June 1933 with headquarters at Milwaukee, WI. The district consisted the geographical area of the following of Milwaukee county. Discontinued 31 March 1935.

16th CCC Forestry District

HQ-Savanna, IL 1933 Camp Black Hawk, Rock Island, IL

Established 14 June 1933 with headquarters at Savanna, IL. The district consisted the geographical area of the following counties in Illinois: Grant, Iowa, Dane, Lafayette, Green, and Rock. Discontinued 31 March 1935.

17th CCC Forestry District

HQ-Camp Grant, IL 1933-35

Established 14 June 1933 with headquarters at Camp Grant, IL. The district consisted the geographical area of Winnebago County. Discontinued 31 March 1935.

18th CCC Forestry District

HQ-Fort Sheridan, IL 1933-34; Camp Skokie Valley, Glenview, IL

Established 14 June 1933 with headquarters at Fort Sheridan, IL. The district consisted the geographical area of the following counties in Illinois: Cook and Lake. Discontinued 31 March 1935.

19th CCC Forestry District

HQ-Lockport, IL 1933; Marsielles, IL Camp Chicago-Lamont, Willow Springs, IL

Established 14 June 1933 with headquarters at Lockport, IL. The district consisted the geographical area of the following counties in Illinois: Dupage, Will, Grundy, La Salle, and part of Cook. Discontinued 31 March 1935.

20th CCC Forestry District

HQ-Mount Sterling, IL 1933; *Inactive* 1933-35; Camp Marseilles, IL 1935

Established 14 June 1933 with headquarters at Mount Sterling, IL. The district consisted the geographical area of the following counties in Illinois: Peoria, Fulton, Schuyler, Mason, Brown, Cass, Menard, Pike, Scott, Morgan, and Sangamon. Temporarily discontinued 17 November 1933. Reorganized 1 January 1935 with headquarters at Camp Marseilles, Marseilles, IL. Discontinued 31 March 1935.

21st CCC Forestry District

HQ-Jefferson Barracks, MO 1933-35; Camp Springfield, Springfield, IL 1935

Established 14 June 1933 with headquarters at Jefferson Barracks, MO. The district consisted the geographical area of the following counties in Illinois: Calhoun, Greene, and Jersey. Headquarters transferred to Springfield, IL, 8 January 1935. Discontinued 31 March 1935.

22nd CCC Forestry District

HQ-Camp Giant City, Makanda, IL 1933-35

Established 14 June 1933 with headquarters at Makanda, IL. The district consisted the geographical area of the following counties in Illinois: St. Claire, Monroe, Washington, Randolph, Perry, Franklin, Jackson, Williamson, Saline, Gallatin, Union, Johnson, Pope, Pope, Hardin, Alexander, Pulaski, and Massac. Discontinued 31 March 1935.

23rd CCC Forestry District

HQ-Camp Marion, Marion, IL 1933-35

Established 17 November 1933 with headquarters at Marion, IL. Discontinued 31 March 1935.

Fort Brady CCC District

HQ-Fort Brady, MI 1935-41

Established 1 April 1935 with headquarters at Fort Brady, MI. The support unit for this district was the 2nd Infantry. The district consisted of the geographical area of the northern half of the state of Michigan. The district was organized into sub-districts as follows:

- Mackinac Sub-District Mackinac, MI
- Isle Royale Sub-District Isle Royale, MI

Consolidated 28 February 1938 with the Camp Custer CCC District and assumed control of the entire state of Michigan. Location 7 December 1941—Fort Brady, MI.

Commanders, Fort Brady CCC District

Maj. Sevier R. Tupper, 2nd Inf.	1 Apr 35-4 Sep 36	Lt. Col. Hayes Kroner, 2nd Inf.	28 Feb 38-1 Nov 39
Lt. Col. George C. W. Whiting, 2nd Inf.	4 Sep 36-28 Feb 38	Lt. Col. Frank LaRue, 2nd Inf.	1 Nov 39-ao Aug 41

Camp Custer CCC District

HQ-Camp Custer, MI 1935-41

Established 1 June 1935 with headquarters at Camp Custer, MI. The support unit for this district was the 2nd Infantry. The district consisted of the geographical area of the southern half of the state of Michigan. The district was discontinued 28 February 1938 by consolidation with the Fort Brady CCC District.

Commanders, Camp Custer CCC District

Maj. Alexander N. Stark, 6th Inf.	1 Jun 35-4 Jun 36	Maj. Sevier R. Tupper, 2nd Inf.	5 Sep 36-15 Apr 37
Capt. Wilbur J. Fox, 2nd Inf.	4 Jun 36-5 Sep 36	Maj. Brock Putnam, 14th Cav.	15 Apr 37-28 Feb 38

Sparta CCC District

HQ-Camp Douglas, WI 1935-41

Established 1 April 1935 with headquarters at Camp Douglas, WI. Organized from the 10th, 11th, 12th, 13th, 14th, and 15th Forestry Districts. The support unit for this district was the 2nd Infantry. The district consisted of the geographical area of the state of Wisconsin. The district was organized in 1935 into sub-districts as follows:

1st Sub-District	Mountain, WI
2nd Sub-District	Fifield, WI
3rd Sub-District	Cable, WI
4th Sub-District	West Salem, WI
5th Sub-District	Manitowish, WI
6th Sub-District	Laona, WI
7th Sub-District	Superior, WI
8th Sub-District	Fairchild, WI

Location 7 December 1941—Camp Douglas, WI.

Commanders, Sparta CCC District

Lt. Col. Harry D. Chamberlain, 14th Cav.	1 Apr 35-23 Apr 35	Unknown	ao Apr 39-ao Sep 39
Maj. Hamilton E. McGuire, 3rd F.A.	23 Apr 35-19 May 36	Lt. Col. Edward McCreight	ao Sep 39-Mar 41
Maj. David L. Ruffner, 3rd F.A.	19 May 36-ao Apr 39	Maj. Leslie F. Young, F.A., D.O.L.	Mar 41-7 Oct 41
	Lt. Col. Ambrose F. White	7 Oct 41-ao Dec 41	

Fort Sheridan CCC District

HQ-Fort Sheridan, IL 1935-41

Established 1 April 1935 with headquarters at Fort Sheridan, IL. Organized from the 16th, 17th, 18th, and 19th Forestry Districts. The support unit for this district was the 12th Infantry Brigade. The district consisted of the geographical area of the northern half of the state of Illinois. Location 7 December 1941—Fort Sheridan, IL.

Commanders, Fort Sheridan CCC District

Brig. Gen. Dana T. Merrill*	1 Apr 35-2 Jun 37	Brig. Gen. Philip B. Peyton*	14 Aug 37-31 Dec 37
Col. James M. Churchill*	2 Jun 37-14 Aug 37	Maj. Edward J. Rehmann, 2nd Inf.	7 Jan 38-1 Nov 38
	Unknown	1 Nov 38-7 Dec 41	

*Commanders, 12th Infantry Brigade.

Jefferson Barracks CCC District

HQ-Jefferson Barracks, MO 1935-39

Established 1 April 1935 with headquarters at Jefferson Barracks, MO. Organized from the 20th, 21st, 22nd, and 23rd Forestry Districts. The support unit for this district was the 6th Infantry. The district consisted of the geographical area of the southern half of the state of Illinois. The district headquarters was discontinued in 1939 and the responsibility for southern Illinois CCC camps was transferred to the sub-district at Decatur, IL.

Commanders, Jefferson Barracks CCC District

Maj. William A. Smith, 6th Inf.	1 Apr 35-16 May 35	Col. Walter C. Short*	
	Col. Joseph A. Atkins*	1 Jul 36-10 Feb 39	16 May 35-1 Jul 36

*Commanders, 6th Infantry Regiment.

Southern Illinois CCC District

HQ-Decatur, IL 1939-41

Established in late 1939 with headquarters at Camp Wheeler, Decatur, IL, as a sub-district. Redesignated in November 1940 as Headquarters, Southern Illinois CCC District. The district consisted of the geographical area of the southern half of the state of Illinois. Location 7 December 1941—Fort Brady, MI.

Seventh Corps Area

In April 1933, the Seventh Corps Area was allotted 30,000 enrollees and 154 camps. The Seventh Corps Area will take care of 30,000 men in 154 camps. The organization of the CCC in the Seventh Corps Area initially consisted of eight CCC districts which were neatly organized along state lines. Each district, except, Arkansas, was headquartered on the Army post that provided the district its support. In 1936, the corps area underwent a major reorganization. Several state districts were combined into dual-state districts. Three years later, the corps area was reorganized again by shifting several states between districts. The final reorganization took place in late 1941 when the corps area was divided into three districts only, consisting of the North, Central, and Arkansas CCC Districts.

Arkansas CCC District

HQ-Little Rock, AR 1933-41

Established 1 June 1933 with headquarters at East 25th Street and the Rock Island Rail Road building in Little Rock, AR. The support unit for this district was the 17th Infantry. The district consisted of the geographical area of the state of Arkansas and was originally allotted 28 camps. The district was organized into sub-districts as follows:

Ozark Sub-District	Hot Springs, AR
Ouachita Sub-District	Russellville, AR
South Arkansas Sub-District	Fordyce, AR

By 1937, the sub-districts were reorganized as follows:

Little Rock Sub-District	Little Rock, AR
Russellville Sub-District	Russellville, AR
Arkadelphia Sub-District	Arkadelphia, AR
El Dorado Sub-District	El Dorado, AR

Location 7 December 1941—Little Rock, AR.

Commanders, Arkansas CCC District

Maj. John D. Townsend, Inf.	1 Jun 33-11 Sep 33	Maj. Marvin R. Baer, Inf.	1 Mar 35-7 Dec 35
Lt. Col. Felix Emmanuelli, 17th Inf.	11 Sep 33-9 Mar 34	Lt. Col. Woodfin G. Jones, Inf.	7 Dec 35-10 Apr 36
Maj. James C. R. Swenk, Cav.	9 Mar 34-18 May 34	Lt. Col. Grover C. Graham, Inf.	10 Apr 36-ao Oct 41
Lt. Col. William J. Connelly, Inf.	18 May 34-1 Mar 35	Unknown	ao Oct 41-7 Dec 41

Missouri CCC District (1933-36)**Missouri-Kansas CCC District (1936-39)****Missouri CCC District (1939-41)****HQ**-Fort Leavenworth, KS 1933-39; Jefferson Barracks, MO 1939-41

Established 1 June 1933 with headquarters at Fort Leavenworth, KS. The support unit for this district was the 17th Infantry. The district originally consisted of the geographical area of the state of Missouri and was allotted 16 camps. Organized by 1935 into sub-districts as follows:

Northeast Sub-District	Moberly, MO
Northwest Sub-District	Maysville, MO
Southeast Sub-District	Poplar Bluff, MO
Southwest Sub-District	Mount Vernon, MO
East Sub-District	Unknown

The district was consolidated with the Kansas CCC District 1 February 1936 and redesignated as the Missouri-Kansas CCC District. Concurrently, the new district was divided into two sub-districts: the Western Sub-District consisting of the state of Kansas and the Eastern Sub-District consisting of the state of Missouri. Personnel from the district were involved in flood relief efforts in January-February 1937 in the vicinity of Sikeston, MO. The district was reorganized 1 January 1939 to consist of only the state of Missouri. Concurrently, the district headquarters was transferred to Jefferson Barracks, MO. Location 7 December 1941—Jefferson Barracks, MO.

Commanders, Missouri/Missouri-Kansas CCC District

Maj. Gen. Stuart Heintzelman*	1 Jun 33-31 Jan 35	Maj. Charles O. Ashton, 6th Inf.	31 Mar 38-1 Jan 39
Brig. Gen. Herbert J. Brees*	31 Jan 35-20 Jun 36	Lt. Col. George R. Hicks, 6th Inf.	1 Jan 39-28 May 39
Brig. Gen. Charles M. Bundel*	20 Jun 36-30 Nov 36	Maj. Charles O. Ashton, 6th Inf.	28 May 39-1 Jul 39
Lt. Col. Woodfin, G. Jones, Inf., D.O.L.	30 Nov 36-12 Jul 37	Col. Harry B. Crea, 6th Inf.	1 Jul 39-Sep 40
Maj. John L. Rice, 14th Cav.	12 Jul 37-31 Mar 38	Lt. Col. William G. Simpson, Inf.	Sep 40-ao Jan 41

*Commandant, Command & General Staff School

Kansas CCC District**HQ**-Fort Riley, KS 1933-36

Established 1 June 1933 with headquarters at Fort Riley, KS. The support unit for this district was the 2nd Cavalry. The district consisted of the geographical area of the state of Kansas and was originally allotted 7 camps. The district was discontinued 1 February 1936 by consolidation with the Missouri CCC District as the new Missouri-Kansas CCC District.

Commanders, Kansas CCC District

Brig. Gen. Abraham G. Lott*	1 Jun 33-31 May 35	Maj. John L. Rice, Cav.	1 Jun 35-30 Jun 35
	Brig. Gen. Guy V. Henry*	1 Jul 35-1 Feb 36	

*Commandant, Cavalry School

Iowa CCC District**HQ**-Fort Des Moines, IA 1933-41

Established 1 June 1933 with headquarters at Fort Des Moines, IA. The support unit for this district was the 14th Cavalry. The district consisted of the geographical area of the state of Iowa and was originally allotted 16 camps. Personnel from the district were involved in flood relief efforts in the vicinity of eastern Iowa in January-February 1937. Discontinued 1 December 1941 and integrated into the new Central CCC District.

Commanders, Iowa CCC District

Col. Charles E. Stodter*	1 Jun 33-14 Aug 34	Col. John C. Pegram*	25 Jun 36-1 Aug 39
Lt. Col. Butler N. Briscoe*	14 Aug 34-26 Aug 34	Lt. Col. Edward J. Dwan*	1 Aug 39-4 Nov 39
Lt. Col. Edward J. Dwan, Cav.	6 Nov 39-22 Mar 40	Col. Arthur H. Wilson *	4 Nov 39-8 Jan 41
Col. Clarence Lininger*	26 Aug 34-25 Jun 36	Lt. Col. John T. Pierce*	8 Jan 41-1 Dec 41

*Commanders, 14th Cavalry Regiment.

Nebraska CCC District (1933-36)

Nebraska-South Dakota CCC District (1936-39)

Nebraska-Kansas CCC District (1939-41)

Central CCC District (1941)

HQ-Fort Robinson, NE 1933-34; Fort Crook, NE 1934-37; Omaha, NE 1937-41

Established 1 June 1933 with headquarters at Fort Robinson, NE. The support unit for this district was the 17th Infantry. The district originally consisted of the geographical area of the state of Nebraska. It was originally allotted 5 camps. The district was organized into sub-districts as follows:

Southeast Nebraska Sub-District Fort Crook, NE

North west Nebraska Sub-District Fort Robinson, NE

District headquarters was relocated 26 May 34 to Fort Crook, NE. The district was consolidated with the South Dakota CCC District 1 February 1936 and redesignated as the Nebraska-South Dakota CCC District. Headquarters relocated 17 April 1937 to 22nd and Hickory Streets, Omaha, NE. The state of South Dakota was withdrawn in February 1939 and consolidated with the North Dakota CCC District. Concurrently, the state of Kansas was consolidated with Nebraska as the new Nebraska-Kansas CCC District. The district was reorganized 1 December 1941 to consist of the states of Nebraska, Kansas, South Dakota, and Iowa. Concurrently redesignated as the Central CCC District. The Central C.C.C District consisted of two sub-districts: the Fort Des Moines Sub-District, which managed the states of Iowa and Kansas, and the Fort Meade Sub-District which managed the state of South Dakota. Location 7 December 1941—Omaha, NE.

Commanders, Nebraska/Nebraska-South Dakota/Nebraska-Kansas CCC District

Maj. Edwin N. Hardy, Q.M.C.	1 Jun 33-26 May 34	Col. Clyde R. Abraham, 17th Inf.	5 Oct 36-31 Mar 37
Col. Thomas M. Anderson, 17th Inf.	26 May 34-15 Nov 34	Maj. Chauncey H. Hayden, 17th Inf.	17 Apr 37-22 Mar 38
Col. Samuel J. Sutherland, 17th Inf.	15 Nov 34-23 Aug 36	Maj. Malcolm Byrne, 17th Inf.	22 Mar 38-31 Mar 38
Maj. Clarence P. Evers, 17th Inf.	23 Aug 36-30 Sep 36	Unknown	31 Mar 38-ao Oct 40
Lt. Col. John H. Van Vliet, 17th Inf.	30 Sep 36-5 Oct 36	Lt. Col. Thomas G. Poland, Inf.	ao Oct 40-Jun 41

South Dakota CCC District

HQ-Fort Meade, SD 1933-36

Established 1 June 1933 with headquarters at Fort Meade, SD. The support unit for this district was the 4th Cavalry. The district consisted of the geographical area of the state of South Dakota. It was originally allotted 15 camps. The district was discontinued 1 February 1936 by consolidation with the Nebraska CCC District.

Commanders, South Dakota CCC District

Col. Otto W. Rethorst*	1 Jun 33-28 Jun 33	Lt. Col. Richard E. Cummins*	14 Jul 35-19 Aug 35
Col. William R. Pope*	28 Jun 33-14 Jul 35	Col. Robert McC. Beck, Jr.*	19 Aug 35-1 Feb 36

*Commanders, 4th Cavalry Regiment.

Minnesota CCC District (1933-36 & 1937-38)

Minnesota-North Dakota CCC District (1936-41)

Northern CCC District (1941)

HQ-Fort Snelling, MN 1933-40; St. Paul, MN 1940-41

Established 1 May 1933 with headquarters at Fort Snelling, MN. The support unit for this district was the 3rd Infantry. The district consisted of the geographical area of the state of Minnesota. It was originally allotted 61 camps. Organized into five sub-districts as follows:

East Superior Sub-district	Two Harbors, MN
West Superior Sub-district	Ely, MN
International Falls Sub-district	International Falls, MN
Chippewa Sub-district	Cass Lake, MN
Southeast Sub-district	Rochester, MN

The district was reorganized by Jul 35 as follows:

East Superior Sub-district	Two Harbors, MN
Masaba Sub-district	Hibbing, MN
Itasca Sub-district	Park Rapids, MN
Chippewa Sub-district	Cass Lake, MN
Southeast Sub-district	Rochester, MN

Reorganized 1 February 1936 to include the former North Dakota CCC District and redesignated as the Minnesota-North Dakota CCC District. Reorganized 1 March 1937 to include only the geographical area of the state of Minnesota and redesignated as the Minnesota CCC District. District headquarters relocated in 1940 to St. Paul, MN. Reorganized 1 December 1941 to consist of Minnesota, North Dakota, eastern Montana, and northeast Iowa and redesignated as the Northern CCC District. The Northern C.C.C District consisted of one sub-district, the Fort Lincoln Sub-District, which managed the state of North Dakota and eastern Montana. The rest of the district was managed by the district headquarters at St. Paul. Location 7 December 1941—St. Paul, MN.

Commanders, Minnesota/Minnesota-North Dakota/Northern CCC District

Brig. Gen. John H. Hughes*	1 May 33-5 Jul 33	Brig. Gen. Campbell B. Hodges*	16 Feb 37-27 Jul 39
Brig. Gen. David L. Stone*	6 Jul 33-3 Sep 36	Col. George F. N. Dailey*	27 Jul 39-9 Feb 40
Col. Charles F. Thompson*	3 Sep 36-21 Jan 37	Brig. Gen. Campbell B. Hodges*	9 Feb 40-Jun 40
Col. Clyde R. Abraham*	21 Jan 37-16 Feb 37	Unknown	Jun 40-7 Dec 41

*Commanders, 14th Infantry Brigade.

North Dakota CCC District (1933-36 & 1937-39)

Dakota CCC District (1939-41)

HQ-Fort Lincoln, ND 1933-36; 1937-41

Established 1 May 1933 with headquarters at Lincoln, ND. The support unit for this district was the 4th Infantry. The district consisted of the geographical area of the state of North Dakota. The district consisted of eight to eleven camps and no sub-districts. Discontinued 1 February 1936 and consolidated with the Minnesota CCC District. Reorganized as the North Dakota Sub-District. Reestablished 1 March 1937 to consist of the geographical area of the state of North Dakota. Consolidated in February 1939 with the South Dakota CCC District and redesignated as the Dakota CCC District. The Dakota C.C.C District consisted of two sub-districts: the South Dakota Sub-District with headquarters at Fort Meade, SD; and the North Dakota Sub-District with headquarters at Fort Lincoln. The Dakota District was discontinued and broken up 1 December 1941. The state of North Dakota and part of eastern Montana was designated as the Fort Lincoln Sub-District and integrated into the new Northern CCC District. The state of South Dakota was integrated into the new Central CCC District.

Commanders, North Dakota/Dakota CCC District

Col. George W. Harris, Inf., D.O.L.	8 Mar 34-1 Jul 34	Lt. Col. Joseph S. Leonard, 4th Inf.	1 Mar 37-7 Jul 37
Capt. Virgil Bell, Inf.	1 Jul 34-16 Sep 34	Maj. Peter G. Marshall, Jr., 4th Inf.	7 Jul 37-3 Sep 37
Lt. Col. Louis Farrell, Inf.	16 Sep 34-4 Jul 35	Lt. Col. Jacob J. Gerhardt, 4th Inf.	3 Sep 37-16 Jul 39
Lt. Col. Joseph S. Leonard, 4th Inf.	4 Jul 35-1 Feb 36	Lt. Col. William F. Freehoff, 4th Inf.	31 Jul 39-ao Jan 40
Consolidated w/Minnesota CCC District	2 Feb 36-28 Feb 37	Unknown	ao Jan 40-7 Dec 41

Eighth Corps Area

In April 1933, the Eighth Corps Area was allotted 20,000 enrollees and 120 camps allotted to states as follows: Arizona 20; Colorado 25; New Mexico 15; Oklahoma 13; Texas 34; Wyoming (Eighth Corps Area part) 10. The Eighth Corps Area underwent a bewildering number of reorganizations and name changes to its CCC districts. Frequently districts consisted of parts of two states, and at other times consisted of part of only one. Though it began modestly in terms of enrollees assigned, the Eighth Corps Area eventually grew to include up to 62,500 enrollees in a given year, second only to the Ninth Corps Area.

Texas CCC District (1933-35)

West Texas CCC District (1935)

San Antonio CCC District (1935-37)

South Texas CCC District (1937-41)

Texas CCC District (1941)

HQ-Fort Sam Houston, TX 1933-38; San Antonio, TX 1938-41

Established 1 May 1933 with headquarters at Fort Sam Houston, TX. The support unit for this district was the 3rd Infantry Brigade. The district consisted of the geographical area of the state of Texas, less the El Paso CCC Area in the Arizona-New Mexico CCC District, and those portions of the state of Texas included in the Oklahoma CCC District. It was originally allotted about 30 camps. The district was organized into four sub-districts as follows:

Sub-District No. 1	Lufkin, TX
Sub-District No. 2	Cleburne, TX
Sub-District No. 3	Temple, TX
Sub-District No. 4	Fort Sam Houston, TX

The district was reorganized 1 March 1935 to consist of only the geographical area of the former Sub-District No. 4 and redesignated as the West Texas CCC District. Redesignated 1 August 1935 as the San Antonio CCC District. Reorganized 1 November 1937 by consolidation with the East Texas CCC District and redesignated as the South Texas CCC District. Consolidated with the North Texas CCC District 1 October 1941 and redesignated as the Texas CCC District. Location 7 December 1941—San Antonio, TX.

Commanders, Texas/West Texas/San Antonio/South Texas CCC District

Brig. Gen. Charles Howland, 3rd Inf. Brig.	1 May 33-28 Feb 35	Unknown	31 Mar 38-1 Aug 39
Maj. Thomas G. Jenkins, 23rd Inf.	1 Mar 35-31 Mar 38	Lt. Col. Stanley Bacon, F.A.	1 Aug 39-10 Apr 41
	Lt. Col. Roy A. Carter, F.A.	10 Apr 41-ao Sep 41	

East Texas CCC District (1935)

Lufkin CCC District (1935-37)

East Texas CCC District (1937)

HQ-Lufkin, TX 1935-37

Established 1 March 1935 with headquarters at Lufkin, TX. The district, formerly Sub-District No. 1 of the Texas CCC District, consisted of the geographical area of east-central Texas. Redesignated 1 July 1935 as the Lufkin CCC District. Expanded 31 January 1937 by consolidation with the Tyler CCC District. Redesignated 1 April 1937 as the East Texas CCC District. Discontinued by consolidation with the South Texas CCC District 31 October 1937.

Commanders, Lufkin CCC District

Capt. Fred E. Gaillard, 23rd Inf.	1 Mar 35-16 Jan 36	Capt. Charles W. Hanna, 9th Inf.	16 Jan 36-17 Aug 36
	Maj. Marvin W. Marsh, 20th Inf.		17 Aug 36-31 Oct 37

Tyler CCC District

HQ-Tyler, TX 1935-37

Established 1 July 1935 with headquarters at Tyler, TX. The district consisted of the geographical area of northeastern Texas. Discontinued 31 January 1937 by consolidation with the Lufkin CCC District.

Commanders, Tyler CCC District

Maj. Edgar H. Keltner, 3rd Inf. Brig.	1 Jul 35-26 Aug 35	Capt. George A. Ford, 69th C.A.C.	10 Oct 35-8 Jul 36
Capt. Robert T. Foster, 9th Inf.	26 Aug 35-10 Oct 35	Capt. Benjamin A. Thomas, 12th Cav.	8 Jul 36-22 Sep 36
	Maj. John A. Hilldring, 25th Inf.		22 Sep 36-31 Jan 37

Fort Worth CCC District (1935-37)

North Texas CCC District (1937-41)

HQ-Fort Worth, TX 1935-37

Established 1 August 1935 with headquarters at Fort Worth, TX. The district, formerly Sub-District No. 2 of the Texas CCC District, consisted of the geographical area of north-central Texas. Redesignated 1 April 1937 as the North Texas CCC District. Consolidated with the South Texas CCC District 1 October 1941 and discontinued. Headquarters of the South Texas CCC District concurrently redesignated as the Texas CCC District.

Commanders, Fort Worth/North Texas CCC District

Unknown	1 Aug 35-ao Mar 37	Lt. Col. Russell C. Throckmorton, Inf.	ao Mar 37-ao May 40
	Unknown		ao May 40-7 Dec 41

Lubbock CCC District

HQ-Lubbock, TX 1935-36

Established 1 August 1935 with headquarters at Lubbock, TX. The district consisted of three sub-districts south of the Texas panhandle. Discontinued 31 October 1936 by consolidation with the West Texas CCC District.

Commanders, Lubbock CCC District

Maj. Robert Gray, Q.M.C.	1 Aug 35-14 Jun 36	Unknown	14 Jun 36-31 Oct 36
--------------------------	--------------------	---------	---------------------

Colorado CCC District (1933-35)

Colorado-Wyoming CCC District (1937-41)

HQ-Fort Logan, CO 1933-35; *Discontinued* 1935-37; Littleton, CO 1937-41

Established 1 August 1933 with headquarters at Fort Logan, CO. The support unit for this district was the 2nd Engineers. The district consisted of the geographical area of the state of Colorado. It was originally allotted 25 camps. Discontinued 1 October 1935 and the state of Colorado divided into two new districts: the Littleton and Grand

Junction CCC Districts. Reorganized 1 April 1937 by consolidation of the Littleton and Grand Junction CCC Districts with headquarters at Littleton. Reorganized by consolidation with the Wyoming CCC District 1 December 1937 and redesignated as the Colorado-Wyoming CCC District. Location 7 December 1941—Littleton, CO.

Commanders, Colorado/Colorado-Wyoming CCC District

Col. Wildur Willing, 2nd Engr.	1 Aug 33-11 Jul 35	Capt. Thomas H. Sheehan, 8th Cav.	1 Apr 37-31 Mar 38
Col. Jarvis J. Bain, 2nd Engr.	11 Jul 35-30 Sep 35	Lt. Col. John R. Hermann, Inf.	ao Oct 38-5 Apr 40
<i>Discontinued</i>	1 Oct 35-31 Mar 37	Lt. Col. Pearson Menoher, Cav.	5 Apr 40-1 Jul 42

Grand Junction CCC District

HQ-Grand Junction, CO 1935-37

Established 1 August 1935 with headquarters at Grand Junction, CO. The support unit for this district was the 2nd Engineers. The district consisted of the geographical area of about the western third of the state of Colorado. Discontinued 1 April 1937 by consolidation with the Littleton CCC District which effectively reorganized the Colorado CCC District.

Commanders, Grand Junction CCC District

Maj. Albert B. Helsley, 29th Inf.	1 Aug 35-15 Feb 36	Capt. Thomas F. Sheehan, 8th Cav.	24 Feb 36-15 Mar 37
-----------------------------------	--------------------	-----------------------------------	---------------------

Littleton CCC District

HQ-Littleton, CO 1935-37

Established 1 October 1935 with headquarters at Littleton, CO. The support unit for this district was the 2nd Engineers. The district consisted of the geographical area of about the eastern two-thirds of the state of Colorado. Discontinued 1 April 1937 by consolidation with the Grand Junction CCC District which reorganized the Colorado CCC District.

Commanders, Littleton CCC District

Capt. Chester C. Hough, 2nd Engr.	14 Oct 35-25 Feb 36	Maj. Albert B. Helsley, 29th Inf.	25 Feb 36-16 May 37
	Capt. Thomas F. Sheehan, 8th Cav.	16 May 37-31 Mar 37	

New Mexico-Arizona CCC District (1933-35)

Fort Bliss CCC District (1935-37)

New Mexico CCC District (1937-41)

HQ-Fort Bliss, TX 1933-41

Established 1 August 1933 with headquarters at Fort Bliss, TX. The district consisted of the geographical area of the states of Arizona and New Mexico, and the western counties of Texas. It was originally allotted 15 camps. The district was organized into three CCC areas and seven sub-districts as follows:

Huachuca CCC Area (AZ)	Fort Huachuca, AZ
Huachuca Sub-District	Fort Huachuca, AZ
Flagstaff Sub-District	Flagstaff, AZ
Grand Canyon Sub-District	Canyon, AZ
Globe Sub-District	Globe, AZ
Santa Fe CCC Area (NM)	Santa Fe, NM
Santa Fe Sub-District	Santa Fe, NM
Silver City Sub-District	Silver City, NM

El Paso CCC Area (West TX)
Safford Sub-District

Fort Bliss, TX
Safford, TX

Reorganized 1 July 1935 to consist of only the geographical area of the former El Paso CCC Area and redesignated as the Fort Bliss CCC District. The geographical areas of the states of Arizona and New Mexico reorganized into the Arizona and New Mexico CCC districts respectively. Reorganized 1 November 1937 by consolidation of the Fort Bliss CCC District with the Albuquerque and Silver City CCC Districts (encompassing the entire state of New Mexico and the former Fort Bliss CCC District). Concurrently redesignated as the New Mexico CCC District. Location 7 December 1941—Fort Bliss, TX.

Commanders, New Mexico-Arizona/Fort Bliss/New Mexico CCC District

Maj. Harold E. Eastwood, 8th Cav.	1 Sep 35-31 Dec 35	Capt. Samuel R. Goodwin, 7th Cav.	1 Jan 36-31 Oct 37
	Maj. Gilbert X. Cheves, 8th Cav.	1 Nov 37-30 Apr 38	

Albuquerque CCC District

HQ-Albuquerque, NM 1935-37

Established 1 August 1935 with headquarters at Albuquerque, NM. The district, formerly part of the New Mexico-Arizona CCC District, consisted of the geographical area of roughly the northern half of the state of New Mexico. The support unit for this district was the 7th Cavalry Regiment. Discontinued 31 October 1937 by consolidation with the newly organized New Mexico CCC District.

Commanders, Albuquerque CCC District

Capt. Samuel R. Goodwin, 7th Cav.	1 Aug 35-2 Sep 35	Maj. Edward M. Fickett, 7th Cav.	2 Sep 35-1 Mar 36
	Maj. John A. Chase, 1st F.A.	1 Mar 36-31 Oct 37	

Silver City CCC District

HQ-Silver City, NM 1935-37

Established 1 August 1935 with headquarters at Silver City, NM. The district, formerly part of the New Mexico-Arizona CCC District, consisted of the geographical area of roughly the southern half of the state of New Mexico. Discontinued 31 October 1937 by consolidation with the newly organized New Mexico CCC District.

Commanders, Silver City CCC District

Maj. Horace K. Heath, 25th Inf.	1 Jul 35-23 Sep 36	Maj. William W. Eagles, 9th Inf.	24 Sep 36-11 Oct 36
	Capt. Benjamin A. Thomas, 12th Cav.	11 Oct 36-31 Aug 37	

Phoenix CCC District (1935-37)

Arizona CCC District (1937-41)

HQ-Phoenix, AZ 1935-41

Established 1 June 1935 with headquarters at Phoenix, AZ. The district consisted of the geographical area of roughly the northern half of the state of Arizona. The support unit for this district was the 25th Infantry. Consolidated with the Tucson CCC District 1 April 1937 and redesignated as the Arizona CCC District. The new district consisted of the geographical area of the state of Arizona. Location 7 December 1941—Phoenix, AZ.

Commanders, Phoenix/Arizona CCC District

Maj. L. J. Whitlock, 82nd F.A.	1 Jul 35-22 May 37	Maj. John H. Hilldring, 25th Inf.	22 May 37-22 Feb 38
	Lt. Col. Randolph Gordon, Inf.	22 Feb 38-ao Apr 41	

Tucson CCC District

HQ-Tucson, AZ 1935-37

Established 1 August 1935 with headquarters at Tucson, AZ. The district consisted of the geographical area of roughly the southern half of the state of Arizona. The support unit for this district was the 25th Infantry. Discontinued by consolidation with the Phoenix CCC District 1 April 1937 as part of the newly organized Arizona CCC District.

Commanders, Tucson CCC District

Maj. Holmes G. Paullin, 8th Cav.	1 Aug 35-8 Feb 36	Maj. Carl B. Byrd, Cav., D.O.L.	8 Feb 36-8 Feb 37
	Maj. John H. Hilldring, 25th Inf.	8 Feb 37-31 Mar 37	

Oklahoma CCC District

HQ-Fort Sill, OK 1933-35; Oklahoma City, OK 1935-41

Established 1 May 1933 with headquarters at Fort Sill, OK. Headquarters transferred 25 April 1935 to Oklahoma City, OK. The district originally consisted of the geographical area of the state of Oklahoma, the Texas panhandle and a tier of north Texas counties from the panhandle to the east Texas border. It was originally allotted 20 camps. The district was organized into seven sub-districts as follows:

Sub-District A	Wilburton, OK
Sub-District B	Oklahoma City, OK
Sub-District C	Fort Sill, OK
Sub-District D	Canyon, TX
Sub-District E	Sulphur, OK
Sub-District F	Denison, TX
Sub-District G	Eagleton, OK

The headquarters was transferred 25 April 1935 to Oklahoma City, OK. The district was reorganized 1 May 1935 to consist of western Oklahoma and the Texas panhandle. The district was consolidated 1 May 1937 with the Muskogee CCC District. Oklahoma CCC District now consisted of the entire state of Oklahoma and the Texas panhandle. Location 7 December 1941—Oklahoma City, OK.

Commanders, Oklahoma CCC District

Brig. Gen. William Cruikshank*	1 May 33-1 Aug 34	Capt. Carley C. Marshall, 9th Inf.	22 Oct 36-1 May 37
Brig. Gen. Henry W. Butner*	1 Aug 34-25 Apr 35	Maj. Everette M. Graves, 1st F.A.	1 May 37-22 Jun 37
Maj. Orva E. Beezley, 1st F.A.	25 Apr 35-22 May 36	Capt. Carley C. Marshall, 9th Inf.	22 Jun 37-29 Mar 38
Maj. Tobin C. Rote, 20th Inf.	22 May 36-14 Oct 36	Lt. Col. John N. Hauser, F.A., D.O.L.	29 Mar 38-15 Feb 41
	Lt. Col. Kenneth S. Whittemore, Inf.	15 Apr 41-ao Dec 41	

*Commandant, Field Artillery School.

Muskogee CCC District

HQ-Muskogee, OK 1935-37

Established 15 July 1935 with headquarters at Muskogee, OK. The district consisted of the geographical area of eastern Oklahoma. The district was organized into sub-districts as follows:

Sub-District A	Smithville, OK
Sub-District B	Okmulgee, OK
Sub-District C	Tulsa, OK
Sub-District D	Muskogee, OK

Consolidated 30 April 1937 with the Oklahoma CCC District. Headquarters at Muskogee discontinued.

Commanders, Muskogee CCC District

Maj. Everette M. Graves, 1st F.A. 15 Jul 35-30 Apr 37

Wyoming CCC District (1933-35)

Casper CCC District (1935-37)

Wyoming CCC District (1937)

HQ-Fort F. E. Warren, WY 1933-35; Casper, WY 1935-37

Established in May 1933 with headquarters at Fort F. E. Warren, WY. The support unit for this district was the 1st Infantry Regiment. The district consisted of the geographical area of the state of Wyoming. It was originally allotted 10 camps. Headquarters relocated 1 August 1935 to Casper, WY, and concurrently redesignated as the Casper CCC District. Redesignated 1 April 1937 as the Wyoming CCC District. Discontinued 1 December 1937 by consolidation with the Colorado CCC District and redesignated as the Colorado-Wyoming CCC District with headquarters at Littleton, CO.

Commanders, Wyoming/Casper CCC District

Brig. Gen. Caspar H. Conrad, Jr.	May 33-31 Jul 35	Maj. Merritt E. Olmstead, 1st Inf.	5 Aug 35-1 Jan 36
Col. Paul H. McCook, 1st Inf.	1 Aug 35-4 Aug 35	Capt. James N. Ancrum, 1st Inf.	1 Jan 36-30 Nov 37

Ninth Corps Area

In April 1933, the Ninth Corps Area was allotted 84,000 enrollees and 460 camps allotted to states as follows: California 148; Idaho 96; Montana 31; Nevada 4; Oregon 64; Utah 26; Washington 57; and Wyoming 14. The Ninth was the largest corps area both in terms of geographical area and the number of districts, camps, and enrollees assigned. In the last three categories, it exceeded all other corps areas by at least twice the number. As originally organized the Ninth Corps Area's CCC organization consisted of 22 districts. After the first year, six of these districts were discontinued and their areas consolidated under other district headquarters. In 1936, another three were discontinued with two more by 1938. By this time, about half of the remaining headquarters district headquarters were located on military installations, but most of the others, mainly in California, were located in areas distant from direct military support. The organization of the districts remained more or less constant after 1938.

Baker CCC District

HQ-Baker, OR 1933-34

Established 17 May 1933 with headquarters at the Hotel Baker, Baker OR. This district appears to have been discontinued in 1934.

Commanders, Baker CCC District

Maj. Albert E. Searle, F.A., D.O.L. 11 May 33-ao Jun 33

Boise CCC District

HQ-Boise Barracks, ID 1933-41

Established 11 May 1933 with headquarters at the Chamber of Commerce Building in Boise, ID. The support unit for this district was the 38th Infantry. The district consisted of the geographical area of southwestern Idaho. Consolidated 31 March 1938 with the Lewiston CCC District. Consolidated 1 September 1938 with the Pocatello CCC District. Retained the designation of Boise CCC District and assumed control over the entire state of Idaho with the exception of the counties north of Idaho county. Location 7 December 1941—Boise Barracks, ID.

Commanders, Boise CCC District

Maj. Marshall H. Quesenberry, 38th Inf.	11 May 33-6 Jun 33	Maj. Patrick J. Dodd, 38th Inf.	19 Dec 33-1 Jul 36
Lt. Col. Charles L. Sampson, 30th Inf.	6 Jun 33-19 Dec 33	Maj. Stewart D. Hervey, 38th Inf.	1 Jul 36-1 Jul 37
	Maj. Charles W. Jones, 7th Inf.	1 Jul 37-ao Aug 39	

Eugene CCC District

HQ-Eugene, OR 1933-34

Established 17 May 1933 with headquarters at the Hampton Building, Eugene, OR. Discontinued 7 June 1934.

Commanders, Eugene CCC District

Maj. Charles H. Corlett, 7th Inf.	18 May 33-1 Mar 34	Maj. Casper B. Rucker, 7th Inf.	1 Mar 34-19 May 34
	Capt. Ercil D. Porter, Inf., D.O.L.	19 May 34-7 Jun 34	

Eureka CCC District

HQ-Eureka, CA 1933-36

Established 8 May 1933 with headquarters at Eureka Inn, Eureka, CA. Discontinued 30 April 1936.

Commanders, Eureka CCC District

Maj. Louis L. Pendleton, 6th C.A.	8 May 33-19 Jul 34	Capt. James J. Hea, Inf., D.O.L.	15 Oct 34-16 Nov 34
Maj. Robert W. Yates, 76th F.A.	19 Jul 34-15 Oct 34	Capt. James S. Rodwell, 11th Cav.	16 Nov 34- 6 May 35
	Maj. Vincent S. Burton, 7th Inf.	6 May 35-30 Apr 36	

Fort Douglas CCC District

HQ-Fort Douglas, UT 1933-41

Established 5 May 1933 with headquarters at Fort Douglas, UT. The support unit for this district was the 6th Infantry Brigade. The district consisted of the geographical area of the state of Utah and portions of the states of Nevada and southeastern Idaho. Location 7 December 1941—Fort Douglas, UT.

Commanders, Fort Douglas CCC District

Lt. Col. Edwin Butcher, 38th Inf.	5 May 33-11 Jul 33	Col. Irving J. Phillipson*	1 Jun 38-3 Jul 38
Brig. Gen. Pegram Whitworth*	11 Jun 33-10 May 35	Brig. Gen. Donald C. Cubbison *	3 Jul 38-8 Jun 39
Col. Walter C. Sweeney, 38th Inf.	10 May 35-6 Sep 35	Lt. Col. Mose Kent, Inf.	8 Jun 39-4 Jun 40
Brig. Gen. Clement A. Trott*	6 Sep 35-10 Jan 36	Col. Frederick E. Uhl, 38th Inf.	4 Jun 40-3 Aug 40
Lt. Col. C. E. McCarthy, 38th Inf.	10 Jan 36-26 Jan 36	Lt. Col. Mose Kent, Inf.	3 Aug 40-10 May 41
Brig. Gen. Walter C. Sweeney*	26 Jan 36-1 Jun 38	Lt. Col. Ralph Hall, Inf.	10 May 41-ao Dec 41

*Commanders, 6th Infantry Brigade.

Fresno CCC District

HQ-Fresno, CA 1933-41

Established 9 May 1933 with headquarters at 326 Brix Building, Fresno, CA. Location 7 December 1941— Fresno, CA.

Commanders, Fresno CCC District

Maj. Harrison Herman, 11th Cav.	9 May 33-14 Jun 33	Maj. Donald S. Perry, 11th Cav.	5 Jun 36-25 Feb 37
Lt. Col. John A. Barry, Cav., D.O.L.	14 Jun 33-23 Aug 33	Maj. James C. Ward, 11th Cav.	25 Feb 37-19 Sep 37
Maj. Paul E. Peabody, 30th Inf.	23 Aug 33-24 May 34	Lt. Col. Edward J. Dwan, 11th Cav.	19 Sep 37-1 Aug 39
Maj. Harrison C. Browne, 38th Inf.	24 May 34-5 Jul 34	Maj. Maurice Morgan, C.A.	1 Aug 39-Sep 39
Maj. Edward C. McGuire, 11th Cav.	5 Jul 34-5 Jun 36	Lt. Col. Alfred E. Dedicke, Inf.	Sep 39-18 Mar 41
	Maj. Lewis S. Sorley, Inf.	18 Mar 41-15 Sep 41	

Fort Lewis CCC District

HQ-Fort Lewis, WA 1933-41

Established 9 May 1933 with headquarters at Fort Lewis, WA. The support unit for this district was the 3rd Field Artillery Brigade. The district consisted of the geographical area of the northwestern third of the state of Washington. Location 7 December 1941—Fort Lewis, WA.

Commanders, Fort Lewis CCC District

Brig. Gen. Henry W. Butner*	10 Nov 33-29 Jul 34	Maj. Gen. David L. Stone*	22 Sep 36-30 Mar 37
Brig. Gen. Otho B. Rosenbaum*	29 Jul 34-16 Aug 35	Col. Frank S. Bowen, 10th F.A.	1 Apr 37-5 Jul 37
Maj. Gen. Caspar H. Conrad, Jr.*	18 Aug 35-31 Aug 36	Brig. Gen. Alfred T. Smith*	1 Jul 37-31 Mar 38
Col. Frank S. Bowen, 10th F.A.	31 Aug 36-22 Sep 36	Unknown	31 Mar 38-7 Dec 41

*Commanders, 3rd Infantry Division.

Lewiston CCC District

HQ-Lewiston, ID 1933-34; *Inactive* 1933-34; Lewiston, ID 1934; *Inactive* 1934-35; Lewiston, ID 1935-38

Established 17 May 1933 with headquarters at the Lewis and Clark Hotel, Lewiston, ID. The district consisted of the geographical area of the central region of the state of Idaho. The district was discontinued 12 November 1933 and reorganized at Lewiston 27 March 1934. It was discontinued once again on 30 November 1934 and again reorganized at Lewiston 20 March 1935. The district was consolidated 31 March 1938 with the Boise CCC District and discontinued.

Commanders, Lewiston CCC District

Maj. Walter H. Mann, Inf. D.O.L.	18 May 33-6 Jun 33	<i>Inactive</i>	30 Nov 34-20 Mar 35
Col. William A. Alfonte, Inf. D.O.L.	6 Jun 33-12 Nov 33	Maj. Claude E. Stadtman, 30th Inf.	20 Mar 35-18 May 35
<i>Inactive</i>	12 Nov 33-27 Mar 34	Maj. Herman F. Rathjen, 11th Cav.	18 May 35-4 Oct 36
Maj. Henry C. Davis, Jr., 14th C.A.	27 Mar 34-8 Oct 34	Maj. William S. Barrett, 30th Inf.	4 Oct 36-18 Jun 37
Capt. Arcadi Gluckman, 30th Inf.	8 Oct 34-30 Nov 34	Maj. Malcom V. Fortier, 4th Inf.	18 Jun 37-31 Mar 38

Los Angeles CCC District

HQ-Los Angeles, CA 1933-36; Van Nuys, CA 1936-41

Established 15 May 1933 with headquarters at Los Angeles, CA. The support unit for this district was the 3rd Coast Artillery. The district consisted of the geographical area of portions of the state of California. Headquarters relocated 12 March 1936 to Van Nuys, CA. Location 7 December 1941—Van Nuys, CA.

Commanders, Los Angeles CCC District

Maj. Claudius M. Easley, 30th Inf.	12 Mar 36-2 Feb 37	Maj. Louis H. Thompson, 3rd C.A.	11 Jan 38-31 Mar 38
Maj. Louis H. Thompson, 3rd C.A.	2 Feb 37-11 Oct 37	Unknown	31 Mar 38-24 Jan 39
Maj. Claudius M. Easley, 30th Inf.	11 Oct 37-11 Jan 38	Lt. Col. Theodore E. Buechler, 76th F. A.	24 Jan 39-9 Jan 41
	Unknown	9 Jan 41-7 Dec 41	

Fort MacArthur CCC District

HQ-Fort MacArthur, CA 1933-36

Established 6 May 1933 with headquarters at Fort MacArthur, CA. The support unit for this district was the 3rd Coast Artillery Regiment. The district consisted of the geographical area of the portions of the state of California. Consolidated 30 June 1936 with the Los Angeles CCC District and discontinued.

Commanders, Fort MacArthur CCC District

Col. Charles H. Wilson, 3rd C.A.	6 May 33-20 May 34	Lt. Col. Homer R. Oldfield, 63rd C.A.	20 May 30-30 Jun 36
----------------------------------	--------------------	---------------------------------------	---------------------

March Field CCC District

HQ-March Field, CA 1933-36

Established 30 May 1933 with headquarters at March Field, CA. The support unit for this district was the 1st Wing. The district consisted of the geographical area of portions of in the state of California. Discontinued 1 September 1936.

Commanders, March Field CCC District

Lt. Col. Henry H. Arnold, A.C.	1 May 33-23 Jun 34	Lt. Col. Henry H. Arnold, A.C.	11 Oct 34-11 Mar 35
Maj. Leo A. Walton, A.C.	23 Jun 34-11 Oct 34	Lt. Col. Leo A. Walton, A.C.	11 Mar 35-1 Sep 36

Marysville, CA CCC District

HQ-Marysville, CA 1933-34

Established 16 May 1933 with headquarters at the California Packing Corporation Plant, Marysville, CA. The support unit for this district was the 30th Infantry Regiment. The district consisted of the geographical area of portions of in the state of California. Discontinued 15 May 1934.

Commanders, Marysville CCC District

Maj. William J. Morrissey, 30th Inf.	16 May 33-9 Jun 33	Lt. Col. Albert B. Dockery, Inf. D.O.L.	9 Jun 33-14 Nov 33
	Col. William A. Alfonte, Inf. D.O.L.	14 Nov 33-15 May 34	

Medford CCC District

HQ-Medford, OR 1933-41

Established 15 May 1933 with headquarters at Old City Hall, 6th and Front Streets, Medford, OR. The support unit for this district was the 14th Coast Artillery. The district consisted of the geographical area of the southwestern region of the state of Oregon. Location 7 December 1941—Medford, OR.

Commanders, Medford CCC District

Maj. Clare H. Armstrong, 6th C.A.	15 May 33-3 Jun 35	Unknown	31 Mar 38-12 Sep 38
Maj. George R. Owens, 14th C.A.	3 Jun 35-31 Mar 38	Col. Henry H. Fletcher, Inf.	12 Sep 38-24 Aug 40
	Unknown	24 Aug 40-7 Dec 41	

Montana CCC District (1933)

Fort Missoula CCC District (1933-41)

HQ-Fort Missoula, MT 1933-41

Established 1 May 1933 as the Montana CCC District with headquarters building T-316 at Fort Missoula, MT. Redesignated 1 June 1933 as the Fort Missoula CCC District. The support unit for this district was the 4th Infantry Regiment. The district consisted of the geographical area of the state of Montana. The far eastern counties of Montana were transferred to the Seventh Corps Area's Northern CCC District in December 1941. Location 7 December 1941—Fort Missoula, MT.

Commanders, Fort Missoula CCC District

Maj. Walter H. Root, 4th Inf.	1 May 33-10 Jun 33	Maj. Walter H. Root, 4th Inf.	9 Jan 37-18 Apr 37
Lt. Col. William D. Geary, F.A., D.O.L.	10 Jun 33-14 Nov 33	Maj. John D. Chambliss, 4th Inf.	18 Apr 37-1 Jun 37
Maj. Walter H. Root, 4th Inf.	14 Nov 33-29 Mar 34	Maj. Walter H. Root, 4th Inf.	1 Jun 37-29 Aug 37
Maj. William H. Hammond, 4th Inf.	29 Mar 34-18 May 35	Col. Langley F. Whitley, 4th Inf.	29 Aug 37-1 Aug 39
Col. Edward L. Hooper, 4th Inf.	18 May 35-9 Jan 37	Lt. Col. Earl Landreth, 4th Inf.	1 Aug 39-Jun 40
	Unknown	Jun 40-7 Dec 41	

Monterey CCC District

HQ-Presidio of Monterey, CA 1933-41

Established 13 May 1933 with headquarters at the Presidio of Monterey, CA. The support unit for this district was the 11th Cavalry Regiment. The district consisted of the geographical area of portions of in the state of California. Location 7 December 1941—Presidio of Monterey, CA.

Commanders, Monterey CCC District

Col. Ben Lear*	13 May 33-30 Jun 33	Lt. Col. William H. W. Young*	1 May 38-15 Jun 38
Col. Ralph M. Parker*	30 Jun 33-5 Feb 36	Lt. Col. James E. Slack*	15 Jun 38-28 Jun 38
Lt. Col. Harvey D. Higley, 76th F.A.	5 Feb 36-29 Feb 36	Col. Homer N. Groninger*	28 Jun 38-1 Nov 40
Col. Troup Miller*	29 Feb 36-1 May 38	Lt. Col. John T. McLane*	1 Nov 40-27 Nov 40
	Col. Harold M. Raynor*	27 Nov 40-31 Dec 41	

*Commanders, 11th Cavalry Regiment.

Pocatello CCC District

HQ-Pocatello, ID 1933-38

Established 16 May 1933 with headquarters at 650 South 1st Avenue, Pocatello, ID. The district consisted of the geographical area of southeastern Idaho. Consolidated 1 September 1938 with the Boise CCC District and the headquarters at Pocatello discontinued.

Commanders, Pocatello CCC District

Maj. Parley D. Parkinson, Inf., D.O.L.	16 May 33-22 May 35	Maj. Edward W. Bondy, 38th Inf.	15 Aug 37-31 Mar 38
Maj. Everette M. Yon, 38th Inf.	22 May 35-20 May 36	Unknown	31 Mar 38-ao Apr 40
Maj. Earle H. Malone, 38th Inf.	20 May 36-15 Aug 37	Lt. Col. Hugh C. Dorrien, Inf.	ao Apr 40-ao Dec 41

Redding CCC District

HQ-Redding, CA 1933-37

Established 17 May 1933 with headquarters at the Division of Forestry, Redding, CA. Discontinued 31 October 1937.

Commanders, Redding CCC District

Maj. Willis J. Tack, Cav.	17 May 33-ao Nov 34	Capt. John C. Smuck	23 Dec 36-10 Jan 37
Unknown	ao Nov 34-23 Dec 36	Unknown	10 Jan 37-31 Oct 37

Rockwell Field CCC District

HQ-Rockwell Field, CA 1933-34

Established 30 May 1933 with headquarters at Rockwell Field, CA. Discontinued 9 May 1934.

Commanders, Rockwell Field CCC District

Maj. Shepler W. FizGerald, A.C	30 May 33-9 May 34
--------------------------------	--------------------

Sacramento CCC District

HQ-Sacramento, CA 1933-41

Established 9 May 1933 with headquarters at 504 Plaza Building, Sacramento, CA. Location 7 December 1941—Sacramento, CA.

Commanders, Eureka CCC District

Maj. Raymond E. McQuillin, 11th Cav.	9 May 33-5 Jun 33	Maj. Theodore E. T. Haley, 76th F.A.	30 Jun 35-19 May 36
Lt. Col. John C. Starkey, F.A., D.O.L.	5 Jun 33-15 Nov 33	Maj. Martin S. Chester, 30th Inf.	19 May 36-7 Aug 36
Maj. Raymond E. McQuillin, 11th Cav.	15 Nov 33-1 Apr 34	Maj. Paul D. Carter, 30th Inf.	7 Aug 36-Jul 39
Maj. Charles E. McCarthy, Inf., D.O.L.	1 Apr 34-30 Jun 35	Maj. Lewis F. Kosch, F.A., D.O.L.	Jul 39-9 Sep 40
	Lt. Col. Lucian D. Bogan, Inf.	9 Sep 40-ao Dec 41	

Vancouver Barracks CCC District

HQ-Vancouver Barracks, WA 1933-41

Established 15 May 1933 with headquarters at Vancouver Barracks, WA. The support unit for this district was the 5th Infantry Brigade. The district consisted of the geographical area of portions of the states of southwestern Washington and northwestern Oregon. Location 7 December 1941—Vancouver Barracks, WA.

Commanders, Vancouver Barracks CCC District

Col. Harry A. Wells, 7th Inf.	15 May 33-10 Dec 33	Col. Ralph R. Glass, 7th Inf.	3 Jul 38-25 Nov 38
Brig. Gen. James K. Parsons*	10 Dec 33-28 Sep 36	Brig. Gen. George Grunert*	25 Nov 38-16 Oct 39
Col. Henry Hossfeld, 7th Inf.	28 Sep 36-27 Oct 36	Unknown	16 Oct 39-ao Nov 41
Brig. Gen. George C. Marshall*	27 Oct 36-2 Jul 38	Lt. Col. Ralph Hall, Inf.	ao Nov 41-ao Dec 41

*Commanders, 5th Infantry Brigade.

Fort Worden CCC District

HQ-Fort Worden, WA 1933-34

Established in May 1933 with headquarters at Fort Worden, WA. This district appears to have been discontinued in 1934 and consolidated with the Fort Lewis CCC District.

Commanders, Fort Worden CCC District

Unknown May 33-1934

Fort George Wright CCC District

HQ-Fort George Wright, WA 1933-41

Established 28 May 1933 with headquarters at Fort George Wright, WA. The support unit for this district was the 4th Infantry Regiment. The district consisted of the geographical area of the eastern third of the state of Washington. Location 7 December 1941—Fort George Wright, WA.

Commanders, Fort George Wright CCC District

Maj. George S. Clarke*	28 May 33-20 Jun 33	Col. Louis Farrell*	8 Jul 35-19 Aug 36
Col. Wallace McNamara*	20 Jun 33-28 Aug 33	Lt. Col. Owen R. Meredith*	19 Aug 36-5 Sep 36
Maj. Isaac J. Nichol, 30th Inf.	28 Aug 33-10 Nov 33	Col. Walter S. Drysdale*	5 Sep 36-18 Apr 38
Maj. George S. Clarke*	10 Nov 33-6 Aug 34	Col. Langley F. Whitley*	18 Apr 38-13 Jul 38
Col. Frederick G. Knabenshue*	6 Aug 34-20 May 35	Col. Walter R. Wheeler*	13 Jul 38-Apr 40
Maj. George S. Clarke*	20 May 35-8 Jul 35	Col. Vernon G. Olsmith*	Apr 40-28 Aug 40
	Col. Gregory Hoisington*	29 Aug 40-Jun 42	

* Commanders, 4th Infantry Regiment.

Hawaii CCC District

HQ-Schofield Barracks, TH 1933-41

Established 31 May 1933 with headquarters at Schofield Barracks, TH. The support unit for this district was the Hawaiian Division. The district consisted of the geographical area of the Territory of Hawaii.

Commanders, Hawaii CCC District

Unknown 31 May 33-7 Dec 41

Appendix E

Branch and Department Chiefs

1917-41

Secretaries of War

Newton D. Baker	9 Mar 16-4 Mar 21	Patrick J. Hurley	9 Dec 29-3 Mar 33
John W. Weeks	5 Mar 21-13 Oct 25	George H. Dern	4 Mar 33-27 Aug 36
Dwight F. Davis	14 Oct 25-5 Mar 29	Harry H. Woodring	25 Sep 36-20 Jun 40
James W. Good	6 Mar 29-18 Nov 29	Henry L. Stimson	10 Jul 40-21 Sep 45

U.S. Army Chiefs of Staff

Maj. Gen. Peyton C. March	19 May 18-30 Jun 21	Gen. Charles P. Summerall	21 Nov 26-20 Nov 30
Gen. of the Armies John J. Pershing	1 Jul 21-13 Sep 24	Gen. Douglas MacArthur	21 Nov 30-1 Oct 35
Maj. Gen. John L. Hines	14 Sep 24-20 Nov 26	Gen. Malin Craig	2 Oct 35-31 Aug 39
	Gen. George C. Marshall	1 Sep 39-18 Nov 45	

Chiefs of Infantry

Maj Gen. Charles S. Farnsworth	1 Jul 20-28 Mar 25	Maj Gen. Edgar Croft	25 May 33-5 May 37
Maj Gen. Robert H. Allen	28 Mar 25-27 Mar 29	Maj. Gen. George A. Lynch	24 May 37-30 Apr 41
Maj Gen. Stephen O. Fuqua	28 Mar 29-5 May 33	Maj. Gen. Courtney H. Hodges	30 Apr 41-9 Mar 42

Chiefs of Cavalry

Maj. Gen. Willard A. Holbrook	1 Jul 20-24 Jul 24	Maj. Gen. Guy V. Henry	21 Mar 30-21 Mar 34
Maj. Gen. Malin Craig	24 Jul 24-20 Mar 26	Maj. Gen. Leon B. Kromer	22 Mar 34-25 Mar 38
Maj. Gen. Herbert Crosby	20 Mar 26-21 Mar 30	Maj. Gen. John K. Herr	26 Mar 38-28 Feb 42

Chiefs of Field Artillery

Maj. Gen. William J. Snow	10 Feb 18-19 Dec 27	Maj. Gen. Harry G. Bishop	10 Mar 30-9 Mar 34
Maj. Gen. Fred T. Austin	20 Dec 27-15 Feb 30	Maj. Gen. Upton Birnie	10 Mar 34-25 Mar 38
Maj. Gen.	Robert M. Danford	26 Mar 38-9 Mar 42	

Chiefs of Coast Artillery

Maj. Gen. Frank W. Coe	24 May 18-19 Mar 26	Maj. Gen. Harry L. Steele	21 Jan 35-31 Mar 36
Maj. Gen. Andrew Hero, Jr.	20 Mar 26-21 Mar 30	Col. Henry T. Burgin	1 Mar 35-31 Mar 36
Maj. Gen. John W. Gulick	20 Mar 30-21 Mar 34	Maj. Gen. Archibald H. Sunderland	1 Apr 36-31 Mar 40
Maj. Gen. William F. Hase	22 Mar 34-28 Feb 35	Maj. Gen. Joseph A. Green	1 Apr 40-8 Mar 42

Chiefs of Engineers

Maj. Gen. Harry Taylor	20 Sep 18-8 Jan 20	Maj. Gen. Lytle Brown	1 Oct 29-30 Sep 33
Maj. Gen. Lansing H. Beach	9 Jan 20-23 Jun 24	Maj. Gen. Edward Markham	1 Oct 33-1 Oct 37
Maj. Gen. Edgar Jadwin	24 Jun 24-7 Aug 29	Maj. Gen. Julian L. Schley	18 Oct 37-30 Sep 41
Col. Hubert Deakyne	8 Aug 29-30 Sep 29	Lt. Gen. Eugene Reybold	1 Oct 41-30 Sep 45

Chiefs of the Air Service/Air Corps

Maj. Gen. Charles T. Menoher	1 Jul 20-4 Oct 21	Maj. Gen. Benjamin D. Foulois	20 Dec 31-Dec 35
Maj. Gen. Mason M. Patrick	5 Oct 21-13 Dec 27	Maj. Gen. Oscar Westover	Dec 35-21 Sep 38
Maj. Gen. James E. Fechet	14 Dec 27-19 Dec 31	Maj. Gen. Henry H. Arnold	21 Sep 38-Jun 41

Chiefs of the Tank Corps

Brig. Gen. Samuel D. Rockenbach Aug 18-Jun 20

Chiefs of the Chemical Warfare Service

Maj. Gen. William L. Sibert	1 May 18-27 Feb 20	Maj. Gen. Claude E. Brigham	9 May 33-24 May 37
Maj. Gen. Amos A. Fries	28 Feb 20-27 Mar 29	Maj. Gen. Walter C. Baker	25 May 37-30 Apr 41
Maj. Gen. Harry S. Gilchrist	28 Mar 29-8 May 33	Maj. Gen. William N. Porter	30 Apr 41-28 Nov 45

Adjutant General

Maj. Gen. Peter C. Harris	1 Sep 18-31 Aug 22	Maj. Gen. Charles H. Bridges	31 Dec 28-1 Feb 33
Maj. Gen. Robert C. Davis	1 Sep 22-1 Jul 27	Maj. Gen. James F. McKinley	2 Feb 33-31 Oct 35
Maj. Gen. Lutz Wahl	2 Jul 27-30 Dec 28	Maj. Gen. Edgar T. Conley	1 Nov 35-30 Apr 38
	Maj. Gen. Emory S. Adams	1 May 38-28 Feb 42	

Quartermaster General			
Maj. Gen. Henry G. Sharpe	13 Sep 16-12 Jul 18	Maj. Gen. John L. DeWitt	18 Jan 30-2 Feb 34
Maj. Gen. Harry L. Rogers	22 Jul 18-27 Aug 22	Maj. Gen. Louis N. Bash	3 Feb 34-31 Mar 36
Maj. Gen. William H. Hart	28 Aug 22-2 Jan 26	Maj. Gen. Henry Gibbins	1 Apr 36-31 Mar 40
Maj. Gen. B. Franklin Cheatham	3 Jan 26--17 Jan 30	Maj. Gen. Edmund B. Gregory	1 Apr 40-Jan 46
Surgeon General			
Maj. Gen. Merritte W. Ireland	4 Oct 18-31 May 31	Maj. Gen. Charles R. Reynolds	2 Jun 35-31 May 39
Maj. Gen. Robert U. Patterson	1 Jun 31-1 Jun 35	Maj. Gen. James C. Magee	1 Jun 39-31 Oct 43
Inspector General			
Maj. Gen. John L. Chamberlain	6 Oct 17-9 May 21	Maj. Hugh Drum	12 Jan 30-30 Nov 31
Maj. Gen. Eli A. Helmick	10 May 21-27 Sep 27	Maj. Gen. John F. Preston	1 Dec 31-30 Nov 35
Maj. Gen. William C. Rivers	28 Sep 27-11 Jan 30	Maj. Gen. Walter L. Reed	1 Dec 35-23 Dec 39
	Maj. Gen. Virgil L. Peterson	24 Dec 39-Jun 45	
Judge Advocate General			
Maj. Gen. Enoch H. Crowder	6 Oct 17-9 Nov 24	Maj. Gen. Blanton Winship	1 Mar 31-30 Nov 33
Maj. Gen. John A. Hull	10 Nov 24-17 Nov 28	Maj. Gen. Arthur W. Brown	1 Dec 33-30 Nov 37
Maj. Gen. Edward A. Kreger	18 Nov 28-28 Feb 31	Maj. Gen. Allen W. Gullion	1 Dec 37-1 Dec 41
Chiefs of Ordnance			
Maj. Gen. Clarence C. Williams	16 Jul 18-1 Apr 30	Maj. Gen. William H. Tschappat	3 Jun 34-2 Jun 38
Maj. Gen. Samuel Hof	2 Apr 30-2 Jun 34	Maj. Gen. Charles M. Wesson	3 Jun 38-2 Jun 42
Chief Signal Officer			
Maj. Gen. George O. Squier	14 Feb 17-31 Dec 23	Maj. Gen. Irving J. Carr	1 Jul 31-31 Dec 34
Maj. Gen. Charles M. Saltzman	1 Jan 23-8 Jan 28	Maj. Gen. James B. Allison	1 Jan 35-30 Sep 37
Maj. Gen. George S. Gibbs	9 Jan 28-30 Jun 31	Maj. Gen. Joseph O. Mauborgne	30 Sep 37-30 Sep 41
Maj. Gen. Dawson Olmstead		1 Oct 41-30 Jun 43	
Chiefs of Finance			
Maj. Gen. Herbert M. Lord	1 Jul 20-30 Jun 22	Maj. Gen. Frederick W. Coleman	23 Apr 32-22 Apr 36
Maj. Gen. Kenzie W. Walker	1 Jul 22-23 Apr 28	Maj. Gen. Frederick W. Boschen	23 Apr 36-22 Apr 40
Maj. Gen. Roderick L. Carmichael	23 Apr 28-23 Apr 32	Maj. Gen. Howard K. Loughry	23 Apr 40-1 Jun 45
Chiefs of Chaplains			
Col. John T. Axton	15 Jul 20-6 Apr 28	Col. Julius E. Yates	23 Dec 29-23 Dec 33
Col. Edmund P. Easterbrook	7 Apr 28-22 Dec 29	Col. Alva J. Brasted	24 Dec 33-22 Dec 37
	Col. William R. Arnold	23 Dec 37-22 Dec 45	
Chiefs of the Militia Bureau/National Guard Bureau			
Maj. Gen. Jesse McI. Carter	1 Jul 20-28 Jun 21	Maj. Gen. George E. Leach	1 Dec 31-30 Nov 35
Maj. Gen. George C. Rikards	29 Jun 21-28 Jun 25	Col. Harold J. Weiler (acting)	1 Dec 35-16 Jan 36
Maj. Gen. Creed C. Hammond	29 Jun 25-28 Jun 29	Col. John F. Williams (acting)	17 Jan 36-30 Jan 36
Col. Ernest R. Redmond (Acting)	29 Jun 29-30 Sep 29	Maj. Gen. Albert H. Blanding	31 Jan 36-30 Jan 40
Maj. Gen. William G. Everson	1 Oct 29-30 Nov 31	Maj. Gen. John F. Williams	31 Jan 40-30 Jan 44
Bureau of Insular Affairs			
Brig. Gen. Frank McIntyre	8 Oct 17-7 Jan 29	Brig. Gen. Creed F. Cox	9 Jan 33-23 May 37
Brig. Gen. Frank LeJ. Parker	6 Jan 29-8 Jan 33	Brig. Gen. Charles Burnett	24 May 37-30 Jun 39

Appendix F
Annual Summer Training Camp Locations

Infantry Training Camps 1921 – 1930											
Regiment	1921	1922	1923	1924	1925	1926	1927	1928	1929	1930	
32 INF	RA-A	I/A	I/A	I/A	I/A	I/A	N/C	N/C	N/C	DELM	
36 INF	RA-A	I/A	I/A	I/A	I/A	I/A	I/A	N/C	N/C	N/C	
37 INF	RA-A	I/A	I/A	I/A	I/A	I/A	I/A	N/C	N/C	N/C	
39 INF	RA-A	I/A	I/A	I/A	I/A	I/A	FSCR	N/C	N/C	N/C	
40 INF	RA-A	I/A	I/A	I/A	I/A	I/A	I/A	N/C	N/C	N/C	
41 INF	RA-A	I/A	I/A	I/A	I/A	I/A	I/A	N/C	N/C	N/C	
42 INF	RA-A	I/A	I/A	I/A	I/A	I/A	I/A	SAJP	SAJP	SAJP	
47 INF	RA-A	I/A	I/A	I/A	I/A	I/A	FSCR	N/C	N/C	N/C	
51 INF	RA-A	I/A	I/A	I/A	I/A	FSHN	FSHN-GUTC	FSHN-GUTC	FSHN-GUTC	FSHN	
52 INF	RA-A	I/A	I/A	I/A	I/A	JFBK	JFBK-GUTC	JFBK-GUTC	JFBK-CMTC	FSHN	
53 INF	RA-A	I/A	I/A	I/A	I/A	I/A	FDM-RATC	FSNL-GUTC	FSNL-CMTC	FSNL-RATC	
54 INF	RA-A	I/A	I/A	I/A	I/A	I/A	FCRK-RATC	FCRK-GUTC	FSNL-CMTC	FLVN-CMTC	
60 INF	RA-A	I/A	I/A	I/A	I/A	I/A	N/C	FTHO-RATC	FTHO-GUTC	FTHO	
61 INF	RA-A	I/A	I/A	I/A	I/A	I/A	N/C	FBH-RATC	FTHO	FTHO	
67 INF											
68 INF											
69 INF											
1 VA INF	CLEE	R/D 183rd IN							VA Beach	VA Beach	
1 MD INF	Ritchie	Saunders	Saunders	EARS	Ritchie	Ritchie	Ritchie	Ritchie	Ritchie	Ritchie	
5 MD INF	Ritchie	Saunders	Saunders	EARS	Ritchie	Ritchie	Ritchie	Ritchie	Ritchie	Ritchie	
8 IL INF	Cp Lincoln	Grant	Grant	Grant	Grant	Grant	Grant	Grant	Grant	Grant	
10 NY INF	Smith	Smith	Smith	Smith	Smith	Smith	Smith	Smith	Smith	Smith	
14 NY INF	Smith	Smith	Smith	Smith	Smith	Smith	Smith	Smith	Smith	Smith	
71 NY INF	UPTN	Smith	Smith	Smith	Smith	Smith	Smith	Smith	Smith	Smith	
101 INF	FDEV	FDEV	FDEV	FDEV	FDEV	FDEV	FDEV	FDEV	FDEV	FDEV	
102 INF	See 169th IN	See 169th IN	See 170th IN	Niantic	Niantic	Niantic	Niantic	Niantic	Niantic	Niantic	
103 INF	FDEV	FDEV	FDEV	FEA	Keyes	Keyes	Keyes	FDEV	Keyes	FDEV	
104 INF	FDEV	FDEV	FDEV	FDEV	FDEV	FDEV	FDEV	FDEV	FDEV	FDEV	
105 INF	PBRK	Smith	Smith	Smith	Smith	Smith	Pine Cp	Smith	Smith	Smith	
106 INF	Smith	Smith	Smith	Smith	Smith	Smith	Pine Cp	Smith	Smith	Smith	
107 INF	Smith	Smith	Smith	Smith	Smith	Smith	Smith	Smith	Smith	Smith	
108 INF	PBRK	FNIA	Smith	Smith	Smith	Smith	Smith	Smith	Smith	Smith	
109 INF	Mt Gretna	Mt Gretna	Mt Gretna	Mt Gretna	Mt Gretna	Mt Gretna	Mt Gretna	Mt Gretna	Mt Gretna	Mt Gretna	
110 INF	Mt Gretna	Mt Gretna	Mt Gretna	Mt Gretna	Mt Gretna	Mt Gretna	Mt Gretna	Mt Gretna	Mt Gretna	Mt Gretna	
111 INF	Mt Gretna	Mt Gretna	Mt Gretna	Mt Gretna	Mt Gretna	Mt Gretna	Mt Gretna	Mt Gretna	Mt Gretna	Mt Gretna	
112 INF	Mt Gretna	Mt Gretna	Mt Gretna	Mt Gretna	Mt Gretna	Mt Gretna	Mt Gretna	Mt Gretna	Mt Gretna	Mt Gretna	
113 INF	Sea Girt	Sea Girt	Sea Girt	Sea Girt	Sea Girt	Sea Girt	Sea Girt	Sea Girt	Sea Girt	Sea Girt	
114 INF	Sea Girt	Sea Girt	Sea Girt	Sea Girt	Sea Girt	Sea Girt	Sea Girt	Sea Girt	Sea Girt	Sea Girt	
115 INF	See 1 MD IN										
116 INF	CLEE	VA Beach	VA Beach	VA Beach	VA Beach	VA Beach	VA Beach	EGGM	VA Beach	VA Beach	
117 INF	Fountain City	Fountain City	Sevier	Sevier	FMCL	Peay	Peay	CJAC	Peay	Peay	
118 INF	Mt Pleasant	CJAC	FMCL	CJAC	CJAC	CJAC	CJAC	CJAC	CJAC	CJAC	
120 INF	Glenn	Glenn	Glenn	Glenn	Glenn	Glenn	Glenn	CJAC	Glenn	Glenn	
121 INF	See 122a IN			St Simons	Tybee	St Simons	FMCL	CJAC	Foster	Foster	
122a INF	St Simons	St Simons	St Simons	R/D 121st IN							

Infantry Training Camps 1921 – 1930

Regiment	1921	1922	1923	1924	1925	1926	1927	1928	1929	1930
122b INF	See 200th IN			St Simons	Tybee	St Simons	FMCL	FMCL	FMCL	FMCL
124 INF	See 154th IN			CJEJ	CJEJ	CJEJ	CJEJ	CJEJ	Foster	Foster
125 INF	Grayling	Grayling	Grayling	Grayling	Grayling	Grayling	Grayling	Grayling	Grayling	Grayling
126 INF	Grayling	Grayling	Grayling	Grayling	Grayling	Grayling	Grayling	Grayling	Grayling	Grayling
127 INF	Douglas	Douglas	Douglas	Douglas	Douglas	Douglas	Douglas	Williams	Williams	Williams
128 INF	Douglas	Douglas	Douglas	Douglas	Douglas	Douglas	Douglas	Williams	Williams	Williams
129 INF	Grant	Grant	Grant	Grant	Grant	Grant	Grant	Grant	Grant	Grant
130 INF	Grant	Grant	Grant	Grant	Grant	Grant	Grant	Grant	Grant	Grant
131 INF	Grant	Grant	Grant	Grant	Grant	Grant	Grant	Grant	Grant	Grant
132 INF	Cp Lincoln	Grant	Grant	Grant	Grant	Grant	Grant	Grant	Grant	Grant
133 INF	Dodge	Dodge	Dodge	Dodge	Dodge	Dodge	Dodge	Dodge	Dodge	Dodge
134 INF	Dodge	FRK	Ashland	Platsmouth	Ashland	Ashland	Ashland	Ashland	Ashland	Ashland
135 INF	Lake City	Lake City	FSNL	Lake City	Lake City	Lake City	Lake City	Lake City	Lake City	Lake City
137 INF	FRK	FRK	FRK	FRK	FRK	FRK	FRK	FRK	FRK	FRK
138 INF	Clark	Clark	Clark	Clark	Clark	Clark	Clark	Clark	Clark	Clark
140 INF	Clark	Clark	Clark	Clark	Clark	Clark	Clark	Clark	Clark	Clark
141 INF	Mabry	Mabry	Mabry	FCRO	Mabry	Hulen	Hulen	Hulen	Hulen	Hulen
142 INF	Mabry	Mabry	Mabry	FCRO	Mabry	Hulen	Hulen	Hulen	Hulen	Hulen
143 INF	Mabry	Mabry	Mabry	FCRO	Mabry	Hulen	Hulen	Hulen	Hulen	Hulen
144 INF	Mabry	Mabry	Mabry	FCRO	Mabry	Hulen	Hulen	Hulen	Hulen	Hulen
145 INF	Perry	Perry	Perry	Perry	Perry	Perry	Perry	Perry	Perry	Perry
147 INF	Perry	Perry	Perry	Perry	Perry	Perry	Perry	Perry	Perry	Perry
148 INF	Perry	Perry	Perry	Perry	Perry	Perry	Perry	Perry	Perry	Perry
149 INF	N/C	FKNX	FKNX	FKNX	FKNX	FKNX	FKNX	FKNX	FKNX	FKNX
150 INF	N/C	FKNX	FKNX	Nitro	FKNX	FKNX	FKNX	FKNX	FKNX	FKNX
151 INF	N/C	FKNX	FKNX	FKNX	FKNX	FKNX	FKNX	FKNX	FKNX	FKNX
152 INF	N/C	FKNX	FKNX	FKNX	FKNX	FKNX	FKNX	FKNX	FKNX	FKNX
153 INF	N/C	Pike	Pike	Pike	Pike	Pike	Pike	Pike	Pike	Pike
154 INF	CJEJ	CJEJ	CJEJ	R/D 124th IN						
155 INF	Williamson	Williamson	FMCL	FMCL	FMCL	BEAU	BEAU	BEAU	BEAU	BEAU
156 INF	BEAU	BEAU	BEAU	FMCL	BEAU	BEAU	BEAU	BEAU	BEAU	BEAU
157 INF	See 177th IN	West	West	West	West	West	West	West	West	West
158 INF	CHHJ	CHHJ	CHHJ	CHHJ	FHUA	FHUA	FHUA	FHUA	FHUA	Tutthill
159 INF	Yosemite	DELM	DELM	DELM	DELM	DELM	DELM	DELM	SLO	DELM
160 INF	Murray	DELM	DELM	DELM	DELM	DELM	DELM	SLO	SLO	SLO
161 INF	Cp Dengel	Murray	Murray	Murray	Murray	Murray	Murray	Murray	Murray	Murray
162 INF	N/O	FLEW	FLEW	FLEW	Jackson, OR	Jackson, OR	Gearhart, OR	Clatsop	Clatsop	Clatsop
163 INF	FWHH	FLEW	FWHH	FMS	FWHH	FWHH	FWHH	FWHH	FWHH	FWHH
164 INF	N/C	Grafton	Grafton	Grafton	Grafton	Grafton	Grafton	Grafton	Grafton	Grafton
165 INF	Smith	Smith	Smith	Smith	Smith	Smith	FNIA	Smith	Smith	Smith
166 INF	Perry	Perry	Perry	Perry	Perry	Perry	Perry	Perry	Perry	Perry
167 INF	FMCL	FMCL	FMCL	FMCL	FMCL	FMCL	FMCL	FMCL	FMCL	FMCL
168 INF	Dodge	Dodge	Dodge	Dodge	Dodge	Dodge	Dodge	Dodge	Dodge	Dodge
169 INF	Niantic	FDEV	Niantic	Niantic	Niantic	Niantic	Niantic	Niantic	Niantic	Niantic
170 INF	N/O	FDEV	Niantic	R/D 102nd IN						

Infantry Training Camps 1921 – 1930

Regiment	1921	1922	1923	1924	1925	1926	1927	1928	1929	1930
172 INF	FEA	FEA	FEA	FEA	FEA	FEA	Bennington	FEA	FEA	FDEV
174 INF	FNIA	FNIA	Smith	Smith	Smith	Smith	FNIA	Smith	Smith	Smith
177 INF	West	R/D 157th IN								
179 INF	FSIL	FSIL	FSIL	FSIL	FSIL	FSIL	FSIL	FSIL	FSIL	FSIL
180 INF	FSIL	FSIL	FSIL	FSIL	FSIL	FSIL	FSIL	FSIL	FSIL	FSIL
181 INF	FDEV	FDEV	FDEV	FDEV	FDEV	FDEV	FDEV	FDEV	FDEV	FDEV
182 INF	FDEV	FDEV	FDEV	FDEV	FDEV	FDEV	FDEV	FDEV	FDEV	FDEV
183 INF	See 1st VA INF	VA Beach	VA Beach	VA Beach	VA Beach	VA Beach	VA Beach	VA Beach	R/D 1st VA IN	
184 INF	N/O	N/O	N/O	DELM	DELM	DELM	DELM	SLO	SLO	DELM
185 INF	N/O	N/O	N/O	DELM	DELM	DELM	DELM	DELM	SLO	DELM
186 INF	N/O	FLEW	FLEW	FLEW	Jackson	Jackson	Geathart, OR	Clatsop	Clatsop	Clatsop
200 INF	St Simons	St Simons	St Simons	Tybee/Boise	Boise	Boise	I/A	I/A	I/A	I/A
201 INF	N/O	N/O	N/O	Nitro	FKNX	Conley	Conley	Conley	Conley	Dawson
205 INF	FSNL	Lake City	Lake City	FSNL	Lake City	FSNL	Lake City	Lake City	Lake City	Lake City
206 INF	FSNL	FSNL	Lake City	Lake City	FSNL	Lake City	Lake City	Lake City	Lake City	Lake City
295 INF	Salinas	Aricebo	Ponce	Ponce	Aricebo	Rio Piedras	Yauco	Yauco	Yauco	Yauco
296 INF	Aricebo	Aricebo	Ponce	Ponce	Aricebo	Rio Piedras	Yauco	Yauco	Yauco	Yauco
297 INF	N/O	N/O	N/O	N/O	N/O	N/O	N/O	N/O	N/O	N/O
298 INF	SCBK	SCBK	SCBK	SCBK	SCBK	SCBK	SCBK	SCBK	SCBK	SCBK
299 INF	Unknown	Unknown	Unknown	Kilauea	Unknown	Kilauea	Kilauea/Wailuku	Wailuku	Kilauea	Wailuku
301 INF	N/O	FDEV-DGRP	FDEV-DGRP	FDEV-DGRP	FDEV-CMTC	FDEV-GUTC	FDEV-RATC	FDEV-RATC	FDEV-CMTC	FDEV
302 INF	N/O	FDEV-DGRP	FDEV-DGRP	FDEV-DGRP	FDEV	FDEV-GUTC	FDEV-RATC	FDEV-RATC	FDEV-CMTC	FDEV
303 INF	N/O	FDEV-DGRP	FDEV-DGRP	FDEV-DGRP	FMCK-CMTC	Keyes-LUTC	FMCK-RATC	FMMS-RATC	FMCK-CMTC	FDEV-CMTC
304 INF	N/O	FDEV-DGRP	FDEV-DGRP	FDEV-DGRP	FDEV-GUTC	FDEV-GUTC	N/C	Storrs-GUTC	FADM-GUTC	FADM-RATC
305 INF	N/O	FDIX-DGRP	FDIX	PLBK-CMTC	N/C	FSLC-RATC	FSLC-GUTC	EJAY-RATC	N/C	PLBK-CMTC
306 INF	N/O	FDIX-DGRP	FDIX	FDIX-RATC	N/C	FSLC-RATC	FSLC-GUTC	FHAM-RATC	PLBK-CMTC	FDIX-GUTC
307 INF	N/O	FDIX-DGRP	FDIX	FDIX	PLBK-CMTC	FSLC-RATC	FDIX	FDIX-GUTC	FDIX-CMTC	FDIX-GUTC
308 INF	N/O	FDIX-DGRP	FDIX	FDIX	FDIX-RATC	FSLC-RATC	PLBK-CMTC	FDIX-GUTC	FHAM-RATC	FDIX-GUTC
309 INF	N/O	FDIX-DGRP	FDIX	FDIX	FDIX-RATC	FSLC	FWAD	N/C	FWAD-RATC	FDIX-CMTC
310 INF	N/O	FDIX-DGRP	FDIX	FDIX	Sea Girt	PLBK-CMTC	N/C	PLBK-CMTC	N/C	FDIX-GUTC
311 INF	N/O	FDIX-DGRP	FDIX	FDIX	FDIX-RATC	FSLC	FWAD	N/C	PLBK-CMTC	FDIX-GUTC
312 INF	N/O	FDIX-DGRP	FDIX	FDIX-RATC	Sea Girt	FWAD-RATC	N/C	FWAD-RATC	FDIX-CMTC	FDIX-CMTC
313 INF	N/O	EGGM-CMTC	EGGM-DGRP	EGGM-CMTC	N/C	EGGM	N/C	FWAD-RATC	FDIX-CMTC	FWSH-RATC
314 INF	N/O	EGGM-CMTC	EGGM-DGRP	EGGM	EGGM-CMTC	N/C	FWSH	FEUS	EGGM	FEUS-CMTC
315 INF	N/O	EGGM-CMTC	EGGM-DGRP	EGGM-RATC	FEUS-GUTC	FEUS-IND	HOW	EGGM-IND	EGGM-GUTC	N/C
316 INF	N/O	EGGM-CMTC	EGGM-DGRP	EGGM-CMTC	FEUS-IND	FEUS-GUTC	FEUS-GUTC	EGGM-GUTC	EGGM-IND	FEUS-CMTC
317 INF	N/O	EGGM-DGRP	EGGM-DGRP	N/C	EGGM	N/C	FEUS	EGGM-IND	FEUS	EGGM-GUTC
318 INF	N/O	EGGM-DGRP	EGGM-DGRP	N/C	FEUS	EGGM	VA Beach-NG	N/C	FEUS	EGGM-GUTC
319 INF	N/O	EGGM-DGRP	EGGM-DGRP	EGGM	HOW	EGGM	N/C	FEUS-RATC	FEUS	EGGM-GUTC
320 INF	N/O	EGGM-DGRP	EGGM-DGRP	EGGM	EGGM	FEUS	N/C	HOW/FWSH	FEUS	EGGM-GUTC
321 INF	N/O	FMCL-DGRP	FMCL-DGRP	FMCL	EBRG-MOB	FMPH	FMOU-RATC	FMOU-RATC	EBRG-GUTC	N/C
322 INF	N/O	FMCL-DGRP	FMCL-DGRP	FMCL	FMCL-GUTC	FMOU	FBRG-GUTC	FMOU-RATC	FBRG-GUTC	FMOU-RATC
323 INF	N/O	FMCL-DGRP	FMCL-DGRP	FMCL-CMTC	FOGL	FMPH	FOGL-GUTC	FMPH-RATC	FMOU-RATC	FMOU-RATC
324 INF	N/O	FMCL-DGRP	FMCL-DGRP	FMCL	FMPH	FMCL	FOGL-GUTC	FMPH-RATC	FMOU-RATC	FMOU-RATC

Infantry Training Camps 1921 – 1930

Regiment	1921	1922	1923	1924	1925	1926	1927	1928	1929	1930
325 INF	N/O	FMCL-DGRP	FMCL-DGRP	FMCL	FMCL-DGRP	FSCR	FSCR-RATC	FMPH-RATC	FSCR-RATC	N/C
326 INF	N/O	FMCL-DGRP	FMCL-DGRP	FMCL	FMCL	FMPH	FMPH-GUTC	FMPH-RATC	FMPH-RATC	FMPH-RATC
327 INF	N/O	FMCL-DGRP	FMCL-DGRP	FMCL	FMCL	FMPH	FMPH-GUTC	FMPH-RATC	FMPH-RATC	FMPH-RATC
328 INF	N/O	FMCL-DGRP	FMCL-DGRP	FMCL	FSCR	FSCR	FSCR-RATC	FSCR-GUTC	FSCR-GUTC	FSCR-RATC
329 INF	N/O	FKNX-DGRP	FKNX-DGRP	FKNX-DGRP	FTHO	FTHO-RATC	FTHO-CMTC	FTHO-GUTC	FTHO-CMTC	FTHO-CMTC
330 INF	N/O	FKNX-DGRP	FKNX-DGRP	FKNX-CMTC	FKNX	FTHO-RATC	FKNX-RATC	FTHO-GUTC	FTHO-GUTC	FTHO
331 INF	N/O	FKNX-DGRP	FKNX-DGRP	FKNX-CMTC	N/C	FTHO-RATC	FTHO-GUTC	FTHO-GUTC	FTHO-GUTC	FTHO
332 INF	N/O	FKNX-DGRP	FKNX-DGRP	FKNX-DGRP	FTHO	FTHO-RATC	FTHO-GUTC	FTHO-CMTC	FTHO-CMTC	FTHO
333 INF	N/O	FKNX-DGRP	FKNX-DGRP	FKNX-DGRP	N/C	FTHO-RATC	FTHO-GUTC	FTHO-GUTC	FTHO-GUTC	FTHO
334 INF	N/O	FKNX-DGRP	CCUS	FKNX-DGRP	N/C	FTHO-RATC	N/C	FTHO-GUTC	FTHO-GUTC	FTHO-RATC
335 INF	N/O	FKNX-DGRP	FKNX-DGRP	FKNX-DGRP	N/C	FTHO-RATC	Culver-LUTC	Culver-LUTC	FKNX-CMTC	Culver-LUTC
336 INF	N/O	FKNX-DGRP	FKNX-DGRP	FKNX-DGRP	FKNX-CMTC	FTHO-RATC	Culver-LUTC	Culver-LUTC	FKNX-CMTC	Culver-LUTC
337 INF	N/O	CCUS-DGRP	N/C	CCUS-GUTC	N/C	CCUS-GUTC	N/C	Grayling-NG	CCUS	CCUS
338 INF	N/O	CCUS-DGRP	N/C	CCUS-GUTC	CCUS-RATC	N/C	CCUS-GUTC	Grayling-NG	CCUS	CCUS
339 INF	N/O	CCUS-DGRP	N/C	CCUS-CMTC	SELF	N/C	CCUS-GUTC	CCUS-CMTC	CCUS	CCUS
340 INF	N/O	CCUS-DGRP	N/C	CCUS	CCUS	N/C	CCUS-GUTC	CCUS-CMTC	Grayling-NG	CCUS
341 INF	N/O	CCUS-DGRP	CCUS-DGRP	CCUS-GUTC	N/C	N/C	CCUS-GUTC	CCUS-CMTC	Grayling-NG	CCUS
342 INF	N/O	CCUS-DGRP	CCUS-DGRP	CCUS-DGRP	N/C	JFBK-GUTC	FSHN-GUTC	N/C	FSHN-GUTC	FSHN-CMTC
343 INF	N/O	CCUS-DGRP	CCUS-DGRP	CCUS-RATC	N/C	JFBK-GUTC	FSHN-GUTC	N/C	FSHN-GUTC	Grant-NG
344 INF	N/O	CCUS-DGRP	CCUS-DGRP	N/C	CCUS	Peoria	N/C	JFBK-CMTC	JFBK-CMTC	Peoria-Tank
345 INF	N/O	FMCL-DGRP	FMCL-DGRP	FMCL	FMPH-GUTC	N/C	JFBK-GUTC	JFBK-GUTC	JFBK-CMTC	Peoria-Tank
346 INF	N/O	FMCL-DGRP	FMCL-DGRP	FMPH	FMPH-GUTC	FMPH	FMPH-RATC	FMPH-RATC	FMCL-GUTC	FMCL-RATC
347 INF	N/O	FMCL-DGRP	FMCL-DGRP	FMCL	FMPH-GUTC	FMPH	FMCL-GUTC	FMPH-RATC	FMCL-GUTC	N/C
348 INF	N/O	FMCL-DGRP	FMCL-DGRP	FMCL	FMCL-MOB	FMPH	FMPH-RATC	FMPH-RATC	FMPH-RATC	BEAU-CMTC
349 INF	N/O	FSNL-DGRP	Unknown	RIA-GUTC	EMOU	FMCL	FMCL-GUTC	FSCR-GUTC	FMPH-RATC	FMCL-RATC
350 INF	N/O	FSNL-DGRP	Unknown	FSNL-DGRP	FSNL	FSNL	FDM-CMTC	FDM-CMTC	FDM-CMTC	FSNL-CMTC
351 INF	N/O	FSNL-DGRP	Unknown	FSNL-DGRP	FSNL	FSNL-CMTC	FDM-CMTC	FDM-CMTC	FDM-CMTC	FDM-GUTC
352 INF	N/O	FSNL-DGRP	Unknown	FSNL-GUTC	FSNL	FSNL-RATC	N/C	FSNL-RATC	FSNL-GUTC	FSNL-CMTC
353 INF	N/O	FDM-DGRP	FDM-DGRP	FDM-GUTC	FSNL	N/C	FSNL-RATC	FSNL-RATC	FLCN-CMTC	FLCN-CMTC
354 INF	N/O	FDM-DGRP	FDM-DGRP	FDM-DGRP	FDM	FDM	FCRK	N/C	FCRK-RATC	FCRK-RATC
355 INF	N/O	FDM-DGRP	FDM-DGRP	FDM-GUTC	FCRK-LUTC	LUTC	FCRK	FCRK-CMTC	FCRK-CMTC	FCRK-RATC
356 INF	N/O	FDM-DGRP	FDM-DGRP	FDM-DGRP	FDM	FCRK	FCRK	N/C	FCRK-CMTC	FCRK-RATC
357 INF	N/O	FSH-DGRP	FSH-DGRP	FSH-CMTC	FSH	FSH-RATC	FSH-RATC	FSH-RATC	FSH-RATC	FSH
358 INF	N/O	FSH-DGRP	FSH-DGRP	FSH-DGRP	FSH-CMTC	FSH-RATC	FSH-RATC	FSH-RATC	FSH-RATC	FSH
359 INF	N/O	FSH-DGRP	FSH-DGRP	FSH-DGRP	FCRO	FSH-RATC	FSH-RATC	FSH-RATC	FSH-RATC	FSH
360 INF	N/O	FSH-DGRP	FSH-DGRP	FSH-DGRP	FCRO	FSH-RATC	FSH-RATC	FSH-RATC	FSH-GUTC	FSH
361 INF	N/O	PMON-DGRP	Unknown	DELIM	PSF-CMTC	N/C	DELIM-RATC	DELIM-GUTC	PMON-CMTC	PMON-CMTC
362 INF	N/O	PMON-DGRP	Unknown	PSF	PSF-CMTC	DELIM	DELIM-RATC	DELIM-GUTC	PMON-CMTC	DELIM
363 INF	N/O	PMON-DGRP	Unknown	DELIM	DELIM	PMON	DELIM-GUTC	DELIM-GUTC	PMON-GUTC	PMON-CMTC
364 INF	N/O	PMON-DGRP	Unknown	DELIM	DELIM	DELIM	DELIM-GUTC	DELIM-GUTC	PMON-GUTC	PMON-CMTC
369 INF	N/O	Smith	Smith	Smith	Smith	Smith	Smith	Smith	Smith	Smith
372 INF	N/O	N/O	N/O	N/O	N/O	N/O	N/O	N/O	N/O	N/O
A Co	N/O	Saunders	Saunders	Saunders	Saunders	Saunders	Ritchie	Ritchie	Ritchie	Ritchie
2 Bn	N/O	N/O	N/O	Perry	Perry	Perry	Perry	Perry	Perry	Perry
3 Bn	N/O	FDEV	FDEV	FDEV	FDEV	FDEV	FDEV	FDEV	FDEV	FDEV

Infantry Training Camps 1921 – 1930

Regiment	1921	1922	1923	1924	1925	1926	1927	1928	1929	1930
373 INF	N/O	SAJP	SAJP	SAJP-CMTC	N/C	SAJP-RATC	SAJP-CMTC	SAJP-CMTC	SAJP	SAJP
374 INF	N/O	SAJP	SAJP	N/C	SAJP-RATC	N/C	I/A	I/A	I/A	I/A
375 INF	N/O	SAJP	SAJP	SAJP	N/C	SAJP	I/A	I/A	I/A	I/A
376 INF	N/O	FDEV-DGRP	FDEV-DGRP	FDEV	FDEV	FDEV-GUTC	FDEV-RATC	FDEV-RATC	FDEV-GUTC	FDEV
377 INF	N/O	FSIL-DGRP	FSIL-DGRP	FSIL-DGRP	FSIL	FSIL-RATC	FSIL-CMTC	FSIL-CMTC	FSIL-GUTC	FSIL-CMTC
378 INF	N/O	FSIL-DGRP	FSIL-DGRP	FSIL-DGRP	FSIL	FSIL-DGRP	FSIL-GUTC	FSIL-CMTC	FSIL-CMTC	FSIL
379 INF	N/O	FSIL-DGRP	FSIL-DGRP	FSIL-DGRP	FSIL	FSIL-LUTC	FSIL-GUTC	FSIL-CMTC	FSIL-GUTC	FSIL-CMTC
380 INF	N/O	FSIL-DGRP	FSIL-DGRP	FSIL-DGRP	FSIL	FSIL-CMTC	FSIL-GUTC	FSIL-CMTC	FSIL-CMTC	FSIL
381 INF	N/O	FLEW-DGRP	FLEW-DGRP	FLEW	FLEW	VCBK-RATC	VCBK-RATC	VCBK-RATC	VCBK-RATC	VCBK
382 INF	N/O	FLEW-DGRP	FLEW-DGRP	FLEW	FLEW	N/C	VCBK-RATC	VCBK-RATC	VCBK-RATC	VCBK
383 INF	N/O	FLEW-DGRP	FLEW-DGRP	FLEW	FLEW	N/C	FLAW-GUTC	VCBK-RATC	VCBK-GUTC	VCBK
384 INF	N/O	FLEW-DGRP	FLEW-DGRP	FLEW-DGRP	FGWR-RATC	FGWR-RATC	FGWR-RATC	FGWR-RATC	FGWR-RATC	FGWR-RATC
385 INF	N/O	FDEV-DGRP	FDEV-DGRP	FDEV-CMTC	Providence	N/C	Storrs-GUTC	N/C	FADM-CMTC	N/C
386 INF	N/O	FDEV-DGRP	FDEV-DGRP	N/C	N/C	FMCK	FMCK-RATC	FWMS-GUTC	FWMS-RATC	FWMS-RATC
387 INF	N/O	FDEV-DGRP	FDEV-DGRP	Weirs-LUTC	FMCK	N/C	FEA-CMTC	FWMS-GUTC	FMCK-CMTC	N/C
388 INF	N/O	FDEV-DGRP	FDEV-DGRP	N/C	FEA-GUTC	FMCK-CMTC	FEA-GUTC	FWMS-GUTC	FEA-CMTC	N/C
389 INF	N/O	FDIX-DGRP	FDIX-DGRP	PLBK-CMTC	Wadsworth	FONT-RATC	FNIA-GUTC	FNIA-CMTC	N/C	PLBK-CMTC
390 INF	N/O	FDIX-DGRP	FDIX-DGRP	N/C	FNIA-RATC	N/C	PLBK-CMTC	FNIA-CMTC	FNIA-GUTC	FNIA-CMTC
391 INF	N/O	FDIX-DGRP	FDIX-DGRP	Wadsworth	Wadsworth	FNIA-RATC	FNIA-CMTC	PLBK-CMTC	FNIA-CMTC	FNIA
392 INF	N/O	FDIX-DGRP	FDIX-DGRP	N/C	Wadsworth	FNIA-RATC	FNIA-CMTC	FNIA-GUTC	FNIA-CMTC	FNIA-CMTC
393 INF	N/O	FGGM-DGRP	FGGM-DGRP	FGGM-GUTC	N/C	FEUS	N/C	FWSH	HOW/FWWSH	FGGM-GUTC
394 INF	N/O	FGGM-DGRP	FGGM-DGRP	FGGM-GUTC	FEUS	N/C	HOW	N/C	HOW/FWWSH	FGGM-GUTC
395 INF	N/O	FGGM-DGRP	FGGM-DGRP	FGGM-GUTC	FGGM-CMTC	FGGM	N/C	HOW-GUTC	HOW/FWWSH	FGGM-GUTC
396 INF	N/O	FGGM-DGRP	FGGM-DGRP	FGGM-GUTC	FGGM-CMTC	N/C	FEUS	N/C	HOW/FWWSH	FGGM-GUTC
397 INF	N/O	FKNX-DGRP	FKNX-DGRP	FKNX-DGRP	N/C	FTHO-RATC	FTHO-RATC	FTHO-CMTC	FTHO	N/C
398 INF	N/O	FKNX-DGRP	FKNX-DGRP	FKNX-DGRP	Nitro-LUTC	Nitro-LUTC	FTHO-RATC	FTHO-CMTC	FTHO	FTHO-CMTC
399 INF	N/O	FKNX-DGRP	FKNX-DGRP	FKNX-DGRP	N/C	FTHO-RATC	FTHO-RATC	FTHO-CMTC	FTHO	N/C
400 INF	N/O	FKNX-DGRP	FKNX-DGRP	FKNX-DGRP	FBH-RATC	FBH-RATC	FTHO-RATC	FKNX-RATC	FTHO	FKNX-CMTC
401 INF	N/O	CCUS-DGRP	CCUS-DGRP	CCUS-GUTC	N/C	FSHN-GUTC	N/C	FSHN-CMTC	CCUS	Williams-NG
402 INF	N/O	CCUS-DGRP	CCUS-DGRP	N/C	N/C	FSHN-GUTC	Douglas-NG	N/C	FBDY-CMTC	FSHN
403 INF	N/O	CCUS-DGRP	CCUS-DGRP	N/C	CCUS	N/C	Douglas-NG	FSHN-GUTC	N/C	Williams-NG
404 INF	N/O	CCUS-DGRP	CCUS-DGRP	CCUS-RATC	N/C	FBDY	N/C	Williams-NG	FSHN-GUTC	FSHN
405 INF	N/O	JFBK-DGRP	JFBK-DGRP	FLVN-DGRP	FLVN	LUTC	FLVN	FLVN	Pike-NG	Pike-NG
406 INF	N/O	JFBK-DGRP	JFBK-DGRP	FLVN-DGRP	N/C	FLVN-RATC	N/C	FLVN-CMTC	FLVN-CMTC	FRK-GUTC
407 INF	N/O	JFBK-DGRP	JFBK-DGRP	FLVN-DGRP	FLVN	N/C	N/C	FLVN-CMTC	FLVN-CMTC	FRK-GUTC
408 INF	N/O	JFBK-DGRP	JFBK-DGRP	FLVN-DGRP	FLVN	FLVN-CMTC	FLVN	FLVN	FRK-NG	FLVN-CMTC
409 INF	N/O	Unknown	Unknown	Unknown	CSDL	CSDL-RATC	CSDL-RATC	CSDL-RATC	FHUA-RATC	CSDL-RATC
410 INF	N/O	Unknown	Unknown	Unknown	FLOG	CSDL-RATC	CSDL-RATC	CSDL-RATC	CSDL-RATC	CSDL-RATC
411 INF	N/O	FLOG-DGRP	Unknown	Unknown	FLOG	FLOG-RATC	FLOG-RATC	FDAR-RATC	FDAR-RATC	FEW-GUTC
412 INF	N/O	FLOG-DGRP	Unknown	Unknown	FLOG	FLOG-RATC	FLOG-RATC	FDAR-RATC	FDAR-RATC	FEW-GUTC
413 INF	N/O	FDOU-DGRP	Unknown	Unknown	N/C	FDOU-RATC	FDOU-RATC	FDOU-RATC	FDOU	FDOU-RATC
414 INF	N/O	FDOU-DGRP	Unknown	Unknown	N/C	N/C	FDOU-RATC	FDOU-RATC	FDOU	FDOU-RATC
415 INF	N/O	FDOU-DGRP	Unknown	Unknown	N/C	FDOU-RATC	FDOU-RATC	FDAR-RATC	FDAR-GUTC	FEW-GUTC
416 INF	N/O	FDOU-DGRP	Unknown	Unknown	FMIS	FMIS-RATC	FMIS-RATC	FMIS-RATC	FMIS-RATC	FMIS-RATC
417 INF	N/O	FDEV-DGRP	FDEV-DGRP	FDEV-GUTC	FDEV-GUTC	Storrs-LUTC	Storrs-LUTC	FDEV-GUTC	N/C	FADM-RATC

Infantry Training Camps 1921 – 1930

Regiment	1921	1922	1923	1924	1925	1926	1927	1928	1929	1930
418 INF	N/O	FDEV-DGRP	FDEV-DGRP	FDEV-GUTC	FDEV	Bridgeport-LUTC	Bridgeport-LUTC	Storrs-GUTC	FADM-CMTC	N/C
419 INF	N/O	FDEV-DGRP	FDEV-DGRP	FDEV	N/C	FDEV-GUTC	FDEV-RATC	FDEV-RATC	FDEV-GUTC	FDEV-GUTC
420 INF(LT)										
421 INF(LT)										
422 INF(LT)										
423 INF(LT)										
424 INF(LT)										
425 INF(LT)										
426 INF(LT)										
428 INF	N/O	N/O	N/O	N/C	N/C	FDEV-NG	Smith-NG	N/C	N/C	N/C
429 INF	N/O	N/O	N/O	N/C	N/C	N/C	Smith-NG	N/C	N/C	N/C
447 INF	N/O	N/O	N/O	N/C	N/C	N/C	N/C	N/C	N/C	N/C
448 INF	N/O	N/O	N/O	N/C	N/C	N/C	N/C	N/C	N/C	N/C
449 INF	N/O	N/O	N/O	N/C	N/C	Perry	N/C	N/C	N/C	Perry-NG
450 INF	N/O	N/O	N/O	N/C	N/C	N/C	N/C	N/C	N/C	N/C
451 INF	N/O	N/O	N/O	N/C	N/C	FLVN-GUTC	FLVN	N/C	N/C	N/C
452 INF	N/O	N/O	N/O	N/C	FLVN	N/C	FLVN	N/C	N/C	N/C
453 INF	N/O	N/O	N/O	N/C	FLVN	LUTC	FLVN	N/C	N/C	N/C
454 INF	N/O	N/O	N/O	N/C	N/C	N/C	N/C	N/C	N/C	N/C
455 INF	N/O	N/O	N/O	N/O	N/O	N/O	N/O	N/O	N/C	N/C
18 Tank Bn	N/O	I/A	I/A	I/A	I/A	N/C	N/C	FGGM	N/C	N/C
19 Tank Bn	N/O	N/O	N/O	N/O	N/O	N/C	FGGM	FGGM	N/C	N/C
8 Tank Gp	N/O	N/C	N/C	N/C	N/C	N/C	N/C	N/C	FTHO-GUTC	N/C
9 Tank Gp	N/O	N/C	N/C	CCUS-GUTC	FGGM-GUTC	N/C	Peoria	Peoria	Peoria	N/C
507 INF BN				N/C	N/C	N/C	FBDY	N/C	D/B 5 Sep 28	
509 INF BN				N/C	N/C	VGBK-GUTC	N/C	N/C	D/B 5 Sep 28	
512 INF BN				N/C	N/C	FDEV	N/C	N/C	D/B 5 Sep 28	
516 INF BN				N/C	N/C	N/C	SAJP	SAJP	SAJP	SAJP
530 INF BN				N/C	N/C	N/C	FBDY	FBDY	D/B 5 Sep 28	
531 INF BN				N/C	N/C	N/C	JFBK-GUTC	JFBK-GUTC	D/B 5 Sep 28	
532 INF BN				N/C	N/C	N/C	JFBK-GUTC	JFBK-GUTC	D/B 5 Sep 28	
533 INF BN				N/C	N/C	N/C	FSHN-GUTC	FSHN-GUTC	D/B 5 Sep 28	
536 INF BN				N/C	N/C	FLVN-GUTC	N/C	FLVN-GUTC	D/B 5 Sep 28	
537 INF BN				N/C	N/C	N/C	FLVN-GUTC	N/C	D/B 5 Sep 28	
542 INF BN				N/C	N/C	DELM	N/C	N/C	D/B 5 Sep 28	
544 INF BN				N/C	N/C	VBRK-GUTC	VBRK-GUTC	N/C	D/B 5 Sep 28	

Infantry 1931 – 1940											
Regiment	1931	1932	1933	1934	1935	1936	1937	1938	1939	1940	
32 INF	DELM	PMON-GUTC	PMON-GUTC	PMON-GUTC	PMON-GUTC	PMON-GUTC	FORD-GUTC	FORD-GUTC	PMON-CMTC	FLEW-MAN	
36 INF	N/C	FDIX	FDIX	FDIX-GUTC	FDIX-GUTC	FDIX-GUTC	FDIX-GUTC	FDIX-GUTC	FNIA-CMTC	FDIX-GUTC	
37 INF	N/C	FDIX	FDIX	FDIX-GUTC	N/C	FDIX-GUTC	FDIX-GUTC	FDIX-GUTC	FDIX-CMTC	FNIA-CMTC	
39 INF	N/C	N/C	N/C	FMOU-GUTC	FMOU-CMTC	FMOU-GUTC	FMOU-RATC	DeSoto-MAN	FMPH-GUTC	FMOU-CMTC	
40 INF	N/C	FNIA	FNIA	FNIA-RATC	FNIA-GUTC	FDIX	FDIX-GUTC	FDIX-GUTC	PLBK-GUTC	FDIX-GUTC	
41 INF	N/C	FNIA	FNIA	FNIA-RATC	FDIX-GUTC	FDIX	FDIX-GUTC	FNIA-CMTC	FNIA-CMTC	FDIX-GUTC	
42 INF	SAJP	CBUC	SAJP	N/C	CBUC-CMTC	CBUC-CMTC	CBUC-CMTC	CBUC-CMTC	CBUC-CMTC	EMIL-CMTC	
47 INF	N/C	N/C	N/C	FMPH-IND	FMPH-RATC	BEAU-CMTC	FMPH-GUTC	BEAU-CMTC	FSCR-RATC	BEAU-CMTC	
51 INF	N/C	FSHN-GUTC	N/C	N/C	CCUS-CMTC	CCUS-MAN	FSHN-CMTC	FSHN-GUTC	FSHN-CMTC	McCoy-MAN	
52 INF	N/C	FSHN-GUTC	N/C	N/C	N/C	CCUS-MAN	FSHN-CMTC	JFBK-CMTC	CCUS-GUTC	CCUS-CMTC	
53 INF	FSNL-GUTC	FSNL-CMTC	N/C	FSNL-CMTC	FSNL-CMTC	FSNL-CMTC	FSNL-CMTC	FSNL-CMTC	FSNL-CMTC	FSNL-GUTC	
54 INF	FCRK-GUTC	FCRK-CMTC	N/C	FCRK-GUTC	FCRK-CMTC	FCRK-CMTC	FCRK-CMTC	FCRK-CMTC	FCRK-GUTC	FCRK-GUTC	
60 INF	FBH-GUTC	FKNX	FKNX-CMTC	FKNX-GUTC	N/C	FSNL-RATC	FBH-CMTC	FKNX-GUTC	N/C	FBH-CMTC	
61 INF	FTHO-GUTC	FKNX-GUTC	N/C	FKNX-GUTC	N/C	FBNG-CMTC	N/C	FKNX-GUTC	N/C	FBH-CMTC	
67 INF	N/C	N/C	N/C	N/C	N/C	N/C	FBNG-GUTC	N/C	N/C	N/C	
68 INF	N/C	N/C	N/C	N/C	N/C	RIA-GUTC	N/C	JFBK-GUTC	JFBK-GUTC	FLEW-MAN	
69 INF	N/C	N/C	N/C	N/C	FSNL-CMTC	FSNL-GUTC	FSNL-CMTC	FSNL-GUTC	FSNL-GUTC	FSNL-GUTC	
1 VA INF	VA Beach	VA Beach	VA Beach	VA Beach	Ind Gap-MAN	VA Beach	VA Beach	VA Beach	MNVA-MAN	NNYS-MAN	
1 MD INF	Ritchie	Ritchie	Ritchie	Ritchie	Ind Gap-MAN	Ritchie	Ritchie	Ritchie	MNVA-MAN	NNYS-MAN	
5 MD INF	Ritchie	Ritchie	Ritchie	Ritchie	Ind Gap-MAN	Ritchie	Ritchie	Ritchie	MNVA-MAN	NNYS-MAN	
8 IL INF	Grant	Grant	Grant	Grant	Grant	CCUS-MAN	Grant	Grant	Grant	McCoy	
10 NY INF	Smith	Smith	Smith	Smith	Smith	Smith	Smith	Smith	Smith	NNYS-MAN	
14 NY INF	Smith	Smith	Smith	Smith	Pine Cp-MAN	Smith	Smith	Smith	PLBK-MAN	NNYS-MAN	
71 NY INF	Smith	Smith	Smith	Smith	Smith	Smith	Smith	Smith	PLBK-MAN	NNYS-MAN	
101 INF	FDEV	FDEV	FDEV	FDEV	Pine Cp-MAN	Edwards	Edwards	Edwards	PLBK-MAN	NNYS-MAN	
102 INF	Niantic	Niantic	Niantic	Niantic	Pine Cp-MAN	Niantic	Edwards	Edwards	PLBK-MAN	NNYS-MAN	
103 INF	Keyes	Keyes	Keyes	Keyes	Pine Cp-MAN	Keyes	Keyes	Keyes	PLBK-MAN	NNYS-MAN	
104 INF	FDEV	FDEV	FDEV	FDEV	Pine Cp-MAN	Edwards	Edwards	Edwards	PLBK-MAN	NNYS-MAN	
105 INF	Smith	Smith	Smith	Smith	Pine Cp-MAN	Smith	Smith	Smith	PLBK-MAN	NNYS-MAN	
106 INF	Smith	Smith	Smith	Smith	Smith	Smith	Smith	Pine Cp	Smith	NNYS-MAN	
107 INF	Smith	Smith	Smith	Smith	Smith	Smith	Pine Cp	Smith	PLBK-MAN	NNYS-MAN	
108 INF	Smith	Smith	Smith	Smith	Smith	Smith	Smith	Smith	Smith	NNYS-MAN	
109 INF	Mt Gretna	Mt Gretna	Mt Gretna	Mt Gretna	Ind Gap-MAN	Ind Gap	Ind Gap	Ind Gap	MNVA-MAN	NNYS-MAN	
110 INF	Mt Gretna	Mt Gretna	Mt Gretna	Mt Gretna	Ind Gap-MAN	Ind Gap	Ind Gap	Ind Gap	MNVA-MAN	NNYS-MAN	
111 INF	Mt Gretna	Mt Gretna	Mt Gretna	Mt Gretna	Ind Gap-MAN	Ind Gap	Ind Gap	Ind Gap	MNVA-MAN	NNYS-MAN	
112 INF	Mt Gretna	Mt Gretna	Mt Gretna	Mt Gretna	Ind Gap-MAN	Ind Gap	Ind Gap	Ind Gap	MNVA-MAN	NNYS-MAN	
113 INF	Sea Girt	Sea Girt	Sea Girt	Sea Girt	Pine Cp-MAN	Sea Girt	Sea Girt	Sea Girt	PLBK-MAN	NNYS-MAN	
114 INF	Sea Girt	Sea Girt	Sea Girt	Sea Girt	Pine Cp-MAN	Sea Girt	Sea Girt	Sea Girt	PLBK-MAN	NNYS-MAN	
115 INF	N/C	N/C	N/C	N/C	N/C	N/C	N/C	N/C	N/C	N/C	
116 INF	VA Beach	VA Beach	VA Beach	VA Beach	Ind Gap-MAN	VA Beach	VA Beach	VA Beach	MNVA-MAN	NNYS-MAN	
117 INF	Peay	Peay	Peay	Peay	Peay	CJAC	CJAC	Desoto-MAN	CJAC	KNLA-MAN	
118 INF	CJAC	CJAC	CJAC	CJAC	CJAC	Foster	CJAC	Desoto-MAN	CJAC	KNLA-MAN	
120 INF	Glenn	Glenn	Glenn	Glenn	Glenn	CJAC	CJAC	Desoto-MAN	CJAC	KNLA-MAN	
121 INF	Foster	Foster	Foster	Foster	Foster	Foster	CJAC	Desoto-MAN	CJAC	KNLA-MAN	

Infantry 1931 – 1940

Regiment	1931	1932	1933	1934	1935	1936	1937	1938	1939	1940
122a INF										
122b INF	FMCL	FMCL	FMCL	FMCL	FMCL	FMCL	FMCL	Desoto-MAN	FMCL	KNLA-MAN
124 INF	Foster	Foster	Foster	Foster	Foster	FMCL	FMCL	Desoto-MAN	Foster	KNLA-MAN
125 INF	Grayling	Grayling	Grayling	Grayling	Grayling	CCUS-MAN	Grayling	Grayling	Grayling	McCoy
126 INF	Grayling	Grayling	Grayling	Grayling	Grayling	CCUS-MAN	Grayling	Grayling	Grayling	McCoy
127 INF	Williams	Williams	Williams	Williams	Williams	CCUS-MAN	Williams	Williams	Williams	McCoy
128 INF	Williams	Williams	Williams	Williams	Williams	CCUS-MAN	Williams	Williams	Williams	McCoy
129 INF	Grant	Grant	Grant	Grant	Grant	CCUS-MAN	Grant	Grant	Grant	McCoy
130 INF	Grant	Grant	Grant	Grant	Grant	CCUS-MAN	Grant	Grant	Grant	McCoy
131 INF	Grant	Grant	Grant	Grant	Grant	CCUS-MAN	Grant	Grant	Grant	McCoy
132 INF	Grant	Grant	Grant	Grant	Grant	CCUS-MAN	Grant	Grant	Grant	McCoy
133 INF	Dodge	Dodge	Dodge	Dodge	Dodge	Dodge	Ripley-MAN	Dodge	Dodge	Ripley
134 INF	Ashland	Ashland	Ashland	Ashland	Ashland	Ashland	FRK-MAN	Ashland	Ashland	Ripley
135 INF	Ripley	Ripley	Ripley	Ripley	Ripley	Ripley	Ripley-MAN	Ripley	Ripley	Ripley
137 INF	FRK	FRK	FRK	FRK	FRK	FRK	FRK-MAN	FRK	FRK	Ripley
138 INF	Clark	Clark	Clark	Clark	Clark	Clark	FRK-MAN	Clark	Clark	Ripley
140 INF	Clark	Clark	Clark	Clark	Clark	Clark	FRK-MAN	Clark	Clark	Ripley
141 INF	Hulen	Hulen	Hulen	Hulen	Hulen	Hulen	Hulen	CBUL-MAN	Hulen	Ripley
142 INF	Hulen	Hulen	Hulen	Hulen	Hulen	Hulen	Hulen	CBUL-MAN	Hulen	KNLA-MAN
143 INF	Hulen	Hulen	Hulen	Hulen	Hulen	Hulen	Hulen	CBUL-MAN	Hulen	KNLA-MAN
144 INF	Hulen	Hulen	Hulen	Hulen	Hulen	Hulen	Hulen	CBUL-MAN	Hulen	KNLA-MAN
145 INF	Perry	Perry	Perry	Perry	Perry	FKNX-MAN	Perry	Perry	Perry	McCoy
147 INF	Perry	Perry	Perry	Perry	Perry	FKNX-MAN	Perry	Perry	Perry	McCoy
148 INF	Perry	Perry	Perry	Perry	Perry	FKNX-MAN	Perry	Perry	Perry	McCoy
149 INF	FKNX	FKNX	FKNX	FKNX	FKNX	FKNX	FKNX	FKNX	FKNX	McCoy
150 INF	Conley	Conley	Conley	Conley	Conley	FKNX-MAN	Conley	Conley	Conley	McCoy
151 INF	FKNX	FKNX	FKNX	FKNX	FKNX	FKNX-MAN	FKNX	FKNX	FKNX	McCoy
152 INF	FKNX	FKNX	FKNX	FKNX	FKNX	FKNX-MAN	FKNX	FKNX	FKNX	McCoy
153 INF	Pike	Pike	Pike	Pike	Pike	Pike	FRK-MAN	CJTR	CJTR	CJTR
154 INF										
155 INF	BEAU	BEAU	BEAU	BEAU	BEAU	BEAU	Shelby	Desoto-MAN	Shelby	KNLA-MAN
156 INF	BEAU	BEAU	BEAU	BEAU	BEAU	BEAU	BEAU	Desoto-MAN	BEAU	KNLA-MAN
157 INF	West	West	West	West	West	West	West	FFEW-MAN	West	KNLA-MAN
158 INF	Tuthill	Tuthill	Tuthill	Tuthill	Tuthill	Tuthill	Tuthill	FHUA-MAN	Tuthill	KNLA-MAN
159 INF	DELM	DELM	DELM	DELM	DELM	DELM	SLO-MAN	SLO	DELM	FLEW
160 INF	SLO	SLO	SLO	SLO	SLO	SLO	SLO-MAN	SLO	SLO	FLEW
161 INF	Murray	Murray	Murray	Murray	Murray	Murray	FLEW-MAN	Murray	Murray	FLEW
162 INF	Clatsop	Clatsop	Clatsop	Clatsop	Clatsop	Clatsop	FLEW-MAN	Murray	Clatsop	FLEW
163 INF	FWHH	FWHH	FWHH	FWHH	FWHH	FWHH	FLEW-MAN	Murray	FWHH	FLEW
164 INF	Grafton	Grafton	Grafton	Grafton	Grafton	Grafton	Ripley-MAN	Grafton	Grafton	FLEW
165 INF	Smith	Smith	Smith	Smith	Smith	Smith	Smith	Smith	PLBK-MAN	NNYS-MAN
166 INF	Perry	Perry	Perry	Perry	Perry	FKNX-MAN	Perry	Perry	Perry	McCoy
167 INF	FMCL	FMCL	FMCL	FMCL	FMCL	FMCL	FMCL	Desoto-MAN	Foster	KNLA-MAN
168 INF	Dodge	Dodge	Dodge	Dodge	Dodge	Dodge	Ripley-MAN	Dodge	Dodge	Ripley
169 INF	Niantic	Niantic	Niantic	Niantic	Niantic	Niantic	Niantic	Niantic	PLBK-MAN	NNYS-MAN

Regiment	Infantry 1931 – 1940											
	1931	1932	1933	1934	1935	1936	1937	1938	1939	1940		
170 INF												
172 INF	FEA	FEA	FEA	FEA	Pine Cp-MAN	FEA	FEA	FEA	PLBK-MAN	NNYS-MAN		
174 INF	Smith	Smith	Smith	Smith	Pine Cp-MAN	Smith	Smith	Smith	PLBK-MAN	NNYS-MAN		
177 INF												
179 INF	FSIL	FSIL	FSIL	FSIL	FSIL	FSIL	FSIL	FSIL	FSIL	KNLA-MAN		
180 INF	FSIL	FSIL	FSIL	FSIL	FSIL	FSIL	FSIL	FSIL	FSIL	KNLA-MAN		
181 INF	FDEV	FDEV	FDEV	FDEV	Pine Cp-MAN	Edwards	Edwards	Edwards	Edwards	NNYS-MAN		
182 INF	FDEV	FDEV	FDEV	FDEV	Pine Cp-MAN	Edwards	Edwards	Edwards	Edwards	NNYS-MAN		
183 INF												
184 INF	DELM	DELM	DELM	DELM	DELM	DELM	SLO-MAN	DELM	DELM	FLEW		
185 INF	DELM	DELM	DELM	DELM	DELM	DELM	SLO-MAN	DELM	DELM	FLEW		
186 INF	Clatsop	Clatsop	Clatsop	Clatsop	Clatsop	Clatsop	FLEW-MAN	Clatsop	Clatsop	FLEW		
200 INF	I/A	I/A	I/A	I/A	I/A	I/A	I/A	I/A	I/A	I/A		
201 INF	Dawson	Dawson	Dawson	Dawson	Dawson	FKNX-MAN	Dawson	Dawson	Dawson	McCoy		
205 INF	Ripley	Ripley	Ripley	Ripley	Ripley	Ripley	Ripley-MAN	Ripley	Ripley	Ripley		
206 INF	Ripley	Ripley	Ripley	Ripley	Ripley	Ripley	Ripley-MAN	Ripley	Ripley	Ripley		
295 INF	Ponce	Yauco	Aricebo	Aricebo	Aricebo	Aricebo	Aricebo	S. Isabel	Aricebo	Vega Baja		
296 INF	Ponce	Yauco	Aricebo	Aricebo	Aricebo	Aricebo	Aricebo	S. Isabel	Aricebo	Vega Baja		
297 INF	N/O	N/O	N/O	N/O	N/O	N/O	N/O	N/O	N/O	N/O		
298 INF	SCBK	SCBK	FKAM	Coco Head	SCBK	Kawathapal	SCBK	SCBK	SCBK	SCBK		
299 INF	Kliauea	Paukukalo	Paukukalo	Paukukalo	Paukukalo	Paukukalo	Paukukalo	Paukukalo/Lihue	Paukukalo	Paukukalo		
301 INF	FDEV-GUTC	N/C	Unknown	N/C	FDEV-GUTC	FDEV-GUTC	FDEV-GUTC	FDEV-GUTC	FDEV-GUTC	N/C		
302 INF	FDEV-GUTC	N/C	Unknown	N/C	FDEV-CMTC	N/C	FMCK-CMTC	N/C	FEA-GUTC	N/C		
303 INF	N/C	N/C	FDEV-COC	FDEV-COC	Keyes-LUTC	N/C	N/C	FMCK-CMTC	N/C	FMCK-CMTC		
304 INF	FADM-GUTC	FADM-GUTC	FDEV-COC	FDEV-COC	N/C	FDEV	N/C	FDEV-CMTC	N/C	FDEV-CMTC		
305 INF	FDIX-GUTC	FDIX-CMTC	FDIX	FDIX-GUTC	FDIX-CMTC	PLBK-CMTC	FDIX-CPX	FDIX-CMTC	FDIX-GUTC	FDIX-DGRP		
306 INF	FDIX-GUTC	FDIX-CMTC	FDIX	FDIX-CMTC	FDIX-RATC	PLBK-CMTC	FDIX-CPX	FDIX-CMTC	FDIX-GUTC	PLBK-CMTC		
307 INF	FDIX-CMTC	FDIX-GUTC	FDIX	FDIX-CMTC	FDIX-RATC	FNIA-CMTC	FDIX-CPX	PLBK-CMTC	FDIX-GUTC	FDIX-DGRP		
308 INF	PLBK-CMTC	FDIX-GUTC	FDIX	FDIX-GUTC	FDIX-CMTC	FDIX-RATC	FDIX-CPX	PLBK-CMTC	FDIX-GUTC	FDIX-DGRP		
309 INF	FDIX	FDIX-GUTC	PLBK-CMTC	FDIX-GUTC	N/C	FDIX-RATC	FNIA-CMTC	FDIX-CMTC	FDIX-CMTC	FDIX-GUTC		
310 INF	FDIX-CMTC	FDIX-GUTC	FDIX	FDIX-GUTC	N/C	FDIX-RATC	FDIX-GUTC	FDIX-DGRP	FDIX-CMTC	FDIX-GUTC		
311 INF	FDIX	FDIX-GUTC	PLBK-CMTC	FDIX-GUTC	N/C	FDIX-CMTC	FDIX-CMTC	FDIX-DGRP	PLBK-CMTC	FDIX-GUTC		
312 INF	PLBK-CMTC	FDIX-GUTC	FDIX-CMTC	N/C	FDIX-CPX	FDIX-CMTC	FDIX-CMTC	FDIX-DGRP	PLBK-CMTC	FDIX-GUTC		
313 INF	FGGM-GUTC	FGGM-SA	FHOW-CMTC	FEUS-CMTC	FGGM-SA	FGGM-GUTC	FGGM-CMTC	FGGM-SMT	FGGM-SMT	FGGM-CMTC		
314 INF	FGGM-GUTC	FGGM-SA	VFMA-LUTC	FEUS-CMTC	FGGM-SA	FGGM-GUTC	FGGM-CMTC	FGGM-CPX	FGGM-SMT	FGGM-CPX		
315 INF	FEUS-CMTC	FGGM-SA	FGGM-CMTC	FGGM-CMTC	FGGM-SA	FGGM-GUTC	N/C	FGGM-CPX	FGGM-RATC	FGGM-CMTC		
316 INF	FEUS-CMTC	FGGM-SA	VFMA-LUTC	FGGM-CMTC	FGGM-SA	FGGM-GUTC	FGGM-CMTC	FGGM-CPX	FGGM-RATC	FGGM-CMTC		
317 INF	FGGM-GUTC	FWSH-CMTC	FGGM	FGGM-STE	FGGM-SA	FGGM-GUTC	FGGM-CPX	FGGM-RATC	FGGM-CMTC	FGGM-CPX		
318 INF	FGGM-GUTC	FGGM-CMTC	FGGM	FGGM-STE	FGGM-SA	FGGM-GUTC	FGGM-CPX	FGGM-RATC	FGGM-GUTC	FGGM-CPX		
319 INF	FGGM-GUTC	FHOW-CMTC	FGGM	FGGM-STE	FGGM-SA	FGGM-GUTC	FGGM-CPX	FGGM-RATC	FGGM-GUTC	FGGM-CPX		
320 INF	FGGM-GUTC	FGGM-CMTC	FGGM	FGGM-STE	FGGM-SA	FGGM-GUTC	FGGM-CPX	FGGM-RATC	FGGM-GUTC	FGGM-CPX		
321 INF	FMOU-CMTC	FMOU-RATC	FBRG-GUTC	FMOU-GUTC	FMOU-CMTC	FMOU-CMTC	FMOU-CMTC	DeSoto-MAN	FMPH-GUTC	FMOU-CMTC		
322 INF	FMOU-GUTC	FMOU-RATC	FBRG-GUTC	FMOU-GUTC	FMOU-CMTC	FMOU-CMTC	FMPH-GUTC	FMOU-CMTC	FMPH-RATC	FMOU-GUTC		
323 INF	N/C	FMOU-CMTC	FBRG-GUTC	FMOU-RATC	BEAU-CMTC	FMOU-CMTC	FMOU-RATC	DeSoto-MAN	FMPH-GUTC	FMOU-CMTC		

Infantry 1931 – 1940

Regiment	1931	1932	1933	1934	1935	1936	1937	1938	1939	1940
324 INF	FMCL-GUTC	BEAU-CMTC	FBRG-GUTC	FMOU-RATC	BEAU-CMTC	FMCL-DGRP	FMCL-RATC	BEAU-CMTC	FMPH-RATC	FMCL-GUTC
325 INF	BEAU-CMTC	FSCR-RATC	FSCR-GUTC	FSCR-CMTC	FMPH-RATC	FMOU-CMTC	FMPH-GUTC	DeSoto-MAN	FSCR-CMTC	FBNG-GUTC
326 INF	FSCR-RATC	FSCR-RATC	EMPH	EMPH-RATC	FMPH-RATC	FSCR-CMTC	FMPH-GUTC	DeSoto-MAN	FSCR-RATC	FSCR-CMTC
327 INF	FMPH-GUTC	FMOU-GUTC	FMOU-GUTC	FSCR-GUTC	FSCR-CMTC	FMPH-DGRP	FMOU-RATC	DeSoto-MAN	FMOU-RATC	FMOU-CMTC
328 INF	FMPH-RATC	FMPH-RATC	FSCR-GUTC	FSCR-RATC	FSCR-CMTC	FBNG-GUTC	FSCR-CMTC	DeSoto-MAN	FSCR-RATC	FSCR-CMTC
329 INF	FBH	FKNX-GUTC	N/C	FTHO-CMTC	N/C	FKNX-GUTC	FBH-CMTC	FBH-CMTC	N/C	FKNX-GUTC
330 INF	FTHO-CMTC	N/C	FKNX-GUTC	N/C	FKNX-GUTC	FBH-CMTC	N/C	FBH-CMTC	FKNX-GUTC	FKNX-GUTC
331 INF	FBH	FBH-CMTC	N/C	FKNX-GUTC	FBH-CMTC	N/C	FKNX-GUTC	FBH-CMTC	FKNX-GUTC	FKNX-GUTC
332 INF	FBH	N/C	FKNX-CMTC	FTHO-CMTC	N/C	FBH-CMTC	N/C	FKNX-GUTC	FBH-CMTC	FKNX-GUTC
333 INF	Culver-LUTC	FKNX-CMTC	N/C	FBH-GUTC	N/C	FBH-CMTC	N/C	FBH-CMTC	N/C	FKNX-GUTC
334 INF	FBH-CMTC	N/C	FBH-GUTC	EKNX-GUTC	FBH-CMTC	N/C	FBH-CMTC	N/C	FKNX-GUTC	FBH-CMTC
335 INF	Culver-LUTC	FBH-GUTC	N/C	FBH-CMTC	N/C	FKNX-GUTC	N/C	FBH-CMTC	FKNX-GUTC	FKNX-GUTC
336 INF	Culver-LUTC	N/C	FBH-CMTC	FKNX-GUTC	FKNX-GUTC	N/C	FBH-CMTC	N/C	FBH-CMTC	FKNX-GUTC
337 INF	CCUS-GUTC	N/C	Unknown	Grayling-NG	N/C	FBDY-CMTC	CCUS-DGRP	FBDY-CMTC	N/C	CCUS-CMTC
338 INF	CCUS-CMTC	N/C	Unknown	Grayling-NG	N/C	CCUS-CMTC	CCUS-DGRP	FSHN-CMTC	N/C	FBDY-CMTC
339 INF	N/C	CCUS-GUTC	Unknown	N/C	CCUS-CMTC	N/C	CCUS-CMTC	Unknown	FBDY-CMTC	CCUS-GUTC
340 INF	N/C	CCUS-CMTC	Unknown	N/C	Grayling-NG	N/C	FBDY-CMTC	Unknown	CCUS-CMTC	N/C
341 INF	Arcadia Rng	N/C	Unknown	FSHN-CMTC	N/C	JFBK-CMTC	N/C	JFBK-CMTC	CCUS-GUTC	FSHN-CMTC
342 INF	FSHN-CMTC	N/C	Unknown	FSHN-GUTC	N/C	JFBK-CMTC	N/C	JFBK-CMTC	CCUS-GUTC	FSHN-CMTC
343 INF	N/C	FSHN-CMTC	Unknown	N/C	JFBK-CMTC	N/C	JFBK-CMTC	FSHN-GUTC	JFBK-CMTC	JFBK-GUTC
344 INF	N/C	JFBK-CMTC	Unknown	N/C	JFBK-RATC	N/C	CCUS-CMTC	FSHN-GUTC	JFBK-CMTC	N/C
345 INF	N/C	BEAU-CMTC	Unknown	BEAU-CMTC	FMPH-GUTC	FMPH-DGRP	FMCL-GUTC	DeSoto-MAN	FMCL-CMTC	FMCL-GUTC
346 INF	BEAU-CMTC	FMCL-GUTC	FMCL-GUTC	BEAU-CMTC	FMPH-RATC	FMPH-DGRP	FMCL-GUTC	DeSoto-MAN	FMCL-RATC	FMCL-CMTC
347 INF	BEAU-CMTC	N/C	BEAU-CMTC	FMCL-RATC	BEAU-CMTC	FMPH-DGRP	FMCL-GUTC	DeSoto-MAN	FMCL-RATC	BEAU-CMTC
348 INF	N/C	BEAU-CMTC	FMCL-GUTC	BEAU-CMTC	FMPH-GUTC	FMPH-DGRP	FMCL-CMTC	DeSoto-MAN	BEAU-CMTC	FMCL-GUTC
349 INF	FDM-CMTC	FSNL-CMTC	Unknown	FSNL-CMTC	FSNL-CMTC	FSNL-CMTC	Ripley-MAN	FDM-CMTC	FDM-CMTC	FDM-CMTC
350 INF	FSNL-CMTC	FDM-CMTC	Unknown	EDM-CMTC	FDM-CMTC	FDM-CMTC	FDM-CMTC	FDM-CMTC	FDM-CMTC	FDM-CMTC
351 INF	FSNL-CMTC	FSNL-CMTC	Unknown	FSNL-CMTC	FSNL-CMTC	FSNL-CMTC	FSNL-CMTC	FSNL-CMTC	FSNL-CMTC	FSNL-CMTC
352 INF	FLCN-CMTC	FSNL-GUTC	Unknown	FLCN-GUTC	FLCN-GUTC	FSNL-GUTC	Ripley-MAN	FSNL-CMTC	FSNL-CMTC	FSNL-CMTC
353 INF	FLVN-CMTC	FLVN-CMTC	FLVN-CMTC	FLVN-CMTC	FLVN-CMTC	FLVN-CMTC	FLVN-CMTC	FRK-CMTC	FRK-CMTC	FLVN-CMTC
354 INF	FLVN-CMTC	FLVN-CMTC	Unknown	FLVN-CMTC	FLVN-CMTC	FORK-GUTC	FLVN-CMTC	FLVN-CMTC	FLVN-CMTC	FLVN-CMTC
355 INF	FCRK-CMTC	FCRK-GUTC	Unknown	FCRK-CMTC	Ashland-NG	FCRK-CMTC	FCRK-CMTC	FCRK-CMTC	FCRK-CMTC	FCRK-CMTC
356 INF	FSNL-CMTC	FLCN-CMTC	Unknown	FCRK-CMTC	FLCN-CMTC	FLCN-CMTC	FLCN-CMTC	FLCN-CMTC	FLCN-CMTC	FLCN-CMTC
357 INF	CBUL-RATC	CBUL-RATC	FSH-CMTC	CBUL-RATC	CBUL-RATC	CBUL-CMTC	CBUL-GUTC	CBUL-CMTC	FSH/CBUL	CBUL-GUTC
358 INF	CBUL-RATC	CBUL-RATC	CBUL-RATC	CBUL-RATC	CBUL-RATC	CBUL-CMTC	CBUL-GUTC	CBUL-CMTC	FSH/CBUL	CBUL-GUTC
359 INF	CBUL-RATC	CBUL-RATC	CBUL-GUTC	CBUL-RATC	FSH-CMTC	CBUL-RATC	CBUL-CMTC	CBUL-MAN	FSH/CBUL	CBUL-GUTC
360 INF	CBUL-RATC	CBUL-RATC	CBUL-RATC	CBUL-RATC	CBUL-CMTC	CBUL-RATC	CBUL-CMTC	CBUL-MAN	FSH/CBUL	CBUL-GUTC
361 INF	DELM	PMON-GUTC	PMON-CMTC	PMON-GUTC	PMON-CMTC	PMON-GUTC	FORD-GUTC	FORD-GUTC	FORD-GUTC	FORD-CMTC
362 INF	DELM	PMON-GUTC	PMON-GUTC	PMON-GUTC	PMON-GUTC	PMON-GUTC	FORD-GUTC	FORD-GUTC	FORD-GUTC	FORD-CMTC
363 INF	DELM	PMON-GUTC	PMON-GUTC	PMON-GUTC	PMON-GUTC	PMON-GUTC	FORD-GUTC	FORD-GUTC	PMON-CMTC	FLEW-MAN
364 INF	DELM	PMON-GUTC	PMON-GUTC	PMON-GUTC	PMON-GUTC	PMON-GUTC	PMON-CMTC	FORD-GUTC	FORD-GUTC	FLEW-MAN
369 INF	Smith	Smith	Smith	Smith	Smith	Smith	Smith	Smith	Smith	Smith
372 INF	Ritchie	Ritchie	Ritchie	Ritchie	Ritchie	Ritchie	Ritchie	Ritchie	Ritchie	Ritchie
A Co	Perry	Perry	Perry	Perry	Perry	Perry	Perry	Perry	Perry	McCoy
2 Bn										

Infantry 1931 – 1940

Regiment	1931	1932	1933	1934	1935	1936	1937	1938	1939	1940
3 Bn	FDEV	FDEV	FDEV	Unknown	Unknown	Edwards	Edwards	Edwards	Edwards	Edwards
373 INF	SAJP	CBUC	SAJP	SAJP	N/C	SAJP	CBUC-CMTC	CBUC-CMTC	CBUC-CMTC	FMIL-CMTC
374 INF	I/A	I/A	I/A	I/A	I/A	I/A	I/A	I/A	I/A	I/A
375 INF	I/A	I/A	I/A	I/A	I/A	I/A	I/A	I/A	I/A	I/A
376 INF	FDEV-GUTC	FDEV-CMTC	Unknown	N/C	N/C	FDEV-CMTC	N/C	FEA-GUTC	N/C	FDEV-CMTC
377 INF	FSIL-RATC	FSIL-CMTC	FSIL-CMTC	FSIL-RATC	FSIL-CMTC	FSIL-CMTC	FSIL-GUTC	FSIL-CMTC	FSIL-GUTC	FSIL-GUTC
378 INF	FSIL-CMTC	FSIL-RATC	FSIL-CMTC	FSIL-CMTC	FSIL-CMTC	FSIL-CMTC	FSIL-GUTC	FSIL-CMTC	FSIL-GUTC	FSIL-GUTC
379 INF	FSIL-RATC	FSIL-CMTC	FSIL-RATC	FSIL-CMTC	FSIL-IND	CBUL-RATC	FSIL-CMTC	CBUL-MAN	FSIL-CMTC	FSIL-GUTC
380 INF	FSIL-CMTC	FSIL-RATC	FSIL-RATC	FSIL-CMTC	FSIL-IND	CBUL-RATC	FSIL-CMTC	CBUL-MAN	FSIL-CMTC	FSIL-GUTC
381 INF	VCBK-RATC	VCBK-RATC	VCBK-RATC	VCBK-RATC	VCBK-GUTC	VCBK-RATC	VCBK-CMTC	VCBK-CMTC	VCBK-GUTC	FLEW-MAN
382 INF	VCBK-RATC	VCBK-RATC	VCBK-RATC	VCBK-RATC	VCBK-GUTC	VCBK-RATC	N/C	VCBK-CMTC	VCBK-GUTC	VCBK-RATC
383 INF	VCBK-RATC	VCBK-RATC	VCBK-RATC	VCBK-RATC	VCBK-GUTC	VCBK-RATC	VCBK-CMTC	VCBK-GUTC	FLEW-GUTC	FLEW-MAN
384 INF	FGWR-RATC	FGWR-RATC	FGWR-GUTC	FGWR-GUTC	FGWR/FMIS	FGWR-GUTC	FGWR-CMTC	FGWR-GUTC	FGWR-GUTC	FGWR-GUTC
385 INF	FADM-RATC	N/C	FADM	N/C	FDEV-CMTC	N/C	FDEV-CMTC	N/C	FEA-GUTC	N/C
386 INF	N/C	FEA-RATC	FDEV/IND	FDEV/IND	Keyes-LUTC	N/C	Keyes-NG	N/C	FMCK-CMTC	N/C
387 INF	FEA-RATC	N/C	N/C	N/C	N/C	FDEV-CMTC	FEA	FDEV-CMTC	N/C	FEA-GUTC
388 INF	FEA	N/C	FDEV/IND	FDEV-CMTC	N/C	N/C	FEA-GUTC	N/C	FDEV-CMTC	N/C
389 INF	FNIA-CMTC	PLBK-CMTC	N/C	PLBK-CMTC	PLBK-CMTC	N/C	PLBK-GUTC	N/C	FDEV-CMTC	N/C
390 INF	PLBK-CMTC	PLBK-GUTC	FNIA-CMTC	FNIA-CMTC	PLBK-CMTC	N/C	PLBK-GUTC	FNIA-GUTC	FDIX-CPX	PLBK-CMTC
391 INF	FDIX-CMTC	PLBK-GUTC	FNIA-CMTC	FNIA-CMTC	FNIA-CMTC	N/C	PLBK-CMTC	FNIA-GUTC	FDIX-CPX	PLBK-CMTC
392 INF	FNIA-CMTC	PLBK-CMTC	N/C	PLBK-CMTC	FNIA-CMTC	N/C	PLBK-GUTC	PLBK-GUTC	FDIX-CPX	FDIX-CMTC
393 INF	FEUS-CMTC	FGGM-STE	FGGM-SA	FGGM-SA	FGGM-CMTC	N/C	Ind Gap-SMT	FGGM-CMTC	FWSH-CPX	FGGM-T&IT
394 INF	FWHM-CMTC	FGGM-STE	FGGM-SA	FGGM-SA	FGGM-SA	Ind Gap-CPX	Ind Gap-SMT	FGGM-CMTC	FWSH-CPX	FGGM-T&IT
395 INF	FGGM-CMTC	FGGM-STE	FGGM-SA	FGGM-SA	FGGM-CMTC	Ind Gap-CPX	FGGM-SMT	FGGM-CMTC	FWSH-CPX	FGGM-SMT
396 INF	FWSH-CMTC	FGGM-STE	FGGM-SA	FGGM-SA	FGGM-SA	Ind Gap-CPX	FGGM-SMT	FGGM-CMTC	FWSH-CPX	FGGM-SMT
397 INF	FTHO	FTHO-CMTC	FNIX-GUTC	FNIX-GUTC	N/C	FNIX-GUTC	FBH-CMTC	FNIX-GUTC	N/C	FBH-CMTC
398 INF	FTHO	N/C	FNIX-GUTC	N/C	FNIX-CMTC	N/C	FNIX-GUTC	N/C	FBH-CMTC	FNIX-GUTC
399 INF	FNIX-CMTC	N/C	FNIX-GUTC	N/C	FBH-CMTC	N/C	FNIX-GUTC	N/C	FBH-CMTC	FNIX-GUTC
400 INF	FTHO	FNIX-GUTC	N/C	FNIX-GUTC	N/C	FBH-CMTC	N/C	FBH-CMTC	FNIX-GUTC	FNIX-GUTC
401 INF	N/C	FSHN-GUTC	Unknown	N/C	FSHN-CMTC	N/C	FSHN-CMTC	Unknown	FSHN-CMTC	N/C
402 INF	N/C	Williams-NG	Unknown	FBDY	N/C	JFBK-CMTC	Grant-IND	FSHN-CMTC	N/C	CCUS-GUTC
403 INF	FBDY-CMTC	N/C	Unknown	FSHN-GUTC	CCUS-IND	FSHN-CMTC	Grant-IND	FSHN-CMTC	N/C	FSHN-CMTC
404 INF	N/C	N/C	Unknown	N/C	FBDY-CMTC	CCUS-CMTC	Grant-IND	FSHN-CMTC	N/C	CCUS-CMTC
405 INF	FLVN-CMTC	Pike-CMTC	Unknown	Pike-CMTC	Pike-CMTC	Pike-NG	Pike-CMTC	CJTR-GUTC	FLVN-GUTC	FLVN
406 INF	FRK-GUTC	Pike-CMTC	Unknown	FCRK-GUTC	Pike-CMTC	Pike-NG	FRK-MAN	CJTR-GUTC	FLVN-GUTC	FLVN
407 INF	Pike-NG	Pike-CMTC	Unknown	FCRK-GUTC	FLVN-CMTC	FLVN-CMTC	Pike-CMTC	FLVN-GUTC	Pike-NG	CJTR-CMTC
408 INF	FLVN	FLVN-CMTC	Unknown	FLVN-CMTC	FLVN-GUTC	FLVN-CMTC	FLVN-CMTC	FLVN-GUTC	FLVN-CMTC	FLVN-CMTC
409 INF	CSDL-RATC	CSDL-RATC	FHUA-RATC	FHUA-RATC	FHUA-RATC	FHUA-RATC	FHUA-RATC	FHUA-RATC	FHUA-RATC	FHUA-RATC
410 INF	CSDL-RATC	CSDL-RATC	CSDL-RATC	FHUA-RATC	FHUA-RATC	FHUA-RATC	FLOG-CMTC	FHUA-RATC	FHUA-RATC	FHUA-RATC
411 INF	FEW-GUTC	FEW-RATC	FEW-RATC	FEW-RATC	FEW-RATC	FEW-RATC	FEW-RATC	FHUA-RATC	FHUA-RATC	FHUA-RATC
412 INF	FEW-GUTC	FEW-RATC	FEW-RATC	FEW-RATC	FEW-RATC	FEW-RATC	FEW-RATC	FLOG-CMTC	FEW-RATC	FEW-RATC
413 INF	FDOU-RATC	FDOU-GUTC	FDOU	FDOU-RATC	FDOU-RATC	FDOU-RATC	FLOG-CMTC	N/C	FEW-RATC	FLOG-CMTC
414 INF	FDOU-CMTC	Boise-NG	Boise-NG	Boise-NG	Boise-NG	Boise-NG	N/C	FDOU-GUTC	N/C	FDOU-CMTC
415 INF	FEW-GUTC	N/C	FEW-GUTC	FEW-GUTC	FEW-GUTC	N/C	Boise-NG	Boise-NG	N/C	FDOU-CMTC
416 INF	FDOU-GUTC	FDOU-GUTC	FMIS-GUTC	FMIS-GUTC	N/C	FMIS-GUTC	N/C	N/C	FMIS-GUTC	FLEW-MAN

Infantry 1931 – 1940											
Regiment	1931	1932	1933	1934	1935	1936	1937	1938	1939	1940	
417 INF	FADM	N/C	FADM	N/C	N/C	FDEV	FDEV-CMTC	N/C	FDEV-CMTC	N/C	
418 INF	FDEV-CMTC	N/C	Unknown	N/C	FADM-GUTC	N/C	N/C	FEA-GUTC	N/C	FMCK-CMTC	
419 INF	N/C	EDEV-RATC	Unknown	N/C	N/C	FDEV-CMTC	N/C	FDEV-CMTC	N/C	FEA-GUTC	
420 INF(LT)		FGGM-GUTC	Unknown	Arcadia	N/C	JFBK-GUTC	N/C	FSHN-GUTC	JFBK-GUTC	JFBK-CMTC	
421 INF(LT)		FGGM-GUTC	FGGM	FGGM-GUTC	N/C	N/C	N/C	N/C	FGGM-RATC	FGGM-SMT	
422 INF(LT)		N/C	FBNG-GUTC	FBNG-GUTC	FBNG-GUTC	FMCL-CMTC	FBNG-GUTC	N/C	FBNG-GUTC	FMCL-CMTC	
423 INF(LT)		Arcadia (312T)	N/C	N/C	FSHN-GUTC	N/C	JFBK-CMTC	N/C	FSNL-GUTC	FSHN-CMTC	
424 INF(LT)		FGGM (306T)	MELD	MELD-GUTC	MELD-GUTC	MELD-RATC	MELD-GUTC	N/C	MELD-RATC	N/C	
425 INF(LT)		N/C	FGGM	FGGM-GUTC	N/C	N/C	N/C	N/C	FGGM-RATC	FGGM-SMT	
426 INF(LT)		N/C	FKNX-IND	FKNX-IND	FKNX-GUTC	N/C	FBH-CMTC	FKNX-GUTC	FBH-CMTC	FKNX-GUTC	
428 INF	EDEVNG	EDEVNG	FHNT	FWSH-IND	FHOW-IND	FHOW-CMTC	FHOW-CMTC	FHOW-CMTC	FHOW-CMTC	FHOW-CMTC	
429 INF	FDEVNG	FDEVNG	FHNT	FWSH-IND	FHOW-IND	FHOW-CMTC	FHOW-CMTC	FHOW-CMTC	I/A	I/A	
447 INF	N/C	N/C	Unknown	N/C	N/C	N/C	FMPI	FMOU-CMTC	FMOU-RATC	FMCL/FMOU	
448 INF	N/C	N/C	Unknown	N/C	N/C	N/C	N/C	FSCR-CMTC	FMCL-RATC	FBNG/FMPH	
449 INF	Perry-NG	Perry-NG	Perry-NG	N/C	N/C	N/C	N/C	Perry-NG	Perry-NG	Perry-NG	
450 INF	N/C	N/C	N/C	N/C	N/C	N/C	N/C	BEAU-CMTC	FSCR-RATC	BEAU-CMTC	
451 INF	N/C	N/C	N/C	N/C	N/C	N/C	N/C	N/C	N/C	N/C	
452 INF	N/C	N/C	N/C	N/C	N/C	N/C	N/C	N/C	N/C	N/C	
453 INF	N/C	N/C	N/C	N/C	N/C	N/C	N/C	N/C	N/C	N/C	
454 INF	N/C	N/C	N/C	N/C	N/C	N/C	N/C	FSCR-CMTC	FMCL-RATC	FSCR-CMTC	
455 INF	N/C	N/C	N/C	N/C	N/C	CBUI-GUTC	CBUI-CMTC	CBUI-IND	CBUI-GUTC	CBUI-CMTC	
507 INF BN											
509 INF BN											
512 INF BN											
516 INF BN	SAJP	SAJP	Unknown	N/C	HBRK	HBRK	N/C	HBRK	SAJP	SAJP	
530 INF BN											
531 INF BN											
532 INF BN											
533 INF BN											
536 INF BN											
537 INF BN											
542 INF BN											
544 INF BN											

Cavalry Training Camps 1921 – 1931

Regiment	1921	1922	1923	1924	1925	1926	1927	1928	1929	1930
15 CAV	RA-A	I/A	I/A	I/A	I/A	I/A	FRK-GUTC	FRK-GUTC	N/C	FRK-GUTC
16 CAV	RA-A	I/A	I/A	I/A	I/A	I/A	N/C	N/C	N/C	N/C
17 CAV	RA-A	I/A	I/A	I/A	I/A	I/A	N/C	N/C	N/C	N/C
101 CAV	FEA	FDEV	Pine Cp	Huntington, LI	FEA	Pine Cp	Pine Cp	Pine Cp	Pine Cp	PMON-RATC
102 CAV	Sea Girt	Sea Girt	Sea Girt	Sea Girt	Sea Girt	Sea Girt	Sea Girt	Sea Girt	Sea Girt	Pine Cp
103 CAV	Mt Gretna	Mt Gretna	Mt Gretna	Cokeburg	Mt Gretna	Mt Gretna	Mt Gretna	Mt Gretna	Mt Gretna	Sea Girt
104 CAV	Mt Gretna	Cokeburg	Mt Gretna	Mt Gretna	Mt Gretna	Mt Gretna	Mt Gretna	Mt Gretna	Mt Gretna	Mt Gretna
105 CAV	Williams	Douglas	Douglas	Williams	Williams	Williams	Williams	Williams	McCoy	Williams
106 CAV	Grant/Grayling	Grant/Grayling	Grayling	Grant/Grayling	Grant/Grayling	Grant/Grayling	Grant/Grayling	Grant/Grayling	Grant/Grayling	Grant/Grayling
107 CAV	Perry	Perry	Perry	Perry	Perry	Perry	Perry	Perry	Perry	Perry
108 CAV	FOGL	FOGL	BEAU/FMCL	EMCL	FOGL	BEAU/FOGL	BEAU/FOGL	BEAU/FOGL	FOGL	FOGL
109 CAV	FOGL	FOGL	FMCL	FMCL/Sevier	FOGL	FOGL	FOGL	FOGL	FOGL	FOGL
110 CAV	Quonsett	Quonsett	Quonsett	EDEV/Quonsett	Quonsett	Quonsett	Quonsett	Quonsett	Quonsett	Quonsett
111 CAV	N/C	FBLs	FBLs	FBLs	FBLs	FBLs	FBLs	FBLs	Luna	Luna
112 CAV	Mabry	Mabry	Mabry	CSTA	CSTA	CSTA	Wolters	Wolters	Wolters	Wolters
113 CAV	Dodge	Dodge	Dodge	Dodge	Dodge	Dodge	FRK	FRK	Dodge	Dodge
114 CAV	FRK	FRK	FRK	FRK	FRK	FRK	FRK	FRK	FRK	FRK
115 CAV	PMMR	PMMR	FDAR	PMMR	PMMR	PMMR	PMMR	PMMR	PMMR	PMMR
116 CAV	Boise	Boise	FDAR	Pavette/FDAR	Boise	Boise	Boise	Boise	Boise	Boise
117 CAV SQ	FDAR	West	West	FDAR	FDAR	West	West	West	West	West
121 CAV	N/A	N/A	N/A	N/A	N/A	N/A	N/A	N/A	N/A	N/A
122 CAV	N/A	N/A	N/A	N/A	N/A	N/A	N/A	N/A	N/A	N/A
123 CAV	N/A	N/A	N/A	N/A	N/A	N/A	N/A	N/A	N/A	N/A
124 CAV	N/A	N/A	N/A	N/A	N/A	N/A	N/A	N/A	N/A	N/A
301 CAV	N/C	FDIX-DGRP	FDIX-DGRP	N/C	FEA-RATC	FEA-RATC	N/C	FEA-CMTC	N/C	Wolters
302 CAV	N/C	FDIX-DGRP	FDIX-DGRP	N/C	Sea Girt-LUTC	FEA-RATC	N/C	FEA-CMTC	N/C	FEA-GUTC
303 CAV	N/C	FDIX-DGRP	FDIX-DGRP	N/C	FEA-RATC	FEA	FEA-GUTC	FEA-CMTC	N/C	FEA-GUTC
304 CAV	N/C	FDIX-DGRP	FDIX-DGRP	FEA-CMTC	N/C	FEA	FEA-GUTC	N/C	FEA-CMTC	N/C
305 CAV	N/C	FGGM-DGRP	FGGM-DGRP	FGGM	FMYR	Mt Gretna-NG	FMYR	Mt Gretna-NG	FMYR-CMTC	FMYR
306 CAV	N/C	FGGM-DGRP	FGGM-DGRP	FMYR	N/C	FMYR	Mt Gretna-NG	FMYR	FMYR	FMYR-CMTC
307 CAV	N/C	FGGM-DGRP	FGGM-DGRP	FMYR	N/C	FMYR	Mt Gretna-NG	FMYR	FMYR	FMYR-CMTC
308 CAV	N/C	FGGM-DGRP	FGGM-DGRP	FGGM	FMYR	Mt Gretna-NG	FMYR	Mt Gretna-NG	FMYR-CMTC	FMYR
309 CAV	N/C	FOGL	FMCL-DGRP	FMCL	FOGL	FOGL	N/C	FOGL-CCT	FOGL	FOGL-RATC
310 CAV	N/C	FOGL	FMCL-DGRP	FMCL-CMTC	FOGL	FOGL	FOGL-GUTC	FOGL-GUTC	FOGL	FOGL-RATC
311 CAV	N/C	FCLK	FCLK	FCLK	FCLK	FCLK	FCLK	FCLK	FCLK	FCLK/FBLS
312 CAV	N/C	Unk	FSIL	FSIL/FHUA	FCLK/FHUA	FCLK/FBLS	FCLK/FBLS	FCLK/FBLS	FCLK/FBLS	FCLK/FBLS
313 CAV	N/C	FKNX	FKNX	FKNX-CMTC	Culver	FKNX-GUTC	FKNX-GUTC	FKNX-GUTC	FKNX-GUTC	FKNX
314 CAV	N/C	FKNX	FKNX	FKNX-CMTC	FOGL	FKNX-GUTC	FKNX-GUTC	FKNX-GUTC	FKNX-GUTC	FKNX
315 CAV	N/C	N/C	FEA-CMTC	FEA-CMTC	FEA-CMTC	FEA	FEA-GUTC	FEA	FEA	FEA
316 CAV	N/C	N/C	N/C	EDEV	N/C	FEA	N/C	FEA-RATC	FEA	FEA-GUTC
317 CAV	N/C	Unknown	FDM	CCUS	N/C	FSHN-GUTC	FSHN-CMTC	FSHN-GUTC	FSHN-GUTC	FSHN-GUTC
318 CAV	N/C	Unknown	FDM	CCUS	N/C	N/C	FSHN-GUTC	FSHN-RATC	FSHN-GUTC	FSHN-GUTC
319 CAV	N/C	Unknown	FDM	CCUS	N/C	N/C	FSHN-GUTC	FSHN-RATC	N/C	FSHN-GUTC
320 CAV	N/C	Unknown	Unknown	CCUS-RATC	N/C	FSHN-GUTC	FSHN-GUTC	N/C	FSHN-GUTC	FSHN-GUTC
321 CAV	N/C	Unknown	FDM	N/C	FRK	N/C	FRK-GUTC	FMEA	FRK-GUTC	FRK-GUTC
322 CAV	N/C	Unknown	FDM	FRK	N/C	FRK	N/C	FRK-GUTC	CMTC	FRK
323 CAV	N/C	Unknown	Unknown	PMON-GUTC	N/C	PMON-RATC	PMON-RATC	DELM-GUTC	PMON-GUTC	PMON-RATC
324 CAV	N/C	FDAR	FDAR	FDAR	PMMR	PMMR	FDAR	FMEA	FMEA-GUTC	FMEA-RATC

Cavalry 1931 – 1940

Regiment	1931	1932	1933	1934	1935	1936	1937	1938	1939	1940
15 CAV	FRK-GUTC	N/C	FLVN-CMTC	N/C	N/C	FDM-GUTC	FDM-CMTC	N/C	N/C	N/C
16 CAV	N/C	N/C	N/C	N/C	N/C	N/C	N/C	N/C	N/C	N/C
17 CAV	N/C	FLEW-GUTC	FLEW-GUTC	FLEW-GUTC	PMON-RATC	PMON-GUTC	FORD-GUTC	FORD-GUTC	FORD-GUTC	FLEW-MAN
101 CAV	Pine Cp	Pine Cp	Pine Cp	Pine Cp	Pine Cp	Pine Cp	Pine Cp	Pine Cp	PLBK-MAN	NNYS-MAN
102 CAV	Sea Girt	Sea Girt	Sea Girt	Sea Girt	Sea Girt	Sea Girt	Ind Gap	Ind Gap	Ind Gap	NNYS-MAN
103 CAV	Mt Gretna	Mt Gretna	Mt Gretna	Mt Gretna	Mt Gretna	Mt Gretna	Ind Gap	Ind Gap	MNVA-MAN	NNYS-MAN
104 CAV	Mt Gretna	Mt Gretna	Mt Gretna	Mt Gretna	Mt Gretna	Mt Gretna	Ind Gap	Ind Gap	MNVA-MAN	NNYS-MAN
105 CAV	Williams	Williams	Williams	Williams	Williams	Williams	Williams	Williams	Williams	McCoy
106 CAV	Grant/Grayling	Grant/Grayling	Grant/Grayling	Grant/Grayling	Grant/Grayling	Grant/Grayling	Grant/Grayling	Grant/Grayling	Williams	McCoy
107 CAV	Pery	Pery	Pery	Pery	FKNX	FKNX	FKNX	Pery	FKNX	McCoy
108 CAV	BEAU/FOGL	BEAU/FOGL	FMCL	BEAU/FOGL	BEAU/FOGL	BEAU/FOGL	BEAU/FOGL	DeSoto-MAN	FOGL	KNLA-MAN
109 CAV	FOGL	FOGL	FMCL	FOGL	FOGL	FOGL	FOGL	DeSoto-MAN	FOGL	KNLA-MAN
110 CAV	FDEV	FDEV	Niantic	Niantic	FDEV	Edwards	Edwards	Ind Gap	Ind Gap	Unknown
111 CAV	Luna	Luna	Luna	Luna	Luna	Luna	Luna	FBLs	Luna	R/D 207 CA
112 CAV	Walters	Walters	Walters	Walters	Walters	Walters	Walters	CBUL-MAN	Walters	KNLA-MAN
113 CAV	Dodge	Dodge	Dodge	Dodge	Dodge	Dodge	Ripley	Dodge	Dodge	Ripley-MAN
114 CAV	FRK	FRK	FRK	FRK	FRK	FRK	FRK-MAN	FRK	FRK	Ripley-MAN
115 CAV	PMMR	PMMR	WY at Large	PMMR	PMMR	FFEW	PMMR	Guernsey	Guernsey	FLEW
116 CAV	Boise	Boise	Boise	Boise	Boise	Boise	Boise	Bonneville	Bonneville	FLEW
117 CAV SQ	West	West	West	R/D 2nd Bn, 168th FA						
121 CAV	Pine Cp	Pine Cp	Pine Cp	Pine Cp	Pine Cp	Pine Cp	Pine Cp	Pine Cp	PLBK-MAN	NNYS-MAN
122 CAV	Niantic	Niantic	Niantic	Niantic	Waterbury	Niantic	Niantic	R/D as elmts 110th Cav		
123 CAV	FKNX	FKNX	FKNX	FKNX	FKNX	FKNX	FKNX	FKNX	FKNX	FKNX
124 CAV	Walters	Walters	Walters	Walters	Walters	Walters	Walters	CBUL-MAN	Walters	KNLA-MAN
301 CAV	FEA	FMYR-GUTC	N/C	FEA-GUTC	N/C	FEA-GUTC	FMYR-RATC	FEA-CPX	FBEL-GUTC	FEA-MOB
302 CAV	FEA	FMYR-GUTC	N/C	FEA-GUTC	N/C	FEA-GUTC	FMYR-RATC	FEA-CPX	FBEL-GUTC	FEA-MOB
303 CAV	FEA-GUTC	N/C	FEA	N/C	FMYR	FEA-GUTC	FMYR-RATC	FEA-CPX	FBEL-GUTC	FEA-MOB
304 CAV	FEA-GUTC	N/C	FEA	N/C	FMYR	FEA-GUTC	FMYR-RATC	FEA-CPX	FBEL-GUTC	FEA-MOB
305 CAV	FMYR-CMTC	FMYR-GUTC	FMYR	FMYR-CMTC	FMYR-GUTC	FMYR-GUTC	FMYR-RATC	FBEL-CMTC	FBEL-GUTC	FBEL-GUTC
306 CAV	FMYR	FMYR-CMTC	FMYR	FMYR-GUTC	FMYR-CMTC	FMYR-GUTC	FBEL-GUTC	FBEL-GUTC	FBEL-CMTC	FBEL-CMTC
307 CAV	FMYR	FMYR-CMTC	FMYR	FMYR-GUTC	FMYR-CMTC	FMYR-GUTC	FBEL-GUTC	FBEL-GUTC	FBEL-CMTC	FBEL-CMTC
308 CAV	FMYR-CMTC	FMYR-GUTC	FMYR-CMTC	FMYR-GUTC	FMYR-GUTC	FMYR-GUTC	FMYR-CMTC	FBEL-GUTC	FBEL-GUTC	NNYS-MAN
309 CAV	FOGL-RATC	FOGL-RATC	FOGL-GUTC	FOGL-RATC	FOGL-CMTC	FOGL-RATC	FOGL-CMTC	DeSoto-MAN	FOGL-CMTC	FOGL-GUTC
310 CAV	FOGL-RATC	FOGL-RATC	FOGL-GUTC	FOGL-RATC	FOGL-RATC	FOGL-CMTC	FOGL-CMTC	FOGL-RATC	FOGL-RATC	FOGL-CMTC
311 CAV	FCLK/FBLS	FCLK/FBLS	FCLK/FBLS	FCLK	FCLK/FBLS	FCLK/FBLS	FCLK/FBLS	CBUL-MAN	FCLK-GUTC	FCLK/FBLS
312 CAV	FCLK/FBLS	FCLK/FBLS	FCLK/FBLS	FCLK/FBLS	FCLK/FBLS	FCLK/FBLS	FCLK/FBLS	FBLs-MAN	FBLs-CMTC	FCLK/FBLS
313 CAV	N/C	N/C	FKNX-GUTC	N/C	FOGL-GUTC	N/C	FOGL-GUTC	N/C	FOGL-GUTC	FOGL-GUTC
314 CAV	N/C	FKNX-GUTC	N/C	FOGL-GUTC	FOGL-GUTC	FOGL-GUTC	N/C	CCUS-GUTC	N/C	FOGL-GUTC
315 CAV	FEA-GUTC	N/C	FEA-COC	FEA-COC	FEA	N/C	FEA-GUTC	N/C	FEA-GUTC	N/C
316 CAV	FEA	FEA-RATC	FEA-COC	FEA-COC	FEA-CMTC	FEA-GUTC	N/C	FEA-GUTC	FEA-CMTC	FEA-RATC
317 CAV	N/C	FSHN-GUTC	N/C	FSHN-GUTC	FSHN-GUTC	Chicago-CPX	FSHN-CMTC	CCUS-GUTC	FSHN-CMTC	FSHN-CMTC
318 CAV	N/C	FSHN-GUTC	N/C	N/C	FSHN-CMTC	FSHN-CMTC	FSHN-GUTC	FSHN-CMTC	FSHN-GUTC	FSHN-CMTC

Cavalry 1931 – 1940

Regiment	1931	1932	1933	1934	1935	1936	1937	1938	1939	1940
319 CAV	FSHN-GUTC	N/C	N/C	FSHN-GUTC	N/C	CCUS-CMTC	N/C	CCUS-GUTC	FSHN-GUTC	FSHN-GUTC
320 CAV	FSHN-GUTC	N/C	Williams	N/C	N/C	CCUS-CMTC	N/C	Unknown	FSHN-CMTC	FSHN-GUTC
321 CAV	FRK-NG	N/C	FLVN-CMTC	FRK-GUTC	FRK-GUTC	FDM-CMTC	FDM-CMTC	FRK-GUTC	FRK	FRK-CMTC
322 CAV	FRK-GUTC	N/C	FLVN-CMTC	FRK-GUTC	FDM-CMTC	FDM-CMTC	FDM-CMTC	FDM-CMTC	FDM-CMTC	FRK/FDM
323 CAV	PMON-RATC	PMON-GUTC	PMON-RATC	PMON-CMTC	PMON-RATC	PMON-GUTC	FORD-GUTC	FORD-GUTC	FORD-GUTC	FORD-CMTC
324 CAV	N/C	FMEA-RATC	FMEA-RATC	FMEA-RATC	FMEA-RATC	FMEA-GUTC	N/C	FMEA-GUTC	FMEA-IND	N/C

Machinegun and Armored Car Squadron Training Camps 1921 – 1930											
Squadron	1921	1922	1923	1924	1925	1926	1927	1928	1929	1930	
51 MG SQ	FEA	SQA Farm	FDIX	FEA	FEA	Pine Cp	Pine Cp	Pine Cp	D/B	D/B	
52 MG SQ	Mt Gretina	Mt Gretina	Mt Gretina	Mt Gretina	Mt Gretina	Mt Gretina	Mt Gretina	Mt Gretina	D/B	D/B	
53 MG SQ	N/O	FKNX	FKNX	FKNX	FKNX	FKNX	FKNX	FKNX	D/B	D/B	
54 MG SQ	N/O	N/O	FKNX	FKNX	FKNX	FKNX	FKNX	FKNX	D/B	D/B	
55 MG SQ	N/O	FMCL	FMCL	FMCL	FOGL	FMCL	FOGL	FOGL	D/B	D/B	
56 MG SQ	Mabry	Mabry	CSTA	CSTA	CSTA	Wolters	Wolters	Wolters	D/B	D/B	
57 MG SQ	N/O	N/O	N/O	N/O	N/O	N/O	N/O	N/O	D/B	D/B	
58 MG SQ	N/O	Murray/PMMR	Murray/PMMR	Murray/PMMR	PMMR	PMMR	PMMR	PMMR	D/B	D/B	
151 MG SQ	N/O	FDIX-DGRP	N/C	N/C	Sea Girt-GUTC	FEA-RATC	N/C	FEA-RATC	D/B	D/B	
152 MG SQ	N/O	FDIX-DGRP	N/C	N/C	Sea Girt-GUTC	N/C	N/C	FEA-GUTC	D/B	D/B	
153 MG SQ	N/O	FGGM-DGRP	N/C	N/C	N/C	N/C	N/C	N/C	D/B	D/B	
154 MG SQ	N/O	FGGM-DGRP	N/C	N/C	N/C	N/C	N/C	N/C	D/B	D/B	
155 MG SQ	N/O	Unknown	N/C	N/C	FOGL-GUTC	N/C	N/C	N/C	D/B	D/B	
156 MG SQ	N/O	Unknown	N/C	FBL-S-GUTC	FBL-S-GUTC	FBL-S-GUTC	FBL-S-GUTC	FBL-S-GUTC	D/B	D/B	
157 MG SQ	N/O	N/C	FKNX-DGRP	N/C	FKNX-NG	FKNX-GUTC	FKNX-GUTC	FKNX-NG	D/B	D/B	
158 MG SQ	N/O	Unknown	N/C	FDEV	FEA-GUTC	FEA-GUTC	N/C	FEA-RATC	D/B	D/B	
159 MG SQ	N/O	CCUS-DGRP	N/C	CCUS	FSHN-GUTC	FSHN-GUTC	FSHN-IND	FSHN-GUTC	D/B	D/B	
160 MG SQ	N/O	CCUS-DGRP	N/C	N/C	CCUS-GUTC	N/C	FSHN-GUTC	N/C	D/B	D/B	
161 MG SQ	N/O	Unknown	N/C	N/C	N/C	FMEA-RATC	FSHN-GUTC	N/C	D/B	D/B	
162 MG SQ	N/O	Unknown	N/C	PMON-GUTC	N/C	PMON-GUTC	PMON-GUTC	DELM-GUTC	D/B	D/B	
1 A/C SQ									N/C	N/C	
2 A/C SQ									N/O	N/O	
3 A/C SQ									N/O	N/O	
4 A/C SQ									N/O	N/O	
21 Recon SQ									N/O	N/O	
22 Recon SQ									N/O	N/O	
23 Recon SQ									N/O	N/O	
24 Recon SQ									N/O	N/O	
461 A/C SQ									N/C	N/C	
462 A/C SQ									N/C	N/C	
463 A/C SQ									N/C	N/C	
464 A/C SQ									N/C	N/C	
465 A/C SQ									N/C	N/C	
466 A/C SQ									N/C	FSHN-GUTC FRK-GUTC	

Machinegun and Armored Car Squadron Training Camps 1931 - 1940										
Squadron	1931	1932	1933	1934	1935	1936	1937	1938	1939	1940
51 MG SQ										
52 MG SQ										
53 MG SQ										
54 MG SQ										
55 MG SQ										
56 MG SQ										
57 MG SQ										
58 MG SQ										
151 MG SQ										
152 MG SQ										
153 MG SQ										
154 MG SQ										
155 MG SQ										
156 MG SQ										
157 MG SQ										
158 MG SQ										
159 MG SQ										
160 MG SQ										
161 MG SQ										
162 MG SQ										
1 A/C SQ	N/C	N/C	N/C	N/C	N/C	N/C	FBL-S-GUTC	FBL-S-GUTC	FBL-S-GUTC	
2 A/C SQ	N/C	N/C	N/C	N/C	N/C	N/C	N/C	FRK-GUTC	FRK-GUTC	FRK-GUTC
3 A/C SQ	FRK-IND	N/C	N/C	N/C	N/C	N/C	N/C	FRK-GUTC	FRK-GUTC	FRK-GUTC
4 A/C SQ	N/O	N/O	N/O	N/O	N/O	N/O	N/O	FDM-GUTC	FDM-GUTC	FDM-GUTC
21 Recon SQ	N/O	N/O	N/O	N/O	N/O	N/O	N/O	N/O	N/O	NNYS-MAN
22 Recon SQ	N/O	N/O	N/O	N/O	N/O	N/O	N/O	N/O	N/O	McCoy-MAN
23 Recon SQ	N/O	N/O	N/O	N/O	N/O	N/O	N/O	N/O	N/O	McCoy-MAN
24 Recon SQ	N/O	N/O	N/O	N/O	N/O	N/O	N/O	N/O	N/O	FLEW-MAN
461 A/C SQ	N/C	FGGM-GUTC	N/C	MFLD-GUTC	N/C	FEA-GUTC	FKNX-GUTC	N/C	N/C	N/C
462 A/C SQ	N/C	FMYR-GUTC	FMYR-GUTC	FMYR-IND	FMYR-IND	FMYR-CMTC	FMYR-IND	FKNX-GUTC	FKNX-GUTC	FKNX-GUTC
463 A/C SQ	N/C	FOGL-GUTC	FOGL-GUTC	N/C	N/C	FKNX-GUTC	FOGL-GUTC	N/C	FOGL-GUTC	FOGL-GUTC
464 A/C SQ	N/C	N/C	FKNX-GUTC	FKNX-RATC	N/C	FKNX-GUTC	N/C	N/C	N/C	FKNX-GUTC
465 A/C SQ	FSHN-GUTC	N/C	N/C	N/C	N/C	N/C	N/C	N/C	N/C	FKNX-GUTC
466 A/C SQ	FRK-GUTC	N/C	ELVN-CMTC	N/C	N/C	N/C	N/C	N/C	N/C	N/C

Field Artillery Training Camps 1921 – 1930

Year	1921	1922	1923	1924	1925	1926	1927	1928	1929	1930
3 FA	RA-A	RA-A	I/A	I/A	I/A	I/A	RA-A	RA-A	RA-A	McCoy-RATC
9 FA	RA-A	I/A	I/A	I/A	I/A	I/A	McCoy	Unknown	ERK-GUTC	I/A (-1st Bn)
14 FA	RA-A	I/A	I/A	I/A	I/A	McCoy	McCoy-RATC	McCoy-RATC	McCoy-GUTC	McCoy-RATC
19 FA	RA-A	I/A	I/A	I/A	I/A	I/A	FKNX-GUTC	N/C	FKNX	FKNX-RATC
20 FA	RA-A	I/A	I/A	I/A	I/A	I/A	N/C	FKNX-IND	N/C	FKNX-IND
21 FA	RA-A	I/A	I/A	I/A	I/A	N/C	N/C	FKNX-IND	N/C	FKNX-RATC
22 FA	RA-A	RA-A	I/A	I/A	I/A	I/A	N/C	N/C	N/C	McCoy
25 FA	D/B	D/B	I/A	I/A	I/A	I/A	I/A	I/A	I/A	N/C
26 FA	D/B	D/B	I/A	I/A	I/A	I/A	I/A	FKNX-IND	N/C	FKNX-RATC
27 FA	D/B	D/B	I/A	I/A	I/A	I/A	N/C	N/C	N/C	FKNX-RATC
28 FA	D/B	D/B	I/A	I/A	I/A	I/A	N/C	FKNX-IND	FKNX-IND	N/C
29 FA	D/B	D/B	I/A	I/A	I/A	I/A	N/C	N/C	N/C	N/C
30 FA	D/B	D/B	I/A	I/A	I/A	I/A	N/C	N/C	N/C	N/C
31 FA	D/B	D/B	D/B	D/B	D/B	D/B	D/B	D/B	I/A	N/C
32 FA	D/B	D/B	D/B	D/B	D/B	D/B	D/B	D/B	N/C	FLEW
33 FA	D/B	D/B	D/B	D/B	D/B	D/B	D/B	D/B	I/A	N/C
34 FA	D/B	D/B	D/B	D/B	D/B	D/B	D/B	D/B	I/A	FKNX-RATC
35 FA	D/B	D/B	D/B	D/B	D/B	D/B	D/B	D/B	I/A	FKNX-IND
36 FA	D/B	D/B	D/B	D/B	D/B	D/B	D/B	D/B	I/A	N/C
37 FA	D/B	D/B	D/B	D/B	D/B	D/B	D/B	D/B	D/B	D/B
41 FA	D/B	D/B	D/B	D/B	D/B	D/B	D/B	D/B	D/B	D/B
42 FA	D/B	D/B	D/B	D/B	D/B	D/B	D/B	D/B	D/B	D/B
43 FA										
44 FA										
45 FA										
46 FA										
47 FA										
50 FA										
51 FA										
52 FA										
53 FA										
54 FA										
55 FA										
57 FA										
58 FA										
67 FA										
69 FA										
70 FA										
75 FA	D/B	D/B	D/B	D/B	D/B	D/B	D/B	D/B	D/B	D/B
77 FA	I/A	I/A	I/A	I/A	I/A	I/A	FRK-GUTC	N/C	FRK-GUTC	N/C
78 FA	I/A	I/A	I/A	I/A	I/A	McCoy	McCoy-RATC	Williams-NG	McCoy-GUTC	McCoy-RATC
79 FA	I/A	I/A	I/A	I/A	I/A	I/A	I/A	N/C	N/C	FRK
80 FA	I/A	I/A	I/A	I/A	I/A	I/A	I/A	N/C	N/C	McCoy
84 FA	I/A	I/A	I/A	I/A	I/A	I/A	Fort Collins	N/C	Fort Collins	N/C

Field Artillery Training Camps 1921 – 1930											
Year	1921	1922	1923	1924	1925	1926	1927	1928	1929	1930	
85 FA	D/B	D/B	I/A	I/A	I/A	I/A	I/A	I/A	I/A	4CA	
86 FA											
89 FA											
90 FA											
91 FA											
92 FA											
94 FA											
99 FA											
100 FA											
101 FA	Barnstable	Barnstable	FDEV	Barnstable	FDEV	FDEV	FDEV	FDEV	FDEV	FDEV	
102 FA	Barnstable	Barnstable	FDEV	Barnstable	FDEV	FDEV	FDEV	FDEV	FDEV	FDEV	
103 FA	Quonsett	Charlestown	Charlestown	Charlestown	Charlestown	Charlestown	Charlestown	Charlestown	Charlestown	Charlestown	
104 FA	Welsh	Welsh	Smith	Pine Cp	Pine Cp	Pine Cp	Pine Cp	Pine Cp	Pine Cp	Pine Cp	
105 FA	Welsh	Welsh	Smith	Pine Cp	Pine Cp	Pine Cp	Pine Cp	Pine Cp	Pine Cp	Pine Cp	
106 FA	Pine Cp	Tobyhanna	Smith	Tobyhanna	Pine Cp	Pine Cp	Pine Cp	Pine Cp	Pine Cp	Pine Cp	
107 FA	FBRG	Tobyhanna	Tobyhanna	Tobyhanna	Tobyhanna	Tobyhanna	Tobyhanna	Tobyhanna	Mt Gretna	Tobyhanna	
108 FA	FBRG	Tobyhanna	Tobyhanna	Tobyhanna	Tobyhanna	Tobyhanna	Mt Gretna	Tobyhanna	Tobyhanna	Tobyhanna	
109 FA	FBRG	Tobyhanna	Tobyhanna	Tobyhanna	Tobyhanna	Tobyhanna	Mt Gretna	Tobyhanna	Mt Gretna	Tobyhanna	
110 FA	Saunders	Tobyhanna	Tobyhanna	Tobyhanna	Tobyhanna	Tobyhanna	Tobyhanna	Tobyhanna	Tobyhanna	Tobyhanna	
111 FA		FBRG	FBRG	FBRG	Tobyhanna	Tobyhanna	Tobyhanna	Tobyhanna	Tobyhanna	Tobyhanna	
112 FA	Welsh	Welsh	Tobyhanna	Pine Cp	Pine Cp	Pine Cp	Pine Cp	Pine Cp	Pine Cp	Pine Cp	
113 FA	See 117a	See 117a	See 117a	See 117a	See 117a	See 117a	See 117a	See 117a	See 117a	See 117a	
114 FA	N/O	N/O	N/O	N/O	N/O	N/O	N/O	N/O	N/O	N/O	
115 FA	N/O	N/O	FBRG	FBRG	FBRG	FBRG	FBRG	FBRG	FBRG	FBRG	
116 FA	N/O	FBRG	FBRG	FBRG	FBRG	FBRG	FBRG	FBRG	FBRG	FBRG	
117a FA	N/O	FBRG	FBRG	FBRG	FBRG	FBRG	FBRG	FBRG	FBRG	FBRG	
117b FA	See 141a	See 141a	See 141a	See 141a	See 141a	See 141a	See 141a	See 141a	See 141a	See 141a	
118 FA	FBRG	FBRG	FBRG	FBRG	FBRG	FBRG	FBRG	FBRG	FBRG	FBRG	
119 FA	Graying	CCUS	Graying	CCUS	Graying	Graying	Graying	Graying	Graying	Graying	
120 FA	Douglas	CCUS	Douglas	CCUS	Graying	Graying	Graying	Graying	Graying	Graying	
121 FA	Douglas	Douglas	Douglas	CCUS	Graying	Graying	Graying	Graying	Graying	Graying	
122 FA	Grant	CCUS	CCUS	CCUS	Graying	Graying	Graying	Graying	Graying	Graying	
123 FA	Grant	CCUS	CCUS	CCUS	Graying	Graying	Graying	Graying	Graying	Graying	
124 FA	Grant	CCUS	CCUS	CCUS	Graying	Graying	Graying	Graying	Graying	Graying	
125 FA	FSNL	Lake City	Douglas	CCUS	Graying	Graying	Graying	Graying	Graying	Graying	
128 FA	FKNX	Clark	FSIL	FRK	FRK	FRK	FRK	FRK	FRK	FRK	
130 FA	FSIL	FSIL	FRK	FRK	FRK	FRK	FRK	FRK	FRK	FRK	
131 FA	CSTA	FSIL	CSTA	CSTA	CSTA	CSTA	CSTA	CSTA	CSTA	CSTA	
132 FA	CSTA	FSIL	CSTA	CSTA	CSTA	CSTA	CSTA	CSTA	CSTA	CSTA	
133 FA	N/O	N/O	N/O	N/O	N/O	N/O	N/O	N/O	N/O	N/O	
134 FA	FKNX	FKNX	FKNX	FKNX	FKNX	FKNX	FKNX	FKNX	FKNX	FKNX	
135 FA	FKNX	FKNX	FKNX	FKNX	FKNX	FKNX	FKNX	FKNX	FKNX	FKNX	
136 FA	N/O	N/O	N/O	N/O	N/O	N/O	N/O	N/O	N/O	N/O	
138 FA	FKNX	FKNX	FKNX	FKNX	FKNX	FKNX	FKNX	FKNX	FKNX	FKNX	
139 FA	FKNX	FKNX	FKNX	FKNX	FKNX	FKNX	FKNX	FKNX	FKNX	FKNX	

Field Artillery Training Camps 1921 – 1930

Year	1921	1922	1923	1924	1925	1926	1927	1928	1929	1930
141a FA	CJAC	FMCL	FBRG	BEAU/FBRG	FBRG	BEAU	R/D 141st FA Bn	BEAU	I/A	I/A
141b FA							BEAU	BEAU	BEAU	BEAU
142 FA	N/O	N/O	N/O	N/O	N/O	N/O	N/O	N/O	N/O	N/O
143 FA	FLEW	FLEW	DELM	FLEW	FLEW	DELM	SLO	SLO	SLO	SLO
144 FA	N/O	N/O	N/O	N/O	N/O	N/O	N/O	N/O	N/O	N/O
145 FA	FLEW	FLEW	WG Wms	WG Wms	FLEW	WG Wms	WG Wms	WG Wms	WG Wms	WG Wms
146 FA	FLEW	FLEW	Murray	Murray	Murray	Murray	Murray	Murray	Murray	Murray
147 FA	N/O	FMEA	Pierre	Rapid City	McCoy	Rapid City	Rapid City	Rapid City	Mitchell, SD	Rapid City
148 FA	N/O	N/O	FLEW	FLEW	FLEW	Boise/Murray	Boise/Murray	Murray	Murray	Murray/Boise
150 FA	FKNX	FKNX	FKNX	FKNX	FKNX	FKNX	FKNX	FKNX	FKNX	FKNX
151 FA	FSNL	McCoy	Douglas	McCoy	McCoy	McCoy	McCoy	McCoy	McCoy	McCoy
152 FA	FDEV	FDEV	Keyes	Keyes	Keyes	Keyes	FDEV	FDEV	Keyes	FDEV
156 FA	N/O	N/O	N/O	Pine Cp	Pine Cp	Pine Cp	Pine Cp	Pine Cp	Pine Cp	Pine Cp
157 FA	N/O	N/O	N/O	N/O	N/O	N/O	N/O	N/O	N/O	N/O
158 FA	FSIL/FBLS	FSIL/FBLS	FSIL/FBLS	FSIL/FBLS	FSIL/FDAR	FSIL/West	FSIL/FBLS	FSIL/FBLS	FSIL/Luna	FSIL/Luna
160 FA	FSIL	FSIL	FSIL	FSIL	FSIL	FSIL	FSIL	FSIL	FSIL	FSIL
161 FA	FSIL	FSIL	FRK	FRK	FRK	FRK	FRK	FRK	FRK	FRK
162 FA	N/O	N/O	N/O	N/O	N/O	N/O	N/O	N/O	N/O	N/O
168 FA BN	N/O	N/O	N/O	N/O	N/O	West	West	West	West	West
168 FA										
172 FA	Tobyhanna	Warner, NH	FDEV	Warner, NH	Tobyhanna	Warner, NH	Salisbury, NH	Webster, NH	Webster, NH	Webster, NH
176 FA	Tobyhanna	Tobyhanna	Tobyhanna	Tobyhanna	Tobyhanna	Tobyhanna	Tobyhanna	Tobyhanna	Tobyhanna	Tobyhanna
178a FA	N/O	N/O	N/O	N/O	FBRG	FKNX	FKNX	FKNX	FBRG/FKNX	FKNX
178b FA	N/O	N/O	N/O	N/O	N/O	N/O	N/O	N/O	N/O	N/O
179 FA	N/O	N/O	N/O	N/O	N/O	N/O	N/O	N/O	N/O	N/O
182 FA	Grayling	Grayling	Grayling	CCUS	Grayling	Grayling	Grayling	Grayling	Grayling	Grayling
185 FA	FKNX	FKNX	FKNX	FKNX	FKNX	McCoy	McCoy	McCoy	McCoy	McCoy
189 FA	FSIL	FSIL	FSIL	FSIL	FSIL	FSIL	FSIL	FSIL	FSIL	FSIL
192 FA	FDEV	FEUS	FEUS	FEUS	Tobyhanna	Tobyhanna	Tobyhanna	Tobyhanna	Tobyhanna	Niantic
196 FA										
218 FA	FLEW	FLEW	FLEW	FLEW	FSTV	Cp Jackson	FSTV	FSTV	FSTV	FSTV
222 FA	N/O	N/O	N/O	WG Wms	FLEW	WG Wms	WG Wms	WG Wms	WG Wms	WG Wms
258 FA	Weish	FEUS	FEUS	FEUS	FEUS	FONT	FONT	FONT	FONT	FONT
301 FA	N/O	FDEV-DGRP	FDEV-DGRP	FDEV-DGRP	FEA-RATC	FEA-CMTC	FEA-GUTC	N/C	FEA-RATC	FEA
302 FA	N/O	FDEV-DGRP	FDEV-DGRP	FDEV-DGRP	Charlestown	FEA-GUTC	FEA-GUTC	Charlestown	FEA	N/C
303 FA	N/O	FDEV-DGRP	FDEV-DGRP	FDEV-DGRP	FEA-RATC	FEA-GUTC	FEA-CMTC	N/C	FEA-RATC	N/C
304 FA	N/O	FDIX-DGRP	FDIX-DGRP	N/C	N/C	Pine Cp	Pine Cp	N/C	Pine Cp	N/C
305 FA	N/O	FDIX-DGRP	FDIX-DGRP	N/C	N/C	Pine Cp	N/C	Pine Cp	Pine Cp	N/C
306 FA	N/O	FDIX-DGRP	FDIX-DGRP	N/C	N/C	Pine Cp-RATC	MDBK-Ind	N/C	N/C	FHOY-RATC
307 FA	N/O	FDIX-DGRP	FDIX-DGRP	N/C	MDBK	Pine Cp	Pine Cp	N/C	N/C	FHOY-RATC
308 FA	N/O	FDIX-DGRP	FDIX-DGRP	N/C	N/C	Pine Cp-RATC	N/C	Pine Cp	N/C	N/C
309 FA	N/O	FDIX-DGRP	FDIX-DGRP	MDBK-IND	MDBK-CMTC	Pine Cp	N/C	FBRG-RATC	FBRG-GUTC	N/C
310 FA	N/O	FGGM-DGRP	FGGM-DGRP	FGGM-GUTC	N/C	FHOY	FHOY-IND	FEUS-GUTC	N/C	FHOY-RATC

Field Artillery Training Camps 1921 – 1930												
Year	1921	1922	1923	1924	1925	1926	1927	1928	1929	1930		
311 FA	N/O	FGGM-DGRP	FGGM-DGRP	N/C	FGGM	N/C	FHOY-CMTC	N/C	FHOY-RATC	FHOY-RATC		FHOY-RATC
312 FA	N/O	N/O	N/O	N/O	N/O	N/O	N/O	N/O	N/C	N/C		FGGM
313 FA	N/O	FGGM-DGRP	FGGM-DGRP	FHOY-GUTC	FGGM	FHOY	N/C	FHOY-RATC	FHOY-RATC	FHOY-RATC		Tobyhanna
314 FA	N/O	FGGM-DGRP	FGGM-DGRP	FGGM	FGGM	N/C	FHOY-CMTC	N/C	FHOY-RATC	FHOY-RATC		FHOY-RATC
315 FA	N/O	N/O	N/O	N/O	N/O	N/O	N/O	N/O	FBRG-GUTC	FBRG-GUTC		FGGM
316 FA	N/O	FMCL-DGRP	FMCL-DGRP	N/C	FBRG-CCT	FBRG	FBRG-GUTC	FBRG	FBRG-GUTC	FBRG-GUTC		FBRG-GUTC
317 FA	N/O	FMCL-DGRP	FMCL-DGRP	FBRG	FBRG-CCT	FBRG	FBRG-GUTC	FBRG	FBRG	FBRG		N/C
318 FA	N/O	N/O	N/O	N/O	N/O	N/O	N/O	N/O	N/C	N/C		N/C
319 FA	N/O	FMCL-DGRP	FMCL-DGRP	FBRG	FBRG-MOB	N/C	FBRG-GUTC	FBRG	FBRG-GUTC	FBRG-RATC		FBRG-RATC
320 FA	N/O	FMCL-DGRP	FMCL-DGRP	FBRG	FBRG-MOB	N/C	FBRG-RATC	FBRG	FBRG-GUTC	FBRG-GUTC		FBRG-GUTC
321 FA	N/O	N/O	N/O	N/O	N/O	N/O	N/O	N/O	N/C	N/C		N/C
322 FA	N/O	FKNX-DGRP	FKNX-DGRP	FKNX	N/C	FBH-RATC	FKNX-GUTC	FKNX-GUTC	FKNX-GUTC	FKNX-GUTC		N/C
323 FA	N/O	FKNX-DGRP	FKNX-DGRP	FKNX	FKNX	FKNX-GUTC	FKNX-GUTC	FKNX-GUTC	FKNX-GUTC	FKNX-GUTC		N/C
324 FA	N/O	N/O	N/O	N/O	N/O	N/O	N/O	N/O	N/C	N/C		N/C
325 FA	N/O	FKNX-DGRP	FKNX-DGRP	FKNX	FBH	FKNX-NG	FKNX-GUTC	FKNX-GUTC	FKNX-GUTC	FKNX-RATC		FKNX-RATC
326 FA	N/O	FKNX-DGRP	FKNX-DGRP	FKNX	FKNX	FKNX-NG	FKNX-GUTC	FKNX-NG	FKNX-NG	FKNX-NG		FKNX-NG
327 FA	N/O	N/O	N/O	N/O	N/O	N/O	N/O	N/O	N/C	N/C		N/C
328 FA	N/O	CCUS-DGRP	CCUS-DGRP	CCUS-GUTC	McCoy	N/C	McCoy-GUTC	N/C	Grayingling-NG	Grayingling-NG		McCoy-RATC
329 FA	N/O	CCUS-DGRP	CCUS-DGRP	N/C	McCoy	N/C	McCoy-GUTC	Grayingling-NG	N/C	McCoy-RATC		McCoy-RATC
330 FA	N/O	N/O	N/O	N/O	N/O	N/O	N/O	N/O	N/C	N/C		N/C
331 FA	N/O	CCUS-DGRP	CCUS-DGRP	CCUS-RATC	N/C	McCoy	N/C	McCoy-CMTC	McCoy-GUTC	McCoy-GUTC		N/C
332 FA	N/O	CCUS-DGRP	CCUS-DGRP	N/C	McCoy	N/C	McCoy-GUTC	McCoy-GUTC	N/C	N/C		N/C
333 FA	N/O	N/O	N/O	N/O	N/O	N/O	N/O	N/O	N/C	N/C		N/C
334 FA	N/O	FMCL-DGRP	FMCL-DGRP	FBRG	FBRG	FBRG	N/C	FBRG-GUTC	FSH-GUTC	FSH-GUTC		FSH-GUTC
335 FA	N/O	N/O	N/O	N/O	N/O	N/O	N/O	N/O	N/C	N/C		N/C
336 FA	N/O	FMCL-DGRP	FMCL-DGRP	FBRG	BEAU	FBRG	BEAU-GUTC	FBRG-GUTC	FSH-GUTC	FSH-GUTC		FSH-GUTC
337 FA	N/O	FSNI-DGRP	FSNI-DGRP	FDM	N/C	McCoy	McCoy-GUTC	McCoy-GUTC	McCoy	McCoy-RATC		McCoy-RATC
338 FA	N/O	FSNI-DGRP	FSNI-DGRP	FDM	McCoy	FDM-RATC	McCoy-GUTC	McCoy-GUTC	McCoy	McCoy-RATC		McCoy-RATC
339 FA	N/O	N/O	N/O	N/O	N/O	N/O	N/O	N/O	McCoy	McCoy		McCoy-RATC
340 FA	N/O	FDM-DGRP	FDM-DGRP	FDM	N/C	McCoy	McCoy-GUTC	FRK-GUTC	FRK-GUTC	FRK-GUTC		FRK-GUTC
341 FA	N/O	FDM-DGRP	FDM-DGRP	N/C	McCoy	FDM	McCoy-GUTC	N/C	FDM-CMTC	FDM-CMTC		FDM-CMTC
342 FA	N/O	N/O	N/O	N/O	N/O	N/O	N/O	N/O	N/C	N/C		N/C
343 FA	N/O	FSH-DGRP	FSH-DGRP	FSH	N/C	FSH-RATC	FSH-RATC	FSH-RATC	N/C	FSH-RATC		FSH-RATC
344 FA	N/O	FSH-DGRP	FSH-DGRP	FSH	N/C	FSH-RATC	FSH-RATC	FSH-RATC	N/C	FSH-RATC		FSH-RATC
345 FA	N/O	N/O	N/O	N/O	N/O	N/O	N/O	N/O	N/C	N/C		N/C
346 FA	N/O	PMON-DGRP	Unknown	DELM	PMON	PMON-RATC	PMON-GUTC	PMON-GUTC	PMON-GUTC	PMON-RATC		PMON-RATC
347 FA	N/O	PMON-DGRP	Unknown	DELM	PMON	PMON-RATC	PMON-GUTC	PMON-GUTC	PMON-GUTC	PMON-RATC		PMON-RATC
348 FA	N/O	N/O	N/O	N/O	N/O	N/O	N/O	N/O	N/C	PMON-RATC		PMON-RATC
349 FA	N/O	N/O	N/O	N/O	N/O	N/O	N/O	N/O	N/C	N/C		N/C
350 FA	N/O	N/O	N/O	N/O	N/O	N/O	N/O	N/O	N/C	N/C		N/C
351 FA	N/O	N/O	N/O	N/O	N/O	N/O	N/O	N/O	N/C	N/C		N/C
352 FA	N/O	N/O	N/O	N/O	N/O	N/O	N/O	N/O	FEA-CMTC	FEA-CMTC		N/C
353 FA												N/C
354 FA												N/C
355 FA	N/O	FDEV-DGRP	FDEV-DGRP	FDEV-DGRP	FEA-GUTC	N/C	FEA-GUTC	FEA-RATC	N/C	FEA-RATC		FEA-RATC

Field Artillery Training Camps 1921 – 1930

Year	1921	1922	1923	1924	1925	1926	1927	1928	1929	1930
356 FA	N/O	FDEV-DGRP	FDEV-DGRP	FDEV-DGRP	FEA	FEA	FEA-GUTC	FEA-RATC	FEA-CMTC	N/C
358 FA	N/O	FSIL-DGRP	FSIL-DGRP	FSIL-GUTC	FSIL	FSIL-RATC	FSIL-RATC	FSIL-RATC	FSIL-GUTC	FSIL-GUTC
359 FA	N/O	FSIL-DGRP	FSIL-DGRP	FSIL-GUTC	N/C	FSIL-RATC	FSIL-RATC	FSIL-RATC	N/C	FSIL
360 FA	N/O	N/O	N/O	N/O	N/O	N/O	N/O	N/O	N/C	N/C
361 FA	N/O	FLEW-DGRP	FLEW-DGRP	FLEW	FLEW	FLEW-RATC	FLEW-RATC	FLEW-GUTC	FLEW	FLEW
362 FA	N/O	FLEW-DGRP	FLEW-DGRP	FLEW	FLEW	FLEW-RATC	FLEW-RATC	FLEW-GUTC	FLEW	FLEW
363 FA	N/O	N/O	N/O	N/O	N/O	N/O	N/O	N/O	N/C	FLEW
364 FA	N/O	N/C	N/C	N/C	N/C	N/O	N/O	N/C	N/C	N/C
365 FA	N/O	FDEV-DGRP	FDEV-DGRP	FDEV-DGRP	FEA-GUTC	FEA-GUTC	FEA-GUTC	FEA-RATC	N/C	FEA-RATC
366 FA	N/O	N/O	N/O	N/O	N/O	N/O	N/O	N/O	N/C	N/C
367 FA	N/O	FDIX-DGRP	FDIX-DGRP	FDIX-DGRP	MDBK	N/C	Pine Cp	Pine Cp	N/C	Pine Cp
368 FA	N/O	FDIX-DGRP	FDIX-DGRP	FDIX-DGRP	MDBK	Pine Cp-RATC	N/C	Pine Cp	N/C	N/C
369 FA	N/O	N/O	N/O	N/O	N/O	N/O	N/O	N/O	N/C	N/C
370 FA	N/O	FGGM-DGRP	FGGM-DGRP	FGGM-GUTC	FGGM	N/C	FMYR-GUTC	N/C	FHOY-RATC	Tobyhanna
371 FA	N/O	FGGM-DGRP	FGGM-DGRP	FGGM	FGGM	FHOY	N/C	FHOY-GUTC	FHOY-RATC	Tobyhanna
372 FA	N/O	N/O	N/O	N/O	N/O	N/O	N/O	N/O	N/C	EGGM
373 FA	N/O	FKNX-DGRP	FKNX-DGRP	FKNX	N/O	N/O	N/O	N/O	N/C	N/C
374 FA	N/O	FKNX-DGRP	FKNX-DGRP	FKNX	N/C	FBNH-RATC	FKNX-GUTC	FKNX-GUTC	FKNX-GUTC	N/C
375 FA	N/O	N/O	N/O	FKNX	N/O	N/O	FKNX-GUTC	FKNX-GUTC	FKNX-GUTC	N/C
376 FA	N/O	CCUS-DGRP	CCUS-DGRP	CCUS-GUTC	McCoy	McCoy	N/C	McCoy-GUTC	McCoy-GUTC	N/C
377 FA	N/O	CCUS-DGRP	CCUS-DGRP	N/C	McCoy	N/C	McCoy-GUTC	McCoy-GUTC	N/C	McCoy
378 FA	N/O	N/O	N/O	N/O	N/O	N/O	N/O	N/O	N/C	N/C
379 FA	N/O	JFBK-DGRP	JFBK-DGRP	N/C	FRK	FRK	N/C	FRK-GUTC	N/C	FRK-NG
380 FA	N/O	JFBK-DGRP	JFBK-DGRP	FLVN	N/C	N/C	FRK-GUTC	FRK-GUTC	N/C	FRK-NG
381 FA	N/O	N/O	N/O	N/O	N/O	N/O	N/O	N/O	N/C	FRK-NG
382 FA	N/O	FLOG-DGRP	FLOG-DGRP	FBL-S-GUTC	FBL-S	FBL-S-RATC	FBL-S-RATC	FBL-S-RATC	FBL-S-RATC	FBL-S-RATC
383 FA	N/O	FLOG-DGRP	FLOG-DGRP	FBL-S-GUTC	FBL-S	FBL-S-RATC	FBL-S-RATC	FDAR-RATC	FDAR-RATC	FEW-GUTC
384 FA	N/O	N/O	N/O	N/O	N/O	N/O	N/O	N/O	N/C	N/C
385 FA	N/O	FDOU-DGRP	FDOU-DGRP	FDOU-GUTC	FDAR-RATC	FDAR-RATC	FDAR-RATC	FDAR-RATC	FDAR-GUTC	FEW-GUTC
386 FA	N/O	FDOU-DGRP	FDOU-DGRP	FDOU-GUTC	FDAR	FDAR-RATC	FDAR-RATC	FDAR-RATC	FDAR-GUTC	FEW-GUTC
387 FA	N/O	N/O	N/O	N/O	N/O	N/O	N/O	N/O	N/O	N/O
388 FA	N/O	Unknown	Unknown	N/C	N/C	N/C	FEA	FEA-RATC	FEA	FEA-RATC
389 FA	N/O	FDEV-DGRP	FDEV-DGRP	FDEV-DGRP	FDEV-GUTC	FDEV-GUTC	N/C	FEA-RATC	N/C	FEA-RATC
390 FA	N/O	N/C	FDEV-DGRP	FDEV-DGRP	FDEV-GUTC	FDEV-GUTC	FDEV-GUTC	FEA-RATC	FEA	N/C
391 FA	N/O	Unknown	Unknown	MDBK-CMTC	MDBK	Pine Cp	N/C	Pine Cp	Pine Cp	Pine Cp
392 FA	N/O	N/O	N/O	N/O	N/O	N/O	N/C	N/C	FKNX-IND	I/A
394 FA	N/O	Unknown	Unknown	N/C	FEUS	Tobyhanna	N/C	N/C	FEUS-GUTC	N/C
395 FA	N/O	Unknown	Unknown	N/C	FEUS-GUTC	N/C	Tobyhanna	N/C	Tobyhanna-NG	I/A
396 FA	N/O	Unknown	Unknown	N/C	Tobyhanna	N/C	N/C	Tobyhanna	N/C	I/A
397 FA (I)	N/O	Unknown	Unknown	FBRG	BEAU	FBRG-GUTC	FBRG-GUTC	FBRG-RATC	FBRG-GUTC	R/D 318 FA
397 FA (II)										
398 FA (I)	N/O	Unknown	Unknown	N/C	FMCL	FBRG-GUTC	FMCL-GUTC	FBRG-GUTC	FBRG-GUTC	R/D 335th FA
399 FA	N/O	Unknown	Unknown	N/C	FBRG-MOB	N/C	FBRG-GUTC	FBRG-GUTC	D/B 6-10-28	
400 FA	N/O	Unknown	Unknown	FKNX	FBH	FKNX-RATC	N/C	N/C	FKNX-IND	I/A
401 FA	N/O	N/O	N/O	N/O	N/O	N/C	N/C	N/C	FKNX-IND	I/A

Year	1921	1922	1923	1924	1925	1926	1927	1928	1929	1930
402 FA	N/O	Unknown	Unknown	N/C	N/C	FBH-RATC	FKNX-GUTC	N/C	FKNX-IND	I/A
403 FA	N/O	Unknown	Unknown	N/C	McCoy	N/C	N/C	McCoy-GUTC	N/C	McCoy
404 FA	N/O	Unknown	Unknown	CCUS-GUTC	N/C	N/C	McCoy-GUTC	N/C	McCoy-GUTC	N/C
405 FA	N/O	Unknown	Unknown	N/C	N/C	N/C	I/A	I/A	D/B 6-10-28	N/C
406 FA	N/O	Unknown	Unknown	N/C	N/C	McCoy	N/C	N/C	N/C	N/C
407 FA	N/O	Unknown	Unknown	N/C	FKNX-NG	N/C	McCoy-GUTC	I/A	I/A	I/A
408 FA	N/O	Unknown	Unknown	N/C	N/C	N/C	McCoy-GUTC	N/C	I/A	I/A
409 FA	N/O	Unknown	Unknown	FSIL-GUTC	FSIL	FSIL-RATC	FSIL-RATC	FSIL-RATC	FSIL-GUTC	FSIL-GUTC
410 FA	N/O	Unknown	Unknown	N/C	FSIL	FSH-RATC	N/C	McCoy-GUTC	McCoy	N/C
411 FA	N/O	Unknown	Unknown	N/C	FSH	FSH-RATC	FSH-RATC	FSH-RATC	FSH-RATC	FSH-RATC
412 FA	N/O	Unknown	Unknown	N/C	N/C	FLEW-RATC	FLEW-RATC	FLEW-GUTC	FLEW	N/C
413 FA	N/O	Unknown	Unknown	N/C	N/C	FLEW-RATC	FLEW-RATC	FLEW-RATC	FLEW-GUTC	FLEW
414 FA	N/O	Unknown	Unknown	DELM	N/C	PMON-RATC	PMON-GUTC	PMON-GUTC	PMON-GUTC	PMON-RATC
426 FA	N/O	N/O	N/O	N/O	N/O	N/C	PMON-GUTC	PMON-GUTC	PMON-GUTC	N/C
427 FA	N/O	N/O	N/O	N/O	BEAU	FBRG-GUTC	FBRG-GUTC	N/C	N/C	I/A
431 FA	N/O	N/C	N/C	N/C	FTRY-GUTC	N/C	N/C	N/C	FEA	I/A
432 FA	N/O	Unknown	Unknown	N/C	N/C	FHAN-RATC	FBRG-IND	N/C	N/C	FBRG
434 FA	N/O	Unknown	Unknown	N/C	FBRG	FBRG-GUTC	FBRG-GUTC	N/C	N/C	N/C
435 FA	N/O	Unknown	Unknown	N/C	N/C	FBH-RATC	FKNX-GUTC	N/C	FKNX-IND	I/A
436 FA	N/O	Unknown	Unknown	N/C	McCoy	McCoy	N/C	N/C	N/C	N/C
437 FA	N/O	Unknown	Unknown	N/C	N/C	McCoy	N/C	N/C	N/C	N/C
438 FA	N/O	Unknown	Unknown	N/C	FSH	FSH-RATC	I/A	I/A	I/A	I/A
439 FA	N/O	Unknown	Unknown	DELM	N/C	PMON-RATC	PMON-GUTC	PMON-GUTC	PMON-GUTC	PMON-RATC
440 FA	N/O	Unknown	Unknown	N/C	N/C	N/C	I/A	I/A	I/A	I/A
441 FA	N/O	Unknown	Unknown	N/C	Blauvelt-LUTC	Pine Cp	N/C	Pine Cp	Pine Cp	N/C
442 FA	N/O	Unknown	Unknown	N/C	N/C	FHAN-RATC	FBRG-IND	FBRG-GUTC	FBRG	N/C
443 FA	N/O	Unknown	Unknown	N/C	N/C	FRK	N/C	FRK-GUTC	FRK-GUTC	N/C
444 FA	N/O	N/O	N/O	N/C	FBRG	FBRG	N/C	FBRG-GUTC	D/B 5-09-28	N/C
445 FA	N/O	N/O	N/O	N/O	N/O	N/O	FKNX-GUTC	N/C	D/B 5-09-28	N/C
446 FA	N/O	N/O	N/O	N/O	N/O	N/C	PMON-GUTC	PMON-GUTC	D/B 5-09-28	N/C
447 FA	N/O	N/O	N/O	N/O	N/O	N/C	PMON-GUTC	PMON-GUTC	D/B 5-09-28	N/C
448 FA	N/O	N/O	N/O	N/O	FBRG	FBRG	FBRG-GUTC	FBRG-GUTC	D/B 5-09-28	N/C
449 FA	N/O	N/O	N/O	N/O	N/C	N/C	FKNX-GUTC	N/C	D/B 5-09-28	N/C
452 FA	N/O	N/O	N/O	N/O	FBRG	FBRG	N/C	FBRG-GUTC	FBRG-GUTC	R/D 321 FA
453 FA	N/O	N/O	N/O	N/O	N/O	N/O	PMON-GUTC	PMON-GUTC	PMON-GUTC	I/A
455 FA	N/O	N/O	N/O	N/O	N/C	FKNX-CMTC	FKNX-GUTC	N/C	FKNX-IND	N/C
459 FA	N/O	N/O	N/O	N/C	N/C	N/C	N/C	FBRG-GUTC	D/B 5 Sep 28	N/C
461 FA	N/O	FDIX-DGRP	FDIX-DGRP	N/C	N/C	Pine Cp-RATC	N/C	N/C	R/D 861 FA	N/C
462 FA	N/O	FGGM-DGRP	FGGM-DGRP	N/C	FHOY	FGGM-RATC	N/C	FEUS-RATC	R/D 862 FA	N/C
463 FA	N/O	N/C	N/C	N/C	N/C	FBRG	N/C	FBRG-GUTC	R/D 863 FA	N/C
464 FA	N/O	Unknown	Unknown	FKNX	FKNX	FKNX-RATC	FKNX-GUTC	FKNX-RATC	R/D 864 FA	N/C
465 FA	N/O	Unknown	Unknown	CCUS	N/C	N/C	N/C	McCoy-GUTC	R/D 865 FA	N/C
466 FA	N/O	Unknown	Unknown	N/C	FRK	FRK	FRK-GUTC	FRK-GUTC	R/D 866 FA	N/C
471 FA	N/O	N/C	N/C	N/C	N/C	N/C	Pine Cp	I/A	I/A	I/A
472 FA	N/O	N/C	N/C	N/C	N/C	Pine Cp-RATC	MDBK-Ind	I/A	I/A	I/A

Field Artillery Training Camps 1921 – 1930

Year	1921	1922	1923	1924	1925	1926	1927	1928	1929	1930
473 FA	N/O	N/C	N/C	N/C	FEUS	N/C	Tobyhanna	N/C	I/A	I/A
474 FA	N/O	N/C	N/C	N/C	N/C	FKNX-RATC	N/C	N/C	I/A	I/A
475 FA	N/O	N/O	N/O	N/O	N/C	N/C	FKNX-GUTC	N/C	FKNX-IND	N/C
476 FA	N/O	N/O	N/O	N/O	N/C	N/C	N/C	N/C	FKNX-IND	N/C
477 FA	N/O	N/C	N/C	N/C	N/C	N/C	McCoy-GUTC	N/C	McCoy-GUTC	I/A
478 FA	N/O	N/O	N/O	N/O	N/C	N/C	FDM-RATC	N/C	N/C	N/C
479 FA	N/O	N/C	N/C	N/C	McCoy	N/C	N/C	N/C	N/C	N/C
481 FA	N/O	N/C	N/C	N/C	N/C	N/C	Pine Cp	I/A	I/A	I/A
482 FA	N/O	N/C	N/C	N/C	FEUS	N/C	N/C	Tobyhanna-NG	N/C	I/A
486 FA	N/O	Unknown	Unknown	N/C	McCoy	N/C	N/C	McCoy-GUTC	N/C	I/A
487 FA	N/O	N/O	N/O	N/O	N/C	McCoy	McCoy	McCoy-NG	N/C	I/A
488 FA	N/O	Unknown	Unknown	N/C	N/C	N/C	FDM-RATC	I/A	N/C	N/C
489 FA	N/O	Unknown	N/C	N/C	FTRY-GUTC	FDEV-GUTC	I/A	I/A	I/A	I/A
490 FA	N/O	N/O	N/C	N/C	Pine Cp	Pine Cp	N/C	I/A	I/A	I/A
491 FA	N/O	Unknown	Unknown	N/C	FEUS	N/C	N/C	FEUS-GUTC	N/C	I/A
492 FA	N/O	Unknown	Unknown	N/C	N/C	N/C	N/C	N/C	FKNX-IND	N/C
494 FA	N/O	Unknown	Unknown	N/C	N/C	McCoy	N/C	N/C	N/C	N/C
495 FA	N/O	N/O	N/C	N/C	FEUS	N/C	N/C	N/C	N/C	N/C
496 FA	N/O	N/C	N/C	N/C	Tobyhanna	N/C	FEUS	N/C	N/C	I/A
497 FA	N/O	N/O	N/C	N/C	N/C	McCoy	N/C	McCoy-GUTC	N/C	McCoy-RATC
498 FA	N/O	N/O	N/C	N/C	I/A	N/C	FRK-GUTC	I/A	I/A	I/A
499 FA	N/O	N/O	N/C	N/C	N/C	N/C	FRK-GUTC	I/A	I/A	I/A
500 FA	N/O	N/C	N/C	N/C	N/C	N/C	N/C	N/C	FLEW	FLEW
560 FA	N/O	N/O	N/O	N/C	N/C	N/C	FBRG-IND	N/C	N/C	N/C
562 FA	N/O	N/O	N/C	N/C	N/C	N/C	FBRG-GUTC	N/C	N/C	I/A
563 FA	N/O	N/C	N/C	N/C	N/C	N/C	N/C	N/C	FKNX-IND	N/C
564 FA	N/O	N/C	N/C	N/C	N/C	N/C	I/A	I/A	I/A	I/A
565 FA	N/O	N/C	N/C	N/C	N/C	N/C	N/C	N/C	FKNX-IND	N/C
566 FA	N/O	N/C	N/C	N/C	N/C	N/C	N/C	N/C	N/C	N/C
567 FA	N/O	N/C	N/C	Taylorville	N/C	N/C	McCoy-GUTC	N/C	McCoy-GUTC	McCoy-RATC
569 FA	N/O	N/C	N/C	N/C	N/C	N/C	Pine Cp	N/C	N/C	N/C
570 FA	N/O	N/C	N/C	N/C	N/C	MDBK-CMTC	MDBK-Ind	N/C	N/C	FBRG
571 FA	N/O	N/C	N/C	N/C	N/C	Tobyhanna	N/C	N/C	FHOY-RATC	N/C
572 FA	N/O	N/O	N/O	N/O	N/C	N/C	McCoy-GUTC	N/C	McCoy-GUTC	McCoy
573 FA	N/O	N/C	N/C	N/C	FEUS	N/C	FEUS	N/C	N/C	I/A
574 FA	N/O	N/O	N/O	N/O	N/C	N/C	N/C	N/C	FKNX-IND	I/A
575 FA	N/O	N/O	N/O	N/O	N/O	N/C	McCoy-GUTC	N/C	McCoy-GUTC	N/C
576 FA	N/O	N/C	N/C	N/C	N/C	N/C	FBRG-GUTC	I/A	I/A	I/A
577 FA	N/O	N/C	N/C	N/C	N/C	N/C	FBRG-GUTC	N/C	N/C	FBRG-RATC
578 FA	N/O	N/C	N/C	N/C	FEUS	N/C	N/C	N/C	FEUS-GUTC	N/C
579 FA	N/O	N/C	N/C	N/C	N/C	N/C	McCoy-GUTC	N/C	McCoy-GUTC	N/C
580 FA	N/O	N/C	N/C	N/C	N/C	N/C	N/C	FEUS-RATC	N/C	Tobyhanna
581 FA	N/O	N/C	N/C	N/C	N/C	N/C	McCoy-GUTC	N/C	N/C	McCoy
590 FA			N/O	N/O	N/C	N/C	N/C	FBRG-GUTC	FBRG-GUTC	N/C
861 FA								Was 461 FA Bn	Pine Cp	N/C

Field Artillery Training Camps 1921 – 1930										
Year	1921	1922	1923	1924	1925	1926	1927	1928	1929	1930
862 FA								Was 462 FA Bn	FHOY-RATC	FGGM
863 FA								Was 463 FA Bn	FBRG-GUTC	N/C
864 FA								Was 464 FA Bn	EKNX-GUTC	EKNX-RATC
865 FA								Was 465 FA Bn	McCoy-GUTC	N/C
866 FA								Was 466 FA Bn	FRK-RATC	FRK-GUTC

Field Artillery Training Camps 1931 - 1940										
Regiment	1931	1932	1933	1934	1935	1936	1937	1938	1939	1940
3 FA	McCoy-GUTC	McCoy-GUTC	Unknown	McCoy-GUTC	N/C	McCoy-GUTC	McCoy-MAN	McCoy-GUTC	McCoy-GUTC	McCoy-GUTC
9 FA	I/A (-1st Bn)	I/A (-1st Bn)	I/A (-1st Bn)	I/A (-1st Bn)	I/A (-1st Bn)	I/A (-1st Bn)	I/A (-1st Bn)	I/A (-1st Bn)	I/A (-1st Bn)	I/A (-1st Bn)
14 FA	McCoy-GUTC	N/C	N/C	N/C	N/C	CCUS-MAN	N/C	FSNL-CMTC	FSNL-CMTC	FSNL/FRK
19 FA	FKNX-GUTC	FKNX-RATC	FKNX-IND	FKNX-GUTC	N/C	FBN-CMTC	N/C	N/C	N/C	RAA
20 FA	I/A	N/C	FKNX-GUTC	N/C	N/C	FKNX-GUTC	N/C	FKNX-GUTC	N/C	FKNX-GUTC
21 FA	FKNX-GUTC	N/C	FKNX-GUTC	N/C	FKNX-GUTC	N/C	FKNX-GUTC	N/C	N/C	RAA
22 FA	McCoy-GUTC	McCoy-GUTC	N/C	N/C	N/C	McCoy-CMTC	N/C	McCoy-GUTC	McCoy-GUTC	McCoy-GUTC
25 FA	Ripley-GUTC	Ripley-GUTC	N/C	I/A	N/C	N/C	N/C	Pine Cp	N/C	N/C
26 FA	FKNX-GUTC	N/C	FKNX-GUTC	N/C	N/C	N/C	FEA-CMTC	N/C	FEA-GUTC	RAA
27 FA	FKNX-GUTC	N/C	FKNX-GUTC	N/C	FKNX-GUTC	N/C	FKNX-GUTC	N/C	FKNX-GUTC	FKNX-GUTC
28 FA	FHOY-GUTC	N/C	N/C	N/C	N/C	N/C	N/C	FHOY-RATC	N/C	RAA
29 FA	N/C	N/C	N/C	N/C	FBRG-IND	FBRG-GUTC	FBRG-IND	DeSoto-MAN	FBRG-RATC	RAA
30 FA	N/C	N/C	N/C	N/C	FBRG-IND	FBRG-GUTC	FBRG-IND	FKNX-GUTC	N/C	FKNX-GUTC
31 FA	N/C	N/C	N/C	I/A	I/A	I/A	PMON-CMTC	N/C	N/C	RAA
32 FA	N/C	N/C	FLEW-GUTC	FLEW-GUTC	FLEW-GUTC	FLEW-GUTC	FLEW-GUTC	FLEW-GUTC	FLEW-GUTC	FLEW-GUTC
33 FA	N/C	N/C	N/C	N/C	FKNX-GUTC	N/C	FKNX-GUTC	N/C	FKNX-GUTC	FKNX-GUTC
34 FA	FKNX-GUTC	FKNX-GUTC	N/C	N/C	N/C	N/C	N/C	N/C	FEA-GUTC	RAA
35 FA	N/C	FKNX-GUTC	N/C	FKNX-IND	FKNX-GUTC	N/C	FKNX-GUTC	N/C	FKNX-GUTC	FKNX-GUTC
36 FA	N/C	N/C	N/C	N/C	FBRG-IND	FBRG-GUTC	FBRG-CMTC	DeSoto-MAN	FBRG-GUTC	RAA
37 FA	D/B	D/B	D/B	N/C	N/C	N/C	N/C	N/C	FEA-GUTC	RAA
41 FA	D/B	D/B	D/B	N/C	N/C	N/C	N/C	EGGM-CPX	N/C	FHOY-GUTC
42 FA	D/B	D/B	D/B	I/A	I/A	I/A	I/A	I/A	N/C	FHOY-GUTC
43 FA			N/C	N/C	McCoy-GUTC	N/C	McCoy-GUTC	McCoy-GUTC	McCoy-GUTC	McCoy-GUTC
44 FA	N/C	N/C	N/C	N/C	N/C	Ripley-GUTC	N/C	FSNL-CMTC	FRK-GUTC	FRK-GUTC
45 FA			N/C	N/C	N/C	Ripley-GUTC	N/C	FRK-GUTC	N/C	FRK-GUTC
46 FA			N/C	N/C	N/C	FSIL-GUTC	FSIL-GUTC	CBUL-MAN	N/C	FSIL-GUTC
47 FA			N/C	N/C	N/C	FSIL-GUTC	N/C	FSNL-CMTC	FSNL-CMTC	FSNL-CMTC
50 FA			N/C	N/C	N/C	N/C	N/C	N/C	N/C	Pine Cp-GUTC
51 FA			N/O	N/O	N/C	FSIL-GUTC	FSIL-GUTC	CBUL-MAN	N/C	FSIL-GUTC
52 FA			N/O	N/O	CBUL-CMTC	N/C	N/C	N/C	N/C	McCoy-GUTC
53 FA			CBUL-GUTC	CBUL-GUTC	CBUL-CMTC	MATX-RATC	N/C	CBUL-MAN	N/C	CBUL-GUTC
54 FA			N/O	N/O	N/O	N/C	FORD-GUTC	N/C	N/C	N/C
55 FA			N/O	N/O	N/O	N/C	N/C	N/C	FORD-GUTC	N/C
57 FA			N/O	N/O	N/O	N/O	N/O	N/O	N/C	FBRG-GUTC
58 FA			N/O	N/O	N/O	N/O	N/O	N/O	N/C	FBRG-GUTC
67 FA			N/C	N/C	N/C	N/C	N/C	N/C	McCoy-GUTC	McCoy-MAN
69 FA			N/C	N/C	N/C	N/C	N/C	N/C	McCoy-GUTC	McCoy-CMTC
70 FA			N/C	N/C	N/C	N/C	N/C	FSNL-CMTC	FRK-GUTC	FRK-GUTC
75 FA	D/B	D/B	D/B	N/C	McCoy-GUTC	CCUS-MAN	McCoy-GUTC	McCoy-GUTC	McCoy-GUTC	McCoy-GUTC
77 FA	N/C	N/C	I/A	N/C	N/C	N/C	MATX-RATC	MATX-RATC	RAA	RAA
78 FA	McCoy-RATC	McCoy-GUTC	N/C	N/C	N/C	N/C	McCoy-CMTC	McCoy-GUTC	McCoy-GUTC	McCoy-GUTC
79 FA	FRK-GUTC	Ripley-GUTC	N/C	FRK-GUTC	N/C	Ripley-GUTC	N/C	FRK-GUTC	N/C	N/C
80 FA	McCoy-GUTC	Ripley-GUTC	N/C	Ripley-GUTC	N/C	Ripley-GUTC	N/C	FDIM-GUTC	FRK-GUTC	FRK
84 FA	N/C	N/C	N/C	N/C	N/C	N/C	FRK-NG	FRK-GUTC	FRK-GUTC	FRK-GUTC

Regiment	Field Artillery Training Camps 1931 – 1940												
	1931	1932	1933	1934	1935	1936	1937	1938	1939	1940			
85 FA	N/C	N/C	N/C	N/C	FBRG-IND	FBRG-GUTC	N/C	FKNX-GUTC	N/C	FKNX-GUTC			
86 FA	N/C	N/C	N/C	N/C	FBRG-IND	FBRG-GUTC	FBRG-IND	DeSoto-MAN	N/C	N/C			
89 FA	N/C	N/C	N/C	N/C	N/C	N/C	N/C	N/C	N/C	Pine Cp-GUTC			
90 FA	N/C	N/C	N/C	McCoy-GUTC	N/C	CCUS-MAN	N/C	McCoy-GUTC	McCoy-CMTC	McCoy-MAN			
91 FA	N/C	N/C	N/C	N/C	N/C	FRK/Ripley-NG	N/C	FRK-GUTC	N/C	FRK-GUTC			
92 FA	N/C	N/C	N/C	N/C	N/C	FSIL-GUTC	FSIL-GUTC	CBUL-MAN	N/C	FSIL-GUTC			
94 FA	N/C	N/C	N/C	N/C	N/C	N/C	N/C	N/C	FBRG-GUTC	FBRG-GUTC			
99 FA	N/C	N/C	N/C	N/C	N/C	N/C	N/C	N/C	FRK-GUTC	FRK-GUTC			
100 FA	N/C	N/C	N/C	N/C	N/C	N/C	N/C	N/C	FRK-GUTC	FRK-GUTC			
101 FA	FDEV	FDEV	FDEV	FEA	Pine Cp-MAN	FEA	Edwards	Edwards	PLBK-MAN	NNYS-MAN			
102 FA	FDEV	FDEV	FDEV	FEA	Pine Cp-MAN	FEA	Edwards	Edwards	PLBK-MAN	NNYS-MAN			
103 FA	FDEV	FDEV	FDEV	FEA	Pine Cp-MAN	FEA	FEA	FEA	PLBK-MAN	NNYS-MAN			
104 FA	Pine Cp	Pine Cp	Pine Cp	Pine Cp	Pine Cp-MAN	Pine Cp	Pine Cp	Pine Cp	PLBK-MAN	NNYS-MAN			
105 FA	Pine Cp	Pine Cp	Pine Cp	Pine Cp	Pine Cp-MAN	Pine Cp	Pine Cp	Pine Cp	PLBK-MAN	NNYS-MAN			
106 FA	Pine Cp	Pine Cp	Pine Cp	Pine Cp	Pine Cp-MAN	Pine Cp	Pine Cp	Pine Cp	PLBK-MAN	NNYS-MAN			
107 FA	Tobyhanna	Tobyhanna	Ind Gap	Ind Gap	Ind Gap-MAN	Tobyhanna	Tobyhanna	Tobyhanna	MNVA-MAN	NNYS-MAN			
108 FA	Tobyhanna	Tobyhanna	Ind Gap	Ind Gap	Ind Gap-MAN	Tobyhanna	Tobyhanna	Tobyhanna	MNVA-MAN	NNYS-MAN			
109 FA	Tobyhanna	Tobyhanna	Ind Gap	Ind Gap	Ind Gap-MAN	Tobyhanna	Tobyhanna	Tobyhanna	MNVA-MAN	NNYS-MAN			
110 FA	Tobyhanna	Tobyhanna	Ritchie	Ind Gap	Mt Gretna	Mt Gretna	Ind Gap	Ind Gap	MNVA-MAN	NNYS-MAN			
111 FA	Tobyhanna	Tobyhanna	Tobyhanna	Ind Gap	Ind Gap-MAN	Ind Gap	Ind Gap	Ind Gap	MNVA-MAN	NNYS-MAN			
112 FA	Pine Cp	Pine Cp	Pine Cp	Pine Cp	Pine Cp-MAN	Pine Cp	Ind Gap	Ind Gap	PLBK-MAN	NNYS-MAN			
113 FA	FBRG	FBRG	FBRG	FBRG	FBRG	FBRG	FBRG	DeSoto-MAN	FBRG	KNLA-MAN			
114 FA	FBRG	FBRG	FKNX	FKNX/FBRG	FKNX/FBRG	FKNX	Shelby	DeSoto-MAN	Shelby	KNLA-MAN			
115 FA	CJAC	CJAC	CJAC	CJAC	CJAC	CJAC	CJAC	DeSoto-MAN	CJAC	KNLA-MAN			
116 FA	CJAC	CJAC	CJAC	CJAC	BEAU	CJAC	CJAC	DeSoto-MAN	Shelby	KNLA-MAN			
117a FA	BEAU	BEAU	BEAU	BEAU	CJAC/BEAU	CJAC	BEAU	DeSoto-MAN	Shelby	KNLA-MAN			
117b FA	CJAC	CJAC	CJAC	CJAC	CJAC	CJAC	CJAC	DeSoto-MAN	FBRG	KNLA-MAN			
118 FA	Grayling	Grayling	Grayling	Grayling	Grayling	CCUS-MAN	Grayling	Grayling	Grayling	McCoy-MAN			
119 FA	McCoy	McCoy	McCoy	McCoy	McCoy	CCUS-MAN	McCoy	McCoy	McCoy	McCoy-MAN			
120 FA	McCoy	McCoy	McCoy	McCoy	McCoy	CCUS-MAN	McCoy	McCoy	McCoy	McCoy-MAN			
121 FA	Grant	Grant	Grant	Grant	McCoy	CCUS-MAN	McCoy	Grant	McCoy	McCoy-MAN			
122 FA	Grant	Grant	Grant	Grant	McCoy	CCUS-MAN	McCoy	Grant	McCoy	McCoy-MAN			
123 FA	Grant	Grant	Grant	Grant	McCoy	CCUS-MAN	McCoy	Grant	McCoy	McCoy-MAN			
124 FA	Grant	Grant	Grant	Grant	McCoy	CCUS-MAN	McCoy	Grant	McCoy	McCoy-MAN			
125 FA	Ripley	Ripley	Ripley	Ripley	Ripley	Ripley	Ripley	Ripley	Ripley	Ripley-MAN			
128 FA	FRK	FRK	FRK	FRK	FRK	FRK	FRK	FSIL	FSIL	Ripley-MAN			
130 FA	FRK	FRK	FRK	FRK	FRK	FRK	FRK	FRK	FRK	Ripley-MAN			
131 FA	CBUL	CBUL	Hulen	Hulen	Hulen	Hulen	Hulen	CBUL-MAN	CSTA	KNLA-MAN			
132 FA	CBUL	CBUL	Hulen	Hulen	Hulen	Hulen	Hulen	CBUL-MAN	CSTA	KNLA-MAN			
133 FA	N/O	N/O	N/O	N/O	Hulen	Hulen	Hulen	CBUL-MAN	CSTA	KNLA-MAN			
134 FA	FKNX	FKNX	FKNX	FKNX	FKNX	FKNX-MAN	FKNX	FKNX	FKNX	McCoy-MAN			
135 FA	FKNX	FKNX	FKNX	FKNX	FKNX	FKNX-MAN	FKNX	FKNX	FKNX	McCoy-MAN			
136 FA	N/O	N/O	N/O	N/O	N/O	N/O	N/O	FKNX	FKNX	McCoy-MAN			
138 FA	FKNX	FKNX	FKNX	FKNX	FKNX	FKNX-MAN	FKNX	FKNX	FKNX	McCoy-MAN			
139 FA	FKNX	FKNX	FKNX	FKNX	FKNX	FKNX-MAN	FKNX	FKNX	FKNX	McCoy-MAN			

Field Artillery Training Camps 1931 – 1940

Regiment	1931	1932	1933	1934	1935	1936	1937	1938	1939	1940
141a FA	I/A	I/A	I/A	I/A	I/A	I/A	I/A	I/A	I/A	I/A
141 FA Bn	BEAU	BEAU	BEAU	BEAU	BEAU	BEAU	BEAU	DeSoto-MAN	R/D 141b	
141b FA									BEAU	KNLA-MAN
142 FA	Pike	Pike	FRK	FRK	FRK	FRK	FRK-MAN	FSIL	FSIL	KNLA-MAN
143 FA	SLO	SLO	SLO	SLO	SLO	SLO	SLO-MAN	WG Wms	SLO	FLEW-MAN
144 FA	N/O	N/O	N/O	N/O	N/O	SLO	SLO-MAN	SLO	SLO	FLEW-MAN
145 FA	WG Wms	WG Wms	WG Wms	WG Wms	WG Wms	WG Wms	SLO-MAN	WG Wms	WG Wms	FLEW-MAN
146 FA	Murray	Murray	Murray	Murray	Murray	Murray	FLEW-MAN	Murray	Murray	FLEW-MAN
147 FA	Rapid City	Rapid City	Rapid City	Rapid City	Rapid City	Rapid City	Ripley-MAN	Rapid City	Rapid City	Ripley-MAN
148 FA	Murray/Boise	Murray	Boise	Murray/Boise	Murray	Murray/Boise	FLEW-MAN	Murray/Boise	Murray/Boise	FLEW-MAN
150 FA	FKNX	FKNX	FKNX	FKNX	FKNX	FKNX-MAN	FKNX	FKNX	FKNX	McCoy-MAN
151 FA	Ripley	Ripley	Ripley	Ripley	Ripley	Ripley	Ripley-MAN	Ripley	Ripley	Ripley-MAN
152 FA	Bangor, ME	Brewer, ME	Keyes	Keyes	Pine Cp-MAN	FEA	FEA	FEA	FDEV	NNYS-MAN
156 FA	Pine Cp	Pine Cp	Pine Cp	Pine Cp	Pine Cp-MAN	Pine Cp	Pine Cp	Pine Cp	PLBK-MAN	NNYS-MAN
157 FA	N/O	N/O	N/O	N/O	N/O	Pine Cp	Ind Gap	Ind Gap	PLBK-MAN	NNYS-MAN
158 FA	FSIL/Luna	FSIL/Luna	FSIL/Luna	FSIL/Luna	FSIL	FSIL	FSIL	CBUL-MAN	FSIL	KNLA-MAN
160 FA	FSIL	FSIL	FSIL	FSIL	FSIL	FSIL	FSIL	CBUL-MAN	FSIL	KNLA-MAN
161 FA	FRK	FRK	FRK	FRK	FRK	FRK	FRK-MAN	FRK	FRK	Ripley-MAN
162 FA	N/O	N/O	N/O	N/O	N/O	N/O	N/O	N/O	N/O	
168 FA BN	West	West	R/D 168 FA							
168 FA		West	West	West	West	Pueblo	West	FFEW-MAN	West	KNLA-MAN
172 FA	Webster, NH	Webster, NH	Webster, NH	Tobyhanna	Pine Cp-MAN	FEA	Tobyhanna	FEA	PLBK-MAN	NNYS-MAN
176 FA	Tobyhanna	Tobyhanna	Ind Gap	Ind Gap	Ind Gap-MAN	Ind Gap	Tobyhanna	Ind Gap	Ind Gap-MAN	NNYS-MAN
178a FA	N/O	N/O	N/O	N/O	FBRG	FKNX	FKNX	FKNX	FBRG/FKNX	FKNX
178b FA	N/O	N/O	N/O	N/O	N/O	N/O	N/O	DeSoto-MAN	CJAC	KNLA-MAN
179 FA	N/O	N/O	N/O	N/O	N/O	N/O	N/O	N/O	FBRG	KNLA-MAN
182 FA	Grayling	Grayling	Grayling	Grayling	Grayling	CCJUS-MAN	Grayling	Grayling	Grayling	McCoy-MAN
185 FA	McCoy	Ripley	Unknown	Ripley	Ripley	Ripley	Ripley-MAN	Ripley/Grafton	Ripley/Grafton	Ripley-MAN
189 FA	FSIL	FSIL	FSIL	FSIL	FSIL	FSIL	FSIL	CBUL-MAN	FSIL	KNLA-MAN
192 FA	Tobyhanna	Niantic	Niantic	FEA	Pine Cp-MAN	FEA	FEA	FEA	PLBK-MAN	NNYS-MAN
218 FA	FSTV	FSTV	FSTV	Clatsop	Murray	Clatsop	FLEW-MAN	Clatsop	Clatsop	FLEW-MAN
222 FA	WG Wms	WG Wms	WG Wms	WG Wms	WG Wms	WG Wms	SLO-MAN	WG Wms	WG Wms	FLEW-MAN
258 FA	FONT	FONT	FONT	FONT	Smith	FONT	Pine Cp	Pine Cp	PLBK-MAN	FBRG
301 FA	N/C	FEA-RATC	N/C	N/C	N/C	N/C	FEA-GUTC	N/C	FEA-GUTC	FEA-GUTC
302 FA	FEA-GUTC	N/C	N/C	N/C	FEA-GUTC	FEA-GUTC	N/C	FEA-GUTC	N/C	FEA-GUTC
303 FA	FEA	FEA-RATC	N/C	N/C	N/C	FEA-GUTC	N/C	FEA-NG	N/C	FEA-GUTC
304 FA	FHOY	FHOY-GUTC	FHOY-GUTC	Pine Cp	MDBK-CMTC	Pine Cp	N/C	MDBK-CMTC	Pine Cp	N/C
305 FA	FHOY	FHOY-GUTC	FHOY-GUTC	Pine Cp	MDBK-CMTC	Pine Cp	N/C	MDBK-CMTC	Pine Cp	N/C
306 FA	FHOY-GUTC	FBRG-GUTC	FHOY-GUTC	Pine Cp	Pine Cp	Pine Cp	N/C	N/C	Pine Cp	N/C
307 FA	FHOY-GUTC	N/C	FHOY-GUTC	Pine Cp	N/C	N/C	N/C	N/C	Pine Cp	N/C
308 FA	FHOY-GUTC	FHOY-GUTC	FHOY-GUTC	Pine Cp	N/C	Pine Cp	FDIX-DGRP	FDIX-DGRP	MDBK-CMTC	Pine Cp
309 FA	FBRG-GUTC	Pine Cp	N/C	N/C	FDIX-CPX	MDBK-CMTC	Pine Cp	FDIX-DGRP	N/C	Pine Cp
310 FA	FHOY-RATC	FHOY-GUTC	FHOY-CMTC	FHOY-CMTC	FHOY-IND	FHOY-GUTC	FHOY-CMTC	EGGM-CPX	FHOY-GUTC	FHOY-CMTC
311 FA	FHOY-RATC	N/C	FHOY-RATC	FHOY-CMTC	FHOY-IND	FHOY-GUTC	FHOY-RATC	EGGM-CPX	FHOY-GUTC	FHOY-CMTC
312 FA	N/C	FBRG-GUTC	Unknown	N/C	FHOY-IND	FHOY-GUTC	FHOY-CMTC	EGGM-CPX	FHOY-GUTC	N/C

Field Artillery Training Camps 1931 – 1940

Regiment	1931	1932	1933	1934	1935	1936	1937	1938	1939	1940
313 FA	FHOY-GUTC	FHOY-CMTC	FHOY-RATC	FHOY-GUTC	FHOY-IND	FHOY-CMTC	Ind Gap-CPX	FHOY-GUTC	FHOY-CMTC	FGGM-CPX
314 FA	FHOY-GUTC	FHOY-CMTC	FGGM	FGGM-STE	FHOY-IND	FHOY-CMTC	Ind Gap-CPX	FHOY-GUTC	FHOY-CMTC	FGGM-CPX
315 FA	N/C	FBRG-GUTC	Unknown	N/C	FHOY-IND	FHOY-GUTC	Ind Gap-CPX	FHOY-GUTC	FHOY-CMTC	FGGM-CPX
316 FA	FBRG-RATC	FBRG-RATC	FBRG-GUTC	FBRG-GUTC	N/C	FBRG-GUTC	FBRG-RATC	FBRG-CMTC	FBRG-RATC	FBRG-GUTC
317 FA	FBRG-GUTC	FBRG-RATC	FBRG-GUTC	FBRG-GUTC	FBRG-CMTC	FBRG-GUTC	FBRG-RATC	FBRG-CMTC	FBRG-RATC	FBRG-GUTC
318 FA	N/C	N/C	FBRG-GUTC	FBRG-GUTC	FBRG-RATC	FBRG-GUTC	FBRG-RATC	FBRG-CMTC	FBRG-RATC	FBRG-GUTC
319 FA	FBRG-GUTC	FBRG-RATC	FBRG-GUTC	FBRG-GUTC	FBRG-RATC	FBRG-CMTC	FBRG-RATC	DeSoto-MAN	FBRG-RATC	FBRG-CMTC
320 FA	N/C	FBRG-RATC	FBRG-GUTC	FBRG-GUTC	FBRG-RATC	FBRG-CMTC	FBRG-RATC	DeSoto-MAN	FBRG-RATC	FBRG-CMTC
321 FA	N/C	FBRG-RATC	FBRG-GUTC	FBRG-GUTC	FBRG-RATC	FBRG-CMTC	FBRG-RATC	DeSoto-MAN	FBRG-RATC	FBRG-CMTC
322 FA	FKNX-RATC	N/C	FKNX-CMTC	N/C	N/C	FKNX-GUTC	FKNX-GUTC	N/C	FKNX-GUTC	FKNX-GUTC
323 FA	FKNX-RATC	FKNX-GUTC	N/C	FKNX	FBH-CMTC	FBH-CMTC	FKNX-GUTC	N/C	FKNX-GUTC	FKNX-GUTC
324 FA	FKNX-RATC	N/C	N/C	N/C	FKNX-GUTC	N/C	FKNX-GUTC	N/C	FKNX-GUTC	FKNX-GUTC
325 FA	Culver/FKNX	N/C	FKNX-GUTC	FBH-CMTC	FKNX-GUTC	N/C	FKNX-GUTC	N/C	FKNX-GUTC	FKNX-GUTC
326 FA	Culver	FKNX-GUTC	N/C	FKNX-RATC	N/C	FBH-CMTC	N/C	FKNX-GUTC	N/C	FKNX-GUTC
327 FA	Culver	N/C	N/C	N/C	FKNX-GUTC	N/C	FKNX-GUTC	N/C	FKNX-GUTC	FKNX-GUTC
328 FA	N/C	McCoy-GUTC	Unknown	McCoy-GUTC	N/C	CCUS-MAN	N/C	N/C	N/C	N/C
329 FA	N/C	Grayling-NG	Unknown	N/C	McCoy-GUTC	N/C	Grayling-NG	N/C	Grayling-NG	N/C
330 FA	N/C	N/C	Unknown	McCoy-GUTC	N/C	McCoy-CMTC	Grayling-NG	N/C	McCoy-GUTC	N/C
331 FA	McCoy-GUTC	N/C	Unknown	McCoy-GUTC	N/C	McCoy-CMTC	Grayling-NG	N/C	McCoy-GUTC	N/C
332 FA	McCoy-GUTC	N/C	Unknown	McCoy-GUTC	N/C	McCoy-GUTC	CCUS-DGRP	McCoy-CMTC	McCoy-GUTC	N/C
333 FA	N/C	N/C	Unknown	McCoy-GUTC	N/C	McCoy-GUTC	CCUS-DGRP	McCoy-CMTC	McCoy-GUTC	N/C
334 FA	CSTN-RATC	CBUL-GUTC	CBUL-GUTC	CBUL-GUTC	N/C	McCoy-GUTC	N/C	N/C	McCoy-GUTC	N/C
335 FA	N/C	N/C	CBUL-GUTC	CBUL-GUTC	CBUL-GUTC	CBUL-GUTC	FBRG-RATC	DeSoto-MAN	FBRG-CMTC	FBRG-GUTC
336 FA	CSTN-RATC	CBUL-GUTC	CBUL-GUTC	CBUL-GUTC	CBUL-GUTC	CBUL-GUTC	FBRG-RATC	DeSoto-MAN	FBRG-CMTC	FBRG-GUTC
337 FA	McCoy-RATC	Ripley-GUTC	Unknown	Ripley-GUTC	FSNL-CMTC	Ripley-GUTC	FBRG-RATC	DeSoto-MAN	FBRG-CMTC	FBRG-GUTC
338 FA	McCoy-RATC	Ripley-GUTC	Unknown	Ripley-GUTC	FSNL-CMTC	Ripley-GUTC	FSNL-CMTC	FDM-GUTC	FRK-GUTC	FRK-GUTC
339 FA	McCoy-RATC	Ripley-GUTC	Unknown	Ripley-GUTC	Ripley-GUTC	Ripley-GUTC	FSNL-CMTC	FDM-GUTC	FRK-GUTC	FRK-GUTC
340 FA	FROB-RATC	FRK-GUTC	Unknown	FRK-GUTC	FDM-GUTC	FRK-GUTC	FRK-MAN	FDM-GUTC	FRK-GUTC	FDM-CMTC
341 FA	FROB-RATC	Ripley-GUTC	Unknown	Ripley-GUTC	FDM-GUTC	FDM-GUTC	FRK-MAN	FDM-GUTC	FRK-GUTC	FDM-CMTC
342 FA	FROB-RATC	Ripley-GUTC	Unknown	Ripley-GUTC	FDM-GUTC	FDM-GUTC	FRK-MAN	FDM-GUTC	FDM-GUTC	FDM-CMTC
343 FA	CSTN-RATC	CBUL-RATC	CBUL-RATC	CBUL-RATC	CBUL-RATC	CBUL-RATC	FRK-MAN	FDM-GUTC	FDM-GUTC	FRK-GUTC
344 FA	CSTN-RATC	CBUL-RATC	FSH-RATC	CBUL-RATC	CBUL-RATC	CBUL-RATC	FRK-MAN	FDM-GUTC	FDM-GUTC	FRK-GUTC
345 FA	CSTN-RATC	CBUL-RATC	CBUL-RATC	CBUL-RATC	CBUL-RATC	N/C	FRK-MAN	FDM-GUTC	FDM-GUTC	FRK-GUTC
346 FA	PMON-RATC	N/C	PMON-GUTC	PMON-GUTC	PMON-GUTC	PMON-GUTC	FRK-MAN	FDM-GUTC	FDM-GUTC	FRK-GUTC
347 FA	PMON-RATC	N/C	PMON-GUTC	PMON-GUTC	PMON-GUTC	PMON-GUTC	FRK-MAN	FDM-GUTC	FDM-GUTC	FRK-GUTC
348 FA	PMON-RATC	N/C	PMON-GUTC	PMON-GUTC	PMON-GUTC	FLEW-GUTC	FRK-MAN	FDM-GUTC	FDM-GUTC	FRK-GUTC
349 FA	N/C	CBUL-RATC	CBUL-RATC	CBUL-RATC	CBUL-RATC	MATX-RATC	FRK-MAN	FDM-GUTC	FDM-GUTC	FRK-GUTC
350 FA	N/C	N/C	Unknown	N/C	N/C	N/C	FRK-MAN	FDM-GUTC	FDM-GUTC	FRK-GUTC
351 FA	N/C	N/C	Unknown	N/C	N/C	N/C	FRK-MAN	FDM-GUTC	FDM-GUTC	FRK-GUTC
352 FA	N/C	Pine Cp	Pine Cp	MDBK-CMTC	N/C	Pine Cp	FRK-MAN	FDM-GUTC	FDM-GUTC	FRK-GUTC
353 FA	N/C	N/C	N/C	N/C	N/C	N/C	FRK-MAN	FDM-GUTC	FDM-GUTC	FRK-GUTC
354 FA	N/C	N/C	Unknown	N/C	N/C	N/C	FRK-MAN	FDM-GUTC	FDM-GUTC	FRK-GUTC
355 FA	N/C	N/C	Unknown	N/C	FEA-GUTC	N/C	FRK-MAN	FDM-GUTC	FDM-GUTC	FRK-GUTC
356 FA	FEA-GUTC	N/C	Unknown	N/C	FEA-GUTC	FEA-GUTC	FRK-MAN	FDM-GUTC	FDM-GUTC	FRK-GUTC
358 FA	FSIL-RATC	FSIL-RATC	N/C	FSIL-RATC	N/C	FSIL-GUTC	FRK-MAN	FDM-GUTC	FDM-GUTC	FRK-GUTC

Field Artillery Training Camps 1931 – 1940

Regiment	1931	1932	1933	1934	1935	1936	1937	1938	1939	1940
359 FA	FSIL-RATC	FSIL-RATC	FSIL-RATC	FSIL-RATC	N/C	FSIL-GUTC	FSIL-CMTC	CBUL-MAN	FSIL-GUTC	FSIL-GUTC
360 FA	FSIL-RATC	FSIL-RATC	FSIL-RATC	FSIL-RATC	N/C	FSIL-GUTC	FSIL-GUTC	FSIL-CMTC	FSIL-GUTC	FSIL-GUTC
361 FA	FLEW-RATC	FLEW-GUTC	FLEW-GUTC	N/C	FLEW-GUTC	FLEW-GUTC	N/C	FLEW-CMTC	FLEW-GUTC	FLEW-GUTC
362 FA	FLEW-RATC	FLEW-GUTC	FLEW-GUTC	FLEW-GUTC	FLEW-GUTC	FLEW-GUTC	N/C	FLEW-CMTC	FLEW-GUTC	FLEW-GUTC
363 FA	FLEW-RATC	FLEW-GUTC	FLEW-GUTC	FLEW-GUTC	FLEW-GUTC	FLEW-GUTC	N/C	FLEW-CMTC	FLEW-GUTC	FLEW-GUTC
364 FA	N/C	FEA-GUTC	Unknown	N/C	FEA-GUTC	N/C	FEA-GUTC	N/C	FEA-GUTC	N/C
365 FA	N/C	N/C	Unknown	N/C	N/C	N/C	FEA-GUTC	N/C	FEA-GUTC	N/C
366 FA	N/C	N/C	Unknown	N/C	N/C	N/C	I/A	I/A	I/A	I/A
367 FA	N/C	N/C	Pine Cp	Pine Cp	Pine Cp	N/C	Pine Cp	Pine Cp	FDIX-CPX	MDBK-CMTC
368 FA	Pine Cp	Pine Cp	Pine Cp	Pine Cp	Pine Cp	N/C	MDBK-CMTC	Pine Cp	FDIX-CPX	N/C
369 FA	Pine Cp	Pine Cp	Pine Cp	Pine Cp	Pine Cp	N/C	Pine Cp	Pine Cp	FDIX-CPX	N/C
370 FA	FHOY-CMTC	FHOY-GUTC	Unknown	N/C	FHOY-CMTC	Ind Gap-CPX	FHOY-RATC	FHOY-RATC	FWSH-CPX	N/C
371 FA	FHOY-CMTC	N/C	Unknown	N/C	FHOY-CMTC	Ind Gap-CPX	FHOY-RATC	FHOY-CMTC	FWSH-CPX	N/C
372 FA	N/C	FBRG-GUTC	Unknown	N/C	FHOY-GUTC	Ind Gap-CPX	FHOY-RATC	FHOY-CMTC	FWSH-CPX	N/C
373 FA	N/C	N/C	N/C	N/C	N/C	N/C	N/C	FKNX-CPX	N/C	N/C
374 FA	N/C	N/C	N/C	N/C	FKNX-GUTC	FKNX-GUTC	FKNX-GUTC	FKNX-CPX	FKNX-GUTC	FKNX-GUTC
375 FA	N/C	FKNX-RATC	N/C	N/C	N/C	N/C	FKNX-GUTC	FKNX-CPX	FKNX-GUTC	FKNX-GUTC
376 FA	McCoy-GUTC	N/C	Unknown	McCoy-GUTC	N/C	McCoy-GUTC	N/C	McCoy-CMTC	N/C	McCoy-IND
377 FA	FKNX	McCoy-GUTC	Unknown	N/C	McCoy-GUTC	N/C	N/C	Unknown	N/C	McCoy-IND
378 FA	FKNX	N/C	Unknown	D/B 1-10-33						
379 FA	FRK-NG	FRK-NG	Unknown	FRK-NG	Ripley-GUTC	FRK-GUTC	FRK-MAN	FRK-GUTC	FRK-IND	FRK-GUTC
380 FA	FRK-NG	N/C	Unknown	FRK-NG	Ripley-GUTC	FRK-GUTC	FRK-MAN	FRK-GUTC	FRK-IND	FDM-CMTC
381 FA	N/C	Ripley-GUTC	Unknown	FRK-GUTC	Ripley-GUTC	FRK-GUTC	FRK-MAN	FRK-GUTC	FRK-IND	FRK-GUTC
382 FA	FBLS-RATC	FBLS	FBLS	FBLS	FBLS	N/C	N/C	MATX-RATC	FBLS	FBLS
383 FA	FEW-RATC	FEW-RATC	FEW-RATC	FEW-RATC	FEW-RATC	FEW-RATC	FEW-RATC	FEW-RATC	FEW-RATC	FEW-RATC
384 FA	FBLS/FEW	FBLS/FEW	FBLS/FEW	FBLS/FEW	FBLS/FEW	FBLS/FEW	FBLS/FEW	MATX-RATC	FBLS/FEW	FBLS/FEW
385 FA	FEW-RATC	FEW-RATC	N/C	FEW-RATC	FEW-RATC	N/C	FEW-GUTC	FEW-RATC	FEW-GUTC	FEW-RATC
386 FA	FEW-RATC	FEW-RATC	FEW-RATC	FEW-RATC	FEW-RATC	FEW-GUTC	N/C	Boise-NG	N/C	FEW-RATC
387 FA	FEW-RATC	FEW-RATC	FEW-RATC	FEW-RATC	FEW-RATC	FEW-GUTC	FEW-GUTC	Boise-NG	N/C	FEW-RATC
388 FA	N/C	N/C	Unknown	N/C	FEA-GUTC	N/C	FEA-GUTC	N/C	FEA-GUTC	N/C
389 FA	N/C	FEA-GUTC	N/C	N/C	FEA-GUTC	N/C	FEA	FEA	FEA-GUTC	N/C
390 FA	FEA-GUTC	N/C	Unknown	N/C	N/C	FEA-GUTC	N/C	FEA-GUTC	N/C	N/C
391 FA	N/C	Pine Cp	Pine Cp	Pine Cp	N/C	Pine Cp	N/C	Pine Cp	N/C	Pine Cp
392 FA	I/A	I/A	N/C	FBRG	N/C	N/C	N/C	N/C	N/C	N/C
394 FA	N/C	N/C	N/C	N/C	N/C	N/C	N/C	N/C	I/A	I/A
395 FA	I/A	I/A	I/A	I/A	I/A	I/A	I/A	I/A	I/A	I/A
396 FA	I/A	I/A	I/A	I/A	I/A	I/A	I/A	I/A	I/A	I/A
397 FA (I)										
397 FA (II)	N/C	N/C	N/C	N/C	N/C	N/C	N/C	N/C	N/C	FBRG-GUTC
398 FA (I)										
399 FA										
400 FA	I/A	I/A	I/A	I/A	I/A	I/A	I/A	I/A	I/A	FKNX-GUTC
401 FA	I/A	I/A	I/A	I/A	I/A	I/A	FKNX-GUTC	N/C	FKNX-GUTC	FKNX-GUTC
402 FA	I/A	I/A	I/A	I/A	I/A	I/A	I/A	I/A	I/A	I/A
403 FA	N/C	McCoy-GUTC	Unknown	N/C	N/C	N/C	N/C	N/C	N/C	N/C

Field Artillery Training Camps 1931 – 1940

Regiment	1931	1932	1933	1934	1935	1936	1937	1938	1939	1940
404 FA	Grant-NG		Unknown	McCoy-GUTC	N/C	McCoy-GUTC	N/C	McCoy-GUTC	McCoy-GUTC	McCoy-CMTC
405 FA	N/C	N/C	N/C	N/C	N/C	N/C	N/C	N/C	N/C	N/C
406 FA	N/C	N/C	N/C	N/C	N/C	N/C	N/C	N/C	N/C	N/C
407 FA	I/A	N/C	Unknown	N/C	N/C	N/C	N/C	N/C	N/C	N/C
408 FA	I/A	I/A	I/A	I/A	I/A	I/A	I/A	I/A	I/A	I/A
409 FA	FSIL-RATC	FSIL-RATC	FSIL-RATC	FSIL-RATC	N/C	FSIL-GUTC	FSIL-GUTC	CBUL-MAN	N/C	FSIL-GUTC
410 FA	N/C	N/C	I/A	I/A	N/C	N/C	N/C	N/C	N/C	N/C
411 FA	CSTN-RATC	CBUL-RATC	N/C	CBUL-RATC	CBUL-RATC	N/C	MATX-RATC	CBUL-MAN	N/C	CBUL-RATC
412 FA	N/C	N/C	N/C	D/B 1-10-33						
413 FA	FLEW-GUTC	FLEW-GUTC	FLEW-GUTC	FLEW-GUTC	FLEW-GUTC	FLEW-GUTC	FLEW-GUTC	N/C	N/C	N/C
414 FA	PMON-RATC	PMON-GUTC	Unknown	N/C	N/C	FLEW-GUTC	FORD-GUTC	FORD-GUTC	FORD-GUTC	N/C
426 FA	PMON-RATC	PMON-GUTC	Unknown	N/C	N/C	FLEW-GUTC	FORD-GUTC	FORD-GUTC	PMON-CMTC	FORD-GUTC
427 FA	I/A	I/A	I/A	I/A	I/A	I/A	I/A	I/A	I/A	I/A
431 FA	I/A	I/A	I/A	I/A	I/A	I/A	I/A	I/A	I/A	I/A
432 FA	Pine Cp	Pine Cp	N/C	N/C	Pine Cp	N/C	Pine Cp	N/C	Pine Cp	N/C
434 FA	N/C	N/C	Unknown	FBRG-GUTC	FBRG-RATC	N/C	N/C	FKNX-GUTC	N/C	FKNX-GUTC
435 FA	I/A	I/A	I/A	N/C	FKNX-GUTC	N/C	N/C	N/C	N/C	N/C
436 FA	N/C	N/C	N/C	N/C	N/C	N/C	N/C	N/C	N/C	N/C
437 FA	FLEW-GUTC	N/C	N/C	N/C	N/C	N/C	N/C	N/C	N/C	N/C
438 FA	I/A	I/A	I/A	I/A	I/A	MATX-RATC	N/C	CBUL-MAN	N/C	CBUL-GUTC
439 FA	PMON-RATC	PMON-GUTC	N/C	N/C	N/C	FWS-GUTC	FFUN-GUTC	FORD/SLO	FORD/SLO	FORD-CMTC
440 FA	I/A	FKNX-RATC	FKNX-IND	FKNX-GUTC	N/C	FKNX-GUTC	N/C	FKNX-GUTC	N/C	FKNX-GUTC
441 FA	N/C	FHOY-GUTC	Pine Cp	Pine Cp	N/C	Pine Cp	N/C	Pine Cp	N/C	Pine Cp
442 FA	FBRG-GUTC	N/C	Pine Cp	MDBK-CMTC	N/C	Pine Cp	N/C	Pine Cp	N/C	Pine Cp
443 FA	N/C	N/C	I/A	I/A	I/A	MATX-RATC	N/C	N/C	N/C	N/C
444 FA										
445 FA										
446 FA										
447 FA										
448 FA										
449 FA										
452 FA	R/D 321 FA									
453 FA	I/A	I/A	I/A	I/A	I/A	I/A	N/C	N/C	N/C	FKNX-GUTC
455 FA	N/C	FKNX-RATC	FKNX-IND	FKNX-GUTC	N/C	FKNX-GUTC	N/C	N/C	N/C	N/C
459 FA										
461 FA										
462 FA										
463 FA										
464 FA										
465 FA										
466 FA										
471 FA	I/A	I/A	I/A	D/B 1-10-33						
472 FA	I/A	I/A	I/A	I/A	I/A	I/A	I/A	I/A	I/A	I/A
473 FA	I/A	I/A	I/A	D/B 1-10-33						
474 FA	N/C	N/C	N/C	D/B 1-10-33						

Field Artillery Training Camps 1931 – 1940

Regiment	1931	1932	1933	1934	1935	1936	1937	1938	1939	1940
475 FA	N/C	N/C	FKNX-GUTC	FKNX-RATC	N/C	FKNX-GUTC	N/C	N/C	N/C	N/C
476 FA	N/C	FKNX-CMTC	FKNX-GUTC	FKNX-IND	FKNX-RATC	N/C	N/C	N/C	N/C	N/C
477 FA	I/A	I/A	I/A	N/C	N/C	N/C	N/C	I/A	I/A	I/A
478 FA	N/C	N/C	N/C	N/C	N/C	N/C	N/C	N/C	N/C	N/C
479 FA	N/C	N/C	N/C	N/C	N/C	N/C	N/C	N/C	N/C	N/C
481 FA	I/A	I/A	I/A	D/B 1-10-33	N/C	N/C	N/C	N/C	N/C	N/C
482 FA	I/A	I/A	I/A	D/B 1-10-33	I/A	I/A	I/A	I/A	I/A	I/A
486 FA	I/A	I/A	I/A	I/A	I/A	I/A	I/A	I/A	I/A	I/A
487 FA	I/A	I/A	I/A	N/C	N/C	N/C	N/C	N/C	N/C	N/C
488 FA	N/C	N/C	N/C	N/C	N/C	N/C	N/C	N/C	N/C	N/C
489 FA	N/C	N/C	FKNX-GUTC	FKNX-RATC	N/C	FKNX-GUTC	N/C	FKNX-GUTC	N/C	FKNX-GUTC
490 FA	I/A	I/A	I/A	I/A	I/A	I/A	I/A	I/A	I/A	I/A
491 FA	I/A	I/A	I/A	I/A	I/A	I/A	I/A	I/A	I/A	I/A
492 FA	N/C	N/C	FKNX-IND	FKNX-RATC	N/C	FKNX-GUTC	N/C	FKNX-GUTC	I/A	I/A
494 FA	N/C	N/C	N/C	I/A	N/C	MATX-RATC	I/A	I/A	I/A	I/A
495 FA	N/C	N/C	Unknown	D/B 1-10-33	N/C	N/C	I/A	I/A	I/A	I/A
496 FA	I/A	I/A	I/A	I/A	I/A	I/A	I/A	I/A	I/A	I/A
497 FA	N/C	McCoy-GUTC	Unknown	N/C	McCoy-CMTC	N/C	McCoy-GUTC	McCoy-GUTC	McCoy-CMTC	N/C
498 FA	I/A	I/A	I/A	I/A	I/A	I/A	I/A	I/A	I/A	I/A
499 FA	I/A	I/A	I/A	I/A	I/A	I/A	I/A	I/A	I/A	I/A
500 FA	FLEW-GUTC	N/C	N/C	N/C	N/C	I/A	I/A	N/C	N/C	N/C
560 FA	N/C	N/C	Unknown	FBRG-GUTC	N/C	FBRG	FBRG	N/C	N/C	FBRG-GUTC
562 FA	I/A	I/A	I/A	D/B 1-10-33	N/C	N/C	N/C	I/A	I/A	I/A
563 FA	N/C	N/C	FKNX-GUTC	D/B 1-10-33	N/C	N/C	N/C	I/A	I/A	I/A
564 FA	I/A	I/A	I/A	D/B 1-10-33	N/C	N/C	N/C	I/A	I/A	I/A
565 FA	N/C	FKNX-RATC	FKNX-IND	FKNX-RATC	N/C	FKNX-GUTC	N/C	FKNX-GUTC	N/C	FKNX-GUTC
566 FA	FHOY-GUTC	Pine Cp	N/C	N/C	Pine Cp	N/C	Pine Cp	N/C	Pine Cp	N/C
567 FA	N/C	McCoy-GUTC	Unknown	N/C	N/C	McCoy-CMTC	N/C	McCoy-GUTC	McCoy-GUTC	McCoy-GUTC
569 FA	N/C	N/C	N/C	N/C	N/C	N/C	N/C	N/C	N/C	N/C
570 FA	FHOY-GUTC	FHOY-GUTC	N/C	N/C	Pine Cp	N/C	Pine Cp	N/C	Pine Cp	N/C
571 FA	N/C	N/C	FBRG-GUTC	FHOY-GUTC	N/C	N/C	FHOY-RATC	FHOY-GUTC	N/C	FHOY-GUTC
572 FA	N/C	FSHN-CMTC	Unknown	N/C	McCoy-GUTC	N/C	McCoy-CMTC	N/C	McCoy-GUTC	McCoy-CMTC
573 FA	I/A	I/A	I/A	I/A	I/A	I/A	I/A	I/A	I/A	I/A
574 FA	I/A	I/A	I/A	I/A	I/A	I/A	N/C	FKNX-GUTC	N/C	FKNX-GUTC
575 FA	I/A	I/A	I/A	N/C	N/C	N/C	N/C	I/A	N/C	N/C
576 FA	I/A	I/A	I/A	I/A	I/A	I/A	I/A	I/A	I/A	I/A
577 FA	FBRG	N/C	Pine Cp	N/C	Pine Cp	N/C	Pine Cp	N/C	Pine Cp	N/C
578 FA	N/C	FBRG-GUTC	Unknown	N/C	FHOY-GUTC	N/C	FHOY-CMTC	N/C	FBRG-GUTC	FHOY-CMTC
579 FA	Grayling-NG	N/C	Unknown	N/C	McCoy-GUTC	N/C	McCoy-GUTC	N/C	Grayling-NG	N/C
580 FA	FBRG-GUTC	N/C	FBRG-GUTC	FHOY-GUTC	N/C	FHOY-CMTC	N/C	EGGM-CPX	FHOY-CMTC	FBRG-GUTC
581 FA	N/C	N/C	Unknown	D/B 1-10-33	N/C	N/C	N/C	N/C	N/C	N/C
590 FA	N/C	N/C	N/C	N/C	N/C	N/C	N/C	N/C	N/C	N/C
861 FA	Pine Cp	Pine Cp	N/C	N/C	Pine Cp	N/C	Pine Cp	FEA-CPX	N/C	FEA-MOB
862 FA	FHOY-GUTC	FHOY-GUTC	FHOY-CMTC	FHOY-GUTC	FHOY-GUTC	FHOY-GUTC	FHOY-RATC	FHOY-RATC	FHOY-GUTC	FHOY-GUTC
863 FA	N/C	N/C	FBRG-GUTC	FBRG-GUTC	FBRG-RATC	FBRG-GUTC	FBRG-RATC	DeSoto-MAN	FBRG-RATC	FBRG-GUTC

Field Artillery Training Camps 1931 – 1940										
Regiment	1931	1932	1933	1934	1935	1936	1937	1938	1939	1940
864 FA	FKNX-GUTC	FKNX-RATC	N/C	FKNX-RATC	N/C	FKNX-GUTC	N/C	N/C	N/C	N/C
865 FA	McCoy-GUTC	McCoy-GUTC	Unknown	N/C	McCoy-NG	N/C	McCoy-CMTC	Grant-NG	McCoy-GUTC	N/C
866 FA	FRK-GUTC	N/C	Unknown	FRK-GUTC	FRK	FRK-GUTC	FRK-MAN	FRK-GUTC	FRK-GUTC	FRK-GUTC

Ammunition Train and Field Artillery Observation Battalion Training Camps 1921 – 1930											
Train	1921	1922	1923	1924	1925	1926	1927	1928	1929	1930	
Second Army											
Third Army											
2 Am Tn	RA-A	RA-A	RA-A	RA-A	RA-A	RA-A	RA-A	RA-A	RA-A	RA-A	
5 Am Tn	RA-A	I/A	I/A	I/A	I/A	I/A	I/A	N/C	N/C	N/C	
6 Am Tn	RA-A	I/A	I/A	I/A	I/A	I/A	N/C	Williams-NG	CCUS-IND	McCoy-IND	
7 Am Tn	RA-A	I/A	I/A	I/A	I/A	I/A	I/A	N/C	FRK-GUTC	FRK-GUTC	
13 Am Tn	RA-A	RA-A	RA-A	RA-A	RA-A	RA-A	RA-A	RA-A	RA-A	I/A	
14 Am Tn			N/O	N/O	N/O	N/O	N/O	N/C	N/C	N/C	
15 Am Tn	N/O	N/O	N/O	N/O	N/O	N/O	N/O	N/O	N/O	N/O	
18 Am Tn	N/O	N/O	N/O	N/O	N/O	N/O	N/O	N/O	N/O	N/O	
22 Am Tn	N/O	N/O	N/O	N/O	N/O	N/O	N/O	N/O	N/O	N/O	
101 Am Tn	FDEV	FDEV	FDEV	FDEV	FDEV	FDEV	FDEV	FDEV	FDEV	FDEV	
102 Am Tn	I/A	Welsh	Tobyhanna	Pine Cp	MDBK	Pine Cp	Pine Cp	Pine Cp	I/A	I/A	
103 Am Tn	I/A	Tobyhanna	Tobyhanna	Tobyhanna	Tobyhanna	Mt Gretna	Tobyhanna	Tobyhanna	Mt Gretna	Tobyhanna	
105 Am Tn	I/A	I/A	I/A	FBRG	FBRG	I/A	I/A	I/A	I/A	I/A	
106 Am Tn	I/A	I/A	I/A	FBRG	FBRG	BEAU	BEAU	BEAU	BEAU	BEAU	
107 Am Tn	McCoy	CCUS	Douglas	Douglas	McCoy	McCoy	McCoy	I/A	I/A	I/A	
112 Am Tn	I/A	FKNX	I/A	I/A	I/A	I/A	I/A	I/A	I/A	I/A	
113 Am Tn	I/A	FKNX	FKNX	I/A	I/A	I/A	I/A	I/A	I/A	I/A	
114 Am Tn	I/A	I/A	FMCL	I/A	I/A	I/A	I/A	I/A	I/A	I/A	
120 Am Tn	N/O	N/O	FSIL	FSIL	FSIL	I/A	I/A	I/A	I/A	I/A	
132 Am Tn	N/O	Welsh	FEUS	I/A	I/A	I/A	I/A	I/A	I/A	I/A	
301 Am Tn	I/A	I/A	N/C	N/C	N/C	N/C	N/C	N/C	N/C	N/C	
302 Am Tn	I/A	I/A	N/C	N/C	N/C	N/C	N/C	N/C	N/C	N/C	
303 Am Tn	I/A	N/C	N/C	N/C	N/C	N/C	N/C	N/C	N/C	N/C	
304 Am Tn	I/A	N/C	N/C	N/C	N/C	N/C	N/C	N/C	N/C	N/C	
305 Am Tn	I/A	N/C	N/C	N/C	N/C	N/C	N/C	N/C	N/C	N/C	
306 Am Tn	I/A	N/C	N/C	N/C	N/C	N/C	N/C	N/C	N/C	N/C	
307 Am Tn	I/A	N/C	N/C	N/C	N/C	N/C	N/C	N/C	N/C	N/C	
308 Am Tn	I/A	Unknown	N/C	N/C	N/C	N/C	N/C	N/C	N/C	N/C	
309 Am Tn	I/A	Unknown	N/C	N/C	N/C	N/C	N/C	N/C	N/C	N/C	
310 Am Tn	I/A	CCUS-DGRP	N/C	N/C	N/C	N/C	N/C	N/C	N/C	N/C	
311 Am Tn	I/A	CCUS-DGRP	N/C	N/C	N/C	N/C	N/C	N/C	N/C	N/C	
312 Am Tn	I/A	Unknown	N/C	N/C	N/C	N/C	N/C	N/C	N/C	N/C	
313 Am Tn	I/A	Unknown	N/C	N/C	N/C	N/C	N/C	N/C	N/C	N/C	
314 Am Tn	I/A	Unknown	N/C	N/C	N/C	N/C	N/C	N/C	N/C	N/C	
315 Am Tn	I/A	Unknown	N/C	N/C	N/C	N/C	N/C	N/C	N/C	N/C	
316 Am Tn	I/A	Unknown	N/C	N/C	N/C	N/C	N/C	N/C	N/C	N/C	
319 Am Tn	I/A	Unknown	N/C	N/C	N/C	N/C	N/C	N/C	N/C	N/C	
320 Am Tn	I/A	Unknown	N/C	N/C	N/C	N/C	N/C	N/C	N/C	N/C	
321 Am Tn	N/O	Unknown	N/C	N/C	N/C	N/C	N/C	N/C	N/C	N/C	
322 Am Tn	N/O	Unknown	N/C	N/C	N/C	N/C	N/C	N/C	N/C	N/C	
323 Am Tn	N/O	Unknown	N/C	N/C	N/C	N/C	N/C	N/C	N/C	N/C	

Ammunition Train and Field Artillery Observation Battalion Training Camps 1921 – 1930												
Train	1921	1922	1923	1924	1925	1926	1927	1928	1929	1930		
324 Am Tn	N/O	Unknown	N/C	N/C	N/C	N/C	N/C	N/C	N/C	FHOY-GUTC		
325 Am Tn	N/O	Unknown	N/C	N/C	N/C	N/C	N/C	N/C	N/C	N/C		
326 Am Tn	N/O	Unknown	N/C	N/C	N/C	N/C	N/C	McCoy-IND	FKNX-IND	N/C		
327 Am Tn	N/O	Unknown	N/C	N/C	N/C	FRK-LUTC	N/C	FRK-GUTC	McCoy-IND	McCoy-GUTC		
328 Am Tn	N/O	Unknown	N/C	N/C	FLEW-GUTC	N/C	FBL-S-GUTC	FRK-IND	FRK-IND	FRK-GUTC		
329 Am Tn	N/O	Unknown	N/C	N/C	FDAR	N/C	N/C	FBL-S-GUTC	FBL-S-GUTC	FFEW-GUTC		
330 Am Tn	N/O	N/O	N/C	N/C	N/C	N/C	N/C	N/C	N/C	N/C		
341 Am Tn	N/O	N/C	N/C	N/C	N/C	N/C	N/C	N/C	N/C	N/C		
342 Am Tn	N/O	N/C	N/C	N/C	N/C	N/C	N/C	N/C	N/C	N/C		
343 Am Tn	N/O	N/C	N/C	N/C	N/C	N/C	N/C	N/C	N/C	N/C		
344 Am Tn	N/O	N/C	N/C	N/C	N/C	N/C	N/C	N/C	N/C	N/C		
346 Am Tn	N/O	N/C	N/C	N/C	N/C	N/C	McCoy	N/C	CCUS-GUTC	I/A		
347 Am Tn	N/O	N/C	N/C	N/C	N/C	FRK-GUTC	N/C	N/C	N/C	N/C		
348 Am Tn	N/O	N/C	N/C	N/C	N/C	FSH-RATC	I/A	I/A	I/A	N/C		
349 Am Tn	N/O	N/C	N/C	N/C	N/C	N/C	PMON	PMON-GUTC	PSF-GUTC	PMON-IND		
363 Am Tn	N/O	N/C	N/C	FMEA	N/C	N/C	N/C	N/C	N/C	N/C		
363 Am Tn	N/O	N/C	N/C	N/C	N/C	McCoy	N/C	N/C	N/C	N/C		
370 Am Tn	N/O	N/C	N/C	N/C	N/C	N/C	N/C	N/C	N/C	N/C		
7 FA OBS												
8 FA OBS												
306 FA OBS	N/O	N/C	N/C	N/C	N/C	N/C	McCoy	N/C	N/C	N/C		
308 FA OBS	N/O	N/C	N/C	N/C	N/C	FSIL-GUTC	N/C	N/C	N/C	N/C		
309 FA OBS	N/O	N/C	N/C	N/C	N/C	N/C	N/C	N/C	N/C	N/C		
312 FA OBS	N/O	N/C	N/C	N/C	N/C	FSIL-GUTC	N/C	N/C	N/C	N/C		
314 FA OBS	N/O	N/C	N/C	N/C	N/C	N/C	N/C	N/C	N/C	N/C		
316 FA OBS	N/O	N/C	N/C	N/C	N/C	N/C	N/C	FBRG-GUTC	N/C	N/C		
317 FA OBS	N/O	N/O	N/O	N/O	N/C	N/C	N/C	N/C	N/C	I/A		
319 FA OBS	N/O	N/C	N/C	N/C	N/C	N/C	N/C	N/C	N/C	N/C		

Ammunition Train and Field Artillery Observation Battalion Training Camps 1931 – 1940											
Train	1931	1932	1933	1934	1935	1936	1937	1938	1939	1940	
Second Army			N/O	N/O	N/C	N/C	N/C	FKNX-IND	N/C	N/C	N/C
Third Army			N/O	N/O	N/C	FSIL-GUTC	FSIL-GUTC	N/C	N/C	N/C	N/C
2 Am Tn	I/A	N/C	N/C	N/C	N/C	N/C	FSH-GUTC	N/C	N/C	N/C	D/B
5 Am Tn	N/C	N/C	N/C	FKNX-IND	N/C	N/C	N/C	N/C	N/C	N/C	D/B
6 Am Tn	N/C	N/C	N/C	N/C	N/C	N/C	McCoy-GUTC	McCoy-GUTC	McCoy-IND	McCoy-IND	D/B
7 Am Tn	N/C	N/C	N/C	N/C	N/C	Ripley-GUTC	N/C	FSNL-IND	FRK-GUTC	FRK-GUTC	D/B
13 Am Tn	I/A	I/A	I/A	I/A	N/C	N/C	N/C	N/C	EBRG-GUTC	N/C	N/C
14 Am Tn	N/C	N/C	FKNX-IND	FKNX-IND	N/C	N/C	N/C	N/C	N/C	N/C	N/C
15 Am Tn	N/C	N/C	Unknown	I/A	I/A	I/A	N/C	N/C	N/C	N/C	N/C
17 Am Tn	N/O	N/O	N/O	N/O	N/C	N/C	N/C	FRK-BRC	N/C	N/C	N/C
18 Am Tn	N/O	N/O	N/O	N/O	N/C	FSIL-GUTC	FSIL-GUTC	N/C	N/C	N/C	N/C
22 Am Tn	N/O	N/O	N/O	N/O	N/C	N/C	McCoy-GUTC	McCoy-GUTC	McCoy-IND	McCoy-IND	N/C
101 Am Tn	FDEV	FDEV	FDEV	FDEV	Pine Cp-MAN	FEA	Edwards	Edwards	I/A	I/A	I/A
102 Am Tn	I/A	I/A	I/A	I/A	I/A	I/A	I/A	I/A	I/A	I/A	I/A
103 Am Tn	Tobyhanna	Tobyhanna	Ind Gap	Ind Gap-MAN	Ind Gap	Ind Gap	Ind Gap	Ind Gap	MNVA-MAN	MNVA-MAN	I/A
105 Am Tn	I/A	I/A	I/A	I/A	I/A	I/A	I/A	I/A	I/A	I/A	I/A
106 Am Tn	BEAU	BEAU	CJAC	CJAC	CJAC	CJAC	CJAC	DeSoto-MAN	CJAC	CJAC	I/A
107 Am Tn	I/A	I/A	I/A	I/A	I/A	I/A	I/A	I/A	I/A	I/A	I/A
112 Am Tn	I/A	I/A	I/A	I/A	I/A	I/A	I/A	I/A	I/A	I/A	I/A
113 Am Tn	I/A	I/A	I/A	I/A	I/A	I/A	I/A	I/A	I/A	I/A	I/A
114 Am Tn	I/A	I/A	I/A	I/A	I/A	I/A	I/A	I/A	I/A	I/A	I/A
120 Am Tn	I/A	I/A	I/A	I/A	I/A	I/A	I/A	I/A	I/A	I/A	I/A
132 Am Tn	I/A	I/A	I/A	I/A	I/A	I/A	I/A	I/A	I/A	I/A	I/A
301 Am Tn	N/C	N/C	N/C	N/C	N/C	N/C	N/C	N/C	FEA-GUTC	FEA-GUTC	N/C
302 Am Tn	FHOY-GUTC	N/C	N/C	N/C	N/C	Pine Cp	N/C	N/C	N/C	N/C	N/C
303 Am Tn	N/C	N/C	N/C	N/C	N/C	N/C	N/C	N/C	N/C	N/C	N/C
304 Am Tn	N/C	N/C	N/C	N/C	N/C	N/C	N/C	N/C	N/C	N/C	N/C
305 Am Tn	N/C	N/C	N/C	N/C	N/C	N/C	N/C	N/C	N/C	N/C	N/C
306 Am Tn	EBRG-GUTC	N/C	EBRG-GUTC	N/C	N/C	EBRG-GUTC	N/C	N/C	N/C	N/C	N/C
307 Am Tn	N/C	N/C	N/C	N/C	N/C	EBRG-GUTC	N/C	N/C	N/C	N/C	N/C
308 Am Tn	N/C	N/C	N/C	N/C	N/C	N/C	N/C	N/C	N/C	N/C	N/C
309 Am Tn	N/C	N/C	N/C	N/C	N/C	N/C	N/C	N/C	N/C	N/C	N/C
310 Am Tn	N/C	N/C	N/C	N/C	N/C	N/C	N/C	N/C	N/C	N/C	N/C
311 Am Tn	N/C	N/C	N/C	N/C	N/C	N/C	N/C	N/C	N/C	N/C	N/C
312 Am Tn	N/C	N/C	N/C	N/C	N/C	N/C	N/C	McCoy-GUTC	McCoy-IND	McCoy-IND	N/C
313 Am Tn	McCoy-IND	Ripley-NG	N/C	N/C	N/C	EBRG-GUTC	N/C	N/C	N/C	N/C	N/C
314 Am Tn	N/C	N/C	N/C	N/C	N/C	N/C	N/C	N/C	N/C	N/C	N/C
315 Am Tn	CSTA-RATC	CBUL-RATC	CBUL-RATC	CBUL-RATC	N/C	CBUL-RATC	CBUL-GUTC	N/C	N/C	N/C	N/C
316 Am Tn	N/C	N/C	N/C	N/C	N/C	N/C	N/C	N/C	N/C	N/C	N/C
319 Am Tn	FEA-GUTC	Unknown	N/C	N/C	N/C	N/C	N/C	N/C	N/C	N/C	N/C
320 Am Tn	FSIL-IND	FSIL-GUTC	FSIL-GUTC	FSIL-GUTC	N/C	FSIL-GUTC	FSIL-GUTC	N/C	N/C	N/C	N/C
321 Am Tn	N/C	N/C	N/C	N/C	N/C	N/C	N/C	N/C	N/C	N/C	N/C
322 Am Tn	N/C	N/C	N/C	N/C	N/C	N/C	N/C	FEA-IND	N/C	N/C	N/C
323 Am Tn	N/C	N/C	N/C	Pine Cp-GUTC	Pine Cp-GUTC	N/C	N/C	N/C	N/C	N/C	N/C

Ammunition Train and Field Artillery Observation Battalion Training Camps 1931 – 1940											
Train	1931	1932	1933	1934	1935	1936	1937	1938	1939	1940	
324 Am Tn	N/C	N/C	N/C	N/C	N/C	N/C	FHOY-GUTC	N/C	N/C	N/C	
325 Am Tn	N/C	N/C	N/C	FKNX-IND	N/C	N/C	N/C	N/C	N/C	N/C	
326 Am Tn	N/C	N/C	N/C	N/C	N/C	N/C	N/C	N/C	N/C	N/C	
327 Am Tn	FRK-ING	N/C	N/C	N/C	N/C	N/C	N/C	N/C	N/C	N/C	
328 Am Tn	FFEW-RATC	FFEW-RATC	FFEW-RATC	FFEW-RATC	FFEW-RATC	FFEW-RATC	PMMR-MAN	N/C	N/C	N/C	
329 Am Tn	FFEW-RATC	N/C	N/C	N/C	N/C	N/C	N/C	N/C	FLEW-IND	N/C	
330 Am Tn	N/C	N/C	I/A	FSIL	N/C	N/C	N/C	N/C	N/C	N/C	
341 Am Tn	N/C	N/C	FKNX-IND	N/C	N/C	N/C	N/C	N/C	N/C	N/C	
342 Am Tn	N/C	N/C	N/C	N/C	N/C	N/C	I/A	N/C	N/C	Pine Cp-GUTC	
343 Am Tn	N/C	N/C	N/C	N/C	FHOY-GUTC	N/C	N/C	FHOY-GUTC	N/C	FHOY-GUTC	
344 Am Tn	N/C	N/C	N/C	FBRG-GUTC	Unknown	N/C	N/C	N/C	FBRG-GUTC	N/C	
346 Am Tn	I/A	I/A	I/A	I/A	I/A	N/C	N/C	N/C	N/C	N/C	
347 Am Tn	N/C	N/C	N/C	N/C	N/C	N/C	N/C	N/C	N/C	N/C	
348 Am Tn	N/C	N/C	N/C	N/C	N/C	N/C	N/C	N/C	N/C	N/C	
349 Am Tn	N/C	N/C	N/C	N/C	N/C	N/C	I/A	I/A	I/A	I/A	
363 Am Tn	N/C	N/C	N/C	D/B 1-10-33							
363 Am Tn	N/C	N/C	N/C	D/B 1-10-33							
370 Am Tn	N/C	N/C	FKNX-IND	D/B 1-10-33							
7 FA OBS			N/O	N/O	N/O	N/O	N/O	FRK-BRC	N/C	N/C	
8 FA OBS			N/O	N/C	N/C	N/C	FSIL-GUTC	N/C	N/C	N/C	
306 FA OBS	FBRG-GUTC	N/C	N/C	N/C	N/C	McCoy-NG	N/C	McCoy-GUTC	McCoy-IND	N/C	
308 FA OBS	N/C	N/C	N/C	N/C	N/C	N/C	N/C	N/C	N/C	N/C	
309 FA OBS	N/C	N/C	N/C	N/C	N/C	N/C	N/C	N/C	N/C	N/C	
312 FA OBS	N/C	FFEW-RATC	FFEW-RATC	FFEW-RATC	FFEW-RATC	FFEW-RATC	N/C	N/C	N/C	N/C	
314 FA OBS	FEA-GUTC	N/C	N/C	N/C	FEA-GUTC	N/C	N/C	N/C	N/C	N/C	
316 FA OBS	N/C	N/C	N/C	N/C	FBRG-GUTC	N/C	N/C	N/C	N/C	N/C	
317 FA OBS	I/A	I/A	I/A	D/B 1-10-33							
319 FA OBS	FSIL-GUTC	FSIL-GUTC	FSIL-GUTC	N/C	FSIL-GUTC	N/C	N/C	N/C	N/C	N/C	

Coast Artillery Training Camps 1921 – 1930

Regiment	1921	1922	1923	1924	1925	1926	1927	1928	1929	1930
22 CA										
42 CA	N/O	N/O	N/O	N/O	N/O	N/C	N/C	N/C	N/C	N/C
43 CA	N/O	N/O	N/O	N/O	N/O	N/O	N/C	N/C	N/C	N/C
44 CA	N/O	N/O	N/O	N/O	N/O	N/O	N/C	N/C	N/C	N/C
57 CA	N/O	N/O	N/O	N/O	N/O	N/O	N/O	N/C	N/C	FWFS
65 CA										
67 CA	N/O	N/O	N/O	RA-A	RA-A	RA-A	RA-A	RA-A	RA-A	RA-A
68 CA	N/O	N/O	N/O	N/O	N/O	N/O	N/C	N/C	N/C	N/C
141 CAC	N/O	N/O	N/O	FSIL	R/D 206th C.A.	N/O	N/C	FAND-GUTC	FHWL-CMTC	N/C
197 CA	EGRE	Warner	FADM	Warner	Rye	Rye	Rye	Rye	Rye	Rye
198 CA	Bethany	Bethany	UPTN	EGRE	New Castle	Bethany	Bethany	Bethany	Bethany	Bethany
200 CA	N/O	FMON	FMON	FMON	FMON	FBRG	D/B 5-09-27			
202 CA	Grant	CCUS	CCUS	FMON	Sparta	Grayling	Grayling	Grayling	FONT	Grant
203 CA	Clark	CCUS	FSIL	FSIL	FSIL	FSIL	FSIL	FSIL	FBAR	Clark
204 CA	N/O	N/O	N/O	N/O	N/O	N/O	N/O	N/O	N/O	N/O
205 CA	N/O	N/O	N/O	N/O	N/O	N/O	N/O	N/O	N/O	N/O
206 CA	N/O	N/O	FSIL	FSIL	FSIL	FSIL	FSIL	FSIL	Pike	FBAR
207 CA	N/O	N/O	N/O	N/O	N/O	N/O	N/O	N/O	N/O	N/O
211 CA	FDEV	FDEV	FTRY	FTRY	FTRY	FTRY	FHWG	Sandwich	Sandwich	Sandwich
212 CA	N/O	FTOT	UPTN	UPTN	FONT	FONT	FONT	FONT	FONT	FONT
213 CA	N/O	Mt Gretina	FMON	FMON	FMON	FMON	FMON	Mt Gretina	Bethany	FMON
214 CA	N/O	N/O	N/O	N/O	N/O	N/O	N/O	N/O	N/O	N/O
240 CA	FWMS	FWMS	FWMS	FWMS	FWMS	FWMS	FWMS	FWMS	FWMS	FWMS
241 CA	FHWG	FHWG	FHWG	FHWG	FHWG	FHWG	FHWG	FHWG	FHWG	FHWG
242 CA	FTRY	FHWG	FHWG	FHWG	FHWG	FTRY	FHWG	FTRY	FHWG	FHWG
243 CA	FHWG	FHWG	FHWG	FHWG	FHWG	FHWG	FHWG	FHWG	FHWG	FHWG
244 CA	Unknown	FHWG	FHWG	FEUS	FONT	FONT	FONT	FONT	FONT	FONT
245 CA	FHWG	FHWG	FHWG	FHWG	FHWG	FHWG	FHWG	FHWG	FHWG	FHWG
246 CA	N/O	FMON	FMON	FMON	FMON	FMON	FMON	FMON	FMON	FMON
248 CA	N/O	FWOR	FWOR	FWOR	FWOR	FWOR	FWOR	FWOR	FWOR	FWOR
249 CA	FSTV	FWOR	FBRV	FBRV	FSTV	FSTV	FSTV	ESTV/Claitsop	ESTV	ESTV
250 CA	FMAC	FMAC	FMAC	FMAC	FBRV	McQuaide	McQuaide	McQuaide	McQuaide	McQuaide
251 CA	FMAC	FMAC	FMAC	FMAC	FMAC	FMAC	FMAC	FMAC	FMAC	FMAC
252 CA	N/O	FMOU	FMON	FMON	FMON	FMPH	FMOU	FMOU	FMOU	FMOU
260 CA	N/O	N/O	N/O	N/O	FMON	FMON	FMON	FMON	FMON	FMON
261 CA	N/O	N/O	N/O	FHAN	FHAN	FHAN	New Castle	FHAN	FHAN	FHAN
263 CA	N/O	N/O	FMON	FMON	FMOU	FMPH	FMOU	FMOU	FMOU	FMOU
264 CA	N/O	N/O	N/O	N/O	N/O	N/O	N/O	N/O	N/O	FMOU
265 CA	N/O	N/O	FMON	FMON	FBAR	FBAR	FBAR	FBAR	FBAR	FBAR
501 CA	N/O	N/C	Unknown	N/C	N/C	FTRY-GUTC	FADM-GUTC	N/C	N/C	N/C
502 CA	N/O	N/C	Unknown	N/C	FTIL-RATC	N/C	UPTN	N/C	FTIL-GUTC	N/C
503 CA	N/O	N/C	FMON	FMON	N/C	FMON	FMON	FMON-RATC	FMON-GUTC	N/C
504 CA	N/O	N/C	FBAR-GRP	N/C	FBAR	FBAR	FBAR-GUTC	FBAR-GUTC	FBAR	N/C
505 CA	N/O	N/C	Unknown	N/C	FMON	FMON	FKNX-GUTC	FKNX-GUTC	FKNX-GUTC	N/C

Regiment	Coast Artillery Training Camps 1921 – 1930												
	1921	1922	1923	1924	1925	1926	1927	1928	1929	1930			
506 CA	N/O	N/C	Unknown	N/C	FSIL	N/C	N/C	FKNX-GUTC	N/C	N/C	FKNX-GUTC	N/C	
507 CA	N/O	N/C	Unknown	N/C	N/C	N/C	FKNX-GUTC	N/C	N/C	N/C	FKNX	FKNX-GUTC	
508 CA	N/O	N/C	Unknown	EBLS	FSIL	FSIL-GUTC	N/C	N/C	N/C	N/C	N/C	N/C	
509 CA	N/O	N/C	Unknown	N/C	N/C	Santa Cruz	N/C	N/C	N/C	N/C	N/C	N/C	
510 CA	N/O	N/C	FMON	FMON	N/C	N/C	FMON-RATC	N/C	N/C	N/C	FMON-GUTC	N/C	
511 CA	N/O	N/C	Unknown	N/C	N/C	FMON	FKNX-GUTC	FKNX-GUTC	N/C	N/C	FKNX-GUTC	N/C	
513 CA	N/O	N/C	Unknown	UPTN	UPTN-RATC	N/C	N/C	N/C	N/C	N/C	UPTN-RATC	N/C	
514 CA	N/O	N/C	Unknown	N/C	N/C	FHAN-CMTC	N/C	N/C	N/C	N/C	N/C	APG-RATC	
515 CA	N/O	N/C	Unknown	N/C	N/C	N/C	N/C	N/C	N/C	N/C	N/C	N/C	
516 CA	N/O	N/C	Unknown	N/C	FMON	N/C	FMON-RATC	N/C	N/C	N/C	N/C	FMON-CMTC	
517 CA	N/O	N/C	Unknown	N/C	N/C	N/C	Capitolia-NG	N/C	N/C	N/C	N/C	FMAC-RATC	
518 CA	N/O	N/C	Unknown	N/C	N/C	N/C	N/C	N/C	N/C	N/C	N/C	N/C	
519 CA	N/O	N/C	Unknown	N/C	N/C	McQuaide	N/C	N/C	N/C	N/C	N/C	N/C	
521 CA	N/O	N/C	Unknown	N/C	N/C	FTOT	UPTN	N/C	N/C	N/C	FTIL-GUTC	N/C	
522 CA	N/O	N/C	Unknown	UPTN	UPTN-RATC	N/C	FTOT	N/C	N/C	N/C	N/C	APG-RATC	
523 CA	N/O	N/C	Unknown	N/C	N/C	FMON	FMON	FMON-GUTC	N/C	N/C	N/C	FMON-CMTC	
524 CA	N/O	N/C	FBAR-GRP	N/C	FBAR-MOB	FBAR	FBAR-RATC	FBAR-GUTC	FBAR	N/C	N/C	N/C	
525 CA	N/O	N/C	Unknown	N/C	FMON	FMON	FKNX-GUTC	FKNX-GUTC	FKNX-GUTC	N/C	N/C	N/C	
526 CA	N/O	N/C	Unknown	N/C	N/C	FMON	FKNX-GUTC	N/C	N/C	N/C	N/C	N/C	
527 CA	N/O	N/C	Unknown	N/C	N/C	FSIL.w/206CA	N/C	FKNX-GUTC	N/C	N/C	N/C	N/C	
528 CA	N/O	N/C	Unknown	N/C	N/C	N/C	FKNX-GUTC	N/C	N/C	N/C	N/C	N/C	
529 CA	N/O	N/C	Unknown	FSIL	I/A	N/C	Capitolia-NG	N/C	N/C	N/C	I/A	N/C	
530 CA	N/O	N/C	Unknown	N/C	N/C	N/C	N/C	FTOT	N/C	N/C	N/C	APG-RATC	
531 CA	N/O	CCUS-IND	Unknown	N/C	Sparta-NG	N/C	FKNX-GUTC	N/C	N/C	N/C	FKNX-GUTC	N/C	
532 CA	N/O	N/C	Unknown	N/C	N/C	N/C	N/C	FKNX-GUTC	N/C	N/C	N/C	N/C	
533 CA	N/O	N/C	Unknown	UPTN-RATC	N/C	UPTN-CMTC	FTOT	UPTN	N/C	N/C	APG-RATC	N/C	
534 CA	N/O	N/C	FBAR-GRP	N/C	FBAR	FBAR	FBRG-GUTC	FBAR-GUTC	FBAR	N/C	N/C	N/C	
535 CA	N/O	N/C	Unknown	FMON	N/C	N/C	FKNX-GUTC	FKNX-GUTC	FKNX-GUTC	N/C	N/C	N/C	
536 CA	N/O	N/C	Unknown	CCUS	N/C	N/C	FKNX-GUTC	N/C	N/C	N/C	N/C	N/C	
537 CA	N/O	N/C	Unknown	N/C	N/C	FSIL.w/206CA	N/C	FKNX-GUTC	FSNL-GUTC	N/C	N/C	N/C	
538 CA	N/O	N/C	Unknown	N/C	FSIL	N/C	Lawrence KS	N/C	N/C	N/C	N/C	N/C	
539 CA	N/O	N/C	Unknown	UPTN	UPTN	FHAN-CMTC	N/C	UPTN	N/C	N/C	N/C	APG-RATC	
540 CA	N/O	N/C	FBAR-GRP	N/C	FBAR-MOB	FBAR	N/C	N/C	N/C	N/C	N/C	FBAR-RATC	
541 CA	N/O	N/C	Unknown	N/C	N/C	N/C	FKNX-GUTC	FKNX-GUTC	FKNX-GUTC	N/C	N/C	N/C	
542 CA	N/O	N/C	Unknown	N/C	N/C	FTRY-GUTC	I/A	I/A	I/A	N/C	N/C	N/C	
543 CA	N/O	N/C	Unknown	N/C	FTRY-GUTC	FTRY-GUTC	N/C	N/C	N/C	N/C	N/C	FHW-RATC	
544 CA	N/O	N/C	Unknown	N/C	FTRY-GUTC	FTRY-GUTC	FADM-GUTC	N/C	N/C	N/C	N/C	N/C	
545 CA	N/O	N/C	Unknown	FBAR	FBAR	FBAR	FBAR-RATC	N/C	N/C	N/C	FBAR	BEAU-CMTC	
547 CA	N/O	N/O	N/O	N/C	FMON	N/C	FMON-RATC	FMON-GUTC	D/B 5-09-28				
548 CA	N/O	N/O	N/O	N/C	FMOU	FBAR	FBAR-GUTC	FBAR-GUTC	D/B 5-09-28				
555 CA	N/O	N/O	N/O	N/O	N/O	N/O	CCUS/FKNX	Grant-NG	D/B 5-09-28				
601 CA	N/O	N/O	N/O	FHAN	FAND-GUTC	N/C	FADM	N/C	FHW-CMTC	N/C	N/C	N/C	
602 CA	N/O	N/O	N/O	UPTN	FHAN-CMTC	FHAN-RATC	N/C	FHAN-GUTC	N/C	N/C	FHAN	N/C	
603 CA	N/O	N/O	N/O	FEUS	FEUS	FEUS	FMON	FEUS-RATC	FMON-GUTC	N/C	FMON-GUTC	FMON-CMTC	
604 CA	N/O	N/O	N/O	FWFS	N/C	FMAC	N/C	N/C	FMAC-RATC	N/C	N/C	N/C	

Coast Artillery Training Camps 1921 – 1930

Regiment	1921	1922	1923	1924	1925	1926	1927	1928	1929	1930
605 CA	N/O	N/O	N/O	N/O	N/O	N/O	N/O	N/O	N/O	N/O
606 CA	N/O	N/O	N/O	N/O	N/O	N/O	N/O	N/O	N/O	N/O
607 CA	N/O	N/O	N/O	N/O	N/O	N/O	N/O	N/O	N/O	N/O
608 CA	N/O	N/O	N/O	N/O	N/O	N/O	N/O	N/O	N/O	N/O
609 CA	N/O	N/O	N/O	N/O	N/O	N/O	N/O	N/O	N/O	N/O
613 CA	N/O	N/O	N/O	N/O	N/O	N/O	N/O	N/O	N/O	N/O
614 CA	N/O	N/O	N/O	N/O	N/O	N/O	N/O	N/O	N/O	N/O
615 CA	N/O	N/O	N/O	N/O	N/O	N/O	N/O	N/O	N/O	N/O
616 CA	N/O	N/O	N/O	N/O	N/O	N/O	N/O	N/O	N/O	N/O
618 CA	N/O	N/O	N/O	N/O	N/O	N/O	N/O	N/O	N/O	N/O
619 CA	N/O	N/O	N/O	N/O	N/O	N/O	N/O	N/O	N/O	N/O
620 CA	N/O	N/O	N/O	N/O	N/O	N/O	N/O	N/O	N/O	N/O
621 CA	N/O	N/O	N/O	N/O	N/O	N/O	N/O	N/O	N/O	N/O
622 CA	N/O	N/O	N/O	N/O	N/O	N/O	N/O	N/O	N/O	N/O
623 CA	N/O	N/O	N/O	N/O	N/O	N/O	N/O	N/O	N/O	N/O
624 CA	N/O	N/O	N/O	N/O	N/O	N/O	N/O	N/O	N/O	N/O
625 CA	N/O	N/O	N/O	N/O	N/O	N/O	N/O	N/O	N/O	N/O
626 CA	N/O	N/O	N/O	N/O	N/O	N/O	N/O	N/O	N/O	N/O
627 CA	N/O	N/O	N/O	N/O	N/O	N/O	N/O	N/O	N/O	N/O
628 CA	N/O	N/O	N/O	N/O	N/O	N/O	N/O	N/O	N/O	N/O
629 CA	N/O	N/O	N/O	N/O	N/O	N/O	N/O	N/O	N/O	N/O
630 CA	N/O	N/O	N/O	N/O	N/O	N/O	N/O	N/O	N/O	N/O
901 CA										
902 CA										
903 CA										
904 CA										
906 CA										
907 CA										
908 CA										
909 CA										
910 CA										
913 CA										
916 CA										
917 CA										
921 CA										
922 CA										
923 CA										
924 CA										
925 CA										
932 CA										
933 CA										
938 CA										
945 CA										
946 CA										
947 CA										

Coast Artillery Training Camps 1921 – 1930

Regiment	1921	1922	1923	1924	1925	1926	1927	1928	1929	1930
948 CA									N/C	FKNX-GUTC
949 CA									N/C	FKNX-GUTC
950 CA									N/C	FKNX-GUTC
951 CA									N/C	N/C
955 CA									N/C	FKNX-GUTC
958 CA									N/C	FKNX-GUTC
960 CA									N/C	FKNX-GUTC
969 CA									N/C	N/C
970 CA									N/C	N/C
971 CA									N/C	N/C
972 CA									N/C	N/C
973 CA									N/C	N/C
974 CA									N/C	N/C
975 CA									N/C	FMAC-GUTC
976 CA									N/C	N/C
977 CA									N/C	FMAC-RATC
979 CA									N/C	N/C

Coast Artillery Training Camps 1931 – 1940

Regiment	1931	1932	1933	1934	1935	1936	1937	1938	1939	1940
22 CA										FMCK-CMTC
42 CA	N/C	N/C	Unknown	N/C	N/C	N/C	N/C	FMON-GUTC	FMON-GUTC	FMON-BC
43 CA	N/C	N/C	Unknown	N/C	N/C	N/C	N/C	FMON-GUTC	FMON-GUTC	FMON-GUTC
44 CA	N/C	N/C	Unknown	N/C	N/C	N/C	N/C	FMON-GUTC	FMON-GUTC	FMON-GUTC
57 CA	FWES	FWFS-RATC	FFUN-GUTC	FFUN-GUTC	N/C	FWFS-GUTC	N/C	FMON	N/C	FMAC-RATC
65 CA	RA-A	RA-A	I/A	I/A	I/A	I/A	I/A	FWFS	FWFS-GUTC	N/C
67 CA	N/C	N/C	Unknown	FBAR-GUTC	FBAR-CMTC	FBAR-GUTC	FBAR-RATC	FBAR-RATC	FBAR-RATC	FBAR-GUTC
68 CA	N/C	N/C	FHGW-COC	N/C	FHGW-RATC	N/C	N/C	FADM-CMTC	N/C	N/C
141 CAC										
197 CA	Rye	Rye	Rye	Rye	Rye	Rye	Rye	Rye	PLBK-MAN	NNYS-MAN
198 CA	Bethany	Bethany	Bethany	Bethany	Bethany	Bethany	Bethany	Bethany	Bethany	NNYS-MAN
200 CA										
202 CA	Grant	FBAR	FSHN	CCUS	FSHN	CCUS-MAN	Logan	FSHN/Logan	Logan	Logan/McCoy
203 CA	FSHN	FBAR	Clark	Clark	FSHN	Hulen	FRK-MAN	FBAR	FBAR	Ripley
204 CA	N/O	N/O	N/O	N/O	N/O	N/O	N/O	N/O	N/O	BEAU
205 CA	N/O	N/O	N/O	N/O	N/O	N/O	N/O	N/O	N/O	FWOR
208 CA	FBAR	FBAR/Pike	FBAR	Pike	FSHN	Hulen	FBAR	CJTR	FBAR	Ripley
207 CA	N/O	N/O	N/O	N/O	N/O	N/O	N/O	N/O	N/O	Luna
211 CA	Sandwich	Sandwich	Sandwich	Sandwich	Sandwich	Edwards	Edwards	Edwards	Edwards	NNYS-MAN
212 CA	FONT	FONT	FONT	FONT	Smith	FONT	Pine Cp	FONT	PLBK-MAN	NNYS-MAN
213 CA	Mt Gretina	VA Beach	VA Beach	Ind Gap	Bethany	Bethany	Ind Gap	ESTY	MNVA-MAN	NNYS-MAN
214 CA	N/O	N/O	N/O	N/O	N/O	N/O	N/O	N/O	N/O	FBAR
240 CA	FWMS	FWMS	FWMS	FWMS	FWMS	FWMS	FWMS	FWMS	FWMS	FWMS
241 CA	FHGW	FHGW	FHGW	FHGW	FHGW	FHGW	FHGW	FHGW	FHGW	FHGW
242 CA	FTRY	FTRY	FTRY	FTRY	FTRY	FTRY	FTRY	FTRY	FTRY	FTRY
243 CA	FHGW	FHGW	FHGW	FHGW	FHGW	FHGW	FHGW	FHGW	FHGW	FHGW
244 CA	FONT	FONT	FONT	FONT	Smith	FONT	Pine Cp	FONT	Smith	NNYS-MAN
245 CA	FHGW	FHGW	FHGW	FHGW	Smith	FHGW	FHGW	FHGW	FHGW	FHGW
246 CA	FMON	FMON	FMON	FMON	FMON	FMON	ESTY	ESTY	ESTY	ESTY
248 CA	FWOR	FWOR	FWOR	FWOR	FWOR	FWOR	FWOR	FWOR	FWOR	FWOR
249 CA	FSTV	FSTV	FSTV	FSTV	FSTV	FSTV	Clatsop	Clatsop	Clatsop	Clatsop
250 CA	McQuaide	McQuaide	McQuaide	McQuaide	McQuaide	McQuaide	SLO-MAN	McQuaide	McQuaide	McQuaide
251 CA	FMAC	FMAC	FMAC	SLO	Ventura	Ventura	SLO-MAN	Ventura	Ventura	Ventura
252 CA	EMOU	EMOU	EMOU	EMOU	EMOU	FBRG	FBRG	EMOU	EMOU	EMOU
260 CA	Richie	FSTY	FMON	Road March	FMON	FMON	FSTY	FSTY	MNVA-MAN	NNYS-MAN
261 CA	FHAN	FHAN	FHAN	FHAN	FHAN	FHAN	FHAN	FHAN	FHAN	FHAN
263 CA	EMOU	EMOU	EMOU	EMOU	EMOU	EMOU	EMOU	EMOU	EMOU	EMOU
264 CA	FBAR	EMOU	EMOU	EMOU	FBAR	EMOU	EMOU	FBAR	FBAR	EMOU
265 CA	KWBK	KWBK	KWBK	KWBK/FBAR	FBAR	FBAR	KWBK	KWBK	KWBK	KWBK
501 CA	N/C	N/C	Unknown	D/B 1-10-33						
502 CA	FTIL-RATC	FDIX/FTIL	FDIX/FTIL	N/C	FTIL-RATC	N/C	FHAN-CMTC	FHAN	FTOT-RATC	FTOT-MOB
503 CA	EMON-CMTC	N/C	Unknown	N/C	EMON-GUTC	EMON-CMTC	FMON-GUTC	N/C	FMON-GUTC	FMON-CMTC
504 CA	FBAR-GUTC	N/C	FBAR-GUTC	N/C	FBAR-RATC	FBAR-GUTC	FBAR-RATC	FBAR-CMTC	FBAR-CMTC	FBAR-GUTC
505 CA	N/C	N/C	FSHN-GUTC	N/C	FSHN-GUTC	N/C	FSHN-GUTC	N/C	FSHN-GUTC	FSHN-GUTC

Coast Artillery Training Camps 1931 – 1940

Regiment	1931	1932	1933	1934	1935	1936	1937	1938	1939	1940
506 CA	FSHN-GUTC	FSHN-GUTC	Unknown	N/C	FSHN-GUTC	N/C	FSHN-GUTC	FSHN-GUTC	FSHN-GUTC	FSHN-GUTC
507 CA	N/C	FSHN-GUTC	Unknown	N/C	FSHN-GUTC	FSHN-GUTC	FSHN-GUTC	FSHN-GUTC	FSHN-GUTC	FSHN-GUTC
508 CA	FMON-CMTC	N/C	FMON-RATC	FMON-RATC	N/C	FMON-CMTC	N/C	FMON-GUTC	N/C	FMON-GUTC
509 CA	N/C	FWOR-GUTC	Unknown	N/C	FWOR-GUTC	N/C	FWOR-GUTC	N/C	FWOR-CMTC	N/C
510 CA	FMON-GUTC	N/C	FMON-CMTC	FMON-CMTC	N/C	N/C	FMON-RATC	FMON-RATC	N/C	N/C
511 CA	N/C	N/C	FSHN-GUTC	FSHN-GUTC	FSHN-GUTC	N/C	FSHN-GUTC	N/C	FSHN-GUTC	FSHN-GUTC
513 CA	FTIL-GUTC	FDIX/FTIL	FDIX/FTIL	FHAN-CMTC	N/C	FTOT-RATC	N/C	FTOT-RATC	FTOT-RATC	N/C
514 CA	N/C	FTIL-RATC	FHAN-CMTC	FTOT-RATC	N/C	FHAN-CMTC	N/C	FTOT-RATC	FTOT-RATC	FHAN-CMTC
515 CA	FSHN-GUTC	N/C	Unknown	FSHN-GUTC	FSHN-IND	FSHN-GUTC	FSHN-GUTC	FSHN-GUTC	FSHN-GUTC	FSHN-GUTC
516 CA	N/C	FMON-RATC	FMON-CMTC	D/B 1-10-33	N/C	N/C	FSHN-GUTC	FSHN-GUTC	FSHN-GUTC	FSHN-GUTC
517 CA	N/C	N/C	Unknown	N/C	FWFS-CMTC	N/C	N/C	FWFS-GUTC	N/C	FWFS-GUTC
518 CA	FWFS-RATC	N/C	Unknown	N/C	N/C	N/C	N/C	N/C	N/C	N/C
519 CA	FMAC-RATC	N/C	Unknown	FMAC-RATC	N/C	FMAC-GUTC	FMAC-RATC	N/C	FMAC-GUTC	N/C
521 CA	FHAN-CMTC	FTIL/FDIX	FTIL/FDIX	FTOT-RATC	N/C	FTOT-RATC	N/C	FTOT-RATC	FHAN-CMTC	N/C
522 CA	N/C	FTIL-RATC	N/C	D/B 1-10-33	N/C	N/C	N/C	N/C	N/C	N/C
523 CA	N/C	FMON-RATC	Unknown	N/C	FMON-RATC	FMON-CMTC	N/C	N/C	FMON-GUTC	FMON-CMTC
524 CA	FBAR-GUTC	FBAR-RATC	FBAR-GUTC	FBAR-GUTC	FBAR-CMTC	FBAR-CMTC	FBAR-GUTC	FBAR-RATC	FBAR-CMTC	FBAR-GUTC
525 CA	N/C	FSHN-GUTC	N/C	FSHN-GUTC	N/C	FSHN-IND	FSHN-IND	FBAR-GUTC	N/C	FSHN-GUTC
526 CA	FSHN-GUTC	N/C	N/C	FSHN-GUTC	N/C	FSHN-GUTC	N/C	FSHN-GUTC	N/C	FSHN-GUTC
527 CA	FSHN-GUTC	N/C	N/C	FSHN-GUTC	FSHN-IND	FSHN-GUTC	FSHN-GUTC	FSHN-GUTC	FSHN-GUTC	FSHN-GUTC
528 CA	N/C	N/C	N/C	N/C	N/C	N/C	N/C	FSHN-GUTC	FSHN-GUTC	FSHN-GUTC
529 CA	I/A	I/A	FWOR-GUTC	N/C	FWOR-GUTC	N/C	FWOR-GUTC	N/C	FWOR-GUTC	I/A
530 CA	N/C	FTIL-RATC	N/C	FHAN-CMTC	N/C	FTOT-RATC	N/C	FHAN-CMTC	N/C	FTOT-GUTC
531 CA	FSHN-GUTC	FSHN-GUTC	N/C	N/C	N/C	FSHN-GUTC	N/C	FSHN-GUTC	FSHN-GUTC	N/C
532 CA	FSHN-GUTC	FSHN-GUTC	N/C	N/C	N/C	FSHN-GUTC	N/C	FSHN-GUTC	FSHN-GUTC	JFBK-CMTC
533 CA	N/C	FHAN-CMTC	N/C	FTOT-RATC	N/C	FTOT-RATC	N/C	FTOT-RATC	N/C	FTOT-GUTC
534 CA	FBAR-GUTC	N/C	Unknown	N/C	FBAR-RATC	FBAR-CMTC	FBAR-GUTC	FBAR-CMTC	FBAR-GUTC	FBAR-GUTC
535 CA	N/C	N/C	FSHN-GUTC	FSHN-GUTC	N/C	FSHN-IND	N/C	FSHN-GUTC	N/C	FSHN-GUTC
536 CA	FSHN-GUTC	FSHN-GUTC	N/C	N/C	FSHN-GUTC	FSHN-GUTC	FSHN-GUTC	FSHN-GUTC	FSHN-GUTC	N/C
537 CA	FSHN-GUTC	N/C	Unknown	FSHN-GUTC	FSHN-IND	FSHN-GUTC	FSHN-GUTC	FSHN-GUTC	FSHN-GUTC	FSHN-GUTC
538 CA	FSHN-GUTC	N/C	Unknown	FSHN-GUTC	FSHN-IND	FSHN-GUTC	FSHN-GUTC	FSHN-GUTC	FSHN-GUTC	FSHN-GUTC
539 CA	N/C	FHAN-CMTC	N/C	N/C	FTIL-RATC	N/C	FTOT-RATC	N/C	N/C	I/A
540 CA	N/C	FBAR-CMTC	Unknown	FBAR-GUTC	N/C	N/C	FBAR-CMTC	FBAR-GUTC	FBAR-CMTC	FBAR-CMTC
541 CA	N/C	N/C	FSHN-GUTC	FSHN-GUTC	FSHN-GUTC	FSHN-IND	N/C	N/C	N/C	N/C
542 CA	N/C	FHGW-RATC	Unknown	N/C	N/C	FHGW-GUTC	N/C	N/C	FADM-CMTC	N/C
543 CA	N/C	FHGW-RATC	Unknown	N/C	N/C	FADM-CMTC	N/C	N/C	FADM-CMTC	N/C
544 CA	FADM-CMTC	N/C	Unknown	FHGW	FHGW-RATC	N/C	N/C	FADM-CMTC	FADM-GUTC	N/C
545 CA	FBAR-GUTC	N/C	FBAR-GUTC	N/C	FBAR-RATC	FBAR-GUTC	FBAR-CMTC	FBAR-CMTC	FBAR-RATC	FBAR-GUTC
547 CA										
548 CA										
555 CA										
601 CA	FHGW	FHAN-GUTC	Unknown	N/C	N/C	N/C	FADM-CMTC	N/C	N/C	N/C
602 CA	N/C	FHAN-CMTC	N/C	N/C	FHAN-GUTC	N/C	FHAN-RATC	FHAN	FHAN-MOB	FHAN-GUTC
603 CA	N/C	FMON-RATC	Unknown	FMON-CMTC	FMON-RATC	N/C	FMON-RATC	FMON-CMTC	N/C	N/C
604 CA	FWFS-RATC	N/C	FFUN-GUTC	FFUN-GUTC	N/C	N/C	N/C	N/C	FWFS-GUTC	N/C

Coast Artillery Training Camps 1931 – 1940

Regiment	1931	1932	1933	1934	1935	1936	1937	1938	1939	1940
605 CA	N/C	FWFS-RATC	FFUN-GUTC	D/B 1-10-33						
606 CA	N/C		Unknown	N/C	N/C	N/C	FADM-CMTC		FADM-CMTC	N/C
607 CA	N/C	FHAN-GUTC	N/C	N/C	FHAN-GUTC	N/C	FHAN-RATC	FHAN-RATC	FHAN-RATC	N/C
608 CA	N/C	FWFS-RATC	Unknown	D/B 1-10-33						
609 CA										
613 CA	N/C	N/C	Unknown	N/C	N/C	I/A	I/A	I/A	I/A	I/A
614 CA	N/C	N/C	Unknown	FWMS-NG	N/C	N/C	FADM-CMTC	I/A	I/A	I/A
615 CA	N/C	FADM-CMTC	Unknown	N/C	N/C	N/C	N/C	FHAN-RATC	FHAN-RATC	FHAN-RATC
616 CA	FHGW	FHGW-RATC	Unknown	N/C	N/C	FADM-CMTC	I/A	I/A	I/A	I/A
618 CA	N/C	N/C	Unknown	N/C	N/C	N/C	N/C	N/C	N/C	FHAN-RATC
619 CA	FHAN-CMTC	N/C	FHAN	FHAN-GUTC	N/C	FHAN-GUTC	N/C	FHAN-RATC	N/C	FHAN-RATC
620 CA	N/C	FHAN-GUTC	N/C	N/C	FHAN-GUTC	N/C	FHAN-RATC	FHAN	FHAN-RATC	N/C
621 CA	FHAN-GUTC	N/C	FHAN-CMTC	N/C	FHAN-GUTC	N/C	FHAN-RATC	FHAN	FHAN-RATC	FHAN-RATC
622 CA	FMON-GUTC	N/C	FMON-RATC	FMON-RATC	FMON-CMTC	FMON-GUTC	N/C	FMON-GUTC	FMON-CMTC	FMON-GUTC
623 CA	FBAR-GUTC	N/C	Unknown	N/C	N/C	N/C	FBAR-RATC	FBAR-GUTC	FBAR-RATC	FBAR-GUTC
624 CA	N/C	FGRO	FMAC-IND	FBAR-GUTC	N/C	FMAC-GUTC	N/C	FCRO-RATC	FCRO-RATC	FCRO-RATC
625 CA	FWFS-RATC	N/C	FFUN-GUTC	N/C	FMAC-GUTC	FMAC-GUTC	N/C	N/C	N/C	N/C
626 CA	N/C	FWFS-RATC	Unknown	N/C	FMAC-GUTC	FMAC-GUTC	N/C	N/C	FMAC-GUTC	FMAC-RATC
627 CA	FWFS-RATC	N/C	FFUN-GUTC	FFUN-GUTC	N/C	FWFS-GUTC	N/C	FWFS-GUTC	N/C	FWFS-GUTC
628 CA	FCRO-GUTC	N/C	Unknown	N/C	FMAC-GUTC	FMAC-GUTC	FFUN-IND	FWFS-GUTC	N/C	N/C
629 CA	FWOR-RATC	N/C	FWOR-GUTC	FWOR-GUTC	N/C	N/C	FSTV-GUTC	N/C	FSTV-GUTC	N/C
630 CA	FWOR-GUTC	N/C	FWOR-GUTC	FWOR-GUTC	N/C	FWOR-GUTC	N/C	FWOR-GUTC	N/C	FWOR-GUTC
901 CA	FHGW	N/C	Unknown	N/C	N/C	FADM-CMTC	N/C	N/C	N/C	N/C
902 CA	N/C	N/C	Unknown	N/C	FADM-CMTC	N/C	N/C	EHGW-GUTC	N/C	EMCK-CMTC
903 CA	FHGW	N/C	Unknown	FHGW	FHGW-RATC	N/C	N/C	FDAM-CMTC	N/C	N/C
904 CA	FHGW	N/C	Unknown	D/B 1-10-33			FHGW-GUTC	N/C	N/C	N/C
906 CA	N/C	N/C	Unknown	FADM	N/C	N/C	N/C	N/C	N/C	N/C
907 CA	FHGW	N/C	Unknown	N/C	N/C	N/C	N/C	N/C	N/C	N/C
908 CA	FHAN-CMTC	FTEL/FDIX	FTEL/FDIX	D/B 1-10-33						
909 CA	FTEL-GUTC	FTEL/FDIX	FTEL/FDIX	D/B 1-10-33						
910 CA	FTEL-RATC	FDIX/FTEL	FDIX/FTEL	N/C	FHAN-CMTC	UPTN	FTOT-RATC	FTOT-RATC	FTOT-RATC	N/C
913 CA	EMON-GUTC	N/C	Unknown	EMON-RATC	EMON-RATC	Unknown	Unknown	EMON-GUTC	EMON-CMTC	N/C
916 CA	N/C	FMON-CMTC	Unknown	N/C	N/C	FMON-RATC	FMON-CMTC	N/C	N/C	FMON-GUTC
917 CA	N/C	FMON-CMTC	Unknown	N/C	N/C	FMON-RATC	FMON-CMTC	N/C	FMON-GUTC	FMON-GUTC
921 CA	N/C	FBAR-RATC	N/C	D/B 1-10-33						
922 CA	FBAR-GUTC	N/C	FBAR-GUTC	D/B 1-10-33						
923 CA	N/C	FBAR-RATC	N/C	D/B 1-10-33						
924 CA	FBAR-GUTC	N/C	FBAR-GUTC	D/B 1-10-33						
925 CA	N/C	FBAR-RATC	N/C	FBAR-GUTC	FBAR-GUTC	FBAR-CMTC	FBAR-CMTC	FBAR-GUTC	FBAR-RATC	FBAR-CMTC
932 CA	N/C	N/C	N/C	FSHN-GUTC	N/C	FSHN-GUTC	N/C	N/C	FSHN-GUTC	FSHN-GUTC
933 CA	N/C	FSHN-GUTC	N/C	FSHN-GUTC	N/C	FSHN-GUTC	N/C	FSHN-GUTC	N/C	FSHN-GUTC
938 CA	N/C	FSHN-GUTC	N/C	FSHN-GUTC	N/C	FSHN-GUTC	N/C	FSHN-GUTC	N/C	FSHN-GUTC
945 CA	FSHN-GUTC	N/C	N/C	FSHN-GUTC	N/C	FSHN-GUTC	N/C	FSHN-GUTC	N/C	FSHN-GUTC
946 CA	FSHN-GUTC	N/C	N/C	D/B 1-10-33						
947 CA	N/C	FSHN-GUTC	N/C	N/C	N/C	N/C	N/C	N/C	N/C	N/C

Coast Artillery Training Camps 1931 – 1940											
Regiment	1931	1932	1933	1934	1935	1936	1937	1938	1939	1940	
948 CA	FSHN-GUTC	FSHN-GUTC	N/C	N/C	N/C	N/C	N/C		N/C	N/C	
949 CA	N/C	FSHN-GUTC	N/C	N/C	N/C	N/C	N/C		N/C	N/C	
950 CA	FSHN-GUTC	N/C	N/C	N/C	FSHN-GUTC	N/C	FSHN-GUTC		FSHN-GUTC	N/C	
951 CA	N/C	N/C	Unknown	N/C	FSHN-GUTC	N/C	FSHN-GUTC	FSHN-GUTC	FSHN-GUTC	N/C	
955 CA	N/C	FSHN-GUTC	Unknown	N/C	FSHN-GUTC	FSHN-GUTC	FSHN-GUTC	FSHN-GUTC	FSHN-GUTC	FSHN-GUTC	
958 CA	N/C	FSHN-GUTC	Unknown	N/C	FSHN-GUTC	FSHN-GUTC	FSHN-GUTC	FSHN-GUTC	FSHN-GUTC	FSHN-GUTC	
960 CA	N/C	FSHN-GUTC	Unknown	N/C	FSHN-GUTC	FSHN-GUTC	FSHN-GUTC	FSHN-GUTC	FSHN-GUTC	FSHN-GUTC	
969 CA	FCRO-GUTC	FCRO-GUTC	FBAR	FBAR-GUTC	FCRO-RATC	FCRO-RATC	FCRO-RATC	FCRO-RATC	FCRO-RATC	FCRO-RATC	
970 CA	FCRO-GUTC	FCRO-GUTC	FBAR	FBAR-GUTC	FCRO-RATC	N/C	I/A	I/A	I/A	I/A	
971 CA	FCRO-GUTC	FCRO-GUTC	Unknown	D/B 1-10-33							
972 CA	FCRO-GUTC	FCRO-GUTC	FBAR	FBAR-GUTC	FCRO-RATC	N/C	FCRO-RATC	N/C	FCRO-RATC	FCRO-RATC	
973 CA	FCRO-GUTC	FCRO-GUTC	FBAR	FBAR-GUTC	FCRO-RATC	FCRO-RATC	N/C	N/C	FCRO-RATC	FCRO-RATC	
974 CA	FCRO-GUTC	FCRO-GUTC	FBAR	FBAR-GUTC	N/C	N/C	FCRO-RATC	FCRO-RATC	FCRO-RATC	FCRO-RATC	
975 CA	N/C	FMAC-RATC	Unknown	N/C	FMAC-GUTC	N/C	N/C	FMAC-RATC	N/C	FMAC-RATC	
976 CA	FMAC-RATC	N/C	Unknown	FMAC-RATC	N/C	N/C	FMAC-CMTC	N/C	N/C	FROS-GUTC	
977 CA	N/C	FMAC-RATC	Unknown	N/C	FMAC-CMTC	N/C	N/C	FMAC-RATC	N/C	FMAC-RATC	
979 CA	N/C	FWOR-GUTC	Unknown	D/B 1-10-33							

Medical Unit Training Camps 1921 – 1930												
Regiment	1921	1922	1923	1924	1925	1926	1927	1928	1929	1930		
2 MED SQ							N/C	N/C	N/C	N/C		
3 MED SQ							N/O	N/C	FSNL-GUTC	N/C		
3 MED	RA-A	RA-A	I/A	I/A	I/A	I/A	I/A	N/C	FLEW	N/C		
4 MED	RA-A	I/A	I/A	I/A	I/A	I/A	I/A	N/C	N/C	N/C		
5 MED	RA-A	I/A	I/A	I/A	I/A	I/A	FKNX-GUTC	N/C	N/C	N/C		
6 MED	RA-A	I/A	I/A	I/A	I/A	I/A	FSNL	N/C	FSNL	N/C		
7 MED	RA-A	I/A	I/A	I/A	I/A	I/A	FSNL	FSNL-GUTC	FSNL-GUTC	N/C		
8 MED		I/A	I/A	I/A	I/A	I/A	N/C	N/C	N/C	N/C		
9 MED		I/A	I/A	I/A	I/A	I/A	N/C	N/C	N/C	N/C		
14 MED							N/C	N/C	N/C	N/C		
15 MED							N/C	N/C	FKNX-GUTC	FKNX-BC		
16 MED							N/C	N/C	FSNL-GUTC	N/C		
17 MED							N/C	N/C	FLEW	FLEW		
18 MED							N/C	N/C	N/C	N/C		
19 MED							N/C	N/C	FSNL-GUTC	FSNL-GUTC		
31 MED												
101 MED	FDEV Smith	FDEV Smith	FDEV Smith	FDEV Smith	FDEV Smith	FDEV Smith	FDEV Smith	FDEV Smith	FDEV Smith	FDEV Smith		
102 MED	N/O	Mt Gretna	Mt Gretna	Mt Gretna	Mt Gretna	Mt Gretna	Mt Gretna	Mt Gretna	Mt Gretna	Mt Gretna		
104 MED	N/O	N/O	FGGM	CBRK	CBRK	CBRK	CBRK	CBRK	CBRK	CBRK		
105 MED	N/O	N/O	N/O	FMCL	FMCL	FMCL	FBRG	C-JAC	C-JAC	C-JAC		
106 MED	N/O	N/O	N/O	FMCL	FMCL/Beau	FMCL/Beau	FMCL/Beau	FMCL/Beau	FMCL/Beau	FMCL/Beau		
107 MED	N/O	Graying	Douglas	Graying	Graying	Graying	Graying	Graying	Graying	Graying		
108 MED	N/O	Grant	Grant	Grant	Grant	Grant	Grant	Grant	Grant	Grant		
110 MED	N/O	N/O	Ashland	Ashland	Ashland	Ashland	Ashland	Ashland	Ashland	Ashland		
111 MED	N/O	N/O	Mabry	FCRO	Mabry	FCRO	Hulen	Hulen	Hulen	Hulen		
112 MED	Perry	Perry	Perry	FKNX	Perry	FKNX	Perry	Perry	Perry	Perry		
113 MED	N/O	FKNX	FKNX	FKNX	FKNX	FKNX	FKNX	FKNX	FKNX	FKNX		
115 MED	N/O	Unknown	DELM	DELM	DELM	DELM/WG	DELM/WG	DELM/WG	DELM/WG	DELM/WG		
116 MED	N/O	N/O	N/O	Murray	Murray	Murray	Murray	Murray	Murray	Murray		
118 MED	N/O	N/O	Niantic	Niantic	Niantic	Niantic	Niantic	Niantic	Niantic	Niantic		
119 MED	Sea Girt	Sea Girt	Sea Girt	Sea Girt	Sea Girt	Sea Girt	Sea Girt	Sea Girt	Sea Girt	Sea Girt		
120 MED	N/O	FSIL	FSIL	FSIL	FSIL	FSIL	FSIL	FSIL	FSIL	FSIL		
123 MED SQ	N/O	Douglas	Douglas	Douglas	Unknown	FBRG	FOGL	FOGL	FOGL	FOGL		
136 MED	N/O	N/O	N/O	N/O	Dodge	Dodge	Dodge	Dodge	Dodge	Dodge		
301 MED	N/O	FDEV-DGRP	FDEV-DGRP	FDEV-DGRP	N/C	CBRK	Niantic-NG	Niantic-NG	N/C	FDEV		
302 MED	N/O	CBRK	CBRK	CBRK	N/C	CBRK	CBRK	EDIX-CPX	N/C	CBRK		
303 MED	N/O	Unknown	Unknown	N/C	N/C	CBRK	CBRK	N/C	CBRK	N/C		
304 MED	N/O	EGGM-DGRP	EGGM-DGRP	CBRK	CBRK	CBRK	CBRK	CBRK-GUTC	CBRK	CBRK		
305 MED	N/O	EGGM-DGRP	EGGM-DGRP	N/C	N/C	CBRK	CBRK	CBRK-GUTC	CBRK	CBRK		
306 MED	N/O	FMCL-DGRP	FMCL-DGRP	N/C	N/C	N/C	FOGL-GUTC	N/C	FOGL-GUTC	N/C		
307 MED	N/O	FMCL-DGRP	FMCL-DGRP	N/C	N/C	CBRK	N/C	N/C	FMOU	FMPH		

Medical Unit Training Camps 1921 – 1930

Regiment	1921	1922	1923	1924	1925	1926	1927	1928	1929	1930
308 MED	N/O	FKNX-DGRP	FKNX-DGRP	N/C	N/C	FKNX-GUTC	FKNX-GUTC	FKNX-GUTC	FKNX-GUTC	FKNX-BC
309 MED	N/O	FKNX-DGRP	FKNX-DGRP	N/C	FBH	FKNX-NG	FKNX-GUTC	FKNX-GUTC	FKNX-GUTC	FKNX-BC
310 MED	N/O	CCUS-DGRP	CCUS-DGRP	FSNL	N/C	N/C	CCUS-GUTC	Grayling-NG	FSNL-GUTC	N/C
311 MED	N/O	CCUS-DGRP	CCUS-DGRP	FSNL	N/C	N/C	FSNL	FSHN-GUTC	FSNL-GUTC	N/C
312 MED	N/O	FMCL-DGRP	FMCL-DGRP	N/C	N/C	FOGL	N/C	N/C	N/C	N/C
313 MED	N/O	FSNL-DGRP	FSNL-DGRP	FSNL	FSNL	FSNL	FSNL	FSNL-GUTC	FSNL-GUTC	FSNL
314 MED	N/O	FSNL-DGRP	FSNL-DGRP	FSNL	FSNL	FSNL	N/C	FSNL-GUTC	N/C	FSNL
315 MED	N/O	FSH-DGRP	FSH-DGRP	N/C	FSH	FSH-RATC	FSH-RATC	FSH-RATC	FSH-RATC	N/C
316 MED	N/O	PMON-DGRP	Unknown	N/C	FLEW	N/C	FLEW	DELM-GUTC	PMON-GUTC	FLEW
319 MED	N/O	FDEV-DGRP	FDEV-DGRP	CBRK	N/C	N/C	N/C	CBRK-GUTC	FDEV-GUTC	N/C
320 MED	N/O	FSIL-DGRP	FSIL-DGRP	N/C	FSIL-NG	FSH-RATC	FSH-RATC	FSH-RATC	FSH-GUTC	FSH-RATC
321 MED	N/O	FLEW-DGRP	Unknown	FLEW	FLEW	N/C	FLEW	FLEW-GUTC	FLEW	FLEW
322 MED	N/O	N/C	N/C	FDEV	CBRK	N/C	FDEV	FDEV-GUTC	FDEV-GUTC	N/C
323 MED	N/O	FDIX-DGRP	FDIX-DGRP	CBRK	N/C	CBRK	N/C	N/C	CBRK	N/C
324 MED	N/O	FGGM-DGRP	FGGM-DGRP	CBRK	N/C	CBRK	CBRK	CBRK-GUTC	CBRK	CBRK
325 MED	N/O	FKNX-DGRP	FKNX-DGRP	N/C	N/C	ETHO	FKNX-GUTC	FKNX-GUTC	FKNX-GUTC	FKNX-BC
326 MED	N/O	CCUS-DGRP	CCUS-DGRP	FSNL	N/C	N/C	FSNL	N/C	FSNL-GUTC	FSNL
327 MED	N/O	JFBK-DGRP	Unknown	FSNL	FSNL	FSNL	FSNL	FSNL-GUTC	FSNL-GUTC	FSNL
328 MED	N/O	FLOG-DGRP	FLOG-DGRP	FBLS	Fitzsimons	Fitzsimons	FSH-RATC	FSH-RATC	FSH-GUTC	FSH-RATC
329 MED	N/O	FDOU-DGRP	FDOU-DGRP	FDOU	FLEW	N/C	N/C	FLEW-GUTC	FDOU	FLEW
341 MED	N/O	Unknown	Unknown	CBRK	N/C	N/C	CBRK	N/C	N/C	N/C
342 MED	N/O	Unknown	Unknown	N/C	N/C	N/C	CBRK	N/C	N/C	N/C
343 MED	N/O	Unknown	Unknown	CBRK	N/C	CBRK	N/C	CBRK-GUTC	CBRK	CBRK
344 MED	N/O	Unknown	Unknown	N/C	N/C	N/C	N/C	EBAR	N/C	N/C
345 MED	N/O	Unknown	Unknown	N/C	FKNX	N/C	N/C	N/C	FKNX-GUTC	FKNX-BC
346 MED	N/O	CCUS-GRP	Unknown	N/C	FSNL	N/C	N/C	N/C	FSNL-GUTC	FSNL
347 MED	N/O	Unknown	Unknown	N/C	FSNL	FSNL	FSNL	FSNL-GUTC	Marshalltown	FSNL
348 MED	N/O	Unknown	Unknown	FSH	FSH	FSH	FSH-RATC	FSH-GUTC	FSH-GUTC	FSH
349 MED	N/O	Unknown	Unknown	FLEW	N/C	N/C	FLEW	FLEW-GUTC	FLEW	FLEW
350 MED	N/O	Unknown	Unknown	N/C	N/C	CBRK	CBRK	N/C	N/C	CBRK
361 MED	N/O	Unknown	Unknown	N/C	N/C	N/C	CBRK	N/C	N/C	N/C
361 MED SQ	N/O	N/O	Unknown	N/O	N/O	N/C	N/C	N/C	N/C	CBRK
362 MED	N/O	Unknown	Unknown	N/C	N/C	N/C	N/C	CBRK-GUTC	CBRK	I/A
362 MED SQ	N/O	N/O	Unknown	N/O	N/O	CBRK	N/C	N/C	N/C	N/C
363 MED	N/O	Unknown	Unknown	N/C	N/C	N/C	CBRK	N/C	N/C	N/C
363 MED SQ	N/O	N/O	Unknown	N/O	N/O	N/C	N/C	N/C	N/C	N/C
Regiment	1921	1922	1923	1924	1925	1926	1927	1928	1929	1930
364 MED	N/O	Unknown	FGGM	N/C	CBRK	CBRK	N/C	CBRK-GUTC	CBRK	CBRK
364 MED SQ	N/O	N/O	N/O	N/O	N/O	N/C	FKNX-GUTC	FKNX-GUTC	FKNX-GUTC	FKNX-BC
365 MED	N/O	Unknown	Unknown	N/C	N/C	CBRK	FSNL	CBRK-GUTC	CBRK	I/A
365 MED SQ	N/O	N/O	N/O	N/O	N/O	N/C	N/C	N/C	FSNL-GUTC	FSNL
366 MED	N/O	Unknown	Unknown	N/C	N/C	FMPH	N/C	FBRG-GUTC	N/C	N/C
366 MED SQ	N/O	N/O	N/O	N/O	N/O	N/C	N/C	N/C	N/C	N/C
367 MED	N/O	Unknown	Unknown	N/C	N/C	FKNX-GUTC	N/C	N/C	FKNX-GUTC	FKNX-BC
368 MED	N/O	Unknown	Unknown	N/C	N/C	N/C	N/C	N/C	FKNX-GUTC	FKNX-BC

Medical Unit Training Camps 1921 – 1930											
Regiment	1921	1922	1923	1924	1925	1926	1927	1928	1929	1930	
369 MED	N/O	Unknown	Unknown	CCUS-RATC	N/C	FSNL	N/C	N/C	FSNL-GUTC	N/C	
370 MED	N/O	Unknown	Unknown	N/C	N/C	FSNL	N/C	N/C	FSNL-GUTC	I/A	
371 MED	N/O	Unknown	Unknown	N/C	N/C	FSNL	FSNL	FSNL-GUTC	FSNL-GUTC	FSNL	
372 MED	N/O	Unknown	Unknown	N/C	N/C	FSNL	FSNL	FSNL	FSNL-GUTC	I/A	
373 MED	N/O	Unknown	Unknown	N/C	N/C	CBRK-GUTC	N/C	CBRK	N/C	N/C	
374 MED	N/O	Unknown	Unknown	N/C	N/C	CBRK-GUTC	N/C	N/C	CBRK	N/C	
375 MED	N/O	Unknown	Unknown	N/C	N/C	CBRK	N/C	CBRK-GUTC	CBRK	I/A	
376 MED	N/O	Unknown	Unknown	N/C	N/C	N/C	N/C	EMCL-GUTC	I/A	I/A	
377 MED	N/O	N/O	N/O	N/O	N/C	N/C	N/C	N/C	FKNX-GUTC	FKNX-BC	
378 MED	N/O	Unknown	Unknown	FSNL-GUTC	N/C	N/C	FSNL	JFBK-GUTC	FSNL-GUTC	FSHN-GUTC	
379 MED	N/O	Unknown	Unknown	N/C	N/C	FSNL	FSNL	N/C	N/C	N/C	

Medical Unit Training Camps 1931 – 1940												
Regiment	1931	1932	1933	1934	1935	1936	1937	1938	1939	1940		
2 MED SQ	FSNL-GUTC	N/C	Unknown	N/C	N/C	N/C	N/C	N/C	N/C	N/C		N/C
3 MED SQ	FSNL-GUTC	N/C	Unknown	N/C	N/C	N/C	N/C	N/C	N/C	N/C		N/C
3 MED	N/C	N/C	PMON-GUTC	PMON-GUTC	N/C	N/C	N/C	N/C	N/C	N/C		N/C
4 MED	N/C	N/C	Unknown	N/C	N/C	N/C	N/C	N/C	N/C	N/C		N/C
5 MED	N/C	N/C	Unknown	N/C	CBRK-GUTC	FKNX-GUTC	FKNX-GUTC	CBRK-GUTC	N/C	CBRK-GUTC		CBRK-GUTC
6 MED	FSNL-GUTC	N/C	Unknown	N/C	FSHN-GUTC	CCUS-MAN	N/C	CCUS-GUTC	N/C	N/C		N/C
7 MED	FSNL-GUTC	N/C	Unknown	N/C	N/C	N/C	N/C	N/C	N/C	N/C		N/C
8 MED	N/C	N/C	N/C	CBRK	N/C	N/C	CBRK	N/C	N/C	N/C		N/C
9 MED	N/C	N/C	N/C	CBRK	N/C	N/C	CBRK	N/C	N/C	N/C		N/C
14 MED	CBRK-IND	N/C	Unknown	N/C	N/C	N/C	CBRK-GUTC	N/C	N/C	N/C		N/C
15 MED	FKNX-BC	FKNX-GUTC	N/C	FKNX-GUTC	N/C	FKNX-GUTC	N/C	CBRK-GUTC	N/C	CBRK-GUTC		FKNX-GUTC
16 MED	FSNL-GUTC	N/C	Unknown	N/C	N/C	N/C	N/C	N/C	CJTR-GUTC	CJTR		CJTR
17 MED	DELM	PMON-GUTC	PMON-GUTC	PMON-GUTC	N/C	PMON-GUTC	FORD-GUTC	FORD-GUTC	FORD-IND	FORD-CMTC		FORD-CMTC
18 MED	CBRK	N/C	N/C	N/C	CBRK	N/C	CBRK	N/C	N/C	N/C		N/C
19 MED	FSNL-GUTC	N/C	Unknown	FSHN-GUTC	N/C	N/C	N/C	CCUS-GUTC	N/C	N/C		N/C
31 MED		N/C	N/O	N/C	N/C	N/C	N/C	CBRK	N/C	N/C		N/C
101 MED	FDEV	FDEV	FDEV	FDEV	Pine Cp-MAN	Edwards	Edwards	Edwards	PLBK-MAN	PLBK-MAN		PLBK-MAN
102 MED	Smith	Smith	Smith	Smith	Pine Cp-MAN	Smith	Smith	Smith	PLBK-MAN	PLBK-MAN		PLBK-MAN
103 MED	Mt Gretna	Mt Gretna	Mt Gretna	Mt Gretna	Ind Gap-MAN	Ind Gap	Ind Gap	Ind Gap	MNVA-MAN	MNVA-MAN		MNVA-MAN
104 MED	CBRK	CBRK	CBRK	CBRK	Ind Gap-MAN	Ind Gap	CBRK	Ritchie	MNVA-MAN	MNVA-MAN		MNVA-MAN
105 MED	CJAC	CJAC	CJAC	CJAC	CJAC	CJAC	CJAC/FMCL	DeSoto-MAN	CJAC	CJAC		KNLA-MAN
106 MED	BEAU	BEAU/FMCL	BEAU/FMCL	BEAU/FMCL	BEAU/CJAC	BEAU/CJAC	Foster	DeSoto-MAN	BEAU	BEAU		KNLA-MAN
107 MED	Grayling	Grayling	Grayling	Grayling	Grayling	CCUS-MAN	Grayling	Grayling	Grayling	Grayling		McCoy
108 MED	Grant	Grant	Grant	Grant	Grant	CCUS-MAN	Grant	Grant	Grant	Grant		McCoy
110 MED	Ashland	Ashland	Ashland	Ashland	Ashland	Ashland	FRK-MAN	Ashland	Ashland	Ashland		Ashland
111 MED	Hulen	Hulen	Hulen	Hulen	Hulen	Hulen	Hulen	CBUL	Hulen	Hulen		KNLA-MAN
112 MED	Perry	Perry	Perry	Perry	Perry	FKNX-MAN	Perry	Perry	Perry	Perry		McCoy
113 MED	FKNX	FKNX	FKNX	FKNX	FKNX	FKNX-MAN	FKNX	FKNX	FKNX	FKNX		McCoy
115 MED	DELM/WG	DELM/WG	DELM/WG	DELM/WG	DELM/WG	DELM/WG	DELM/WG	DELM/WG				
116 MED	Murray/Clatsop	Murray/Clatsop	Murray/Clatsop	Murray/Clatsop	Murray	Murray/Clatsop	SLO-MAN	SLO	SLO	SLO		FLEW
118 MED	Niantic	Niantic	Niantic	Niantic	Niantic	Niantic	FLEW-MAN	Murray/Clatsop	Murray/Clatsop	Murray/Clatsop		FLEW
119 MED	Sea Girt	Sea Girt	Sea Girt	Sea Girt	Pine Cp-MAN	Niantic	Quonsett	Niantic	PLBK-MAN	PLBK-MAN		NNYS-MAN
120 MED	FSIL	FSIL	FSIL	FSIL	Pine Cp-MAN	Sea Girt	Sea Girt	Sea Girt	PLBK-MAN	PLBK-MAN		NNYS-MAN
123 MED SQ	FOGL	FOGL	FOGL	FOGL	FSIL	FSIL	FSIL	CBUL	FSIL	FSIL		KNLA-MAN
135 MED	Williams	Williams	Williams	Williams	FOGL	FOGL	FOGL	DeSoto-MAN	Williams	Williams		KNLA-MAN
301 MED	Dodge	Dodge	Dodge	Dodge	Williams	Williams	Williams	Williams	Williams	Williams		McCoy
302 MED	N/C	N/C	N/C	N/C	Dodge	Dodge	Ribley-MAN	Dodge	Dodge	Dodge		Dodge
303 MED	FDIX-GUTC	CBRK	CBRK	CBRK	N/C	N/C	Quonsett-NG	N/C	N/C	N/C		N/C
304 MED	FDIX-GUTC	N/C	CBRK	CBRK	CBRK	CBRK	FDIX-CPX	FDIX-CMTC	N/C	N/C		FDIX-DGRP
305 MED	CBRK	CBRK	CBRK	CBRK-GUTC	N/C	CBRK-IND	FDIX-CMTC	FDIX-DGRP	PLBK-CMTC	PLBK-CMTC		CBRK-IND
306 MED	CBRK	CBRK	CBRK	CBRK-GUTC	CBRK	CBRK	CBRK-GUTC	EGGM-CPX	CBRK-RATC	CBRK-RATC		EGGM-CPX
307 MED	N/C	FMPH-GUTC	FBRG-GUTC	N/C	N/C	CBRK	N/C	CBRK-RATC	CBRK-RATC	CBRK-RATC		EGGM-CPX
	FMPH-GUTC	N/C	Unknown	N/C	N/C	CJAC-NG	CBRK-IND	DeSoto-MAN	N/C	N/C		N/C
							CBRK-IND	DeSoto-MAN	N/C	N/C		N/C

Medical Unit Training Camps 1931 – 1940

Regiment	1931	1932	1933	1934	1935	1936	1937	1938	1939	1940
308 MED	FKNX-GUTC	N/C	FKNX-GUTC	FKNX-GUTC	N/C	CBRK-GUTC	N/C	N/C	N/C	N/C
309 MED	FKNX-BC	N/C	N/C	CBRK-BC	N/C	N/C	CBRK-GUTC	N/C	CBRK-GUTC	N/C
310 MED	CCUS-GUTC	N/C	Unknown	N/C	N/C	N/C	N/C	Unknown	N/C	N/C
311 MED	FSHN-GUTC	N/C	Unknown	N/C	JFBK-GUTC	N/C	N/C	CCUS-GUTC	N/C	N/C
312 MED	N/C	N/C	Unknown	N/C	N/C	FSH-GUTC	CBRK-IND	DeSoto-MAN	N/C	N/C
313 MED	FSNL-GUTC	N/C	Unknown	N/C	N/C	N/C	N/C	N/C	N/C	CJTR-GUTC
314 MED	FSNL-GUTC	N/C	Unknown	N/C	N/C	N/C	N/C	FORK-CMTC	N/C	CJTR-GUTC
315 MED	FSH-RATC	FSHMAN	FSH-RATC	N/C	FSH-RATC	CBUL-RATC	CBUL-GUTC	CBUL-MAN	CBUL-GUTC	CBUL-GUTC
316 MED	DELM	PMON-GUTC	PMON-GUTC	PMON-GUTC	PMON-GUTC	N/C	FORD-GUTC	FORD-GUTC	FORD-GUTC	FLEW-MAN
319 MED	FDEV	CBRK	Unknown	N/C	FDEV-CMTC	N/C	N/C	Edwards-NG	N/C	N/C
320 MED	FSH-RATC	FSH-RATC	FSIL-GUTC	FSIL-GUTC	FSIL-NG	FSIL-GUTC	N/C	CBUL-MAN	CBUL-GUTC	N/C
321 MED	FLEW-GUTC	FLEW-GUTC	FLEW-GUTC	FLEW-GUTC	FLEW-GUTC	FLEW-GUTC	N/C	FLEW-GUTC	FLEW-GUTC	FLEW-MAN
322 MED	N/C	FEA-GUTC	Unknown	N/C	N/C	FDEV-GUTC	N/C	N/C	N/C	FDEV-GUTC
323 MED	FNIA-CMTC	FNIA	CBRK	CBRK	CBRK	N/C	CBRK	N/C	FDIX-CPX	PBRK-CMTC
324 MED	CBRK	CBRK	CBRK	CBRK-GUTC	CBRK	Ind Gap-CPX	N/C	CBRK-RATC	FWSH-CPX	CBRK-GUTC
325 MED	FKNX-BC	N/C	N/C	N/C	FKNX-GUTC	CBRK-GUTC	CBRK-GUTC	N/C	CBRK-GUTC	N/C
326 MED	N/C	N/C	Unknown	N/C	McCoy-GUTC	N/C	N/C	CCUS-GUTC	N/C	N/C
327 MED	FSH-RATC	N/C	Unknown	N/C	N/C	N/C	N/C	FRK-GUTC	N/C	CJTR-GUTC
328 MED	FSH-RATC	FEW-MAN	FEW-RATC	FEW-RATC	FEW-RATC	FEW-RATC	FEW-RATC	FEW-MAN	CBUL-GUTC	N/C
329 MED	N/C	FLEW	Unknown	FLEW-GUTC	N/C	FLEW-GUTC	N/C	FLEW-GUTC	N/C	FLEW-MAN
341 MED	N/C	N/C	Unknown	N/C	N/C	N/C	N/C	N/C	N/C	N/C
342 MED	N/C	N/C	Unknown	N/C	N/C	N/C	N/C	N/C	FDIX-GUTC	N/C
343 MED	CBRK	CBRK	Unknown	N/C	CBRK	N/C	CBRK-GUTC	N/C	CBRK-RATC	CBRK-GUTC
344 MED	N/C	N/C	Unknown	N/C	N/C	N/C	CBRK-IND	DeSoto-MAN- Man	N/C	N/C
345 MED	I/A	I/A	I/A	N/C	FKNX-GUTC	N/C	N/C	N/C	N/C	N/C
346 MED	FSNL-GUTC	N/C	Unknown	FSHN-GUTC	N/C	N/C	N/C	CCUS-GUTC	N/C	N/C
347 MED	FSNL-GUTC	N/C	Unknown	N/C	N/C	FSNL-GUTC	N/C	FDM-CMTC	CJTR-GUTC	CJTR
348 MED	FSH-RATC	FSH-GUTC	FSH-RATC	FSH-RATC	FSH-RATC	FSH-RATC	PMMR-MAN	FHUA/CBUL	FBL S-GUTC	N/C
349 MED	FLEW-GUTC	N/C	N/C	N/C	N/C	I/A	I/A	I/A	I/A	I/A
350 MED	N/C	N/C	CBRK	CBRK	CBRK	N/C	FDEV-CPX	CBRK	N/C	N/C
361 MED	N/C	N/C	N/C	N/C	N/C	N/C	CBRK	N/C	N/C	N/C
361 MED SQ	FNIA-CMTC	N/C	CBRK	CBRK	N/C	FEA-GUTC	N/C	FEA-CPX	N/C	FEA-MOB
362 MED	I/A	I/A	I/A	I/A	I/A	I/A	I/A	I/A	I/A	I/A
362 MED SQ	CBRK	CBRK	CBRK	CBRK-GUTC	CBRK	CBRK-GUTC	N/C	CBRK-RATC	CBRK-RATC	CBRK-GUTC
363 MED	I/A	I/A	I/A	I/A	I/A	I/A	I/A	I/A	I/A	I/A
363 MED SQ	N/C	N/C	FOGL-GUTC	N/C	N/C	FOGL-RATC	N/C	DeSoto-MAN	FOGL-RATC	FOGL-IND
364 MED	CBRK	N/C	CBRK	CBRK-GUTC	N/C	CBRK	N/C	CBRK-RATC	N/C	N/C
364 MED SQ	FKNX-BC	N/C	N/C	N/C	N/C	CBRK	N/C	N/C	N/C	N/C
365 MED	I/A	I/A	I/A	I/A	I/A	I/A	I/A	I/A	I/A	I/A
365 MED SQ	FSNL-GUTC	N/C	N/C	N/C	N/C	N/C	N/C	CCUS-GUTC	N/C	N/C
366 MED	FSNL-GUTC	N/C	N/C	N/C	N/C	N/C	N/C	N/C	N/C	N/C
366 MED SQ	N/C	N/C	N/C	N/C	N/C	N/C	N/C	N/C	N/C	CJTR-GUTC
367 MED	FKNX-IND	I/A	I/A	I/A	I/A	I/A	I/A	I/A	I/A	I/A
368 MED	FKNX-IND	CBRK-GUTC	N/C	N/C	FKNX-GUTC	N/C	N/C	CBRK-GUTC	CBRK-GUTC	CBRK-GUTC

Medical Unit Training Camps 1931 – 1940

Regiment	1931	1932	1933	1934	1935	1936	1937	1938	1939	1940
369 MED	FSNL-GUTC	N/C	I/A	I/A	I/A	I/A	FORD-GUTC	FORD-GUTC	FORD-GUTC	N/C
370 MED	FSNL-GUTC	N/C	N/C	N/C	N/C	N/C	N/C	N/C	N/C	N/C
371 MED	N/C	N/C	N/C	D/B 1-10-33						
372 MED	I/A	N/C	N/C	N/C	N/C	N/C	N/C	FCRK-CMTC	CJTR-GUTC	CJTR
373 MED	N/C	N/C	N/C	D/B 1-10-33						
374 MED	N/C	CBRK	N/C	N/C	CBRK	N/C	N/C	N/C	N/C	N/C
375 MED	I/A	I/A	I/A	I/A	I/A	I/A	I/A	I/A	I/A	I/A
376 MED	I/A	I/A	I/A	I/A	I/A	I/A	I/A	I/A	I/A	I/A
377 MED	FKNX-IND	N/C	N/C	I/A	I/A	I/A	N/C	N/C	N/C	N/C
378 MED	FSNL-GUTC	N/C	N/C	N/C	FSHN-GUTC	N/C	N/C	I/A	I/A	I/A
379 MED	FSNL-GUTC	N/C	I/A	I/A	N/C	N/C	N/C	FSIL-CMTC	I/A	I/A

Engineer Regiment Training Camps 1921 – 1930

Regiment	1921	1922	1923	1924	1925	1926	1927	1928	1929	1930
4 ENG	RA-A	I/A	I/A	I/A	I/A	N/C	N/C	N/C	N/C	FBNG-GUTC
5 ENG	RA-A	I/A	I/A	I/A	I/A	N/O	FRK-GUTC	FRK-GUTC	FRK-GUTC	FRK
7 ENG	RA-A	I/A	I/A	I/A	I/A	FKNX-IND	N/C	FBH-GUTC	N/C	FBH
10 ENG	N/O	N/O	N/O	N/O	N/O	N/O	I/A	N/C	N/C	RA-A
13 ENG	RA-A	RA-A	RA-A	RA-A	RA-A	RA-A	RA-A	RA-A	RA-A	RA-A
15 ENG	N/O	N/O	N/O	N/O	N/O	N/O	N/C	N/C	FDuP	FDuP
21 ENG							N/O	N/O	FDuP-GUTC	FDuP
22 ENG							N/O	N/O	N/O	FAAH-RATC
23 ENG							N/O	N/O	N/O	N/O
24 ENG							N/O	N/O	CCUS-GUTC	FAAH-RATC
25 ENG							N/O	N/O	FRK-GUTC	FRK
26 ENG							N/O	N/C	N/C	FLEW
34 ENG										
35 ENG										
36 ENG										
37 ENG										
38 ENG										
39 ENG										
41 ENG										
43 ENG										
44 ENG										
45 ENG										
47 ENG										
101 ENG	Hanover	Hanover	Hanover	Hanover	FDEV	FDEV	FDEV	FDEV	FDEV	FDEV
102 ENG	Smith	Smith	Smith	Smith	Smith	Smith	Smith	Smith	Smith	Smith
103 ENG	Mt Gretna	Mt Gretna	Mt Gretna	Mt Gretna	Mt Gretna	Mt Gretna	Mt Gretna	Mt Gretna	Mt Gretna	Mt Gretna
104 ENG	Smith	Sea Girt	Sea Girt	Sea Girt	Sea Girt	Sea Girt	Sea Girt	Sea Girt	Sea Girt	Sea Girt
105 ENG	FMCL	FMCL	FBRG	FBRG	FBRG/C/JAC	FBRG	FBRG/C/JAC	C/JAC	FBRG	FBRG
106 ENG	N/O	N/O	FMCL/C/JEJ	FMCL	FMCL	BEAU/C/JEJ	BEAU/C/JEJ	BFM/C/JEJ	Foster	BEM
107 ENG	Douglas	Douglas	Douglas	Douglas	Douglas	Douglas	Douglas	Douglas	Douglas	Douglas
108 ENG	N/O	N/O	N/O	Grant	Grant	Grant	Grant	Grant	Grant	Grant
109 ENG	N/O	N/O	N/O	Rapid City	Aberdeen	Rapid City	Rapid City	Rapid City	Huron	Rapid City
110 ENG	Clark	Sedalia	Clark	Clark	Clark	Clark	Clark	Clark	Clark	Clark
111 ENG	N/O	N/O	Mabry	ECRO	Mabry	FCRO	Hulen	Hulen	Hulen	Hulen
112 ENG	N/O	FKNX	FKNX	FAAH	Perry	Perry	Perry	Perry	Perry	Perry
113 ENG	N/O	FKNX	FKNX	FKNX	FKNX	FKNX	FKNX	FKNX	FKNX	FKNX
114 ENG	N/O	FMCL	FBRG/JEJ	R/D	I/A	I/A	I/A	I/A	I/A	I/A
115 ENG	N/O	N/O	N/O	N/O	N/O	N/O	N/O	N/O	N/O	N/O
116 ENG	N/O	N/O	FLEW	DELM	N/O	Boise/Jackson	Boise	Boise	Boise	Boise
118 ENG	N/O	N/O	N/O	N/O	N/O	N/O	Quonsett	Niantic	Niantic	FDEV
120 ENG	N/O	N/O	FBL/FSIL	FBL/FSIL	Luna/FSIL	Luna/FSIL	Luna/FSIL	FBL S/FSIL	Luna/FSIL	Luna/FSIL
121 ENG	N/O	FWSH	Simms	Simms	VA Beach	FAAH	FAAH	Ritchie	Ritchie	FAAH
132 ENG	N/O	Mt Gretna	I/A	I/A	I/A	I/A	I/A	D/B	I/A	I/A
133 ENG	N/O	FMCL	FMCL/FBRG	Tybee	Tybee	Unknown	Unknown	C/JAC	I/A	I/A

Regiment	Engineer Regiment Training Camps 1921 – 1930									
	1921	1922	1923	1924	1925	1926	1927	1928	1929	1930
136 ENG	N/C	FMEA	Pierre	R/D, 109th EN						
137 ENG	N/C	FBLs	R/D 120th EN 23-02-23							
164 ENG	N/O	FMCL	FBRG	FBRG	FBRG	Unknown	Peay	CJAC	Peay	Peay
301 ENG	N/O	FDEV-DGRP	EDEV-DGRP	FDEV-DGRP	FDEV-GUTC	FDuP-RATC	FDEV-GUTC	FDEV-GUTC	FDEV-GUTC	FDEV-GUTC
302 ENG	N/O	FDIX-DGRP	FDIX-DGRP	FDuP	FDuP-CMIC	FDuP-RATC	FDuP	FDIX-CPX	FDIX	FDuP
303 ENG	N/O	FDIX-DGRP	FDIX-DGRP	FDuP	FDuP-RATC	FDuP-RATC	N/C	FWAD	N/C	FDuP
304 ENG	N/O	EGGM-DGRP	EGGM-DGRP	N/C	FAAH	FAAH	FAAH-GUTC	FAAH-GUTC	FAAH-GUTC	FAAH-RATC
305 ENG	N/O	EGGM-DGRP	EGGM-DGRP	N/C	FAAH	FAAH	FAAH-RATC	FAAH-GUTC	FAAH-GUTC	FAAH-RATC
308 ENG	N/O	FMCL-DGRP	FMCL-DGRP	N/C	FOGL	FBRG	FOGL-GUTC	N/C	FBRG	FBRG-GUTC
307 ENG	N/O	FMCL-DGRP	FMCL-DGRP	FBRG	N/C	FBRG	N/C	N/C	FBRG	N/C
308 ENG	N/O	FMCL-DGRP	FMCL-DGRP	N/C	FAAH	FKNX	FBH	FBH-GUTC	FBH-GUTC	FBH
309 ENG	N/O	FMCL-DGRP	FMCL-DGRP	N/C	FAAH	FKNX	N/C	FBH-GUTC	FBH-GUTC	FBH
310 ENG	N/O	CCUS-DGRP	CCUS-DGRP	CCUS-GUTC	CCUS	N/C	CCUS-GUTC	CCUS-IND	CCUS-GUTC	CCUS
311 ENG	N/O	CCUS-DGRP	CCUS-DGRP	CCUS-GUTC	N/C	CCUS-GUTC	N/C	CCUS-GUTC	N/C	CCUS
312 ENG	N/O	FMCL-DGRP	FMCL-DGRP	FBRG	FBRG	N/C	FMCL-GUTC	N/C	FBRG	N/C
313 ENG	N/O	FSNL-DGRP	FSNL-DGRP	FSNL	FRK	FRK	FRK-GUTC	N/C	FSNL-GUTC	FSNL
314 ENG	N/O	EDM-DGRP	EDM-DGRP	FDM	FRK	FRK	FRK-GUTC	N/C	FRK-GUTC	FRK
315 ENG	N/O	FSD-DGRP	FSD-DGRP	FSD	FRK	FRK	FRK-GUTC	N/C	FRK-GUTC	FRK
316 ENG	N/O	PMON-DGRP	PMON-DGRP	DELIM	FSH	FSH-RATC	FSH-RATC	FMCL-RATC	FMCL-RATC	FMCL-RATC
319 ENG	N/O	FDEV-DGRP	FDEV-DGRP	DELIM	DELIM	DELIM	DELIM-GUTC	DELIM-GUTC	PMON-GUTC	DELIM
320 ENG	N/O	FDEV-DGRP	FDEV-DGRP	FDEV	Hanover	N/C	FDEV-GUTC	FDEV-GUTC	FDEV-GUTC	FDEV-GUTC
321 ENG	N/O	FSIL-DGRP	FSIL-DGRP	N/C	N/C	FSH-RATC	N/C	FBL-S-RATC	FLOG-RATC	FMCL-RATC
322 ENG	N/O	FLEW-DGRP	FLEW-DGRP	FLEW	FLEW	N/C	FLEW-RATC	FLEW-GUTC	FLEW	FLEW
323 ENG	N/O	FDEV-DGRP	FDEV-DGRP	FDEV-DGRP	FEA-LUTC	FEA-RATC	FMCK-GUTC	FMCK-GUTC	FDEV-GUTC	FDEV-GUTC
324 ENG	N/O	FDIX-DGRP	FDIX-DGRP	FDuP	FDuP	FWAD	FDuP	N/C	FDIX-CMTC	N/C
325 ENG	N/O	EGGM-DGRP	EGGM	N/C	FAAH	FAAH	FAAH-RATC	FAAH-GUTC	FAAH-Ind	FAAH-RATC
326 ENG	N/O	FKNX-DGRP	FKNX-DGRP	N/C	N/C	FAAH	N/C	FAAH-GUTC	FAAH-GUTC	FBH
327 ENG	N/O	CCUS-DGRP	CCUS-DGRP	CCUS-GUTC	N/C	CCUS-GUTC	CCUS-GUTC	CCUS-IND	CCUS-GUTC	CCUS
328 ENG	N/O	JFBK-DGRP	JFBK-DGRP	FLVN	N/C	FRK	FRK-GUTC	FRK-GUTC	FRK-GUTC	Clark-NG
329 ENG	N/O	FLOG-DGRP	FLOG-DGRP	FBLs	FBLs	FBLs-RATC	N/C	FLOG-RATC	FLOG-RATC	FLOG-RATC
335 ENG	N/O	FDOU-DGRP	FDOU-DGRP	FDOU	FLEW	FLEW-RATC	FDOU-GUTC	FDOU-GUTC	FDOU	FLOG-BC
338 ENG	N/O	N/O	N/O	N/O	N/O	N/O	N/O	N/O	FAAH-IND	N/C
339 ENG	N/O	N/O	N/O	N/O	N/O	N/O	N/O	N/O	N/O	FRK
340 ENG	N/O	N/O	N/O	N/C	N/C	DELIM	N/C	I/A	I/A	I/A
341 ENG	N/O	N/C	N/C	N/C	FDEV-GUTC	N/C	FDEV-GUTC	N/C	FDEV-GUTC	N/C
342 ENG	N/O	N/C	N/C	FDuP-CMTC	FDuP-CMTC	FDuP	N/C	FDuP-RATC	N/C	FDuP
343 ENG	N/O	EGGM	EGGM	N/C	FAAH	FAAH	FAAH-RATC	FAAH-GUTC	FAAH-GUTC	FAAH-GUTC
344 ENG	N/O	N/C	Unknown	N/C	FBRG	FBRG	N/C	FMCL-GUTC	FMCL-GUTC	N/C
345 ENG	N/O	N/C	Unknown	FKNX	FKNX	FKNX-GUTC	N/C	CCUS-IND	FBH-IND	N/C
346 ENG	N/O	CCUS-DGRP	Unknown	N/C	N/C	N/C	CCUS	CCUS-IND	CCUS-GUTC	CCUS
347 ENG	N/O	N/C	Unknown	N/C	FRK	N/C	FRK-GUTC	FRK-GUTC	FRK-GUTC	N/C
348 ENG	N/O	N/C	Unknown	N/C	FBLs	FBLs-RATC	I/A	I/A	I/A	FBRG-GUTC
349 ENG	N/O	N/C	Unknown	DELIM	N/C	DELIM	N/C	DELIM-GUTC	PMON-GUTC	DELIM
351 ENG	N/O	N/C	FDIX	FDuP-RATC	N/C	FDuP-CMTC	N/C	FDuP-GUTC	FDuP-GUTC	I/A

Engineer Regiment Training Camps 1921 – 1930

Regiment	1921	1922	1923	1924	1925	1926	1927	1928	1929	1930
352 ENG	N/O	N/C	Unknown	N/C	N/C	FDuP-RATC	N/C	N/C	FDuP-GUTC	FDuP
353 ENG	N/O	N/C	EGGM	N/C	FAAH	N/C	N/C	N/C	N/C	I/A
354 ENG	N/O	N/C	Unknown	EGGM-GUTC	N/C	N/C	N/C	N/C	FAAH-Ind	I/A
355 ENG	N/O	N/C	Unknown	N/C	N/C	N/C	N/C	FBRG	FBRG	N/C
356 ENG	N/O	N/C	Unknown	N/C	N/C	FKNX-GUTC	N/C	N/C	FBH-IND	I/A
357 ENG	N/O	N/C	Unknown	N/C	CCUS	N/C	N/C	N/C	I/A	I/A
358 ENG	N/O	N/C	Unknown	N/C	N/C	N/C	CCUS-GUTC	N/C	CCUS-GUTC	CCUS
359 ENG	N/O	N/C	Unknown	N/C	N/C	N/C	FSH	N/C	FRK	Clark-NG
360 ENG	N/O	N/C	Unknown	FDuP	N/C	FDuP	FDuP	FDuP	FDuP-GUTC	FDuP
361 ENG	N/O	N/C	Unknown	N/C	N/C	N/C	N/C	N/C	N/C	N/C
362 ENG	N/O	N/C	Unknown	N/C	N/C	FRK-GUTC	N/C	N/C	N/C	N/C
363 ENG	N/O	N/C	Unknown	FDuP	FDuP-RATC	FDuP	FDuP	FDuP	FDuP-GUTC	FDuP
364 ENG	N/O	N/C	Unknown	N/C	N/C	N/C	N/C	N/C	FBH-IND	I/A
365 ENG	N/O	N/C	Unknown	N/C	N/C	N/C	FRK-GUTC	N/C	I/A	I/A
366 ENG	N/O	N/O	N/O	N/O	N/O	N/C	N/C	N/C	FBH-IND	I/A
367 ENG	N/O	N/C	Unknown	N/C	N/C	FRK-GUTC	N/C	N/C	N/C	N/C
368 ENG	N/O	N/C	Unknown	N/C	N/C	FDuP-RATC	N/C	FDuP-GUTC	N/C	FDuP
371 ENG			N/O	N/O	N/C	FDEV-GUTC	N/C	N/C	FDEV-GUTC	N/C
372 ENG			N/O	N/O	N/C	N/C	I/A	FDEV-GUTC	N/C	N/C
373 ENG			N/O	N/C	FDuP-RATC	N/C	FDuP	N/C	FDuP-GUTC	FDuP
374 ENG			N/O	N/C	N/C	FDuP	N/C	FDuP-GUTC	N/C	I/A
375 ENG			N/O	N/O	FAAH	FAAH	FAAH	FAAH-GUTC	FAAH	FAAH-RATC
376 ENG	1921		N/O	N/O	N/C	N/C	FAAH	FAAH-GUTC	N/C	N/C
377 ENG		1922	N/O	N/C	1925	1926	1927	1928	1929	1930
378 ENG			N/O	N/C	N/C	FBRG	N/C	FMPH-GUTC	I/A	FBNG-GUTC
379 ENG			N/O	N/O	BEAU	N/C	FMCL-GUTC	N/C	FBNG	N/C
380 ENG			N/O	CCUS	N/C	N/C	N/C	N/C	FBH-IND	N/C
381 ENG			N/O	CCUS-GUTC	N/C	N/C	CCUS-GUTC	N/C	FBH-IND	N/C
382 ENG			N/O	N/C	N/C	N/C	FSHN	N/C	CCUS-GUTC	CCUS
383 ENG			N/O	N/O	N/C	FRK-GUTC	N/C	N/C	N/C	I/A
385 ENG			N/O	N/O	N/C	N/C	N/C	FRK-GUTC	N/C	FRK
386 ENG			N/O	N/O	DELM	N/C	DELM-GUTC	DELM-GUTC	PMON-GUTC	DELM
387 ENG			N/O	N/O	DELM	N/C	DELM-GUTC	N/C	PMON-GUTC	DELM
			N/O	N/O	N/C	N/C	FRK-GUTC	N/C	N/C	N/C

Engineer Regiment Training Camps 1931 - 1940												
Regiment	1931	1932	1933	1934	1935	1936	1937	1938	1939	1940		
4 ENG	N/C	N/C	FBNG-GUTC	N/C	FBNG-GUTC	FBNG-IND	FBNG-IND	FBNG-IND	FBNG-RATC	FBNG-RATC		FBNG-RATC
5 ENG	N/C	N/C	Unknown	N/C	N/C	RA-A	RA-A	RA-A	RA-A	RA-A		RA-A
7 ENG	FKNX-GUTC	FKNX-GUTC	FKNX-GUTC	N/C	FKNX-GUTC	N/C	FKNX-GUTC	N/C	N/C	N/C		FKNX-GUTC
10 ENG	FKNX-GUTC	FKNX-GUTC	N/C	N/C	CCUS-GUTC	CCUS-MAN	Grant-MAN	CCUS-GUTC	CCUS-CMTC	CCUS-CMTC		N/C
13 ENG	RA-A	RA-A	RA-A	RA-A	RA-A	RA-A	N/C	FRK-GUTC	FSNL-CMTC	FSNL-CMTC		FSNL-CMTC
15 ENG	FduP-GUTC	N/C	FduP	N/C	N/C	N/C	FDEV-GUTC	N/C	N/C	N/C		FDEV-GUTC
21 ENG	FduP-GUTC	N/C	FduP-GUTC	FduP-GUTC	N/C	FduP-GUTC	N/C	N/C	N/C	N/C		FduP-GRP
22 ENG	N/C	N/C	FAAH-GUTC	FAAH-GUTC	N/C	FBEL-GUTC	FBEL-GUTC	FBEL-GUTC	N/C	FSNL		FSNL
23 ENG	FAAH-GUTC	N/C	N/C	N/C	N/C	N/C	N/C	N/C	N/C	N/C		NAC-GUTC
24 ENG	CCUS-GUTC	N/C	N/C	CCUS-GUTC	N/C	CCUS-GUTC	N/C	CCUS-GUTC	CCUS-CMTC	CCUS-GUTC		CCUS-GUTC
25 ENG	N/C	N/C	N/C	N/C	N/C	FLOG-RATC	N/C	N/C	FSNL-GUTC	FDM-GUTC		FDM-GUTC
26 ENG	N/C	N/C	N/C	N/C	N/C	N/C	N/C	N/C	N/C	N/C		N/C
34 ENG			N/O	N/C	N/C	FSIL-GUTC	N/C	N/C	N/C	N/C		N/C
35 ENG			N/O	N/C	N/C	N/C	N/C	FBEL-RATC	N/C	N/C		N/C
36 ENG			FduP-GUTC	FduP-GUTC	N/C	FduP-GUTC	N/C	N/C	N/C	N/C		FduP-GRP
37 ENG			N/O	FAAH-GUTC	N/C	FBEL-GUTC	FBEL-GUTC	FBEL-GUTC	N/C	N/C		N/C
38 ENG			N/O	FKNX	FKNX-GUTC	N/C	FKNX-GUTC	N/C	N/C	N/C		FKNX-GUTC
39 ENG			N/O	N/C	CCUS-GUTC	CCUS-MAN	Grant-MAN	CCUS-GUTC	CCUS-CMTC	CCUS-GUTC		CCUS-GUTC
41 ENG			N/O	N/O	N/C	N/C	N/C	FBNG-GUTC	N/C	N/C		N/C
43 ENG			N/O	N/C	N/C	N/C	N/C	N/C	N/C	N/C		NAC-GUTC
44 ENG			N/O	N/C	N/C	FRK-GUTC	N/C	N/C	FSNL-GUTC	FDM-GUTC		FDM-GUTC
45 ENG			N/O	N/C	N/C	N/C	N/C	N/C	N/C	N/C		FDM-GUTC
47 ENG			N/O	N/C	N/C	FRK-GUTC	N/C	N/C	N/C	N/C		N/C
101 ENG	FDEV	FDEV	FDEV	FDEV	Pine Cp-MAN	Edwards	Edwards	Edwards	PLBK-MAN	NNYS-MAN		NNYS-MAN
102 ENG	Smith	Smith	Smith	Smith	Pine Cp-MAN	Smith	Smith	Smith	PLBK-MAN	NNYS-MAN		NNYS-MAN
103 ENG	Mt Gretina	Mt Gretina	Mt Gretina	Mt Gretina	Ind Gap-MAN	Ind Gap	Ind Gap	Ind Gap	MNVA-MAN	NNYS-MAN		NNYS-MAN
104 ENG	Sea Girt	Sea Girt	Sea Girt	Sea Girt	Pine Cp-MAN	Sea Girt	Sea Girt	Sea Girt	PLBK-MAN	NNYS-MAN		NNYS-MAN
105 ENG	CJAC	CJAC	CJAC	CJAC	CJAC	FMOU	CJAC	DeSoto-MAN	CJAC	KNLA-MAN		KNLA-MAN
106 ENG	BFM/Foster	BEAU/Foster	BEAU/Foster	BEAU/Foster	BEAU/Foster	FMCI	Shelby	DeSoto-MAN	Foster	KNLA-MAN		KNLA-MAN
107 ENG	Douglas	Douglas	Douglas	I/A	I/A	I/A	Grayling	Grayling	Grayling	McCoy-MAN		McCoy-MAN
108 ENG	Grant	Grant	Grant	Grant	Grant	CCUS-MAN	Grant	Grant	Grant	McCoy-MAN		McCoy-MAN
109 ENG	Rapid City	Rapid City	Rapid City	Rapid City	Rapid City	Rapid City	Ripley	Rapid City	Rapid City	Ripley		Ripley
110 ENG	Clark	Clark	Clark	Clark	Clark	Clark	FRK	Clark	Clark	Ripley		Ripley
111 ENG	Hulen	Hulen	Hulen	Hulen	Hulen	Hulen	Hulen	CBUL-MAN	Hulen	KNLA-MAN		KNLA-MAN
112 ENG	Perry	Perry	Perry	Perry	Perry	FKNX-MAN	Perry	Perry	Perry	McCoy		McCoy
113 ENG	FKNX	FKNX	FKNX	FKNX	FKNX	FKNX-MAN	FKNX	FKNX	FKNX	McCoy		McCoy
114 ENG	I/A	I/A	I/A	I/A	I/A	I/A	I/A	I/A	I/A	I/A		I/A
115 ENG	SLO	SLO	SLO	SLO	SLO	SLO	SLO	SLO	SLO/Boise	FLEW		FLEW
116 ENG	Boise	Boise	Boise	Boise	Murray	Boise	Murray	Boise	Boise	FLEW		FLEW
118 ENG	Quonsett	Quonsett	Quonsett	Quonsett	Pine Cp-MAN	Quonsett	Quonsett	Quonsett	PLBK-MAN	NNYS-MAN		NNYS-MAN
120 ENG	Luna/FSIL	Luna/FSIL	Luna/FSIL	Luna/FSIL	Luna	Luna	Luna/FSIL	FBL'S/CBUL	Luna/FSIL	KNLA-MAN		KNLA-MAN
121 ENG	VA Beach	Ritchie	Ritchie	Ritchie	Ind Gap-MAN	VA Beach	Ritchie	Ritchie	MNVA-MAN	NNYS-MAN		NNYS-MAN
132 ENG												
133 ENG	I/A	I/A	I/A	D/B 1-10-33								

Engineer Regiment Training Camps 1931 – 1940

Regiment	1931	1932	1933	1934	1935	1936	1937	1938	1939	1940
136 ENG										
137 ENG										
164 ENG	Peay	Peay	Peay	Peay	Peay	FMCI	Peay	D/B 1-04-38		
301 ENG	N/C	N/C	Unknown	FDEV-GUTC	N/C	N/C	FDEV-GUTC	N/C	N/C	FDEV-GUTC
302 ENG	FDIX-GUTC	FDUP-GUTC	FDIX	N/C	FDUP-GUTC	FDUP-GUTC	N/C	FDIX	N/C	FDUP-GRP
303 ENG	N/C	N/C	N/C	N/C	FDIX-CPX	N/C	FDUP-RATC	FDIX-DGRP	N/C	FDUP-GRP
304 ENG	FAAH-GUTC	FAAH-GUTC	FAAH-GUTC	FAAH-RATC	FBEL-IND	FBEL-GUTC	FBEL-GUTC	FGGM-CPX	FBEL-GUTC	FGGM-CPX
305 ENG	FAAH-GUTC	FAAH-GUTC	FAAH-GUTC	FAAH-GUTC	FBEL-IND	FBEL-GUTC	N/C	FBEL-RATC	FBEL-GUTC	FGGM-CPX
306 ENG	N/C	FBNG-GUTC	FBNG-GUTC	FBNG-GUTC	FBNG-GUTC	FBNG-GUTC	FBNG-GUTC	FBNG-GUTC	FBNG-RATC	FBNG-RATC
307 ENG	FBNG	FBNG-GUTC	FBNG-GUTC	FBNG-GUTC	FBNG-GUTC	FBNG-GUTC	FBNG-GUTC	FBNG-GUTC	FBNG-RATC	FBNG-RATC
308 ENG	FKNX-GUTC	N/C	FKNX-GUTC	N/C	FKNX-GUTC	FKNX-GUTC	FKNX-GUTC	N/C	FBH-CMTC	FKNX-GUTC
309 ENG	FKNX-GUTC	FKNX-GUTC	N/C	FKNX-GUTC	N/C	FKNX-GUTC	N/C	FKNX-GUTC	FKNX-GUTC	FBH-CMTC
310 ENG	CCUS-GUTC	N/C	Unknown	CCUS-GUTC	N/C	CCUS-GUTC	N/C	CCUS-GUTC	N/C	CCUS-CMTC
311 ENG	Grant-NG	N/C	Unknown	CCUS-GUTC	N/C	CCUS-MAN	N/C	CCUS-GUTC	N/C	N/C
312 ENG	FBNG	FBNG-GUTC	FBNG-GUTC	FBNG-GUTC	FBNG-GUTC	BEAU-CMTC	FBNG-GUTC	FBNG-GUTC	FBNG-RATC	FBNG-RATC
313 ENG	FRK-GUTC	FSNL-GUTC	Unknown	FRK-GUTC	FLOG-GUTC	N/C	FLOG-IND	FRK-GUTC	FSNL-CMTC	FSNL-CMTC
314 ENG	FRK-GUTC	FRK-GUTC	FMCI	FRK-GUTC	FLOG-GUTC	FRK-GUTC	FLOG-IND	FRK-GUTC	FSNL-GUTC	FDM/FCRK
315 ENG	FMCH-RATC	FMCI	FMCH-RATC	FMCH-RATC	FMCH-RATC	FMCI-GUTC	FMCI/CBUL	FMCI-RATC	CBUL-GUTC	CBUL-GUTC
316 ENG	DELM	PMON-GUTC	PMON-GUTC	PMON-GUTC	N/C	PMON-GUTC	N/C	N/C	FORD-GUTC	FLEW-MAN
319 ENG	FDUP	FDUP-GUTC	Unknown	N/C	N/C	FDEV-GUTC	N/C	N/C	FDEV-GUTC	N/C
320 ENG	FMCH-RATC	FMCH-RATC	FSIL-GUTC	FSIL-GUTC	FSIL-NG	FSIL-GUTC	Lumb-NG	CBUL-MAN	N/C	NAC-GUTC
321 ENG	FLEW-RATC	FLEW-GUTC	FLEW-GUTC	FLEW-GUTC	FLEW-GUTC	FLAW-RATC	FLAW-GUTC	FLAW-GUTC	FLAW-GUTC	FLEW-MAN
322 ENG	FAAH-GUTC	N/C	Unknown	N/C	N/C	FDEV-GUTC	N/C	N/C	FDEV-GUTC	N/C
323 ENG	FDUP-GUTC	PLBK-GUTC	FDUP	FDUP-GUTC	FDUP-GUTC	FDIX	FDUP-RATC	N/C	FDIX-CPX	FDUP-GRP
324 ENG	FAAH-GUTC	FAAH-GUTC	FAAH-GUTC	FAAH-GUTC	FBEL-IND	Ind Gap-CPX	FBEL-GUTC	FBEL-GUTC	FWSH-CPX	FBEL-GUTC
325 ENG	FKNX-GUTC	FKNX-GUTC	N/C	FKNX-GUTC	N/C	FKNX-GUTC	N/C	FKNX-GUTC	N/C	FKNX-GUTC
326 ENG	CCUS	Williams-NG	Unknown	N/C	CCUS-GUTC	N/C	FSHN-GUTC	CCUS-GUTC	N/C	CCUS-GUTC
327 ENG	FRK-GUTC	FRK-GUTC	Unknown	FRK-GUTC	FRK-IND	FRK-GUTC	FLOG-IND	Clark-NG	N/C	FDM-GUTC
328 ENG	N/C	FLOG	FLOG-RATC	FLOG-RATC	FLOG-RATC	FLOG-CMTC	FLOG-CMTC	FLOG-CMTC	NAC-GUTC	NAC-GUTC
329 ENG	FDOU-GUTC	N/C	FLEW-GUTC	FLEW-GUTC	FLEW-GUTC	FLAW-RATC	N/C	N/C	FLEW-GUTC	FLEW-MAN
335 ENG	N/C	N/C	Unknown	N/C	N/C	N/C	N/C	I/A	I/A	I/A
338 ENG	N/C	N/C	Unknown	FRK-GUTC	N/C	FLOG-RATC	N/C	N/C	FSNL-GUTC	FSNL/FDM
339 ENG	I/A	I/A	I/A	I/A	I/A	N/C	N/C	N/C	FMCI	NAC-GUTC
340 ENG										
341 ENG	FDUP	N/C	Unknown	N/C	FDEV-GUTC	N/C	N/C	CCUS-GUTC	N/C	N/C
342 ENG	N/C	FDUP-GUTC	N/C	N/C	FDUP-GUTC	N/C	FDUP-RATC	FDEV-GUTC	N/C	N/C
343 ENG	FAAH-GUTC	FAAH-GUTC	FAAH-GUTC	FAAH-GUTC	FBEL-IND	FBEL-GUTC	FBEL-GUTC	FDUP-IND	FDUP-IND	FDUP-GRP
344 ENG	N/C	FBNG-GUTC	FBNG-GUTC	FBNG-GUTC	N/C	FBNG-IND	N/C	FBEL-GUTC	N/C	FBEL
345 ENG	N/C	FKNX-GUTC	N/C	FKNX-GUTC	N/C	FKNX-GUTC	N/C	FBNG-IND	FBNG-RATC	N/C
346 ENG	Williams-NG	N/C	Unknown	FKNX-GUTC	N/C	FKNX-GUTC	N/C	FKNX-GUTC	N/C	FKNX-GUTC
347 ENG	N/C	N/C	Unknown	CCUS-GUTC	N/C	CCUS-GUTC	N/C	Unknown	CCUS-GUTC	N/C
348 ENG	N/C	FBNG-GUTC	Unknown	FRK-GUTC	N/C	FLOG-RATC	N/C	N/C	FSNL-GUTC	FSNL/FDM
349 ENG	DELM	PMON-GUTC	FBNG-GUTC	FBNG-IND	N/C	N/C	N/C	DeSoto-MAN	N/C	N/C
351 ENG	I/A	I/A	I/A	PMON-GUTC	N/C	PMON-GUTC	N/C	FORD-GUTC	N/C	N/C
352 ENG	FDUP	FDUP-GUTC	N/C	D/B 1-10-33	FDUP-GUTC	N/C	FDUP-RATC	FDUP-IND	FDUP-IND	FDUP-GRP

Regiment	Engineer Regiment Training Camps 1931 – 1940										
	1931	1932	1933	1934	1935	1936	1937	1938	1939	1940	
353 ENG	I/A	I/A	I/A	D/B 1-10-33							
354 ENG	I/A	I/A	I/A	D/B 1-10-33							
355 ENG	FBNG-GUTC	FBNG-GUTC	FBNG-GUTC	N/C	N/C	N/C	N/C	FBNG-GUTC	N/C	N/C	
356 ENG	I/A	I/A	I/A	D/B 1-10-33							
357 ENG	I/A	I/A	I/A	I/A	N/C	N/C	N/C	N/C	CCUS-GUTC	N/C	
358 ENG	N/C	Grant-NG	Unknown	N/C	N/C	CCUS-GUTC	N/C	N/C	CCUS-CMTC	N/C	
359 ENG	FRK-GUTC	Clark-NG	Unknown	N/C	N/C	Clark-NG	N/C	CCUS-GUTC	N/C	N/C	
360 ENG	FDuP	FDuP	N/C	N/C	FDuP-GUTC	N/C	FDuP-RATC	FDuP-IND	N/C	FDuP-GRP	
361 ENG	FBNG-GUTC	FBNG-GUTC	FBNG-GUTC	FBNG-IND	N/C	N/C	N/C	N/C	N/C	N/C	
362 ENG	N/C	N/C	N/C	N/C	Clark-NG	N/C	N/C	FRK-GUTC	N/C	FDM-GUTC	
363 ENG	FDuP-GUTC	FDuP	FDuP	FDuP-GUTC	N/C	FDuP-GUTC	N/C	FDuP-IND	FDuP-IND	FDuP-GRP	
364 ENG	I/A	I/A	I/A	D/B 1-10-33							
365 ENG	I/A	I/A	I/A	D/B 1-10-33							
366 ENG	I/A	I/A	I/A	D/B 1-10-33							
367 ENG	N/C	N/C	N/C	D/B 1-10-33							
368 ENG	FDuP	FDuP-GUTC	N/C	N/C	FDuP-GUTC	N/C	FDuP-RATC	N/C	FDuP-IND	FDuP-GRP	
371 ENG	FDuP	FDuP-GUTC	Unknown	N/C	FDEV-GUTC	N/C	FDEV-GUTC	N/C	N/C	FDEV-GUTC	
372 ENG	N/C	N/C	N/C	N/C	N/C	I/A	I/A	N/C	N/C	N/C	
373 ENG	FDuP-GUTC	N/C	FDuP	FDuP-GUTC	N/C	FDuP-GUTC	N/C	FDuP-IND	FDuP-IND	FDuP-GRP	
374 ENG	I/A	I/A	I/A	D/B 1-10-33							
375 ENG	FAAH-GUTC	FAAH-GUTC	FAAH-GUTC	FAAH-RATC	N/C	FBEL-GUTC	FBEL-GUTC	FBEL-RATC	N/C	N/C	
376 ENG	N/C	FAAH-GUTC	FAAH-GUTC	FAAH-GUTC	FBEL-IND	FBEL-GUTC	FBEL-GUTC	FBEL-GUTC	N/C	N/C	
377 ENG	N/C	FBNG-GUTC	FBNG-GUTC	FBNG-IND	N/C	N/C	I/A	I/A	I/A	N/C	
378 ENG	N/C	FBNG-GUTC	FBNG-GUTC	FBNG-IND	N/C	N/C	N/C	N/C	N/C	N/C	
379 ENG	N/C	FKNX-GUTC	N/C	FKNX-GUTC	N/C	FKNX-GUTC	N/C	N/C	N/C	N/C	
380 ENG	N/C	N/C	FKNX-GUTC	FKNX-GUTC	N/C	FKNX-GUTC	N/C	FKNX-GUTC	N/C	FKNX-GUTC	
381 ENG	CCUS-GUTC	N/C	Unknown	N/C	CCUS-GUTC	N/C	CCUS-GUTC	CCUS-CMTC	CCUS-CMTC	N/C	
382 ENG	I/A	I/A	I/A	I/A	N/C	N/C	N/C	N/C	CCUS-GUTC	N/C	
383 ENG	N/C	N/C	Unknown	N/C	N/C	N/C	N/C	FRK-GUTC	FSNL-GUTC	FDM/FCRK	
385 ENG	DELM	PMON-GUTC	PMON-GUTC	PMON-GUTC	PMON-GUTC	N/C	FORD-GUTC	FRK-GUTC	FORD-GUTC	N/C	
386 ENG	DELM	PMON-GUTC	PMON-GUTC	PMON-GUTC	PMON-GUTC	N/C	FORD-GUTC	N/C	FORD-GUTC	N/C	
387 ENG	N/C	N/C	N/C	D/B 1-10-33							
401 ENG.SQ	N/C	FDuP-GUTC	N/C	N/C	FDuP-GUTC	FEA	FDuP-RATC	N/C	FDuP-IND	FEA-MOB	
402 ENG.SQ	FAAH-GUTC	FAAH-GUTC	FMYR	FAAH-GUTC	N/C	FBEL-GUTC	FBEL-GUTC	FBEL-RATC	FBEL-GUTC	FBEL-GUTC	
403 ENG.SQ	FBNG-GUTC	FOGL-GUTC	FOGL-GUTC	FOGL-GUTC	FBNG-GUTC	FOGL-GUTC	FBNG-GUTC	FBNG-GUTC	FOGL-RATC	FBNG-RATC	
404 ENG.SQ	FKNX-GUTC	N/C	N/C	N/C	FKNX-GUTC	FKNX-GUTC	FKNX/FAAH	FKNX-GUTC	FKNX-GUTC	N/C	
405 ENG.SQ	N/C	CCUS-GUTC	Unknown	N/C	N/C	CCUS-GUTC	N/C	CCUS-GUTC	CCUS-CMTC	N/C	
406 ENG.SQ	FRK-GUTC	FLOG-GUTC	Unknown	FRK-GUTC	FRK-IND	N/C	FLOG-IND	N/C	N/C	FSNL-GUTC	

Engineer Battalion Training Camps 1921 - 1930										
Battalion	1922	1923	1924	1925	1926	1927	1928	1929	1930	
1 EN (Camo)	N/O	N/O	N/O	N/O	N/O	N/O	N/C	N/C	FDuP	
9 EN SQ	RA-A	I/A	I/A	I/A	I/A	N/C	West	West	FLOG-IND	
12 EN SQ	N/O	N/O	N/O	N/O	CCUS-GUTC	CCUS-GUTC	CCUS-CMTC	CCUS	FAAH-GUTC	
19 EN	N/O	N/O	N/O	N/O	N/O	N/O	N/C	N/C	N/C	
40 EN	N/O	N/O	N/O	N/O	N/O	FDuP-RATC	N/C	FDuP-GUTC	FDuP	
45 EN	N/O	N/O	N/O	N/O	N/O	N/O	N/C	N/C	N/C	
47 EN	N/O	N/O	N/O	N/O	N/O	N/O	N/C	N/C	N/C	
49 EN	N/O	N/O	N/O	N/O	N/O	N/O	N/C	N/C	N/C	
50 EN (RY)	N/O	N/O	N/O	N/O	N/O	N/O	N/C	N/C	N/C	
51 EN	N/O	N/O	N/O	N/O	N/O	N/O	N/C	N/C	N/C	
53 EN (RY)	N/O	N/O	N/O	N/O	N/O	N/O	N/C	N/C	N/C	
53 EN (Sep)	N/O	N/O	N/O	N/O	N/O	N/O	N/C	N/C	N/C	
56 EN (Sep)	N/O	N/O	N/O	N/O	N/O	N/O	N/C	N/C	N/C	
58 EN (RY)	N/O	N/O	N/O	N/O	N/O	N/O	N/C	N/C	FLOG	
61 EN (Sep)	N/O	N/O	N/O	N/O	N/O	N/O	N/C	FDuP	FDuP	
62 EN (Sep)	N/O	N/O	N/O	N/O	N/O	N/O	N/C	N/C	N/C	
63 EN (Sep)	N/O	N/O	N/O	N/O	N/O	N/O	N/C	N/C	N/C	
64 EN (Sep)	N/O	N/O	N/O	N/O	N/O	N/O	N/C	N/C	N/C	
65 EN (Sep)	N/O	N/O	N/O	N/O	N/O	N/O	N/C	N/C	N/C	
66 EN (Sep)	N/O	N/O	N/O	N/O	N/O	N/O	N/C	N/C	N/C	
67 EN (Sep)	N/O	N/O	N/O	N/O	N/O	N/O	N/C	N/C	N/C	
68 EN (Sep)	N/O	N/O	N/O	N/O	N/O	N/O	N/C	N/C	N/C	
69 EN (Sep)	N/O	N/O	N/O	N/O	N/O	N/O	N/C	N/C	N/C	
70 EN (Sep)	N/O	N/O	N/O	N/O	N/O	N/O	N/C	CCUS	CCUS	
71 EN (Sep)	N/O	N/O	N/O	N/O	N/O	N/O	N/C	N/C	N/C	
72 EN (Sep)	N/O	N/O	N/O	N/O	N/O	N/O	N/C	N/C	N/C	
73 EN (Sep)	N/O	N/O	N/O	N/O	N/O	N/O	N/C	N/C	N/C	
74 EN (Sep)	N/O	N/O	N/O	N/O	N/O	N/O	N/C	N/C	N/C	
76 EN (WS)	N/O	N/O	N/O	N/O	N/O	N/O	N/C	N/C	N/C	
80 EN (WS)	N/O	N/O	N/O	N/O	N/O	N/O	N/C	N/C	N/C	
84 EN (Camo)	N/O	N/O	N/O	N/O	N/O	N/O	N/C	N/C	N/C	
89 EN HQ	N/O	N/O	N/O	N/O	N/O	N/O	N/C	N/C	N/C	
90 EN (HP)	N/O	N/O	N/O	N/O	N/O	N/O	N/C	N/C	N/C	
97 EN (Sep)	N/O	N/O	N/O	N/O	N/O	N/O	N/C	N/C	N/C	
125 EN SQ	N/O	N/O	Mt Gretina	Mt Gretina	Mt Gretina	Mt Gretina	Mt Gretina	I/A	I/A	
126 EN SQ	Douglas	N/O	N/O	N/O	FMCI	FOGL	FOGL	FOGL	FMCI	
401 ENG SQ	FDIX-DGRP	FDIX-DGRP	N/C	Blauvelt-LUTC	N/C	FDuP-RATC	N/C	FDuP	FDuP	
402 ENG SQ	FGGM-DGRP	FGGM-DGRP	N/C	FAAH-GUTC	FAAH	N/C	FAAH-GUTC	FMYR	FAAH-RATC	

Engineer Battalion Training Camps 1921 - 1930

Battalion	1922	1923	1924	1925	1926	1927	1928	1929	1930
403 ENG. SQ	N/C	FMCL-DGRP	N/C	N/C	N/C	N/C	N/C	FOGL	FOGL-RATC
404 ENG. SQ	Unknown	FKNX-DGRP	N/C	FAAH	FKNX	N/C	FBH-GUTC	FBH-GUTC	FBH
405 ENG. SQ	Unknown	Unknown	CCUS-GUTC	N/C	N/C	N/C	CCUS-CMTC	N/C	CCUS
406 ENG. SQ	Unknown	Unknown	N/C	FRK	FRK	FRK	N/C	FRK-RATC	FRK
413 EN (Sep)			N/C	N/C	N/C	FDEV	N/C	FDEV	N/C
414 EN (Sep)			N/C	N/C	FduP	N/C	FduP	N/C	FduP
415 EN (Sep)			N/C	N/C	FduP	FduP	FduP	N/C	N/C
416 EN (Sep)			N/C	N/C	FduP	N/C	FduP	N/C	N/C
418 EN (Sep)			N/C	N/C	N/C	N/C	N/C	N/C	N/C
420 EN (Sep)			N/C	N/C	N/C	N/C	N/C	FBNG	N/C
421 EN (Sep)			N/C	N/C	N/C	N/C	N/C	FBNG	N/C
422 EN (Sep)			N/C	N/C	N/C	N/C	N/C	N/C	FBNG
425 EN (Sep)			N/C	N/C	N/C	N/C	N/C	N/C	N/C
426 EN (Sep)			N/C	N/C	N/C	N/C	N/C	CCUS	N/C
427 EN (Sep)			N/C	N/C	N/C	N/C	N/C	N/C	FSHN
428 EN (Sep)			N/C	N/C	N/C	N/C	N/C	N/C	FBNG
429 EN (Sep)			N/C	N/C	N/C	N/C	FKNX	N/C	N/C
430 EN (Sep)			N/C	N/C	N/C	N/C	N/C	N/C	N/C
431 EN (Sep)			N/C	N/C	N/C	N/C	N/C	N/C	N/C
432 EN (Sep)			FLOG	FBLs	FBLs	N/C	N/C	N/C	N/C
433 EN (Sep)			N/C	N/C	FBLs	N/C	N/C	N/C	N/C
434 EN (Sep)			FLOG	FBLs	FBLs	N/C	N/C	N/C	N/C
435 EN (Sep)			N/C	N/C	N/C	Del Monte	N/C	Del Monte	N/C
436 EN (Sep)			N/C	FLEW	FLEW	FLEW	FLEW	FLEW	N/C
437 EN (Sep)			N/C	N/C	N/C	FLEW	FLEW	FLEW	N/C
438 EN (Sep)			N/C	FduP	N/C	FduP	N/C	FduP	N/C
439 EN (Sep)			N/C	N/C	FduP	N/C	FduP	N/C	FduP
440 EN (Sep)			N/C	N/C	N/C	N/C	N/C	FBNG	N/C
443 EN (Sep)			N/C	N/C	N/C	N/C	N/C	N/C	N/C
444 EN (Sep)			DELM	N/C	DELM	N/C	DELM	DELM	DELM
446 EN (Sep)			N/C	N/C	N/C	N/C	N/C	N/C	N/C
447 EN (Sep)			N/C	N/C	FAAH	N/C	FduP	FDIX	N/C
448 EN (Sep)			N/C	N/C	N/C	N/C	N/C	N/C	N/C
449 EN (Sep)			N/C	N/C	N/C	N/C	N/C	N/C	N/C
450 EN (Sep)			N/C	N/C	N/C	N/C	N/C	N/C	N/C
451 EN (Sep)			N/C	N/C	N/C	N/C	N/C	N/C	N/C
452 EN (Sep)			N/C	N/C	N/C	N/C	N/C	N/C	N/C
453 EN (Sep)			N/C	N/C	N/C	N/C	N/C	N/C	N/C
454 EN (Sep)			N/C	N/C	N/C	N/C	N/C	N/C	N/C

Engineer Battalion Training Camps 1921 - 1930										
Battalion	1922	1923	1924	1925	1926	1927	1928	1929	1930	
455 EN (Sep)			N/C	N/C	N/C	N/C	N/C	N/C	N/C	N/C
456 EN (Sep)			N/C	N/C	N/C	N/C	N/C	N/C	N/C	N/C
457 EN (Sep)			N/C	N/C	N/C	N/C	N/C	N/C	N/C	N/C
458 EN (Sep)			N/C	CCUS	N/C	N/C	N/C	N/C	N/C	N/C
460 EN (Sep)			N/C	FSH	FSH	FSH	FLOG	FLOG	FLOG	FLOG
461 EN (Sep)			N/C	FBL S	FBL S	FBL S	FBL S	FBL S	FBL S	FBL S
462 EN (Sep)			N/C	FSH	FSH	FSH	FSH	FSH	FSH	FSH
463 EN (Sep)			N/C	N/C	N/C	N/C	N/C	N/C	N/C	N/C
464 EN (Sep)			N/C	N/C	DELM	DELM	DELM	DELM	DELM	DELM
465 EN (Sep)			N/C	N/C	DELM	DELM	DELM	DELM	DELM	DELM
466 EN (Sep)			N/C	N/C	DELM	DELM	DELM	DELM	DELM	N/C
467 EN (Sep)			N/C	N/C	DELM	N/C	N/C	N/C	N/C	N/C
473 EN (WS)			N/C	N/C	N/C	FDuP	N/C	N/C	N/C	N/C
492 EN (RY)			N/C	N/C	N/C	N/C	FAAH	N/C	N/C	N/C
495 EN (Sep)			N/C	N/C	N/C	N/C	N/C	N/C	N/C	N/C
498 EN (Sep)			N/C	N/C	N/C	N/C	N/C	N/C	N/C	N/C
499 EN (Sep)			N/C	N/C	N/C	N/C	N/C	N/C	N/C	N/C
500 EN (Sep)			N/C	N/C	N/C	N/C	N/C	N/C	N/C	N/C
504 EN (Topo)			N/C	N/C	N/C	N/C	N/C	N/C	N/C	N/C
506 EN (RY)			N/C	N/C	N/C	N/C	CCUS	N/C	N/C	N/C
510 EN (Sep)			N/C	N/C	N/C	N/C	N/C	N/C	N/C	N/C
511 EN (Sep)			N/C	FSH	FSH	FSH	FLOG	FLOG	FLOG	FLOG
512 EN (Sep)			N/C	N/C	FSH	N/C	N/C	N/C	N/C	N/C
513 EN (Sep)			N/C	N/C	FSH	FSH	FLOG	FLOG	FLOG	FLOG
515 EN (WS)			N/C	N/C	FSH	FSH	FLOG	FLOG	FLOG	FLOG
516 EN (WS)			N/C	N/C	N/C	FDuP	N/C	N/C	N/C	N/C
524 EN (Sep)			N/C	N/C	N/C	FDuP	N/C	N/C	N/C	N/C
525 EN (Sep)			N/C	N/C	N/C	N/C	N/C	N/C	N/C	N/C
528 EN (Sep)			N/C	N/C	N/C	N/C	N/C	N/C	N/C	N/C
534 EN (WS)			N/C	N/C	N/C	FDuP	N/C	N/C	N/C	N/C
553 EN (RY)			N/C	N/C	N/C	N/C	N/C	N/C	N/C	N/C
554 EN (Sep)			N/C	N/C	FDuP	N/C	N/C	N/C	N/C	N/C
555 EN (Sep)			N/C	N/C	N/C	N/C	N/C	N/C	N/C	N/C
566 EN (Sep)			N/C	N/C	N/C	N/C	N/C	N/C	N/C	N/C
574 EN (WS)			N/C	N/C	N/C	N/C	N/C	N/C	N/C	N/C
590 EN (Sep)			N/C	N/C	N/C	N/C	N/C	N/C	N/C	N/C
591 EN (RY)			N/C	N/C	N/C	N/C	N/C	N/C	N/C	N/C
601 EN (Camo)			N/C	N/C	N/C	N/C	N/C	N/C	N/C	N/C

Engineer Battalion Training Camps 1921 - 1930									
Battalion	1922	1923	1924	1925	1926	1927	1928	1929	1930
604 EN (Camo)			N/C	N/C	N/C	N/C	N/C	N/C	N/C
605 EN (Camo)			N/C	N/C	N/C	N/C	N/C	N/C	N/C
606 EN (RY)			N/C	FSH	FSH	FSH	N/C	FSH	FLOG
607 EN (RY)			N/C	FSH	FSH	FSH	FMCI	FMCI	N/C
608 EN (RY)			N/C	FSH	FSH	FSH	FLOG	FLOG	FLOG
616 EN (RY)			N/C	N/C	N/C	N/C	N/C	N/C	DELM
617 EN (RY)			N/C	N/C	N/C	N/C	N/C	FLEW	N/C
626 EN (Sep)			N/C	N/C	N/C	N/C	N/C	N/C	N/C
641 EN (Sep)			N/C	N/C	N/C	N/C	N/C	N/C	N/C
680 EN HQ			N/C	N/C	N/C	N/C	N/C	FMCI	N/C
694 EN (Sep)			N/C	N/C	N/C	N/C	N/C	N/C	N/C
699 EN (Sep)			N/C	N/C	N/C	N/C	N/C	N/C	DELM
951 EN (Sep)			N/C	N/C	N/C	N/C	N/C	N/C	FDuP
952 EN (Sep)			N/C	N/C	N/C	N/C	N/C	N/C	FDuP
955 EN (Sep)			N/C	N/C	N/C	N/C	N/C	N/C	N/C
957 EN (Sep)			N/C	N/C	N/C	N/C	N/C	N/C	N/C
958 EN (Sep)			N/C	N/C	N/C	N/C	N/C	N/C	N/C
971 EN (Sep)			N/C	N/C	N/C	N/C	N/C	N/C	N/C

Engineer Battalion Training Camps 1931 - 1940										
Battalion	1931	1932	1933	1934	1935	1936	1937	1938	1939	1940
1 EN (Camo)	R/D									
9 ENG SQ	N/C	FLOG	Unknown	FLOG-RATC	N/C	N/C	N/C	FRK-RATC	FSNL-GUTC	FSNL
12 ENG SQ	CCUS	CCUS-GUTC	CCUS	FRK	FRK	FRK	FRK	N/C	FRK	N/C
19 EN	N/C	N/C	N/C	N/C	N/C	N/C	N/C	FKNX	N/C	N/C
40 ENG	Fdup-GUTC	Fdup	FTOT	Fdup/FTOT	FTOT	FTOT	N/C	N/C	EBEL-GUTC	N/C
45 EN	N/C	N/C	N/C	N/C	FKNX	N/C	FKNX	N/C	N/C	FDM
47 EN	N/C	N/C	N/C	N/C	N/C	FRK	N/C	FRK	FSNL	FSNL
49 EN	N/C	N/C	N/C	N/C	N/C	N/C	N/C	FORD	N/C	N/C
50 EN (RY)	N/C	N/C	N/C	N/C	N/C	N/C	Fdup	N/C	N/C	N/C
51 EN	N/C	N/C	N/C	N/C	N/C	N/C	FDEV	N/C	N/C	FDEV
53 EN (RY)	FKNX-IND	N/C	N/C	N/C	N/C	N/C	N/C	N/C	N/C	N/C
53 EN (Sep)	N/C	N/C	N/C	N/C	N/C	FBEL	FBEL	N/C	N/C	N/C
56 EN (Sep)	N/C	N/C	N/C	N/C	CCUS	N/C	CCUS	N/C	N/C	N/C
58 EN (RY)	FLOG	FLOG	FLOG	FLOG	FLOG	FLOG	N/C	N/C	N/C	N/C
61 EN (Sep)	N/C	N/C	Fdup	Fdup	Fdup	Fdup	N/C	N/C	N/C	N/C
62 EN (Sep)	N/C	N/C	N/C	N/C	N/C	FBEL	FBEL	N/C	N/C	N/C
63 EN (Sep)	FBNG	FBNG	FBNG	N/C	N/C	N/C	N/C	N/C	N/C	N/C
64 EN (Sep)	N/C	FBNG	FBNG	N/C	N/C	N/C	N/C	N/C	N/C	N/C
65 EN (Sep)	FBNG	FBNG	FBNG	N/C	N/C	N/C	N/C	N/C	N/C	N/C
66 EN (Sep)	N/C	FBNG	FBNG	N/C	N/C	N/C	N/C	N/C	N/C	N/C
67 EN (Sep)	FBNG	FBNG	FBNG	N/C	N/C	N/C	N/C	N/C	N/C	N/C
68 EN (Sep)	FKNX-IND	N/C	N/C	N/C	N/C	N/C	N/C	N/C	N/C	N/C
69 EN (Sep)	FKNX-IND	N/C	N/C	N/C	FKNX	FKNX	N/C	N/C	N/C	N/C
70 EN (Sep)	CCUS	N/C	N/C	N/C	CCUS	CCUS	N/C	N/C	N/C	N/C
71 EN (Sep)	N/C	N/C	N/C	FRK	N/C	N/C	FLOG	FRK	FSNL	N/C
72 EN (Sep)	N/C	N/C	N/C	N/C	N/C	N/C	N/C	N/C	FSNL	FSNL
73 EN (Sep)	N/C	N/C	FLOG	FLOG	FLOG	FLOG	FHUA	FRK	N/C	N/C
74 EN (Sep)	N/C	N/C	N/C	N/C	N/C	N/C	N/C	N/C	FSNL	N/C
76 EN (WS)	N/C	N/C	N/C	N/C	N/C	N/C	N/C	N/C	N/C	N/C
80 EN (WS)	FKNX	N/C	N/C	N/C	N/C	N/C	N/C	N/C	N/C	N/C
84 EN (Camo)	FKNX	N/C	N/C	N/C	N/C	N/C	N/C	N/C	N/C	N/C
89 EN HQ	N/C	N/C	N/C	N/C	N/C	N/C	N/C	N/C	N/C	N/C
90 EN (HP)	N/C	N/C	N/C	N/C	N/C	FBEL	FBEL	N/C	N/C	N/C
97 EN (Sep)	N/C	N/C	N/C	N/C	N/C	N/C	N/C	CCUS	CCUS	CCUS
125 ENG SQ	I/A	I/A	I/A	I/A	I/A	I/A	I/A	I/A	I/A	I/A
127 ENG SQ	FOGL	FOGL	FMCL	FMCL	FMCL	FMCL	FMCL	DeSoto-MAN	FOGL	KNLA-MAN
401 ENG SQ	Fdup-GUTC	N/C	N/C	Fdup-GUTC	FEA	Fdup-RATC	N/C	Fdup-IND	FEA-MOB	
402 ENG SQ	FAAH-GUTC	FMYR	FAAH-GUTC	N/C	FBEL-GUTC	FBEL-GUTC	FBEL-RATC	FBEL-GUTC	FBEL-GUTC	

Engineer Battalion Training Camps 1931 - 1940											
Battalion	1931	1932	1933	1934	1935	1936	1937	1938	1939	1940	
403 ENG. SQ	FOGL-GUTC	FOGL-GUTC	FOGL-GUTC	FBNG-GUTC	FOGL-GUTC	FBNG-GUTC	FBNG-GUTC	FOGL-RATC	FBNG-RATC		
404 ENG. SQ	N/C	N/C	N/C	FKNX-GUTC	FKNX-GUTC	FKNX/FAAH	FKNX-GUTC	ETHO-GUTC	N/C		
405 ENG. SQ	CCUS-GUTC	Unknown	N/C	N/C	CCUS-GUTC	N/C	CCUS-GUTC	CCUS-CMTC	N/C		
406 ENG. SQ	FLOG-GUTC	Unknown	FRK-GUTC	FRK-IND	N/C	FLOG-IND	N/C	N/C	FSNL-GUTC		
413 EN (Sep)	FDEV	N/C	N/C	N/C	N/C	N/C	N/C	FDEV	N/C	N/C	
414 EN (Sep)	N/C	FDuP	N/C	N/C	FDuP	N/C	FDuP	N/C	N/C	N/C	
415 EN (Sep)	N/C	N/C	N/C	N/C	N/C	N/C	N/C	N/C	N/C	N/C	
416 EN (Sep)	N/C	N/C	N/C	N/C	N/C	N/C	N/C	N/C	N/C	N/C	
418 EN (Sep)	N/C	N/C	N/C	N/C	FKNX	N/C	N/C	N/C	N/C	N/C	
420 EN (Sep)	N/C	FBNG	FBNG	N/C	N/C	N/C	N/C	N/C	N/C	N/C	
421 EN (Sep)	N/C	FBNG	FBNG	N/C	N/C	N/C	N/C	N/C	N/C	N/C	
422 EN (Sep)	N/C	FBNG	FBNG	N/C	N/C	N/C	N/C	N/C	N/C	N/C	
425 EN (Sep)	N/C	N/C	N/C	N/C	N/C	N/C	N/C	FKNX	N/C	N/C	
426 EN (Sep)	CCUS	N/C	N/C	N/C	CCUS	N/C	CCUS	CCUS	CCUS	CCUS	
427 EN (Sep)	N/C	CCUS	N/C	N/C	CCUS	CCUS	N/C	CCUS	CCUS	CCUS	
428 EN (Sep)	N/C	FBNG	FBNG	N/C	N/C	N/C	N/C	N/C	N/C	N/C	
429 EN (Sep)	N/C	N/C	N/C	FKNX	N/C	FKNX	N/C	N/C	N/C	N/C	
430 EN (Sep)	N/C	N/C	N/C	N/C	N/C	N/C	N/C	N/C	N/C	N/C	
431 EN (Sep)	N/C	N/C	N/C	N/C	N/C	N/C	N/C	N/C	FSNL	FSNL	
432 EN (Sep)	N/C	N/C	N/C	N/C	N/C	N/C	N/C	N/C	FSNL	FSNL	
433 EN (Sep)	N/C	N/C	N/C	N/C	N/C	N/C	N/C	N/C	N/C	N/C	
434 EN (Sep)	N/C	N/C	N/C	N/C	N/C	N/C	N/C	N/C	N/C	N/C	
435 EN (Sep)	N/C	N/C	N/C	N/C	N/C	N/C	N/C	N/C	N/C	N/C	
436 EN (Sep)	N/C	N/C	N/C	N/C	N/C	N/C	N/C	N/C	N/C	N/C	
437 EN (Sep)	N/C	N/C	N/C	N/C	N/C	N/C	N/C	N/C	N/C	N/C	
438 EN (Sep)	FDuP	FDuP	FDuP	N/C	FDuP	FDuP	N/C	N/C	N/C	N/C	
439 EN (Sep)	N/C	FDuP	N/C	N/C	FDuP	N/C	FDuP	N/C	N/C	N/C	
440 EN (Sep)	N/C	FBNG	FBNG	N/C	N/C	N/C	N/C	N/C	N/C	N/C	
443 EN (Sep)	N/C	N/C	N/C	N/C	N/C	N/C	N/C	N/C	N/C	N/C	
444 EN (Sep)	DELM	PMON	N/C	N/C	PMON	N/C	FORD	N/C	N/C	N/C	
446 EN (Sep)	N/C	N/C	N/C	N/C	N/C	N/C	FLOG	N/C	N/C	FSNL	
447 EN (Sep)	N/C	N/C	N/C	N/C	N/C	N/C	N/C	N/C	N/C	N/C	
448 EN (Sep)	FBNG	FBNG	FBNG	N/C	N/C	N/C	N/C	N/C	N/C	N/C	
449 EN (Sep)	FBNG	N/C	N/C	N/C	N/C	N/C	N/C	N/C	N/C	N/C	
450 EN (Sep)	FBNG	N/C	FBNG	N/C	N/C	N/C	N/C	N/C	N/C	N/C	
451 EN (Sep)	FBNG	FBNG	FBNG	N/C	N/C	N/C	N/C	N/C	N/C	N/C	
452 EN (Sep)	FBNG	FBNG	FBNG	N/C	N/C	N/C	N/C	N/C	N/C	N/C	
453 EN (Sep)	FBNG	FBNG	N/C	N/C	N/C	N/C	N/C	N/C	N/C	N/C	
454 EN (Sep)	FBNG	FBNG	N/C	N/C	N/C	N/C	N/C	N/C	N/C	N/C	

Engineer Battalion Training Camps 1931 - 1940

Battalion	1931	1932	1933	1934	1935	1936	1937	1938	1939	1940
455 EN (Sep)	FBNG	N/C	FBNG	N/C	N/C	N/C	N/C	N/C	N/C	N/C
456 EN (Sep)	FBNG	FBNG	FBNG	N/C	N/C	N/C	N/C	N/C	N/C	N/C
457 EN (Sep)	FBNG	N/C	FBNG	N/C	N/C	N/C	N/C	N/C	N/C	N/C
458 EN (Sep)	CCUS	CCUS	N/C	N/C	N/C	N/C	N/C	N/C	N/C	N/C
460 EN (Sep)	FLOG	N/C	FLOG	FLOG	FLOG	N/C	N/C	N/C	N/C	N/C
461 EN (Sep)	FMCI	FMCI	FMCI	FMCI	FMCI	N/C	N/C	N/C	N/C	N/C
462 EN (Sep)	FMCI	FMCI	FMCI	FMCI	FMCI	N/C	N/C	N/C	N/C	N/C
463 EN (Sep)	FMCI	FMCI	FMCI	FMCI	FMCI	N/C	N/C	N/C	N/C	N/C
464 EN (Sep)	DELM	PMON	N/C	N/C	PMON	PMON	N/C	FORD	N/C	N/C
465 EN (Sep)	DELM	PMON	N/C	N/C	PMON	N/C	FORD	N/C	FORD	N/C
466 EN (Sep)	N/C	N/C	N/C	N/C	N/C	N/C	N/C	N/C	N/C	FSNL
467 EN (Sep)	N/C	N/C	N/C	N/C	N/C	N/C	N/C	N/C	N/C	N/C
473 EN (WS)	N/C	N/C	N/C	N/C	N/C	N/C	N/C	N/C	N/C	N/C
492 EN (RY)	N/C	N/C	N/C	N/C	N/C	N/C	N/C	N/C	N/C	N/C
495 EN (Sep)	FBNG	FBNG	FBNG	N/C	N/C	N/C	N/C	N/C	N/C	N/C
498 EN (Sep)	N/C	FBNG	FBNG	N/C	N/C	N/C	N/C	N/C	N/C	N/C
499 EN (Sep)	FBNG	FBNG	FBNG	N/C	N/C	N/C	N/C	N/C	N/C	N/C
500 EN (Sep)	FBNG	FBNG	FBNG	N/C	N/C	N/C	N/C	N/C	N/C	N/C
504 EN (Topo)	N/C	N/C	N/C	N/C	FKNX	N/C	FKNX	N/C	N/C	N/C
506 EN (RY)	N/C	N/C	N/C	N/C	N/C	N/C	N/C	N/C	N/C	N/C
510 EN (Sep)	N/C	N/C	N/C	N/C	N/C	FRK	N/C	FRK	FSNL	FSNL
511 EN (Sep)	N/C	FMCI	FMCI	FMCI	N/C	N/C	N/C	N/C	N/C	N/C
512 EN (Sep)	N/C	N/C	N/C	N/C	N/C	N/C	N/C	N/C	N/C	N/C
513 EN (Sep)	FMCI	FMCI	FMCI	FMCI	N/C	N/C	N/C	N/C	N/C	N/C
515 EN (WS)	N/C	N/C	FDuP	FDuP	FDuP	FDuP	N/C	N/C	N/C	N/C
516 EN (WS)	N/C	N/C	N/C	N/C	N/C	N/C	N/C	N/C	N/C	N/C
524 EN (Sep)	FBNG	FBNG	FBNG	N/C	N/C	N/C	N/C	N/C	N/C	N/C
525 EN (Sep)	FBNG	FBNG	FBNG	N/C	N/C	N/C	N/C	N/C	N/C	N/C
528 EN (Sep)	FBNG	FBNG	FBNG	N/C	N/C	N/C	N/C	N/C	N/C	N/C
534 EN (WS)	N/C	N/C	N/C	N/C	N/C	N/C	N/C	N/C	N/C	N/C
553 EN (RY)	N/C	N/C	FDuP	FDuP	N/C	N/C	N/C	N/C	N/C	N/C
554 EN (Sep)	N/C	N/C	N/C	N/C	N/C	FBEL	FBEL	N/C	N/C	N/C
555 EN (Sep)	N/C	N/C	N/C	N/C	N/C	N/C	N/C	N/C	N/C	N/C
566 EN (Sep)	N/C	CCUS	N/C	N/C	CCUS	N/C	CCUS	N/C	N/C	N/C
574 EN (WS)	N/C	CCUS	N/C	N/C	CCUS	N/C	N/C	N/C	CCUS	N/C
590 EN (Sep)	N/C	FDuP	N/C	N/C	N/C	N/C	N/C	FDEV	N/C	N/C
591 EN (RY)	N/C	N/C	N/C	N/C	N/C	N/C	N/C	FDEV	N/C	N/C
601 EN (Camo)	N/C	N/C	N/C	N/C	N/C	FBEL	FBEL	N/C	N/C	N/C

Engineer Battalion Training Camps 1931 - 1940											
Battalion	1931	1932	1933	1934	1935	1936	1937	1938	1939	1940	
604 EN (Carmio)	N/C	N/C	N/C	N/C	N/C	N/C	N/C	N/C	FORD	N/C	
605 EN (Carmio)	FDuP	N/C	FDuP	N/C	N/C	N/C	N/C	N/C	N/C	N/C	
606 EN (RY)	FLOG	FLOG	FLOG	FLOG	FLOG	FLOG	N/C	N/C	N/C	N/C	
607 EN (RY)	FMCJ	N/C	FMCJ	FMCJ	FMCJ	FMCJ	N/C	N/C	N/C	N/C	
608 EN (RY)	FLOG	FLOG	FLOG	FLOG	FLOG	FLOG	N/C	N/C	N/C	N/C	
616 EN (RY)	DELM	PMDN	N/C	N/C	N/C	N/C	N/C	N/C	N/C	N/C	
617 EN (RY)	N/C	N/C	N/C	N/C	N/C	N/C	N/C	N/C	N/C	N/C	
626 EN (Sep)	N/C	N/C	N/C	N/C	N/C	FBEL	FBEL	N/C	N/C	N/C	
641 EN (Sep)	N/C	N/C	N/C	N/C	N/C	N/C	FLOG	FRK	FSNL	FSNL	
680 EN HQ	N/C	N/C	N/C	N/C	N/C	N/C	N/C	N/C	N/C	N/C	
694 EN (Sep)	N/C	FBNG	FBNG	N/C	N/C	N/C	N/C	N/C	N/C	N/C	
699 EN (Sep)	DELM	PMDN	N/C	N/C	N/C	PMDN	N/C	FORD	N/C	N/C	
951 EN (Sep)	N/C	FDuP	N/C	N/C	N/C	N/C	FDuP	N/C	N/C	N/C	
952 EN (Sep)	N/C	N/C	FDuP	FDuP	FDuP	FDuP	N/C	N/C	N/C	N/C	
955 EN (Sep)	N/C	N/C	N/C	N/C	N/C	N/C	FBEL	N/C	N/C	N/C	
957 EN (Sep)	FBNG	FBNG	FBNG	N/C	N/C	N/C	N/C	N/C	N/C	N/C	
958 EN (Sep)	FBNG	N/C	N/C	N/C	N/C	N/C	N/C	N/C	N/C	N/C	
971 EN (Sep)	DELM	N/C	N/C	N/C	N/C	N/C	N/C	FORD	N/C	N/C	

Quartermaster Training Camps 1921 - 1930

Regiment	1921	1922	1923	1924	1925	1926	1927	1928	1929	1930
2 CD Tn/ 17 QM.SQ			N/O	N/O	N/O	N/O	FBLS-RATC	N/C	N/C	N/C
3 CD Tn/18 QM.SQ			N/O	N/O	N/O	N/O	N/O	FBLS-RATC	N/C	N/C
4 QM	I/A	I/A	I/A	I/A	I/A	I/A	N/C	N/C	N/C	N/C
5 QM	I/A	I/A	I/A	I/A	I/A	I/A	N/C	QJMD-IND	N/C	N/C
6 QM	I/A	I/A	I/A	I/A	I/A	I/A	FSHN-GUTC	FSHN-IND	N/C	N/C
7 QM	I/A	I/A	I/A	I/A	I/A	I/A	FSNL	FCRK-GUTC	FCRK-GUTC	N/C
8 QM	I/A	I/A	I/A	I/A	I/A	I/A	N/C	QJMD-IND	N/C	N/C
9 QM	I/A	I/A	I/A	I/A	I/A	I/A	N/C	N/C	N/C	N/C
24 QM										
25 QM										
26 QM										
29 QM										
36 QM										
40 QM										
44 QM										
48 QM										
55 QM										
58 QM										
62 QM										
65 QM										
22 CD Tn/1 122 QM.SQ	Douglas	Douglas	Douglas	Douglas	Douglas	Douglas	I/A	I/A	I/A	I/A
26 Div Tn/ 101 QM	FDEV	FDEV	FDEV	FDEV	FDEV	FDEV	FDEV	FDEV	FDEV	FDEV
27 Div Tn/ 102 QM	Smith	Smith	Smith	Smith	Smith	Smith	Smith	Smith	FDIX-CPX	Smith
28 Div Tn/ 103 QM	Mt Gretna	Mt Gretna	Mt Gretna	Mt Gretna	Mt Gretna	Mt Gretna	Mt Gretna	Mt Gretna	Mt Gretna	Mt Gretna
29 Div Tn/ 104 QM	N/O	N/O	N/O	N/O	N/O	N/O	N/O	N/O	N/O	N/O
30 Div Tn/ 105 QM	Unknown	Unknown	Unknown	Glenn/C.JAC	Glenn/C.JAC	Glenn/C.JAC	C.JAC	C.JAC	C.JAC	C.JAC
31 Div Tn/ 106 QM	N/O	N/O	N/O	FMCL	FMCL	FMCL	FMCL	FMCL	FMCL/BEM	FMCL/BEM
32 Div Tn/ 107 QM	N/O	Douglas	Douglas	Douglas	Douglas	Douglas	Douglas	Williams	Williams	Williams
33 Div Tn/ 108 QM	Unknown	Unknown	Grant	Grant	Grant	Grant	Grant	Grant	Grant	Grant
34 Div Tn/ 109 QM	Unknown	Unknown	Unknown	Unknown	Aberdeen	Rapid	Rapid	Rapid	Mitchell	Rapid
35 Div Tn/ 110 QM	Unknown	Unknown	Ashland	Ashland	Ashland	Ashland	Ashland	Ashland	Ashland	Ashland
36 Div Tn/ 111 QM	N/O	N/O	Mabry	FCRO	Mabry	Hulen	Hulen	Hulen	Hulen	Hulen

Quartermaster Training Camps 1921 – 1930

Regiment	1921	1922	1923	1924	1925	1926	1927	1928	1929	1930
37 Div Tn / 112 QM	Perry	Perry	Perry	Perry	Perry	Perry	Perry	Perry	Perry	Perry
38 Div Tn / 113 QM	FKNX	FKNX	FKNX	FKNX	FKNX	FKNX	FKNX	FKNX	FKNX	FKNX
39 Div Tn / 114 QM	N/O	N/O	FMCL	I/A	I/A	I/A	I/A	I/A	I/A	I/A
40 Div Tn / 115 QM	N/O	N/O	N/O	N/O	N/O	N/O	N/O	N/O	N/O	N/O
41 Div Tn / 116 QM	N/O	N/O	N/O	N/O	N/O	Murray	Murray	Murray	Murray	Murray
43 Div Tn / 118 QM	N/O	N/O	N/O	N/O	Niantic	Niantic	Niantic	Niantic	Niantic	Niantic
44 Div Tn / 119 QM	N/O	N/O	N/O	Sea Girt	Sea Girt	Sea Girt	Sea Girt	Sea Girt	FDIX-CPX	Sea Girt
45 Div Tn / 120 QM	N/O	FSIL	FSIL	FSIL	FSIL	FSIL	FSIL	FSIL	FSIL	FSIL
61 CD Tn / 461 QM.SQ	N/O	FDIX-DGRP	FDIX-DGRP	N/C	N/C	FEA-RATC	N/C	N/C	N/C	FHAN
62 CD Tn / 462 QM.SQ	N/O	EGGM-DGRP	EGGM-DGRP	N/C	N/C	FEUS-GUTC	N/C	N/C	N/C	N/C
63 CD Tn / 463 QM.SQ	N/O	N/C	FMCL-DGRP	N/C	N/C	N/C	N/C	N/C	N/C	N/C
64 CD Tn / 464 QM.SQ	N/O	Unknown	FKNX-DGRP	N/C	N/C	N/C	JQMD	JQMD	FKNX/JQMD	FBH
65 CD Tn / 465 QM.SQ	N/O	Unknown	Unknown	N/C	N/C	N/C	N/C	N/C	FSHN-IND	N/C
66 CD Tn / 466 QM.SQ	N/O	Unknown	Unknown	N/C	N/C	N/C	N/C	N/C	N/C	FRK-IND
76 Div Tn / 401 QM	N/O	FDEV-DGRP	FDEV-DGRP	FDEV-DGRP	FDIX	N/C	Storrs-GRP	FDEV	HQMD-IND	HQMD
77 Div Tn / 402 QM	N/O	FDIX-DGRP	FDIX-DGRP	N/C	N/C	N/C	FHAN	FHAN/HQMD	N/C	FHAN
78 Div Tn / 403 QM	N/O	FDIX-DGRP	FDIX-DGRP	N/C	N/C	N/C	FHAN	N/C	FHAN-GUTC	N/C
79 Div Tn / 404 QM	N/O	EGGM-DGRP	Unknown	N/C	HQMD-GUTC	N/C	HQMD-GUTC	N/C	HQMD-IND	N/C
80 Div Tn / 405 QM	N/O	EGGM-DGRP	EGGM-DGRP	N/C	N/C	N/C	N/C	HQMD-GUTC	HQMD-IND	N/C
81 Div Tn / 406 QM	N/O	FMCL-DGRP	FMCL-DGRP	N/C	N/C	N/C	N/C	N/C	N/C	N/C
82 Div Tn / 407 QM	N/O	FMCL-DGRP	FMCL-DGRP	N/C	N/C	N/C	N/C	N/C	N/C	N/C
83 Div Tn / 408 QM	N/O	FKNX-DGRP	FKNX-DGRP	N/C	N/C	JQMD	JQMD	JQMD	FKNX/JQMD	FBH
84 Div Tn / 409 QM	N/O	FKNX-DGRP	FKNX-DGRP	N/C	N/C	N/C	JQMD	JQMD	FKNX/JQMD	FBH
85 Div Tn / 410 QM	N/O	CCUS-DGRP	CCUS-DGRP	N/C	N/C	N/C	CCUS-GUTC	CCUS	N/C	N/C

Quartermaster Training Camps 1921 – 1930

Regiment	1921	1922	1923	1924	1925	1926	1927	1928	1929	1930
86 Div Tn / 411 QM	N/O	CCUS-DGRP	CCUS-DGRP	N/C	N/C	N/C	N/C	FSHN-IND	N/C	N/C
87 Div Tn / 412 QM	N/O	FMCL-DGRP	FMCL-DGRP	N/C	N/C	N/C	N/C	N/C	N/C	N/C
88 Div Tn / 413 QM	N/O	FSNL-DGRP	Unknown	N/C	N/C	FSNL	FSNL	FCRK-GUTC	FCRK-GUTC	FCRK
89 Div Tn / 414 QM	N/O	EDM-DGRP	EDM-DGRP	N/C	N/C	FSNL	N/C	N/C	N/C	N/C
90 Div Tn / 415 QM	N/O	FSH-DGRP	FSH-DGRP	FSH-GUTC	N/C	N/C	FSH-RATC	N/C	FSH-RATC	N/C
91 Div Tn / 416 QM	N/O	PMON-DGRP	Unknown	N/C	PSF	N/C	PSF	DELM-GUTC	PMON-GUTC	PSF
94 Div Tn / 419 QM	N/O	FDEV-DGRP	FDEV-DGRP	N/C	N/C	N/C	HQMD-GUTC	FEA-GUTC	HQMD/FEA	HQMD
95 Div Tn / 420 QM	N/O	FSIL-DGRP	FSIL-DGRP	N/C	N/C	FSH-RATC	FSH-RATC	N/C	N/C	FSH-RATC
96 Div Tn / 421 QM	N/O	FLEW-DGRP	Unknown	N/C	N/C	FLEW-RATC	N/C	N/C	FLEW	FLEW
97 Div Tn / 422 QM	N/O	FDEV-DGRP	FDEV-DGRP	N/C	N/C	FEA	FEA-GUTC	N/C	N/C	N/C
98 Div Tn / 423 QM	N/O	FDIX-DGRP	FDIX-DGRP	N/C	N/C	N/C	N/C	N/C	N/C	N/C
99 Div Tn / 424 QM	N/O	EGGM-DGRP	EGGM-DGRP	N/C	N/C	N/C	N/C	HQMD-GUTC	HQMD-IND	N/C
100 Div Tn / 425 QM	N/O	FKNX-DGRP	FKNX-DGRP	N/C	N/C	N/C	JQMD	JQMD	FKNX/JQMD	FBH
101 Div Tn / 426 QM	N/O	CCUS-DGRP	CCUS-DGRP	N/C	N/C	N/C	N/C	McCoy	N/C	N/C
102 Div Tn / 427 QM	N/O	JFBK-DGRP	Unknown	N/C	N/C	FSNL	N/C	FCRK-GUTC	FCRK-GUTC	N/C
103 Div Tn / 428 QM	N/O	FLOG-DGRP	FLOG-DGRP	N/C	FSH	FSH-RATC	FSH-RATC	FSH-RATC	FSH-GUTC	FFEW-GUTC
104 Div Tn / 429 QM	N/O	FDOU-DGRP	Unknown	N/C	N/C	N/C	N/C	FDOU-GUTC	FDOU	FDOU
492 QM										
499 QM										
511 QM										
521 QM										
592 QM										
I Corps Tn	N/O	N/C	N/C	N/C	N/C	HQMD-BRC	HQMD-GUTC	N/C	N/C	N/C
II Corps Tn	N/O	N/C	N/C	N/C	N/C	N/C	N/C	N/C	N/C	FHAN
III Corps Tn	N/O	N/C	N/C	N/C	N/C	N/C	N/C	N/C	N/C	N/C
IV Corps Tn	N/O	N/C	N/C	N/C	N/C	N/C	N/C	N/C	N/C	N/C
V Corps Tn	N/O	N/C	N/C	N/C	N/C	N/C	JQMD	N/C	FKNX-BC	N/C
VI Corps Tn	N/O	N/C	N/C	N/C	N/C	N/C	N/C	N/C	N/C	FHAN
VII Corps Tn	N/O	N/C	N/C	N/C	FSNL	N/C	FSNL	FCRK-GUTC	N/C	N/C
VIII Corps Tn	N/O	N/C	N/C	N/C	FSIL	FSH-RATC	FSH-RATC	N/C	FSH-GUTC	N/C

Quartermaster Training Camps 1921 – 1930

Regiment	1921	1922	1923	1924	1925	1926	1927	1928	1929	1930
IX Corps Tn	N/O	N/C	N/C	N/C	PSF	PMON	PSF	DELM-GUTC	PMON-GUTC	FSHN
XI Corps Tn	N/O	N/C	N/C	FDEV	HQMD	HQMD-BRC	HQMD-GUTC	N/C	N/C	N/C
XII Corps Tn	N/O	N/C	N/C	FDIX	N/C	FHAN	FHAN	FHAN-GUTC	FHAN-GUTC	N/C
XIII Corps Tn	N/O	N/C	N/C	N/C	N/C	HQMD-GUTC	N/C	N/C	N/C	N/C
XIV Corps Tn	N/O	N/C	N/C	N/C	N/C	N/C	N/C	N/C	N/C	N/C
XV Corps Tn	N/O	N/C	N/C	N/C	N/C	N/C	N/C	N/C	FKNX-BC	N/C
XVI Corps Tn	N/O	N/C	N/C	N/C	N/C	N/C	N/C	N/C	FSHN-GUTC	N/C
XVII Corps Tn	N/O	N/C	N/C	N/C	N/C	FSNL	N/C	FCRK-GUTC	N/C	N/C
XVIII Corps Tn	N/O	N/C	N/C	N/C	FSH	FSH-RATC	FSH-RATC	N/C	FSIL-GUTC	N/C
Regiment	1921	1922	1923	1924	1925	1926	1927	1928	1929	1930
XIX Corps Tn	N/O	N/C	N/C	N/C	N/C	PMON	FLEW-GUTC	FCRK-GUTC	N/C	N/C
First Army Tn	N/O	N/C	N/C	N/C	N/C	FHAN	FHAN	FHAN-GUTC	FHAN-GUTC	FHAN
Second Army Tn	N/O	N/C	N/C	N/C	N/C	N/C	N/C	N/C	N/C	N/C
Third Army Tn	N/O	N/C	N/C	N/C	N/C	N/C	N/C	N/C	N/C	N/C
Fourth Army Tn	N/O	N/C	N/C	N/C	N/C	FHAN	FHAN	FHAN-GUTC	FHAN-GUTC	FHAN
Fifth Army Tn	N/O	N/C	N/C	N/C	N/C	N/C	N/C	N/C	N/C	N/C
Sixth Army Tn	N/O	N/C	N/C	N/C	N/C	N/C	N/C	N/C	N/C	N/C

Quartermaster Training Camps 1931 - 1940

Regiment	1931	1932	1933	1934	1935	1936	1937	1938	1939	1940
2 CD Tn/ 17 QM SQ	N/C	N/C	N/C	N/C	N/C	N/C	N/C	N/C	N/C	N/C
3 CD Tn/ 18 QM SQ	N/C	N/C	N/C	N/C	N/C	N/C	N/C	N/C	N/C	N/C
4 Div Tn/4 QM	N/C	N/C	N/C	N/C	N/C	N/C	FMPH	N/C	N/C	N/C
5 Div Tn/5 QM	EKNX-BC	N/C	N/C	N/C	N/C	N/C	N/C	N/C	N/C	N/C
6 Div Tn/6 QM	FSHN-GUTC	N/C	N/C	N/C	N/C	N/C	N/C	McCoy-GUTC	N/C	N/C
7 Div Tn/7 QM	N/C	N/C	N/C	N/C	N/C	N/C	N/C	N/C	N/C	N/C
8 Div Tn/8 QM	N/C	N/C	N/C	N/C	N/C	N/C	N/C	N/C	N/C	N/C
9 Div Tn/9 QM	N/C	N/C	N/C	N/C	N/C	N/C	N/C	N/C	N/C	N/C
24 QM						N/O	FMPH		N/C	N/C
25 QM						N/O			N/C	N/C
26 QM						N/O	N/C		N/C	FKNX-IND
29 QM						N/O	N/C	McCoy-GUTC	N/C	N/C
36 QM						N/O	FORD-GUTC	FORD-GUTC	N/C	N/C
40 QM						N/C	N/C	N/C	N/C	FKNX-IND
44 QM						N/O	FORD-GUTC	FORD-IND	N/C	N/C
48 QM						N/O	N/C	N/C	McCoy-GUTC	N/C
55 QM						N/C	N/C	N/C	N/C	FKNX-IND
58 QM						N/C	NQMD-RATC	N/C	N/C	N/C
62 QM						N/C	FORD-GUTC	FORD-IND	N/C	N/C
65 QM						N/C	N/C	FLOG-CMTC	N/C	N/C
22 CD Tn/ 122 QM SQ	I/A	I/A	I/A	I/A	I/A	I/A	I/A	I/A	I/A	NNYS-MAN
26 Div Tn/ 101 QM	FDEV	FDEV	FDEV	FDEV	Pine Cp-MAN	Edwards	Edwards	Edwards	PLBK-MAN	NNYS-MAN
27 Div Tn/ 102 QM	Smith	Smith	Smith	Smith	Pine Cp-MAN	Smith	Pine Cp	Smith	PLBK-MAN	NNYS-MAN
28 Div Tn/ 103 QM	Mt Gretna	Mt Gretna	Mt Gretna	Mt Gretna	Ind Gap-MAN	Mt Gretna	Mt Gretna		MNVA-MAN	NNYS-MAN
29 Div Tn/ 104 QM	N/O	N/O	N/O	N/O	N/O	Ritchie	Ritchie	Ritchie/VA Beach	MNVA-MAN	NNYS-MAN
30 Div Tn/ 105 QM	CJAC/Peay	CJAC/Peay	CJAC/Peay	CJAC/Peay	CJAC/Peay	Foster/Peay	CJAC/Peay	DeSoto-MAN	CJAC	KNLA-MAN
31 Div Tn/ 106 QM	BFM/FMCL/ BEAU	FMCL	BEAU/FMCL	BEAU/FMCL	BEAU/Foster	BEAU/FMCL	BEAU/FMCL	DeSoto-MAN	Foster/Shelby	KNLA-MAN
32 Div Tn/ 107 QM	Williams	Williams	Williams	Williams	Williams	Williams	Williams/ Grayling	Williams/ Grayling	Williams/ Grayling	McCoy
33 Div Tn/ 108 QM	Grant	Grant	Grant	Grant	Grant	Grant	Grant	Grant	Grant	McCoy
34 Div Tn/ 109 QM	Rapid	Rapid	Rapid	Rapid	Rapid	Rapid	Ripley	Rapid/Ripley	Rapid/Ripley	Ripley
35 Div Tn/ 110 QM	Ashland	Ashland	Ashland	Ashland	Ashland	Ashland	FRK	Ashland	Ashland	Ripley
36 Div Tn/ 111 QM	Hulen	Hulen	Hulen	Hulen	Hulen	Hulen	Hulen	CBUL-MAN	Hulen	KNLA-MAN

Regiment	Quartermaster Training Camps 1931 – 1940											
	1931	1932	1933	1934	1935	1936	1937	1938	1939	1940		
37 Div Tn/ 112.QM	Perry	Perry	Perry	Perry	Perry	FKNX-MAN	Perry	Perry	Perry	McCoy		
38 Div Tn/ 113.QM	FKNX	FKNX	FKNX	FKNX	FKNX	FKNX-MAN	FKNX	FKNX	FKNX	McCoy		
39 Div Tn/ 40 Div Tn/ 115.QM	I/A	I/A	I/A	I/A	I/A	I/A	I/A	I/A	I/A	I/A		
41 Div Tn/ 116.QM	N/O	N/O	N/O	N/O	N/O	SLO	SLO	SLO	SLO	FLEW		
43 Div Tn/ 118.QM	Murray	Murray	Murray	Murray	Murray	Murray/FEFW	Murray	Murray/FWHH	Murray/FWHH	FLEW		
44 Div Tn/ 119.QM	Niantic	Niantic	Niantic	Niantic	Pine Cp-MAN	Niantic	FEA/FWMS	Niantic/FWMS	PLBK-MAN	NNYS-MAN		
45 Div Tn/ 120.QM	Sea Girt	Sea Girt	Sea Girt	Sea Girt	Pine Cp-MAN	Sea Girt	Sea Girt/Ind Gap	Sea Girt	PLBK-MAN	NNYS-MAN		
61 CD/ 461.QM.SQ	FSIL	FSIL	FSIL	FSIL	FSIL	FSIL	FSIL	CBUL/FEFW	FSIL	KNLA-MAN		
62 CD/ 462.QM.SQ	FHAN	N/C	FHAN	FHAN-GUTC	N/C	FDIX-GUTC	FDIX-GUTC	FEA-CPX	N/C	FEA-MOB		
63 CD/ 463.QM.SQ	N/C	HQMD	HQMD	HQMD-GUTC	N/C	N/C	N/C	N/C	N/C	N/C		
64 CD/ 464.QM.SQ	N/C	N/C	FMPH	N/C	N/C	N/C	N/C	N/C	FOGL-RATC	FOGL-IND		
65 CD/ 465.QM.SQ	FKNX-BC	N/C	N/C	N/C	N/C	N/C	N/C	N/C	N/C	N/C		
66 CD/ 466.QM.SQ	N/C	CCJUS-GUTC	Unknown	N/C	N/C	N/C	N/C	N/C	N/C	N/C		
76 Div Tn / 401.QM	ERK-IND	N/C	Unknown	N/C	N/C	N/C	N/C	N/C	N/C	N/C		
77 Div Tn / 402.QM	N/C	FDEV-GRP	Unknown	N/C	FDEV-GUTC	N/C	FDEV-GUTC	N/C	N/C	FDIX-MOB		
78 Div Tn / 403.QM	FHAN	N/C	Unknown	N/C	FHAN-GUTC	FDIX-GUTC	FDIX-GUTC	N/C	FDIX-GUTC	EGGM-IND		
79 Div Tn / 404.QM	FDIX-GUTC	N/C	FHAN	FDIX	N/C	FDIX-GUTC	FDIX-GUTC	FDIX-DGRP	FDIX-GUTC	HQMD-GUTC		
80 Div Tn / 405.QM	HQMD	HQMD	HQMD	HQMD-GUTC	N/C	N/C	N/C	EGGM-CPX	N/C	EGGM-CPX		
81 Div Tn / 406.QM	HQMD	HQMD	HQMD	HQMD-GUTC	N/C	N/C	N/C	N/C	N/C	EGGM-CPX		
82 Div Tn / 407.QM	N/C	N/C	FMPH	N/C	N/C	FMLC-DGRP	N/C	DeSoto-MAN	FMPH-GUTC	FMLC-GUTC		
83 Div Tn / 408.QM	N/C	N/C	FMPH	N/C	N/C	FMPH-DGRP	N/C	DeSoto-MAN	FMPH-GUTC	FBNG-RATC		
84 Div Tn / 409.QM	FKNX-BC	N/C	Unknown	N/C	N/C	N/C	N/C	N/C	N/C	FKNX-IND		
85 Div Tn / 410.QM	FKNX-BC	N/C	Unknown	N/C	FKNX-GUTC	N/C	N/C	N/C	N/C	FKNX-IND		
	CCJUS-GUTC	N/C	Unknown	N/C	N/C	N/C	N/C	McCoy-GUTC	N/C	N/C		

Quartermaster Training Camps 1931 – 1940

Regiment	1931	1932	1933	1934	1935	1936	1937	1938	1939	1940
86 Div Tn / 411 QM	N/C	N/C	Unknown	N/C	N/C	CCUS-GUTC	N/C	McCoy-GUTC	N/C	N/C
87 Div Tn / 412 QM	N/C	N/C	EMPH	N/C	N/C	EMPH-DGRP	N/C	DeSoto-MAN	EMPH-GUTC	FMCL-GUTC
88 Div Tn / 413 QM	Unknown	N/C	Unknown	N/C	N/C	N/C	Ripley-MAN	N/C	N/C	N/C
89 Div Tn / 414 QM	N/C	N/C	Unknown	N/C	N/C	N/C	FRK-MAN	N/C	N/C	N/C
90 Div Tn / 415 QM	FSH-RATC	FSH-MAN	FSH-RATC	FSH-GUTC	FSHBC	N/C	CBUL-GUTC	CBUL-MAN	CBUL-GUTC	CBUL-GUTC
91 Div Tn / 416 QM	N/C	PMON-GUTC	Unknown	N/C	N/C	N/C	FORD-GUTC	FORD-IND	FORD-IND	FLEW-MAN
94 Div Tn / 419 QM	FDEV/HQMD	HQMD-BC	Unknown	N/C	FDEV-GUTC	N/C	N/C	FDEV-GUTC	N/C	N/C
95 Div Tn / 420 QM	FSH-RATC	FSH-RATC	FSIL-RATC	FSIL-GUTC	N/C	FSIL-GUTC	FSIL-GUTC	CBUL-MAN	N/C	N/C
96 Div Tn / 421 QM	FLEW-RATC	FLEW-GUTC	Unknown	FLEW-RATC	FLEW-GUTC	FLEW-GUTC	FLEW-GUTC	FLEW-GUTC	FLEW-GUTC	FLEW-MAN
97 Div Tn / 422 QM	HQMD-GUTC	HQMD-BC	Unknown	N/C	FDEV-GUTC	FDEV-GUTC	N/C	N/C	N/C	N/C
98 Div Tn / 423 QM	FHAN	N/C	FHAN	N/C	FNIA	FDIX-CPX	FDIX-GUTC	N/C	FDIX-CPX	HQMD-GUTC
99 Div Tn / 424 QM	HQMD-GUTC	Mt. Gettna-NG	HQMD	HQMD-GUTC	N/C	Ind Gap-CPX	N/C	N/C	FWSH-CPX	N/C
100 Div Tn / 425 QM	FKNX-BC	N/C	Unknown	N/C	N/C	N/C	N/C	N/C	N/C	FKNX-IND
101 Div Tn / 426 QM	FSHN-GUTC	N/C	Unknown	N/C	N/C	N/C	FSHN-GUTC	McCoy-GUTC	McCoy-GUTC	N/C
102 Div Tn / 427 QM	N/C	N/C	Unknown	N/C	N/C	N/C	FRK-MAN	N/C	N/C	N/C
103 Div Tn / 428 QM	FFEW-GUTC	FFEW-GUTC	FFEW-RATC	FFEW-RATC	FFEW-RATC	FFEW-RATC	PMMR-MAN	FFEW-MAN	N/C	N/C
104 Div Tn / 429 QM	FDOU-GUTC	FDOU-GUTC	Unknown	FDOU-GUTC	FDOU-GUTC	N/C	N/C	FDOU-GUTC	FDOU-GUTC	FLEW-MAN
492 QM						FDIX-IND	N/C	N/C	EDIX-GUTC	N/C
499 QM						N/C	FORD-GUTC	FORD-IND	EDIX-GUTC	N/C
511 QM						FDIX-IND	N/C	N/C	EDIX-GUTC	N/C
521 QM						FDIX-IND	N/C	N/C	EDIX-GUTC	HQMD-GUTC
592 QM						FDIX-IND	N/C	N/C	N/C	N/C
I Corps Tn	N/C	N/C	N/C	N/C	N/C					
II Corps Tn	FHAN	N/C	N/C	N/C	N/C					
III Corps Tn	N/C	N/C	N/C	N/C	N/C					
IV Corps Tn	N/C	N/C	N/C	N/C	N/C					
V Corps Tn	N/C	N/C	N/C	N/C	N/C					
VI Corps Tn	FHAN	FHAN	FHAN	FHAN-GUTC	FHAN-GUTC					
VII Corps Tn	N/C	N/C	N/C	N/C	N/C					
VIII Corps Tn	N/C	N/C	N/C	N/C	N/C					

Quartermaster Training Camps 1931 – 1940										
Regiment	1931	1932	1933	1934	1935	1936	1937	1938	1939	1940
IX Corps Tn	PMON-GJUTC	PMON-GJUTC	N/C	N/C	N/C	N/C				
XI Corps Tn	N/C	N/C	N/C	N/C	N/C	N/C				
XII Corps Tn	N/C	FHAN	N/C	N/C	N/C	N/C				
XIII Corps Tn	N/C	N/C	N/C	N/C	N/C	N/C				
XIV Corps Tn	N/C	N/C	N/C	N/C	N/C	N/C				
XV Corps Tn	N/C	N/C	N/C	N/C	N/C	N/C				
XVI Corps Tn	N/C	N/C	N/C	N/C	N/C	N/C				
XVII Corps Tn	N/C	N/C	N/C	N/C	N/C	N/C				
XVIII Corps Tn	N/C	N/C	N/C	N/C	N/C	N/C				
XIX Corps Tn	N/C	N/C	N/C	N/C	N/C	N/C				
First Army Tn	FHAN	FHAN	FHAN	FHAN-GJUTC	FHAN-GJUTC					
Second Army Tn	N/C	N/C	N/C	N/C	N/C					
Third Army Tn	N/C	N/C	N/C	N/C	N/C					
Fourth Army Tn	FHAN	N/C	N/C	N/C	N/C					
Fifth Army Tn	N/C	N/C	N/C	N/C	N/C					
Sixth Army Tn	N/C	N/C	N/C	N/C	N/C					

Division Headquarters Training Camps 1921 – 1930

Division	1921	1922	1923	1924	1925	1926	1927	1928	1929	1930
2 Cav Div	N/O	N/O	N/O	N/O	N/O	N/O	N/O	N/C	N/C	N/C
3 Cav Div			N/O	N/O	N/O	N/O	N/O	N/C	N/C	N/C
6 Div	I/A	I/A	I/A	I/A	I/A	FSHN	FSHN-GUTC	N/C	FSHN-GUTC	N/C
7 Div	I/A	I/A	I/A	I/A	I/A	I/A	I/A	Unknown	Unknown	Unknown
21 Cav Div	N/O	N/O	N/O	N/O	N/O	N/O	N/O	N/O	N/O	N/O
22 Cav Div	N/O	N/O	Douglas	Douglas	Douglas	Douglas	Douglas	Williams	Williams	Williams (HQITP)
23 Cav Div	N/O	FMCL (HQITp)	FMCL (HQITp)	N/O	N/O	N/O	N/O	N/O	N/O	FMCL (HQITP)
24 Cav Div	N/O	N/O	N/O	N/O	N/O	N/O	N/O	N/O	N/O	Murray (HQITP)
26 Div	N/O	N/O	FDEV	FDEV	FDEV	FDEV	FDEV	FDEV	FDEV	FDEV
27 Div	N/O	Smith	Smith	Smith	Smith	Smith	Smith	Smith	FDIX-CPX	Smith
28 Div	N/O	Mt Gretna	Mt Gretna	Mt Gretna	Mt Gretna	Mt Gretna	Mt Gretna	Mt Gretna	Mt Gretna	EGGM-CPX
29 Div	N/O	N/O	N/C	FAAH	VA Beach	VA Beach	Ritchie	Ritchie	Ritchie	EGGM-CPX
30 Div	N/O	N/O	N/O	N/O	N/O	C/JAC	C/JAC	C/JAC	C/JAC	C/JAC
31 Div	N/O	N/O	N/O	N/O	FMCL	FMCL	BEAU	C/JEJ	FMCL	FMCL
32 Div	N/O	N/O	N/O	Douglas	Grayling	Grayling/Douglas	Grayling/Douglas	Grayling	Grayling	Grayling
33 Div	N/O	N/O	N/O	Grant	Grant	Grant	Grant	Grant	Grant	Grant
34 Div	N/O	N/O	N/O	Dodge	FSNL	Dodge	FSNL	Dodge	Dodge	Dodge
35 Div	N/O	N/O	N/O	N/O	N/O	N/O	N/O	N/O	N/O	N/O
36 Div	N/O	N/O	Mabry	FCRO	Mabry	Hulen	Hulen	Hulen/FSH	Hulen	Hulen
37 Div	N/O	N/O	Perry	Perry	Perry	Perry	FKNX	Perry	FKNX-CPX	Perry
38 Div	N/O	N/O	FKNX	FKNX	FKNX	FKNX	FKNX	FKNX	FKNX-CPX	FKNX
39 Div	N/O	N/O	I/A	I/A	I/A	I/A	I/A	I/A	I/A	I/A
40 Div	N/O	N/O	N/O	N/O	N/O	CSLO	PMON	CSLO	CSLO	CSLO
41 Div	N/O	N/O	N/O	N/O	N/O	N/O	FLEW	FLEW	FLEW	FLEW
43 Div	N/O	N/O	N/O	N/O	Niantic/FEA	Niantic/FEA	Niantic/FEA	Niantic	Niantic	FDEV
44 Div	N/O	N/O	N/O	Sea Girt	Sea Girt	Sea Girt	Sea Girt	Sea Girt	FDIX-CPX	Sea Girt
45 Div	N/O	N/O	N/O	FSIL	FSIL	FSIL	FSIL	FSIL/FSH	FSIL	FSIL
61 Cav Div	N/O	FDIX-DGRP	FDIX-DGRP	N/C	N/C	N/C	N/C	N/C	EDIX-CPX	N/C
62 Cav Div	N/O	FGGM-DGRP	FGGM-DGRP	N/C	N/C	N/C	N/C	N/C	N/C	FGGM-CPX
63 Cav Div	N/O	N/C	FMCL-DGRP	N/C	N/C	N/C	N/C	N/C	FOGL-CPX	FOGL-RATC
64 Cav Div	N/O	Unknown	FKNX-DGRP	FKNX-DGRP	N/C	Fisherville, KY	FOGL-GRP	N/C	EKNX-CPX	FKNX-GUTC
65 Cav Div	N/O	Unknown	Unknown	N/C	N/C	N/C	N/C	N/C	N/C	FSHN-GUTC
66 Cav Div	N/O	Unknown	Unknown	N/C	N/C	N/C	N/C	N/C	ERK-Staff	N/C
76 Div	N/O	FDEV-DGRP	FDEV-DGRP	FDEV-DGRP	N/C	Storrs-GRP	Storrs-GRP	Storrs-GRP	N/C	FDEV-Staff
77 Div	N/O	FDIX-DGRP	FDIX-DGRP	N/C	Blauvelt-GUTC	MFLD/Smith	FSL C-GUTC	FDIX-CPX	FDIX-CPX	FDIX-GUTC
78 Div	N/O	FDIX-DGRP	FDIX-DGRP	N/C	FDIX-Staff	Sea Girt-CNT	Sea Girt-CNT	Sea Girt-GUTC	FDIX-CPX	Sea Girt-GUTC
79 Div	N/O	FGGM-DGRP	FGGM-DGRP	FGGM-DGRP	N/C	N/C	N/C	N/C	N/C	FGGM-CPX
80 Div	N/O	FGGM-DGRP	FGGM-DGRP	N/C	N/C	N/C	N/C	N/C	N/C	FGGM-CPX
81 Div	N/O	FMCL-DGRP	FMCL-DGRP	N/C	N/C	N/C	N/C	N/C	N/C	N/C
82 Div	N/O	FMCL-DGRP	FMCL-DGRP	N/C	N/C	N/C	N/C	N/C	N/C	N/C
83 Div	N/O	FKNX-DGRP	FKNX-DGRP	FKNX-DGRP	N/C	Columbus, OH	N/C	N/C	EKNX-CPX	FTHO-GUTC
84 Div	N/O	FKNX-DGRP	FKNX-DGRP	FKNX-DGRP	N/C	FBH	N/C	N/C	FKNX-CPX	FBH-GUTC

Division Headquarters Training Camps 1921 – 1930

Division	1921	1922	1923	1924	1925	1926	1927	1928	1929	1930
85 Div	N/O	CCUS-DGRP	CCUS-DGRP	N/C	N/C	N/C	N/C	CCUS-GUTC	Detroit-IND	CCUS-IND
86 Div	N/O	CCUS-DGRP	CCUS-DGRP	N/C	N/C	N/C	N/C	N/C	N/C	FSHN-IND
87 Div	N/O	FMCL-DGRP	FMCL-DGRP	N/C	N/C	.JKBK	N/C	N/C	N/C	N/C
88 Div	N/O	FSNL-DGRP	FSNL-DGRP	FSNL-DGRP	N/C	N/C	Lawrence, KS	N/C	N/C	N/C
89 Div	N/O	FDM-DGRP	FDM-DGRP	FDM-DGRP	N/C	N/C	Lawrence, KS	N/C	FCRK-GUTC	FCRK-IND
90 Div	N/O	FSH-DGRP	FSH-DGRP	N/C	N/C	FSH-RATC	FSH-RATC	FSH-CPX	FSH-RATC	N/C
91 Div	N/O	PMON-DGRP	Unknown	DELM	N/C	N/C	N/C	N/C	PMON-GUTC	DELM-GUTC
94 Div	N/O	FDEV-DGRP	FDEV-DGRP	FDEV-DGRP	N/C	N/C	N/C	N/C	N/C	FDEV-Staff
95 Div	N/O	FSIL-DGRP	FSIL-DGRP	N/C	N/C	FSH-RATC	FSH-RATC	FSH-CPX	N/C	N/C
96 Div	N/O	FLEW-DGRP	Unknown	N/C	N/C	N/C	N/C	N/C	N/C	FLEW-Staff
97 Div	N/O	FDEV-DGRP	FDEV-DGRP	FDEV-DGRP	N/C	N/C	N/C	FWMS-Staff	FDEV-Staff	FDEV-Staff
98 Div	N/O	FDIX-DGRP	FDIX-DGRP	N/C	N/C	N/C	FNIA-GUTC	FDIX-CPX	FDIX-CPX	N/C
99 Div	N/O	FGGM-DGRP	FGGM-DGRP	FGGM-DGRP	N/C	N/C	N/C	N/C	N/C	FGGM-CPX
100 Div	N/O	FKNX-DGRP	FKNX-DGRP	FKNX-DGRP	N/C	Huntington, WV	N/C	N/C	FKNX-CPX	FTHO-GUTC
101 Div	N/O	CCUS-DGRP	CCUS-DGRP	N/C	McCoy	N/C	N/C	N/C	N/C	N/C
103 Div	N/O	FLOG-DGRP	FLOG-DGRP	N/C	N/C	FSH-RATC	FSH-RATC	FSH-CPX	FDAR-RATC	FFEW-GUTC
104 Div	N/O	FDOU-DGRP	FDOU-DGRP	FDOU	FDOU	N/C	N/C	N/C	N/C	FDOU-Staff

Division Headquarters Training Camps 1931 – 1940

Division	1931	1932	1933	1934	1935	1936	1937	1938	1939	1940
2 Cav Div	FRK-IND	N/C	Unknown	N/C	N/C	N/C	N/C	N/C	N/C	RA-A
3 Cav Div	FRK-IND	N/C	Unknown	N/C	N/C	N/C	N/C	N/C	N/C	D/B
6 Div	FSHN-IND	N/C	Unknown	N/C	N/C	FSHN-CPX	N/C	N/C	FSHN-GUTC	RA-A
7 Div	Unknown	Unknown	Unknown	Unknown	Unknown	Unknown	Unknown	Unknown	Unknown	RA-A
21 Cav Div	N/O	N/O	N/O	FDIX-CPX	N/O	N/O	N/O	N/O	N/O	N/C
22 Cav Div	Williams (HOTP)	N/O	N/O	FDIX-CPX	N/O	N/O	N/O	N/O	N/O	NNYS-MAN
23 Cav Div	N/O	N/O	N/O	N/O	N/O	N/O	N/O	N/O	N/O	NNLA-MAN
24 Cav Div	Murray (HOTP)	N/O	N/O	N/O	N/O	Guernsey	Dodge	Guernsey	Boise	FLEW-MAN
26 Div	FDIX-CPX	FDEV	FDEV	FDIX-CPX	Pine Cp-MAN	FDEV-CPX	FDEV-CPX	Edwards	PLBK-MAN	NNYS-MAN
27 Div	FDIX-CPX	Smith	Smith	FDIX-CPX	Pine Cp-MAN	FDEV-CPX	FDEV-CPX	Smith	PLBK-MAN	NNYS-MAN
28 Div	FDIX-CPX	Mt Gretna	Mt Gretna	FDIX-CPX	Ind Gap-MAN	FDEV-CPX	FDEV-CPX	FGGM-CPX	MNVA-MAN	NNYS-MAN
29 Div	Ritchie	VA Beach	Ritchie	FDIX-CPX	Ind Gap-MAN	FDEV-CPX	FDEV-CPX	FGGM-CPX	MNVA-MAN	NNYS-MAN
30 Div	CJAC	CJAC	CJAC	CJAC	CJAC	CBUL-CPX	CJAC	DeSoto-MAN	KNLA-MAN	KNLA-MAN
31 Div	FMCL	FMCL	FOGL-CPX	FOGL	BEAU	CBUL-CPX	BEAU	DeSoto-MAN	Shelby-CPX	KNLA-MAN
32 Div	CCUS-CPX	Grayling	Chicago-CPX	FDIX-CPX	Grayling	CCUS-MAN	Grayling	FKNX-CPX	Grayling	McCoy-MAN
33 Div	CCUS-CPX	CCUS-CPX	Chicago-CPX	FDIX-CPX	Grant	CCUS-MAN	Grant	FKNX-CPX	Grant	McCoy-MAN
34 Div	Dodge	Dodge	Dodge	Dodge	FLEW-CPX	Dodge	Ripley-MAN	Dodge/Ripley	PSF-CPX	Ripley-MAN
35 Div	N/O	N/O	N/O	FRK	FLEW-CPX	Ashland	FRK-MAN	Clark	PSF-CPX	Ripley-MAN
36 Div	Hulen	Hulen	Hulen	Hulen	Hulen	CBUL-CPX	Hulen	CBUL-MAN	Hulen	KNLA-MAN
37 Div	Perry	Perry	Perry	FDIX-CPX	Perry	FKNX-MAN	Perry	FKNX-CPX	Perry	McCoy-MAN
38 Div	FKNX	FKNX	FKNX	FDIX-CPX	FKNX	FKNX-MAN	FKNX	FKNX-CPX	FKNX	McCoy-MAN
39 Div	I/A	I/A	I/A	I/A	I/A	I/A	I/A	I/A	I/A	I/A
40 Div	CSLO	CSLO	CSLO	CSLO	FLEW-CPX	CSLO	CSLO-MAN	CSLO	PSF-CPX	FLEW-MAN
41 Div	Murray	Murray	Murray	Murray	FLEW-CPX	FLEW-CPX	FLEW-MAN	FWHH	PSF-CPX	FLEW-MAN
43 Div	FDIX-CPX	Keyes	FEA	FDIX-CPX	Pine Cp-MAN	FDIX-CPX	FDEV-CPX	FEA	PLBK-MAN	NNYS-MAN
44 Div	FDIX-CPX	Sea Girt	Sea Girt	FDIX-CPX	Pine Cp-MAN	FDIX-CPX	FDEV-CPX	Sea Girt	PLBK-MAN	NNYS-MAN
45 Div	FSIL	FSIL	FSIL	FSIL	FSIL	CBUL-CPX	FSIL	CBUL-MAN	FSIL	KNLA-MAN
61 Cav Div	N/C	FMYR-Staff	N/C	N/C	FMYR-GUTC	FEA-GUTC	N/C	FEA-CPX	N/C	FEA-GUTC
62 Cav Div	N/C	N/C	Unknown	FMYR-GUTC	N/C	N/C	FOGL-Staff/CPX	FGGM-CPX	N/C	N/C
63 Cav Div	FOGL-GUTC	N/C	Unknown	N/C	N/C	CBUL-CPX	N/C	N/C	FOGL-CMTC	N/C
64 Cav Div	FKNX/Gulver	N/C	N/C	N/C	FKNX-CPX	N/C	N/C	FKNX-CPX	FKNX-CPX	McCoy-MAN
65 Cav Div	CCUS-CPX	Chicago-CPX	Chicago-CPX	N/C	N/C	N/C	Unknown	CCUS-GUTC	FSHN-GUTC	McCoy-MAN
66 Cav Div	N/C	FRK-GUTC	Unknown	FDM-GUTC	FLEW-CPX	FDM-RATC	Unknown	N/C	PSF-CPX	FLEW-MAN
76 Div	Storrs-GRP	Storrs-GRP	FADM-DGRP	FDEV-GRP	FDEV-GUTC	N/C	N/C	N/C	N/C	N/C
77 Div	FDIX-GUTC	N/C	FDIX-CCX	FDIX-CPX	N/C	N/C	FDIX-CPX	N/C	FJAY-GUTC	FDIX-MOB
78 Div	FDIX-GUTC	N/C	FDIX-GUTC	FDIX-GUTC	FDIX-CPX	N/C	FDIX-CCT	FDIX-GUTC	N/C	N/C
79 Div	FGGM-GUTC	FGGM-SA	Unknown	N/C	N/C	Philadelphia	N/C	FGGM-CPX	N/C	FGGM-CPX
80 Div	N/C	N/C	Unknown	N/C	N/C	N/C	Ind Gap-CPX	FGGM-CPX	N/C	FGGM-CPX
81 Div	FMPH-IND	FMPH-IND	FBRG-GUTC	N/C	N/C	CBUL-CPX	FMPH-GUTC	DeSoto-MAN	EMPH-GUTC	N/C
82 Div	FMPH-IND	FMPH-IND	Unknown	N/C	N/C	CBUL-CPX	FMPH-GUTC	DeSoto-MAN	FMOU-GUTC	N/C
83 Div	FKNX-BC	FKNX-CPX	N/C	N/C	N/C	N/C	N/C	FKNX-CPX	N/C	N/C
84 Div	FKNX-BC	N/C	FKNX-CPX	N/C	N/C	N/C	FKNX-Staff	FKNX-CPX	FKNX-CPX	N/C

Division Headquarters Training Camps 1931 – 1940

Division	1931	1932	1933	1934	1935	1936	1937	1938	1939	1940
85 Div	CCUS-CPX	CCUS-CPX	Chicago-CPX	N/C	N/C	N/C	FSHN-GUTC	FKNX-CPX	CCUS-Staff	McCoy-MAN
86 Div	CCUS-CPX	CCUS-CPX	Chicago-CPX	N/C	N/C	FSHN-CPX	N/C	FKNX-CPX	FSHN-GUTC	McCoy-MAN
87 Div	EMPH-IND	EMPH-IND	Unknown	N/C	N/C	CBUL-CPX	FMCL-GUTC	DeSoto-MAN	N/C	N/C
88 Div	N/C	N/C	Unknown	FSNL-GUTC	FLEW-CPX	N/C	Ripley-MAN	N/C	PSF-CPX	FSNL-GUTC
89 Div	N/C	N/C	Unknown	FCRK-GUTC	FLEW-CPX	N/C	FRK-MAN	N/C	PSF-CPX	FCRK-GUTC
90 Div	FSH-RATC	FSH-MAN	FSH-RATC	CBUL-GUTC	CBUL-GUTC	CBUL-CPX	CBUL-DGRP	CBUL-MAN	CBUL-GUTC	CBUL-GUTC
91 Div	DELM-GUTC	PMON-GUTC	PMON	PMON-GUTC	FLEW-CPX	N/C	N/C	N/C	PSF-CPX	FLEW-MAN
94 Div	FDEV-IND	N/C	FDEV-CPX	FDEV-IND	FDEV-GUTC	N/C	N/C	N/C	N/C	N/C
95 Div	FSH-RATC	FSH-RATC	FSH-RATC	FSIL-GUTC	FSIL	CBUL-CPX	FSIL-DGRP	CBUL-MAN	N/C	FSIL-GUTC
96 Div	FLEW-GUTC	FLEW-GUTC	Unknown	N/C	FLEW-CPX	N/C	N/C	N/C	PSF-CPX	FLEW-MAN
97 Div	FDEV-Staff	FEA-GRP	FMCK-DGRP	FDEV>Note	FDEV-GUTC	N/C	N/C	N/C	N/C	N/C
98 Div	FDIX-GUTC	PLBK-GUTC	FDIX-CPX	N/C	N/C	FDIX-CPX	N/C	N/C	FDIX-CPX	FEA-MOB
99 Div	N/C	FGGM-STE	FGGM-SA	N/C	N/C	Ind Gap-CPX	N/C	FGGM-CPX	FWSH-CPX	N/C
100 Div	FTHO-BC	N/C	N/C	FKNX-CPX	N/C	N/C	N/C	FKNX-CPX	N/C	McCoy-MAN
101 Div	CCUS-CPX	CCUS-CPX	Chicago-CPX	N/C	N/C	N/C	N/C	FKNX-CPX	N/C	McCoy-MAN
102 Div	N/C	N/C	Unknown	FCRK-GUTC	FLEW-CPX	N/C	FRK-MAN	N/C	PSF-CPX	FCRK-GUTC
103 Div	FFEW-RATC	FFEW-MAN	FFEW-RATC	FFEW-RATC	FFEW-RATC	CBUL-CPX	N/C	PMMR-MAN	N/C	N/C
104 Div	N/C	FDOU-Staff	Unknown	N/C	FLEW-CPX	N/C	N/C	N/C	PSF-CPX	FLEW-MAN

Brigade Training Camps 1921 – 1930

Brigade	1921	1922	1923	1924	1925	1926	1927	1928	1929	1930
7. INF BRIG	I/A	I/A	I/A	I/A	I/A	I/A	I/A	I/A	I/A	N/C
9. INF BRIG	I/A	I/A	I/A	I/A	I/A	I/A	N/C	FTHO-IND	N/C	N/C
11. INF BRIG	I/A	I/A	I/A	I/A	I/A	I/A	FSHN-GUTC	FSHN-IND	N/C	FSHN-IND
13. INF BRIG	I/A	I/A	I/A	I/A	I/A	I/A	FSNL-IND	I/A	N/C	FSNL-GUTC
15. INF BRIG	I/A	I/A	I/A	I/A	I/A	N/C	I/A	I/A	I/A	I/A
51. INF BRIG	FDEV	FDEV	FDEV	FDEV	FDEV	FDEV	FDEV	FDEV	FDEV	FDEV
52. INF BRIG	FDEV	FDEV	FDEV	FDEV	FDEV	FDEV	FDEV	FDEV	FDEV	FDEV
53. INF BRIG	I/A	Smith	Smith	Smith	Smith	Smith	Pine Cp	Smith	FDIX-CPX	Smith
54. INF BRIG	Smith	FNIA	Smith	Smith	Smith	Smith	Smith	Smith	FDIX-CPX	Smith
55. INF BRIG	I/A	Mt Gretna	Mt Gretna	Mt Gretna	Mt Gretna	Mt Gretna	Mt Gretna	Mt Gretna	Mt Gretna	EGGM-CPX
56. INF BRIG	I/A	Mt Gretna	Mt Gretna	Mt Gretna	Mt Gretna	Mt Gretna	Mt Gretna	Mt Gretna	Mt Gretna	EGGM-CPX
57. INF BRIG	Sea Girt	Sea Girt	Sea Girt	Sea Girt	Sea Girt	Sea Girt	Sea Girt	Sea Girt	FDIX-CPX	Sea Girt
58. INF BRIG	I/A	I/A	I/A	I/A	I/A	I/A	I/A	I/A	Ritchie	EGGM-CPX
59. INF BRIG	I/A	I/A	St Simons	St Simons	Tybee	St Simons	FMCL	C-JAC	C-JAC	C-JAC
60. INF BRIG	I/A	I/A	I/A	I/A	I/A	I/A	FMCL	C-JAC	C-JAC	C-JAC
61. INF BRIG	I/A	I/A	BEAU	FMCL	FMCL	FMCL	FMCL	BEM	FMCL	FMCL
62. INF BRIG	I/A	I/A	FMCL	FMCL	FMCL	FMCL	FMCL	FMCL	FMCL	FMCL
63. INF BRIG	I/A	Grayling	Grayling	Grayling	Grayling	Grayling	Grayling	Grayling	Grayling	Grayling
64. INF BRIG	I/A	Douglas	Douglas	Douglas	Douglas	Douglas	Douglas	Williams	Williams	Williams
65. INF BRIG	I/A	I/A	I/A	Grant	Grant	Grant	Grant	Grant	Grant	Grant
66. INF BRIG	I/A	I/A	I/A	Grant	Grant	Grant	Grant	Grant	Grant	Grant
67. INF BRIG	I/A	Dodge	Dodge	Dodge	Dodge	Dodge	FSNL	Dodge	Dodge	Dodge
68. INF BRIG	I/A	Lake City	Lake City	Lake City	Lake City	Lake City	FSNL	Lake City	Grafton	Grafton/ Lake City
69. INF BRIG	I/A	I/A	FRK	FRK	FRK	FRK	FRK	FRK	FRK	FRK
70. INF BRIG	I/A	Clark	Clark	Clark	Clark	Clark	Clark	Clark	Clark	Clark
71. INF BRIG	I/A	Mabry	Mabry	Mabry	Hulen	Hulen	Hulen	Hulen	Hulen	Hulen
72. INF BRIG	I/A	Mabry	Mabry	Mabry	Hulen	Hulen	Hulen	Hulen	Hulen	Hulen
73. INF BRIG	Perry	Perry	Perry	Perry	Perry	Perry	FKNX	Hulen	Hulen	Hulen
74. INF BRIG	Perry	Perry	Perry	Perry	Perry	Perry	FKNX	Hulen	Hulen	Hulen
75. INF BRIG	I/A	I/A	FKNX	FKNX	FKNX	FKNX	FKNX	FKNX	FKNX	FKNX
76. INF BRIG	I/A	I/A	FKNX	FKNX	FKNX	FKNX	FKNX	FKNX	FKNX	FKNX
77. INF BRIG	I/A	FMCL	FMCL	FMCL	FMCL	FMCL	FMCL	FMCL	FMCL	FMCL
78. INF BRIG	I/A	I/A	I/A	I/A	I/A	I/A	I/A	I/A	I/A	I/A
79. INF BRIG	I/A	I/A	PMON	DELM	DELM	DELM	PMON	CSLO	CSLO	CSLO
80. INF BRIG	I/A	I/A	I/A	I/A	I/A	I/A	I/A	CSLO	CSLO	CSLO
81. INF BRIG	I/A	I/A	I/A	FLEW	Murray	Murray	Murray	Murray	Murray	Murray
82. INF BRIG	I/A	I/A	FLEW	FLEW	FLEW	Jackson	Jackson	Clatsop	Clatsop	Clatsop
85. INF BRIG	N/O	N/O	Niantic	Niantic	Niantic	Niantic	Niantic	Niantic	Niantic	FDEV
86. INF BRIG	N/O	N/O	FDEV	FEA	Keys/FEA	Keys/FEA	Keys/FEA	FDEV	Niantic	FDEV
87. INF BRIG	N/O	Smith	Smith	Smith	Smith	Smith	Smith	Smith	FDIX-CPX	Smith
89. INF BRIG	N/O	N/O	N/O	N/O	N/O	N/O	FHUA	FHUA	FHUA	Tutill
90. INF BRIG	FSIL	FSIL	FSIL	FSIL	FSIL	FSIL	FSIL	FSIL	FSIL	FSIL
91. INF BRIG	N/O	VA Beach	VA Beach	VA Beach	VA Beach	VA Beach	VA Beach	VA Beach	VA Beach	EGGM-CPX

Brigade Training Camps 1921 – 1930

Brigade	1921	1922	1923	1924	1925	1926	1927	1928	1929	1930
92 INF BRIG	N/O	N/O	N/O	N/O	N/O	N/O	FSNL	Lake City	Dodge	Lake City
93 INF BRIG	N/O	N/O	N/O	N/O	N/O	N/O	N/O	Smith	FDIX-CPX	Smith
151 INF BRIG	I/A	I/A	FDEV-DGRP	FDEV-DGRP	N/C	N/C	N/C	N/C	N/C	N/C
152 INF BRIG	I/A	I/A	FDEV-DGRP	FDEV-GUTC	N/C	N/C	N/C	N/C	N/C	N/C
153 INF BRIG	I/A	FDIX-DGRP	FDIX-DGRP	FDIX-BRC	Blauvelt-GUTC	FSLC-GUTC	FSLC-GUTC	FDIX-GUTC	FDIX-CPX	FDIX-GUTC
154 INF BRIG	I/A	FDIX-DGRP	FDIX-DGRP	FDIX-BRC	Blauvelt-GUTC	N/C	FSLC-GUTC	FDIX-GUTC	FDIX-CPX	FDIX-GUTC
155 INF BRIG	I/A	FDIX-DGRP	FDIX-DGRP	FDIX-BRC	Sea Gift-GUTC	N/C	N/C	N/C	FDIX-CPX	N/C
156 INF BRIG	I/A	FDIX-DGRP	FDIX-DGRP	FDIX-BRC	Sea Gift-GUTC	N/C	N/C	N/C	FDIX-CPX	N/C
157 INF BRIG	I/A	EGGM-DGRP	EGGM-DGRP	Unknown	N/C	N/C	N/C	N/C	N/C	EGGM-CPX
158 INF BRIG	I/A	EGGM-DGRP	EGGM-DGRP	Unknown	N/C	N/C	N/C	N/C	N/C	EGGM-CPX
159 INF BRIG	I/A	EGGM-DGRP	EGGM-DGRP	Unknown	N/C	N/C	FSHN-GUTC	N/C	N/C	EGGM-CPX
160 INF BRIG	I/A	EGGM-DGRP	EGGM-DGRP	Unknown	N/C	N/C	N/C	N/C	N/C	EGGM-CPX
161 INF BRIG	I/A	FMCL-DGRP	FMCL-DGRP	Unknown	N/C	N/C	N/C	FMOU-GUTC	FBRG-GUTC	N/C
162 INF BRIG	I/A	FMCL-DGRP	FMCL-DGRP	Unknown	N/C	N/C	FOGL-GUTC	FMPH-RATC	FMOU-GUTC	N/C
163 INF BRIG	I/A	FMCL-DGRP	FMCL-DGRP	Unknown	N/C	McCoy-GUTC	N/C	FMPH-RATC	FSCR-RATC	N/C
164 INF BRIG	I/A	FMCL-DGRP	FMCL-DGRP	Unknown	N/C	N/C	N/C	FSCR-GUTC	FMPH-RATC	N/C
165 INF BRIG	I/A	FKNX-DGRP	FKNX-DGRP	Unknown	N/C	N/C	FBH-GUTC	N/C	FTHO-GUTC	FTHO-GUTC
166 INF BRIG	I/A	FKNX-DGRP	FKNX-DGRP	Unknown	N/C	N/C	FBH-GUTC	N/C	FTHO-GUTC	FTHO-GUTC
167 INF BRIG	I/A	FKNX-DGRP	FKNX-DGRP	Unknown	N/C	N/C	Culver-GUTC	FBH-IND	FTHO-GUTC	FBH-GUTC
168 INF BRIG	I/A	FKNX-DGRP	FKNX-DGRP	Unknown	N/C	N/C	Culver-GUTC	FBH-IND	FTHO-GUTC	FBH-GUTC
169 INF BRIG	I/A	I/A	CCUS-DGRP	Unknown	N/C	N/C	CCUS-GUTC	Grayling-NG	CCUS-IND	CCUS-IND
170 INF BRIG	I/A	CCUS-DGRP	CCUS-DGRP	Unknown	N/C	N/C	CCUS-GUTC	Grayling-NG	Grayling-NG	CCUS-IND
171 INF BRIG	I/A	CCUS-DGRP	CCUS-DGRP	Unknown	N/C	N/C	N/C	FSHN-GUTC	FSHN-GUTC	FSHN-IND
172 INF BRIG	I/A	CCUS-DGRP	CCUS-DGRP	Unknown	N/C	N/C	N/C	FSHN-GUTC	Grant-NG	JEBK-IND
173 INF BRIG	I/A	FMCL-DGRP	FMCL-DGRP	Unknown	N/C	N/C	N/C	FMPH-RATC	FMCL-GUTC	N/C
174 INF BRIG	I/A	FMCL-DGRP	FMCL-DGRP	Unknown	N/C	N/C	N/C	FSCR-GUTC	FMPH-RATC	N/C
175 INF BRIG	I/A	FSNL-DGRP	Unknown	Unknown	N/C	N/C	FDM-GUTC	N/C	N/C	FDM-IND
176 INF BRIG	I/A	FSNL-DGRP	Unknown	Unknown	N/C	N/C	N/C	FSNL-GUTC	N/C	FSNL-IND
177 INF BRIG	I/A	FDM-DGRP	FDM-DGRP	Unknown	N/C	N/C	N/C	N/C	FGRK-GUTC	N/C
178 INF BRIG	I/A	FDM-DGRP	FDM-DGRP	Unknown	N/C	N/C	N/C	N/C	FGRK-GUTC	N/C
179 INF BRIG	I/A	FSH-DGRP	FSH-DGRP	FSH-DGRP	N/C	FSH-RATC	FSH-RATC	N/C	FSH-RATC	FSH-RATC
180 INF BRIG	I/A	FSH-DGRP	FSH-DGRP	FSH-DGRP	N/C	FSH-RATC	FSH-RATC	N/C	FSH-RATC	FSH-RATC
181 INF BRIG	I/A	PMON-DGRP	Unknown	DELM-DGRP	N/C	N/C	N/C	DELM-IND	DELM-GUTC	DELM-GUTC
182 INF BRIG	I/A	I/A	I/A	I/A	N/C	N/C	N/C	DELM-IND	DELM-GUTC	DELM-GUTC
187 INF BRIG	I/A	FDEV-DGRP	FDEV-DGRP	FDEV-DGRP	N/C	N/C	FDEV-RATC	FDEV-GUTC	FDEV-GUTC	N/C
188 INF BRIG	I/A	FDEV-DGRP	FDEV-DGRP	FDEV-DGRP	N/C	N/C	FDEV-RATC	FDEV-GUTC	FDEV-GUTC	N/C
189 INF BRIG	N/O	N/O	Unknown	FSIL-DGRP	N/C	FSIL-GUTC	N/C	N/C	FSIL-GUTC	FSIL-GUTC
190 INF BRIG	N/O	FSIL-DGRP	FSIL-DGRP	FSIL-DGRP	N/C	FSIL-GUTC	N/C	FSIL-GUTC	FSIL-GUTC	FSIL-GUTC
191 INF BRIG	N/O	FLEW-DGRP	FLEW-DGRP	Unknown	N/C	N/C	N/C	N/C	N/C	VCRK-IND
192 INF BRIG	N/O	FLEW-DGRP	FLEW-DGRP	Unknown	N/C	N/C	N/C	N/C	N/C	N/C
193 INF BRIG	N/O	FDEV-DGRP	FDEV-DGRP	FDEV-DGRP	N/C	N/C	N/C	N/C	N/C	N/C
194 INF BRIG	N/O	FDEV-DGRP	FDEV-DGRP	FDEV-DGRP	N/C	N/C	N/C	N/C	N/C	N/C
195 INF BRIG	N/O	FDIX-DGRP	FDIX-DGRP	FDIX-BRC	N/C	N/C	N/C	N/C	FDIX-CPX	N/C
196 INF BRIG	N/O	FDIX-DGRP	FDIX-DGRP	FDIX-BRC	N/C	FNIA-GUTC	N/C	N/C	FDIX-CPX	N/C
197 INF BRIG	N/O	EGGM-DGRP	EGGM-DGRP	EGGM-GUTC	N/C	N/C	N/C	N/C	N/C	EGGM-CPX

Brigade Training Camps 1921 – 1930

Brigade	1921	1922	1923	1924	1925	1926	1927	1928	1929	1930
198 INF BRIG	N/O	FGGM-DGRP	FGGM-DGRP	FGGM-GUTC	N/C	N/C	N/C	N/C	N/C	FGGM-CPX
199 INF BRIG	N/O	EKNX-DGRP	EKNX-DGRP	EKNX-DGRP	N/C	N/C	ETHO-GUTC	ETHO-IND	ETHO-GUTC	N/C
200 INF BRIG	N/O	EKNX-DGRP	EKNX-DGRP	EKNX-DGRP	N/C	N/C	ETHO-GUTC	ETHO-IND	ETHO-GUTC	N/C
201 INF BRIG	N/O	N/O	Unknown	Unknown	N/C	N/C	N/C	Williams-NG	Williams-NG	Williams-NG
202 INF BRIG	N/O	CCUS-DGRP	Unknown	Unknown	N/C	N/C	Douglas-NG	N/C	N/C	FSHN-IND
203 INF BRIG	N/O	JFBK-DGRP	Unknown	Unknown	N/C	N/C	FLVN-GUTC	FLVN-GUTC	N/C	Pike-NG
204 INF BRIG	N/O	JFBK-DGRP	Unknown	Unknown	N/C	N/C	FLVN-GUTC	FLVN-GUTC	N/C	FRK-IND
205 INF BRIG	N/O	Unknown	Unknown	CSDL-GUTC	N/C	FSH-RATC	FSH-RATC	CSDL-GUTC	CSDL-RATC	CSDL-RATC
206 INF BRIG	N/O	FLOG-DGRP	FLOG-DGRP	FLOG-GUTC	N/C	FSH-RATC	FSH-RATC	FDAR-GUTC	FDAR-RATC	FEW-RATC
207 INF BRIG	N/O	FDOU-DGRP	FDOU-DGRP	FDOU-DGRP	N/C	N/C	N/C	N/C	N/C	FDOU-Staff
208 INF BRIG	N/O	N/O	Unknown	FDOU-DGRP	N/C	N/C	N/C	N/C	N/C	FDOU-Staff
211 INF BRIG	N/O	Unknown	Unknown	Unknown	N/C	SA,JP	I/A	I/A	I/A	I/A
3 CAV BRIG			N/O	N/O	N/O	N/O	Unknown	FBL-S-RATC	FBL-S-RATC	FBL-S-RATC
4 CAV BRIG			N/O	N/O	N/O	N/O	Unknown	FBL-S-RATC	FBL-S-RATC	FBL-S-RATC
5 CAV BRIG										
51 CAV BRIG	N/O	FDEV	FDIX	FEA	FEA	Pine Cp	Pine Cp	Pine Cp	FDIX-CPX	Pine Cp
52 CAV BRIG	N/O	Mt Gretna	Mt Gretna	Mt Gretna	Mt Gretna	Mt Gretna	Mt Gretna	Mt Gretna	Mt Gretna	FGGM-CPX
53 CAV BRIG	N/O	Douglas	Douglas	Douglas	Douglas	Douglas	Douglas	Williams	Williams	Williams
54 CAV BRIG	N/O	Perry	Perry	Perry	Perry	Perry	Perry	Perry	EKNX	Perry
55 CAV BRIG	N/O	N/O	N/O	N/O	N/O	N/O	N/O	FOGL	FOGL	N/O
56 CAV BRIG	Mabry	Mabry	Mabry	CSTA	CSTA	CSTA	Walters	Walters	Walters	Walters
57 CAV BRIG	N/O	N/O	N/O	N/O	N/O	N/O	N/O	N/O	N/O	N/O
58 CAV BRIG	N/O	N/O	N/O	N/O	N/O	PMMR	PMMR	PMMR	I/A	I/A
59 CAV BRIG	N/O	N/O	N/O	N/O	N/O	N/O	N/O	N/O	N/O	N/O
151 CAV BRIG	N/O	FDIX-DGRP	FDIX-DGRP	N/C	FEA-GUTC	FEA-RATC	N/C	FEA-GUTC	FDIX-CPX	FEA-GUTC
152 CAV BRIG	N/O	EDIX-DGRP	EDIX-DGRP	N/C	N/C	N/C	FEA-GUTC	N/C	FDIX-CPX	N/C
153 CAV BRIG	N/O	FGGM-DGRP	FGGM-DGRP	N/C	N/C	N/C	N/C	N/C	N/C	FGGM-CPX
154 CAV BRIG	N/O	FGGM-DGRP	FGGM-DGRP	N/C	N/C	N/C	N/C	N/C	N/C	FGGM-CPX
155 CAV BRIG	N/O	Unknown	FMCL-DGRP	Unknown	FOGL-GUTC	N/C	N/C	FOGL-GUTC	FOGL-GUTC	FOGL-GUTC
156 CAV BRIG	N/O	Unknown	Unknown	FCLK-GUTC	FCLK-GUTC	FCLK-GUTC	FCLK-GUTC	FCLK-GUTC	FCLK-GUTC	FCLK-RATC
157 CAV BRIG	N/O	Unknown	Unknown	EKNX-DGRP	N/C	N/C	EKNX-GUTC	EKNX-IND	EKNX-GUTC	EKNX-DGRP
158 CAV BRIG	N/O	Unknown	Unknown	FDEV-IND	N/C	N/C	N/C	N/C	N/C	N/C
159 CAV BRIG	N/O	CCUS-DGRP	Unknown	N/C	N/C	N/C	FSHN-GUTC	FSHN-GUTC	FSHN-IND	FSHN-IND
160 CAV BRIG	N/O	CCUS-DGRP	Unknown	N/C	N/C	N/C	FSHN-GUTC	N/C	FSHN-IND	FSHN-IND
161 CAV BRIG	N/O	Unknown	Unknown	N/C	N/C	N/C	N/C	N/C	N/C	N/C
162 CAV BRIG	N/O	Unknown	Unknown	N/C	N/C	N/C	N/C	N/C	N/C	N/C
4 FABRIG	I/A	I/A	I/A	I/A	I/A	N/C	N/C	N/C	N/C	N/C
5 FABRIG	I/A	I/A	I/A	I/A	I/A	I/A	I/A	EKNX-IND	N/C	N/C
6 FABRIG	I/A	I/A	I/A	I/A	I/A	McCoy-GUTC	McCoy-GUTC	Williams-NG	CCUS-IND	McCoy-IND
7 FABRIG	I/A	I/A	I/A	I/A	I/A	McCoy	McCoy	N/C	N/C	N/C
9 FABRIG										
17 FA BRIG										
18 FA BRIG										

Brigade Training Camps 1921 – 1930

Brigade	1921	1922	1923	1924	1925	1926	1927	1928	1929	1930
22 FA BRIG										
51 FA BRIG	FDEV	FDEV	FDEV	FDEV	FDEV	FDEV	FDEV	FDEV	FDEV	FDEV
52 FA BRIG	Welsh	Welsh	Tobyhanna	Pine Cp	MDBK	Pine Cp	Pine Cp	Pine Cp	FDIX-CPX	Pine Cp
53 FA BRIG	I/A	Tobyhanna	Tobyhanna	Tobyhanna	Tobyhanna	Mt Gretina	Tobyhanna	Tobyhanna	Mt Gretina	EGGM-CPX
54 FA BRIG	I/A	I/A	I/A	I/A	I/A	I/A	I/A	I/A	I/A	I/A
55 FA BRIG	I/A	I/A	FBRG	FBRG	FBRG	FBRG	FBRG	FBRG	CJAC	CJAC
56 FA BRIG	I/A	I/A	I/A	I/A	FBRG	FBRG	FBRG	FBRG	FMCL	FMCL
57 FA BRIG	I/A	I/A	I/A	I/A	McCoy	McCoy	McCoy	McCoy	McCoy	McCoy
58 FA BRIG	I/A	I/A	I/A	I/A	I/A	FKNX	FKNX	McCoy	McCoy	McCoy
59 FA BRIG	I/A	I/A	I/A	FKNX	McCoy	McCoy	FSNL	McCoy	McCoy	McCoy
60 FA BRIG	I/A	I/A	FRK	FRK	FRK	FRK	FRK	FRK	FRK	FRK
61 FA BRIG	I/A	I/A	I/A	CSTA	CSTA	Hulen	Hulen	Hulen	Hulen	Hulen
62 FA BRIG	I/A	I/A	FKNX	FKNX	FKNX	FKNX	FKNX	FKNX	FKNX	FKNX
63 FA BRIG	I/A	I/A	FKNX	FKNX	FKNX	FKNX	FKNX	FKNX	FKNX	FKNX
64 FA BRIG	I/A	I/A	I/A	I/A	I/A	I/A	I/A	I/A	I/A	I/A
65 FA BRIG	I/A	I/A	I/A	I/A	I/A	I/A	I/A	I/A	I/A	I/A
66 FA BRIG	I/A	I/A	I/A	I/A	I/A	I/A	I/A	I/A	Murray	Murray
68 FA BRIG	I/A	I/A	I/A	I/A	I/A	I/A	I/A	I/A	I/A	Niantic
69 FA BRIG	N/O	I/A	I/A	I/A	I/A	I/A	I/A	I/A	Sea Girt	Sea Girt
70 FA BRIG	N/O	I/A	I/A	FSIL	FSIL	FSIL	FSIL	FSIL	FSIL	FSIL
151 FA BRIG	N/O	FDEV-DGRP	FDEV-DGRP	FDEV-DGRP	N/C	N/C	N/C	N/C	N/C	N/C
152 FA BRIG	N/O	FDIX-DGRP	FDIX-DGRP	MDBK-BRC	N/C	Pine Cp	FSIL-C-GUTC	FDIX-GUTC	FDIX-CPX	N/C
153 FA BRIG	N/O	FDIX-DGRP	FDIX-DGRP	MDBK-BRC	Sea Girt-GUTC	Pine Cp	N/C	N/C	FDIX-CPX	N/C
154 FA BRIG	N/O	EGGM-DGRP	EGGM-DGRP	EGGM-DGRP	N/C	N/C	N/C	N/C	N/C	EGGM-CPX
155 FA BRIG	N/O	EGGM-DGRP	EGGM-DGRP	EGGM-DGRP	N/C	N/C	N/C	N/C	N/C	EGGM-CPX
156 FA BRIG	N/O	FBRG-DGRP	Unknown	Unknown	N/C	N/C	N/C	FBRG-GUTC	FBRG-GUTC	N/C
157 FA BRIG	N/O	FBRG-DGRP	Unknown	Unknown	N/C	N/C	N/C	FBRG-GUTC	FBRG-GUTC	N/C
158 FA BRIG	N/O	FKNX-DGRP	FKNX-DGRP	FKNX-DGRP	N/C	N/C	FKNX	FKNX-IND	FKNX-IND	FKNX-GUTC
159 FA BRIG	N/O	FKNX-DGRP	FKNX-DGRP	FKNX-DGRP	N/C	N/C	FKNX	FKNX-IND	FKNX-IND	FKNX-NG
160 FA BRIG	N/O	CCUS-DGRP	CCUS-DGRP	CCUS-DGRP	N/C	N/C	McCoy	N/C	CCUS-GUTC	McCoy-IND
161 FA BRIG	N/O	CCUS-DGRP	CCUS-DGRP	CCUS-DGRP	N/C	N/C	N/C	McCoy-GUTC	CCUS-GUTC	N/C
162 FA BRIG	N/O	FBRG-DGRP	Unknown	Unknown	N/C	N/C	N/C	FBRG-GUTC	FSH-GUTC	N/C
163 FA BRIG	N/O	FSNL-DGRP	FSNL-DGRP	FSNL-DGRP	N/C	FDM-RATC	McCoy	McCoy-GUTC	McCoy-GUTC	N/C
164 FA BRIG	N/O	FDM-DGRP	FSH-DGRP	FSH-DGRP	N/C	FDM-RATC	N/C	N/C	FRB-RATC	N/C
165 FA BRIG	N/O	FSH-DGRP	FSH-DGRP	FSH-DGRP	N/C	FSH-RATC	FSH-RATC	FSH-RATC	N/C	FSH-RATC
166 FA BRIG	N/O	PMON-DGRP	Unknown	DELM-DGRP	N/C	N/C	N/C	DELM-IND	PSE-IND	DELM-IND
169 FA BRIG	N/O	FDEV-DGRP	FDEV-DGRP	FDEV-DGRP	N/C	N/C	N/C	N/C	N/C	N/C
170 FA BRIG	N/O	FSIL-DGRP	FSIL-DGRP	FSIL-GUTC	N/C	FSIL-GUTC	N/C	FSIL-GUTC	N/C	FSIL-GUTC
171 FA BRIG	N/O	FLEW-DGRP	Unknown	Unknown	N/C	N/C	N/C	N/C	N/C	FLEW-IND
172 FA BRIG	N/O	FDEV-DGRP	FDEV-DGRP	FDEV-DGRP	N/C	N/C	N/C	N/C	N/C	N/C
173 FA BRIG	N/O	FDIX-DGRP	Unknown	MDBK-BRC	N/C	N/C	MDBK-IND	N/C	FDIX-CPX	N/C
174 FA BRIG	N/O	EGGM-DGRP	EGGM-DGRP	EGGM-DGRP	N/C	N/C	N/C	N/C	N/C	EGGM-CPX
175 FA BRIG	N/O	FKNX-DGRP	FKNX-DGRP	FKNX-DGRP	N/C	N/C	FKNX	N/C	FKNX-IND	FKNX-GUTC
176 FA BRIG	N/O	CCUS-DGRP	CCUS-DGRP	CCUS-DGRP	N/C	N/C	McCoy	McCoy-IND	CCUS-IND	N/C
177 FA BRIG	N/O	JFBK-DGRP	Unknown	Unknown	N/C	FRK-RATC	N/C	FRK-GUTC	FRK-GUTC	FRK-IND

Brigade Training Camps 1921 – 1930

Brigade	1921	1922	1923	1924	1925	1926	1927	1928	1929	1930
178 FA BRIG	N/O	FLOG-DGRP	FLOG-DGRP	FBLG-GUTC	N/C	FSH	FBLG-GUTC	FBLG-GUTC	FBLG-GUTC	FFEW-RATC
179 FA BRIG	N/O	FDOU-DGRP	FDOU-DGRP	FDOU-DGRP	FDAR-GUTC	N/C	FDAR-GUTC	N/C	FDAR-GUTC	FFEW-RATC
180 FA BRIG	N/O				N/C	N/C	FDEV-RATC	N/C	N/C	N/C
187 FA BRIG	N/O				N/C	FSH-RATC	N/C	N/C	N/C	N/C
34 CA BRIG	I/A	I/A	I/A	I/A	I/A	I/A	I/A	I/A	I/A	I/A
38 CA BRIG	I/A	I/A	I/A	I/A	I/A	I/A	I/A	I/A	I/A	I/A
40 CA BRIG	I/A	I/A	I/A	I/A	I/A	I/A	I/A	I/A	I/A	I/A
41 CA BRIG	I/A	I/A	I/A	I/A	I/A	I/A	I/A	I/A	I/A	I/A
NY CA BRIG	N/O	N/O	N/O	N/O	N/O	N/O	N/O	N/O	FONT	FONT
199 CA BRIG	N/O	N/C	N/C	FMON	N/C	N/C	N/C	N/C	N/C	N/C
202 CA BRIG	N/O	N/C	N/C	FBAR-IND	N/C	N/C	N/C	N/C	FBAR-GUTC	N/C
SCF										
CS,SCF										
FS,SCF										
GS,SCF										

Brigade Training Camps 1931 - 1940												
Brigade	1931	1932	1933	1934	1935	1936	1937	1938	1939	1940		
7 INF BRIG	N/C	N/C	N/C	FMPH-IND	N/C	N/C	FMPH-IND	N/C	FMPH-IND	N/C		
9 INF BRIG	N/C	N/C	N/C	N/C	N/C	N/C	N/C	N/C	N/C	N/C		
11 INF BRIG	FSHN-IND	FSHN-IND	N/C	N/C	N/C	FSHN-CPX	N/C	FSHN-RATC	FSHN-GUTC	N/C		
13 INF BRIG	FSNL-IND	FSNL-IND	N/C	N/C	N/C	N/C	N/C	FSNL-IND	N/C	N/C		
15 INF BRIG	I/A	I/A	N/C	N/C	N/C	N/C	N/C	N/C	N/C	I/A		
51 INF BRIG	FDEV	FDEV	FDEV	FDEV	Pine Cp-MAN	Edwards	Edwards	Edwards	PLBK-MAN	NNYS-MAN		
52 INF BRIG	FDEV	FDEV	FDEV	FDEV	Pine Cp-MAN	Edwards	Edwards	Edwards	PLBK-MAN	NNYS-MAN		
53 INF BRIG	Smith	Smith	Smith	Smith	Pine Cp-MAN	Smith	Smith	Smith	PLBK-MAN	NNYS-MAN		
54 INF BRIG	Smith	Smith	Smith	Smith	Pine Cp-MAN	Smith	Smith	Smith	Smith	NNYS-MAN		
55 INF BRIG	Mt Gretna	Mt Gretna	Mt Gretna	Ind Gap	Ind Gap-MAN	Ind Gap	Ind Gap	Ind Gap	MNVA-MAN	NNYS-MAN		
56 INF BRIG	Mt Gretna	Mt Gretna	Mt Gretna	Mt Gretna	Ind Gap-MAN	Ind Gap	Ind Gap	Ind Gap	MNVA-MAN	NNYS-MAN		
57 INF BRIG	Sea Girt	Sea Girt	Sea Girt	Sea Girt	Pine Cp-MAN	Sea Girt	Sea Girt	Sea Girt	PLBK-MAN	NNYS-MAN		
58 INF BRIG	Ritchie	Ritchie	Ritchie	Ritchie	Ind Gap-MAN	Ind Gap	Ritchie	Ritchie	MNVA-MAN	NNYS-MAN		
59 INF BRIG	CJAC	CJAC	CJAC	CJAC	CJAC	Foster	CJAC	DeSoto-MAN	CJAC	KNLA-MAN		
60 INF BRIG	CJAC	CJAC	CJAC	CJAC	CJAC	CJAC	CJAC	DeSoto-MAN	CJAC	KNLA-MAN		
61 INF BRIG	FMCL	FMCL	FOGL	FOGL	BEAU	BEAU	BEAU	DeSoto-MAN	Shelby	KNLA-MAN		
62 INF BRIG	FMCL	FMCL	FOGL	FOGL	BEAU	FMCL	FMCL	DeSoto-MAN	Foster	KNLA-MAN		
63 INF BRIG	Grayling	Grayling	Grayling	Grayling	Grayling	CCUS-MAN	Grayling	Grayling	Grayling	McCoy-MAN		
64 INF BRIG	Williams	Williams	Williams	Williams	Williams	CCUS-MAN	Williams	Williams	Williams	McCoy-MAN		
65 INF BRIG	Grant	Grant	Grant	Grant	Grant	CCUS-MAN	Grant	Grant	Grant	McCoy-MAN		
66 INF BRIG	Grant	Grant	Grant	Grant	Grant	CCUS-MAN	Grant	Grant	Grant	McCoy-MAN		
67 INF BRIG	Dodge	Dodge	Dodge	Dodge	Dodge	Dodge	Ripley-MAN	Dodge	Dodge	Ripley-MAN		
68 INF BRIG	Grafton/Ripley	Grafton/Ripley	Grafton/Ripley	Grafton/Ripley	Ripley	Grafton	Ripley-MAN	Dodge/Ripley	Ripley	Ripley-MAN		
69 INF BRIG	FRK	FRK	FRK	FRK	FRK	FRK/Ashland	FRK-MAN	Ashland	Ashland	Ripley-MAN		
70 INF BRIG	Clark	Clark	Clark	Clark	Clark	Clark	FRK-MAN	Clark	Clark	Ripley-MAN		
71 INF BRIG	Hulen	Hulen	Hulen	Hulen	Hulen	Hulen	Hulen	CBUL-MAN	Hulen	KNLA-MAN		
72 INF BRIG	Hulen	Hulen	Hulen	Hulen	Hulen	Hulen	Hulen	CBUL-MAN	Hulen	KNLA-MAN		
73 INF BRIG	Perry	Perry	Perry	Perry	Perry	FKNX-MAN	Perry	Perry	Perry	McCoy-MAN		
74 INF BRIG	Perry	Perry	Perry	Perry	Perry	FKNX-MAN	Perry	Perry	Perry	McCoy-MAN		
75 INF BRIG	FKNX	FKNX	FKNX	FKNX	FKNX	FKNX-MAN	FKNX	FKNX	FKNX	McCoy-MAN		
76 INF BRIG	FKNX	FKNX	FKNX	FKNX	FKNX	FKNX-MAN	FKNX	FKNX	FKNX	McCoy-MAN		
77 INF BRIG	I/A	I/A	I/A	I/A	I/A	I/A	I/A	I/A	I/A	I/A		
78 INF BRIG	I/A	I/A	I/A	I/A	I/A	I/A	I/A	I/A	I/A	I/A		
79 INF BRIG	CSLO	CSLO	CSLO	CSLO	CSLO	CSLO	CSLO-MAN	CSLO	CSLO	ELEW-MAN		
80 INF BRIG	CSLO	CSLO	CSLO	CSLO	CSLO	CSLO	CSLO-MAN	CSLO	CSLO	ELEW-MAN		
81 INF BRIG	Murray	Murray	Murray	Murray	Murray	Murray	Murray-MAN	Murray	Murray	ELEW-MAN		
82 INF BRIG	Clatsop	Clatsop	Clatsop	Clatsop	Murray	Clatsop	Murray-MAN	Clatsop	Murray	ELEW-MAN		
85 INF BRIG	Niantic	Niantic	FEA	Quonsett	Pine Cp-MAN	Niantic	Niantic	FEA	PLBK-MAN	NNYS-MAN		
86 INF BRIG	Keyes	Keyes	FEA/Keyes	Quonsett	Pine Cp-MAN	Keyes	Keyes	FEA	PLBK-MAN	NNYS-MAN		
87 INF BRIG	Smith	Smith	Smith	Smith	Pine Cp-MAN	Smith	Smith	Smith	PLBK-MAN	NNYS-MAN		
89 INF BRIG	Tuthill	Tuthill	Tuthill	West	West	West	West	FHUA-MAN	West	KNLA-MAN		
90 INF BRIG	FSIL	FSIL	FSIL	FSIL	FSIL	FSIL	FSIL	CBUL-MAN	FSIL	KNLA-MAN		
91 INF BRIG	VA Beach	VA Beach	Ritchie	Ritchie	Ind Gap-MAN	Ind Gap	VA Beach	Front Royal	MNVA-MAN	NNYS-MAN		
92 INF BRIG	Ripley	Ripley	Ripley	Ripley	Ripley	Ripley	Ripley-MAN	Ripley	Ripley	Ripley-MAN		

Brigade Training Camps 1931 – 1940

Brigade	1931	1932	1933	1934	1935	1936	1937	1938	1939	1940
93 INF BRIG	Smith	Smith	Smith	Smith	Pine Cp-MAN	Smith	Smith	Smith	PLBK-IMAN	NINYS-MAN
151 INF BRIG	N/C	N/C	Unknown	N/C	N/C	N/C	N/C	N/C	N/C	N/C
152 INF BRIG	N/C	N/C	Unknown	N/C	N/C	N/C	N/C	N/C	N/C	N/C
153 INF BRIG	FDIX-GUTC	N/C	N/C	FDIX-CPX	N/C	PLBK-CMTC	FDIX-CPX	FDIX-CMTC	N/C	FDIX-MOB
154 INF BRIG	FDIX-GUTC	FDIX-GUTC	N/C	FDIX-CPX	N/C	FDIX-CPX/ FNIA-CMTC	FDIX-CPX	PLBK-CMTC	N/C	FDIX-MOB
155 INF BRIG	N/C	N/C	N/C	N/C	FDIX-CPX	N/C	FNIA-CMTC	FDIX-DGRP	FDIX-CMTC	N/C
156 INF BRIG	N/C	N/C	N/C	N/C	FDIX-CPX	FDIX-CMTC	FDIX-CMTC	FDIX-DGRP	PLBK-CMTC	N/C
157 INF BRIG	N/C	EGGM-SA	Unknown	N/C	N/C	N/C	N/C	EGGM-CPX	N/C	N/C
158 INF BRIG	N/C	EGGM-SA	Unknown	N/C	N/C	N/C	N/C	EGGM-CPX	N/C	N/C
159 INF BRIG	N/C	N/C	Unknown	N/C	N/C	N/C	Ind Gap-CPX	EGGM-GUTC	N/C	EGGM-CPX
160 INF BRIG	N/C	N/C	Unknown	N/C	N/C	N/C	Ind Gap-CPX	EGGM-GUTC	N/C	EGGM-CPX
161 INF BRIG	N/C	N/C	FBRG-GUTC	N/C	N/C	FMCL-GUTC	FMPH-GUTC	N/C	FMPH-GUTC	FMCL-IND
162 INF BRIG	N/C	N/C	FBRG-GUTC	N/C	N/C	FMCL-GUTC	FMCL-GUTC	N/C	N/C	FMCL-IND
163 INF BRIG	N/C	N/C	Unknown	N/C	N/C	FMPH-GUTC	FMPH-GUTC	N/C	FSCR-GUTC	FBNG-IND
164 INF BRIG	N/C	N/C	Unknown	N/C	N/C	FMPH-GUTC	FMOU-GUTC	N/C	FMOU-GUTC	FBNG-IND
165 INF BRIG	N/C	FKNX-CPX	N/C	FKNX-IND	N/C	N/C	FKNX-CPX	N/C	N/C	FKNX-SA
166 INF BRIG	N/C	FKNX-CPX	N/C	N/C	N/C	N/C	FKNX-CPX	N/C	N/C	FKNX-SA
167 INF BRIG	N/C	N/C	FKNX-CPX	N/C	N/C	N/C	FKNX-CPX	N/C	FKNX-CPX	FKNX-SA
168 INF BRIG	Culver-GUTC	N/C	FKNX-CPX	N/C	N/C	N/C	FKNX-CPX	N/C	FKNX-CPX	FKNX-SA
169 INF BRIG	N/C	N/C	Unknown	N/C	N/C	N/C	N/C	N/C	N/C	N/C
170 INF BRIG	N/C	N/C	Unknown	N/C	N/C	N/C	N/C	N/C	Gravling-NG	N/C
171 INF BRIG	N/C	FSHN-IND	Unknown	N/C	N/C	FSHN-GUTC	N/C	N/C	FSHN-GUTC	N/C
172 INF BRIG	N/C	FSHN-IND	Unknown	N/C	N/C	FSHN-GUTC	N/C	N/C	FSHN-GUTC	N/C
173 INF BRIG	N/C	N/C	Unknown	N/C	N/C	FMCL-GUTC	FMCL-GUTC	N/C	FMCL-GUTC	FMCL-IND
174 INF BRIG	N/C	N/C	Unknown	N/C	N/C	FMCL-GUTC	N/C	N/C	FMCL-GUTC	FMCL-IND
175 INF BRIG	N/C	N/C	Unknown	FSNL-DGRP	N/C	N/C	N/C	FSNL-IND	FSNL-GUTC	FSNL-GUTC
176 INF BRIG	FSNL-IND	FSNL-IND	Unknown	FSNL-DGRP	N/C	N/C	N/C	FSNL-IND	FSNL-GUTC	FSNL-GUTC
177 INF BRIG	N/C	N/C	Unknown	N/C	N/C	N/C	N/C	FLVN-CMTC	FLVN-CMTC	FLVN-CMTC
178 INF BRIG	N/C	N/C	Unknown	N/C	N/C	N/C	N/C	FCRK-CMTC	FCRK-CMTC	FCRK-GUTC
179 INF BRIG	CBUL-RATC	CBUL-RATC	CBUL-GUTC	CBUL-GUTC	N/C	CBUL-RATC	CBUL-GUTC	N/C	CBUL-GUTC	CBUL-IND
180 INF BRIG	CBUL-RATC	CBUL-RATC	CBUL-GUTC	CBUL-GUTC	N/C	CBUL-RATC	CBUL-GUTC	N/C	CBUL-GUTC	CBUL-IND
181 INF BRIG	DELM-IND	N/C	Unknown	N/C	N/C	N/C	N/C	N/C	N/C	N/C
182 INF BRIG	DELM-GUTC	N/C	Unknown	N/C	N/C	N/C	N/C	N/C	N/C	N/C
187 INF BRIG	FDEV-GUTC	N/C	Unknown	FDEV-BRC	FDEV-GUTC	N/C	N/C	N/C	N/C	N/C
188 INF BRIG	N/C	FDEV-IND	Unknown	FDEV-BRC	N/C	N/C	N/C	FEA-GUTC	N/C	N/C
189 INF BRIG	FSIL-IND	FSIL-GUTC	FSIL-GUTC	FSIL-GUTC	FSIL-CMTC	FSIL-CMTC	FSIL-GUTC	FSIL-CMTC	FSIL-GUTC	FSIL-IND
190 INF BRIG	FSIL-IND	FSIL-GUTC	FSIL-GUTC	FSIL-GUTC	FSIL-CMTC	CBUL-GUTC	FSIL-CMTC	N/C	FSIL-GUTC	FSIL-IND
191 INF BRIG	VCBK-IND	N/C	Unknown	N/C	N/C	N/C	N/C	N/C	N/C	N/C
192 INF BRIG	N/C	N/C	Unknown	N/C	N/C	N/C	N/C	N/C	N/C	N/C
193 INF BRIG	N/C	FDEV-DGRP	Unknown	N/C	N/C	N/C	N/C	N/C	N/C	N/C
194 INF BRIG	N/C	FDEV-DGRP	Unknown	N/C	N/C	N/C	N/C	N/C	N/C	N/C
195 INF BRIG	N/C	PLBK-GUTC	Unknown	PLBK-GUTC	PLBK-CMTC	FDIX-CPX	PLBK-GUTC	FNIA-GUTC	FDIX-CPX	PLBK-CMTC
196 INF BRIG	N/C	PLBK-GUTC	Unknown	FNIA-GUTC	FNIA-CMTC	FDIX-CPX	PLBK-GUTC	PLBK-GUTC	FDIX-CPX	FDIX-CMTC
197 INF BRIG	N/C	N/C	Unknown	N/C	N/C	Ind Gap-CPX	N/C	N/C	FWAS-CPX	EGGM-T&TT

Brigade Training Camps 1931 – 1940

Brigade	1931	1932	1933	1934	1935	1936	1937	1938	1939	1940
198 INF BRIG	N/C	N/C	Unknown	N/C	N/C	Ind Gap-CPX	N/C	N/C	FWAS-CPX	EGGM-SMT
199 INF BRIG	ETHO-IND	N/C	N/C	FKNX-CPX	N/C	N/C	N/C	FKNX-CPX	N/C	FKNX-SA
200 INF BRIG	ETHO-IND	N/C	N/C	FKNX-CPX	N/C	N/C	N/C	FKNX-CPX	N/C	FKNX-SA
201 INF BRIG	N/C	FSHN-GUTC	Unknown	N/C	N/C	N/C	N/C	N/C	N/C	N/C
202 INF BRIG	N/C	N/C	Unknown	N/C	N/C	N/C	N/C	N/C	N/C	N/C
203 INF BRIG	FRK-IND	N/C	Unknown	N/C	N/C	N/C	N/C	CJTR-GUTC	N/C	FLVN-GUTC
204 INF BRIG	FRK-IND	N/C	Unknown	N/C	N/C	N/C	N/C	FLVN-GUTC	N/C	FCRK-GUTC
205 INF BRIG	CSDL-RATC	CSDL-RATC	FHUA-RATC	FHUA-RATC	FHUA-RATC	FHUA-RATC	FHUA-RATC	FHUA-RATC	FHUA-RATC	FHUA-IND
206 INF BRIG	FEW-RATC	FEW-RATC	FEW-RATC	FEW-RATC	FEW-RATC	FEW-RATC	FEW-RATC	FEW-RATC	FEW-RATC	FEW-IND
207 INF BRIG	N/C	FDOU-DGRP	N/C	N/C	N/C	N/C	N/C	N/C	N/C	N/C
208 INF BRIG	N/C	FDOU-DGRP	N/C	N/C	N/C	N/C	N/C	N/C	FDOU-GUTC	N/C
211 INF BRIG	I/A	I/A	I/A	I/A	I/A	I/A	I/A	I/A	I/A	I/A
3 CAV BRIG	FBL-S-RATC	Unknown	Unknown	I/A	I/A	I/A	FDM-IND	FDM-IND	FDM-IND	FDM-IND
4 CAV BRIG	FBL-S-RATC	Unknown	Unknown	PMON-IND	PMON-IND	I/A	FDM-IND	FDM-IND	FDM-IND	FDM-IND
5 CAV BRIG	N/O	N/O	N/O	N/O	N/O	N/O	N/O	N/O	FRK-IND	RA-A
51 CAV BRIG	Pine Cp	Pine Cp	Pine Cp	Pine Cp	Pine Cp	Pine Cp	Pine Cp	Pine Cp	PLBK-MAN	NNYS-MAN
52 CAV BRIG	Mt Gretna	Mt Gretna	Mt Gretna	Mt Gretna	Mt Gretna	Ind Gap	Ind Gap	Ind Gap	Ind Gap	NNYS-MAN
53 CAV BRIG	Williams	Williams	Williams	Williams	Williams	Williams	Williams	Williams	Williams	McCoy-MAN
54 CAV BRIG	FKNX	Perry	Perry	FKNX	FKNX	FKNX-MAN	FKNX	Perry	FKNX	McCoy-MAN
55 CAV BRIG	N/O	N/O	N/O	N/O	FOGL	FOGL	FOGL	DeSoto-MAN	FOGL	KNLA-MAN
56 CAV BRIG	Wolters	Wolters	Wolters	Wolters	Wolters	Wolters	Wolters	CBUL-MAN	Wolters	KNLA-MAN
57 CAV BRIG	FRK/Dodge	FRK/Dodge	FRK/Dodge	FRK/Dodge	FRK/Dodge	FRK/Dodge	FRK-MAN	FRK/Dodge	FRK/Boise	Ripley-MAN
58 CAV BRIG	PMMR	PMMR	PMMR	Boise/PMMR	Boise/PMMR	Boise/PMMR	FEW	Boise	Boise	FLEW-MAN
59 CAV BRIG	N/O	N/O	N/O	N/O	N/O	N/O	Sea Girt	Ind Gap	Ind Gap	NNYS-MAN
151 CAV BRIG	N/C	FMYR-GUTC	N/C	FEA-IND	N/C	FEA-GUTC	FBEL	FEA-CPX	FBEL	FEA-GUTC
152 CAV BRIG	FEA-GUTC	N/C	N/C	N/C	FMYR-IND	FEA-GUTC	FBEL	FEA-CPX	FBEL	FEA-GUTC
153 CAV BRIG	N/C	N/C	Unknown	N/C	N/C	N/C	N/C	FBEL-IND	N/C	N/C
154 CAV BRIG	N/C	FMYR-GUTC	Unknown	N/C	N/C	N/C	N/C	FBEL-IND	N/C	N/C
155 CAV BRIG	N/C	N/C	FOGL-GUTC	FOGL-IND	N/C	N/C	FOGL-IND	N/C	FOGL-CMTC	FOGL-IND
156 CAV BRIG	FCLK-RATC	N/C	FCLK-RATC	FCLK-RATC	FCLK-RATC	FBL-S-CMTC/ FCLK	FBL-S-CMTC/ FCLK	FBL-S-CMTC/ FCLK	FBL-S-CMTC/ FCLK	FCLK/FBL-S- IND
157 CAV BRIG	Culver-GUTC	N/C	N/C	N/C	N/C	N/C	N/C	N/C	FKNX-CPX	N/C
158 CAV BRIG	N/C	FEA-IND	Unknown	N/C	N/C	N/C	FEA-IND	N/C	N/C	N/C
159 CAV BRIG	N/C	FSHN-CPX	Unknown	FSHN-IND	N/C	Chicago-CPX	N/C	CCUS-GUTC	FSHN-GUTC	N/C
160 CAV BRIG	N/C	N/C	Unknown	FSHN-IND	N/C	N/C	N/C	N/C	FSHN-GUTC	FSHN-GUTC
161 CAV BRIG	FRK-IND	FRK-DGRP	Unknown	FDM-DGRP	N/C	N/C	N/C	FRK-GUTC	FDM-IND	FRK-GUTC
162 CAV BRIG	N/C	N/C	Unknown	N/C	N/C	N/C	N/C	FMEA-GUTC	FORD-IND	N/C
4 FA BRIG	N/C	N/C	N/C	N/C	N/C	N/C	FSIL-RATC	FSIL-RATC	FSIL-RATC	N/C
5 FA BRIG	FKNX-IND	N/C	N/C	N/C	N/C	N/C	N/C	N/C	N/C	N/C
6 FA BRIG	N/C	N/C	N/C	N/C	N/C	N/C	McCoy-GUTC	McCoy-GUTC	McCoy-IND	N/C
7 FA BRIG	N/C	N/C	N/C	N/C	N/C	Ripley-GUTC	N/C	FDM-GUTC	FRK-GUTC	FRK-GUTC
9 FA BRIG	N/C	N/C	FKNX-IND	N/C	N/C	N/C	N/C	N/C	N/C	N/C
17 FA BRIG	N/C	N/C	N/O	N/C	N/C	N/C	N/C	FRK-BRC	N/C	N/C

Brigade Training Camps 1931 – 1940

Brigade	1931	1932	1933	1934	1935	1936	1937	1938	1939	1940
18 FA BRIG			N/O	N/C	N/C	FSIL-GUTC	FSIL-GUTC	N/C	N/C	N/C
22 FA BRIG			N/O	N/C	N/C	N/C	McCoy-GUTC	N/C	N/C	N/C
51 FA BRIG	FDEV	FDEV	FDEV	FEA	Pine Cp-MAN	FEA	Edwards	Edwards	PLBK-MAN	NNYS-MAN
52 FA BRIG	Pine Cp	Pine Cp	Pine Cp	Pine Cp	Pine Cp-MAN	Pine Cp	Pine Cp	Smith	PLBK-MAN	NNYS-MAN
53 FA BRIG	Tobyhanna	Tobyhanna	Ind Gap	Ind Gap	Ind Gap-MAN	Ind Gap	Ind Gap	Ind Gap	MNVA-MAN	NNYS-MAN
54 FA BRIG	N/C	Tobyhanna	Tobyhanna	Ind Gap	Ind Gap-MAN	Ind Gap	Ind Gap	Ind Gap	MNVA-MAN	NNYS-MAN
55 FA BRIG	C/JAC	C/JAC	C/JAC	C/JAC	C/JAC	C/JAC	C/JAC	DeSoto-MAN	C/JAC	KNLA-MAN
56 FA BRIG	FMCL	FMCL	FOWL	FOWL	BEAU	C/JAC	C/JAC	DeSoto-MAN	Shelby	KNLA-MAN
57 FA BRIG	McCoy	McCoy	McCoy	McCoy	McCoy	CCUS-MAN	McCoy	McCoy	McCoy	McCoy-MAN
58 FA BRIG	Grant	Grant	Grant	Grant	McCoy	CCUS-MAN	McCoy	Grant	McCoy	McCoy-MAN
59 FA BRIG	Ripley	Ripley	Ripley	Ripley	Ripley	Ripley	Ripley-MAN	Ripley	Ripley	Ripley-MAN
60 FA BRIG	FRK	FRK	FRK	FRK	FRK	FRK	FRK-MAN	FRK	FRK	Ripley-MAN
61 FA BRIG	CSTA	CBUL	Hulen	Hulen	Hulen	Hulen	Hulen	CBUL-MAN	Hulen	KNLA-MAN
62 FA BRIG	FKNX	FKNX	FKNX	FKNX	FKNX	FKNX-MAN	FKNX	FKNX	FKNX	McCoy-MAN
63 FA BRIG	FKNX	FKNX	FKNX	FKNX	FKNX	FKNX-MAN	FKNX	FKNX	FKNX	McCoy-MAN
64 FA BRIG	I/A	I/A	I/A	I/A	I/A	I/A	I/A	I/A	I/A	I/A
65 FA BRIG	I/A	WG Wms	WG Wms	WG Wms	WG Wms	WG Wms	CSLO-MAN	WG Wms	CSLO	FLEW-MAN
66 FA BRIG	Murray	Murray	Murray	Murray	Murray	Murray	Murray-MAN	Murray	Murray	FLEW-MAN
68 FA BRIG	Niantic	Keyes	FDEV	Quonsett	Pine Cp-MAN	FEA	FEA	FEA	PLBK-MAN	NNYS-MAN
69 FA BRIG	Sea Girt	Sea Girt	Sea Girt	Sea Girt	Pine Cp-MAN	Sea Girt	Ind Gap	Sea Girt	PLBK-MAN	NNYS-MAN
70 FA BRIG	FSIL	FSIL	FSIL	FSIL	FSIL	FSIL	FSIL	CBUL-MAN	FSIL	KNLA-MAN
151 FA BRIG	N/C	N/C	Unknown	FEA-GUTC	N/C	N/C	N/C	N/C	N/C	N/C
152 FA BRIG	FHOY-GUTC	N/C	N/C	FDIX-CPX	N/C	Pine Cp-GUTC	FDIX-CPX	N/C	N/C	FDIX-MOB
153 FA BRIG	N/C	N/C	N/C	Pine Cp	FDIX-CPX	MDBK-CMTC	Pine Cp	FDIX-DGRP	N/C	N/C
154 FA BRIG	N/C	N/C	Unknown	N/C	FHOY-GUTC	FHOY-GUTC	N/C	FGGM-CPX	FHOY-GUTC	N/C
155 FA BRIG	N/C	N/C	Unknown	N/C	FHOY-GUTC	N/C	Ind Gap-CPX	FHOY-GUTC	N/C	EGGM-CPX
156 FA BRIG	N/C	N/C	FBRG-GUTC	N/C	N/C	FBRG-GUTC	FBRG-GUTC	FBRG-GUTC	FBRG-GUTC	FBRG-GUTC
157 FA BRIG	N/C	N/C	Unknown	N/C	N/C	N/C	FBRG-GUTC	N/C	FBRG-GUTC	FBRG-GUTC
158 FA BRIG	FKNX-GUTC	FKNX-CPX	Unknown	N/C	N/C	N/C	FKNX-CPX	N/C	N/C	FKNX-SA
159 FA BRIG	Culver-GUTC	N/C	FKNX-CPX	N/C	N/C	N/C	FKNX-CPX	N/C	FKNX-CPX	FKNX-SA
160 FA BRIG	N/C	N/C	Unknown	N/C	N/C	N/C	N/C	N/C	Graying-NG	N/C
161 FA BRIG	N/C	N/C	Unknown	FSH-IND	N/C	N/C	N/C	N/C	McCoy-GUTC	N/C
162 FA BRIG	N/C	N/C	Unknown	N/C	N/C	N/C	FBRG-GUTC	N/C	N/C	FBRG-GUTC
163 FA BRIG	McCoy-GUTC	Ripley-NG	Unknown	Ripley-NG	N/C	FSNL-CMTC	N/C	FDM-GUTC	FRK-GUTC	FRK-GUTC
164 FA BRIG	N/C	N/C	Unknown	N/C	N/C	FDM-GUTC	N/C	FDM-GUTC	FRK-GUTC	N/C
165 FA BRIG	CSTA-RATC	CBUL-RATC	CBUL-RATC	CBUL-RATC	N/C	CBUL-CMTC	N/C	N/C	CBUL-RATC	CBUL-IND
166 FA BRIG	DELM-IND	N/C	Unknown	N/C	N/C	N/C	N/C	N/C	FORD-IND	N/C
169 FA BRIG	N/C	FEA-GUTC	Unknown	N/C	N/C	N/C	N/C	N/C	N/C	N/C
170 FA BRIG	FSIL-GUTC	FSIL-GUTC	FSIL-GUTC	FSIL-GUTC	N/C	FSIL-GUTC	FSIL-GUTC	FSIL-CMTC	N/C	FSIL-IND
171 FA BRIG	FLEW-IND	N/C	Unknown	N/C	N/C	N/C	N/C	N/C	N/C	N/C
172 FA BRIG	N/C	N/C	Unknown	N/C	N/C	N/C	N/C	N/C	N/C	N/C
173 FA BRIG	N/C	PLBK-GUTC	Unknown	Pine Cp-GUTC	Pine Cp-GUTC	Pine Cp-GUTC	N/C	N/C	FDIX-CPX	N/C
174 FA BRIG	N/C	N/C	FHOY-GUTC	FHOY-GUTC	N/C	Ind Gap-CPX	FHOY-GUTC	N/C	FWAS-CPX	FHOY-GUTC
175 FA BRIG	N/C	N/C	Unknown	N/C	N/C	N/C	N/C	FKNX-CPX	N/C	FKNX-SA
176 FA BRIG	N/C	N/C	Unknown	N/C	N/C	N/C	N/C	N/C	N/C	N/C

Brigade Training Camps 1931 – 1940

Brigade	1931	1932	1933	1934	1935	1936	1937	1938	1939	1940
177 FA BRIG	FRK-NG	N/C	Unknown	N/C	Ripley-NG	N/C	N/C	FRK-BRC	N/C	N/C
178 FA BRIG	FFEW-RATC	FFEW-RATC	FFEW-RATC	FFEW-RATC	FFEW-RATC	FFEW-RATC	PMMR-MAN/ West-NG	N/C	FFEW-BRC	FBLs-IND
179 FA BRIG	FFEW-RATC	FDOL-DGRP	FFEW-RATC	FFEW-IND	N/C	N/C	FFEW-RATC	N/C	FLEW-GUTC	N/C
180 FA BRIG	N/C	N/C	N/C	N/C	N/C	N/C	N/C	N/C	N/C	N/C
187 FA BRIG	N/C	N/C	N/C	N/C	N/C	N/C	N/C	N/C	N/C	N/C
34 CA BRIG	N/O	N/O	N/O	N/C	N/C	N/C	N/C	FBAR-GUTC	N/C	FBAR-GUTC
38 CA BRIG	N/O	N/O	N/O	N/C	N/C	N/C	N/C	FBAR-GUTC	FBAR-GUTC	FBAR-GUTC
40 CA BRIG	N/O	N/O	N/O	N/C	N/C	N/C	N/C	N/C	FSHN-GUTC	N/C
41 CA BRIG	N/O	N/O	N/O	N/C	N/C	FSHN-GUTC	FSHN-GUTC	N/C	N/C	FSHN-GUTC
NY CA BRIG	FONT	FONT	FONT	FONT	Smith	FONT	FONT	FONT	Smith	Pine Cp
199 CA BRIG	N/C	N/C	N/C	N/C	N/C	N/C	N/C	FSHN	N/C	N/C
202 CA BRIG	N/C	N/C	N/C	N/C	N/C	N/C	N/C	FBAR-GUTC	FBAR-GUTC	N/C
HQ. SCF								FBAR-GUTC	FBAR-GUTC	FBAR-GUTC
HQ. CS.SCF								FBAR-GUTC	FBAR-GUTC	FBAR-GUTC
HQ. FS.SCF								FBAR-GUTC	FBAR-GUTC	FBAR-GUTC
HQ. GS.SCF								FBAR-GUTC	FBAR-GUTC	FBAR-GUTC

Chemical Training Regiment Training Camps 1921 – 1940

Regiment	1921	1922	1923	1924	1925	1926	1927	1928	1929	1930
1						RA-A	RA-A	RA-A	RA-A	RA-A
2										
301	N/O	N/O	N/O	N/C	EARS-GUTC	N/C	FBNG-GUTC	FBNG/CJAC	FBNG-GUTC	N/C
302	N/O	N/O	N/O	N/O	N/C	DELM-GUTC	PSF-GUTC	PSF-GUTC	DELM-GUTC	DELM-GUTC
303										
304										
305										
306										
Regiment	1931	1932	1933	1934	1935	1936	1937	1938	1939	1940
1	RA-A	RA-A	RA-A	N/C	N/C	EARS-GUTC	EARS-GUTC	N/C	EARS-GUTC	N/C
2	N/O	N/O	N/O	N/O	FBNG-GUTC	FMPH-CMTC	FBNG-GUTC	FBNG-GUTC	FBNG-GUTC	FBNG-GUTC
301	N/C	FBNG-GUTC	FBNG-GUTC	N/C	FBNG-GUTC	FMPH-CMTC	FBNG-GUTC	FBNG-GUTC	FMCL-CMTC	FBNG-GUTC
302	DELM-GUTC	PMON-GUTC	PMON-GUTC	PMON-GUTC	PMON-GUTC	PMON-GUTC	N/C	FORD-GUTC	N/C	N/C
303	N/C	N/C	N/C	EARS-GUTC	Pine Cp	EARS-GUTC	EARS-GUTC	EARS-GUTC	N/C	N/C
304	N/C	N/C	N/C	N/C	N/C	CCUS-GUTC	N/C	CCUS-GUTC	N/C	CCUS-GUTC
305	N/C	FDEV-GUTC	N/C	N/C	N/C	N/C	N/C	N/C	N/C	N/C
306	N/C	FSH/FLOG	FSH-RATC	CBUL-GUTC	CBUL-GUTC	CBUL-RATC	CBUL-GUTC	N/C	CBUL-IND	N/C

Air Corps Squadron Training Camps 1921 – 1930

Squadron	1921	1922	1923	1924	1925	1926	1927	1928	1929	1930
45 Obsn			N/O	N/O	N/O	N/O	N/O	N/O	N/C	Love-GUTC
49 Serv										
77 Obsn										
101 Obsn	N/O	MITF	MITF	MITF	LNGF	LNGF	MITF	N/C	N/C	N/C
102 Obsn	N/O	N/O	MFLD	MITF	MFLD	Pine Cp	MITF	MITF	FDEV	FDEV
103 Obsn	N/O	N/O	N/O	LNGF	LNGF	LNGF	Pine Cp	Pine Cp	FDIX	Pine Cp
104 Obsn	N/O	LNGF	LNGF	LNGF	LNGF	LNGF	LNGF	MAD	MAD	LNGF
105 Obsn	N/O	N/O	MAXF	Woodstock	MAXF	MAXF	Shepard	Shepard	Shepard	LNGF
106 Obsn	N/O	N/O	N/O	MAXF	MAXF	MAXF	MAXF	CJAC	CJAC	CJAC
107 Obsn	N/O	N/O	N/O	N/O	N/O	MAXF	MAXF	Mobile	FMCL	FMCL
108 Obsn	N/O	N/O	N/O	N/O	N/O	N/O	Grayling	Grayling	Grayling	Grayling
109 Obsn	N/O	FSNL	Speedway	Speedway	Wold-Cham	Wold-Cham	Grant	Grant	Grant	Grant
110 Obsn	N/O	N/O	Clark	Clark	Wold-Cham	Wold-Cham	Wold-Cham	Wold-Cham	Wold-Cham	Wold-Cham
111 Obsn	N/O	N/O	ELLF	ELLF	Clark	MSHF	Anglum	Anglum	MSHF	MSHF
112 Obsn	N/O	N/O	ELLF	ELLF	ELLF	ELLF	Hulen	Hulen	Hulen	Hulen
113 Obsn	N/O	N/O	N/O	N/O	N/O	N/O	GODF	Perry	Perry	Perry
114 Obsn	N/O	N/O	WWF	WWF	WWF	WWF	GODF	GODF	GODF	GODF
115 Obsn	N/O	N/O	MAXF	I/A	I/A	I/A	I/A	I/A	I/A	I/A
116 Obsn	N/O	N/O	N/O	Clover	Clover	Griffith	Capitola	SLO	SLO	SLO
118 Obsn	N/O	N/O	N/O	Felts	Felts	Felts	GRYF	GRYF	GRYF	GRYF
119 Obsn	N/O	N/O	N/O	MITF	MITF	MITF	MITF	Niantic	Trumbull	Trumbull
120 Obsn	N/O	N/O	N/O	N/O	N/O	N/O	N/O	N/O	Newark	Newark
135 Obsn	N/O	N/O	N/O	Golden	PSTF	Lowry	Lowry	Lowry	Lowry	Lowry
136 Obsn	N/O	MAXF	I/A	I/A	I/A	I/A	I/A	I/A	I/A	I/A
137 Obsn	N/O	MAXF	I/A	I/A	I/A	I/A	I/A	I/A	I/A	I/A
154 Obsn	N/O	WWF	I/A	I/A	I/A	I/A	I/A	I/A	I/A	I/A
157 Obsn	N/O	N/O	N/O	N/O	N/O	LRAID	LRAID	LRAID	LRAID	FBAR
301 Obsn	N/O	Unknown	Unknown	N/C	MITF-GUTC	MITF-GUTC	MITF-GUTC	MITF-IND	MITF-IND	N/C
302 Obsn	N/O	Unknown	MITF-GUTC	N/C	MITF-GUTC	N/C	MITF-GUTC	MITF-RATC	MITF-GUTC	MITF-GUTC
303 Obsn	N/O	Unknown	MITF-GUTC	N/C	MITF-GUTC	MITF-GUTC	N/C	MITF-RATC	MITF-GUTC	MITF-GUTC
304 Obsn	N/O	Unknown	LNGF	N/C	N/C	LNGF-RATC	N/C	LNGF-GUTC	LNGF-GUTC	N/C
305 Obsn	N/O	Unknown	LNGF	N/C	N/C	N/C	N/C	LNGF-GUTC	LNGF-GUTC	N/C
306 Obsn	N/O	Unknown	MAXF-GUTC	MAXF-GUTC	MAXF-GUTC	N/C	MAXF-GUTC	MAXE-RATC	POPE	N/C
307 Obsn	N/O	Unknown	MAXF-GUTC	MAXF-GUTC	N/C	MAXF-GUTC	MAXF-GUTC	N/C	MAXF-RATC	MAXF-RATC
308 Obsn	N/O	Unknown	WWF-GUTC	WWF-GUTC	WWF-GUTC	WWF-GUTC	N/C	N/C	SELF-GUTC	N/C
309 Obsn	N/O	Unknown	WWF-GUTC	WWF-GUTC	N/C	WWF-GUTC	N/C	SELF-GUTC	SELF-GUTC	N/C
310 Obsn	N/O	Unknown	Unknown	CHNF-GUTC	N/C	CHNF-GUTC	N/C	SELF-GUTC	SELF-GUTC	N/C
311 Obsn	N/O	Unknown	Unknown	CHNE-GUTC	N/C	N/C	SELF-GUTC	SELF-GUTC	SELF-GUTC	N/C
312 Obsn	N/O	Unknown	MAXF-GUTC	MAXF-GUTC	MAXF-GUTC	N/C	MAXF-GUTC	MAXF-RATC	MAXF-RATC	MAXF-RATC
313 Obsn	N/O	Unknown	Richards	Richards	Richards	MSHF-GUTC	MSHF-GUTC	MSHF-GUTC	Wold-Cham	N/C
314 Obsn	N/O	Unknown	Richards	Richards	Richards	MSHF-GUTC	MSHF-GUTC	MSHF-GUTC	Richards	N/C
315 Obsn	N/O	Unknown	BIGF	BRKF-GUTC	BRKF-GUTC	N/C	DODF-RATC	DODF-RATC	Love-GUTC	Love-GUTC
316 Obsn	N/O	Unknown	Unknown	DELM	DELM	N/C	CRSF-RATC	CRSF-RATC	CRSF-RATC	N/C
319 Obsn	N/O	Unknown	MITF-GUTC	N/C	MITF-GUTC	MITF-GUTC	Boston	MITF-IND	MITF-IND	N/C
320 Obsn	N/O	Unknown	Unknown	PSTF-GUTC	PSTF-GUTC	PSTF-GUTC	DODF-RATC	DODF-RATC	Love-GUTC	Love-GUTC

Air Corps Squadron Training Camps 1921 – 1930											
Squadron	1921	1922	1923	1924	1925	1926	1927	1928	1929	1930	
321 Obsn	N/O	Unknown	Unknown	GRYE-GUTC	GRYE-GUTC	PEAF-GUTC	PEAF-GUTC	PEAF-GUTC	PEAF-GUTC	PEAF-GUTC	
322 Obsn	N/O	Unknown	MITF-GUTC	N/C	MITF-GUTC	MITF-GUTC	Contoord	MITF-IND	MITF-GUTC	MITF-GUTC	
323 Obsn	N/O	Unknown	MITF-GUTC	N/C	N/C	MITE-GUTC	N/C	N/C	N/C	N/C	
324 Obsn	N/O	Unknown	LNGF	N/C	N/C	LNGF-RATC	LNGF-GUTC	LNGF-GUTC	LNGF-GUTC	LNGF-GUTC	
325 Obsn	N/O	Unknown	WWF-GUTC	WWF-GUTC	WWF-GUTC	WWF-GUTC	N/C	SELF-GUTC	SELF-GUTC	N/C	
326 Obsn	N/O	Unknown	Unknown	CHNF-GUTC	N/C	CHNF-GUTC	SELF-GUTC	SELF-GUTC	SELF-GUTC	N/C	
327 Obsn	N/O	Unknown	Richards	Richards	Richards	MSHF-GUTC	N/C	MSHF-GUTC	Richards	N/C	
328 Obsn	N/O	FLOG	BIGF	BIGF-GUTC	BRKF-GUTC	BRKF-GUTC	N/C	DODF-RATC	Love-GUTC	Love-GUTC	
329 Obsn	N/O	Unknown	Unknown	N/C	Woodward	N/C	Woodward	Woodward	Woodward	Woodward-SLC	
339 Serv	N/O	Unknown	Unknown	N/C	N/C	N/C	N/C	N/C	SELF-GUTC	N/C	
341 Serv	N/O	Unknown	Unknown	MITF	N/C	KELF-GUTC	N/C	N/C	N/C	N/C	
349 Serv	N/O	Unknown	Unknown	N/C	N/C	N/C	N/C	N/C	SELF-GUTC	N/C	
350 Serv	N/O	Unknown	Unknown	N/C	N/C	KELF-GUTC	FCRO-RATC	N/C	N/C	N/C	
351 Obsn	N/O	Unknown	MITF-GUTC	MITF	MITF-GUTC	N/C	N/C	N/C	N/C	N/C	
353 Obsn	N/O	Unknown	Unknown	MITF	N/C	N/C	MITF-GUTC	N/C	N/C	N/C	
354 Obsn	N/O	Unknown	Unknown	MITF	N/C	N/C	N/C	MITF-RATC	N/C	N/C	
355 Obsn	N/O	Unknown	Unknown	LNGF	N/C	N/C	N/C	N/C	N/C	LNGF-GUTC	
357 Obsn	N/O	Unknown	Unknown	MAXF	N/C	MAXF-GUTC	MAXF-GUTC	MAXE-RATC	N/C	N/C	
358 Obsn	N/O	Unknown	Unknown	MAXF	N/C	MAXF-GUTC	N/C	MAXF-RATC	N/C	MAXF-RATC	
359 Obsn	N/O	Unknown	Unknown	WWF-GUTC	N/C	N/C	N/C	N/C	N/C	N/C	
360 Obsn	N/O	Unknown	Unknown	N/C	N/C	N/C	N/C	FCRO-RATC	N/C	I/A	
361 Obsn	N/O	Unknown	Unknown	N/C	N/C	CHNF-GUTC	N/C	SELF-GUTC	SELF-GUTC	I/A	
362 Obsn	N/O	Unknown	Unknown	N/C	CHNF-GUTC	N/C	SELF-GUTC	SELF-GUTC	SELF-GUTC	I/A	
363 Obsn	N/O	Unknown	Unknown	Richards	Richards	N/C	N/C	N/C	N/C	N/C	
364 Obsn	N/O	Unknown	Unknown	Richards	N/C	MSHF-GUTC	N/C	N/C	N/C	N/C	
365 Obsn	N/O	Unknown	Unknown	PSTF-GUTC	PSTF-GUTC	BIGF-GUTC	DODF-RATC	DODE-RATC	Love-GUTC	Love-GUTC	
366 Obsn	N/O	Unknown	Unknown	N/C	PSTF-GUTC	BIGF-GUTC	DODF-RATC	FCRO-RATC	Love-GUTC	Love-GUTC	
367 Obsn	N/O	Unknown	Unknown	N/C	ROCF-GUTC	ROCF-GUTC	CRSF-RATC	CRSF-RATC	CRSF-RATC	N/C	
368 Obsn	N/O	Unknown	Unknown	N/C	ROCF-GUTC	ROCF-GUTC	CRSF-RATC	CRSF-RATC	CRSF-RATC	I/A	
369 Obsn	N/O	Unknown	Unknown	MITF	Unknown	Unknown	Unknown	Unknown	MITF-GUTC	MITF-GUTC	
370 Obsn	N/O	Unknown	Unknown	N/C	MITF-GUTC	MITE-GUTC	N/C	N/C	N/C	N/C	
371 Obsn	N/O	Unknown	Unknown	KELF-GUTC	KELF-GUTC	BIGF-GUTC	DODF-RATC	N/C	N/C	N/C	
372 Obsn	N/O	Unknown	Unknown	ROCF-GUTC	N/C	N/C	N/C	N/C	N/C	N/C	
380 Serv	N/O	Unknown	Unknown	N/C	KELF-GUTC	KELF-GUTC	N/C	N/C	Love-GUTC	N/C	
381 Serv	N/O	Unknown	Unknown	N/C	N/C	ROCF-GUTC	N/C	N/C	CRSF-RATC	N/C	
383 Serv	N/O	Unknown	Unknown	MAXF	N/C	MAXF-GUTC	N/C	N/C	N/C	I/A	
387 Serv	N/O	Unknown	Unknown	N/C	N/C	KELF-GUTC	N/C	N/C	N/C	N/C	
396 Purs	N/O	Unknown	Unknown	MITF	N/C	MITF-GUTC	N/C	N/C	N/C	I/A	
397 Purs	N/O	Unknown	Unknown	MITF	N/C	N/C	N/C	MITF-RATC	N/C	I/A	
399 Atk	N/O	Unknown	Unknown	MITF	MITF-GUTC	N/C	N/C	N/C	N/C	N/C	
400 Atk	N/O	Unknown	Unknown	MITF	N/C	N/C	MITF-GUTC	N/C	N/C	N/C	
401 Atk	N/O	Unknown	Unknown	MITF	N/C	N/C	N/C	MITF-RATC	N/C	I/A	
402 Atk	N/O	Unknown	Unknown	MITF	N/C	MITF-GUTC	N/C	N/C	N/C	I/A	
403 Purs	N/O	Unknown	Unknown	LNGF	N/C	LNGF-RATC	N/C	N/C	I/A	I/A	

Air Corps Squadron Training Camps 1921 – 1930											
Squadron	1921	1922	1923	1924	1925	1926	1927	1928	1929	1930	
404 Purs	N/O	Unknown	Unknown	LNGF	LNGF-GUTC	N/C	N/C	N/C	N/C	LNGF-GUTC	
405 Purs	N/O	Unknown	Unknown	LNGF	N/C	N/C	N/C	N/C	N/C	LNGF-GUTC	
406 Purs/Atk	N/O	Unknown	Unknown	LNGF	N/C	N/C	N/C	N/C	N/C	N/C	
409 Atk	N/O	Unknown	Unknown	LNGF	N/C	N/C	N/C	LNGF-GUTC	N/C	LNGF-GUTC	
411 Obsn	N/O	Unknown	Unknown	LNGF	N/C	N/C	N/C	N/C	LNGF-GUTC	I/A	
412 Obsn	N/O	Unknown	Unknown	MAXF	N/C	MAXF-GUTC	N/C	N/C	N/C	I/A	
414 Purs	N/O	Unknown	Unknown	WWF-GUTC	N/C	N/C	N/C	SELF-GUTC	SELF-GUTC	SELF-GUTC	
415 Purs	N/O	Unknown	Unknown	N/C	N/C	N/C	N/C	SELF-GUTC	SELF-GUTC	SELF-GUTC	
416 Purs	N/O	Unknown	Unknown	WWF-GUTC	N/C	N/C	N/C	SELF-GUTC	SELF-GUTC	SELF-GUTC	
417 Purs	N/O	Unknown	Unknown	N/C	N/C	SELF-GUTC	N/C	SELF-GUTC	SELF-GUTC	SELF-GUTC	
418 Obsn	N/O	Unknown	Unknown	N/C	N/C	WWF-GUTC	N/C	SELF-GUTC	SELF-GUTC	SELF-GUTC	
419 Obsn	N/O	Unknown	Unknown	N/C	N/C	CHNF-GUTC	N/C	SELF-GUTC	SELF-GUTC	N/C	
420 Obsn	N/O	Unknown	Unknown	N/C	N/C	CHNF-GUTC	N/C	SELF-GUTC	SELF-GUTC	I/A	
421 Purs	N/O	Unknown	Unknown	N/C	SELF-GUTC	N/C	SELF-GUTC	SELF-GUTC	SELF-GUTC	N/C	
422 Purs	N/O	Unknown	Unknown	N/C	SELF-GUTC	N/C	SELF-GUTC	SELF-GUTC	SELF-GUTC	N/C	
423 Purs/Atk	N/O	Unknown	Unknown	SELF-GUTC	N/C	CHNF-GUTC	SELF-GUTC	SELF-GUTC	SELF-GUTC	N/C	
424 Purs	N/O	Unknown	Unknown	SELF-GUTC	N/C	CHNF-GUTC	SELF-GUTC	SELF-GUTC	SELF-GUTC	I/A	
425 Atk	N/O	Unknown	Unknown	CHNF-GUTC	N/C	N/C	SELF-GUTC	SELF-GUTC	SELF-GUTC	N/C	
426 Atk	N/O	Unknown	Unknown	N/C	N/C	N/C	SELF-GUTC	SELF-GUTC	SELF-GUTC	I/A	
427 Atk	N/O	Unknown	Unknown	N/C	CHNF-GUTC	N/C	SELF-GUTC	SELF-GUTC	SELF-GUTC	N/C	
428 Atk	N/O	Unknown	Unknown	N/C	N/C	N/C	SELF-GUTC	SELF-GUTC	SELF-GUTC	N/C	
429 Purs	N/O	Unknown	Unknown	Richards	N/C	N/C	MSHF-GUTC	N/C	N/C	N/C	
430 Purs	N/O	Unknown	Unknown	Richards	N/C	N/C	MSHF-GUTC	N/C	Richards	MSHF-GUTC	
431 Purs	N/O	Unknown	Unknown	Richards	Richards	N/C	N/C	N/C	N/C	N/C	
432 Purs	N/O	Unknown	Unknown	Richards	Richards	N/C	N/C	N/C	N/C	N/C	
433 Obsn	N/O	Unknown	Unknown	Richards	N/C	MSHF-GUTC	N/C	N/C	N/C	N/C	
434 Obsn	N/O	Unknown	Unknown	BIGF-GUTC	BIGF-GUTC	KELF-GUTC	N/C	N/C	I/A	I/A	
435 Purs	N/O	Unknown	Unknown	KELF-GUTC	N/C	KELF-GUTC	DODF	N/C	N/C	Love-GUTC	
436 Purs	N/O	Unknown	Unknown	BIGF-GUTC	BIGF-GUTC	KELF-GUTC	DODF	N/C	N/C	N/C	
437 Purs	N/O	Unknown	Unknown	N/C	N/C	KELF-GUTC	DODF	N/C	N/C	N/C	
438 Purs	N/O	Unknown	Unknown	N/C	BIGF-GUTC	KELF-GUTC	DODF	N/C	N/C	N/C	
440 Obsn	N/O	Unknown	Unknown	N/C	N/C	ROCF-GUTC	N/C	N/C	N/C	N/C	
441 Obsn	N/O	Unknown	Unknown	N/C	N/C	ROCF-GUTC	N/C	N/C	I/A	I/A	
445 Purs	N/O	Unknown	MITF-GUTC	N/C	MITF-GUTC	N/C	N/C	N/C	N/C	N/C	
447 Purs	N/O	Unknown	Unknown	MITF	MITF-GUTC	N/C	N/C	MITF-RATC	N/C	N/C	
448 Purs	N/O	Unknown	Unknown	MITF	MITF-GUTC	N/C	N/C	N/C	MITF-GUTC	N/C	
449 Purs	N/O	Unknown	Unknown	MITF	N/C	N/C	MITF-GUTC	N/C	N/C	N/C	
451 Obsn	N/O	Unknown	Unknown	MITF	N/C	N/C	N/C	N/C	MITF-GUTC	N/C	
452 Obsn	N/O	Unknown	Unknown	MITF	N/C	N/C	N/C	N/C	MITF-GUTC	N/C	
453 Obsn	N/O	Unknown	Unknown	LNGF	N/C	N/C	LNGF-GUTC	N/C	MITF-GUTC	N/C	
455 Purs/Bomb	N/O	Unknown	Unknown	MAXF	N/C	MAXF-GUTC	MAXF-GUTC	MAXF-RATC	I/A	I/A	
456 Purs	N/O	Unknown	Unknown	MAXF	N/C	N/C	N/C	N/C	MAXF-RATC	N/C	
457 Purs	N/O	Unknown	Unknown	MAXF	N/C	N/C	N/C	N/C	MAXF-RATC	N/C	
458 Purs/Bomb	N/O	Unknown	Unknown	MAXF	N/C	N/C	Candler-IND	N/C	MAXF-RATC	N/A	
459 Obsn	N/O	Unknown	Unknown	MAXF	N/C	MAXF-GUTC	N/C	MAXF	I/A	I/A	

Air Corps Squadron Training Camps 1921 – 1930											
Squadron	1921	1922	1923	1924	1925	1926	1927	1928	1929	1930	
460 Obsn	N/O	Unknown	Unknown	N/C	N/C	WWF-GUTC	N/C	SELF-GUTC	SELF-GUTC	I/A	
461 Obsn	N/O	Unknown	Unknown	N/C	N/C	N/C	N/C	SELF-GUTC	SELF-GUTC	I/A	
462 Purs	N/O	Unknown	Unknown	N/C	N/C	N/C	N/C	SELF-GUTC	SELF-GUTC	I/A	
463 Purs	N/O	Unknown	Unknown	N/C	N/C	SELF-GUTC	N/C	SELF-GUTC	SELF-GUTC	I/A	
464 Purs	N/O	Unknown	Unknown	WWF-GUTC	N/C	N/C	N/C	SELF-GUTC	SELF-GUTC	I/A	
465 Purs/Atk	N/O	Unknown	Unknown	WWF-GUTC	N/C	N/C	N/C	SELF-GUTC	SELF-GUTC	I/A	
466 HQ	N/O	Unknown	Unknown	WWF-GUTC	N/C	N/C	N/C	N/C	I/A	I/A	
467 Atk	N/O	Unknown	Unknown	CHNF-GUTC	N/C	CHNF-GUTC	SELF-GUTC	SELF-GUTC	SELF-GUTC	N/C	
468 Atk	N/O	Unknown	Unknown	CHNF-GUTC	N/C	N/C	SELF-GUTC	SELF-GUTC	SELF-GUTC	N/C	
469 Atk	N/O	Unknown	Unknown	N/C	CHNF-GUTC	N/C	SELF-GUTC	SELF-GUTC	I/A	I/A	
470 Atk	N/O	Unknown	Unknown	CHNF-GUTC	N/C	N/C	SELF-GUTC	SELF-GUTC	N/C	N/C	
471 Obsn	N/O	Unknown	Unknown	Richards	MSHF-GUTC	N/C	MSHF-GUTC	MSHF-GUTC	I/A	I/A	
472 Atk	N/O	Unknown	Unknown	N/C	PSTF-GUTC	KELF-GUTC	FCRO-RATC	N/C	N/C	N/C	
473 Atk	N/O	Unknown	Unknown	N/C	PSTF-GUTC	KELF-GUTC	FCRO-RATC	N/C	N/C	N/C	
474 Atk	N/O	Unknown	Unknown	N/C	N/C	KELF-GUTC	FCRO-RATC	N/C	N/C	N/C	
475 Atk	N/O	Unknown	Unknown	KELF-GUTC	KELF-GUTC	KELF-GUTC	FCRO-RATC	N/C	N/C	N/C	
476 Purs/Atk	N/O	Unknown	Unknown	N/C	ROCF-GUTC	Clover-RATC	Clover-GUTC	ROCF-GUTC	ROCF-GUTC	I/A	
477 Purs	N/O	Unknown	Unknown	N/C	ROCF-GUTC	Clover-RATC	Clover-GUTC	ROCF-GUTC	ROCF-GUTC	N/C	
478 Purs	N/O	Unknown	Unknown	ROCF	ROCF-GUTC	Clover-RATC	Clover-GUTC	ROCF-GUTC	ROCF-GUTC	Long Beach	
479 Purs	N/O	Unknown	Unknown	N/C	N/C	Clover-RATC	Clover-GUTC	ROCF-GUTC	ROCF-GUTC	Long Beach	
481 Bomb				N/O	N/C	N/C	N/C	N/C	N/C	LNGF-GUTC	
482 Bomb				N/O	N/C	LNGF-RATC	N/C	N/C	N/C	I/A	
483 Bomb				N/O	N/C	PHIF-RATC	N/C	N/C	N/C	I/A	
484 Bomb				N/O	N/O	N/O	N/O	N/C	N/C	N/C	
489 Bomb				N/O	ROCF-GUTC	ROCF-GUTC	PEAF-GUTC	PEAF-GUTC	PEAF-GUTC	PEAF-GUTC	
490 Bomb				N/O	ROCF-GUTC	ROCF-GUTC	PEAF-GUTC	PEAF-GUTC	N/C	N/C	
491 Bomb				N/O	N/C	PEAF-GUTC	N/C	N/C	N/C	N/C	
492 Bomb				N/O	N/C	PEAF-GUTC	N/C	N/C	N/C	N/C	
493 Bomb				N/O	N/O	N/C	SELF-GUTC	SELF-GUTC	SELF-GUTC	I/A	
494 Bomb				N/O	N/O	N/C	N/C	SELF-GUTC	SELF-GUTC	N/C	
495 Bomb				N/O	N/O	N/C	SELF-GUTC	SELF-GUTC	SELF-GUTC	I/A	
496 Bomb/Atk				N/O	N/O	N/C	SELF-GUTC	SELF-GUTC	SELF-GUTC	I/A	
497 Purs				N/O	N/C	N/C	N/C	N/C	SELF-GUTC	N/C	
498 Purs				N/O	N/C	N/C	N/C	N/C	SELF-GUTC	N/C	
499 Purs				N/O	N/C	N/C	N/C	N/C	SELF-GUTC	N/C	
500 Purs				N/O	N/C	N/C	N/C	N/C	SELF-GUTC	N/C	
501 Purs/Ttn	N/O	Unknown	Unknown	LNGF	N/C	N/C	N/C	N/C	SELF-GUTC	I/A	
502 Purs/Ttn	N/O	Unknown	Unknown	LNGF	N/C	LNGF-RATC	N/C	N/C	N/C	I/A	
503 Purs/Ttn	N/O	Unknown	Unknown	N/C	LNGF-GUTC	N/C	N/C	N/C	N/C	I/A	
505 Purs/Ttn	N/O	Unknown	Unknown	N/C	BIGF-GUTC	KELF-GUTC	DODF	N/C	N/C	N/C	
506 Purs/Ttn	N/O	Unknown	Unknown	N/C	N/C	KELF-GUTC	DODF	N/C	N/C	N/C	
507 Purs	N/O	Unknown	Unknown	KELF-GUTC	KELF-GUTC	KELF-GUTC	DODF	N/C	N/C	N/C	
508 Purs/Serv	N/O	Unknown	Unknown	KELF-GUTC	KELF-GUTC	KELF-GUTC	DODF	N/C	N/C	N/C	
514 Obsn	N/O	Unknown	Unknown	N/C	ROCF-GUTC	ROCF-GUTC	ROCF-GUTC	ROCF-GUTC	ROCF-GUTC	I/A	
526 Purs				N/C	N/C	N/C	MSHF-GUTC	N/C	N/C	N/C	

Air Corps Squadron Training Camps 1921 – 1930										
Squadron	1921	1922	1923	1924	1925	1926	1927	1928	1929	1930
527 Purs/Tm				N/C	N/C	MSHF-GUTC	N/C	N/C	N/C	N/C
530 Purs/Tm				N/C	N/C	MSHF-GUTC	N/C	N/C	N/C	N/C
534 Purs				N/C	N/C	MSHF-GUTC	N/C	N/C	N/C	N/C
555 Purs				N/C	N/C	N/C	N/C	SELF-GUTC	SELF-GUTC	SELF-GUTC
556 Purs				N/C	N/C	N/C	N/C	SELF-GUTC	SELF-GUTC	SELF-GUTC
803 Obsn				N/O	N/C	MSHF-GUTC	MSHF-GUTC	N/C	N/C	N/C
861 Obsn									MITF-GUTC	N/C
862 Obsn									N/O	N/C
863 Obsn									N/O	N/C

Air Corps Squadron Training Camps 1931 - 1940										
Squadron	1931	1932	1933	1934	1935	1936	1937	1938	1939	1940
45 Obsn	Hensley	Hensley	Unknown	D/B 1-10-33						
49 Serv				N/O	N/O	N/O	Long Beach	I/A	I/A	I/A
77 Obsn	Hensley	N/C	RA-A	RA-A	RA-A	RA-A	RA-A	RA-A	RA-A	RA-A
101 Obsn	Marston	Marston	Marston	Pine Cp-MAN	Pine Cp-MAN	Marston	Trumbull	Marston	PLBK-MAN	NNYS-MAN
102 Obsn	Pine Cp	Pine Cp	Pine Cp	Pine Cp-MAN	Pine Cp	Pine Cp	Pine Cp	Pine Cp	PLBK-MAN	NNYS-MAN
103 Obsn	MAD	MAD	MAD	MAD	MAD	MAD	MAD	Indiantown	MNVA-MAN	NNYS-MAN
104 Obsn	Detrick	Detrick	Detrick	Detrick	MAD	MAD	Detrick	VA Beach	MNVA-MAN	NNYS-MAN
105 Obsn	CJAC	CJAC	CJAC	CJAC/POPF	CJAC/FMOU	Valp/FBAR/ POPF/FMOU	Valp/CJAC/ POPF/KWBK/ FMOU	DeSoto-MAN	CJAC/POPF	KNLA-MAN
106 Obsn	FMCL	FMCL	FMCL	FBAR/FMOU	BEAU/KWBK	Valp/KWBK/ GODF	Valp/CJAC/ BEAU/Sheiby	DeSoto-MAN	BFM/BEAU/ KWBK/Foster	KNLA-MAN
107 Obsn	Grayling	Grayling	Grayling	Grayling	Grayling	CCUS-MAN	Grayling	Grayling	Grayling	McCoy-MAN
108 Obsn	Grant	Grant	Grant	Grant	Grant	CCUS-MAN	Grant	Grant	Grant	McCoy-MAN
109 Obsn	Ripley	Ripley	Ripley	Ripley	Ripley	Ripley	Ripley-MAN	Ripley	Ripley/Dodge	Ripley-MAN
110 Obsn	MSHF	MSHF/FBAR	MSHF	MSHF/Clark	MSHF/Hulen	MSHF/Hulen	FRK-MAN	Valp	PSTF	Ripley-MAN
111 Obsn	Hulen	Hulen	Hulen	Hulen/Woitors	Hulen	Hulen	Hulen	CBUL-MAN	Hulen	KNLA-MAN
112 Obsn	Perry	Perry	Perry	Perry	Perry	FKNX-MAN	Perry	Perry	Perry	McCoy-MAN
113 Obsn	GODF	GODF	GODF	GODF	GODF	FKNX-MAN	GODF	Valp	GODF	McCoy-MAN
114 Obsn	I/A	I/A	I/A	I/A	I/A	I/A	I/A	I/A	I/A	I/A
115 Obsn	SLO	SLO	SLO	SLO	SLO	SLO	SLO-MAN	SLO	SLO	FLEW-MAN
116 Obsn	GRYE	GRYE	GRYE	GRYE	GRYE	GRYE	FLEW-MAN	GRYE	GRYE	FLEW-MAN
118 Obsn	Trumbull	Trumbull	Trumbull	Trumbull	Pine Cp-MAN	Trumbull	Trumbull	Trumbull	PLBK-MAN	NNYS-MAN
119 Obsn	Newark	Newark	FDIX	FDIX	Pine Cp-MAN	FDIX	FDIX	Sea Girt	PLBK-MAN	NNYS-MAN
120 Obsn	Lowry	PSTF	PSTF	Lowry	Lowry	Lowry	PSTF	CBUL-MAN	Boise	KNLA-MAN
135 Obsn	I/A	I/A	I/A	I/A	I/A	I/A	I/A	I/A	I/A	I/A
136 Obsn	I/A	I/A	I/A	I/A	I/A	I/A	I/A	I/A	I/A	I/A
137 Obsn	I/A	I/A	I/A	I/A	I/A	I/A	I/A	I/A	I/A	I/A
154 Obsn	LRAID/FBAR	MSHF/FBAR	Unknown	MSHF	Unknown	Hulen	FRK-MAN	Valp	PSTF	Ripley-MAN
301 Obsn	MITE-IND	Marston-NG	N/C	Boston-IND	Trumbull-IND	Trumbull-IND	N/C	N/C	N/C	N/C
302 Obsn	MITE-GUTC	N/C	MITE-GUTC	MITE-GUTC	N/C	MITE-GUTC	MITE-GUTC	N/C	N/C	N/C
303 Obsn	N/C	MITE-GUTC	Unknown	N/C	N/C	N/C	N/C	I/A	I/A	I/A
304 Obsn	LNGF-GUTC	N/C	Unknown	N/C	N/C	N/C	N/C	N/C	I/A	I/A
305 Obsn	N/C	N/C	Unknown	N/C	N/C	N/C	N/C	N/C	I/A	I/A
306 Obsn	MAXF-RATC	Candler-GUTC	MAXF-CCT	Candler-IND	Candler-IND	Candler-IND	Candler-IND	N/C	I/A	I/A
307 Obsn	N/C	Candler-GUTC	MAXF-CCT	Candler-IND	Candler-IND	Candler-IND	Candler-IND	N/C	I/A	I/A
308 Obsn	SELF-GUTC	N/C	PATE-IND	N/C	N/C	N/C	N/C	N/C	N/C	N/C
309 Obsn	SELF-GUTC	N/C	PATE-IND	Schoen-GUTC	N/C	N/C	N/C	N/C	N/C	N/C
310 Obsn	N/C	N/C	Unknown	N/C	N/C	N/C	N/C	N/C	N/C	N/C
311 Obsn	SCTF-GUTC	N/C	Unknown	N/C	N/C	N/C	N/C	N/C	N/C	N/C
312 Obsn	MAXF-RATC	Candler-GUTC	Unknown	Candler-IND	Candler-IND	Candler-IND	Candler-IND	N/C	N/C	N/C
313 Obsn	N/C	N/C	Unknown	N/C	N/C	N/C	N/C	N/C	N/C	N/C
314 Obsn	N/C	MSHF-GUTC	Unknown	MSHF-GUTC	MSHF-GUTC	Ripley-GUTC	Ripley-MAN	Dodge	Richards	I/A
315 Obsn	Hensley	Hensley	Hensley	Hensley	Hensley	Hensley	Hensley	Hensley	N/C	N/C

Squadron	Air Corps Squadron Training Camps 1931 - 1940									
	1931	1932	1933	1934	1935	1936	1937	1938	1939	1940
316 Obsn	CRSF-RATC	MTHF	HAMF-GUTC	HAMF-GUTC	HAMF-GUTC	HAMF-GUTC	MOFF-GUTC	N/C	N/C	N/C
319 Obsn	MITF-IND	Marston-NG	N/C	Boston-GUTC	Trumbull-GUTC	Trumbull-IND	N/C	N/C	N/C	N/C
320 Obsn	Hensley	Hensley	Hensley	Hensley	N/C	Hensley	Hensley	Hensley	N/C	N/C
321 Obsn	PEAF-GUTC	PEAF-GUTC	PEAF-GUTC	PEAF-GUTC	PEAF-GUTC	PEAF-GUTC	PEAF-GUTC	PEAF-GUTC	N/C	PEAF-GUTC
322 Obsn	MITF-IND	Marston-NG	N/C	Boston-IND	Trumbull-IND	Trumbull-IND	N/C	N/C	N/C	N/C
323 Obsn	N/C	N/C	Unknown	N/C	N/C	N/C	N/C	N/C	N/C	N/C
324 Obsn	LNGF-GUTC	N/C	LNGF-GUTC	LNGF-GUTC	LNGF-GUTC	LNGF-GUTC	LNGF-GUTC	N/C	N/C	N/C
325 Obsn	SELF-GUTC	N/C	PATF-IND	D/B 1-10-33	Schoen-GUTC	N/C	N/C	N/C	N/C	N/C
326 Obsn	N/C	N/C	Unknown	N/C	N/C	N/C	N/C	N/C	N/C	N/C
327 Obsn	N/C	N/C	Unknown	N/C	N/C	N/C	N/C	N/C	N/C	N/C
328 Obsn	Hensley	Hensley	Hensley	Hensley	N/C	Hensley	Hensley	Hensley	N/C	N/C
329 Obsn	CRSF-RATC	Woodward	Woodward	Woodward	Woodward	N/C	N/C	N/C	N/C	Woodward
339 Serv	N/C	N/C	Unknown	D/B 1-10-33						
341 Serv	N/C	N/C	Unknown	N/C	N/C	N/C	N/C	N/C	N/C	N/C
349 Serv	N/C	N/C	Unknown	N/C	N/C	N/C	N/C	N/C	N/C	N/C
350 Serv	N/C	N/C	Unknown	N/C	N/C	N/C	N/C	N/C	N/C	N/C
351 Obsn	N/C	N/C	Unknown	N/C	N/C	N/C	N/C	N/C	N/C	N/C
353 Obsn	N/C	N/C	Unknown	N/C	N/C	N/C	N/C	N/C	N/C	N/C
354 Obsn	N/C	N/C	Unknown	D/B 1-10-33						
355 Obsn	N/C	LNGF-GUTC	Unknown	D/B 1-10-33						
357 Obsn	N/C	N/C	Unknown	Candler-IND	Candler-IND	Candler-IND	I/A	I/A	I/A	I/A
358 Obsn	MAXF-RATC	Candler-GUTC	Unknown	Candler-IND	Candler-IND	Candler-IND	I/A	I/A	I/A	I/A
359 Obsn	N/C	N/C	Unknown	Schoen-GUTC	N/C	N/C	I/A	I/A	I/A	I/A
360 Obsn	I/A	I/A	I/A	I/A	I/A	I/A	I/A	I/A	I/A	I/A
361 Obsn	I/A	I/A	I/A	D/B 1-10-33						
362 Obsn	I/A	I/A	I/A	D/B 1-10-33						
363 Obsn	N/C	N/C	Unknown	D/B 1-10-33						
364 Obsn	N/C	N/C	Unknown	D/B 1-10-33						
365 Obsn	Hensley	Hensley	Hensley	N/C	Hensley	Hensley	I/A	I/A	I/A	I/A
366 Obsn	Hensley	Hensley	Hensley	Hensley	Hensley	Hensley	I/A	I/A	I/A	I/A
367 Obsn	CRSF-RATC	MTHF	HAMF-GUTC	HAMF-GUTC	HAMF-GUTC	HAMF-GUTC	SLO-MAN	I/A	I/A	I/A
368 Obsn	I/A	I/A	I/A	I/A	I/A	I/A	I/A	I/A	I/A	I/A
369 Obsn	MITF-GUTC	N/C	MITF-GUTC	MITF-GUTC	MITF-GUTC	MITF-GUTC	MITF-GUTC	N/C	N/C	N/C
370 Obsn	N/C	N/C	Unknown	D/B 1-10-33						
371 Obsn	N/C	N/C	Unknown	D/B 1-10-33						
372 Obsn	N/C	N/C	Unknown	D/B 1-10-33						
380 Serv	N/C	N/C	Unknown	N/C	N/C	N/C	I/A	I/A	I/A	I/A
381 Serv	N/C	N/C	Unknown	N/C	N/C	N/C	MOFF-GUTC	N/C	I/A	I/A
383 Serv	I/A	I/A	I/A	I/A	I/A	I/A	I/A	I/A	I/A	I/A
387 Serv	N/C	N/C	Unknown	D/B 1-10-33						
396 Purs	I/A	I/A	I/A	D/B 1-10-33						
397 Purs	I/A	I/A	I/A	D/B 1-10-33						
399 Atk	N/C	N/C	Unknown	N/C	N/C	N/C	N/C	N/C	N/C	N/C
400 Atk	N/C	N/C	Unknown	N/C	N/C	N/C	N/C	N/C	N/C	N/C

Air Corps Squadron Training Camps 1931 - 1940											
Squadron	1931	1932	1933	1934	1935	1936	1937	1938	1939	1940	
401 Aik	I/A	I/A	Unknown	N/C	N/C	N/C	N/C				
402 Aik	I/A	I/A	Unknown	N/C	N/C	N/C	N/C				
403 Purs	I/A	I/A	Unknown	D/B 1-10-33							
404 Purs	N/C	LNGF-GUTC	Unknown	N/C	N/C	N/C	N/C	N/C	N/C	I/A	
405 Purs	LNGF-GUTC	N/C	LNGF-GUTC	LNGF-GUTC	LNGF-GUTC	N/C	N/C	N/C	N/C	N/C	
406 Purs/Aik	LNGF-GUTC	N/C	LNGF-GUTC	LNGF-GUTC	N/C	LNGF-GUTC	N/C	N/C	N/C	I/A	
409 Aik	N/C	LNGF-GUTC	Unknown	N/C	LNGF-GUTC	LNGF-GUTC	LNGF-GUTC	N/C	N/C	N/C	
411 Obsn	I/A	I/A	I/A	D/B 1-10-33							
412 Obsn	I/A	I/A	I/A	I/A	I/A	I/A	I/A	I/A	I/A	I/A	
414 Purs	SELF-GUTC	Schoen-GUTC	Unknown	Schoen-GUTC	N/C	N/C	I/A	I/A	I/A	I/A	
415 Purs	SELF-GUTC	Schoen-GUTC	Unknown	D/B 1-10-33							
416 Purs	SELF-GUTC	Schoen-GUTC	Unknown	D/B 1-10-33							
417 Purs	SELF-GUTC	Schoen-GUTC	Unknown	D/B 1-10-33							
418 Obsn	SELF-GUTC	Schoen-GUTC	Unknown	D/B 1-10-33							
419 Obsn	N/C	SELF-GUTC	Unknown	D/B 1-10-33							
420 Obsn	I/A	I/A	I/A	D/B 1-10-33							
421 Purs	SCTF-GUTC	N/C	Unknown	N/C	N/C	SELF-GUTC	N/C	N/C	N/C	N/C	
422 Purs	N/C	SELF-GUTC	Unknown	N/C	N/C	N/C	N/C	N/C	N/C	N/C	
423 Purs/Aik	SCTF-GUTC	SELF-GUTC	Unknown	N/C	N/C	N/C	N/C	N/C	N/C	N/C	
424 Purs	I/A	I/A	I/A	D/B 1-10-33							
425 Aik	SCTF-GUTC	SCTF-GUTC	Unknown	N/C	N/C	N/C	N/C	N/C	N/C	N/C	
426 Aik	I/A	I/A	Unknown	I/A	I/A	I/A	I/A	I/A	I/A	I/A	
427 Aik	N/C	N/C	Unknown	N/C	N/C	N/C	N/C	I/A	I/A	I/A	
428 Aik	N/C	SELF-GUTC	Unknown	N/C	N/C	N/C	N/C	N/C	N/C	N/C	
429 Purs	N/C	N/C	Unknown	D/B 1-10-33							
430 Purs	MSHF-GUTC	MSHF-GUTC	Unknown	MSHF-GUTC	MSHF-GUTC	Ripley-GUTC	N/C	Dodge	Richards	I/A	
431 Purs	N/C	N/C	Unknown	D/B 1-10-33							
432 Purs	N/C	N/C	Unknown	D/B 1-10-33							
433 Obsn	N/C	N/C	Unknown	D/B 1-10-33							
434 Obsn	I/A	I/A	I/A	D/B 1-10-33							
435 Purs	Hensley	Hensley	Hensley	Hensley	Hensley	N/C	I/A	I/A	I/A	I/A	
436 Purs	N/C	N/C	Hensley	Hensley	N/C	N/C	I/A	I/A	I/A	I/A	
437 Purs	N/C	N/C	Unknown	D/B 1-10-33							
438 Purs	N/C	N/C	Unknown	D/B 1-10-33							
440 Obsn	N/C	N/C	Unknown	D/B 1-10-33							
441 Obsn	I/A	I/A	I/A	D/B 1-10-33							
445 Purs	N/C	N/C	Unknown	D/B 1-10-33							
447 Purs	N/C	N/C	Unknown	N/C	N/C	N/C	N/C	N/C	N/C	N/C	
448 Purs	N/C	N/C	Unknown	N/C	N/C	N/C	N/C	N/C	N/C	N/C	
449 Purs	N/C	N/C	Unknown	N/C	N/C	N/C	N/C	N/C	N/C	N/C	
451 Obsn	N/C	N/C	Unknown	D/B 1-10-33							
452 Obsn	N/C	N/C	Unknown	D/B 1-10-33							
453 Obsn	I/A	I/A	I/A	D/B 1-10-33							
455 Purs/Bomb	I/A	I/A	I/A	I/A	I/A	I/A	I/A	I/A	I/A	I/A	
456 Purs	MAXF-RATC	Candler-GUTC	MAXF-CCT	Candler-IND	Candler-IND	Candler-IND	Candler-IND	N/C	N/C	N/C	

Air Corps Squadron Training Camps 1931 - 1940											
Squadron	1931	1932	1933	1934	1935	1936	1937	1938	1939	1940	
457 Purs	MAXF-RATC	Candler-GUTC	MAXF-CCT	Candler-IND	Candler-IND	Candler-IND	Candler-IND	N/C	N/C	N/C	
458 Purs/Bomb	Candler-IND	Candler-IND	MAXF-CCT	N/C	N/C	N/C	N/C	N/C	N/C	N/C	
459 Obsn	I/A	I/A	I/A	I/A	I/A	I/A	I/A	I/A	I/A	I/A	
460 Obsn	I/A	I/A	I/A	D/B 1-10-33							
461 Obsn	I/A	I/A	I/A	D/B 1-10-33							
462 Purs	I/A	I/A	I/A	D/B 1-10-33							
463 Purs	I/A	I/A	I/A	D/B 1-10-33							
464 Purs	I/A	I/A	I/A	I/A	I/A	I/A	I/A	I/A	I/A	I/A	
465 Purs/Atk	I/A	I/A	Unknown	D/B 1-10-33							
466 HQ	I/A	I/A	I/A	I/A	I/A	I/A	I/A	I/A	I/A	I/A	
467 Atk	SCTF-GUTC	N/C	Unknown	N/C	N/C	N/C	N/C	N/C	N/C	N/C	
468 Atk	SCTF-GUTC	N/C	Unknown	N/C	N/C	N/C	N/C	N/C	N/C	N/C	
469 Atk	I/A	I/A	I/A	I/A	I/A	I/A	I/A	I/A	I/A	I/A	
470 Atk	N/C	N/C	Unknown	N/C	N/C	N/C	N/C	N/C	N/C	N/C	
471 Obsn	I/A	I/A	I/A	I/A	I/A	I/A	I/A	I/A	I/A	I/A	
472 Atk	N/C	N/C	Hensley	Hensley	N/C	N/C	I/A	I/A	I/A	I/A	
473 Atk	N/C	N/C	Hensley	Hensley	N/C	N/C	I/A	I/A	I/A	I/A	
474 Atk	N/C	N/C	Unknown	N/C	N/C	N/C	I/A	I/A	I/A	I/A	
475 Atk	N/C	N/C	Unknown	N/C	N/C	N/C	I/A	I/A	I/A	I/A	
476 Purs/Atk	I/A	I/A	I/A	I/A	I/A	I/A	I/A	I/A	I/A	I/A	
477 Purs	I/A	I/A	I/A	D/B 1-10-33							
478 Purs	Long Beach	Long Beach	Long Beach	D/B 1-10-33							
479 Purs	Long Beach	Long Beach	Long Beach	Long Beach	Long Beach	Long Beach	Long Beach	I/A	I/A	I/A	
481 Bomb	N/C	LNGF-GUTC	Unknown	N/C	LNGF-GUTC	LNGF-GUTC	LNGF-GUTC	N/C	N/C	I/A	
482 Bomb	I/A	I/A	I/A	I/A	I/A	I/A	I/A	I/A	I/A	I/A	
483 Bomb	I/A	I/A	I/A	I/A	I/A	I/A	I/A	I/A	I/A	I/A	
484 Bomb	N/C	N/C	Hensley	Hensley	N/C	N/C	I/A	I/A	I/A	I/A	
489 Bomb	PEAF-GUTC	PEAF-GUTC	PEAF-GUTC	PEAF-GUTC	PEAF-GUTC	N/C	GRYF-GUTC	GRYF-GUTC	N/C	PEAF-GUTC	
490 Bomb	N/C	N/C	Unknown	N/C	N/C	N/C	I/A	I/A	I/A	I/A	
491 Bomb	N/C	N/C	Unknown	N/C	N/C	N/C	I/A	I/A	I/A	I/A	
492 Bomb	N/C	N/C	Unknown	N/C	N/C	N/C	I/A	I/A	I/A	I/A	
493 Bomb	I/A	I/A	Unknown	I/A	I/A	I/A	N/C	N/C	N/C	N/C	
494 Bomb	SCTF-GUTC	N/C	Unknown	N/C	N/C	N/C	N/C	N/C	N/C	N/C	
495 Bomb	I/A	I/A	I/A	I/A	I/A	I/A	I/A	I/A	I/A	I/A	
496 Bomb/Atk	I/A	I/A	I/A	I/A	I/A	I/A	I/A	I/A	I/A	I/A	
497 Purs	N/C	N/C	Unknown	D/B 1-10-33							
498 Purs	N/C	N/C	Unknown	D/B 1-10-33							
499 Purs	N/C	N/C	Unknown	D/B 1-10-33							
500 Purs	N/C	N/C	Unknown	D/B 1-10-33							
501 Purs/Ttn	I/A	I/A	I/A	I/A	I/A	I/A	I/A	I/A	I/A	I/A	
502 Purs/Ttn	I/A	I/A	I/A	I/A	I/A	I/A	I/A	I/A	I/A	I/A	
503 Purs/Ttn	I/A	I/A	I/A	I/A	I/A	I/A	I/A	I/A	I/A	I/A	
505 Purs/Ttn	N/C	N/C	Unknown	N/C	N/C	N/C	I/A	I/A	I/A	I/A	
506 Purs/Ttn	N/C	N/C	Unknown	N/C	N/C	N/C	I/A	I/A	I/A	I/A	
507 Purs	N/C	N/C	Unknown	D/B 1-10-33							

Air Corps Squadron Training Camps 1931 - 1940										
Squadron	1931	1932	1933	1934	1935	1936	1937	1938	1939	1940
508 Purs	N/C	N/C	Unknown	D/B 1-10-33	Long Beach	Long Beach	Long Beach	D/B 11-06-37		
514 Obsn	I/A	Long Beach	Unknown	Long Beach	N/C	N/C	N/C	N/C	N/C	I/A
526 Purs	N/C	N/C	Unknown	N/C	N/C	N/C	N/C	N/C	N/C	N/C
527 Purs/Tin	N/C	N/C	Unknown	N/C	N/C	N/C	N/C	N/C	N/C	N/C
530 Purs/Tin	N/C	N/C	Unknown	D/B 1-10-33						
534 Purs	N/C	N/C	Unknown	D/B 1-10-33						
555 Purs	SELF-GUTC	N/C	Unknown							
556 Purs	SELF-GUTC	N/C	Unknown							
803 Obsn	N/C	N/C	Unknown	D/B 1-10-33						
861 Obsn	N/C	MITF-GUTC	Unknown	N/C	MITF-GUTC	MITF-GUTC	MITF-GUTC			
862 Obsn	N/C	N/C	LNGF-GUTC	D/B 1-10-33						
863 Obsn	MAXF-RATC	Candler-GUTC	Unknown	D/B 1-10-33						

Military Police Battalion Training Camps 1921 - 1930

Battalion	1922	1923	1924	1925	1926	1927	1928	1929	1930
14 MP Bn	N/O	N/O	N/O	N/O	N/O	N/O	N/C	N/C	N/C
15 MP Bn	N/O	N/O	N/O	N/O	N/O	N/O	N/C	FTHO	N/C
16 MP Bn	N/O	N/O	N/O	N/O	N/O	N/O	N/C	Unknown	FSHN
17 MP Bn	N/O	N/O	N/O	N/O	N/O	N/O	N/C	PSF	DELM
302 MP Bn			N/C	N/C	N/C	N/C	N/C	Unknown	PBRK
304 MP Bn			N/C	N/C	N/C	N/C	N/C	FSCR	N/C
305 MP Bn			N/C	N/C	N/C	N/C	N/C	N/C	N/C
306 MP Bn			N/C	N/C	N/C	N/C	FSHN	N/C	N/C
307 MP Bn			N/C	N/C	FLVN	N/C	FLVN	N/C	N/C
308 MP Bn			N/C	N/C	FSH	N/C	N/C	N/C	N/C
309 MP Bn			N/C	N/C	FMAC	FMAC	FMAC	FMAC	N/C
310 MP Bn			N/C	N/C	N/C	N/C	N/C	N/C	PBRK
312 MP Bn			N/C	N/C	N/C	N/C	N/C	N/C	N/C
313 MP Bn			N/C	N/C	N/C	N/C	N/C	N/C	N/C
314 MP Bn			N/C	N/C	N/C	N/C	N/C	N/C	JFBK
316 MP Bn			N/C	N/C	N/C	N/C	N/C	N/C	N/C
317 MP Bn			N/C	N/C	N/C	N/C	N/C	N/C	N/C
321 MP Bn			N/C	Blauvelt	N/C	FWAD	N/C	N/C	PBRK
322 MP Bn			CCUS	N/C	N/C	N/C	N/C	FSHN	N/C
323 MP Bn			N/C	N/C	N/C	FLVN	N/C	N/C	N/C
324 MP Bn			N/C	N/C	N/C	N/C	N/C	N/C	N/C
325 MP Bn			CCUS	N/C	N/C	N/C	N/C	FSHN	N/C

Military Police Battalion Training Camps 1931 – 1940										
Battalion	1931	1932	1933	1934	1935	1936	1937	1938	1939	1940
14 MP Bn	N/C	N/C	N/C	N/C	N/C	N/C	N/C	N/C	JFBK	N/C
15 MP Bn	FBH	N/C	N/C	N/C	N/C	N/C	N/C	N/C	N/C	N/C
16 MP Bn		N/C	N/C	PBRK	PBRK	PBRK	PBRK	PBRK	N/C	N/C
17 MP Bn	Unknown	FMAC	N/C	N/C	N/C	N/C	FORD	N/C	FSNL	N/C
302 MP Bn	PBRK	PBRK	PBRK	PBRK	PBRK	PBRK	PBRK	PBRK	N/C	N/C
304 MP Bn	N/C	N/C	N/C	N/C	N/C	FMCL	N/C	N/C	FMCL	FBNG
305 MP Bn	N/C	N/C	N/C	N/C	EKNX	N/C	N/C	N/C	N/C	N/C
306 MP Bn	N/C	N/C	N/C	N/C	N/C	N/C	N/C	N/C	N/C	N/C
307 MP Bn	N/C	N/C	N/C	N/C	N/C	N/C	N/C	N/C	N/C	FCRK
308 MP Bn	N/C	N/C	N/C	N/C	N/C	N/C	N/C	N/C	N/C	N/C
309 MP Bn	N/C	FMAC	N/C	N/C	N/C	N/C	FORD	N/C	N/C	N/C
310 MP Bn	PBRK	PBRK	PBRK	PBRK	PBRK	PBRK	PBRK	PBRK	N/C	N/C
312 MP Bn	N/C	N/C	N/C	N/C	N/C	N/C	N/C	N/C	FMCL	FMCL
313 MP Bn	N/C	N/C	N/C	N/C	N/C	N/C	N/C	N/C	JFBK	N/C
314 MP Bn	N/C	JFBK	N/C	N/C	N/C	N/C	N/C	JFBK	N/C	N/C
316 MP Bn	N/C	N/C	N/C	N/C	N/C	N/C	FHUA	FHUA	N/C	N/C
317 MP Bn	FSNL	FSNL	N/C	N/C	N/C	N/C	N/C	FSNL	FSNL	FSNL
321 MP Bn	PBRK	PBRK	PBRK	PBRK	PBRK	PBRK	PBRK	PBRK	N/C	N/C
322 MP Bn	N/C	N/C	N/C	N/C	N/C	N/C	N/C	N/C	N/C	N/C
323 MP Bn	N/C	N/C	N/C	N/C	N/C	N/C	N/C	N/C	N/C	FCRK
324 MP Bn	N/C	N/C	N/C	N/C	N/C	N/C	N/C	N/C	FMCL	N/C
325 MP Bn	N/C	N/C	N/C	N/C	N/C	FSHN	N/C	FSHN	JFBK	N/C

Special Troops Unit Training Camps 1921 – 1930

HQ, Sp Ips	1921	1922	1923	1924	1925	1926	1927	1928	1929	1930
GHQ					N/O	N/O	N/O	N/C	FHAN-GUTC	N/C
VII Corps					N/C	N/C	FLVN-GUTC	N/C	N/C	N/C
VIII Corps					N/C	FSH-RATC	FSH-IND	N/C	N/C	N/C
XVIII Corps					N/C	FSH-RATC	FSH-IND	N/C	N/C	N/C
Third Army					N/C	N/C	N/C	N/C	FGRK-GUTC	N/C
Fourth Army					N/C	FJAY-GUTC	N/C	N/C	N/C	N/C
Sixth Army					N/C	N/C	FLVN-GUTC	N/C	N/C	N/C
2 Cav Div	N/O	N/O	N/O	N/O	N/O	N/O	N/C	FBL(S)(HQ) Peoria(T)	Peoria(T) FCRK(S)	Peoria FCRK(S)
3 Cav Div	N/O	N/O	N/O	N/O	N/O	N/O	N/C	Peoria(T)	Peoria(T)	Peoria
4 Div	N/O	N/O	N/O	N/O	N/O	N/O	N/C	N/C	N/C	N/C
5 Div	N/O	N/O	N/O	N/O	N/O	N/C	FKNX(S)	FKNX(S)	FKNX(S)	N/C
6 Div	N/O	N/O	N/O	N/O	N/O	FSHN	FSHN(S) McCoy(O) Peoria(T)	FSHN(S) Peoria(T) RIA(O)	FSHN(HQ,S,Sv) Peoria(T) RIA(O)	FSHN(S,Sv)=IND
7 Div	N/O	N/O	N/O	N/O	N/O	FCRK(HQ)	FSNL(T)	FCRK(S)	RIA(O)	FSNL(T)
8 Div	N/O	N/O	N/O	N/O	N/O	N/O	N/C	N/C	N/C	FGGM
9 Div	N/O	N/O	N/O	N/O	N/O	N/O	N/O	N/C	N/C	N/C
21 Cav Div	N/O	N/O	N/O	N/O	N/O	N/O	N/O	N/O	N/O	N/O
22 Cav Div	N/O	Douglas(HQIp)	Douglas(HQIp)	Douglas(HQIp)	IA	IA	IA	IA	IA	IA
23 Cav Div	N/O	FMCL(HQIp)	FMCL(HQIp)	FMCL(HQIp)	FOGL(HQIp)	FOGL(HQIp)	FOGL(HQIp)	FOGL(HQIp)	FOGL(HQIp)	FMCL(HQIp)
24 Cav Div	N/O	N/O	N/O	N/O	Murray(HQIp)	Murray(HQIp)	Murray(HQIp)	Murray(HQIp)	Murray(HQIp)	Murray(HQIp)
26 Div	N/O	N/O	N/O	N/O	FDEV	FDEV	FDEV	FDEV	FDEV	FDEV
27 Div	N/O	Smith	Smith	Smith	Smith,FGGM	Smith	Smith	Smith	FDIX-CPX RARS(O) FGGM(T)	Smith FGGM
28 Div	N/O	Mt Gretina FGGM(T)	Mt Gretina FGGM(T)	Mt Gretina FGGM	Mt Gretina FGGM	Mt Gretina FGGM	Mt Gretina	Mt Gretina	Mt Gretina	Mt Gretina FGGM
29 Div	N/O	FGGM(T)	FGGM(T)	FGGM(T)	VA Beach FGGM(T)	VA Beach FGGM	Ritchie FGGM(T)	Ritchie FGGM(T)	Ritchie FGGM(T)	Ritchie FGGM(T)
30 Div	N/O	FMCL(S)	Glenn(S)	Glenn(S)	Glenn(S)	Glenn(S)	FMCL(T)	CJAC	CJAC(S,MP) FMCL(T)	CJAC FMCL(T)
31 Div	N/O	N/O	N/O	FMCL(T)	FMCL(T)	FMCL(T)	FMCL(T)	FMCL(T)	FMCL(T,S,O)	FMCL(T,S,O)
32 Div	N/O	Gray Wms(MP,T)	Gray Wms(MP,T)	Gray Wms(MP,T)	Gray Wms(MP,T)	Gray Wms(MP,T)	Gray Wms(MP,T)	Gray Wms(MP,T)	Gray Wms(MP,T)	Gray Wms(MP,T)
33 Div	N/O	N/O	N/O	Grant	Grant	Grant	Grant	Grant	Grant	Grant
34 Div	N/O	N/O	N/O	N/O	N/O	N/O	N/O	N/O	N/O	N/O
35 Div	N/O	FRK(S)	FRK(S)	FRK(S)	FRK(S)	FRK(S)	FRK(S)	FRK(S)	FRK(S)	FRK(S)
36 Div	N/O	Mabry	Mabry	Mabry	Hulen	Hulen	Hulen	Hulen	Hulen	Hulen
37 Div	N/O	Perry	Perry	Perry	Perry	Perry	Perry	Perry	Perry	Perry
38 Div	N/O	FKNX	FKNX	FKNX	FKNX	FKNX	FKNX	FKNX	FKNX	FKNX
39 Div	N/O	FMCL(T)	FMCL(T)	IA	IA	IA	IA	IA	IA	IA

Special Troops Unit Training Camps 1921 – 1930

HQ, Sp, Ibs	1921	1922	1923	1924	1925	1926	1927	1928	1929	1930
40 Div	DELM(S)	DELM(S)	DELM(S)	DELM(S,I)	DELM(S,I)	DELM(S,I)	DELM(S,I)	DELM(S,I)	SLO	SLO
41 Div	N/O	Murray(T)	Murray(T)	Murray(T)	Murray	Murray	Murray	Murray	Murray	Murray
43 Div	N/O	N/O	Niantic	Niantic	Niantic	Niantic	Niantic	Niantic	Niantic	FDEV
44 Div	N/O	N/O	Sea Girt	Sea Girt	Sea Girt	Sea Girt	Sea Girt	Sea Girt	FDIX-CPX	Sea Girt
45 Div	N/O	FSIL West	FSIL West (T)	FSIL West (T)	FSIL West (T)	FSIL West (T)	FSIL West (T)	FSIL West (T)	FSIL West (T)	FSIL West (T)
61 Cav Div	N/O	FDIX-DGRP	FDIX-DGRP	N/C	Sea Girt-GUTC	N/C	N/C	N/C	N/C	FMON (S)
62 Cav Div	N/O	EGGM-DGRP	EGGM-DGRP	N/C	N/C	N/C	N/C	N/C	FMON(S)	MFLD(O)
63 Cav Div	N/O	N/C	FMCL-DGRP	N/C	FOGL-GUTC	FKNX	N/C	N/C	N/C	EGGM(S)
64 Cav Div	N/O	Unknown	FKNX-DGRP	FKNX-DGRP	FKNX(HQ,S)	N/C	N/C	FKNX-IND	FKNX(S)	FKNX(S)
65 Cav Div	N/O	Unknown	Unknown	N/C	CCUS	N/C	FSHN(HQ,S)	FSHN	FSHN(HQ,S)	FSHN-IND
66 Cav Div	N/O	Unknown	Unknown	N/C	FLVN	N/C	N/C	N/C	FRK-GUTC	FRK(T)
76 Div	N/O	FDEV-DGRP	FDEV-DGRP	FDEV-DGRP	FDEV-GUTC	N/C	N/C	N/C	FMON	FMON(S)
77 Div	N/O	FDIX-DGRP	FDIX-DGRP	FDIX-DGRP	Blauvelt FDIX(T,S)	FSLC(S,MP) FDIX MELD(T,O)	FSLC(S,MP) FDIX MELD(T,O)	FDIX(MP,T,S) MFLD(O) FHAN(S)	FMON(S) MELD(T,O)	FDIX(T) MFLD (O) FMON(S)
78 Div	N/O	FDIX-DGRP	FDIX-DGRP	FDIX-DGRP	Sea Girt FDIX(T,S)	N/C	N/C	N/C	FMON(S)	FDIX(T) MFLD(O) FMON(S)
79 Div	N/O	EGGM-DGRP	EGGM-DGRP	EGGM-DGRP	N/C	N/C	N/C	N/C	FMON(S)	EGGM(S)
80 Div	N/O	EGGM-DGRP	EGGM-DGRP	EGGM-DGRP	N/C	N/C	N/C	N/C	FMCL	EGGM(S)
81 Div	N/O	FMCL-DGRP	FMCL-DGRP	FMCL-DGRP	FMON(S)	FMCL Glenn	N/C	FMCL	FMCL	FMCL(T) FBRG(O)
82 Div	N/O	FMCL-DGRP	FMCL-DGRP	FMCL-DGRP	FMON(S)	FMCL Glenn	N/C	FMCL	FMCL	FMCL(T) FBRG(O)
83 Div	N/O	FKNX-DRGP	FKNX-DRGP	FKNX-DRGP	N/C	FKNX RIA	FBH FKNX	FBH FKNX FTHO	FBH(HQ,MP,T) FKNX(S)	FKNX(S) FTHO-GUTC
84 Div	N/O	FKNX-DRGP	FKNX-DRGP	FKNX-DRGP	N/C	FKNX (S) FBH (T) RIA (O)	Cuiver FBH (T) FKNX	FBH (T) FKNX	FBH(T) FKNX(S)	FKNX(S)
85 Div	N/O	CCUS-DGRP	CCUS-DGRP	CCUS(S)	CCUS	FSHN	FSHN(S)	FSHN	CCUS(HQ)	FSHN Peoria Grav
86 Div	N/O	CCUS-DGRP	CCUS-DGRP	CCUS(S)	CCUS	FSHN	FSHN(HQ,MP,S)	FSHN	FSHN(S,SV)	FSHN Peoria
87 Div	N/O	FMCL-DGRP	FMCL-DGRP	FMCL-DGRP	FMON(S)	FMCL	N/C	FMCL	FMCL	FMCL(T) FBRG(O)
88 Div	N/O	FSNL-DGRP	FSNL-DGRP	FSNL	FSNL(HQ,MP,S,O) FLVN	FSNL(HQ,Sv,T) RIA(O)	FSNL(HQ,Sv,T) RIA(O)	FSNL-GUTC	N/C	FSNL(All)
89 Div	N/O	FDM-DGRP	FDM-DGRP	FDM-DGRP	FDM	FCRK-GUTC	FCRK-GUTC	FCRK-GUTC	FCRK-GUTC	FCRK-GUTC

Special Troops Unit Training Camps 1921 – 1930

HQ. Sp. Tps	1921	1922	1923	1924	1925	1926	1927	1928	1929	1930
90 Div	N/O	FSH-DGRP	FSH-DGRP	FSH-DGRP	N/C	N/C	FSH-RATC	N/C	FSH-RATC	N/C
91 Div	N/O	PMON-DGRP	PMON-DGRP	PMON-DGRP	N/C	N/C	PSF (S,MP,Svc) DELM(T) BARS(O)	PSF (S,MP,Svc) DELM(T)	DELM(HQ,S,Sv,MP) BARS(O) FLEW(T)	DELM(HQ,S,Sv,MP) FLEW(T)
94 Div	N/O	FDEV-DGRP	FDEV-DGRP	FDEV-DGRP	N/C	N/C	N/C	N/C	N/C	FMON SPAR
95 Div	N/O	ESIL-DGRP	ESIL-DGRP	ESIL-DGRP	ESIL-GUTC	FSH-RATC	FSH-RATC	FSH-RATC	FSH-RATC	FSH-RATC
96 Div	N/O	FLEW-DGRP	FLEW-DGRP	FLEW-DGRP	N/C	FLEW	N/C	FLEW-GUTC	FLEW-GUTC	FLEW-GUTC
97 Div	N/O	FDEV-DGRP	FDEV-DGRP	FDEV-DGRP	N/C	N/C	N/C	N/C	FDEV-GUTC	FMON(S)
98 Div	N/O	FDIX-DGRP	FDIX-DGRP	FDIX-DGRP	FDIX(T,S)	FMON-CMTC(S)	MFLD(T) RARS(O)FNIA (HQ,MP,S)		FMON(S) MFLD(TO)	FMON(S) MFLD(T)
99 Div	N/O	EGGM-DGRP	EGGM-DGRP	EGGM-DGRP	N/C	N/C	N/C	N/C	FMON	EGGM(S)
100 Div	N/O	FKNX-DRGP	FKNX-DRGP	FKNX-DRGP	N/C	FKNX(S) FTHO RIA(O)	FTHO(HQ,MP) FBH(T) FKNX(S)	FKNX(O,S) FTHO(HO)	FBH(HQ,MP) FBH(T)	FKNX(S)
101 Div	N/O	CCUS-DGRP	CCUS-DGRP	CCUS(S)	CCUS	FSHN	FSHN(HQ,S)	FSHN Peoria (T)	FSHN(HQ,S) Peoria (T) Grant (O)	FSHN Peoria (T) GrantRIA
102 Div	N/O	JEBK-DGRP	JEBK-DGRP	JEBK-DGRP	FLVN	FLVN(HQ,MP,T,S) RIA(O)		N/C	N/C	N/C
103 Div	N/O	FLOG-DGRP	FLOG-DGRP	FLOG-DGRP	FSH	FSH-RATC	FSH-RATC	FSH-RATC	FSH-RATC	FSH-RATC
104 Div	N/O	FDOU-DGRP	FDOU-DGRP	FDOU-DGRP	FDOU-GUTC	FLEW	N/C	N/C	N/C	N/C

Special Troops Unit Training Camps 1931 - 1940

HQ. Sp. Tps	1931	1932	1933	1934	1935	1936	1937	1938	1939	1940
GHQ	N/C	N/C	N/C	N/C	N/C	N/C	N/C	N/C	N/C	N/C
VII Corps	N/C	N/C	N/C	N/C	N/C	N/C	N/C	N/C	N/C	N/C
VIII Corps	N/C	N/C	N/C	N/C	N/C	N/C	N/C	N/C	N/C	N/C
XVIII Corps	N/C	N/C	N/C	N/C	N/C	N/C	N/C	N/C	N/C	N/C
Third Army	N/C	N/C	N/C	N/C	N/C	N/C	N/C	N/C	N/C	N/C
Fourth Army	N/C	N/C	N/C	N/C	N/C	N/C	N/C	N/C	N/C	N/C
Sixth Army	N/C	N/C	N/C	N/C	N/C	N/C	N/C	N/C	N/C	N/C
2 Cav Div	Arcadia (T)	N/C	N/C	N/C	N/C	N/C	N/C	N/C	N/C	N/C
3 Cav Div	Arcadia (T)	N/C	N/C	N/C	N/C	N/C	N/C	N/C	N/C	N/C
4 Div	N/C	N/C	N/C	N/C	FMPH-IND	FBNG (T)	N/C	N/C	FMPH-GUTC	N/C
5 Div	FKNX (S)	N/C	N/C	N/C	N/C	N/C	N/C	N/C	N/C	N/C
6 Div	FSHN (S)-IND Arcadia (T)	FSHN-IND	N/C	N/C	N/C	N/C	N/C	N/C	JFBK (MP.T)	CCUS (S)
7 Div	N/C	N/C	N/C	N/C	N/C	N/C	N/C	FSNL (T)	FSNL (T)	FCRK (MP)
8 Div	N/C	N/C	N/C	N/C	N/C	N/C	N/C	EGGM (S)-CMTC	EGGM (S)-CMTC	
9 Div	CCUS (Sv)	N/C	N/C	N/C	N/C	N/C	N/C	FEA (S)	N/C	N/C
21 Cav Div	N/O	N/O	N/O	N/O	N/O	N/O	N/O	N/O	N/O	NNYS-MAN
22 Cav Div	IA	IA	IA	IA	IA	IA	IA	IA	IA	McCoy-MAN
23 Cav Div	FOGL (HQIp)	FOGL (HQIp)	N/O	N/O	N/O	N/O	N/O	N/O	N/O	KNL-A-MAN
24 Cav Div	Murray (HQIp)	Murray (HQIp)	Murray (HQIp)	Murray (HQIp)	Murray (HQIp)	Murray (HQIp)	FRK-MAN	Murray (HQIp)	Murray (HQIp)	FILEW-MAN
26 Div	FDEV	FDEV	FDEV	FDEV	Pine Cp-Man	Edwards	Edwards	Edwards	PLBK-MAN	NNYS-MAN
27 Div	Smith EGGM (O.T)	Smith EGGM (O.T)	Smith EGGM (O.T)	Smith RARS (O)	Pine Cp-Man	Smith RARS (O)	Smith PC (O)	Smith FGGM (T) RARS (O)	PLBK-MAN	NNYS-MAN
28 Div	Mt Gretna Ritchie EGGM (T)	Mt Gretna VA Beach EGGM (T)	Mt Gretna Ritchie EGGM (T)	Mt Gretna Ind Gap (O)	Ind Gap-Man	Ind Gap	Ind Gap	Ind Gap Fr Royal EGGM (T)	MNVA-MAN	NNYS-MAN
29 Div	N/C	N/C	N/C	N/C	Ind Gap-MAN	Ind Gap	N/C	Ind Gap	MNVA-MAN	NNYS-MAN
30 Div	CJAC FMCL (T)	CJAC FMCL (T)	CJAC FMCL (T)	CJAC FMCL (T)	CJAC FMCL (T) Peay (MP)	CJAC FMCL (T) Peay (MP)	CJAC FMCL (O.T)	DeSoto-MAN	CJAC	KNL-A-MAN
31 Div	FMCL (T,S,O)	FMCL	FOGL	FOGL FMCL (T,O)	FMCL FBRG (O) FMCL (T,MP)	FMCL FBRG (O)	FMCL BEAU (S)	DeSoto-MAN	Foster (T,MP) Shelby (S,O)	KNL-A-MAN
32 Div	Gray Wms (MP.T)	Gray Wms (MP.T)	Gray Wms (MP.T)	Gray Wms (MP.T)	Gray Wms (MP.T)	CCUS-MAN	Gray Wms (MP.T)	Gray Wms (MP.T)	Gray Wms (MP.T)	McCoy-MAN
33 Div	Grant	Grant	Grant	Grant	Grant	CCUS-MAN	Grant	Grant	Grant	McCoy-MAN
34 Div	Dodge (S)	Dodge (S)	Dodge (S)	Dodge (S)	Ripley	Ripley	Ripley-MAN	Dodge (HQ, Med) Ripley (T)	Dodge (HQ, Med, S) Ripley (T)	Ripley-MAN
35 Div	FRK (S) Clark (T)	FRK (S) Clark (T)	FRK (S) Clark (T)	FRK (S) Clark (T)	FRK (S) Clark (T)	Ashland (S) Clark (T)	FRK-MAN	Clark (T,S, HQ) FRK (MP)	Clark (T) FRK (HQ, MP, S)	Ripley-MAN
36 Div	Hulen	Hulen	Hulen	Hulen	Hulen	Hulen	Hulen	CBUL-MAN	Hulen	KNL-A-MAN
37 Div	Perry EGGM (T)	Perry	Perry	Perry	Perry	FKNX-MAN	Perry	Perry	Perry	McCoy-MAN
38 Div	FKNX	FKNX	FKNX	FKNX	FKNX	FKNX-MAN	FKNX	FKNX	FKNX	McCoy-MAN

		Special Troops Unit Training Camps 1931 - 1940											
HQ. Sp Tps	1931	1932	1933	1934	1935	1936	1937	1938	1939	1940			
39 Div	IA	IA	IA	IA	IA	IA	IA	IA	IA	IA	IA	IA	
40 Div	SLO	SLO	SLO	SLO	SLO	SLO	SLO-MAN	SLO	SLO	SLO	SLO	FLEW-MAN	
41 Div	Murray	Murray	Murray	Murray	Murray	Murray	Murray-MAN	Murray Clat(S)	Murray	Murray	Murray	FLEW-MAN	
43 Div	Niantic	Niantic Keyes(HS)	Niantic FEA(S)	Niantic Quonsett Niantic(T)	Pine Cp-MAN	Niantic	Niantic Keyes(HQ.S)	FEA	PLBK-MAN	PLBK-MAN	NNYS-MAN	NNYS-MAN	
44 Div	Sea Girt PC(O)	Sea Girt FSIL West (T)	Sea Girt FSIL West (T)	Sea Girt FSIL West (T)	Pine Cp-MAN FSIL West (T)	Sea Girt FSIL West (T)	Sea Girt FSIL West (T)	Sea Girt CBUL FFEW(T)	PLBK-MAN FSIL West (T)	PLBK-MAN FSIL West (T)	NNYS-MAN FSIL West (T)	NNYS-MAN KNLA-MAN	
45 Div	West (T)	West (T)	West (T)	West (T)	West (T)	West (T)	West (T)	West (T)	West (T)	West (T)	West (T)	KNLA-MAN	
61 Cav Div	FDIX(S,O)	FDIX(S)	Unknown	FDIX(S) RARS(O)	FEA(S)	N/C	RARS(O)	FEA-CPX	N/C	N/C	N/C	N/C	
62 Cav Div	FGGM,CMTC(S)	FGGM(T,S)-CMTC	FGGM(T,S)	FGGM(T,S)-CMTC	FGGM(T,S)-CMTC	FGGM(T,S)-CMTC	Unknown	FGGM(S,T)	FGGM(S)-CMTC	FGGM(S)-CMTC	FGGM(S)-CMTC	Unknown	
63 Cav Div	N/C	N/C	Unknown	N/C	FBRG(O)	N/C	FOGL(T)	N/C	FOGL-CMTC	FOGL-CMTC	FOGL-GUTC	FOGL-GUTC	
64 Cav Div	FKNX(S)	N/C	N/C	FKNX(S)	FKNX-CPX	N/C	N/C	N/C	FKNX-CPX	FKNX-CPX	FKNX-SA	FKNX-SA	
65 Cav Div	N/C	ESHN-CPX(S)	Unknown	N/C	N/C	N/C	N/C	N/C	JFBK(T)	JFBK(T)	N/C	N/C	
66 Cav Div	ERK-IND	N/C	Unknown	N/C	ERK-IND	N/C	N/C	FSNL(T)	FSNL(T)	FSNL(T)	N/C	N/C	
76 Div	FDEV	N/C	Unknown	N/C	FDEV(S)	N/C	N/C	N/C	N/C	N/C	N/C	N/C	
77 Div	FDIX	FDIX(S)	Unknown	FDIX-CPX	N/C	MFLD(T) FDIX(S)-CPX	FDIX-CPX	RARS(O)	RARS(O)	RARS(O)	RARS(O)	N/C	
78 Div		FDIX(S) MFLD(T) RARS(O) EWD(T)	Unknown	N/C	N/C	N/C	FDIX	FDIX(S) RARS(O)	RARS(O)	RARS(O)	RARS(O)	FDIX(S)	
79 Div	FGGM(T,S)-CMTC	FGGM(T,S)-CMTC	FGGM(T,S)	FGGM(T,S)-CMTC	FGGM(T,S)-CMTC	FGGM(T,S)-CMTC	FGGM(T,S)-CMTC	FGGM(S,T)	FGGM(S)-CMTC	FGGM(S)-CMTC	FGGM(S)-CMTC	N/C	
80 Div	FGGM(T)	FGGM(T,S)-CMTC	FGGM(T,S)	FGGM(T,S)-CMTC	FGGM(T,S)-CMTC	FGGM(T,S)-CMTC	FGGM(T,S)-CMTC	FGGM(S,T)	FGGM(S)-CMTC	FGGM(S)-CMTC	FGGM(S)-CMTC	FGGM-CPX	
81 Div	FBRG(O)	FBRG(O)	FBRG(O,S)	FBRG(O)	FMOU FBRG(O)	FMCL FBRG(T)	FMPH FBNG(S)	N/C	N/C	N/C	N/C	FMCL-IND	
82 Div	FBRG(O)	FBRG(O)	FBRG(O)	FBRG(O)	FMCL FBRG(O)	FMPH FBRG(T)	FMPH FBNG(S)	N/C	FMOU-GUTC	FMOU-GUTC	FMOU-GUTC	FBNG-IND	
83 Div	FKNX(S,O)	FKNX-CPX	Unknown	N/C	N/C	FKNX-MAN(S)	N/C	N/C	N/C	N/C	N/C	FKNX-SA	
84 Div	FKNX(S,O)	N/C	FKNX-CPX	N/C	N/C	N/C	N/C	N/C	FKNX-CPX	FKNX-CPX	FKNX-CPX	FKNX-SA	
85 Div	N/C	FSHN RIA(O)	Unknown	N/C	N/C	CCUS(S)	CCUS RIA(O)	N/C	N/C	N/C	N/C	N/C	
86 Div	RIA(O)	FSHN	Unknown	N/C	N/C	N/C	N/C	N/C	N/C	N/C	N/C	CCUS(S)	
87 Div	FBRG(O)	FBRG(O)	FBRG(O)	FBRG(O)	FBRG(O)	FBRG(T)	FMCL FBNG(S)	N/C	FMCL-GUTC	FMCL-GUTC	FMCL-GUTC	FMCL-IND	
88 Div	FSNL	FSNL-IND	Unknown	N/C	N/C	N/C	N/C	FSNL(T)	FSNL(T,MP)	FSNL(T,MP)	FSNL(T,MP)	N/C	
89 Div	N/C	N/C	Unknown	N/C	N/C	N/C	N/C	FCRK(S) FLCN(T,MP)	FLCN-CMTC	FLCN-CMTC	FLCN-CMTC	FCRK-GUTC	
90 Div	N/C	FSH-MAN	FSH-RATC	FSH(S) CBUL	N/C	FSH(S) CBUL	CBUL-GUTC	CBUL(S)	CBUL	CBUL	CBUL	N/C	

Special Troops Unit Training Camps 1931 - 1940

HQ. Sp. Tps	1931	1932	1933	1934	1935	1936	1937	1938	1939	1940
91 Div	DELM(HQ,S,Sv,MP) FLEW(T)	BARS(O) PIMON(S)	Unknown	N/C	N/C	N/C	FORD(S,MP) BARS(O)	FLEW FORD(S) SLO (T)	PIMON(T)	N/C
94 Div	FDEV APG(O)	FDEV(S-CMTC) APG(O)	Unknown	N/C	FDEV(S)	N/C	N/C	N/C	N/C	N/C
95 Div	FSH-RATC	FSH-RATC	FSH-RATC	FSIL-GUTC	N/C	N/C	ESIL-GUTC	FSIL-CMTC	N/C	N/C
96 Div	FLEW-GUTC	FLEW-GUTC	Unknown	FLEW-GUTC	FLEW-GUTC	FLEW-GUTC	FLEW-GUTC	N/C	FLEW(S,O)	N/C
97 Div	APG(O)	EDEV-DGRP	Unknown	N/C	FDEV(S)	N/C	FDIX(S) MFLD(T)	N/C	N/C	N/C
98 Div	FDIX(S,O)	PBRK(S)	Unknown	MFLD(T) RARS(O)	MFLD(T) RARS(O)	FDIX-CPX	PBRK(MP) RARS(O)	FDIX(S) RARS(O)	FDIX-CPX	N/C
99 Div	FGGM(T,S-CMTC)	FGGM(T,S- CMTC)	FGGM(T,S)	FGGM(T,S- CMTC)	FGGM(T,S- CMTC)	Ind_Gap-CPX	FGGM(T,S- CMTC)	FGGM(S,T)	FGGM(S)-CMTC	N/C
100 Div	FKNX(S,O)	N/C	Unknown	FKNX-CPX	N/C	N/C	N/C	N/C	N/C	FKNX-SA
101 Div	FSHN(S)	FSHN	Unknown	N/C	N/C	N/C	CCJUS(S)	N/C	CCJUS(S)	N/C
102 Div	N/C	N/C	Unknown	N/C	N/C	N/C	N/C	N/C	N/C	FORK-GUTC
103 Div	FFEW-GUTC	FFEW-GUTC	FFEW-RATC	FFEW-GUTC	FFEW-RATC	FLOG-CMTC FFEW-IND	FBL S	FFEW(S) FHUA-CMTC		N/C
104 Div	N/C	N/C	Unknown	N/C	N/C	N/C	N/C	N/C	FLEW-GUTC	N/C

Training Codes and Abbreviations

National Guard, Reserve, & Misc. Locations

Aberdeen	Aberdeen, SD	Grant	Camp Grant, IL
Arecibo	Aricebo, PR	Grayling	Camp Grayling, MI
Ashland	Camp Ashland, NE	Guernsey	Camp Guernsey, WY
Augusta	(See Camp Keyes, ME)	Hanover	Hanover, MA
BEAU	Camp Beaugard, LA	Hulen	Camp Hulen, TX
Bennington	Bennington, VA	Huron	Huron, SD
Bethany	Bethany Beach, DE	Ind Gap	Indiantown Gap, PA
BFM	Camp Benjamin F. McClellan, MS	Jackson	Camp Jackson, OR
Blauvelt	Camp Blauvelt, NY	JKBK	Jackson Barracks, LA
Boise	Boise Barracks, ID	CJEJ	Camp Joseph E. Johnston, FL
Bonneville	Camp Bonneville, ID	Kawaihapai	Kawaihapai Military Reservation, Oahu, TH
Brewer	Brewer, ME	Keyes	Camp Keyes (Augusta), ME
Bridgeport	Bridgeport, CT	KNLA	Kisatchie National Forest, LA (Louisiana Maneuver Area)
Capitola	Capitola, CA	Lake City	Lake City, MN
Cascade	(See Camp Ritchie, MD)	Logan	Camp Logan, IL
Charlestown	Charlestown, RI	Luna	Camp Maximilian Luna, NM
CJAC	Camp Jackson, SC	Mabry	Camp Mabry, TX
CJTR	Camp Joseph T. Robinson, AR	McCoy	Camp McCoy, Sparta, WI
Clark	Camp Clark, MO	McQuaide	Camp McQuaide, CA
Clatsop	Camp Clatsop, OR	Mitchell	Mitchell, SD
Conley	Camp William G. Conley, WV	MNVA	Manassas, VA
Culver	Culver Military Academy, Culver, IN	Mt Gretna	Mount Gretna, PA
Dawson	Camp Dawson, WV	Murray	Camp Murray, WA
DELM	Del Monte, CA	New Castle	New Castle, DE
DeSoto	DeSoto National Forest, MS	NAC	Nacogdoches, TX
Devil's Lake	(See Camp Grafton, ND)	Niantic	Niantic, CT
Dodge	Camp Dodge, IA	Nitro	Nitro, NV
Douglas	Camp Douglas, WI	NNYS	Northern New York State
Edwards	Camp Edwards (Falmouth), MA	Paukukalo	Paukukalo Military Reservation, TH
Falmouth	(See Camp Edwards, MA)	Peay	Camp Peay, TN
Fort Collins	Fort Collins, CO	Peoria	Tank Training Center Peoria, IL
Foster	Camp Clifford J. Foster, FL	Perry	Camp Perry, OH
FWHH	Fort William Henry Harrison, MT	Pierre	Pierre, SD
Gearhart	Gearhart, OR	Pine Cp	Pine Camp, NY
Glenn	Camp Glenn, NC	Pike	Camp Pike, AR
Grafton	Camp Grafton (Devil's Lake), ND	Platsmouth	Platsmouth, NE
		Ponce	Ponce, PR

Pueblo	Pueblo, CO
Providence	Providence, RI
Quonsett	Quonsett Point, RI
Rapid	Camp Rapid, SD
Rio Pedres	Rio Pedres, PR
Ripley	Camp Ripley, MN
Ritchie	Camp Ritchie (Cascade), MD
Rye	Rye Beach, NH
Salisbury	Salisbury, NH
Sandwich	South Sandwich, MA
Saunders	Saunders Range, MD
Sea Girt	Sea Girt, NJ
Sedalia	Sedalia, MO
Sevier	Camp John Sevier, TN
Simms	Camp Simms, DC
Shelby	Camp Shelby, MS
SLO	Camp San Luis Obispo, CA
Smith	Camp Smith (Peekskill), NY
St Simons	St. Simons Island, GA
Storrs	Connecticut Agricultural College, Storrs, CT
Taylorville	Taylorville, IL
Tuthill	Fort Tuthill (Flagstaff), AZ
Tybee	Tybee Island, GA
VA Beach	Virginia Beach, VA
Ventura	Ventura, CA
VFMA	Valley Forge Military Academy, PA
Wadsworth	Camp Wadsworth, NY
Wailuku	Wailuku Military Reservation, TH
Warner	Warner, NH
W. Barnstable	W. Barnstable, MA
Webster	Webster, NH
Weirs	The Weirs, NH
Welsh	Camp Welsh, Montauk, NY
WG Wms	Camp W. G. Williams, UT
West	Camp George West (Golden), CO
Williams	Camp Williams, WI
Wolters	Camp Wolters, TX
Williamson	Camp Williamson, MS
Yauco	Yauco, PR

Federal Locations

APG	Aberdeen Proving Ground, MD
Arcadia	Arcadia Target Range, MO
CBRK	Carlisle Barracks, PA
CBUC	Camp Buchanan, PR
CBUL	Camp Bullis, TX
CCUS	Camp/Fort Custer, MI
CDOU	Camp Douglas, AZ
CHHJ	Camp Harry H. Jones, AZ
CJTR	Camp Joseph T. Robinson, AR
CLEE	Camp Lee, VA
CSDL	Camp Stephen D. Little, AZ
CSTA	Camp Stanley, TX
EARS	Edgewood Arsenal, MD
FAAH	Fort Andrew A. Humphreys, VA
FADM	Fort Adams, RI
FAND	Fort Andrews, MA
FBAR	Fort Barrancas, FL
FBDY	Fort Brady, MI
FBLS	Fort Bliss, TX
FBNG	Camp/Fort Benning, GA
FBEL	Fort Belvoir, VA
FBRG	Camp/Fort Bragg, NC
FBRY	Fort Barry, CA
FBH	Fort Benjamin Harrison, IN
FCRK	Fort Crook, NE
FCRO	Fort Crockett, TX
FDAR	Fort D. A. Russell, WY
FDEV	Camp/Fort Devens, MA
FDIX	Camp/Fort Dix, NJ
FDM	Fort Des Moines, IA
FDOU	Fort Douglas, UT
FDuP	Fort DuPont, DE
FEA	Fort Ethan Allen, VT
FEUS	Fort Eustis, VA
FFEW	Fort Francis E. Warren, WY
FFUN	Fort Funston, CA
FGGM	Camp/Fort George G. Meade, MD
FGRE	Fort Greble, RI
FHAM	Fort Hamilton, NY
FHNT	Fort Hunt, VA
FHOW	Fort Howard, MD

Speedway	Speedway Field, Minneapolis, MN
Trumbull	Trumbull Field, Hartford, CT
Wold-Cham	Wold-Chamberlain Field, Minneapolis, MN
Woodstock	Woodstock Airport, Memphis, TN

Federal Air Fields

BIGF	Biggs Field, TX
BRKF	Brooks Field, TX
CHNF	Chanute, Field, IL
CRSF	Crissy Field, CA
DODF	Dodd Field, TX
ELLF	Ellis Field, TX
GODF	Godman Field, KY
GRYF	Gray Field, WA
HAMF	Hamilton Field, CA
KELF	Kelly Field, TX
LNGF	Langley Field, VA
LRAID	Little Rock Air Intermediate Depot, AR
MAD	Middletown Air Depot, PA
MAXF	Maxwell Field, AL
MFLD	Miller Field, NY
MITF	Mitchel Field, NY
MSHF	Marshall Field, KS
MTHF	Mather Field, CA
PATF	Patterson Field, OH
PEAF	Pearson Field, WA
POPF	Pope Field, NC
PSTF	Post Field, OK
SCTF	Scott Field, IL
SELF	Selfridge Field, MI
ROCF	Rockwell Field, CA
Valp	Valparaiso Field, FL
WWF	Wilbu Wright Field, OH

Types of Organized Reserve Camps

GUTC	General Unit Training Camp
CMTC	Citizens Military Training Camp
RATC	Regular Army Training Camp
LUTC	Local Unit Training Camp
BRC	Branch Specific Camp
CCT	Command and Combat Training
CNT	Contact Camp
CPX	Command Post Exercise
C&S	Command and Staff Camp
DGRP	Division Group Camp
GRP	Officer Group Camp--Non-Branch Specific
Ind	Individual attendance, not as a unit
MAN	Maneuver Participation
MOB	Mobilization Training/Exercise
NG	Camp with a National Guard unit
SA	School of Arms
SMT	School of Minor Tactics
STE	School of Tactical Exercises
Staff	Staff Training Camp
T&TT	Troop and Tactical Training

Other Codes

D/B	Unit demobilized or disbanded--no camp
HQ	Headquarters Company
HQTp	Headquarters Troop
I/A	Unit inactive--no camp
MP	Military Police Company
N/C	No Camp (unit did not attend camp)
N/O	Unit not organized--no camp
O	Ordnance Company
RA-A	Regular Army active unit
R/D	Unit redesignated; see new designation for further camps
S	Signal Company
SV	Service Company
T	Tank Company