

ELECTRICAL

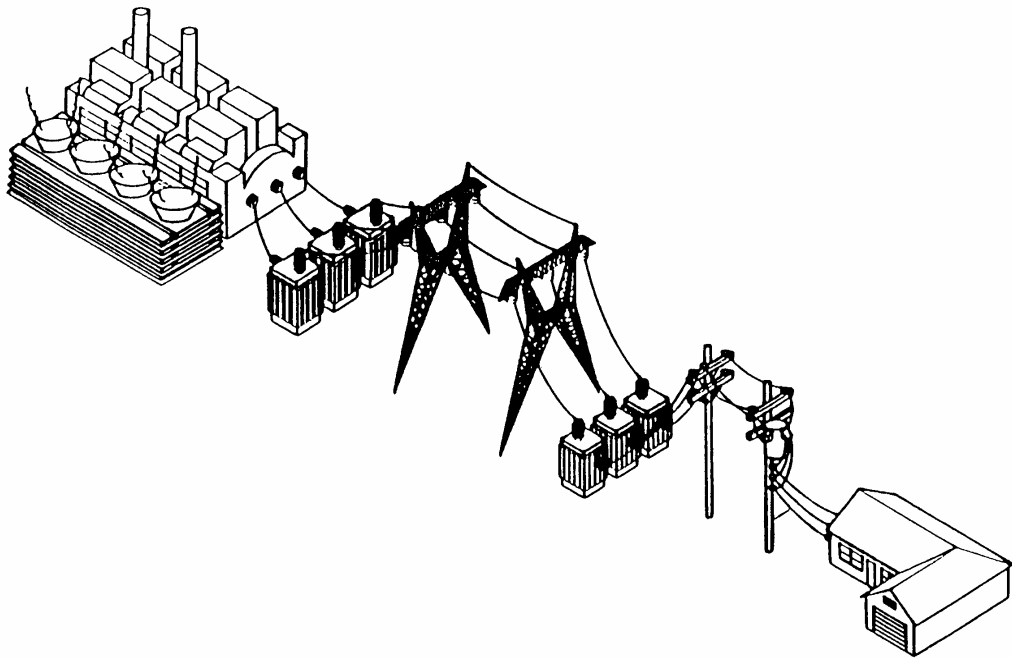

These materials were developed by OSHA's Office of Training and Education and are intended to assist employers, workers, and others as they strive to improve workplace health and safety. While we attempt to thoroughly address specific topics, it is not possible to include discussion of everything necessary to ensure a healthy and safe working environment in a presentation of this nature. Thus, this information must be understood as a tool for addressing workplace hazards, rather than an exhaustive statement of an employer's legal obligations, which are defined by statute, regulations, and standards. Likewise, to the extent that this information references practices or procedures that may enhance health or safety, but which are not required by a statute, regulation, or standard, it cannot, and does not, create additional legal obligations. Finally, over time, OSHA may modify rules and interpretations in light of new technology, information, or circumstances; to keep apprised of such developments, or to review information on a wide range of occupational safety and health topics, you can visit OSHA's website at www.osha.gov.

ELECTRICAL

Examination, Installation, and Use of Equipment
Identification of Disconnecting Means and Circuits
Working Space About Electrical Equipment
Guarding of Live Parts
Identification of Conductors
Polarity of Connections
Grounding
Grounding Path
Grounding of Equipment Connected by Cord and Plug
Ground Fault Circuit Interrupters (GFCI's)
Cabinets, Boxes, and Fittings
Flexible Cords and Cables

Reference:

OSHA General Industry Standards, Subpart S, *Electrical*

Additional Source of Information:

NFPA 70, *National Electrical Code*

ELECTRICAL

INTRODUCTION

Electricity has become an essential of modern life, both at home and on the job. Some employees work with electricity directly, as is the case with engineers, electricians, or people who do wiring, such as overhead lines, cable harnesses, or circuit assemblies. Others, such as office workers and salespeople, work with it indirectly. As a source of power, electricity is accepted without much thought to the hazards encountered. Perhaps because it has become such a familiar part of our surroundings, it often is not treated with the respect it deserves.

OSHA's electrical standards address the government's concern that electricity has long been recognized as a serious workplace hazard, exposing employees to such dangers as electric shock, electrocution, fires and explosions. The objective of the standards is to minimize such potential hazards by specifying *design* characteristics of safety in use of electrical equipment and systems.

OSHA's electrical standards were carefully developed to cover only those parts of any electrical system that an employee would normally use or contact. The exposed and/or operating elements of an electrical installation - lighting equipment, motors, machines, appliances, switches, controls, enclosures, etc. - must be so constructed and installed as to minimize electrical dangers to people in any workplace.

The OSHA electrical standards were based on the National Fire Protection Association's standard NFPA 70E, *Electrical Safety Requirements for Employee Workplaces*, and the NFPA 70 Committee derived Part I of their document from the 1978 edition of the *National Electrical Code* (NEC). The standards extracted from the NEC were those considered to most directly apply to employee safety and least likely to change with each new edition of the NEC. OSHA's electrical standards are performance oriented; therefore they contain few direct references to the NEC. However, the NEC contains specific information as to how the required performance can be obtained.

This discussion does not cover OSHA's *Electrical Safety-Related Work Practices* Standard, which contains requirements for working on or near energized and de-energized electrical equipment, the use of personal protective equipment, and the safe use of electrical equipment.

This discussion covers requirements in OSHA's Design Safety Standards for Electrical Systems that are frequently overlooked and may present serious hazards. The reader is encouraged to consult the complete text of OSHA's electrical standards for all of OSHA's requirements.

EXAMINATION, INSTALLATION AND USE OF EQUIPMENT

Examination

Electrical equipment shall be free from recognized hazards that are likely to cause death or serious physical harm to employees¹. Safety of equipment shall be determined using the following considerations:

- Suitability for installation and use in conformity with the provisions of this subpart. Suitability of equipment for an identified purpose may be evidenced by listing or labeling for that identified purpose.
- Mechanical strength and durability, including, for parts designed to enclose and protect other equipment, the adequacy of the protection thus provided.
- Electrical insulation.
- Heating effects under conditions of use.
- Arcing effects.
- Classification by type, size, voltage, current capacity, and specific use.
- Other factors which contribute to the practical safeguarding of employees using or likely to come in contact with the equipment.

Installation and Use

Listed or labeled equipment shall be used or installed in accordance with any instructions included in the listing or labeling.

¹ Note that this requirement is, in effect, an electrical “general duty clause” similar to Section 5(a)(1) of the OSH Act: “each employer shall furnish . . . a place of employment which is free from recognized hazards that are causing or are likely to cause death or serious physical harm to his employees.”

IDENTIFICATION OF DISCONNECTING MEANS AND CIRCUITS

Each disconnecting means required by this subpart for motors and appliances shall be legibly marked to indicate its purpose, unless located and arranged so the purpose is evident. Each service, feeder, and branch circuit, at its disconnecting means or overcurrent device, shall be legibly marked to indicate its purpose, unless located and arranged so the purpose is evident. These markings shall be of sufficient durability to withstand the environment involved.

A disconnecting means is a switch that is used to disconnect the conductors of a circuit from the source of electric current. Disconnect switches are important because they enable a circuit to be opened, stopping the flow of electricity, and thus can effectively protect workers and equipment.

Each disconnect switch or overcurrent device required for a service, feeder, or branch circuit must be clearly labeled to indicate the circuit's function, and the label or marking should be located at the point where the circuit originates. For example, on a panel that controls several motors or on a motor control center, each disconnect must be clearly marked to indicate the motor to which each circuit is connected. In the figure below, the Number 2 circuit breaker in the panel box supplies current only to disconnect Number 2, which in turn controls the current to motor Number 2. This current to motor Number 2 can be shut off by the Number 2 circuit breaker or the Number 2 disconnect.

If the purpose of the circuit is obvious, no identification of the disconnect is required.

All labels and markings must be durable enough to withstand weather, chemicals, heat, corrosion, or any other environment to which they may be exposed.

Each Disconnect and Circuit Requires Identification

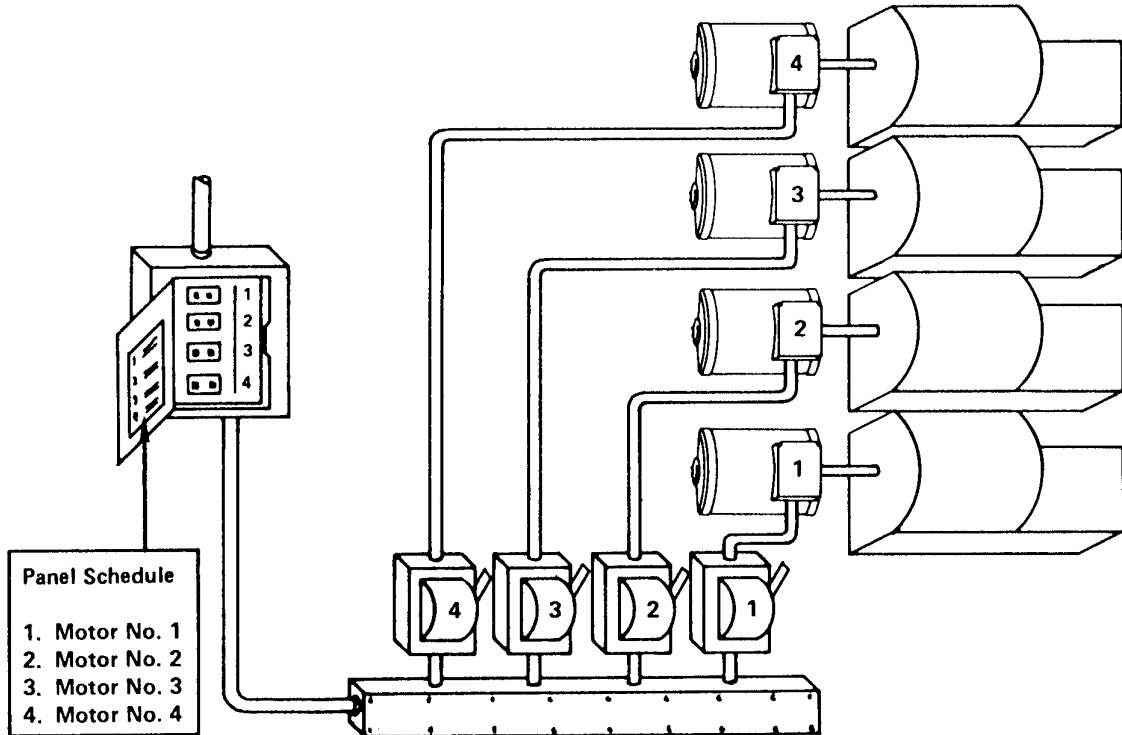

**Motor No. 1 is Controlled by
Disconnect No. 1 and Circuit
Breaker No. 1**

NOTE: As shown in diagram, the purposes of these disconnecting switches are clearly evident. In such cases identification may be omitted. In the actual installation however, the motors may not be within sight of the disconnects or arranged in such a way that the purpose is not evident and identification would be required.

WORKING SPACE ABOUT ELECTRIC EQUIPMENT

Note that this particular section is concerned with the safety of a *person qualified to work on the equipment* (presumably an electrician). Obviously, the hazard must be treated in a different way if the person will remove guards and enclosures and actually work on the live parts. Sufficient access and working space shall be provided and maintained about all electric equipment to permit ready and safe operation and maintenance of such equipment.

Clear Spaces

Working space required by this subpart may not be used for storage. When normally enclosed live parts are exposed for inspection or servicing, the working space, if in a passageway or general open space, shall be suitably guarded.

GUARDING OF LIVE PARTS

It should be noted that the purpose of this requirement is to protect *any person* who may be in the vicinity of electrical equipment against accidental contact. These people are presumably not electricians working on the equipment, and are not qualified or trained to be in close proximity to live parts.

Except as required or permitted elsewhere in this subpart, live parts of electric equipment operating at 50 volts or more shall be guarded against accidental contact by approved cabinets or other forms of approved enclosures, or by any of the following means:

- By location in a room, vault, or similar enclosure that is accessible only to qualified persons.
- By suitable permanent, substantial partitions or screens so arranged that only qualified persons will have access to the space within reach of the live parts. Any openings in such partitions or screens shall be so sized and located that persons are not likely to come into accidental contact with the live parts or to bring conducting objects into contact with them. It is good practice to use covers, screens or partitions which can only be removed by use of tools, so that unqualified persons are less likely to violate them.
- By location on a suitable balcony, gallery, or platform.
- By elevation of 8 feet or more above the floor or other working surface. Note that, although equipment elevated at least 8 feet is considered to be guarded, this may not be adequate if material being handled is likely to make contact with live parts.

In locations where electric equipment would be exposed to physical damage, enclosures or guards shall be so arranged and of such strength as to prevent such damage.

Entrances to rooms and other guarded locations containing exposed live parts shall be marked with conspicuous warning signs forbidding unqualified persons to enter.

You should be constantly aware of hazards in your workplace. New work or changes may create a new hazard, or poor maintenance may allow reappearance of old ones.

IDENTIFICATION OF CONDUCTORS

A conductor used as a grounded conductor shall be identifiable and distinguishable from all other conductors. A conductor used as an equipment grounding conductor shall be identifiable and distinguishable from all other conductors.

The grounded conductor is an energized circuit conductor that is connected to earth through the system ground. It is commonly referred to as the *neutral*. The equipment grounding conductor is not an energized conductor under normal conditions. The equipment grounding conductor acts as a safeguard against insulation failure or faults in the other circuit conductors. The equipment grounding conductor is energized *only* if there is a leak or fault in the normal current path, and it directs this current back to the source. Directing the fault current back to the source enables protective devices, such as circuit breakers or fuses, to operate thus preventing fires and reducing the hazard of electrical shocks.

The grounded and equipment grounding conductors of an electrical circuit must be marked or color coded in a way that allows employees to identify them and tell them apart from each other and from the other conductors in the circuit.

The figure below illustrates a distribution panelboard. One means by which each conductor's use is identified and made distinguishable from the other circuit conductors is the use of color coding. Acceptable color coding includes the method required by the *National Electrical Code*, Section 210-5. The Code states: "The grounded conductor of a branch circuit shall be identified by a continuous white or natural gray color." Also, "The equipment grounding conductor of a branch circuit shall be identified by a continuous green color or a continuous green color with one or more yellow stripes unless it is bare." Bare copper or aluminum wire is permitted for use as a grounding conductor.

Distribution Panelboard

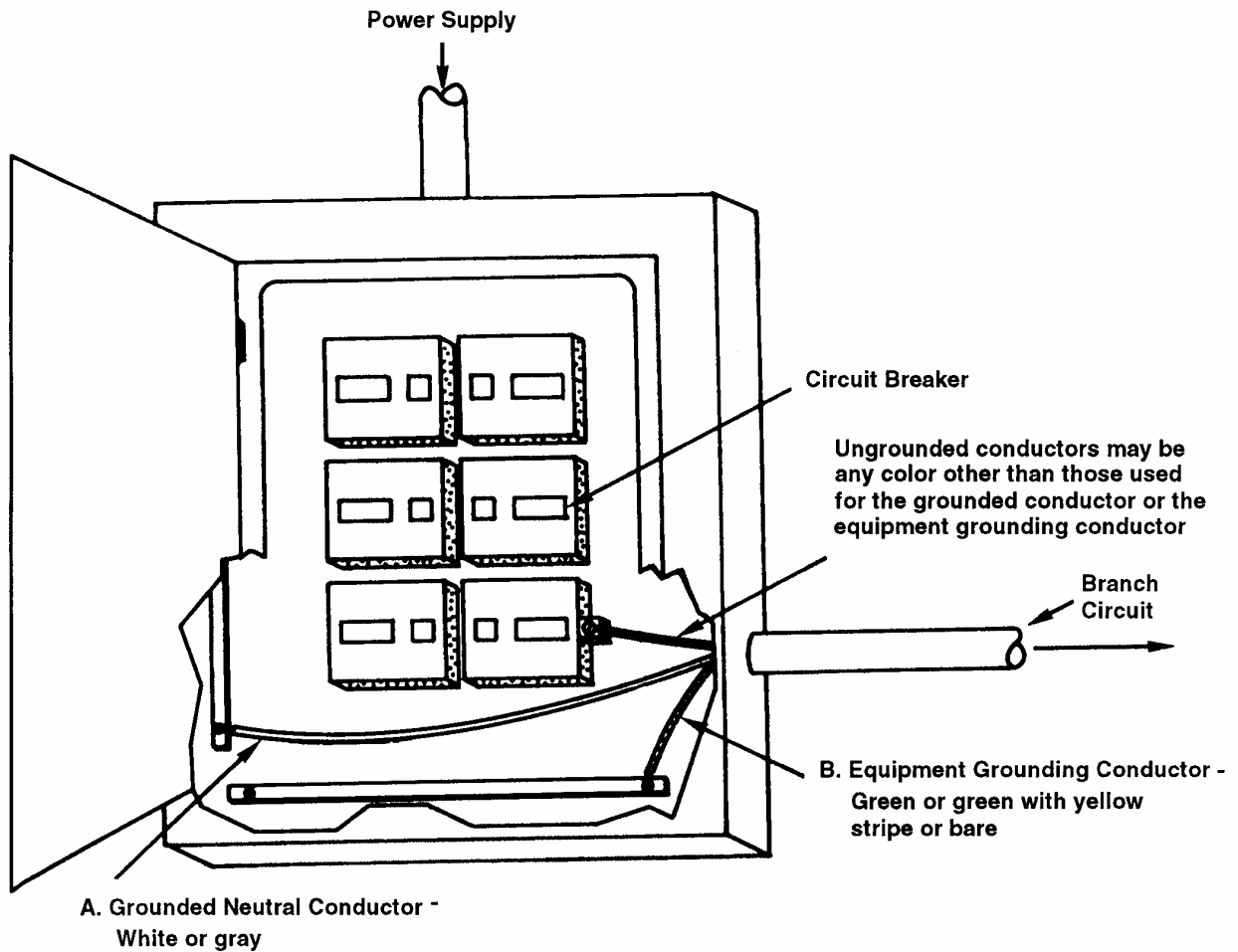

- A. The grounded conductor is identified and distinguished from other conductors by using white or gray color-coded insulated wires.
- B. The equipment grounding conductor is identified and distinguished from other conductors by using green, or green with yellow stripe, color coding on wires, or run as a bare conductor.

POLARITY OF CONNECTIONS

No grounded conductor may be attached to any terminal or lead so as to reverse designated polarity.

A grounding terminal or grounding-type device on a receptacle, cord connector, or attachment plug may not be used for purposes other than grounding.

The above two subparagraphs dealing with polarity of connections and use of grounding terminals and devices address one potentially dangerous aspect of alternating current: many pieces of equipment will operate properly even though the supply wires are not connected in the order designated by design or the manufacturer. Improper connection of these conductors is most prevalent on the smaller branch circuit typically associated with standard 120 volt receptacle outlets, lighting fixtures and cord- and plug-connected equipment.

When plugs, receptacles, and connectors are used in an electrical branch circuit, correct polarity between the ungrounded (hot) conductor, the grounded (neutral) conductor, and the grounding conductor must be maintained.

Reversed polarity is a condition when the identified circuit conductor (the grounded conductor or neutral) is incorrectly connected to the ungrounded or "hot" terminal of a plug, receptacle, or other type of connector.

The figure below shows the correct wiring for the common 120-volt outlet with a portable hand tool attached.

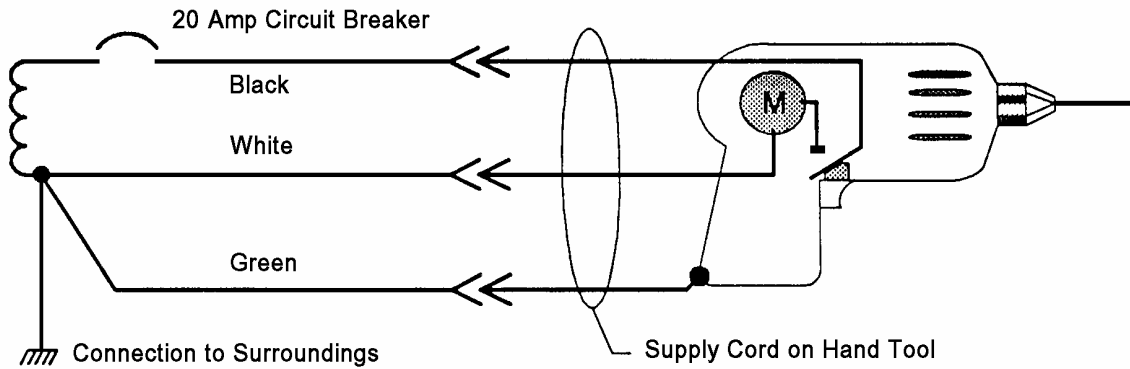

Typical 120 Volt Branch Circuit with Correct Wiring

Suppose now that the black (ungrounded) and white (grounded) conductors are reversed as shown in the figure below. This is the traditional **reversed polarity**. Although a shock hazard may not exist, there are other mechanical hazards that can occur.

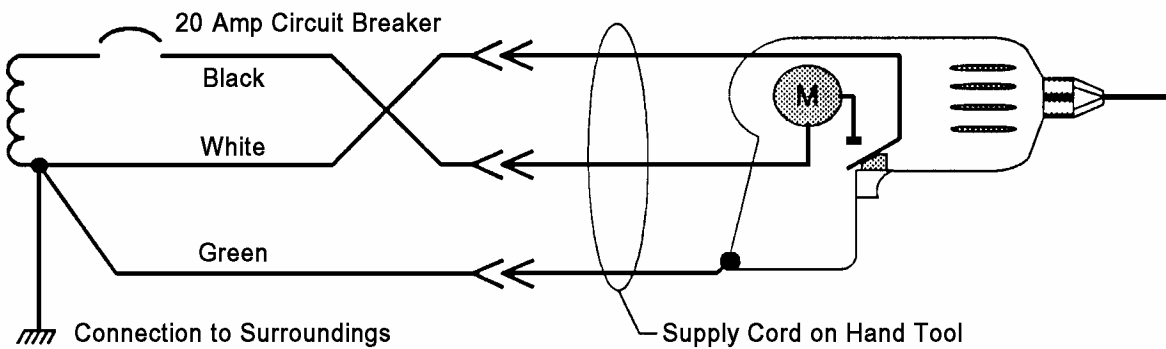

120 Volt Branch Circuit with Black and White Wires Reversed

For example, if an internal fault should occur in the wiring as shown in the figure below, the equipment would not stop when the switch is released or would start as soon as a person plugs the supply cord into the improperly wired outlet. This could result in serious injury.

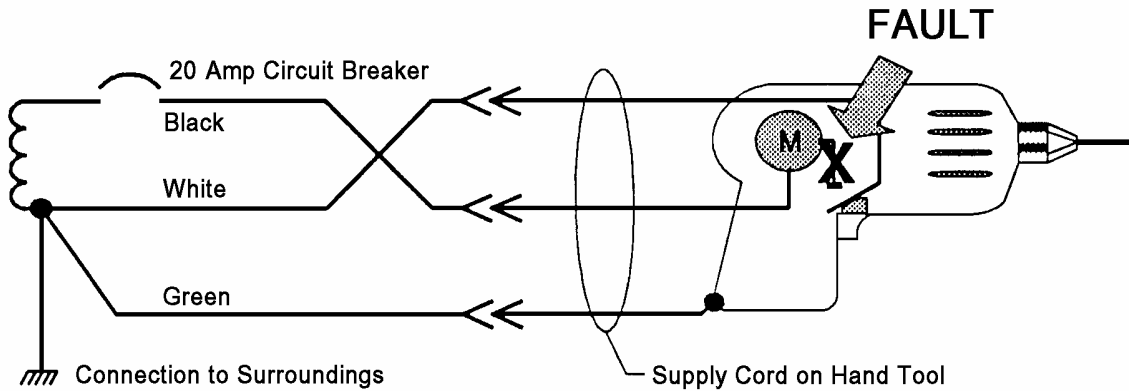

**120 Volt Branch Circuit with Black and White Wires Reversed
Internal Fault in Equipment Wiring**

The figure below shows the white (grounded) and green (grounding) conductors reversed. Although it is not fitting, considering OSHA or code terminology, to call this *reversed polarity*, a hazard can still exist. In this case, due to the wiring error, the white wire is being used to provide equipment grounding. Under certain conditions, this could be dangerous.

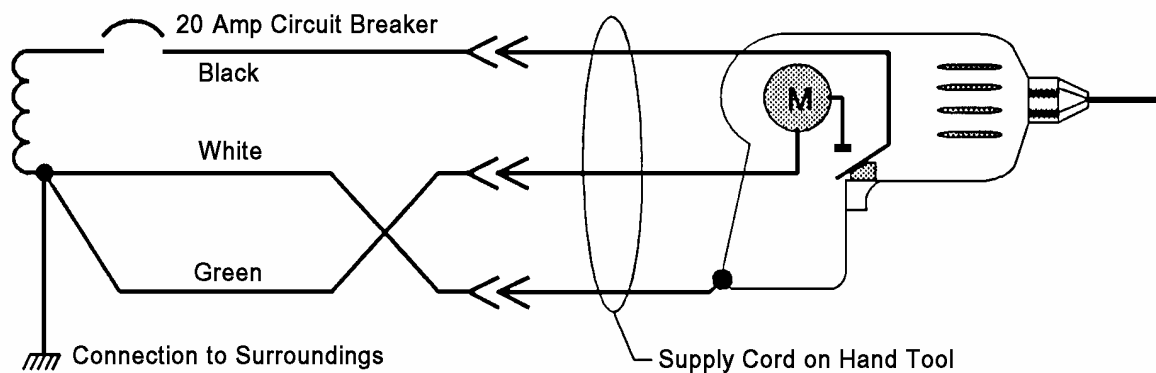

White and Green Wires Reversed

The figure below shows an *extremely* dangerous situation. In this example, the black (ungrounded) and green (grounding) conductors have been reversed. The metal case of the equipment is at 120 volts with reference to the surroundings. As soon as a person picks up the equipment and touches a conductive surface in their surrounding, they will receive a serious, or even deadly, shock.

Although the equipment will not work with this wiring error, it would not be unusual for a person to pick up the equipment before realizing this. The person may even attempt to troubleshoot the problem before unplugging the power cord.

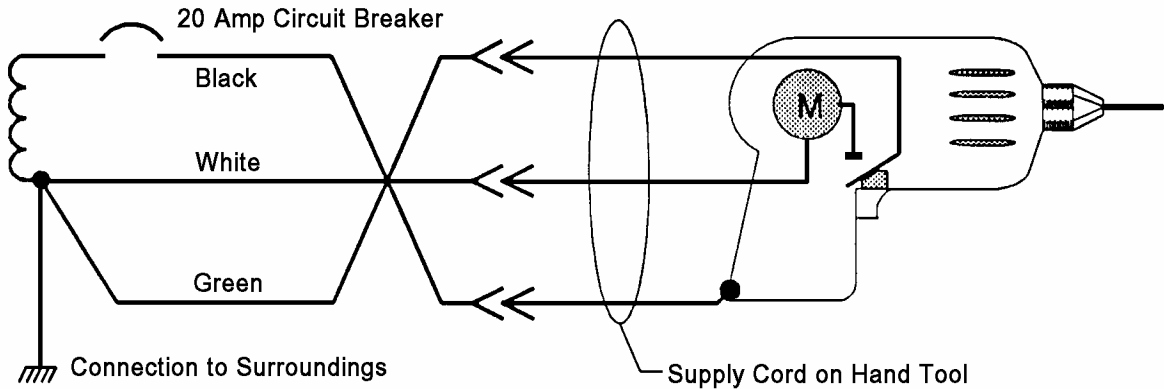

Black and Green Wires Reversed

Correct polarity is achieved when the grounded conductor is connected to the corresponding grounded terminal and the ungrounded conductor is connected to the corresponding ungrounded terminal. The reverse of the designated polarity is prohibited. The figure below illustrates a duplex receptacle correctly wired. Terminals are designated and identified to avoid confusion. An easy way to remember the correct polarity is "white to light" - the white (grounded) wire should be connected to the light or nickel-colored terminal; "black to brass" - the black or multi-colored (ungrounded) wire should be connected to the brass terminal; and "green to green" - the green or bare (grounding) wire should be connected to the green hexagonal head terminal screw.

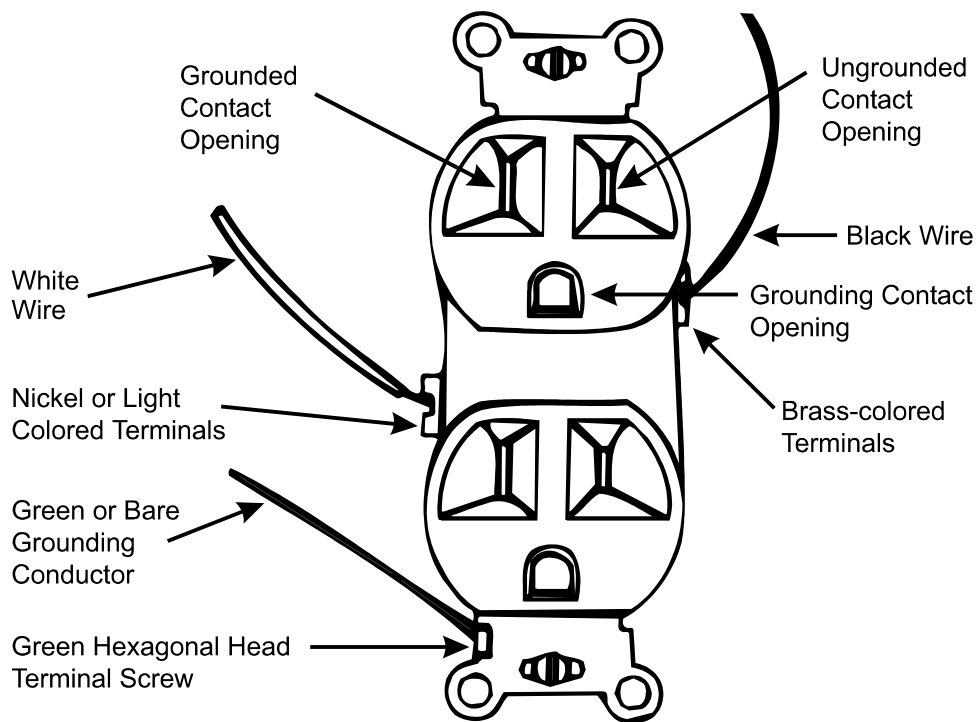

Duplex Receptacle Correctly Wired to Designated Terminals

GROUNDING

This section contains grounding requirements for systems, circuits, and equipment.

Grounding electrical circuits and electrical equipment is required to protect employees against electrical shock, safeguard against fire, and protect against damage to electrical equipment. There are two kinds of grounding: (1) electrical circuit or system grounding, and (2) electrical equipment grounding. Electrical system grounding is accomplished when one conductor of the circuit is intentionally connected to earth. This is done to protect the circuit should lightning strike or other high voltage contact occur. Grounding a system also stabilizes the voltage in the system so "expected voltage levels" are not exceeded under normal conditions.

The second kind of ground is equipment grounding. This is accomplished when all metal frames of equipment and enclosures containing electrical equipment or conductors are grounded by means of a permanent and continuous connection or bond. The equipment grounding conductor provides a path for dangerous fault current to return to the system ground at the supply source of the circuit should an insulation failure take place. If installed properly, the equipment grounding conductor is the current path that enables protective devices, such as circuit breakers and fuses, to operate when a fault occurs. The figure below illustrates both types of grounding.

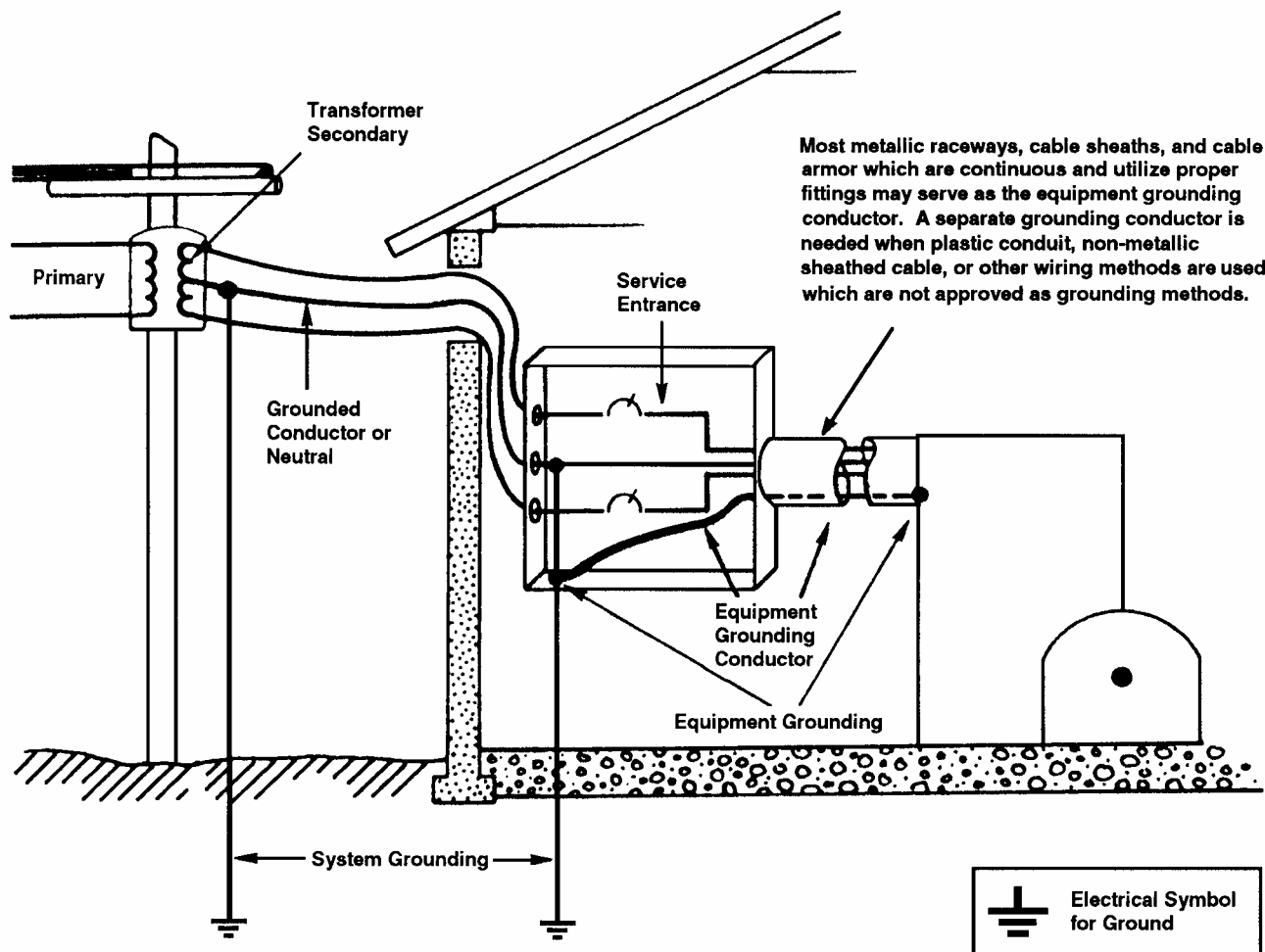

SYSTEM AND EQUIPMENT GROUNDING

GROUNDING PATH

The path to ground from circuits, equipment, and enclosures shall be permanent and continuous.

This requirement was extracted from NEC 250-51, *Effective Grounding Path*, which is more complete and fundamental to the understanding of electrical safety. It states that the path to ground:

1. "shall be permanent and continuous." (If the path is installed in such a way that damage, corrosion, loosening, etc. may impair the continuity during the life of the installation, then shock and burn hazards will develop.)
2. "shall have capacity to conduct safely any fault current likely to be imposed on it." (Fault currents may be many times normal currents, and such high currents may melt or burn metal at points of poor conductivity. These high temperatures may be a hazard in themselves, and they may destroy the continuity of the ground-fault path.)
3. "shall have sufficiently low impedance to limit the voltage to ground and to facilitate the operation of the circuit protective devices in the circuit." (If the ground-fault path has a high impedance, there will be hazardous voltages whenever fault currents attempt to flow. Also, if the impedance is high, the fault current will be limited to some value so low that the fuse or circuit breaker will not operate promptly, if at all.)

It is important to remember the following regarding safe grounding paths:

1. The fault current in A-C circuits will be limited by the sum of resistance and reactance, and the only low-reactance path is that which closely follows the circuit conductors.
2. If a metallic raceway system is used, make sure that the metallic system is continuous and permanent.
3. In cases where a metallic raceway system is not used, provide a green or bare equipment-grounding conductor close to the supply conductors to assure that all enclosures are bonded together and to the source.

GROUNDING OF EQUIPMENT CONNECTED BY CORD AND PLUG

Under any of the conditions described below, exposed non-current-carrying metal parts of cord- and plug-connected equipment which may become energized shall be grounded.

- a. If in a hazardous (classified) location.
- b. If operated at over 150 volts to ground, except for guarded motors and metal frames of electrically heated appliances if the appliance frames are permanently and effectively insulated from ground.
- c. If the equipment is of the following types:
 - Refrigerators, freezers, and air conditioners;
 - Clothes-washing, clothes-drying and dishwashing machines, sump pumps, and electrical aquarium equipment;
 - Hand-held motor-operated tools;
 - Motor-operated appliances of the following types: hedge clippers, lawn mowers, snow blowers, and wet scrubbers;
 - Cord- and plug-connected appliances used in damp or wet locations or by employees standing on the ground or on metal floors or working inside of metal tanks or boilers;
 - Portable and mobile X-ray and associated equipment;
 - Tools likely to be used in wet and conductive locations; and
 - Portable hand lamps.

Under the conditions described above, exposed non-current-carrying metal parts of cord- and plug-connected equipment must be grounded. Grounding metal parts is not required where the equipment is supplied through an isolating transformer with an ungrounded secondary of not over 50 volts or if portable tools are protected by an approved system of double insulation. To ground cord- and plug-connected equipment, a third wire is commonly provided in the cord set and a third prong in the plug. The third wire serves as an equipment grounding conductor which is connected to the metal housing of a portable tool and a metal grounding bus inside the service entrance equipment. The service entrance equipment is located at the entrance point of the electric supply for a building or plant and contains, or serves other panelboards which contain, branch circuit protective devices such as fuses and circuit breakers. The third wire provides a path for fault current should an insulation failure occur. In this manner, dangerous fault current will be directed back to the source, the service entrance, and will enable circuit breakers or fuses to operate, thus opening the circuit and stopping the current flow.

The figure below illustrates the potential shock hazard that exists when no third wire, grounding conductor, is used. If a fault occurs, most of the current will follow the path of least resistance. If the worker provides a path to ground as shown, some portion of the current will flow away from the grounded white conductor (neutral) and return to ground through the worker. The severity of the shock received will depend on the amount of current that flows through the worker.

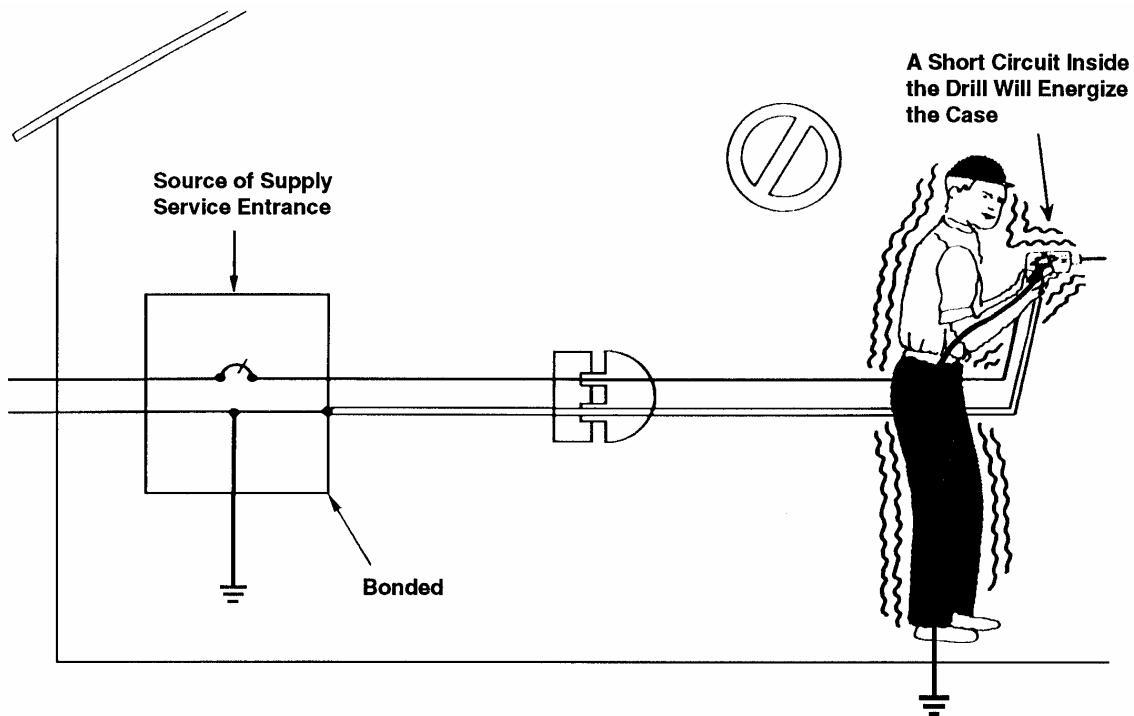

Cord- and Plug-Connected Equipment Without a Grounding Conductor

The figure below illustrates the advantage of a properly connected grounded conductor. It should be noted that properly bonded conduit and associated metal enclosures can also serve as a grounding conductor.

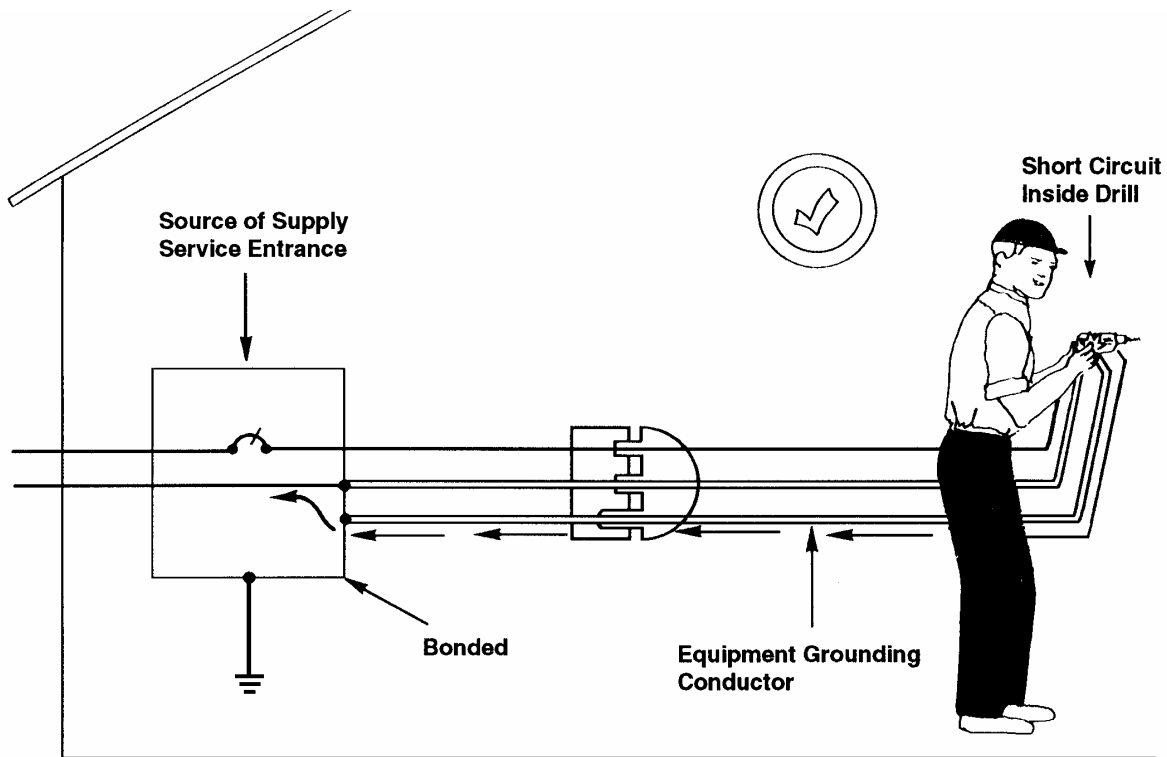

Cord- and Plug-Connected Equipment With a Grounding Conductor

Tools likely to be used in wet and conductive locations need not be grounded if supplied through an isolating transformer with an ungrounded secondary of not over 50 volts. Listed or labeled portable tools and appliances protected by an approved system of double insulation, or its equivalent, need not be grounded. If such a system is employed, the equipment shall be distinctively marked to indicate that the tool or appliance utilizes an approved system of double insulation.

GROUND-FAULT CIRCUIT-INTERRUPTERS

Introduction

In most cases, **insulation** and **grounding** are used to prevent injury from electrical wiring systems or equipment. However, there are instances when these recognized methods do not provide the degree of protection required. To help appreciate this, let's consider a few examples of where ground fault circuit interrupters would provide additional protection.

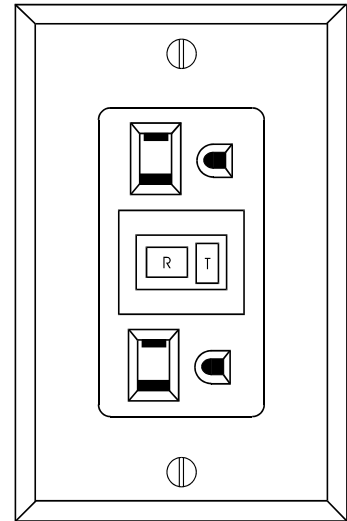

- Many portable hand tools, such as electric drills, are now manufactured with non-metallic cases. If approved, we refer to such tools as **double insulated**. Although this design method assists in reducing the risk from grounding deficiencies, a shock hazard can still exist. In many cases, persons must use such electrical equipment where there is considerable moisture or wetness. Although the person is *insulated* from the electrical wiring and components, there is still the possibility that water can enter the tool housing. Ordinary water is a conductor of electricity. Therefore, if the water contacts energized parts, a path will be provided from inside the housing to the outside, bypassing the *double insulation*. When a person holding a hand tool under these conditions touches another conductive surface in their work environment, an electric shock will result.
- Double-insulated equipment or equipment with non-metallic housings, that does not require grounding under the *National Electrical Code*, is frequently used around sinks or in situations where the equipment could be dropped into water. Frequently, the initial human response is to grab for the equipment. If a person's hand is placed in the water and another portion of their body is in contact with a conductive surface, a serious or deadly electric shock can occur.
- In construction work and regular factory maintenance work, it is frequently necessary to use extension cord sets with portable equipment. These cords are regularly exposed to physical damage. Although safe work procedures require adequate protection, it is not possible to prevent all damage. Frequently, the damage is only to the insulation, exposing energized conductors. It is not unusual for a person to handle the cord often with the possibility of contacting the exposed wires while holding a metal case tool or while in contact with other conductive surfaces.

The amount of current which flows under such conditions will be enough to cause serious human response. This can result in falls or other physical injury and in

many cases death.

Since neither *insulation* (double insulation) nor *grounding* can provide protection under these conditions, it is necessary to use other protective measures. One acceptable method is a ground fault circuit interrupter, commonly referred to as a GFCI.

How Ground-Fault Circuit-Interrupters Work

A ground-fault circuit-interrupter is not an overcurrent device like a fuse or circuit breaker. GFCI's are designed to sense an imbalance in current flow over the normal path.

The GFCI contains a special sensor that monitors the strength of the magnetic field around each wire in the circuit when current is flowing. The magnetic field around a wire is directly proportional to the amount of current flow, thus the circuitry can accurately translate the magnetic information into current flow.

If the current flowing in the *black (ungrounded) wire* is within 5 (plus or minus 1) milliamperes (mA) of the current flowing in the *white (grounded) wire* at any given instant, the circuitry considers the situation normal. All the current is flowing in the normal path. If, however, the current flow in the two wires differs by more than 5mA, the GFCI will quickly open the circuit. This is illustrated in the figure below.

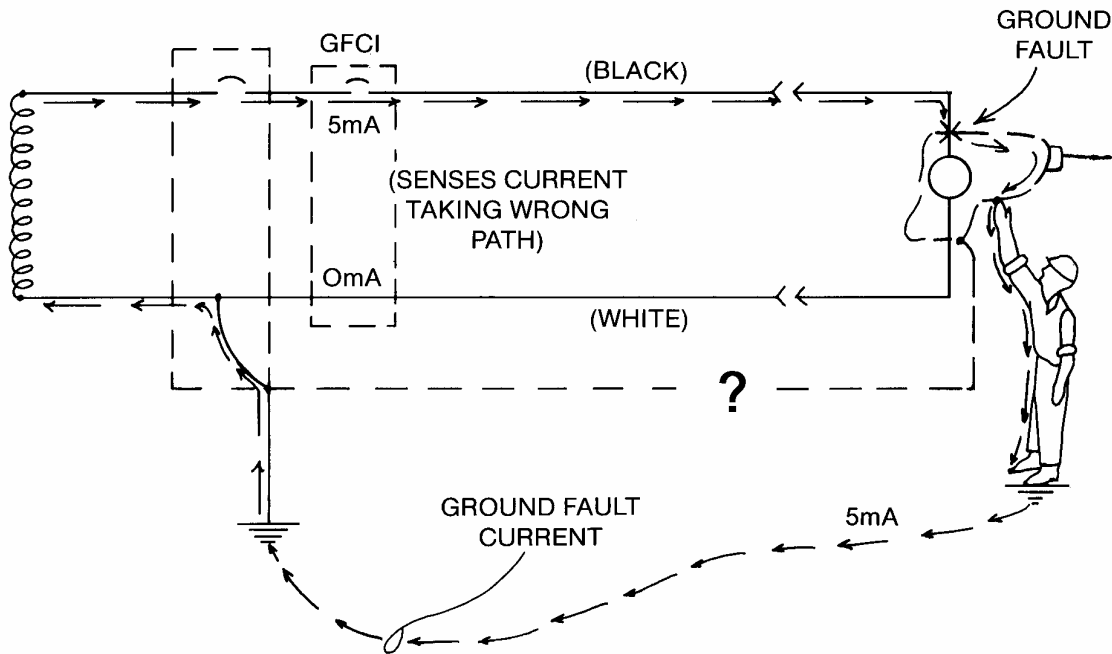

HOW THE GFCI PROTECTS PEOPLE

(BY OPENING THE CIRCUIT WHEN CURRENT FLOWS THROUGH A GROUND-FAULT PATH)

Note that the GFCI will open the circuit if 5 mA or more of current returns to the service entrance by any path other than the intended white (grounded) conductor. If the equipment grounding conductor is properly installed and maintained, this will happen *as soon as the faulty tool is plugged in*. If by chance this grounding conductor is not intact and of low-impedance, the GFCI may not trip out *until a person provides a path*. In this case, the person will receive a shock, but the GFCI should trip out so quickly that the shock will not be harmful.

Types of Ground-Fault Circuit-Interrupters

There are several types of GFCI's available, with some variations to each type. Although all types will provide ground-fault protection, the specific application may dictate one type over another.

- **Circuit-Breaker Type**

The circuit-breaker type includes the functions of a standard circuit breaker with the additional functions of a GFCI. It is installed in a panelboard and can protect an entire branch circuit with multiple outlets. It is a direct replacement for a standard circuit breaker of the same rating.

- **Receptacle Type**

The receptacle style GFCI incorporates within one device one or more receptacle outlets, protected by the GFCI. Such devices are becoming very popular because of their low cost. Most are of the duplex receptacle configuration and can provide GFCI protection for additional non-GFCI type receptacles connected "down stream" from the GFCI unit.

- **Permanently Mounted Type**

The permanently mounted types are mounted in an enclosure and designed to be permanently wired to the supply. Frequently they are used around large commercial swimming pools or similar wet locations.

- **Portable Type**

Several styles of portable GFCI's are available. The portable types are designed to be easily transported from one location to another. They usually contain one or more integral receptacle outlets protected by the GFCI module. Some models are designed to plug into existing non-GFCI protected outlets, or in some cases, are connected with a cord and plug arrangement. The portable type also incorporate a no-voltage release device which will disconnect power to the outlets if any supply conductor is open. Units approved for use outdoors will be in enclosures suitable for the environment. If exposed to rain, they must be listed as rainproof.

- **Cord Connected Type**

The power supply cord type GFCI consists of an attachment plug which incorporates the GFCI module. It provides protection for the cord and any equipment attached to the cord. The attachment plug has a non-standard appearance and is equipped with test and reset buttons. Like the portable type, it incorporates a no-voltage release device which will disconnect power to the load if any supply conductor is open.

Classes of Ground-Fault Circuit-Interrupters

Ground-Fault Circuit-Interrupters are divided into two classes: Class A and Class B. The Class A device is designed to trip when current flow, in other than the normal path, is 6 milliamperes or greater. The specification is 5 milliamperes \pm 1 milliampere. The Class B device will trip when current flow, in other than the normal path, is 20 milliamperes or greater. Class B devices are approved for use on underwater swimming pool lighting installed prior to the adoption of the 1965 *National Electrical Code*.

Testing Ground-Fault Circuit-Interrupters

Due to the complexity of a GFCI, it is necessary to test the device on a regular basis. For permanently wired devices, a monthly test is recommended. Portable type GFCI's should be tested each time before use. GFCI's have a built-in test circuit which imposes an artificial ground fault on the load circuit to assure that the ground-fault protection is still functioning. Test and reset buttons are provided for testing.

CABINETS, BOXES, AND FITTINGS

Conductors Entering Boxes, Cabinets, or Fittings

Since conductors can be damaged if they rub against the sharp edges of cabinets, boxes, or fittings, they must be protected from damage where they enter. To protect the conductors, some type of clamp or rubber grommet must be used. The device used must close the hole through which the conductor passes as well as provide protection from abrasion. If the conductor is in a conduit and the conduit fits tightly in the opening, additional sealing is not required.

The knockouts in cabinets, boxes, and fittings should be removed only if conductors are to be run through them. However, if a knockout is missing or if there is another hole in the box, the hole or opening must be closed.

Covers and Canopies

All pull boxes, junction boxes, and fittings shall be provided with covers approved for the purpose. If metal covers are used, they shall be grounded. In completed installations, each outlet box shall have a cover, faceplate, or fixture canopy. Covers of outlet boxes having holes through which flexible cord pendants pass shall be provided with bushings designed for the purpose or shall have smooth, well-rounded surfaces on which the cords may bear.

FLEXIBLE CORDS AND CABLES

This standard for safe use of flexible cords is one of the most frequently violated electrical standards, particularly in smaller plants. There is a definite need and place for cords, but there is also a temptation to misuse them because they seem to offer a quick and easy way to carry electricity to where it is needed. The basic problem is that flexible cords in general are more vulnerable than the fixed wiring of the building. Therefore, cords should not be used if one of the recognized wiring methods could be used instead.

Use of Flexible Cords and Cables

Flexible cords and cables shall be approved and suitable for conditions of use and location. The standard lists specific situations in which flexible cords may be used. Flexible cords and cables shall be used only for:

- a. Pendants (a lampholder or cord-connector body suspended by a length of cord properly secured and terminated directly above the suspended device);
- b. Wiring of fixtures;
- c. Connection of portable lamps or appliances;
- d. Elevator cables;
- e. Wiring of cranes and hoists (where flexibility is necessary);
- f. Connection of stationary equipment to facilitate their frequent interchange (equipment which is not normally moved from place to place, but might be on occasion);
- g. Prevention of the transmission of noise or vibration. (In some cases vibration might fatigue fixed wiring and result in a situation more hazardous than flexible cord.)
- h. Appliances where the fastening means and mechanical connections are designed to permit removal for maintenance and repair (e.g. water coolers, exhaust fans);
- i. Data processing cables approved as a part of the data processing system.

Note that all of the above situations involve conditions where flexibility is necessary. Unless specifically permitted by one of these situations, flexible cords and cables may not be used:

- a. As a substitute for the fixed wiring of the structure;
- b. Where run through holes in walls, ceilings, or floors;

- c. Where run through doorways, windows, or similar openings;
- d. Where attached to building surfaces; or
- e. Where concealed behind building walls, ceilings, or floors.

There is usually not much question about use of the short length of cord which is furnished as part of an approved appliance or tool; there is usually no question about an extension cord used temporarily to permit use of the appliance or tool in its intended manner at some distance from a fixed outlet; but there are questions when the usage is not obviously temporary, and when the cord is extended to some distant outlet in order to avoid providing a fixed outlet where needed.

Flexible cord used in violation of this standard is likely to be damaged by activities in the area; by door or window edges; by staples or fastenings; by abrasion from adjacent materials; or simply by aging. If the conductors become partially exposed over a period of time, there will be danger of shocks, burns, or fire.

Identification, Splices and Terminations

Flexible cords shall be used only in continuous lengths without splice or tap. Hard service flexible cords, No. 12 or larger, may be repaired if spliced so that the splice retains the insulation, outer sheath properties, and usage characteristics of the cord being spliced.

Flexible cords shall be connected to devices and fittings so that strain relief is provided which will prevent pull from being directly transmitted to joints or terminal screws.