

# EVS26

**GREAT MINDS THINK ELECTRIC**

GRANDES MENTES PENSAM ELETRICAMENTE  
LAS MENTES BRILLANTES TIENEN IDEAS ELÉCTRICAS

LES GRANDS ESPRITS S'ILLUMINENT

AGAR BUDDHIMAN HO BIJI YAAD KARO

GROTE GEESTEN ZIJN VERLICHT KLUGE KÖPFE DENKEN ELETRISCH

*26th International Electric Vehicle Symposium*

## Mitigation of Vehicle Fast Charge Grid Impacts with Renewables and Energy Storage

Mike Simpson

National Renewable Energy Laboratory

8 May 2012

NREL/PR-5400-55080

ORGANIZED BY THE WORLD ELECTRIC VEHICLE ASSOCIATION, WEVA

HOSTED BY ELECTRIC DRIVE TRANSPORTATION ASSOCIATION, EDTA

IN COLLABORATION WITH



AVERE



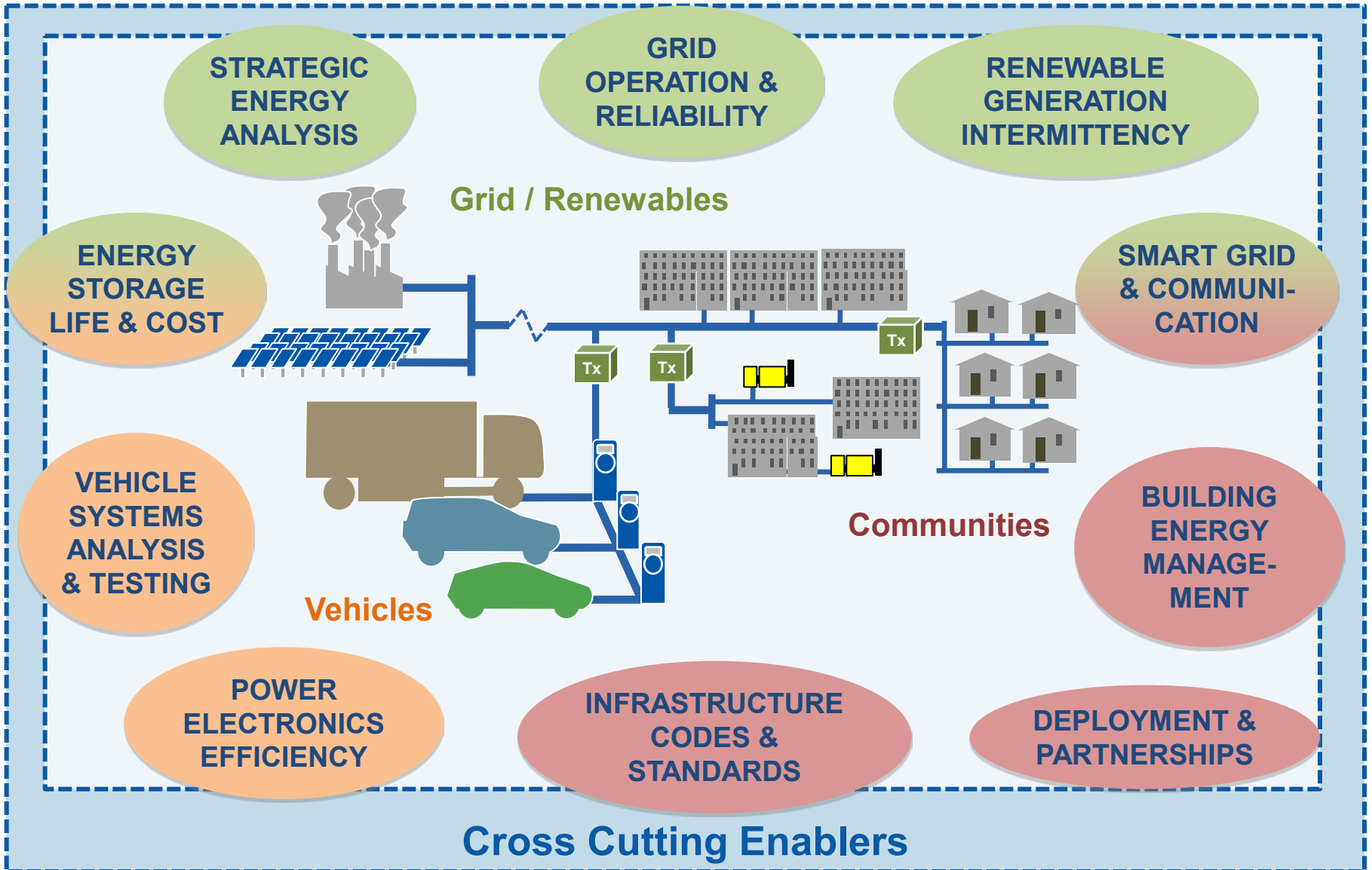

# Vehicle Test Facilities at NREL



Photo by Dennis Schroeder, NREL/PIX 19757



Photo by Dennis Schroeder, NREL/PIX 20045



Photo by Dennis Schroeder, NREL/PIX 19699



Photo by Dennis Schroeder, NREL/PIX 20040

# How Will Fast Chargers Impact the Grid?

- How will drivers use fast chargers?
- What does the time-dependent demand look like?
- How does the aggregate fast charge demand correlate with grid peaks?
- How can photovoltaics (PV) and energy storage reduce the impact and thus the cost of fast charging?

# Fast Charge Grid Impact Mitigation

- Identify system benefits
  - Add efficient, electric transportation miles cost effectively
  - Enable competitive performance from all-electric vehicles
    - long-distance travel fueled with renewables
- Address fast charging concerns / barriers
  - Minimize power spikes on the local grid
  - Avoid exacerbating peak demand
  - Reduce system costs
  - Quantify battery utilization

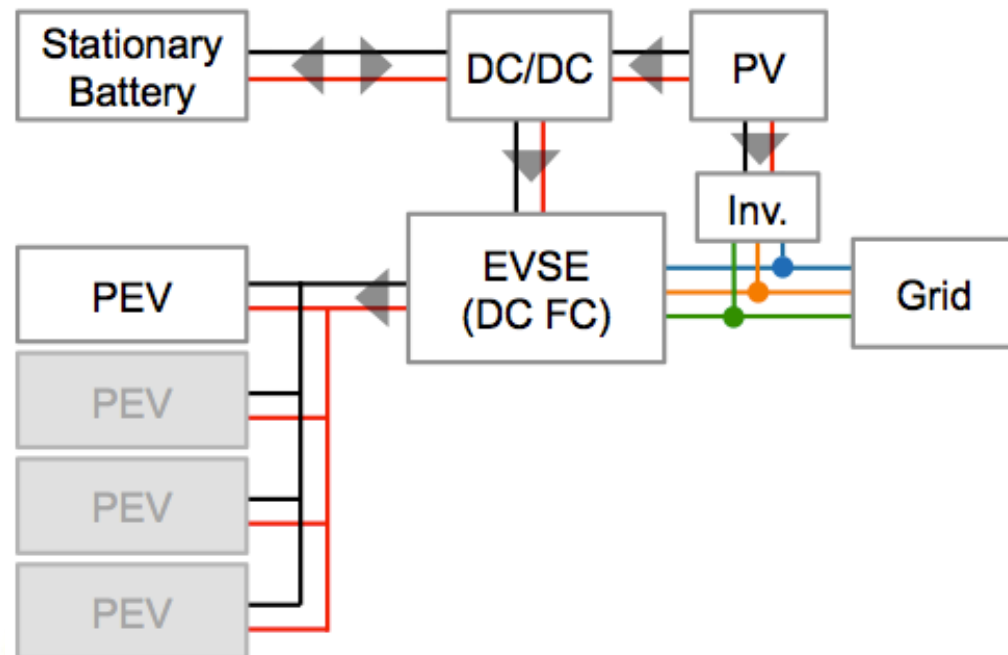

- Multiple fast charges of both CHAdeMO compliant vehicles
- Real-world traffic patterns [*Puget Sound Regional Council Traffic Choices Study*] and solar data incorporated
- Simulation assesses impacts of multiple vehicle adoption rates and station configurations
- PV and storage sizing conducted to mitigate impact

Time of Day that Vehicle Trips Start

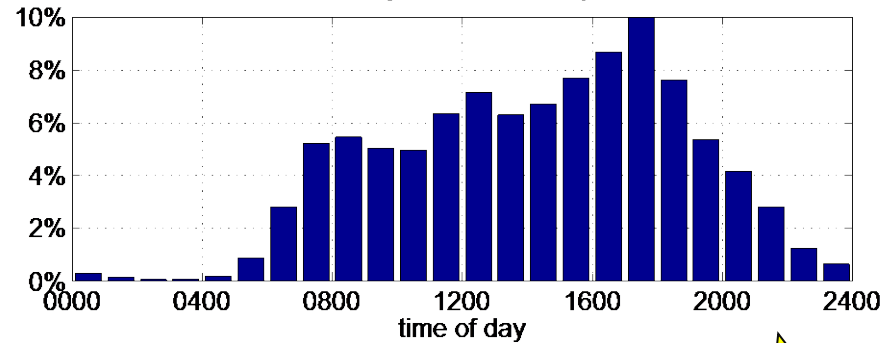

Average Speed of Vehicle Trips

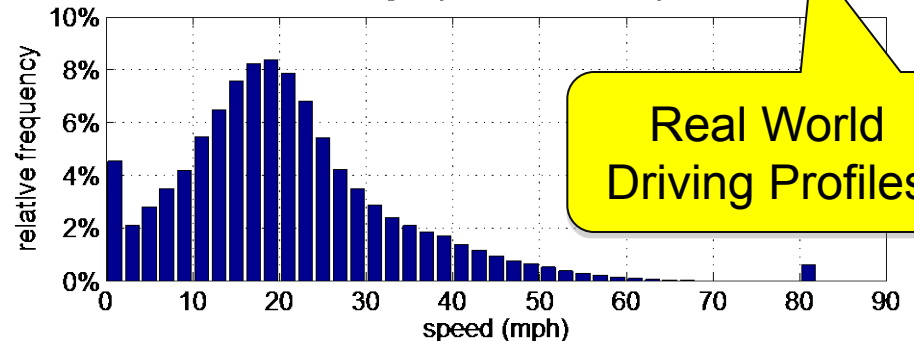

Real World Driving Profiles

Average Distance of Vehicle Trips

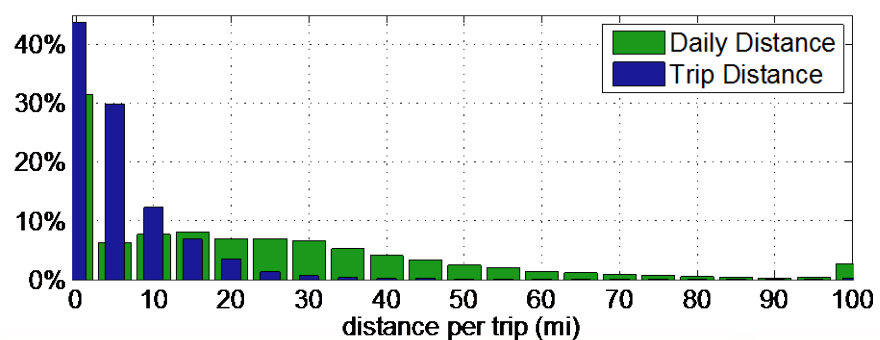



NREL PIX #20144

### Leaf Fast Charge Profile

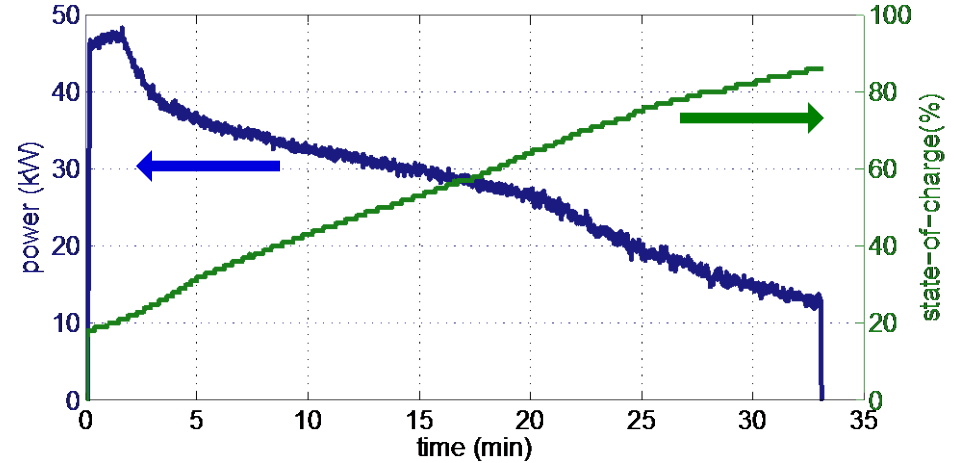

### i-MiEV Fast Charge Profile

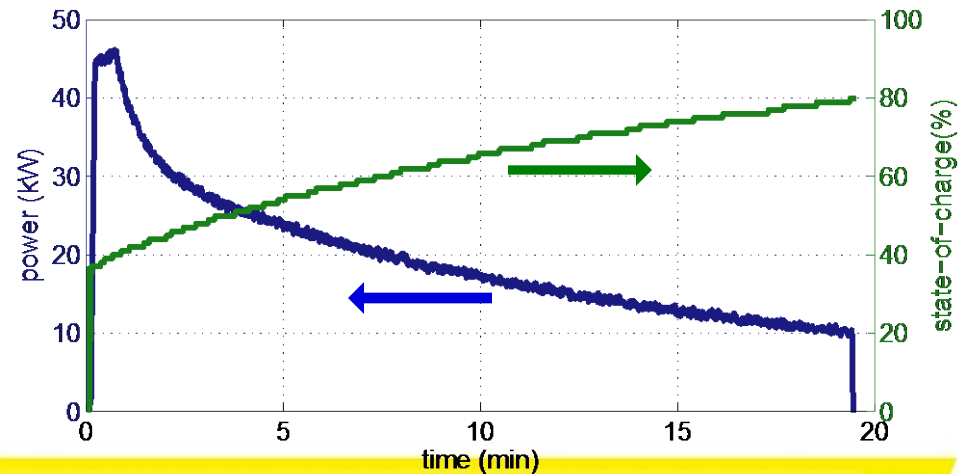

## Model Assumptions

Assumption	Value	Units/Notes
Vehicle State-of-Charge Window	80%	<i>Min: 10%, Max: 90%</i>
Vehicle Energy Consumption Rate	300	Wh/mi
Forgetfulness Factor	10%	<i>User forgets to plug-in roughly 1 in every 10 days of driving</i>
Home Charge Power	3.3	kW
Fast Charger Efficiency	85%	<i>Source-to-Battery</i>
Fast Charger Power (max)	50	kW
Fast Charger Max SOC	80%	<i>Charger cuts off at 80% SOC</i>
Stationary Battery SOC Window	75%	<i>Min: 15%, Max: 90%</i>

- Home charging begins at midnight if the car is stationary and the driver doesn't forget
- Fast charges occur only secondary to home charging when, in the middle of a trip, the battery approaches minimum SOC



## Simulations Indicate High Potential Utilization

### Times of Day when Fast Charges Occur

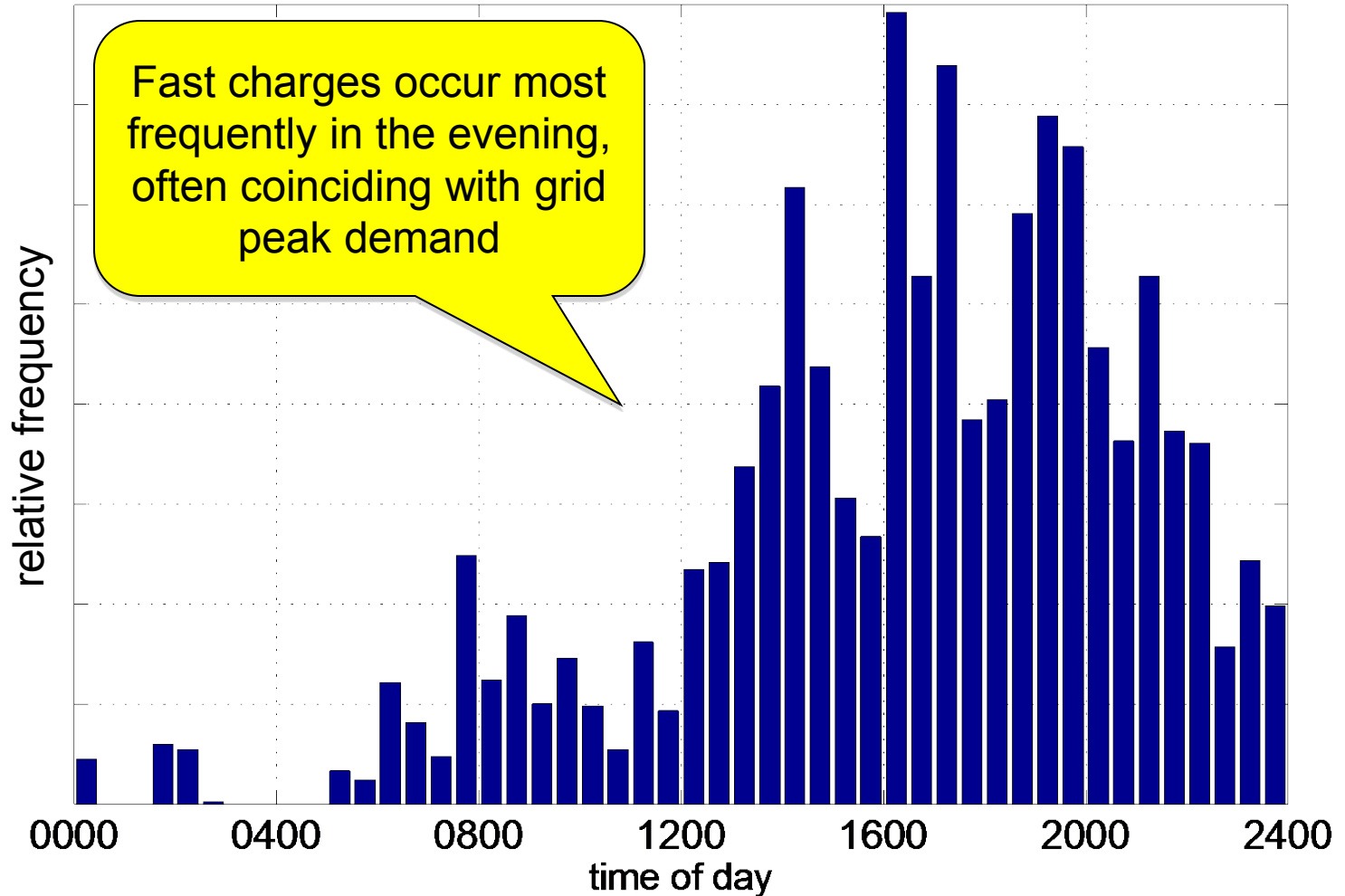

### PV and Battery Required to Renewably Fast Charge

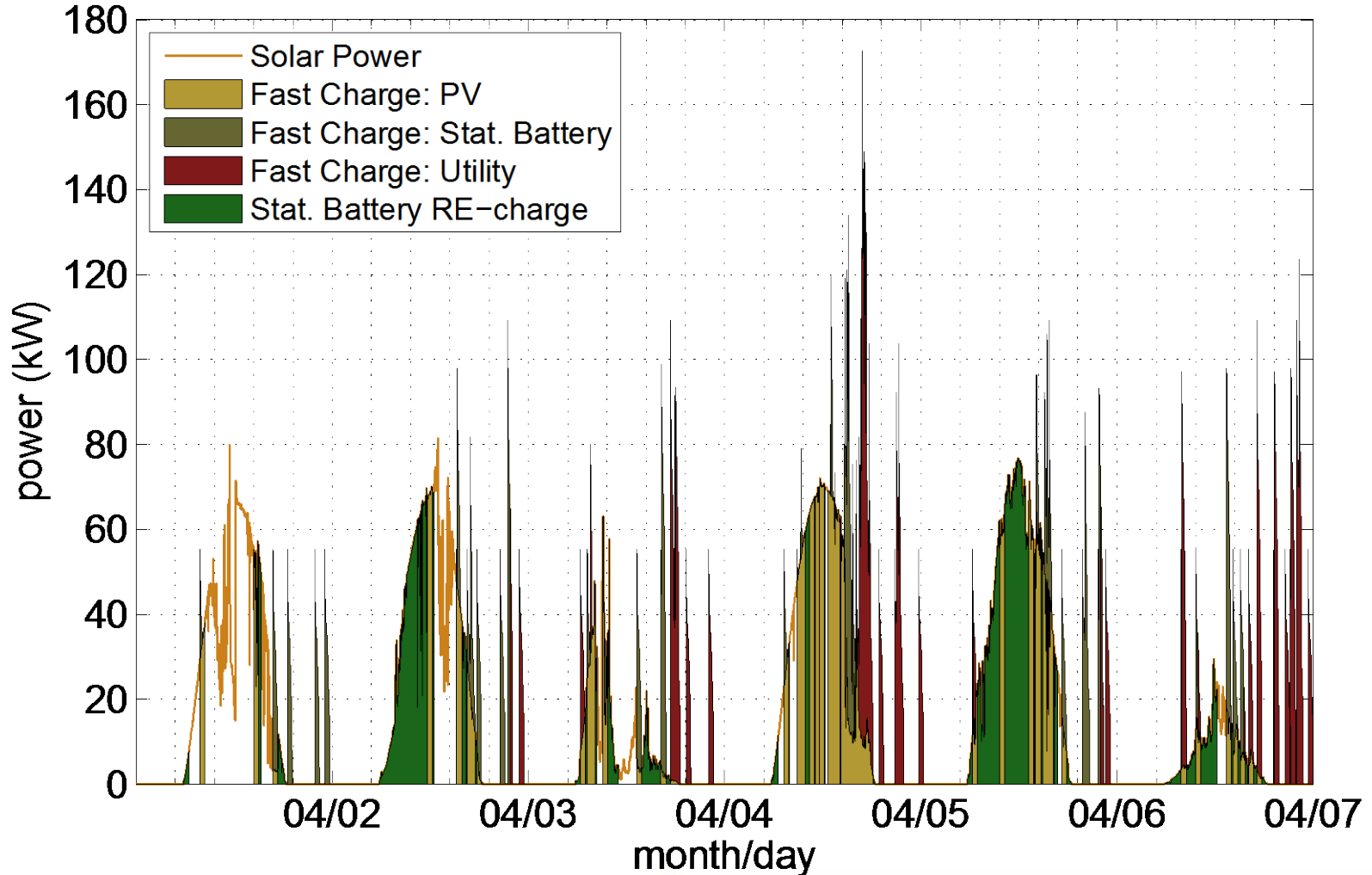

Assuming 4 ports, 200 vehicles, 24 kWh per vehicle, 100-kW PV, 100-kW stationary battery

## Single Day System Operation 200 PEVs, 100-kW PV, 100-kWh Battery

### PV and Battery Required to Renewably Fast Charge

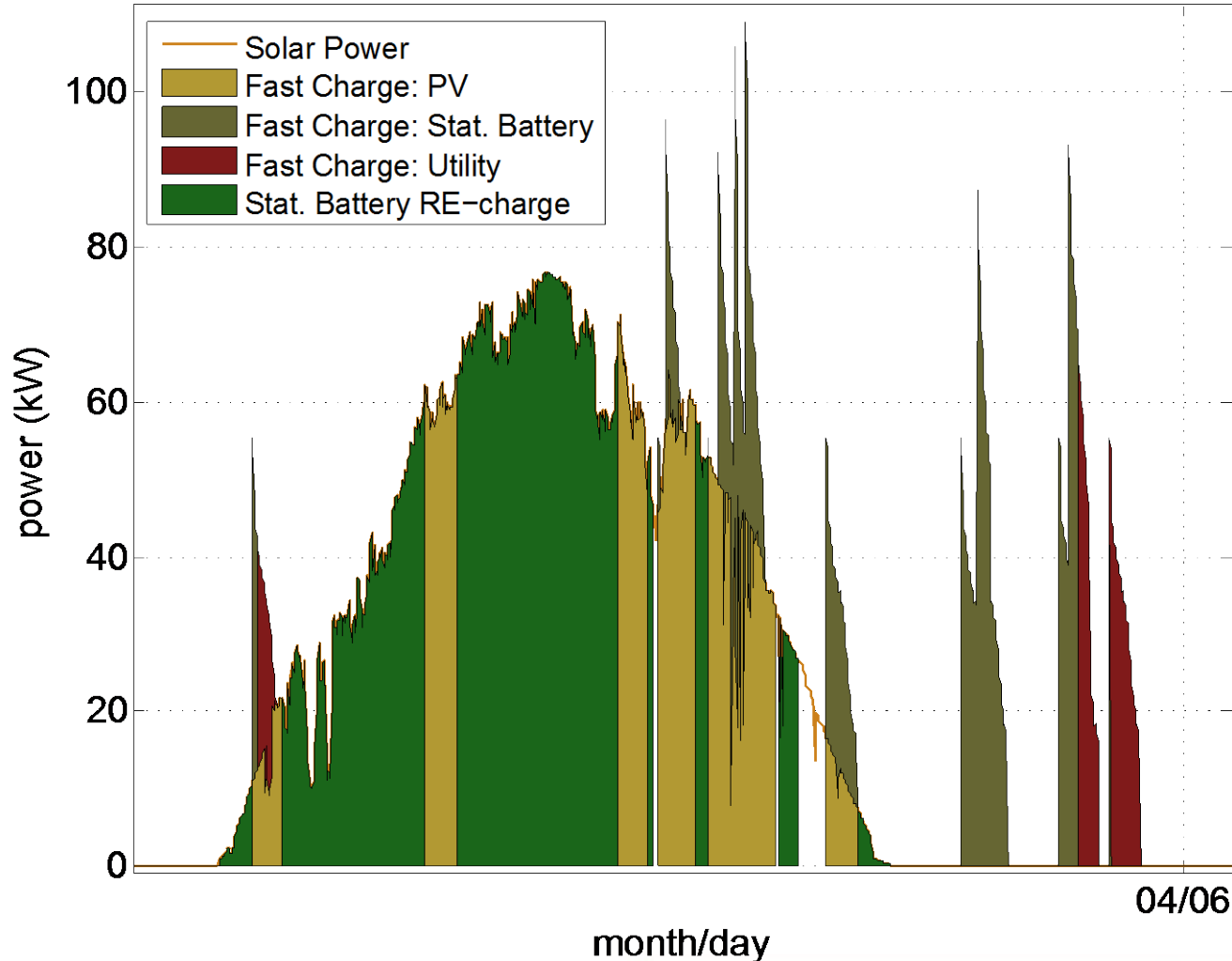

Assuming 4 ports, 200 vehicles, 24 kWh per vehicle, 100-kW PV, 100-kWh stationary battery

## Avoiding expensive energy and demand charges on your bill...

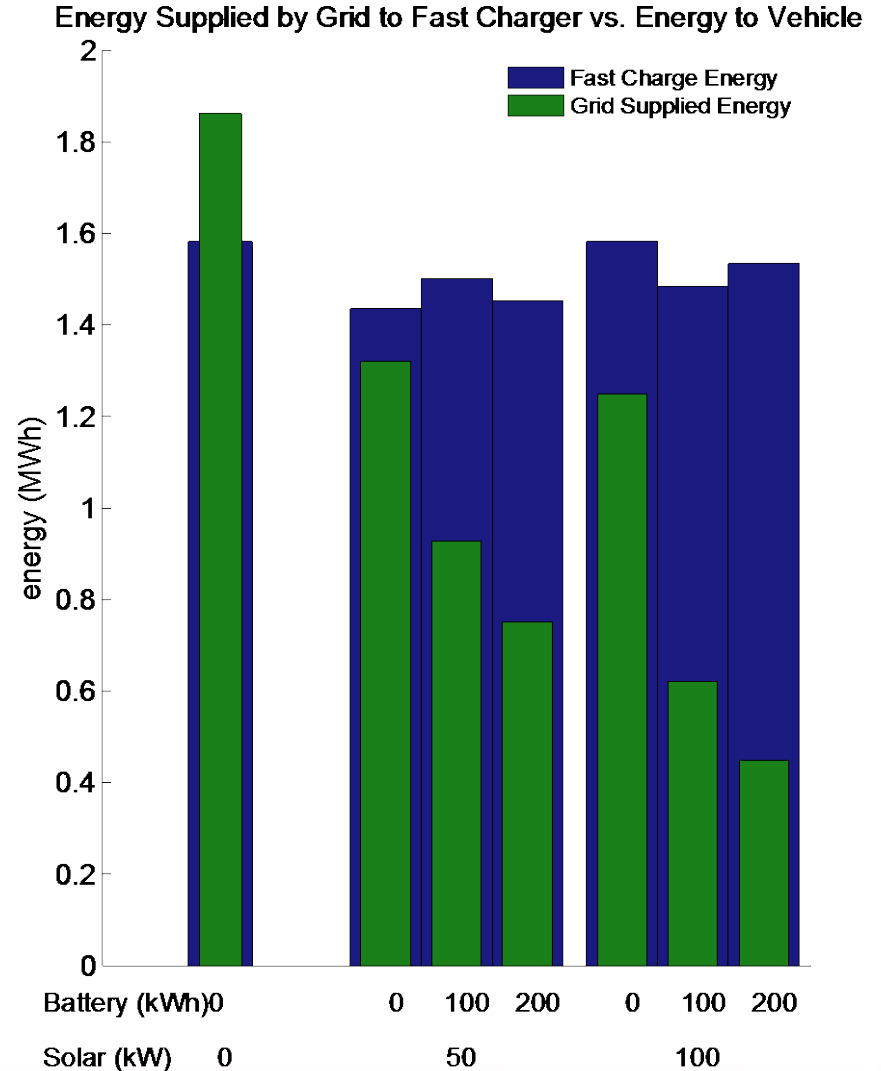
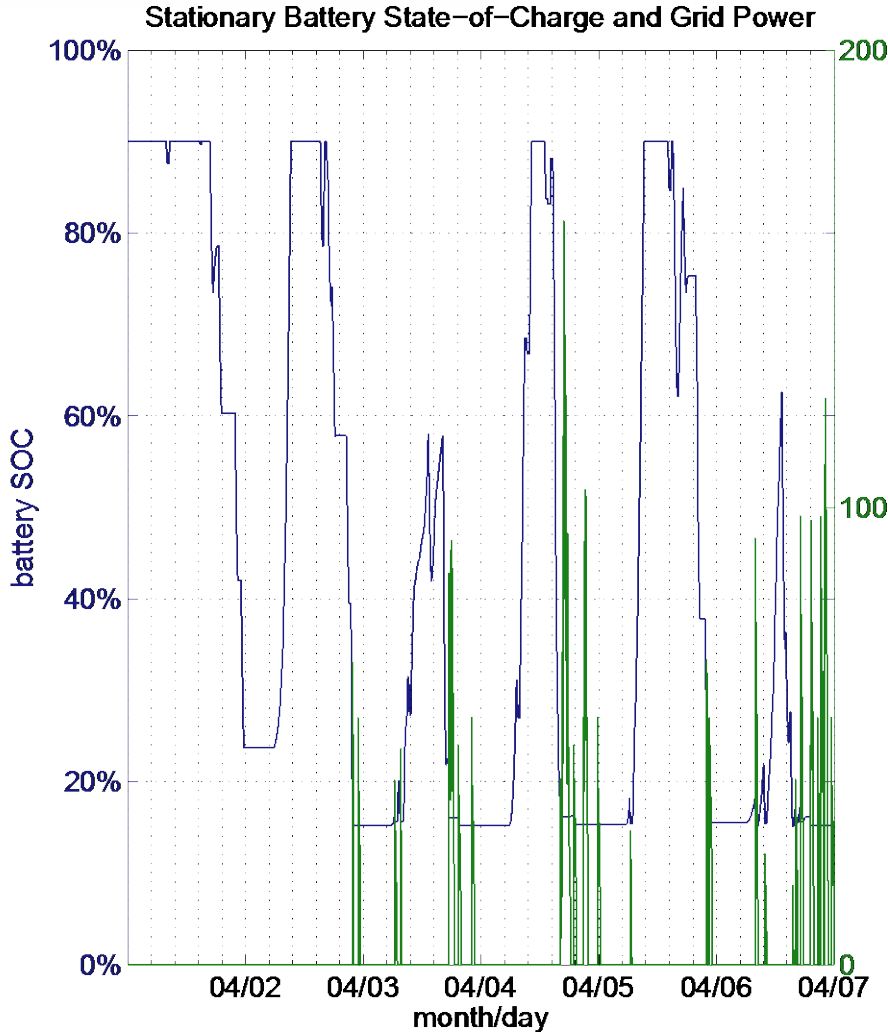

Assuming 4 ports, 200 vehicles, 24 kWh per vehicle, 100-kW PV, 100-kW stationary battery

## Reduced Wait Times with More Installed Ports

Fast Charge Wait Times for Fleet of 400, 24kWh Vehicles

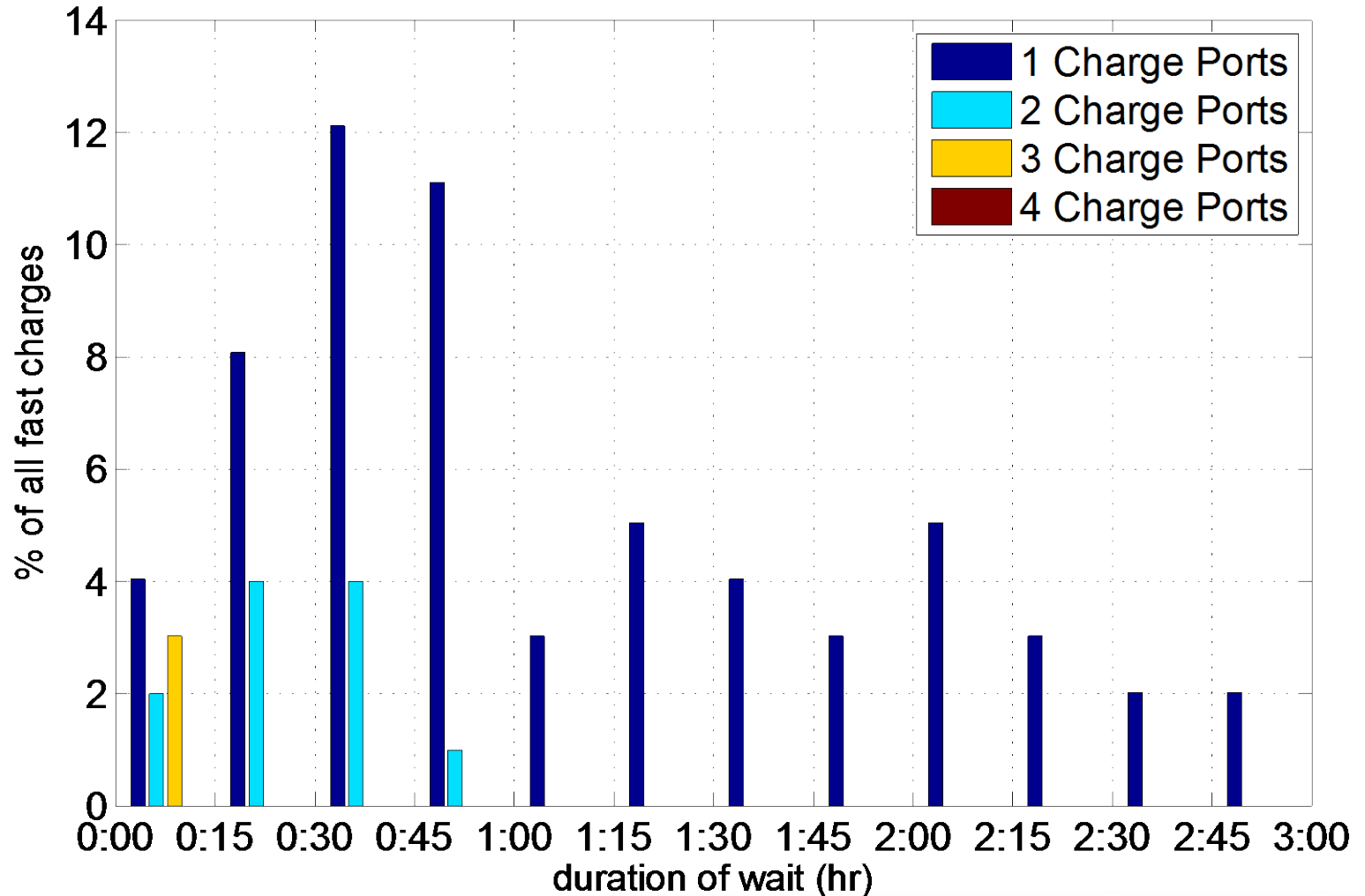

- Fast charge utilization simulation developed
- Grid impact options identified
- Next steps:
  - Include economics in design of experiments

# EVS26

**GREAT MINDS THINK ELECTRIC**

GRANDES MENTES PENSAM ELETRICAMENTE

LAS MENTES BRILLANTES TIENEN IDEAS ELÉCTRICAS

LES GRANDS ESPRITS S'ILLUMINENT

AGAR BUDDHIMAN HO BIJLI YAAD KARO

GROTE GEESTEN ZIJN VERLICHT KLUGE KÖPFE DENKEN ELETRISCH

## 26th International Electric Vehicle Symposium

*Special Thanks to:*

Lee Slezak and David Anderson,  
Vehicle Technologies Program,  
U.S. Department of Energy

### Questions?

[Mike.Simpson@NREL.gov](mailto:Mike.Simpson@NREL.gov)

ORGANIZED BY THE WORLD ELECTRIC VEHICLE ASSOCIATION, WEVA

HOSTED BY ELECTRIC DRIVE TRANSPORTATION ASSOCIATION, EDTA

IN COLLABORATION WITH



AVERE

